

BUILD A HORN-TYPE SPEAKER

APRIL 1956

RADIO - ELECTRONICS

TELEVISION • SERVICING • HIGH FIDELITY

HUGO CERNSBACK, Editor



- Scope Amplifier Compensation
- Midget Receiver for Model Control
- Tape Recorders— a Service Survey
- Electronic Voltage Regulation
- Tunable Traps in Color TV Sets
- How to Deal With Do-It-Yourself

35¢

U. S. and CANADA

Modern High-Fidelity C...

See page 4

RULTON 1 A 3-57
% PAUL S BOLLARO
434 FULTON ST
ELIZABETH 1 N J

you can't match **TRIPLET** model 630 VOM

for **SPEED
ACCURACY
DURABILITY
CONVENIENCE!**

heavy molded case
—1/4" thick for high impact.
Fully insulated.

sure grip battery contacts

Balanced double-spring tension grip assures permanent contact.

"this wide-range model

tests AC-DC Volts (DC at 20,000 O/V); DC Microamperes, Milliampere, and Amperes; Ohms (to 100 Megohms); Decibel and Output. Its easy-to-read scales are the longest in this type tester."

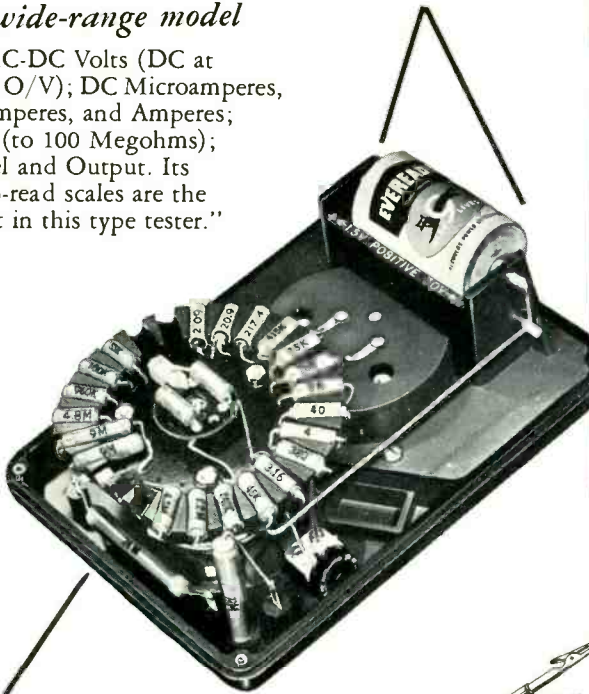

BURTON BROWNE ADVERTISING



streamlined design

No protruding knobs on switch or ohms control—both are flush with the panel.

king size recessed knob

—Only one switch; (fully enclosed) selects both circuit and range. Just turn the switch and make your reading.

for quick positive connections

—Banana jacks and plugs on test leads are best. Alligator clips are provided to slip on test prods for extra convenience.

for convenience in reading

—Available as an extra (only 50c), this special stand tilts meter at best angle for easy reading

for most efficient meter use

—With every Model 630 you receive complete, simplified instructions on how to use and maintain most efficiently.

no slip feature

Four rubber feet furnished as standard equipment fit in back of the case to prevent slipping on smooth surfaces.

advanced engineering

—Molded mounting for resistors and shunts allow direct connections without cabling. No chance for shorts. Longer life and easy-to-replace resistors in their marked positions.

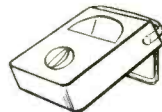
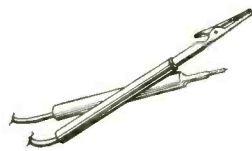

TRIPLET ELECTRICAL INSTRUMENT CO.
Bluffton, Ohio

MODEL 630 \$39.50



THE MIGHTY NINE VOM LINE

- | | | | | | | | | |
|--|---|--|---|--|--|--|--|---|
| 631
Combination
V.O.M.—VTVM | 630-NA
For Best Testing
Around The Lab,
Production Line
or Bench | 630
The Popular
All-Purpose
V.O.M. | 630-A
A Good Lab and
Production Line
V.O.M. | 310
The Smallest
Complete V.O.M.
With Switch | 630-T
For Telephone
Service | 666-HH
Medium Size
For
Field Testing | 625-NA
The First V.O.M.
With 10,000
Ohms/Volt AC | 666-R
Medium Size
With
630 Features |
|--|---|--|---|--|--|--|--|---|

You Practice **SERVICING** with Kits I Send You



Nothing takes the place of PRACTICAL EXPERIENCE. That's why NRI training is based on LEARNING BY DOING. You use parts I send to build many circuits common to Radio and Television. With my Servicing Course you build the modern Radio shown at left. You build a Multitester and use it to help make \$10, \$15 a week fixing sets in spare time while training. All equipment is yours to keep. Coupon below will bring book of important facts. It shows other equipment you build.

You Practice **BROADCASTING** with Kits I Send You



As part of my Communications Course I send you parts to build low-power Broadcasting Transmitter at left. Use it to get practical experience. You put this station "on the air" . . . perform procedures demanded of broadcasting station operators. An FCC Commercial Operator's License can be your ticket to a bright future. My Communications Course trains you to get your license. Mail coupon. Book shows other equipment you build for practical experience.

I Will Train You at Home in Spare Time to be a **RADIO-TELEVISION** Technician



TELEVISION

Making Jobs, Prosperity

25 million homes have Television sets now. Thousands more sold every week. Trained men needed to make, install, service TV sets. About 200 television stations on the air. Hundreds more being built. Good job opportunities here for qualified technicians, operators, etc.



America's Fast Growing Industry Offers You Good Pay, Success

Training PLUS opportunity is the PERFECT COMBINATION for job security, advancement. When times are good, the trained man makes the BETTER PAY, gets PROMOTED. When jobs are scarce, the trained man enjoys GREATER SECURITY. NRI training can help assure you and your family more of the better things of life. Radio is bigger than ever with over 3,000 broadcasting stations and more than 115 MILLION sets in use, and Television is moving ahead fast.

N.R.I. Training Leads to Good Jobs Like These

I TRAINED THESE MEN



"I have progressed very rapidly. My present position is Studio Supervisor with KEDD Television, Wichita."—Elmer Frewaldt, 3026 Stadium, Wichita, Kans.

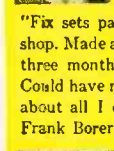

"Fix sets part time in my shop. Made about \$500 first three months of the year. Could have more but this is about all I can handle."—Frank Borer, Lorain, Ohio.



"I've come a long way in Radio and Television since graduating. Have my own business on Main Street."—Joe Travers, Asbury Park, New Jersey.



"I didn't know a thing about Radio. Now have a good job as Studio Engineer at KMMJ"—Bill Delzell, Central City, Neoraska.



BROADCASTING: Chief Technician, Chief Operator, Power Monitor, Recording Operator, Remote Control Operator. **SERVICING:** Home and Auto Radios, Television Receivers, FM Radios, P.A. Systems. **IN RADIO PLANTS:** Design Assistant, Technician, Tester, Serviceman, Service Manager. **SHIP AND HARBOR RADIO:** Chief Operator, Radio-Telephone Operator. **GOVERNMENT RADIO:** Operator in Army, Navy, Marine Corps, Forestry Service Dispatcher, Airways Radio Operator. **AVIATION RADIO:** Transmitter Technician, Receiver Technician, Airport Transmitter Operator. **TELEVISION:** Pick-up Operator, Television Technician, Remote Control Operator.

Start Soon to Make \$10, \$15 a Week Extra Fixing Sets

My training is practical, complete; is backed by 40 years of success training men at home. My well-illustrated lessons give you basic principles you need and my skillfully developed kits of parts "bring to life" things you learn from the lessons. I start sending you special booklets the day you enroll, that show you how to fix sets. Multitester you build with my parts helps you discover and correct set troubles, helps you make money fixing neighbors' sets in spare time while training. Many make \$10, \$15 a week extra this way.

Mail Coupon — Find Out What Radio-Television Offer You

Act now to get more of the good things of life. I send actual lesson to prove NRI home training is practical, thorough. My 64-page book "How to be a Success in Radio-Television" shows what my graduates are doing and earning. It gives important facts about your opportunities in Radio-Television. Take NRI training for as little as \$5 a month. Many graduates make more than the total cost of my training in two weeks. Mail coupon now to: J. E. SMITH, President, Dept. 6DF, National Radio Institute, Washington 9, D. C. Our 40th year.

AVAILABLE to all qualified VETERANS UNDER G.I. BILLS

Good for Both—FREE

MR. J. E. SMITH, President, Dept. 6DF
National Radio Institute, Washington 9, D. C.
Mail me Sample Lesson and 64-page Book, FREE.
(No salesman will call. Please write plainly.)

Name..... Age.....
Address.....
City..... Zone... State.....

VETS write in date of discharge

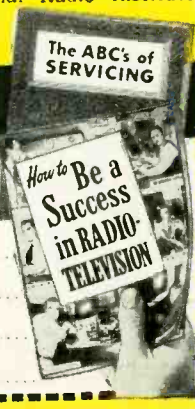

Mail Today-Tested Way to Better Pay

RADIO - ELECTRONICS

Formerly RADIO CRAFT • Incorporating SHORT WAVE CRAFT • TELEVISION NEWS • RADIO & TELEVISION*

Hugo Gernsback
Editor and Publisher

M. Harvey Gernsback
Editorial Director

Fred Shunaman
Managing Editor

Robert F. Scott
W2PWG, Technical Editor

Jerome Kass
Associate Editor

I. Queen
Editorial Associate

Matthew Mandl
Television Consultant

Elizabeth Stalcup
Production Manager

Angie Pascale
Editorial Production

Wm. Lyon McLaughlin
Tech. Illustration Director

Sol Ehrlich
Art Director

Lee Robinson
General Manager

John J. Lamson
Sales Manager

G. Aliquo
Circulation Manager

Adam J. Smith
Director, Newsstand Sales

Robert Fallath
Promotion Manager

GERNSBACK PUBLICATIONS, INC.

Executive, Editorial and Advertising Offices, 154 West 14 St., New York 11, N. Y. Telephone ALgonquin 5-7755.

Hugo Gernsback
Chairman of the Board

M. Harvey Gernsback
President

G. Aliquo
Secretary

ON THE COVER

High-fidelity installation made by Custom Sound Systems, Orange, N. J. in home of Robert Ossorio, New York City. Lower two drawers contain a De Jur tape recorder and Audiosphere stereophonic tape player. Rek-O-Kut record player and Altec amplifier are in upper drawers, and H. H. Scott control panel and an FM receiver (left) are above.

Color original by Dan Rubin.
Posed by Mona McHenry



Average Paid Circulation over 175,000

APRIL 1956

Vol. XXVII, No. 4

Editorial (Page 33)

Radio Astronomy Progress By Hugo Gernsback 33

Audio—High Fidelity (Pages 34-42)

A Horn-Type Speaker for Golden Ears.....by George Augspurger 34

Tape Recorder Operation.....by Sol Heller 36

For Golden Ears Only: Rex changer; H. H. Scott 310 FM tuner; Fentone B & O and P-12 phono cartridges.....by Monitor 38

More About Load Lines.....by Norman Crowhurst 40

Test Instruments (Pages 43-47)

Compensating Oscilloscope Amplifiers.....by Robert G. Middleton 43

New Easy-to-Read VTVM's.....by Robert F. Scott 44

Technical Reports (Page 48)

What's New..... 48

Television (Pages 49-58)

Sunspots and Communications.....by E. P. Tilton 49

Interference vs Signal Strength.....by Hardin G. Stratman 51

Traps in Color TV Receivers.....by Matthew Mandl 52

TV Service Clinic.....Conducted by Jerry Kass 54

Dealing With Do-It-Yourself.....by Art Margolis 56

Improving Low-Priced TV Sets.....by H. Ray Lundy 58

Electronics (Pages 59-82)

Transistor-Operated Geiger Counter.....by Thomas G. Knight 59

The Cordless Radio Iron.....by Mohammed Ulysses Fips 61

Versatile Thermistor Thermometer.....by James Robert Squires 75

Radio (Pages 84-103)

Miniature Receiver for Model Control.....by Rufus P. Turner, K6AI 84

Practical Electronic Voltage Regulation.....L. B. Hedge 88

Information Theory.....by Paul Penfield, Jr. 96

Much Fuss About Plus.....by Sol D. Prenskey 102

DEPARTMENTS

Books	140	People	131
Business	134	Question Box	125
Corrections	114	Radio Month	6
Correspondence	12	Radio-Electronic Circuits.....	121
New Devices	108	Technical Literature	138
New Records.....	104	Technicians' News	106
New Tubes and Transistors.....	112	Technotes	118
Patents	115	Try This One.....	128

Associate Member of Institute of High Fidelity Mfrs., Inc.



RADIO-ELECTRONICS, April, 1956. Vol XXVII, No. 4. Published monthly at Mt. Morris, Ill., by Gernsback Publications, Inc. Second-class mail privileges authorized at Mt. Morris, Ill. Copyright 1956 by Gernsback Publications, Inc. All rights reserved under Universal, International and Pan-American Copyright Conventions.

SUBSCRIPTIONS: Address correspondence to Radio-Electronics, Subscription Dept., 404 N. Wesley Ave., Mt. Morris, Ill., or 154 West 14 St., New York 11, N. Y. When ordering a change please furnish an address stencil impression from a recent wrapper. Allow one month for change of address.

SUBSCRIPTION RATES: U. S., U. S. possessions and Canada, \$3.50 for one year; \$6.00 for two years; \$8.00 for three years; single copies 35c. Pan-American countries \$4.00 for one year; \$7.00 for two years; \$9.50 for three years. All other countries \$4.50 a year; \$8.00 for two years; \$11.00 for three years.

BRANCH ADVERTISING OFFICES: Chicago: 1413 Howard St. Tel. ROvers Park 4-8000. Los Angeles: Ralph W. Harker and Associates, 600 South New Hampshire, Tel. DUinkirk 7-2328. San Francisco: Ralph W. Harker and Associates, 582 Market St., Tel. GARfield 1-2481. FOREIGN AGENTS: Great Britain: Atlas Publishing and Distributing Co., Ltd., London E.C. 4. Australia: McGill's Agency, Melbourne. France: Brentano's, Paris 2e. Belgium: Agence de Messageries de la Presse, Brussels. Holland: Trilectron, Heemstede. Greece: International Book & News Agency, Athens. So. Africa: Central News Agency Ltd., Johannesburg. Capetown, Natal. Universal Book Agency, Johannesburg. Middle East: Steinmatz Middle East Agency, Jerusalem. India: Broadway News Centre, Dadar, Bombay #14. Pakistan: Paradise Book Stall, Karachi 3. POSTMASTER: If undeliverable send form 3578 to: RADIO-ELECTRONICS, 154 West 14 St., New York 11, N. Y. *Trademark registered U. S. Patent Office.

NATIONAL SCHOOLS

proudly presents

FOR MEN WHO WANT TO EARN MORE MONEY

TELERAMA* • ALL 8 BRANCHES OF TELEVISION • ELECTRONICS • RADIO

IN ONE DYNAMIC, MODERN SHOP METHOD, HOME TRAINING COURSE

*Registration applied for

Another great advance in **HOME STUDY TRAINING**. Let National Schools, of Los Angeles, a practical Technical Resident Trade School for over 50 years, train you at home by Shop-Method, for today's unlimited opportunities in **ALL 8 BRANCHES** of the Television, Electronics, Radio Industry.

Check all you receive in *One Master Course* at One Low Tuition

1. Television — Including Color TV
2. Radio — FM and AM
3. Industrial Electronics
4. Sound Recording and Hi-Fidelity
5. Preparation for FCC License
6. Automation
7. Radar and Sonar
8. Communications

ALL OF THIS MODERN, NEWEST, PRACTICAL EQUIPMENT IS YOURS TO KEEP!

- Parts to Build a modern TV set, including large screen Picture Tube.
- Parts to build a powerful Superhet Receiver, standard broadcast and short wave.
- Parts to conduct many experiments and build Continuity Checker, RF Oscillator, TV Circuits, Audio Oscillator, TRF Receiver, Signal Generator.
- Professional Multitester
- These are a MUST for all technicians.

YOU DO MANY PRACTICAL JOBS.

You do servicing, circuit analysis and many other down-to-earth experiments. You build a modern TV set from the ground up . . . with equipment kits we give you, including a new large screen picture tube and professional Multitester, at no additional charge.

EARN AS YOU LEARN! Many of our students earn their entire tuition and more in Spare Time jobs we show them how to do while learning. **YOU GET GRADUATE ADVISORY SERVICE, TOO.**

ALL YOURS TO KEEP

L. J. ROSENKRANZ
President of NATIONAL SCHOOLS



This Master-Shop-Method course is completely up-to-date. Here in Los Angeles, the TV and Electronics center of the world, we are able to keep in constant touch with the industries' latest developments. As a student, you will quickly master all phases at home . . . in your spare time. Your earning power will grow with every lesson. Just as thousands of National Schools graduates do every day, you can handle servicing, manufacturing, repairing, hundreds of other jobs, or make good money in your own business. **SECURE YOUR FUTURE—NOW. SEND COUPON BELOW.**



IN THESE MODERN TV STUDIOS, SHOPS AND LABORATORIES, your Shop Method Home Study Course was developed by experienced instructors and engineers. What an advantage that is to you at home — each lesson is tested, proved, easy to understand. You can master the most up-to-date projects, such as color TV set repair, printed circuits — even prepare for F.C.C. License and industrial electronics without taking a special course. **TAKE YOUR FIRST STEP NOW TO A TOP-PAY JOB IN TV, ELECTRONICS, RADIO. SEND COUPON BELOW TODAY.**

APPROVED FOR VETERANS AND NON-VETERANS



NATIONAL SCHOOLS

4000 S. FIGUEROA ST., LOS ANGELES 37, CALIF.
187 N. LA SALLE ST., CHICAGO 1, ILL.

IN CANADA: 811 W. Hastings St., Vancouver, B. C.

MEMBER



FREE!

Fully illustrated "CAREER" BOOK in TV, Radio, Electronics. AND actual Sample Lesson—yours at no cost, no obligation **SEND COUPON NOW—TODAY!**



NATIONAL SCHOOLS

TECHNICAL TRADE TRAINING SINCE 1905
Los Angeles, California

GET FAST SERVICE — MAIL NOW TO OFFICE NEAREST YOU!

NATIONAL SCHOOLS, DEPT. RG-46

4000 S. FIGUEROA ST. OR 187 N. LA SALLE ST.
LOS ANGELES 37, CALIF. CHICAGO 1, ILL.

Rush free TV-Radio "Opportunity" Book and sample lesson. No salesman will call.

NAME _____ BIRTHDAY _____ 19 _____

ADDRESS _____

CITY _____ ZONE _____ STATE _____

VETERANS: Give Date of Discharge _____

EXTENDED RANGE
HIGH-FIDELITY

3-WAY TRX

INTEGRATED TRIAXIAL

12 and 15-inch
REPRODUCERS

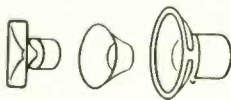

Concentrically
Combines E-V
Super-Sonax,
Radax Propagator,
and Bass Cone

Brings advantage of distortion-free
wider range found in E-V separate
3-way systems, in one compact speaker

E-V concentric triaxial design gets the most from specialized driving media for each portion of the audio spectrum. Augmented bass response, full bodied mid-range and silky-smooth upper octaves to the highest audible frequencies provide excellent musical balance without masking effects or imposed distortions.

Model 12TRXB. 12¼-in. diameter.
Magnet wt. 1 lb. 2 oz. Net, \$59.70

Model 12TRX. 12¼-in. diameter.
Magnet wt. 3¼ lb. Net, \$114.00

Model 15TRXB. 15½-in. diameter.
Magnet wt. 1 lb. 2 oz. Net, \$78.00

Model 15TRX. 15½-in. diameter.
Magnet wt. 5¾ lb. Net, \$135.00

Each speaker includes brilliance control

- Exclusive E-V Concentric Mounting Insures Smooth, Full Range, Complete Room Coverage
- Balanced Response Characteristic Provides Realism and Presence
- Adjustable Brilliance Control for Remote Mounting. Allows Matching to Room Acoustics
- Edgewise Wound Voice Coil Design Affords 18% More Efficiency and Lower Distortion

Send 25c for Catalog and Guide No. 117-W64

Electro-Voice
BUCHANAN, MICHIGAN

the Radio month



TRANSISTOR TESTER about the size of a pocket radio (see photo) has been announced by General Electric. The portable instrument, expected to be a boon to service technicians and experimenters, was designed to fill the need for a device to determine quickly if a transistor is usable in an electronic circuit when a large laboratory type tester is not available. The tester checks all junction transistors for short circuits, opens, leakage and current gain.

The instrument contains two scales: the lower one, divided into three sections by different colors, indicates high leakage, borderline and no significant

is a layer approximately 50 millionths (.000050) of an inch thick.

A diffusion process—used in treating silicon for the Bell solar battery—is used in which minute amounts of impurities are introduced in controlled amounts into a material. The transis-



tor consists of a three-layer chemical "sandwich," the center layer being the base and the other two the emitter and collector. The narrower the base layer, the higher the frequency at which the transistor will operate. Diffusion provides a high degree of control over microscopic dimensions.

The new transistor could amplify 2,500 telephone conversations simultaneously on a telephone line, three times as many as could be handled by the best previous transistor. The new device, made of both germanium and silicon, is expected to be extremely useful in monochrome and color TV.

This transistor was mentioned in RADIO-ELECTRONICS, page 8, in December, 1955, following an announcement by Paul Galvin, president of Motorola, that the transistor would be produced in volume in 1 or 2 years.

NEW TV STATIONS on the air since our last report: KPIC, Roseburg, Ore., channel 4, and KPAR-TV, Sweetwater-Abilene, Tex., 12.

WNBK, Cleveland, Ohio, channel 3, has changed its call letters to KYW-TV; WPTZ, Philadelphia, Pa., channel 3, to WRCV-TV.

MULTIPLEX WEATHER REPORTS

have become a regular service of station WNYC-FM as the result of the FCC's granting a Subsidiary Communications Authorization to New York City's Municipal Broadcasting System. The continuous and comprehensive weather broadcast, available on a cost-free basis to anyone in the area having the necessary receiving equipment, has the approval and cooperation of the U.S. Weather Bureau.

This is the first of the 45 authorizations issued by the FCC to date to provide this unique service—the other 44 are being used for music and store broadcasting.

The FCC also ruled that the weather



leakage; the upper checks current gain—a button is pushed and the amount of needle jump noted. Separate plug-in sockets for n-p-n and p-n-p transistors are provided.

According to G-E engineers, transistors should be checked only on instruments specifically designed for that purpose. General-purpose instruments such as ohmmeters or vtm's are impractical because they either do not give the information needed unless special involved circuitry is also attached to each transistor or they cause too much current to flow through the transistor and damage it.

The G-E transistor testers are sold through G-E tube distributors and come with five universal type transistors and a transistor interchangeability chart.

UHF TRANSISTOR reported by Bell Telephone Laboratories is described as a major breakthrough in transistor technology. The unit reaches a cutoff between 500 and 600 mc. Key to the new device (see photo) is improved fabricating techniques which include controls over microscopic chemical layers—the heart of the new transistor

FREE

YOUR CHOICE OF ANY ONE OF THESE MAGNIFICENT SETS OF THREE 12" COLUMBIA (LP) RECORDS

If you join the Columbia (LP) Record Club now—and agree to accept as few as 4 selections during the coming 12 months

3-RECORD
SET #1

Treasury of Great Classics

Eugene Ormandy conducting The Philadelphia Orchestra

TCHAIKOVSKY

Symphony No. 6 "Pathétique"

Sir Thomas Beecham, Bart., conducting
the Royal Philharmonic Orchestra

BEETHOVEN SYMPHONY NO. 8

SCHUBERT SYMPHONY NO. 8 "Unfinished"

Bruno Walter Conducting the Philharmonic-
Symphony Orchestra of New York

BRAHMS Variations on a Theme by Haydn
—Academic Festival Overture

WAGNER Siegfried Idyll **SMETANA** The Moldau



3-RECORD
SET #3

TREASURY OF GREAT MOOD MUSIC

STRAUSS WALTZES by

ANDRE KOSTELANETZ

Andre Kostelanetz and his
Orchestra play ten waltzes.

IN THE DANCING MOOD

LES BROWN ☆ **ERROLL GARNER**

HARRY JAMES ☆ **LES ELGART**

PERCY FAITH ☆ **SAMMY KAYE**

America's most popular orchestras
play your favorite music for
dancing. 12 numbers in all.

AMONG MY SOUVENIRS

PAUL WESTON and his Orchestra

Dreamy arrangements of *Embraceable You*, *Pennies From Heaven*, *I'll See You Again*, and more.



3-RECORD
SET #2

JAZZ HALL OF FAME

BRUBECK JAZZ GOES TO COLLEGE

Jazz At Columbia — Swing

- ☆ Benny Goodman ☆ Harry James
- ☆ Gene Krupa ☆ Duke Ellington
- ☆ Charlie Barnet ☆ Buck Clayton
- ☆ Count Basie ☆ Lionel Hampton

Jazz At Columbia — Collector's Items

- ☆ Bix Beiderbecke ☆ Louis Armstrong ☆ Bessie Smith
- ☆ Red McKenzie ☆ Eddie Condon ☆ Wally Rose ☆ Billie Holiday
- ☆ Bunk Johnson ☆ Pete Johnson
- ☆ Jimmy Lunceford ☆ Teddy Wilson

These 3 records are a jazz library
in themselves — presenting jazz
greats of every period and style.

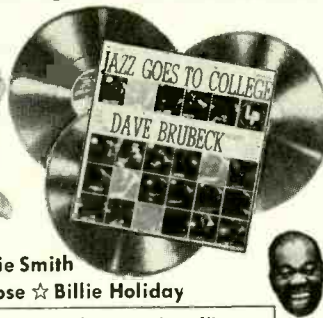

3-RECORD
SET #4

BROADWAY HALL OF FAME

THE PAJAMA GAME

(Original Broadway Cast Recording)

Starring John Raitt, Janis Paige, Carol Haney, Eddie Foy Jr. — singing all the tunes from this musical.

SONGS TO REMEMBER

DOROTHY KIRSTEN

Percy Faith, Russell Case and Orchestras
join Miss Kirsten in
15 songs.

BEWITCHED

MORTON GOULD

11 songs arranged and conducted by
Morton Gould. Includes *September Song*, *So In Love*, *Where or When*.



Build a Fine Library of the World's Greatest Music—at Tremendous Savings!

Yes! You may have, FREE, any one of these valuable record sets, each containing three magnificent 12" Columbia (LP) records!

We make this unique offer to introduce you to the money-saving program of the Columbia (LP) Record Club... a program that selects for you each month the greatest works in every field of music—performed by the world's finest artists and reproduced with the astonishing brilliance for which Columbia (LP) records are famous!

HOW THE CLUB OPERATES

To enjoy the benefits of the Club's program—and to receive your 3-record set free—fill in and mail the coupon, indicating the Club division that best suits your musical taste: Classical; Jazz; Listening and Dancing; Broadway, Movies, Television and Musical Comedies.

Each month you will receive free the informative Club Magazine which describes the current selections in all four divisions. You may accept or reject the monthly selection for your division. You may also take records from other divisions, or you may tell us to send you NO record in any month.

Your only obligation as a member is to accept as few as four selections from the almost 100 that will be offered to you during the next 12 months, and you may cancel your membership at any time thereafter. The records you want are mailed to your home and billed to you at the low price of only \$3.98 plus a small mailing charge.

FREE BONUS RECORDS GIVEN REGULARLY

The 3 records sent to you now represent an "advance" of the Club's bonus system—given to you at once. After you have fulfilled your membership obligation by purchasing four records, you will receive an additional free Bonus record of your choice for every two additional Club selections you accept. These 12" Columbia (LP) Bonus records are pressed exclusively for Club members in limited editions, not available elsewhere at any price!

CHOOSE YOUR 3-RECORD SET NOW

Indicate which 3-record set you want free, and the division you prefer. Then mail the coupon at once. You must be delighted with membership or you may cancel without obligation by returning the free set within 10 days.

MAIL THIS COUPON NOW!

COLUMBIA (LP) RECORD CLUB, Dept. 344
165 West 46th Street, New York 36, N. Y.

Please send me as my FREE gift the 3-Record Set checked here:

- Set #1. GREAT CLASSICS Set #3. GREAT MOOD MUSIC
 Set #2. JAZZ Set #4. BROADWAY HALL OF FAME

and enroll me in the following Division of the Club: (Check one box only)

- Classical Jazz Listening and Dancing
 Broadway, Movies, Television and Musical Comedies

Each month you will send me the Columbia (LP) Record Club Magazine which describes the records offered in all four Club divisions. I have the privilege of accepting the monthly selection in the division checked above, or any other selection described, or none at all. My only obligation is to accept a minimum of four records in the next twelve months at the regular list price plus a small mailing charge. After accepting four records, I will receive a free Bonus record for every two additional records I purchase. If not delighted with my membership, I may cancel within 10 days by returning all records.

Name.....
(Please print)

Address.....

City..... Zone..... State.....

CANADA: Prices slightly higher. 11-13 Soho St., Toronto 2B
If you wish to have this membership credited to an established Columbia Records dealer, authorized to accept subscriptions, please fill in the following information:

Dealer's name.....

Dealer's address.....

COLUMBIA (LP) RECORD CLUB 165 West 46th St.
New York 36, N. Y.

© "Columbia", (LP) Merca's Reg. ® T.M.

**TUBES FOR THE
FINEST IN HI-FI**

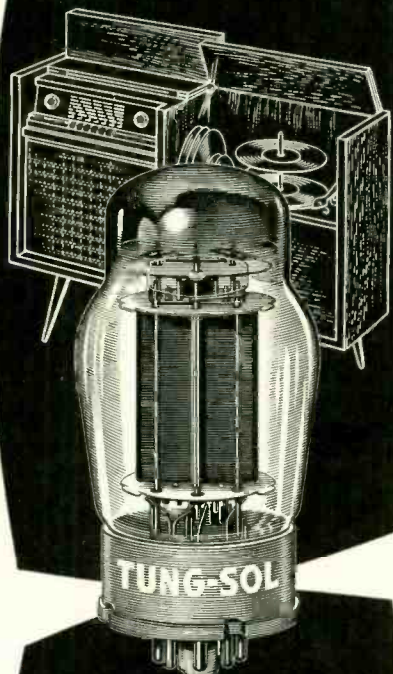

Almost without exception, makers of the finest high-fidelity sets depend upon Tung-Sol Audio Amplifier Tubes to help deliver the performance expected of their products.

Through these tubes—the "5881" and the "6550"—Tung-Sol clearly demonstrates its ability to meet and maintain high-fidelity's critical design requirements in volume production.

This achievement is indicative of the quality and dependability of Tung-Sol Hi-Fi, Radio and TV Tubes . . . products of America's largest independent electron tube manufacturer. Tung-Sol Electric Inc. Newark 4, N. J.

TUNG-SOL
ELECTRON TUBES

Tung-Sol Automotive & Electronic Products



broadcasts could be made available without cost for retransmission by any radio station in the WNYC-FM service area.

Calendar of Events

Exhibit of Airborne Electrical Apparatus, Components and Auxiliary Equipment, Southwest District Meeting of AIEE, April 2-4, Baker Hotel, Dallas, Tex.

Special Technical Conference on Magnetic Amplifiers, April 5-6, Hotel Syracuse, Syracuse, N. Y.

13th Annual Radio Components Show, April 10-12, Grosvenor House, London, England.

10th Annual Spring Television Conference of Cincinnati Section of IRE, April 13-14, Engineering Society of Cincinnati Building, Cincinnati, Ohio.

London Audio Fair 1956, April 13-15, Washington Hotel, London, England.

79th Convention of Society of Motion Picture & Television Engineers, April 29-May 4, Hotel Statler, New York City.

1956 Electronic Components Symposium, May 1-3, Department of Interior Auditorium, Washington, D. C.

1956 Electronic Parts Distributors Show, May 21-24, Conrad Hilton Hotel, Chicago. (A closed show for distributors, manufacturers and their representatives.)

RETMA Symposium on Reliable Applications of Electron Tubes, May 21-22, Irvine Auditorium, University of Pennsylvania, Philadelphia, Pa.

FEEDBACK TECHNIQUES produce fail-safe monitoring. The new technique for monitoring the output of any operating system also serves to check the monitoring system itself. Failure of either the operating or monitoring system will produce a warning signal or correct the defect.

Basically, a periodic checking signal which modulates the normal, or safe, operating condition of the monitoring system is fed back from the output to the input. Failure of either the operating or monitoring system cuts off the signal and sounds the alarm or makes the correction.

Invented by William G. Rowell, chief engineer of the Scully Signal Co., the system (see photo) has been used successfully on fire-detection equipment, and similar devices.

SOLAR - POWERED RECEIVER, weighing only 10 ounces and capable of operating more than 8 months (500

hours) in total darkness without recharging, has been developed by G-E. Built by the Advanced Circuits Sub-section, the unit's major advantages over previously developed solar-powered radio receivers are size and length of operation without light.

Long operation in total darkness is made possible by a miniature storage battery contained in a transparent plastic case along with four transistors, seven solar cells and other components. The case is 5½ inches wide, 1¼ inches thick and 3 inches high.

Under normal daylight conditions, light rays strike the selenium cells which convert the solar energy to electrical current, fed directly to the transistors in the daytime, powering the receiver. Simultaneously, the miniature storage battery charges and is used when sun power is lacking. Artificial light, such as a 100-watt lamp, may be used in place of sunlight.

General Electric indicated that highly efficient solar batteries such as those used in the receiver are still too expensive to justify manufacture of devices in which they play an important part.

TEACHER RESERVE has been proposed by David Sarnoff, board chairman of RCA. In a speech before the National Industrial Security Association he stated, "Our safety and our industrial strength rest upon our success in expanding the nation's reservoir of physicists and scientists, trained engineers and technicians."

He then went on to propose the establishment of a National Educational Reserve consisting of qualified teachers in mathematics, physics, chemistry, engineering and related subjects to be drawn from the technological ranks of industry. Sarnoff suggested that the number of teachers recruited—with full pay for at least 1 year—from any single organization would be too small to entail hardship for anyone, but the total number of the corps could be drawn from such an extensive list of organizations that it would be large enough to give new impetus to teaching of the sciences in our school system. This would be especially true at the high school level, described as our present major bottleneck. **END**

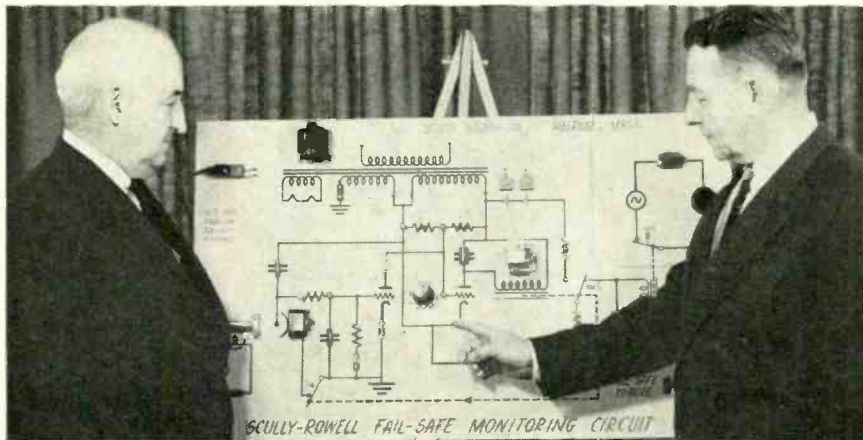

William G. Rowell, chief engineer of Scully Signal Co., explains system.

Now IN YOUR OWN HOME Learn

AUTOMATION
ELECTRONICS

TELEVISION
RADIO-ELECTRONICS

the Amazingly Effective

D.T.I. WAY

—with the aid of BOTH
HOME EQUIPMENT
and HOME MOVIES

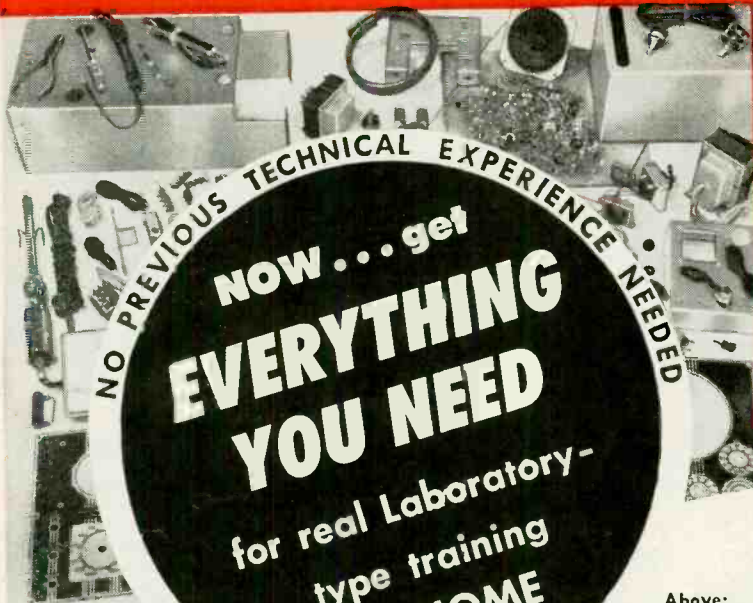

NO PREVIOUS TECHNICAL EXPERIENCE NEEDED

NOW... get
EVERYTHING
YOU NEED

for real Laboratory-
type training
AT HOME

Above:
Work over
300
fascinating
experiments
with this
equipment

What will mailing the coupon below do for YOU? Just this! You'll find out about one of today's most remarkable... practical ways to prepare to get into America's amazing billion dollar opportunity field of TELEVISION-RADIO-ELECTRONICS. You'll see how to get into fascinating work that pays well... that offers one of America's most promising futures... that enables you to start your own business almost "on a shoe string," if you prefer this to a job opportunity.

And above all, you'll get some GOOD NEWS especially welcomed by men anxious to earn REAL MONEY in this thrilling field. For you'll see that NOW you can get the kind of practical, laboratory-type training so desirable for making real progress in Television-Radio-Electronics AND WITHOUT LEAVING HOME.

You'll see that DeVry Technical Institute sends everything needed to set up your own HOME LABORATORY. You get and keep the same type of basic electronic equipment used in our modern Chicago Training Laboratories. You get home training that includes the knowledge and experience gained from training thousands of students first hand in Chicago. And to top it all, you use DTI's amazingly effective and exclusive home training aid—INSTRUCTIVE MOVIES. But why not get the complete story? Mail coupon today for information-packed literature.

MODERN LABORATORIES

If you prefer, get all your preparation in our new Chicago Training Laboratories—one of the finest of its kind. Ample instructors, modern equipment. Write for details!

MILITARY SERVICE!

If you're subject to military service, the information we have for you should prove very helpful. Mail coupon today.

1. Build over 300 fascinating experiments from 16 BIG SHIPMENTS of Electronic-Radio parts which you KEEP.
2. Build valuable commercial-type test equipment—as shown to the left—which you KEEP. This includes a quality 5 INCH oscilloscope and vacuum tube voltmeter—both highly useful for Television work.
3. Build and keep a big 21 INCH TV Set. (D.T.I. offers another home training in Television-Radio-Electronics, but without the TV set.)
4. Use a 16 mm. movie projector and new series of highly instructive movies—a wonderful aid to help you grasp important fundamentals faster... easier... better.
5. Enjoy well-illustrated, easy-to-read lessons with handy FOLD-OUT diagrams.
6. Get an honest-to-goodness EMPLOYMENT SERVICE to help you get a good job after graduating—or assistance in starting your OWN SALES AND SERVICE BUSINESS. Mail coupon today for the complete details.



OSCILLOSCOPE

VACUUM TUBE
VOLT METER



21 INCH

Build and keep this BIG DTI Engineered TV set—easily converted to U.H.F. (DTI offers another home training, but without the TV set.)



HOME MOVIES

89 WAYS TO EARN MONEY
IN TELEVISION
RADIO-ELECTRONICS

Get this information-packed publication

FREE!

Mail Coupon Today



"One of America's Foremost Electronics Training Centers"

DEVRY TECHNICAL INSTITUTE
CHICAGO 41, ILLINOIS
FORMERLY
DEFOREST'S TRAINING, INC.



DEVRY TECHNICAL INSTITUTE
4141 BELMONT AVE., CHICAGO 41, ILL.

MEMBER OF NATIONAL HOME STUDY COUNCIL

I would like your Opportunity News Bulletin showing "89 Ways to Earn Money in Television-Radio-Electronics"; also, complete facts about the training opportunity made possible by your organization.

Name _____ Age _____
Address _____ (PLEASE PRINT) Apt. _____
City _____ Zone _____ State _____
D.T.I.'s Training is available in Canada Dept. _____ RE-4-M

"2300 RAYTHEON TUBES PERFORMANCE TESTED WITHOUT ONE FAILURE"

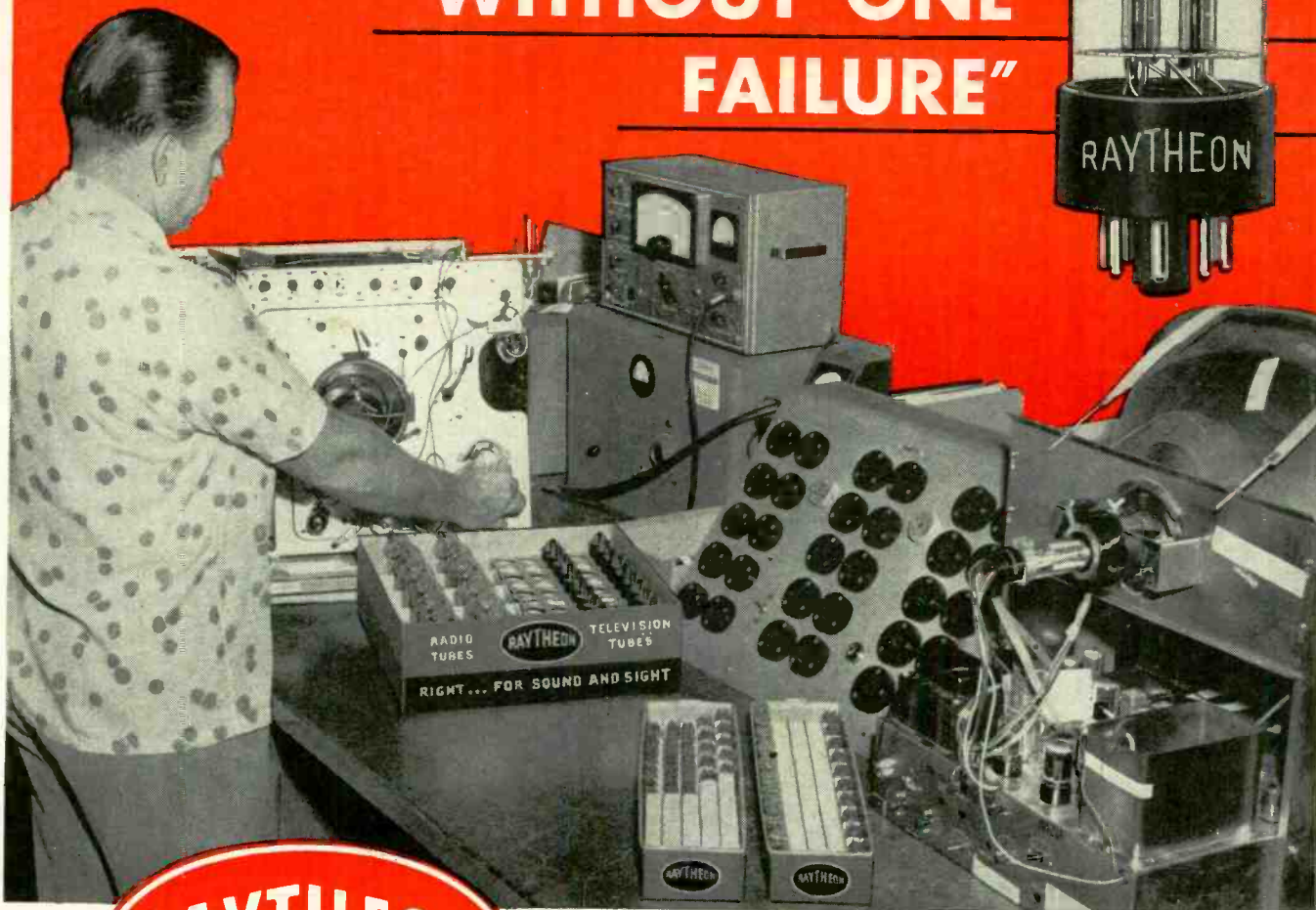

RAYTHEON RECEIVING TUBES for replacement
pass every test for performance and quality
at **HOWARD W. SAMS & CO., INC.**

The results of this thorough, impartial test of regular production Raytheon Tubes provide potent evidence that Raytheon Tubes are tops in quality and performance. Here's what the report says:

"Raytheon tubes were substituted in basic chassis, representing several hundred models. In these tests 2300 Raytheon tubes were tried in 230 different circuit applications with no apparent tube performance failure. Conditions were arranged to simulate fringe area as well as prime signal area, when testing tube types in RF, IF, Video,

Sync, Vertical Oscillator and Horizontal Oscillator Circuits. Low Voltage Rectifiers, High Voltage Rectifiers, Vertical and Horizontal Oscillator, and Horizontal Output Tube types were also checked under low line voltage conditions. No types were found incapable of providing satisfactory results in these circuits, after adjustments of service controls."

What more can we add to this conclusive proof that Raytheon Receiving Tubes are truly **RIGHT . . . For SOUND and SIGHT.**



RAYTHEON MANUFACTURING COMPANY

Receiving and Cathode Ray Tube Operations

Newton, Mass. • Chicago, Ill. • Atlanta, Ga. • Los Angeles, Calif.

Raytheon makes all these Receiving and Picture Tubes, Reliable Subminiature and Miniature Tubes, Semiconductor Diodes, Power Rectifiers and Transistors, Nucleonic Tubes, Microwave Tubes



Excellence in Electronics

Visit Raytheon Booth No. 4 at the **ELECTRONICS PARTS DISTRIBUTORS SHOW** May 21-24—Badges issued only in advance—No registration at the show

There's Money
For You In...

MOBILE Communication and MICRO-WAVE

SERVICING 2-WAY MOBILE RADIO SYSTEMS PAYS BIG MONEY

**Get Your FCC
COMMERCIAL RADIO OPERATOR
LICENSE
IN A MINIMUM OF TIME!**

**Get These
Amazing
Booklets
FREE**

**Money-Making
FCC
Commercial Radio
Operator
LICENSE
Information**

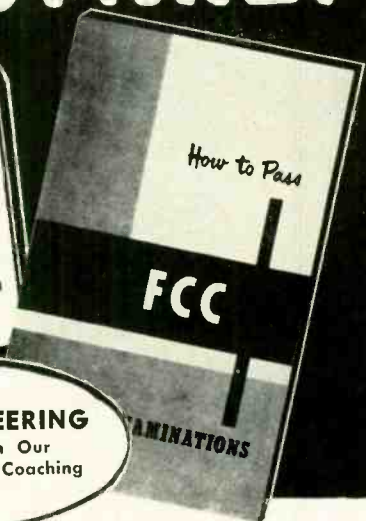

TV ENGINEERING
Included in Our
Training and Coaching

TELLS HOW

**WE GUARANTEE
TO TRAIN AND COACH YOU AT HOME
IN SPARE TIME UNTIL YOU GET
YOUR FCC LICENSE**

TELLS HOW

**Employers Make Job Of-
fers To Our Graduates
Every Month In Practic-
ally Every Field Of Radio!**

NATIONAL MANUFACTURER of Mobile Communications Equipment has several openings in the Southwest for FCC licensed, experienced technicians in the field of 2-way Radio Mobile Communications. Salary commensurate with experience and ability.

TECHNICIANS: Wanted by nationally known Airlines at Washington, D. C. office, in all phases of aircraft and ground radio maintenance and troubleshooting. Starting salary \$340 per month with automatic advancement under present wage scale. 1st or 2nd class license required.

TELLS HOW

**Our Amazingly Effective JOB FINDING
SERVICE Helps CIRE Students Get Better Jobs.**

**GETS 2-WAY MOBILE
RADIO JOB**

"After receiving my 1st class phone license and looking over several jobs on your Job-Opportunities Bulletin, have decided on one with Transcontinental Gas Pipe Line Corp."
James Driver,
6419 Fitzhugh Avenue,
Richmond, Virginia

GETS AIRLINE JOB

"Many thanks for your assistance in obtaining employment. I am now working for United Airlines."

Charles P. Krause,
4026 W. 57th Place,
Chicago 29, Illinois

GETS LABORATORY JOB

"I am happy to tell you that I have obtained a job at Collins Radio Company as a senior laboratory assistant, and I wish to thank you for the assistance you gave me in obtaining this job."

James M. Schoening,
1300 Oakland Road, N. E.,
Apt. 1308, Cedar Rapids, Iowa

**Get All 3
Booklets Free
MAIL
COUPON
NOW**



Cleveland Institute of Radio Electronics
4900 Euclid Avenue, Desk RE-90, Cleveland 3, Ohio
(Address to Desk No. to Avoid Delay)

I want to know how I can get my FCC ticket in a minimum of time. Send me your FREE booklet, "How To Pass FCC License Examinations" (does not cover exams for Amateur License), as well as a Sample FCC-type lesson and the amazing new booklets, "Money-Making FCC License Information" and "There's Money For You in 2-Way Mobile Radio Servicing". Be sure to tell me about your Television Engineering Course.
Please Print Clearly

NAMEAGE.....
ADDRESS
CITYZONE.....STATE.....

FOR PROMPT RESULTS SEND AIR MAIL
Special tuition rates to members of the U. S. Armed Forces. Electronic Training Available to Canadian Residents.

NEW Tape recorder microphone



TURNER 908

Low Cost—Balanced for

hand or desk use (will not tip with weight of cable)

ACTUAL
SIZE

Available in Crystal (Model 908) or Ceramic (Model 907) interiors.

Model	Response	Level
908 Crystal	60-8500 cps	-45 db
907 Ceramic	60-8500 cps	-55 db

Model 908, 907 . . . List price \$8.00



912 17th St., N.E., Cedar Rapids, Iowa

Write for Descriptive Literature No. 971

When signal conditions
demand a **TOWER...**
choose one built by **AERMOTOR**

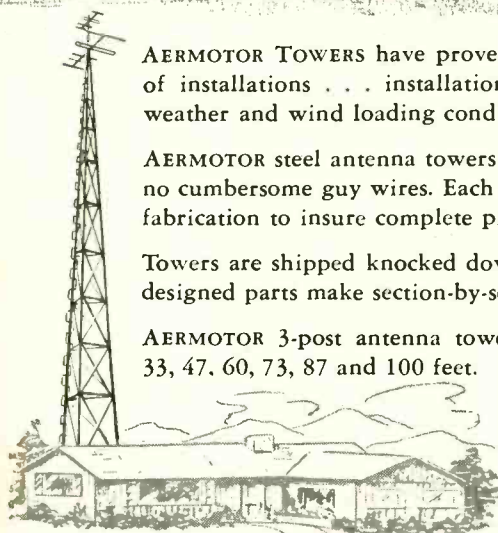

AERMOTOR TOWERS have proven their excellence in thousands of installations . . . installations exposed to the most severe weather and wind loading conditions.

AERMOTOR steel antenna towers are self supporting . . . require no cumbersome guy wires. Each part is heavily galvanized *after* fabrication to insure complete protection from exposure.

Towers are shipped knocked down in convenient bundles; well designed parts make section-by-section assembly easy.

AERMOTOR 3-post antenna towers are available in heights of 33, 47, 60, 73, 87 and 100 feet.

WRITE FOR ADDITIONAL INFORMATION ABOUT THE AERMOTOR TOWERS AND A DEALER FRANCHISE IN YOUR TERRITORY.

SINCE 1888, MANUFACTURERS OF QUALITY BUILT TOWERS

• **AERMOTOR COMPANY** •

2500 W. ROOSEVELT RD.—CHICAGO 8, ILLINOIS U.S.A. DEPT. 12 U 4

Correspondence



COLORDAPTOR CORRECTIONS

Dear Editor:

We have noted the following errors in the article on the Colordaptor, appearing in the January, 1956, issue:

1. The V10 (5Y3-GT) heater connections are to pins 2 and 8, not 2 and 5.
2. Resistor to pin 8 of V1-b (½ 6U8) chroma video is 1.5K, not 15K.
3. Add a .01- μ f bypass capacitor from pin 7 of V6-b (cathode of the pentode section of 6U8) to ground, shunting the 270-ohm cathode resistor.
4. Variable capacitors TC11 and TC12 are 30-300- μ f trimmers.
5. There should be a .01- μ f 600-volt capacitor in series with the horizontal sync lead from the TV set to the Colordaptor.

The following items in the parts list should read: 8—30-30- μ f trimmers; 4—30-300- μ f trimmers; 7—diodes.

If a 3.579545-mc color crystal is purchased from Colordaptor, series tuning capacitor TC9 is not required. Our crystals are specially ground for this circuit.

In adjusting the Colordaptor for operation from the TV set, connect a 50,000-ohm potentiometer in parallel with R2 to adjust the horizontal pulse amplitude for maximum reference test-point voltage. Adjust the fine tuning on TV to reduce the test-point voltage to about 1 volt before adjusting.

PERRY H. VARTANIAN
ROBERT W. DEGRASSE

Colordaptor
Palo Alto, Calif.

SUPERCONDUCTIVITY

Dear Editor:

Regarding your editorial on "Space Electronics" in the February issue, here is some additional information on the subject of low-temperature electronics.

Superconductivity was discovered by Kammerlingh Onnes in 1911, 3 years after he successfully liquified helium. While extending electrical measurements to this new low temperature, he found that at 4.12 Kelvin the resistance of mercury fell suddenly to zero. We now know of 21 elements and many alloys and compounds which become superconductive from 0-17 Kelvin.

Naturally, the first question about superconductors is: "Is the resistance really zero?" No one has succeeded in measuring any resistance but in an experiment started on Mar. 16, 1954, by Prof. S. C. Collins of MIT, a current of several hundred amperes was produced

free

ALLIED'S 1956 value-packed 324-PAGE CATALOG

the only **COMPLETE** catalog
for everything in **TV, Radio, Hi-Fi**
and **Industrial Electronics**

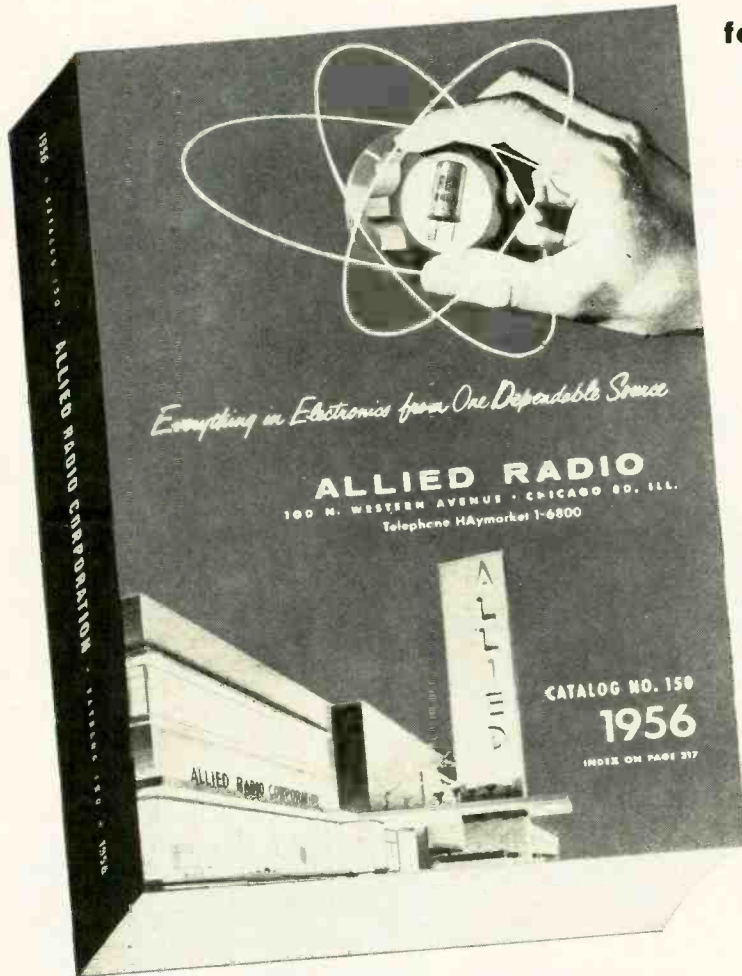

Get ALLIED'S 1956 Catalog—it's *complete*, up-to-date—324 pages packed with the world's largest selection of quality electronic equipment at lowest, money-saving prices. Get *every* buying advantage at ALLIED: fastest shipment, expert personal help, lowest prices, assured satisfaction. Send today for your **FREE** copy of the big 1956 ALLIED Catalog.

World's Most Complete Stocks

- Latest Hi-Fi Systems and Components
 - P.A. Systems and Accessories
- Recorders and Supplies • TV Tubes, Antennas, Accessories • Amateur Receivers, Transmitters, Station Gear
- Specialized Industrial Electronic Equipment • Test and Lab Instruments
- Huge Listings of Parts, Tubes, Transistors, Tools, Books

Featuring Super-Value Knight-Kits—
top quality electronic equipment
in precision-designed kit form
BUY DIRECT AND SAVE

EASY-PAY TERMS

Use our liberal Easy Payment Plan—only 10% down, 12 months to pay—no carrying charges if you pay in 60 days. Available on Hi-Fi and P.A. units, recorders, TV chassis, test instruments, kits, Amateur gear, etc.

HI-FI SPECIALISTS

To keep up with the latest and best in High Fidelity, look to ALLIED. Count on us for *all* the latest releases and largest stocks of Hi-Fi equipment. We specialize, too, in TV supply—and are foremost in the field of Builders' Kits.



send for the leading
electronic supply guide

ALLIED RADIO CORP., Dept. 2-D-6
100 N. Western Ave., Chicago 80, Ill.

Send **FREE** 324-Page 1956 ALLIED Catalog.

Name _____

Address _____

City _____ Zone _____ State _____



ALLIED RADIO

World's Largest Electronic Supply House

Your
HIGH FIDELITY
System

IS OFF TO A
Perfect Start
with a
REK-O-KUT

Rondine*
TURNTABLE
and
TURNTABLE ARM

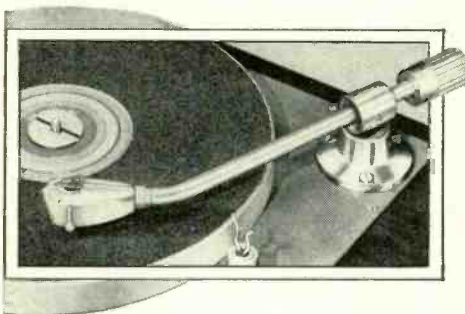

REK-O-KUT TURNTABLES:

3-Speed

- Rondine Deluxe (hysteresis motor) . **\$129.95**
- Rondine (4-pole induction motor) . **79.95**

2-Speed (4-pole induction motors)

Rondine Jr.

- Model L-34 (33 $\frac{1}{3}$ and 45 rpm) . . . **\$49.95**
- Model L-37 (33 $\frac{1}{3}$ and 78 rpm) . . . **49.95**

REK-O-KUT ARMS:

- Model 120 (12") **\$26.95**
- Model 160 (16") **29.95**



See them at your high fidelity dealer or write to Dept. RD-13

REK-O-KUT COMPANY
38-01 Queens Blvd., Long Isl. City 1, N.Y.

Makers of fine recording and playback equipment
Engineered for the Studio • Designed for the Home

CORRESPONDENCE (Continued)

in a superconducting lead ring by applying an impulse of electric field. The magnitude of this current has been checked periodically by measuring the intensity of the magnetic field it produces. These measurements show that the original current is still flowing with no perceptible decrease in amplitude! This tells us that the L-R time constant is very large, leading to an extremely small, if not zero, resistance.

Experimentally it has been found that the temperature of the superconducting transition can be altered by applying an external magnetic field. When the critical field for any one temperature is exceeded at that temperature, the superconducting state is destroyed. As a result of this quenching effect, a superconducting wire exhibits a nonlinear volt-ampere characteristic.

The phenomenon of magnetic quenching has very recently been utilized in developing a new circuit component, the cryotron. The basic cryotron consists of a superconductive wire upon which is wound a solenoid of conventional wire. By a small current in the solenoid, it is possible to turn the proper conducting state on and off in the center wire, and thereby control the flow of power in the circuit to which the superconductor is connected.

Here at MIT, several graduate and undergraduate theses are being written concerning superconductors and low-temperature electronics. Low-noise amplifiers are being studied at the moment. My own thesis will probably be on a pulse transformer with superconductive windings and shield, which should exhibit perfect flux linkage and, naturally, no winding resistance.

ROBERT J. HOCHMAN, '56
Massachusetts Institute of Technology
Cambridge, Mass.

DIAL CALIBRATION

Dear Editor:

Relative to my "Potentiometer" article in the February issue of RADIO-ELECTRONICS, the dial scale shown in Fig. 5 appears to be linear, possibly due to the small size of the illustration. This is misleading since the 10,000-ohm voltage divider loads the potentiometer, resulting in nonlinearity. This is pointed out in the third paragraph from bottom of page 49. The original scale was calibrated from the following calibration table:

point on scale	Degrees From Electrical Zero
0	0
0.1	28
0.2	57
0.3	86
0.4	114.5
0.5	143.5
0.6	172
0.7	200
0.8	228
0.9	254
1.0	280

The points between these 10 divisions may be subdivided linearly.

(Continued on page 18)

Merit
FIRST IN EXACT REPLACEMENT.

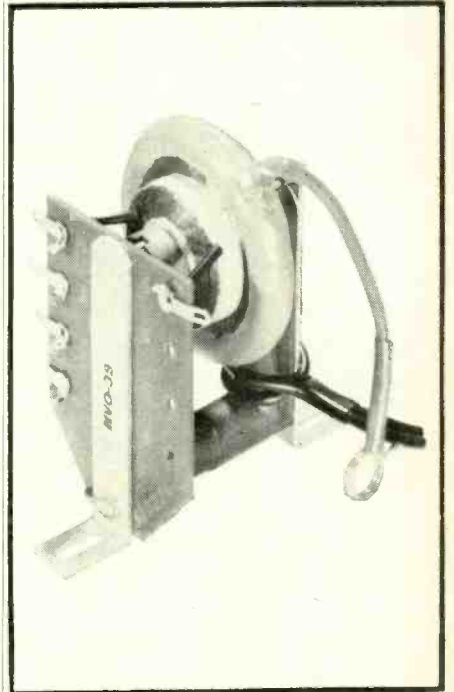
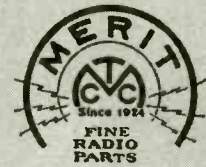

HVO-38 and HVO-54 FOR EXACT REPLACEMENT in ADMIRAL . . . another in the complete Merit line of exact and universal transformers, yokes and coils. Merit is the only manufacturer of transformers, yokes and coils who has complete production facilities for all parts sold under their brand name.

Merit
MERIT COIL & TRANSFORMER COMPANY
4427 N. CLARK ST., CHICAGO 40, ILL.

RADIO-ELECTRONICS

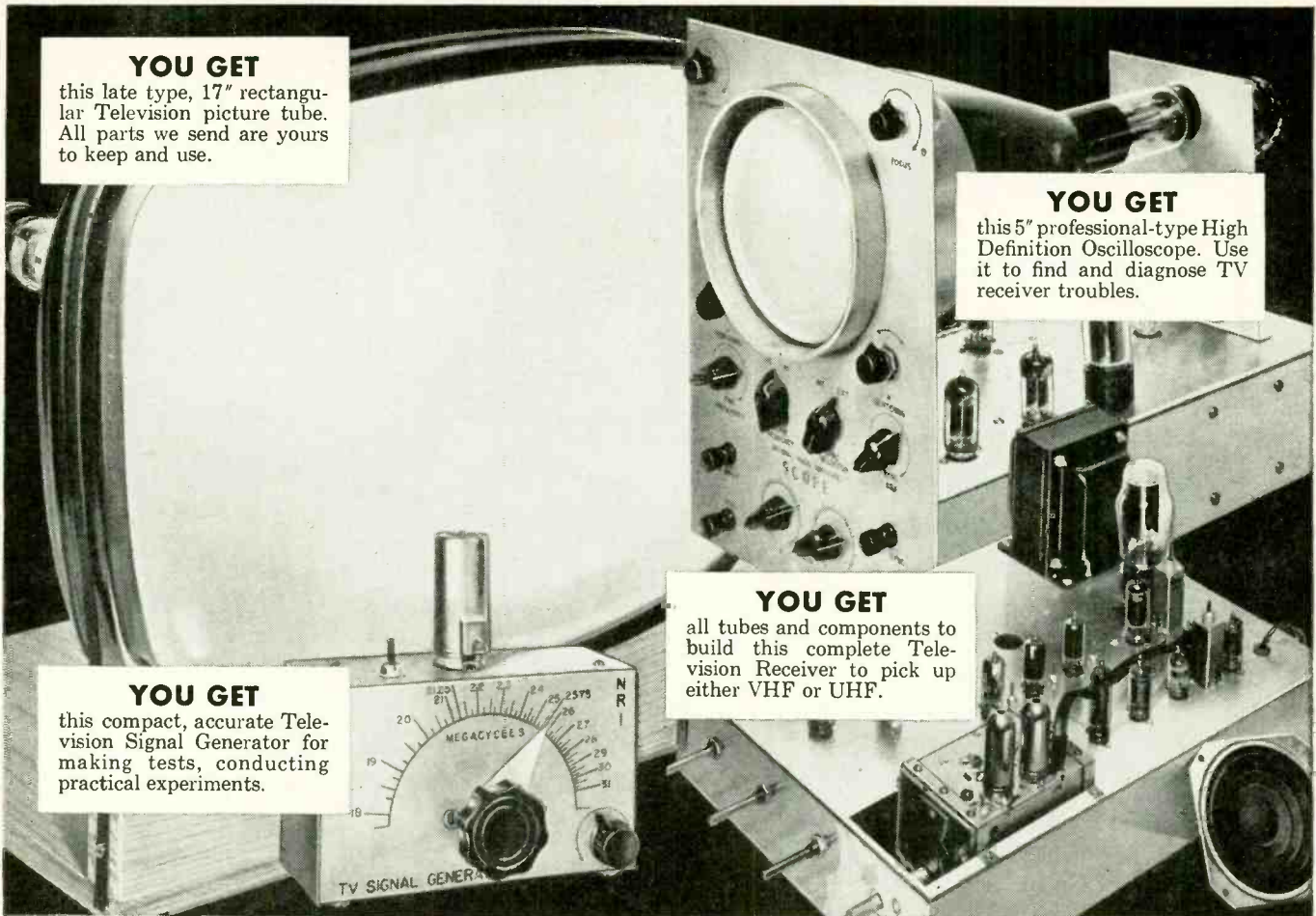

YOU GET
this late type, 17" rectangular Television picture tube. All parts we send are yours to keep and use.

YOU GET
this 5" professional-type High Definition Oscilloscope. Use it to find and diagnose TV receiver troubles.

YOU GET
this compact, accurate Television Signal Generator for making tests, conducting practical experiments.

YOU GET
all tubes and components to build this complete Television Receiver to pick up either VHF or UHF.

Learn to Service TV Sets Quickly N.R.I. All Practice Method Trains You at Home

*You are Ready for Top Pay when you have Thorough KNOW-HOW
Fix TV Sets, Solve Problems Quickly, Correctly*

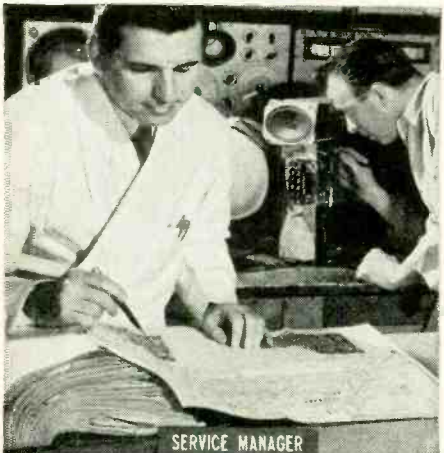

TV's growth has already brought higher pay and greater opportunity to thousands of TV Servicemen. Since Television started booming in 1948 the shortage of TRAINED TV Servicemen has been a problem. The U.S. Dept. of Labor reports: "Excellent Opportunities for men thoroughly trained in Television expected in many cities. Long-run employment trend upward." This means but one thing . . . opportunity. Opportunity for top jobs at top pay. How good are these top jobs? Statistics show that, as a Professional Television Technician, your earnings can be right up there with many college-trained engineers and skilled craftsmen; doctors and lawyers.

Assure the Kind of Future You Want

If you want a business of your own, here's a way to make it possible. If you want better pay as a skilled Technician here is your opportunity. Right in your own home, in your spare time, NRI's practical training in Professional Television Servicing provides the knowledge you need to get ahead.

Learn-by-Doing "ALL THE WAY"

You get practical knowledge through planned, experienced guidance. You experiment with power supply and other TV receiver circuits, tubes, resistors, condensers, and other components. Measure gain, study diode detectors, align sound i.f. amplifiers, practice trouble shooting, learn about sync amplifiers, sync separators, sweep circuits. You get the kind of training that makes you an EXPERT who can service any make, any model TV set accurately, quickly and professionally. You get a Diploma that certifies to your training.

TV MEN SAY . . . NRI TRAINING IS BEST
National Radio Institute is the oldest and largest home study Radio-TV school. For over 40 years we've been training men for better pay, better jobs. Lawrence Martin, NRI graduate of New Orleans, La. says: "I have just finished your All-Practice TV Course. As you know, I did not have to ask one question. Everything was so clear. I will give anyone \$100 if they have a TV I cannot fix, thanks to NRI."

NOT FOR BEGINNERS

This course is for men who know basic theory, either from Radio or TV servicing experience or planned training and who want the advantages of more knowledge. If you want to go places in TV, act quickly to find out what you get and how. NRI's Professional TV Servicing course will help you. Mail the coupon today for FREE BOOK. Paste on post card or mail in envelope addressed to: Professional TV Servicing, NRI, Dept. 6DFT, 16th and U Sts., N.W., Washington 9, D.C.

MAIL COUPON TODAY

NATIONAL RADIO INSTITUTE
Dept. 6DFT, 16th & U Sts., N.W., Washington 9, D.C.

Please send my FREE copy of "How to Reach the Top in TV Servicing." (No salesman will call.)

Name _____ Age _____
Address _____
City _____ Zone _____ State _____
APPROVED MEMBER, National Home Study Council

NRI All-Practice TV Training gives you Professional Techniques, Tricks of the Trade That Open the Way to Top Pay in TV Servicing. Instead of reading "how to do it" . . . you actually DO IT with NRI practical training. You gain a thorough knowledge of TV servicing at home in your spare time by practicing with ten big kits of TV components. You build, experiment with circuits, testing instruments, learn time saving, professional TV servicing techniques. It's the practical way.

Dealers by the thousands are
making the **SWITCH**
to this great insulator idea!

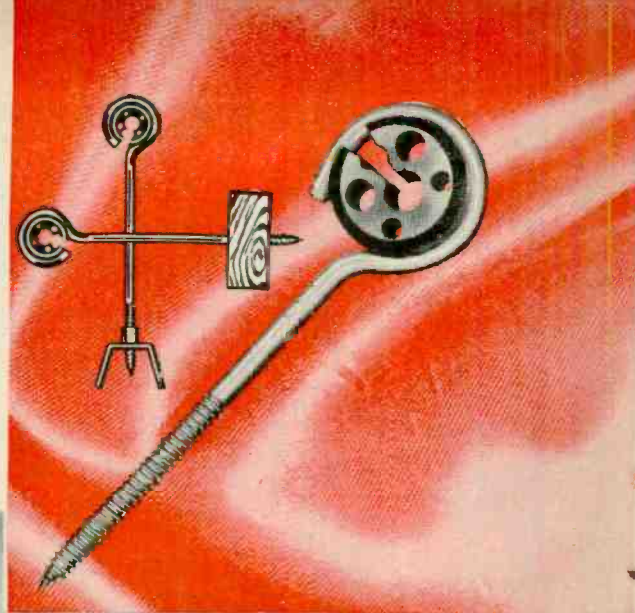

when we say

SWITCH

*we mean
business!*

New indoor antenna has
gliding **SWITCH**

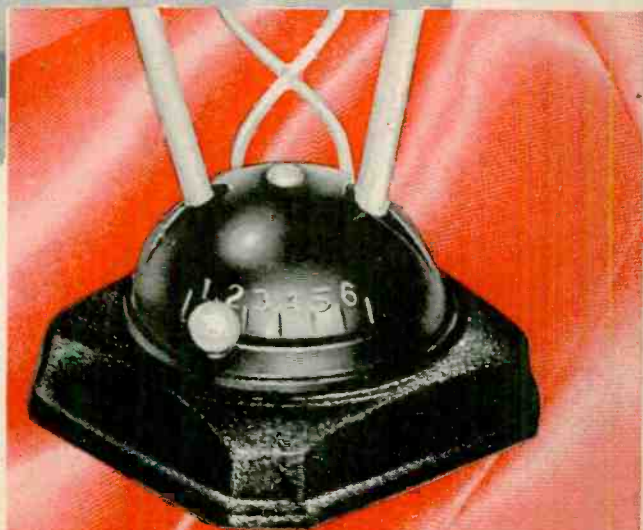

Only **CHANNEL MASTER®**

STANDOUT

insulators

have this revolutionary
2 in 1 design

It's a wood-screw insulator
... it's a machine-screw insulator
... and it's **BETTER** in both applications!

STANDOUT insulators and buckles are already outselling all others — after only a few months on the market! This remarkable record provides positive proof of the solid acceptance STANDOUTs have won among dealers all over the country.

Why has the response to STANDOUTs been so enthusiastic? BECAUSE they cut space and dollar investments in accessories by more than 65% ... BECAUSE they increase space and dollar turnover by more than 200% ... BECAUSE they are easier to install, stronger, more durable.

Millions already sold!
Here's why:

"T-Nut" buckle with 8 threads.

More threads than any other buckle (nut type or extruded) — 8 full machined threads! Tighten as hard as you want, you can't strip it!



Pointed Screw makes positive contact.

Strap won't slip while you're tightening. Won't twist or slip on mast after installation. Straps have convenient "taper-tip."



Needle-sharp point

Finer thread, sharper point means easier starting — even in hardwood. Minimizes possibility of splitting.

Ordinary standoff point



STANDOUT point.

All popular types and sizes available, including full assortment of specialized hardware. See your Channel Master distributor

CHANNEL MASTER'S

new **Glide-o-Matic**

INDOOR TV ANTENNA

The Glide-o-Matic's sensational low-loss **gliding switch** is different from all others! Provides highest electrical efficiency ... AND — it's the most convenient to operate!

Glide-o-Matic also gives you:

- Maximum performance on all channels — VHF and UHF.
- Weighted tip-proof base — with "can't scratch" felt covering.
- Ready for COLOR TV.
- Powerful retail merchandising support.

Available in
4
popular color
harmonies:

Mahogany	with brass	model no. 3700
Ebony	with brass	model no. 3701
Ivory	with brass	model no. 3702
Ebony	with aluminum	model no. 3703

A performance hit
with men...

A style hit with
women!

Glide-o-Matic practically sells itself. Smartly styled ... blends into any setting. Packed in colorful "tell and sell" carton with convenient "carry away" handle.



\$9.95
list

Also available:

CHANNEL MASTER'S ALL-VU \$8⁹⁵
model no. 381, all-VHF, all UHF.



CHANNEL MASTER'S PRE-VU \$7⁹⁵
model no. 380 all-channel VHF.



© Trade Mark Reg. U.S. Pat. Off.

CHANNEL MASTER CORP.
ELLENVILLE, N. Y.

WORLD'S LARGEST MANUFACTURER OF TV ANTENNAS AND ACCESSORIES

Give customers "hi-fi satisfaction" —profitably!

THE BRILLIANT NEW "3" SERIES SONOTONE CERAMIC

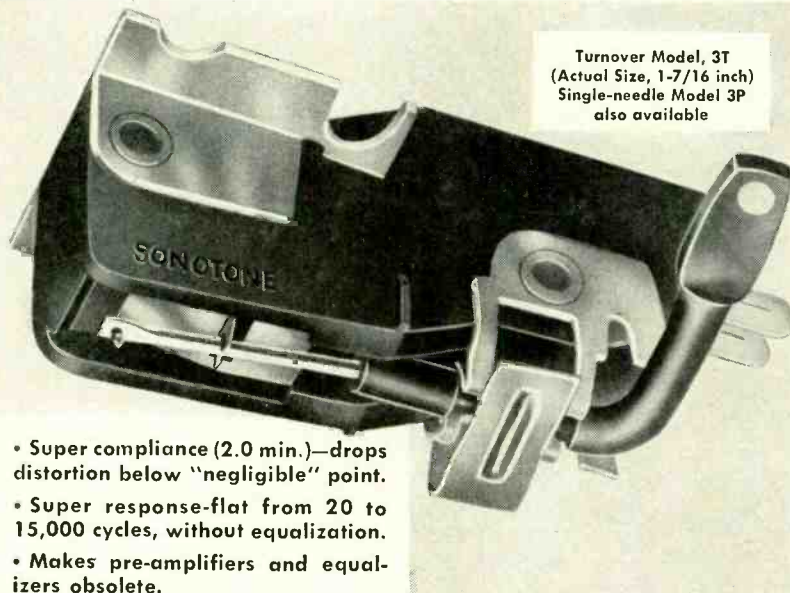

Turnover Model, 3T
(Actual Size, 1-7/16 inch)
Single-needle Model 3P
also available

- Super compliance (2.0 min.)—drops distortion below "negligible" point.
- Super response—flat from 20 to 15,000 cycles, without equalization.
- Makes pre-amplifiers and equalizers obsolete.

If you've followed the development of ceramic cartridges since Sonotone pioneered them in 1946, you know of their enormous advances.

Now Sonotone presents the "3" Series, which sets utterly new standards of performance and opens the door to profitable "hi-fi" business for you.

The Sonotone "3" Series ceramic cartridge can be used as a replacement in nearly any phonograph circuit. It delivers a brilliance and clarity of sound which will be noticed and commented upon by delighted customers. Because these cartridges deliver a whopping 0.5 volts (roughly 50 times as much as most velocity types), they do not need preamplification and equalization circuits. And naturally the non-magnetic structure eliminates motor hum.

There are two basic models, a turnover (3T-S) for all record speeds and a single-needle model (3P-1S) for 33 and 45 rpm records. They have standard 1/2 or 5/8 inch mounting centers and fit any of the widely used tone arms. Prices begin at \$12.50 list (sapphire needles).

Use the brilliant new Sonotone Series "3" on your next replacement job. You'll find yourself on the way to profitable "hi-fi" business.

SONOTONE®

CORPORATION, ELMSFORD, N. Y.



Write Department CE-46 for free cartridge replacement chart.
In Canada—Atlas Radio Corp. Ltd., 50 Wingold Ave., Toronto.

CORRESPONDENCE (Cont'd from page 14)

The statement in the last paragraph on page 49, should be interpreted as meaning that the electrical center occurs at 0.5 on the scale when the 1,000-ohm potentiometer is loaded with a 10,000-ohm resistance. A simpler procedure is to position the arm so that it travels equal distances past the 0 and 1 marks to the mechanical stops.

FORREST H. FRANTZ, SR.

Physics Dept.
Mississippi State College

PATENT EXAMINERS

Dear Editor:

American industry is facing long delays in obtaining patent coverage for products and processes otherwise ready for the market. These delays stem from the great increase in the number of patent applications filed during the past few years, coupled with the fact that the number of patent examiners has not kept pace with the increase in patent applications.

Salaries for examiners start at \$4,345 a year and it is possible to reach a salary of \$7,570 in 5½ years, with salaries in excess of \$13,000 available. Vacations and sick leave and pension benefits are liberal.

Engineers and scientists holding a college degree in engineering or applied science or a degree with a major in chemistry or physics or with certain combined credits in these fields, are eligible for appointment as patent examiners, without examination, upon application to the Commissioner of Patents, Washington, D. C.

HENRY E. SHARPE

New York Patent Law
Association
New York, N. Y.

AUSTRALIAN TV

Dear Editor:

Here are a few details of the television setup in Australia. The first six stations are expected to begin operation during 1956 in time for the Olympic games that are scheduled to be held in Melbourne.

They will use 625-line interlaced scanning at 25 frames per second. The video channels will be 7 mc wide and the channels will be on the following frequencies: 1. 49-56, 2. 63-70, 3. 85-92, 4. 132-139, 5. 139-146, 6. 174-181, 7. 181-188, 8. 188-195, 9. 195-202, 10. 209-216 mc. For future use 50 channels are reserved between 500 and 855 mc.

The video carrier will be 1.25 mc above the low end of the channel, the audio carrier 0.25 mc below the upper end. The recommended if channel is 30.25-37.25 mc, the video carrier being at 36 mc and the audio carrier at 30.5 mc. Thus, the intercarrier sound is at 5.5 mc.

The sound carrier will be FM with a maximum deviation of plus and minus 50 kc and audio modulation up to 15 kc.

GERALD MILLERD
South Melbourne, Australia

END

how long would it take you to solve this service problem?

SYMPTOM: Sound bars in the picture. Bars vary in intensity and position according to the audio being transmitted. Need for alignment has been established.

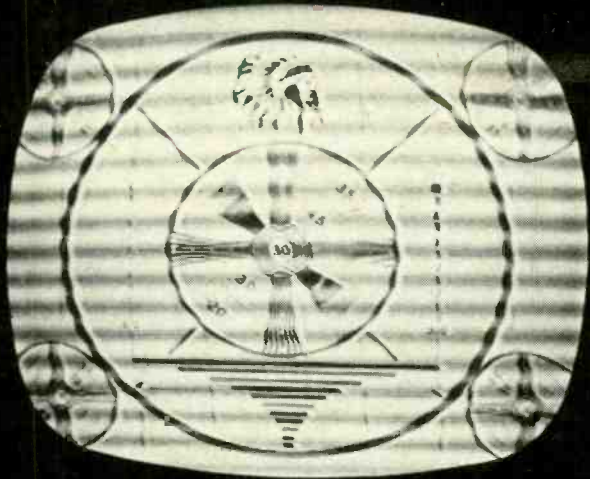

Valuable time can be spent searching for alignment points, adjustments and frequencies if you are relying on hit-or-miss methods or incomplete service data. With a PHOTOFACT Folder by your side you have all the information in just minutes. Here's why:

ALIGNMENT INSTRUCTIONS						
SWEEP GENERATOR FREQUENCY	SWEEP GENERATOR TO SCOPE AND FROM 4740 OF 2 LUM. LOW 150-175	MARKER GENERATOR FREQUENCY	CHANNEL	CONNECT SCOPE	ADJUST	REMARKS
42.55MC	100MC 3rd	42.55MC	Between any two channels	Vert. amp. 1174 to pin 9 (total of 8CB8 IV3). Low side to chassis.	A1 A2 A4	Adjust for response curve similar to Fig. 1. Adjust A1 to place 42.55MC marker in notch. Adjust A2 to place 47.55MC in notch. A3 to place 42.55MC marker on frequency side of curve. A4 to place 45.75 at 70% on high frequency side of response curve.
Not used	44.0MC	44.0MC	Use VTVM DC probe to pin 10. Chassis to chassis	A5	A5	Adjust for maximum deflection.
	42.55MC				A8	

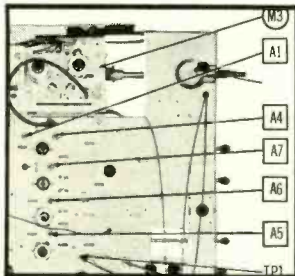
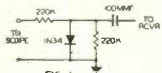

In just seconds, you find the complete Alignment Instructions. It's in every PHOTOFACT Folder, in the form of an easy-to-use chart*, with step-by-step instructions. It gives frequencies, adjustments, connection points for oscilloscope or VTVM, dummy antenna and detectors required, and oscilloscope response curves with marker frequencies and placement. Whenever possible, instructions are given for using either an oscilloscope or a VTVM.

Adjustments called for in the alignment chart are readily located by reference to chassis photographs* with call-outs keyed to alignment chart and Standard Notation Schematic*. In minutes, you make the video IF alignment and eliminate the sound bars.

To eliminate the buzz, you can either follow the alignment chart for a complete sound IF alignment or, as advised in the Field Servicing notes on this model, merely adjust the ratio detector, A-11. For speedy reference to this adjustment as well as to other service adjustments and picture tube removal or safety glass cleaning, see the Servicing In the Field* notes. They save you even more time.

SERVICING IN THE FIELD
SOUND IF DETECTOR BUZZ ADJUSTMENT
 To eliminate sound IF detector buzz, adjust the ratio detector secondary slug (A11) located on top of chassis. (See tube placement chart).

From start to finish, you solve your service problems in just minutes... you service more sets and earn more daily with PHOTOFACT by your side!

*One of 32 features found exclusively in PHOTOFACT—the world's finest service data covering over 20,000 TV and radio models



MONEY BACK GUARANTEE!

Got a tough repair? Try this—at Howard W. Sams' own risk: see your Parts Distributor and buy the proper PHOTOFACT Folder Set covering the receiver. Then use it on the actual repair. If PHOTOFACT doesn't save you time, doesn't make the job easier and more profitable for you, Howard W. Sams wants you to return the complete Folder Set direct to him and he'll refund your purchase price promptly. GET THE PROOF FOR YOURSELF—TRY PHOTOFACT NOW!

free



Send for Sams' INDEX TO PHOTOFACT FOLDERS—your guide to virtually any receiver model ever to come into your shop; helps you locate the proper PHOTOFACT Folder you need to solve any service problem on any model. You'll want this valuable reference guide. Send coupon now.

HOWARD W. SAMS & CO., INC.

Howard W. Sams & Co., Inc.
 2205 E. 46th St., Indianapolis 5, Ind.

- Send FREE Index to PHOTOFACT Folders
- I am a Service Technician

Name _____

Address _____

City _____ Zone _____ State _____

An intrstng exprmnt in spch

Some day your voice may travel by a sort of electronic "shorthand" when you telephone. Bell Laboratories scientists are experimenting with a technique in which a sample is snipped off a speech sound—just enough to identify it—and sent by wire to a receiver which rebuilds the original sound. Thus voices can be sent by means of fewer signals. More voices may economically share the wires.

This is but one of many transmission techniques that Laboratories scientists are exploring in their search for ways to make Bell System wire and radio channels serve you more efficiently. It is another example of the Bell Telephone Laboratories research that keeps your telephone the most advanced on earth. *The oscilloscope traces at right show how the shorthand technique works.*



**BELL TELEPHONE
LABORATORIES**

*World center of communications research
Largest industrial laboratory in the United States*

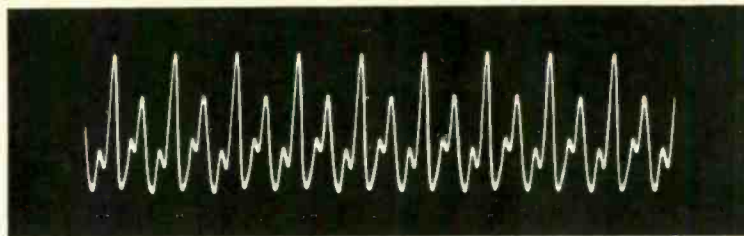

Vibrations of the sound "or" in the word "four." Pattern represents nine of the "pitch periods" which originate in puffs of air from the larynx when a word is spoken.

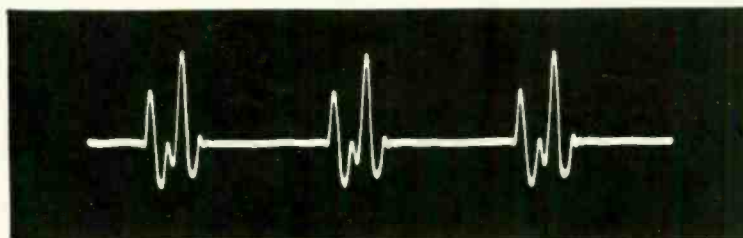

An electronic sampling of the "or" sound. One "pitch period" in three has been selected for transmission. This permits great naturalness when voice is rebuilt. Intelligible speech could be sent through a 1 in 6 sampling.

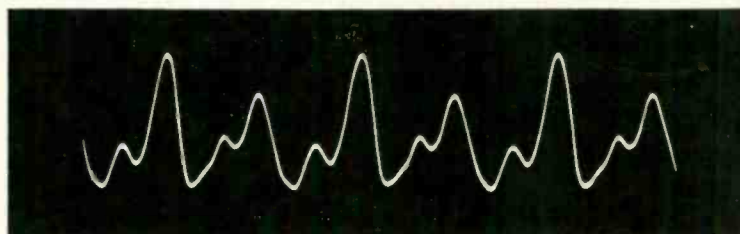

The selected samples are "stretched" for transmission. They travel in a narrower frequency band than complete sound.

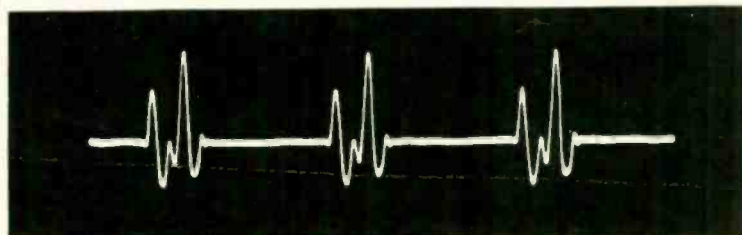

Using the stretched sample as a model, the receiver restores original frequency. In all speech, sounds are intoned much longer than is needed for recognition—even by the human ear. Electronic machines perform recognition far faster than the ear.

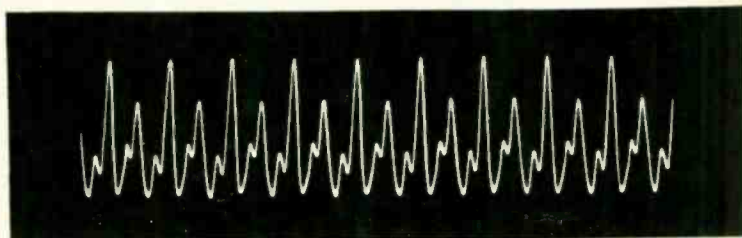

The receiver fills in gaps between samples, recreating total original sound. Under new system, three or four voices could travel at once over a pair of wires which now carries only one—and come out clearly at the end!

ALLIED knight-kits

FINEST ELECTRONIC EQUIPMENT IN LOW-COST KIT FORM

YOU SAVE MORE BECAUSE YOU BUY DIRECT

LOW COST—huge buying power and DIRECT SALE pass biggest savings on to you. You do the easy assembly and your built-up instrument is equal in appearance and performance to equipment selling for several times the KNIGHT-KIT price.

ADVANCED DESIGN—months of research, development and field testing go into each KNIGHT-KIT. And to assure top performance, premium quality parts are supplied throughout.

EASIEST ASSEMBLY—all chassis and panels are punched for accurate assembly; all parts are fully identified. Instruction manuals are a marvel of simplicity and clarity, featuring "Step-and-Chek" assembly, "King-Size" diagrams and "Spotlight" pictorials. For easy assembly you need only a soldering iron, pliers and screwdriver.

ALLIED—the reliable name in Electronics—gives you the greatest value in KNIGHT-KITS through the economies of DIRECT SELLING

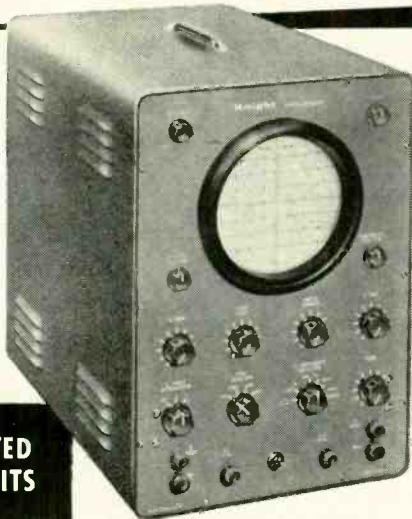

PRINTED
CIRCUITS

Model F-144
\$69⁰⁰

\$6.90 down,
12 months to
pay balance

knight-kit WIDE-BAND 5" OSCILLOSCOPE KIT

Wide-band 5" Oscilloscope equal or superior to commercially-wired 'scopes costing several times the price. Vertical response from 5 cycles to 5 mc—ideal for the professional laboratory, for color TV servicing, and high frequency applications. Response —1 db at 3.58 mc; —3 db at 5 mc. Two printed circuit boards and laced wiring harness reduce assembly time. Has very wide sweep range—from 15 to 600,000 cps. Locks in frequencies as high as 9 mc. High vertical sensitivity of 25 rms millivolts/inch. Input capacitance 36 mmf. Outstanding features: cathode-follower vertical and horizontal inputs; 1400 volts at 2nd anode provides high-intensity trace; push-pull vertical and horizontal amplifiers; positive and negative locking; faithful square wave response; frequency-compensated input attenuator; Z-axis input for intensity modulation; one volt peak-to-peak calibrating voltage; internal astigmatism control; blanking circuit to eliminate retrace lines; DC positioning control. Complete with all tubes and parts, ready for easy assembly. Handsome professional case finished in blue, with gray control panel. Shpg. wt., 40 lbs.

Model F-144. 5" Oscilloscope Kit. Net only **\$69.00**
Model F-148. Demodulator Probe. Net. **\$3.45**
Model F-147. Low Capacity Probe. 12 mmf. Net. **\$3.45**

ALSO AVAILABLE: Refer to your 324-page 1956 Allied Catalog for dozens of other KNIGHT-KIT values, including 20,000 Ohms/Volt VOM, Signal Generator, Audio Generator, Resistor-Capacitor Tester, Signal Tracer, Resistance and Capacitance Substitution Boxes. Additional test instrument kits appear on the next page, followed by famous Hobbyist, Ham and Hi-Fi KNIGHT-KITS.



knight-kit PRINTED CIRCUIT VTVM KIT

Model F-125
\$24⁹⁵

New, extremely stable, highly accurate VTVM. Greatly simplified wiring—entire chassis is a printed circuit board. Features maximum convenience in arrangement of scales and controls. With peak-to-peak scale for FM and TV work. Ranges: AC peak-to-peak volts, 0-4-14-40-140-400-1400-4000; AC rms volts and DC volts, 0-1.5-5-15-50-150-500-1500; ohms, 0-1000, 10K, 100K; 1-10-100-1000 megs; db scale, —10 to +5. Response, 30 cps to 3 mc. Uses low-leakage switches and 1% precision resistors. Balanced-bridge, push-pull circuit permits switching to any range without adjusting zero set. 4 1/2" meter, 200 microamp movement. Polarity reversing switch. Input resistance, 11 megs. Complete kit, ready to assemble. Shpg. wt., 6 lbs.

Model F-125. Printed Circuit VTVM Kit. Net only **\$24.95**
Model F-126. Hi-Voltage Probe; extends DC range to 50,000 Volts. Net. **\$4.75**
Model F-127. Hi-Frequency Probe; extends AC range to 250 mc. Net. **\$3.45**

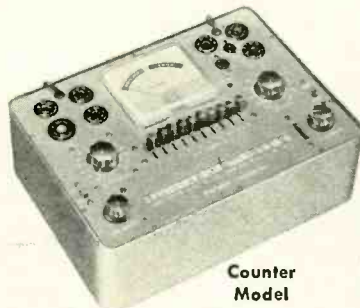

knight-kit TUBE TESTER KIT An Outstanding Value

Model F-143
\$29⁷⁵

Counter
Model



Portable
Model

Expertly designed, up-to-date, ideal for the laboratory or service shop. Remarkably low priced, yet it offers high accuracy, top versatility and convenience. Illuminated roll chart lists over 700 tube types. Features provision for testing 600-ma tubes; roll-chart includes data for all popular series-string types. Tests 4, 5, 6 and 7-pin large, regular and miniature types, octals, loctals, 9-pin miniatures and pilot lamps. Tests for open, short, leakage, heater continuity and quality (by amount of cathode emission). 4 1/2" square meter with clear "GOOD—?—REPLACE" scale. With line-voltage indicator and line-adjust control. Choice of 14 filament voltages from .63 to 117 volts. Blank socket for future type tubes. Universal-type selector switches for any combination of pin connections. Single-unit, 10-lever function switch simplifies assembly. Complete kit, ready for easy assembly. Shpg. wt., 14 lbs.

Model F-143. Counter Model Tube Tester Kit. Net only **\$29.75**
Model F-142. As above, but with carrying case. Net only . . . **\$34.75**
Model F-141. TV Picture Tube Adapter for above. Net only . . . **\$3.75**

EASY PAYMENT TERMS: If your total kit order comes to over \$45, take advantage of our liberal Time Payment Plan—only 10% down, 12 full months to pay. Write for application form.

Order from **ALLIED RADIO**
100 N. WESTERN AVE., CHICAGO 80, ILLINOIS

SEE FOLLOWING PAGES

ALLIED knight-kits...Top Quality

knight-kit IN-CIRCUIT CAPACITOR CHECKER KIT



SAVE UP TO 70%

Model F-119

\$11.65

SUPER-VALUE

Tests capacitors while they are still wired in the circuit! Saves time and trouble. Just press a button and the "magic eye" instantly shows opens and shorts. Checks practically any bypass, blocking, coupling and filter capacitors for opens or shorts. Tests for opens can be made on any capacitor of 20 mmf or greater, even when capacitor is in parallel with resistance as low as 50 ohms. Tests for opens on any capacitor up to 2000 mfd, even when shunted by as low as 20 ohms. Housed in professionally styled case, sturdy steel in blue wrinkle finish with gray control panel. Complete kit, ready for easy assembly. Shpg. wt., 5 lbs.

Model F-119. Capacitor Checker Kit. \$11.65 Net only



knight-kit VOM KIT
1000 Ohms/Volt

Model F-128

\$15.95

Exceptional accuracy and versatility at amazing low cost. Ideal for service shop, lab and Amateur use. Uses 4 1/2" meter (400 microamp movement) with separate scales for AC voltage and current, DC voltage and current, decibels and resistance. 38 ranges include: AC, DC and Output volts, 0-1-5-10-50-100-500-5000 (1000 ohms/volt sensitivity); Resistance, 0-1000-100,000 ohms and 0-1 meg.; Current, AC or DC, 0-1-10-100 ma and 0-1 amps; Decibels, -20 to +69 in 6 ranges. Uses 1% precision resistors. 3-position function switch and 12-position range switch. Complete kit with bakelite case, battery and test leads. Shpg. wt., 2 1/2 lbs.

Model F-128. 1,000 ohms/volt VOM Kit. Net only \$15.95

EASY PAYMENT TERMS:

If your total kit order comes to over \$45, take advantage of our liberal Time Payment Plan—only 10% down, 12 full months to pay. Write for application form.

BUY WITH CONFIDENCE • BUILD WITH CONFIDENCE

- Advanced Electronic Design
- Precision Quality Performance
- Professional Streamlined Styling
- Premium Quality Components
- Crystal-Clear Instruction Manuals
- "Step-and-Chek" Building Method

BUY DIRECT • YOU SAVE MORE • YOU GET MORE FOR YOUR KIT DOLLAR

FAMOUS knight-kits FOR HOBBYISTS

"SPACE-SPANNER" RECEIVER KIT



Model S-243 Featuring Bandswitching for Thrilling Short Wave and Broadcast Reception. All-new 2-band receiver—easy to build—a great value! Pulls in thrilling short wave including amateur, aircraft, police and marine radio (6 to 17 mc), and standard broadcast. Features special highly sensitive regenerative circuit. Has 4" PM speaker and beam-power output tube for plenty of volume. Kit includes calibrated panel, punched chassis, all parts and tubes, detailed instructions (less wire and solder). 7 x 10 1/2 x 6", for 110-120 v. 50-60 cycles AC or DC. Shpg. wt., 4 1/2 lbs.

Model S-243. "Space-Spanner" Kit. \$13.95 Net Only (less cabinet)..... \$13.95
S-247. Matching cabinet for above..... \$2.85

GEIGER COUNTER KIT

Super-sensitive Uranium Locator and Radioactivity Detector. Get started in uranium prospecting now with this extremely sensitive instrument—comparable to costly equipment, yet easy to build at only a fraction of the price. Just turn it on, flip the high-voltage switch and listen to the clicks in the headphone when you hit a radioactive source. Uses low-cost long-life batteries. Kit includes all parts, tubes, carrying case with shoulder strap, 22 1/2 and 1 1/2 v. batteries, headphone, AEC prospecting booklet, radioactive sample and complete assembly instructions. Shpg. wt., 2 1/2 lbs.

Model S-242. Geiger Counter Kit. Net only... \$15.95



FAMOUS 10-IN-1 LAB KIT

Model S-265 Build Any One of 10 Fascinating Projects. Instructive and fun to build. Construct a sensitive Broadcast Receiver; Amplifier (for phono or mike); Wireless Phono Oscillator; Home "Broadcast Station"; Code Practice Oscillator; Capacity-Operated Relay or any one of four other fascinating projects. Kit includes mounting board, special "safety designed" low voltage power transformer, tubes, all parts, microphone, 12-page builder's manual (less wire and solder). For 110-120 v. 50-60 cycles AC. Shpg. wt., 10 lbs.

Model S-265. "10-in-1" Kit. Net only..... \$12.45



PORTABLE RADIO KIT

Powerful 3-Way Operation. Top-quality, portable AM receiver for AC, DC or battery operation. Tunes full broadcast band, 535-1650 kc. Features sensitive superhet circuit; 5" PM dynamic speaker; built-in loop-stick antenna; automatic volume control; handsome carrying case. Complete with all parts, tubes and easy-to-follow instructions (less wire, solder and batteries). For 110-120 v., 50-60 cycle AC, DC, or batteries. Shpg. wt., 6 lbs.

Model S-730. Portable Radio Kit. Net only \$19.95
S-651. Battery Kit for above. Net..... \$2.40



TRANSISTOR RADIO KIT

Printed Wiring—Works From Flashlight Cell. Experiment with the marvel of transistors in this printed-circuit radio. No tubes—no crystal! Small enough to fit in the palm of the hand—yet it provides powerful reception over the complete AM broadcast band. Operates from single flashlight cell. For use with headphones. Printed circuit eliminates solder and easy-to-follow instructions. Less solder, antenna and headphone. Shpg. wt., 8 oz.

Model S-765. Transistor Radio Kit. Net only..... \$3.95



RECEIVER KIT ACCESSORIES

J-149. 4000 ohm extra-sensitive double headset. Net..... \$1.98
C-100. Antenna kit for use with all Knight-Kit receivers. Net..... \$1.05

All Prices Net F.O.B. Chicago

Order from **ALLIED RADIO**

100 N. WESTERN AVE., CHICAGO 80, ILL.

Easiest-to-Build Electronic Equipment in Kit Form

**BUY DIRECT
AND SAVE!**

LOW-COST HAM GEAR



knight-kit 50 WATT CW TRANSMITTER KIT

Model SX-255

\$42⁵⁰

Built-in Pi-Type Antenna Coupler

Check the features packed into this new transmitter kit and you'll see why it's one of the greatest Amateur values ever offered. Compact and versatile, it is the perfect low-power rig for the beginning Novice or seasoned veteran. Features: 50 watts input to 807 final; high-efficiency 6AG7 modified-Pierce oscillator takes crystal or VFO without circuit changes; bandswitching coverage of 80, 40, 20, 15, 11-10 meters; pi-section antenna output matches line impedances from 50 to 1200 ohms—permits use with any type of antenna. Crisp, clean, cathode keying of oscillator and final. Power take-off plug supplies filament and B-plus voltages for other equipment. Copper-finished chassis and cabinet interior, filtering, shielding, bypassing, and coaxial SO-239 antenna connector provide excellent TVI suppression. Meter reads either plate or grid current of final. Jacks for VFO, crystal, and key. Supplied with all parts, tubes and step-by-step instructions. Less crystal and key. Size, 8³/₄ x 11¹/₄ x 8³/₄". For 110-120 volts, 50-60 cycle AC. Shpg. wt., 18 lbs.

SX-255, 50-Watt Transmitter Kit. Net. **\$42.50**



knight-kit SELF-POWERED VFO KIT

Model S-725
\$27⁵⁰

Complete with built-in power supply! Careful design and voltage regulation assure high stability. Excellent oscillator keying characteristic for fast break-in without clicks or chirps. Full TVI suppression. Has plenty of bandspread: separate calibrated scales for 80, 40, 20, 15, 11 and 10 meters; vernier drive mechanism. 2-chassis construction keeps heat from frequency determining circuits. Output cable plugs into crystal socket of transmitter. Output on 80 and 40 meters. With Spot-Off-Transmit switch for "no swish" tuning. Extra switch contacts for operating relays and other equipment. Complete kit for easy assembly. Shpg. wt., 8 lbs.

Model S-725, Self-Powered VFO Kit. Net. **\$27.50**



knight-kit CODE PRACTICE OSCILLATOR KIT

Model S-239

\$3⁹⁵ Transistorized—
Powered by Flash-
light Battery

An ideal new code practice oscillator. Uses transistor circuit. Extremely low current consumption—powered by single penlight battery. Provides crisp, clear tone (400 to 600 cps). Has input jack for earphone; screw-type terminal strip for key. In compact bakelite case (2³/₈ x 3³/₄ x 1¹/₂"") with anodized aluminum panel. Complete with all parts, battery and easy-to-follow instructions. Shpg. wt., 1 lb.

Model S-239, Code Practice Oscillator Kit **\$3.95**

BUILD-YOUR-OWN HIGH FIDELITY knight-kits

knight-kit BASIC 25-WATT LINEAR-DELUXE HI-FI AMPLIFIER KIT

Model S-755

\$41⁵⁰

Custom Quality
Williamson-type Circuit

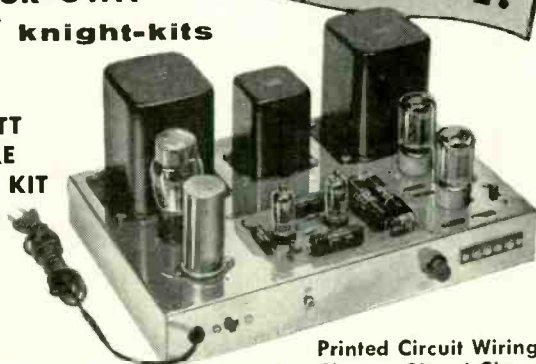

Printed Circuit Wiring
Chrome-Plated Chassis

Designed to satisfy the most critical listener. Intended for use with tuners incorporating built-in preamp or with separate preamp. Uses latest Williamson-type circuit. Has potted, matched transformers. Output: Maximum, 45 watts; rated, 25 watts. Frequency response: ± 0.5 db, 10 to 120,000 cps, measured at 20 watts. Harmonic distortion is only 0.15% right up to 30 watts. Intermodulation is only 0.27% at 17 watts and only 1% at 20 watts, using 60 cps and 7 kc, 1:4 ratio. Hum level is 85 db below rated output. Output impedance, 4, 8, 16 ohms. Uses two 12AU7's, two 5881's, and a 5V4. Printed circuit is utilized in voltage amplifier and phase inverter stages. Has output tube balancing control, variable damping control, and on-off switch. Handsome chrome-plated chassis, 14" x 9" x 2". Overall height, 7". Complete with all parts, tubes and construction manual (less wire and solder). Shpg. wt., 27 lbs.

Model S-755, Basic 25 watt Hi-Fi Linear-Deluxe Amplifier Kit. Net. **\$41.50**

Model S-706, Knight Preamplifier-Equalizer. Ideal for use with above amplifier. Provides 5 selectable inputs. Completely wired—ready to use. Net. **\$36.95**



knight-kit 10-WATT HI-FI AMPLIFIER KIT

Model S-234

\$22⁹⁵

Famous for wide response and smooth reproduction at low cost. Only 0.5 volt drives amplifier to full output. Response: ± 1 db, 30-20,000 cps at 10 watts. Harmonic distortion less than 0.5% at 10 watts. Intermodulation is less than 1.5% at full output. Controls: On-off-volume, bass, treble. Input for crystal phono or tuner. Chassis punched to take preamp kit for magnetic cartridges. Matches 8 ohm speakers. Shpg. wt., 14 lbs. Complete kit (less wire and solder).

Model S-234, Amplifier Kit. Net. **\$22.95**

Model S-235, Preamp Kit for above. Net. **\$2.75**



knight-kit 20-WATT HI-FI AMPLIFIER KIT

Model S-750

\$35⁷⁵

True hi-fi for less! Response, ± 1 db, 20 to 20,000 cps at 20 watts. Distortion, 1% at 20 watts. Hum and noise level: Tuner input, 90 db below 20 watts; magnetic phono, 72 db below 20 watts. Sensitivity: Tuner input, 0.6 volt for 20 watts output; magnetic phono, .007 volts. 4 inputs: Magnetic phono, microphone, crystal phono or recorder, and tuner. Controls: Bass, Treble, Volume, Selector with compensation positions for 78 and LP records. Chrome-plated chassis. Wt., 23 lbs. Complete kit (less wire and solder).

Model S-750, 20-Watt Hi-Fi Amplifier Kit. Net. **\$35.75**

ALLIED RADIO

Everything in Electronics from One Reliable Source

OUR
35TH
YEAR

Allied Radio Corp., Dept. 2-D-6
100 N. Western Ave., Chicago 80, Ill.

Ship me the following KNIGHT-KITS:

Quantity	Description	Model No.	Price

\$ enclosed. For parcel post include postage (express is shipped collect).

Send FREE 324-Page ALLIED Catalog listing the complete Knight-Kit line.

Name _____

Address _____

City _____ Zone _____ State _____

ORDER TODAY →

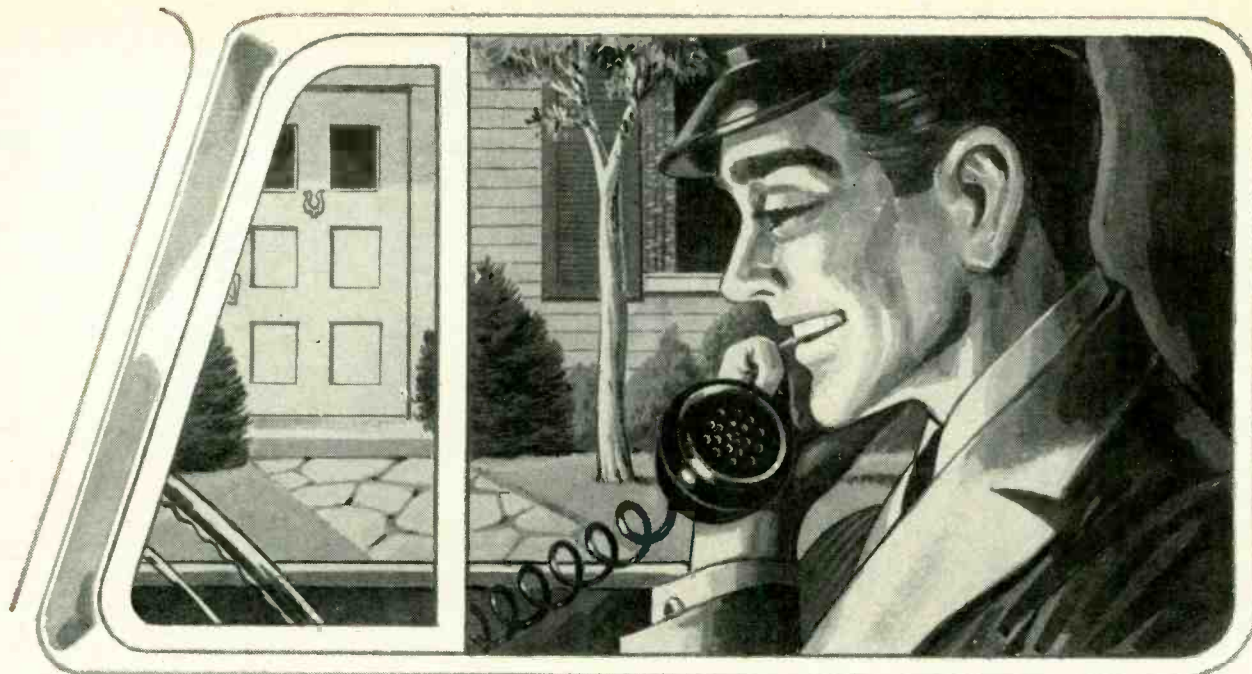

RADIART features
 the complete line of
COMMUNICATION VIBRATORS
 in 6 Volt and 12 Volt Series

These Ten Types Offer Complete Replacement for ORIGINAL Communication Equipment.

Old No.	New No.	
	6 volt	6/12 volt
5515	5715	6715
5518	5718	6718
★	5721	6721
★	5722	6722
★	5725	6725
5605	5805	6805
5620	5820	6820
5621	5821	6821
5622	5822	6822
★	5824	6824

For Specific Applications See Latest Radiart Vibrator Guide

Again because of SUPERIOR ENGINEERING and CONSISTENTLY INCREASED QUALITY, Radiart offers you communication vibrators that are DEPENDABLE! The RIGHT vibrator... for EACH application! See for yourself... You're RIGHT WITH RADIART.

SUBSIDIARY OF



THE **RADIART** CORPORATION

CLEVELAND 13, OHIO

TV ANTENNAS • AUTO AERIALS • VIBRATORS • ROTORS • POWER SUPPLIES

RADIO-ELECTRONICS

L. C. Lane, B.S., M.A.
 President, Radio-Television
 Training Association
 Executive Director, Pierce
 School of Radio & Television.



VETERANS - - NON-VETERANS
**Do You Want a BETTER
 JOB with MORE MONEY?**

**I will train you AT HOME in your SPARE TIME
 for a top-pay lifetime job in TELEVISION**

The world's leading manufacturers, dealers and service organizations employ men I trained. Even if you've never had any experience in the Television-Radio-Electronics field, you'll recognize most

of the names of just a few of the firms where RTTA-trained men are holding down good jobs with a secure future —

LEARN BY DOING

As part of your training I give you the equipment you need to set up your own home laboratory and prepare for a BETTER-PAY TV JOB. You build and keep an Electromagnetic TV RECEIVER designed and engineered to take any size picture tube up to 21-inch. (10-inch tube furnished. Slight extra cost for larger sizes.) . . . also a Super-Het Radio Receiver, AF-RF Signal Generator, Combination Voltmeter-Ammeter-Ohmmeter, C-W Telephone Transmitter, Public Address System, AC-DC Power supply. Everything supplied, including all tubes.



STUDY NEWEST DEVELOPMENTS

My training covers all the latest developments in the fast-growing Television-Radio-Electronics industry. You learn about FM — RADAR — COLOR TV — TRANSISTORS — PRINTED CIRCUITS, etc.

CHOOSE FROM THREE COMPLETE COURSES
 covering all phases of Radio, FM and TV

1. Radio, FM and Television Technician Course — no previous experience needed.
2. FM-TV Technician Course — previous training or experience in radio required
3. TV Cameraman and Studio Technician Course — advanced training for men with Radio or TV training or experience.

EXTRA TRAINING IN NEW YORK CITY AT NO EXTRA COST!

After you finish your home study training in Course 1 or 2 you can have two weeks, 50 hours, of intensive Lab work on modern electronic equipment at our associate resident school, Pierce School of Radio & Television. THIS EXTRA TRAINING IS YOURS AT NO EXTRA COST WHATSOEVER!

FCC COACHING COURSE

Important for BETTER-PAY JOBS requiring FCC License! You get this training AT NO EXTRA COST! Top TV jobs go to FCC-licensed technicians.

EARN WHILE YOU LEARN

Almost from the very start of your course you can earn extra money by repairing sets for friends and neighbors. Many of my students earn up to \$25 a week . . . pay for their entire training with spare time earnings . . . start their own profitable service business.

Radio Television Training Association

52 EAST 19th STREET • NEW YORK 3, N. Y.
 Licensed by the State of New York • Approved for Veteran Training

RCA • SYLVANIA • WESTINGHOUSE
 BOEING • GENERAL ELECTRIC • LEWY
 EMERSON • DOUGLAS AIRCRAFT
 CAPEHART-FARNSWORTH • PHILCO
 CANADAIR, LTD. • WESTERN ELECTRIC
 OAK RIDGE NATIONAL LABORATORY
 AMERICAN AIRLINES • COLUMBIA
 BELL TELEPHONE • ADMIRAL • DUMONT
 REDIFFUSION, INC. • BELL AIRCRAFT
 RAYTHEON • CONVAIR

I can do for you what I did for my hundreds of successful graduates. Many of the men I trained are now their own bosses—making a wonderful living in their own growing business.

You, too, can win a place in the booming Television-Radio-Electronics industry . . . earn big money as a trained TV Technician . . . with my famous "Learn by Doing" home study method.

FREE!

I'll send you my new 40-page book, "How to Make Money in Television-Radio-Electronics," a Free sample lesson, and other literature showing how and where you can get a top-pay job in Television.



VETERANS!

My School fully approved to train Veterans under new Korean G. I. Bill. Don't lose your school benefits by waiting too long. Write discharge date on coupon.

MAIL THIS COUPON TODAY!

Mr. Leonard C. Lane, President
 RADIO-TELEVISION TRAINING ASSOCIATION
 Dept. R-4C, 52 East 19th Street, New York 3, N. Y.
 Dear Mr. Lane: Send me your NEW FREE BOOK, FREE SAMPLE LESSON, and FREE aids that will show me how I can make TOP MONEY IN TELEVISION. I understand I am under no obligation.

(PLEASE PRINT PLAINLY)

Name _____ Age _____

Address _____

City _____ Zone _____ State _____

- I AM INTERESTED IN:
- Radio-FM-TV Technician Course
 - FM-TV Technician Course
 - TV Cameraman & Studio Technician Course

VETERANS!

Write discharge date

NO OBLIGATION!

THIS IS THE GUN YOU ASKED FOR

BUILT TO SERVICE MAN'S SPECIFICATIONS

Designed TO INCLUDE ALL THE BIG FEATURES
EVERYBODY WANTS

- LONGER REACH TIPS
- LONGER LIFE TIPS
- MORE RIGID TIPS
- LIGHTER WEIGHT—25% less than comparable products
- SHATTER PROOF CASE

Your No. 1 Gun—*ideal* for the kind of work you do—and it SHOULD be, because it was designed and built specifically to meet the service man's requirements. Develops AMPLE heat—*fast!* Cools quickly too. Is so light, so beautifully balanced, the work goes easier. And the long, narrow, rigid tips reach right into those tight "inaccessible" places. Automatically spotlights its work. Fully guaranteed.

WEN
NEW HEAVY DUTY
MODEL
288

DEVELOPS OVER 200 WATTS HEAT

IN 5 seconds



"Quick-Hot"
ELECTRONIC
SOLDERING GUN

JUST
\$9.95
LIST

AT BETTER JOBBERS EVERYWHERE

WEN

PRODUCTS, INC.

5808 NORTHWEST HIGHWAY • CHICAGO 31, ILL.

Export sales, Scheel International, Inc., Chicago

Get this FREE Booklet Today!

THE DATA THAT LAUNCHED THOUSANDS OF CAREERS IS YOURS FREE . . . TO SHOW HOW YOU CAN BE SUCCESSFUL IN RADIO-TV-ELECTRONICS

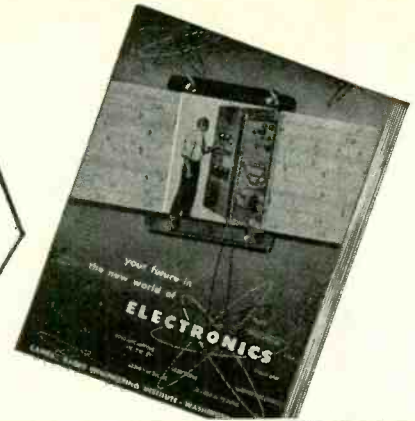

“YOUR FUTURE IN THE NEW WORLD OF ELECTRONICS”—
contains a proved plan for your successful career in:

- ★ BROADCASTING
- ★ TELEVISION
- ★ MANUFACTURING
- ★ COMMUNICATIONS
- ★ SERVICING
- ★ AERONAUTICAL ELECTRONICS
- ★ ARMY, NAVY, AIR FORCE, COAST GUARD ELECTRONICS

A PROVED CAREER-PREPARATION PLAN THAT WORKS!

This free book has brought success home to thousands of men just like you! They are now enjoying responsible jobs, good pay and the good things of life. So can you! In less time than you think! We tell you how you can carve out a bigger better-paying job. Our proved career-preparation plan works because it was written by authorities who know exactly what the varied electronic industries want, need and expect from you!

ELECTRONICS' FUTURE CAN BE YOUR FUTURE

You can't keep up with the tremendous changes in the electronic industries. What's predicted for next year becomes outdated in a few months! All phases of the electronic industries are experiencing phenomenal growth. There are thousands of career openings, big ones. Industry can't find enough trained manpower to fill them—in manufacturing, testing, servicing, broadcasting and telecasting.

TAKE TV FOR EXAMPLE!

Over 430 TV stations are on the air! Many more are building or in the plans

stage; there are over 35 million TV sets in use. Color TV is coming alive! This same phenomenal growth picture is repeated in every phase of business employing electronics—crime prevention, aeronautics, fire-fighting, communications, to name but a few. CREI has the plan to keep you moving upward, to help you assume your rightful place!

CREI GRADS ARE IN DEMAND!

The big companies know CREI men have what it takes! CREI grads are at work in America's biggest corporations, in positions ranging from technicians to engineers to top management. Companies such as United Air Lines, Canadian Broadcasting Corporation, Trans-Canada Airlines, Sears-Roe-

THOUSANDS LIKE YOU HAVE SUCCEEDED WITH CREI'S PLAN! "CREI TRAINING IS BEST"



“I chose CREI training upon recommendation of two top engineers. Before I had completed the course I became transmitter chief of a 5 KW station. I am now employed as a technician at a 100 KW TV station, and in spare time have a good TV sales and service business. Anyone interested in his electronic future should have CREI training.” —Arlie D. Patton, San Antonio, Texas

“I know of no case in which a man who applied himself and completed the CREI course failed to better himself through promotion and increase in salary.” —Wendell L. Fraser, San Diego, Calif.

“CREI has raised me to professional status as a radioman. Thanks to your instructors who always gave me needed help.” —Victor Menzler, Wilmington, Del.

“I have been in radio and electronics for 24 years. I fully recommend CREI as the best school I have seen.” —L. McManus, Montreal, Canada

CAPITOL RADIO ENGINEERING INSTITUTE

Accredited Technical Institute Curricula
Founded in 1927
3224—16th Street, N.W.
Washington 10, D.C.

CREI also offers resident instruction: at the same high technical level, day or night, in Washington, D.C. New classes start frequently during the year. If this type of instruction meets your requirements, check the coupon for Residence School catalog. Qualified residence graduates may earn the degree of Associate in Applied Science.

INFORMATION FOR VETERANS

If you were discharged after June 27, 1950—let the new G.I. Bill of Rights help you obtain resident instruction. Check the coupon for full information.

MAIL THIS COUPON Today!

CAPITOL RADIO ENGINEERING INSTITUTE
Dept. 144C, 3224 16th St., N. W., Washington 10, D. C.

Please send me your course outline and FREE illustrated Booklet "Your Future in the New World of Electronics" . . . describing opportunities and CREI home study courses in Practical Electronics Engineering.

CHECK
FIELD OF
GREATEST
INTEREST

- Practical Radio Electronics Engineering
- Broadcast Radio Engineering (AM, FM, TV)
- Practical Television Engineering
- Aeronautical Electronics Engineering

Name _____

Street _____

City _____ Zone _____ State _____

CHECK: Home Study Residence School Korean Veteran

To help us answer your request intelligently, please give the following information:

EMPLOYED BY _____

TYPE OF PRESENT WORK _____

SCHOOL BACKGROUND _____

RADIO ELECTRONIC EXPERIENCE _____

IN WHAT BRANCH OF ELECTRONICS ARE YOU MOST INTERESTED?



It's easier to sell CBS

Silver Vision

the
"High-Fidelity"

Aluminized Tube

Your customer is aware that Hi-Fi does sound better . . . that it faithfully reproduces the original sound. And you can prove by demonstration that advanced-engineered CBS Silver Vision tubes can do for video what Hi-Fi does for audio.

You know Silver Vision's aluminization . . . silver-activated phosphors . . . and small-spot gun can accomplish this. But technical details do not interest the lady. She does appreciate Silver Vision's sparkling whites . . . deep blacks . . . and wide range of middle gray tones. She likes the way they can be blended to give her truly high-fidelity reproduction of the telecast picture.

Here's a tube whose performance sells it. And Garry Moore makes it still easier by convincing your women customers over the CBS Television Network: "There are no better tubes made than CBS tubes, the tubes with the Good Housekeeping Guaranty Seal." Sell the easy way, follow Garry's lead. Sell CBS Silver Vision . . . the "high-fidelity" aluminized picture tube.

Always show her the CBS carton with the Good Housekeeping Guaranty Seal.



CBS-HYTRON, Danvers, Massachusetts
 A Division of
 Columbia Broadcasting System, Inc.

RCA offers you the
 finest training
 at home in
 Radio-TV
 electronics,
 TV servicing,
 Color TV

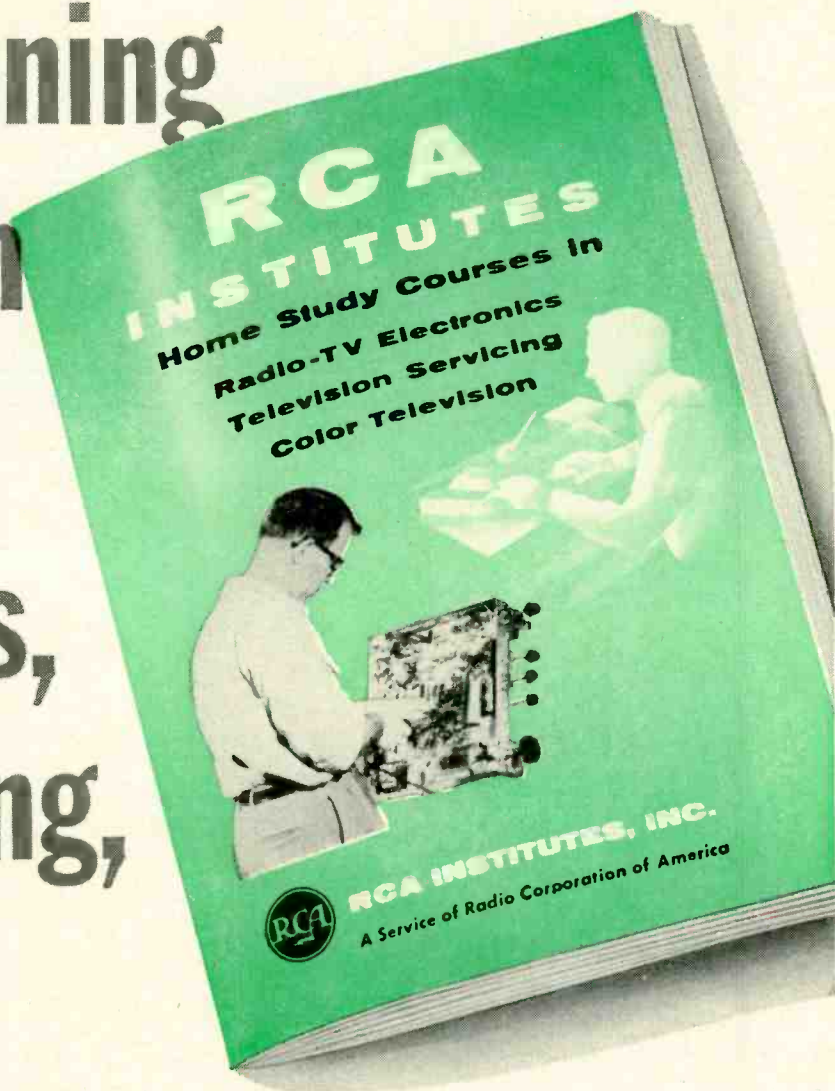

**SEND FOR THIS FREE
 BOOK NOW!**

The instruction you receive and equipment you get (and keep) will start you on your way. Pay-as-you-learn. You pay for only one study group at a time. This 52 page book contains complete information on Home Study Courses for the beginner and the advanced student.



RCA INSTITUTES, INC.
 A SERVICE OF RADIO CORPORATION OF AMERICA
 350 WEST FOURTH STREET, NEW YORK 14, N.Y.

RCA Institutes, Inc., Home Study E-46,
 350 West Fourth Street New York 14, N. Y.
 Without obligation, send me FREE CATALOG
 on Home Study Courses in Radio, Television
 and Color TV. No salesman will call.

Name Please Print
 Address
 City Zone State

IMPORTANT
 Be sure to write
 for RCA Institutes
 catalog before
 signing up for any
 Radio-TV course

Belden 8411

If it's worth an Engineer's time . . .

Belden 8422

. . . it's worth an Engineered Cable

Belden 8412

**Belden
microphone
cables**

Whatever the installation,
whatever the requirements,
there is an accurately
rated Belden Microphone
Cable built for the job.



1001 WIRES FOR EVERY ELECTRONIC NEED

4-8

**NEW! COLOR and Black-&White
LAB & TV 5" OSCILLOSCOPE #460
KIT \$79.95. Wired \$129.50**

The **FINEST** professional 5 mc wide-band scope value. Ideal for research, h-f & complex waves, plus Color & Monochrome TV servicing. Flat from DC to 3.58 mc ± 1 db (color burst freq.), flat DC to 4.5 mc +1, -3 db. Vert. sens. 25 rms mv/in. Vert. Z 3 megs. Has the following outstanding features not found in scopes up to several times its price, kit or wired:

VERTICAL AMPLIFIER: direct-coupled (DC) thruout to eliminate 1-f phase shift; push-pull thruout for negligible distortion; K-follower coupling between push-pull pentode stages for extended h-f resp. (minimizes h-f phase shift, extends useful resp. to 10 mc); full-screen undistorted vert. defl; 4-step freq-compensated decade step attenuator up to 1000:1. **SWEEP CIRCUIT:** perfectly linear sweeps, 10 cps - 100 kc (ext. cap. for down to 1 cps); pre-set **TV vert. & hor. positions** (30 & 7875 cps); automatic sync. ampl. & limiter eliminates sync amplitude adj. **PLUS:** direct or cap. coupling; bal. or unbal. inputs; edge-lit engraved lucite graph screen; dimmer; anti-glare filter; bezel fits std photo equipmt. **OTHER IMPORTANT FEATURES:** High intensity trace CRT. Finest sq. wave resp. (.06 usec rise time). Push-pull hor. ampl., flat to 400 kc, sens. 0.6 rms mv/in. Built-in voltage calibration. Intensity mod. Sawtooth & 60 cps outputs. Astigmatism control. Retrace blanking.

Instant, drift-free full-screen vert. positioning & 2X full-screen hor. positioning. Bal., cal., astig. adj. externally accessible. 5U1 CRT, 2-6AU8, 2-6CB6, 1-12AU7A, 2-6J6, 1-6AX5, 1-1V2. Deep-etched satin aluminum panel, rugged grey wrinkle steel cabinet. Designed for easy building at home with no special equipment. 13" x 8 1/2" x 16". 30 lbs.

SCOPE DIRECT PROBE* #PD: KIT \$2.75. Wired \$3.95. Eliminates stray-pick-up & signal re-radiation.

SCOPE DEMODULATOR PROBE* #PSD: KIT \$3.75. Wired \$5.75. Demodulates AM carriers between 150 kc and 250 mc.

SCOPE LOW CAPACITY PROBE* #PLC: KIT \$3.75. Wired \$5.75. For signal tracing in high frequency, high impedance & wide-band circuits (as in TV) without distortion from overloading or frequency discrimination.

for **COLOR** and Monochrome TV servicing

**New! PEAK-to-PEAK VTVM #232
& UNI-PROBE (pat. pend.)
KIT \$29.95. Wired \$49.95**

UNI-PROBE: exclusive with EICO! Terrific time-saver! Only 1 probe performs all functions—a half-turn of probe-tip selects DC or AC-Ohms.

The new leader in professional peak-to-peak VTVMs. Latest circuitry, high sensitivity & precision, wide ranges & versatility. Calibration without removing from cabinet. New balanced bridge circuit. High Z input for negligible loading. 4 1/2" meter, can't-burn-out circuit. 7 non-skip ranges on every function. 4 functions: +DC Volts, -DC Volts, AC Volts, Ohms.

Uniform 3 to 1 scale ratio for extreme wide-range accuracy. Zero center. One zero-adj. for all functions & ranges. 1% precision ceramic multiplier resistors. Measure directly peak-to-peak voltage of complex & sine waves: 0-4, 14, 42, 140, 420, 1400, 4200. DC/RMS sine volts: 0-1.5, 5, 15, 50, 150, 500, 1500 (up to 30,000 v. with HVP probe, & 250 mc with PRF probe). Ohms: 0.2 ohms to 1000 megs. 12AU7, 6AL5, selenium rectifier; xfmr-operated. 8 1/2" x 5" x 5". Deep-etched satin aluminum panel, rugged grey wrinkle steel cabinet. 7 lbs.

**New! DELUXE PEAK-to-PEAK VTVM #249
with 7 1/2" METER & UNI-PROBE (pat. pend.)
KIT \$39.95. Wired \$59.95**

All the advanced & exclusive features of #232—PLUS the extra convenience and readability of its big 7 1/2" meter. Your ideal bench instrument.

VTVM RF PROBES* #PRF-11 or PRF-25: KIT \$3.75. Wired \$4.95. Accuracy $\pm 10\%$. Use with any 11 or 25 megohm VTVM.

VTVM HV PROBE #HVP-2: Wired \$4.95. Complete with multiplier resistor. Measures up to 30 kv with any VTVM or 20,000 ohms/volt VOM.



Calibration without removing from cabinet.

*Only EICO Probes have all these features: fully shielded; rugged terminal board parts mounting; shock-mounted floating construction; swivel-action; color-coding; easy parts accessibility.

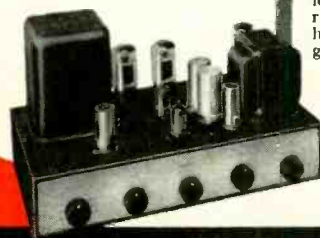

150 kc to 435 mc
with ONE generator!

**New! RF SIGNAL GENERATOR #324
KIT \$26.95. Wired \$39.95**

for **COLOR** and Monochrome TV servicing

New wide-range, stable generator — better value than generators selling at 2 or 3 times its cost! Ideal for: IF-RF alignment, signal tracing & trouble-shooting of TV, FM & AM sets; marker gen.; 400 cps audio testing; lab. work. 6 fund. ranges: 150-400 kc, 400-1200 kc, 1.2-3.5 mc, 3.5-11 mc, 11-37 mc, 37-145 mc; 1 harmonic band 111-435 mc. Freq. accurate to $\pm 1.5\%$; 6:1 vernier tuning & excellent spread at most important alignment freqs. Etched tuning dial, plexiglass windows, edge-lit hairlines. Colpitts RF osc., directly plate-modulated by K-follower for improved mod. Variable depth of int. mod. 0-50% by 400 cps Colpitts osc. Variable gain ext. mod. amplifier: only 3.0 volts needed for 30% mod. Turret-mounted coils slug-tuned for max. accuracy. Fine & Coarse (3-step) RF attenuators. RF output 100,000 uv; AF sine wave output to 10 volts. 50-ohm output Z. 5-way jack-top binding posts for AF in/out; coaxial connector & shielded cable for RF out. Tubes: 12AU7, 12AV7, selenium rectifier; xfmr-operated. Deep-etched satin aluminum panel, rugged grey wrinkle steel cabinet. 8" x 10" x 4 3/4". 10 lbs.

The specs are the proof...

**4 NEW BEST BUYS
by EICO**

**COMPLETE
with Preamplifier, Equalizer and Control Section
New! 20-WATT Ultra-Linear Williamson-
type HIGH FIDELITY AMPLIFIER #HF20
KIT \$49.95. Wired \$79.95**

A low-cost, complete-facility amplifier of the highest quality that sets a new standard of performance at the price, kit or wired. Every detail, down to the etched, brushed solid brass control plate, is of the fine quality EICO is famous for.

Rated power output: 20 watts (34 w peak). **IM distortion** (60 cps: 6 kc/4:1) at rated power: 1.3%. **Mid-band harmonic distortion** at rated power: 0.3%. **Maximum harmonic distortion** between 20 and 20,000 cps at 1 db under rated power: approx. 1%. **Power response** (20w): ± 0.5 db 20-20,000 cps; ± 1.5 db 10-40,000 cps. **Frequency response** (1/4 w): ± 0.5 db ± 13 -35,000 cps; ± 1.5 db 7-50,000 cps.

5 feedback equalizations for LP's & 78's including RIAA. Variable turnover feedback tone controls do not affect volume & permit large boost or cuts at either end of audio spectrum with mid-freqs. unaffected. Loudness control & separate level set control on front panel. Low Z output to tape recorder. 4 hi-level switched inputs: tuner, tv, tape, auxiliary (xtal/ceramic phono or 2nd tuner); 2 low-level inputs for proper loading with all leading magnetic, FM & quality xtal cartridges. Hum bal. control. Extremely fine output transformer has interleaved windings, tight coupling, careful balancing & grain-oriented steel. 8 1/2" x 15" x 10". 24 lbs.

These amazing EICO values are NOW IN STOCK at your nearest distributor. Examine them side-by-side with ANY competitor. You'll see for yourself why indeed EICO is your BEST BUY. Fill out coupon on reverse page.

TURN PAGE FOR MORE EICO VALUES...

84 Withers Street, Brooklyn 11, New York

Prices 5% higher on West Coast.

Do you OVERPAY for QUALITY instruments?

EICO's mass purchasing and world-wide distribution, together with advanced electronic design, produce values never before possible . . . to give you Laboratory Precision at Lowest Cost!

GET THE MOST for YOUR MONEY! Don't buy ANY test instrument till you put the EICO INSTRUMENT (kit or wired) equivalent before you—and . . .

Compare advanced electronic design: see the latest in circuitry and features.

Compare finest components: see the famous brands you know and trust, such as GE, Centralab, Mallory, etc.

Notice ease of construction and operation: Exclusive "Beginner-Tested" Manuals make assembly and operation step-by-step, quick, crystal-clear. "You build them in one evening—they last a lifetime!"

Check 5-Way Guarantee: Only EICO gives you this exclusive complete protection! EICO guarantees components, instructions and satisfactory operation — AND guarantees service and calibration for the LIFETIME of the instrument, at less than cost of handling.

Compare feature for feature, dollar for dollar.

There's an EICO distributor right nearby in your own neighborhood — over 1200 coast-to-coast. EICO planned it that way so that you can easily examine EICO BEFORE YOU PUT DOWN ONE CENT OF YOUR MONEY!

COMPARE any of EICO's 46 models SIDE BY SIDE with ANY competitor. Then YOU judge who's giving you the MOST for your money.













Over 500,000 EICO instruments in use . . . You'll agree EICO gives you LABORATORY PRECISION AT LOWEST COST.

Turn page for other EICO ad



FREE 1956 EICO CATALOG!

Tells you how to SAVE 50% on
your test equipment costs!

 <p>TUBE TESTER #625 KIT \$34.95 Wired \$49.95</p> <ul style="list-style-type: none"> • tests 600 mil series string type tubes • Illuminated roll-chart <p>Pix Tube Test Adapter\$4.50</p>	<p>New! GEIGER COUNTER #803 KIT \$19.95 Wired \$29.95</p>  <p>(less batteries) Professional, all-electronic, sensitive, rugged—at lowest cost! Indicates by neon lamp & headphone clicks.</p>	<p>5" PUSH-PULL OSCILLOSCOPE #425 KIT \$44.95 Wired \$79.95</p>  <p>7" PUSH-PULL OSCILLOSCOPE #470 KIT \$79.95 Wired \$129.50</p>
 <p>VACUUM TUBE VOLTMETER #221 KIT \$25.95 Wired \$39.95</p> <p>DELUXE VTVM #214 (7 1/2" METER) KIT \$34.95 Wired \$54.95</p>	 <p>RF SIGNAL GENERATOR #320 KIT \$19.95 Wired \$29.95</p> <p>150 kc-34 mc, calibrated harmonics to 102 mc. Pure or mod. RF, & Colpitts osc. 400 cps sine outputs.</p>	<p>CATHODE RAY TUBE CHECKER #630 KIT \$17.95 Wired \$24.95</p>  <p>Easy, fast test of all types & sizes TV pix & scope CR tubes, in set or carton.</p>
 <p>#944 FLYBACK TRANSFORMER & YOKE TESTER KIT \$23.95 Wired \$34.95</p> <ul style="list-style-type: none"> • fast check all flybacks & yokes in or out of set. • spots even 1 shorted turn! 	 <p>TV/FM SWEEP GENERATOR #360 5MC-4.5MC CRYSTAL \$3.95 ea.</p> <p>Range 500 kc-228 mc on fund. Cont. sweep width control, 0-30 mc.</p> <p>KIT \$34.95 Wired \$49.95</p>	 <p>DELUXE RF SIGNAL GENERATOR #315</p> <p>1% accuracy on all 7 ranges. Range 75 kc-150 mc. Volt reg.</p> <p>KIT \$39.95 Wired \$59.95</p>
 <p>6V & 12V BATTERY ELIMINATOR & CHARGER #1050</p> <p>Sep. volt-meter & ammeter KIT \$29.95 Wired \$38.95</p>	 <p>DELUXE MULTI-SIGNAL TRACER #147</p> <p>Sep. hi-gain RF & lo-gain audio inputs. Special noise locator. Calibrated wattmeter.</p> <p>KIT \$24.95 Wired \$39.95</p>	 <p>R-C BRIDGE & R-C-L COMPARATOR #950B</p> <p>Reads 0.5 ohms -500 megs, 10 mmfd-5000 mfd power factor.</p> <p>KIT \$19.95 Wired \$29.95</p>
 <p>New! BATTERY TESTER #584 KIT \$9.95 Wired \$12.95</p> <p>Tests A & B portable radio, hearing-aid, lantern, other batteries—in or out of equipment.</p>	 <p>20,000 Ohms/Volt MULTIMETER #565 KIT \$24.95 Wired \$29.95</p>  <p>1000 Ohms/Volt MULTIMETER #536 KIT \$12.90 Wired \$14.90</p>	<p>VTVM PROBES KIT Wired</p> <p>Peak-to-Peak \$4.95 \$6.95</p> <p>RF \$3.75 \$4.95</p> <p>High Voltage Probe-1 \$6.95</p> <p>High Voltage Probe-2 \$4.95</p> <p>SCOPE PROBES</p> <p>Demodulator \$3.75 \$5.75</p> <p>Direct \$2.75 \$3.95</p> <p>Low Capacity \$3.75 \$5.75</p>

For FREE 1956 catalog, mail coupon NOW!



84 Withers St. • Brooklyn 11, N. Y.

Prices 5% higher on West coast ©55 and subject to change without notice.

EICO, 84 Withers Street C-4
Brooklyn 11, New York

Send FREE 1956 Catalog and name of neighborhood EICO jobber.

Name.....

Home Address.....

City.....Zone.....State.....

Occupation.....

1945 to 1955: a decade of Know-How & Value Leadership in Kits & Instruments—over 1/2 million sold to date!

RADIO ASTRONOMY PROGRESS

... *Celestial Radio Waves Open New Vistas* ...

IN January that young branch of electronics, *radio astronomy*, received recognition and a material boost from a high place. President Eisenhower, no less, asked Congress for \$7,000,000 to build "the nation's first major radio astronomy center."

It is only 25 years since Dr. Karl G. Jansky of the Bell Telephone Laboratories of New York discovered formerly unobserved radio signals coming from the direction of the Milky Way.

Today radio telescopes are located in many countries. The largest, 250 feet in diameter, is in Britain. In the United States, the largest—a 60-foot "dishpan"—is located at Harvard College Observatory. There is also a 50-foot one at the Naval Research Laboratory in Washington, D. C.

While the President gave no details, it is understood that the proposed radio astronomy center would start with a 140-foot telescope. Consideration is also being given to building a 500- or 600-foot model. As with optical telescopes, the larger they are, the more radiation can be collected and the farther they can reach out into space.

Nearly all radio telescopes are built of heavy wire in the shape of a paraboloid, for the efficient collection of the intercepted radio waves. The British model, in addition, is placed on rails so that the huge telescope can be turned in any desired direction to explore nearly every quadrant of the northern parts of the heavens.

Why is radio astronomy now so important that even the President of the United States feels compelled to urge its exploitation? Radio astronomy is no longer an experimental science. With electronics and atomics—to which it is linked closely—it has become a practical research instrumentality. It is a most important tool to help us unravel the many intimately related puzzles of our universe: gravitation, cosmic radiation and the as yet unexplored sections of the electromagnetic spectrum. These may in time lead to the discovery of new sources of energy.*

What has radio astronomy accomplished so far? Our own Sun has been found to be a "radio star"—a source of radio energy radiation.† Curiously enough, the radio Sun is appreciably larger in diameter than the optically-visible one. The apparent surface from which the radio sphere of energy emanates lies hundreds of thousands of miles above the solar surface in the Sun's corona. It has been ascertained that when solar activity is high and huge prominences or flares appear over the Sun's surface, radio emissions become high, too.

Radio astronomy furthermore has discovered over 1,000 sources of radio energy in our universe. These unexplained radio emitters are routinely called "radio stars" by our astrophysicists, although we do not as

of the time of this writing know their true nature.

One thing we do know, however, and that is that many of these radio energy sources are not visible in our *optical* telescopes. A few of the most intense sources appear to be colliding galaxies or gaseous envelopes of stars that have exploded.

Some scientists think that these radio stars are old, nearly extinct *cold* stars or perhaps *new* stars in the making and thus not visible. Others believe that the radio energy comes from live, luminous stars, whose light is obscured by "dust clouds" intervening between us and the star. More probably, the radio emissions come from colliding masses of gas.

Most scientists today take the position that hydrogen is the most widely distributed element throughout the universe. Routinely, we think of hydrogen as an inert and invisible gas, which it is normally—*on Earth*. In outer space—particularly if far removed from a star (a sun)—hydrogen may no longer be a gas. *It becomes a liquid or a solid*. In many parts of interstellar space we have temperatures of near absolute zero, which is -459°F . Hydrogen aggregations become liquid at -253°F and *solid* at -260°F .

Scientists have reason to believe that *hydrogen itself is a generator of radio waves* with a length of 21 centimeters. Dr. Donald H. Menzel, director of the Harvard College Observatory, in a communication to us, says that hydrogen atoms colliding with one another have their electrons flipped over into an abnormal position that is not quite stable. Once in a million years or so, the electron rights itself and sends out radio waves on 21 centimeters.

This hydrogen radiation provides basic information about the structure of our Milky Way system.

Deuterium, a heavy hydrogen, which radiates on another wavelength, has also been reported.

Dr. Menzel gives us two further insights into radio astronomy: The radio stars sometimes have some of their energy absorbed by the upper levels of the Earth's atmosphere, the ionosphere. They "twinkle" like ordinary stars and from this twinkling we may gauge the state of ionospheric disturbances. Our radar waves sent skyward from dish-shaped reflectors may bounce from meteors or meteor trails and return to earth. These reflected waves furnish data for calculating the speeds, directions and general motion of these incoming bodies. Using radar, astronomers have detected meteor groups or showers previously unsuspected because they occur in the daytime when they cannot be seen.

One conclusion is certain: radio astronomy is bound to increase vastly our future knowledge of the outside world and, in consequence, enrich our lives in a manner undreamed of today. We are facing a period of research in which the radio telescope will open new vistas of astronomy.

—H.G.

* See editorial "Radio Astronomy," in the March, 1953, issue of this magazine.

† See editorial "Celestial Electronics," April, 1937.

By GEORGE L. AUGSPURGER

A HORN-TYPE SPEAKER SYSTEM

FOR GOLDEN EARS

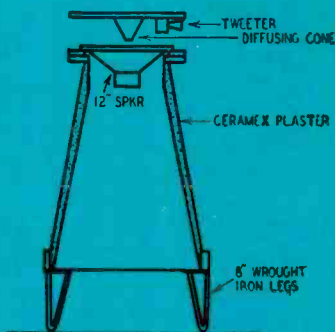
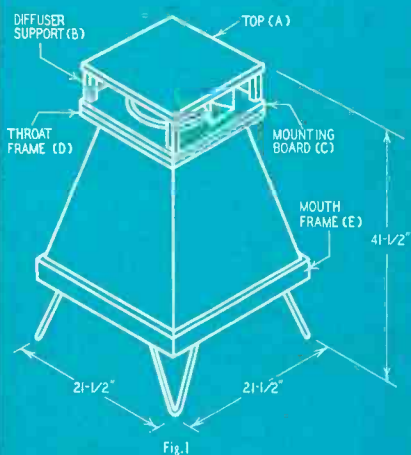

Fig. 2

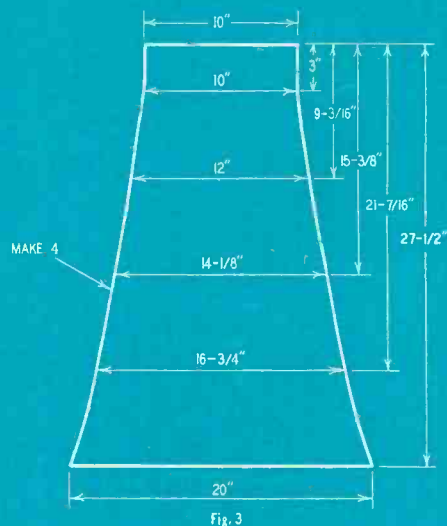
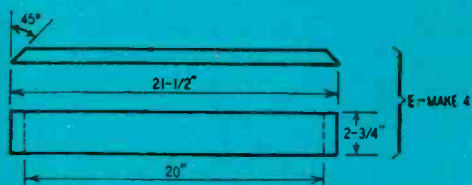
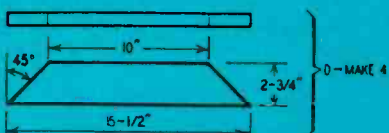
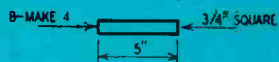
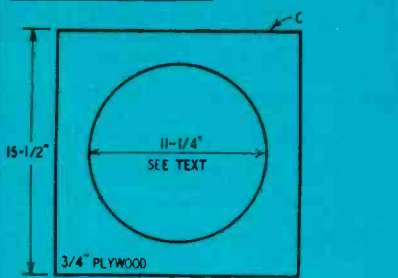

Fig. 3

A— SAME AS C WITHOUT HOLE



B, D & E CUT FROM 1" X 3" STOCK

Fig. 4

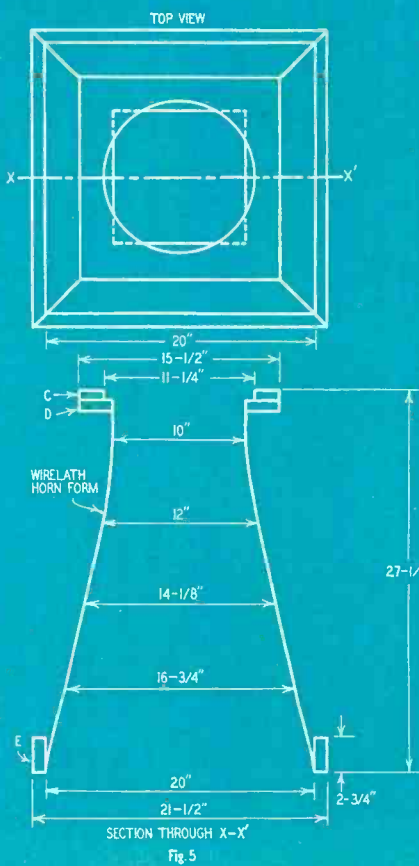

Fig. 5

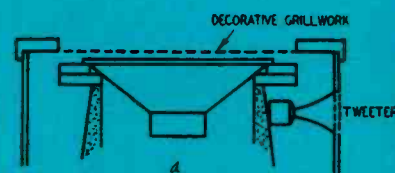

Fig. 4

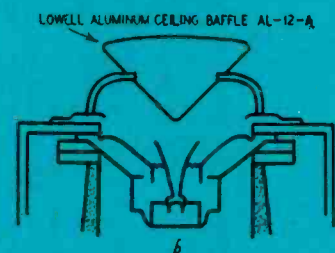

Fig. 5

Fig. 1—Sketch of complete system.

Fig. 2—Ceramex system cross-section.

Fig. 3—Side patterns for horn.

Fig. 4—Wooden pieces for speaker mounting board, horn throat and mouth frames.

Fig. 5—Horn ready for plaster.

Fig. 6—Horn variations.

NOW that unemployed movie promoters are writing audio copy "revolutionary" speaker systems are no longer unique. The design described here doesn't pretend to be a revolutionary ultra-super reproducer. The Ceramex horn (Fig. 1) is an experiment in designing a straight-forward noncritical reproducer housing as free from spurious resonances and tonal coloration as possible—it is almost as inert as solid concrete.

Ceramex construction, plus nondirectional high-frequency response, originating at optimum height, contribute to extremely natural reproduction. Furthermore, response is not augmented with any tricks using acoustic reactance or Helmholtz resonance—bass notes are discrete and nonresonant.

The basic design of the Ceramex system (Fig. 2) is a straight, vertical, rear-loaded horn terminating in a radial slot at floor level. Frequencies above 1,000 cycles are supplied by 360° front radiation plus an auxiliary tweeter. Although the reproducer can be used in any location, it works best when placed diagonally in a corner. In this position the length and flare of the horn match the natural horn made by the room corner and acoustic loading is almost purely resistive from 60 to 1,000 cycles.

In tests made with four commonly used speakers (three were 12-inch units), the Ceramex system provided a highly uniform acoustic load. All the speakers showed a marked reduction in impedance peaks (as compared to the free-air condition), without any new dips or spikes, down to 60 cycles. The test indicated that the Electro-Voice SP-12B had the most desirable impedance characteristics for the Ceramex horn, and in listening tests this speaker was the one I preferred. A 15-inch driver (mounted on a small coupling chamber) was included to see if the larger size would make any noticeable difference. It didn't.

Contrary to a lot of claims in print, impedance peaks and cone resonances are not necessarily the same. While an exponential horn lowers the point of maximum driver impedance both in frequency and degree, the physical resonance of the cone is shifted only slightly. Consequently, a driver having a low free-air resonance (40–50 cycles) gives the smoothest possible bass response in a resistive system.

Regardless of which driver is used in the Ceramex horn, the upper limit of horn radiation is around 2,000 cycles. The mid-range rise of most 12-inch speakers will compensate for a loss in efficiency between 1,000 and 4,000 cycles, but above this point the response curve really begins to wilt. An auxiliary tweeter or duplex cone arrangement which takes over at about 3,500 cycles is needed to keep the higher frequencies from slowly expiring. The tweeter was a University 4401.

Before setting out on the steps outlined, read *all* the instructions, look at

the diagrams, make sure you understand exactly how the unit is built and check to make sure you have all the materials.

Step-by-step assembly instructions

1. Lay out the pattern for the horn sides (Fig. 3) on a large sheet of cardboard. Use this pattern to cut out four identical wire-lath sides.

2. Cut the wooden pieces required as shown in Fig. 4. Before sawing out the circular speaker mounting hole C, check the diameter against the actual speaker to be used. Note that the speaker mounts with the rear of its mounting ring against the mounting board as shown in Fig. 2.

3. With glue and screws or nails, fasten the four throat frame sections to the speaker mounting board as in Fig. 5.

4. Assemble the horn mouth frame as above and attach the four wrought-iron legs for rigidity and to keep the assembly square.

5. Using wiring staples, roofing nails or upholstery nails, attach the four horn sides to the throat frame.

6. Attach the wire-lath sides to the horn mouth frame as above (Fig. 5).

7. Using 2-inch scraps of No. 16-22 wire, tie the four wire-lath horn sides together at their adjoining edges. Just loop a piece of wire through the adjacent pieces and twist the ends together. Pieces should be wired at 3-inch intervals along each horn corner.

8. Apply Ceramex plaster (see mixing instructions) about ½ to ¾ inch thick with mason's trowel. Be careful to keep full thickness at corners to guard against holes and cracks.

9. Let the horn dry about 48 hours.

10. Cut a ring from a sponge-rubber ironing board pad about ½ inch wide with the proper inside diameter to form a sealing gasket between the speaker and the mounting board.

11. Attach the 12-inch speaker to its mounting board. Wires can be run out either through the horn mouth or a small hole drilled through the throat frame. This hole should be sealed with putty after the wires are in place.

12. Knock the spout off a 6-inch funnel—it has now become a diffusing cone (Fig. 2). Cut a 6½-inch disc from the sponge rubber to form a mounting cushion and attach the cone to the plywood diffusing panel with small wood screws.

13. Mount the tweeter on the diffusing baffle as shown in Fig. 2.

14. Fasten the diffusing assembly to the speaker mounting board with the four 5-inch posts. (Any other method such as dowel rods or bolts and bushings may be used.) Allow a 5-inch clearance between the speaker board and the plywood diffusing baffle.

15. After several weeks, when the Ceramex plaster has become thoroughly cured, small cracks may appear between the plaster and the throat frame. These must be sealed with putty. For proper operation the horn should be airtight.

Any type of decorative cabinet can be built around the Ceramex horn provided that sufficient free space is provided for high-frequency radiation. The overall height of the system can be reduced to about 3 feet with the configuration of Fig. 6-a. The only drawbacks to this scheme are that the tweeter is farther from the woofer and you can't set things on top of the cabinet.

Steps 12 through 14 can be eliminated if the high-frequency diffusing system, shown in Fig. 2, is replaced by a Lowell 12-inch diffusing baffle AL-12-A (Fig. 6-b). This spun-aluminum baffle is available from most radio parts wholesalers. The Lowell baffle or some similar arrangement is necessary if a coaxial speaker is used in place of the woofer-tweeter combination since the diffusing system of Fig. 2 forms an acoustic 4,000-cycle cutoff filter.

In evaluating the performance of the Ceramex or any other speaker system it is important to remember that room acoustics exert a tremendous influence on the response of a reproducer. For example, in my living room the horn is flat to about 50 cycles but when moved to another room it puts out solid fundamentals down to 24 cycles!

The reason we don't ordinarily notice the peaks and dips introduced by diffraction effects and standing waves is that our ear notices a change in timbre much more readily than a corresponding change in volume. We can change seats in a concert hall without having to reidentify all the instruments because we unconsciously compensate for diffraction and interference conditions. Resonance in a reproducing system, however, is immediately noticed by the ear whether it shows up on a sound-pressure curve or not.

Parts and materials for horn

2—pieces of 2 x 8-foot wire lath; 2—pieces ¾-inch plywood, 15½ inches square; 2—8-foot lengths of 1 x 3-inch pine board; 1—bag of Portland cement; 1—bag of Zonolite; 1—6-inch diameter funnel; 1—set of 8-inch wrought-iron legs; 1—sponge-rubber ironing-board cover; 10—pounds of industrial lime (not absolutely necessary but it will make things easier); miscellaneous screws, glue, nails, etc.

No equipment was available to make calibrated sound-pressure readings for the Ceramex horn, but sweep-frequency checks made under normal listening conditions sound smooth and free from objectionable resonance effects.

Mixing the Ceramex plaster

1. This is going to be messy. Put newspapers over the floor and find a large washtub or something similar in which to mix the plaster.

2. Use one part cement to two parts Zonolite plus enough water to make a mixture about the same consistency as soft butter. A small amount of lime added will make the plaster slipperier and easier to apply.

3. Don't make too much at once—mix plaster as you need it. END

tape

recorder

operation

A description of the techniques used in these increasingly popular units

By SOL HELLER

TAPE recorder servicing can be very profitable. Relatively few technicians, however, are prepared to service them. One difficulty is that many technicians lack a good overall knowledge of how a tape recorder works.

An overall view

To record, a magnetic material (tape) is drawn past an electromagnet called a *recording head*. Audio currents flowing in the magnet coil of the head, magnetize the tape. The degree of magnetization developed at any instant in the tiny section of tape in contact with the head varies with the audio current in the head coil. On playback the magnetized tape is drawn past a *playback head*. The varying magnetic patterns on the tape induce corresponding current fluctuations in the coil of the playback head. The audio voltages developed as a result of this action are amplified and converted into sound.

Before recording, the tape is made to pass an *erase head* which removes or "erases" any previous recording present, leaving the tape free for a new recording.

An oscillator stage supplies a *bias voltage* to the recording head to make the tape recording linear. The oscillator commonly feeds the erase head as well.

There are three basic groups of components in the commercial tape recorder: the tape transport mechanism; the magnetic heads; the electronic system. We'll consider each separately.

Tape transport mechanism

This unit moves the tape across a small air gap in the magnetic heads. The gap concentrates the magnetic field in the area through which the tape is passing. The tape must be transported at a constant speed; should the speed vary, the signal being recorded or reproduced will change in frequency producing distortion.

A unit called a *capstan* (see Fig. 1 and photo) pulls the tape. The capstan rotates at a constant speed. It is attached to a rather heavy flywheel, the inertia of which prevents slight changes in line voltage from producing corresponding changes in capstan speed. The flywheel is driven by an electric motor to which it is mechanically coupled by a rubber belt or a pulley-and-idler system.

To maintain the tape under fairly constant tension, clutches are used in

many machines. In more expensive recorders, separate motors are provided for the take-up reel, supply reel and capstan. This permits much better balancing of the forces acting on the tape (Fig. 2), improving tension uniformity. In a new tape transport system, recently developed by the International Scientific Industries Corp., tape tension is maintained at a very constant level through magnetic action. See "New Developments in Tape Recorders" in the June, 1955, issue.

To bring the tape to a smooth and quick stop, some form of braking is employed. This braking must not be too abrupt or the tape may snap. In most machines mechanical brakes are used; in some units dc is inserted into the ac motor that drives the reel to bring the motor to a stop.

Magnetic heads

Electromagnets called *heads* are used in tape recorders to convert audio currents into magnetic patterns — and vice versa — as well as to erase magnetic patterns. Heads fall into three categories: recording, playback and erase. In some machines separate heads are used for recording, playback and erase. In others, one head is used for recording and playback and another for erase. Infrequently, a single head is used for all three functions.

The pressure of the tape against the head across which it is traveling must

be kept constant. A relatively slight change in the spacing between the head and the tape will produce a large change in the loudness of the reproduced sound. Felt pressure pads or guide pins (Fig. 1) are commonly used to keep the tape in intimate, fairly uniform contact with the heads.

Electronic section of tape recorder

This is used to amplify the signals developed in the playback and recording heads; it is also used to develop suitable erase currents. Block diagrams of the basic circuits are shown in Fig 3.

The signal developed in the playback head is fed to a few stages of audio amplification and finally applied to a loudspeaker. In the record position the microphone input is amplified and fed to the recording head which makes a magnetic impression of the signals on the tape. The oscillator stage deserves separate discussion since its action is rather complicated.

Recording bias oscillator

When a magnetic material (such as tape) is used, we are concerned with a characteristic similar to that of a tube's $e_c - i_p$ curve. This characteristic is sometimes called the *transduction curve* or the *transfer characteristic* of tape. Such

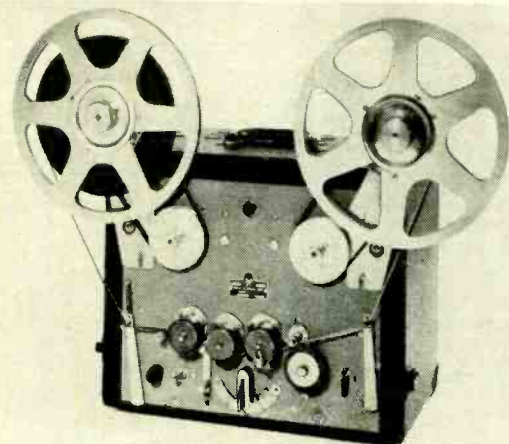

A professional type tape recorder.

Courtesy Presto Recording Corp.

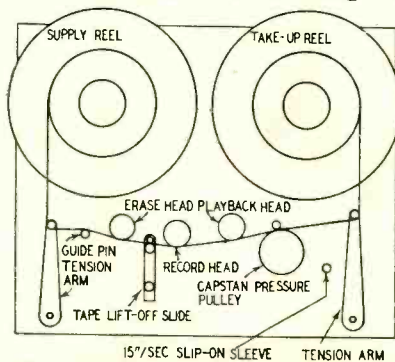

Fig. 1—Tape-recorder mechanism.

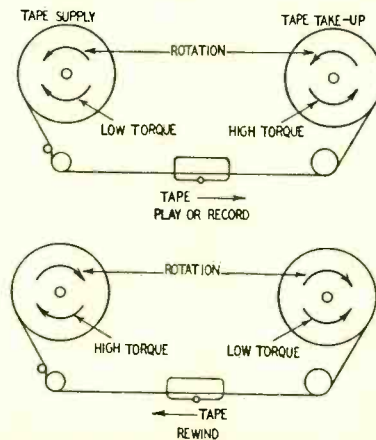

Fig. 2—Wind and rewind forces.

a curve (Fig. 4) shows the magnetic flux produced in a specific material by different values of magnetizing force.

A magnetic transfer characteristic is inherently nonlinear. If it were not corrected in some way, but used in the manner shown in Fig. 4, a linear input signal would become nonlinear during the recording process.

One solution to the problem lies in using a relatively small linear section of the characteristic. Such sections are indicated as A-B and C-D in Fig. 5. By using a suitable level of positive or negative bias, the signal may be shifted up or down the characteristic so that it falls along A-B or C-D.

This solution (dc biasing) was used in early tape recorders. One drawback was that the recorded signal could not be made very large, since less than half of the transfer characteristic could be used. This restricted the range of amplitudes (dynamic range) in the reproduced signal. Furthermore, the steady tape magnetization produced by the dc bias generated a rather high magnetic noise level which lowered the maximum signal-noise ratio obtainable.

These disadvantages were overcome by using an ultrasonic ac bias. This bias permits the audio signal to be shifted alternately from one to the other linear sections of the transfer characteristic. Since this very rapid shift occurs at a frequency too high to be recorded—or to be heard even if recorded—the bias signal does not interfere with the recording process.

Considerably less noise is developed when ac biasing is used. Noise is present only during bias signal peaks, rather than continuously as with dc biasing. A better signal-noise ratio can be obtained.

The frequency of the bias signal is made a number of times higher than the highest audio frequency to be reproduced and generally falls somewhere between 50 and 300 kc. It is made this high (at least five times greater than

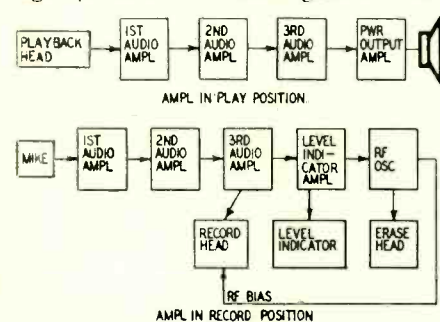

Fig. 3—Circuits used in Federal Manufacturing and Engineering Corp. 37B.

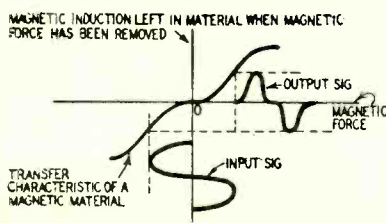

Fig. 4—Tape transfer characteristic.

the highest audio signal frequency) to prevent beating with harmonics of the audio signals.

Erasing

This is the name given to the process of demagnetizing tape so that it becomes free for other recordings. The tape is erased by passing it through an erase head; the current passing through this head demagnetizes the tape.

A dc erase system was commonly used in early tape recorders. It is still used in some of the less expensive machines. Under this system enough flux is generated by the dc flowing through the erase head to completely saturate the tape. When the demagnetizing force is removed, the tape returns to its original state or close to it. Slight irregularities in the residual magnetic field remain, however, after the erase process is over. As a result, noise is produced in the subsequent recording. This noise characteristic makes a dc erase system undesirable.

Ac erase is commonly used today. The tape is subjected to an alternating field that progressively diminishes in strength, bringing the residual flux in the tape down to smaller and smaller values, finally to zero, in a short period of time. (If the erase cycles of current did not progressively decrease in amplitude to zero, the residual flux left in the tape at the end of the final cycle might be appreciable.)

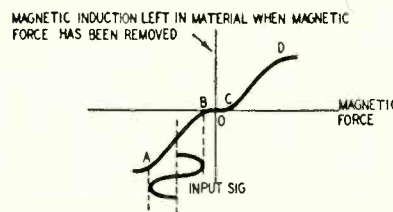

Fig. 5—Applying small signal along linear section of the transfer curve.

A high-frequency current is used for ac erasing. It is similar to the one used for supplying bias during recording; but its amplitude is greater. The oscillator that generates the recording bias signal often supplies the erase current as well.

Equalization

When tape moves past the playback head the voltage induced in the head tends to go up as the frequency rises from 100 to 1,000 cycles. This is because the magnetic flux induced in the head becomes greater as the frequency increases. Above 1,000 cycles, increased losses in the core of the head, reduced efficiency of coupling between tape and head and other factors tend to reduce the voltage output of the head. The playback characteristic starts to fall off at around 3 kc; at 10 kc it falls to a level approximately 15 db below the maximum voltage developed. Thus, equalization circuits are needed to flatten the playback response and prevent frequency distortion. The response needs boosting at both the high- and low-frequency ends.

If frequency correction is made dur-

ing recording, it is called *pre-equalization*; when made during playback the process is referred to as *post-equalization*. Low-frequency equalization is generally achieved in playback; high frequencies are commonly boosted during recording.

Recording speed

Recording speed has an important relation to frequency response. Let's consider the link between the two.

The formula for the wavelength (on tape) of the recorded signal is $\lambda = \frac{S}{f}$, where λ is wavelength; S, tape speed; f, frequency of recorded signal. The wavelength varies *directly* with the speed of tape travel and *inversely* with the frequency. At high frequencies the wavelength is very short.

When the wavelength of the recorded signal is the same as the length of the gap in the pickup head, the voltage induced in the head by the tape will be close to zero. This is because the magnetic flux in one half of the cycle cancels that in the other half of a recorded signal one wavelength long. The voltage induced in the head will thus be maximum when the length of the head is equal to one-half the wavelength of the recorded signal. As a result, it is desirable to operate the tape at a speed such that the recorded wavelength of the highest frequency is approximately twice the gap length.

The greater the speed at which the tape is transported past a gap of a given length, the longer will be the recorded wavelength for a given high frequency, and the smaller will be the self-demagnetizing effect. Tape speeds of 3 3/4, 7 1/2 and 15 inches per second have become standard. Machines providing 15-inch speeds are capable of a higher degree of fidelity than those that offer lower speeds only. With tape run at 15 ips, a frequency range of 30-15,000 cycles becomes possible. The disadvantage is, however, that playing time is reduced. The same length of tape that provides 30 minutes of play at a speed of 7 1/2 ips will play for only 15 minutes at 15 ips. A tape speed of 3 3/4 ips is suited primarily for recording speech.

Twin-track system

In machines using the twin-track system, two sound tracks are recorded side by side on a single tape. While one half of the tape is played, the other half rewinds. The advantage of this method is that there is no waiting for the tape to rewind. On some machines the tape directions can be reversed almost instantly and the recording (or playback) can continue immediately. On others, the reels must be transposed. Double the playing time is also achieved by this more efficient use of tape. The disadvantage of the twin-track system lies in the reduced output that it provides—perhaps 6 db or so. This is not considered a serious disadvantage, except perhaps in professional type machines where a very high signal-noise ratio is sought.

FOR GOLDEN EARS ONLY

*The Rex changer; H. H. Scott
310 FM tuner; Fentone B & O
and P-12 phono cartridges*

By MONITOR

THE Rex changer, a product of Perpetuum-Ebner of West Germany, is very popular on the Continent. A unique feature of the Rex is its ability to play any mixture of any sized records; not only the standard sizes but any conceivable size between 5 and 12 inches in diameter. The record first drops about an inch and hangs; the arm moves over, touches the edge and thus sets up the setdown mechanism to suit the size of the record. The arm then moves back, the record drops to the table and the arm comes down about 1/4 inch from the edge of the record. Another unique feature is that the trip for the return of the arm at the end of the record is actuated (on most records) even when there is no runout spiral.

Only the lack of a 16-rpm speed (records are already on the market) and the inability of the device to change speed automatically (which so far no changer can do and perhaps never will) stands in the way of perfect versatility.

Very simple to load and unload, the changer is converted to manual operation simply by changing to a short spindle. It is just about completely fool-proof (the arm can be seized by hand and even forced in the middle of a cycle with no damage or change in operation). Speed is changed with a three-position

switch (78, 33 and 45 rpm). There is also a three-position rolloff filter.

The rumble, wow, flutter, hum, etc., are just below the best obtainable in at least one other changer and will not prove troublesome or annoying unless terrific bass boosts are used. The arm bearings are good enough to produce perfect tracking of a big-hole 7-inch record when it is placed over the small spindle to obtain the greatest possible eccentric swing.

The position of the mounting holes will provide good overhang for average cartridges. Plug-in heads accept just about any cartridge with 1/2-inch mounting centers. Beside the normal two contacts for the pickup leads there is a third which can be used to ground the cartridge frame on cartridges which do not otherwise ground the frame.

Mounting is exceptionally simple. Actually, the Rex is already suspended on a stand through tuned springs—it is necessary only to cut out a rectangular hole. But the changer could be placed on a shelf or mounted to slides with no other base whatever. The only respect in which the Rex slips is the needle-pressure adjustment which is awkward in comparison with those of other changers. This could be greatly improved by replacing the inadequate knob with something capable of being grasped and turned with the fingers. But even then it would be more awkward and less delicate than the average.

Another product of Perpetuum-Ebner is the Fentone P-12, a crystal cartridge that—measured by magnetic cartridge

standards—comes out about equal to the average magnetic cartridge and possesses some points of superiority. The high end is sharp, clean and free of "crystal sound." Some listeners may prefer it to that of flatter magnetic cartridges. Loaded with 100,000 ohms, it may be fed into and equalized with a magnetic preamp. With 1 megohm input resistance, response is as shown in Fig. 1.

H. H. Scott 310 FM tuner

The Scott 310 belongs in the very top category of FM tuners. Its noise figure is at least as good as any I have measured and the absolute sensitivity is also tops; any signal which can be detected in the noise is readable. However, it takes higher input to obtain quieting adequate for hi-fi listening largely because avc is applied to the rf and first if stages. While this reduces sensitivity, it also insures against overload on strong signals and distortion, which might be annoying on strong signals.

Tuning ease is excellent, except that the tuning knob has smooth metal edges. A fluted knob would reduce finger slippage. The drive is free of backlash but rather heavily loaded. The tuning meter, which works off the if stage with avc, is excellent and very sensitive at the low end.

The interchannel noise suppressor is called a "Dynaural" suppressor but is actually a normal squelch. Though the switching transients are lower than in most squelches, they are nevertheless present and will produce some audible thumps on very-wide-range amplifier—

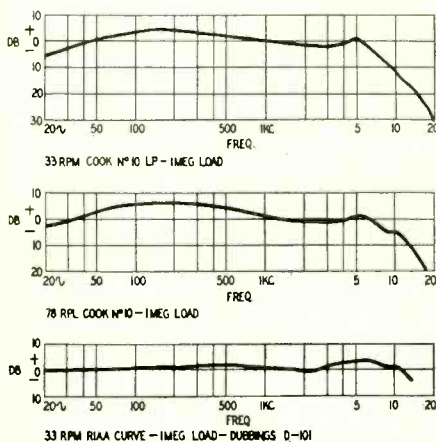

Fig. 1—Response of the Fentone P-12.

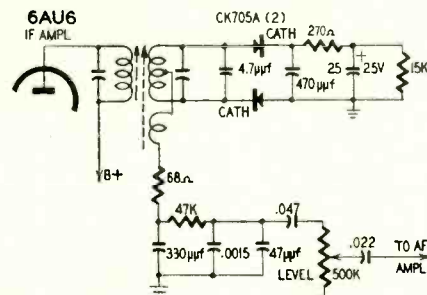

Fig. 2—Scott ratio detector circuit.

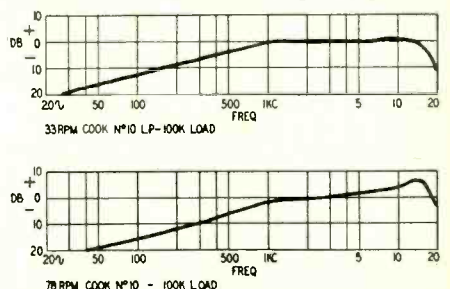

Fig. 3—Response of Fentone B & O.

speaker systems. The model I tested showed occasionally a trace of spurious response apparently due to the hot rf stage going off with changes in input loading. The drift characteristics are superb.

Like the National Criterion this uses a 2-mc wide-band detector but achieves this wide band with a ratio detector using crystal diodes (Fig. 2). A superb FM tuner, surpassed possibly in sensitivity and selectivity by one or two others but surpassing them, in turn, in other characteristics.

B & O phono cartridge

This contribution of Bang & Olufsen of Denmark to high fidelity represents an extremely fine value at the price of \$8 with two sapphire needles, \$20 with one diamond and one sapphire. The curves (Fig. 3) were taken directly off the pickup (with a 100,000-ohm load) and are pretty representative of what is obtainable with average preamps and control units. The response above 15,000 cycles will improve if the preamp has lower-than-average input capacitance. The low impedance of the cartridge, the high output and the high immunity to hum permit dispensing with a shielded cable under favorable circumstances and this, too, would reduce loading capacitance and improve response above 15,000 cycles.

The only respect in which the cartridge falls below average is in the rather high magnetic pull. Metal filings are strongly attracted through the thickness of one record. When an iron or steel turntable is used, allow for the magnetic pull in adjusting needle pressure. However, if adjusted for 7 or 8 grams 1/16 inch above the table, the pressure will be right.

The design is very unusual in two respects: Eight poles are used in the movement; the needles are mounted side-by-side on the same cantilever—when one is in the groove the other is elevated to one side and at an angle. The listening quality is very good indeed and remarkably good on old 78-rpm shellac records even when they are played back with no rolloff of the highs. The cartridge is removable from the mount which is then easily screwed in place in any arm capable of accepting mounts with 1/2-inch mounting centers. Needles are easily changed by prying up the old one with a knife blade and pushing in the new one. Dirt and lint cannot permeate the movement and can be brushed off the needles without damage to damping materials.

The latest version presents a unique and exclusive feature—a strip of radioactive foil built into the cartridge to neutralize static charge on records. Sometimes it takes two plays to neutralize a highly charged 12-inch record but the neutralization is achieved and maintained; 7-inch records are neutralized by one playing of one side only. These models are designated as A type and cost \$1.80 more than the regular ones. **END**

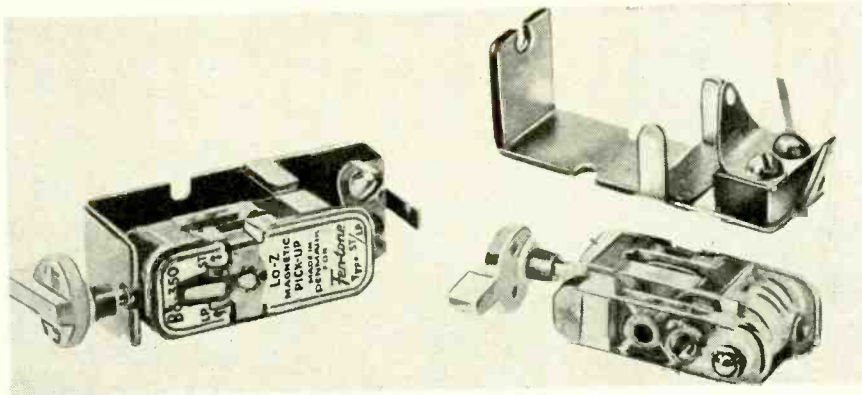

The Fentone B & O magnetic cartridge.

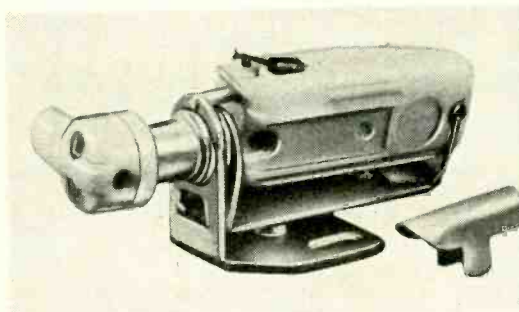

The Fentone P-12 crystal cartridge.

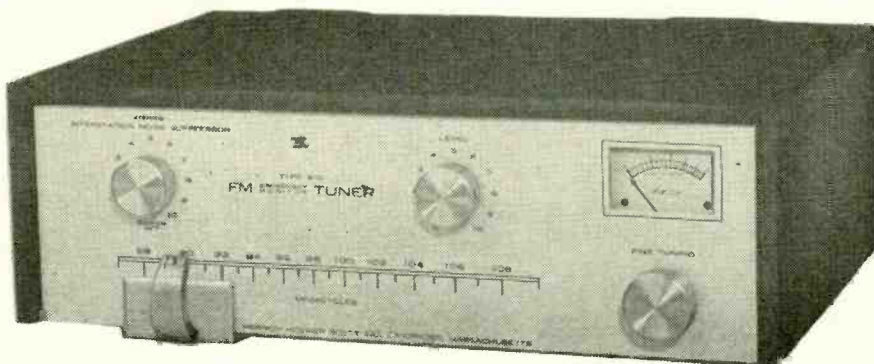

The Herman H. Scott model 310 FM tuner.

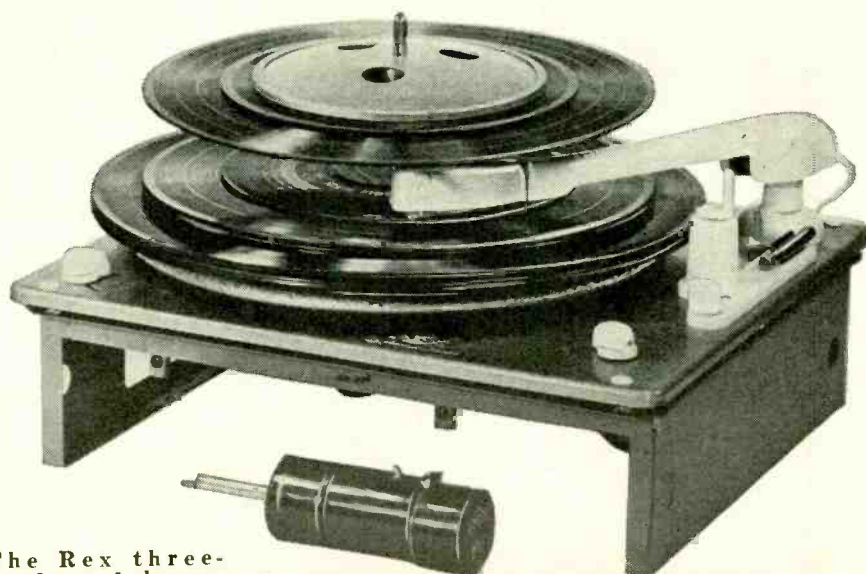

The Rex three-speed record changer.

more about load lines

When capacitance and inductance get into the picture, the load line becomes an unfamiliar "load ellipse"

By NORMAN CROWHURST

THE earlier article "What Is a Load Line?" (RADIO-ELECTRONICS, June, 1955) covers several of the difficulties of understanding the advantages of using load lines and of knowing just what they mean. Several aspects of the application of load lines could not be covered in that article. They remain mystifying to many people, including a good many engineers whose education should have made the subject clear to them. The fault does not necessarily rest with the engineer, but with the kind of approach often used in teaching this subject.

Reactance loads

When reactance is incorporated into the load of the tube, the load line becomes elliptical. This fact is fairly gen-

erally recognized, but not too often properly understood.

First let us consider the relationship between voltage and current in a pure reactance. When we were talking about the voltage and current in a resistance, any variation in applied voltage resulted in a proportionate change in current flowing through the resistance. The voltage across the resistance and the current flowing through it always vary *in phase with each other*, consequently the load line corresponding to resistance looks like a straight line.

In a reactance, however, the voltage and current do not vary in phase.

(Let us note, before going any further, that the ellipse representing voltage and current in a reactance is not by any means so universal in application as the straight line representing a resistance. The ellipse represents the variation of voltage and current in the reactance for only one frequency and at only one signal amplitude. Changing the amplitude of the signal will change the size of the ellipse, while changing the frequency will change its proportions. However, to save getting involved too much in the relationship between frequency and amplitude, it is easier to consider the reactance itself as changing rather than bothering to try and fit frequency into the picture.)

Taking the variation of voltage and

current in a reactance of a sinusoidal waveform at one particular frequency, the voltage in an inductance leads the current by 90°. The voltage reaches its maximum when the current is zero, and by the time the current has reached its maximum the voltage is zero. This is shown in the waveform relations of Fig. 1.

If these waveforms are injected simultaneously into the vertical and horizontal circuits of an oscilloscope, the trace displayed will be either an ellipse or a circle. This is precisely the basis for drawing an ellipse to represent a load line of a pure reactance.

Pure reactance—ideal tube

Let us now apply this to a theoretical tube characteristic rather than to

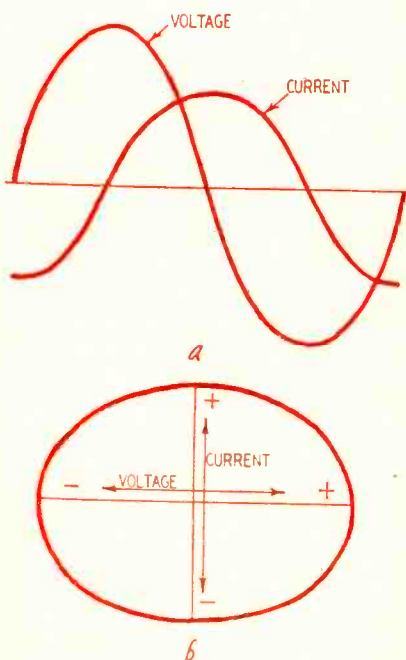

Fig. 1-a—Current and voltage in pure reactance; b—how it looks on the scope.

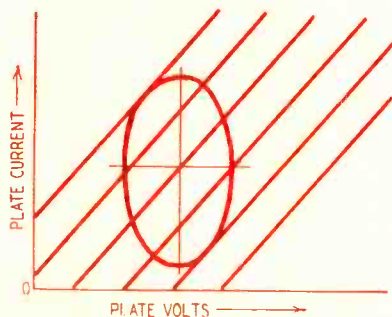

Fig. 2—Load line of pure reactance.

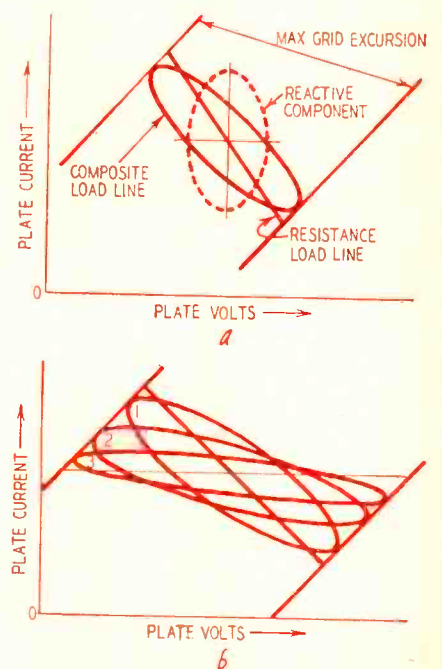

Fig. 3-a—Series resistance-reactance load line; b—a series of such lines.

practical ones, because the curvature of practical tube characteristics involves us in the complication of distortion. The sloping lines in Fig. 2 represent plate-current vs. plate-voltage curves for different values of applied grid voltage. So sinusoidal variation of grid input will require the operating point on these curves to move to and fro across these sloping lines in sinusoidal fashion to suit the applied grid voltage. The relationship between plate voltage and plate current which this movement follows will be controlled by the reactance.

In the pure reactance we are now considering, there is a 90° displacement between voltage and current waveforms, so the resultant shape must be elliptical in form with the axes of the ellipse vertical and horizontal. The proportions will be determined by the value of reactance that the ellipse represents. Using the scale employed for plotting the plate-current vs. plate-voltage curves, represented by the sloping lines, the reactance is given by the ratio of the axes of the ellipse. The entire length of the horizontal axis (the maximum width of the ellipse) represents the total voltage fluctuation while the length of the vertical axis (the maximum height of the ellipse) represents the current fluctuation.

The fact that the voltage and current fluctuations are displayed by 90° is shown by the spot crossing the axes at points of maximum and minimum value of the other quantity: The maximum current, which is the top of the ellipse, occurs where the voltage is at its mean value represented by the vertical axis of the ellipse; the maximum voltage is on the horizontal axis of the ellipse, which represents the mean value of current.

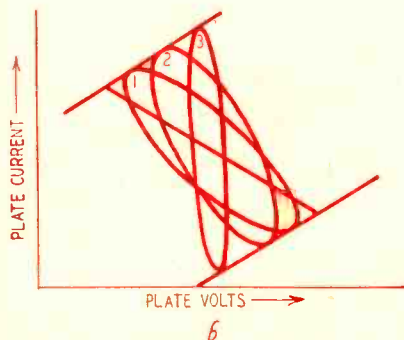
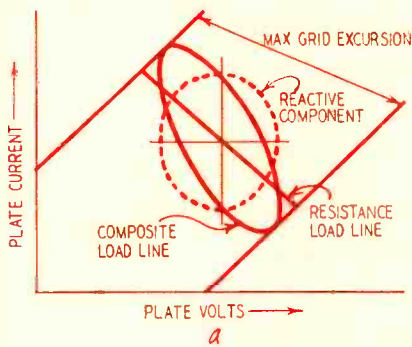

Fig. 4—*a*—Parallel resistance-reactance load line; *b*—a family of them.

Realize that this ellipse could represent either inductive or capacitive reactance simply by imagining that the spot on the ellipse is rotating in opposite directions. Inductance can be represented by clockwise rotation: Starting from the left side on the horizontal axis, we are at the position of maximum voltage drop across the inductance, and therefore at the position of mean current, but with the current moving in the direction of maximum. From this point the sequence around in clockwise direction can easily be traced.

Similarly the same ellipse could represent a capacitive reactance. Starting in this case from a point of maximum current flow, this current will be building in the capacitance to produce maximum voltage. Maximum current is represented by the top of the ellipse on the vertical axis and maximum voltage by the left end of the horizontal axis. Moving counterclockwise the sequence of operation with a pure capacitance can be traced. The principal difficulty here, however, is that, because the current is flowing in only one direction, the voltage should continue to go on up and up in that direction rather than following a cycle.

Obviously, a few other elements would be necessary to this circuit from a practical sense to achieve this result, since a tube with only a capacitor as plate load would not draw current! In considering the arrangement for a capacitance the ellipse is therefore only of a theoretical value.

Notice that the points where the ellipse touches the sloping lines (Figs. 2, 3) representing the extreme value of grid voltage (provided by the sine-wave drive) do not coincide with either maximum voltage or maximum current conditions represented by the ends of the ellipse, respectively, but are at a point intermediate between them. This corresponds in practice with the fact that the pure reactance is being fed from a resistive source, and the value of resistance is indicated by the slope of the lines representing plate-voltage vs. plate-current "curves" for different applied grid voltages.

The slope of these lines corresponds with the a.c. resistance of the tube. If these lines were vertical—which would represent a tube of zero a.c. resistance—the excursion of grid voltage would correspond with the excursion of plate

voltage, maximum and minimum values of grid voltage touching the ellipse at the ends of a horizontal axis, which correspond with maximum and minimum excursions of plate voltage. If the characteristic lines for the tube were horizontal—which would represent a tube of infinite a.c. resistance—the extreme values of grid voltage would touch the ellipse at its top and bottom, corresponding with maximum and minimum current. But practical values of a.c. resistance touch the ellipse at intermediate points. This shows that both current and voltage in the reactance have a phase shift from the drive voltage applied to the grid, although the relationship between voltage and current in the reactance itself is fixed at a phase difference of 90°.

Changing the value of resistance alters the slope of the straight line representing the resistance as a load line, but changing the value of a reactance alters the proportions of the ellipse that represents it. Assuming a constant voltage applied to the reactance, the length of its horizontal axis will be constant but the height of the vertical axis will depend upon the current which the reactance takes. Hence halving the reactance which causes it to take twice the current, will also cause the load line representing it to have a vertical axis twice as high.

Change of signal amplitude will mean that the ellipse will get larger or smaller but keep in the same proportion. For practical purposes it is not usually necessary to consider the effect of changing amplitude since we will mostly be concerned with what happens when an elliptical load line is used either at a comparatively low signal level or at a level corresponding with the maximum signal-handling capacity of the tube. What happens between these conditions need not be drawn in detail because, if we watch the extremes, the middle will fall into line automatically.

So much for the consideration of a theoretical pure reactance. In practice we're usually concerned with circuits where reactance is combined with resistance. An example is the case where the reactance of a coupling capacitor becomes significant, so that the plate load of a tube is not merely the combined resistance of the plate coupling resistance and grid resistor in parallel, but the coupling capacitor introduces a

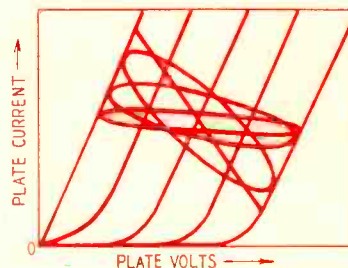

Fig. 5—Effect of series reactance component in practical triode tube load.

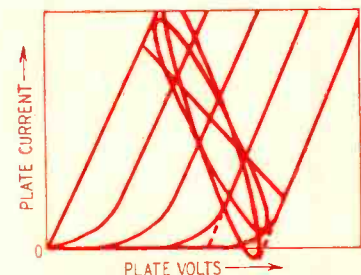

Fig. 6—Shunt reactance causes distortion in practical triode tube load.

AUDIO—HIGH FIDELITY

component of reactance. Another case is that of output tubes, where the load is not a pure resistance but a loudspeaker which has varying components of reactance in its impedance at different frequencies. What is the best way to approach a combination of resistance and reactance?

Practical impedances—ideal tube

The easiest and most practical approach is to consider a resistance load line of specific length as a starting point. Then imagine the reactance to be added as a component either in series or parallel with the resistance. This is closest to what happens in practice. The reactance of the coupling capacitor is added as a component in series with the grid resistor, for instance. The reactance components in the loudspeaker load are added in series with the resistance of the voice coil, all multiplied of course by the impedance-matching ratio of the output transformer.

Fig. 3-a shows the construction for an ellipse combining resistance and reactance in series. The starting point is the sloping line representing resistance. The vertical ellipse shown dotted represents the reactance component of the composite ellipse shown in solid line. Notice that the vertical extremes of these two ellipses are parallel, indicating that the same excursions of current occur in both. The voltage excursion—represented by movement horizontally—is greatest in the sloping ellipse, representing the combined impedance of the resistance (sloping line) and the reactance (vertical dotted ellipse). The sloping line and the combined ellipse lie between the diagonal lines representing the same grid voltage. This indicates the effect of adding the reactance in series with the resistance, keeping the same grid drive voltage.

By applying this method, a family of ellipses can be drawn as shown at Fig. 3-b to represent successively increasing values of reactance in series with the same constant value of resistance and using the same grid drive voltage.

Fig. 4-a shows the method used for producing an ellipse to represent a combination of reactance and resistance in parallel. Here again the resistance load line is the starting point. The slanting ellipse is the load line of the combination and the dotted ellipse that of the reactance component of the total.

Notice in this case, though, that the two ellipses are between the same parallel vertical lines—voltage excursions are equal—and the composite ellipse lies between the same grid voltage curves as the original resistance load line.

At Fig. 4-b is a family of ellipses representing a constant value of resistance shunted by successively smaller values of reactance.

Practical impedances—real tubes

The practical purpose of drawing elliptical load lines is to show how reactance in different positions in the circuit affects the distortion a tube will produce. So we need to draw elliptical load lines on practical tube characteristics rather than on the ideal ones used so far. It is much more convenient—to get the idea of how elliptical load lines are derived—to use ideal tube characteristics. Then we don't get involved in too many things at once. The reader will be quite familiar with tube characteristics for triode and pentode types and Figs. 5 to 8 show the effect of reactance added in series or in parallel with a resistance as load lines to these two varieties of tubes.

These are not completely accurate since the ellipses are drawn as true ellipses as a matter of convenience. In practice, it would become extremely difficult to draw an accurate load line for a combined reactive load including the effect of distortion. The principal reason is that, as soon as distortion enters the picture, the reactance is no longer a constant or simple value such as may be represented in a true ellipse.

The presence of distortion means that frequencies other than the original sinusoidal input are present in the output. Also they are present in different proportions in the current and voltage waveforms in the load, due to the fact that the reactance differs for different components of the output waveform. It is possible to estimate the resultant shape, as shown in Fig. 9, which represents a guess at the shape of a resultant load line in a distortion region, which would be helpful in plotting the waveform of voltage and current in the load.

However, in modern amplifiers, it is not so important to determine the exact degree and quantity of distortion as to find out whether appreciable distortion occurs as a result of introducing

the reactance. This can be quite simply shown by using the method adopted in Figs. 5 to 8 where the true ellipses are shown, rather than the correct load line including the effect of distortion.

The fact that distortion occurs can be seen (as in the case of resistance load lines) by the ellipse taking an excursion into the region where consecutive tube characteristic curves converge. Where this occurs, distortion is inevitable. To avoid distortion the ellipse should be kept well clear of these regions. From the Figs. 5 to 8 we can deduce the following general rules: In the triode tube, operation into a reactance that shunts the normal resistance load will eventually cause distortion, while reactance effectively in series with the normal load resistance will not introduce appreciable distortion. In the pentode or tetrode type tube reactance in series with the normal resistance load will lead into distortion regions, while shunting reactance tends to lead away from those regions.

From the latter deduction we can see why a pentode output tube operating into a loudspeaker tends to cause harsh reproduction. The rise in loudspeaker impedance, occurring at the dynamic resonance of the speaker in the region of 100 cycles and again at the upper end of the response due to the inductance of the voice coil, leads into distortion regions, resulting in harmonic and intermodulation products.

To overcome some of this the capacitor which was commonly placed from plate to ground of a pentode output stage, before the introduction of feedback became so popular, would at least eliminate some of the distortion at the high-frequency end. This capacitor introduced a shunt reactance instead of the series one produced by the loudspeaker, and the resultant load line was quite satisfactory from the point of view of the pentode's characteristic. This not only avoided the overemphasis of high frequencies produced by the pentode stage but also avoided the distortion of these high frequencies, also characteristic of this circuit.

There is still quite a lot to cover in the discussion of load lines, so such matters as the use of tube characteristics and load lines for predicting the performance of push-pull output stages and the use of load lines in conjunction with feedback, will be reserved for a later date. END

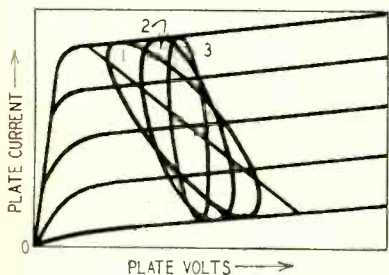

Fig. 7—Series reactance in load produces distortion in practical pentode.

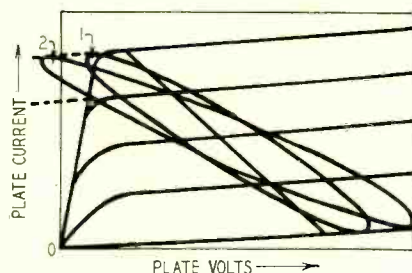

Fig. 8—Effect of shunt reactance in practical pentode loads is not serious.

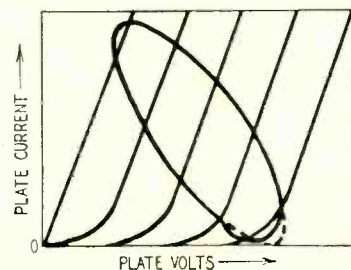

Fig. 9—Completing true ellipse in load line to estimate the distortion.

COMPENSATING OSCILLOSCOPE AMPLIFIERS

By
ROBERT G. MIDDLETON*

SCOPE amplifiers are built around the basic resistance-coupled circuit shown in Fig. 1-a. This is an uncompensated arrangement and has a frequency response as shown in Fig. 1-b. The rate of attenuation at high frequencies can be improved by lowering the value of plate load resistor R_L but this of course reduces the gain of the amplifier.

Practical scope applications require both high gain and extended high-frequency response. Hence high-frequency compensation must be applied (Fig. 2-a). The enormous improvement in high-frequency response then obtained is shown in Fig. 2-b. Peaking coil L1 is a series peaking coil, peaking coil L2 is a shunt peaking coil. Using combined series and shunt peaking provides maximum gain and bandwidth from a scope.

Television service work requires reproduction of pulses and other waveforms of the square-wave family. Thus, the transient response of the amplifier as well as its frequency response must be good. Fig. 3 shows the 100-kc square-wave response of an amplifier. There is a slight tendency for the amplifier to ring (transient oscillation) at the leading and trailing edges of the waveform. This tendency is minimized by damping the series peaking coil with resistor R1 (Fig. 2-a).

Typical values for the circuit arrangement which will provide flat response out to 4 mc are given in Fig. 2-a. Some prefer to use an adjustable series peaking coil so that a fine adjustment of the high-frequency response can be made. The value of R_L (3,900 ohms for Fig. 2-a) is semicritical and incorrect values will cause an uphill or downhill tilt in the frequency response. An uphill tilt is especially undesirable in that any ringing tendency is greatly increased.

The necessity for low-frequency compensation will become apparent from Fig. 4-b. In most cases the output from the scope amplifier will be coupled to the next circuit via a grid capacitor C_c (Fig. 4-a) and a grid-leak resistor R_g . (Unless, of course, the scope is a dc unit.) Unless C_c and R_g are made very large, the low-frequency response will be inadequate for TV troubleshooting. However, C_c can-

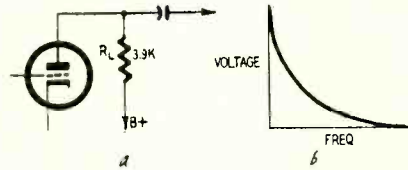

Fig. 1—A basic resistance-coupled circuit and its frequency response.

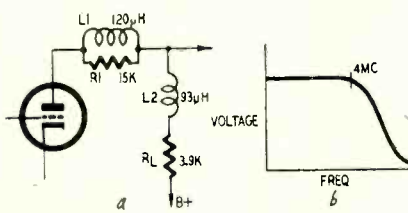

Fig. 2—Diagram and response of circuit compensated for high-frequency gain.

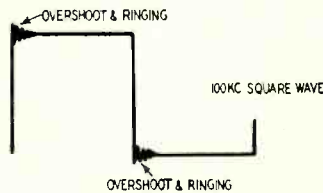

Fig. 3—Oscillation in a square wave.

not be extremely large (such as 2 or 3 μ f), without encountering leakage problems—B-plus voltage leakage into the grid circuit. Likewise, the grid resistor cannot be made extremely large (4 or 5 megohms) without danger of damaging the tube and creating unstable operation due to traces of grid emission, gas current, etc.

Hence, it is better to use smaller values of C_c and R_g and to restore the low-frequency response with low-frequency compensation as shown in Fig. 5-a. The improvement in low-frequency response is indicated in Fig. 5-b. Here is how it works: At high frequencies, compensating resistor R2 is effectively out of the circuit, being shunted by capacitor C1. But at lower frequencies the reactance of C1 increases and resistor R2 begins to appear as an increased plate load. Hence, the gain of the stage goes up at low frequencies, compensating for the attenuation through C_c and R_g .

It might be supposed that if R2 is smaller (in Fig. 5), then C1 could be made larger, thereby maintaining the same time constant and obtaining low-frequency compensation. However, this is not so. The values of R2 and C1 are semicritical for best compensation and typical values used in a commercial scope are: R2, 18,000 ohms; C1, 2 μ f. If R2 is made 9,000 ohms and C1 4 μ f,

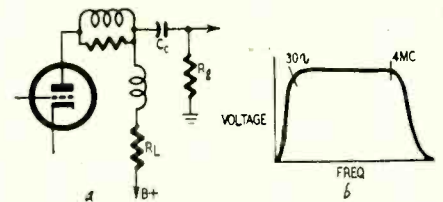

Fig. 4—Diagram and response of circuit requiring low-frequency compensation.

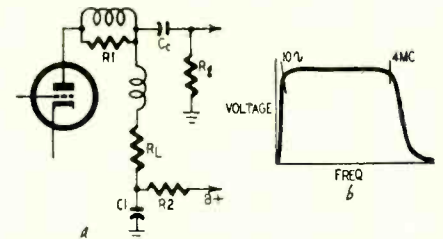

Fig. 5—Diagram and response curve show improvement over Fig. 4 circuit.

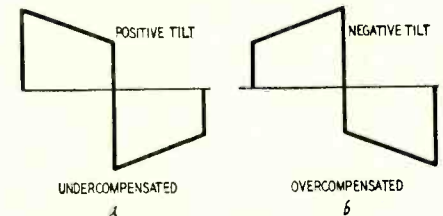

Fig. 6—Typical square-wave response.

low-frequency distortion and partial compensation result. In other words, the characteristic of C_c and R_g must be matched in the opposite direction by R2 and C1.

The beginner is usually surprised to find out that if a scope amplifier is flat down to 60 cycles, the 60-cycle square-wave response is very poor. For good 60-cycle square-wave response the amplifier must be flat down to 10 or 20 cycles. The reason for this is that proper reproduction of square waves and pulses depends upon the phase characteristic as much as on frequency. A linear phase characteristic will be obtained only if the frequency response extends considerably below the fundamental frequency of the square wave.

Fig. 6 shows the typical 60-cycle square-wave responses of a scope amplifier under various conditions. Fig. 6-a shows the results of undercompensating the circuit of Fig. 5; Fig. 6-b shows the results of overcompensating. When the values of R2 and C2 are made just right, the top of the 60-cycle square wave is exactly flat, as it should be.

These are the fundamental essentials of oscilloscope amplifiers, upon which all constructors must base their procedures. If these basic points are clearly fixed in mind, many hours of wasted effort can be avoided. The essential factor is to recognize the causes of distortion in the scope amplifiers so that aimless trial-and-error attacks are made unnecessary. END

* Chief field engineer, Simpson Electric Co.

NEW *easy-to-read* VTVM'S

*Circuitry and analysis of the
Hycon 615 and Leitch 20-55
automatic volt-ohmmeters*

By ROBERT F. SCOTT

TECHNICAL EDITOR

IN the August, 1955, issue we discussed several new conventional type multimeters and vtvm's. Now we will consider two radically new vacuum-tube volt-ohmmeters — the Hycon 615 and Leitch 20-55 (see photos). The Hycon 615 is a general-purpose instrument with a digital type scale or read-out on which all indications appear in Arabic numerals on three cylindrical drums. Illuminated polarity symbols and decimal points (controlled by the range and function switches) minimize scale errors. The Leitch Meter-Matic 20-55, features automatic range switching with the range in use indicated by small red lights behind the scales.

Hycon 615 operation

The circuit of the model 615 digital volt-ohmmeter is shown in Fig. 1. The

three-digit dial (see photo) is operated by a servo motor controlled by a voltage that is the difference between the voltage being measured and an internal reference voltage.

Dc voltages are read in ranges of 1, 10, 100 and 1,000 with an input impedance of 11 megohms and an accuracy of 1% of full scale. Ac voltages are measured in 10-, 100- and 1,000-volt ranges with an input impedance of 1.4 megohms shunted by 60 μ f. Accuracy is 2% of full scale. Frequency response is 30 cycles to 3 mc with the direct probe and 50 kc to 250 mc with the crystal probe. Resistance ranges are 1,000, 10,000 and 100,000 ohms and 1 and 10 megohms; accuracy is 1% of full scale.

When there is no voltage on the test prods, the motor is off and the dials read 000. When a voltage is applied to

the input terminals, the motor starts —driving the indicating dials and precision potentiometer—and continues to run until the voltage from the potentiometer equals a known proportion of the voltage being measured. The motor then stops and the dials indicate the test voltage.

The amplifier

Fig. 2 shows the basic circuit used for dc voltage measurements. The range selector switch is a voltage divider that attenuates the test voltage so a maximum of approximately 1 volt appears at the arm of the switch on any range. This voltage is applied to one input terminal of a 60-cycle spdt chopper. The other chopper input terminal is fed a reference voltage from the motor-driven potentiometer across BATT3. The 60-cycle output of the chopper is amplified and fed to the control winding to start the servo motor. When no test voltage is being applied to the input, the arm of the potentiometer is at ground potential and the motor is stopped with the dials indicating 000.

Applying a test voltage starts the motor. Since the chopper output is taken alternately from the test and reference voltages, the amplified 60-cycle signal applied to the control winding on the motor depends on the relative value of these two voltages. The motor turns the dials and potentiometer until the reference and test voltages balance and the voltage on the control winding drops to zero. The dials now indicate the value of the test voltage.

If the test voltage is too high for the range in use, the limit switch keeps the dials from rotating more than 40 digits beyond 999. The neon lamp protects the chopper against voltage overloads and the capacitor bypasses any ac voltage that may be superimposed on the voltage being applied to the chopper.

The function selector (see Fig. 1) is wired so the polarities of the reference and test voltages are the same so the motor runs forward. Mechanical and electrical stops keep the dials from being damaged if the input polarity or selector setting is incorrect.

Measuring ac voltages

The basic circuit for ac voltages up

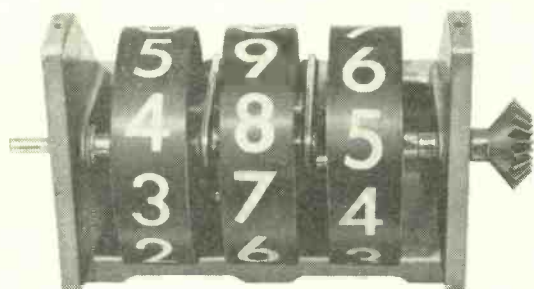

The Hycon model 615 digital vtvm with a close-up of the drum-type dial mechanism.



to 50 kc is shown in Fig. 3. The input voltage is applied to a frequency-compensated voltage-divider network (R1, R2, C2 and C5) through blocking capacitor C1. This voltage or portion of it, depending on the range, is applied to rectifier V1 through C3. The signal is rectified in V1-a. V1-b clamps the plate to V1-a close to ground potential and causes the full peak-to-peak voltage to appear across C4. This voltage is then applied to the dc voltage divider and from there on is handled in the same way as a positive dc test voltage.

V1-c bucks out the contact potential of V1-a. The bucking voltage is adjusted to the required value for each range by taps on a voltage divider consisting of R4, R5, R6 and R7 (Fig. 1).

A crystal diode probe is recommended for greater accuracy when measuring voltages with frequencies above about 50 kc. In this case, the instrument is set up for positive dc measurements and the probe output is fed into the DC input jack.

Resistance measurements

When the model 615 is used to measure resistance, one of the chopper inputs is connected to a Wheatstone bridge so unbalance causes the motor to operate. A simplified circuit is shown in Fig. 4.

The resistance in arm A-B consists

of OHMS CALIBRATE control R33 and R18 in series, arm B-C is a multiplier resistor (R8-R11) selected by the function selector. (On the $R \times 10K$ range the multiplier consists of R4 and R11 in series.) Arm A-D is the unknown resistance R_x in series with a trimmer resistance (R46-R50) switched in through the range selector. Arm C-D represents potentiometer R13, R32 and the motor-driven pot R29 in series.

Bridge current is supplied by 1.35-volt mercury cells BATT1 and BATT2 in series. A 10-ma fuse protects servo potentiometer R29 against accidental overloads.

Unbalance in the bridge causes unequal voltages to be fed to the chopper contacts. The difference in the two chopper input voltages is amplified and fed to the motor. The motor starts and moves the arm of R29 in a direction that tends to balance the bridge.

When the bridge is balanced the chopper input voltages are equal, the amplifier output is zero and the motor stops so the value of the unknown resistance can be read directly from the dials on the instrument.

The Meter-Matic 20-55

This instrument measures dc and ac voltages from 0.1 to 1,500 and resistances from 0.5 ohm to 1,000 megohms with automatic range switching for

each type of measurement. Dc voltages are metered with an input impedance of 12 megohms and an accuracy of $\pm 3\%$ of full scale. On ac the instrument indicates rms values accurate to $\pm 5\%$ of full scale. Up to 500 volts, frequency response is relatively flat from 30 cycles to 3 mc. Above 500 volts the response is best around 60 cycles. Center-scale values are 100, 1,000, 10,000 and 100,000 ohms and 1 and 10 megohms. Indicator lamps show the voltage scale or the center-scale value of the resistance range in use.

The automatic range selector circuit is designed so that on all except the lowest range, the needle always indicates on the upper two-thirds of the scale where accuracy and ease of reading are greatest. When an unknown voltage or resistance is connected across the test prods, the meter adjusts itself for the lowest range on which the reading falls on the upper two-thirds of the scale and remains there until the prods are removed from the circuit under test. The instrument then immediately resets to the lowest voltage or highest resistance range. Range search time does not exceed 1 second.

The Meter-Matic measures an ac voltage superimposed on a dc voltage or dc axis of an ac voltage. It is protected against burnout or damage by voltages up to 2,000 on voltage ranges

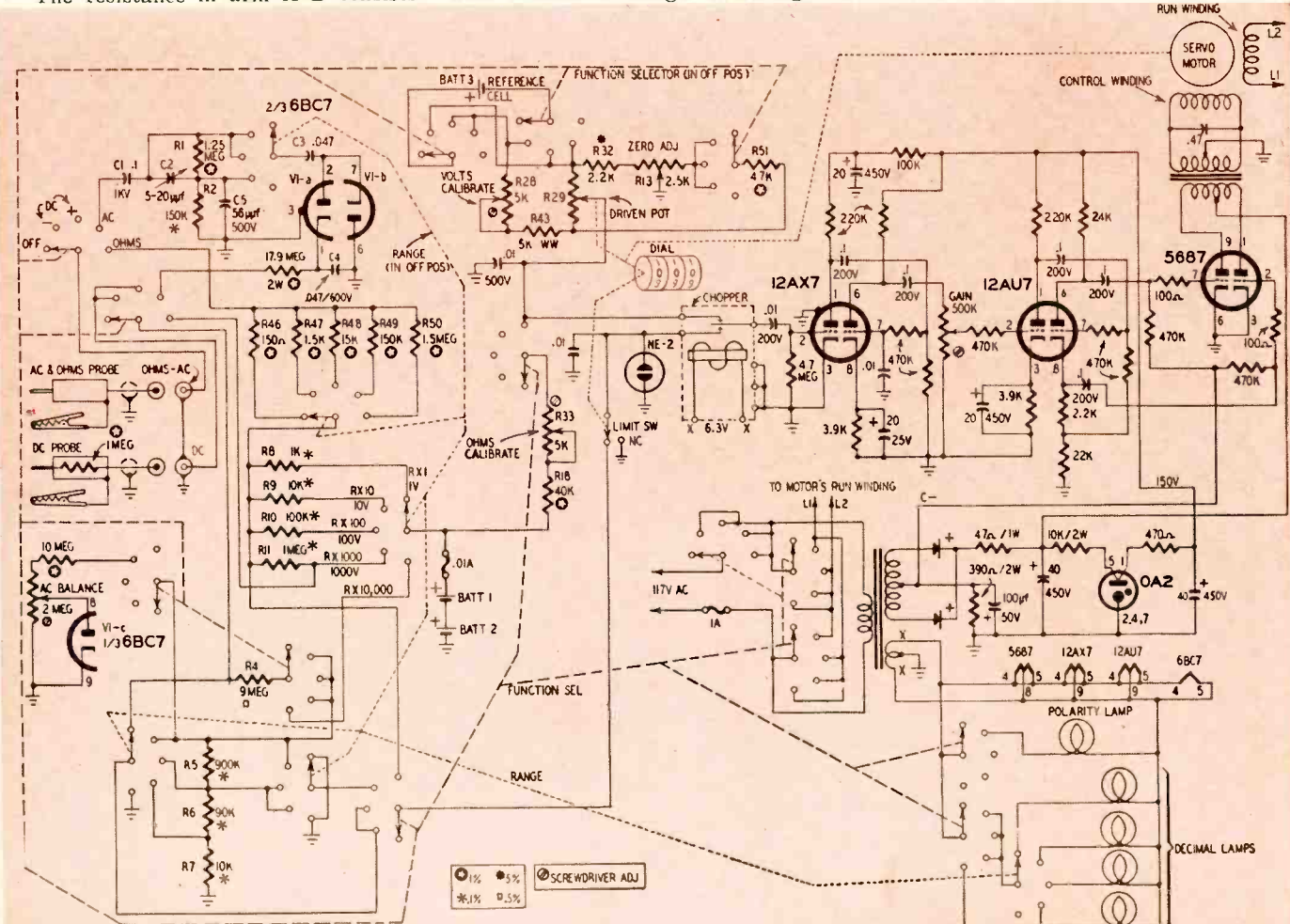
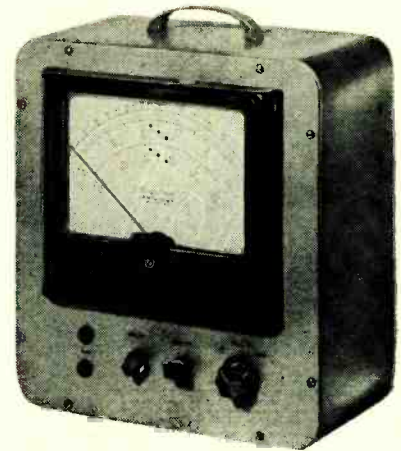
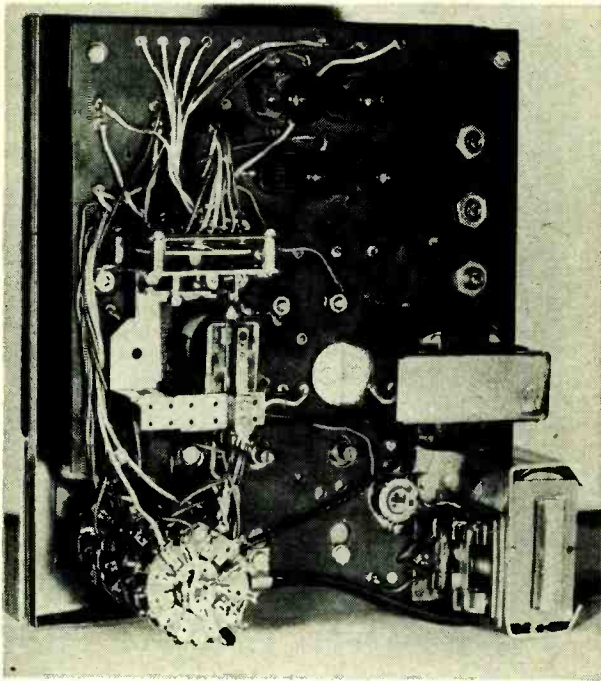

Fig. 1—Schematic diagram of the Hycon model 615 digital volt-ohmmeter. The dial is operated by a servo motor.

TEST INSTRUMENTS



The Leitch Meter-Matic model 20-55 (above). Rear-chassis view is at left. The relay type ratchet motor is in middle of left side. Each time the relay coil is energized the armature throws a ratchet, driving the rotary type switch mounted above it.

and damage by accidental application of ac or dc voltages up to 300 when measuring resistance.

Measuring dc voltage

The circuit of the Meter-Matic is shown in Fig. 5. The basic circuit is a conventional balance dc bridge type vtvm with the meter connected between the cathodes of a 12AU7 (V1). The voltage being measured is fed through part of the function selector S1-b and then to a voltage divider network. Section S2-b of the automatic range selector switch taps off all or a part of

this voltage, depending on the range, and feeds it to the grid of V1-b and causes the meter to deflect.

V2 is the automatic range selector control tube. V2-a has a 10,000-ohm relay in its plate circuit. Its grid is connected to one side of the meter so the voltage that deflects the meter controls its bias. This tube is normally biased at or close to cutoff by a positive voltage applied to the cathode through the ADVANCE control and by a negative voltage applied to the grid through S2-c.

When the voltage across the meter is

high enough to deflect the pointer off-scale, V2-a conducts and operates RY2, closing its contacts and applying power to the coil of stepping relay RY1. The armature of RY1 pulls in to operate the ratchet and advance S2 to the next higher range. When the armature of RY1 is pulled in, it closes a set of auxiliary spst contacts that apply a high negative voltage to the grid of V2-a. The plate current drops, releasing RY2 and again allowing the voltage across the meter to affect the grid circuit. If the voltage across the meter is still too high, the cycle repeats until a range is reached where the voltage across the meter does not cause off-scale deflection.

V2-b operates when the voltage being metered drops and calls for a lower range. The grids of V2-a and V2-b are tied together through a 1.5-megohm resistor. The plate voltage of V2-b is applied through a 1-megohm resistor. A NE-2 neon lamp connects to the plate through 100,000 ohms and to the grid of V2-a through two 1-megohm resistors in series. When the bias on the grid of V2-b is sufficiently negative, the neon lamp fires and places a positive voltage on the grid of V2-a. The circuit cycles through progressively higher ranges. After passing the highest range it again reaches the lowest one.

At this point, the grid of V2-a is again biased highly negative by the voltage applied through S2-c and the coils of RY1 and RY2 are de-energized. If the voltage across the meter is high enough to drive the pointer off-scale, V2-a conducts and the stepper moves S2 through successively higher ranges until a range is reached where the pointer falls in the upper two-thirds of the scale. The range is indicated by one of the lamps controlled by S2-d.

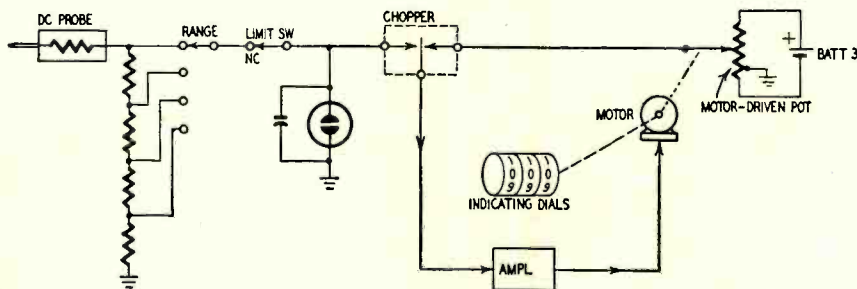

Fig. 2—Simplified dc input circuit.

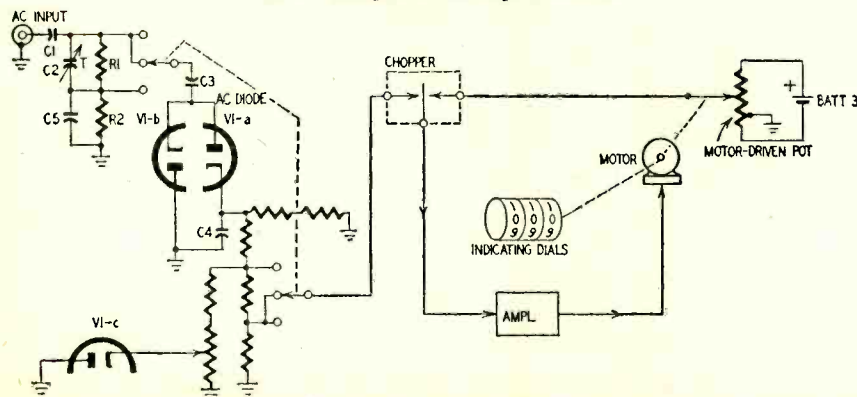

Fig. 3—Basic circuit for ac voltages.

Measuring ac voltage

The function selector S1 is thrown to AC. S1-a and S1-b shunt a 6X4 diode rectifier across the input circuit to convert the incoming ac to dc for application to the bridge. Diode contact potential is bucked out by a dc voltage tapped off the AC BALANCE control and applied to the diode through four 22- and one 10-megohm resistor connected in series.

The dc output of the rectifier is applied to the input of the metering circuit through the arm of S1-b and the instrument then operates in the same manner as when dc is applied to the input terminals.

A set of two test probes, one black and the other red with a black band at one end, are used for all voltage and resistance measurements. The black probe is the common or ground and the red connects to the hot side of the circuit being metered. The red probe has a removable tip that can be plugged into either end.

When measuring dc voltages and ac above 500 volts, the tip is plugged into the black end. This automatically connects a 6-megohm resistance in series with the input circuit to minimize circuit loading and detuning. This series resistance is removed from the circuit by plugging the tip into the red end when measuring resistance and voltages below 500.

Measuring resistance

When S1 is thrown to OHMS, S1-g

grounds the black or common input connector and S1-a and S1-e connect the red or high input terminal to the grid circuit of V1-b. A 3-volt battery and a suitable multiplier resistance (selected by S2-a) are connected in series across the test probes and the input to V1-b.

S1-f inserts the OHMS SET control in series with the meter so it deflects less for the same voltage that would be applied to the grids of V2 during voltage checks. This is done because resistances are read down from the top range and the stepping relay normally rests with S2 set for the highest resistance range.

When the test probes are connected across a resistance, the meter drops toward zero to indicate the correct value. If the resistance is sufficiently low, V2 operates and selects a lower range. Center-scale values of 100, 1k, 10k, 100k, 1M and 10M are indicated by scale lamps selected by selector switch S2-d.

The protective circuit

If the dc voltage applied to the probes exceeds 1,500 or if the 6-megohm probe resistance is not in the circuit, the meter would read off-scale on the 1,500-volt range and some of the circuit components might be damaged. However, the spark gap prevents this by breaking down, blowing fuse F1 and disconnecting the common test lead from the input circuit.

If voltage is inadvertently applied to the test probes while measuring resist-

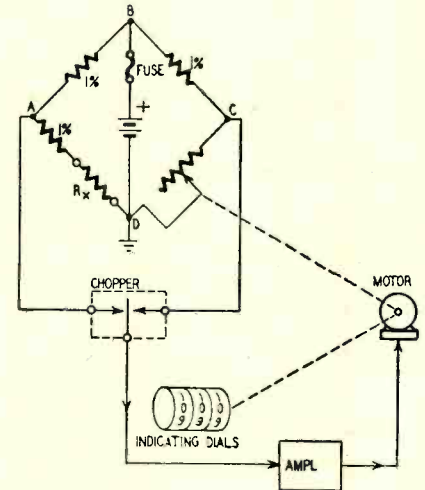

Fig. 4—The basic resistance circuit.

ance, F2 blows and prevents damage to the meter. Since F2 is in series with the battery and the resistance multipliers, the ohms range must be recalibrated whenever the fuse is replaced. After replacing F2, the red end of the red probe is touched to the TEST POINT and the fuse compensating potentiometer is adjusted so the meter reads exactly 100 ohms.

As indicated in the diagram, fuse F1 may be either 1/16 or 1/32 ampere; F2 is 1/32 ampere. END

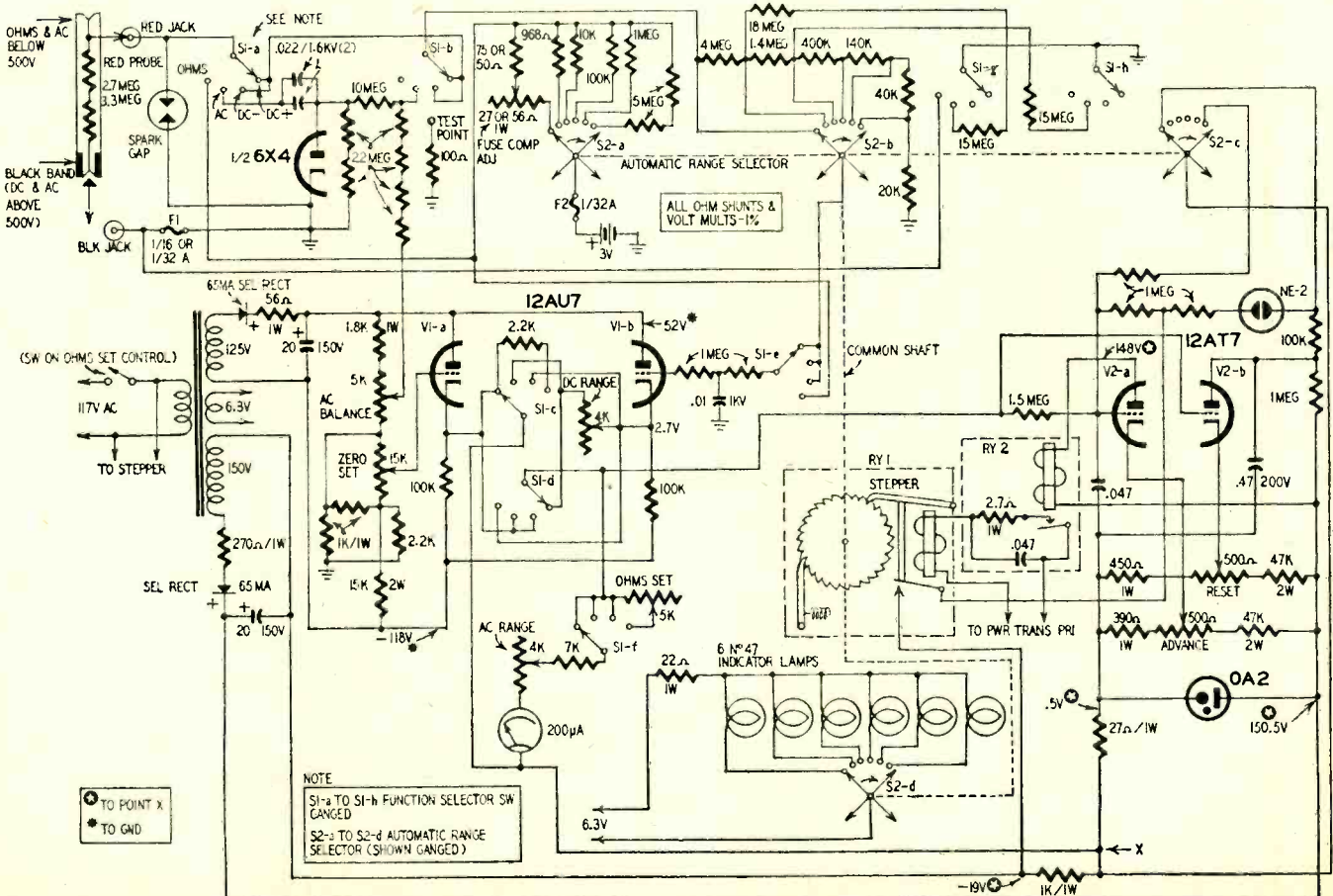

Fig. 5—Diagram of the Meter-Matic automatic vacuum-tube volt-ohmmeter. Unit features automatic range switching.

what's

new

?



WORLD'S SMALLEST

TV Camera is what the manufacturer calls the little unit above. Made by Grundig-Werke of Fuerth, Bavaria, it is a little less than 6 inches long and 2.5 inches in diameter. The Resistron picture tube is 3.5 inches long. The amplifier tubes in the camera are of the sub-miniature type.



AUTOMATION in tube testing has arrived with the instrument at left. Built with a roll chart, it is set up by simply turning the roll chart into position and plugging the tube into the indicated socket. The chart is made like a player-piano roll, with slots through which contacts are made to connect correct filament and other voltages, loads and other circuit connections for the tube being tested. Called model 400 by the American Scientific Development Co. of Fort Atkinson, Wis., manufacturers of self-service and other tube testers, it also tests for shorts and gas.



TINY TRIM made by Daystrom, is the world's smallest wirewound precision potentiometer. Measuring $\frac{1}{2} \times \frac{1}{2} \times \frac{3}{16}$ inch, the unit illustrated has a resistance of 5,000 ohms. An important use for the pot is as a trimming capacitor in computer and other systems where high accuracy must be maintained. The pot is adjusted with a small screwdriver control in the side.



"**HIGH-FI** Appreciation Meter" might well be the name of the instrument used by the young lady above. To check her hearing range she uses a variable-frequency signal, increasing the frequency until the note is audible and reading the frequency direct from the scale. For sensitivity at any frequency, the instrument is set and the attenuation control advanced until the note can no longer be heard. The instrument is provided as a customer self-service by Federated Purchaser's roadside store at Mountainside, N.J.

TRAFFIC TV is being tried experimentally by the city of Detroit in cooperation with the Michigan Bell Telephone Co. A number of TV cameras were posted on pedestrian bridges overlooking critical expressways and a monitoring center established. The photo at right shows engineers pretesting monitoring equipment. The large screen at right is a central station monitor; the smaller one at left is a type used in trucks at the transmitting points.

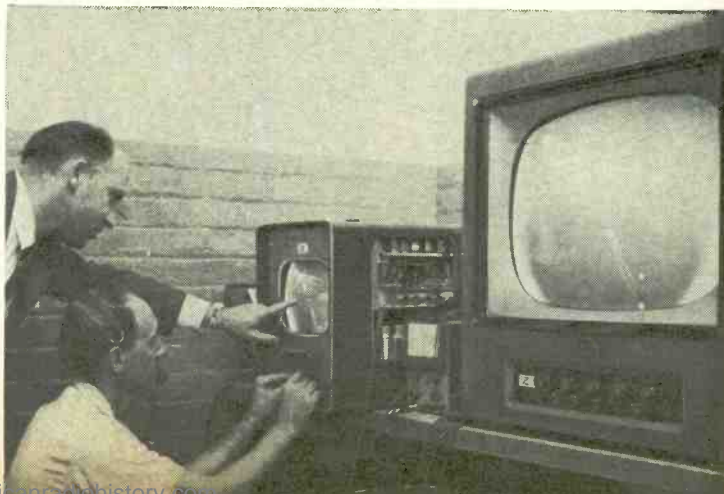

SUNSPOTS *and* COMMUNICATIONS

By E. P. TILTON

WE tend to think of sunspots as a phenomenon only recently discovered by modern science. Yet their existence has been known for thousands of years. They are described in Chinese writings before the Christian era as birds flying across the surface of the Sun. In medieval times they were regarded as harbingers of great events, including the death of Charlemagne. Something of their true nature was first discovered by the great astronomer Galileo, following his invention of the telescope. He published a scholarly paper on his sunspot observations in 1613!

The cyclic nature of the appearance of sunspots has also been long known to man and there is an accurate record of sunspot numbers and cycles dating back to 1750. In the more than 200 years since that time cycles of war and peace, dictatorship and democracy, feast and famine, boom and bust have all been ascribed to the effects of sunspots. And since the Sun is the ultimate source of all the Earth's energy, trying to find correlation between major economic and political cycles and the variations in the number of sunspots is certainly not unreasonable. At least one correlation has been well documented: the tie-in between sunspot cycles and radio propagation conditions.

Worldwide use of radio brought into sharp focus the need for some reliable means of anticipating these variations. This need became particularly acute in the early stages of World War II when long-range bombers began flying missions that took them hundreds and even thousands of miles from their home bases. Planning optimum frequency usage for such missions became one of the highest priority projects of the war period and out of this work came the Central Radio Propagation Laboratory of the National Bureau of Standards, whose predictions we now accept so casually.

That there was a marked rise and fall in the maximum frequency that could be used for long-distance communication and that this fluctuation was related to the sunspot cycle had been known since the late Twenties,

but accurate prediction for a given path at a given moment was unknown before the demands of war made it a vital matter.

Our physicists now know that there are many factors in the picture in addition to the number of sunspots. Observatories all over the world collect information on solar conditions. Magnetic observations are recorded in great detail. Automatic soundings of the ionosphere are made around the clock at scores of observation points scattered all over the Earth's surface. Data from these and other sources are gathered together and studied; from them, and with one eye on past experience, our scientists can make remarkably accurate predictions as to what frequencies will be usable for long-distance communication anywhere in the world, months in advance.

These predictions are published monthly and may be obtained at a cost of \$1.50 yearly by subscribing to *Basic Radio Propagation Predictions*, available from the Superintendent of Documents, Washington 25, D. C. The charts

shown herewith are reproduced from this publication.

What is a sunspot cycle?

There are several well-defined cycles of solar activity, of which sunspots are only one visible manifestation. Some solar phenomena that affect radio conditions are predictable only in a general way and even how a sunspot cycle will turn out is never completely known until it is over. We've all heard of "the 11-year cycle" but actually the cycles are by no means as regular as this popular term implies. They have been known to run as long as 15 years and as short as 7 and, though we have an accurate record of sunspot numbers for over 200 years, no two cycles have yet been quite alike.

It might be said that there are "cycles of cycles" too. The cycle we were just entering at the end of World War II turned out to be a humdinger, hitting a higher peak (in 1948) than any recorded in the past hundred years. The long record shows no cases of single exceptional cycles, but rather

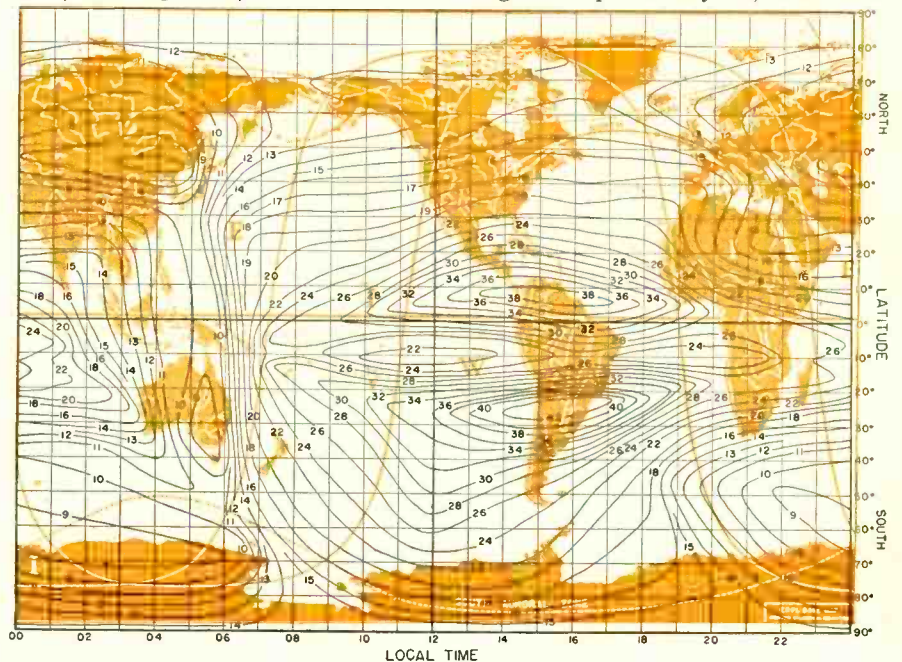

Fig. 1—Predicated propagation conditions for April, 1955. A projection of the world, with a signal path from Chicago to Rome, is placed behind the maximum usable frequencies chart.

TELEVISION

that strong cycles run in groups of about four. The cycle just concluded was the second in a series of hot ones, so it's a reasonable guess that the new cycle now getting under way will be a mighty interesting one to follow. We've been wallowing in the depths between them for the past couple of years but hams who like to work dx on 14, 21 and 28 mc don't need to be told that happy days are here again.

What will the new cycle hold for us? If we knew exactly, it would cut the fun in half. One thing is sure: the amateur observer who keeps his eyes and ears open will have good opportunities of making contributions to our knowledge of radio propagation in the coming two or three years. And this includes amateurs in the fields of astronomy, radio communication and television dx reception.

The curve of sunspot cycles does not follow a smooth sine-wave rise and fall. It is more of a variegated saw-tooth wave, with a steep-rising front, an indefinite crest of a year or so and then a slow decay as we drop back into the trough before the next wave comes along. How rapidly conditions are changing as we move up the slope of the new cycle can be seen from the prediction charts for the Western Hemisphere for April, 1955, and April, 1956, reproduced here.

These charts represent a flat projection of the Earth's surface. You spot your location by latitude on a similar projection of the world (which with a great-circle chart and a few others appears in the "Instructions for the Use of Radio Propagation Predictions" issued with each subscription to the *Predictions*). You also note the location of the point with which you wish to communicate. These are marked on a piece of tracing paper, on which the

equator line is also drawn. The paper is then transferred to the great-circle chart and a great circle laid out between the two points. This is the path the radio signal will (probably) travel. Now you transfer your tracing paper to the chart of maximum usable frequencies (keeping the equator line coinciding with that of the chart) and slide it along the chart till your location coincides with the hour you wish to communicate. You then check a point 1,200 miles out from your location along the great-circle path, and that point gives the figure for the maximum usable frequency (MUF) for communication via the ionospheric F2 layer at any given time. It will be seen that the shape and position of the curves on these two charts are very similar for the two years, but notice the marked rise in the figures representing the maximum usable frequency. That early-afternoon area just north of the equator, for example, showed 38 mc in April, 1955, but it rises to 50 mc one year later. In the Southern Hemisphere the maximum rose from 42 to 54 mc. Good news for hams in the Latin-American countries who watch for dx openings on the 50-mc band! Possibly, even, it may be a harbinger of international television interference on channel 2!

The high latitudes, both north and south of the equator, still do not show encouraging prospects for the higher frequencies. Routes that lie over the poles will still not be much good for the 10-meter band, or even for 15 meters, until perhaps next fall. Communication between this country and Europe, except in the lower latitudes, will not be possible too often on 28 mc until after the summer has passed. But this is only the beginning. The charts show more of interest than appeared

at this same point in the sunspot cycle some 10 years ago. The indications are that this is going to be a hot one.

Checking the MUF

The maximum usable frequency for long-distance communication can be checked readily by anyone who has a receiver that will tune the necessary frequency ranges, provided he has a little patience. There are radio stations everywhere and they transmit on just about every frequency. If you want to find the highest frequency open for long-distance work at any moment, merely tune your receiver slowly higher in frequency until you run out of signals. That's it.

During the last sunspot cycle, amateur observers found this system quite adequate for checking the possibility of trans-Atlantic dx on the 50-mc amateur band. Hams in this country and in Europe monitored the frequencies between 30 and 50 mc daily, beginning with the fall of 1946, comparing notes on reception by way of the 10-meter band. The BBC television station, then one of the few in the world, was checked on its sound (41.5 mc) and video (45 mc). Often the sound would be heard but not the video, showing that the MUF was above 41.5 but below 45 mc. By mid-October, the 45-mc video was being heard daily and various signals, many of them harmonics of European and African commercial stations between 45 and 49 mc, began to appear on the better days.

Checks for a few days running will show if the MUF is rising or falling. When an exceptionally high frequency is heard, make note of the date for it is likely that a repeat performance will be staged 27 to 29 days later, this being the period required for the Sun to turn on its axis. If you have the prediction charts on hand, you can tell what time of day to make your observations and in what directions—but don't take the charts too literally. They are based on reliable results for a whole month so the peaks may run considerably higher. The first 50-mc contact across the Atlantic was made in November, 1946, when the charts showed an MUF of only 44 mc.

The same technique may be used by TV dx enthusiasts, if they have communications receivers capable of tuning the frequencies just below the vhf television channels. It is unlikely that frequencies as high as channel 2 will be open across the Atlantic but the prediction for April, 1956, shown here offers at least a chance of channel-2 reception from South America in our more southerly states. By 1957-58 anything may happen! The spring and fall months are the periods to watch.

Effect on sporadic-E

The TV dx that most of us are familiar with is a summer phenomenon, the result of sporadic ionization of the E region of the ionosphere. There is considerable difference of opinion as

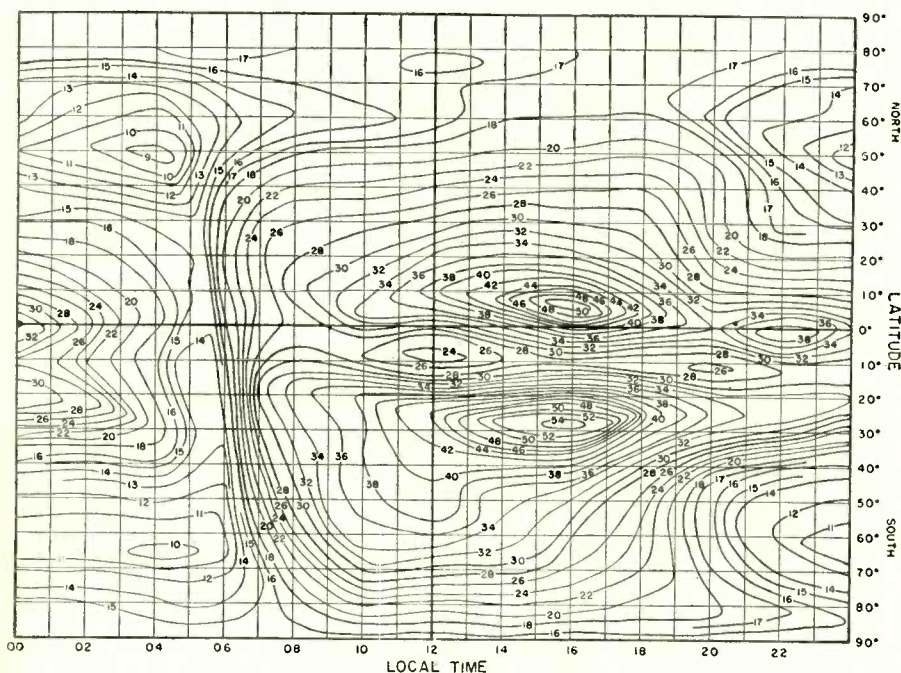

Fig. 2—Propagation predictions showing expected maximum usable frequencies for April, 1956.

to the effects of the solar cycle on sporadic-E, so TV dx enthusiasts and amateur users of the 50- and 144-mc bands have a fine opportunity to observe and report results during the coming cycle peak.

Aurora and ionospheric disturbances generally are sure to increase, both in intensity and frequency of occurrence. Here, again, will be more opportunities for the observant amateur.

TV dx chasing has become a major hobby for thousands—during a period when conditions were at their lowest ebb. A whole new generation of transmitting amateurs has come along since we went through the last solar peak. Both camps are in for some real surprises in the months to come.

What about lower frequencies?

Oddly enough, the best signals over long paths are received at close to the highest frequency that can be used. This is because the ionosphere comes closest to having a mirrorlike quality at that frequency. Higher frequencies go right on through the ionospheric layers and are lost in outer space. Lower frequencies than the optimum working frequency (OWF) are absorbed to a considerable degree, the absorption increasing as the frequency is lowered.

Thus it is that at the lowest spot in the cycle our 3.5-mc amateur band was good for transoceanic work. It will not be so much longer. When the 7-mc band is at its best, 3.5 mc is relatively poor for the same path. When the 14-mc band opens up, 7-mc signals over similar circuits weaken or disappear. When 28 mc is good, it is very, very good and 14-mc signals drop off. Probably not many hams realized it but, when the Europeans came through on 50 mc in 1947, they were stronger much of the time than the same stations would have been on 28 mc. We don't have everything at once; however, when the MUF for east-west paths begins to rise very high, the routes over the poles begin to open up for 14 or 28 mc better, so the peak years of the sunspot cycle tend to be better for dx-ers on any band.

Anyone who attempts to write of such a complex subject as this in the simplest terms inevitably lays himself open to the charge of oversimplification. The author pleads guilty and urges the interested reader to pursue the subject further. Good texts on technical subjects are not commonly very enjoyable reading but at least two books have appeared in recent years that treat this fascinating matter of sunspots in an entertaining as well as instructive manner. We heartily recommend *Sunspots in Action*, by Dr. Harlan T. Stetson (Ronald Press, 15 East 26 St., New York 10, N. Y.), and *Our Sun*, one of the Harvard University astronomy series by Dr. Donald H. Menzel (Blakiston Co., Philadelphia and Toronto).

END

INTERFERENCE VS SIGNAL STRENGTH

By HARDIN G. STRATMAN*

WHILE designing a new FM broadcast transmitter, the question came up as to just how far spurious emissions must be reduced to prevent interference on local TV sets tuned to stations many miles away. Since I had watched distant stations for several years and had been plagued by interference before local stations came on the air, I became curious. Consequently, I took a Jerrold model 704-A field-strength meter home and measured the intensity of signals from TV stations 110-210 miles away. The table reproduced here resulted.

The set used was an RCA model 7-T-103 which was 4 years old but in good condition. No booster was used. The diagram shows the hookup. A signal generator was used to inject artificial interference. The generator is capacitively coupled to the test setup by taping its 300-ohm output lead to a section of the antenna lead-in. The outside antenna was a two-bay conical with rotator.

To obtain the measurements given in the table S1 was closed and S2

thrown to Tv. The antenna was then rotated to receive the best picture on some particular channel, and picture quality was rated. S2 was then switched to METER and the signal strength of both the sound and picture parts of the channel were measured. S2 was then placed back in the TV position and the signal generator

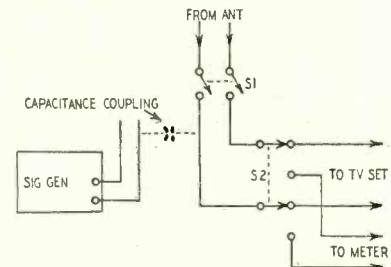

Test setup used in making the checks.

adjusted till it created just enough interference to ruin the picture. S1 was then opened and S2 placed in METER position and the field strength of the interference measured.

The amount of interference needed to ruin the picture was not entered on the chart for the simple reason that in all cases an interfering signal from one-fourth to one-third as strong as the desired signal became intolerable. For example, if the signal strength of the station was 200 μv , it took only 50 μv of interference to destroy the picture. The interference to the sound portion was not nearly so noticeable.

Audio field-strength and quality ratings were omitted from the chart because anything over 20 μv was limited in the sound if section and the sound was good. Also, in almost all cases the aural field strength was within 5 μv of the visual.

These measurements were made over a period of two weekends and strength of some stations varied as indicated. In determining picture quality, my wife's opinion was considered. There were some differences over what constituted a fair and a poor picture. I feel that this is because in this region, just a slight amount of interference can ruin the picture.

END

CARRIER STRENGTH vs. PICTURE QUALITY			
Chan- nel	Station	Video Carrier (μv)	Picture Rating
7	KHQa, local (Hannibal, Mo.)	180,000
10	WGEM-TV, local (Quincy, Ill.)	34,000
5	KSD-TV, St. Louis, Mo.	280; 160; 120*	excellent; excellent; good
3	WCIA, Champaign, Ill.	90; 70*	Fair; fair
4	KWK-TV, St. Louis, Mo.	220	Excellent
8	KRNT-TV, Des Moines, Iowa	8	Very poor
2	WMT-TV, Cedar Rapids, Iowa	220; 60; 35*	Excellent; fair; poor
3	KYTV, Springfield, Mo.	40	Fair
6	WOC, Davenport, Iowa	100; 28	Good; poor

*Different dates.
Ratings of Picture Quality:
Excellent: No noticeable snow. Would just as soon watch as a local station.
Good: Slight snow but not really objectionable.
Fair: Lots of snow, some fading. Would watch if favorite program.
Poor: Hardly worth watching. Hard on eyes because of snow.
Very poor: Barely holds sync. Pictures hardly visible at times.

TRAPS in

COLOR TV Receivers

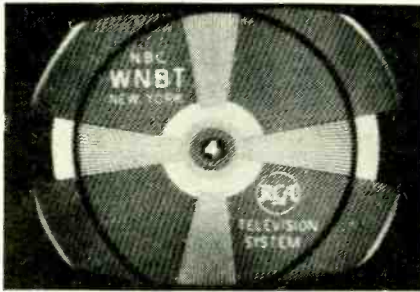

Fig. 1—Adjacent-channel interference.

Color TV expands use of traps reduced to a minimum in black-and-white sets

By MATTHEW MANDL
TELEVISION CONSULTANT

FOR a long time the number of interference traps in the if systems of black-and-white receivers has been at a minimum. Early receivers such as the Admiral 30A1 and the RCA 630 (which is still holding on) had a full complement of adjacent-channel traps as well as traps for their own sound. When properly aligned these sets came close to the ideal 4-mc if bandpass and the traps were required to minimize adjacent-channel interference.

During the past few years the if bandpass for most receivers has been falling somewhere between 3 and 3.5 mc. The narrow if response makes the system less subject to adjacent-channel interference and relatively few recent receivers use more than an occasional sound or 4.5-mc intercarrier trap.

In color receivers it is necessary to have an if bandpass of approximately 4.2 mc for proper color rendition. Such a wide bandpass means that color receivers must use the various traps found in the early black-and-white receivers. The traps consist of: own sound if; lower adjacent channel; upper adjacent channel; 4.5 mc. Occasionally other traps are required to minimize interference during both black-and-white and color reception.

Trap frequencies

Each trap in a receiver has a fixed frequency related to the if. For a system using 45.75 mc for the picture and 41.25 for the sound (currently used in color receivers), the upper adjacent-channel trap frequency would be 39.75 mc.

Assume the receiver is tuned to channel 3 and the local oscillator is operating at 107 mc. The upper adjacent-channel picture frequency mixes with the local oscillator signal as follows:

107.00 mc local oscillator
67.25 mc channel-4 video
—
39.75 mc resultant

The 39.75-mc signal is sufficiently close to the 41.25-mc channel-3 sound to cause interference, usually taking the form of thin diagonal lines (Fig. 1). If upper adjacent-channel interference is particularly strong, the blanking and even some of the picture information may be visible. Since the interfering station will not be locked in, it will shift back and forth while superimposed on the desired station. The shifting horizontal blanking bars produce a condition sometimes referred to as "windshield wiper" effect.

For any receiver using the if mentioned above, the upper adjacent-channel trap would be 39.75 mc, regardless of the station tuned in since the local oscillator frequency changes with each channel and the difference frequency of

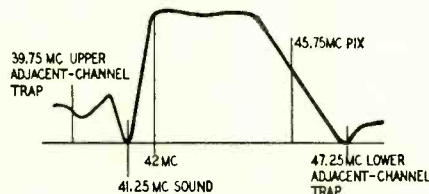

Fig. 2—A color if response curve.

39.75 mc is maintained. For instance, if the receiver is tuned to channel 8, the local oscillator would be generating a frequency of 227 mc. When this mixes with the channel-8 picture carrier, the desired 45.75-mc if is produced. The channel-9 picture carrier can also mix, as shown below, again producing the same 39.75 mc which must be trapped out to minimize interference.

227.00 mc local oscillator
187.25 mc channel-9 video
—
39.75 mc resultant

A lower adjacent-channel trap is used to minimize the interference which would result from the heterodyning of the lower adjacent-channel sound carrier with the local-oscillator frequency. Again, assume the receiver is tuned to

channel 3 and the local oscillator is operating at 107 mc. The lower adjacent-channel sound carrier mixes with the local oscillator signal as follows:

107.00 mc local oscillator
59.75 mc channel-2 audio
—
47.25 mc resultant

This 47.25 mc is close enough to the 45.75-mc video if to cause interference. The heterodyne interference again takes the form of a changing diagonal-line pattern.

The sound if must be attenuated to prevent sound-bar interference on the screen and to provide proper proportions of sound and picture if signals for mixing at the second detector to produce the final 4.5-mc sound if.

In color television receivers, however, the 41.25-mc signal must be attenuated an additional amount to minimize cross-modulation between the sound carrier and the color picture subcarrier information. Two 41.25-mc traps are usually employed—one in the early stages of the if system, the other following the sound take-off point. Thus there is a much sharper dip in the sound frequency on the response curve for a color re-

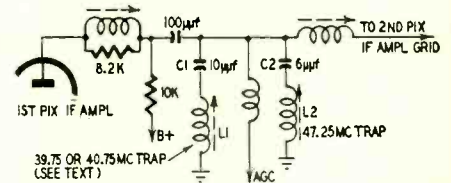

Fig. 3—Diagram shows traps used following first video if amplifier.

ceiver (Fig. 2). Just as the picture if is higher in frequency than the sound if (because of the mixing process), so the lower adjacent-channel trap is higher in frequency than the upper adjacent-channel trap.

Color television receivers also use an adjustable 4.5-mc trap preceding the bandpass amplifier to avoid the *tweet*

line interference which this frequency would cause in the picture.

Typical circuits

The adjacent-channel trapping for both the RCA model 21CT55 color television receiver and the CBS-Columbia model 205 is done after the first and the fifth picture if amplifiers. The traps after the first picture if amplifier are shown in Fig. 3. Each trap consists of a shunt series-resonant circuit tuned to the *undesired* frequency. Because a series-resonant circuit has a low impedance for the frequency to which it is tuned, it will attenuate such a signal by shunting it.

In the CBS model 205 color receiver the first trap (C1 and L1) is tuned to the upper adjacent-channel interfering frequency of 39.75 mc. The second trap (C2 and L2) is tuned for the lower adjacent-channel interfering frequency of 47.25 mc.

In the RCA receiver the first trap is tuned to 40.7 mc instead of the upper

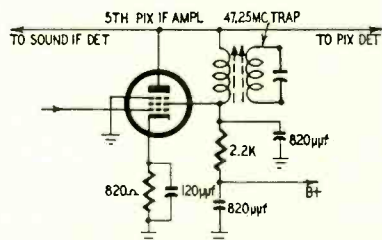

Fig. 4—Absorption trap is used in plate circuit of fifth if amplifier.

adjacent-channel frequency. This trap minimizes interference resulting from the color subband signal. The 40.7 megacycles are produced (again using channel 3 as a reference):

- 61.25 mc channel-3 video
- 3.58 mc color subcarrier from black-and-white carrier

64.83 mc color subcarrier

When this frequency combines with the local-oscillator signal, the resultant is:

- 107.00 mc local oscillator
- 64.83 mc color carrier

42.17 mc color if subcarrier

Subtracting from this frequency the 1.5-mc color sideband, produces the following trap frequency:

- 42.17 mc color if subcarrier
- 1.50 mc color sideband

40.67 mc trap frequency (40.7 mc)

In addition to the 47.25-mc trap in the output of the first video if amplifier, both the CBS and RCA receivers employ an additional 47.25-mc trap after the fifth picture if amplifier (Fig. 4). This is an absorption trap of the type frequently used in older black-and-white receivers. Because of the sharp attenuation of the sound if signals, the video detector is not used to get the 4.5-mc sound if. Instead, the signal is

taken off after the fifth picture if stage and applied to a separate crystal detector, a 1N60, to produce the 4.5-mc inter-carrier if signal.

Fig. 5 illustrates a filter employed in the grid circuit of the first picture if amplifier for trapping the 41.25-mc signal. The degree of attenuation is controlled by resistor R1, the *sound-level* control. An additional 41.25-mc filter trap follows the sound take-off and another variable resistor is used to regulate the amount of sound-signal attenuation. The second potentiometer is usually referred to as the *sound reject* control.

The 4.5-mc trap used in both these color receivers is in the cathode circuit of the first video amplifier (Fig. 6). Inductor L1 and capacitor C1 form a parallel-resonant circuit which offers a high impedance to the signal to which it is tuned, trapping the 4.5-mc frequency from the bandpass amplifier. Resistor R1 completes the cathode return circuit and resistor R2 is the color or *chroma* control in the RCA receiver; R2 is the contrast control in the CBS receiver, followed by the chroma control before the I and Q demodulator tubes.

Trap alignment

As with if alignment, proper trap adjustment requires an accurate marker generator. In contrast to the if stages where the transformers are tuned for maximum response, the traps must be tuned for minimum output.

A fixed bias should be applied to the age line, as is done in if alignment, to prevent age changes from affecting stage gain. A minus potential of 3 volts is usually sufficient. A vtvm is placed

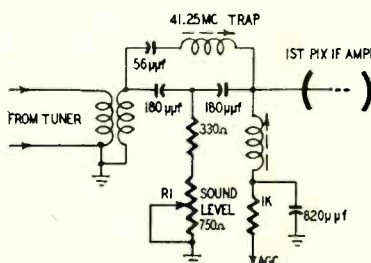

Fig. 5—Filter for the 41.25-mc signal

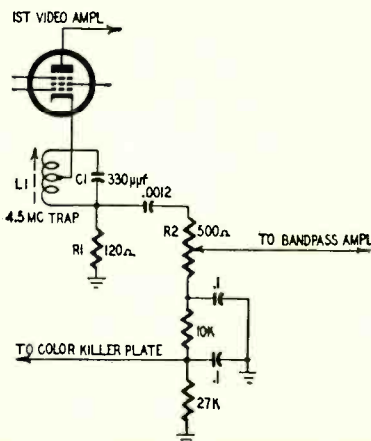

Fig. 6—Video amplifier cathode trap.

across the output of the video detector, preferably across the video-detector load resistor which is usually between 2,000 and 4,000 ohms.

The marker generator can be placed at the input of the mixer stage or at the grid of the stage preceding the trap to be adjusted. The frequency for a particular trap is injected and the trap adjusted for minimum output as indicated on the vtvm. With two identical-frequency traps such as the 41.25-mc sound traps, it is advisable to detune the second trap before adjusting the first. The marker generator can then be placed beyond the first trap for adjustment of the second one. If this isn't done, there will be too small a reading during first-trap adjustment because the second trap will cut down the signal before it reaches the vtvm.

Where threaded cores permit the cores to run through the entire trap, two dips will be obtained on the vtvm. Best results are obtained with the cores away from the chassis ends of the coils.

Proper trap adjustments are essential even though no adjacent channels can be received. Improper trap adjustments may result in the trapping out of a portion of the if response, with consequent color loss or degradation of picture quality.

For maximum rejection of adjacent-channel interference, trap adjustments are rather critical. After adjusting the various traps receiver performance should be checked.

The overall response curve (Fig. 2) should be viewed on a scope, using a sweep generator and marker to check the 4.2-mc flat response. If these are satisfactory, no more need be done if it is known the sweep generator has a flat output and the marker signal is accurate.

In an area where there is adjacent-channel interference, performance should be checked for each station since even accurate alignment sometimes needs slight retouching to reduce interference lines to a minimum. If interference still persists, slight antenna orientation may help. Transmission-line stubs formed from sections of lead-in also help occasionally.

In some localities it is difficult to get distant stations clearly because of the overpowering interference from strong locals. Raising the antenna doesn't always help since an increase in height increases local- as well as distant-station signal strength. If you double the sensitivity of the antenna, for instance, you may raise the 1,000 µv from the local to 2,000 and the 200 µv from the distant station to 400. The voltage at the antenna is now doubled for both stations, but the local represents an increase of 1,000 while the distant only 200. Thus, adjacent-channel interference is aggravated rather than lessened.

Even though adjacent-channel interference can't be reduced in some localities, it is still important to adjust traps properly to avoid their removing sections of the edges of the response. END



HAVING satisfied himself the raspy noise emitted from the TV loudspeaker is buzz and not hum (see TV Clinic, March, 1956), the technician can save considerable troubleshooting time by determining whether the trouble is fixed or tunable buzz. Fixed buzz remains fairly constant when the fine tuning is varied and the set is switched to an inactive channel. Tunable buzz appears only when the set is tuned to a station. Its tone can be changed by varying the fine-tuning control. This type is generally much more difficult to service.

Any coupling between the vertical deflection circuits and the audio amplifier produces fixed or nontunable buzz. This type of trouble can be identified by varying the vertical hold control. This changes the vertical oscillator frequency slightly and varies the tone of the buzz. Another check consists of removing the vertical oscillator tube—this will remove nontunable buzz. (In series-string sets use a dummy tube having all but the heater pins clipped.) A final check consists of removing the last if amplifier tube. This eliminates the incoming video and audio signals (in intercarrier sets) and definitely establishes the buzz as being the result of coupling from the vertical sweep circuits.

Vertical pulses can find their way into the audio circuits in numerous

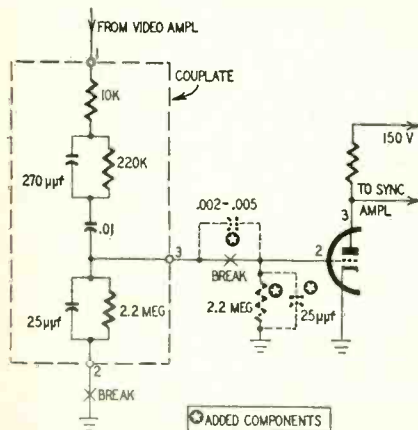

Fig. 1—Modifications to sync input circuit of Crosley 431-2 TV chassis.

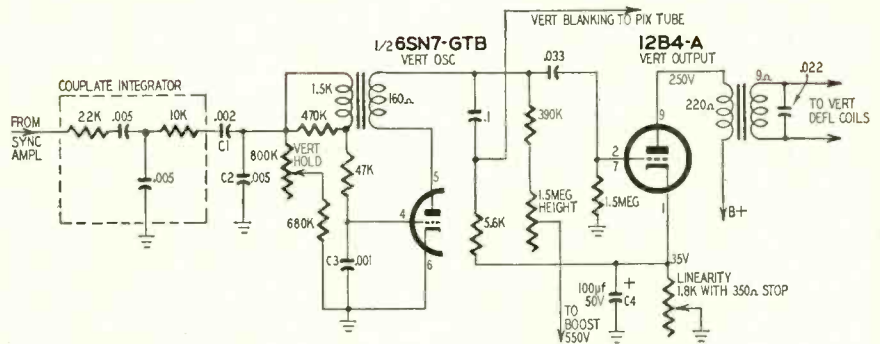

Fig. 2—The vertical sweep circuit in the Capehart series CX-43 chassis.

ways. A metal tube is often replaced with a glass one in the audio output stage of old sets. This removes the tube's shielding action and permits stray fields from the vertical sweep section to induce 60-cycle voltages in the tube elements. There is usually a pretty strong field around the vertical output transformer.

A frequent meeting place for vertical and audio signals is in defective bypass capacitors common to both circuits. Paper capacitors are generally not troublesome unless they open. However, electrolytics will often lose much of their capacitance. This greatly increases their capacitive reactance and provides an ideal coupling impedance. Be on the lookout for dual capacitors. Even under good conditions there may be some coupling between sections. If one of these units appears aged and below rated capacitance, replace it, using individual capacitors for each section.

Another major cause of this undesirable coupling is inadequate shielding. Concentrate on the arch-villain, the vertical output transformer—anything less than optimum shielding can cause trouble. Make sure the transformer frame (or shield can, if used) is properly grounded to the chassis. If the can was removed and replaced, see that any internal shields were put back in place. Also check the lead dress from this transformer, keeping it away—as much as possible—from audio leads. Make sure all shielded audio leads are properly grounded, paying particular attention to the lead from the volume control to the audio input stage.

If the vertical output transformer was removed and replaced with new holes drilled, check the orientation of the transformer for minimum buzz. In less common cases, wrapping the vertical leads to the yoke with tinfoil (grounded) will help. Inspect carefully all wiring dress in and around the sound detector and audio input circuits.

Tunable buzz

The 4.5-mc intercarrier sound signal is produced by beating the video and audio if signals in the video detector.

Thus the intercarrier signal will always be exactly the difference frequency, 4.5 mc, and the loss of either carrier will remove the audio signal. In some cases, while transmitting maximum white information, the amplitude of the video carrier may fall almost to zero. This produces excessive video amplitude modulation, with the vertical sync pulses rising to maximum amplitude at an audio rate and interrupting the heterodyning in the video detector. The video cuts off the intercarrier signal 60 times per second, producing the so-called intercarrier buzz. In recent years this has been minimized because broadcast stations keep the maximum white level at least 10% of the blanking level.

Even in a predominantly white picture where the video does not drop to zero, the amplitude difference between the white and blanking levels causes severe amplitude variations which are not fully removed by the ratio detector, and produce 60-cycle buzz. This can be eliminated or minimized by careful alignment of the ratio-detector transformer and intercarrier circuitry, keeping the amplitude of the sound if as low as 2%, if necessary, of the maximum amplitude of the video if.

Another buzz producer is the video amplifier in cases where the 4.5-mc takeoff occurs after the signal passes through this stage. In some circuits the negative sync pulses are great enough to cut off the video amplifier at the sync rate, interrupting the intercarrier signal and producing 60-cycle buzz.

When operating on the nonlinear portion of a tube's E_c-I_p curve, in a stage amplifying two rf or if signals, modulation of one signal may appear on another. This is cross-modulation and is often produced by signal overload, the result of a defective tube, insufficient age voltage or excessive signal strength. Check these conditions by replacing signal-carrying tubes, checking age voltage and placing an attenuator pad in the receiver input. Also check plate, screen and bias voltages against manufacturer's values.

In video amplifiers that pass the intercarrier signal, cross-modulation can take place. Video and sync peaks

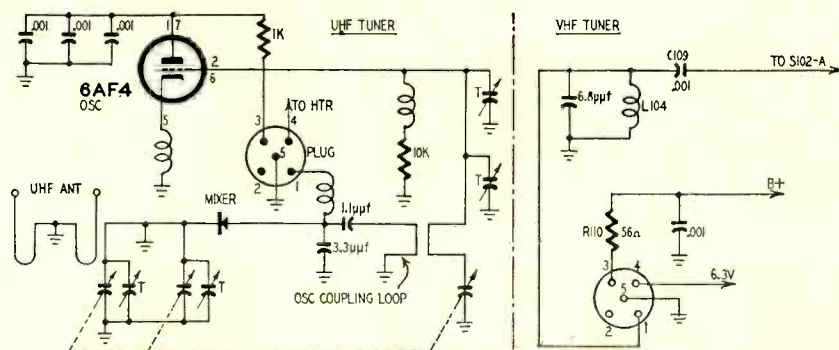

Fig. 3—Simplified uhf tuner circuit.

often modulate the intercarrier signal to such an extent that buzz is produced. This audio distortion varies with the picture content, showing that it is being caused by video in the sound. Vary the contrast control in the cathode circuit. If the buzz varies, the trouble is originating, not in the rf or if stages, but in the video amplifier. Check all voltages and components in this stage.

The poorly regulated high-voltage supply will usually vary in output with the vertical sync pulses. During pulse time the picture tube is cut off and the high voltage is at its maximum. Between pulses the high voltage will drop somewhat, depending upon the brightness of the picture. The high-voltage filter capacitor cannot remove this low-frequency ripple and any capacitive coupling between the high-voltage and audio circuits produces 60-cycle buzz. This can be checked by reducing the brightness, which should reduce the buzz. Turning the contrast down should also reduce buzz intensity. Another quick test is to remove the socket or the high-voltage connector from the picture tube—this will stop buzz caused by pulse modulation of the high-voltage supply.

Carefully dress all audio leads away from the high-voltage supply and the picture tube, especially from a metal one. Make sure tubes having an outer conductive coating are thoroughly grounded.

Rock and roll

A Crosley chassis 431-2 is in the shop with a complaint of intermittent bending at the top of the picture. This happens frequently and is sometimes accompanied by vertical roll. I have checked all tubes in the if, vertical and sync circuits against the manufacturer's schematic. Voltages given on the diagram check out almost perfectly and I have checked many components in these circuits that might affect the signal to cause the bending and vertical roll.

When the picture rolls, it does so slowly. When it stops, the vertical hold is locked very tightly. Switching channels will temporarily eliminate the

symptoms and on most stations they never occur. I have experimented with attenuating the signal but find that signal strength does not matter. The trouble occurs on some strong and weak stations and never shows up on others—strong or weak.

I have observed the signal with a scope but have not seen anything unusual. If you have any ideas on this I would appreciate your sending them along.—E. L., South Bend, Ind.

Significant is the fact that the bending and rolling occur on some strong and weak stations and never occur on others. Since signal strength is not involved, the receiver may not be entirely at fault. By this I mean that the receiver may not be responding properly to some stations having excessive modulation or hum content.

The symptoms you describe occurred often in the early days of television and were due to hum in the received signal. In most cases the trouble could be cured by speeding up the time constant in the sync clipper circuit, enabling the clipping action of the circuit to follow the signal variations better. Unfortunately the grid circuit of the 6AW8 is part of a couple and individual parts cannot be replaced. However, remove the ground connection of the printed-circuit R-C network (Fig. 1) and insert a capacitor of .002-.005 μ f in the sync clipper grid circuit. Then connect a 25- μ f capacitor and 2.2-megohm resistor in parallel, from grid to ground. The added parts are indicated by broken lines.

As an additional precaution, replace the 6AW8 with a 6BA8, a tube having a more remote cutoff and not as critical in signal variations.

Critical vertical hold

A Capehart CX-43 chassis came in with an extremely critical vertical hold. Once the vertical sync was stabilized, the picture would hold. But any change in station or even camera caused vertical roll. Most of my checking has consisted of replacing the vertical circuit tubes and looking for abnormal voltages.

Horizontal sync is perfect and the

picture is good in all other respects.—R. K., Green Bay, Wis.

The key to checking the trouble you describe is the signal at the grid of the vertical oscillator (Fig. 2). You should measure approximately -55 volts with a peak-to-peak signal of 330 volts. If the sync signal is normal replace C4, the vertical output cathode bypass capacitor—many of these have shorted. Try a new 12B4-A and carefully check the vertical output transformer. Another component often found defective is the 1,800-ohm linearity control.

If the sync signal at the grid of the vertical oscillator appears abnormal, carefully check the vertical oscillator blocking transformer and replace C3 and C2. Something to really be on the lookout for is a defective printed-circuit integrator network. This cannot be easily checked and should be replaced if all other checks fail. If you do not have a replacement part, build up an equivalent with individual components. Replace C1 and substitute a new 6SN7-GTB vertical oscillator tube.

The above is a listing of the most common faults in this relatively new chassis. If they do not remove the defect, make further checks in this circuit. However, much time can be saved if you first determine whether the trouble lies before or after the grid of the vertical oscillator.

No uhf operation

A Capehart CX-38 is on the bench with a defective tuner. The trouble is limited only to the uhf section with vhf operation excellent. I am not too keen on tearing into the uhf section and have tried to diagnose the trouble with voltage measurements. However, everything appears intermittent. B-plus voltages come and go and I have been unable to do any signal tracing in the uhf section. Before taking the "thing" apart I would appreciate any hints on what to check for.—R. T., Trenton, N. J.

You have stated very little of what you have checked so far. However, first clear up the B-plus problem. For a quick check, replace the 6AF4 oscillator before doing anything else. Check pins 1 and 7 of the 6AF4 (or 6T4) for B plus. If it is missing or intermittent, replace R110, a 56-ohm resistor (Fig. 3). Carefully check the contact at pin 3 on the interconnection plug.

If B plus is obtained and still no picture, replace C109, the 1,000- μ f coupling capacitor. This unit has a bad habit of opening. A companion culprit is coil L104, which also opens frequently. Make a thorough check of the interconnecting plug, especially pins 1 and 4. Another unit with a bad reputation is switch S102. Check all contacts on this unit.

Most of the remaining units in this uhf section are pretty reliable and should be looked into only after checking the above. When working on the tuner be particularly careful not to alter the position of any wires. END

DEALING WITH DO-IT-YOURSELF

By ART MARGOLIS

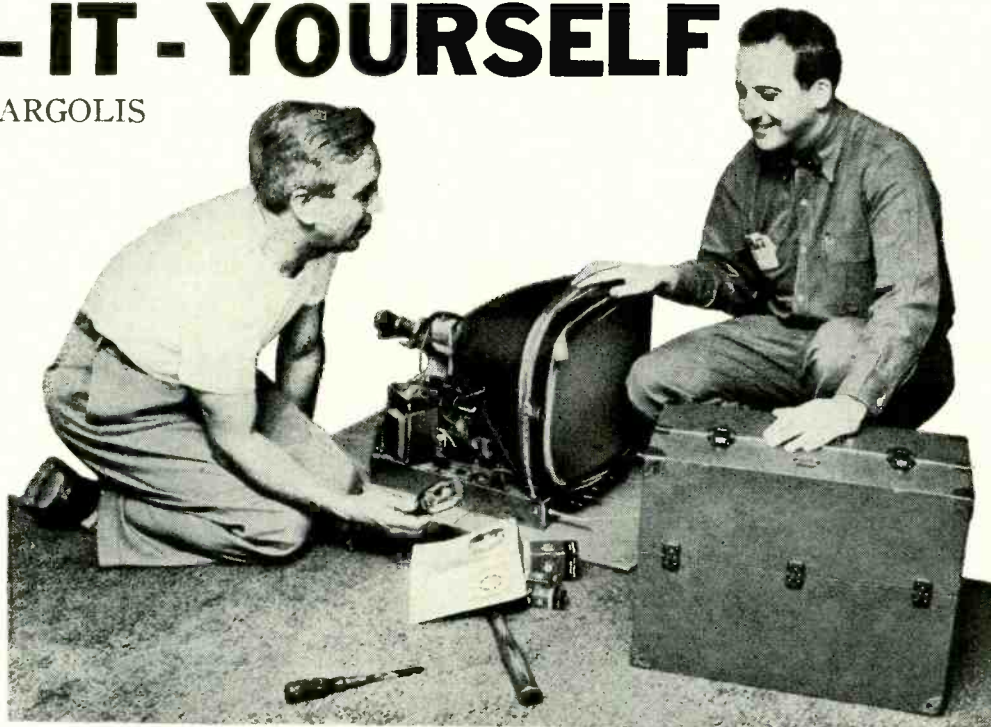

"They're all OK. I just had them checked!"

SENSED trouble as I eased my tube caddy onto the living room floor. A 6-month-old blond 21-inch Admiral with a doughnut chassis was sitting in the center of the room. Its perforated pressed-wood back was lying in a far corner. The customer, a young-looking typewriter mechanic, sat deadpan watching me. He had tried to fix it himself and failed.

After the usual banalities I plugged in my cheater cord. There was good sound but no brightness. The high-voltage lead spit sparks nicely onto the chassis and into the picture-tube well. All heaters were lit. I turned the brightness control on full and adjusted the ion trap but couldn't get a flicker on the screen.

I started pulling tubes. My host spoke up authoritatively, "I don't want you to check the tubes. They're all OK. I had them checked."

Not being permitted to start with tubes, I poked around but couldn't locate a thing. I informed him the chassis would be best repaired in the shop. He replied flatly, "No, fix it here!"

The only thing left to do was collect a service charge and leave the still-broken TV. I felt very annoyed and dissatisfied.

In your yesterday's batch of calls how many backs were off sets? How many interlock cords were already customer cheated? How many tubes were pointed out to you as already changed? How many of your clients had made some attempt to execute TV service do-it-yourself style?

I just checked through the house calls I made in the last 4 weeks. One of my customers is a sharp-eyed undertaker who has a 10-inch Motorola. I found his TV with these symptoms: When the receiver was turned on it performed perfectly but after about 5 minutes it developed a classic example of horizontal foldover, the kind where the horizontal sawtooth transforms itself to a sine wave.

First thing I changed was the 6W4 damper. I was in luck for that cleaned up the ailment. The expert embalmer told me firmly, "That can't be the trouble. I had that tube checked this morning at the drugstore!" I had to put the old tube back in and let the condition occur again to convince him.

Another customer who called me only as a last resort is a steel worker. He has a 12-inch G-E. I walked in and found the set showing a picture. The TV performers had flat heads and long legs. A black margin showed on both top and bottom. His opening words were, "It can't be a tube, I checked them all."

I changed the 12AU7 vertical oscillator and the vertical spread out all the way with room to spare. He still didn't believe it was a tube till I showed him how he had missed this one because it was hidden well out of sight in front of the high-voltage cage.

A 21-inch Stewart Warner owner had a condition of nothing—no sound, no pix, no visible heaters. I opened the high-voltage cage and checked the 5-amp fuse. It was good. Routinely I

asked the customer if anyone had been monkeying with the set. He swore sincerely not an amateur's hand had touched the receiver. At that moment I discovered the trouble; the 5-amp fuse was in the high-voltage 0.25-amp's clip and the 0.25-amp fuse was where the 5-amp unit should have been.

Another call was on an old 12-inch Admiral. The symptoms were screwy. When you turned on the set, brightness would grace the screen. Then, as the sound started, the high voltage whined to a stop. After a bit of snooping I changed the metal 6AC7 and the set began playing normally. The heater was open in the 6AC7 (Fig. 1). That meant no sync signal was fed to the sync separator, removing the bias on the sync inverter, changing the phasing of the horizontal sync discriminator, putting a positive bias on the horizontal oscillator sync input grid, killing the oscillator and thus the high voltage. Well, anyway the 6AC7 was bad. My customer confessed once the set was perking, "I checked all the tubes except that one. I didn't know that little black thing was a tube."

I figure that in 4 out of every 10 calls I run off, some effort by a do-it-yourself fan has been made. I guess we have to face it. This do-it-yourself craze is no fly-by-night headache for the TV repairman. Our company has decided to make some definite adjustments to handle the problem. We have set up some policies to turn the aggravation into money.

Before establishing policy we asked

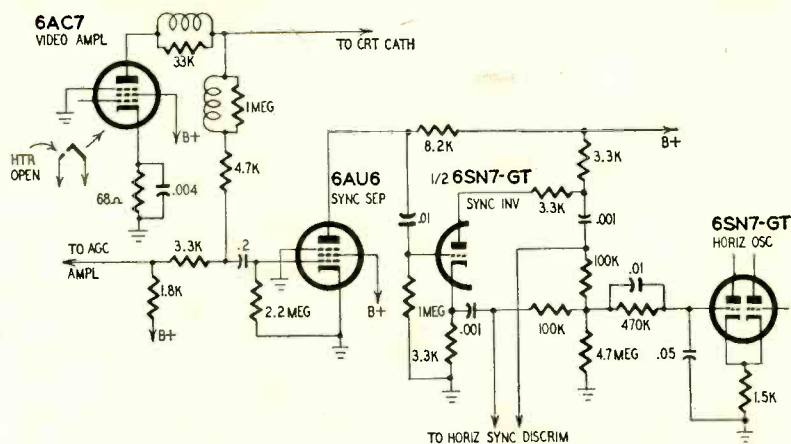

Fig. 1—Open heater in 6AC7 caused chain reaction, killing high voltage.

around to see how some of the other boys are handling it. I can't say that our firm agrees with all of them. One of the question targets was a husky, sandy-haired, good-looking boy. He growled, "All I hafta see is a chassis out of the cabinet." Then he went on with this case: He was called out to service a 17-inch Philco. The dual chassis was sitting outside of, but connected to, the picture tube mounted in the cabinet on the dining room table. After the set was turned on for a few minutes, the picture would get very contrasty and weave. This service technician was a decisive fellow. His policy was that if any do-it-yourself action had been made by the set owner, the set had to go to the shop. No ifs, ands or buts. When the customer told him, "It can't be a tube, I checked them all," he carted the chassis out of the house.

Once on the bench he easily located the trouble. The 6CB6 first if was oscillating parasitically. The extra added oscillation mounted itself piggy-back onto the carrier and ran rampant with the sensitive agc voltage. A new 6CB6 was all that was needed. Then he delivered the chassis with the usual shop charges.

I asked a tall, thin bespectacled service technician whom I knew from the old days what he did. His was an established radio and TV business dating back about 15 years. He always worked alone; wouldn't have anyone work for him as he felt no one could do the job he did. His answer was final, "If I find any of these do-it-yourself shenanigans in my customers I walk out. They either let me service their set completely or they can call someone else."

Those were a couple of reactions but the majority of the guys were not so violent. Rather than taking customer fix-it-himself as a personal affront, most of the technicians I asked are swallowing their pride and viewing the situation from an objective money-making point of view.

Put yourself in the poor frustrated set-owner's place. Here is his plight before you arrive. A TV owner's beloved set goes kaput. Inspired by the

national do-it-yourself movement and urged by the shortness of his bankroll, he decides he'll take a crack at the repair. He goes through much sweating and straining plus a pinched finger taking out the 1/4-inch hex back screws with pliers instead of Spintites. He then finds the set won't play without the back on. Finally, he works out the

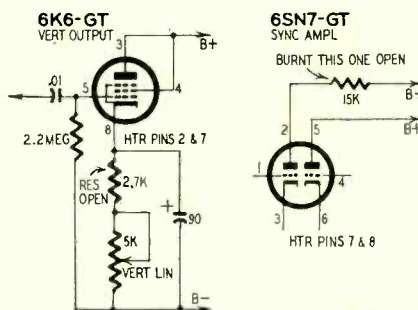

Fig. 2—Open cathode resistor in 6K6 caused original trouble. Swapping tubes burned out 6SN7 plate resistor.

method to cheat the safety interlock. Then he burns his finger on the 5U4, discharges the 12-kv high-voltage capacitor through himself and manages to fill a paper bag with tubes, breaking the pins off only two miniatures.

The local drugstore's faulty emission checker sells him four new tubes in addition to the ones he broke, none of which he actually needed. With great expenditure of time and cuss words he gets all the tubes back into the set. Then comes his reward. Black-and-white smoke pours from under the chassis.

That's when you get your service call. That's why he is sometimes glum on your appearance. Our firm has decided that giving him a "Ha! ha! Boy you're stupid!" at this moment can serve no useful purpose. I arrived at one home right after lunch to find a very sad, gray-haired gentleman sitting next to his 12-inch RCA. The picture tube showed no vertical sweep. Being of an inquisitive mind he had looked up in his TV fix-it book the measures recommended to restore his picture. The book told him to check the vertical output and oscillator tubes.

To be doubly sure he pulled the sync tubes too.

He had been waiting at our store door when it opened, clutching three 6SN7's and a 6K6. I checked the tubes on our transconductance checker. One side of one of the 6SN7's was a hairline weak. I sold him a new double triode. A half-hour later he called for service—his set was smoking. I brought the chassis into the shop.

He had taken the 6K6 vertical output tube and put it in the 6SN7 sync amplifier socket. The 6K6 heater is pins 2 and 7; on the 6SN7, pins 7 and 8. Pin 2 on the 6SN7 is a plate (Fig. 2). He had very neatly grounded B plus by the tube swap. The smelling and smoke was a 15,000-ohm plate resistor reacting strongly against the heavy current being pumped through it to ground. I replaced the resistor, swapped the tubes and was back to where he had started. The lack of vertical sweep turned out to be an open 2,700-ohm resistor in the cathode leg of the 6K6 vertical output stage.

My poor customer's efforts had almost doubled his bill. But, agonizingly, resisting temptation, I said, "Lucky for you there wasn't much extra damage." With his once-more-operating TV and the added thought there was fortunately little extra damage, we had a satisfied customer. Belittling him would have caused only business harm.

Sometimes if the extra costs are too high and too obvious we find it's best to just keep quiet. One of our set owners confidently swaggered into the store and ordered a 17BP4. He assured us since he was a shoe salesman he was perfectly capable of installing it himself. He was also absolutely certain his picture tube was dead. I sold him the tube. A few hours later he was back. He asked me if the dud was still worth money for he had cracked the neck. I assured him it didn't matter. Then he casually said, "I have the new picture tube installed but I don't think I have it adjusted right. Would you come over and adjust it?"

The set was a department-store mongrel with no name. The symptoms were confusing. The pix-tube heater was lit. There was plenty of high voltage getting into the well but there was no light on the screen although I adjusted the ion trap. Then I noticed the 5U4 running a little purplish. I told him that he had additional troubles besides the picture tube. I pulled the chassis into the shop.

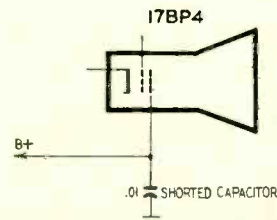

Fig. 3—Shorted .01- μ f bypass capacitor gave pseudo picture-tube symptoms.

On the bench I checked the picture-tube base voltages. There was no screen voltage at all. I located a .01- μ f capacitor measuring about 50 ohms from the screen grid to ground (Fig. 3). This B-plus short was why there was no brightness. It was also the reason for the 5U4 running too hot.

The new picture tube had been unnecessary. Now, on top of the tube tab he had to come up with some more dough for the shop job. He had even cracked his dud, eliminating any possibility of putting the original tube back. I could see actual anguish on his face. The only thing to say was nothing.

Other times it is wise to tell everything as completely and thoroughly as possible. A phonograph-record store-clerk customer of ours is a hi-fi enthusiast from a music-appreciation point of view. He has never had any electronic training. He burst into the shop and told me he was having trouble with his 20-inch Sylvania. As I reached for my tube caddy he said, "You don't have to bother, I know what's wrong." He described his condition. It sounded like the vertical sync was a bit unstable.

I tried tactfully to convince him that the trouble was most likely not the control but the more I talked the more insistent he became. So I looked up the pot's value and sold him one. The next morning he came lugging the chassis into the shop. Now it had no vertical sweep.

When I got on it later, the first thing I had to do was rewire his mistakes on the pot. Then I had to remove a short where he had inadvertently pressed a capacitor lead to ground. Then I was back to where we had started—the vertical and sync circuits. Not a flaw in the bunch. I put a scope on the vertical integrator input and output. They both matched the pictures on the schematic. Then I noticed it. A barely perceptible 120-cycle ripple creeping slowly through the finished vertical sync pulse. Checking back into the power supply I found the symptom's source—an 80- μ f filter capacitor (Fig. 4) was leaking to the tune of about 2 or 3 megohms.

I gave the platter purveyor a blow-by-blow report complete with a scope look. He felt better when he learned it was such a difficult complex repair.

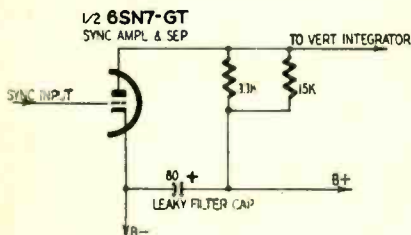

Fig. 4—Cause of vertical instability.

Uh-oh, my auto mechanic just pulled up outside. I tried to adjust the carburetor on the truck this morning. Now the motor won't start. I hope I didn't break anything. END

Improving Low-Priced TV Sets

MANY moderately priced TV sets perform poorly when receiving a weak signal, especially when a small amount of interference is present.

The circuit in Fig. 2 has been used on several makes including Sparton and Hallicrafters and is surprisingly effective. Although using only one tube and a germanium diode noise clipper, performance rivals that of many expensive sets. (Provided the set has sufficient gain to start with, which usually means a cascade tuner and at least three video i.f. stages.) The sound is clear and free from buzz and picture stability good even with the contrast backed off.

In the original circuit (Fig. 1) the 4.5-mc sound i.f. is taken from the plate circuit of the video amplifier, amplified by a single 6AU6 sound i.f. stage and transformer-coupled to the ratio detector. Sync pulses are also taken off here and fed to a 6SN7 sync separator. While some sync clipping takes place in the video amplifier at maximum contrast setting, there is little or none when contrast is reduced. Noise pulses fed to the horizontal phase detector and vertical integrator cause roll and tearing.

To improve sync a germanium diode clipper is added (Fig. 2) which effectively removes noise pulses exceeding the sync tip level. On ordinary impulse type interference this works much better than a vacuum-tube diode and approaches the efficiency of converter type tubes used as clippers.

A 6AU6 sound i.f. (Fig. 2) is added taking its signal directly from the video detector. L1 and L2 are small coils of the type used as 4.5-mc traps. With the added gain it is possible to reduce the screen voltage of the original sound i.f. to make it function effectively as a limiter.

Layout is not critical. Usually a spot can be found for the 6AU6 socket close to the video detector tube, between it and the original sound i.f. tube. Drill holes for mounting the coils on opposite sides of the socket and as close as possible. One precaution: keep these coils at least 2 inches away from the sound trap (4.5 mc) in the video amplifier plate circuit.

Alignment is easy: simply peak the slugs for maximum voltage across the ratio detector filter capacitor on a reasonably strong TV station signal. —H. Ray Lundy

END

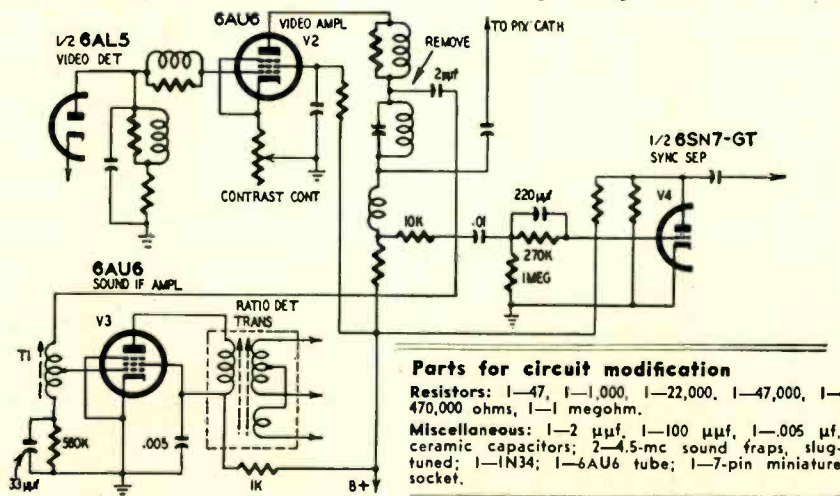

Fig. 1.—Diagram of typical sound i.f. and sync takeoff circuitry.

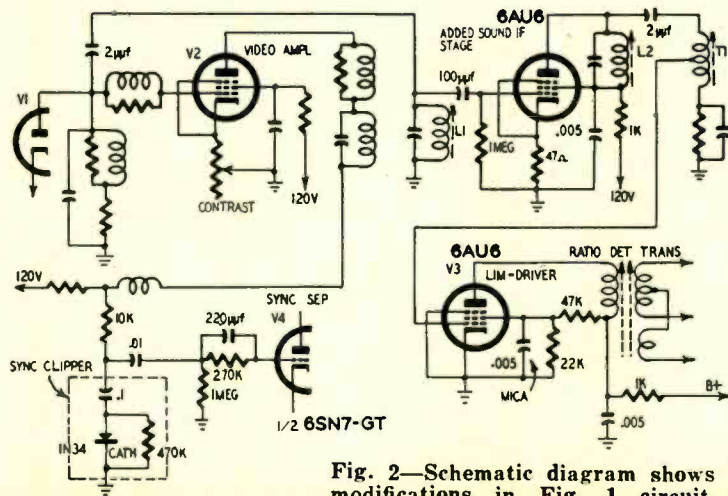
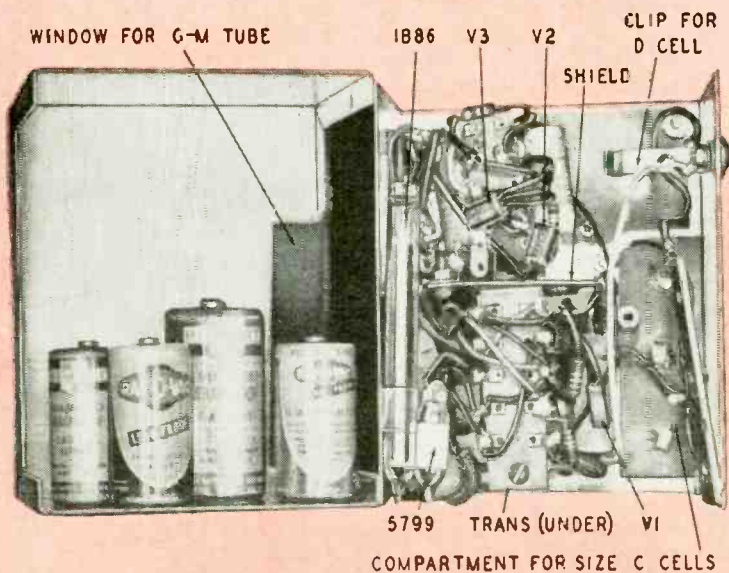
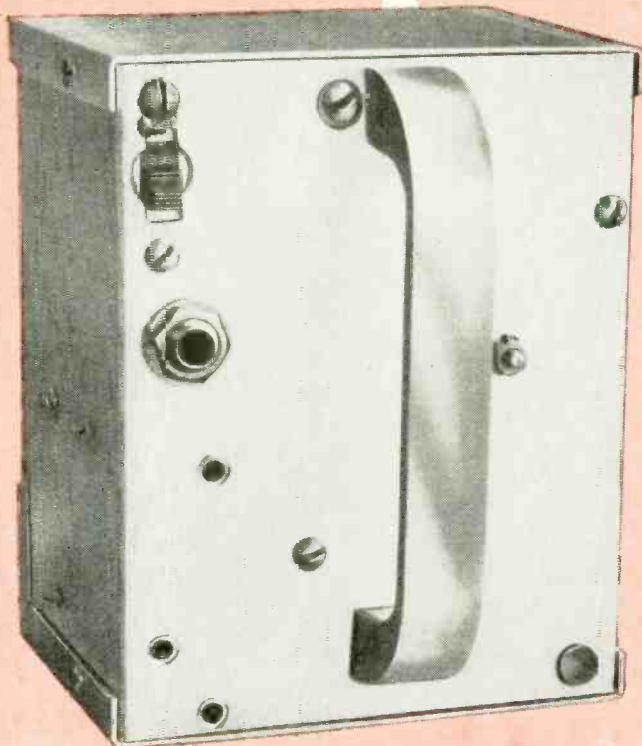

Fig. 2—Schematic diagram shows modifications in Fig. 1 circuit.

Transistors and four flashlight cells insure success and convenience of this G-M counter

TRANSISTOR-OPERATED GEIGER COUNTER



An underchassis view showing major parts. Slot in cases exposes G-M tube.

By THOMAS G. KNIGHT

ONE of the most unfortunate features of the usual portable Geiger counter is the short life of the expensive high-voltage batteries. These 300-volt units run down very quickly—especially in very hot or humid weather—whether used or not. Here is a portable Geiger counter that operates from only four flashlight cells. A transistor oscillator furnishes high voltage for the G-M tube while a two-stage transistor amplifier drives the headphones.

The unit is built into a standard 3 x 4 x 5-inch aluminum two-piece cabinet and weighs 2½ pounds with batteries installed (see photo). Battery life is well over 150 hours of continuous operation. Three standard low-cost junction transistors are used along with a 300-volt G-M tube and one low-drain filament type diode rectifier.

Circuit operation

Fig. 1 shows the circuit. Transistor V1 and the audio transformer comprise the 1,000-cycle blocking oscillator. An extra winding of 125 turns of fine wire is placed on the transformer for feedback in the oscillator circuit. The 0.25- μ f capacitor couples the feedback winding to the transistor base while an 18,000-ohm resistor provides correct bias. The secondary voltage of the transformer is rectified by the 5799 diode while a single .05- μ f 600-volt capacitor provides complete dc filtering. A voltage regulator consisting of one 4.7-megohm resistor and four NE-2 neon bulbs in series keeps the voltage output at approximately 300 to compensate for variations in battery input voltage.

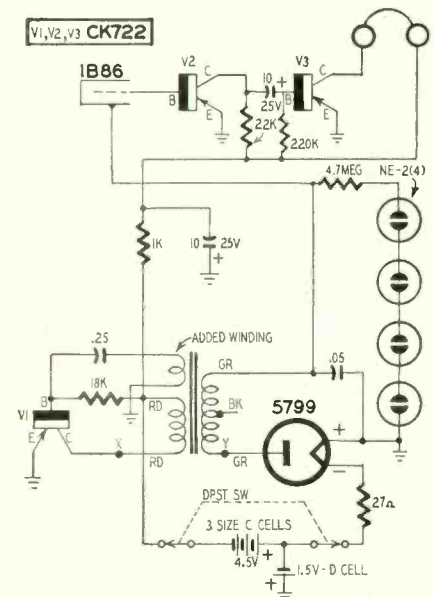

Fig. 1—Diagram of the G-M counter.

ELECTRONICS

This 300 volts dc is applied to the G-M tube and the base-emitter circuit of transistor V2 in series. Discharge impulses of the G-M tube are thus applied to the first transistor amplifier and in turn amplified again by transistor V3 which drives the headphones. A 1,000-ohm resistor and a 10- μ f capacitor in the amplifier battery lead act as an audio-frequency filter to decouple the oscillator from the audio amplifier.

Construction details

All parts are standard. The transformer, a Merit A-2918, is the only one requiring modification. It is a line-to-grid unit with a 100-ohm primary and 400,000-ohm secondary, with 125 turns of No. 36 (or smaller) enameled copper wire wound over the existing windings and leads. It may be necessary to remove a layer of the kraft paper covering the original windings to make room for the added winding. However, the old windings and their terminal leads need not be disturbed. Cover the added winding with Scotch tape before replacing the core. When wiring this transformer into the circuit, see Fig. 2 for correct phasing of the leads. This guarantees oscillation and provides peak voltage output from the secondary winding by using the higher side of the unsymmetrical output waveform.

All parts should be fastened securely, preferably with terminal strips. Placement is not critical, the only shielding necessary is a sheet of 1/16-inch aluminum sheet between the transformer and the first transistor amplifier, V2. This reduces electrostatic coupling to a minimum. The oscillator transformer radiates a rather strong magnetic field and if you use a transformer-coupled amplifier instead of the R-C type used here more shielding will be necessary. Be sure and cut a window in the cabinet for the G-M tube.

Other diode rectifiers may be used in the power supply but the Victoreen 5799 provides the lowest filament drain (8 to 10 ma). Successful rectification was obtained experimentally with a 1T4 connected as a diode and with only 28 ma of filament current. High-voltage selenium rectifiers are the ideal solution but none were available.

The voltage regulator is absolutely necessary and prevents too much voltage from "spilling" or continuously discharging—and damaging—the G-M tube.

Correct polarity on the G-M tube is of utmost importance. Reverse polarity will ruin the tube. Note that this par-

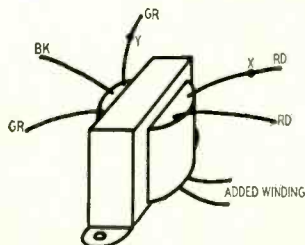

Fig. 2—Coded transformer terminals insure proper connection to the counter.

ticular high-voltage supply has the positive side grounded and the G-M tube must be connected as shown for proper operation. Note also the flashlight battery supply has the positive side grounded. Three size-C cells and one D cell are used in preference to four size-C cells to equalize service life as the lower or ground-end cell must supply filament current to the 5799 as well as transistor current. A battery box may be constructed for ease of battery replacement or the cells may be wired together permanently. A 7.5-volt battery (Eveready No. 773 or equivalent) may also be used but life will be reduced.

After all other wiring has been completed correct polarity for the added feedback winding must be determined. Incorrect polarity prevents oscillation and may send excessive collector current through V1. To check polarity insert the flashlight batteries and carefully turn on the power switch. If the neon voltage-regulator tubes do not light *immediately*, quickly turn off the switch and reverse the feedback winding leads. When the neon bulbs light, the power unit is functioning properly. To check the high-voltage dc output use a meter with 20,000-ohms-per-volt sensitivity, or better, set on the 1,000-volt scale. A reading of 300 to 320 volts is satisfactory. When the circuit is operating correctly, the following currents are typical: Blocking oscillator collector current 4 to 6 ma; 5799 filament current 8 to 10 ma; total amplifier current with earphones inserted 0.2 ma.

Operation is simple. Turn on the power and listen for the normal background counting rate (approximately 30 clicks per minute). The clicks should be clear and crisp while the only other

sound should be the normal background transistor noise (a soft hiss). The 1,000-cycle note of the blocking oscillator should be only barely audible in the output. A radioactive source, such as a luminous watch or clock face, brought near to the G-M tube will increase the counting rate appreciably.

Headphone impedance may be anything from 600 to 20,000 ohms; however, the higher impedances work best.

Parts for Geiger counter

Resistors: 1—27, 1—1,000, 1—18,000, 1—22,000, 1—220,000 ohms; 1—4.7 megohms, 1/3 watt.

Capacitors: 1—0.25 μ f, 200 volts; 1—.05 μ f, 600 volts, paper; 2—10 μ f, 25 volts, electrolytic.

Miscellaneous: 3—CK722 transistors; 1—5799 diode (Victoreen); 1—1B86 G-M tube (Victoreen); 1—af input transformer, primary 100 ohms, secondary 400,000 ohms ct (Merit A-2918 or equivalent); 4—NE-2 neon lamps; 1—3 x 4 x 5-inch aluminum chassis; 3—size-C, 1—size-D flashlight cells; phones, terminal strips, hookup wire, hardware.

The completed unit makes an ideal field Geiger counter. It is light, portable and is powered with easy-to-obtain flashlight batteries. The life of the transistors is estimated to be over 10,000 actual working hours. Battery life computed at 2 hours service per day, 7 days per week, will exceed 20 days of operation! END

References

Alan R. Pearlman, "Transistor Power Supply for Geiger Counters." *Electronics*, August, 1954; pp. 144-45.

R. W. Smyth and A. R. Pearlman, "Research Study Leading to Use of Transistor in Radiac Survey Meters." *Technical Operations Report No. TO1-53-11 to U. S. Army Signal Corps*.

Peter G. Sulzer, "Junction Transistor Circuit Applications." *Electronics*, August, 1953; pp. 170-73.

G. W. Bryan, Jr., "Application of Transistors to High-Voltage Low-Current Supplies." *Proceedings of the IRE*, November, 1952; pp. 1521-23.

Louis E. Garner, Jr., *Transistors and Their Applications*. Coyne Electrical School, Chicago, 1953.

BATTERY HOLDERS

When transistors were first put on the market, it seemed that the problem of a handy power supply had finally been solved. A battery is so small and costs so little that it made a perfect transistor supply. Only two problems remained: how to hold the cells singly or in groups and how to connect them to the transistor circuit.

For example, suppose a 4½- or 6-volt battery were needed. One "simple" method would be to bind penlight cells in series with a rubber band or masking tape, solder the terminals (positive of one cell to negative of the next), and make some sort of clamp to hold battery against the chassis or panel. More often than not, the heat of the iron would break off the top

brass contact or develop a leak in the zinc case.

Metal holders are now available for all penlight cell sizes, certain Mallory cells and the tiny U-size batteries. Multiple holders are available for from one to four cells in a group. Each cell has its own pair of solder lug terminals so they may be connected in series or parallel as desired.—IQ

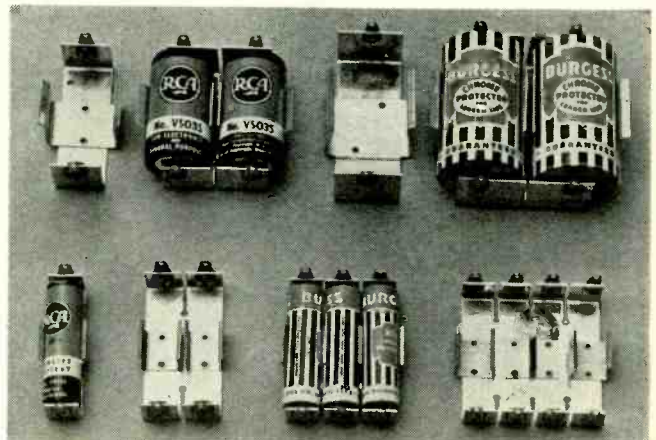

Courtesy Lafayette Radio

By MOHAMMED ULYSSES FIPS, IRE*

the CORDLESS RADIO IRON



The ideal iron—no dangling cords!

MY wife is a furious ironer, one of those females who wears out and neatly frazzles an ironing cord a week. This has been going on for years and has kept us poor. Last month, what with 10 children in the house and all the resulting wash, she wore out *two* cords in one week, so I said, "This must stop."

The electrical industry, notorious for its backwardness, having done nothing to improve old-fashioned irons, I decided to remedy the situation once and for all.

I immediately got busy with one of our old irons, which I took apart and started to rebuild after I had completed all the theoretical engineering on the job. Instead of putting the electric cord on the iron, I put it where it belongs, *on the ironing board*. This board can be built by anyone, as per photo given here. The board is made of Bakelite instead of wood. It is $\frac{3}{4}$ inch thick and has 65 $\frac{1}{2}$ -inch round depressions into which fit 65 copper energizing induction coils $\frac{1}{2}$ inch high. Flush with the top of the Bakelite, these coils heat the iron by induction. These coils are all connected in parallel through special circuitry and the connecting cord feeds 117-volt alternating current to them. The cord must be heavier than normal as it has to carry as much as 2,000 watts for short periods of time, as will be apparent further on.

The Bakelite board is later covered with a very thin sheet of asbestos on top of which goes the usual ironing cloth as commonly used.

It will be noted from the photos that underneath the ironing board there is a



box which contains the electronic equipment, as shown at left, above.

When the iron is passed over the board, it may cover two or three coils, rarely four. By means of an ingenious capacitance arrangement between the iron and the induction coils directly underneath, the electronic circuitry places two or three or perhaps four coils in the circuit. It is not possible to have *all* coils in the circuit simultaneously for the very simple reason that the current draw would have to be between *30 and 40 kilowatts*, sufficient to blow all the fuses in the neighborhood. For this reason, only three, or at the most four, coils are energized at any one time *and then only briefly* while the iron passes over them. Each of the 65 coils has a relay which does not function until the capacitance of the iron actuates it, placing the coils in the circuit. The instant the iron leaves any inductance coil, the circuit is broken and that coil is then disconnected. Hence, at the most, the load will never be more than 2,000 watts at

any time. Routinely it may not be more than between 1,000 to 1,100 watts.

The action of the iron is rather simple. In it are three series-connected 2-inch inductance coils of heavy Nichrome resistance ribbon, as will be seen in Fig. 1. They heat by induction, being energized by the ironing-board coils. The Nichrome coils in the iron have been engineered in such a manner that they are slightly overloaded and *therefore heat rapidly*. To obtain the best inductive efficiency, the bottom of the iron cannot be of magnetic material. I used a special aluminum-nickel-bronze, $\frac{1}{8}$ inch thick, so not too much energy is lost.

There is also a thermostat inside the iron which cuts off the current when the iron gets too hot, i.e., over 525°. When it cools, the Nichrome coils are cut into the circuit once more. The thermostat can be regulated by a small knob at the back of the iron. Thus the usual temperatures between 225° and 525° can easily be obtained by the user.

Triggering the inductance coils so that those under the iron would be in circuit, and all others inactive, was simple. I had thought first of using radar to indicate the position and distance of the iron but decided that at such a short distance it would be better to use a direction finder and fix the iron's position by triangulation. When I actually started to work on the problem, it was obvious that all such complication was necessary. Capacitance of iron and the board's coils gives sufficient, direct, simple interaction.

Here's how it works: The inductance coils have a magnetic core for better

* International Radio Enterprises

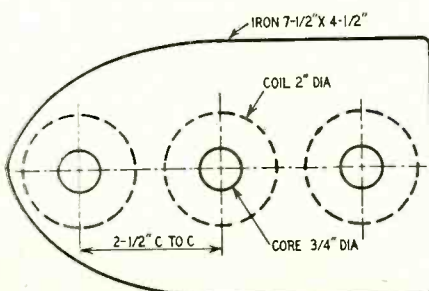

Fig. 1—How heater coils are placed.

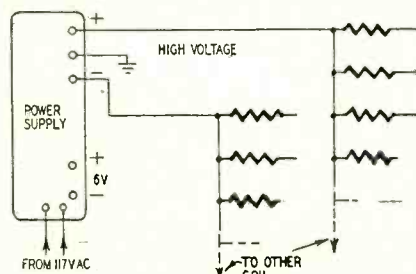

Fig. 2—Relay system power supply.

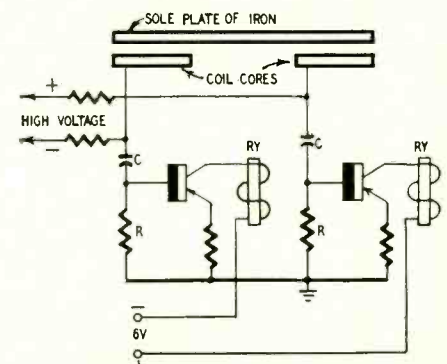
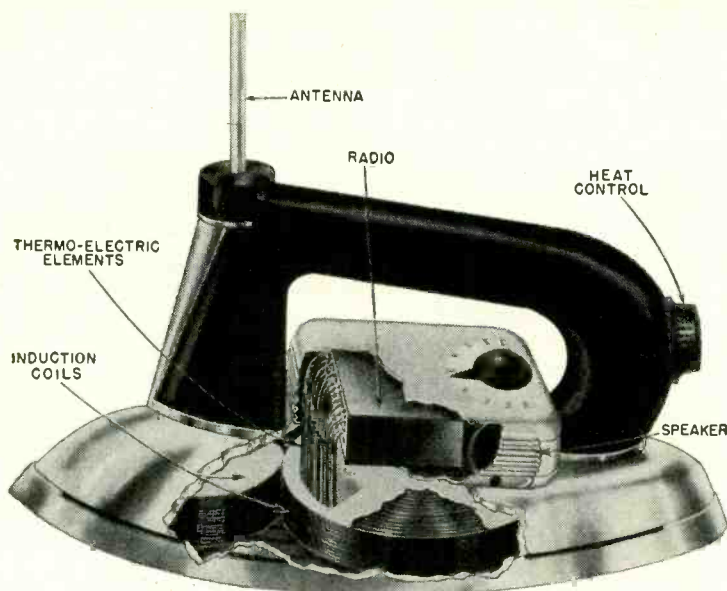

Fig. 3—How the relays operate.



Cutaway shows how thermocouples supply power to iron's radio.

concentration of the flux. A high static charge is given them from a high-voltage low-current power supply. Half of the coils have a high positive charge; the other half a high negative charge. Cores next to each other are opposite in sign. All the cores are supplied in parallel through resistors which isolate them from each other. The power supply is shown in Fig. 2.

To each of these cores is connected—through a large capacitor—the input of a transistor relay-triggering circuit. The schematic of a pair of these is shown in Fig. 3. Unfortunately, my patent attorney advises strongly against revealing transistor types or circuit constants (or even giving out as much information as I have done here). But I hope to be able to publish all that at an early date.

As you see in Fig. 3, the circuit is from the inductance coil cores (which are actually plates of a capacitor) through isolating capacitor C and through R to ground, with the transistor base connected to the junction of C and R. Resistors in the base and emitter circuits are so proportioned that a small current flows in the collector circuits at all times, but not enough to operate the relay. The negative core circuits use p-n-p transistors—those with a positive charge, n-p-n units.

When the iron passes over a pair of coils of opposite polarity, the capacitance between their cores is increased. That causes a small charging current to flow through the isolating resistors. This causes a voltage drop across them and it is passed through capacitors C to the transistor bases. Collector current increases and relays RY supplying current to the coils are actuated. I have not bothered to show the relay contacts for the 60-cycle current for the coils. They have only one feature worth mentioning—they are bridged with short pieces of resistance wire so that a small but not negligible amount

of current flows through the coils at all times. This was done simply to prevent sparking and thus avoid radio interference and pitting of the contacts.

The power supply shown in Fig. 2 is conventional and consists of a transistor-operated high-voltage supply and selenium rectifiers for the low voltage used by the transistors in the relay-triggering circuits.

I have found in practice that this wireless iron works very well. It is easy to handle without the cord nuisance and doesn't cost any more to operate than other irons.

While I was building this revolutionary iron, it occurred to me that the electric iron industry was not very up to date so I set about giving the housewife something in addition that will gladden her heart and make her work more pleasant. It is a *combination electric iron and radio*. The housewife, thanks to this improvement, can now have, not only hot jazz, but every kind of music, *hot music*, that is. It did not take me long to engineer this unusual combination. To be sure in an electric iron, which gets pretty hot, 525° F, you cannot use batteries, but why use batteries *when you have an abundance of heat?*

Thermoelectricity was the answer. Every schoolboy knows that you can make a thermocouple by twisting two wires, one, let us say, nickel and the other iron. By heating the end where the two wires contact, while the other is open, with a match or another heat source you have a thermocouple. The old classic experimenters of course used antimony and bismuth, which worked satisfactorily, but I wanted something much better. Accordingly, I did some research and found to my surprise that germanium and silicon are far and away the most efficient thermoelectric couples in existence.

If you will consult any standard electric or physics handbook, you will find that the thermoelectric power of anti-

mony equals +35 and of bismuth -74. On the other hand, germanium gives us +302 and silicon -408, a tremendous difference.

I next constructed a small super-heterodyne radio set made with five transistors. The electric current to energize the receiver is obtained from a series of thin 2-inch germanium and silicon rods welded together alternately. The welded ends pass through the top of the iron and come within 1/64 inch of the Nichrome coils in the iron. The thermocouples are insulated by a thin piece of asbestos 1/64 inch thick, so that a maximum amount of heat passes through the asbestos, energizing the germanium-silicon thermoelements. The cool end of the germanium-silicon rods project directly into the radio housing where they are sufficiently cooled to give an adequate thermoelectric current.

The curious part of this radio is, of course, *that it requires no on or off switch.* The radio is "off" when the iron is not being used and it is "on" only when in use. A switch is superfluous. Otherwise the radio has no new features. It has the usual station selector to bring in the various stations.

In front of the iron you will note the standard tubular antenna which can be extended to about 18 inches if necessary. Normally, at least in my home, it was found that only 6 inches of antenna were needed to bring in all the locals with good volume.

It might be thought that the constant heating and cutting out of the coils in the ironing board would make a terrific racket in the radio. Surprisingly enough, this does not happen. There is, of course, a certain degree of noise, but this has been eliminated by a special high-capacitance filter which tends to absorb nearly all relay contact noise.

Inasmuch as no part of the radio is in physical (electrical) contact with the iron or with the ironing board, the filtering is much simpler. For this reason, I did not use the current from the Nichrome coils to operate the receiver because this would have made the set far too noisy.

So far I have built only two models, but I have not been able to interest any of the electric-iron people in building them commercially. The first thing they usually ask me is the cost of building the ironing board with the heavy, expensive Bakelite sheet and all those 65 induction coils. I always must admit that it cost me over \$250. After a bit of figuring the manufacturers do not think that such an ironing board with all the coils and relays, plus the iron and radio combination could possibly be sold for less than \$200—an impossible price for the average household.

The last attempt I made was with one of the big firms, the Jiffy Flat-Iron Corp. After he had done his figuring, the manager gave me a long queer look, glanced at the calendar, shook his head sadly and said:

APRIL FOOL

Heathkits

FOR THE ENTIRE ELECTRONICS INDUSTRY

more than 65 top-quality models to choose from, including such outstanding kit designs as

V-7A VACUUM TUBE VOLTMETER: Easily the world's largest selling VTVM. Features peak-to-peak scales—etched metal circuit board—1% precision resistors—full wave rectifier and AC input circuit—reads rms and peak-to-peak AC, DC, and ohms.

O-10 LABORATORY TYPE OSCILLOSCOPE: The world's largest selling oscilloscope kit, and the most successful oscilloscope in history. Designed especially for color and black-and-white TV service work. Its 5 megacycle bandwidth and new 500 Kc sweep generator readily qualify it for laboratory applications. Features easy-to-assemble etched metal circuit board construction.

WA-P2 HIGH FIDELITY PREAMPLIFIER: This is the world's largest selling hi fi preamplifier kit. Features complete equalization, 5 separate switch-selected inputs with individual pre-set level controls, beautiful modern appearance, high-quality components.

HIGH FIDELITY AMPLIFIERS: Five Heathkit Models to choose from at prices ranging from \$16.95 to \$59.75. Power output range from 7 to 25 watts.

DX-100 TRANSMITTER: A 100 watt phone and CW ham transmitter, offering the greatest dollar value available in the ham radio field today.

THE
WORLD'S LEADING
MANUFACTURER
OF ELECTRONIC
KITS . . .

AMATEUR
RADIO



RADIO & TV
SERVICEMEN



INDUSTRIAL
LABORATORIES

TRAINING
SCHOOLS



HI-FI
ENTHUSIASTS



Greatest Dollar Value Through Factory-To-You Selling!

ONLY Heathkits CAN GIVE YOU ALL OF THESE DISTINCTIVE ADVANTAGES!

- *The Most Complete Construction Manuals for Easy Assembly.*
- *Originality of Design—Developed Through Pioneering in the Kit Instrument Field.*
- *Greatest Dollar Value—Finest Quality with Real Economy.*
- *Direct Contact with Manufacturer—Lower Price, Guaranteed Performance.*
- *Etched Metal, Prewired Circuit Boards—Save Construction Time, Improve Performance.*
- *High Quality Standard Components for Long-Life Service.*

HEATH COMPANY

A Subsidiary
of Daystrom, Inc.

BENTON HARBOR 20, MICHIGAN

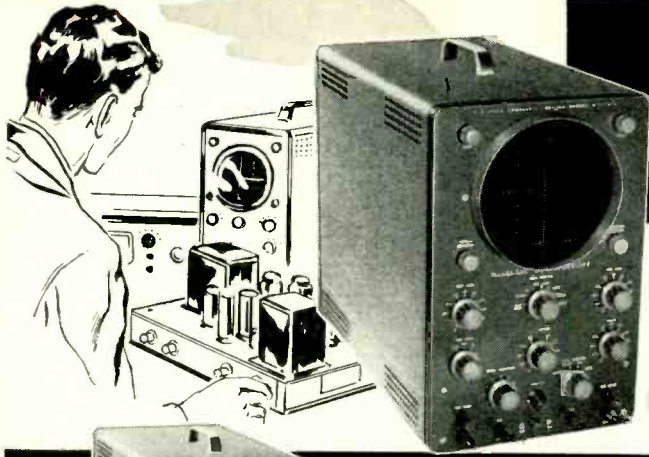

there is no substitute for
HEATHKIT QUALITY

YOU GET MORE: All first-run, top quality parts—the latest in electronic design—complete and comprehensive step-by-step assembly instructions with large pictorial diagrams and assembly drawings. Proven performance through the production of thousands of kits.

MODEL O-10
1



2

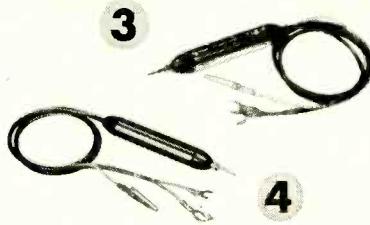

3

4

5



1 *Heathkit* ETCHED CIRCUIT
COLOR-TV
5" OSCILLOSCOPE KIT

This deluxe quality oscilloscope has proven itself through thousands of operating hours in service shops and laboratories. Features the best in components—and the best in circuit design.

Features amplifier response to 5 Mc for color TV work, and employs the radically new sweep circuit to provide stable operation up to 500,000 cps. In addition, etched metal, pre-wired circuit boards cut assembly time almost in half, and permit a level of circuit stability never before achieved in an oscilloscope of this type.

Vertical amplifiers flat within ± 2 db -5 db from 2 cps to 5 Mc, down only $1\frac{1}{2}$ db at 3.58 Mc. Vertical sensitivity is 0.025 volts, (rms) per inch at 1 Kc. 11 tube circuit employs a 5U1 CRT.

Plastic molded capacitors used for coupling and bypass—preformed and cabled wiring harness provided.

Features built-in peak-to-peak calibrating source—retrace blanking amplifier—push-pull amplifiers and step-attenuated input.

MODEL O-10
\$6950
Shpg. Wt. 21 Lbs.

2 *Heathkit* ETCHED CIRCUIT
5" OSCILLOSCOPE KIT

This is a general purpose oscilloscope for the more usual applications in the service shop or lab, yet is comparable to scopes costing many dollars more.

Features full size 5" CRT (5BP1), built-in peak-to-peak voltage calibration—3 step input attenuator—phasing control—push-pull deflection amplifiers—and etched metal pre-wired circuit boards.

Vertical channel flat within ± 3 db from 2 cps to 200 Kc, with 0.09 V. rms/inch, peak-to-peak sensitivity at 1 Kc. Sweep circuit from 20 cps to 100,000 cps. A scope you will be proud to own and use.

MODEL OM-1
\$4950
Shpg. Wt. 21 Lbs.

3 *Heathkit* LOW CAPACITY
PROBE KIT

Scope investigation of circuits encountered in TV requires the use of special low capacity probe to prevent loss of gain, circuit loading, or distortion. This probe features a variable capacitor to provide correct instrument impedance matching. Also the ratio of attenuation can be controlled.

NO. 342
\$350
Shpg. Wt. 1 Lb.

4 *Heathkit* ETCHED CIRCUIT
SCOPE DEMODULATOR PROBE KIT

Extend the usefulness of your Oscilloscope by observing modulation envelope of R.F. or I.F. carriers found in TV and radio receivers. Functions like AM detector to pass only modulation of signal and not signal itself. Applied voltage limits are 30 V. RMS and 500 V. DC.

NO. 337-C
\$350
Shpg. Wt. 1 lb.

5 *Heathkit* ETCHED CIRCUIT
3" OSCILLOSCOPE KIT

This compact little oscilloscope measures only $9\frac{1}{2}$ " H. x $6\frac{1}{2}$ " W. x $11\frac{3}{4}$ " D., and weighs only 11 lbs! Easily employed for home service calls, for work in the field or is just the ticket for use in the ham shack or home workshop. Incorporates many of the features of the Model OM-1, but yet is smaller in physical size for portability.

Employing etched circuit boards, the Model OL-1 features vertical response within ± 3 db from 2 cps to 200 Kc. Vertical sensitivity is 0.25 V. RMS/inch peak-to-peak, and sweep generator operates from 20 cps to 100,000 cps. Provision for r.f. connection to deflection plates for modulation monitoring, and incorporates many features not expected at this price level. 8-tube circuit features a type 3GP1 Cathode Ray Tube.

MODEL OL-1
\$2950
Shpg. Wt. 14 Lbs.

HEATH COMPANY A Subsidiary of Daystrom, Inc. **BENTON HARBOR 20, MICHIGAN**

fill your test requirements
WITH HEATHKITS

DESIGNED FOR YOU: Heath Company test equipment is designed for the maximum in convenience. Besides being functional, Heathkits represent the very latest in modern physical appearance, and incorporate all the latest circuit design features for comprehensive test coverage.

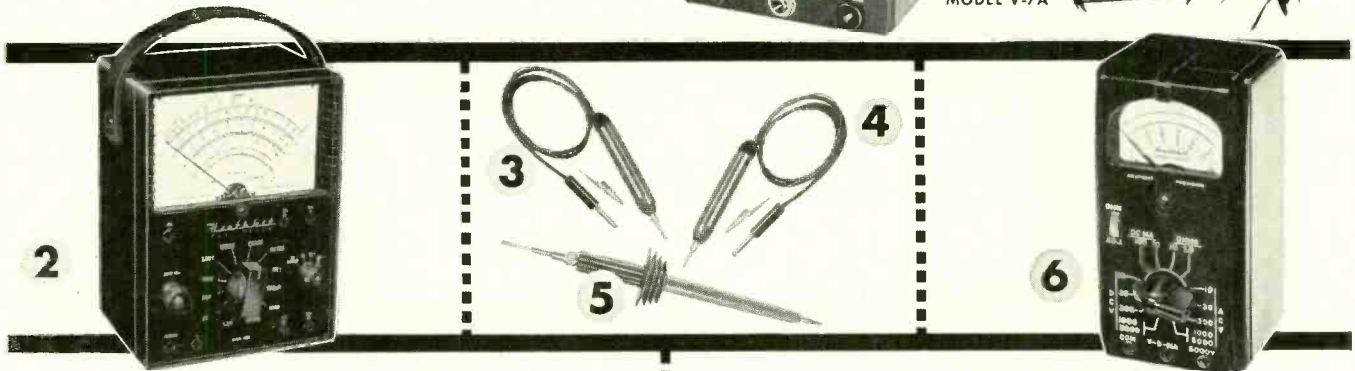
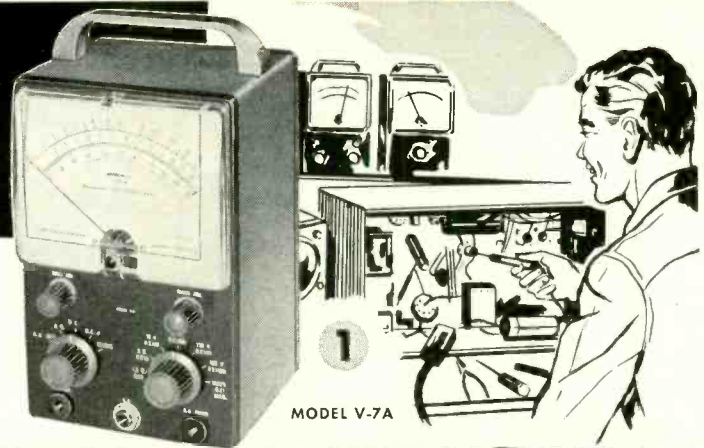

1 Heathkit ETCHED CIRCUIT
VACUUM TUBE **VOLTMETER KIT**

Besides measuring AC (rms), DC and resistance, the modern-design V-7A incorporates peak-to-peak measurement for FM and television servicing.

AC (rms) and DC voltage ranges are 1.5, 5, 15, 50, 150, 500, and 1500. Peak-to-peak AC voltage ranges are 4, 14, 40, 140, 400, 1400, and 4000. Ohmmeter ranges are X1, X10, X100, X1000, X10K, X100K, and X1 megohm. Also a db scale is provided. A polarity reversing switch provided for DC measurements, and zero center operation within range of front panel controls. Employs a 200 μ a meter for indication. Input impedance is 11 megohms.

Etched metal, pre-wired circuit board for fast, easy assembly and reliable operation is 50% thicker for more rugged physical construction. 1% precision resistors for utmost accuracy.

MODEL V-7A
\$2450
Shpg. Wt. 7 Lbs.

2 Heathkit 20,000 OHMS/VOLT
MULTIMETER KIT

The MM-1 is a portable instrument for outside servicing, for field testing, or for quick portability in the service shop. Combines attractive physical appearance with functional design. 20,000 ohms/v. DC, and 5000 ohms/v. AC. AC and DC voltage ranges are 0-1.5, 5, 50, 150, 500, 1500 and 5000 volts. Direct current ranges are 0-150 μ a., 15 ma., 150 ma., 500 ma., and 15 amperes. Resistance ranges are X1, X100, X10,000 providing center scale readings of 15, 1500 and 150,000 ohms. DB ranges cover -10 db to -65 db.

Features a 4 1/2" 50 μ a. meter. Provides polarity reversal on DC measurements. 1% precision resistors used in multiplier circuits. Not affected by RF fields.

MODEL MM-1
\$2950
Shpg. Wt. 6 Lbs.

3 Heathkit ETCHED CIRCUIT
RF PROBE KIT

The Heathkit RF Probe used in conjunction with any 11 megohm VTVM will permit RF measurements up to 250 Mc with \pm 10% accuracy. Uses etched circuits for increased circuit stability and ease of assembly.

NO. 309-C
\$350
Shpg. Wt. 1 lb.

4 Heathkit ETCHED CIRCUIT
PEAK-TO-PEAK PROBE KIT

Now read peak-to-peak voltages on the DC scale of any 11 megohm VTVM with this new probe, employing etched circuit for stability and low loss. Readings made directly from VTVM scales, from 5 Kc to 5 Mc. Not required for Heathkit Model V-7A VTVM.

NO. 338-C
\$550
Shpg. Wt. 2 Lbs.

5 Heathkit 30,000 VOLT D.C.
HIGH VOLTAGE PROBE KIT

For TV service work or similar application for measurement of high DC voltage. Precision multiplier resistor mounted inside plastic probe. Multiplication factor of 100 on the ranges of Heathkit 11 megohm VTVM.

NO. 336
\$450
Shpg. Wt. 2 Lbs.

6 Heathkit
HANDITESTER KIT

The Model M-1 measures AC or DC voltage at 0-10, 30, 300, 1000, and 5000 volts. Measures direct current at 0-10 ma. and 0-100 ma. Provides ohmmeter ranges of 0-3000 (30 ohm center scale) and 0-300,000 ohms (3000 ohms center scale). Features a 400 μ a. meter for sensitivity of 1000 ohms/volt. Because of its size, the M-1 is a very handy portable instrument that will fit in your coat pocket, tool box, glove compartment, or desk drawer. Makes a fine standby unit in the service shop when the main instruments are in use, or is ideal for the hobbyist or beginner. An unusual dollar value.

MODEL M-1
\$1450
Shpg. Wt. 3 Lbs.

HEATH COMPANY

A Subsidiary
of Daystrom, Inc.

BENTON HARBOR 20, MICHIGAN

Heathkit
TV ALIGNMENT
**GENERATOR
KIT**



1



2



3



4

**HEATH
COMPANY**
A SUBSIDIARY OF DAYSTROM INC.

The Model TS-4 features a controllable inductor for all-electronic sweep, improved oscillator and automatic gain circuitry, high RF output, center sweep operation, and improved linearity. It sets a new high standard for sweep generator operation, and is absolutely essential for the up-to-date service shop doing FM, black-and-white TV, and color TV work.

Voltage regulation and effective AGC action insure flat output over a wide frequency range. Electronic sweep insures complete absence of mechanical vibration. Sweep deviation controllable from 0 up to 40 Mc, depending upon base frequency. Effective two-way blanking.

Fundamental output from 3.6 Mc to 220 Mc in 4 bands. Crystal provides markers at 4.5 Mc and multiples thereof. Crystal included with kit. Variable marker covers from 19 Mc to 60 Mc on fundamentals, and up to 180 Mc on harmonics. Provision for external marker.



MODEL TS-4
\$4950
Shpg. Wt. 16 Lbs.

1

Heathkit LINEARITY PATTERN
GENERATOR KIT

The new-design Model LP-1 produces vertical or horizontal bar patterns, a cross-hatch pattern, or white dots on the screen of the TV set under test. No internal connections required. Special clip is attached to the TV antenna terminals. Instant selection of the pattern desired for adjustment of vertical and horizontal linearity, picture size, aspect ratio, and focus. Dot pattern presentation is a *must* for color convergence adjustments on color TV sets.

Extended operating range covers all television channels from 2 to 13. Produces 6 to 12 vertical bars or 4 to 7 horizontal bars.

MODEL LP-1
\$2250
Shpg. Wt. 7 Lbs.

2

Heathkit LABORATORY
GENERATOR KIT

The Heathkit Model LG-1 Laboratory Generator is a high-accuracy signal source for applications where metered performance is essential. It covers from 100 Kc to 30 Mc on fundamentals in 5 bands. Modulation is at 400 cycles, and modulation is variable from 0-50%. RF output from 100,000 μ v. to 1 μ v. 200 μ a. meter reads the RF output in microvolts, or percentage of modulation. Fixed step and variable output attenuation provided.

Features voltage regulation, and double copper plated shielding for stability. Provision for external modulation. Coaxial output cable (50 ohms).

MODEL LG-1
\$3950
Shpg. Wt. 16 Lbs.

3

Heathkit CATHODE RAY
TUBE CHECKER KIT

This new-design instrument holds the key to rapid and complete picture tube testing, either in the set, on the work-bench, or in the carton. Tests for shorts, leakage, and emission. Features Shadow-graph test (a spot of light on the screen) to indicate whether the tube is capable of functioning.

The Model CC-1 tests all electromagnetic deflection picture tubes normally encountered in television servicing. Supplies all operating voltages to the tube under test, and indicates the condition of the tube on a large "GOOD-BAD" scale. Features spring loaded test switches for operator protection.

The CC-1 is housed in an attractive portable case and is light in weight - ideal for outside service calls.

MODEL CC-1
\$2250
Shpg. Wt. 10 Lbs.

4

Heathkit DIRECT READING
CAPACITY METER KIT

Not only is this instrument popular in the service shop, but it has found extensive application in industrial situations. Ideal for quality control work, production line checking, or for matching pairs.

Features direct reading linear scales from 100 mmf to .1 mfd full scale. Necessary only to connect a capacitor of unknown value to the insulated binding posts, select the correct range, and read the meter. The CM-1 is not susceptible to hand capacity, and has a residual capacity of less than 1 mmf.

MODEL CM-1
\$2950
Shpg. Wt. 7 Lbs.

BENTON HARBOR 20, MICHIGAN
RADIO-ELECTRONICS



MODEL SG-8 **\$1950**
Shpg. Wt. 8 Lbs.

This is one of the biggest signal generator bargains available today. The tried and proven Model SG-8 offers all of the outstanding features required for a basic service instrument. High quality components and outstanding performance.

The SG-8 covers 160 Kc to 110 Mc on fundamentals in 5 bands, and calibrated harmonics extend its usefulness up to 220 Mc. The output signal is modulated at 400 cps, and the RF output is in excess of 100,000 uv. Output controlled by both a continuously variable and a fixed step attenuator. Also, audio output may be obtained for amplifier testing. Don't let the

low price deceive you. This is a professional type service instrument to fulfill the signal source requirements in the service lab.

1 *Heathkit* . . . IMPEDANCE BRIDGE KIT

The IB-2 features built-in adjustable phase shift oscillator and amplifier, and has panel provisions for external generator. Measures resistance, capacitance, inductance, dissipation factors of condensers, and storage factor of inductance.

D, Q, and DQ functions combined in one control. 1/2% resistors and 1/2% silver-mica capacitors especially selected for this instrument. A 100-0-100 microammeter provides null indications. Two-section CRL dial provides 10 separate "units" with an accuracy of .5%. Fractions of units read on variable control.

MODEL IB-2
\$5950
Shpg. Wt. 12 Lbs.



2 *Heathkit* "Q" METER KIT

The Heathkit Model QM-1 will measure the Q of inductances and the RF resistance and distributed capacity of coils. Employs a 4 1/2" 50 microampere meter for direct indication. Will test at frequencies of 150 Kc to 18 Mc in 4 ranges. Measures capacity from 40 mmf to 450 mmf within ± 3 mmf. Indispensable for coil winding and determining unknown condenser values. A worthwhile addition to your laboratory at an outstandingly low price. Useful for checking wave traps, chokes, peaking coils, etc. Laboratory facilities are now available to the service shop and home lab.

MODEL QM-1
\$4450
Shpg. Wt. 14 Lbs.



3 *Heathkit* 6-12 VOLT BATTERY ELIMINATOR KIT

This modern battery eliminator will supply 6 or 12 volt output for ordinary automobile radios as well as 12 volts for the new models in the latest model cars. Output voltage is variable from 0-8 volts DC, or 0-16 volts DC. Will deliver up to 15 amperes at 6 volts, or up to 7 amperes at 12 volts. Two 10,000 microfarad filter capacitors insure smooth DC output. Two panel meters monitor output voltage and current. Will double as a battery charger. Definitely required for automobile radio service work.

MODEL BE-4
\$3150
Shpg. Wt. 17 Lbs.



4 *Heathkit* DECADE RESISTANCE KIT

Twenty 1% precision resistors provide resistance from 1 to 99,999 ohms in 1 ohm steps. Indispensable around service shop laboratory, ham shack, or home workshop. Well worth the extremely low Heathkit price.

MODEL DR-1
\$1950
Shpg. Wt. 4 Lbs.

3

5 *Heathkit* VIBRATOR TESTER KIT

Tests vibrators for proper starting and indicates the quality of the output on a large "GOOD-BAD" scale. Checks both interrupter and self-rectifier types in 5 different sockets. Operates from any battery eliminator delivering variable voltage from 4 to 6 volts DC at 4 amps. Ideal companion to the Model BE-4.

MODEL VT-1
\$1450
Shpg. Wt. 6 Lbs.

4

6 *Heathkit* DECADE CONDENSER KIT

Provides capacity values from 100 mmf to 0.111 mfd in steps of 100 mmf. ± 1% precision silver-mica condensers used. High quality ceramic switches for reduced leakage. Polished birch cabinet. Extremely valuable in all electronic activity.

MODEL DC-1
\$1650
Shpg. Wt. 3 Lbs.



5

6

**HEATH
COMPANY**

A SUBSIDIARY OF DAYSTROM INC.

BENTON HARBOR 20, MICHIGAN

Heathkit TUBE CHECKER KIT

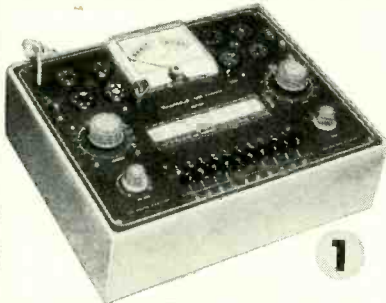

1 The Heathkit Model TC-2 is an emission type tube tester that represents a tremendous saving over the price of a comparable unit from any other source. At only \$29.50, you can have a tube tester of your own, even if you are an experimenter, or only do part time service work. Extremely popular with radio servicemen, it uses a 4½" meter with 3-color meter face for simple "GOOD-BAD" indications that the customer can understand. Will test all tubes commonly encountered in radio and TV service work.

Ten 3-position lever switches for "open" or "short" tests on each tube element. Neon bulb indicates filament continuity or short between tube elements. Line adjust control provided. The roll chart is illuminated.

Sockets provided for 4, 5, 6, and 7-pin, octal, and loctal tubes, 7 and 9 pin miniature tubes, and the 5 pin Hytron tubes. Blank space provided for future socket addition. Tests tubes for opens, and shorts, and for quality on the basis of total emission. 14 different filament voltage values provided.

MODEL TC-2
\$29.50
Shpg. Wt. 12 Lbs.

2 Heathkit PORTABLE TUBE CHECKER KIT

The Model TC-2P is identical to the Model TC-2 except that it is housed in a rugged carrying case. This strikingly attractive and practical two-tone case is finished in proxylin impregnated fabric. The cover is detachable, and the hardware is brass plated. This case imparts a real professional appearance to the instrument. Ideal for home service calls, or any portable application.

MODEL TC-2P
\$34.50
Shpg. Wt. 15 Lbs.



3 Heathkit TV PICTURE TUBE TEST ADAPTER

The Heathkit TV picture tube test adapter is designed for use with the Model TC-2 Tube Checker. Test picture tubes for emission, shorts, and thereby determine tube quality. Consists of 12-pin TV tube socket, 4 ft. cable, octal connector, and necessary technical data. (Not a kit.)

MODEL 355
\$4.50
Shpg. Wt. 1 lb.

4 Heathkit . . . CONDENSER CHECKER KIT

Use this Condenser Checker to quickly and accurately measure those unknown condenser and resistor values. All readings taken directly from the calibrated panel scales without any involved calculation. Capacity measurements in four ranges from .00001 to 1000 mfd. Checks paper, mica, ceramic and electrolytic condensers. A power factor control is available for accurate indication of electrolytic condenser efficiency. Leakage test switch—selection of five polarizing voltages, 25 volts to 450 volts DC to indicate condenser operating quality under actual load conditions. Spring-return test switch automatically discharges condenser under test and eliminates shock hazard to the operator.

Resistance measurements can be made in the range from 100 ohms to 5 meg-ohms. Here again, all values are read directly on the calibrated scales. Increased sensitivity coupled with an electron beam null indicator increases overall instrument usefulness.

For safety of operation, the circuit is entirely transformer operated. An outstanding low kit price for this surprisingly accurate instrument.

MODEL C-3
\$19.50
Shpg. Wt. 7 Lbs.



5 Heathkit VISUAL-AURAL SIGNAL TRACER KIT

This signal tracer is extremely valuable in servicing AM, FM, and TV receivers, especially when it comes to isolating trouble to a particular stage of the circuit under test.

This visual-aural tracer features a high gain RF input channel to permit signal tracing from the receiver antenna input clear through all RF, IF, detector, and audio stages to the speaker. Separate low-gain channel provided for audio circuit exploration. Both visual and aural indication by means of a speaker or headphone, and electron beam "eye" tube as a level indicator. Also incorporates a noise locator circuit for DC noise checks, and a built-in calibrated wattmeter (30-500 watts). Panel terminals provided for "patching" output transformer or speaker into external circuit for test purposes. Designed especially for the radio and TV serviceman. Cabinet size: 9½" wide x 6½" high x 5" deep. A real test equipment bargain.

MODEL T-3
\$23.50
Shpg. Wt. 9 Lbs.



**HEATH
COMPANY**
A SUBSIDIARY OF DAYSTROM INC

BENTON HARBOR 20, MICHIGAN

RADIO-ELECTRONICS



MODEL HD-1

Shpg. Wt. 13 Lbs. **\$4950**

Used with a sine wave generator, the Model HD-1 will check the harmonic distortion output of audio amplifiers under a variety of conditions. Reads distortion directly on the meter as a percentage of the input signal. Operates between 20 and 20,000 cps. High impedance VTVM circuit for initial reference settings and final distortion readings. Ranges are 0-1, 3, 10, and 30 volts full scale. 1% precision resistors. Distortion scales are 0-1, 3, 10, 30 and 100% full scale. Requires only .3 volt input for distortion test.

Heathkit HARMONIC DISTORTION METER KIT

1 Heathkit AUDIO ANALYZER KIT

This instrument consists of an audio wattmeter, an AC VTVM, and a complete IM analyzer, all in one compact unit.

Use the VTVM to measure noise, frequency response, output gain, power supply ripple, etc. Use the wattmeter for measurement of power output. Internal loads provided for 4, 8, 16, or 600 ohms. VTVM also calibrated for DBM units. High or low impedance IM measurements made with built-in 6KC and 60 cps generators. VTVM ranges are .01, to 300 volts in 10 steps. Wattmeter ranges are .15 mw. to 150 w. in 7 steps. IM scales are 1% to 100% in 5 steps. Shpg. Wt. 13 Lbs.

MODEL AA-1

\$5950



2 Heathkit AUDIO GENERATOR KIT

This new Heathkit Model features step-tuning from 10 cps to 100 Kc with three rotary switches that provide two significant figures and multiplier. Less than .1% distortion. Frequency accurate to within $\pm 5\%$.

Output monitored on a large 4½" meter that reads voltage or db. Both variable and step-type attenuation provided. Meter reads zero-to-maximum at each attenuator position. Output ranges (and therefore meter ranges) are 0-.003, .01, .03, .1, .3, 1, 3, 10 volts. Step-tuning provides rapid positive selection of the desired frequency, and allows accurate return to any given frequency. Shpg. Wt. 8 Lbs.

MODEL AG-9

\$3450



3 Heathkit AUDIO OSCILLATOR KIT

(SINE WAVE — SQUARE WAVE)

The Model AO-1 features sine wave or square wave coverage from 20-20,000 cps in 3 ranges. It is an instrument specifically designed to completely fulfill the needs of the serviceman and high fidelity enthusiast. Offers high level output across the entire frequency range, low distortion and low impedance output. Features a thermistor in the second amplifier stage to maintain essentially flat output through the entire frequency range. Produces an excellent sine wave for audio testing, or will produce good, clean, square waves with a rise time of only 2 microseconds.

MODEL AO-1

\$2450

Shpg. Wt. 10 Lbs.



4 Heathkit RESISTANCE SUBSTITUTION BOX KIT...

Provides switch selection of 36 RTMA 1 watt standard 1% resistors ranging from 15 ohms to 10 megohms. Numerous applications in radio and TV work, and essential in the developmental laboratory.

MODEL RS-1

\$550

Shpg. Wt. 2 Lbs.

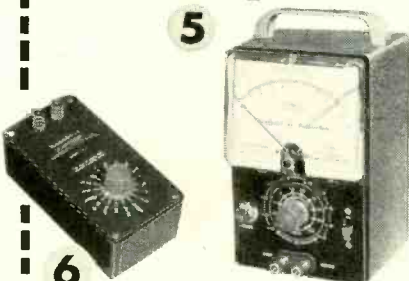

5 Heathkit AC VACUUM TUBE VOLTMETER KIT...

The Heathkit AC VTVM features high impedance, wide frequency range, very high sensitivity, and extremely wide voltage range. Will accurately measure a voltage as small as 1 mv. at high impedance. Excellent for sensitive AC measurements required by laboratories, audio enthusiasts and experimenters. Frequency response is substantially flat from 10 cps to 50 Kc. Ranges are .01, .03, .1, .3, 1, 3, 10, 30, 100, and 300 v. RMS. Total db range -52 to + 52 db. Input impedance 1 megohm at 1 Kc.

MODEL AV-2

\$2950

Shpg. Wt. 5 Lbs.

HEATH COMPANY

A SUBSIDIARY OF DAYSTROM INC.

6 Heathkit CONDENSER SUBSTITUTION BOX KIT...

Very popular companion to Heathkit RS-1. Individual selection of 18 RTMA standard condenser values from .0001 mfd to .22 mfd. Includes 18" flexible leads with alligator clips.

MODEL CS-1

\$550

Shpg. Wt. 2 Lbs.

BENTON HARBOR 20, MICHIGAN



MODEL DX-100

HEATHKIT HAM GEAR

for high quality at moderate cost

DOLLAR VALUE: You get more for your Heathkit dollar because your labor is used to build the kit instead of paying for someone else's. Also, the middleman's margin of profit is eliminated when you deal directly with the manufacturer.



2



3



4

1 Heathkit DX-100 PHONE & CW TRANSMITTER KIT

The reception given this amateur transmitter has been tremendous. Reports from radio amateurs using the DX-100 are enthusiastic in praising its performance and the high quality of the components used in its assembly. Actual "on the air" results reflect the careful design that went into its development.

The DX-100 features a built-in VFO, modulator, and power supplies, and is completely bandswitching for phone or CW operation on 160, 80, 40, 20, 15, 11, and 10 meters. All parts necessary for construction are supplied in the kit, including tubes, cabinet, and detailed step-by-step instructions. Easy to build, and a genuine pleasure to operate.

Employs push-pull 1625's modulating parallel 6146's for RF output in excess of 100 watts on phone and 120 watts on CW. May be excited from the built-in VFO or from crystals (crystals not included with kit). Features five-point TVI suppression: (1) pi network interstage coupling to reduce harmonic transfer to the final stage; (2) pi network output coupling; (3) extensive shielding; (4) all incoming and outgoing circuits filtered; (5) inter-locking cabinet seams to eliminate radiation except through the coaxial output connector. Pi network output coupling will match 50 to 600 ohm non-reactive load. Illuminated VFO dial and meter face. Remote control socket provided.

The chassis is made of extra-strong #16 gauge copper-plated steel. It employs potted transformers, ceramic switch and variable capacitor insulation, solid silver loading switch terminals, and high-grade well-rated components throughout. Features a pre-formed wiring harness, and all coils are pre-wound.

High-gain speech amplifier for dynamic or crystal microphones, and restricted speech range for increased intelligence. Plenty of audio power reserve. Measures 20⁷/₈" W. x 13³/₄" H. x 16" D. Schematic diagram and complete technical specifications on request.

MODEL DX-100

\$189⁵⁰

Shpg. Wt. 120 Lbs.

Shipped Motor Freight Unless Otherwise Specified
\$50.00 Deposit Required on C.O.D. Orders

2 Heathkit VFO KIT

The Model VF-1 covers 160-80-40-20-15-11 and 10 meters with three basic oscillator frequencies. Better than 10-volt average RF output on fundamentals. Features illuminated and pre-calibrated dial scale. Cable and plug provided to fit crystal socket of any modern transmitter.

Enjoy the convenience and flexibility of VFO operation at no more than the price of crystals. May be powered from plug on the Heathkit Model AT-1 transmitter, or supplied with power from most transmitters. Measures: 7" H. x 6¹/₂" W. x 7" D.

MODEL VF-1

\$19⁵⁰

Shpg. Wt. 7 Lbs.

3 Heathkit CW AMATEUR TRANSMITTER KIT

The Model AT-1 is an ideal novice transmitter, and may be used to excite a higher power rig later on.

This CW transmitter is complete with its own power supply, and covers 80, 40, 20, 15, 11, and 10 meters. Features single-knob bandswitching, and panel meter indicates grid or plate current for the final amplifier. Designed for crystal operation or external VFO. Crystal not included in kit. Incorporates such features as key click filter, line filter, copper-plated chassis, pre-wound coils, 52 ohm coaxial output, and high quality components throughout. Instruction book simplifies assembly. Employs a 6AG7 oscillator, 6L6 final amplifier. Operates up to 35 watts plate power input.

MODEL AT-1

\$29⁵⁰

Shpg. Wt. 15 Lbs.

4 Heathkit ... ANTENNA COUPLER KIT

The Model AC-1 will properly match your low power transmitter to an end-fed long wire antenna. Also attenuates signals above 36 Mc, reducing TVI. 52 ohm coax. input-power up to 75 watts-10 through 80 meters-tapped inductor and variable condenser-neon RF indicator-copper plated chassis and high quality components. Ideal for use with Heathkit AT-1 Transmitter.

MODEL AC-1

\$14⁵⁰

Shpg. Wt. 4 Lbs.

HEATH COMPANY

A Subsidiary
of Daystrom, Inc.

BENTON HARBOR 20, MICHIGAN

"AMATEUR-ENGINEERED"

Equipment For The Ham

MODERN DESIGN: You can be sure of getting all the latest and most desirable design features when you buy Heathkits. Advanced-design is a minimum standard for new Heathkit models.

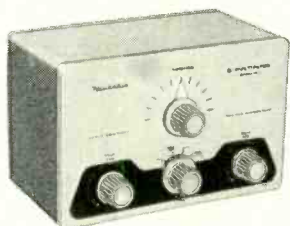
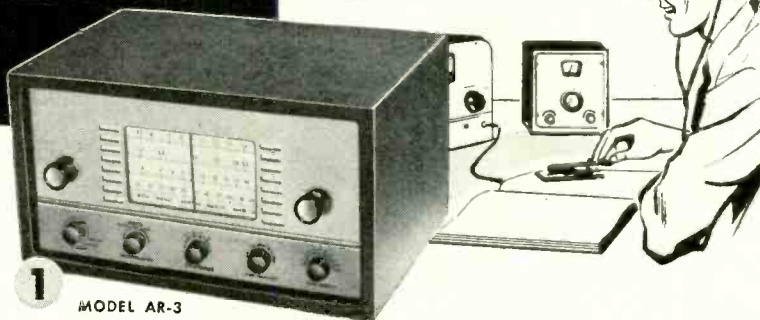

2



3



4



5

1 Heathkit COMMUNICATIONS-TYPE ALL BAND RECEIVER KIT

The new Model AR-3 features improved IF and RF performance, along with better image rejection on all bands. Completely new chassis layout for easier assembly, even for the beginner.

Covers 550 Kc to 30 Mc in four bands. Provides sharp tuning and good sensitivity over the entire range. Features a transformer-type power supply—electrical bandspread—separate RF and AF gain controls—antenna trimmer—noise limiter—AGC—BFO—headphone jacks—5½" PM speaker and illuminated tuning dial.

CABINET: Fabric covered cabinet with aluminum panel as shown. Part No. 91-15, shipping weight 5 lbs. \$4.50.

MODEL AR-3
\$27⁹⁵

Shpg. Wt. 12 lbs.
(Less Cabinet)

2 Heathkit "Q" MULTIPLIER KIT

Here is the Heathkit Q Multiplier you hams have been asking for. A tremendous help on the phone and CW bands when the QRM is heavy. Provides an effective Q of approximately 4,000 for extremely sharp "peak" or "null." Use it to "peak" the desired signal or to "null" an undesired signal, or heterodyne. Tunes to any signal within the IF band-pass of your receiver. Also provides "broad peak" for conditions where extreme selectivity is not required.

Operates with any receiver having an IF frequency between 450 and 460 Kc. Will not function with AC-DC type receivers. Requires 6.3 volts AC at 300 ma. and 150 to 250 VDC at 2 ma. Derives operating power from your receiver. Uses a 12AX7 tube, and special High-Q shielded coils. Simple to connect with the cable and plugs supplied. Measures only 4-11/16"H.x7¾"W.x4¼"D. A really valuable addition to the receiving equipment in your ham shack.

MODEL QF-1
\$9⁹⁵

Shpg. Wt. 3 lbs.

3 Heathkit VARIABLE VOLTAGE REGULATED POWER SUPPLY KIT

Provides well filtered DC output, variable from zero to 500 volts at no load and regulated for stability. Will supply up to 10 ma. at 450 VDC, and up to 130 ma. at 200 VDC. Voltage or current monitored on front panel meter. Also provides 6.3 VAC at 4A. for filament. Filament voltage isolated from B+, and both isolated from ground. Invaluable around the ham shack for supplying operating potentials to experimental circuits. Use in all types of research and development laboratories as a temporary power supply, and to determine design requirements for ultimate power supply.

MODEL PS-3
\$35⁵⁰

Shpg. Wt. 17 lbs.

4 Heathkit ANTENNA IMPEDANCE METER KIT

Use in conjunction with a signal source for measuring antenna impedance, line matching, adjustment of beam and mobile antennas, etc. Will double as a phone monitor or relative field strength indicator. 100 µa. meter employed. Covers the range from 0-600 ohms. An instrument of many uses for the amateur.

MODEL AM-1
\$14⁵⁰

Shpg. Wt. 2 lbs.

5 Heathkit GRID DIP METER KIT

This is an extremely valuable tool for accomplishing literally hundreds of jobs on all types of equipment. Covering from 2 Mc to 250 Mc, the GD-1B is compact and can be operated with one hand. Uses a 500 µa. meter for indication, with a sensitivity control and headphone jack. Includes prewound coils and rack. Indispensable instrument for hams, engineers, or servicemen.

MODEL GD-1B
\$19⁵⁰

Shpg. Wt. 4 lbs.

HEATH KIT COMPANY

A Subsidiary
of Daystrom, Inc.

BENTON HARBOR 20, MICHIGAN

Heathkits
 PROVIDE THE
 "CONSTRUCTIVE"
 APPROACH TO
HIGH-FIDELITY



EASY TO BUILD: *The assembly instructions supplied with Heathkits are so complete and detailed that anyone can assemble the kits without difficulty. Plenty of pictorial diagrams and step-by-step instructions. Information on resistor color codes, soldering, use of tools, etc. Build-it-yourself with confidence!*



1

1 *Heathkit* **ADVANCED-DESIGN**
HIGH FIDELITY **AMPLIFIER KIT**

The 25 Watt Model W-5 is one of the most outstanding high fidelity amplifiers available today—at any price. Incorporates the very latest design features to achieve true "presence" for the super-critical listener.

Features a new-design Peerless output transformer, and KT66 output tubes handle power peaks up to 42 watts. The unique "tweeter-saver" suppresses high frequency oscillation. A new type balancing circuit results in closer "dynamic" balance between output tubes. Features improved phase shift characteristics and frequency response, with reduced IM and harmonic distortion. Color styling harmonizes with the Heathkit WA-P2 Preamplifier and the FM-3 Tuner.

Frequency response—within ± 1 db from 5 cps to 160 Kc at 1 watt. Harmonic distortion only 1% at 25 watts, 20-20,000 cps. IM distortion only 1% at 20 watts, using 60 and 3,000 cps. Output impedance 4, 8, or 16 ohms. Hum and noise—99 db below rated output. Uses two 12AU7's, two KT66's and a 5R4GY.

KIT COMBINATIONS:

W-5M Amplifier Kit: Consists of main amplifier and power supply, all on one chassis. Complete with all necessary parts, tubes, and comprehensive manual. Shpg. Wt. 31 lbs. Express only.

\$59⁷⁵

W-5 Combination Amplifier Kit: Consists of W-5M Amplifier Kit listed above plus Heathkit Model WA-P2 Preamplifier Kit. Complete with all necessary parts, tubes, and construction manuals. Shpg. Wt. 38 lbs. Express only.

\$79⁵⁰

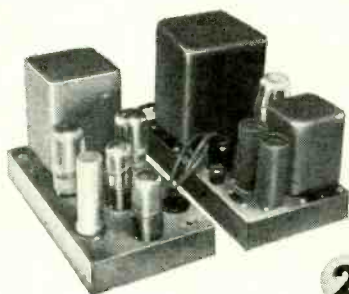

2

2 *Heathkit* **DUAL-CHASSIS WILLIAMSON TYPE**
HIGH FIDELITY **AMPLIFIER KIT**

This is a very popular high fidelity amplifier kit that features dual-chassis type construction. The resulting physical dimensions offer an additional margin of flexibility in installation. It features the famous Acrosound TO-300 "ultra-linear" output transformer, and has a frequency response within ± 1 db from 6 cps to 150 Kc at 1 watt. Harmonic distortion only 1% at 21 watts. IM distortion at 20 watts only 1.3% at 60 and 3,000 cps. Rated power output is 20 watts. Output impedance 4, 8, or 16 ohms. Hum and noise—88 db below 20 watts. Uses two 6SN7's, two 5881's, and a 5V4G.

KIT COMBINATIONS:

W-3M: Consists of main amplifier and power supply for separate chassis construction. Includes all tubes and components necessary for assembly. Shpg. Wt. 29 lbs., Express only.

\$49⁷⁵

W-3: Consists of W-3M Kit listed above plus Heathkit Model WA-P2 Preamplifier described on opposite page. Shpg. Wt. 37 lbs., Express only.

\$69⁵⁰



3

3 *Heathkit* **SINGLE-CHASSIS WILLIAMSON TYPE**
HIGH FIDELITY **AMPLIFIER KIT**

This is the lowest priced Williamson type amplifier ever offered in kit form, and yet it retains all the usual features of the Williamson type circuit. Main amplifier and power supply combined on one chassis, and uses a new-design Chicago output transformer. Frequency response—within ± 1 db from 10 cps to 100 Kc at 1 watt. Harmonic distortion only 1.5% at 20 watts. IM distortion at rated output, 2.7% at 60 and 3,000 cps. Rated power output is 20 watts. Output impedance 4, 8, or 16 ohms. Hum and noise—95 db below 20 watts. Uses two 6SN7's, two 5881's, and one 5V4G.

Instructions are so complete that the kit may be assembled successfully even by a beginner in electronics.

KIT COMBINATIONS:

W-4AM: Consists of main amplifier and power supply for single chassis construction. Includes all tubes and components necessary for assembly. Shpg. Wt. 28 lbs. Express only.

\$39⁷⁵

W-4A: Consists of W-4AM Kit listed above plus Heathkit Model WA-P2 Preamplifier described on opposite page. Shpg. Wt. 35 lbs. Express only.

\$59⁵⁰

**HEATH
 COMPANY**

A SUBSIDIARY OF DAYSTROM INC.

BENTON HARBOR 20, MICHIGAN

RADIO-ELECTRONICS

ATTRACTIVELY STYLED: *Heathkit high fidelity instruments are not only functional, but are most attractive in physical design. Such units as the preamplifier and the W-5 main amplifier are designed for beauty as well as performance. They blend with any room decor and are the kind of instruments you will be proud to own.*



enjoy....
**THE VERY BEST
 IN AUDIO WITH
 "BUILD-IT-YOURSELF"
 HEATHKITS**

1 *Heathkit* HIGH FIDELITY
PREAMPLIFIER KIT

This outstanding preamplifier is designed specifically for use with the Heathkit Williamson type amplifiers. It completely fulfills the requirements for remote control, compensation and preamplification, and exceeds even the most rigorous specifications for high fidelity performance.

Features five separate switch-selected input channels (2 low level and 3 high level), each with its own input control. Full record equalization with four-position turnover control and four-position rolloff control.

Output jack for tape recorder — separate bass control with 18 db boost and 12 db cut at 50 cps. — treble control offering 15 db boost and 20 db cut at 15,000 cps — special hum control to insure minimum hum level — and many other desirable features. Overall frequency response (with controls set to "flat" position) is within 1 db from 25 cps to 30,000 cps. Will do justice to the finest available program sources. Beautiful satin-gold finish.

Power requirements from the Heathkit Williamson type high fidelity amplifier — 6.3 VAC at 1 amp., and 300 VDC at 10 Ma. Uses two 12AX7's and one 12AU7.

MODEL WA-P2
\$1975
 Shpg. Wt. 7 Lbs.



1

2 *Heathkit* 20-WATT HIGH FIDELITY
AMPLIFIER KIT

This Heathkit Model offers you the least expensive route to high fidelity performance. Frequency response is ± 1 db from 20-20,000 cps. Features full 20 watt output using push-pull 6L6's, and incorporates separate bass and treble tone controls. Preamplifier and main amplifier are built on the same chassis. Four switch-selected compensated inputs and separate bass and treble tone controls provide all necessary functions at minimum investment. Features miniature tube types for low hum and noise.

Uses 12AX7, two 12AU7's, two 6L6G's and a 5V4G. A most interesting "build-it-yourself" project, and an excellent hi-fi amplifier for home use. Well suited, also, for public address applications because of its high power output and high quality audio reproduction. Another Heathkit "best-buy" for you!

MODEL A-9B
\$3550
 Shpg. Wt. 23 Lbs.

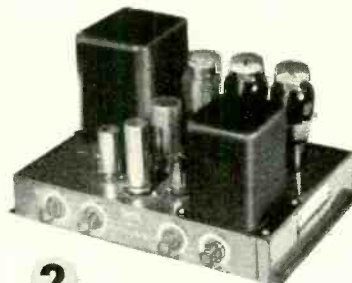

2

3 *Heathkit* 7-WATT
AMPLIFIER KIT

The redesigned Model A-7D features a new type output transformer for tapped screen operation, and provides improved sensitivity, reduced distortion, and increased power output.

The full 7-watt output of the Model A-7D is more than adequate for normal home installations. Frequency characteristics are $\pm 1\frac{1}{2}$ db from 20 to 20,000 cps. Potted output and power transformers employed. Push-pull output — detailed construction manual — top quality parts — high quality audio without great expense. Output transformer tapped at 4, 8, and 16 ohms. Bass and treble tone controls provided on the front chassis apron.

MODEL A-7D
\$1695
 Shpg. Wt. 10 Lbs.

Model A-7E: Provides a preamplifier stage with two switch-selected inputs and RIAA compensation for variable reluctance or low level cartridges. Preamplifier built on same chassis as main amplifier. Model A-7E. Shipping weight 10 lbs. \$18.50.



3

**HEATH
 COMPANY**
 A SUBSIDIARY OF DAYSTROM INC.

BENTON HARBOR 20, MICHIGAN

APRIL, 1956

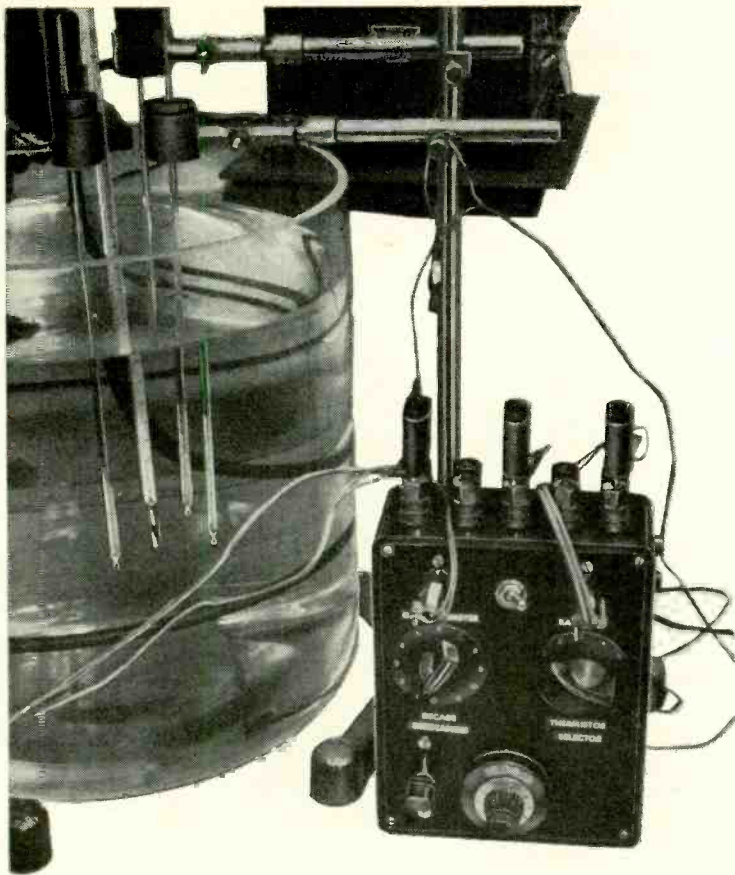

versatile THERMISTOR THERMOMETER

*Precision bridge circuit
measures resistance changes
in temperature-sensitive device*

By JAMES ROBERT SQUIRES

Thermistor thermometer in operation.

RECENT wide interest in semiconductors, brought about by the development of the transistor, has been just what the doctor ordered for its cousin, the thermistor. With improvements in industrial manufacturing techniques, the thermistor will soon outdate the thermocouple as a temperature-sensing device. A thermistor thermometer that measures temperatures from well below 0° to 150°C is possible.

Among the big headaches of temperature measurement are the thermometer's size, precision and adaptability to electronic instruments. Thermistors overcome most of these objections successfully.

The rod, bead, disc or washer are the general shapes in which thermistors are manufactured. They come in sizes ranging from a 1½-inch disc to beads so small they are almost invisible to the eye. Thermistors are usually made of metallic oxides and a binder sintered at high temperature to form the desired shape.

Certain characteristics of the thermistor govern its use as a temperature sensing device.

An interesting one is their negative temperature coefficient. That is, for a given increase in the thermistor's temperature there is a corresponding decrease in resistance. Thermistors, often classified by their room-temperature resistances, are available in steps from 10 ohms to 5 megohms.

Another important feature of this temperature-sensing device is its ability to respond swiftly to changes in temperature. This characteristic is called its thermal time constant and depends on the medium surrounding it. Thermistors may be purchased with thermal time constants ranging from 0.1 to 150 seconds. One of 2 seconds covers most situations and is used in the thermistor

thermometer of the type discussed here.

The dissipation constant of the thermistor is the amount of power dissipated within it which will raise its temperature 1°C above room temperature. In thermometer work the dissipation constant serves as a power limit in choosing the operating characteristics of a Wheatstone bridge constructed to measure the thermistor's resistance.

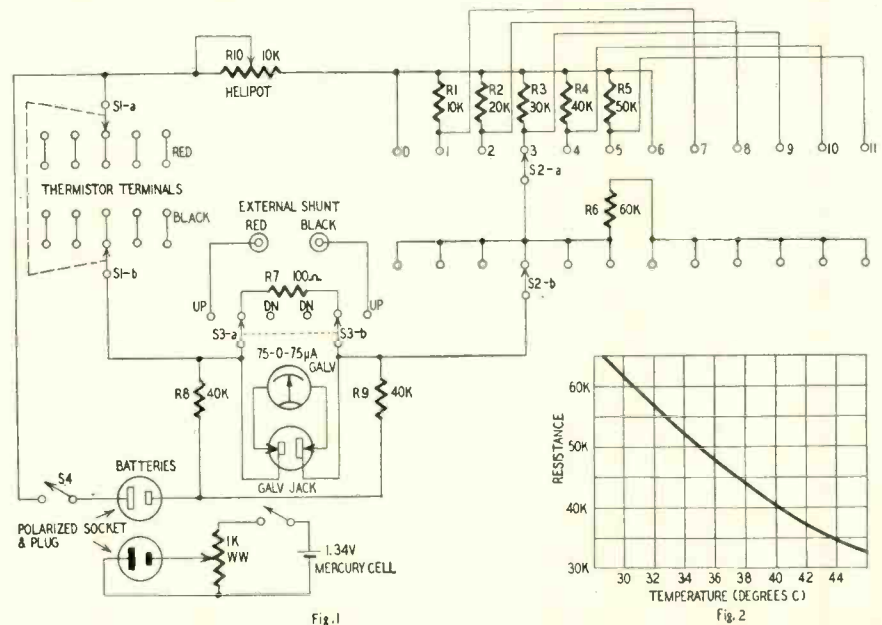
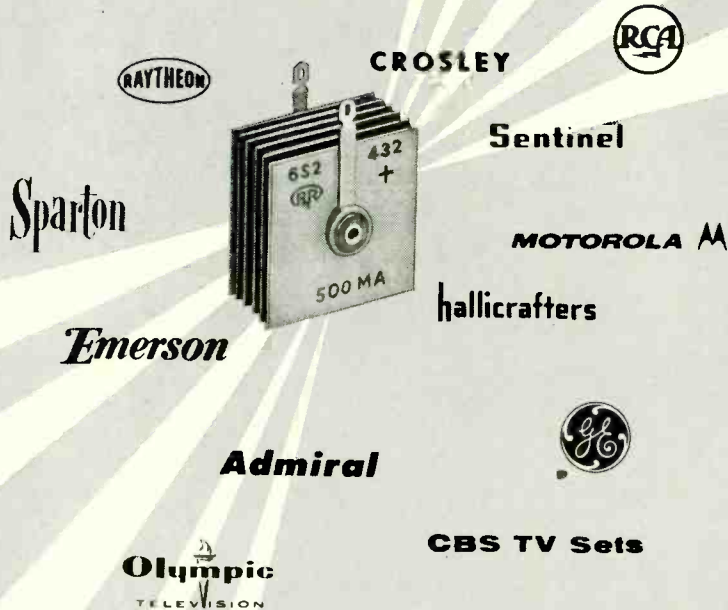

Fig. 1—Schematic diagram of bridge circuit and external voltage supply. Fig. 2—A thermistor calibration curve.

Original components in these and other leading Radio and TV sets since 1948



RADIO RECEPTOR

Selenium  Rectifiers

That's why they're the best replacements in any Radio and TV circuit!

These famous trademarks represent a few of the many long-time users of RRCo. Selenium Rectifiers. The complete list reads like a "Who's Who" in electronics.

Manufacturers' choice in so many models, RRCo. "Safe Center" rectifiers are ideal replacements in any set. Your parts distributor can supply you with standard Radio Receptor replacements for sets of all radio and TV manufacturers. Demand "Safe Center" rectifiers and insure the quality of your repair work.

Semiconductor Division



RADIO RECEPTOR COMPANY, INC.

In Radio and Electronics Since 1922

240 WYTHE AVENUE, BROOKLYN 11, N. Y. • EVERGREEN 8-6000

ELECTRONICS

The thermistor will produce a change in resistance as a result of either of two heating methods: a change in the temperature of the object the thermistor is touching—used in thermistor thermometry; internal heating—used in other applications of the thermistor but which introduces error in thermometry.

The thermistor is essentially a semiconductor resistor which heats when current is passed through it as any conventional resistor does. Because of the large temperature coefficient the internal heat produces a comparatively large change in resistance. The Wheatstone bridge detects this resistance change which is interpreted as a new temperature.

When interested only in temperature changes of objects the thermistor is in contact with, that component of resistance change due to internal heating is undesirable and does not truly repre-

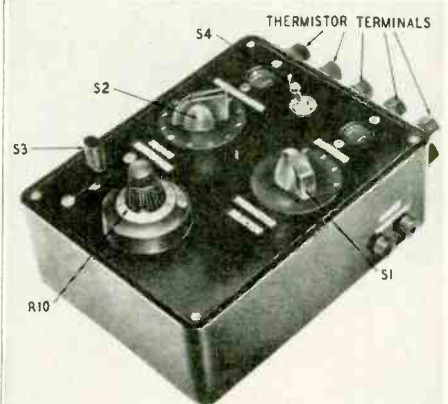

Front-panel view of the bridge chassis.

sent the object's temperature. To keep the dissipation constant so small that its effect is negligible, the power dissipated in the thermistor (E^2/R) is made small by using a battery potential of 1 volt. This is provided by a potentiometer across a mercury cell.

One other very important point must be stressed. The semiconductor material in thermistors is subject to a phenomenon known as aging, a cycling or conditioning which stabilizes the semiconductor material and increases its ability to provide a given resistance for a given temperature consistently. The aging process is continually in operation as long as the thermistor is subject to heating from any source. The outward effect of thermistor aging is a gradual increase in its room-temperature resistance over long periods of time.

A large part of this aging can be condensed into a few hundred hours by leaving the thermistor in the kitchen oven at approximately 250°F overnight for about 10 consecutive nights.

Thermistor-thermometer circuit

The modified Wheatstone bridge of Fig. 1 is used during the thermistor's calibration and for future temperature measurements. To permit monitoring temperatures at five points at once, the

Revolutionary NEWS in Receiving Tubes

**6 MILLION
HOUR
FIELD TEST**

—now, Sylvania tests every important TV tube type under actual set conditions to give you "time-tested" protection against call-backs

—6 million hours! To date that's the grand total of tube-testing in Sylvania's newest and biggest attack against common tube troubles and costly call-backs. To simulate "home operation" Sylvania tubes were taken from inventory and tested in 139 stock TV sets of leading manufacturers.

The "6-million-hour field test" is an important part of Sylvania's continuous design and development program to give you the most dependable tubes available for servicing all TV makes and models.

By giving Sylvania tubes rugged and dynamic tests at

accelerated line voltages, the common tube troubles of modern "hard working" circuits are corrected before they start digging into your profits.

Design improvements resulting from these tests give you superior replacement tubes, which often out-perform original equipment designs.

Look for the yellow and black carton—it represents a new kind of tube dependability backed by the 6-million-hour field test.



SYLVANIA[®]

SYLVANIA ELECTRIC PRODUCTS INC.
1740 Broadway, New York 19, N. Y.
In Canada: Sylvania Electric (Canada) Ltd.,
University Tower Bldg., Montreal

LIGHTING • RADIO • ELECTRONICS • TELEVISION • ATOMIC ENERGY

NEW



PHAOSTRON

NONE FINER

"777"
V. T. V. M.
(VACUUM TUBE VOLTMETER)

YOUR KEY TO EXCELLENCE



The MODEL "777" V.T.V.M. is a completely self-contained, ready-to-use test instrument. Its accessories and the HF co-ax cable, DC Probe, AC line cord and instruction book all fit in the genuine California Saddle Leather carrying case that is furnished with the instrument.

- 42 Unduplicated Ranges
- Illuminated Dial (5000 hour self-contained lamps)
- Die Cast Chrome Finished Bezel
- Metal Case, unbreakable, ultra compact
- Doubly Shielded, time proven 200 microamp movement
- Permanent Accuracy . . . 3% DC, 5% AC
- Large, Easy to Read Scales 4 7/8" Long
- Color Coded Scales: green—ohms; black—AC, DC; Red—P. to P.
- 2 Zero Center Scales for FM Discriminator Alignment
- Separate Range and Function Switches
- Only 2 Jacks for All Measurements
- New, High Style, Easy-to-Use Chrome Bar Knobs
- Dual Purpose Handle also serves as AC line cord reel

"777" V.T.V.M. complete with Coaxial Cable, DC Probes and Leather Case at your PARTS DISTRIBUTOR **\$69⁹⁵**

PHAOSTRON INSTRUMENT AND ELECTRONIC COMPANY
151 PASADENA AVE., SOUTH PASADENA, CALIF.

ELECTRONICS

bridge is modified to accommodate five thermistor inputs.

Features of the bridge include a 10-turn Helipot potentiometer and selector switch S2. The combination of the potentiometer and the selector switch in one arm of the bridge allows the thermistor in the opposite arm to have any value of resistance from almost zero to 110,000 ohms. The resistors are precision 1% Nobeloys. Switches S1, S2 and S3 are of the shorting type to prevent transient-current damage to the galvanometer. The galvanometer should have approximately 2,000 ohms internal resistance to get a high degree of sensitivity from the bridge. A galvanometer having a sensitivity of 75-0-75 microamperes is sufficient for all but the most precise temperature measurements.

The thermistor terminal banana jacks are spaced to take the General

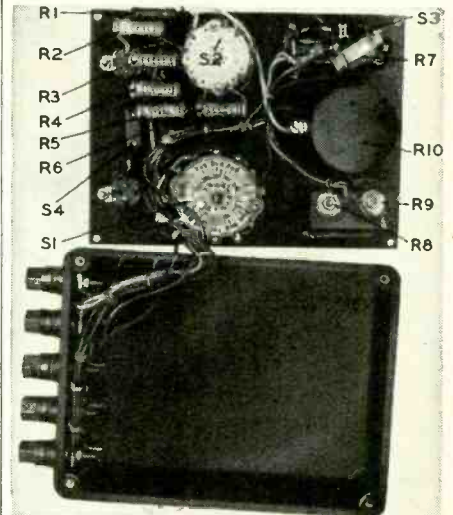

Layout of the bridge-circuit parts.

Radio double banana plug. This same spacing, 3/4 inch, is also used for the external galvanometer shunt jacks located on the lower right side of the bridge box.

The galvanometer shunting circuit is set up so that any size shunt resistor may be added externally. Fixed internal shunt R7 is 100 ohms. When using the 2,000-ohm galvanometer this would reduce its sensitivity to 5% of the original value. This is handy when using five thermistors all operating at unknown temperatures. The operation of the bridge with the shunt in is not as critical when determining the general operating point of a particular thermistor. Once this operating point has been found, a switch is made to the sensitive scale of the galvanometer to find a precise bridge balance and the thermistor's resistance.

The entire thermistor thermometer, with two exceptions, is mounted in a large meter case (see photos). The two exceptions are the galvanometer and the 1.34-volt mercury cell and its potentiometer.

During a series of temperature mea-

Exclusive!

The First **MULTI-CHANNEL** YAGI...PRE-TUNED TO CHANNELS OF YOUR CHOICE

New! **WINEGARD**



- ... Gives You More Gain on Channels in Your Area
- ... Because it's Peaked to Channels in Your Area

There has never been an antenna like the COMBO — the first MULTI-CHANNEL TV ANTENNA that is actually PRE-TUNED TO YOUR AREA. The Combo is factory peaked in 16 different channel combinations — one of which will give you the ultimate in performance on the specific channels you want.

This is the first logical, practical TV antenna development in years. The Winegard COMBO is guaranteed to give better performance on all channels in your area, regardless of size or number of bays of the antenna you are now using.

Another original by WINEGARD!

Available in 16 Factory Pre-Tuned Combinations

Custom-Combo Model No.	Channels Peaked for												
TC3-A	2	3	4	5	6	7	8	9	10	11	12	13	
TC3-B	2	3	4	5	6	7	8	9	10				
TC3-C	2	3	4	5	6		8	9	10	11			
TC3-D	2	3	4	5	6				10	11	12	13	
TC3-E	2	3	4			7	8	9	10	11	12	13	
TC3-F	2	3	4			7	8	9	10				
TC3-G	2	3	4				8	9	10	11			
TC3-H	2	3	4							10	11	12	13
TC3-I		3	4	5	6	7	8	9	10	11	12	13	
TC3-J		3	4	5	6	7	8	9	10				
TC3-K		3	4	5	6		8	9	10	11			
TC3-L		3	4	5	6					10	11	12	13
TC3-M			4	5	6	7	8	9	10	11	12	13	
TC3-N			4	5	6	7	8	9	10				
TC3-O			4	5	6		8	9	10	11			
TC3-P			4	5	6					10	11	12	13



Designed for

BLACK & WHITE

AND

COLOR

Single bay Combo — \$29.95 Double bay Combo — \$59.95

5 GOOD REASONS TO INSTALL THE COMBO:

1. Pre-Peaked to Your Channels
2. Electro-Lens* Director System
3. Completely Pre-Assembled
4. Automatic Twin-Lock Hardware
5. All Aluminum and Stainless Steel Construction

MAIL TODAY

WINEGARD COMPANY
3000 Scotten Boulevard
Burlington, Iowa

1.

Please RUSH COMBO Bulletin No. WL11135
 Address of nearest distributor

NAME OF FIRM _____

ADDRESS _____

CITY _____

ZONE _____

STATE _____

SIGNATURE _____



Steelman Twin Speaker
"Sonorama", Model 3D15

Steelman ...
famous manufacturer of Hi-Fidelity Phonographs

CHOOSES GENERAL INDUSTRIES

Smooth Power

PHONOMOTORS

Steelman chooses GI Phonomotors for original equipment in its famous line of Hi-Fidelity plural speed phonographs because experience has proved that there is no substitute for the best. GI Phonomotors have shown by years of trouble-free performance that GI is always the one best choice. When you need phonomotors, take a cue from Steelman, you, too, will find that it pays . . . to rely on GI!

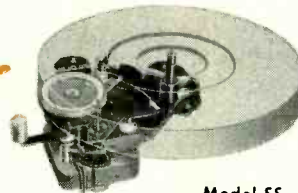

Model 55
Three Speed Motor

Other General Industries AC induction type motors for applications ranging from 1/40 HP to 1/1100 HP.

Write for specifications and quantity-price quotations today.



THE GENERAL INDUSTRIES CO.

DEPT. GE • ELYRIA, OHIO

DESIGNED FOR THE BOOKSHELF
with **LARGE SYSTEM PERFORMANCE**

Only 17 1/4" x 11 1/4" x 10"
Only 1 Cubic Ft.

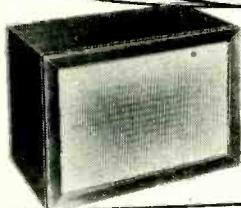

KARLSON "8"
FOR 8" SPEAKERS

INCREDIBLE!

- Cleanness of Response
- Bass Response
- Dispersion Of The Highs

Complete line of Models

FIR PLYWOOD KIT (Model 8K) \$1790

PEBBLE-TONE FINISHED UNIT (Model 8P) \$3450

ASSEMBLED PLYWOOD UNIT (Model 8U) \$2844

KARLSONITE FINISHED UNIT (Model 8B & 8M) \$4950

THERE'S A KARLSON FOR YOU

KARLSON ASSOCIATES, INC.

DEPT. T

1610 Neck Road • Brooklyn 29, New York

KARLSON
ULTRA-FIDELITY
ENCLOSURES

Please send copy of your latest book "The Karlson Enclosure"



ELECTRONICS

surements, the resistive load on the mercury cell will change slightly. Also, I found that for each new voltage to the bridge, a new calibration curve was necessary. For these reasons the bridge potential is adjusted to 1 volt and maintained at that during calibration and subsequent temperature measurement.

Thermistor calibration

The most important step before putting the thermistor to work is its calibration. Because semiconductor materials have not reached such a stage of reliability that each unit is like its mates in the way that 6SN7's are like theirs, the manufacturer cannot publish a general curve to cover any particular thermistor. Therefore, each one requires its own calibration curve. One such curve is shown in Fig. 2 and was plotted from the following data:

Temperature (degrees C)	Resistance (ohms)
30	61,790
32	57,200
34	52,430
36	48,170
38	44,250
40	40,750
42	37,480
44	34,550

The calibration curve is simple to produce. The equipment needed includes a large dishpan or sink, some method of heating the water in the dishpan, some method of stirring this water (such as the wife's electric mixer) and a good thermometer. The thermistor is placed in the water after having been insulated from it by some method such as a coating of wax. The water is then slowly heated and stirred. Start at a temperature below that expected in practice and go beyond the highest anticipated. As the temperature of the water rises, the resistance of the thermistor drops. From the thermometer record the temperature and from the direct-reading bridge the thermistor's resistance. These points plotted on graph paper make up that particular thermistor's calibration curve. To "read the thermometer" one simply reads the resistance from the bridge and finds the corresponding temperature from the calibration curve.

Thermistor availability

Due to the newness of the thermistor, most general radio distributors do not handle it. The one used in this thermometer was selected from an experimenter's kit No. M-168, manufactured by Victory Engineering Corp., Union, N. J.

These thermistors have been aged only 24 hours and will normally require further aging for precise temperature work. Bendix-Friez, 1400 Taylor Ave., Baltimore 4, Md., also handles experimenter kits.

The thermistor thermometer was

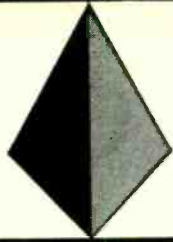

NO. 57

PYRAMID

technical

bulletin

**THERE IS MORE TO A CAPACITOR
THAN ITS DESIGN FORMULA:**

$$C = \frac{K D}{A}$$

Pyramid's production and life tests of their capacitors are among the most stringent in the industry. Production test for voltage breakdown, capacitance, power factor, insulation resistance and seal are performed on 100% basis. In consisting of life, temperature and immersion cycling, vibration, and corrosion where applicable. These serve to guarantee that the capacitors you purchase are consistently as represented to be.

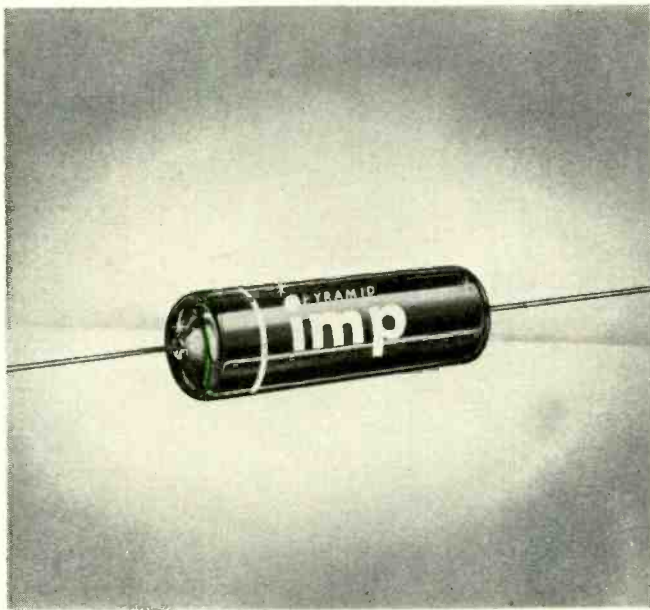

Pyramid capacitors also owe their exceptional performances to the type of materials used in their manufacture and the production methods which Pyramid engineers have devised. For example, in the new Pyramid IMP capacitor, a new, exclusive plastic molding technique was developed which bonds casing, impregnated element, and tinned copperweld leads into one compact assembly capable of withstanding severe physical abuse. In addition, this unit is heat and moisture resistant withstanding the RETMA humidity-resistance test to a remarkable degree. In another capacitor, type MT metallized paper units, vacuum impregnation is employed and the ends of the capacitor are sealed with plastic. Then, as a final step, the entire unit is completely coated with a highly moisture resistant wax. It is production techniques such as these which, in conjunction with high quality papers, impregnants (such as Halowax, Mineral Oil, or Silicone Base Synthetic Oil), and metals, that account for the excellent stability and long life that Pyramid capacitors exhibit.

Pyramid capacitors, particularly electrolytic capacitors, are specifically designed for long shelf life. To achieve this goal requires that the various materials and chemicals used in the manufacture of these units possess a high quality and long term stability. Another contributing factor to long shelf life is the care which is taken to provide maximum protection against the corrosive effects of chemicals in the atmosphere. This necessitates a container which is well insulated against the intrusion of moisture, i.e., one which is air tight and hermetically sealed.

* * * * *

The number of different types of capacitors that Pyramid manufactures is extensive. Included in this line are the following:

1. Electrolytic capacitors, type TD, with each unit sealed in a metal tubular case. Available in single sections, dual sections, and triple sections.
2. Electrolytic capacitors in screw base metal containers, type MC. Available in single and dual sections.
3. Twist-Mount electrolytic capacitors, type TM. Available in single, dual, and triple sections. Different sections may have different working voltages.
4. HI-TEMP Twist-Mount Electrolytic capacitors, type TWH. Designed for 100°C operation.
5. Dry Electrolytic capacitors in wax-filled, impregnated cardboard tubes, type CDB. Available in single, dual, and triple sections. Sections may possess individual leads or share a common negative terminal.
6. Plug-in Electrolytic capacitors, type DO, provided with 4 pins on standard octal base.
7. High-capacitance, low voltage electrolytic capacitors, type PFB.
8. Molded tubular paper capacitors, type IMP.
9. Miniature tubular paper capacitors. Type 85LPT.
10. Ceramic-cased tubular paper capacitors, type CT.
11. Bathtub-Type Oil-Paper Capacitors, types PDM, PDMT, PDMB.
12. Metal-tubular Oil-Paper capacitors, types PTIM, PTDMV, 4PTIM, 4PTIMV, 7PTIM.
13. Small-base oil-paper capacitors, types PKM, PKMF, PKMS, PKMT, and PKMB.
14. High-voltage oil-paper capacitors, types PLM, PLMF, PLMS, PLMU, PLMR.
15. Kraft-tube metallized paper capacitors, type MT.
16. Metal-can metallized paper capacitors, types MP GK, MP GM.
17. Metal-tube metallized paper capacitors, types MPTIK, MPTIM.
18. "Glasseal" subminiature paper tubular capacitors, and many others.

Pyramid capacitors are competitive in price because of the modern production methods that are employed throughout every phase of capacitor production. Whenever possible, automation techniques are being applied so that more uniform high quality may be achieved. Much of Pyramid's success is due also to the aggressiveness of Pyramid engineers in pioneering new products.

PYRAMID ELECTRIC CO.



North Bergen, New Jersey

FOR COMPLETE DATA SEND FOR ENGINEERING BULLETIN—FORM IMP-2

SEE US AT BOOTH 213
AT THE MAY PARTS SHOW

PYRAMID IS THE BIG NAME IN CAPACITORS AND SELENIUM RECTIFIERS TODAY!

64% of the top Engineers PREFER AND USE

HICKOK

DYNAMIC MUTUAL CONDUCTANCE TUBE TESTERS

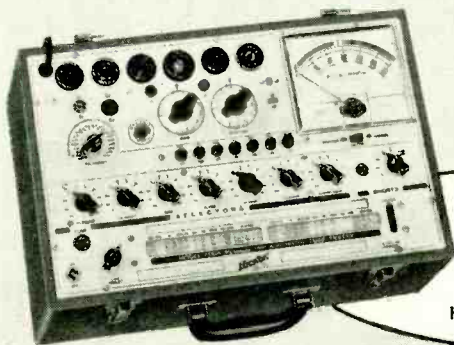

**MODEL
600A**

World's most popular
Tube Tester

"... that 600A is certainly unbeatable! I have sold 4 for you by just letting service centers use mine for part of one day."

Harold F. Tolles, St. Johns, Mich.

"I purchased a 600A last Fall and have found it to be one of the best investments in test equipment that I have ever made."

R. Lytwyn, Nytyl Electronics

All tube testers manufactured today fall into four major classifications.

If you use vacuum tubes in your profession, and if you ever intend to purchase a tube tester please write today for the 28 page book of Tube Tester Facts and learn the advantages of each classification in order that you will be able to more efficiently select for your requirements. This detailed, illustrated and descriptive book also contains circuit diagrams and formulas.



THE HICKOK ELECTRICAL INSTRUMENT CO.

10531 DUPONT AVE. • CLEVELAND 8, OHIO

Gentlemen:

Kindly send me free of charge your new 28 page book of Tube Tester Facts.

NAME _____

COMPANY _____

STREET _____

CITY _____ ZONE _____ STATE _____

ELECTRONICS

built for Victory Engineering thermistor No. 51A4 with a room-temperature resistance of $71,000 \pm 20\%$ (14,200) ohms. The 51A4 is shaped as a bead 1 mm in diameter with approximately 1-inch platinum pigtailed. Due to its small size it can be taped any place the temperature does not exceed the maximum safe continuous temperature specified by the manufacturer. The small dimensions make it possible to mount and use the thermistor in an almost limitless number of places. This greatly increases the usefulness of this type of thermometer. The 51A4 is stable up to 150°C and may be used up to 300°C with caution. All safe operating limits are given in the experimenter's kit. During continuous use of the thermometer, the thermistor should be recalibrated each month or so. This is necessary because the room-temperature resistance will slowly increase with time as the semiconductor material slowly ages.

Parts for thermistor thermometer

Resistors: 1—100, 1—10,000, 1—20,000, 1—30,000, 3—40,000, 1—50,000, 1—60,000 ohms, 1%: 1—1,000 ohms, wirewound; 1—Helipot precision potentiometer, 10-turn model A, 10,000 ohms.

Switches: 1—2-pole 5-position, shorting; 1—2-pole 12-position, shorting; 1—2-pole 3-position, shorting-lever action; 2—spst.

Miscellaneous: 1—75-0-75- μ amp meter, approximately 2,000 ohms internal resistance; 1—large instrument case; 2—jacks for battery and meter; 12 banana jacks (6 red, 6 black); 1—10-turn counting dial (G. W. Borg Microdial or equivalent); 1—mercury cell, 1.34 volts.

The unit described here will measure temperature changes between the limits of approximately -20° to $+300^\circ\text{C}$. The use of glass-embedded thermistors enables the upper limit to be extended to 500°C . Select connecting cable that can endure the temperatures the thermistors will measure. The versatility of the thermistor thermometer is almost unlimited where temperature measurement is concerned, and the experimenter who builds one will be repaid amply for his time and trouble. END

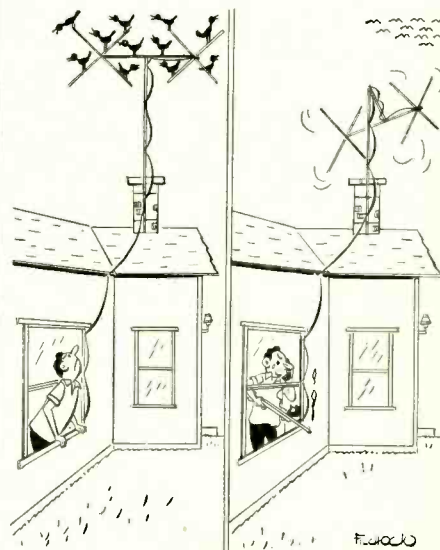

"Hello! Acme Television Service . . ."

Sprague Salutes the Independent Service Dealer

Ask your distributor
for big, window-size
blow-ups of this ad,
or write directly to
Sprague Products Co.,
North Adams, Mass.,
on your letterhead.

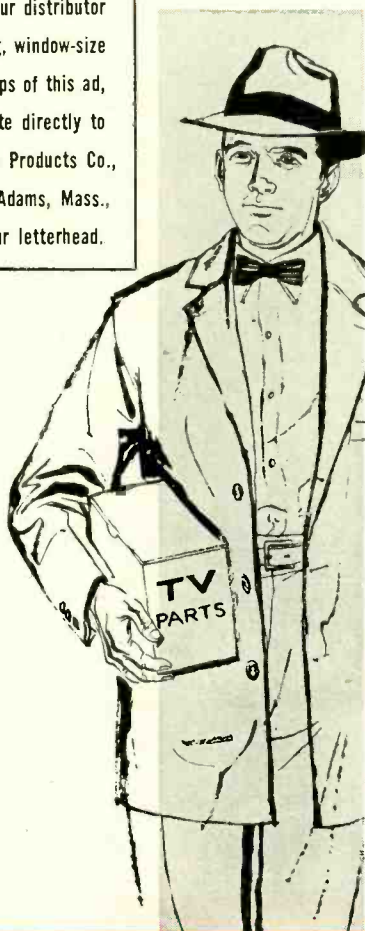

HERE'S TO THE MAN

- ...who assures your enjoyment of the best entertainment in the land.
- ...who competently and conscientiously keeps your TV and radio in top operating condition.
- ...who has become a specialist in his chosen field like your doctor, lawyer, or dentist.
- ...who has the finest service equipment to operate his own business in your home community.
- ...who stands alone ... serving no other boss than you, the customer.
- ...who has earned your patronage, respect, and confidence as an important asset to the community he serves.

YOU CAN DEPEND ON THIS MAN

SPRAGUE

WORLD'S LARGEST MANUFACTURER OF ELECTRONIC COMPONENTS

®

MINIATURE RECEIVER for MODEL CONTROL

Small superregenerative receiver and relay for 27.255-mc operation

By RUFUS P. TURNER, K6AI

ELECTRONICS and mechanically operated models are exciting hobbies. The radio control of models brings these two hobbies together in an interesting fashion.

Radio equipment for model control need not be complicated. Here is a small, good-performing superregenerative control receiver and relay that can be mounted on a small airplane, midget car, boat or train. It is inexpensive and easy to build.

The receiver is designed to operate on the Citizens band control frequency of 27.255 mc. The unit can be used with any of the currently available transmitters built for this range. A small trimmer capacitor tunes the receiver over the range of 23 to 40 mc. However, higher model-control frequencies may be reached by reducing the number of turns in the tuning coil.

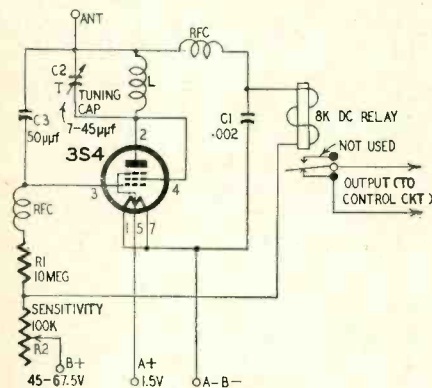

Fig. 1—Schematic diagram shows circuitry of radio-control receiver.

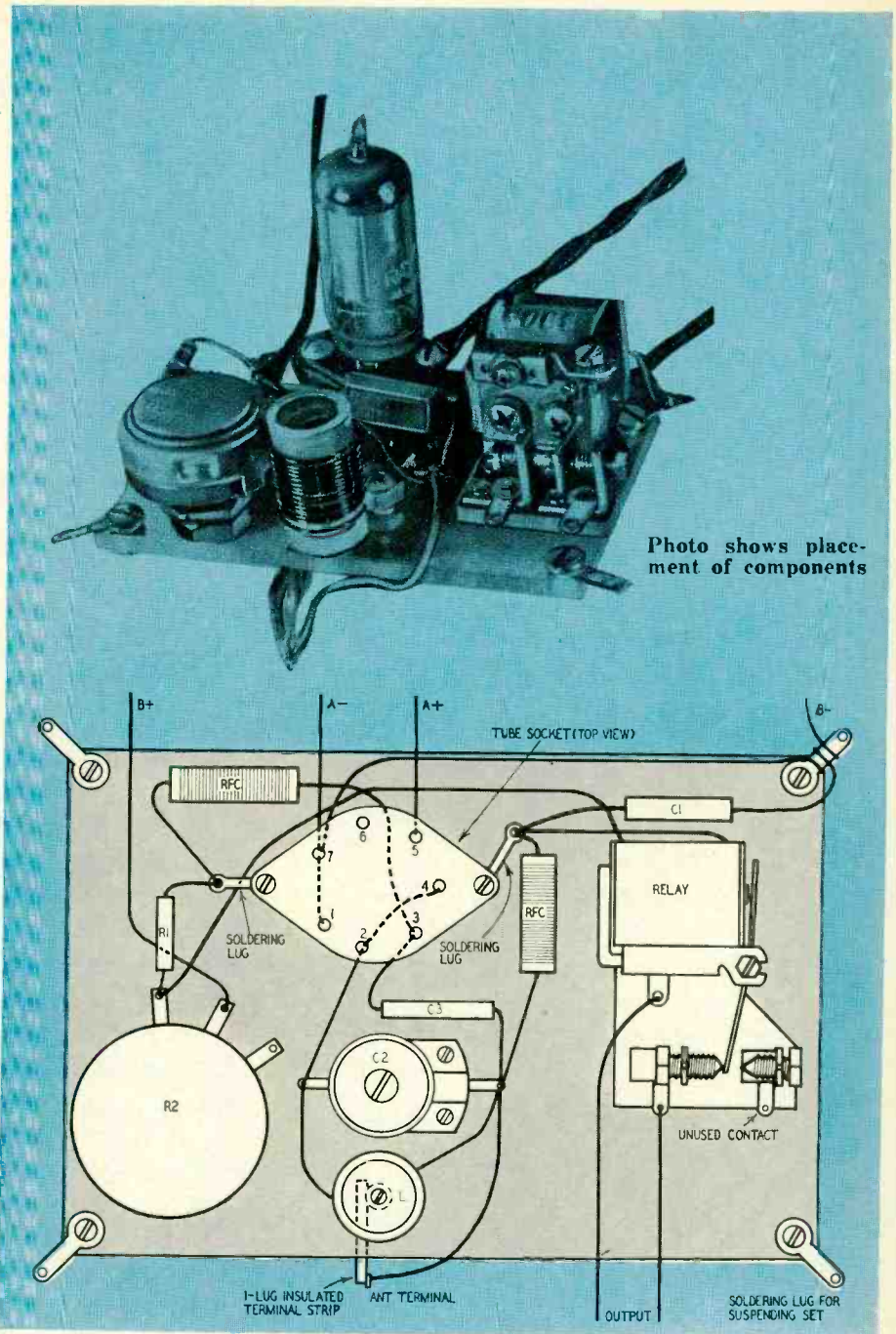

Fig. 2—Pictorial wiring diagram of the radio-control miniature set.

The components are mounted on a Plexiglas plate $3\frac{1}{2}$ inches long, 2 inches wide and $\frac{1}{8}$ inch thick.

The circuit (Fig. 1) is a simple superregenerative detector. The tube is a 3S4 with screen and plate connected together at the socket. The 1½-volt A battery and 45- or 67½-volt B battery furnish all the power required. Since the batteries usually are mounted, along with a switch, in a small box or case or are strapped or clamped inside the model structure, no attempt has been made to include them in the receiver. Instead, four wire leads are brought out for battery connections.

The receiver drives a sensitive Sigma type 4F 8,000-ohm dc relay, available in surplus. Circuit sensitivity is controlled by a 100,000-ohm potentiometer

R2. The tuner consists of coil L and trimmer capacitor C2.

The receiver components are mounted on a small Plexiglas panel. However, Bakelite, fiber or any similar insulating material may be used. The parts are mounted as shown in Fig. 2.

The tube stands upright, although model airplane-control experimenters prefer to lay theirs down for shock protection. I found that the upright position saves space on the mounted panel and does not severely cramp quarters in the receiver installation. However, there is no objection to laying the tube down if this is preferred.

Coil L consists of 15 turns of No. 22 enameled wire (spaced to a winding length of $\frac{5}{8}$ inch) wound on a National PRE-2 9/16-inch diameter polystyrene



FROM DELCO RADIO come the **speakers** with highest performance. You trust them...so do your customers!

Engineering skills of Delco Radio and General Motors combine to offer a full line of speakers for home and auto radios, phonographs, TV, and Hi-Fi. National advertising behind the Delco Wonder Bar Radio develops a bigger service market for you! For fast service call your UMS-Delco Electronics Parts Distributor.

14 Standard Models: Designed and built to R.E.T.M.A. standards with heavily plated metal parts and Alnico-V magnets. Precision felted cones give uniform response over full operating frequency range. All are fully dustproof and dependable.

Dual-Purpose Hi-Fi Model 8007: A superior speaker for custom-built audio systems and for replacements in AM, FM, TV and phonograph sets. Size 8", 50 to 12,500 CPS frequency range; Alnico-V magnet; 10-watt power rating; 4.1 v.c. impedance; 1 $\frac{3}{16}$ " voice coil.

DELCO

WONDER BAR

RADIO

DIVISION OF GENERAL MOTORS, KOKOMO, INDIANA



A GENERAL MOTORS PRODUCT — A UNITED MOTORS LINE
Distributed by Electronics Distributors Everywhere

A complete line of original equipment service parts from the

WORLD LEADER IN AUTO RADIO

Especially

where

space

is

limited



the
GOODMANS

Axiette
8 inch
HIGH FIDELITY
LOUDSPEAKER

MADE IN ENGLAND

ROCKBAR CORPORATION, Dept. LD-9
215 East 37th St., New York 16, N. Y.

In Canada: A. C. Simmonds & Sons, Ltd.,
Toronto, Canada

Please send complete description of the
Goodmans Axiette.

Name.....

Address.....

City..... Zone..... State.....

My Dealer is.....

RADIO

form. This form has a mounting hole in its bottom. The screw that holds the form to the panel also supports a one-lug insulated terminal strip under the panel for connection of the antenna wire.

The sensitivity control potentiometer R2 has a slotted shaft for screwdriver adjustment and is mounted with its shaft extending through to the underside of the panel.

Two solder lugs (labeled in Fig. 2 diagram) are held close to the panel by the tube-socket mounting screws. These lugs are used as tie points for the leads of rf choke RFC2 and resistor R1 and for rf choke RFC1, capacitor C1 and one relay coil lead.

Each of the two rf chokes is made by close-winding 110 turns of No. 36 enameled wire on a 5-megohm 1-watt carbon resistor (resistor diameter ¼ inch). The ends of the winding are soldered directly to the resistor pigtailed which serve as the leads for the rf choke.

The tuning capacitor, an Erie TS2A 7-45- μ f ceramic trimmer, is mounted on the panel close to coil L. Its lugs serve as tie points for various leads, as can be seen in Fig. 2. This capacitor is adjusted with a screwdriver.

A solder lug is fastened to each corner of the panel with a 6-32 screw and

Parts for miniature receiver

1—10-megohm ½-watt carbon resistor; 1—100,000-ohm potentiometer; 1—50- μ f mica capacitor; 1—.002- μ f mica capacitor; 1—7-45- μ f tuning capacitor (Erie Ceramicon trimmer TS2A or equivalent); 1—coil L (see text); 2—rf chokes (see text); 1—8,000-ohm sensitive dc relay (Sigma type 4F or equivalent); 1—354; 1—7-pin miniature socket; 1—1.5-volt A battery; 1—45-67.5-volt B battery; 1—length of antenna wire; 1—insulated chassis; soldering lugs.

nut, providing simple hooks for suspending the receiver by springs, cords or strong rubber bands inside the model. Another shockproof mounting method is to fasten the receiver to a fairly thick cushion of sponge rubber or similar material.

Adjustment

A 1-2-foot length of insulated wire or stiff bus bar should be connected to the receiver as an antenna. Adjustments may be made with the aid of a signal from the control transmitter or from a small 2-5-watt oscillator operated at 27.255 mc.

With no signal input, adjust the sensitivity with potentiometer R2 (starting with the full resistance of this potentiometer) until the circuit is just on the verge of superregeneration; you can tell by a dc milliammeter connected in the B-plus lead. The meter will show about 2 ma under these conditions and the relay will close thereby opening the used contacts. The signal then is tuned in by adjusting capacitor C2. At this point the plate current, as indicated by the milliammeter, will drop to about 0.8 or 0.9 ma and the relay will open, closing the used contacts. END

THE BOOK YOU NEED
TO PRICE WITH SPEED...
for profit

quick check for 60,000 prices
Profit-making time-money-phone
call-saver. 200 pocket-sized pages.
Replacement parts listed by manu-
facturer, product and part number.
up-to-date charging information
Completely revised 4 times a year.



"Very useful to me" - Conway, Penna.

"Been able to find every item" - Frankfort, Ky.

"Nice to have all prices" - Kincaid, Pa.



"It's a perfect book" - Truesdell, Ont.

and the perfect partner...
**DAVE RICE'S OFFICIAL TV-RADIO
SERVICE ORDER BOOK**

For TV, Radio, Phono or Hi-Fi service,
provides separate listings for:

Picture tubes, receiving tubes, parts and
components, serial numbers, labor and
state and local taxes. 5½"X8½"—50 sets
of triplicate orders—carbons bound in.

at parts distributors or send check to

ELECTRONIC PUBLISHING CO., INC.
180 NORTH WACKER DRIVE • CHICAGO 6, ILLINOIS

DIGEST: \$2.50 per copy.

**ORDER BOOK: \$.75 each or \$6.50 per
dustproof box of 10.**

You can service faster...better with these new RCA TEST INSTRUMENTS

NEW SENIOR
VoltOhmyst®,
RCA WV-98A

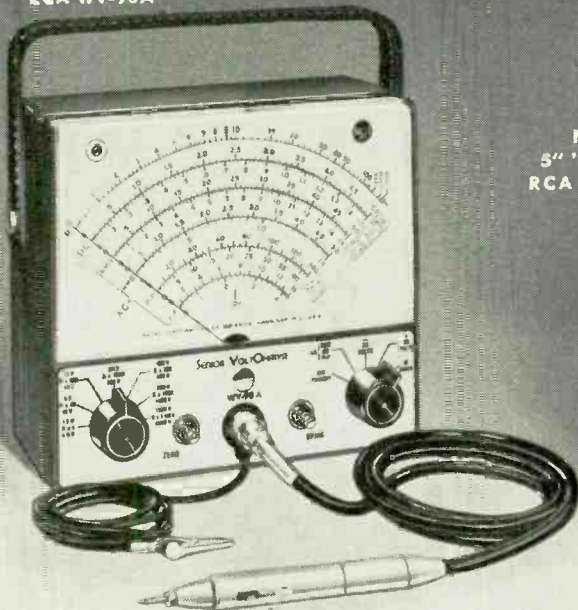

NEW
5" 'SCOPE,
RCA WO-91A



You can service faster with the new RCA WV-98A SENIOR VoltOhmyst because it has such work-simplifying features as full-vision, expanded, easy-to-read meter scales, and a new, streamlined single-unit probe with built-in dc/ac-ohms selector-switch which facilitates trouble-shooting in compact sets. The new RCA 5" 'SCOPE, WO-91A, too, is packed with labor-saving time-saving features usually found in more expensive instruments. It has preset "V" and "H" sweep positions, and there's a built-in semi-automatic voltage-calibrating circuit that automatically disconnects the input circuits during calibration. Improved circuit designs result in exceptional stability, contributing to faster—better service jobs!

NEW SENIOR VoltOhmyst®, RCA WV-98A — has separate, color-coded peak-to-peak and rms-voltage scales—factory calibrated with the finest laboratory instruments • 14 ac ranges • 7 dc ranges • 7 resistance ranges • 11 megohms input resistance on dc • $\pm 3\%$ accuracy full-scale on both ac- and dc-voltage measurements • tracking error 1% or better. RCA WV-98A is supplied with the new slim, single-unit WG-299A DC/AC-Ohms switch-probe and shielded cable, ground cable, alligator clip, and instruction booklet—complete price \$75.00*

*User Price (optional)

NEW 5" 'SCOPE, RCA WO-91A — a dual-bandwidth 'scope • can be used to observe and measure color-burst signals, for signal tracing, and for aligning wide-band video amplifiers and chrominance circuits • multi-scale graph screen, scaled directly in peak-to-peak volts, makes direct reading of voltages as simple as with a VTVM • response within ± 1 db from 10 cps to 4.5 Mc in wide-band position • sensitivity 0.05 volt peak-to-peak (0.018 volt rms) in narrow-band position • polarity-reversal switch • facilities for "Z"-axis modulation. RCA WO-91A, including WG-300A two-way direct/low-capacitance probe and cable, alligator clip, ground cable, green-graph screen, and instruction booklet—complete price \$229.50*

Speed-up your service jobs...keep-up your quality...with "serviceman priced" RCA TEST EQUIPMENT—now—at your RCA Distributor! For data, write RCA, Commercial Engineering, Section D39W, Harrison, N. J.



TEST EQUIPMENT
RADIO CORPORATION OF AMERICA
Harrison, N. J.

Electronic Voltage Regulation

By L. B. HEDGE *Principles and applications of glow-tube and feedback regulator*

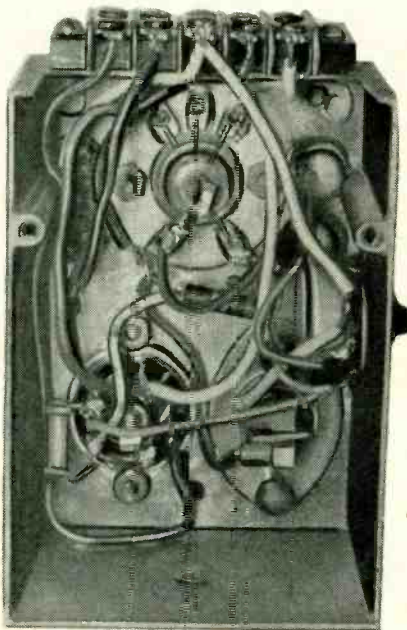
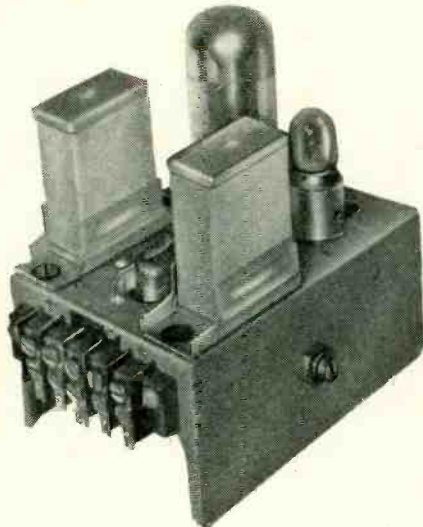

Topside and underchassis view of the Fig. 7 feedback voltage regulator.

A group of typical glow tubes.

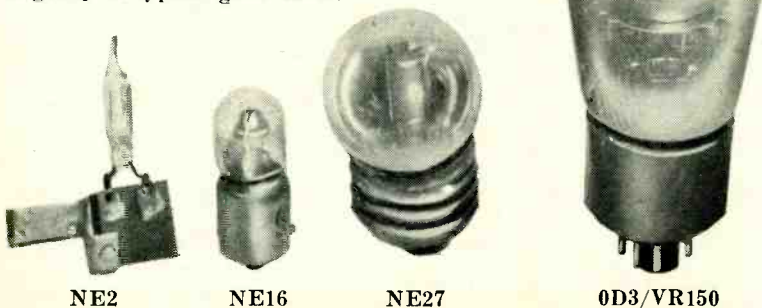

A VOLTAGE-REGULATED power supply for electronic equipment is a feature seldom absolutely necessary but frequently highly desirable. Voltage regulation increases stability in oscillators, amplifiers and measuring instruments. It provides a freedom from hum in high-quality amplifiers which is well nigh unattainable without it.

Because voltage regulators are sometimes complicated, always involve a certain amount of additional equipment and space and are not necessary to the basic operation of most devices, they are regarded by many designers and equipment builders as luxury items. This attitude, although it may have been justified in times past, is certainly no longer valid. With the current low prices and general availability of special-purpose and nonpreferred tube types, a relatively complicated feedback amplifier type voltage regulator may well be cheaper, lighter and more effective than a conventional filter for reducing ripple to a required low level. The stabilization and effective low impedance of the regulated output is then pure profit!

Voltage regulators for direct-current operation are of two basic types—constant-voltage-drop load devices (glow lamps), feedback amplifier regulators (servo systems in the strictest sense). Since glow lamps are usually used as voltage reference elements in feedback amplifier regulators, the glow lamp is properly regarded as the basic element in practical dc voltage regulation.

The constant-voltage-drop glow lamp is available in a variety of standard

types which operate over a considerable range of voltages and currents. The glow lamp is basically a pair of metal electrodes enclosed in an envelope containing gas (usually neon or argon). The size, composition and structure of

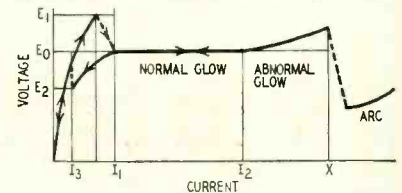

Fig. 1—Glow-tube characteristics.

the electrodes and the composition and pressure of the gas in which they are immersed determine the characteristics of the various glow-tube types. Glow-tube operation is most easily described by analyzing a typical characteristic curve (Fig. 1) in connection with the circuit (Fig. 2) used to determine it.

Variable voltage source E_s is connected to a glow tube through resistor R (an appropriate value for R will be discussed later), and a voltmeter and milliammeter are connected as indicated to measure the current through and voltage across the glow tube.

A minute current (a few microamperes—undetectable on the milliammeter) will flow in the tube as E_s is increased to E_1 (Fig. 1). When E_s reaches E_1 —the *striking or breakdown* voltage—the gas in the tube provides an ionized conduction path for current flow between the electrodes and the voltage across the glow tube drops to E_0 —the *operating voltage*—while the current rises to I_1 . This conduction in the ionized gas of the tube produces a luminous glow at the cathode of the glow tube. If the value of R is such as to keep this current within the normal operating range of the tube, the glow will be of moderate intensity and cover a small or large part of the cathode depending on the actual current value.

If E_s is now gradually increased, the current flowing in the tube will increase while the voltage across it remains substantially constant at E_0 . If the current rises beyond I_1 —the maximum normal operating current—the tube will begin to glow brightly and the voltage drop across it will increase steadily. This is a danger zone of operation since the abnormal discharge tends to disintegrate the electrodes and the excessive heat dissipated in the tube raises the gas pressure in the envelope.

Glow-tube operation in the region of *abnormal glow* will shorten the tube's

Federal

...America's pioneer
selenium rectifier

FIRST IN PREFERENCE!

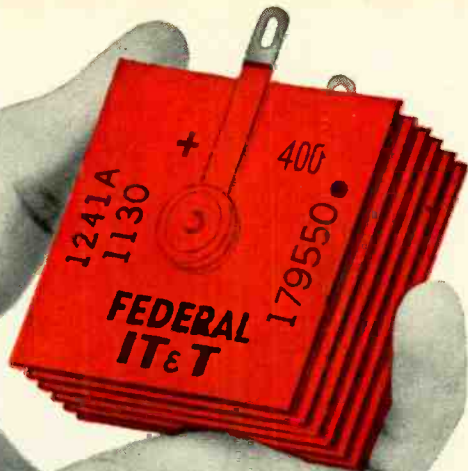

with **MORE**
Manufacturers

with **MORE**
Distributors

with **MORE**
Servicemen

More radio and TV manufacturers—through their design and component engineers—have placed their OK on Federal Selenium Rectifiers than any other make! Consequently, *more* distributors stock Federal to take care of *more* calls from servicemen for "replacement by Federal."

Literally tens of millions of Federal types have been factory-installed. Federal is OK with manufacturers because Federal means *dependable* receiver performance...

OK with distributors because Federal is in such high favor and big demand... OK with servicemen because Federal is profitable and customer-satisfying. Whatever *your* rectifier requirements you can meet them with Federal's *Universal* and *Regular* Lines... one source of supply for the radio-TV industry! Write today to Dept. F-163.

Here are the clinching reasons behind
Federal's coast-to-coast leadership:

- Longer life
- Higher output voltage
- Lower temperature rise
- Superior humidity resistance
- More uniform quality
- Proven mechanical construction
- 85° C. UL acceptance
- Conservative ratings
- Largest plant capacity
- More engineering know-how

Federal Telephone and Radio Company

A Division of INTERNATIONAL TELEPHONE AND TELEGRAPH CORPORATION
COMPONENTS DIVISION • 100 KINGSLAND ROAD • CLIFTON, N. J.

In Canada: Standard Telephones and Cables Mfg. Co. (Canada) Ltd., Montreal, P. Q.
Export Distributors: International Standard Electric Corp., 67 Broad St., New York

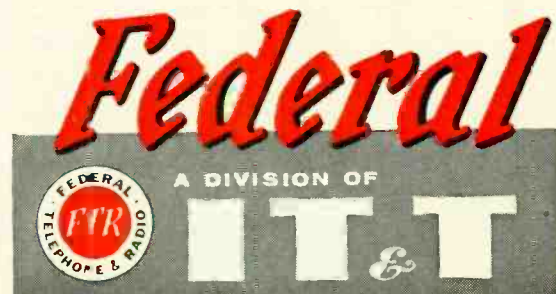



RCA

ANNOUNCES OPPORTUNITIES

**In Guided Missile Test Instrumentation
For Electronic Technicians**

At the following locations

PATRICK AIR FORCE BASE, FLORIDA	CAPE CANAVERAL	
Engineering development technicians	Radar	Timing
Radar	Radio	Telephone
Communications	Telemetry	Optics
Test Equipment		

*Enjoy pleasant Florida living and working at these locations.
Liberal company benefits. Relocation assistance.*

INTERESTING DOWN-RANGE ASSIGNMENTS

Radar	Telemetry	Telephone
Radio	Timing	Optics

These positions are located on the Islands shown on the map above. Salary, 30% incentive, meals and lodging furnished. Return to U.S. every 3 months.

→ *For information and arrangements for personal interview, send complete resume to:*

Mr. H. C. Laur
Technical Employment, Dept. N-15D
Missile Test Project
RCA Service Co., Inc.
P.O. Box 1226, Melbourne, Florida



ELECTRONICS

life and alter its characteristics permanently. If E_s (and E and I) is increased in the abnormal glow region, a value X will be reached at which an arc will form between the electrodes. At this point the voltage across the tube will again drop sharply and the current will rise abruptly.

If the glow tube is allowed to reach

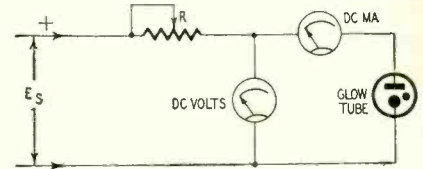

Fig. 2—Simple glow-tube test circuit.

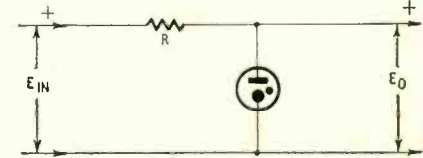

Fig. 3—Glow-tube regulator circuit.

Table 1—Glow-Tube Characteristics

Type	Operating Voltage E_0	Starting Voltage E_1	Normal Current Range (ma) I_1 I_2	
NE16	68	92	0.4	2.0
OA3/VR75	75	100	5.0	40.0
NE 2	78	96	0.2	1.0
OB3/VR90	90	110	5.0	40.0
OB2	105	115	5.0	30.0
OC3/VR105	105	115	5.0	40.0
NE 27	130	150	0.5	4.0
OA2	150	155	5.0	30.0
OD3/VR150	150	160	5.0	40.0

the arc point, it will be destroyed very quickly. Even if not destroyed, its characteristics will be greatly altered and its usefulness as a regulator ended. Since *arcing voltage* X varies considerably from tube to tube and must not be reached in a working regulator, the glow tube should be kept within its normal glow or normal operating range.

If E_s is reduced while the glow tube is operating in its normal range, the current through the tube will drop steadily with E_s while the voltage across it will remain essentially constant at E_0 . When the current drops below I_1 —the minimum normal operating current—the voltage across the tube will drop slightly with the current. This action will continue until E_2 —the *extinction voltage*—is reached, at which point the gas in the tube de-ionizes, the glow is extinguished and the current drops to virtually zero. The values of E_1 and E_2 are less sharply defined than is that of E_0 ; they depend on ambient conditions

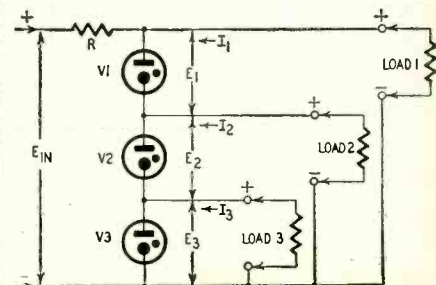

Fig. 4—Series regulator connection.

SELLING OUT!

COMPLETE STOCK OF NATIONALLY ADVERTISED
RADIO & TELEVISION TESTING INSTRUMENTS,
PARTS AND ELECTRICAL APPLIANCES TO BE SOLD

This is the opportunity of a lifetime!

REGARDLESS OF COST.
Prices Reduced Up to 80%

Below mentioned units are not kits, but all factory wired and brand new. Some models have been discontinued by the manufacturer, but every one is factory sealed and carries a one year factory guarantee. Satisfaction or money refunded within 10 days.



Model 999 Combination
F.M., A.M. and Television

SIGNAL GENERATOR

A.C. operated, generates R.F. frequencies from 150 kc. to 50 mc. Positive action attenuator provides effective output control at all times. R.F. is obtainable separately or modulated by the Audio Frequency. Complete with test leads, instructions. Reg. \$39.50; **now only \$1950**



TEST CRAFT

Model TC-10 Quality Multitester

AC and DC Voltage Ranges: 0-5/15/150/-1500/3000 Volts. DC Current Ranges: 0-5/50 ma. 0-1.5 Amps. Resistance Ranges: 0-100 ohms. 0-100 K. Complete with batteries, instructions. Size: 6"x3 1/2"x2" Reg. \$16.85 **now only \$985**



TEST CRAFT

Model TC-75 Combination Test Speaker and Signal Tracer

plus speaker substitution plus field substitutor plus voice coil substitutor plus output indicator

Complete with full instructions Reg. \$39.50 **now only \$2450**



Famous-Make

OHMMETER

Has a double range of 0-10 and 0-1000 ohms for accurate measurement of low resistance. Widely used for production testing, armature and field resistances of small motors relay and coil testing transformer winding tests, etc. Complete with test leads, instructions, leather case. Reg. \$36.50 **now only \$1495**



SUPREME

Model 543-S Multimeter

1% WIRE WOUND PRECISION RESISTORS

D.C. Volt Ranges: 0-150-300 D.C. Ma: 0-60-120-300-600. AC Volt Ranges: 0-150-300. Ohm Ranges: 0-1000/100,000. Complete with instructions. Reg. \$24.50 **now only \$995**



SUPERIOR

Model PB-100 Volt-Ohm-Milliammeter

Measures DC Voltages to 2500 Volts, AC Voltages to 1000 Volts, Resistance to 1 Megohm, Output Volts to 1000 Volts, DC Current to 2.5 Amperes, Decibels to plus 55 D.B. Push Button Operation. Complete with instructions and test leads. Reg. \$28.40 **now only \$1500**

	Dealers Net Price	Selling-Out Price
METROPOLITAN GENERAL ELECTRONICS	111 Quality Multitester	21.50 9.95
REINER ELECTRONICS	200, AM-FM & Television Signal Generator, AC operated	39.50 24.50
RADIO CITY PRODUCTS	333, DC Volt-Ohm-Milliammeter	26.95 9.95
SHALLCROSS	668 Electronic Multitester	74.50 39.50
GRUEN	665 AC-DC Volt-Ohm Capacity, VTVM	95.40 49.50
WESTON	630 Wheatstone Resistance Bridge	145.00 75.00
TRIPLETT	2 1/2" DC, D'Arsonval Type, 1 Milliammeter, Meter	9.95 2.95
MARION	Model 507, F.S. 1, 2 Milliam. Meter	12.95 3.95
ACRO	331-JP 30 Amperes, Meter	12.95 4.95
GRAF-O-TONE	3" D'Arsonval Type, 1 Milliam. with calibrated Volt-Ohm Current Scale, Meter	12.95 3.95
MELODISC	Radio & Phonograph Chassis Cradles	6.95 2.95
HOLYOKE	8" Glass Recording Discs, sold only in cartons of 24 discs	.75 each .15
	12" Metal Recording Discs, sold only in cartons of 50 discs	1.50 each .30
	180 Ohm resistance line cords, 6 foot with plug	1.25 each .35
	Electrical Iron Cords, 6 foot with plug	.95 each .25
	Extension line cords, 9 foot with plug	.75 each .30
	Extension line cords, 12 foot with plug	.95 each .40
	No. 22, stranded, finned, copper push-back wire, on 500" spools	5.75 ea. spool 2.50
DUOSONIC	MODEL CAPRI, 3 speed recordplayers, with life time needle, plastic case, speaker and amplifier	Reduced to 16.95 each
MAGUIRE	Automatic Recordchanger	Reduced to 9.95 each
TELE-TONE	Table Radio	Reduced to 9.95 each
MOTOROLA	Table Radio, 5 tubes	Reduced to 12.95 each
	Clock Radios	Reduced to 18.95 each
STANDARD	Portable Radios, 3 Way	Reduced to 14.95 each
PHILCO	Table Radios, 5 tubes	Reduced to 17.95 each
GENERAL ELECTRIC	Portable Radios, 3 Way 5 tubes	Reduced to 24.95 each
ADMIRAL	Portable Radios, 3 Way 5 tubes	Reduced to 24.95 each
PHILCO	Portable Radios, 3 Way 5 tubes	Reduced to 24.95 each
GENERAL ELECTRIC	Clock Radios, 5 tubes	Reduced to 24.95 each
ADMIRAL	Clock Radios, 5 tubes	Reduced to 24.95 each
REVERE	Whistling Tea Kettles	Reduced to 2.95 each
GENERAL ELECTRIC	Automatic Irons	Reduced to 7.95 each
ROLAND	Table Radios, 5 tubes	Reduced to 12.95 each
CUCKOO CLOCK	Genuine, imported Black Forest, hand-carved, cuckoos every 15 minutes	Reduced to 4.95 each
GLO	Electronic, oscillating massager with infra-red heat combined	Reduced to 3.95 each
BRIL-QUICK CHEF	Fully automatic rotisserie and broiler combination, 7 way, with time clock, 3 heat element, double powered	Reduced to 24.50 each
CAPITOL	Infra-red heat, automatic broiler	Reduced to 9.95 each

All prices are f.o.b. New York, 20% deposit with order, balance C.O.D., or full remittance with order.

QUANTITIES ARE LIMITED. WRITE, PHONE OR WIRE FOR IMMEDIATE DELIVERY.

METROPOLITAN ELECTRONICS & INSTRUMENT CO.

106 Fifth Ave., New York 11, N.Y.

Telephone: Oregon 5-1707

Cable Address: METRONICS



SUPERIOR

Model 1553 Volt-Ohm-Milliammeter

Meets U.S. Army requirements for accuracy and durability. Measures AC Voltages: 0-7.5/15/150/750. D.C. Voltages: 0 to 2.5/15/150/750. D.C. Current: 0 to 7.5/75 ma. Resistance: 0 to 5,000/500,000 Ohms. Complete with leather case, instructions. Reg. \$29.25 **now only \$1450**



SUPERIOR

5,000 ohms per Volt, Volt-Ohm-Milliammeter

D.C. Voltages to 1500 Volts. A.C. Voltages to 1500 Volts. Resistance to 2 Megohms, Output Volts to 1500 Volts, D.C. Current to 150 Ma., Decibels to plus 58 D.B. Complete with instructions and test leads. Reg. \$27.65 **now only \$1450**



TEST CRAFT

Model TC-50 TUBE AND SET TESTER

Test all tubes up to date, incl. 4, 5, 6, 7L, octals, loctals, television, magic eye, thyratrons single ended floating filament, mercury vapor, neon miniatures, etc. Multimeter Specifications: DC Current Ranges: 0-1-100-1000-5000. DC Voltage Ranges: 0-10-100-1 Amp. Low Res. Range: 0-10,000 Ohms. Medium Re. Range: 0-100,000 Ohms High Res. Range: 0-1 megohm. Complete with test leads and instructions. Reg. \$49.50 **now only \$2950**

HERE'S WHAT THEY SAY ABOUT THE SHURE SLIM-X Model "777"



... the most versatile low-cost crystal probe microphone ever made!

For Remote Broadcasting

"Selected this microphone after comparison with three other makes in the same price class."

*Station Manager, West Virginia**

For Public Address

"... it surpasses in fidelity all six of the other microphones we have been using—two of which are dynamic mikes."

*Minister, Washington**

For Square Dance Calling

"Callers at square dances favor Shure microphones... I have an order for five SLIM-X Microphones."

*Sound Dealer, Illinois**

For Professional Entertainers

"SLIM-X" is ideal... fits so nicely in pocket of dress coat, and performs perfectly... worked with large PA systems up to 100 watts, using different "mics" but your SLIM-X beats them all."

*Performer, Pennsylvania**

For Tape Recording

"I used it to record a church service last evening... delighted at the results. I thought I would take a minute out to tell you that you have a very nice looking, nice sounding, and easy-to-use microphone."

*New York**

For Ham Transmitting

"... I hit the jackpot with a Shure Model 777 SLIM-X... reports on my signal have been very gratifying. I am sure that any one possessing this microphone is as well pleased with it as I am."

*Radio Amateur, Illinois**

Use it in the hand, on a desk stand, on a floor stand, around the neck—can be removed in a flash, no matter where you use it. Furnished with stand, mounting cradle and lavalier cord.

MODEL 777 List Price \$21.00



The Mark of Quality

SHURE BROTHERS, INC.

225 W. Huron St. • Chicago 10, Ill.

*Names available on request

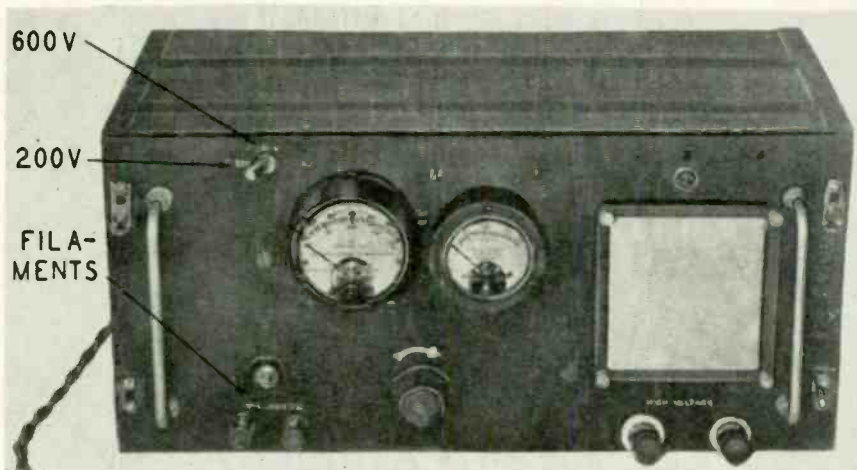
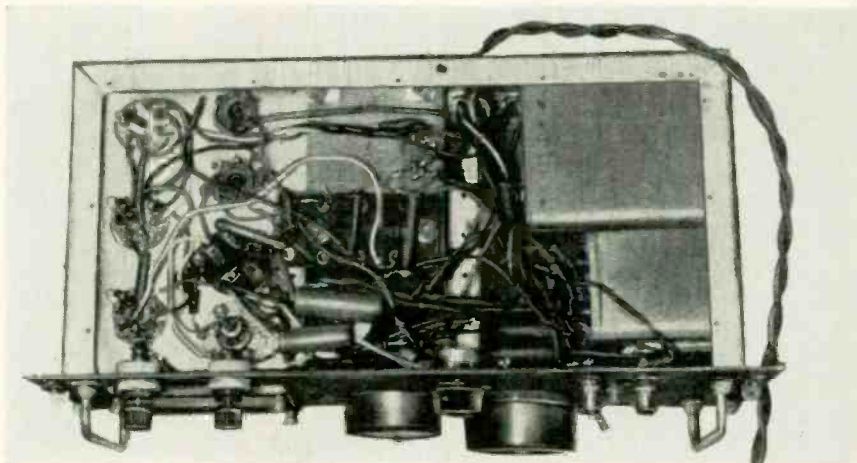
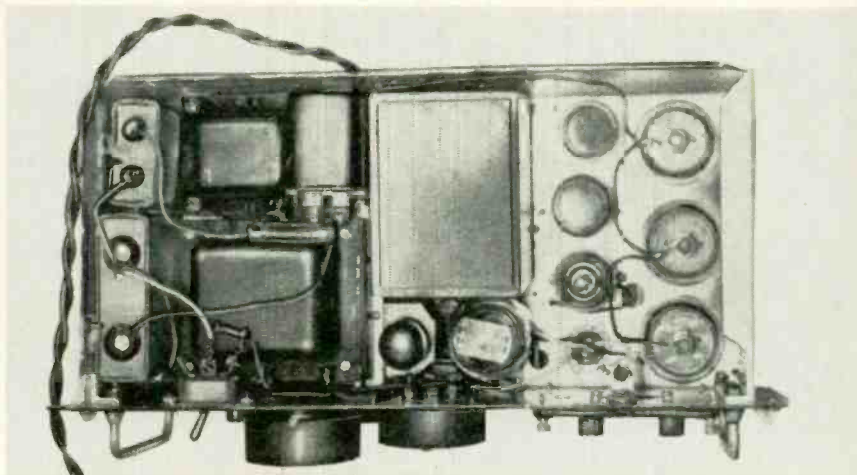

Top, bottom and front-panel views of Fig. 8 feedback voltage regulator.

of temperature, illumination, electrostatic and magnetic fields and other factors. Tube operation in the current range below I_1 and in the voltage range between E_0 and E_2 will be highly unstable.

Characteristics of glow tubes commonly available and used as voltage regulators are summarized in Table I. The basic circuit for a glow-tube-regulated supply is shown in Fig. 3. The value of R must be selected to meet the following conditions:

1. With maximum load current and minimum glow-tube current the voltage drop across R must not exceed the difference between the maximum E_{in} and E_0 .
2. With minimum load current and maximum glow-tube current the voltage drop across R must not be less than the difference between the minimum E_{in} and E_0 .
3. At any operating condition

$$E_{in} - E_0 = R(I_{load} + I_{tube})$$

FREE! LAFAYETTE CATALOG



132 PAGE ELECTRONIC CATALOG

Packed with the largest selection of Electronic, Radio and T.V. Parts, and equipment, P.A., Hi-Fi systems, tubes, antennas, Transistor Kits, parts and components, Test Equipment, new build your own kits, tools, books, Microscope, drafting equipment, Binoculars, Telescopes, All Radio, TV and Ham supplies — ALL AT GREAT SAVINGS — For the economy minded servicemen, dealer, engineer and technician. **CHUCK FULL OF BUYS! SEND FOR YOUR FREE COPY TO-DAY.**

Just a few of Lafayette's Values

2 TRANSISTOR POCKET RADIO KIT



Packed into a 2 1/2" x 3 1/2" x 1 1/4" plastic case. This Two Transistor Plus crystal diode radio kit offers many surprises. Utilizing a regenerative detector circuit with transformer coupled audio stage, gives you high gain and excellent selectivity. Pulls in distant stations with ease with more than ample earphone volume. Kit comes complete with two transistors, crystal diode, loopstick, Arzonne transistor audio transformer, resistors, condensers, plastic case, etc. Including schematic and instructions.

KT-68A Complete Kit less earphones. **11.80**
Net
MS-260 New Super Power Dynamic Earphone. Ideal for Transistor Circuit imp. 8000 ohm, D.C. 2000 ohm **3.95**



HIGH SENSITIVITY 20,000 OHM PER VOLT DC 10,000 OHM PER VOLT AC MULTITESTER

35 up 3" METER SILVER CONTACT SELECTOR SWITCH 1% PRECISION RESISTOR

LOOK AT THESE FULL SCALE RANGES!
D.C. VOLTS: 0-6; 0-30; 0-120; 0-600; 0-1200; 0-6000 Volts—A.C. VOLTS: 0-6; 0-30; 0-120; 0-600; 0-1200 Volts—RESISTANCE: 0-10K; 0-100K; 0-1 Meg; 0-10 Megohms—D.C. CURRENT: 0-60 Microamp; 0-6; 0-60; 0-600 Millamps—DECIBEL: -20 to +17 db 10 db — 0.774V—CAPACITY: .0001 - .01; .005 - .15 mfd—INDUCTANCE: 20-2000 millihenry—OUTPUT RANGES: 0-6; 0-30; 0-120; 0-660; 0-1200 Volts

The new Lafayette high sensitivity Multitester is a complete instrument (not a kit). In addition to its unusual sensitivity of 20,000 OHMS PER VOLT ON D.C. AND 10,000 OHMS PER VOLT ON A.C., and the extraordinary number and scope of its ranges, it is packed with features that would make it cost at least twice as much if made in this country. Uses 1% precision resistors, silver contacts on selector switch, 35 ua 3" meter. Size: 6 1/4" x 4 1/4" x 2 1/2". Complete with batteries and leads. Shipping weight 4 1/2 lbs. **Net 19.95**
RW-30A

Singly, Each **19.95**
In lots of 3, each **19.25**

HIGH-FIDELITY TURNOVER CARTRIDGE



2.75
Reg. Price **8.50**

● **40-14000 CYCLE**
● **NEVER BEFORE AT SUCH A PRICE!**
Lafayette brings you one of the finest high-fidelity turnover cartridges, AT AN UNBELIEVABLE PRICE! Frequency response from 40-14000 cycles + 2 db. Has 2 sapphire styli to play all speeds. Needle pressure only 5 grams on LP cond 12-15 grams on 78. Output is 5 volts. Complete with turnover mechanism and knob, fits Webster, Garrard, VM, Collaro and tone arms of leading manufacturers of record changers and players.

PK-79 Singly, Each **2.75**
In lots of 3, Each **2.50**



NEW! EXCLUSIVE — REVOLUTIONARY DESIGN! TRANSISTOR 2 GANG VARIABLE SUPER-HET CONDENSER — THE SMALLEST SUPER-HET VARIABLE CONDENSER IN THE WORLD!

Lafayette does it again with this new super 2 gang midget variable condenser. An exciting and proven innovation in the transistor parts field! Manufactured for top performance in transistor super-het circuitry, it measures only 1/2" x 1" x 1". Has 2 gangs specifically designed for transistor super-hets — 10 to 208 mmf capacitance on the antenna section, and 10 to 104 mmf on the cut oscillator section. Self contained trimmers. Tunes through 180°. Entirely enclosed in a transparent plastic case! The smallest complete 2 gang variable for super-hets in the world! Offers unlimited possibilities to the experimenter.

MS-270 **Net 1.95**

MATCHED } MS-265—Osc. Coil **Net .79 Ea.**
COIL SET } MS-272—Ant. Coil **Net .95 Ea.**

365 MMF SINGLE GANG SUPER MIDGET VARIABLE CONDENSER

For exceptional performance in TRF and experimental transistor and subminiature circuitry. 10 to 365 mmf single gang. Enclosed in transparent plastic case. 1/2" x 1" x 1".
MS-274 **Net 1.25**



TRANSISTOR CHECKER KIT

● **Checks Shorts, Leakage, and Gain**
A "must" for servicemen, experimenters and engineers. Tests both PNP and NPN type transistors. Gives 2 separate checks; first **GOOD-BAD** check for shorts and leakage, and second for **GAIN**. Gray hammer tone case 5 1/4" x 3" x 2 1/4". Kit includes case, meter, all parts with full assembly and operating instructions. Simple to build. Fast, accurate. Shpg. wt. 3 lbs.
KT-86 Kit **7.95**



NEW POCKET AC-DC VOM MULTITESTER 2,000 ohm per Volt on AC & DC

● **Completely wired — Not a kit**
Accurate VOM with a sensitivity of 2000 ohms per volt on both AC and DC. Single selector switch. 3" 160 amp. meter. Scales: DC Volts: 0-10-50-1000; AC Volts: 0-10-50-600-1000; Ohms: 0-10K, 0-1 Meg; DC Current: 500 ua and 500 ma; Decibel: -20 to +22, +20 to 36; Capacity: 250 mmf to .2 mfd and .005 to 1 mfd. Heavy plastic panel, metal bottom. 4 1/4" x 3 1/2" x 1 3/8". With batteries and test leads. Shpg. wt. 4 lbs.
RW-27A **7.95**

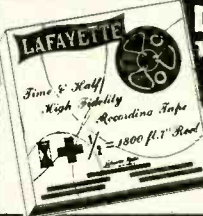

LAFAYETTE TIME + 1/2 TAPE 1800 FT. - 7 INCH REEL

\$2.59 Each, Singly
\$2.45 Each, Lots of 10

AN ENTIRE SYMPHONY ON ONE REEL OF TAPE! NO MORE ANNOYING INTERRUPTIONS!

Lafayette did it again! New plastic base. **TIME + 1/2** High Fidelity Recording Tape at an amazingly low price! Over 1 1/2 hrs. of playing time on a single reel at 7 1/2" per second on dual track recording. At 3 3/4" per second you get 3 hours and 12 minutes. The same quality that has made the Lafayette Standard Tape the nation's outstanding value. 40-15,000 cycle response at 7 1/2" per second assures you of the finest professional quality high fidelity recordings. A true Lafayette value backed up with our Money Back Guarantee. You be the judge—try it!

LAFAYETTE TIME + 1/2 TAPE } Lots of 10, Each **\$2.45**
1800 FT. - 7 INCH REEL } Singly, Each **\$2.59**



NEW! ALL-PURPOSE DYNAMIC EARPHONE

● **FOR RADIO AND TV LISTENING**
● **FOR SUBMINIATURE, MINIATURE AND TRANSISTOR RECEIVERS**

A sensitive all-purpose earphone designed for your listening pleasure. Combines the range of a dynamic earphone with the performance of its special magnet to give you excellent reproduction. Lightweight and equipped with ear support that slips comfortably over your ear. You can relax! The support is practically invisible — the earphone can't slip out — it can't fall off. Ideal for use with TV and radio sets, amplifiers, miniature and transistor receivers etc. Complete with 3 ft cord. A super value for the price!

MS-278 — 3000 ohm impedance, 1000 ohm DC resistance, with phone tip plugs. **Net 1.95**
MS-277 — 6 ohm impedance, with phone tip plugs. **Net 1.95**
MS-273 — 9000 ohm impedance, 1000 ohm DC resistance, with subminiature phone plug and matching phone jack. **Net 2.39**
MS-279 — 6 ohm impedance, with subminiature phone plug and matching phone jack. For Silent Radio and TV Listening or Viewing. **Net 2.39**

CRYSTAL MICROPHONE

COMPARE IT WITH ANY MIKE
AT 2 TO 3 TIMES THE PRICE

A quality crystal Microphone for PA systems, house recorders, etc. Frequency response 30 to 10,000 cycles. Output level -52 db. Provides ample output for use with low gain amplifiers. Complete with 5 ft. of shielded cable. Shpg. wt., 3 1/2" lbs.
PA-24 — in lots of 3, each **3.95**
singly, each **4.25**



REMOTE CONTROL

FOR SILENT
TV VIEWING



● **For Hard-of-Hearing**
● **For Late Listening**
One or two people can both see or hear the program with the loud speaker cut-off. The hard-of-hearing can listen to radio or TV without turning the volume so high that others can't stand the noise. Comes complete with miniature phone and 20 ft. of cable. Shpg. wt. 3 lbs. **Net 6.50**
MS-125

FREE! BUILD YOUR OWN TRANSISTOR RADIOS COMPLETE 8 PAGE BROCHURE

Lafayette Radio DEPT. JD
BRONX, N.Y. 542 E. Fordham Rd
NEWARK, N.J. 24 Central Ave.
100 SIXTH AVE. PLAINFIELD, N.J. 139 West 2nd St.
NEW YORK, N.Y. BOSTON, MASS. 110 Federal St.
Include postage with order.

Send FREE 132-Page Lafayette Catalog

Name _____
Address _____
City _____ Zone _____ State _____

ELECTRONICS

Two or more glow tubes can be used in series to provide higher output volt-

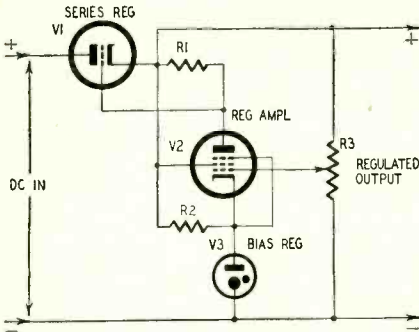

Fig. 5—Simple feedback regulator.

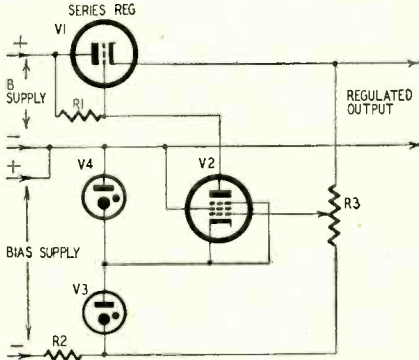

Fig. 6—Supplementary bias supply extends range of regulated output adjustment.

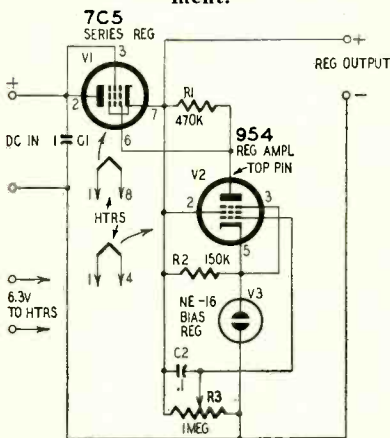

Fig. 7—Schematic diagram of a small feedback amplifier type regulator.

age and regulated lower voltages from the regulator. Fig. 4 is a diagram of a three-tube series regulator. Operation is governed by the equations

$$E_{in} - (E_1 + E_2 + E_3) = R(I_1 + I_{V1})$$

$$I_{V1} = I_2 + I_{V2}$$

$$I_{V2} = I_3 + I_{V3}$$

with I_{V1} , I_{V2} and I_{V3} restricted to the normal operating ranges of glow tubes V_1 , V_2 and V_3 , respectively. Glow tubes cannot be operated satisfactorily in parallel—if the required range of glow-tube current exceeds that of the normal operating range of the appropriate tube or series string of tubes, the load must be divided into subloads supplied by separate regulators or a feedback amplifier regulator must be used.

The basic feedback amplifier type of voltage regulator is shown in Fig. 5. A high-transconductance triode (or triode-connected pentode) V_1 acts as a variable voltage-dropping resistor between the input and the regulated output. This output supplies the plate and screen power for pentode amplifier V_2 whose cathode is maintained at a fixed reference voltage by glow tube V_3 . Potentiometer R_3 establishes the operating point (grid voltage) of V_2 ; the output of V_2 establishes the grid potential of V_1 and the voltage drop through V_1 between the input and output.

A change in the regulated output voltage (whether caused by a change in input-voltage or output-load conditions) produces an in-phase change at the grid of V_2 . This appears amplified and reversed in phase at the grid of V_1 and at the cathode of V_1 (the regulated output). With proper selection of R_1 (which is not critical) this feedback signal will correct the original voltage change and, within the limits of normal operation of the circuit elements, the output voltage will remain constant at the value determined by the setting of R_3 . Resistor R_2 insures ignition of glow tube V_3 on regulator startup, and maintains a stabilizing current flow—added to the cathode current of feedback amplifier V_2 —through V_3 .

The feedback regulator output voltage may be varied, but for a given

supply voltage the maximum output is limited by the minimum drop in V_1 (determined by the steady current rating of this tube); the minimum output by the total drop across R_1 , V_2 and V_3 , necessary to keep V_2 within its normal operating range. The minimum output voltage can be considerably reduced by providing a negative bias to absorb part of this R_1 - V_2 - V_3 drop, as indicated in Fig. 6.

Also indicated in Fig. 6 is another variation of the basic feedback regulator—the plate of amplifier tube V_2 is fed directly from the unregulated input. This arrangement makes for more stable operation where the output voltage is subject to variation (adjustment) over a wide range as the result of changing loads.

The current-carrying capacity of the feedback regulator can be increased by paralleling two or more tubes in the V_1 position. Since slight variations in characteristics of these paralleled tubes may result in unstable operation of the feedback loop, small "grid-stopper" resistors should be placed in the grid

Table II—Typical Feedback Regulators

Type	Plate Current (ma)	G_M (μ mhos)	Dissipation (watts)
Triode-Connected Pentodes			
6Y6, 25C6	60	6,300	14
25L6, 1632	50	6,600	10
6F6, 42, 2A5, 1613, 1621	40	2,600	10
6L6, 1622, 1631, 1614	75	4,700	20
6V6, 7C5, 14C5	50	4,100	13
807, 1625	80	4,200	25
Triodes			
2A3, 6A3, 6A5-G, 6B4-G	80	5,250	15
6A57-G (each section)	125	7,500	14

leads of the V_1 tubes. Suggested limits for operation of selected suitable tubes for feedback regulator application are shown in Table II. Tubes having a high transconductance and high internal dissipation have been listed, with plate-current values which will keep tube operation within the dissipation limits set.

Two practical versions of the feedback regulator, built by the author, are

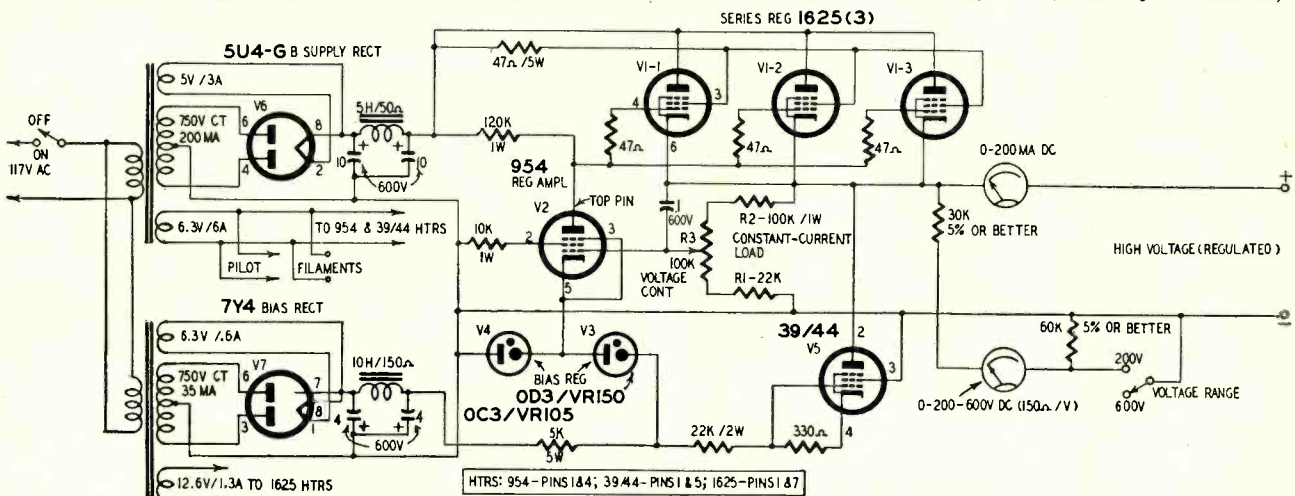

Fig. 8—Diagram of heavy-duty adjustable feedback regulator with power supply.

ELECTRONICS

shown in the photos. The small unit (Fig. 7) follows the circuit of Fig. 5 with two capacitors added—C1 bypasses high-frequency transients which may appear at the regulator input, C2 provides a direct path for ripple fluctuations from the output into the feedback loop, without the varying attenuation introduced by the setting of R3.

The unit was built into a surplus jackbox and is used to provide the high-voltage supply to the sweep multi-vibrator and input stages of the deflection amplifiers of an oscilloscope. With a 300-volt input containing 0.85 volt (rms) of 120-cycle ripple, this unit delivers a voltage adjustable between 125 and 200, with a variation of approximately 0.2 volt with load changes from 0–50 ma, and with a total ac content of less than .003 volt (rms).

The large unit (Fig. 8), with self-contained power supply, is used as a general-purpose bench unit for test and development work. The output of this unit is adjustable from 50 to 400 volts with a load of 50 ma, 100–350 volts with a load of 150 ma, and a total ac output content of less than .01 volt (rms) over this entire useful range.

Besides the basic units discussed, this unit contains an extra tube—the pen-

Parts for Fig. 7 regulator

1—150,000, 1—470,000 ohms, 1/2 watt, resistors; 1—1-megohm potentiometer; 1—0.1, 1—1 µf, capacitors; 1—7C5; 1—954, 9001 or 6SJ7; 1—NE16; 3—sockets for tubes; 1—chassis; 1—6.3-volt heater supply.

Parts for Fig. 8 regulator

Resistors: 3—47, 1—330, 1—22,000, 1—30,000 (5%), 1—60,000 (5%) ohms, 1/2 watt; 1—10,000, 1—100,000, 1—120,000 ohms, 1 watt; 1—22,000 ohms, 2 watts; 1—47, 1—5,000 ohms, 5 watts; 1—100,000-ohm potentiometer.

Capacitors: 1—0.1 µf, 600 volts; 2—4 µf, 2—10 µf, 600 volts.

Tubes: 3—1625; 1—954; 1—0C3/VR105; 1—0D3/VR150; 1—39/44; 1—5U4-G; 1—7Y4.

Miscellaneous: 1—power transformer, 750 volts ct @ 200 ma, 5 volts @ 3 amps, 6.3 volts @ 6 amps; 1—power transformer, 750 volts ct @ 35 ma, 12.6 volts @ 1.3 amps, 6.3 volts @ 1 amp; 2—spst switches; 1—pilot lamp assembly; 1—5-henry, 50-ohm, 200-ma choke; 1—10-henry, 150-ohm, 35-ma choke; 1—0–200 milliammeter; 1—voltmeter, 0–200/0–600 (150 ohms per volt); 9—tube sockets; 1—chassis.

tode V5—which acts as a constant-current bleeder on the output. It is adjusted to a current of about 7 ma and prevents sharp surges when the main load is switched on or off, a condition which the bench unit often faces. Resistors R1 and R2 have been placed at each end of the voltage-control potentiometer to limit the excursions of the grid voltage of V2 to values which will keep the grids of both V1 and V2 negative.

In each of these units the tube components were selected for economy. The 954 acorn pentodes (electrical equivalent to the 9001 and near equivalent of the more commonly used 6SJ7's), the 1625's (12-volt heater versions of the 807) and the 39/44 are all generally available at prices as low as 25c each—the NE16 is one of the cheapest of the glow lamps which will handle the pentode cathode current. The 7C5 and 7Y4 were in the junkbox. **END**

PAYS ITS WAY every day

**TESTS and
REPAIRS
TV PICTURE
TUBES**

**Makes Customers Happy
—Creates New Profits**

Servicemen now earn new servicing dollars in minutes and build satisfied customers—with B&K Deluxe Portable CRT 400.

Spots and corrects picture tube troubles in a few minutes, right in the home, without removing tube from set! Restores emission, stops leakage, repairs inter-element shorts and open circuits. Grid cut-off reading indicates picture quality customer can expect. Life-test checks gas content and predicts remaining useful tube life. Cuts operating costs, eliminates tube transportation. Also saves money on TV set trade-in reconditioning. Profits start the very first day.

Send for Bulletin 104-E



DELUXE CRT 400 with 4 1/2" Plastic Meter

Weights only 5 lbs. mounted in rugged, luggage style, carrying case covered with handsome, durable leatherette. Size: 11 x 7 1/2 x 5". Net \$54.95



**CATHODE
REJUVENATOR
TESTERS**



ECONOMY CRT 200

Every serviceman can cash in on picture tube repairs with this low priced quick profit maker. Performs most of the functions of the CRT 400. Has 3" meter. In leatherette carrying case. Size: 11 x 7 1/2 x 5". Weighs 5 lbs. Net \$39.95

**PROVEN IN
THE FIELD
EVERY DAY
BY OVER
20,000
SERVICEMEN**

Made by the Makers of the DYNA-QUIK Tube Tester

B & K MANUFACTURING CO.
3726 N. Southport Ave. • Chicago 13, Illinois



TeleMatic The Professional Line

TELE-CHECK
A Must for
Every Serviceman

Flexible Design—Each component can be used separately or in combination—Giving TELE-CHECK TRULY UNIVERSAL APPLICATION.
TELEMATIC INDUSTRIES, Inc., 16 Howard Ave., Brooklyn, N. Y.



INFORMATION THEORY

By PAUL PENFIELD, JR.

*An attempt to shed
some light on a subject as
important as it is unknown*

IN the past few years a new and unknown science has grown out of the study of radio communications. Although its effects are already being felt in the electronics field, the science is clouded in mystery to most people. Information theory deals, roughly, with the factors which affect communications rates and means for improving the speed of communications, both by radio and wire. Very little about this very interesting new science has appeared in print in everyday language, since in its complete form, information theory is highly mathematical. However, the results of the author's study will be so presented here that anyone who knows a decimal point from a slide rule can understand them.

The whole subject arose when engineers tried several methods to decrease the bandwidth needed to transmit various types of messages. They found that the more they cut down on the bandwidth in any given system, the less they could transmit during any minute or any second. In 1924 Hartley, the Bell Telephone Co. scientist, came out with a very simple statement about communications rates, which is appropriately called the Hartley theorem.

This one sentence constituted the whole of information theory until 1948: *There is a limit to the rate at which information can be transmitted through any communications channel, this maximum rate being proportional to the bandwidth of the channel.* Thus a radio spectrum 20 kc wide can transmit twice as much information as a spectrum 10 kc wide. This maximum rate, or capacity, does not depend on the type of modulation used — AM, FM or any other. The fact that the channel may

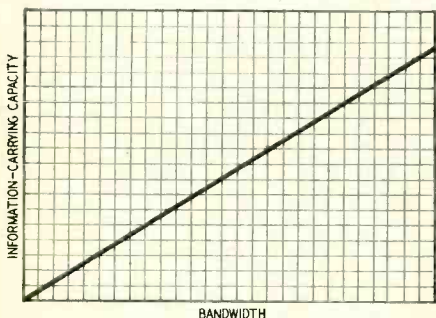

Fig. 1—Old Hartley theorem. Information carried varies with the bandwidth.

not actually be used to transmit as much information as it can indicates some kind of inefficiency. Its information-carrying capacity, as determined by the Hartley theorem, serves as an upper limit only and does not tell the actual rate occurring in any given transmission.

This is shown graphically in Fig. 1 — a straight-line relationship between bandwidth and information-carrying capacity, independent of the type of modulation used. We will see later that this formula is wrong — indeed systems can be devised which have no limit at all. But before proceeding further, let us define a few terms.

What is information?

The reader probably has a pretty good idea of what is meant by “bandwidth” and “communications channel.” However, it is the exceptional reader who has come across a precise definition of “information.” Since the whole science rests on the meaning of this term, let's show what information is and what it isn't by an example:

Suppose you're waiting outside the maternity ward while your wife is having a baby. You of course have no idea whether it will be a boy or a girl and are waiting to find that out, among other things. Suddenly the nurse walks out of the door, saying, “It's a boy!” If you hear and understand what she says, you now know your new baby is a boy.

Certainly she has given you some information. But why? Well, you might say that she told you something. But that's not all. She told you something you didn't already know. If the doctor had told you before the nurse did, her statement wouldn't have given you any information.

Now let us suppose that while you were waiting to find out, somebody had told you your baby would be a girl. When you asked how he happened to know, he said, “I flipped a coin to find out. It always works.” Now has he given you any information? He told you something you didn't already know but the chances are your curiosity wasn't satisfied a bit. That's because you considered the source of the statement unreliable whereas you believed the nurse to be completely reliable. Thus a state-

ment is no information if it is considered unreliable.

Two conditions, then, necessary for you to have “information” are: No previous knowledge; reliability of the statement (which is the same thing as reliability of the source of the statement). Further refinements in the definition are necessary — for example, no statement is 100% reliable, and similarly no statement is 100% unreliable. And you may

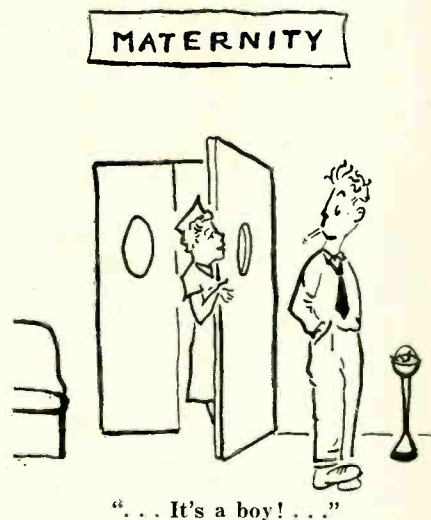

have varying degrees of previous knowledge about a particular statement. So trying to figure out the information content of a particular message is extremely hard.



RADIO

The units in which information is measured are called "bits." The information that your baby was a boy constituted one bit, because it informed you with complete certainty which of two equally probable alternatives about which you had no previous knowledge was true. The information whether a coin landed "heads" or "tails" measures one bit. (Actually this information is slightly more than one bit, because there is always the possibility, however slight, that the coin landed on edge. This creates more than two possibilities, with the result that the answer "heads" or "tails" conveys slightly more than one bit.)

Knowledge about which of four equally probable events occurred (such as learning what season — winter, spring, summer or fall — a person was born in) carries two bits of information to the receiver. This is because the problem can be broken down into two two-way problems, the information for which each carries one bit, making a total of two bits. Similarly, information as to which of 64 counties a person is in (provided it is known that he is in one of the 64) carries 6 bits to the listener.

However, these examples are highly artificial. It is virtually impossible to compute accurately the information content of a typical message. Headlines like *Rioting in Afghanistan Threatens U. S. Embassy There* obviously convey information to the reader — but telling how much is virtually impossible. For engineering purposes it is wise to make certain generalizations and approximations which apply to long messages. These are listed here and should seem perfectly plausible to the reader:

1. The information content of a message, for design purposes, can be considered proportional to the length of the message.
2. Noise in a communications channel reduces its information-carrying capacity, because noise renders some of the received characters unreliable.
3. Repeating a message conveys no more information since the receiver already knows the content of the repeated message. If a particular message is repetitive in nature, then we are not using the communications channel with the most efficiency, since the repetition is using up time without conveying any information.

It should be said here that the value of the information to the receiver does not change its information content.

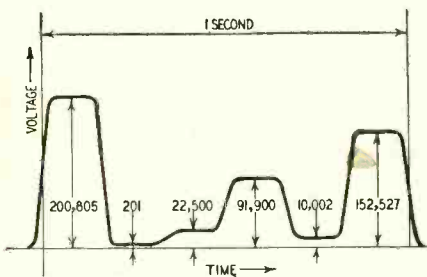

Fig. 2—The coded signal that corresponds to: "The baby is a boy!"

PLUS profits!

with this AMPHENOL PROFIT PROMOTER



CREATES IMPULSE SALES!

check with your **AMPHENOL** distributor
or mail this coupon for details—TODAY!

AMERICAN PHENOLIC CORPORATION
Distributor Division
1830 S. 54th Avenue, Chicago 50, Illinois

Yes, send me full details on how I may obtain a free AMPHENOL Profit Promoter

NAME _____
COMPANY _____
ADDRESS _____
CITY _____ ZONE _____ STATE _____

COMPLETE HI-FI

Golden Ensemble
by **Rauland**

Tuner, Preamp and Amplifier in a single, compact BALANCED HI-FI unit at extremely low cost...

The Very Best for Less!

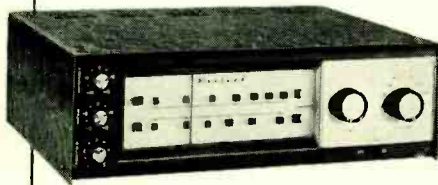

Here's the quality unit for simplest installation—merely add speaker and record changer and have your complete, superb FM-AM-Phono home music system. No cabinet required—saves money, space, installation problems. You get the ultimate in wide-range musical enjoyment and you pay less for it. Features are outstanding. Response: FM ± 0.5 db, 20 to 20,000 cps; AM, ± 3.0 db, 20 to 5,000 cps; Phono, ± 0.5 db, 20 to 20,000 cps. Sensitivity: FM, 3 mv. for 20 db of quieting; AM, 5 mv. for 0.5 watt output. Harmonic distortion: Radio input, less than 2%; Phono input, less than 0.7%. Separate front ends for AM and FM; tuned RF stage on FM; discriminator with dual limiters; AFC with defeat on function switch; FM dipole antenna; AM has RF stage, ferrite loop. Separate bass, treble controls; RIAA record equalization; choice of standard or equal loudness control; full 12 watts output, etc. Ultra-compact design, only $5\frac{3}{4}$ " high; decorator-styled in handsome charcoal black with marbleized gold finish. Fits anywhere beautifully. See and hear the "Golden Ensemble" soon.

NEW! HI-FI SOUND FOR TV!



EXCLUSIVE RAULAND
TV 55 TELEVISION
SOUND TUNER

Designed for use with the "Golden Ensemble". Makes your TV sound "come alive" for thrilling listening or tape recording. Just plug in, tune and enjoy Hi-Fi audio on any VHF channel, played through your RAULAND music system! See it—hear it now.

Visit your Hi-Fi dealer for a personal RAULAND Hi-Fi audition. See and hear the "Golden Ensemble" and TV 55 Sound Tuner—and you'll know you're getting the very best for less.

Write for full details covering the complete RAULAND Hi-Fi line

Rauland

RAULAND-BORG CORPORATION
3515 W. Addison St., Dept. A, Chicago 18, Ill.

RADIO

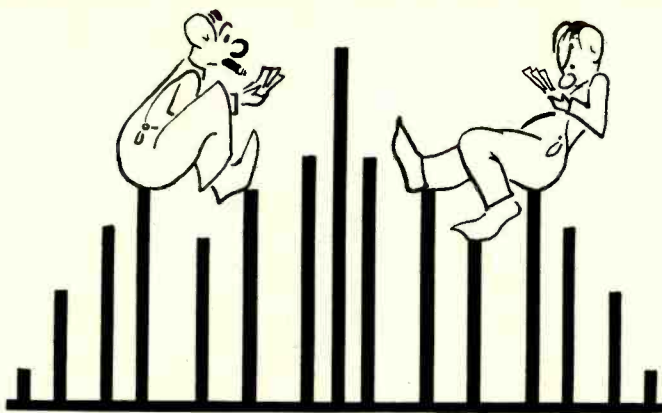

"Sidebands... have physical reality — not merely a mathematicians trick."

There is just as much information in the statement that Mrs. Jones' baby was a boy as there is in a similar statement about your own baby, although the latter may mean more to you.

The new Hartley theorem

So now that we know what information and bandwidth are, let's return to the Hartley theorem: *The maximum rate of transmitting information is proportional to the bandwidth of the channel used.* In other words, only the space below the line in Fig. 1 is theoretically usable. As is well known, this is true for AM. To double the information-carrying or message-handling capacity, we may double the bandwidth or else use two channels. Telephone long-distance "multiplexing" merely takes advantage of the wide bandwidth obtainable with coaxial cable to replace a number of relatively narrow-bandwidth conventional wires.

However, the Hartley theorem had to be revised for three reasons. First, the effect of noise was not well understood. It was thought that noise merely reduced the limit somehow. Second, the advent of FM produced a communications system which did not follow the form of the theorem. Third, and most important, some coding systems were devised which gave information-carrying rates higher than those predicted by the Hartley theorem as the theoretical limit.

It is not very hard to imagine a coding system which in the absence of noise has no theoretical limit of information-carrying capacity. For example, let's suppose the message were "THE BABY IS A BOY." Let's divide it into three-letter groups, including spaces and punctuation. Assign each letter a 2-digit number from 01 to 26 and give the number 00 to the spaces. The message is now THE -BA BY- IS- A-B OY., which becomes "200805 000201 022500 091900 010002 152527" if "27" is assigned to the period. Now suppose we transmit 6 pulses whose relative voltage corresponds to the numbers above—that is, 200,805 units high, 201 units high, etc. This signal could easily be transmitted in only 1 second, looking something like Fig. 2. The bandwidth required is very small, only a few cycles

per second, to transmit 18 characters.

If this system isn't fast enough for you, we can divide the message instead into 4- or 10-letter groups. We can thus extend the information-carrying capacity of a given low-bandpass channel indefinitely high. Of course, even the slightest amount of noise at the receiver would render the small voltage changes between 10002 and 10003 indistinguishable but in the absence of noise, such a coding system, modulating a radio carrier, could transmit information at a rate without any theoretical limit.

The existence of such a coding system is clearly embarrassing to the Hartley theorem and a reformulation would be expected to allow for such operation at extremely low noise levels. Also, we'd expect an expression for the signal-noise ratio at the receiver to be included. Note that the signal-noise ratio is the significant term, since more noise can always be counteracted by more power.

Scientists working for the telephone company came up with the revised version in 1948:

$$C = W \log \left(1 + \frac{S}{N} \right)$$

where C is the information-carrying capacity of a channel of bandwidth W, with a signal-noise ratio of S/N at the receiver (expressed here as a ratio of two powers, not in decibels). Remembering that the logarithm of a number keeps increasing as the number continues to increase, we see that the information capacity of a channel can be very high when the noise level is low. Furthermore, since the logarithm of 1 is zero, it follows that with a very high noise level the information-carrying capacity of a channel drops to zero.

A graph of the revised Hartley theorem is shown in Fig. 3. Each line corresponds to a particular signal-noise ratio at the receiver—the upper lines for low noise and the lower for high.

Now notice that, if an ideal modulation system were devised which allowed transmission of information at a rate just equal to the new theoretical limit, a certain amount of "trading" would be possible between the various terms.

TEST 5 TUBES in 4 SECONDS EACH...ACCURATELY!

WITH THE NEW ADVANCED ENGINEERED

precise MODEL 116

**Gm. & Em. ULTRAFAST
TUBE & TRANSISTOR TESTER**



Completely
New!

PRECISE MODEL 116K in kit form.....\$69.95
PRECISE MODEL 116W factory wired.....\$119.95

Servicemen know the Precise Model 111 (the winner in an independent survey) easily rates "the finest tube tester in the field" at any price, BUT FOR AN ON THE JOB QUICK-TEST . . . the fastest, most accurate is the PRECISE Model 116. What's more you test tubes the foolproof method inherent in the famous Precise Model 111.

Did you ever wish you could plug in 5 of the same type tubes at once and check each one individually by rotating a switch? YOU CAN WITH THE PRECISE MODEL 116—Plug in 5 IF tubes and let them heat up at once and then check each one separately by rotating the TUBE BANK switch. ACTUALLY CHECK 5 TUBES IN 20 SECONDS, 4 SECONDS PER TUBE.

The Precise Model 111 taught the lesson that IF amplifier tubes (like the 6BC5 or 6AU6) should be tested for Gm (mutual transconductance) while the power amplifiers (like the 6L6) should be tested for Em (emission)—that's ULTRAFAST Model 116 test! It checks each section of each tube separately . . . by rotating the FUNCTION SWITCH . . . each triode of a dual triode is checked individually . . . each diode and the triode of a duo-diode-triode is separately tested and not lumped as in other testers . . . and a pentode is tested as a pentode—not a diode. TRANSISTORS, SHORTS, GAS, LIFE, Em, Gm etcetera can be tested with the PRECISE Model 116.

You can inexpensively extend the Precise Model 116 to test filament current, etc. The Model 116 gives an accurate, ultra-fast (3 basic knobs for testing) check of television tubes!

No Surplus—An etched panel—beautiful Moleskin covered wood carrying case and cover and specially simplified instructions makes the PRECISE MODEL 116 THE FINEST FAST-CHECK TUBE TESTER AND DOLLAR EARNING TRAVELING COMPANION A TV SERVICEMAN EVER HAD.

Not yet at your distributor. Order NOW to insure early delivery.
SEE YOUR LOCAL DISTRIBUTOR FOR PROOF OF WHAT WE OFFER—OR WRITE US FOR DOCUMENTARY RESULTS OF AN INDEPENDENT SCIENTIFIC SURVEY.



THE FAMOUS MODEL #111
111K\$79.95
111W\$139.95
Inc. Carrying Case & Cover

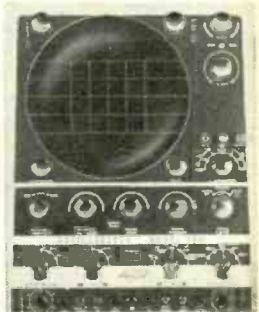

THE FIRST LOW PRICED
7" COLOR SCOPE
300K\$99.95
300W\$199.50

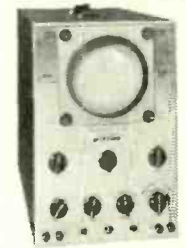

LOW PRICED 5" SCOPE
315K\$49.95
315W\$84.95

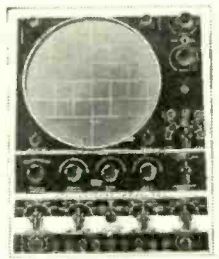

THE FIRST AND ONLY
8 1/2" COLOR SCOPE
308K\$129.50
308W\$229.50



LOWEST PRICED
WIRED 4 1/2" VTVM
909K\$25.98
909W\$37.50



RF-AF-BAR GENERATOR
with pre-assembled* head
630K\$33.95
630KA*\$38.95
630W\$53.95



THE FINEST VOLT, REG,
7" VTVM KIT
9071K\$35.95
9071W\$49.95



LOW PRICED RF SIGNAL GENERATOR
"BEST BUY" IN GEN. FIELD
610K\$23.95
610KA pre-assembled head.....\$28.95
610W\$39.95



UNIV. AF, SINE, SQ, & PULSE GEN.
635K\$33.50
635W\$52.50

Prices slightly higher in the West. Prices and specifications subject to change without notice. PTAK ..\$2.95 PTAW ..\$4.25

WRITE FOR CATALOG RE 4-6

SEE THE MANY MORE PRECISE INSTRUMENTS AND PROBES AT YOUR DISTRIBUTOR TODAY!

precise DEVELOPMENT CORP. OCEANSIDE, NEW YORK, U.S.A.

... another
MALLORY
service-engineered
product



Control
Replacements
are speedy
and sure...
with

Midgetrols®

You'll like Mallory Midgetrols... for the way they save your time. Need a line switch? You can attach it instantly, without taking the control apart. Need a tailor-made shaft? In seconds you can cut the round, tubular shaft and insert a split-knurl or flatted tip.

Your customers will like their performance. The extra-smooth surfaced carbon element, manufactured by a special Mallory process, assures long life and noise-free operation.

See your local Mallory distributor. He's ready to supply you with Midgetrols in the exact resistance values and tapers to fit all popular TV and radio sets.

P. R. MALLORY & CO. Inc.
MALLORY

P. R. MALLORY & CO. Inc., INDIANAPOLIS 6, INDIANA

- Capacitors
- Vibrators
- Resistors
- Power Supplies
- Controls
- Switches
- Rectifiers
- Filters
- Mercury Batteries

RADIO

A decreased signal-noise ratio could be offset by using more bandwidth, or by expecting a lower information-carrying capacity.

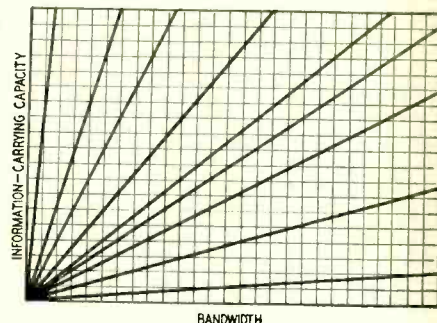

Fig. 3—Newer Hartley theorem. Lines represent different signal-noise ratios.

Amplitude modulation is not an "ideal" system in this sense since it cannot "trade" the quantities around. At low noise levels, AM is not very efficient (it is not too efficient even at high noise levels). Thus, where bandwidth is at a premium, it would not pay to use AM even though the equipment involved may be relatively simple.

Color Television

The television picture is transmitted by AM but in TV work one sideband is cut off, resulting in single-sideband (vestigial-sideband, to be precise) operation. Even then, efficiency is low. Also, much of the program material is repetitious, and occurs at a regular rate. Much of the information transmitted is contained as harmonics of the horizontal and vertical sweep frequencies, 15,750 and 60 cycles. The information transmitted over the TV 4.5-mc bandwidth could theoretically be condensed into a much smaller spectrum.

The new color TV standards take advantage of this inefficiency. According to the old Hartley theorem three times the bandwidth must be used—since three colors are to be transmitted—or else the information content be reduced. Previous color TV systems, such as the older ones of RCA and CBS, used a broader bandwidth or else reduced the information transmitted by lowering the resolution of the picture. The NTSC color TV standards in use now take advantage of the inefficiencies of the black-and-white TV picture signal spacing the color information between the sidebands of the black-and-white signal.

Perhaps a word should be said here about the reality of sidebands. Quite a few people—and competent people at that—tend to think of sidebands as something "imaginary," not really existing, while they have no trouble thinking of the carrier as something "real." They tend to think of a "forbidden zone" surrounding the carrier. The only thing that can be said here is that it is possible with a very sharply tuned circuit to tune to the carrier and the sidebands separately. This is about as convincing proof of their "reality" as can be imagined.

RADIO

Frequency modulation

Unlike AM, FM provides a system which can be used to more advantage for high-speed communication theory. In the formulation of the new Hartley theorem, remember that it turned out that transmitter power, bandwidth and information-carrying capacity could be traded back and forth in an ideal system. Such trading is possible with FM. Reducing the modulation (and therefore the bandwidth) can be counteracted as far as the receiver is concerned by an increase in transmitter power. However, even FM is not used as efficiently as it could be. The messages that are most commonly sent over FM are in some spoken language, which itself is rather inefficient. In addition, the information content is lowered by repetitions, blank spaces, etc. This is of course entertainment from the listeners' viewpoint but it is not communications from an engineer's standpoint. Perhaps if some means were available to put efficient messages over FM, a communications rate approaching the theoretical limit could be achieved.

Exactly this is done in a system known as Pulse Code Modulation or PCM. PCM codes the material in an efficient way and then transmits it over FM. While the details of this system are outside the scope of this article (See "Pulse Code Modulation" in the February, 1948, issue of this magazine) essentially what happens is that an input waveform (such as human speech) is broken up and the instantaneous value of the waveform "sampled" every so often. This sample value is sent in code to the receiving station, where the received coded signals are used to reconstruct the original waveform.

An analysis of this type of communication reveals that the theoretical limit of information transmission is the same as that predicted as the universal limit by the revised Hartley theorem. This system alone is theoretically capable of the fastest communication rates. In practice rates very close to the theoretical limit have been achieved. In the future this type of communication will become more commonplace—it offers real promise for saving considerable spectrum space.

This article has brought only some of the interesting results of information theory to the readers of RADIO-ELECTRONICS. A whole host of less interesting results, hidden behind abstruse mathematics, awaits the reader who wishes to do some further study.* However, the practical results from this interesting sidelight of radio communications are affecting the whole field so a general knowledge of the science is a must for every well informed worker.

If the reader managed to get some "bits" of "information" from this article, then the author's job is done, and he can crawl behind his mathematics again. END

* The best book available is Goldman, Stanford: *Information Theory*, Prentice-Hall, N. Y., 1953.

... another
MALLORY
service-engineered
product



Servicemen's favorites in wire-wound controls

You're sure of giving your customers the best when you use Mallory wire-wound controls. The choice of servicemen and manufacturers everywhere, they have set the standards of the industry for value and performance.

They're conservatively rated—to assure you of cool operation without need for using over-sized units.

They're compact—fit readily into crowded chassis locations.

They're long lasting—give years of stable, dependable service.

They're uniform—made to strict specifications to meet or exceed original equipment requirements.

Mallory 2-watt and 4-watt controls are available in resistance values and tapers to match every replacement need. Your local Mallory distributor has a complete stock—see him today!

P. R. MALLORY & CO. Inc.
MALLORY

P. R. MALLORY & CO. Inc., INDIANAPOLIS 6, INDIANA

- Capacitors
- Controls
- Vibrators
- Switches
- Resistors
- Rectifiers
- Power Supplies
- Filters
- Mercury Batteries

A study of rectifiers and their polarity

*much
fuss*

+ *about...*

PLUS

By SOL D. PRENSKY

FEEL like an argument? A pretty sure way of getting into one is to ask what looks like an innocent enough question, "What's meant by the plus (+) sign on a metallic rectifier?" Judging by past experience, you'll have at least an even chance of getting an answer different from your own, and much better than an even chance of getting into an argument over the interpretation of the answer. And if there should be more than just

the two of you around at the time, don't even bring up the subject! When a group of otherwise civilized people starts making a fuss about plus, that's the beginning of the end of a lot of beautiful friendships.

Let's pin the troublesome question down to a definite circuit. In Fig. 1 we want to measure the forward current through an unknown metallic rectifier with a plus marking on one end. The diagram shows the positive

terminal of the battery already connected correctly to the dc milliammeter. Problem: complete the circuit through the rectifier so that the meter properly reads the forward current.

Having arranged the question as a straightforward problem, let's go ahead to the solution. But wait a moment—someone wants to know whether we're using a selenium or germanium rectifier? A good point because it's not too uncommon to find a particular manufacturer marking his seleniums different from his germaniums—rectifiers, that is. So we'll make it perfectly definite and pick the selenium rectifier, for which the plus (or red) marking on one terminal is established practice. (We'll leave the germaniums for discussion later.)

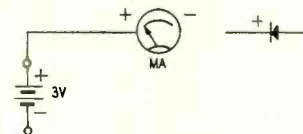

Fig. 1—How is the rectifier connected?

Now, fellow students, the solution: to obtain forward current (greatest conduction) we connect the plus side of the rectifier to the minus side of the battery and complete the circuit. Even though it doesn't seem to sound right, we can check it by flipping the rectifier around—the meter reading will drop to practically zero. So we must admit that the solution is correct.

The solution still does not answer our original question about the meaning of the plus marking on the rectifier. It obviously has a different meaning than on the meter, where it is an indication of the meter terminal to which the positive side of the circuit must be connected. This applies equally to the polarity markings on other passive (nonvoltage-source) elements like electrolytic capacitors. But for a voltage-source (active) element like a battery, the plus sign indicates the positive potential—again a clear-cut definite meaning. Now, about the apparent contradiction in the case of the metallic rectifier . . .

"Just a minute," someone interrupts at this point, "which direction are you using, electron flow or conventional current flow?"

"It doesn't matter at all," say we.

"But they're opposite, aren't they?" continues the interrupter.

"Yes, but . . . (See what I mean, the chances for argument are just beginning!) Just a minute, yourself. We're not going to get all tangled up in that thicket now—that's exactly the reason the circuit wires have been left bare of any directional arrows. We'll cross that electron-flow vs. current-flow bridge when we come to it."

As we were saying before we were so rudely interrupted, about that apparent contradiction in the case of the metallic rectifier, it becomes painfully evident that the plus marking does not make the same sense here that

RADIO

it does for other passive elements, like meters. Somewhere, sometime, in the dim past, the original seleniums were marked in the fashion of active elements like batteries and, unfortunately, the practice, like Topsy, just grew—and is now firmly established. As an aid in keeping the record straight, it is helpful to think of the selenium rectifier, in its most commonly used form, as the rectifying element in a half-wave power-supply circuit (Fig. 2). Note that the plus terminal of the selenium is the one at which the positive dc output appears. At any rate that's the situation that prevails with selenium rectifiers.

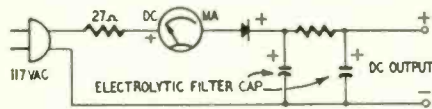

Fig. 2—Polarity marking on selenium rectifier in power-supply circuit.

Fortunately for our sanity, there is a much brighter outlook when we deal with the vacuum-tube diode which has had no such unfortunate history. We can trust it to be our unfailing guide in the matter of polarity by using the terms anode (plate) and cathode. They consistently appear on the tube and, in this way, keep entirely clear of confusing interpretations. Such a guide is shown in Fig. 3, based on accepted standards. In the symbol for the metallic (or crystal or semiconductor) diode, the triangular portion corre-

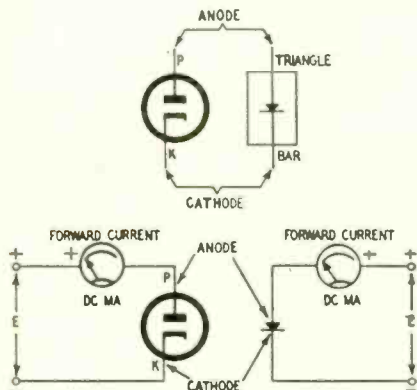

Fig. 3—Comparing conventional tube designation with a semiconductor.

sponds to the tube anode, the bar portion to the diode cathode. This is all that is needed to keep any diode straight, no matter where it is used or who uses it. The standard symbol for the crystal (such as germanium) rectifier was adopted only recently and is now a part of the military standard (MIL-STD-15A) governing all military publications (April 1, 1954).

The actual wording used in spelling out the accepted crystal diode symbol is as follows:

"The arrowhead designates the direction of forward (easy) current, as shown by a dc ammeter. The arrowhead in this case shall be filled."

Short and sweet, and note that not

a word about plus is needed. From here on in, a diode is a diode is a diode. Whether it's selenium, germanium, silicon or tube.

Applications

A good example for practice with diodes (also triodes and transistors) is given in Fig. 4. This miniaturized circuit uses a germanium diode for a flea-power supply to a germanium

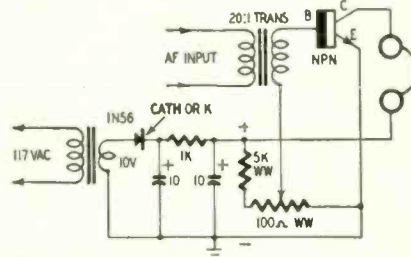

Fig. 4—Germanium diode in power supply for an n-p-n transistor circuit.

junction transistor (n-p-n type), acting as an audio amplifier. Note the following points:

1. The bar in the crystal rectifier symbol corresponds to the cathode, thus conforming to the forward-current direction shown by the symbol arrowhead and producing positive dc output at the bar (cathode).
2. Since the arrowhead on the transistor emitter symbol similarly indicates forward current, as required for transistor bias, the base is connected to a positive point on the power supply.
3. The general requirement for the collector of any transistor is that

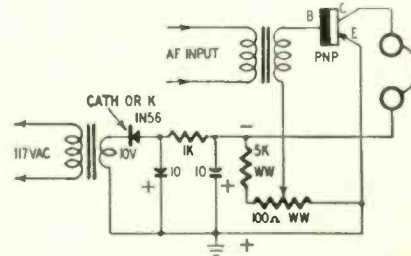

Fig. 5—Germanium diode in power supply for a p-n-p audio amplifier.

it be connected in the back-current direction; consequently, in the n-p-n circuit, the collector goes to the high positive side of the power supply.

In Fig. 5 the n-p-n circuit of Fig. 4 is redrawn for a p-n-p transistor and its power supply. The polarities for the p-n-p transistor are opposite to those used in the previous example. Accordingly, the power supply is now shown "upside down," so that it may conveniently apply the required negative voltage to the p-n-p collector. (The positive side of the power supply is grounded.) The general requirement that bias current should be in the forward direction is met, in the p-n-p case, by connecting the emitter to the positive (ground) side, thus conforming to the basic rule that the arrowhead symbol is always used to indicate forward current.

END

BEST BUY IN SCOPES



new!
Simpson
7"
COLORSCOPE
MODEL 458

Compare the new Simpson Colorscope Model 458 with any oscilloscope on the market. It is an advanced, seven-inch, high-gain, wide-band scope especially designed for color-TV service. Ideal for black and white, too.

100% RESPONSE at 3.58 mc color-burst!

DUAL bandwidth—narrow or wide!
FLAT FREQUENCY RESPONSE, within 1 db to 4.5 mc!

RISE TIME less than 0.05 microsecond (wide band)!

FULL RANGE compensated vertical attenuator!

FOUR ACCESSORY PROBES to provide extra utility!

Price with shielded input cable, manual... **\$229.95**

For complete details, see your distributor or write.



SIMPSON Electric Company

WORLD'S LARGEST MANUFACTURER
OF ELECTRONIC TEST EQUIPMENT

5200 W. Kinzie St., Chicago 44, Illinois

Phone: EStebrook 9-1121

In Canada: Bach-Simpson Ltd., London, Ont.

MEET THE NEW **RCP**
DYNAMIC MUTUAL CONDUCTANCE
 ★ **Tube/Transistor Tester**
Model 325

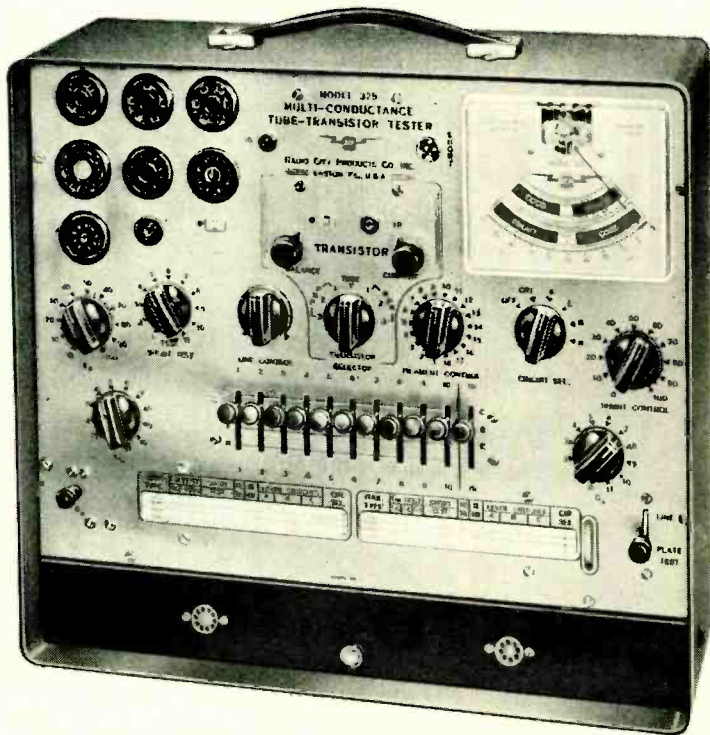

... with these **Most Wanted** Features

- ★ Measures Transistor Gain under full load
- ★ Measures Tube Mutual Conductance under actual operating voltages and loads
- ★ Measures Plate Conductance under full load
- ★ Tests for All Shorts and Leakage with one switch
- ★ Handles Series-String Heater tubes
- ★ Tests Rectifiers and Pentodes at reduced heater voltages
- ★ Tests CR-Tubes
- ★ Reactivates CR-Tubes
- ★ Fused Meter and Line Circuits
- ★ Simplified Lever Switches and Fast-Acting Roll Chart

See the hottest news in instruments—the RCP Model 325—at your RCP jobber . . . or fill in coupon for full details. Combines features, accuracy, and low price no other laboratory-type instrument can match. **ONLY \$129.95**

RADIO CITY PRODUCTS COMPANY, Easton, Pa.

NEW RCP TIME-PAYMENT PLAN

Take 6, 8, or 12 months to pay for any RCP instrument costing \$50. or more. Ask your jobber for full details.

DISTRIBUTORS DIV.
 RADIO CITY PRODUCTS CO., 26 Rittenhouse Place, Ardmore, Pa.
 Please rush me full details on the new RCP Model 325 Dynamic Mutual Conductance TUBE & TRANSISTOR TESTER.

NAME.....
 BUSINESS.....
 ADDRESS.....
 CITY.....ZONE.....STATE.....



Note: Records below are 12-inch LP and play back with RIAA curve unless otherwise indicated.

Traditional Jazz Vols. 6 and 7
 Doc Evans and Knobby Parker and Band
 Audiophile AP 33 and AP 34 (AES bass and -6-db treble or EUR)

Further improvement in Audiophile recordings seems impossible and yet each new issue surpasses its predecessors. Though these two are recorded at 33 rpm (instead of the usual Audiophile 78 rpm) they sound as good as the 78's. Either makes superb demonstration material with the edge probably going to AP 33 for its more familiar music (*Tiger Rag, Sugar Blues, Frankie and Johnnie, Four or Five Times, Waiting for the Robert E. Lee, See See Rider, Black Bottom Stomp, Jelly Roll Blues, Kansas City Stomp and Balling the Jack*) although AP 34 has the *Saints Go Marching In, Temptation Rag, Lena, Dardanella* and in addition *Corinne, Corrina, Mabel's Dream, If I Could Be With You and Song of the Islands*. The presence is at least equal to the best Stereo tape available and astonishing by any standards, given a first-class playback system. This pair is outstanding for the superb recording of the piano and the wonderful brass bass. But there are also some fine percussive highs and transients, a lovely dull drum and the brasses are faithfully brassy without being edgy.

DELIBES: Sylvia and Coppelia Ballet Music
 Monteux conducting Boston Symphony
 RCA LM-1913

Here is one of RCA-Victor's best—a fine demonstration recording with an awesome bass, good drums and plenty of tinkling highs plus some mighty pleasant music likely to appeal even to those with no great familiarity with classical music. I especially liked the very natural balance between bass and highs. The presence and resonance are excellent.

George Wright Plays the Mighty Wurlitzer
 Hifirecord R-701

George Wright Encores
 Hifirecord R-702

Richard Purvis Organ Recital in Grace Cathedral, Vol. II
 Hifirecord R-704

Fritz Kreisler Favorites
 Richard Ellsasser, Organ of John Hays Hammond Museum
 MGM E-3238

If you've a speaker system capable of going down at least to 32 cycles, the first three of these will show it off impressively. The pedal bass is floor-shaking but extraordinarily sharp and well defined—provided your speakers have no hangover and your amplifier doesn't start breathing when energized by them. There are, in addition, plenty of good percussive transients and high-highs, some of them above 10 kc. The music is a potpourri of various pop tunes showing off the full gamut of capabilities of the mighty Wurlitzer.

If I had to choose a single one, I'd pick the *George Wright Encores*. More spectacular

throughout, it has, in addition to the normal Wurlitzer effects including drums, a variety of genuine birds calls in *Quiet Village*. The Purvis is another potpourri but of mostly romantic style organ classics. The lowest octave of the pedal is especially prominent and my 32-cycle window (rattles with a 32-cycle fundamental but not harmonics) testifies to plenty of fundamentals in this region. All three offer very spectacular organ music, and when played on systems that can dish it out in almost life-size volume they are capable of making mouths drop agape.

There is one flaw: portions of all three Hi-Fi records are cut so heavily that with many pickups the distortion on peaks will be very violent. But this provides a trying test, for there are a few pickups that can take even this, and those that can't should be checked for needle condition, tracking and alignment. The Elsassar disc, not in the same class for spectacularity, is cleaner in the peaks and the music is precisely the kind that background listeners adore most. It may be of some technical interest because this particular organ has something called a Dynamic Accentor—apparently an amplifier with which the amplitude or volume can be controlled and accented.

Joe Enos Plays Two Pianos

Hifirecord R-201

Joe manages this feat with the help of multiple-track recording and the resulting sound is fairly awe inspiring. The music is a tasteful melange of pops like *Among My Souvenirs* and popular classics like *Prelude in G Minor* and *Flight of the Bumblebee*. The sound is unusual. The treble piano is very sharp and in spots the rattle of hammers, damping pads and loose pins is plainly audible. The room resonance—or is it the loud pedal?—is very marked. The bass is one of the best piano basses on records. But Hifirecord has not yet reached Audiophile's mastery in recording the piano for in spots there is a touch of piano wow.

BACH, J. S.: Concerto for Two Harpsichords in C Minor
Concerto for Two Harpsichords in C Major
Concerto for Violin and Oboe in D Minor

Pro Musica String Orchestra of Stuttgart, Rolf Reinhardt, Conductor
 Vox PL-9580

The difference between first- and second-rate hi-fi systems is largely in definition. Here is a top-notch test record for definition. What makes it especially good is that the two harpsichords are underlaid in almost every movement with a heavy bass capable, with poor reproducing systems, of generating very high intermodulation distortion. The concerto for violin and oboe is another version of the C minor for two harpsichords and the contrast in tone and style will help sharpen your ear in judging definition in the two-harpsichord concerto. The balance between harpsichords and orchestra is especially good. The recording is very sharp and clean throughout.

RACHMANINOFF: Piano Concerto No. 2 in C Minor
Rhapsody on a Theme by Paganini

Orazio Frugoni, pianist
 Harold Byrns conducting Pro Musica Orchestra of Vienna
 Vox PL-9650

This should make a superior classical demonstration record. The rhapsody has plenty of highs, a huge bass, a fine piano and good balance. The concerto is shorter on highs but otherwise impressive. The concerto is one of the most popular classical works and the rhapsody appeals to anyone willing to take the time to hear it a couple of times. END

Name and address of any manufacturer of records mentioned in this column may be obtained by writing Records, RADIO-ELECTRONICS, 25 West Broadway, New York 7, N.Y.

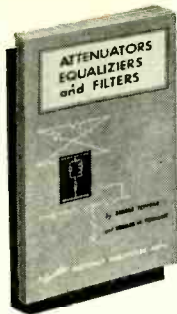

NEW SAMS BOOKS

"ATTENUATORS, EQUALIZERS AND FILTERS"

by Dr. George K. Tefteau and Dr. Howard T. Tremaine

Thoroughly describes design, application and theory of operation of every type of Attenuator, Equalizer and Wave Filter. Covers all types of equalization and attenuation used in audio recording and reproducing systems, both professional and home-type. Includes chapter on Hi-Fi crossover networks. Provides time-saving charts which permit the easy determination of component values required in designing equalizers and filters. Fact-packed, indispensable to technicians in radio broadcasting, television, cinema work and to audiophiles. 176 pages; 5 1/2 x 8 1/2"; fully illustrated. Deluxe hard binding, postpaid. **\$4.00**
 Also available in paper-bound edition, postpaid. **\$.275**

"TAPE RECORDERS—How They Work"

by Charles G. Westcott

Now you can have an expert understanding of tape recording, its theory and characteristics. Tells how a recorder operates; discusses motorboard mechanism, drive motors, volume indicators, bias oscillators, equalization circuits, amplifiers and magnetic heads—includes diagrams, photos and schematics. Tells how to get best frequency response with lowest noise level, how to avoid tape overload, how to obtain best bias settings; includes procedures for testing tape recorders and tape. The comprehensive book about Tape Recorders. 176 pages; 5 1/2 x 8 1/2"; over 150 illustrations. Order today. **\$2.75**

SAMS BOOKS
 keep you ahead in
ELECTRONICS

Sams books cover every phase of Electronics for the service technician, engineer, student or experimenter. Listed below are a few of the many valuable Sams books available at electronic parts distributors and leading book stores.

USE THIS ORDER FORM

- ATTENUATORS, EQUALIZERS AND FILTERS (Deluxe Edition) \$4.00**
 Paper-bound edition **\$.275**
- Principles & Practices of Teletesting Operations.** Discusses equipment and techniques. Covers such subjects as: TV Cameras; Control Rooms; Fundamentals of Studio Lighting; Relay Systems; Maintenance Practices; Technical Production; etc. 600 pages; 6 x 9"; illustrated. **\$7.95**
- Radio Receiver Servicing.** Covers the basic receiver types—gives time-saving hints for solving basic troubles, such as dead set, weak set, noisy set, etc. 192 pages; 5 1/2 x 8 1/2" **\$2.50**
- So You Want to Be a Ham.** Tells you what you need to know about getting your license and acquiring equipment. Covers such subjects as: Conquering the Code; Getting Your Ticket; Going on the Air; Electronics as a Career; etc. 196 pages; 5 1/2 x 8 1/2" **\$2.50**
- Servicing TV Sweep Systems.** Describes the operation, circuit function and circuit variations of vertical and horizontal sweep systems common to most TV receivers. Tells how to analyze circuits; troubleshoots for you. 212 pages; 5 1/2 x 8 1/2"; illustrated. **\$2.75**
- The Recording and Reproduction of Sound.** Widely used by Audio engineers, Hi-Fi enthusiasts, broadcasting stations and recording studios. Authoritative chapters cover: behavior of sound waves; basic recording methods; lateral disc recording; micro-groove recording; phono reproducers; microphones; home music systems; P.A. systems; amplifiers; tuners; etc. 810 pages; 6 x 9"; illustrated. **\$7.95**
- Basic Television Manual.** Deals with all phases of TV receiver operation and design from cathode ray tube to antenna. Includes section on actual projects which demonstrate theory in action. 312 pages; 8 1/2 x 11"; illustrated. **\$5.00**

- TAPE RECORDERS—HOW THEY WORK \$2.75**
- Photofact Television Course.** Gives a clear complete understanding of TV principles, operation, practice. Used by thousands of students. 208 pages, 8 1/2 x 11" **\$3.00**
- Atomic Radiation, Detection and Measurement.** Provides basic understanding of nuclear science and its applications. Thoroughly covers and illustrates circuitry and operation of the many types of detection devices. 200 pages; 5 1/2 x 8 1/2" **\$3.00**
- Color Television for the Service Technician.** Prepares you for the day when you will be installing and servicing color TV. Fully illustrated. 116 pages, 8 1/2 x 11" **\$2.50**
- Basic Radio Manual.** Provides all the basic facts on theory, definitions, components. Includes section devoted to actual projects that translate theory into practice. 248 pages; 8 1/2 x 11"; illustrated. **\$5.00**
- UHF Antennas, Converters & Tuners.** Covers all antenna types, transmission lines, matching networks, UHF converters, tuners. 136 pages, 5 1/2 x 8 1/2" **\$1.50**
- Auto Radio Service Manuals**
- Vol. 5.** Presents complete, accurate service data, schematics, parts lists and photos based on actual laboratory analysis of 87 auto radio models produced during 1954-55. 288 pages; 8 1/2 x 11" **\$3.50**
- Vol. 4.** 48 models; 1953; 288 pages. **\$3.00**
- Vol. 3.** 80 models; 1950-52; 288 pages. **\$3.00**
- Vol. 2.** 90 models; 1948-50; 288 pages. **\$3.00**
- Vol. 1.** 100 models; 1946-49; 396 p. **\$4.95**

There is an authoritative Sams book on virtually any Electronic subject in which you're interested. Check below for FREE Book List describing all Sams books.

Send Book List



HOWARD W. SAMS & CO., INC.

Order from your Parts Jobber today, or mail to Howard W. Sams & Co., Inc., Dept. 2-D6 2201 East 46th St., Indianapolis 5, Indiana.

Send books checked above. My (check) (money order) for \$ is enclosed.

Name

Address

City Zone State

(outside U.S.A. priced slightly higher)



Look for
SAMS BOOKS
 on the
 "Book Tree"
 at your Parts
 Distributor

C-D features the NEW COMPLETE line of Communication Vibrators

... in 6 and 12 Volt Series

that outlast
them all!

Here is everything needed for complete service on communication vibrator replacements! Engineered to rigid U.S. Gov't specifications, these new C-D Vibrators outlast them all... out-perform others and give you the RIGHT vibrator for EACH application!

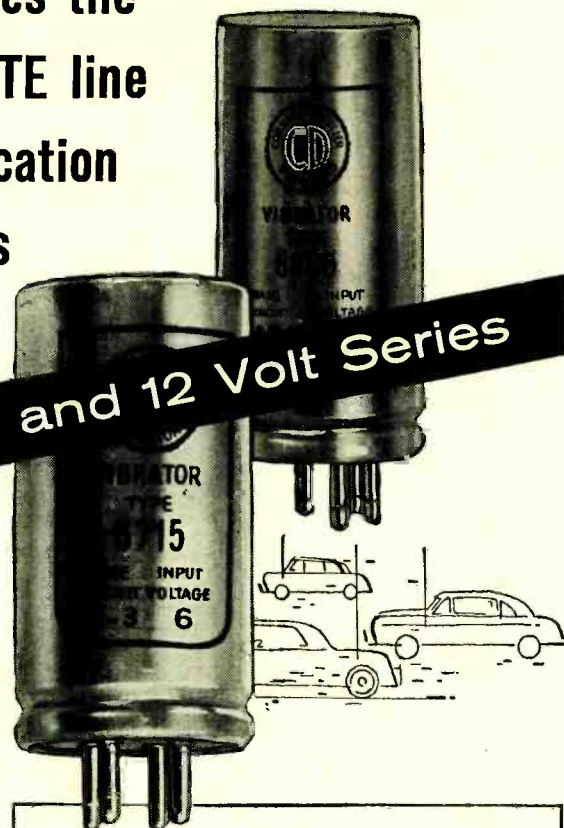

Ten Types Provide Complete Replacement for ORIGINAL Communication Equipment

New No.		Old No.
6 volt	6/12 volt	
5715	6715	5515
5718	6718	5518
5721	6721	*
5722	6722	*
5725	6725	*
5805	6805	5605
5820	6820	5620
5821	6821	5621
5822	6822	5622
5824	6824	*

For Specific Applications, see the NEW C-D Vibrator Guide

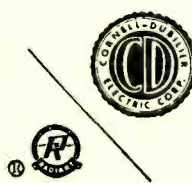

Cornell-Dubilier Vibrators

PLANTS IN SOUTH PLAINFIELD, N. J.; NEW BEDFORD, WORCESTER AND CAMBRIDGE, MASS.; PROVIDENCE AND HOPE VALLEY, R. I.; INDIANAPOLIS, IND.; SANFORD AND FUQUAY SPRINGS, N. C.; SUBSIDIARY: THE RADIART CORPORATION, CLEVELAND, OHIO



JOINT BUYING PROGRAM

The Television Service Dealers Association of Philadelphia has launched a cooperative buying plan to aid its members in the purchase of parts and accessories. At present confined to tubes, it is expected that, if successful, the plan will be extended to other electronic components.

TSDA members were informed that they could make a saving averaging 6 cents per tube on standard brands. Order blanks and instructions have been delivered to members. Orders—accompanied by cash—must be placed by the 1st and 15th of each month. The orders are mailed direct to the purchaser's place of business.

PENNSYLVANIA DRIVE

A new membership program designed to bring in associate members throughout the state was inaugurated at the Pennsylvania Federation of TV-Radio Service Associations held in January. The program is aimed at those technicians who may wish to share the benefits of organization but who live at some distance from any local association. In the past they could join the state organization only through membership in a local association. The Pennsylvania group believes this action will increase its collective strength and ability to help the organized technicians and remedy some of the abuses in the electronic service industry.

At the January meeting also Committee Chairman Milan Krupa swore in the federation's 1956 officers: Bert A. Bregenzer, Pittsburgh, chairman; Wm. Morrow, Chester, vice chairman; Leon J. Helk, Carbondale, secretary; Ray Blackwood, Industry, recording secretary; L. B. Smith, Hershey, treasurer.

TV GYPS JAILED

Prison sentences have been meted out to two men convicted of operating a television repair racket. The "technicians," Bernard Cohen and James Manolius, president and vice president, respectively, of City Television Repair, New York City, were sentenced to 9-month terms.

Assistant District Attorney A. J. Liebler asked the court to impose "stiff sentences" explaining that it would deter others from racketeering in the industry. Detectives and policewomen, renting apartments as married couples, gathered the incriminating evidence by having City Television Repair come to their apartments and make repairs on "doctored" sets.

TRANSISTORS—how they work and how to work with them

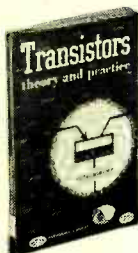

Transistors—Theory and Practice—No. 51. By Rufus P. Turner. 144 Pages—135 Illustrations. \$2.00

Author-engineer Rufus P. Turner writes about transistors from the viewpoint of the practical man. Tells you why and how they work and how to use them in work-a-day circuits. Gives data on tests and measurements. Lists characteristics of commercial transistors. Expanded use of transistors today makes this book a must for all experimenters, engineers, and progressive service technicians.

ON SALE AT BETTER PARTS DISTRIBUTORS

GERNSBACK LIBRARY, INC.
154 West 14th St., New York 11, N.Y.

10 Big Chapters

- Semiconductor Theory
- Transistor Characteristics
- Equivalent Circuits
- Transistor Amplifiers
- Transistor Oscillators
- Duality in Transistor Circuit Design
- Triggers and Switches
- Practical Transistor Circuits
- Test and Measurements
- Characteristics of Commercial Transistors

COSTS AND COMPLAINTS

The Halifax Radio & TV Dealers Association of Daytona Beach, Fla., has started a move to standardize repair costs. Suggested charge for a house call is \$5, to include a half-hour of work. After that, work done in the home or shop would be charged at \$5 per hour. New parts would be marked up not more than 40% above the service dealer's cost.

The association has an organized system of taking care of customer complaints. They are first referred to the organization's grievance committee. In case of continued disagreement, the matter goes before an appointee of the local Better Business Bureau. Bob Conley, head of the bureau, reports that no complaint has been received during the seven months he has been in office.

SELF-LICENSING PLAN

The Federation of TV-Radio Servicemen's Associations of Pennsylvania expects to set up a licensing program early in April, according to its president, Bert Bregenzler.

Local chapters will license service technicians in their own areas, said Mr. Bregenzler. He went on to state that this did not mean that the federation was abandoning the idea of state licensing, for which the federation has fought for a number of years. If the licensing plan is successful, there will be a better chance to push another effort for a state-controlled program, he believed.

LICENSING IN DETROIT?

An ordinance for licensing all TV repair establishments was presented to the Detroit Common Council under the sponsorship of the Television Service Association of Michigan.

As drawn up, the proposed city law would provide for examinations given by a seven-man board appointed by the Mayor. Enforcement would be the responsibility of the Department of Buildings and Safety Engineering. Violation of license conditions—under the terms of the proposed bill—would include loss of license, fines up to \$500 or jail sentences up to 60 days.

GUILD HAS HOME

The Radio-Television Guild of Long Island has acquired permanent headquarters—a large residential building in Hempstead, N. Y. The headquarters will be used for a meeting place and a permanent clinic. Several shop owners have supplied equipment, light fixtures, test bench, TV antenna and a couple of "dog" receivers for use in the association's TV clinic.

Recently elected officers for the 1956 term are: Murray Barlowe, Bethpage, president; James Lyons, Woodhaven, vice president; Abe Smolewitz, Laurelton, treasurer; Chris Stratigos, Rockville Center, secretary; George Volkens, Woodhaven, sergeant-at-arms. Three boards of trustees—one each for Nassau, Suffolk and Queens Counties—were also elected. END

Simpson...the most Complete Line of VOM's

Select the one that fits your needs!

MODEL
260
world's most popular!

Over half a million Model 260's have been sold to date! 20,000 Ohms per volt. You'll find it wherever quick, accurate, electrical checks are needed. It's so handy, so dependable, so sensibly priced! Ask your jobber. Price, including Adjust-A-Vue Handle, only ... **\$38.95**
Carrying Cases from **\$6.75**

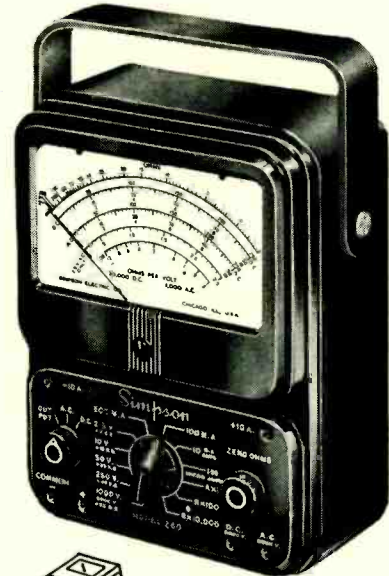

MODEL **262**

Deluxe!

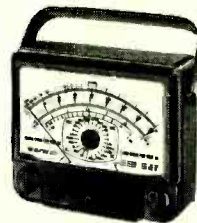

the new VOM with a 7" meter
20,000 Ohms per volt DC and 5,000 Ohms per volt AC sensitivity ... 33 ranges ... compact 7" case with Adjust-A-Vue Handle ... **\$59.50**
Carrying Case ... **\$ 9.95**

MODEL **269**

100,000 Ohms per volt!

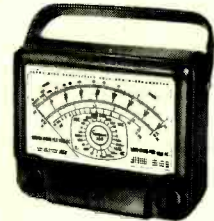

Most sensitive VOM available! A Volt-Ohm-Microammeter with a big 7" meter in a compact 7" case ... 33 ranges ... Adjust-A-Vue Handle ... **\$88.00** price complete. ... **\$ 9.95**
Carrying Case ... **\$ 9.95**

NEW!

- ▶ **MIDGETESTER** Model 355—New shirt-pocket size Volt-Ohmmeter **\$29.95**
- MODEL 240**—Small VOM; 14 ranges; up to 3000 volts AC or DC **\$26.35**
- MODEL 230**—Small VOM; 12 ranges; up to 1000 volts AC or DC **\$24.95**
- ROTO RANGER** Model 221—25 Separate meters at turn of a switch **\$75.00**
- LABORATORY STANDARD**—For instrument calibration. Price on application.

Simpson ELECTRIC COMPANY

World's Largest Manufacturer of Electronic Test Equipment

5200 W. KINZIE ST., CHICAGO 44, ILL. • ESTebrook 9-1121
In Canada: BACH-SIMPSON, LTD., LONDON, ONTARIO

BUILD 16 PRINTED CIRCUIT AND METAL CHASSIS RADIO CIRCUITS

only \$19.95 complete

With the New Deluxe 1956
PROGRESSIVE RADIO "EDU-KIT"

A practical home radio course

Build 16 Receiver, Transmitter,
Code Oscillator, Signal Tracer,
Signal Injector Circuits

- No Knowledge of Radio Necessary
- No Additional Parts Needed
- Excellent Background for TV
- Learn High Fidelity
- Used in 79 Countries
- School Inquiries Invited
- Learn Practical Radio Theory and Construction



Reg. U.S.
Pat. Off.
Pend.

FREE RADIO and TELEVISION SERVICING LITERATURE
ON REQUEST (See Coupon Below)

WHAT THE "EDU-KIT" OFFERS YOU

Our Kit is designed to provide a fundamental background in radio, with the basic facts of Radio Theory and Construction Practice expressed simply and clearly. You will gain a knowledge of basic Radio Principles involved in Radio Reception, Radio Transmission and Audio Amplification.

You will learn how to identify Radio Symbols and Diagrams; how to build radios, using regular radio circuit schematics; how to mount various radio parts; how to wire and solder in a professional manner; you will learn proper chassis layout. You will learn Printed Circuitry. You will learn how to service and trouble-shoot radios. You will learn code. You will receive training for F.C.C. Novice License. You will learn High Fidelity.

In brief, you will receive a practical basic education in Radio, worth many times the small price you pay.

THE KIT FOR EVERYONE

The Progressive Radio "Edu-Kit" was specifically prepared for any person who has a desire to learn Radio. The Kit has been used successfully by young and old in all parts of the world. It is not necessary that you have even the slightest background in science or radio.

The Progressive Radio "Edu-Kit" is used by many Radio Schools and Clubs in this country and abroad. It is used by Armed Forces Personnel and Veterans throughout the world for training and rehabilitation.

The Progressive Radio "Edu-Kit" requires no instructor. All instructions are included. All parts are individually boxed, and identified by name, illustration and diagram. Every step in building these sets is carefully explained.

"LEARN BY DOING"—PROGRESSIVE TEACHING METHOD

The Progressive Radio "Edu-Kit" comes complete with instructions. These instructions are arranged in a clear, simple and progressive manner. The theory of Radio Transmission, Radio Reception, Audio Amplification and servicing by Signal Tracing is clearly explained. Every part is identified by illustration and diagram. You will learn the function and theory of every part used.

The Progressive Radio "Edu-Kit" uses the principle of "Learn by Doing." Therefore you will build radio circuits, perform jobs, and conduct experiments to illustrate the principles which you learn. These circuits are designed in a modern manner, according to the best principles of present-day educational practice. You begin by building a simple radio. The next set that you build is slightly more advanced. Gradually, in a progressive manner, you will find yourself constructing still more advanced multi-tube radio sets and doing work like a professional Radio Technician. Altogether you will build Receiver, Transmitter, Code Oscillator, Signal Tracer, Signal Injector Circuits—16 in all. These sets operate on 105-125 V. AC/DC. For use in Foreign Countries having 210-250 Volt Source, an Adaptor for 210-250 V. AC/DC is available.

THE PROGRESSIVE RADIO "EDU-KIT" IS COMPLETE

You will receive every part necessary to build 16 different radio circuits. Our "Edu-Kits" contain all tubes, tube sockets, chassis, variable, electrolytic, and paper condensers, resistors, tie strips, coils, hardware, tubing, Instruction Manuals, Printed Circuit chassis, Printed Circuit tube sockets and hardware, Printed Circuit Instruction Manual, etc. Selenium rectification is used throughout.

Every part that you need is included. These parts are individually packaged, so that you can easily identify every item. A soldering iron is included, as well as an Electrical and Radio Tester. Complete, easy-to-follow instructions are provided. All parts are guaranteed, brand new, carefully selected and matched.

In addition, the "Edu-Kit" now contains lessons for servicing with the Progressive Signal Tracer and Progressive Signal Injector, F.C.C. Instruction, quizzes, High Fidelity Instructions. The Progressive Radio "Edu-Kit" is a practical home radio course at a rock bottom price.

TROUBLE-SHOOTING LESSONS

Trouble-shooting and servicing are included. You will be taught to recognize and repair troubles. You will build and learn to operate a professional Signal Tracer and Signal Injector. You will receive an Electrical and Radio Tester, and learn to use it for repairs. While you are learning in this practical way, you will be able to do many a repair job for your neighbors and friends, and charge fees which will far exceed the cost of the "Edu-Kit." You can learn radio quickly and easily and have others pay for it. Our Consultation Service will help you with any technical problems which you may have.

PRINTED CIRCUITRY Now Included

You build a Printed Circuit Signal Injector, a servicing instrument that can detect many Radio and TV troubles. A Printed Circuit is a special insulated chassis on which has been deposited a conducting material which takes the place of wiring. Various parts are plugged in and soldered to terminals. This new process is now popular in commercial radios, TV, hearing aids, etc.

FREE EXTRAS

- RADIO & ELECTRICAL TESTER
- ELECTRIC SOLDERING IRON
- TESTER INSTRUCTION MANUAL
- CONSULTATION SERVICE
- HIGH FIDELITY GUIDE
- QUIZZES
- TELEVISION BOOK

30-DAY UNCONDITIONAL MONEY-BACK GUARANTEE

MAIL TODAY—ORDER SHIPPED SAME DAY RECEIVED

- Send "Edu-Kit" Postpaid. I enclose full payment of \$19.95.
- Send "Edu-Kit" C.O.D. I will pay \$19.95 plus Postage.
- Send me FREE additional information describing "Edu-Kit." Include FREE valuable Radio and TV Servicing Literature. No obligation. (Outside U.S.A.—No C.O.D.'s. Send check on U.S. bank or Intern'l M.O. "Edu-Kit" for 105-125 V. AC/DC \$20.95; 210-250 V. AC/DC \$23.45.)

Name _____

Address _____

PROGRESSIVE "EDU-KITS" INC.

497 Union Ave., Room 115G, Progressive Bldg., Brooklyn 11, N.Y.

new Devices



INDOOR TV ANTENNA, *Slide-o-Matic series 3700*, provides clear reception in strong signal areas. 6-position low-loss gliding switch. Brass models with ivory

bridges with suffix US, T, VX, V or V-Max as well as all other makes. *TO-222* turnover series; *RA-395* single stylus.—Ronette Acoustical Corp., 135 Front St., New York 3, N. Y.

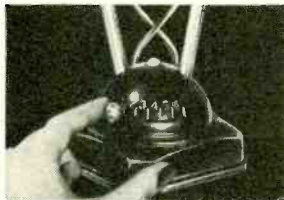

ry, mahogany and ebony bases, aluminum models with ebony. For black-and-white and color TV sets.—**Channel Master Corp.**, Ellenville, N. Y.

ANTENNAS, *Taco Stay-Lok Trappers and Super Trappers models 2880, 2885 and 2890*. Super Trapper provides additional



high-band gain on channels 10-13, Elements lock in without tools.—**Technical Appliance Co.**, Sherburne, N. Y.

SET COUPLERS, *AC40, AC60 and AC70 service savers*, for outdoor use. Permit running lead-ins outside house to rooms desired. Components in airtight block. Insertion-loss reduced to minimum by distributed-line pa-

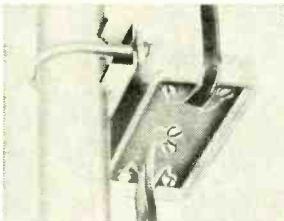

rameter network of bifilar coils and component location. 3 models for matching of 2-, 3- and 4-ohm sets to any 300-ohm antennas—AC40 for 2 sets, AC60 for 3 sets, AC70 for 4 sets.—**JFD Manufacturing Co., Inc.**, 6101 16 Ave., Brooklyn 4, N. Y.

HIGH-OUTPUT PICKUP CARTRIDGES replace Ronette car-



DISTRIBUTION AMPLIFIER, *model DA8-B*, self-powered. Provides 8 isolated TV outlets with



over 10 db gain. Handles either 300-ohm lead-in or 75-ohm coax cable. Coax grounding clamps, solder lugs and terminating resistors for unused outlets. More than 8 TV outlets can be provided using line splitter to feed several *DA8-B* units. Built-in gain control, 10:1 range.—**Blonder-Tongue Labs., Inc.**, 526-536 North Ave., Westfield, N. J.

HI-FI SPEAKER ENCLOSURE, *Empire*, low-boy type. 2- and 3-way systems. Built-in corner for use in corner or flat against one wall. 15-inch coaxial or triaxial speaker or separate 15-inch 2- or 3-way speaker system may be used. Two vertical parallel port-



ing slots to extend lower bass range. Cabinet braced to eliminate spurious resonances. 29 1/2 x 32 x 16 inches. Available as two kits—one for enclosure and one for speaker system.—**Electro-Voice, Inc.**, Buchanan, Mich.

MICROPHONE ARM, *Luxo*, models available in 30-, 37-

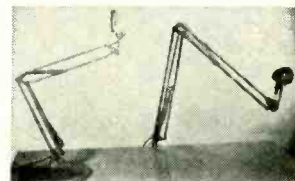

45- or 60-inch operational radius. 360° arc. Neck in two lengths; short 1 1/4 inches, long 2 1/2 inches for various types of mikes. Available in gray and variety of colors.—**Luxo Lamp Corp.**, 102 Columbus Ave., Tuckahoe, N. Y.

NEW DEVICES

HI-FI COMPONENT-CONSOLE ENSEMBLE, model *PT-1040* FM-AM radio phonograph with Garrard RC-80 record changer. *Pilotuner* model *AF-825* for FM and AM. Williamson type amplifier model *AA-902A* delivers 14

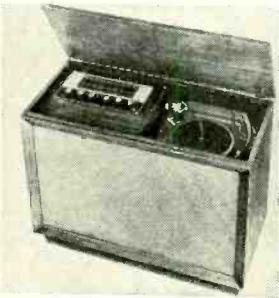

watts undistorted. 3-way 4-speaker systems include 12-inch bass woofer, mid-frequency reproducer in separate vented enclosure and 2 armored tweeters. 50 to more than 16,000 cycles—**Pilot Radio Corp.**, 37-06 36 St., Long Island City 1, N. Y.

LOW-FREQUENCY SPEAKERS, *12A10L* and *15A10L's* (see photo) frequency response



40-5,000 cycles, ± 5 db; resonance point 60 cycles; voice-coil impedance 6-8 ohms; Power-handling capacity 10 watts. Uses same enclosure as Quam

12A10X. Baffle opening 11 1/8 inches; depth 5 3/4 inches. Can be used with Quam *3A15T* or *5A15T* high-frequency tweeter or any other quality tweeter. —**Quam-Nichols Co.**, 234 Marquette Rd., Chicago 37, Ill.

PICKUP ARM, model *120* for records to 12 inches in diameter, model *160* for records to 16 inches. Cartridge shell made of die-cast aluminum, attached to arm by bayonet-lock arrangement. Interchangeability developed for users who prefer individual cartridges for standard and microgroove records. Car-

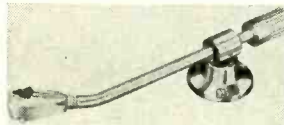

tridge shells available separately.—**Rek-O-Kut Co.**, 38-01 Queens Blvd., Long Island, N. Y.

TRANSISTOR RADIO KIT, *Knight-Kit*. Printed-circuit component mounting board eliminates wiring and reduces soldering. Power supplied by single penlite cell. No tubes employed.

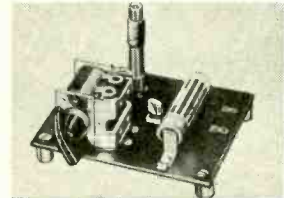

Good selectivity.—**Allied Radio Corp.**, 100 N. Western Ave., Chicago 80, Ill.

TINKER TURRET KIT, No. *1050*. Individual parts assemble any 7-pin turret assembly, 7-pin miniature chassis or in-line



cable connectors. Internal drawings illustrate assembly.—**Eby Sales Co.**, 130 Lafayette St., New York 13, N. Y.

TRANSISTOR RADIO KIT, *Trans-Atomic*. features matched germanium transistor and diode,



calibrated slide-rule dial for precision tuning, loopstick for added power. Operates for months on self-contained flashlight cells.—**Superex Electronics Corp.**, 4-6 Radford Pl., Yonkers, N. Y.

(Continued)

DO-IT-YOURSELF KITS, *EN-CB* and *KEN* series, for hi-fi speaker enclosures. *EN-CB* in unfinished 3/4-inch fir plywood. Utility model of *Classic Deluxe* 3-way speaker system enclosure. 30 x 40 x 24 inches. Used horizontally or vertically or as part of room divider. *KEN* series *KwiKits* cornerless-corner enclosures. 3/4-inch birch hardwood cabinet plywood. Predrilled to go together with household screwdriver. *KEN-15* for 12- or 15-inch extended-range coaxial and triaxial speakers, and 2- and 3-way multispeaker systems with 12- or 15-inch woofer. *KEN-12* for 12-inch extended-range coaxial and triaxial speakers and

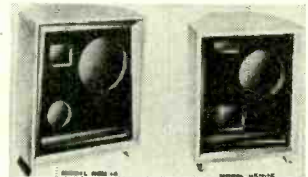

2- and 3-way multispeaker systems with 12-inch woofer.—**University Loudspeakers Inc.**, 80 S. Kensico Ave., White Plains, N. Y.

WIREWOUND CONTROL measures 1 1/2 inches in diameter and 9/16 inch deep; available with



the **1ST COMPLETE LINE OF ELECTRONIC TOOLS...**
ever offered the industry

HUNTER Tools, originators of the TV Slug Retriever, now offer the only complete line of Electronic Tools available. Each is designed to do a specific job — and **HUNTER** manufactures these tools with the exacting requirements of the serviceman in mind. Complete satisfaction guaranteed. **HUNTERS** years of experience in the hand tool field assures you of the finest Electronic Tools.

Famous HUNTER Tools...

- ★ SLUG RETRIEVERS
- ★ SCREWHOLDING SCREW-DRIVERS
- ★ NUT DRIVERS
- ★ DURA TIP SCREW-DRIVERS
- ★ SPIN DRIVERS
- ★ INSULATED DRIVERS
- ★ BELT TOOL KITS
- ★ HEX DRIVERS
- ★ DRIVE ALL JUNIOR
- ★ SMITTY (Allen Type) DRIVERS
- ★ TENSION TWEEZIE
- ★ HOT TUBE PULLERS
- ★ ALIGNMENT TOOLS
- ★ SEPARATELY OR COMPLETE KITS

ALL TOOLS IN SIZES TO FIT YOUR SPECIFIC NEEDS!
Write for a free copy of our new complete catalog, today!

HUNTER TOOLS
BOX 564 • WHITTIER, CALIFORNIA

TOOLS DESIGNED FOR THE ELECTRONICS INDUSTRY

JOBBERS:
Order your matched displays, today!



Service Master #100

DISPLAYS THAT COMPLIMENT YOUR STORE



Service Master #500

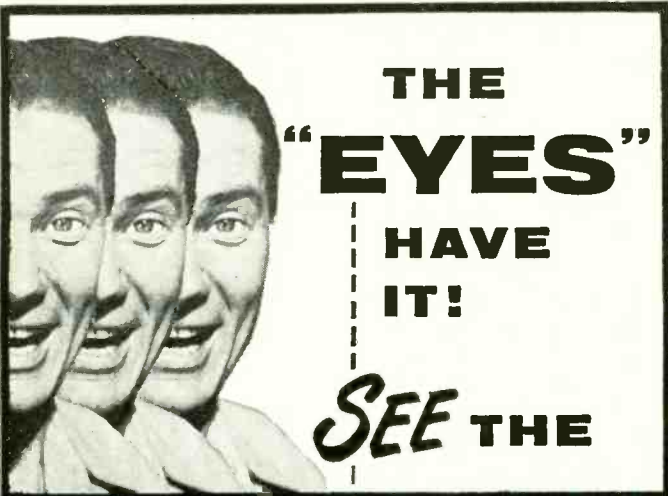

**THE
"EYES"
HAVE
IT!
SEE THE**

**FEATURE-BY-FEATURE
SUPERIORITY OF
EMC TEST EQUIPMENT**

**NEW RF
SIGNAL GENERATOR
EMC Model 501**

With leads—
\$37.90 (Wired & Tested)
\$24.90 (Kit Form)



A professional, 6-band (115 KC to 220 MC) generator • produces dependable signals for precision alignment, tuning and adjustment of all types of circuits including COLOR TV.

**NEW COMBINATION RESISTANCE-
CAPACITY SUBSTITUTION BOX
EMC Model 900**

\$17.90 (Wired & Tested)
\$10.25 (Kit Form)



World's first combination substitution box • quickly determines exact values • provides 18 RETMA Capacity Values and 36 RETMA Resistance Values.

**NEW WHITE DOT—CROSS HATCH
—BAR GENERATOR
EMC Model 800**

With leads—
\$39.90 (Wired & Tested)
\$22.50 (Kit Form)



Lowest priced, quality color and monochrome generator available • easily adjusts color convergence, width, linearity, ion trap and yoke, etc.

FREE!

Yes, I want to see for myself, send me—FREE—a detailed catalog of the complete EMC line of precision test equipment.

NAME _____ RE-4,
STREET _____
CITY _____ STATE _____

EMC ELECTRONIC MEASUREMENTS CORPORATION
280 LAFAYETTE STREET, NEW YORK 12, N. Y.
EXPORT DEPT - 370 BROADWAY, N. Y. 13, N. Y.

NEW DEVICES

or without tap. Tap mechanically positioned 180° from center terminal, but can be electrically positioned to any percentage of resistance. Resistance values from 1-50,000 ohms.—Clarostat Mfg. Co., Inc., Dover, N. H.

VOM PROBES, model 261 High-Ohms, extend ohmmeter range of VOM X 10. Measure resistance values up to 200 megohms. Usable with any 20,000-ohms-per-volt VOM having center-



scale indication of 12 ohms and internal ohmmeter battery of 7.5 volts. Plugs into meter in place of conventional test lead.—Futuramic Co., 2500 W. 23 St., Chicago, Ill.

PORTABLE TUBE TESTER, model 539B, has latest dynamic mutual conductance circuits. 6 μ mo ranges: 60,000, 30,000, 15,000, 6,000, 3,000, 600 μ mos. Rectifier diode range and voltage regulator range. 4 ac signals: 0.25, 0.5, 1 or 2.5 volts may be applied to grid of tube under test, in addition to dc grid bias.

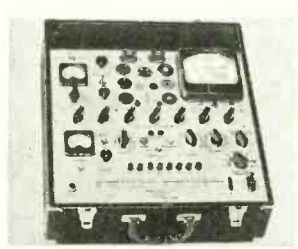

Separate dc voltmeter measures grid bias. Separate ac meter for line voltage.—Hickok Electrical Instrument Co., 10531 Dupont Ave., Cleveland 8, Ohio.

TUBE AND TRANSISTOR TESTER, RCP model 325, tests n-p-n and p-n-p transistors and all radio and TV tubes, including magnetically deflected black-and white and color picture tubes. Tests all essential characteristics of commercially used transistors under operating conditions — mutual conductance, emission and shorts. Signal and bias voltages applied to tube grid. Current amplification measured using constant-current bridge and low-impedance power



supply. Diode limiting circuit protects 50- μ a meter against burnouts due to shorted transistors.—Radio City Products Co., 26 Rittenhouse Pl., Ardmore, Pa.

(Continued)

JUNIOR VOLTOHMYST, model WV-77B. As dc voltmeter measures .05-1,200 volts dc in 5 ranges; as ac voltmeter from 0.1-1,200 volts ac (rms) in 5 ranges; as wide-range ohmmeter from 0.2 ohm to 1,000 megohms in 5 ranges. Probe, containing



built-in selection switch and cable (WG-299A) supplied. Probe and cable insulated.—Radio Corp. of America, RCA Tube Dept., Harrison, N. J.

TV TROUBLESHOOTER, VI Video Probe Meter, a broad-band probe, rf absorption meter and 500-volt dc meter for checking and signal tracing in radio and TV circuits. The probe coil picks

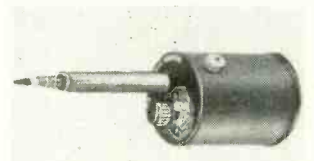

up by induction or capacitance, signals from rf, if, video, deflection, and audio circuits and indicates the relative strength on the meter. Ground-return lead used only for dc voltage measurements.—Research Inventions & Mfg. Co., 617 F Street N. W., Washington 1, D. C.

LEAKAGE CHECKER, model LC2, checks grid-cathode, cathode-heater and capacitor leakage. Detects grid emission and gassiness. Test leads for checking all capacitors including elec-



trolytics. Assembled or kit form.—Service Instrument Co., 171 Official Rd., Addison, Ill.

INSTANT SOLDER GUN with 3/8-inch tip. Hot in few seconds without heavy transformer or

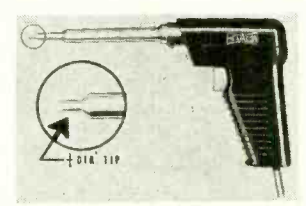

fragile thermostat. 8 ounces. Lifetime tip cannot wear, corrode or bend. Any degree of

NEW DEVICES

heat without overheating. Long, thin reach for tight places, and effective spotlight. — Hexacon Electric Co., 186 W. Clay Ave., Roselle Park, N. J.

LINE CHEK, model 3000. Checks line under load, connecting electrical load equal to that of ap-



pliance. Weighs 4 pounds, 3/4 x 5 1/2 x 7 1/2 inches.—Triplett Electrical Instrument Co., Bluffton, Ohio.

TRANSCONDUCTANCE TUBE TESTER, model TV-12, tests all tubes including lock-in, hearing aid, thyratron, miniature, sub-miniature and proximity fuse types. Amplification factor, plate resistance and cathode emission correlated in one meter reading.

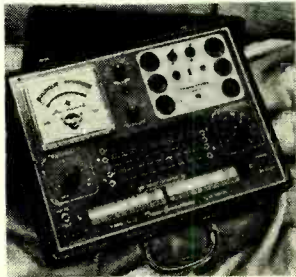

No roll-chart backlash and slip-page. Accommodates all transistors: n-p-n, p-n-p, photo and tetrode, germanium or silicon, point contact or junction types. — Superior Instruments Co., 2435 White Plains Rd., New York 67, N. Y.

DYNAMIC SWEEP-CIRCUIT ANALYZER, Win-Tronix model 820. 60-cycle sawtooth, 15-kc horizontal sawtooth and horizontal output transformer drive for troubleshooting sync and sweep circuits by signal substi-

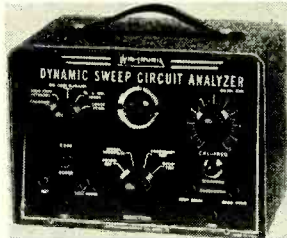

tution. Accessory probes for synchronization pulses. Positive test of flyback transformers and yokes, using oscillating neon indicator. Checks insulation leakage up to 500 megohms. Tests for open or leaky capacitors.—Winston Electronics, Inc., 4312 Main St., Philadelphia 27, Pa.

14 REPLACEMENT FLYBACKS for use in Admiral, Emerson, General Electric, Motorola, Philco, Sentinel, Wells-Gardner and Westinghouse TV receivers. Electrically and mechanically interchangeable with original equipment.—Triad Transformer

Corp., 4055 Redwood Ave., Venice, Calif.

FLYBACK TRANSFORMERS. X126 (composite) replaces flybacks 12E-23939 and 12E-24612 for Airline, Coronado, Firestone, Raytheon, and Truetone, including 28 chassis and 81 models. Autotransformer type used in 66-70° horizontal-deflection-angle system. Delivers 13-15 kv under normal operation conditions.

X127 (composite) covers

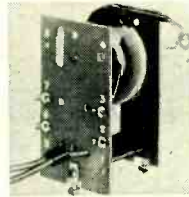

X-126

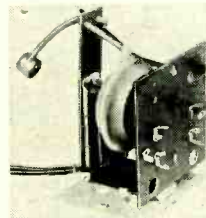

X-127

Westinghouse numbers V-11548, V11548-1, V-11548-2, V-12073, V-14346, V-14627, V-15324-1, V15324-2 and V15650. For both 66-70°, 90° systems. Delivers 15-19 kv, under normal load conditions.—Ram

All specifications given on these pages are from manufacturers' data.

Electronics Sales Co., So. Buckhout St., Irvington-On-Hudson, N.Y.

ENLARGER TIMER KIT, Heathkit model ET-1, controls enlarger exposure time. Dial calibrated from 5-60 seconds,

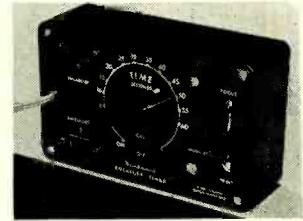

timing cycle started by moving spring-lever switch to PRINT. Internal relay handles up to 350 watts. When switch is moved to focus, enlarger remains on for focusing and masking. Set timer dial, depress switch to print and timing cycle automatically controlled.—Heath Co., Benton Harbor, Mich.

PLIERS, No. 62, combine needle-nose plus narrow-end nippers for work in miniature and sub-miniature chassis. Spring return



permits thumb and finger operation in close quarters.—Xcelite Inc., Orchard Park, N. Y. END

Get This Valuable Book **Just for Examining COYNE'S New 6-Volume Set**

FREE



"Applied Practical Radio-Television"



Yes, you get this big, brand new book, "150 Radio-Television Picture Patterns and Diagrams Explained", absolutely FREE! Just off the press! Gives complete 11x22" Schematic Diagrams on leading models Radio and Television Sets. Easy-to-read, large 8 1/2 x 11" pages, with full instructions on how to read and use the diagrams. A "must" in every Radio and Television service-man's repair kit. You get this valuable book as a FREE Gift for asking to see Coyne's great new 6-book set, "Applied Practical Radio-Television"!

ON 7 DAY FREE TRIAL!

At Last! Money-Making "Know-How" on Transistors, Color TV and Servicing

Coyne's great new 6-volume set gives you all the answers to servicing problems—quickly! For basic "know-how" that is easy to understand, you'll find everything you want in volumes 1 to 5 which contain over 5000 practical facts and data. They cover every step from principles to installing, servicing, trouble-shooting and aligning all types of radio and TV sets. So up-to-date it includes COLOR TV and UHF, adapters, converters. Also covers latest data on TRANSISTORS.

Extra! 900-Page Television Cyclopeda Included

And then, for speedy on-the-job use, you get volume 6—the famous Coyne TELEVISION CYCLOPEDIA. It answers today's television problems on servicing, alignment, installation and others. In easy-to-find ABC order, cross indexed. Use this 6 volume TV-RADIO LIBRARY free for 7 days; get the valuable Servicing Book ABSOLUTELY FREE!

SEND NO MONEY! Just mail coupon for 6-volume set on 7 days free trial. We'll include book of 150 TV-Radio Patterns & Diagrams. If you keep the set, pay \$2 in 7 days and \$2 per month until \$22.50 plus postage is paid. (Cash price \$20.95). Or you can return the library at our expense in 7 days and owe nothing. **YOU BE THE JUDGE.** Either way, the book of TV-Radio Patterns is yours FREE to keep! Offer is limited. Act NOW!

FREE BOOK—FREE TRIAL COUPON!

Educational Book Publishing Division
COYNE ELECTRICAL SCHOOL, Dept. 46-T1
 500 S. Paulina St., Chicago 12, Ill.
 YES! Send 6-volume "Applied Practical Radio-Television" for 7 days FREE TRIAL per your offer. Include TV-Radio Patterns & Diagram Book FREE.

Name _____ Age _____
 Address _____
 City _____ Zone _____ State _____
 Where Employed _____
 Check here if you want library sent COD. You pay postman \$20.95 plus COD postage on delivery. 7-day money-back guarantee.

Educational Book Publishing Division
COYNE ELECTRICAL SCHOOL
 500 S. Paulina St., Dept 46-T1, Chicago 12, Ill.

HIGH EFFICIENCY at Lower Cost

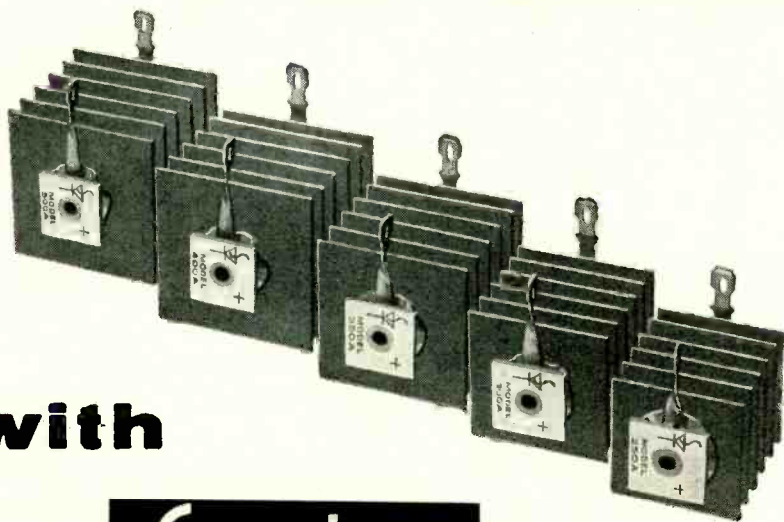

with



HIGH DENSITY RECTIFIERS

NEW

Sarkes Tarzian High Density Rectifiers provide safe field replacements at lower cost. Better for you and better for your customers. Get the new High Density Rectifiers at your distributors. The same high performance and long warranty as all Sarkes Tarzian Selenium Rectifiers.

SPECIFICATIONS

Model No.	Max. A.C. Input Volts	Max. D.C. Load Current	Plate Size	Overall Length	Replaces Model
250A	130	250	1.25" sq.	1 7/8"	200-250
300A	130	300	1.4" sq.	1 7/8"	300
350A	130	350	1.6" sq.	2 5/32"	350
400A	130	400	1.8" sq.	1 5/8"	400
500A	130	500	1.8" sq.	1 15/16"	500

Write for your copy of the latest Replacement Guide. Address Dept. R-2.

Sarkes Tarzian, Inc., Rectifier Division
415 N. COLLEGE AVENUE, BLOOMINGTON, INDIANA

In Canada: 700 Weston Rd., Toronto 9, Tel. Murray 7535 • Export: Ad Auriema, Inc., New York City

new Tubes Transistors



2N155, 2N156, 2N157, 2N158

A new series of power transistors featuring high power gain and uniform characteristics has been developed by CBS-Hytron. The four units—2N155, 2N156, 2N157, 2N158—offer a wide range of current gain and operating supply voltage.

The transistors (see photo) are p-n-p germanium-alloy junction units, 13/16 inch long and 1/2 inch in diameter, especially designed for use in audio power output stages. Other suitable applications include use in servo amplifiers, power converters and low-speed switching circuits. For efficient heat dissipation, the transistors' copper bases are bolted to the chassis, providing a large area of heat radiation.

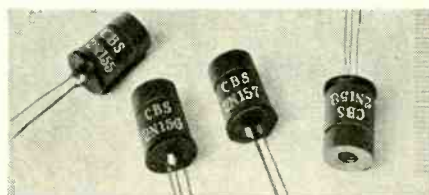

Using two 2N158's in a push-pull class-AB amplifier (common emitter connected), typical values are: collector supply voltage, -28; collector current (zero signal) -25 ma; (maximum signal) -500 ma; base current (zero signal) -0.5 ma; (maximum signal) -17 ma; power input, 20 mw; power output, 17 watts; power gain, 29 db.

CK790, CK791, CK793

Three new p-n-p silicon transistors (see photo) have been added to the Raytheon line. They are designed for use in low-frequency amplifiers, switching circuits and other applications in electronic equipment that must operate at high ambient temperatures.

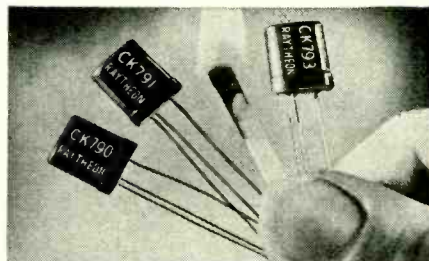

The CK790 is a medium-gain unit having maximum ratings (at 25°C) of: collector voltage, -45; emitter voltage, -22; collector current, -50 ma; collector dissipation, 200 mw; emitter current, 50 ma. Seated height is 0.46 inch.

The CK791 is a high-gain transistor

**Improves
phono
quality...**

Ronette

new replacement cartridges

A new Ronette Fonofluid cartridge to enhance the sound of your present record player—regardless of make or model.

The Ronette high compliance, low intermodulation distortion and full frequency response assures peak performance from your equipment. Yet the cost is unbelievably low.

Acclaimed by critics and used by leading original equipment manufacturers, Ronette new replacement cartridges are available in high or low output, turnover or single needle models, and in a new universal mounting bracket that will fit your tone arm.

AT YOUR PARTS DISTRIBUTOR OR RETURN COUPON BELOW.

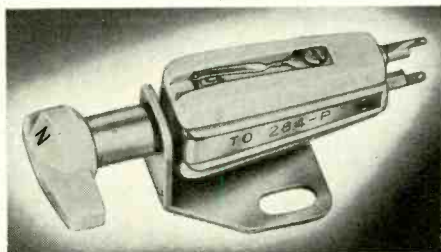

Model TO-284P (Illustrated): with 2 non-interacting sapphire needles \$7.50 net
Other models from 4.35 net

Diamond needles available at extra cost.

ELECTRONIC **CONRAD** PARTS DISTRIBUTORS SHOW

CONRAD HILTON HOTEL
CHICAGO

room 609-A

Hear all the music you are paying for... use a Ronette.

RONETTE ACOUSTICAL CORP. E
135 Front Street, New York 5, N. Y.

Please send literature describing in detail the entire line of Ronette Fonofluid Cartridges and other Ronette audio components.

Name.....

Address.....

City..... Zone..... State.....

NEW TUBES and TRANSISTORS (Continued)

with the same maximum ratings as the CK790 except for a collector voltage of -30. The CK793 is a low-noise unit for particular application in preamplifiers. Its maximum ratings are the same as the CK791's.

6BS8, 4BS8

Two new high-gain, sharp-cutoff, cascode rf amplifiers, the 6BS8 and 4BS8, have been introduced by Westinghouse. The nine-pin, twin-triode, miniature tubes have higher gain, lower noise and a 20% lower dissipation factor than the 6BZ7 and 6BQ7-A, which the 6BS8 directly replaces. The 4BS8 is designed for series-string application.

Typical cascode conditions for these tubes are: plate supply voltage, 250; control-grid voltage, -1; plate current, 16 ma; transconductance, 10,000 micromhos.

8DP4

The RCA 8DP4 (see photo) is a small, directly viewed, rectangular, glass picture tube with low-voltage electrostatic focus, magnetic deflection type and a

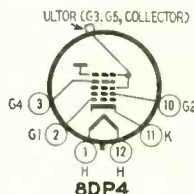

90° deflection angle. Intended primarily for low-cost, lightweight, compact applications, the tube has a spherical filter-glass faceplate and a 7 3/16 x 5 3/8-inch screen.

The 8DP4 has an overall length of only 10 3/4 inches and weighs less than 3 pounds. It requires a single-field ion-trap magnet and has an external conductive bulb coating which with the internal conductive coating forms a high-voltage filter capacitor. The maximum high-voltage rating of the tube (see base diagram) is 6,000.

12AD7

A nine-pin miniature double triode, the 12AD7, has been announced byylvania. Designed as a low-hum preamplifier for audio applications, tube ratings of the 12AD7 assure a hum level of less than 3 millivolts rms on the plate of each triode when the tube is operated in a typical resistance-coupled amplifier circuit. This has been achieved by design features that include a reverse-coil heater which helps cancel magnetic coupling.

6CU5 and 12CU5

Two new beam-power tubes of the seven-pin miniature type have been announced by RCA. The 6CU5 and the 12CU5 are designed for use in the audio output stage of television receivers. Because of their high power sensitivity and high efficiency at low plate and screen voltages, the tubes are capable

**don't do it
the hard way!**

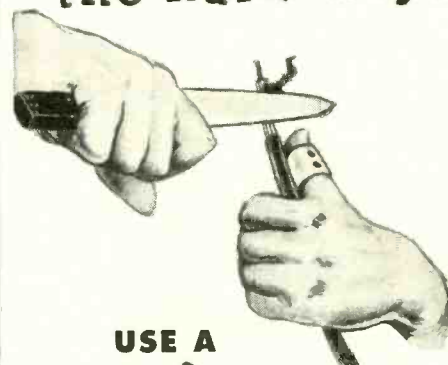

USE A



ROTARY CABLE STRIPPER

Model S-1

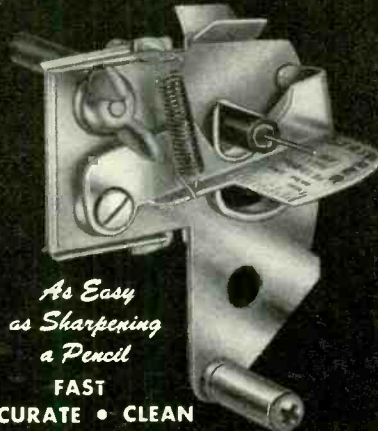

*As Easy
as Sharpening
a Pencil*

**FAST
ACCURATE • CLEAN**

and Practically **AUTOMATIC**

- Cuts and strips the outer covering of coax cable without injuring the shielding.
- Cuts the shielding without pulling, fraying or unbraiding.
- Cuts and strips the inner insulation and...
- Measures just the right length of lead desired.
- Ideal for stripping all insulated wire and cable—as well as non-metallic tubing.

— and its **ONLY \$3⁷⁵** LIST

**A Must For Your Kit —
Get One Today**
at your Parts Distributor.

BLONDER-TONGUE LABORATORIES, INC.

Dept. JD-3, Westfield, New Jersey



Manufacturers of TV Cameras,
TV Amplifiers, Boosters,
UHF Converters, TV Accessories
and Originators of the Masterline
and 'Add-A-Unit'
Master TV Systems.

WIN-TRONIX

Makes Sweep and Sync Circuit Trouble-Shooting Easy! LOW-COST DYNAMIC SWEEP CIRCUIT ANALYZER

for
Black-and-White TV
and color too!
only
\$69.95
dealer net



Model 820

TWO
INSTRUMENTS
IN ONE

1. Horizontal and vertical sawtooth-square wave and sync pulse generator.
2. Complete compatible flyback and yoke tester.

ISOLATE SWEEP/SYNC TROUBLES RAPIDLY IN FIVE EASY STEPS!!!

1. VERTICAL TROUBLESHOOTING
Inject 60 cps on vertical
output grid from "vertical
grid drive" jack.



2. HORIZONTAL TROUBLESHOOTING
Inject 15,734 cps on hor-
izontal output grid from
"horizontal grid drive" jack.

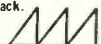

3. HORIZONTAL TROUBLESHOOTING
Drive horizontal output xfmr
directly from "xfmr drive"
jack.



4. COMPONENT TESTING
Test flyback transformer and deflec-
tion yoke in receiver with Model 820.
5. SYNC CIRCUIT TROUBLESHOOTING
Inject vertical and horizontal sync
pulses, stage by stage, in sync ampli-
fiers, with accessory probes.

SPECIFICATIONS

Signal Outputs
15,734 cps sawtooth and pulse
adjustable.
15,734 square wave adjustable.
60 cps sawtooth locked to line.
Overload indicator for safety and test.
Oscillating neon indicator with D.C.
amplifier for flyback/yoke test.
Calibrated for color and black-and-
white.
Test leads supplied.
Operates on 105-125 VAC.

OTHER WIN-TRONIX LOW-COST TV TEST INSTRUMENTS—

Buy Now for Bl. & Wh. Service—be ready for color!

WHITE DOT—Linearity
Generator

Model
160



\$79.95

RAINBOW GENERATOR

Model
150



Patent Pending \$49.95

COMPATIBLE FIELD
STRENGTH METER

Model
330



\$129.95

FLYBACK AND YOKE
TESTER

Model
810



\$29.95

- Compatible advanced design prevents obsolescence!
- Low cost with high quality!
- Portability!
- Standard warranty on all instruments!

SEE YOUR PARTS JOBBER!
WRITE FOR FREE LITERATURE!

COMPATIBLE CRYSTAL
CALIBRATOR

Model
120



\$59.95

WINSTON ELECTRONICS, INC.

RE-456

4312 Main St., Philadelphia 27, Pa.

NEW TUBES and TRANSISTORS (Continued)

of providing a high power output.

Under typical operating conditions as a class-A amplifier with plate voltage 120, screen-grid voltage 110, control-grid voltage -8, peak of grid signal 8, the zero-signal plate current is 49 ma, maximum-signal plate current 50 ma, zero-signal screen-grid current 4 ma and maximum-signal screen-grid current 8.5 ma. Plate resistance is 10,000 ohms, transconductance 7,500 mhos, load resistance 2,500 ohms and total harmonic distortion 10%. Maximum-signal power output is 2.3 watts.

The 12CU5 and 6CU5 are alike except that the 12CU5 has a 12.6-volt 600-ma heater with controlled warmup time for series-string operation. The heater of the 6CU5 operates at 6.3 volts and 1.2 amperes.

6810

A head-on type of multiplier photo-tube intended for use in scintillation counters and in other applications involving low-level light sources, the 6810 (see photo) announced by RCA features fast response, high current gain, relative freedom from after pulses and small spread in electron-transit time.

The response of this tube is from about 3,000 to 6,500 angstroms and



peaks at about 4,400.

Design features include a 1 11/16-inch diameter cathode on the inner surface of the face end of the tube; 14 electrostatically focused multiplying (dynode) stages; an accelerating electrode with an external connection to minimize the effect of space charge. END

CORRECTIONS

In Fig. 6 of the article "R-C Controlled Oscillator," in the December, 1955, issue a 150- μ f capacitor is shown between the grid of the 6J7 and the lower bank of switched resistors. The diagram also shows this capacitor shorted out by a lead. The capacitor is not needed and should be removed.

We thank Rev. J. H. Unferfate, of Youngstown, Ohio, for calling this to our attention.

Mr. Jaski reports that the feedback resistor marked "1,200 ohms" in his tremolo oscillator (page 47, December, 1955) has just enough resistance to sustain oscillations and provide the best waveform. A slightly higher value may be needed in some cases.

RADIOTELEPHONE
LICENSE
MANUAL

RADIOTELEPHONE LICENSE MANUAL

PREPARES FOR LICENSE
EXAMINATION

Contains 4 elements:

- I. Questions on basic law
- II. Basic operating practice
- III. Basic radiotelephone
- IV. Advanced radio-telephone

UP-TO-THE-MINUTE
(Dec. 1955)

\$3.75

SURPLUS RADIO CONVERSION MANUAL.
VOL. I. Practical conversions. Write for list of contents. \$2.50*

SURPLUS RADIO CONVERSION MANUAL.
VOL. II. Companion to Volume I. \$2.50*

RADIO HANDBOOK, GIANT 14TH EDITION.
A one-volume library of radio information with extensive, simplified theory. Detailed how-to-build-it data on dozens of items of practical radio equipment. \$7.50*

WORLD'S RADIO TUBES (BRANS' VADE MECUM). NEW 12TH EDITION. Lists over 15,000 tubes from every tube making country. Printed in 16 languages. \$5.00*

BETTER TV RECEPTION (in fringe and low-signal areas). SECOND EDITION. The standard guide for installation technicians. A popular text for TV enthusiasts. \$2.50*

ANTENNA MANUAL. A practical comprehensive book on antennas, for everyone interested in transmission and reception. Over 300 pages. \$3.50*

*Plus any tax Send three cent stamp for circular



BUY FROM YOUR DISTRIBUTOR
Add 10% on direct mail orders to
EDITORS and ENGINEERS, Ltd.
Summerland 3, California

E-Z WAY TOWERS

Looking for a tower that is easy to erect yet strong enough to withstand severe winds? This is it! E-Z Way Towers will stand a wind load of 40-60 lbs. per sq. ft. And with the new E-Z Way portable gin pole it's easy to erect a 120 ft. tower in one piece without leaving the ground. Unbelievable, isn't it? But E-Z Way Towers have been tested and proven. Thousands of E-Z Way Towers are giving outstanding service in all parts of the country and abroad. That's why E-Z Way is the Industry's New Leader. Find out about E-Z Way now!

SEND TODAY FOR
FREE CATALOG

Dept. CE, E-Z Way Towers
P. O. Box 5491, Tampa, Florida

Send me your FREE catalogue on the following towers:

AM Radio Television
 Ham Radio Two-Way Communication
I am interested in a tower _____ ft. high.
I will use a _____ antenna.
(State type and model)

Type of Rotor _____

Name _____

Address _____

City _____ State _____

E-Z WAY TOWERS Inc.

P. O. Box 5491 • Tampa, Fla.

Phone • 4-3916

Patents

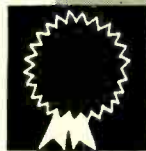

PHASE SHIFTER

Patent No. 2,702,365

Abraham Hyman, New York, N. Y.

(May be manufactured or used by U. S. Government without royalty payment)

This phase shifter provides a range of 180° and maintains constant output impedance. It is a bridge containing two current paths. One path (L-R1), passes a lagging current I₁. The other current, I₂, is leading and flows through C-R2. R1, R2 are ganged, so their sum remains constant.

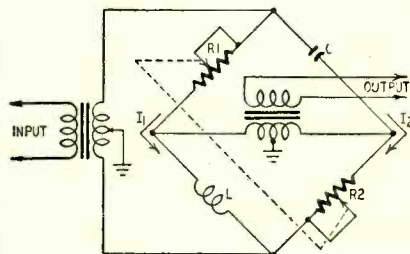

When R1 is near zero, R2 is near maximum, I₁ is large and I₂ negligible. The output of the bridge is a current that lags the bridge voltage by nearly 90°. With R1 maximum, the bridge current leads by nearly 90°, so a shift of 180° is available.

Reversing either winding of either transformer, shifts phase through the remaining 180°.

TWO-BAND AMPLIFIER

Patent No. 2,716,161

George W. Gray, Lambertville, N. J.

(Assigned to Radio Corp. of America)

Designed for the entire vhf television spectrum, this amplifier uses a duo-triode tube in a common-grid amplifier circuit. One triode tunes the low and the other the high band. High gain is provided on each channel.

The input circuit is broadly resonant to from channel 2 to 13. The output transformer has a tapped primary as shown. One portion (for

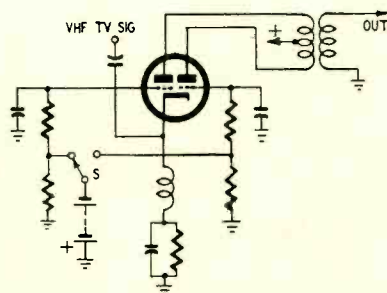

example, the lower half) resonates over channels 2-6. To tune in one of these channels switch S is connected to the left triode, biasing it off so that only the right triode is operative. The upper section of the primary winding is tuned to the high band (channels 7-13). To select one of these stations, S is connected to the right triode. This switches in the left one.

A gain of 6 is obtained with a 6J6 in this circuit. This compares with a gain of only 2 if both triodes are connected in parallel.

ALL-CLEAR TV PICTURES

with the new



ANTENNA BOOSTER

(BROADBAND VHF)

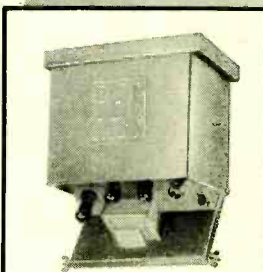

Features the
Exclusive B-T
Swing-Down Chassis*

MODEL AB

4 TUBES

25DB

GAIN

\$95.00

LIST

WITH

MULTI

VOLTAGE

POWER

SUPPLY

- Low-noise, all-triode circuit
- Easy mast-mounting
- Automatic 'on/off' from set
- 24 and 110v AC available plus step-ups for long-line drop
- Single lead line carries power 'up' and signal 'down'

*For Servicing and Maintenance... chassis swings down - trap door fashion - for easy handling and tube replacements.

For complete
details, use this
coupon



BLONDER-TONGUE LABORATORIES, INC.
Dept. GD-3, Westfield, New Jersey

Please send complete specs of your new Antenna Booster. I am also interested in:

- TV Amplifiers UHF Converters
 Master TV Systems

Name _____

Address _____

City _____ Zone _____ State _____



Time for REPLACEMENT?

Specify
OXFORD
SPEAKERS

Speakers is our prime business and we supply more of the BEST manufacturers of original equipment. Since we have quality replacement speakers for any and every application . . . you will actually better the original sound with OXFORD SPEAKERS.

Why wait . . . find out TODAY why more and more servicemen are switching to OXFORD SPEAKERS . . . when it's time for replacement!

Our latest catalog is available . . . write today!
...at better jobbers!

OXFORD ELECTRIC CORPORATION

Distributor Sales Division

556 West Monroe Street, Chicago 6, Ill.

In Canada: Atlas Radio Corp., Ltd., Toronto

Export: Roburn Agencies, New York City

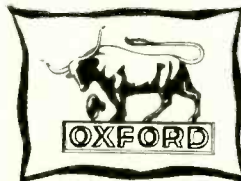

TAPE RECORDERS

Tapes—Accessories
Nationally Advertised Brands
UNUSUAL VALUES
Send for Free Catalog
DRESSNER
69-02 RE 174 St.
Flushing 65, N.Y.

MERITAPE
Low Cost, High
Quality Record-
ing Tape—in
boxes or cans.

DERO
THE *PersonnaTone* EXTENSION SPEAKER
Long range, hi-quality sound for general applications. No distortion, chair-side listening. 4x6" speaker, balance to others. Speaker and control volume in comfort of easy chair. \$6.97 net

DERO • 63 GILROY AVE. UNIONDALE, L.I. N.Y.

REPAIR TV PICTURE TUBES WITHOUT COST OR EQUIPMENT

Give new life to old or defective tubes. Remove shorts. Restore emission and brightness. Servicemen do it—you can, too! Months of extra service. Results compare with most expensive instruments. Save money by fixing your own tubes. Earn extra money fixing tubes for others. Be prepared, earn large profits repairing expensive color picture tubes. Learn this easy, tried and tested method now and cash in! Order now!

SPECIAL OFFER complete instructions \$1

TELEPARTS CO.

172 Narragansett St. Edgewood 5, R.I.

LMB BOX CHASSIS

Flangelocking

Precision Engineered



Interlocking

65 sizes and shapes for the laboratory, manufacturer, industrial, experimenter, builder, and general applications where metal boxes are required. Stocked by all electronic and geophysical distributors. Send for free catalog.

LMB 1011 Venice Blvd.
Los Angeles 15, Calif.

HIGH-POWER TRANSISTOR

Patent No. 2,721,965

Robert N. Hall, Schenectady, N. Y.

(Assigned to General Electric Co.)

The small, closely spaced elements of the transistor permit high gain and low impedance. But they prevent it from handling high power, which requires relatively large contact areas and dissipative surfaces. This invention shows how to combine many small semiconductors in parallel. The total power capacity is the sum of power from each unit.

A slab of n-type germanium is separated from a sheet of metal by a layer of solder. A trace of

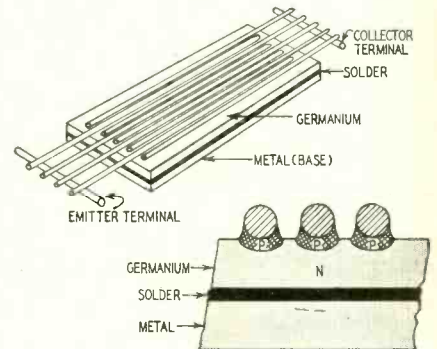

antimony, added to the solder, serves as the source of electron supply for the semiconductor.

A grid of nickel wires is then bonded to the germanium by solder to which indium (or other acceptor) is added (see insert to the figure). The acceptor gives rise to areas of p-type conductivity. Odd wires are connected to form one p terminal of the transistor, while the even wires are tied to form the other p terminal. The metal plate serves as the base or n-type element of the transistor.

Any two adjacent wires and the germanium between them form a p-n-p transistor. When constructed as shown here, the effect is that of many transistors in parallel.

ULTRASONIC TESTER

Patent No. 2,724,107

Heinz Born, Frankfurt am Main, Germany.

(Assigned to Ultraschall-Gerätebau Dr. Born & Co., Frankfurt am Main)

Ultrasonic vibrations are often used for chemical agitation, mechanical tests and analysis, medical therapy and many other applications. Some method of testing the ultrasonic generator must be provided to prevent damage or injury during its use. An automatic indicator is described in this invention.

An ultrasonic generator consisting of a pen-

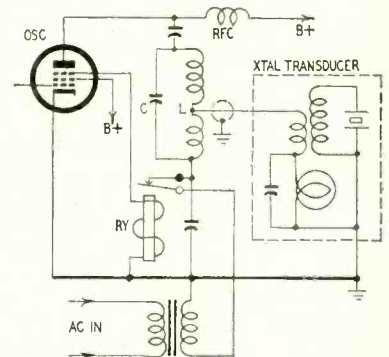

tode oscillator-amplifier is connected to the transducer or treatment head through a shielded cable. A sensitive relay has its coil connected in series with the suppressor grid lead. Normally, relay RY is not energized so there is a continuous path from the ac source through the normally closed relay contacts, part of tank coil L, the connecting cable and the indicating lamp.

The oscillator tank circuit (L and C) is tuned to resonance. This produces minimum plate,

PATENTS

(Continued)

screen and suppressor currents. Current flow in the suppressor circuit is insufficient to operate the relay.

Any change in acoustic impedance (the load), as may be caused by improper use of the transducer or mechanical defects in the circuit, is reflected back into the oscillator. When this occurs, plate, screen and suppressor currents increase. The increased current in the suppressor circuit energizes the relay and causes the lamp to go out.

SINGLE-CORE BINARY COUNTER

Patent No. 2,713,675

William F. Schmitt, Philadelphia, Pa.
(Assigned to Remington Rand, Inc.)

This magnetic counter delivers one output pulse for each pair of input pulses. It uses a magnetic core with nearly rectangular hysteresis loop (Fig. 1). This curve shows the relationship between magnetizing force H and flux density B. H may be generated by a current through a winding. If it is large enough, it will drive the core either to positive or negative saturation S, depending upon the direction of H. When the current is zero, the operating point will be on the B axis (where H is zero).

The core permeability is high so the inductance of its winding will be large except in the regions near saturation. Here the flux density remains nearly constant, so the inductance necessarily tends to approach zero.

Fig. 2 shows a binary counter using a single core. Assume an initial flux density equal to B1

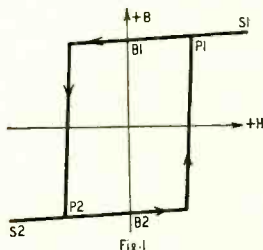

when current through L is zero. A positive input pulse drives the core to S1. In this region the core has low inductance (and reactance). Thus most of the signal voltage appears across C and very little across L. C charges and generates an output pulse. At the end of the signal, the core flux density drops back to B1 (where H is zero). C begins to discharge in the reverse direction and drives the core to negative saturation along the

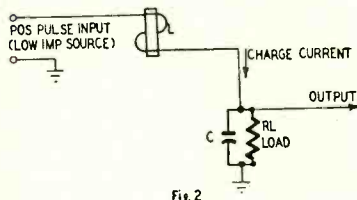

path P2, S2. From here the operating point slips back to B2 where it remains.

The second pulse drives the core density along the path P1 to S1. Along this path the core inductance is very high, so a large voltage appears across L and very little is available to charge the capacitor. Therefore the discharge current from C will not be sufficient this time to reverse the polarity of the core. Flux density remains at B1 at the end of the second pulse.

It is clear that two input pulses generate a single magnetizing cycle. Only the odd pulses account for an output signal, thus making this a scale-of-two device. The advantage of this magnetic storage system is that no power need be expended to maintain the positive or negative polarity of the core. **END**

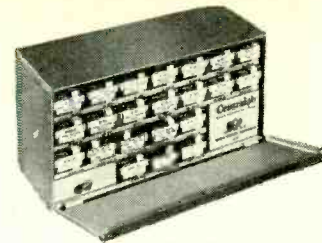

BA Kit
\$19.40 complete
BB Kit
\$21.48 complete
Suggested net prices

NO QUESTION
about which control it pays to stock

The ones you need most often are in these two

Centralab Blue Shaft® Radiohm® Kits

Convenient, low-cost bench stocks of the radio and TV replacements which sales records show you use most often.

BA Kit — 22 volume controls, plain and switch types, in 1/2-meg. and 1-meg. audio tapers only.

BB Kit — 22 controls, plain and switch types, 1,000 ohms to 5 megs. — plus 4 extra switches — covering front-panel and "hidden" controls.

Both kits come in metal cabinets. You pay only the regular cost for the contents — get the cabinet free!

You pay less — get Centralab's extra quality. All controls have double-wiping action — take Fastatch® line switches — are 100% factory-tested and guaranteed.

Ask your Centralab distributor about these kits. Or send coupon for Catalog 29 that describes them.

Centralab

A DIVISION OF GLOBE-UNION INC.
922D East Keefe Avenue, Milwaukee 1, Wisconsin B-5616

Send me Centralab Catalog 29.

Name.....

Company.....

Address.....

City..... Zone..... State.....



the smoother the tape, the greater the fidelity...

...because of better head-to-tape contact

irish
BRAND
FERRO-SHEEN TAPE
has the smoothest surface
of them all!*

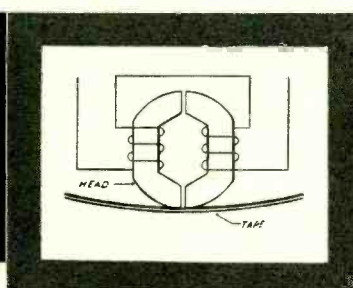

The oxide coating of recording tape must make close contact with the head for accurate reproduction of the upper frequencies. The high frequencies correspond to such small physical dimensions in the magnetic recording process that the minutest discontinuities in the oxide coating will interfere with the magnetic influence of the head on the oxide. Hence, the coating should have as little "grain" in it as possible. The **FERRO-SHEEN** process results in the smoothest and most homogeneous magnetic surface ever produced on tape, improving high-frequency reproduction and overall tonal fidelity on any tape recorder.

* Make Your Own Test in 20 Seconds!

Place a sample of **irish FERRO-SHEEN** tape side by side with strips of the other leading brands of recording tape. You will see at a glance the obvious difference in surface between **FERRO-SHEEN** and all the others. And... the difference you can SEE is responsible for the improvement you will HEAR!

FOUR Great irish FERRO-SHEEN Tapes:

- SHAMROCK #300:** The ultimate in professional tape for broadcast and studio use.....1200' on 7" reel
- LONG-PLAY #600:** Extends playing time 50% over conventional tapes; Mylar base.....1800' on 7" reel
- DOUBLE-PLAY #7-2400:** Doubles your playing time on standard 7" reel; Mylar base.....2400' on 7" reel
- SOUND PLATE #220:** Super-tough tape for masters and recording under adverse climate conditions. 1200' on 7" reel



ORRADIO INDUSTRIES, INC., Opelika, Alabama

EXPORT DIVISION: Morhan Exporting Corp.,
458 Broadway, New York 13, N. Y., U. S. A.
IN CANADA: Atlas Radio Corp., Ltd., Toronto, Ontario

If not available at
your favorite dealer,
write to manufacturer.

REAL ESTATE BE A BROKER

PAYS BIG! SEND FOR FREE, BIG, ILLUSTRATED CATALOG NOW! Graduates report making substantial incomes. Start and run your own business quickly. Men, women of all ages learn easily. Course covers Sales, Property Management, Appraising, Loans, Mortgages, and related subjects. **STUDY AT HOME** or in classrooms in leading cities. Diploma awarded. Write TODAY for free book! No obligation. Approved for World War II and Korean Veterans.
WEAVER SCHOOL OF REAL ESTATE (Est. 1916)
2022L Grand Kansas City, Missouri

NEW JENSEN MANUAL TELLS HOW TO BUILD YOUR OWN HI-FI SPEAKER SYSTEMS
Save money... have fun building your own Jensen. 2-way or 3-way hi-fi speaker system. New 36-page manual tells how to make enclosures and assemble 18 different systems with 8 new Jensen speaker kits. Send 50c today for Jensen Manual 1060.
JENSEN MFG. CO. Dept. H 6601 S. Laramie, Chicago 38

TV TUNER REPAIRS
48-HOUR SERVICE
Defective tuners rebuilt to factory standards. New tuner guarantee. Ship prepaid.
RADIO PRODUCTS CO.
College Point 56 New York
We carry a full stock of Replacement Tuners for all makes of T.V.

INVENTORS
Send for **PATENT INFORMATION** Book and **INVENTORS RECORD** without obligation
GUSTAVE MILLER
RE-46 WARNER BUILDING WASHINGTON 4, D. C.
REGISTERED PATENT ATTORNEY
ASSOCIATE EXAMINER U.S. PAT. OFF. 1922-1929
Patent Attorney & Advisor U.S. Navy Dept. 1930-1947
PATENT LAWYER

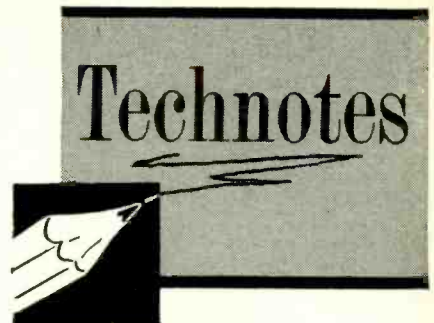

ZENITH J2026R

A common occurrence in this and similar models using the 20J20 and 21J20 series chassis is the loss of high voltage. During this time the sound is normal. The horizontal output tube (6BQ6-GT) and horizontal flyback

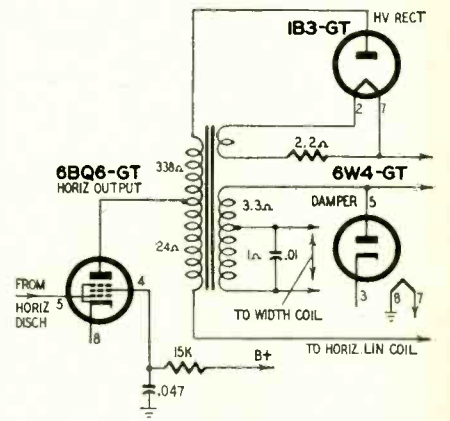

transformer become very hot. The trouble is usually a short in the transformer winding between the plate of the horizontal output tube (see diagram) and the plate of the 1B3-GT. The resistance between these points should be about 336 ohms but in one particular case I measured 308 ohms. The 6BQ6 and the flyback transformer were replaced.—Michael L. Tortariello

WESTINGHOUSE H203 AM-FM

Oscillation and poor sensitivity on the FM band of this receiver is difficult to fix. Here is a procedure I have used with great success: Check to see if there is a 470,000-ohm resistor connected between terminal No. 2 of the first if transformer and the selector switch. If it is missing, insert it. Then remove all capacitors connected from the avc line to ground, one at a time. Removing one of these capacitors will do the job. Realign the set.—Bill Kerns

COMMON IMPEDANCE PATH

In numerous modern television sets the vertical and horizontal hold controls are located near each other on a small subpanel or equivalent near the front of the chassis (see photo). The chassis ground currents from these controls will thus mix. The chassis has relatively low resistance and reactance, hence a low impedance to currents of these frequencies. But the large flyback pulse of the vertical oscillator can feed directly into the horizontal oscillator circuit and distort

TECHNOTES

(Continued)

the first few lines of the horizontal sweep, causing a hook or bending at the top of the picture. Additional afe control line filtering will not help much in this situation; neither will more

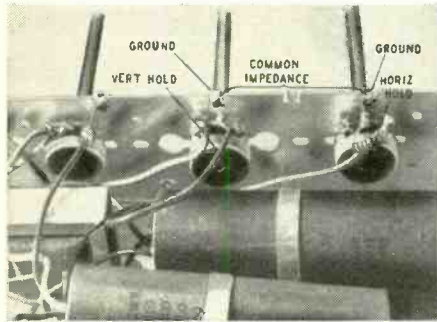

complete filtering of the B-plus line to the vertical output tube remedy this situation appreciably.

The cure is to disconnect the ground lead from the vertical control and re-route it via a wire—or, if available, braid—to the main chassis, as remote as possible from the ground of the horizontal control. Keep this new grounding point away from the other horizontal circuit grounds. In some cases tying the grounds together with heavy braid will do the job.

Even a small fraction of an ohm of impedance may develop an interfering voltage. For large voltages or very high frequencies, the chassis ceases to be an unipotential ground.—James A. McRoberts

RCA MODEL 17T211

The trouble was very heavy interference in the picture on channel 2 only; the other channels were perfect. After considerable checking I found that the antenna line was pushed against the wire of the built-in antenna in the set. It was not making a direct electrical contact, yet it was causing the interference. Removing the built-in antenna restored normal operation.—Morris Gluecklich

PHILCO 50-T1630

A replaced picture-tube insulating cone can be prevented from riding up on the bell of the tube by taping the leading edge of the cone to the rim of the tube before the insulating ring is installed. Cellophane tape is satisfactory for this purpose.—George Taylor

POOR VERTICAL HOLD

In an Emerson model 611 the vertical hold control (1 megohm) had to be set at the lowest resistance to restore sync. After a half hour or so the picture would roll a few times and then return to proper sync for about 30 seconds and then roll again. After about 15 minutes of this vertical hold would be lost completely.

I replaced the vertical oscillator and output tubes without success. Voltage and resistance check revealed nothing. After checking the circuits feeding the

from the VOICE OF AUTHORITY IN SWEEPS...

SPOT and FIX TV FAULTS FAST!

FREE RAM BOOK SHOWS HOW!

Typical latest field-proven servicing data you'll find in your RAM book:

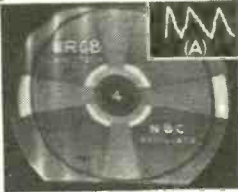

FAULT: "Ringing."
CAUSE: Incorrect value of balancing R-C network across one-half of H. Yoke winding.
(A): H. Yoke current wave-form. Obtained by connecting scope across 10-ohm resistor inserted in series.

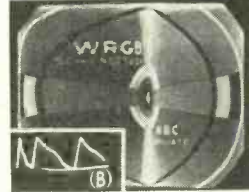

FAULT: Picture compression and stretching.
CAUSE: Capacitance value of boost capacitor (connected to linearity coil) too low.
(B): H. Yoke current wave-form. Leaky boost capacitor could cause similar effect.

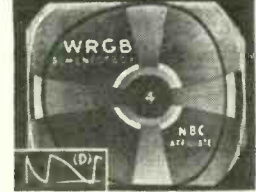

FAULT: Picture stretching at left and compression at right.
CAUSE: 0.02 mf boost capacitor (connected to linearity coil) used instead of 0.1 mf capacitor.
(D): H. Yoke current wave-form.

For over 10 years, RAM has specialized and pioneered in sweeps exclusively. RAM designs them, makes them, counsels TV set manufacturers on them, field-services them, educates Servicemen on them — leads the industry.

No one but RAM can bring you such proven data — as shown here and in the RAM Manual. In manufacturing know-how and field experience, you can depend on RAM for...

THE VOICE OF AUTHORITY IN SWEEPS

Send coupon today — get the BEST information from the FOREMOST manufacturer now!



RAM ELECTRONICS SALES CO. - Irvington, N. Y.

Canadian Sales Division: Telequipment Mfg. Co., Ltd., Ontario

Export Dept: Dage Corp., 219 E. 44 St., New York, N. Y.

ATLAS Cobra-Jectors

- wide angle dispersion
- indestructible fiber-glass
- all-weather construction



Weatherproof universal line transformer, \$5.10 Net.



CJ-14 Net \$16.80

Designed for wide angle coverage, sagging, high efficiency intercom, sens five talk-back. Tops in articulation. Convenient omni-directional mounting bracket. In appearance, they're "beauts".

SPECIFICATIONS	CJ-30	CJ-14
Input pwr (cont.)	15 w	5 w
Input imp.	4 or 8 Ω	4, 8 or 45 Ω
Response (cps)	250-9,000	400-10,000
Dispersion	120° x 60°	120° x 60°
Bell Size	14" x 6"	9 1/2" x 5 1/2"
Over-all length	14"	8 1/2"

Amazing "power packages" — use the Cobra-Jectors for the "tough" jobs.

ATLAS SOUND WRITE FOR COMPLETE CATALOG
ATLAS SOUND CORP.
 1443—39 St., Bklyn. 18, N. Y.
 In Canada: Atlas Radio Corp., Ltd., Toronto, Ont.

COYNE
 TRAINS YOU IN SPARETIME AT HOME
TELEVISION
 RADIO-COLOR TV

Only from famous COYNE do you get this modern up-to-the minute TV Home Training. Easy to follow instructions—fully illustrated with 2150 photos and diagrams. Not an old Radio Course with Television tacked on. Includes UHF and COLOR TV. Personal guidance by Coyne Staff. Practical Job Guides to help you EARN MONEY QUICKLY IN A TV-RADIO SALES AND SERVICE BUSINESS—part time or full time. COSTS MUCH LESS—pay only for training—no costly "put together kits."

SEND COUPON FOR FREE BOOK
 SEND COUPON BELOW for Free Book and full details including EASY PAYMENT PLAN. NO COST OR OBLIGATION—NO SALESMAN WILL CALL.

B. W. COOKE, Pres. **COYNE** ELECTRICAL SCHOOL FOUNDED 1899

TECHNICAL TRADE INSTITUTE OPERATED NOT FOR PROFIT
 500 S. Paulina Dept. 46-HT-4 Chicago 12, Illinois

COYNE ELECTRICAL SCHOOL
 Television Home Training Div.
 500 S. Paulina St., Chicago 12, Ill., Dept. 46-HT-4

Send FREE BOOK and details of your Television Home Training offer.

Name _____
 Address _____
 City _____ State _____



why build a high fidelity turntable like a battleship?

A high fidelity turntable, like a battleship, must be rugged, heavy, massive . . . yet easy to control. Both must be completely dependable, smooth in performance, and quiet in operation.

52 POUNDS OF LISTENING PLEASURE

Imagine the pound by pound advantages found only in Gray's turntable assembly designed exclusively for High Fidelity recordings:

- A 1/4" steel motorboard for complete rigidity.
- An 18 lb. flywheel action turntable with a 4-inch tapered bearing that positively eliminates wobble forever.
- A turntable and motorboard assembly that is 10 times the mass of the motor, prevents the transference of all mechanical disturbance.

For the gentle touch, Gray's floating action, Viscous Damped Tone Arm, and the novel cue light for accurate starting groove location, add the ultimate in operating enjoyment.

Be assured you are obtaining maximum performance from your High Fidelity system. Only Gray has a turntable "built like a battleship". Styled by one of the country's leading designers, this unit adds a note of distinction to any surroundings. The standard finishes are pebbled gray, red, green, or yellow. Deluxe models are available in mahogany, walnut, and blond.



Models \$89.00 to \$175.00 depending upon the completeness of assembly and choice of motor.

Write for more information or see your local dealer.

GRAY RESEARCH & DEVELOPMENT COMPANY, INC.
Manchester, Connecticut
Subsidiary of The Gray Manufacturing Company

Look what RADIO-ELECTRONICS

has in store for you in the months ahead . . .

- | | |
|---|---|
| <ul style="list-style-type: none"> • ELECTRONICS IN THE AIR FORCE
By Aaron Nadell • COLOR DEMODULATOR ALIGNMENT
By Walter J. Cerveny • SERVICING HOME TAPE RECORDERS
By Herman Burstein • ROLE OF THE Y SIGNAL IN MATRIX OPERATION
By Robert G. Middleton • WAVEFORM GENERATOR
By Ed Bukstein • AUDIO TRANSFORMERS
By Norman H. Crowhurst | <ul style="list-style-type: none"> • UNDERSTANDING COLOR BAR GENERATORS
By Robert G. Middleton • TROUBLESHOOTING AGC CIRCUITS
By Cyrus Glickstein • CIVIL-DEFENSE RADIATION METER
By E. N. Kaufman • HIGH-GAIN TRANSISTOR AUDIO AMPLIFIER
By Joseph Braunbeck • PHOTOELECTRIC LIGHT COMPUTER
By John R. Satter |
|---|---|

The MAY issue of RADIO-ELECTRONICS goes on sale April 24th at better parts distributors and newsstands.

SUBSCRIPTION RATES

One year \$3.50
154 WEST 14th ST.

Two years \$6.00

Three Years \$8.00
NEW YORK 11, N.Y.

TECHNOTES

(Continued)

vertical oscillator, I started replacing components in the oscillator circuit. When I removed the 1.5-megohm resistor in series with the vertical hold control and replaced it with a 500,000-ohm carbon resistor, the oscillator synchronized perfectly in the center of the hold setting.—*Joseph Di Franco*

OLDER MOTOROLAS

Some of these sets have compression at the top of the picture; a few show it at the bottom too. Varying the settings of the vertical linearity and size controls produces no improvement. Connecting a 22,000-ohm resistor from the high side of the vertical yoke winding to the high side of the peaking resistor (see diagram) is a simple cure.

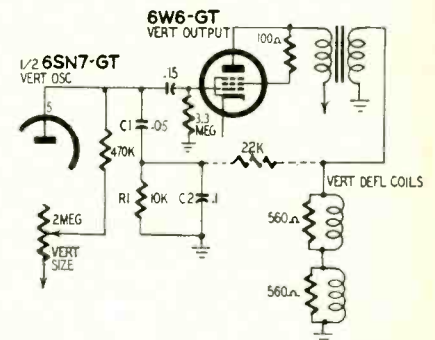

The resistor can be installed on the terminal strip which joins the green yoke lead and the yellow transformer lead. It can be connected between this lug and the adjacent (unused) one, from which a lead can be run to the lug which forms the junction of R1, C1 and C2. Be careful not to break the terminal on the 4.5-mc trap coil.—*Blackburn Hall*

DU MONT RECEIVERS

When these sets are troubled with picture overload and cannot be corrected by adjusting the age control, look for a leaky .05-μf capacitor in the age voltage-divider circuit. Increased gain with less snow on weak signals can be had by substituting an 8-megohm resistor in place of the 10-megohm age unit. This raises the signal at the input of the video strip and overrides the tube noises in this stage.—*Carl Hennig*

G-E 814

In this and earlier models a common defect is a slight wiggle at the left edge of the first few lines at the top of the raster. When this occurs check the 0.5-μf capacitor in series with the low side of the horizontal deflection coils. Also see if this capacitor is shunted with a 330-ohm resistor. If not, install one—many sets do not contain it.—*Wayne Miller*

SYLVANIA CHASSIS 1-502-1

Complaints of intermittent audio buzz in models using this chassis can often be solved by replacing the four-section electrolytic filter capacitor (one section of this unit is used as a cathode bypass capacitor in the vertical output amplifier).—*Sidney S. Goodkin* END

radio-electronic Circuits



CONTINUITY TESTER

Many times in our shop we have to test continuity of multiconductor cables with two types of plugs or connectors on them. The cable might have a Jones type connector on one end and an Amphenol on the other. It is a time-

consuming task to check each conductor with a meter. Both ends of the cable to be tested are plugged into matching connectors on the board. Both switches are then rotated to position 1. The pilot lamp connected to this circuit will light if

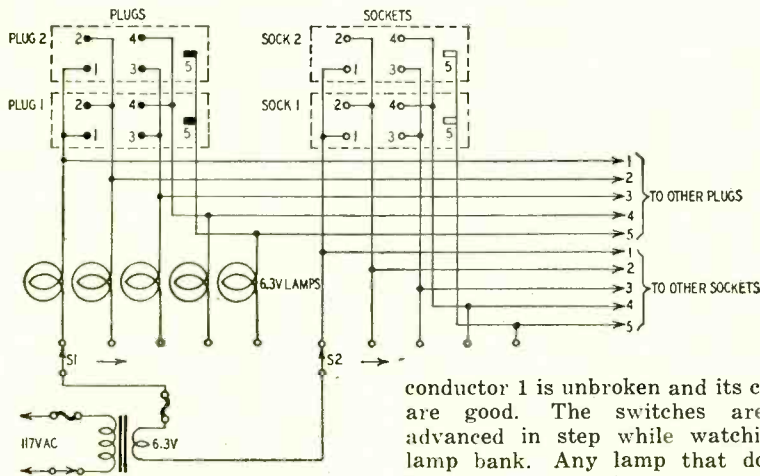

consuming task to check each conductor with a meter.

To solve this problem we made a test rig with all common varieties of male connectors on one end of a board and common female types on the other. All male connectors are connected in parallel as shown in the diagram. That is, all pins with the same number are tied together and then carried to the corresponding position on a tap switch (S1) through a 6-volt pilot lamp.

The female side of the board is wired the same way with the exception the pilot lights were eliminated. The female

conductor 1 is unbroken and its contacts are good. The switches are then advanced in step while watching the lamp bank. Any lamp that does not light when the switches are set to its position indicates an open circuit in that conductor.

After checking continuity, S1 may be set to a given position and S2 rotated through all positions to check for shorts between any conductors in the cable. In this case, the lamp lights when there is a short between the conductors selected by S1 and S2.

The number of switch positions is determined by the maximum number of conductors in the cable. The 6-volt filament transformer may be replaced by batteries for portable applications. —Tom Horn

RELAY CIRCUITRY

In many relay applications we want to actuate the relay with as little current as possible. As the current in the coil is increased from zero, it reaches a point where it operates the relay. This is known as the *pull-in* current. If the current decreases from this value, the relay remains in until the current reaches a lower value known as the *drop-out* current. The range of current between the drop-out and pull-in levels is known as the *hysteresis* of the relay.

This can be measured with the circuit shown at *a* in Fig. 1, where R is a variable resistor of the proper value to give the desired current range.

If a current below the drop-out level is allowed to flow continuously through

the relay coil, then to turn the relay on and off it is necessary only to switch a current slightly greater than the difference between the pull-in and drop-out currents. A circuit for doing this is shown at *b* in Fig. 1. With the switch open, resistors R1 and R2 allow a current slightly less than the drop-out level to flow in the circuit. However, with the switch closed, R2 is shorted out. R1 then allows a current slightly greater than the pull-in current to flow and actuate the relay. Opening the switch drops the current to its lower value and the relay opens.

R1 should be chosen first to give the desired pull-in current, and then R2 should be adjusted for the desired drop-

**TOP JOBS go to
Men Who Think Ahead!**

become an
expert in . . .

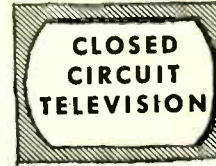

Edward M. Noll, nationally known TV consultant, teacher, and writer gives you all the information you need in

Closed Circuit and Industrial Television

This one book could guarantee your future!

The television camera is moving out of the studio and into industry, business, and education. \$4.95 will buy you a complete expert's course in constructing, installing, operating, and servicing closed circuit systems.

Easy to learn

You already know all the basic principles! Make the knowledge you have *really* pay-off. This book gives you, in clear non-mathematical terms, both the theory and practical techniques needed to handle the special transmission systems, scanning processes, picture signals, sync and deflection generators, closed-circuit cameras, and video amplifier systems used in closed circuit television.

This book will help you qualify for one of the hundreds of high-paying jobs opening up every day.

The only book in its field

This specially designed, paper-back volume is packed with technical know-how, industrial applications, and hundreds of photographs and schematics.

Learn Color, UHF, and Monochrome Television

Television for Radiomen

New Revised Edition, \$10 by Edward M. Noll

Complete Course in One Volume

At much less cost than the average course of lessons—you'll get THOROUGH, practical training for the best jobs in TV. You'll know the fundamentals of both transmission and receiving; the practical techniques of installation, alignment, adjustment, trouble-shooting; as well as the latest improvements—transistor circuits, UHF, color.

The easy inexpensive way

You'll learn each detail of the NTSC color system; the function of each circuit, the special installation and adjustment techniques, the service problems and how to handle them. You'll know the principles and all practical details of the intercarrier I-F system, the best antenna installations for UHF.

These up-to-date, thorough books are your ticket to the best jobs in TV!

STUDY ONE OR BOTH FREE for 10 days without obligation

CLIP AND MAIL TODAY

The Macmillan Co., Dept. RE-1
60 Fifth Avenue, New York 11, N. Y.

Please send me:

Closed Circuit and Industrial Television \$4.95
 Television for Radiomen \$10.00

I will either remit the full price or return the book in ten days. (Save: Send check or money order now and we pay delivery charge.)

Name

Address

City..... Zone..... State.....

(This offer good only within Continental Limits of U.S.A.)

NEW The Solution to Your Troublesome **INTERMITTENT** Problems!



Model SL10
SECO
MONITRON

**SIGNAL TRACER
AND INTERMITTENT
LOCALIZER**

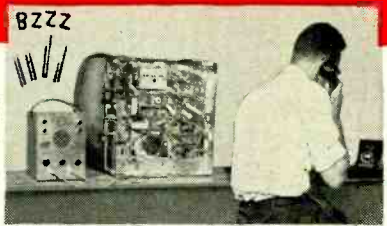

\$119.50 ... monitors circuits without attention
NEW for Television and Industrial Use

In servicing TV receivers, transmitters and similar electronic equipment where the output signal does not energize a sound producing indicator, a device is needed to acuate visible and audible alarm in case of a break in the signal path. The Seco MONITRON does just that and more!

Performs 4 basic functions:

1. Monitors circuits without attention.
2. Monitors 2 circuits at once (on same or separate chassis.)
3. Operates as a signal tracer.
4. Makes point to point gain measurements.

Another Serviceman's Timesaver joining these indispensable Seco Testers.

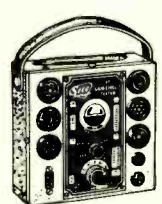

SECO
Model GCT-5
GRID CIRCUIT
TUBE TESTER



SECO
Model FB-4
FLYBACK CIRCUIT
AND INDUCTANCE
ANALYZER

Your Jobber has 'em or write for information.



SECO MFG. CO. 5015 Penn Avenue S.
Minneapolis, Minn.

Give generously to the CANCER FUND

EASY TO LEARN CODE

It is easy to learn or increase speed with an Instructograph Code Teacher. Affords the quickest and most practical method yet developed. For beginners or advanced students. Available tapes from beginner's alphabet to typical messages on all subjects. Speed range 5 to 40 WPM. Always ready—no QRM.

ENDORSED BY THOUSANDS!

The Instructograph Code Teacher literally takes the place of an operator-instructor and enables anyone to learn and master code without further assistance. Thousands of successful operators have "acquired the code" with the Instructograph System. Write today for convenient rental and purchase plans.



INSTRUCTOGRAPH COMPANY

4701 Sheridan Rd., Dept. RC, Chicago 40, Ill.

ELECTRONICS

Prepare for unlimited opportunities of the Electronic Age! Earn your B.S. degree in 27 months at Indiana Technical College. Intensive, specialized course. Comprehensive training in math and electrical engineering, advanced radio theory and design, television, electronics. Modern laboratories. Low rate. Also B.S. DEGREE IN 27 MONTHS in Aeronautical, Chemical, Civil, Electrical and Mechanical Engineering. G.I. approved. Enter June, September, December, March. Earn part of your expenses in Fort Wayne while studying. Write for catalog.

INDIANA TECHNICAL COLLEGE
1746 E. Washington Blvd., Fort Wayne 2, Ind.

Please send me free information on B.S. ENGINEERING DEGREE IN 27 MONTHS as checked.

- Electronics Chemical Aeronautical
 Civil Mechanical Electrical

Name
Address

RADIO-ELECTRONICS CIRCUITS (Continued)

out current. This scheme is applicable to a.c. relays if the battery in Fig. 1 is replaced with suitable a.c. power.

Assume that a d.c. contactor has a pull-in current of 6 amps and a drop-out current of 4 amps. With this arrangement the contacts controlling it would have to break only a little

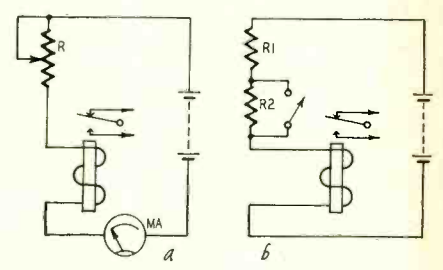

Fig. 1

over 2 instead of the full 6 amps as in the usual connection.

The benefits of this scheme are obtained only at the cost of an increase in power consumption. With a.c. relays, the standby current may result in objectionable buzzing.

The picture is entirely different for relays controlled by vacuum tubes. Tubes control the current in the relay

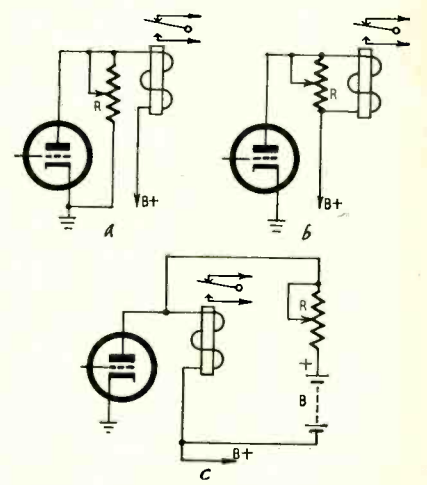

Fig. 2

coils so a reduction in the operating current range increases circuit sensitivity. Circuit a of Fig. 2 is used with tubes that are normally cut off. Potentiometer R parallels the tube and carries the relay standby current. With the tube cut off, decrease the resistance until the relay pulls in and then back off until the relay just drops out. As an example of what can be gained in this way, consider a sensitive relay with a pull-in current of 5 ma and a drop-out current of 4 ma. With the tube normally cut off, the plate current would have to change 5 ma to operate the relay. However, with R in the circuit and adjusted to draw almost 4 ma a tube-current of only a little over 1 ma will operate the relay and result in almost a fivefold gain in sensitivity.

Use circuit b of Fig. 2 when the tube is normally conducting. Tube current in excess of the relay pull-in

RADIO-ELECTRONIC CIRCUITS (Continued)
current is diverted through potentiometer R. Decrease its value until the relay drops out and then increase it until the relay just pulls in.

Consider the relay of the previous case, with a tube current of 10 ma. The normal variation of tube current required to drop out the relay is 6 ma. However, if R were adjusted to take a little less than half the total plate current, then the relay would drop out at about 8 ma and the tube-current swing would be reduced to 2 ma.

Greater sensitivity can be obtained from the circuit *c* of Fig. 2, in which the battery and resistor R are used to send a current through the relay coil to buck the tube current partially. R would be adjusted in the same manner as R in the previous case. In the above example, the circuit would be adjusted for a little less than 5 ma of bucking current. Then the necessary plate-current excursion would be reduced to a little more than 1 ma.—Charles Erwin Cohn
END

Radio Thirty-Five Years Ago In Gernsback Publications

HUGO GERNSBACK, Founder

Modern Electrics	1908
Wireless Association of America	1908
Electrical Experimenter	1913
Radio News	1919
Science & Invention	1920
Television	1927
Radio-Craft	1929
Short-Wave Craft	1930
Television News	1931

Some larger libraries still have copies of ELECTRICAL EXPERIMENTER on file for interested readers.

In April 1922 Science and Invention (formerly Electrical Experimenter)

- A Simple Radiophone Receiver, winner of First Prize (\$100), by James Leo McLaughlin
- Paris Radio Controlled House
- Radiophone Now a Household Necessity, by Mrs. Christine Frederick
- National Radio Broadcast by Bell System
- Radio Set in a Match Box, by A. N. Mirzaoff
- Simple Receiving Set
- Radio Loud-Talkers, by Henry Townsend, Jr.
- First Authentic List of Radio Broadcasting Stations
- Radio for the Beginner, by Armstrong Perry. Installment 2
- The Radio Oracle



SERVICE TECHNICIANS . . .

Here's How to Make Up to 50% More Money! and . . .

have more time to relax!

Yes, it's true! You can actually take home more money than ever before . . . increase your business . . . do a better, faster servicing job . . . yet have more time to enjoy the "fun" things of life!

Just sit back and let the **WORLD'S SMARTEST ELECTRONIC EXPERTS WORK FOR YOU!**

Let these experts help you solve even the toughest servicing problems . . . in half the usual time! Let them give you never-before-available inside information on every servicing problem! Now, at last, the **GERNSBACK TECHNICIANS' LIBRARY** gives YOU the know-how of famous authorities on every phase of servicing.



Never before has this subject been covered so completely . . . in such practical language! No more articles to clip and store! No more rummaging through old files when you need the right answer in a hurry! Now you can have **AT YOUR FINGERTIPS** complete diagrams and schematics! **ALL** the money-making, hard-to-get information you need to handle every servicing job . . . faster . . . better . . . easier! And these books are written in down-to-earth terms—no useless, extra words to slow you down!

for instance . . . **THE V.T.V.M.**

One of the brand new books you can't afford to miss is **THE V.T.V.M.**, by Rhys Samuel, well-known RCA test instrument engineer and technical writer. Here, in **ONE** handy book, are **ALL** the tips . . . **ALL** the inside dope that makes the Vacuum-Tube Voltmeter worth its weight in gold. Learn to pinpoint hidden trouble spots in seconds . . . use the V.T.V.M. for TV troubleshooting, AM & FM alignment and repair, checking components, taking voltage measurements! Here, for the first time, are literally hundreds of new detailed uses for this "electronic workhorse"!

THESE BOOKS ARE READY FOR YOU NOW!

THE OSCILLOSCOPE by George Zwick; **PROBES** by Bruno Zucconi and Martin Clifford; **SWEEP and MARKER GENERATORS** for TELEVISION and RADIO by Robert G. Middleton; **THE V.T.V.M.** by Rhys Samuel.

AND THESE BOOKS ARE IN PREPARATION!

SERVICING RECORD CHANGERS by Harry Mileaf; **RAPID TV REPAIR** by G. Warren Heath; **COLOR TV CIRCUITS**; **HOW TO SERVICE COLOR TV RECEIVERS** by Robert G. Middleton; **TV and RADIO TUBE TROUBLES** by Sol Heller; **TELEVISION—IT'S A CINCH** by E. Aisberg . . . and many others.

JOIN THE MONEY-SAVING, NO-RISK GERNSBACK TECHNICIANS' LIBRARY AND SAVE 27%

You may buy any or all of these books at the low retail price of only \$4.60 per copy. OR, as a member of the Library Plan you pay the special member's low price of only \$3.35—YOU SAVE 27%!

HOW THE LIBRARY PLAN WORKS

- 1) Each book is sent to you for a 10 day **FREE EXAMINATION**. If you don't like it, return it . . . doesn't cost a penny!
- 2) One new book will be sent to you for your **FREE TRIAL** every three months.
- 3) You pay only \$3.35 per book if you agree to take a total of 4 out of the 12 or more books.

JOIN TODAY

Hurry! Get all the up-to-date, inside dope you need to make more money, faster! Fill out the coupon and mail it NOW!

NO-RISK COUPON

GERNSBACK LIBRARY, INC., Dept. 456
154 West 14 St., New York 11, N.Y.

- Catch me up to the other member technicians immediately! Send me all the 4 books so far published: **THE OSCILLOSCOPE—PROBES—SWEEP GENERATORS—THE V.T.V.M.** (retail value \$18.40) for only \$13.40 TOTAL (no postage or handling charges).
- Start my membership with just the book or books checked below at \$3.35 each, postpaid.
 - THE OSCILLOSCOPE**
 - PROBES**
 - SWEEP GENERATORS**
 - THE V.T.V.M.**
- I have 10 days in which to return the books if I am not satisfied, otherwise I will pay promptly when I get your bill.
- Send me more information about the **GERNSBACK TECHNICIANS' LIBRARY**.

NAME _____
(please print)

STREET ADDRESS _____

CITY _____ ZONE _____ STATE _____

THE #630 TV RECEIVER remains unmatched for quality and performance ••• RCA designed and developed this set quality-wise *not* price-wise ••• The original 10" set retailed at \$375.00 ••• Subsequent TV sets serve to prove the sacrifice of quality for price ••• what better proof can there be of its superiority than the fact that it is the choice of TV engineers and TV technicians! Herewith we offer you—YOUR BEST BUYS IN TV!—All you pay is the price shown ••• Excise taxes have already been paid by us.

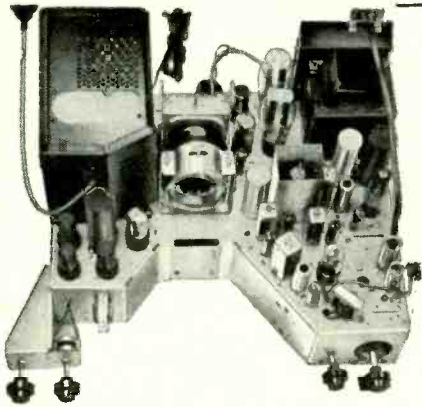

Build your own #630 Super De Luxe TV CHASSIS

With a #630 SUPER DE LUXE 31-TUBE TV KIT

OPERATES 16" to 21" PICTURE TUBES • Engineered in strict adherence to the genuine RCA #630 plus added features • **FULL 4MC BANDWIDTH** • **CASCADE TUNER** • **COSINE DEFLECTION YOKE** • **LARGER POWER TRANSFORMER** • **KEYED AGC** • **12" SPEAKER** • **CONDENSERS** and **RESISTORS** at rated capacities and tolerances. You receive a COMPLETE SET of PARTS and TUBES, everything needed is included (less CRT & wire). All I.F. Coils and Transformers are factory pre-aligned and tuned. You will enjoy building it with "LIFE-SIZE easy to follow step-by-step ASSEMBLING INSTRUCTIONS" included with each KIT.

Slashed to **\$99.99**

Similar KIT for 24", 27" and all 90° CRT's' **\$110.39**

#630 SUPER DE LUXE TV CHASSIS

LICENSED UNDER RCA PATENTS
COMPLETE READY TO PLUG IN AND PLAY
Similar in features to the 16" to 21" TV KIT above.

Slashed to **\$142.27** (less CRT)

#630 B TECHMASTER

COMPLETE LINE AT SPECIAL PRICES
Catalog mailed on request

STANDARD CASCADE TUNER

For better all around performance
Complete with tubes and Brooks CASCADE MANUAL with step-by-step instructions and all extra parts needed. **\$15.97**

FREE WITH THESE PACKAGE DEALS

CONDENSER & RESISTOR CODE CHARTS... with all orders
New 10-SIZE HEX. WRENCH with every \$5 order
STEEL CABINET 12 x 8", 16 lucite see-thru Drawers, 48 Sections with every \$25 order.

Every Assortment contains the most desirable types and sizes to enable you to get most repairs done with the least investment. All items are STANDARD, BRAND NEW and AMERICAN MADE.

100 ASSORTED TUBULAR CONDENSERS

All Are Standard Brands & Desirable Sizes **\$3.69**
\$15.00 Value Only

100— ASSORTED 1/2 WATT RESISTORS **\$2.88**

15 — Asst. Radio Electrolytic CONDENSERS **\$3.49**

15 — Assorted TV Electrolytic CONDENSERS **\$4.97**

100— ASSORTED MICA CONDENSERS **\$3.72**

100— ASSORTED CERAMIC CONDENSERS **\$3.72**

100— ASSORTED 1 WATT RESISTORS **\$4.62**

100— ASSORTED SOCKETS Octal, Locfal & Miniature **\$2.79**

100— ASSORTED KNOBS SCREW & PUSH-ON **\$2.84**

10 — VOLUME CONTROLS ASSORTED, WITH SWITCH 1/4, 1/2, 1, 2 meg. and others **\$2.63**

CUSTOM-BUILT CABINETS FROM FACTORY TO YOU

3 LEADING 1956 STYLES in genuine Mahogany or walnut (blond 10% extra) • Ready drilled for any 2630 TV chassis and cutout for any 16", 17", 19", 20" or 21" picture tube at no extras in price • Also supplied with undrilled knob panel for any other TV set • EVERYTHING NECESSARY for an easy perfect chassis and CRT assembly is included • Each cabinet is delivered complete as pictured with mask, safety glass, mounting brackets, backboard, backcup, hardware and assembling instructions • Each cabinet is shipped in an air cushioned carton from FACTORY TO YOU!

GEM **\$35.91**

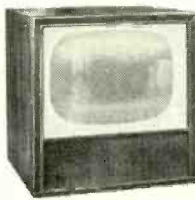

H-25" W-26" D-22"

GEM also available for 24" or 27" picture tube **\$59.54**

WESTCHESTER **\$88.70**

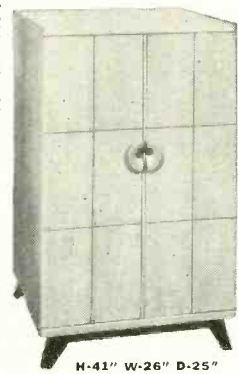

H-41" W-26" D-25"

MANHATTAN **\$53.43**



H-39" W-25" D-23"

MANHATTAN also available for 24" or 27" picture tube **\$79.22**

UNIVERSAL PICTURE TUBE MOUNTING BRACKETS

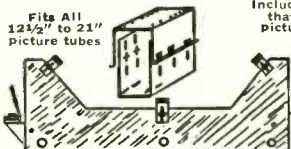

Fits All 12 1/2" to 21" Picture tubes

Complete — including band that holds picture tube

\$4.97

PULSE KEYED AGC KIT

Finest, most accurate and the easiest Kit to install in any make TV RECEIVER including the No. 630. Improves performance and insures a steady picture on all channels.

COMPLETE SET OF PARTS **\$2.99**
Including 6AU6 tube & Instructions

SPECIAL TV PUBLICATIONS

- Brooks LIFE-SIZE TV INSTRUCTIONS for building any #630 TV Receiver from the original 10" to the latest 27"..... **\$1.25** postpaid
- 90° TV CONVERSION MANUAL, how to convert any TV SET to 24", 27", etc..... **50¢** postpaid
- 70° TV CONVERSION MANUAL, how to convert any TV SET to 17", 21", etc..... **50¢** postpaid
- HINTS FOR BETTER PERFORMANCE on your #630 TV receiver..... **50¢** postpaid
- Brooks CASCADE MANUAL, how to install Cascade Tuner in any make TV set..... **25¢** postpaid
- A.G.C. STEP-BY-STEP INSTRUCTIONS, how to add A.G.C. to any make TV Receiver..... **25¢** postpaid

FREE CATALOG mailed on request

FLYBACK TRANSFORMER

Latest single 1B3 type, for the 21" and all 70° Picture Tubes. It is similar to the popular No. X-053 and goes up as high as 16KV. With it you receive easy-to-follow instructions and schematic diagrams that apply to improve practically all makes of TV Receivers. **\$4.86**

21" TV CONVERSION KIT

NOW... Anyone with even a limited knowledge of TV—can Convert any Size, any Make TV RECEIVER to operate 21" or any 70° Picture Tube.

COMPLETE SET OF ESSENTIAL PARTS includes matched set of Todd 70° COSINE DEFLECTION YOKE and TODD HV FLYBACK TRANSFORMER, FOCALIZER, 20KV FILTER, DRIVE TRIMMER, LINEARITY COIL, CONDENSERS, RESISTORS.

Your price... **\$13.97** List Price \$33.50
Incl. CONVERSION MANUAL with Step-by-Step Instructions & Diagrams.

27" TV CONVERSION KIT

Convert any Size any Make TV RECEIVER to operate the 27", 24" or any 90° Picture Tube.

COMPLETE SET OF ESSENTIAL PARTS includes matched set of Todd 90° COSINE DEFLECTION YOKE and TODD 18KV FLYBACK TRANSFORMER, 30KV FILTER, 6AX4 TUBE, YOKE BRACKETS, WIDTH CONTROL, CONDENSERS, RESISTORS.

Your Price... **\$15.98** List Price \$39.75
Incl. CONVERSION MANUAL with Step-by-Step Instructions & Diagrams. Illustrations for mounting TV Sets flush with wall extending into garage, closet or wall recess included.

BROOKS RADIO & TV CORP., 84 Vesey St., Dept. A, New York 7, N.Y. TELEPHONE CORtland 7-2359

Question Box



BROADCAST PREAMPLIFIER

Please print the diagram of a two-stage broadcast-band preamplifier for use between a Hallicrafters SX-100 receiver and the rotatable loop antenna (February, 1955) to bring in distant

wave rectifier power supply shown. Broadcast-band antenna coils with 72- or 300-ohm balanced input circuits are not readily available on the market so we recommend that you use

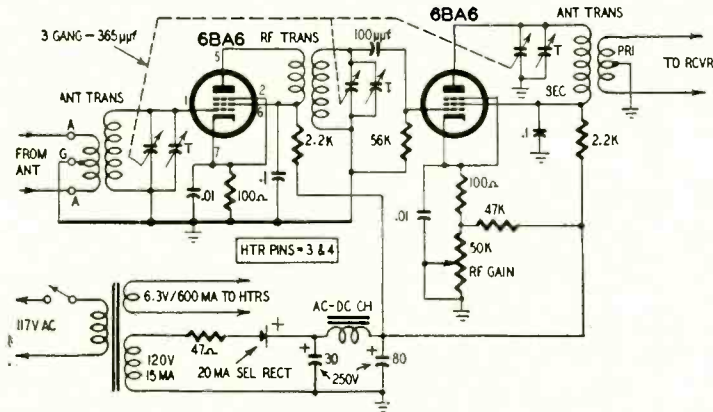

stations. Please provide 72-ohm balanced input and a 300-ohm balanced output.—J. R. W., Caldwell, N. J.

Here is the circuit you request. You can operate the preamplifier from the receiver, from any convenient source delivering 90 to 150 volts dc at 10 ma or so or you can use the built-in half-

standard antenna coils. If you wish, you can try winding your own primaries on the coils. Start with 20 turns or so (center-tapped) and adjust the total number of turns for optimum performance. Use the number of turns that gives good gain without reducing selectivity too much.

BROADCAST INTERFERENCE

I am troubled by a strong local station which drowns out signals over a large part of the broadcast band. I got a so-called "wavetrap" but it doesn't help much. Is there anything better?—T. L., Lachine, Canada.

This double-tuned wavetrap should do the job. L1 and L2 are primary and secondary, respectively, of a slug-tuned broadcast antenna coil and L3 is the secondary of a slug-tuned broadcast antenna or rf coil with the primary removed. You can substitute J. W. Miller type 813-BC double-tuned traps for the frequency range of the interfering station. Regardless of the type of traps you use, they should be carefully shielded and mounted as close as practical to the set's antenna post.

If the set uses a loop antenna, use one of the Miller series 816 wavetraps connected between the grid terminal of the loop and ground or the grid return

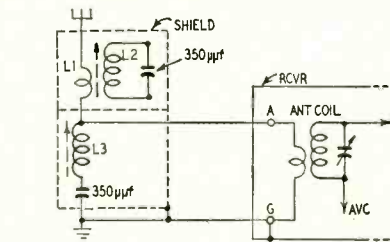

for the input stage.

There is a possibility that the interfering signal is strong enough to cause stray rectification within the set. If so, it will occur most likely in the grid circuit of the first audio stage. If the grid resistor for the first af stage is above about 2.5 megohms, replace it with one no larger than this value and shunt it with a 100–250-μf mica capacitor. Try a good line filter or bypass both sides of the power line to ground through .005-μf 600-volt units.

PHOTOELECTRIC ALARM

In the service shop of a large appliance store, the workbench area is separated from the entrance and office by a partition. When the secretary is temporarily out of the office, we can-

not hear a customer enter the office because of the high noise level in the shop. I want to build a photoelectric alarm that will sound a gong or flash a light when anyone approaches the

COMPLETE TRAINING FOR BETTER RADIO-TV SERVICE JOBS



Let these two great new Ghirardi training books teach you to handle all types of AM, FM and TV service jobs by approved professional methods—and watch your efficiency and earnings soar!

Completely modern, profusely illustrated and written so you can easily understand every word, these books pave the way to fast, accurate service on any type of home radio-TV electronic equipment ever made. Each book is brand new. Each contains the latest data on the latest methods and equipment—NOT a rehash of old, out-of-date material. Each is co-authored by A. A. Ghirardi whose famous RADIO PHYSICS COURSE and MODERN RADIO SERVICE were, for 20 years, more widely used for military, school and home study training than any other books of their type!

THE NEW Ghirardi RADIO-TV SERVICE LIBRARY

Almost 1500 pages and over 800 clear illustrations show step-by-step how to handle every phase of modern troubleshooting and servicing.

1—Radio and Television Receiver TROUBLESHOOTING & REPAIR

A complete guide to profitable professional methods. For the novice, it is a comprehensive training course. For the experienced serviceman, it is a quick way to "brush up" on specific jobs, to develop improved techniques or to find fast answers to puzzling service problems. Includes invaluable "step-by-step" service charts. 820 pages, 417 illus., price \$8.75 separately.

2—Radio and Television Receiver CIRCUITRY AND OPERATION

This 669-page volume is the ideal guide for servicemen who realize it pays to know what really makes modern radio-TV receivers "tick" and why. Gives a complete understanding of basic circuits and circuit variations; how to recognize them at a glance; how to eliminate guesswork and useless testing in servicing them. 417 illus. Price separately \$8.50.

New low price... You Save \$1.25!

If broken into lesson form and sent to you as a "course," you'd regard these two great books as a bargain at \$50 or more! Together, they form a complete modern servicing library to help you work faster, more efficiently and more profitably.

Under this offer you buy them both for only \$12.00. You save \$1.25 on the price of the two books—and have the privilege of paying in easy installments while you use them.

10-DAY FREE TRIAL

Dept. RE-46, RINEHART & CO., Inc.
232 Madison Ave., New York 16, N. Y.

Send books below for 10-day FREE EXAMINATION in 10 days. I will either remit price (plus postage) or return books postpaid and owe you nothing.

Radio & TV Receiver TROUBLESHOOTING & REPAIR (Price \$8.75 separately)

Radio & TV Receiver CIRCUITRY & OPERATION (Price \$8.50 separately)

Check here for MONEY-SAVING COMBINATION OFFER... Save \$1.25. Send both of above big books at special rate of only \$12.00 for the two (Regular price \$13.25... you save \$1.25.) Payable at rate of \$3 (plus postage) after 10 days if you decide to keep books and \$3 a month for 3 months until \$12 has been paid.

Name

Address

City, Zone, State

Outside U.S.A.—\$7.25 for TROUBLESHOOTING & REPAIR; \$7.00 for CIRCUITRY & OPERATION; \$13.00 for both books. Cash with order, but money refunded if you return books in 10 days.

Now Available! NEW...

VACO

Hollow Shaft NUT DRIVERS in Color

Nothing else like them anywhere! Choice of 28 types and sizes! New plastic kit at right contains 7 most popular drivers in self-standing bag for service work or bench use.

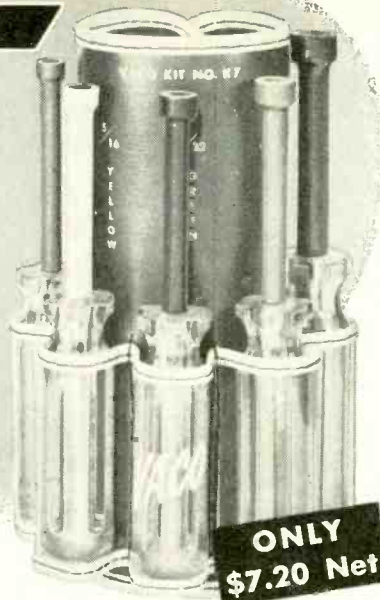

ONLY \$7.20 Net

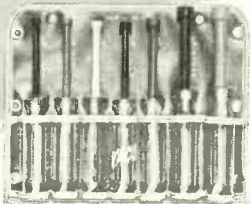

**No. K7 Self-Standing Service Kit
Stands Up! Hangs Up! Folds Up!**

Stands upright for easy accessibility. May be hung flat on wall or may be folded. Each driver fits in individual holder marked for size, color.

Check These 6 Important VACO Features

NEW! Each size color-keyed!

NEW! All-hollow shafts

NEW! Extra large VACO Comfordome Handles!

NEW! Extra hard long wearing sockets!

NEW! Shafts insulated from handle to tip!

NEW! Available in 4 shaft lengths and 7 Hex sizes!

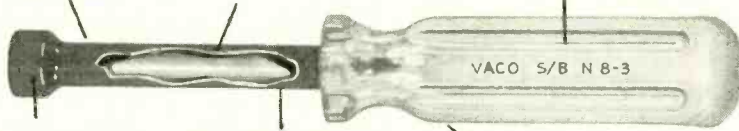

THIS COUPON WORTH \$1.20

Name..... R. E.
Street.....
City..... Zone..... State.....

VACO PRODUCTS COMPANY
317 E. Ontario St., Chicago 11, Ill.
In Canada: Vaco-Lynn Products Co., Ltd., Montreal 1, Que.

Coupon only valid for use as stated below. Not valid in states where prohibited.

Take this coupon to your jobber. It is worth \$1.20 when filled in and used to purchase one VACO K 7 Kit. If your jobber cannot supply you, write direct.

Watch for the May RADIO-ELECTRONICS on sale April 24

ADAPTER



Write for Bull. 354R
TYPE 7B \$2.25
TYPE 8B \$2.50
TYPE 9B \$2.75
(ILLUSTRATED)
plus shipping chgs.

- Min. size for use in crowded spaces
 - RETMA color coded terminals
 - Uses (All above chassis)
1. Modify circuits for max. performance and testing without soldering or unsoldering.
 2. Break into any circuit for trouble shooting.
 3. Measure voltage, resistance and current in conjunction with standard instruments.

A. L. PRODUCTS CO., INC.

311 Hickory St., Kearny, N.J.

CONVERT TO COLOR TV

With COLORDAPTOR, a simple 10 tube circuit & rotating color wheel as described in Jan., Feb. '56 Radio Elect.

- K-9 3.579545 mc crystal..... \$ 3.25
- K-10A Tricolor filter material (sets to 17")..... 2.35
- K-11A Small Parts kit—K-9, 10A & all other coils..... 19.75
- K-1 Complete parts kit (less color wheel, drive)..... 79.95
- S-1 Construction info on new improved Mod C415 2.95

All other Colordaptor parts, motors, & wired chassis available. Write for information, prices.
COLORDAPTOR, 3471 Ramona, Palo Alto, Calif.

NOW IN STOCK at ELMAR ELECTRONICS

140-11 Street Oakland 7, Calif.



COLOR & BLACK & WHITE

5" — 5 MC SCOPE

KIT \$79.95 Wired \$129.50



QUESTION BOX

(Continued)

office service counter. Please print a suitable circuit.—E. C. S., Columbus, Ga.

This circuit should do the trick. The unit should be housed in a case that permits light to enter only through an opening directly in front of the photo-

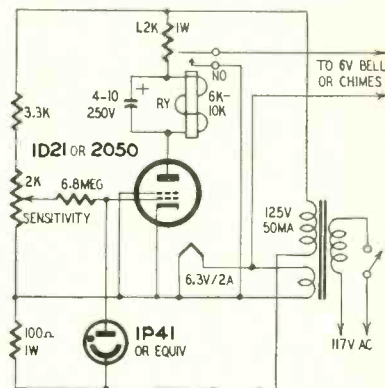

tube's cathode. A lens system may be needed to focus the collected light on the cathode. The light source may be a focusing type flashlight modified for ac operation. Its rays should be focused on the cathode of the phototube.

IMPEDANCE MATCHING STUBS

I have a 300-ohm channel-13 Yagi that I want to feed with 75-ohm coax. Please show a simple matching section for my antenna.—A. C. B., Highland Falls, N. Y.

The simplest method of matching an impedance to another that is higher or lower is to use a quarter-wavelength section of transmission line as an impedance transformer or Q or matching section between the two impedances. The impedance of the line used as a matching section is

$$\sqrt{Z_{in} \times Z_{out}}$$

The physical length of the matching section in inches is $(2,950 \times V)/f$, where V is the velocity factor of the line used in the matching section and f is the frequency of the antenna in megacycles.

The diagram in Fig. 1 shows the setup. Since the antenna input impedance is 300 ohms and the lead-in has a characteristic impedance of 75 ohms, the impedance of the matching section is $\sqrt{300 \times 75} = \sqrt{22,500} = 150$ ohms.

This may be made from 0.5-inch OD tubing spaced 1 inch center to center, Amphenol type 21-442 150-ohm coax or 150-ohm Twin Lead.

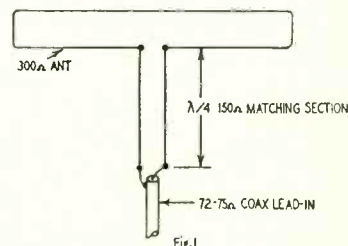

Assuming that the antenna is cut for 213 mc (the center of channel 13) and you use 150-ohm ribbon with a velocity

QUESTION BOX

(Continued)

factor of 0.77, the length of the matching section in inches is $(2,950 \times 0.77) / 213$ or 10.66 inches. If the matching section is made from tubing with air insulation, use 0.98 for the velocity factor.

An antenna with a dipole or folded

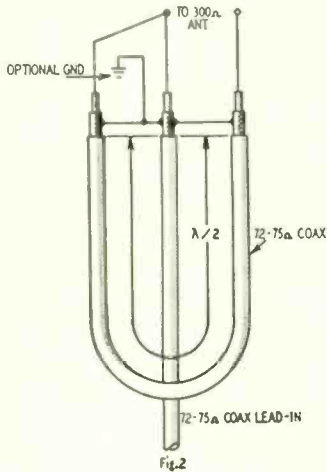

dipole radiator works best when fed from a balanced line so we recommend using a balun (balanced-to-unbalanced) transformer between the balanced antenna and unbalanced coax as in

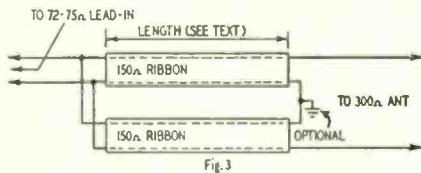

Figs. 2 and 3. These baluns also provide the necessary 4-to-1 impedance ratio. In Fig. 2, the length of the half-wave section of coax in inches is equal to 5,894 divided by the frequency in mc (213). In Fig. 3, quarter-wavelength strips of 150-ohm line are used. The length of each in inches is equal to 2,880 divided by the frequency in megacycles. END



"He's a TV fan—and a bird hater."



FIELD TECHNICIANS

Broaden the scope of your career with Bendix Radio!

Get these BIG ADVANTAGES!

- Professional status
- The prestige of representing the leader in its field.
- Top salaries
- Liberal field allowances

If you have 5 or more years of electronics experience, you benefit many ways as a Bendix Radio Field Engineer. You will receive full pay while you go to our company-sponsored school in Baltimore. Then, you will be given a key assignment in the United States or overseas with responsibility of maintaining search and surveillance radar equipment made by Bendix Radio.

Write, call or wire EMPLOYMENT SUPERVISOR Dept. R

Bendix Radio

DIVISION OF BENDIX AVIATION CORP
Towson 4, Maryland
(Phone VALley 3-2200)

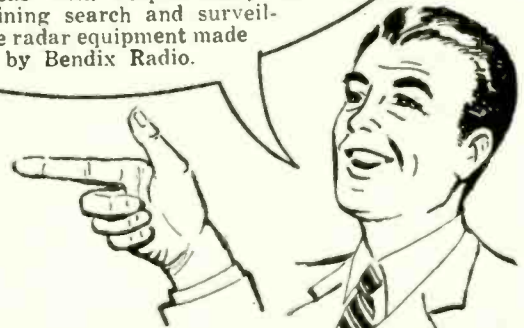

BELIEVE ME — YOU'LL GET PLENTY OF ACTION WHEN YOU START SELLING WALCO NEEDLES . . .



Walco

FOR FREE ILLUSTRATION OF ANITA, WRITE:

TRADE NAME OF
ELECTROVOX CO., INC.
60 Franklin St., East Orange, N. J.

AUDEL'S TV TELLS HOW TO ANSWER RADIO T.V. QUESTIONS SERVICE LIBRARY

HERE IS LATE INFORMATION IN A HANDY FORM FOR TELEVISION AND RADIO REPAIRMEN, SERVICEMEN AND STUDENTS

AUDEL'S T.V. RADIO SERVICE LIBRARY—Highly Endorsed—Over 1500 Pages—1048 Illustrations & Diagrams. 1001 Important Facts & Figures on Modern Television, Radio, Electronic Devices at your finger ends.

INCLUDES TRANSISTORS & Transistor Circuits, Record Changers, Rectifiers, P. A. Systems, Tape Recorders, Phonograph Pick-ups, F.M., Auto Radio; Radio Compass, Short Wave, Radar, etc.

ASK TO SEE IT! IT WILL PAY TO KNOW— The Basic Principles—Construction—Installation—Operation—Repairs—Trouble Shooting. Shows How to get Sharp, Clear T.V. Pictures. Install Aerials—How to Test. Explains Color Systems, Methods of Conversion, Terms, etc. Includes Ultra High Frequency—Valuable for Quick Ready Reference and Home Study.

\$6 COMPLETE

2 VOLUMES Get this Information for Yourself.

7 DAY TEST—PAY ONLY \$1 A Month

MAIL ORDER

AUDEL Publishers, 49 W. 23 St., N.Y. 10, N.Y. Mail AUDEL'S T. V. RADIO SERVICE LIBRARY (2 Volumes) \$6 on 7 days free trial. If O. K. I will remit \$4 in 7 days and \$1 monthly until \$6 is paid. Otherwise I will return them.

Name _____
Address _____
Occupation _____
Employed by _____

Extend your future in

CIRCUIT DESIGN

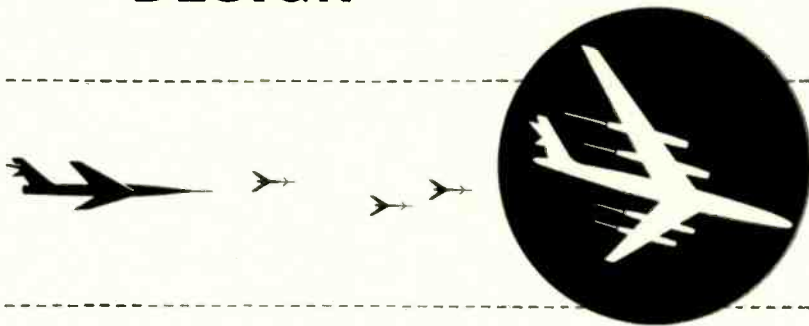

At Hughes we have undertaken development of a system in which advanced radars using array antennas and newer traveling wave tube developments are combined with digital data handling and processing equipment to solve the complex problems of aircraft detection and assignment.

We are already in an enviable position in the intercept and destruction phase of defense through the Hughes airborne radar fire control systems and the Hughes Falcon guided missile. Achievement of these objectives in the very limited space and stringent environmental conditions of the modern defense system provides an unusual challenge to the creative circuit design engineer.

If you are interested in joining us you should have experience in one or more of the following circuit areas:

Transistor—Video—Microwave—Pulse—rf and rf—Switching—Clamping—Phase Shift—Power Supply—Modulator—Electromechanical.



Scientific Staff Relations

HUGHES

RESEARCH AND DEVELOPMENT LABORATORIES

Culver City, Los Angeles County, California

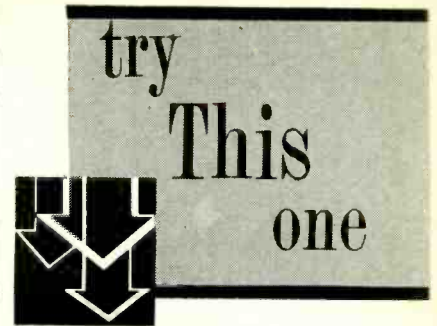

ADDING A REAR-SEAT SPEAKER

The circuits in Figs. 1 and 2 show a simple method of connecting a rear-seat speaker to an auto radio. A control gives the driver his choice of any desired proportion of volume between the front and rear seats.

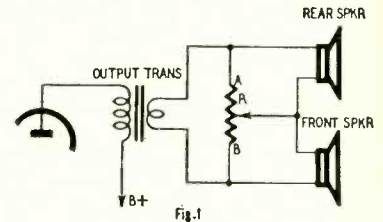
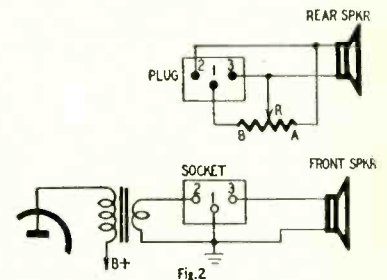

Fig. 1 shows the circuit in a simplified form. R is a wirewound potentiometer with a resistance of about 25 ohms. The value is not critical—values as low as 10 or as high as 50 ohms can be used. When the wiper arm of the control is



advanced to A, the rear speaker is shorted out and the front speaker receives the full output of the receiver. Rotating the arm to B shorts out the front speaker and the rear one operates with full volume. Intermediate settings give any other desired volume level for each speaker.

Fig. 2 shows the same circuit with a plug and socket arrangement. This is the practical way to make the installation so the set may be removed for servicing without removing the rear seat speaker or the control. If it is necessary to operate the radio without the rear speaker and control, simply place a jumper between socket terminals 2 and 3 to complete the circuit. Any polarized plug and socket that is available and easy to install may be used.—James E. Dalley

COVERING VENT PIPES

One very cold day I was on a roof checking lead-in connections and straightening a TV antenna mounted on a vent pipe. Stretching, I could reach all the bolts but the job was

Fen-tone

"INDUCT-O-PHONE"

The latest electronic marvel



No wires, works on fully magnetic induction. Ideal for hospitals, large assemblies, museums, beauty salons and a thousand and one other uses, or simply for fun at parties. Installed in many hospitals—and even in the British Parliament and House of Commons.....List \$15.65

FREE! 1956 *Fen-tone* Catalog. See the many terrific values in the new 1956 Fen-Tone Hi-Fi catalog including mikes, tape decks, cartridges, record changers, silent listening devices, etc.

FENTON COMPANY

15 Moore Street, New York 4, N. Y.

Sold through better Audio Distributors. See yours today!

West of Rockies, prices slightly higher.



VIDEO PROBE METER!

a professional instrument designed for testing a T.V. ABOVE and BELOW chassis!

THE VIDEO PROBE METER!

Saves TWO HOURS PER DAY when used in shop for under chassis work.



With the attachable pick-up loop, (where sufficient signal is available) the Probe Meter can detect and indicate radiation of signal thru I.F. and video amp tubes. (Simply slide loop over tube being tested.) Where internally shielded tubes are encountered, remove tube and insert probe tip into grid pin of socket.

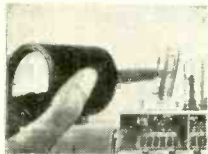

Dealers Net Price \$31.50

Can accurately trace signals in the following T.V. circuits—(from tuner to mix tube) I.F., I.F., Def. Video, Sync, local osc., Hz. osc., Hz. Drive, audio output, sound I.F. (Signal tracing radios.)

EXCELLENT FOR TRACING AND COMPARING COLOR T.V. CIRCUITS.

ADDITIONAL FEATURES

Voltmeter, 0-500V. D.C., 20,000 Ohms/volt. Fully Guaranteed

If your dealer cannot supply you, order direct full purchase price refunded if not satisfied. DEALERS & REPS. INQUIRIES WILL RECEIVE IMMEDIATE ATTENTION.

Research Inventions & Manufacturing Co. 617 F St., N. W., Washington 1, D. C.

TRY THIS ONE

(Continued)

taking longer than I expected and my fingers were getting cold and numb. Realizing that I was likely to drop my wrench or a nut down the vent, I took a wiping rag from my pocket and tied it over the top of the pipe.

Now I always cover any open wells, chimneys and pipes when working around them for any length of time. Plastic dish covers are just right for covering vent pipes and a tool box or piece of heavy cardboard may be used to cover chimneys. Of course, you must not cover a chimney in the winter or any time that it is likely to be in use. —Frank W. Dresser

REVOLVING TV TEST STAND

There are times when an intermittent TV set must be left to "cook" for hours on the service bench. Instead of tying up the bench in the meantime, Don Stanley, a technician of Sarasota, Fla., has his bench built in sections with



casters on the legs. Thus, when a set is intermittent and needs cooking, he rolls out the section that holds the chassis and runs in another to fill the gap. In addition, a plywood turntable, fitted with a pivot shaft and resting on casters, makes it easy to position the chassis conveniently for test or examination without lifting or dragging it. —Harry J. Miller

HANDY BENDING BRAKE

Making neat bends in thin sheet metal for an odd-sized chassis or cabinet is usually a difficult job for the average constructor who does not have a bending brake. Here is a way to simplify this problem.

Have a lumber yard cut three pieces of wood 17 inches long, 4 inches wide and 1 inch thick and then run the saw down the center of the 1-inch side. Make the slot 1 inch deep in one piece, 2 inches deep in another and 3 inches in the last. The saw blade should be approximately 3/32 inch thick.

To use these improvised brakes, simply insert the edge of the metal to be bent into the proper slot (1, 2 or 3 inches, depending on the depth of the bend) and then slowly make the bend to the required angle. You can make neat bends with very little effort. If you have the tools, you can make these brakes yourself from scrap lumber. —Gerald Samkofsky, W2YSF

Choose the right Pliers for faster, better work!

Fine or Sturdy, Long or Short Points ...KRAEUTER makes them

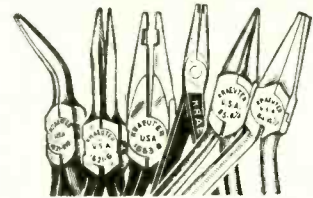

- 1631 — 5½" curved snipe nose
- 1621 — 6" snipe nose
- 1663 — 6" cutters ¼" from tips
- 71 — 8" cutters at tips of jaws
- 85 — 4½" round nose, round jaws
- 84 — 4½" flat nose

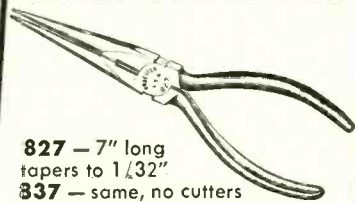

- 827 — 7" long tapers to 1/32"
- 837 — same, no cutters
- 826 — 6", 1/32" points
- 836 — 6", no cutters
- 825 — 5", 1/32" points
- 835 — 5", no cutters
- 83 — 4½", 1/32" points, no cutters

These extra-fine needle point, full polished pliers are used by the skilled electronics technician for delicate, precision wiring.

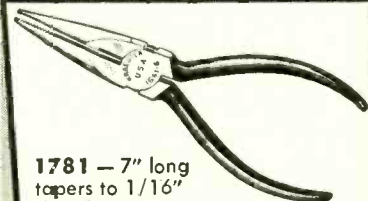

- 1781 — 7" long tapers to 1/16"
- 1771 — same, no cutters
- 1661 — 1/16" points
- 1671 — 6", no cutters
- 1641 — 5", 1/16" points
- 1643 — 5", no cutters

Standard chain nose pliers for general wiring. Polished heads, blued handles.

Your electronics distributor stocks these and other Kraeuter needle nose, diagonal, electrician's side-cutting, slip-joint, and radio-TV pliers.

KRAEUTER

Newark, N. J.

Fine Tools — Since 1860

LEARN

Television-Radio Electricity

REFRIGERATION-ELECTRONICS
IN THE GREAT SHOPS OF **COYNE**

**TRAIN QUICKLY! OLDEST, BEST
EQUIPPED SCHOOL of ITS KIND in U.S.**

Come to the Great Shops of Coyne in Chicago. Get practical training in opportunity fields—TELEVISION—RADIO—ELECTRICITY—ELECTRONICS. Prepare now for a better job and a real future.

Approved for Veterans

Finance Plan—Enroll now, pay most of tuition later. If you need part-time work to help out with living expenses we'll help you get it. Advanced education or previous experience not needed.

FREE BOOK Clip coupon for Big Free Illustrated Book. No obligation and No Salesman Will Call. Act NOW.

B. W. Cooke, President

A TECHNICAL TRADE
INSTITUTE OPERATED
NOT FOR PROFIT
Established 1899
500 S. Paulina, Chicago

COYNE
ELECTRICAL SCHOOL

ELECTRICITY ★ TELEVISION
RADIO ★ REFRIGERATION ★ ELECTRONICS

B. W. COOKE, Pres.

COYNE Electrical School
500 S. Paulina St., Chicago 12, Ill. Dept. 46-81H

Send FREE BOOK and full details on:

TELEVISION-RADIO ELECTRICITY

NAME.....

ADDRESS.....

CITY..... STATE.....

Attention Hams

WANTED

Mine Detectors and Parts 1 to 100
OFFERING

219 Battery Chargers—will charge 6-12-24V Batteries \$6.00 ea. new, BD-93 dynamotors new \$1.95 ea. 28V inPut at 375 Volts out. All other types in stock.

VETS. DIST. CO.

CY-8904

3613 N. WESTERN PKY. LOUISVILLE 12, KY.

Quality,
Style and
Beauty



COMMUNICATIONS RECEIVER

- Six bands; .54 to 31 mc., AM, CW, MCW (FS with convert.)
- Accurate main tuning with full elect. bandspread
- Ferrite transformer, 75 ohm unbal. to bal. input
- One microvolt sensitivity on hf bands
- Image ratio; better than 60 db
- New Audio Selectivity design with variable bandwidth.
- 110 VAC 50/60 cy. appr. 90 Watts

Complete Receiver \$395 net

Matching spkr \$16.00

WRITE FOR BULLETIN RE-179



The **TECHNICAL
MATERIEL
CORPORATION**

IN CANADA:

TMC Canada, LTD.
OTTAWA, ONTARIO

MAMARONECK,
NEW YORK

SPECIAL "HI-FI" OFFER!

Amazing woven saran Hi-Fi Fabrics now available direct to every Hi-Fi enthusiast. Special yarns and constructions mean least distortion. In Mahogany, Walnut, or Blond at the special **INTRODUCTORY PRICE of \$3.19 Ppd.** per Sq. Yd. Money back guarantee. Send check or M.O. to **HI-FI FABRICS INST., P. O. Box 15, Huntington Station, N. Y.**

TRY THIS ONE

(Continued)

PRINTED-CIRCUIT KINK

I recently assembled an instrument kit using a printed-circuit board. The manual read: "bend and solder the tube sockets to foil pattern." But it didn't say what kind of tool to use to bend the socket lugs. The miniature socket lugs could not be bent over very far with even the smallest-nosed pliers I had on hand. I used wood tools and got perfect results.

First have a good solid, flat surface to rest the sockets on. Then, using a piece of wood 1/2 inch square and 8 inches long, bend each socket lug all the way down to the circuit board. When the lugs are lined up in their correct positions, take a 1 1/4-inch square piece of wood and push down all the lugs for a tight, uniform finish—then solder 'em.—*D. W. Frank*

AUTO ANTENNA TOOL

A simple tool makes it easy to tighten aerials on late-model Ford cars without scarring the paint or chrome nut. Take a piece of pipe 1 inch long and 1 1/4 inches in inside diameter. Saw two parallel cuts 1/4 inch deep and 1/8 inch apart across the center of one end. Bend in the tang on each side slightly and weld a handle to the side.—*Stanley Clark*

EMERGENCY CONTACT PLUG

There are times when the constructor, experimenter or ham needs a small male plug and matching receptacle with five, six, or seven pins. He is usually stumped until he can get to the local distributor or order one by mail. Here is a substitute.

Take a miniature tube socket, preferably one of the molded types, and insert in each prong hole a 1-inch length of No. 20 solid copper wire. Extend these wires until they go down through the socket. Solder the extruding ends to socket lugs, allowing sufficient solder to flow in and around wires where they extend through the prongs so that they are firmly held in place to form the male plug prongs. Trim and bend for proper alignment and insertion. You now have an emergency male plug that will pass for the best.—*George D. Philpott*

END



"My television toaster ejects the toast too high."

In Our **20**th Year of Service...
TO THE DEALER-SERVICEMAN, EXPERIMENTER, INDUSTRIALIST AND AMATEUR!

FREE 1956 CATALOG

Jam Packed With Bargains — Everything in Radio, TV and Hi-Fi — Over 15,000 Top-Quality Items.

WORLD RADIO LABORATORIES

"The World's Most Personalized Electronic Supply House!"

- Featuring:
- ★ Only 10% Down Payment
 - ★ Better Than Ever Trade-Ins
 - ★ Personalized Service
 - ★ Up to 50% Savings on Recond. Eqpt.



MAIL THIS COUPON TODAY...

WORLD RADIO LABORATORIES RE-4
3415 W. Broadway Council Bluffs, Iowa

PLEASE RUSH ME:

FREE 1956 CATALOG

LATEST RECONDITIONED EQPT. LIST

AND INFORMATION ON THE WRL TRANSMITTERS

NAME: _____

ADDRESS: _____

CITY & STATE: _____



Leo. I. Meyerson

See What's New in
ELECTRONICS
Radio • TV • High Fidelity



FREE!

Send for
NEWARK'S 1956 CATALOG

See the latest and finest equipment ever offered in High-Fidelity, Radio, TV, Amateur and Electronics. Select the fast, dependable way, from this new 260-page catalog.

NEWARK
ELECTRIC COMPANY

Dept. RE-4, 223 W. Madison, Chicago 6, Ill.

WEST COAST BRANCH
4736 W. Century Blvd., Inglewood, Calif.

WRITE FOR THIS

FREE

LIFETIME
HI-FIDELITY
Sales Kit

**DEALER SALES KIT
MAKE BIG
HI-FI PROFITS**

Sell the finest HI-FI Units for custom building or in BEAUTIFUL CABINETS... Sell **BELOW REGULAR WHOLESALE PRICES** with full dealer mark-up and with price protection.

TRANSVISION Hi-Fi Equipment is
SOLD THRU SELECTED DISTRIBUTORS

TRANSVISION, INC., NEW ROCHELLE, N. Y.
In Canada: 1338 Queen St. W., Toronto 3, Ont.

TRANSVISION, INC., New Rochelle, N. Y.

Rush FREE Dealer SALES KIT on HI-FI and name of nearest distributor.

Name _____
Address _____
City _____ State _____

People



Sidney Levy (left) was elected president of University Loudspeakers, Inc., White Plains, N. Y., and Arthur Blumenfeld (right), secretary-treasurer.



Both were co-founders of the company along with the late Irving Golin. Levy will continue as director of engineering, and Blumenfeld as director of production.

Ken Hathaway, manager of the Electronics Distributor Div. of Ward Leonard Electric Co., was elected treasurer of the Association of Electronic Parts & Equipment Manufacturers. He succeeds Helen Staniland Quam, of the Quam-Nichols Co.,



who resigned from the position after a 20-year term of office.

Russell A. Schlegel joined Weston Electrical Instrument Corp., Newark, N. J., as manager of industrial product sales. He was formerly with the Brown Instrument Div. of Minneapolis-Honeywell Regulator Co.



Frank M. Thomas was appointed manager of equipment development for the Electronics Div. of Sylvania Electric Products, Woburn, Mass. He had been manager of equipment engineering for Sylvania's Atomic Energy Div.



J. Warren Bosiger joined Seco Manufacturing Co., Minneapolis, Minn., as technical field representative. He has had wide experience in the sale and installation of industrial sound equipment and has done field



to
be

SURE!

buy
VOKAR

the original-
equipment
VIBRATOR



Leading manufacturers of original-equipment auto-radios specify Vokar vibrators as components for installation on the production-line. Why? They're sure Vokar quality never varies — will always contribute to top performance demanded of today's radios.

You too can depend on Vokar vibrators—for sure starts, longer life, silent operation. For all replacement jobs, buy Vokar Imperial or Quality Brand vibrators to be sure of satisfied customers.

Now is the time to stock up on 12-volt vibrators—**ONLY TWO VOKAR IMPERIALS ARE NEEDED TO FILL ALL REPLACEMENTS!**



VOKAR—preferred by leading manufacturers of auto-radios.

**VOKAR CORPORATION
DEXTER 2, MICHIGAN**

PUT THE HIGH IN HIGH FIDELITY!

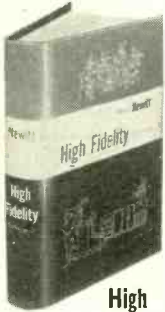

High Fidelity Techniques
by John H. Newitt

The book that says goodbye to guesswork in choosing, building and servicing hi-fi equipment.

512 pages
203 pictures

Whether you specialize in high fidelity service, custom building or simply want to build a top-notch outfit for yourself, this big 512-page book will guide you every step of the way.

Helps you get better results at less cost. Shows what to do . . . what mistakes to avoid. Gives you a full understanding of the many different methods, circuits, designs, equipment, components and other subjects that are debated whenever hi-fi fans get together.

A COMPLETE GUIDE TO BETTER RESULTS

Written by one of the nation's leading experts, High Fidelity Techniques is complete, authentic and easy to understand. From beginning to end, it is chock full of how-to-do-it tips, service hints, custom-building ideas, data, charts and diagrams of the most helpful sort.

10-DAY FREE EXAMINATION!

Dept. RE-46, RINEHART & CO., INC.
232 Madison Ave., New York 16, N.Y.

Send HIGH FIDELITY TECHNIQUES for 10-day FREE EXAMINATION. If I like book, I will then promptly send \$7.50 (plus a few cents postage) in full payment. Otherwise, I will return book postpaid and owe you nothing!

Name

Address

City, Zone, State

OUTSIDE U.S.A.—Price \$8.00 cash with order only. Money back if book is returned in 10 days.



"It's the serviceman—
he forgot to bring a
JENSEN NEEDLE!"

PEOPLE

(Continued)

service and testing work in electronics for Service Engineers, Inc.

Allen B. Du Mont, Jr. was promoted to assistant to the manager of the Television Receiver Div. of Allen B. Du Mont Labs, Clifton, N. J. He was formerly New York State district manager for the division.



Obituaries

W. Le Roy (Roy) Marshall, assistant advertising manager of Remington Rand Div. of Sperry Rand Corp., at his home in Greenwich, Conn. For many years he had been director of advertising for the Victor Talking Machine Co. When that company was taken over by RCA in 1929, Marshall became the first general advertising manager of RCA Victor.

Edward Kleeman, a pioneer in the electronic parts distributing field and more recently associated with Carduner Sales Corp. and British Industries Corp.

March Fisher, manager of the Distribution Accessory Div. of Philco Corp., of a heart ailment at his home in Philadelphia, Pa.

Personnel Notes

. . . Allen E. Reed was elected treasurer of Raytheon Manufacturing Co., Waltham, Mass. In addition to his new position he will continue to serve as comptroller.

. . . J. C. Van Arsdell, assistant general manager of the Electronics Div. of Erie Resistor Corp., Erie, Pa., was promoted to manager of government sales and specifications and will also be in charge of military specifications for the company.

. . . John B. Jolly joined CBS-Hytron Danvers, Mass., as sales manager, semiconductor. He comes to the company from G-E where he had been New York district manager of semiconductor products.

. . . Samuel J. Childs was elected vice president and general manager of Weston Electrical Instrument Corp., Newark, N. J. He had been president of the Daystrom Furniture Div. Weston is an operating unit of Daystrom.

. . . Edward H. Shively joined Wind Turbine Co., West Chester, Pa., manufacturers of Trylon antenna towers and systems, as assistant chief engineer. He had formerly been a project engineer for RCA.

. . . George Silbert, Rek-O-Kut Co., was elected president of the Institute of High Fidelity Manufacturers Inc. Other officers include: vice president, Walter Jablon, Preso Recording Corp., and secretary-treasurer, Vinton K. Ulrich, David Bogen Co. **END**

Thumbs Down on CALL-BACKS

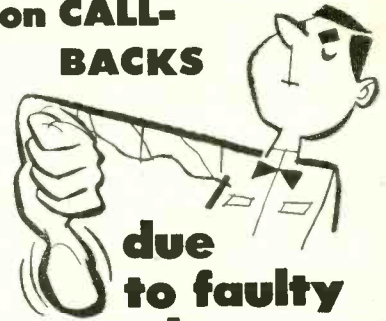

due to faulty replacements

Be Right with
OHMITE®
DEPENDABLE
RESISTANCE UNITS



Little Devil.

COMPOSITION RESISTORS

Meet all MIL-R-11A requirements. Rated at 70 C rather than 40 C. Available in 1/2, 1, and 2-watt sizes in all standard RETMA values.



BROWN DEVIL® RESISTORS

Vitreous enameled. Available in 5, 10, and 20-watt sizes.

TYPE AB POTENTIOMETERS

Resistance material is solid-molded. Noise-free. Rated at 2 watts.

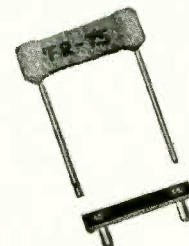

FR-7.5 FUSE RESISTOR

For easy replacement in all television receivers. 1 1/2" Tinned wired leads.

WRITE FOR STOCK CATALOG



OHMITE MANUFACTURING COMPANY
3646 Howard St., Skokie, Ill.
(Suburb of Chicago)

OHMITE®

RADIO-ELECTRONICS

OPPORTUNITY ADLETS

Rates—15c per word (including name, address and initials) Minimum ad 10 words. Cash must accompany all ads except those placed by accredited agencies. Discount, 10% for 12 consecutive issues. Misleading or objectionable ads not accepted. Copy for June issue must reach us before April 15, 1956.

RADIO-ELECTRONICS,
25 W. Broadway, New York 7, N. Y.

PROFITABLE Opportunity in Tape Recording. Free Information. **BARON'S,** L'Arden, Wash.

COMMUNITY TV's: Troubled with wet line losses? Converters and other cable equipment constructed to your requirements. **BLOOMINGROVE TV,** 1407 Bloomington Road, Williamsport, Penna.

475 Single and double contact, 60 cycles, 110 volt relays. Close out price. Box 2535, Tulsa, Okla.

UP TO 80% DISCOUNTS ON NAME BRANDS! Giant 100 page catalog. **BTS Products** Box 217, Oakland 14, N. J.

SPEAKER RECONING: Guaranteed workmanship. **C&M Recone Co.,** 255 Tioga St., Trenton 9, N. J.

TELEVISION Tuner Repairs. **DAN'S Television Laboratory,** 9 West 183rd St., N. Y. 53, N. Y.

1000 EMBOSSED BUSINESS CARDS \$2.95. **DECCO SPEEDY SERVICE,** FERGUSON, MO.

DIAGRAMS FOR REPAIRING RADIOS \$1.00. Television \$2.00. Give Make, Model. **Diagram Service,** Box 672-RE, Hartford 1, Conn.

\$20.00 RETURNS \$400.00. Lifetime Repeats. Sample \$1.00 Refundable. **EZEE,** Bayport 34, Mich.

U.S. CIVIL SERVICE TESTS! Training until appointed. Men—Women. 18-55. Start high as \$350.00 month. Many jobs open. **Quality NOW!** Get FREE 36-page illustrated book showing salaries, requirements, sample tests. **WRITE:** Franklin Institute, Dept. N-54, Rochester, N. Y.

TUBES—TV, RADIO, TRANSMITTING, AND SPECIAL PURPOSE TYPES BOUGHT, SOLD AND EXCHANGED. Send details to **R. E. Gensler W2LNI,** 512 Broadway, N. Y. 12, N. Y.

ALL MAKES OF ELECTRICAL INSTRUMENTS AND TESTING equipment repaired. Write for free catalogue on new and used instruments at a savings. **Hazleton Instrument Co.,** 128 Liberty Street, New York, N. Y.

TRADE IN TV SETS \$14 up. **JONES RADIO,** 1115 Rambler, Pottstown, Pa.

WANTED—Tuner for Firestone 13-G-33 Television. **IRA LEE,** Henagar, Ala.

TAPE RECORDERS, tapes; Wholesale prices. **KARSTAN,** 215 E. 88 St., New York 28, N. Y.

WANTED: AN/APR 4, other, "APR.", "TS-.", "IE-.", ARC-1, ARC-2, ART-13, B-348, etc. Microwave Equipment. Everything Surplus. Special tubes. Tee Manuals. Lab Quality Equipment. Meters. Fast Action. Fair Treatment. **Top Dollar! Littell,** Fairhills Box 26, Dayton 9, Ohio.

JAPAN DIRECTORY. 100 Japan exporters, plus opportunity mail. Just \$1.00 today. **NIPPON ANNAL,** 920-3rd Ave. Seattle 4, Wash.

BUY WHOLESALE. 25,000 Items. Catalog 25c. **Matthews,** 1472-17, Broadway, N. Y. C. 36.

DIAGRAMS: Professional Model Timers, Counters, Intercoms, Organs, etc. \$1.00 each. List free. **Parks,** 101 S.E. 57th, Portland 15, Oregon.

PRINTING—Letterheads, 6% envelopes, statements. 250 for \$2.50. Postpaid. **POOR BOY RE,** Box 1055, Little Rock, Ark.

RADIO, RADAR, TELEVISION instruction leading to Licenses. **Port Arthur (Texas) College.**

FOREIGN jobs list. Technicians needed. \$1. **RATHE,** Box 173, New Orleans 3, La.

MATCHBOX Radio. Make Yourself. Plans \$1.00. **RIDACRAFT,** 28 Cassius, New Haven 11, Conn.

REMAINS 25c. Imported Dutch viewcards 6 for \$1.00. **SCHAUT,** 619 Kamms, Mishawaka, Indiana.

FIDELITY UNLIMITED EXPANDS AND CHANGES ITS NAME TO SOUND MART UNLIMITED, INC. Increased stock and facilities to handle all your **FIDELITY** requirements. See ad below.

SOUND MART UNLIMITED, INC. AUTHORIZED DISTRIBUTORS OF BRAND NEW HI-FIDELITY COMPONENTS. SPECIAL: English Brenell DUAL-TRACK 3-speed 3-MOTOR TAPE DECK AND PRE-AMP. TRUE HI-FI. Frequency response: 30 to 15,000 cps at 15 ips. No clutches, idlers. Wow, Flutter minus .2% 115 VAC. Preamp with VU Meter. All inputs with 3 record curves. Separate Record and playback preamplifiers. **ONLY \$159.50 PREPAID.** Adaptable portable case, only \$5.00. **SPECIAL: TRUE CRAFTSMANSHIP FROM GERMANY. DEKAMIX 3 speed intermix changer.** Non-magnetic heavy turntable—Asynchronous 4 pole motor. Dual plug-in heads—muting switch—absolute **MINIMUM** wow and flutter. Complete with mtg board. \$39.75 **PREPAID. IMMEDIATE DELIVERY.** Full line of amplifiers, tuners, turntables, etc. Everything for prompt delivery. Write today for all hi-fi requirements: 63-03 39th Ave., Woodside 77, N. Y. Retail outlet only: 169A West 57th St., N. Y. C., opposite Carnegie Hall.

PRE-RECORDED tape for listening and dancing featuring Hammond Organ. 3" sample reel \$1.00. **TAPE TOUNS,** Dept. RE, Smithtown, N. Y.

TV FM ANTENNAS. ALL TYPES. Mounts, accessories. Lowest prices. **Wholesale Supply Co.,** Lunenburg 2, Mass.

Quickly locates "TOUGH DOGS" Senco Tube and Capacitor

Leakage Checker Model LC-2



Dealer Net
\$19.95
Kit

Complete with test leads. Simple to operate.

\$24.95 wired

"Two Testers In One"

Now—checks 70 critical tube types

- Quickly locates tubes with gas, grid to cathode or heater to cathode leakage, and grid emission in RF, IF and AGC Circuits.
- Only type tester that finds all tubes causing picture overload, low sensitivity, poor sync, etc.
- Checks all capacitors for leakage with voltage applied.

At Leading Distributors!
Mfg by **SERVICE INSTRUMENTS COMPANY**
171 OFFICIAL ROAD • ADDISON, ILL.

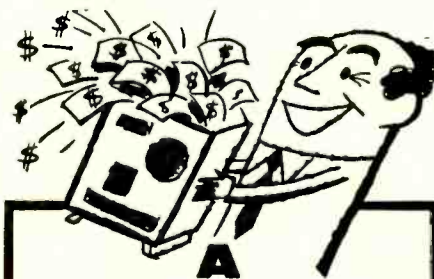

"DO-IT-YOURSELF KIT"...FOR MAKING MONEY!

Make money with the **UNIVERSITY "KwiKit"**, the speaker enclosure you assemble for your customers and profit 2 ways. Besides assembling the finest kit on the market, every kit leads to the sale of a speaker and components. Best of All—"KwiKit's" unique design enables you to take advantage of the wonderful selling features of P.S.E.—University's Progressive Speaker Expansion Plan for custom building.

Interested? For further information write to Desk B-6.

University LOUDSPEAKERS, INC.
80 So. Kensico Ave., White Plains, N. Y.

ANNIVERSARY SALE!

FREE! NEW ANNIVERSARY FLYER
PACKED WITH RARE BARGAINS

In Optics . . . Tools . . . Cameras . . . Electronics

★ ANY KIT FREE WITH \$10 ORDER!

★ FREE GIFT WITH EVERY ORDER!

- 60 TUBULAR CONDENSERS.** 25 values! .0005 to 0.1 mf., up to 6000V. Oils, too. Wt. 2 lbs. Reg. \$10 **\$1**
- 10 FP & TWIST ELECTROLYTICS.** Ass'd. to 1000 mfd. to 450V. Some multi-val. Wt. 2 lbs. Reg. \$12 **\$1**
- 1500 PCS. SPAGHETTI TUBING.** Ass'd. sizes, colors, lengths to 3 ft. Wt. 1/2 lb. Reg. \$7 **\$1**
- 8 PC NUTRIFIER KIT.** Plastic handle. 3/16, 7/32, 1/4, 5/16, 11/32, 3/8, 7/16" steel socket wrenches; plastic case. Wt. 1/2 lb. \$3.50 value **\$1**
- C.E. PREAMPLIFIER KIT.** Chassis, condensers, resistors, wire, socket, schematic (less 68C7 tube) for famous equalizer. Wt. 1 lb. Reg. \$4.50 **\$1**
- 2000 PCS HARDWARE.** Radio, TV, shop, wood-working screws, springs, trimmets, etc. Wt. 2 1/2 lbs. Reg. \$15 **\$1**
- 40 MOULDED CONDENSERS.** Best known makes. .0005 to 0.1 mf to 1000V. Wt. 1/2 lb. Reg. \$13 **\$1**
- 30 CERAMIC DISC CONDENSERS.** 5 mmf to .01 mf. to 3000V. TV repairmen note! Wt. 1/2 lb. Reg. \$13 **\$1**
- 8 TUBULAR ELECTROLYTICS.** Popular values to 450V. Top makes, axial leads. Wt. 1 lb. Reg. \$11 **\$1**
- 60 KNOBS.** Instrument, radio, TV types. Push-on & set screw types. Some 35c ea. Wt. 1 lb. Reg. \$9 **\$1**
- 10 PANEL SWITCHES.** Micro, car, momentary, push & rotary. Wire variety. Wt. 1 lb. Reg. \$12 **\$1**
- 3 LBS. HOOKUP WIRE.** Hundreds of pre-cut, tinned lengths, to 18". Ass'd. colors, sizes. \$1 stranding. Reg. \$10 **\$1**
- 20 POWER RESISTORS.** Wirewound. 25 values. 5 ohms to 12,000. 5 to 50 watts. Candohm, & tubular types. Wt. 2 lbs. **\$1**
- 60 MICA CONDENSERS.** Rare offer! Postage stamp types. 25 values. .00001 to .01; to 1200-VVDC. Many silver. 50¢ tool! Wt. 1/2 lb. Reg. \$21 **\$1**
- 125 CARBON RESISTORS.** 30 values; 100 ohms to 1 meg; 1/8, 1/4, 1 & 2W, Many 50¢. Uninsulated. Wt. 1 lb. Reg. \$21 **\$1**
- 50 RF COILS & CHOKES** and slug-tuned coils for TV, radio, lab. 20 types. **\$1**
- 12 VOLUME CONTROLS.** Handy shop-assist. of radio, TV, lab units. Some w/w. Wt. 1 lb. **\$1**
- 30 POPULAR BULBS.** Special! Wide variety standard miniature, screw and bayonet types. 1-1 thru 6V. \$4 value! **\$1**
- 12 LINE CORDS AC/DC** cords; molded plugs. For all electrical eqpt. Stock up now! Wt. 1 lb. **\$1**
- 100 COIL FORMS.** Experimenters, note! Wide variety of shapes & sizes. Ceramic and bakelite. **\$1**
- 60 CARBON RESISTORS.** Insulated; 93 values, 15 ohms to 10 meg. 1/2, 1 & 2W; 5% tool incl. famous Allen Bradley! **\$1**
- 7 PC MAGNETIC SCOPES.** modulated, micra, paper tubular condensers & carbon resistors. Mid. on term. strips. Wt. 2 lbs. **\$1**
- 25 TUBE SOCKETS.** Scoop! Chassis w/fit. 7 & 9-pin miniatures, 4 to 8-pins. Mica-filled & ceramic; shield base type. **\$1**
- 50 CERAMIC CONDENSERS.** Tubular, disc, button & standoffs! 5 to .01 mfd to 1000V. Wt. 1/2 lb. **\$1**
- 60 TERMINAL STRIPS.** Solder term. strips & boards. 2 to 9 lugs. Builders, note! Wt. 1/2 lb. **\$1**
- KNIFE & OIL STONE SET.** Wonderful gift or pick one up for yourself! 5 in 1 stag handle SCOUT knife, with pocket sharpening stone. Wt. 1 lb. **\$1**
- REMOTE CONTROL SCOOP!** Chassis w/fit. xfrm. 115 to 6.3V @ 1.5A; miniature 3000 ohm SPST relay; plus 12 condensers, resistors, sockets. **\$1**

Anniversary Sale Specials!

- ELECTRIC CLOCK AND TIMER**
Turns radio, TV, lights, etc. "ON" or "OFF" within 12 hours. Instructions included. Wt. 3 lbs. Reg. \$10 **SALE \$269**
- 0-100 microamp WESTON METER**
2 x 1 1/4" "see-thru" plastic case. Wt. only 2 oz. IN ORIG. BOXES. Reg. \$21 **SALE \$333**
- 110 VAC Potter-Brumfield RELAY**
Potter Brumfield MR-1A SPST with 8 ampere contacts. LIMITED QUANTITY! ORDER NOW! Reg. \$2.85 **SALE \$100**

HOW TO ORDER Check items wanted. Return entire ad with check or MO. Incl. sufficient Postage Excess returned. C.O.D. order 25% down. Rated. net 30 days. RE-4

Name _____
Street _____
City _____ Zone _____ State _____

Enclosed \$_____ for kits; \$_____ for postage.

Lektron Specialties

28 Gardener Street Chelsea 50, Mass.
Visit Our Showroom at 131 Everett Avenue, Chelsea.

let
THIS
be your
guide

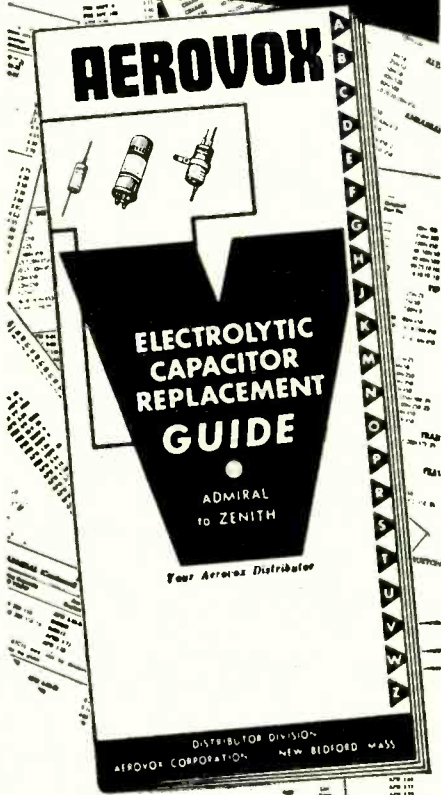

HERE IT IS!

A complete, up-to-date replacement guide for all electrolytic capacitors used in TV sets. Saves time, labor, money, on your service calls. In all cases, this Guide recommends only **ONE** unit replacement for any given Manufacturer's Part No.—not **TWO** units to replace **ONE**.

Ask your distributor for your copy. Or send 25c directly to...



AEROVOX CORPORATION

DISTRIBUTOR SALES DIVISION
NEW BEDFORD, MASS.

In Canada: AEROVOX CANADA LTD., Hamilton, Ont.
Export: Ad Auriemo, Inc., 89 Broad St., New York, N. Y.
Cable: Auriemo, N. Y.

Business



Merchandising and Promotion

Electro-Voice Inc., Buchanan, Mich., awarded first prize in its recent "Week-end With High Fidelity" contest to

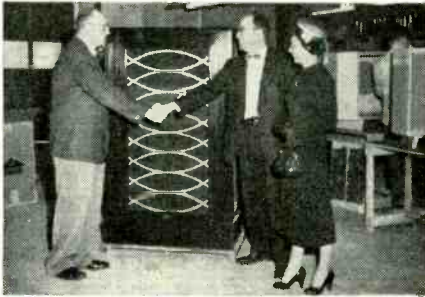

Frank F. Taylor, Roswell, N. M. The winner was awarded a high-fidelity system of his own choice and an all-expense-paid weekend trip for two to Buchanan, Mich. Howard Souther, marketing director (left), is shown congratulating Taylor at the Electro-Voice plant.

Sprague Products Co., North Adams, Mass., announced the winners in its sales improvement program contest. Winners include: George G. Schloss, Fischer Distributing Co., New York City, and Arthur B. Christopherson, Jr., Lay & Nord, Yakima, Wash.

RCA Tube Div., Harrison, N. J., awarded \$12,000 in prizes to winners of its recent *Silverama* aluminized picture-tube window-display contest for service technicians. Service technician winners in each of the eight regions were awarded a \$1,000 U. S. savings bond; \$500 bonds were presented to the distributor salesmen who verified the display and signed the winners' entry blanks.

JFD Manufacturing Co., Brooklyn, N. Y., designed a new display for its Zip Kit do-it-yourself antenna package.

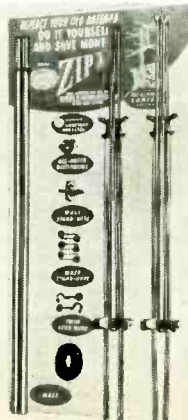

TOP PERFORMANCE

NORELCO
F.R.S. SERIES
FULL RESONANCE
TWIN-CONE
SPEAKERS

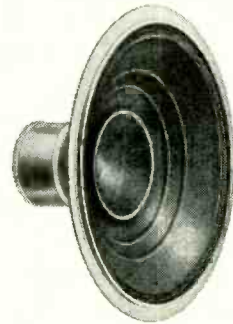

Philips of the Netherlands precision-built full resonance speakers are a special twin-cone design which provide energy transmission almost independent of frequency. Sound pressure within an angle of 90° does not vary by more than ± 6 db. in an ordinary room. Choice of coupling factor between high range and low range cones is responsible for the excellent spatial distribution of the acoustic energy even at highest frequencies.

This sample characteristic curve has been measured in an anechoic chamber without a baffle—and is far below the maximum performance characteristics possible. The low note reproduction will extend linearly down to the fundamental resonance of the speaker with a suitably dimensioned enclosure. Send for recommended enclosure specifications.

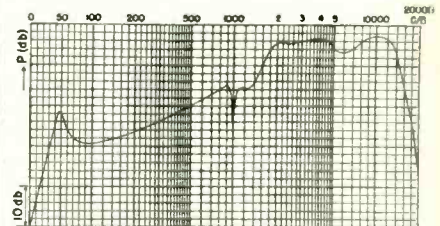

Speaker cones are specially designed to provide maximum resonance for each model. Voice coils are hand wound to assure adequate tension—maximum efficiency. Special alloy magnets provide high power and are individually aligned.

These are the same speakers used in Norelco radios, acclaimed the world over. They are now available to the trade. Speakers range from 12 to 5 inches in all standard impedances and are priced from \$59.98 to \$9.90 audio-ophile net.

ADD TO... and improve any sound system with **Norelco**®
*FULL RESONANCE SPEAKERS



Send to Dept. D4 today for more details

North American Philips Co., Inc.
100 E. 42nd Street
New York 17, N. Y.

STANLEY ELECTRONICS

TUBES & Parts

PAY LESS HERE!



BRAND NEW TUBES

- 26 1C6
- 29/44 1C7G
- 35/51 1D7G
- 1E7GT
- 1F4
- 2A7
- 19
- 33
- 49

STANDARD BRAND

so famous RE won't let us mention the name!

- no electrical or mechanical rejects
- no washed or rebranded tubes
- Bulk packed in original cartons in lots of 100 only

100 TUBES \$18

DUMONT and RCA LICENSED TV-PICTURE TUBES

• All brand new. One year guarantee. Discounts for the Quantity Purchaser. No Dud Required!

10 BP4	\$10.95	16 AP4	\$19.99
12 JP4	\$13.99	16 EP4	\$21.75
12 LP4	\$12.95	16 FP4	\$18.75
12 QP4	\$13.95	16 HP4	\$18.99
14 CP4	\$15.25	16 JP4	\$19.00
14 BP4	\$15.99	16 LP4	\$17.99
15 AP4	\$18.99	17 BP4	\$19.00
15 DP4	\$16.95	17 GP4	\$21.00
16 DP4	\$18.50	17 LP4	\$18.00
16 GP4	\$19.25	17 HP4	\$19.00
16 KP4	\$17.00	19 AP4	\$23.00
16 RP4	\$17.00	20 CP4	\$24.00
		21 ALP4A	\$24.00

write for Stanley's Tube & Parts Catalog

6" x 9" Rear Speaker Kit
Includes Mounting, grill, hardware, 3 way switch with speaker 6" x 9". List Price \$8.97. **\$5.25**

- 2 set TV coupler.....1.99
- Picture Tube Brightener.....1.09
- Indoor Antenna with brass dipoles. List Price \$7.95.....2.89

FREE!

- ★ Premium coupon with every order
- ★ Electric tester with every \$3 order.
- ★ Sylvania Repair Kit with every \$25 order.

TERMS: 25% deposit required on all orders. balance COD. Save COD charges send full remittance plus postage with order. All unused money refunded with order.

NO MINIMUM ORDER. SUBJECT TO PRIOR SALE.

Stanley ELECTRONICS corp.

935 MAIN AVENUE - PASSAIC, N. J.

Dept. RE4

Gregory 1-2498

Si vous lisez le francais technique, vous devez lire

ELECTRONIQUE INDUSTRIELLE

la grande revue francaise de technique moderne
Specimen gratuit sur demande

EDITIONS RADIO

9, rue Jacob — Paris 6° — France

BUSINESS

(Continued)

Service Instruments Co. (Senco), Addison, Ill., brought out a new four-color display board for its small service units.

General Electric Tube Dept., Schenectady, N. Y., launched a five-point promotion campaign for its radio and TV tubes, built around the "Circus of Values" theme. In addition to promoting tubes, the program suggests regular TV and radio tune-ups and seeks to establish participating service tech-



nicians as outstanding service centers in their area. The G-E Service Finance Plan for consumers is also stressed in the promotion. The photo shows John T. Thompson, G-E tube distributor sales manager, and Paul P. Wickman, G-E dealer products sales manager, as ring master.

Philco Corp., Philadelphia, will again sponsor TV and radio coverage of the Democratic and Republican conventions next August over the ABC networks. They will also sponsor presidential election returns in November over the same networks.

Channel Master Corp.'s Harold Harris, vice president in charge of sales and engineering, appeared over WOR,



New York, on the Ruby Mercer Mutual network radio show. The program was devoted entirely to a discussion of TV antennas.

Rogers Electronics Corp., New York City manufacturer of TV deflection components, is holding a series of technical service forums throughout the United States and Canada during the months of February through May, in cooperation with local parts jobbers.

Walsco Electronics Corp., Los Angeles, recently promoted its corner reflector antennas in the Milwaukee area with a special appeal toward improving reception on channel 19.

Pilot

brings to
HIGH FIDELITY
the
'All-On-One'

HF-56

**FM-AM TUNER
PHONO PREAMP
TONE CONTROLS
35-WATT AMPLIFIER**

**All components on
One chassis
for easy
Hi-Fi Installation**

HF-56 \$209.50

CABINET OPTIONAL

- Mahogany \$18.95
- Blond 19.95

prices slightly higher west of Rockies

At PILOT dealers, or send for complete details:

PILOT RADIO CORP. Dept. LD-6
37-06 36th St., L.I. C. 1, New York

Please send complete description of the new HF-56. I am also interested in the following literature.

- Pilot AM-FM Tuners
- Pilot Amplifiers
- Pilot Component-Console Systems

Name.....

Address.....

City.....Zone.....State.....

HERE'S HOW TO GET YOUR START IN RADIO ELECTRONICS

More experts
got their basic
training from this
big book than
any other
of its type!

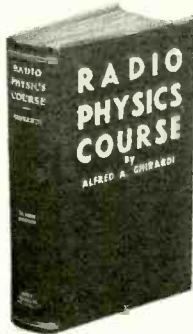

RADIO PHYSICS COURSE

by A. A. Ghirardi

Complete, basic training
for beginners

Here's basic training
you can really understand
... training that can help
fit you for a good pay
radio-television-electronic
career!

Ghirardi's RADIO
PHYSICS COURSE is
the oldest book of its kind
... and still a best seller
because it is so amazingly
clear and complete. Thou-
sands now in electronics
got their start from this
book—and they'll recom-
mend it to you today.

Starts with Basic Electricity (over 300 pages)
then takes you step by step through the entire ra-
dio-electronics field. Covers principles, theories
and practices that are basic to even the most mod-
ern equipment. 972 pages; 508 pictures, 856 helpful
self-review test questions. Price only \$6.50.

STUDY 10 DAYS FREE!

DEPT. RE-46, RINEHART & CO., INC.

232 Madison Ave., New York 16, N.Y.

Send Ghirardi's RADIO PHYSICS COURSE home-
training book for 10 days free examination. I will then
either return book promptly or send you \$6.50 plus
postage in full payment.

(Send \$6.50 with order and we pay postage. Same 10-
day money-back guarantee.)

Name

Address

City, Zone, State.....

OUTSIDE U.S.A.—\$7.25 each only. Money back if book
is returned in 10 days.

Rinehart Books are sold by leading book stores

SENSATIONAL

... is the word for the Miller
#595 NEGATIVE MUTUAL
COUPLED BROADCAST
BAND-PASS DIODE TUNER



Only 4" x 7" x 3 1/2" Deep

The most amazing High Fidelity Broadcast tuner ever
offered to music lovers anywhere. High Fidelity fans
will be pleasantly surprised with the tonal quality,
selectivity, and sensitivity of this marvelous tuner.
The frequency response is limited only by the audio
system used. Freq. Range 540 KC to 1700 KC.

A beautiful Black or Ivory bakelite cabinet houses the
tuner with a Richlow brass etched panel for the
escutcheon. Both combine to complement any decor.

Like all Miller products this #595 tuner is guaranteed
to perform to your satisfaction. Buy from your Radio and
TV Parts Distributor, or High Fidelity Dealer.



#595 Tuner net price only **\$19.50**
plus excise tax.

SEE YOUR DISTRIBUTOR FOR
LITERATURE OR WRITE DIRECT

J. W. MILLER COMPANY
5917 S. MAIN ST., LOS ANGELES 3, CALIF.

BUSINESS

(Continued)

Rohn Manufacturing Co., Bellevue,
Peoria, Ill., acquired a new tractor
trailer for delivering its towers. The



trailer also doubles as a sales display
at distributor and dealer "open houses"
and special events.

ORRadio Industries, Opelika, Ala.,
is offering dealers a self-service mer-



chandising unit for its *Irish Brand*
magnetic recording tape.

Electric Soldering Iron Co., Deep
River, Conn., designed a merchandising
counter display for its *Esico Luger*
soldering gun and its new service tech-
nician's kit of six tips.

G-C Electronics Manufacturing Co.,
Rockford, Ill., a division of General Ce-
ment Manufacturing Co., is offering



purchasers of its carbon resistors one
extra package free with each purchase
to introduce its new *GC-60* line of
packaged *Stackpole* carbon resistors.
The offer is good for a limited time
only.

Production and Sales

RETMA reported that the production
of 7,756,521 TV receivers during 1955
set a new record. Radio production of
14,894,695 was the highest since the
record year, 1948. The association also
noted that manufacturers' sales of 10-
874,234 TV picture tubes and 479,802-
000 receiving tubes during 1955 also set
a record. END

Hi-Fi record reproduction requires a PRECISION turntable...

THE NEW PRESTO

Pirouette
T-18

MADE BY THE WORLD'S LARGEST MAKER
OF PRECISION RECORDING EQUIPMENT

- Improves record performance tremen-
dously...delivers professional broadcast
quality!
- Simple operation—a sideways flick of the
control lever selects 3 speeds—33 1/3, 45,
78 rpm.
- Quiet insured! Precision deep-well turn-
table bearing.
- Quality plus! Extra heavy weight, cast
aluminum 12-inch turntable covered
with non-slip cork.
- Beautiful design—smart telephone black
and brushed chrome finish.
- Easy to install...only rectangular cut-
out needed. Easy to buy at only \$53.50.



Revolutionary 3-Speed Mechanism

The Pirouette embodies the ex-
clusive PRESTO "flick shift" speed
mechanism, with 3 idler wheels
mounted on a single movable plate. Insures
professional speed accuracy and trouble-free
performance.



Presto Pirouette T-18H Turntable
The history-making T-18 with
hysteresis motor...a magnifi-
cent hi-fi instrument. \$108.



Presto Pirouette T-68 Turntable
The 16" version of PRESTO's
flick-shift T-18...for homes with
fine hi-fi collections. \$79.50.



Presto Pirouette T-68H Turntable
A 16" flick-shift turntable with
hysteresis motor...a new pin-
nacle in hi-fi. \$134.

Send this coupon for more information →

PRESTO RECORDING
CORPORATION
Paramus, New Jersey

Export Division: 25 Warren Street, New York 7, N.Y.

Canadian Division: Instantaneous Recording Service, 42 Lombard Street, Toronto

PRESTO RECORDING CORP
Hi-Fi Sales Division, Dept. RE 456
Paramus, New Jersey
Rush catalog sheets on the new PRESTO
Pirouette T-18, T-18H, T-68, T-68H
turntables and name of nearest PRESTO
distributor.
Name _____
Address _____
City _____ Zone _____
State _____

limitless

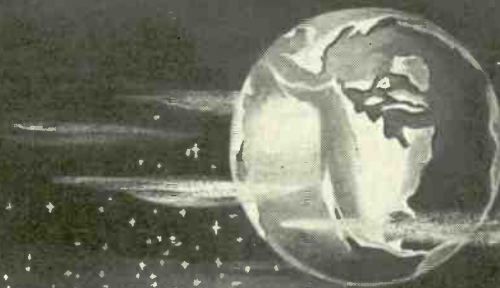

as the future of UNIVAC[®]

When planning your future, it is necessary to choose that company which presents the most complete program for you. The opportunity at Remington Rand Univac can only be limited by the individual. Excellent salaries, benefits and educational programs are yours to guarantee this limitless future.

At UNIVAC you will be working with men who developed much of the basic knowledge of computers—who designed and produced components being used by the manufacturers in the field—who set the standards that the others follow.

Now is the time to come to Univac where ambition and professional skill find their reward in limitless opportunities in an expanding organization.

Immediate openings for:

FIELD LOCATION ENGINEERS with a college degree in a scientific or engineering field and experience in electronics. Extensive electronic background may substitute for some college. Many opportunities for rapid advancement.

FIELD LOCATION TECHNICIANS Technical school background and preferably some experience in electronics. These positions can lead to full engineering responsibility.

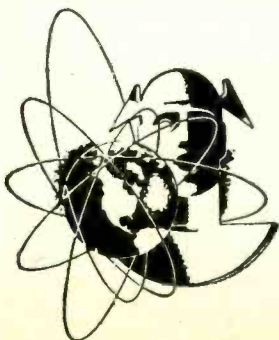

Send complete resumé to

Remington Rand Univac

DIVISION OF SPERRY RAND CORPORATION

AT ANY ONE OF THESE THREE PLANT LOCATIONS

MR. D. A. BOWDOIN
Dept. AP-10
2300 W. Allegheny Ave.
Philadelphia, Pa.

MR. KURT PINKE
Dept. AS-10
1902 W. Minnehaha Ave.
St. Paul W4, Minn.

MR. FRANK KING
Dept. AN-10
Wilson Avenue
South Norwalk, Conn.

© Registered in U. S. Patent Office

STAN-BURN ELECTRONICS

CATHODE RAY TUBE SPECIALS ONE YEAR GUARANTEE

G.E. Type	STAN-BURN	G.E. Type	STAN-BURN
\$13.25 10BP4	\$10.20	\$31.25 17GP4	\$20.75
18.00 10FP4	14.00	32.25 19AP4A	22.50
16.25 12LP4A	13.95	27.40 20CP4	18.95
12QP4	10.50	33.00 21AP4	22.25
28.95 12UP4	14.50	27.40 21EP4	20.15
18.15 14CP4	13.40	33.25 21MP4	23.50
15.00 15DP4	14.50	30.75 21AP4	19.00
31.25 16AP4A	16.00	DUMONT TUBES	
26.25 16KP4	15.75	12QP4A	\$23.75
31.25 16GP4	18.50	15DP4	26.55
29.00 16LP4	15.25	16DP4A	31.00
29.00 16WP4	15.25	16FP4	26.00
22.50 17BP4	15.75	17KP4	25.00
28.15 17CP4	19.50	18AP4/B	33.25
		21KP4	38.50

PRICES SUBJECT TO CHANGE WITHOUT NOTICE.
\$20 WORTH OF ELECTRONIC PARTS IN GRAB-BAG consisting of: Porcelain sockets, coils, speaker, transformers, resistors, condensers, etc.
ONLY \$1.98 (plus 50c postage)

NEW G.E. PHONO CARTRIDGES G.E. ORIGINAL BOXED

RPX050A .001 and .003 (SS)	\$ 6.78
RPX052 Golden Treasure (DS)	19.38
RPX053A Golden Treasure (DD)	28.08
RPX040A .003 Single (S)	5.09
RPX041A .001 Single (S)	5.09
RPJ010A Dual (S) .001 and .003	1.95
RPJ012A Dual (D) .001 and .003	18.43
RPJ013A Dual (DS) .001 and .003	10.66
RPJ014 or RPJ015 Dual (D)	9.53
RPJ015 or RPJ035 Single (S)	1.29
Replacement styli for RPX040 & 041 only.	
RPJ001 or RPJ005 Single (S) G.E.	1.29
RPJ003 or RPJ004 Single (S)	9.53
VM 3 SPEED HI-FI CHANGER—Model 950 with Ronette Sonotone or Astatic flipover cartridge—BRAND NEW ORIGINAL CARTONS	\$21.49
WEBSTER Model 140—3-SPEED Automatic with Ronette Sonotone or Astatic flip-over cartridge	\$22.49
MONARCH 3 SPEED AUTO. INTERMIX CHANGER with crystal cartridge	\$21.95
Same with British variable reluctance	24.95
45 RPM SPINDLE	1.88
TU-8 MONARCH 3 Speed MOTOR	4.95
TURNABLE UNIT (less arm)	\$ 4.95
RECORDING TAPE—Top quality—Famous brands—BOXED 1 to 5—\$1.69 ea. 6 to 11 \$1.59 ea. 12 or more \$1.49 ea.	

HALLICRAFTERS TV

Model 177S700M—Table Model—Dealers net.....\$88.95
Model 21TS460M—Table Model—Dealers net.....129.46

ANTENNA ACCESSORIES

P-800 JFD DOUBLE "V" ant., box of 10.....ea	\$ 1.39
FLASH-DOUBLE "V" lightning arrest.....ea	2.09
Box of 12	
REGO-DYNAMIC BALL, SW/TYPE INDOOR Ant.	2.69
RMS-SW/TYPE INDOOR Ant. List 9.95.....ea	2.19
10' ALUMINUM MASTS.....ea	1.19
5' SWEGED MASTS.....ea	.69
10 ELEMENT MONARCH.....ea	2.19
ZIP 5 JFD 10 ELEMENT CONICAL.....ea	2.39
ZIP 2 JFD 8 ELEMENT CONICAL.....ea	2.19
SPICO 5-8 INDOOR RABBIT EARS Ant.....ea	1.19
JFD TA141 INDOOR RABBIT EARS Ant.....ea	1.19
JFD TA144 INDOOR RABBIT EARS Ant.....ea	1.29
55 MILL 300 OHM WIRE—1000 Feet.....ea	8.95
80 MILL 300 OHM WIRE—1000 Feet.....ea	12.45
100 MILL 300 OHM WIRE—1000 Feet.....ea	13.99

NEW! EICO 20 WATT HIGH FIDELITY AMPLIFIER #20

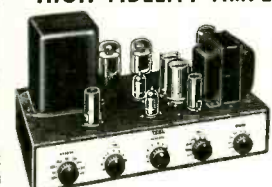

"The Score"
KIT \$45.95
Factory Wired \$79.95

SPECIF: Rated Power Output: 20 watts (34 watt-peak), IM Distortion: (60 cps: 6 kc/4:1) at rated power: 0.3%, Mid-Band Harmonic Distortion at rated power: 0.3%, Maximum Harmonic Distortion between 20 cps & 20,000 cps at 1 db under rated power: approx. 1%
Freq. Response at rated power: —0.5 db 20 to 20,000 cps. Speaker Connections Taps: 4, 8 and 16 ohms.
(For limited time only, all EICO shipments prepaid)
We handle complete EICO line. See ad on pages 31 & 32.

DEALERS: Write for low cost prices and catalogs on '56 models—HALLICRAFTERS, CRESCENT, FANNON, SONORA, WILCOX-GAY, TECHMASTER, G.E., WESTINGHOUSE, TUNG-SOL, DEWALD, MAJESTIC, GRUNDIG, ARKAY KITS, CAPENART, O'LEO, GEN-MOTORS. Address all inquiries to Dept. RE-4.

Our High Fidelity department will promptly quote on any item in the Hi-Fi field. Send us your list for our lowest quotations.

We invite export inquiries and offers. Our export department will give special attention to expediting foreign orders at minimum commissions. We are authorized distributors for United Motors, all Delco and Gen. Motors Auto Radio parts in stock. We also carry a complete line of popular makes of Radio Tubes at 50% discount. Also many other special purpose and transmitting types and all electronic parts and equipment at lowest prices. Send us a list of your requirements for prompt quotations. Terms: 20% with order. Balance C.O.D. All prices F.O.B. NEW YORK Warehouse. Minimum order \$5.00. Write for our latest Price list and Hi-Fi Catalog RE-4

STAN-BURN RADIO and ELECTRONICS CO.
558 CONEY ISLAND AVE. • B'KLYN 18, N. Y.

technical Literature

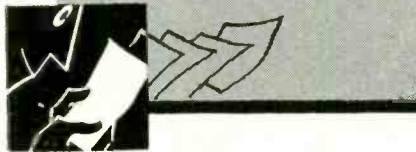

SOUND SYSTEMS

What You Should Know About Sound Systems is a 24-page reprint of a series of three informative articles covering the fundamentals of sound systems operation and installation. It was prepared for those with little previous knowledge of sound and clearly presents basic facts on amplifiers, microphones, speakers, impedance matching and the selection and installation of sound equipment.

David Bogen Co. Inc., 29 Ninth Ave., New York 14, N. Y.

Any or all of these catalogs, bulletins, or periodicals are available to you on request direct to the manufacturers, whose addresses are listed at the end of each item. Use your letterhead—do not use postcards. To facilitate identification, mention the issue and page of RADIO-ELECTRONICS on which the item appears. UNLESS OTHERWISE STATED, ALL ITEMS ARE GRATIS. ALL LITERATURE OFFERS ARE VOID AFTER SIX MONTHS.

REPLACEMENT CAPACITORS

Sprague's new *Auto Radio Replacement Capacitor Manual K-300* provides complete information on every auto radio manufactured from 1946 through 1955. Each brand is listed alphabetically and the proper Sprague *Twist-Lok* electrolytic capacitors are then fully described in terms of capacitance, voltage rating, and list price and cross-referenced to the original part numbers. The booklet measures 5½ x 8½ inches and can be carried in the pocket or tool kit or hung from a hook or nail by a hole in the upper left corner.

Sprague distributors or Sprague Products Co., 81 Marshall St., North Adams, Mass.

NEEDLE CATALOG

Catalog No. 53 illustrates and describes conventional, replacement and cutting needles. It also contains information on antistatic record cloth.

Jensen's Needle Wall Chart contains data on high-fidelity needles.

Jensen Industries Inc., 7333 W. Harrison St., Forest Park, Ill.

TAPE RECORDERS

Ampex series 800 multichannel magnetic tape recorders are described and illustrated in an 8-page bulletin.

Ampex Corp., 934 Carter St., Redwood City, Calif.

CHART AND GUIDE

Sylvania's *TV Picture-Tube Comparison Chart*, newly revised and brought up to date, lists over 170 picture-tube types. It also includes ion-trap listings, focus, deflection and base

DYNAKIT

50 WATT POWER AMPLIFIER KIT



✓ FINEST QUALITY

New circuit designed by David Hafler using the Dynaco A-430 output transformer, sets new performance standards both on the test bench and in listening tests.

✓ EASIEST TO ASSEMBLE

Uses pre-assembled printed circuit board and simple physical arrangement. Only 9" x 9" x 6½" high without sacrifice of performance, and can be assembled in 3 hours.

✓ HIGHEST POWER

50 watts at less than 1% IM for listening ease. 100 watts peak. Full power available 20 cps to 20 kc.

✓ GREATEST VALUE

\$69.75 complete with all top quality components.

Complete specifications and circuitry on this new amplifier kit are available on request.

DYNA COMPANY

Dept. RE, 5142 Master St., Phila. 31, Pa.

Grips the screw!
Drives it too!

**Quick-Wedge
SCREW-HOLDING
SCREWDRIVER**

2" to 14" blades, 4 bit sizes
Unconditionally Guaranteed

ASK FOR IT AT YOUR DEALER
Kedman Co., 233 So. 5th W., Salt Lake City

TECHNICAL LITERATURE (Continued)

diagrams. Face, body, basings and length in inches of all tubes are also included.

Sylvania's *TV Tube Selector Guide* contains much the same information as the wall chart but in a pocket-sized edition.

Sylvania Central Advertising Distribution Dept., 1100 Main St., Buffalo, N. Y.

HI-FI CATALOG

Cabinart's 1956 catalog contains 34 pages of data on hi-fi equipment cabinets, cabinet kits, speaker enclosures and enclosure kits, multiple-unit speaker systems and furniture hardware and accessories for the hi-fi enthusiast.

Cabinart, 99 N. 11th St., Brooklyn 11, N. Y.

TEST EQUIPMENT

Bulletin 3001 gives data on test equipment for servicing refrigeration, air conditioning, heating equipment and appliances.

Bulletin A-103 is a double-sided flyer featuring Simpson's new model 458 7-inch *Colorscope* and model 434 *Vari-dot* white dot generator. It contains pictures of these instruments along with specifications and information concerning proper usage.

Simpson Electric Co., 5200 W. Kinzie St., Chicago 44, Ill.

RIDER CATALOG

A new fall-winter 1955-56 catalog lists and describes all Rider books on electronics, television, high fidelity, radio, electricity and related technical sciences.

John F. Rider, Publisher, Inc., 480 Canal St., New York 13, N. Y.

TUBE BOOKLETS

RCA's booklet *Interchangeability Directory of Industrial Type Electron Tubes, Form 1D-1020A*, lists 2,000 tube designations. The 16-page booklet includes vacuum power tubes, vacuum and gas rectifiers, thyratrons, ignitrons, magnetrons, cold-cathode (glow-discharge) tubes, phototubes and oscilloscope, camera and receiving type tubes for industry and communications.

RCA Picture-Tube Replacement Directory, Form KB106, is divided into two parts. The first section of the 16-page booklet lists the ratings and characteristics of 60 existing picture-tube types including the 15GP22 and 21AXP22 color tubes, and 13 discontinued RCA types. The second section lists recommended RCA replacements for more than 150 industry types.

RCA Photosensitive Devices and Cathode-Ray Tubes, Form CRPD-105, contains 24 pages of technical data on 45 types of phototubes, 6 TV camera and 56 cathode-ray tubes. Each is covered by a text description, tabular data and a socket-connection diagram. Representative units are illustrated throughout the catalog.

RCA tube distributors or Commercial Engineering, RCA Tube Div., Harrison, N. J.; 20¢ each. END

NO FREE GIFTS! NO COUPONS! EXCEPT THE

LOWEST TUBE PRICES

BRAND NEW
famous make
PICTURE TUBES
DUMONT and RCA
licensed
One Year Guarantee
In original factory sealed carton
PRescott 3-0330

NO REPLACEMENT DUD REQUIRED

10 BP4	\$10.95	16 EP4	\$21.75
12 JP4	\$13.99	16 FP4	\$18.75
12 LP4	\$12.95	16 HP4	\$18.99
12 QP4	\$13.95	16 JP4	\$19.00
14 CP4	\$15.25	16 LP4	\$17.99
14 BB4	\$15.99	17 BP4	\$19.00
15 AP4	\$18.99	17 GP4	\$21.00
15 DP4	\$16.95	17 LP4	\$18.00
16 DP4	\$18.50	17 HP4	\$19.00
16 GP4	\$19.25	19 AP4	\$23.00
16 KP4	\$17.00	20 CP4	\$24.00
16 RP4	\$17.00	21 ALP4A	\$24.00
16 AP4	\$19.99		

F.O.B. Passaic, N. J. . . Subject to prior sale. Write for complete tube listing, including Special Purpose and Transmitter tubes.

TUBE MART

The Lokpet Bldg. Passaic, N. J. **DISCOUNT HOUSE**

NEW! For the First Time!

CHECK CAPACITORS UNDER WORKING CONDITIONS!

TEST CONDENSERS IN THE SET!



Satisfaction GUARANTEED OR RETURN WITHIN TEN DAYS FOR REFUND

CAPACITEST

Quickly, Accurately checks:

- PAPER, MICA, CERAMIC CAPACITORS
- ELECTROLYTICS
- CONTINUITY
- AC/DC VOLTAGES
- FLASHBULBS

\$9.95 postpaid Dlr. Net complete, ready for operation

NOT A KIT

FREE Special Introductory Offer for limited time only: Set of test leads—Free with each CAPACITEST. Order direct from manufacturer—include \$3 deposit with C.O.D.'s. Save PP & COD fees, send \$9.95 & we'll pay postage.

Compact: 4"x4"x2"—lightweight, for bench or tool kit.

BAR JAY The Barjay Co. 145 West 40 Street New York 18, N.Y.

BROKEN LEG

IN YOUR ANTENNA LEAD-IN?

BREAK-UP IN PICTURES? SNOWY PICTURES? THEN GET THE NEW CENTURY ALC-2 ANTENNA LINE CHECK



- The ONLY instrument available for this purpose
- Completely self-contained
- Checks antenna lines for breaks in either leg from inside the house
- Locates under-insulation breaks in seconds
- Determines EXACT location of the break if repair is desired

The ALC-2 is simple to use, just disconnect the antenna line from the set and connect it to the test leads of the ALC-2. The balanced bridge and magic eye indicator gives you complete information no other instrument can. With installations getting older this check should be the first one made.

10 DAY FREE TRIAL—PAY AS YOU EARN

FREE BONUS ONLY \$19.95

Order now and receive a handy valuable booklet listing radio and TV tubes (incl. CRT) which can be substituted with NO WIRING CHANGES. Another profit maker.

CENTURY ELECTRONICS CO., Dept. RN-4
111 Roosevelt Avenue, Mineola, N. Y.

Enclosed is \$5.00 down payment. Please send me your ANTENNA LINE CHECK ALC-2. After 10 days, if not completely satisfied, I will return it for a refund—Or I will send \$5.00 a month until the full price of \$19.95 plus postage is paid.

Name _____
Address _____
City _____ State _____

SAVE SHIPPING CHARGES! Enclose \$19.95 with this order then we pay the shipping costs. Same return and refund privileges.

Century Electronics Co. inc.
Manufacturers of Electronic Equipment
MINEOLA, NEW YORK



ARKAY KITS

LABORATORY TESTED



Arkay FM-AM Tuner Kit

7 tube circuit plus selenium rectifier includes separate mixer and Oscillator stages, 3 double tuned IF stages with Foster-Seeley discriminator and grounded grid amplifier for excellent response characteristics:

Sensitivity & Selectivity—FM 5uv for 30db quieting, 200 kc bandwidth 6db down. AM 25uv with 8 kc bandwidth 6db down.

Frequency response —
 FM \pm .5db 20-20,000 cps
 AM \pm 3db 20-5000 cps
 Image rejection —30db minimum
 Hum Level — -65db

AFC control and defeat. \$29.95

Available in FM only. Model FM6

\$23.95

Write for technical information on this model.

Arkay FL-10 High Fidelity Amplifier Pre-Amp Kit;
 Williamson Type Ultra-linear

pushpull 12 watt output; frequency response \pm 2db 20-20,000 cps with extremely low IM and Harmonic distortion; 5 position input selector with record equalizer; loudness, bass, and treble controls; tapped output; extremely low noise level; completely enclosed—no cabinet problem; for clean, flexible, brilliant audio.



\$28.95

Arkay A-12 High Fidelity Amplifier Kit
 Featuring

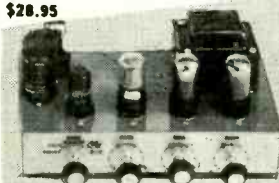

12 watt output—push pull 6V6's; frequency response \pm 1db 20-20,000 cps with low distortion; 5 inputs, master controlled at front panel; tapped output transformer; separate bass and treble control, each with maximum db boost and cut; built-in Pre-Amplifier; ideal for home installations.

\$22.95

Amazing Miniature Radio

Featuring a superheterodyne circuit and hearing aid type ear piece, this radio kit, which has set the industry talking, receives the full AM band. 3 tube circuit brings in all stations clear as a bell and its plastic case measures only 5/8" x 3/4" x 1" as small as a pocket book.



\$12.95

OTHER KITS IN THE ARKAY LINE

- Television Kits
- Testing Equipment • Phonographs
- Audio Amplifiers • Geiger Counters
- Experimenters Equipment • Radios

Visit your local distributor for these wonderful kits and write today for the special FREE Radio Kits Catalogue and list of dealers. Your copy will be sent by return mail with no obligation. Write to

Radio Kits Inc., Dept. R-12
 120 Cedar Street New York

Books

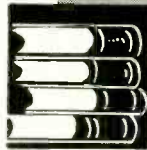

ELEMENTS OF ELECTRONICS, by Henry V. Hickey and William M. Villines. McGraw-Hill Book Co., 330 W. 42nd St., New York 36, N. Y. 487 pages. \$6.50.

Beginning with the molecular structure of matter, the authors cover basic electricity and electronics and include all information the reader needs to construct a simple transmitter or receiver. Mathematics, in the style of Cooke's *Mathematics for Electricians and Radiomen*, is carefully worked into the text as needed. Especially suited for beginners at an intermediate high-school level, the book is equally useful to students in technical schools and junior colleges. Review questions, chapter summaries and problems are included.

PROCEEDINGS OF THE SYMPOSIUM ON PRINTED CIRCUITS sponsored by Radio-Electronics-Television Manufacturers Association, with participation of IRE. Engineering Publishers, GPO Box 1151, New York 1, N. Y. 8 1/2 x 11 inches, 122 pages. \$5.

This up-to-date coverage of all phases of printed circuits contains over 25 papers by authorities.

One article considers the problems of converting an a.c.—d.c. receiver to printed-circuit design. Another tells of progress in England (where printed circuits originated). Other papers compare labor and parts costs as between conventional and printed wiring, inquire into production techniques, reliability, etc.

Many "before and after" photos show the simplifications and space saving that result from printed processes.—IQ

TELEVISION SIMPLIFIED, 5th Edition, by Milton S. Kiver. D. Van Nostrand Co., Inc., New York, N. Y. 6 x 9 inches, 541 pages. \$6.75.

A new edition of the well-known practical manual, written especially for technicians and maintenance personnel, this book is complete in itself. Starting with elementary ideas on TV, circuits, antennas and uhf, it proceeds to more advanced topics and more comprehensive discussions. There are separate chapters on detectors, if amplifiers, deflection, synchronization, FM, etc., so the reader may quickly locate information on the subject he needs. Two television receivers are completely analyzed as to circuit function and alignment. One is an intercarrier type, the other has separate sight-sound channels. Test and repair of TV circuits is covered in detail in another chapter.

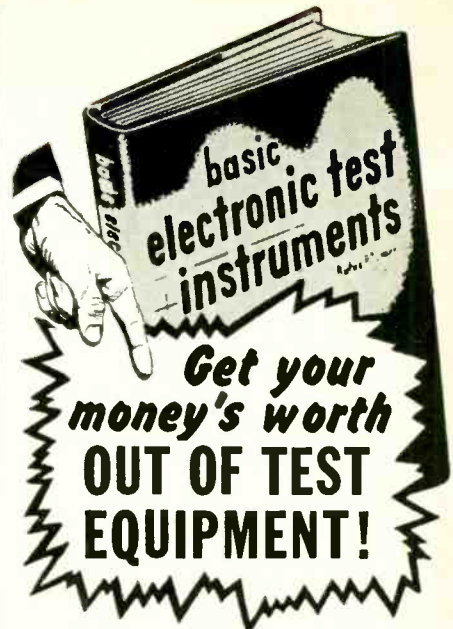

WORK BETTER, FASTER WITH FEWER INSTRUMENTS!

No sooner do you buy one new test instrument than another type comes along that is said to be even better and more useful. You soon realize you've got to draw the line somewhere!

The answer is to really learn about instruments . . . to KNOW exactly what each type CAN and CANNOT do. Actually, you can do first class work with only a few basic instruments. You can save hundreds of dollars by learning to use old instruments more fully.

Remember! It isn't so much the instruments you use . . . it's the instrument "KNOW HOW" that counts! And that's where this famous book can be worth its weight in gold!

GET MORE WORK OUT OF YOUR OLD INSTRUMENTS

BASIC ELECTRONIC TEST INSTRUMENTS by Rufus Turner covers instruments and test equipment from a practical, on-the-job standpoint. No useless theory! In 255 pages and with more than 170 illustrations it shows you how to select the right instruments and how to use them on all kinds of jobs.

It shows how to modernize old types and use them in new ways. It helps you avoid buying unnecessary instruments; teaches you work-saving testing short cuts; shows how to evaluate instrument readings fast and accurately.

COMPLETE WORKING DATA ON OVER 60 INSTRUMENT TYPES

Over 60 types . . . from the latest TV sweep, marker and linearity pattern generators to grid-dip oscillators, special purpose bridges and all the old standbys from V-O-M's and signal generators to oscilloscopes and dozens more . . . are fully covered.

Written especially for servicemen, students, amateurs and experimenters, **BASIC ELECTRONIC TEST INSTRUMENTS** is the only book of its kind. It saves you money . . . helps you earn more money! Price only \$4.00 (\$4.50 outside U.S.A.)

10-DAY FREE TRIAL

- Dept. RE-46, Rinehart & Co., Inc.
- 232 Madison Ave., New York 16, N.Y.
- Send Turner's 255-page **BASIC ELECTRONIC TEST INSTRUMENTS** book for 10-day **FREE EXAMINATION**. If I decide to keep book, I will return \$4.00 plus postage. Otherwise, I will return book postpaid promptly and owe you nothing.
- (Send \$4.00 with order and we pay postage.)
- Same money-back guarantee.

Name.....
 Address.....
 City, Zone, State.....
 OUTSIDE U.S.A.—Price \$4.50 cash only. Money back if book is returned in 10 days.
 Rinehart Books are sold by leading book stores

An important feature of this edition is the rewritten chapter on color. Here, also a typical received is completely described and analyzed.—IQ

RADIO SERVICING COURSE, compiled by M. N. Beitman. Supreme Publications, 1760 Balsam Road, Highland Park, Ill. 8½ x 10½ inches, 192 pages. \$2.50.

Making no pretenses at being anything but an elementary radio servicing course for beginners, this text covers the many things a novice service technician should know. It contains 22 lessons starting with the fundamentals of electricity and ending with a discussion of the problems of the radio service business.

At some points, an experienced reader may note that some of the illustrations are obsolete—a type 37 tube as a B supply rectifier in a vtvm or 6C6's as deflection amplifiers in an oscilloscope diagram.

Particularly helpful to the beginner are the many photographic illustrations showing the physical appearance of virtually every component used in present-day radios. These are supplemented by numerous diagrams, charts and a comprehensive tube-manual insert. Chapters on test equipment and servicing round out the contents of the book.—JK

OUR MODERN ELECTRONIC WORLD, by Leslie L. Tirrell. Pageant Press, Inc., 130 W. 42nd St., New York 36, N. Y. 5½ x 9 inches, 237 pages. \$3.50.

Its title seems to indicate a book on electronic devices and its first chapter reads like science fiction, but actually this is a presentation of new theories which contradict most present-day ideas. The author, a manufacturer and inventor, believes that electrons pervade all space and that they are responsible for sound, magnetism, gravitation, radio and other transmission of force. Furthermore, the particles may be positive or negative (depending on temperature). They may expand, be heated, magnetized, ionized, etc.

The first chapter is an interesting account of experiments with a nearly perfect vacuum. It is found that its weight varies with barometric pressure, and the author feels that this is due to infiltration of electrons through the glass bulb. Neither the patent office nor scientists agreed with this idea.

The author disagrees with modern scientific ideas, their concentration on effects rather than causes. Clearly he prefers a "real" mechanical universe rather than one based on mathematical theory. Thus we find statements that will appear strange to readers who have studied science. For example, in describing a vacuum tube we read: "As positive electrons are more active and reluctant in flowing in conductors, leaks occur in the grid and conduits within the vacuum tube which are picked up by coating the inner surface of the tube with an element."—IQ END

terrific TV antenna values at Concord

8-element VEE-D-X "long john" yagi
 Delta Match!
\$7.95 net **LOTS OF 3 \$7.49 ea.**
 Reg. \$18.50

A. High front-to-back ratio provides high gain for fringe areas. Full 6 mc. band width. Rugged boom bracing for extra strength. Chan. 8, 9, 10; Specify Chan.. Wt. 6 lbs. Stock #99-T-DLJ.

Delco 5-element Yagi **\$6.95**
 T-Match!
8.95
 Vee-D-X 10-element Yagi

B. Channels 7-13. High front-to-back ratio. Pre-assembled. Installs easily. Wt. 9 lbs. Stock #99TX713.

F. Channels 2-6. Pre-assembled for quick installation. Shpg. wt. 12 lbs. Stock #99KBD56.

4-bay VEE-D-X colinear array
\$6.50 net Reg. \$26
C. Broad-band array has attached phasing harness, center terminals for line. Hardware cadmium-plated. Chan. 8, 9, 10, 11, 12, 13. Specify Chan. Wt. 4¼ lbs. Stock #99TV0CA.

10-element DELCO Yagi
 Reg. \$35 **\$7.50 net**
lots of 3 — \$6.95 ea.

D. Inline design with wide element (heavy gauge all-aluminum) spacing for extra-high front-to-back ratio. Twin V-braced crossbar for strength. Chan. 5 & 6. Specify Chan.. Stock #99TB010.

UHF bowtie & reflector by NEPCO
\$2.65 net **LOTS OF 3 \$2.49 ea.**
 Reg. \$6.95
E. For mast mount. High gain & directivity on all UHF bands. Hardware and outfit weather-resistant. Wt. 3 lbs. Stock #T-BTR-1X.

Money-back guarantee. \$5 minimum orders. FOB NYC. 25% deposit on COD's.

send for FREE catalog

Concord Radio, Dept. M19, 45-A Warren St., N.Y. 7
 Please send me items on attached clipping.
 I'm not on your list. Send Bargain Catalogs.
 Send special TV Accessories Close-out List.

name _____
 address _____
 city _____ zone _____ state _____
 check enc. M.O. enclosed Digby 9-1132

2500 W. 23rd St.
 Chicago 8, Ill.

now endorsed by
 R. G. Middleton

Futuramic

You will be amazed at how much more useful your VOM will become when you supplement it with a *Futuramic* probe.

And remember—YOU MUST be satisfied—or you may return the probe and we will refund your money.

NEW TYPE 265

- TYPE 261** VTM HI-OHMS PROBE—Opens up an entirely new field of measurement with any VTVM which has an Rx1meg scale, an input resistance of 10 megohms and an internal battery of 1.5 volts. Most popular serviceman's VTVMs fall in this category and with this probe can be used to make measurements up to 20,000 MEGOHMS! **Net price \$9.95**
 - TYPE 262** VOM HI-OHMS PROBE—Used with the most popular types of VOMs of 20,000 ohms-per-volt sensitivity and 12 ohm center scale indication to extend the resistance range to read 200 MEGOHMS. **Net \$9.95**
 - TYPE 262** SIGNAL TRACING PROBE—Signal trace with your VOM! Accurately diagnose TV troubles without removing chassis. Faster than tube changing, and better. Reads RF, IF, AF and Sync voltages. **Net \$9.95**
 - TYPE 263** POLARITY REVERSING PROBE—End the annoyance of changing leads when reading both positive and negative voltages. Just flip the switch at your finger tip. **Net \$6.95**
 - TYPE 264** VOM RANGE SPLITTER PROBE—Converts the 250 volt D.C. range to a 500 volt range at the flip of a switch. Use with any VOM of 20,000 ohms-per-volt sensitivity and having a 250 and 50 volt range. **Net \$9.95**
- All *Futuramic* probes are gold plated, with high grade components throughout. Complete with full operating instructions. Nothing else to buy. Satisfaction Guaranteed. Stocked by leading jobbers. If your local jobber does not carry the *Futuramic* line, send us his name with your order.



TIME IS MONEY!
 Save Time — Save Money
 with a *Futuramic* probe

Order your *Futuramic* probes from:

U. S. Radio & Television Supplies, Inc.
 634 S. South Ashland Avenue, Chicago 36, Illinois
 Representative inquiries invited.

Please send me the following VOM Probes:
 Type 261; Type 262; Type 263;
 Type 264; or Type 265 VTM probe.
 My favorite jobber is: _____
 I am enclosing \$1.00 down for each probe ordered. Upon delivery, I will pay postman balance, plus postage.
 Name _____
 Address _____
 City _____ State _____

WRITE FOR YOUR BARGAIN "TABOGRAM"
A Free Bonus with Every Order

**NEW "SHAWLITE" ELECTRONIC
Flash Kit 400 II**



Uses NEW low cost to voltage Super Circuit constant bright light output 60 Watt sec'd; light duration 1/600 sec.; color Kelvin 6800°; color #75+; B & W 225+; Cost per flash less than 3¢; 1000 to 2000 flashes per set of (2/240v) batteries. Recycles 2 sec'ds. Patented reflector. Assembled gun. Less batteries.

Compact. Wgt 234 lbs. MODEL 400 II @ \$29.95
"TABLITE" 400V AC & Bat. 60W Sec'd @ \$38.95
SHAWLITE 600 II. 120W Sec'd. Bat. Oper. @ \$43.95
"TABLITE" 600V AC & Bat. 120W Sec'd @ \$59.95
"TABLITE" 1000V. 240W Sec'd. AC & Bat @ \$69.95
TWO (2) 240V BATTERIES..... @ \$10

Write For Complete Data & Specification
Photoflash Cond. S25MFD/450VDC/53WSEC NEW
LOW Leakage, Famous Mfr..... @ \$8; 2/\$15

**VARIABLE 0 to 6 & 12-VOLT/12 AMP
DC Power Supply**

Battery Eliminator, Charger, Model RR, Plater, Aircraft, Marine or any DC Reg. Extra hvy duty Selenium Rectifier, 2 meters V & A. Designed for cont. service & up to 20 Amps intermittent overload.
MODEL T612V12AC..... @ \$29.95



**"TABTRON" HI CURRENT PWR SUPPLIES
ONE YEAR GUARANTEE**

Variable 0-28VDC. Completely Built. Incls: Full Wave Selenium Rectifier, Transformer, Variable Volt & Amp Meters, Switch, Terminals & Fuse. In Hvy duty Steel Cabinet. Standard 115V/60cy Input or 220V and 3 phase

Stk No	Cont. Rating	W-Meters
T28V5A	0-28 VDC at 5 Amp	\$ 50
T28V12A	0-28 VDC at 12 Amp	\$125
T28V24A	0-28 VDC at 24 Amp	\$155
T28V50A	0-28 VDC at 50 Amp	\$285

WRITE FOR COMPLETE LIST

**NEW "TABTRON" SELENIUM BRIDGE
Gtd RECTIFIERS One Yr**

FOLLOWING LIST. FULL WAVE BRIDGE

Curr.	18/14	36/28	52/42	130/100
Cont. Volts	18	36	52	130
1AMP	\$1.40	\$2.30	\$3.70	\$7.40
2AMP	2.00	2.95	5.30	10.25
3AMP	2.90	4.10	5.75	12.70
4AMP	3.50	6.40	11.25	25.00
5AMP	4.15	7.40	12.75	25.00
10AMP	5.85	11.35	19.40	41.25
12AMP	7.20	14.25	22.00	43.85



EMC #208 Tube Tester \$24.90 Reg;
"TAB" SPECIAL..... @ \$18.50

TUBES

FULL RETMA WARRANTY

New, Unused—None Rewashed or Rebranded
No Electrical or Mechanical Rejects

02A	.45 6AV5	.80 6K6	.45 12AX7	.55
1AX2	.95 6AV6	.45 6E4	.45 12BA6	.50
1B3	.65 6AX4	.80 6E47	.50 12DE6	.65
1R5	.50 6AX5	.75 6EJ7	.65 12BH7	.65
1T4	.50 6BA6	.45 6SK7	.50 12BY7	.97
1U5	.45 6C5	.45 6X4	.45 12CT7	.70
1X2	.85 6BE6	.45 6SN7	.55 12SK7	.45
3V4	.75 6BG6	1.24 6SQ7	.55 12SN7	.56
5U4	.45 6BK7A	1.50 7A	1.15 12X7	1.50
5V4	1.28 6BQ7A	1.30 6T8	1.75 25BQ6	.90
5Y3	.65 6BN6	1.19 6V6	.55 25L6	.42
6AC7	.65 6BQ6	.90 6W4	.35 25W4	1.03
6AQ5	.45 6BQ7A	1.30 6X4	.40 25L6	.69
6AK5	.60 6C4	.35 6X5	.45 35W4	.50
6AL5	.40 6CB6	.50 6X8	.85 35Z5	.45
6AQ5	.45 6CQ6	1.08 12AT6	.90 50L5	.70
6AT6	.40 6CF6	1.25 12AT7	.65 50C5	.52
6AU4	.95 6CL6	1.65 12AU6	.41 50L6	.55
6AU6	1.10 6J5	.40 12AU7	.55 50L7	.85
6AU8	.45 6J6	.45 12AX4	1.29 63V	1.22

Write For New Bonus HI FI Catalog

"TAB" HI FI SPEAKERS

Inbuilt network, 2 wires needed for HF & LF Response Famous HI FI mfrs.
Model P25C0 15" Coaxial PM & 5" Tweeter 25 Watt/20-17500 cycles..... \$19.50
Model #12C0 12" Coaxial PM & 3 1/2" Tweeter 12W/45-15K Cy..... \$12.75
Model P8C0 8" Coaxial PM & 2 1/2" Tweeter 8 Watt/70-15K..... \$7.75



FINEST HI-FI RECORDING TAPE

7 1/2" Reel—1200 Ft. Per Reel
\$\$\$ Back Guarantee
Precision Coated & Slit, Gtd Splice Free, Quality Controlled, Plastic Base, Gtd Constant Output, Freq. 7 1/2 IPS
40-15K. Oxide Wnd in @ \$1.68 ea; 3 @ \$1.52 ea; 12 @ \$1.55 ea; 24 @ \$1.45 ea; 72 @ \$1.35 ea.

NEW GE PHONO CARTRIDGES

*GE Original Boxed, \$\$\$ Back Gtd
RPK05CA* 001 & 003 (SS)..... \$6.98
RPK052A* Golden Treasure (DS)..... \$19.98
RPK053A* Golden Treasure (DD)..... \$28.98



Replacement Needles "TETRAD" Diamond
RPJ013A Dual (DS) 001 & 003 "TETRAD"..... \$10.99
RPJ013D or RPJ013D Single (D) "TETRAD"..... \$9.99
RPJ015 or RPJ015 Single (S)..... \$1.35
RPJ003 or RPJ004 Single (D) "TETRAD"..... \$9.99
MG or 78 Single (D) "TETRAD"..... \$9.89

**SAVE YOURSELF \$\$\$ ON THESE
OIL CONDENSERS & XFMRs**

2.5 MFD 330VAC/1000VDC. G.E. w/Brackets @ 79c ea; 10 for 65c ea;
3.3 MFD/220VAC/600VDC. G.E. @ 50c each; 10 for 49c ea;
5 MFD/600 VDC. Tube w/brackets @ \$1.19 ea;
10 for 95c ea; 25 for..... \$24
1200 VCT/200 MA, 5V/3A, 2.5 VCT/10A, 7.5V/3A Upright dble shell..... @ \$6.98; 2 for \$11.95
778 VCT/200 MA, 5V/3A, 6.3 VCT/10A @ \$4.98; 6 for \$24
620 VCT/250 MA, 5V/3A, 6.3 V/10A, Universal mtg. dble shell, el'static shld @ \$3.49; 6 for..... \$18

"TAB"

TERMS: Money Back Gtd (cost of mdsd only) in order. F.O.B. N.Y.C. Add shp charges or for C.O.D. 25% Dep. Tubes gtd via R-Exp Only. Prices shown subject to change.

111 LIBERTY ST., N.Y. 6, N.Y. RECTOR 2-6245
DEPT. 4RE6-CABLE "TABPARTS"



**TELCO TELEVISION HARDWARE
AT YOUR DISTRIBUTOR**

WRITE for your TELCO Catalog or ask your supplier. FREE!

 TELCO TV STAND-OFF All-aluminum; wood-screw; 3 1/2" long. No. 8027-A	 TELCO MAST STRAP STAND-OFF Alum. screw-eye; 9" strap; 3 1/2" long. No. 8253-A	 TELCO E-Z KANT-STRIP MAST STAND-OFF In-line 7 1/2"; galv. strap. No. 8642-B8	 TELCO GROUND ROD Heavy copper plated; 4' long, 3/8" dia. No. 8929
 TELCO SNAP-IN CHIMNEY MOUNT Fits masts to 1 1/4" dia. No. 8610	 TELCO TV PLASTIC PLIERS Rugged; insulated, shock-proof. No. 8387	 TELCO 300-OHM LEAD-IN TOOL Slot, strip, cut; crimp lugs. No. 9220	 TELCO DUPLEX LINE CONNECTOR Connects two leads to TV set. No. 8221
 TELCO GALV. STEEL ANTENNA MASTS Hot dipped; 1 1/4" OD x 5' crimped end. No. 9013	 TELCO DELUXE UNIVERSAL SWING BRACKET All aluminum; fits 1 1/4" masts. No. 8000	 TELCO 6-PACK LIGHT-NING ARRESTORS Six for quick, handy use. No. 8642-6P	 TELCO 2-SET TV COUPLER Couple two sets to one antenna. No. 8920

TELEVISION HARDWARE MFG. CO.

Division of General Cement Mfg. Co. 919 Taylor Avenue • Rockford, Illinois

CRYSTAL CONTROLLED CONVERTERS
50-30 MC POLICE BAND
Frequency to your exact specification. **\$29.95**
Write for Free Catalog net
Kuhn ELECTRONIC PRODUCTS
20 Glenwood Pl. • Cincinnati 17, O.

LEARN TV
the practical way..
17", 21" and 27"
BUILD the New TRANSVISION TV KIT
Designed so that COLOR can be added

do you want to learn TV servicing?
Just master the first few chapters of
ELEMENTS OF TV SERVICING
by ABRAHAM MARCUS (co-author of famous best seller, "Elements of Radio"), and SAMUEL GENDLER
And you are ready for business! Written in the same clear, easy-to-understand style that sold over a million copies of MARCUS' famous ELEMENTS OF RADIO.
Chapters 3 to 5 cover servicing in the field—servicing that takes care of over 80% of all service calls.
Chapters 6 to 14 cover bench servicing which accounts for the remainder of the service calls.
Chapters 15 to 17 cover the theory and servicing procedures for color television.
THE ONLY BOOK THAT GIVES FULL DETAILS OF THE NEW RCA 28-TUBE COLOR TV CIRCUIT
587 pages fully illustrated in black-and-white and in color
Published by Prentice-Hall.
Get your copy today!

*THIS MODEST INVESTMENT gets you started on a most fascinating project— assembling the new "E" type Transvision TV Kit in easy stages. For \$15 you get PACKAGE #1 (standard first package for all new "E" kits). This package gives you the BASIC CHASSIS and required first-stage TV COMPONENTS, with complete instructions. When ready, you order the next stage (pkg. #2), etc.
\$15.00 ONLY gets you started*
PROFIT 3 WAYS:
1 Learn TV
2 Save up to 50%
3 Prepare for COLOR TV
Shows 8 Great TV Kits:
EXCLUSIVE: Only Transvision TV Kits are adaptable to UHF. Ideal for FRINGE AREAS. No Previous Technical Knowledge required. Write now!
FREE CATALOG
TRANSVISION
THE OLDEST NAME IN TV KITS
NEW ROCHELLE, N. Y.
MAIL THIS COUPON TODAY
TRANSVISION, INC., NEW ROCHELLE, N. Y. Dept. RE-4
 I'm enclosing \$ _____ deposit. Send standard kit PACKAGE #1, with all Instruction Material. Balance C.O.D.
 Send FREE copy of your new TV Kit Catalog.
Name _____
Address _____
City _____ State _____

SCHOOL DIRECTORY

LEARN TV

'At the most practical school in the west'

Work on late model sets—using modern equipment and service techniques; under qualified technician instructors. Short resident and correspondence courses—no unnecessary math or theory—also UHF and Color TV.

APPROVED FOR VETERANS . . . day and nite classes.

Write for free literature, Dept. 1A for residence—Dept. 1AC for correspondence.

V.S.I. TELEVISION SCHOOL

4570 Firestone Blvd.
South Gate, California

Get Your F.C.C. LICENSE Quickly!

Guaranteed preparation, in a MINIMUM OF TIME, for F.C.C. commercial operator examinations. Our highly specialized training is available by correspondence, or in resident classes in

WASHINGTON, D. C. and HOLLYWOOD, CALIF.

Write for our free booklet with complete details.

GRANTHAM School of Electronics

Desk 4-C, 821 19th Street N.W., Washington 6, D.C.

RADAR

Our school is now introducing a correspondence course in Radar, Microwaves, and Loran. Get your FCC endorsement, high paying job in industry as a radar technician. Special introductory offer. Write

PROGRESSIVE ELECTRONICS INSTITUTE
P.O. Box 27764 Los Angeles 27, Calif.

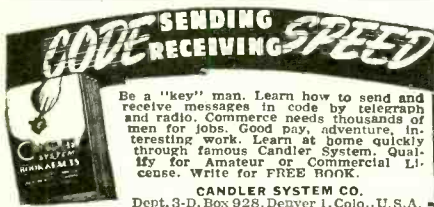

CODE SENDING SPEED
RECEIVING SPEED

Be a "key" man. Learn how to send and receive messages in code by telegraph and radio. Commerce needs thousands of men for jobs. Good pay, adventure, interesting work. Learn at home quickly through famous Candler System. Qualify for Amateur or Commercial License. Write for FREE BOOK

CANDLER SYSTEM CO.
Dept. 3-D, Box 928, Denver 1, Colo., U.S.A.



RCA INSTITUTES, INC.

A service of Radio Corporation of America
350 West 4th St., New York 14, N. Y.

OFFERS COURSES IN ALL TECHNICAL PHASES OF RADIO, TELEVISION, ELECTRONICS

Approved for Veterans
Write Dept. RE-56 for Catalog

ELECTRONICS

Prepare for unlimited opportunities in electronics! B.S. degree in 27 months. Intensive, specialized courses. Math, electrical engineering, TV, advanced radio theory & design. Mod. labs. Low tuition. Self-help. Also Aeronautical, Chemical, Civil, Electrical, Mechanical Engineering. G.I. approved. Enter June, Sept., Dec., Mar. Catalog.

INDIANA TECHNICAL COLLEGE
1546 E. Washington Blvd., Fort Wayne 2, Ind.

TELEVISION

PREPARE FOR A GOOD JOB!

BROADCAST ENGINEER
ELECTRONICS
RADIO SERVICING

Television Servicing

(Approved for Veterans)

SEND FOR FREE LITERATURE

BALTIMORE TECHNICAL INSTITUTE
1425 EUTAW PLACE, BALTIMORE 17, MD.



TV REPAIRMEN EARN TOP MONEY!

IN JUST 12 MONTHS, COMPLETE TV SERVICE TRAINING, INCLUDING COLOR TV. Stream-

lined course gives you all essentials for a good job as service technician. Graduates in great demand; jobs are plentiful in this growing field. Other electronic courses in radio operation and maintenance. Day or evening classes. Opportunity for employment in local industry. Approved for Korean veterans.

Write for Catalog 111 Today

INDIANAPOLIS ELECTRONIC SCHOOL
312 E. Washington, Indianapolis 4, Indiana

GET INTO ELECTRONICS

You can enter this uncrowded, interesting field. Defense expansion, new developments demand trained specialists. Study all phases radio & electronics theory and practice: TV; FM; broadcasting; servicing; aviation, marine, police radio. 18-month course. Graduates in demand by major companies. H.S. or equivalent required. Begin January, March, June, September. Campus life. Write for catalog.



wanted career men

Train for a career instead of a job. Demand for our graduates exceeds supply. Effective placement. Modest costs. Small classes. Well-equipped labs. Beautiful campus. Approved for Vets. Enter June, Sept., Jan., March.

BACH. SCI. DEGREE IN 27 MONTHS
Complete Radio Eng. courses . . . TV, UHF, FM, Electronics. Also Mech., Civil, Elec., Chem., Aero. Eng. 36-month B.S. in Bus. Adm. (Gen. Bus., Acctg., Motor Transport Mgt.) . . . capable students faster. Prep courses. Write Jean McCarthy, Dir. Adm., for catalog and "Your Career in Engineering & Commerce."

TRI-STATE COLLEGE

2446 College Avenue, Angola, Indiana

EARN MORE MONEY— BE A PROFESSIONAL TELEVISION SERVICE TECHNICIAN

GET DOWN-TO-EARTH PRACTICAL TV TRAINING WITH WTI EXPERTS FOR THE TOP PAYING \$5,000-\$10,000 PER YEAR JOBS.

UHF—COLOR—VHF

Master the latest, up-to-the-minute TV and Color TV developments QUICKLY.

SEND FOR

FREE

BOOK TODAY!

WESTERN TV offers real experience on live equipment in our BIG SHOPS AND LABORATORIES in the shortest practical time under expert instructors. Graduates are in big demand because they have the "field experience" necessary for immediate "bench" or supervisory positions. You learn every phase of Radio and TV servicing (AM, FM, VHF, UHF). WTI men win fast promotion . . . can demand better pay . . . develop highly profitable businesses of their own with the latest and most PRACTICAL PERSONALIZED TRAINING BEHIND THEM. You concentrate all your time on being a PROFESSIONAL TV SERVICE TECHNICIAN—non-essential math and engineering theory omitted. YOU CAN EARN WHILE YOU LEARN. Special Finance Plan.

APPROVED FOR VETERANS. Find out how you can get into the TOP PAY GROUP—Send for this fact-packed book NOW!

WESTERN TELEVISION INSTITUTE

America's Leading Television Servicing School

Western Television Institute Dept. E-156
341 W. 18th St., Los Angeles 15, Calif.
Without obligation, please send FREE fully illustrated booklet. (No salesman will call.)

NAME _____ AGE _____

ADDRESS _____

CITY _____ ZONE _____ STATE _____

Your choice of school is highly important to your career in



INDUSTRIAL ELECTRONICS



RADIO



TELEVISION

Become an **ELECTRICAL ENGINEER**

or an **ENGINEERING TECHNICIAN**

at **MSOE in Milwaukee**

Choose from courses in: **ELECTRICAL ENGINEERING** Bachelor of Science degree in 36 to 42 months with a major in electronics or electrical power.

ELECTRICAL TECHNOLOGY Engineering Technician certificate in 12 months in electronics, radio, or electrical power;

Associate in Applied Science degree in 18 months in radio and television.

TECHNICAL SERVICE Service certificate in 6 months in electricity; in 12 months in radio and television.

MSOE—located in Milwaukee, one of America's largest industrial centers—is a national leader in electronics instruction—with complete facilities, including the latest laboratory equipment, visual aid theater, amateur radio transmitter—offers 93 subjects in electrical engineering, electronics, radio, television, electrical power, and electricity.

Advisory committee of leading industrialists. Courses approved for veterans. Over 50,000 former students. Excellent placement record.

TERMS OPEN APRIL, JULY, SEPTEMBER, JANUARY

Choose wisely—your future depends on it. Write for more information today!



MILWAUKEE SCHOOL OF ENGINEERING
Dept. RE-456, 1025 N. Milwaukee St. Milwaukee 1, Wisconsin

Send FREE career booklets on:
 Electrical Engineering Radio-Television

I am interested in _____ (Name of course)

Name _____ Age _____

Address _____

City _____ Zone _____ State _____

If veteran, give discharge date _____ MS-31

Only the 5 TOP QUALITY brands of

STANDARD BRAND TUBES AT SENSIBLE PRICES!

- Individually boxed • First quality only
- Brand New • Standard RTMA guarantee
- No private brands • No rejects
- No rebrands or rewashed bargains

Free! Newest handy air-mail order form for your ordering convenience. Lists over 400 popular replacement types.

WRITE FOR YOUR FREE COPY TODAY!

- Lists ALL popular TV & radio types.
- Makes mail-ordering a real pleasure.
- All tube orders over \$25.00 (with remittance) postpaid.

SPECIAL-PURPOSE TUBES

Write for our complete listing on Transmitting, Industrial, Special-Purpose Tubes, and Crystal Diodes. We stock over 1000 types at excellent prices.

EQUIPMENT SPECIALS!

New & used at bargain prices. Subject to Prior sale. All items guaranteed to be as advertised.

- MICROVOLT SIG. GEN. Hickock 292X L.N. \$115.00
- BINARY SCALAR G. Model 59013 W/59013 New \$11.00
- OSCILLOSCOPE. Millen 90901. W/1CP1. 29.50
- New L.M. NAVY FREQ. METER W. orig. book. xtal. pow. supply & instruction book L.N. 150.00
- RESISTOR-CONDENSER ANALYZER. Sprague model TO-3 L.N. 39.95
- TV CALIBRATOR. RCA model WR-39C. L.N. 175.00
- MARKER GENERATOR. xtal. calib. RCA model WR-89A. L.N. 175.00
- L.A.B. POWER SUPPLY. Electro "BJ". Sec. 49.50
- 6VDC @ 1-25 A. Exc. KAY MEGA-MARKER SR. 13 channel xtal. freq. TV marker. vy. gd. 80.00
- OSCILLOSCOPE. C.R. Model CRO-5A. L.N. 125.00
- TV CALIBRATOR. RCA model WR-39A. Exc. 149.50
- SNOPROSCOPE TUBES. CR1143 or 147. New 3.50
- INFRARED FILTER for above. New 1.50 (free data supplied with either above)
- 115 V. SELENIUM RECTIFIER. 1/2 amp. full wave bridge type. Sarkes-Tarzian. New 3.00
- SELSYN MOTORS. 115 volt. 60 cycle. each. 9.75

2 COLOR TUBE CARTONS

Keeps your tube stock neat. New safety partition prevents tube breakage. Distinctively lithographed in glossy red and black. The most distinctive tube carton available today. Minimum quantity: 100 of any one size. Write for case lot prices.



SIZE	FOR TUBE	PER 100
Miniature	6AUS, etc.	\$1.00
GT	6SN7	1.25
Large GT	183, etc.	1.50
Large G	504G, etc.	2.00

WHITE GLOSSY BOXES
Completely blank. No printing or color. Otherwise same as above. Same high quality, same low prices. Specify "white" when ordering.

TUBE STACKERS

White glossy only. Mistacker holds 10 Mini. tube cartons; "GT" stacker holds 10 "GT" cartons.

SIZE	PER 100
Mistacker	\$1.50
GT	2.00

SMALL PARTS BOXES

Craft colored folding cardboard boxes ideal for kits of small parts, storage of seldom used material, light shipping, and a million and one other uses around the shop. Quantity is limited so order now! Available in two sizes.

SIZE	EITHER SIZE
3" x 4" x 5"	1c ea. (in case lots of 200 boxes)
6" x 6" x 5"	Single boxes 11/2c ea.

DIRECTRON SELENIUM RECTIFIERS

Max. Amps.	Full Wave Bridge Type			
	18VAC 14VDC	36VAC 28VDC	54VAC 42VDC	72VAC 56VDC
1	\$1.35	\$2.35	\$3.75	\$4.50
2	2.90	5.35	8.50	9.75
2 1/2	2.95	4.15	5.85	7.85
3	3.50	6.45	11.35	14.35
4	4.00	12.85	12.85	17.30
6	5.90	11.45	19.50	24.80
10	7.25	14.35	22.10	29.75
12	13.05	25.05	37.25	48.75
14	14.25	28.75	44.50	57.65
20	17.95	34.35	56.50	71.00
24	22.45	42.35	65.00	86.95
30	29.50	54.35	105.45	115.75
100	59.50	119.00		174.00

We build other Selenium Rectifiers. Transformers and Chokes to your specifications.

NEW RECTIFIER TRANSFORMERS

1 Amp	\$ 5.75
2 Amps	6.75
4 Amps	7.85
12 Amps	16.00
24 Amps	35.00
30 Amps	45.00
50 Amps	57.00
100 Amps	108.00

NEW RECTIFIER CHOKES

Continuous Ratings	Hy	1.5 ohm	\$ 4.95
1 Amp	.04 Hy	.9 ohm	5.95
2 Amps	.07 Hy	.6 ohm	7.50
4 Amps	.01 Hy	.2 ohm	14.00
12 Amps	.004 Hy	.025 ohm	29.00
24 Amps	.005 Hy	.01 ohm	54.00

FILTER CAPACITORS

Capacity	W. Voltage	Each
300 MFD	50 V.	.85
1000 MFD	15 V.	.35

WRITE FOR "BARRY'S GREEN SHEET" ISSUED MONTHLY. FREE!

TERMS: 25% deposit with order, balance C.O.D. All merchandise guaranteed. F.O.B. N.Y.C.

BARRY ELECTRONICS CORP.
512 Broadway, Dept. RE, N.Y. 12, N.Y.
Phone: Walker 5-7000.

ADVERTISING INDEX

Radio-Electronics does not assume responsibility for any errors appearing in the index below.

Aermotor Co.	12	Lektron Specialties	133
Aerovox Co.	134	Macmillan Co.	121
A. L. Products Co.	126	Mallory (P. R.) & Co., Inc.	100, 101
Allied Radio Corp.	13, 21-23	Merit Coil & Transformer Co.	14
American Phenolic Corp.	97	Metropolitan Electronics & Instrument Co.	91
Arkey Radio Kits Inc.	140	Miller (Gustave)	118
Atlas Sound Corp.	119	Miller (J. W.) & Co.	136
Audel Publishers	127	Moss Electronics Distributing	146, Inside Back Cover
B & K Manufacturing Co.	95	National Radio Institute	3, 15
Barjay Co.	139	National Schools	5
Barry Electronics	144	Newark Electric Co.	131
Belden Manufacturing Co.	30	North American Phillips Co., Inc.	134
Bell Telephone Labs.	20	Ohmite Manufacturing Co.	132
Bendix Radio	127	ORRadio Industries	118
Blonder-Tongue Labs.	113, 115	Oxford Electric	116
Brooks Radio & TV Corp.	124	Phaotron Co.	78
CBS-Hytron	28	Pilot Radio Corp.	135
Capitol Radio Engineering Institute	27	Precise Development Corp.	99
Centralab Div. of Globe Union	117	Prentice-Hall, Inc.	142
Century Electronics	139	Presto Recording Corp.	136
Channel Master Corp.	16-17	Progressive Edu-Kits, Inc.	108
Cleveland Institute of Radio Electronics	11	Pyramid Electric Co.	81
Colordaptor	126	Quality Electronics	144
Columbia Records	7	Radiart Corp.	24
Concord Radio	141	RCA Institutes, Inc.	29
Cornell-Dubilier Electric Corp.	24, 106	RCA Service Co.	90
Coyne Electrical School	111, 119, 130	RCA Test Equipment	87
Delco Radio Div. of General Motors	85	RCA Tube Division	Back Cover
DeRo	116	Radio City Products	104
DeVry Technical Institute	9	Radio Products Co.	118
Dressner	116	Radio Receptor, Inc.	76
Dyna Co.	138	Radio Television Training Association	25
Editions Radio	135	Ram Electronic Sales Co.	119
Editors & Engineers	115	Rauland Borg Corp.	98
Electro-Voice, Inc.	6	Raytheon Manufacturing Co.	10
Electronic Instrument Co. (EICO)	31, 32	Rek-O-Kut Co.	14
Electronic Measurements Corp.	110	Remington Rand	137
Electronic Publishing Co.	86	Research Inventions & Manufacturing Co.	129
Elmar	126	Rinehart Books, Inc.	125, 132, 136, 140
E-Z Way Towers, Inc.	115	Rockbar	86
Federal Telephone & Radio	89	Ronette Corp.	113
Fenton Co.	129	Sams (Howard W.) & Co.	19, 105
General Cement Manufacturing Co.	142	Seco Manufacturing Co.	122
General Industries Co.	80	Service Instruments Co.	133
Gernsback Library, Inc.	123	Shure Brothers, Inc.	92
Gray Research & Development Co.	120	Simpson Electric Co.	103, 107
Heath Co.	63-74	Sonotone Corp.	18
Hickok Electrical Instrument Co.	82	Sprague Products Co.	83
Hi-Fi Fabrics Institute	130	Stan-Burn Radio & Electronics	138
Hughes Research & Development Labs	128	Stanley Electronics Corp.	135
Hunter Tool Co.	109	Sylvania Electric Products, Inc.	77
International Business Machines	145	"TAB"	142
Indiana Technical College	122	Tarzian (Sarkes), Inc.	112
Instructograph Co.	122	Technical Materiel Corp.	130
Jensen Industries	132	TeleMatic Industries, Inc.	95
Jensen Manufacturing Co.	118	Teleparts Co.	116
Karlson Associates, Inc.	80	Television Hardware Manufacturing Co.	142
Kedman Co.	138	Transvision, Inc.	131, 142
Krauter Co.	129	Triplett Electrical Instrument Co.	Inside Front Cover
Kuhn Electronic Products	142	Tube Mart	139
LMB	116	Tung-Sol Electric Co.	8
Lafayette Radio	93	Turner Co.	12

NEW BE QUALITY WISE... BUY QUAL-KITS!

Hi-Fi AM-FM Tuner
Advanced 7 tube circuit provides full sensitivity and selectivity giving this AM-FM tuner exceptional hi-fi reception. Armstrong FM circuit with limiter, Foster-Seeley Discriminator. 20-20,000 cps response. Full AFC control—no drift.



\$28.95

Hi-Fi Amp.
Complete 6 tube-10 watt amplifier. Push-pull beam power output, built-in pre-amp. 5 position selector switch, 3 position record equalization, LP, RIAA, Eur. Response 1/2 db. 20-20,000 cps. Output 10 watts at less than 2% THD. Low noise level and harmonic distortion.



\$28.50

Cover and legs optional

Every kit complete with step by step, fully illustrated. 26 pg. instruction and assembly manual. Write today for FREE catalog

Quality-Electronics Dept. E-4
319 Church Street New York 13, N. Y.

SCHOOL DIRECTORY PAGE 143

- Baltimore Technical Institute
- Candler System Co.
- Grantham School
- Indiana Technical College
- Indianapolis Electronic School
- Milwaukee School of Engineering
- Progressive Electronics Institute
- RCA Institutes, Inc.
- Tri-State College
- Valparaiso Technical Institute
- V.S.I. Television School
- Western Television Institute

IN RETURN FOR CHARACTER ... A CAREER

Because the finest single attribute anyone can offer is character, this, basically, is what IBM asks of its people, whatever their special aptitudes or abilities. IBM offers them in return—not just a job—but a career.

IBM electronic field technicians, for instance, receive more than training and early responsibility; they have a chance to work with the world's largest computer, use the latest testing equipment, employ

the finest computer testing techniques yet devised. Above all, they have the satisfaction of joining the electronics industry's most advanced program, destined for long-range national importance.

You could ask for no finer future.

If you are between 19 and 32 and have at least a 2-year technical school background, with emphasis on electronics, you can do important work on COMPUTER INPUT-OUTPUT functions. Write: Nelson O. Heyer, IBM, Room 3101, Neighborhood Rd., Kingston, N. Y.

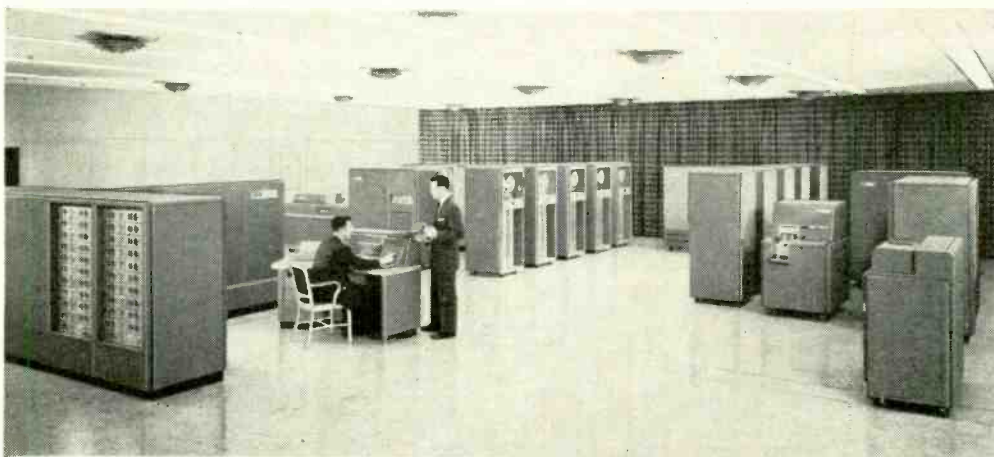

The 702 Electronic Data Processing Machine, typical of advances that have made engineering work at IBM one of the most provocative experiences in electronics.

INTERNATIONAL BUSINESS MACHINES CORPORATION

IBM
®

Producer of electronic data processing machines, electric typewriters, and electronic time equipment.

New!



20,000 OHMS PER VOLT

ALLMETER

New Model TV-60

Includes services never before provided by an instrument of this type. Read and compare features and specifications below!

SPECIFICATIONS

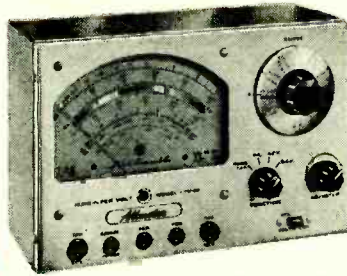

- 8 D.C. VOLTAGE RANGES (At a sensitivity of 20,000 Ohms per Volt) 0 to 15/75/150/300/750/1500/7500/30,000 Volts.
- 7 A.C. VOLTAGE RANGES: (At a sensitivity of 5,000 Ohms per Volt) 0 to 15/75/150/300/750/1500/7500 Volts.
- 3 RESISTANCE RANGES: 0 to 2,000/200,000 Ohms, 0-20 Megohms.
- 2 CAPACITY RANGES: .00025 Mfd. to 30 Mfd.
- 5 D.C. CURRENT RANGES: 0-75 Microamperes, 0 to 7.5/75/750 Milliampere, 0 to 15 Amperes.
- 3 DECIBEL RANGES: -6 db to + 58 db.

R.F. SIGNAL TRACER SERVICE: Enables following the R.F. signal from the antenna to speaker of any radio or TV receiver and using that signal as a basis of measurement to first isolate the faulty stage and finally the component or circuit condition causing the trouble.

AUDIO SIGNAL TRACER SERVICE: Functions in the same manner as the R.F. Signal Tracing service specified above except that it is used for the location of cause of trouble in all audio and amplifier systems.

FEATURES

- ★ Giant recessed 6½ inch 40 Microampere meter with mirrored scale.
- ★ Built-in Isolation Transformer.
- ★ Use of the latest type printed circuit and 1% multipliers assure unchanging accurate readings.

Model TV-60 comes complete with book of instructions; pair of standard test leads; high-voltage probe; detachable line cord; R.F. Signal Tracer Probe and Audio Signal Tracer Probe. Pliofilm bag for all above accessories is also included. Price complete. Nothing else to buy. **ONLY**

\$52⁵⁰ NET

SHIPPED ON APPROVAL NO MONEY WITH ORDER NO C.O.D.

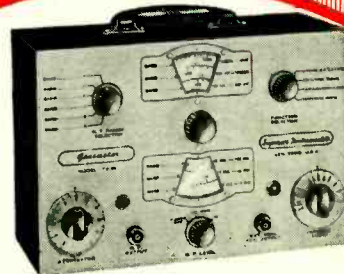

The new Model TV-50

GENOMETER

A versatile all-inclusive GENERATOR which provides ALL the outputs for servicing: A.M. Radio • F.M. Radio • Amplifiers • Black and White TV • Color TV

R. F. SIGNAL GENERATOR: Provides complete coverage for A.M. and F.M. alignment. Generates Radio Frequencies from 100 Kilocycles to 60 Megacycles on fundamentals and from 60 Megacycles to 180 Megacycles on powerful harmonics. • **VARIABLE AUDIO FREQUENCY GENERATOR:** In addition to a fixed 400 cycle sine-wave audio, the Genometer provides a variable 300 cycle to 20,000 cycle peaked wave audio signal. • **BAR GENERATOR:** Projects an actual Bar Pattern on any TV Receiver Screen. Pattern will consist of 4 to 16 horizontal bars or 7 to 20 vertical bars. • **CROSS HATCH GENERATOR:** Genometer will project a cross-hatch pattern on any TV picture tube. The pattern will consist of non-shifting horizontal and vertical lines interlaced to provide a stable cross-hatch effect. • **DOT PATTERN GENERATOR (FOR COLOR TV):** The Dot Pattern projected on any color TV Receiver tube by the Model TV-50 will enable you to adjust for proper color convergence. • **MARKER GENERATOR:** The following markers are provided: 189 Kc., 262.5 Kc., 456 Kc., 600 Kc., 1000 Kc., 1400 Kc., 1600 Kc., 2000 Kc., 2500 Kc., 3579 Kc., 4.5 Mc., 5 Mc., 10.7 Mc., (3579 Kc. is the color burst frequency.)

MODEL TV-50 comes absolutely complete with shielded leads and operating instructions.

Only

\$47⁵⁰ NET

TRY ANY

of the instruments on this or on the facing page, for 10 days before you buy. If completely satisfied **then** send down payment and pay balance as indicated on coupon. **No**

Interest or Finance Charges Added!

If not completely satisfied return unit to us, no explanation necessary.

MOSS ELECTRONIC DISTRIBUTING CO., INC.

Dept. D-223, 3849 Tenth Ave.

New York 34, N. Y.

Please send me the units checked. I agree to pay down payment within 10 days and to pay the monthly balance as shown. It is understood there will be no finance, interest or any other charges, provided I send my monthly payments when due. It is further understood that should I fail to make payment when due, the full unpaid balance shall become immediately due and payable.

Name _____

Address _____

City _____ Zone _____ State _____

- Model TC-55 Total Price \$26.95
\$6.95 within 10 days. Balance \$5.00
monthly for 4 months.
- Model TV-12 Total Price \$72.50
\$22.50 within 10 days. Balance \$10.00
monthly for 5 months.
- Model 670-A Total Price \$28.40
\$7.40 within 10 days. Balance \$3.50
monthly for 6 months.
- Model TV-11 Total Price \$47.50
\$11.50 within 10 days. Balance \$6.00
monthly for 6 months.
- Model TV-40 Total Price \$15.85
\$3.85 within 10 days. Balance \$4.00
monthly for 3 months.
- Model TV-50 Total Price \$47.50
\$11.50 within 10 days. Balance \$6.00
monthly for 6 months.

The new Model TC-55



New!



Streamlined TUBE TESTERS

FOR

The Experimenter or Part-time Serviceman, who has delayed purchasing a higher priced Tube Tester. The Professional Serviceman, who needs an extra Tube Tester for outside calls. The busy TV Service Organization, which needs extra Tube Testers for its field men.

Speedy, yet efficient operation is accomplished by: Elimination of old style sockets used for testing obsolete tubes (26, 27, 57, 59, etc.) and providing sockets and circuits for efficiently testing the new Noval and Sub-Minar types.

Model TC-55 comes complete with operating Instructions and charts and streamlined carrying case.

- You can't insert a tube in wrong socket. Separate sockets are used, one for each type of tube base.
- "Free-point" element switching system Any pin may be used as a filament pin and the voltage applied between that pin and any other pin, or even the "top-cap".
- Checks for shorts and leakages between all elements. Provides a super sensitive method of checking for shorts and leakages up to 5 Megohms between any and all of the terminals. Continuity between various sections is individually indicated.
- Elemental switches are numbered in strict accordance with R.M.A. specification. The 4 position fast-action snap switches are all numbered in exact accordance with the standard R.M.A. numbering system.

\$26⁹⁵ NET



C. R. T. TUBE TESTER

The new Model TV-40



- Tests all magnetically deflected tubes . . . In the set . . . out of the set . . . in the carton!!
- A complete picture tube tester for little more than the price of a "make-shift" adapter!!

The Model TV-40 is absolutely complete! Self-contained, including built-in power supply, it tests picture tubes in the only practical way to efficiently test such tubes; that is by the use of a separate instrument which is designed exclusively to test the ever increasing number of picture tubes!

SPECIFICATIONS

Tests all magnetically deflected picture tubes from 7 inch to 30 inch types. • Tests for quality by the well established emission method. All readings on "Good-Bad" scale. • Tests for inter-element shorts and leakages up to 5 megohms. • Test for open elements.

Model TV-40 comes absolutely complete — nothing else to buy. Housed in round cornered, molded bakelite case. Only . . .

\$15⁸⁵ NET



The new Model TV-11

TUBE TESTER

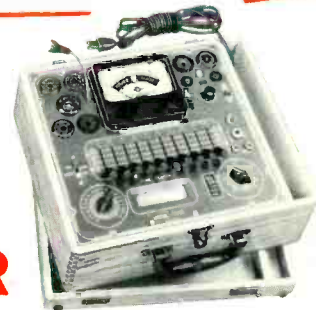

- ★ Uses the new self-cleaning Lever Action Switches for individual element testing. Because all elements are numbered according to pin-number in the RMA base numbering system, the user can instantly identify which element is under test. Tubes having tapped filaments and tubes with filaments terminating in more than one pin are truly tested with the Model TV-11 as any of the pins may be placed in the neutral position when necessary.
- ★ The Model TV-11 does not use any combination type sockets. Instead individual sockets are used for each type of tube. Thus it is impossible to damage a tube by inserting it in the wrong socket.
- ★ Free-moving built-in roll chart provides complete data for all tubes.
- ★ NOISE TEST: Phono-jack on front panel for plugging in either phones or external amplifier will detect microphonic tubes or noise due to faulty elements and loose internal connections.

EXTRA SERVICE — The Model TV-11 may be used as an extremely sensitive Condenser Leakage Checker. A relaxation type oscillator incorporated in this model will detect leakages even when the frequency is one per minute.

The model TV-11 operates on 105-130 Volt 60 Cycles A.C. Comes housed in a beautiful hand-rubbed oak cabinet complete with portable cover.

\$47⁵⁰ NET



TRANS-CONDUCTANCE TUBE TESTER

The new Model TV-12



ALSO TESTS TRANSISTORS!

TESTING TUBES

- ★ Employs improved TRANS-CONDUCTANCE circuit. An in-phase signal is impressed on the input section of a tube and the resultant plate current change is measured. This provides the most suitable method of simulating the manner in which tubes actually operate in Radio & TV receivers, amplifiers and other circuits. Amplification factor, plate resistance and cathode emission are all correlated in one meter reading.
- ★ NEW LINE VOLTAGE ADJUSTING SYSTEM. A tapped transformer makes it possible to compensate for line voltage variations to a tolerance of better than 2%.
- ★ SAFETY BUTTON—protects both the tube under test and the instrument meter against damage due to overload or other form of improper switching.

- ★ NEWLY DESIGNED FIVE POSITION LEVER SWITCH ASSEMBLY. Permits application of separate voltages as required for both plate and grid of tube under test, resulting in improved Trans-Conductance circuit.

TESTING TRANSISTORS

A transistor can be safely and adequately tested only under dynamic conditions. The Model TV-12 will test all transistors in that approved manner, and quality is read directly on a special "transistor only" meter scale.

Model TV-12 housed in handsome rugged portable cabinet sells for only

\$72⁵⁰ NET

EXAMINE BEFORE YOU BUY! USE APPROVAL FORM ON FACING PAGE



"BACKGROUND QUIETNESS"

...for new "front-end" performance!

A MAJOR ENGINEERING FEATURE OF RCA RECEIVING TUBES

Known for their ability to hold tube noise to surprisingly low levels—and produce a cleaner TV picture for the customer—RCA Receiving Tubes are making even more friends with servicemen the country over.

Take a few of the improvements that contribute to background quietness in the famous "front-end" tube—the RCA-6BQ7A: Gold-plated grids reduce reverse grid current; extra heater-to-cathode insulation lowers leakage current and reduces hum; larger grid and cathode connectors minimize "induced" grid noise. . . . features that can give new "front-end" performance!

For increased "background quietness" and a cleaner picture, always replace with RCA Receiving Tubes—and say goodbye to costly callbacks.



RECEIVING TUBES
RADIO CORPORATION OF AMERICA