

# RADIO — K — ELECTRONICS

FEBRUARY 1955

TELEVISION • SERVICING • HIGH FIDELITY

HUGO GERNSBACK, Editor

In this issue:

A Four-Input  
PA Amplifier

Protect Your  
Transistor

Pistol Grip  
Signal Tracer

Two Instruments  
for  
Color TV Service

U.H.F. Antenna  
Installation

35¢

U. S. and  
CANADA



**New Electronic Piano**

(See Page 4)

# It pays to sell ALLIANCE

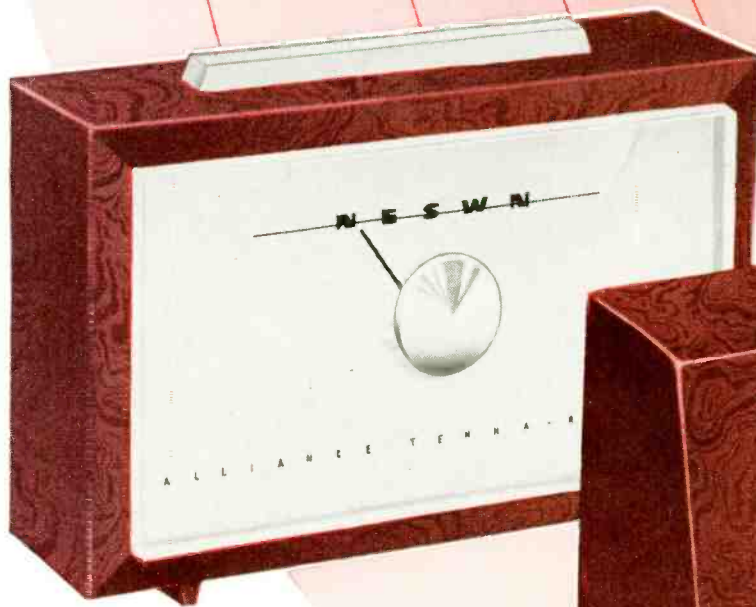

**MODEL T-1C**—fingertip electrical operation. Rocker switch on top controls turning. Highly accurate. Direction indicator dial. Price **\$29.95**

**MODEL U-83**—the only fully automatic rotator! "Set and forget"—antenna turns to proper channel direction and stops. Price **\$34.95**

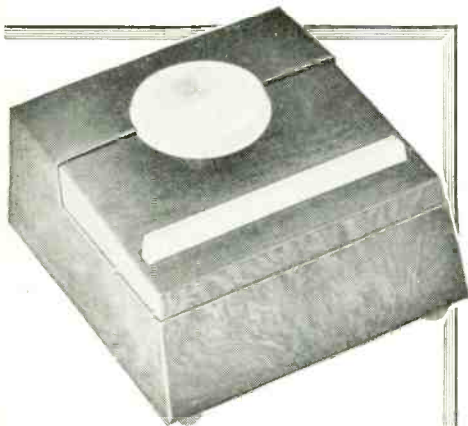
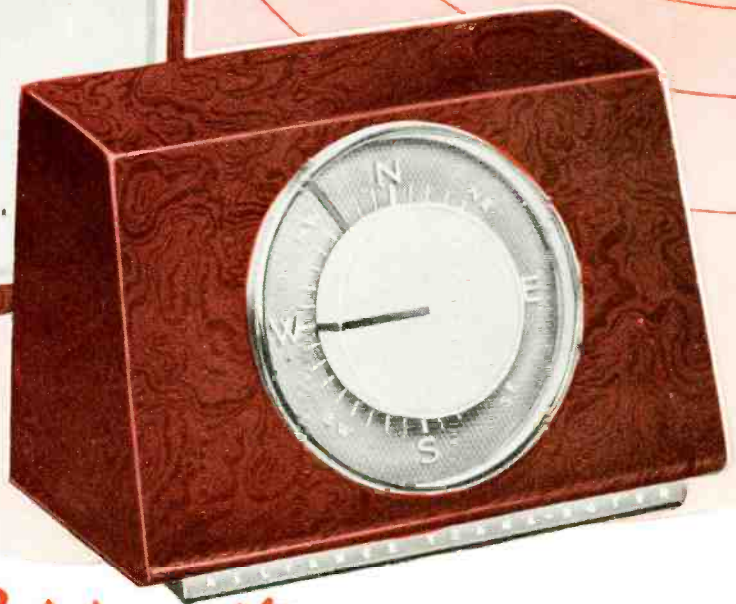

**MODEL K-22**—New Economy Model. Features fingertip control, neat styling. Undoubtedly the biggest value in the industry! Price **\$24.95**

## Add up these reasons—

**Best-known Brand in the Land!** Because more than 30,000,000 viewers see Alliance Tenna-Rotor TV demonstrations regularly—for more than six years Alliance commercials have run in all major markets, nation-wide. Alliance is a leader among TV advertisers! **It pays to sell Alliance!**

**Best Performance!** Let's look at the facts—more than 2,000,000 Alliance Tenna-Rotors have been sold! And one satisfied user tells another. To cash in on public demand, **it pays to sell Alliance!**

**Best Styling!** Alliance Tenna-Rotors are styled for today's homes. They pack more eye-appeal—more buy-appeal. Record-breaking sales prove it! To profit most from the rotators that are seen the most and sold the most, **it pays to sell Alliance!**

**Best Prices!—Biggest Value!** Alliance Tenna-Rotors are now at new low prices . . . to melt sales resistance. Step up your volume and profits. **It pays to sell Alliance!**

**Sell the Alliance Profit Line . . . For Alliance Products are Pre-Sold for You!**



**ALLIANCE MANUFACTURING COMPANY • Alliance, Ohio**

# Learn to Service TV Sets—any make or model—Quickly

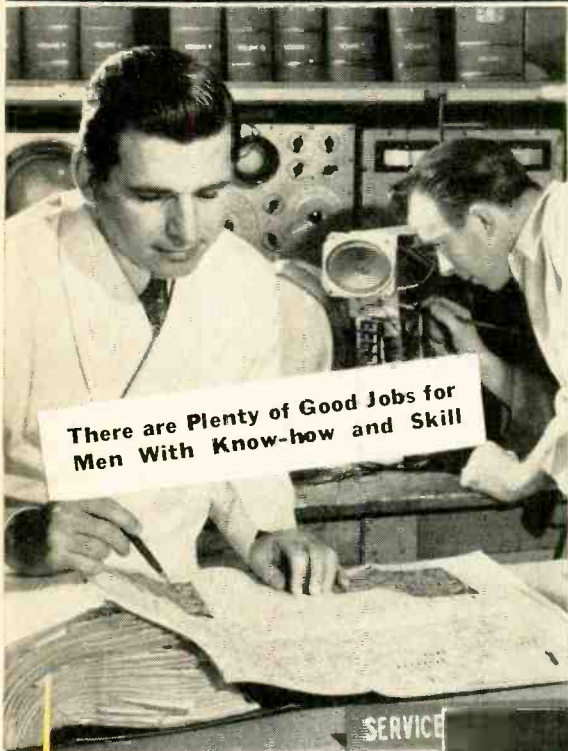

There are Plenty of Good Jobs for Men With Know-how and Skill

## New ALL PRACTICE Method trains you at home to become a Professional TV Serviceman

### You learn the time saving techniques, methods used by top TV Servicemen

This is 100% learn-by-doing, practical training. NRI supplies all necessary equipment, all tubes, including a 17-inch picture tube; and comprehensive manuals covering a thoroughly planned program of practice. You learn how experts diagnose TV receiver defects quickly. You easily learn the causes of defects—audio and video—and how to fix them accurately.

You get actual experience aligning TV receivers, isolating complaints from scope patterns, eliminating interference, using germanium crystals to rectify the TV picture signal, adjusting the ion trap and hundreds of other valuable Professional techniques.

**17" Picture Tube, Components for a TV Receiver, Scope, Signal Generator, HF Probe—all included in introductory price under \$200—Easy Terms**

If you want to go places in TV servicing, you will act quickly to find out what you get, what you practice, what you learn and how NRI's new course in Professional Television Servicing will help you advance through better technical knowledge and training. See pictures of equipment supplied, read what you practice in book offered FREE to ambitious men with some knowledge of Radio or TV fundamentals. Find out about this ALL PRACTICE Professional TV Servicing Course now.

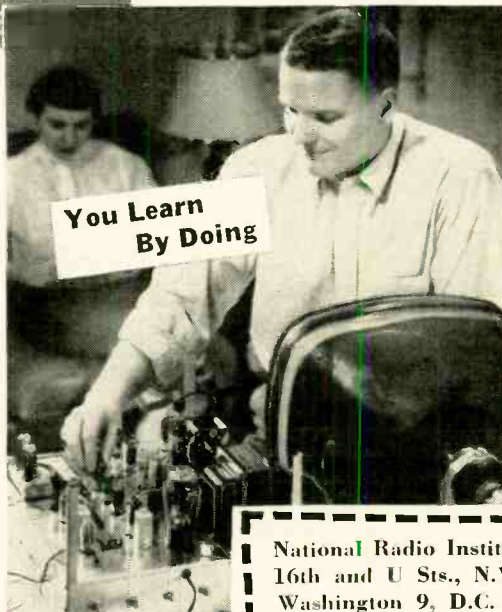

You Learn By Doing

## UHF and COLOR Create Growing Opportunities

To cash in on the present UHF and the coming COLOR TV boom you'll need the kind of knowledge and experience NRI's Course gives. You'll get practice installing front-end channel selector strips in modern UHF-VHF receivers. You learn UHF servicing problems and their solution. Mail the coupon now. Discover how NRI's new course in PROFESSIONAL TELEVISION SERVICING meets the needs of the man who wants to get ahead in TV Servicing.

### Not for Beginners

If you have some knowledge of Radio-TV fundamentals, or have had some Radio Shop experience or some Radio school training, this course IS FOR YOU. Mail coupon today.

**MAIL NOW**



## COUPON BRINGS IMPORTANT BOOK FREE

Get this book and judge for yourself how this course will further your ambition to reach the top in TV Servicing or help to build a more secure business of your own in TV. Many of tomorrow's top TV Servicemen . . . men who can service any make, any model, UHF, VHF or Color TV . . . will be graduates of this training. Mail the coupon now. There is no obligation.

National Radio Institute, Dept. 5BFT,  
16th and U Sts., N.W.  
Washington 9, D.C.

Please send my FREE copy of "How to Reach the Top in TV Servicing." I understand no salesman will call.

Name..... Age.....

Address .....

City..... Zone..... State.....

# RADIO - ELECTRONICS

Formerly RADIO CRAFT • Incorporating SHORT WAVE CRAFT • TELEVISION NEWS • RADIO & TELEVISION\*

Hugo Gernsback  
Editor and Publisher  
M. Harvey Gernsback  
Editorial Director  
Fred Shunaman  
Managing Editor  
Robert F. Scott  
W2PWG, Technical Editor  
Jerome Kass  
Associate Editor  
I. Queen  
Editorial Associate  
Matthew Mandl  
Television Consultant  
Angie Pascale  
Editorial Production  
Wm. Lyon McLaughlin  
Tech. Illustration Director  
Sol Ehrlich  
Art Director

Lee Robinson  
General Manager  
John J. Lamson  
Sales Manager  
G. Aliquo  
Circulation Manager  
Adam J. Smith  
Director, Newsstand Sales  
Robert Fallath  
Promotion Manager  
Seymour Schwartz  
Advertising Production

## GERNSBACK PUBLICATIONS, INC.

Executive, Editorial and Advertising Offices, 25 West Broadway, New York 7, N. Y. Telephone REctor 2-8630.

Hugo Gernsback  
Chairman of the Board  
M. Harvey Gernsback  
President  
G. Aliquo  
Secretary

ON THE COVER (Story on page 64) Model Carol Evans plucks one of the reeds of the Miessner electronic piano. Color original by Daniel R. Rubin.

(We regret that a credit was overlooked on last month's cover. The TV tube shown was supplied through the courtesy of Sylvania Electric Products, to whom our thanks are due.)



## CONTENTS

FEBRUARY 1955

Editorial (Page 31)	
Tec-Teleducation.....	by Hugo Gernsback 31
Test Instruments (Pages 32-41)	
New Color Bar and White Dot Generators.....	by Robert F. Scott 32
Pistol-Grip Signal Tracer.....	by Homer L. Davidson 36
Diode Wattmeter.....	by R. L. Ives 38
Transistor Voltmeter Design Problems.....	by I. Queen 39
New Chromatic Amplifier.....	by Robert G. Middleton 40
Television (Pages 42-57)	
TV DX in 1954.....	by E. P. Tilton 42
Color TV Circuits, Part IX—The Lawrence strip type tube ...	by Ken Kleidon and Phil Steinberg 44
Television—it's a Cinch (Fifteenth conversation, first half— Separating the sync signal, why, where and how; diode and pentode separators.....	by E. Aisberg 47
Ted Tackles Tough TV Problems.....	by Wallace Waner 50
U.H.F. Installation Techniques.....	by Harold Davis 52
The Teledocor.....	by Hugo Gernsback 54
TV Service Clinic.....	Conducted by Jerry Kass 56
Electronics (Pages 58-63)	
How a Computer Works.....	by David B. Mumford 58
Novel High-Voltage Supply.....	60
Phototransistors and Photoelectrets.....	by Edward D. Padgett 61
Audio—High Fidelity (Pages 64-98)	
New Electronic Piano (Cover Feature).....	by Benjamin F. Miessner 64
High-Fidelity Dictionary.....	by Ed Bukstein 70
For Golden Ears Only.....	by Monitor 81
Four-Input Amplifier.....	by Albert Stratmoen 86
Electrostatic Tweeter.....	by Marvin Hobbs 90
Gilding the Golden Ears.....	by Joseph Marshall 91
Radio (Pages 100-107)	
Rotatable Loop Antenna for Broadcast Reception.....	by John A. Dewar 100
Protect Your Transistors.....	by Harold Reed 104
Hi-Fi FM for Your Car.....	106
DEPARTMENTS	
Books.....	146
Business.....	136
Correspondence.....	12
New Devices.....	110
New Tubes and Transistors.....	128
Patents.....	131
People.....	140
Question Box.....	124
The Radio Month.....	6
Radio-Electronic Circuits.....	121
Technical Literature.....	143
Technicians' News.....	116
Technotes.....	133
Try This One.....	134

MEMBER Audit Bureau of Circulation

Average Paid Circulation over 180,000

Vol. XXVI, No. 2

RADIO-ELECTRONICS, February, 1955, Vol. XXVI, No. 2. Published monthly at Mt. Morris, Illinois, by Gernsback Publications, Inc. Entered as Second Class matter June 23, 1954, at the Post Office at Mt. Morris, Ill. Copyright 1955 by Gernsback Publications, Inc. Text and illustrations must not be reproduced without permission of copyright owners. SUBSCRIPTIONS: Address correspondence to Radio-Electronics, Subscription Dept., 404 N. Wesley Ave., Mt. Morris, Ill., or 25 West Broadway, New York 7, N. Y. When ordering a change please furnish an address stencil impression from a recent wrapper. Allow one month for change of address. SUBSCRIPTION RATES: In U. S. and Canada, and in U. S. possessions, \$3.50 for one year; \$6.00 for two years; \$8.00 for three years; single copies 35c. All other foreign countries \$4.50 a year; \$8.00 for two years; \$11.00 for three years. BRANCH ADVERTISING OFFICES: Chicago: 7522 North Sheridan Road, Tel. Rogers Park 4-8000. Los Angeles: Ralph W. Harker and Associates, 1127 Wilshire Boulevard, Tel. MAdison 6-1271. San Francisco: Ralph W. Harker and Associates, 582 Market St., Tel. Garfield 1-2481. FOREIGN AGENTS: Great Britain: Atlas Publishing and Distributing Co., Ltd., London E.C. 4. Australia: McGill's Agency, Melbourne. France: Brentano's, Paris 2e. Belgium: Agence et Messageries de la Presse, Brussels. Holland: Trilectron, Heemstede, Greece: International Book & News Agency, Athens. So. Africa: Central News Agency Ltd., Johannesburg; Capetown, Durban, Natal. Universal Book Agency, Johannesburg. Middle East: Steimatzky Middle East Agency, Jerusalem, India: Broadway News Centre, Dadar, Bombay #14. Pakistan: Paradise Book Stall, Karachi 3. POSTMASTER: If undeliverable send form 3578 to: RADIO-ELECTRONICS, 25 West Broadway, New York 7, N. Y. \*Trademark registered U.S. Patent Office.



## National Schools brings you a new dimension in training for TELEVISION-RADIO-ELECTRONICS

### YOU CAN LEARN BY HOME STUDY, IF—

- you are ambitious to increase your earning power.
- you want to broaden your knowledge and skill.
- you choose the school with the most complete training and service.

### 50 Years of Successful Training

National Schools has been training men for success since 1905. Our graduates are located around the globe, in good-paying jobs in servicing, installation and manufacturing... in public and private industry, or in their own businesses. All this experience and background are your assurance of success.

### What This New Dimension in Home Study Means to You

As a National Schools student, with Shop Method Home Training, you master *all phases* of the industry—TV, Radio, Electronics—theory and practice. You learn HOW and WHY, in one complete course at one low tuition.

Because National Schools' world headquarters are in Los Angeles—"capital city" of TV-Radio-Electronics—our staff is in close touch with industry. Our lessons and manuals are constantly revised to keep you up-to-the-minute on latest developments. We show you how to make spare time earnings as you learn, and we give you free placement assistance upon graduation. National Schools is approved for G. I. Training. Both Resident and Home Study courses are offered. If you are of draft age, our training helps you achieve specialized ratings and higher pay grades.

This *new dimension* enables us to train you as you should be trained at home, regardless of your age or previous education.

### Your Course Includes Valuable Units

We send you important equipment, including a commercial, pro-

fessional Multitester... plus parts to build Receivers, Oscillators, Signal Generator, Continuity Checker, other units, and Short Wave and Standard Broadcast Superhet Receiver.

### Mail Coupon for Complete Information

Get these two free books about this new dimension in Home Training. A comprehensive, illustrated fact-book and a sample National Schools lesson. No obligation, so mail coupon today.

### NATIONAL SCHOOLS

TECHNICAL TRADE TRAINING SINCE 1905  
Los Angeles 37, Calif. • Chicago: 323 W. Polk St.  
In Canada: 811 W. Hastings St., Vancouver, B.C.



### MAIL NOW TO OFFICE NEAREST YOU!

(mail in envelope or paste on postal card)

### NATIONAL SCHOOLS, Dept. RG-25

4000 S. FIGUEROA STREET      OR      323 W. POLK STREET  
LOS ANGELES 37, CALIF.,      CHICAGO 7, ILL.

Rush FREE BOOK, "Your Future in Radio-TV-Electronics," and FREE LESSON. No obligation, no salesman will call.

NAME \_\_\_\_\_ BIRTHDAY \_\_\_\_\_ 19 \_\_\_\_\_

ADDRESS \_\_\_\_\_

CITY \_\_\_\_\_ ZONE \_\_\_\_\_ STATE \_\_\_\_\_

Check if interested ONLY in Resident Training at Los Angeles.

VETERANS: Give date of discharge \_\_\_\_\_

Thrill to  
"silk-and-diamond"  
highs\*

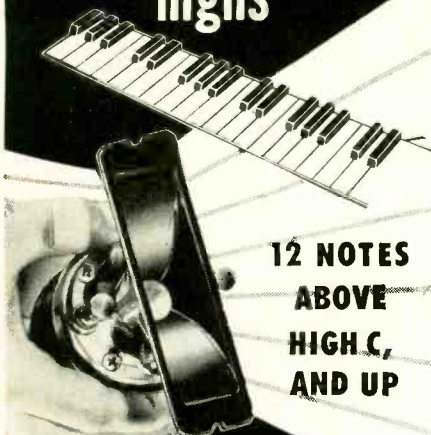

12 NOTES  
ABOVE  
HIGH C,  
AND UP



T 35 Super Sonax

\*Smooth as silk, brilliant as diamonds, the highest octaves you can hear are realistically yours, with an E-V T35 in your high fidelity music installation. This new, very-high-frequency tweeter takes over from 3500 cps to beyond audibility . . . provides 180° dispersion. Is easily installed, along with recommended X36 crossover and AT37 level control.

T35	List \$55.00	Audiophile Net	\$33.00
T35B	List \$35.00	Audiophile Net	\$21.00
X36	List \$14.00	Audiophile Net	\$ 8.40
AT37	List \$ 6.00	Audiophile Net	\$ 3.60

The T35B — for lower powered systems and existing quality AM-FM radio or radio-phonographs, finished in flat matte black. Requires only X36 to attach to music system. Impedance 16 ohms. Shipping weight 2 lbs.

Beautiful T35 Accessory Enclosure

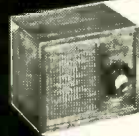

The Piccolino for either the T35 or the T35B. Styled in gleaming tropical mahogany or lusty Korina blonde. List \$15.00 Audiophile net \$9.00.

The Piccolino, complete with Super-Sonax, X36 crossover and AT37 level control wired and ready to connect to your music system; with T35 list \$90.00 Audiophile net \$51.00; with T35B list \$70.00 Audiophile net \$42.00.

Prove the performance of the T35 to yourself!

You hear the difference with this T35 demonstrator. With a flip of the switch you bring in or cut out the T35. Visit your E-V distributor to conduct this amazing test personally.



Today—write for Bulletin 194 and where to buy.

**Electro-Voice**

ELECTRO-VOICE, INC.  
BUCHANAN, MICHIGAN

the  
Radio  
month



**LIGHT AMPLIFIER** demonstrated by General Electric Co. may in the future solve the problem of "picture-on-the-wall" television receivers.

The light amplifier consists of a thin phosphor film between two electrodes. The front electrode is transparent, to permit incident and amplified light to pass, and is made of conductive glass. A voltage in the order of 100, supplied by an ordinary B battery, is connected across the electrodes, putting the phosphor in an electrostatic field.

Light striking atoms of a phosphor cause them to emit electrons, which produce light by collision with other atoms in the phosphor. In the light amplifier, the electrons are speeded up and given more energy by the direct voltage across the phosphor, thus producing more light than would otherwise be the case.

In the demonstration, a small lantern-slide image projected by ultra-violet light on a phosphor screen was brightened gradually from bare visibility to a bright picture by turning the voltage up from 0 to 120.

Amplification was strictly proportional, dark portions of the screen remaining black and the brightest portions coming up to highest brilliance. A total increase of 10 times was reported achieved, but theoretical limits are far beyond present accomplishment.

Drs. Williams and Cusano, who developed the amplifier, were extremely cautious about predicting practical applications for it in the near future. Asked about television screens, they pointed out that practical problems of obtaining phosphors of short enough persistence, producing large enough screens and modulating them with a TV signal were still to be solved.

CANADIAN TV STATIONS AS OF DEC. 20, 1954

CHCT-TV	Calgary, Alta.	2
CFRN-TV	Edmonton, Alta.	3
CBUT	Vancouver, B.C.	2
CBWT	Winnipeg, Man.	4
CKCW-TV	Moncton, N.B.	2
CHSJ-TV	St. John, N.B.	4
CBHT	Halifax, N.S.	3
CJCB-TV	Sydney, N.S.	4
CHCH-TV	Hamilton, Ont.	11
CKWS-TV	Kingston, Ont.	11
CKCO-TV	Kitchener, Ont.	13
CFPL-TV	London, Ont.	10
CBOT	Ottawa, Ont.	4
CFPA-TV	Port Arthur, Ont.	2
CJIC-TV	Sault Ste. Marie, Ont.	2
CKSO-TV	Sudbury, Ont.	5
CBLT	Toronto, Ont.	9
CKLW-TV	Windsor, Ont.	9
CBFT	Montreal, Que.	2
CBMT	Montreal, Que.	6
CFCM-TV	Quebec City, Que.	4
CJBR-TV	Rimouski, Que.	3
CKCK-TV	Regina, Sask.	2
CFQC-TV	Saskatoon, Sask.	8

**SEVEN NEW TV STATIONS** have gone on the air since our January report. These are:

WEDM	Munford, Ala.	7
WPFA-TV	Pensacola, Fla.	15
WIRI	Plattsburg, N.Y.	5
WFMZ-TV	Allentown, Pa.	67
KTRK-TV	Houston, Tex.	13
KCTS	Seattle, Wash.	9
WOAY-TV	Oak Hill, W.Va.	4

Two stations have gone off the air:

KCEB	Tulsa, Okla.	23
WNAM-TV	Neenah, Wis.	42

Five new Canadian stations have gone on the air: CKCW-TV, Moncton, N.B., channel 2; CKWS-TV, Kingston, Ont., channel 11; CJIC-TV, Sault Ste. Marie, Ont., channel 2; CJBR-TV, Rimouski, Quebec, channel 3, and CFQC-TV, Saskatoon, Sask., channel 8. (New list of Canadian stations above includes these).

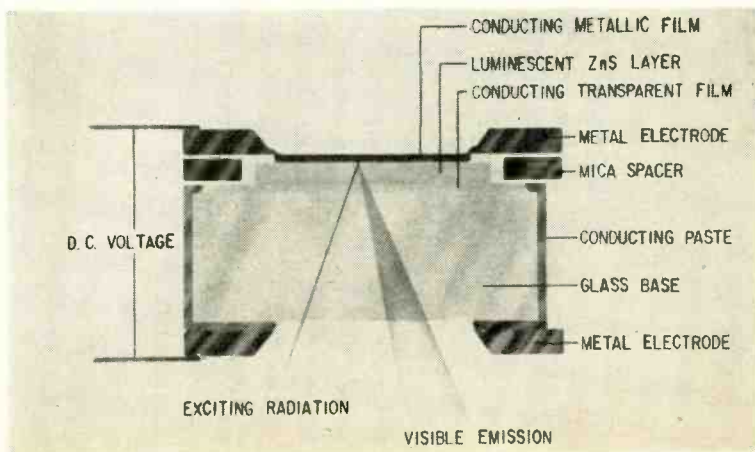

In Spare Time at Home—Prepare for a Better Job—  
or Your Own Business in

# TELEVISION RADIO • ELECTRONICS



You build and keep this valuable Jewel Bearing MULTI-METER.



5 INCH  
"SCOPE"

You also build and keep this high quality 5 INCH oscilloscope—almost a "must" for Television servicing.

If the man who is seeking a better job or a business of his own will take time to compare all the opportunities available to him today, he will undoubtedly consider a career in Television-Radio-Electronics.

A bird's eye view of the tremendous opportunities that exist in this fast-growing American industry reveals that hundreds of TV stations are yet to be built, millions of sets to be manufactured, and other millions of existing sets to be serviced from time to time.

Another marked advantage for men 17 to 45 is the fact that they can prepare to enter these profitable fields in their spare time at home or in our modern laboratory in Chicago. Another distinct advantage is the fact that no previous technical experience or advanced education is required.

After a man completes his training at home or in our Chicago Laboratory, he may get the benefit of our effective EMPLOYMENT SERVICE to help him get started.

Again we say—compare these opportunities and advantages. Send for full facts today. Mail coupon below NOW!



21 INCH

Build and keep this BIG DTI Engineered TV set—easily converted to U.H.F. (DTI offers another home training, but without the TV set.)

## COLOR TELEVISION

D.T.I.'s program also includes training in Color Television

## EMPLOYMENT SERVICE

Upon completing either the Chicago Laboratory or Home Training, DTI's long-established, effective Employment Service is ready to help you start earning real money. Get full facts. Mail coupon today.

## MODERN LABORATORY

If preferred, you can get all of your preparation in our modern Chicago Training Laboratory—one of the finest of its kind. Ample instructors, modern equipment. Write for details!

"One of America's Foremost  
Television Training  
Centers"



## WORK OVER 300 PROJECTS

You set up your own HOME LABORATORY . . . work with and keep the same type of basic electronic parts used in D.T.I.'s modern Chicago Training Center. Now you can get real Laboratory-type training—AT HOME.

## MILITARY SERVICE!

If you're subject to military service, the information we have for you should prove very helpful. Mail coupon today.

89 WAYS TO EARN MONEY IN TELEVISION RADIO-ELECTRONICS

## 16-mm. HOME MOVIES



You use this 16-mm. motion picture projector and many reels of educational film—a wonderful, exclusive, D.T.I. home aid to help you understand important fundamentals faster . . . easier . . . better. It's almost like having a teacher in your home.

**ACT NOW!**

Get information packed publication FREE!!  
Mail Coupon Today.

## DeVRY TECHNICAL INSTITUTE

4141 Belmont Ave., Chicago 41, Ill. Dept. RE-2-L

I would like the facts, including your valuable information-packed publication showing how I may get started toward a good job or my own business in Television-Radio-Electronics.

Name \_\_\_\_\_ Age \_\_\_\_\_  
Street \_\_\_\_\_ Apt. \_\_\_\_\_  
City \_\_\_\_\_ Zone \_\_\_\_\_ State \_\_\_\_\_

D.T.I.'s Training is available in Canada



## DeVRY TECHNICAL INSTITUTE

AFFILIATED WITH

DEFOREST'S TRAINING, INC.

CHICAGO 41, ILLINOIS

# You can build a reputation on Tung-Sol® Quality

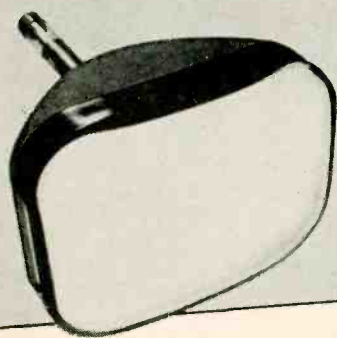

**TUNG-SOL** makes  
All-Glass Sealed Beam Lamps,  
Miniature Lamps,  
Signal Flashers,  
Picture Tubes, Radio, TV,  
Special Purpose Electron Tubes,  
Semiconductor Products.

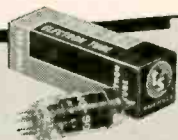

**TUNG-SOL ELECTRIC INC.**  
Newark 4, New Jersey

Sales Offices: Atlanta, Chicago, Columbus, Culver City (Los Angeles), Dallas, Denver, Detroit, Newark, Seattle

## THE RADIO MONTH

**IRE PRESIDENT FOR 1955** is John D. Ryder (see photo), dean of the School of Engineering at Michigan State College. His election carried with it one of the nation's highest professional honors. Ryder succeeds William R. Hewlett, vice president of Hewlett-Packard Co., as head of the international society of 40,000 radio engineers and scientists.

Holder of numerous patents and author of three textbooks on electronics and networks, Ryder, a Fellow of the IRE, has long been active in that organization's affairs.



**FIRST TV STATION** to operate without any local programming was authorized to broadcast on channel 9 from Lufkin, Tex. The station, it was stated, would rebroadcast programs of KPRC-TV (channel 2), Houston. In dissenting from the FCC grant, Commissioner Frieda Hennock stated, "By this action the commission for the first time has authorized the use of a v.h.f. channel by a station operating as a satellite of another v.h.f. station and carrying exclusively the programs of the parent station, which is licensed to serve a distant city.

"On Aug. 5, 1954, the commission announced a new policy under which it will consider applications for stations in the u.h.f. band which do not propose to originate any local programs. No reference was made to the possible use of v.h.f. channels for satellite stations operating off v.h.f. parent stations and carrying exclusively the programs of the latter. The grant thus extends the scope of the Aug. 5 policy and the limits then announced."

**GEORGE ASHLEY CAMPBELL**, scientist and inventor in the field of electrical communications, died Nov. 11, 1954. The 83-year-old mathematical physicist was a staff member of Bell Telephone Labs until his retirement in 1935.

Campbell is credited with contributing to the invention of the loaded line, which made possible long-distance telephone calls. His inventions also include the electric wave filter, which for the first time permitted the sending of many conversations over the same elec-

trical circuit, and the shielded balance, a measuring apparatus.

In 1936 Dr. Campbell received the Medal of Honor of the Institute of Radio Engineers. He joined the American Bell Telephone Co. in Boston in 1897.

**NEW COLOR TV RECEIVER** has been demonstrated by Hazeltine. The receiver, which of course works on the NTSC system, is a projection model using three C-R tubes. Each tube produces one primary color: red, blue or green. The optical assembly contains three 2½-inch projection tubes and a system of lenses and mirrors. It combines and enlarges the outputs of the tubes and projects the color picture on a flat screen slightly larger than the face of a 21-inch direct-view tube. The receiver also operates on monochrome.

The optical assembly containing the three tubes and the necessary lenses and mirrors is a compact unit intended to be adjusted at the factory. It will then maintain adjustment and registry until it becomes necessary to replace one of the color tubes. At that time simple adjustments, of a type which can easily be made by a skilled service technician, would be needed.

It was estimated that the cost of the receiver would be comparable to that of sets using tricolor picture tubes. One outstanding advantage of this set is the cost of picture-tube replacement—the price of the small tubes being many times less than that of the present types of tricolor picture tubes.

**CBS LICENSES RCA** to manufacture direct-view color TV picture tubes of the curved screen mask type, a development of CBS-Hytron. The agreement, a 5-year pact, grants RCA rights to use the original patent as well as other CBS patents that may issue from pending applications. CBS officials announced the move as a definite step toward long-sought-after tube standardization in the color TV field.

RCA's recent announcement of limited commercial production of color TV sets using the company's new 21-inch tricolor tube (21AXP22) was the first use of the licensing agreement. The tube was described as a 21-inch round metal type using a curved screen mask. RCA had previously made tubes of the flat or planar mask type.

**NINE ARRESTS** were the result of a Miami, Fla., drive on dishonest television repair practices. The campaign was due to cooperative action by city and county officials, the local Radio and Television Technicians Guild and the Miami Better Business Bureau. Those arrested were accused of obtaining money by trick and petty larceny. Methods were said to include making unnecessary repairs, charging for parts not installed, inflating bills with labor not performed and substituting used parts for new ones. **END**



# Which Do You Want?

**\$ PAY CHECK**  
Better Pay



A Nice Home



Greater Security



A New Car



Happy Vacation  
and Travel

Get Your FCC Ticket  
-Then Use Our  
Amazingly Effective  
Job-Finding Service  
To Get a Better Job

I can train you to pass your FCC License Exams in a minimum of time if you've had any practical radio experience—amateur, Army, Navy, radio servicing or other. My time-proven plan can help put you, too, on the road to success.

Let me send you FREE the entire story. Just fill out the coupon and mail it. I will send you, free of charge, a copy of "How to Pass FCC License Exams," plus a sample FCC-type Exam, and the amazing new booklet, "Money Making FCC License Information."

Carl E. Smith, E.E.  
President

add technical training to your practical experience and

**Get Your  
FCC COMMERCIAL  
RADIO OPERATOR  
LICENSE  
IN A MINIMUM OF TIME!**



Get This  
Amazing Booklet  
FREE...



TV ENGINEERING  
INCLUDED IN OUR  
TRAINING AND  
COACHING

**TELLS HOW**

**HERE IS YOUR GUARANTEE**  
If you fail to pass your Commercial License exam after completing our course, we guarantee to continue your training without additional cost of any kind, until you successfully obtain your Commercial license, provided you first sit for this examination within 90 days after completing your course.

**TELLS HOW**

**WE GUARANTEE**  
TO TRAIN AND COACH YOU AT HOME IN SPARE TIME  
UNTIL YOU GET **YOUR FCC LICENSE**

An Approved Member



**TELLS HOW** EMPLOYERS MAKE

**JOB OFFERS Like These to Our Graduates Every Month**

Letter from nationally-known Airlines: "Radio Operators and Radio Mechanics are needed for our company. Periodic wage increase with opportunity for advancement. Both positions include many company benefits such as paid vacations, free flight mileage allowance and group insurance."  
Letter from nationally-known manufacturer: "We have a very great need at the present time for radio-electronics technicians and would appreciate any helpful suggestions that you may be able to offer."  
These are just a few examples of the job offers that come to our office periodically. Some licensed radioman filled each of these jobs... it might have been you!

**HERE'S PROOF FCC LICENSES ARE OFTEN SECURED IN A FEW HOURS OF STUDY WITH OUR Coaching AT HOME in Spare Time**

Name and Address	License	Time
Harry G. Frame Box 420, Charlestown, W. Va.	2nd Class	13 Weeks
Charles Ellis Box 449, Charles City, Iowa	1st Class	28 Weeks
Omar Bibbs 1320 E. 27th St., Kansas City, Mo.	1st Class	34 Weeks
Kenneth Rue Dresser, Wisconsin	2nd Class	20 Weeks
B. L. Jordan Seattle, Washington	1st Class	20 Weeks

**CLEVELAND INSTITUTE OF RADIO ELECTRONICS**  
Desk RE-73, 4900 Euclid Bldg., Cleveland 3, Ohio  
CARL E. SMITH, E.E., Consulting Engineer, Pres.

**Our Amazingly Effective JOB-FINDING SERVICE**

**Helps CIRE Students Get Better Jobs**  
Here is just one recent example of Job-Finding Results  
Gets Five Job-Offers from Broadcast Stations

**OURS IS THE ONLY HOME STUDY COURSE WHICH SUPPLIES FCC-TYPE EXAMINATIONS WITH ALL LESSONS AND FINAL TESTS.**

"Your 'Chief Engineer's Bulletin' is a grand way of obtaining employment for your graduates who have obtained their 1st class license. Since my name has been on the list, I have received calls or letters from five stations in the southern states, and am now employed as Transmitter Engineer at WMMT."  
Elmer Powell, Box 274, Sparta, Tenn.

Your FCC ticket is recognized by most employers in the electronic field as proof of your technical ability.

Get All 3 Free  
MAIL  
COUPON  
NOW

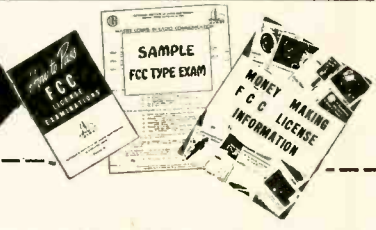

**B CLEVELAND INSTITUTE OF RADIO ELECTRONICS**  
Desk RE-73, 4900 Euclid Bldg., Cleveland 3, Ohio  
(Address to Desk No. to avoid delay)

I want to know how I can get my FCC ticket in a minimum of time. Send me your FREE booklet, "How to Pass FCC License Examination" (does not cover exams for Amateur License), as well as a sample FCC-type exam and the amazing new booklet, "Money-Making FCC License Information." Be sure to tell me about your Television Engineering Course.

Name \_\_\_\_\_  
Address \_\_\_\_\_  
City \_\_\_\_\_ Zone \_\_\_\_\_ State \_\_\_\_\_

For prompt results, send air mail.  
Special tuition rates to members of the U. S. Armed Forces.

the  
most  
complete  
line

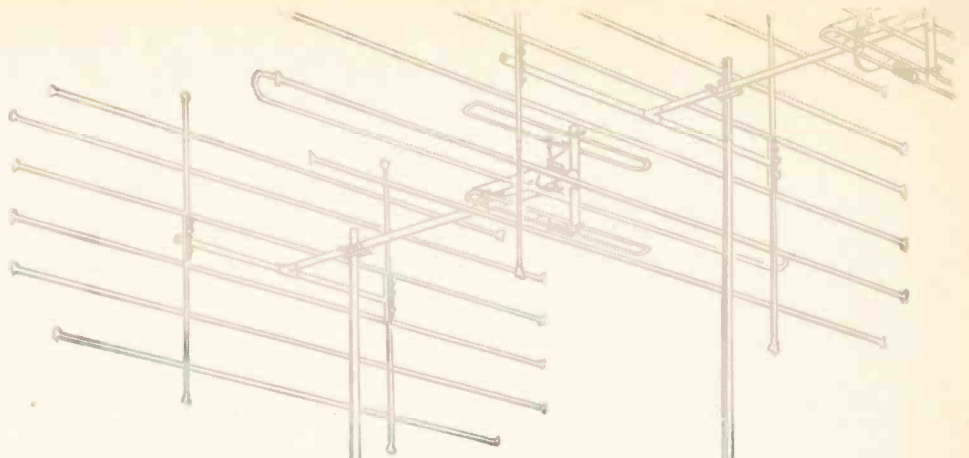

# C·D·R ROTORS are BEST

Most Powerful • Most Reliable Sharpest Tuning

**BEST...**

*from the bottom up...  
inside out...*

**because**

Models TR-11 and 12

Models AR-1 and AR-2

Model TR-4

Model TR-2

**C·D·R ROTORS**  
have  
**AXS 679\***

\* The highest grade premium die cast aluminum... so rugged and durable that it is used for aircraft landing gear.

**PRE-SOLD to MILLIONS**  
*through spot announcements on television.*

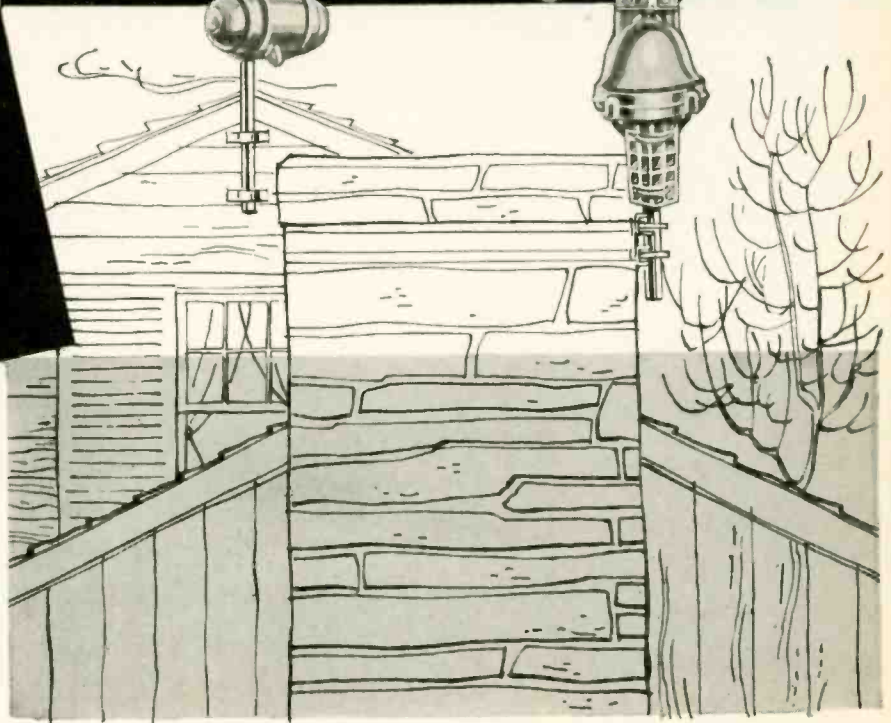

**CORNELL-DUBILIER**  
SOUTH PLAINFIELD, N. J.



**THE RADIART CORP.**  
CLEVELAND 13, OHIO

# RAYTHEON



Makes Long Lasting  
Aluminized Picture Tubes

With **RAYTHEON LUMILAC**

Exclusive Aluminizing Lacquer

Now you can get all the benefits of aluminized picture tubes — sharper picture, superior contrast, high light output — and *excellent picture tube life!*

Raytheon aluminized picture tubes are processed with the purest aluminum *plus* LUMILAC — a lacquer especially blended and used exclusively by Raytheon.

This lacquer produces an extra smooth unbroken surface for the aluminized coating, yet leaves no gas-

producing residues which could impair cathode emission and hence shorten tube life.

Next time you replace a picture tube try a Raytheon LUMILAC Aluminized Picture Tube. You'll be delighted with its performance in any set — amazed at how it will improve the picture of a low cost, low voltage range TV receiver. And so will your customer. Ask your Raytheon Tube Distributor for Raytheon Aluminized Picture Tubes with LUMILAC. Like all Raytheon Picture Tubes they are Right for Sight, Right for You and Always New.



**RAYTHEON MANUFACTURING COMPANY**

Receiving and Cathode Ray Tube Operations  
Newton, Mass., Chicago, Ill., Atlanta, Ga., Los Angeles, Calif.

*Excellence in Electronics*

RAYTHEON MAKES ALL THESE  
RECEIVING AND PICTURE TUBES • RELIABLE SOUND AND MINIATURE TUBES • SEMICONDUCTOR DIODES AND TRANSISTORS • NUCLEONIC TUBES • MICROWAVE TUBES

# The Only COMPLETE Line...

**Model SS**  
3-speed, 2-pole motor

**Model DSS**  
3-speed, 4-pole motor

**Model DR**  
2-speed, 4-pole motor

**Model LC**  
Single speed, 2-pole motor

**Model RM 4**  
Single speed, 4-pole motor

**Model D-10**  
4-pole, shaded pole A.C. Induction type for tape, wire, or disc recorders



**THE GENERAL INDUSTRIES CO.**

DEPARTMENT GE • ELYRIA, OHIO

**OVER 97,000 TECHNICIANS HAVE LEARNED  
HOW TO GET THE MOST OUT OF  
BASIC TEST EQUIPMENT** for AM FM-TV

## 'Servicing by Signal Substitution'

A BEST SELLER FOR OVER 13 YEARS!  
(NEW, UP-TO-DATE, 14th EDITION)

The Modern, Simplified, Dynamic Approach to  
all Receiver Adjustment & Alignment Problems

- ★ Nothing complicated to learn
- ★ No extra equipment to purchase
- ★ Universal . . . non-obsolete
- ★ Employs only Basic Test Instruments

Ask for "S.S.S." at your local Radio  
Parts jobber or remit 40¢ in small  
stamps or coin directly to factory.

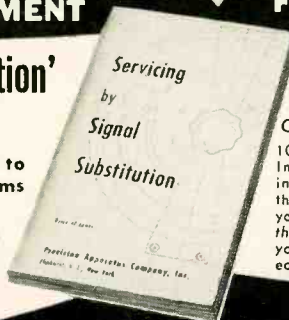

ONLY 40¢

103 pages.  
Invaluable  
information  
that will help  
you redouble  
the value of  
your basic test  
equipment.

PRECISION APPARATUS COMPANY, INC.  
70-31 84th STREET, GLENDALE 27, L. I., N. Y.

## Correspondence

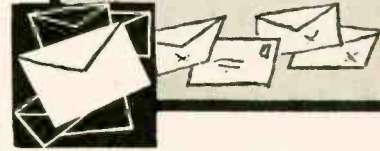

### VOTE OF CONFIDENCE

Dear Editor:

Congratulations on your bold stand in the Correspondence column of the December issue. I too feel that information is often needlessly kept out of more general use simply because of the very poor manner of its presentation. Highly involved articles might delight Mr. Holm but leave most people pretty much in the dark.

I feel that any subject can be presented in such a manner that the content can be grasped on the first reading. And more power to you and RADIO-ELECTRONICS which seems dedicated to this wholesome idea.

ELBERT ROBERSON

Port Washington, N. Y.

### REBUTTAL

Dear Editor:

I think Mr. Holm, in your December Correspondence column, has a legitimate criticism. By your own reply, the article was intended for persons "who would like to have a thorough look into the purposes, ingredients and techniques." You also stated that articles should be "interesting and understandable to the average and intelligent radio-TV technician."

I submit that the average intelligent radio-TV technician is capable of withstanding the shock of hearing that power is not always equal to E times I. If he cannot assimilate this—indeed, if he does not already know this—he has no business in radio-TV servicing.

I have not read the article to which Mr. Holm refers and so cannot say that there are errors in it, and there can be no argument with the editors' position that to communicate information the material must be clear and in language the reader understands. But if this information is *misinformation*, it is worse than none at all.

I think it is perfectly possible to write articles that are simple and accurate. Your magazine publishes one now and then! Such an article is that of D. J. Tomeik in the December, 1954, issue. It proceeds in a clear, logical manner without being overly technical. He adequately lays the groundwork for the concept of critical damping resistance, then discusses the things which affect its value. He even gives a simple mathematical (horrors!) summary of the things he has stated.

(NAME WITHHELD BY REQUEST)

Huntsville, Ala.

(Continued on page 16)

# FREE

## 1955 ALLIED 308-PAGE CATALOG

the only COMPLETE catalog  
for everything in TV, Radio  
and Industrial Electronics

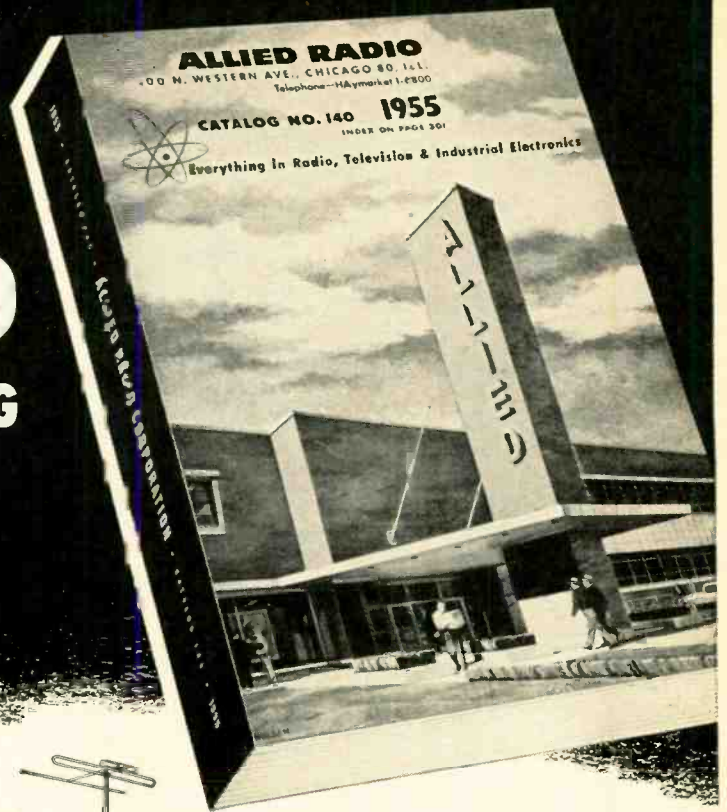

### World's largest Stocks

- All TV and Radio Parts
- All Electron Tube Types
- Test and Lab Instruments
- High Fidelity Equipment
- Custom TV Chassis
- AM, FM Receiving Equipment
- Recorders and Suppliers
- P.A. Systems, Accessories
- Amateur Station Gear
- Builders' Kits, Supplies
- Equipment for Industry

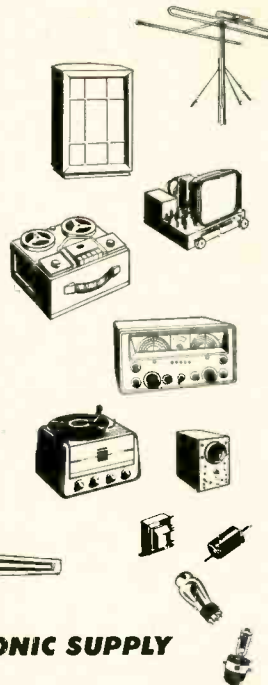

ultra-modern facilities for the  
**FASTEST SERVICE IN ELECTRONIC SUPPLY**

### SEND FOR IT TODAY!

Get ALLIED's 1955 Catalog—308 pages packed with the world's largest selection of quality electronic equipment at lowest, money-saving prices. Select from the latest in High Fidelity systems and components; custom TV chassis, TV antennas and accessories; AM and FM receiving equipment; P. A. systems and accessories; recorders and supplies; Amateur receivers, transmitters and station gear; specialized industrial electronic equipment; test instruments; builders' kits; huge listings of parts, tubes, tools, books—the world's *most complete* stocks of quality equipment. ALLIED gives you *every* buying advantage: fastest shipment, expert personal help, lowest prices, assured satisfaction. Get the big 1955 ALLIED Catalog. Keep it handy. Send for your FREE copy today.

**IT'S VALUE PACKED... SAVE ON  
EVERYTHING IN ELECTRONICS**

**SEND FOR THE LEADING  
ELECTRONIC SUPPLY GUIDE**

**FREE**



**ALLIED RADIO**  
world's largest Electronic Supply House

**EASY-PAY TERMS**  
Use ALLIED'S liberal Easy Payment Plan—only 10% down, 12 months to pay—no carrying charges if you pay in 60 days. Available on Hi-Fi and P.A. units, recorders, TV chassis, test instruments, Amateur gear, etc.

**HI-FI SPECIALISTS**  
To keep up with the latest and best in High Fidelity, look to ALLIED. Count on us for all the latest releases and largest stocks of Hi-Fi equipment. We specialize, too, in TV supply, and are foremost in the field of Builders' Kits.

ALLIED RADIO CORP., Dept. 2-B-5  
100 N. Western Ave., Chicago 80, Illinois

Send FREE 308-Page 1955 ALLIED Catalog.

Name \_\_\_\_\_

Address \_\_\_\_\_

City \_\_\_\_\_ Zone \_\_\_\_\_ State \_\_\_\_\_

PRODUCTION RATE

TV PICTURE TUBES

AS OF DEC. 1st = PLACES

CBS-HYTRON IN "BIG THREE"



*Another demonstration  
of confidence  
in CBS-Hytron  
advanced-engineering*



**CBS-HYTRON** Main Office: Danvers, Massachusetts  
A Division of Columbia Broadcasting System, Inc.

**BRAND  
NEW**

# FEATURES

THAT MAKE **TRIO** THE LEADER IN '55



**HEAVIEST BOOMS!**

Thick-wall, extra-sturdy 1 1/4" diameter booms. Nothing approaching them for strength! Now used on ALL towband yagis.

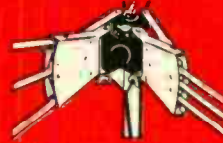

*New* "VARI-CON" HEAD

Four Hi-strength aluminum adjusting arms. Interlocking Butterfly sections. Heavier snap-action spring assembly. The "Vari-Con" is the only antenna with spring dampeners to lessen vibration and breakage. The "Vari-Con" head also used on the popular TRIO 88 Series.



*Sensational*  
**INSTA-LOK CLAMP**  
(Goodbye Nuts)

This revolutionary clamp permits instant slip-out assembly, permanent alignment with ultra strength. Nothing stronger — nothing faster! Insta-Lok employed on ALL TRIO Antennas that have parasitic elements.



*New* MINI-UP CONICAL HEAD

Swing out element mounting plates, fan out elements into snap-fastenings and it's set! Used throughout conical line.

*New* MYCASTYRENE INSULATORS USED THROUGHOUT TRIO LINE

 ZZ12L	 Twin-Six
 C44	 FDLH
 UBT-4	 SQ-1
 SV-2	 44

*New* TRIO ARISTOCRAT ROTATOR

NOW AVAILABLE IN **FOUR** GLORIOUS COLORS!



**TRIO 88**

Far superior construction. Rugged, foolproof — easily installed. Parasitic elements supported by TRIO's revolutionary new "Insta-Lok" clamps. Low channel dipoles supported by the strongest conical head made. No vibration — No element shedding. Completely pre-assembled. Available in single or two bay models.

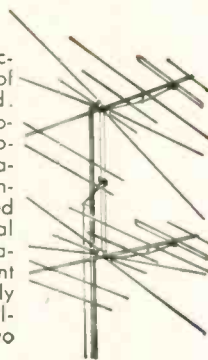

**TRIO 66**

Three dipoles provide exceptionally high gain on all VHF channels. Exclusive TRIO grid reflector gives improved performance. Extremely rugged yet lightweight Pre-assembled — simply unfold and tighten reflector and dipole assemblies. Three vertical braces on reflector screen for increased strength. Available in single or two bay models.

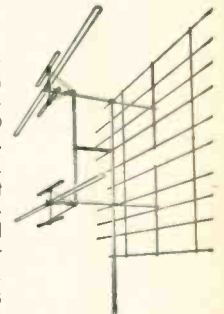

COPYRIGHT 1954 BY TRIO MANUFACTURING CO.

Ask To See America's Most Dependable And Beautiful Rotator:

**TRIO**  
Manufacturing Co.  
GRIGGSVILLE, ILLINOIS

 22U	 98-2	 50 Series	 100 Series
---------	----------	---------------	----------------

**TRIO** Leader in Antenna Development

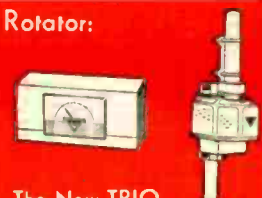

The New TRIO  
**"ARISTOCRAT"**

**NEW! 1955 TV DOCTOR**  
ATTENTION: NOVICE SERVICEMEN



The new TV DOCTOR was written expressly for the novice by H. G. Cisin, noted TV educator and author. Mr. Cisin has trained thousands of TV technicians, many of them now holding important positions in television. His years of experience are embodied in this valuable book!

TV DOCTOR contains just the info you need to start in TV servicing. No theory, math or formulas, but full of practical information. Copyrighted Trouble Shooting Guide pin-points hundreds of TV troubles, enabling you to diagnose faults without previous experience. Method applies to all TV sets, old and new. Special chips on color TV and U.H.F. Useful data about TV sets, tuners, antennas, lead-ins, interference, safety suggestions. How to read schematic diagrams. Practical hints for prospective service men. Many clear illustrations.... **Postpaid \$1**

**ABC OF COLOR TV**

**LEARN COLOR TV THIS EASY WAY!**

Just off the Press!



H. G. Cisin's remarkable book takes the mystery out of Color TV. The only book which explains this fascinating new TV development in a simple down-to-earth manner. It actually translates the highly technical descriptions of research scientists into plain everyday language.

Covers basic color principles, comparable color TV system, the color signal, color TV reception, plus practical pointers on color pix tubes, tests, etc. Just the info TV servicemen must have to cash in on this rapidly expanding new field. Profusely illustrated.... **Postpaid \$1**

**FAMOUS "TV CONSULTANT"**

TV Serviceman's Silent Partner



New, easy-to-use way to solve toughest TV troubles. UHF section includes conversions, installations and servicing. Modern alignment methods shown by pictures, diagrams and simple directions, tell exactly what to do and how to do it. Practical pointers on use of all TV Test Instruments. Over 300 pix, raster and sound symptoms. Detailed directions tell where and how to find faulty parts. Over 135 RAPID CHECKS, many using pix tube as trouble locator. 125 illustr. of scope wave forms, diagrams, station patterns, show various defects—take mystery out of TV servicing. **NO THEORY—NO MATH—NO FORMULAS—just practical service info, covering all types of TV sets....**

**Postpaid \$2**

**NEW! 1954 TV TUBE LOCATOR**

**TROUBLE INDICATING TUBE LOCATION GUIDES** for over 3000 most popular models from Admiral to Zenith, plus **PIX TUBES** used in each model 1947 to 1953 models. A storehouse of valuable TV servicing info. Priced very low for large volume sales.... **Postpaid \$1**

**NEW! Trouble Shooting PIX GUIDE incl. TV TERMS Explained**

Sec. 1 is a fully illustrated **GUIDE** to oft-recurring pix faults. Causes and cures explained. Copyrighted. Trouble Indicating illustrated chart tells where troubles start in typical TV set—illustrations show resulting faults TV pictures. Sec. 2 explains hundreds of TV terms in non-technical language. **Postpaid \$1**

**NEW! TV TROUBLE TRACER**

Each vol. contains different copyrighted "Trouble Indicating TUBE LOCATION GUIDES" of over 500 most popular TV models. Vol. 1 has older sets, vol. 3 newest 1954 models. 40 common picture troubles illustrated, traced to source and cured. **Vols. 1, 2 & 3.... Postpaid 50c ea.**

**H. G. CISIN, PUBLISHER**

Order from your Jobber today, or if not stocked, order postpaid from:

Harry G. Cisin, Dept. E-31  
Amagansett, New York

Enclosed find \$..... Send postpaid

- Color TV
- TV Doctor
- TV Consultant
- TV Tube Locator
- TV Pix Guide
- TV Tracer, Vol. 1
- TV Tracer, Vol. 2
- TV Tracer, Vol. 3

Name .....

Address .....

City..... Zone..... State.....

CORRESPONDENCE

(Continued)

**VOICE FROM THE WEST**

Dear Editor:

Hallelujah!!! is the only way I can open this letter, and I am referring to the controversy between the editors and Mr. Holm.

I am one of the would-be learners that Mr. Holm would deny knowledge to because I haven't sufficient mathematical training. Despite this handicap I am at present studying electronics at a trade school and find that when properly presented, I am capable of understanding technical articles.

I want to thank the editors of RADIO-ELECTRONICS for punching back. It is the first time I have ever read where editors weren't apologizing all over the place. The challenge you presented to Mr. Holm is very commendable.

ARTHUR L. RUTSCHMAN

Silverton, Ore.

**AN AUTHOR COMPLAINS**

Dear Editor:

I have been writing articles for RADIO-ELECTRONICS for some years. The articles have been—I like to think—clear, concise and timely. Most of them have had schematics and construction details. They were written on the premise that most readers of the magazine would have—at least—a knowledge of the fundamentals of electronics.

For some years now I have been receiving letters from the readers of RADIO-ELECTRONICS. They have led me to believe that perhaps I wasn't clear, concise and possessed of much knowledge. Or, is it that too many readers do not really read—especially schematics?

Recently I received a letter that went into a detailed explanation of how the writer had built an amplifier I described in a recent article, but he couldn't make the thing work. Could I help? I could and did. But the trouble wasn't in the amplifier at all. He had not studied the text of the article and had looked at the schematic *only* when he began to wire the parts. The title of the article or the editorial blurb had caught his fancy and he'd decided to build the amplifier. But if he had read the article he would have known of my caution about what *not* to do!

And another: The parts list indicated one value for a resistor and the schematic showed another. Which one to use? Now, I didn't mind straightening him out on this. But any tube manual could have told him the approximate value for a cathode bias resistor for this particular tube.

Did I use a gimmick on the whatsis? Well, the text of that particular article said it could be used but was not recommended. Yet, I received a three-page letter asking me if, in my learned opinion, the gimmick could be used!

So I wonder: have I been clear? Well, I can make a mistake. The editors can make one, too. The drafting department is not immune to errors either. But usually when the editor accepts an article for RADIO-ELEC-

**CANNON**  
Sub-Miniature  
**PLUGS**



TYPE "D" . . . UP TO 50 CONTACTS

**For Your Miniaturization Program!**

Save space . . . save weight . . . rugged. 1000's of uses! Pressed steel shells. Heavily gold-plated copper-alloy 5-amp. contacts give untarnishing high surface conductivity and corrosion resistance. Take #20 solder-tipped wires. Polarization means. Salt-spray resistant shells. Flashover 1700v dc.

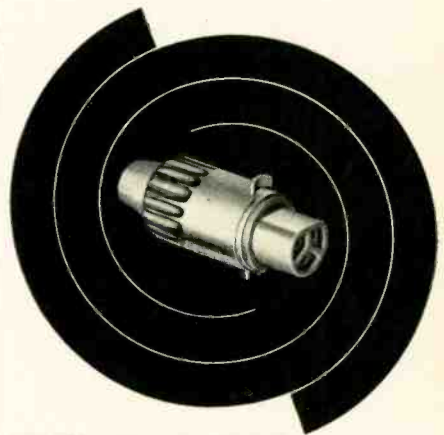

TYPE "U" . . . UP TO 12 CONTACTS

**Receptacles Hermetically-sealed**

Round steel shells. Pin receptacles have fused vitreous insulators to give *true hermetic seal*. Adaptable to box-or panel-mounting. Pin or socket plugs have resilient moisture-sealing insulators, *gold-plated contacts*. Bayonet latch. Cord connectors have resilient sleeves. Contacts 5-amp. Flashover 1700v dc.

Write for Cannon Sub-Miniature Bulletins . . . TODAY! Refer to Dept. 144.

CANNON ELECTRIC COMPANY, 3209 Humboldt St., Los Angeles 31, Calif. Representatives and Cannon distributors in all principal cities.



Since 1915

**CANNON ELECTRIC**

RADIO-ELECTRONICS





← *The data that Launched  
Thousands of Careers  
is yours FREE to show*

**HOW YOU CAN BE SUCCESSFUL  
IN RADIO-TV-ELECTRONICS**

*Send for Your Booklet Today!*

**Y**OU CAN plod along for years, getting a paltry increase now and then, enjoying little security, finding your work dull and drab.

Then something happens. Things look up. You become more confident. Your earnings rise. You feel more important.

"Luck," some may say.

"Contacts," others may suggest.

But in your heart, you will know the answer: "Training." And it all may have started the moment you filled out a coupon requesting a copy of a free booklet named "Your Future in the New World of Electronics." From this data you get knowledge of where you stand in Electronics. Tremendous expansion leaves this gigantic industry pleading for trained men. Top manufacturers sold billions of dollars worth of electronic merchandise in 1953. By 1960, the radio-electronics industry should do no less than 10 billion dollars per year, not counting military orders.

Today there are over 97,000 radio-equipped police cars; an even larger number of taxis are radio equipped (at least 87,000); 32,000 civilian planes have radio; 35,000 American ships have radio.

Today there are over 120,000,000 radios in use. There are 28,000,000 TV sets and 381 TV stations in operation. Color TV is coming into its own. Countless positions must be filled—in development, research, design, production, testing and inspection, manufacture, broadcasting, telecasting and servicing. To fill these posts, trained men are needed—men who somewhere along the line take time to improve their knowledge, their skills. Men who, today, perhaps, take two minutes to send for a booklet.

"Your Future in the New World of Electronics" shows you how CREI Home Study leads the way to greater earnings through the inviting opportunities described above.

However, CREI does not promise you a "snap." With an accredited technical school such as this, you must *study* to convert your ambition into technical knowledge you can sell in the fabulous Electronics market.

Since its founding in 1927, CREI has provided thousands of professional radio men with technical educations. During World War II CREI trained thousands for the Armed Services. Leading firms.

FEBRUARY, 1955

choose CREI courses for group training in electronics, at company expense, among them United Air Lines, Canadian Broadcasting Corporation, Trans-Canada Airlines, Sears, Roebuck and Co., Bendix Products Division, All-American Cables and Radio, Inc., and Radio Corporation of America.

CREI courses are prepared by recognized experts in a practical, easily understood manner. You get the benefit of time-tested materials, under the personal supervision of a CREI Staff Instructor, who *knows and teaches* you what industry wants. This is accomplished on your own time, during hours selected by you, and controlled by your own will power. This complete training is the reason that graduates find their CREI diplomas keys-to-success in Radio, TV and Electronics. CREI alumni hold top positions in America's leading firms. At your service is the CREI Placement Bureau, which finds positions for advanced students and graduates. Although CREI does not guarantee jobs, requests for personnel far exceed current supply.

Now is the time of decision for you. Luck will not propel you forward unless it finds you trained. Contacts won't budge you an inch unless you have the skill to back them up. The answer is: Technical Training . . . and willingness to learn. Together they will bring you increased earning in this new

Age of Electronics. Fill out the coupon below and mail it now. We'll promptly send you your free copy of "Your Future in the New World of Electronics." The rest—your future—is up to you.

CREI resident instruction (day or night) is offered in Washington, D.C. New classes start once a month.  
**VETERANS:** If you were discharged after June 27, 1950—let the new G.I. Bill of Rights help you obtain CREI resident instruction. Check the coupon for full information.

**MAIL THIS COUPON Today!**

**CAPITOL RADIO ENGINEERING INSTITUTE**

Accredited Technical Institute Curricula  
Dept. 142-B, 3224 16th St., N. W., Washington 10, D.C.

Please send me your course outline and FREE Illustrated Booklet "Your Future in the New World of Electronics" . . . describing opportunities and CREI home study courses in Practical Electronics Engineering.

- CHECK FIELD OF GREATEST INTEREST** }  Practical Radio Engineering  
 Broadcast Radio Engineering (AM, FM, TV)  
 Practical Television Engineering  
 Aeronautical Electronics Engineering  
 TV, FM & Advanced AM Servicing

Name.....

Street.....

City..... Zone..... State.....

CHECK:  Residence School  Veteran

To help us answer your request intelligently, please give the following information:

EMPLOYED BY.....

TYPE OF PRESENT WORK.....

SCHOOL BACKGROUND.....

ELECTRONICS EXPERIENCE.....

IN WHAT BRANCH OF ELECTRONICS ARE YOU MOST INTERESTED?  
.....

STEP  
AHEAD of the  
"CUT and TRY" BOYS

with the NEW

# Radion

FIELD STRENGTH METER



Model FSM 5000 Only **\$9750**  
less batteries

BATTERY OPERATED - FOR VHF-UHF

Move forward into bigger business. Save time, money. No guessing whether antenna or receiver is at fault. Find your problem immediately.

On new installations you KNOW which antenna location is best before proceeding. A Radion Meter builds customer confidence, often pays for itself in two months time.

Beautifully designed, easy to use. All TV channels 2 to 83 and FM band. Weighs only 16 lbs. with standard batteries. Absolute readings in microvolts. Monitoring jack for audio. Size 11 x 8½ x 6 in. Ask your distributor or write direct for specifications.



No guesswork  
in your methods.



Quickly locate cause  
of weak signals.

# Radion

THE RADION CORPORATION

Dept. G, 1130 W. Wisconsin Ave.  
Chicago 14, Ill.

CORRESPONDENCE

(Continued)

TRONICS he is pretty sure the author has something that works, written up so that it can be understood. And he is reasonably certain that most of his readers will like the article and will want to build whatever is described.

The letters I receive—and I've had several for every article—show that articles get read. But I think some of them must have been read with one eye on the TV screen and the other gazing into space at the finished product before the soldering iron gets hot.

So this is a plea, for myself and all authors:

*Read the text of the article several times, especially if you're going to build something.*

Study the diagrams. Are there any possible mistakes? Some puzzling use of circuitry? New tubes, techniques?

Don't start changing things before you've even tried the author's values.

And if you must write, remember the author is flattered to receive letters (he has readers!) but write so he can read! Use a typewriter, if possible, and refer to the page and issue of RADIO-ELECTRONICS as well as the title of the article. Outline your trouble, ask your questions or make your comments. But keep it short and to the point. And let the author know you've really read the article.

DON V. R. DRENNER

Coffeyville, Kans.

## CAPACITORS

Dear Editor:

Mr. Rogers' article, "A Low-Cost Crossover Network," in the November, 1954, issue was just what I have been looking for. But—other articles on cross-over networks have stated that paper capacitors should be used in such circuits. Mr. Rogers used electrolytics.

MAJ. JESSE D. THOMPSON

Wright-Patterson A. F. B., Ohio

(Theoretically paper capacitors are superior. Actually it has been recognized for many years that electrolytics can be used like paper capacitors where voltages are low. Each unit should be measured, however, since capacitance tolerances are greater than for paper capacitors. The old Solar capacitor checker—and presumably most of the others of the same general type—tested and measured electrolytics with a low-voltage alternating current. Electrolytics have been used in cross-over networks where their greater convenience may outweigh any possible disadvantages. One of the late E. T. Flevelling's prized souvenirs of a certain type of engineering mentality was a set of electrolytics from the network of his audio system, the patent on which he had just sold to a large radio company. The company's engineer had clipped them out immediately, because "paper capacitors should be used," in spite of the fact that they had performed sufficiently well in the equipment to sell the idea to the company!

—Editor)

## NEW! SHOW-HOW BOOK

BRINGS YOU PRACTICAL

SERVICING KNOW-HOW



Saves Your  
Time So You

EARN  
MORE  
DAILY

ONLY \$250

JOHN T. FRYE'S

## "Radio Receiver Servicing"

A new book with the practical slant on servicing for which this author is noted. Covers each of the three common types of radio receivers: the power-transformer set, the AC-DC series-filament type and the 3-way portable type. Each is discussed separately, since many troubles are peculiar to only one type of receiver. Each basic trouble (dead set, weak set, intermittent set, noisy set, etc.) is separately treated. Clear organization and discussion makes it easy to refer to specific trouble. Another desirable feature is the progression from easy-to-solve problems to those that are more difficult. Special receivers, such as FM sets, all-wave sets, auto radios and storage battery portables are covered in separate chapters.

### Servicing Through Symptoms:

Invaluable time-saving hints, such as easy trouble-shooting through reference to symptoms, make this book a real "right hand" for busy servicemen. You'll save time, you'll earn more with this latest Howard W. Sams' publication. 192 pages. 5½ x 8½". You'll want it for quick help on shop and outside repairs.

ORDER RS-1 **\$250**  
Only.....

ORDER  
TODAY

HOWARD W. SAMs & CO., INC.

Order from your Parts Jobber today, or write to Howard W. Sams & Co., Inc., 2205 East 46th St., Indianapolis 5, Ind.

My (check) (money order) for \$..... enclosed. Send.....copy(ies) of "Radio Receiver Servicing" (RS-1, \$2.50)

Name.....

Address.....

City.....Zone.....State.....

(outside U.S.A. priced slightly higher)

the KEY to your problem

# phastron "555" metal-cased MULTIMETERS

the NEW LOOK in



**POCKET SIZE WITH A 4 7/8" LENGTH SCALE**

## WE LEAVE IT TO YOU

WOULD YOU BUY A PLASTIC-CASED WRIST WATCH . . .

if you could buy the finest movement in a magnetically shielded metal case?

Phastron, world famous manufacturer of ENVIRONMENT FREE PRECISION AIRCRAFT EQUIPMENT for Military and Industrial uses introduces a new concept in Multimeters. This magnetically shielded, metal-cased "555" compares with plastic-cased multimeters as a fine watch in a precious metal case would compare with a plastic wrist watch.

The shielded, shatterproof and anti-magnetic case insures continued accuracy and integrity of this instrument for years to come.

Phastron "555" Multimeter incorporates more ranges, including AC current, greater visibility, simplified and functional controls and the greatest value offered to date.

See the Phastron "555", note its many outstanding features, its beautiful satin chrome case, its compactness and light weight, and you will know why

**"YOU CANNOT BUY BETTER"**



AC CURRENT RANGES  
SEPARATE RANGE & FUNCTION SWITCHES  
ONLY 2 JACKS

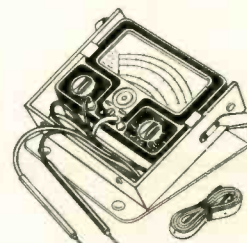

ACCURACY 3% DC, 4% AC

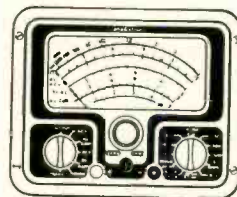
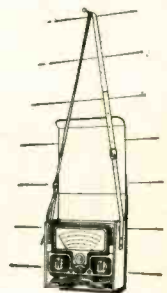

Panel Mounting Adapter \$1.50

Genuine Leather Carrying Case  
\$4.95

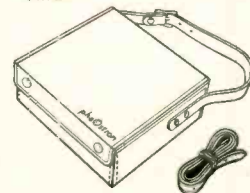

**"555" MULTIMETER**

**\$39.95** at your **PARTS DISTRIBUTOR**

Manufactured by PHAOSTRON COMPANY • 151 Pasadena Avenue • South Pasadena, Calif., U.S.A.

*Introducing the WALSCO Star...*

## FIRST INDOOR ANTENNA TO BE COMPARED WITH OUTDOOR INSTALLATIONS

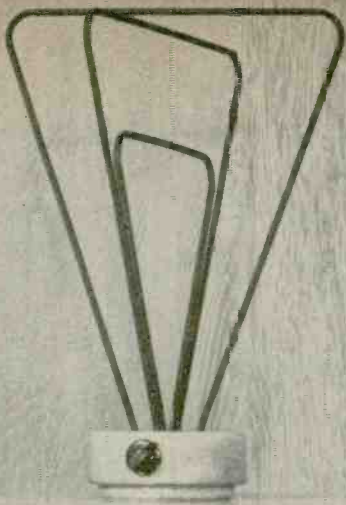

Attractive, compact in design...the new Walsco *Star* doesn't stick out like a sore thumb. Smart styling and distinctive colors (chartrreuse, sand, green) are being recommended by interior decorators. No ugly rods to manipulate. Proven comparable in performance to a good *outdoor* antenna in most metropolitan and suburban areas.

Electronic tuner selects right combination of elements automatically for crystal-clear picture reception. Receives VHF and UHF stations in opposite directions or on widely separated channels. The Walsco *Star* is the most advanced indoor antenna ever built.

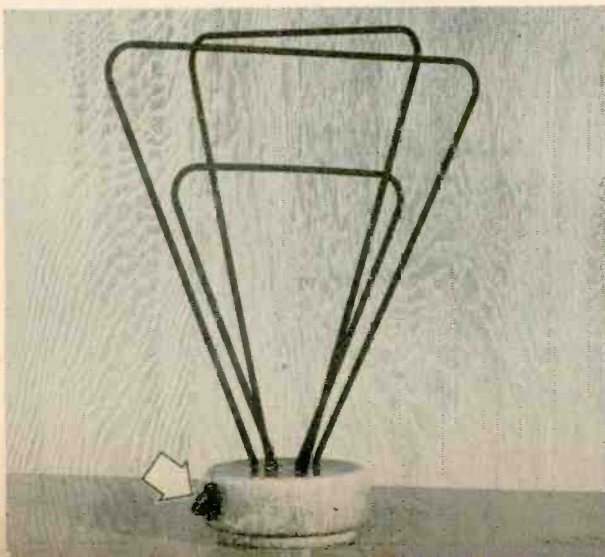

*Los Angeles*...A new standard in the design and performance of indoor antennas can be found in two new models recently introduced by Walsco. This is the first indoor antenna with a built-in, electronic rotating and tuning control that changes its directivity. Without moving, twisting or pulling, the new Walsco *Star* can be positioned perfectly by a simple turn of the control. Ghosts and interference are reduced or eliminated completely...and the correct combination of elements provides perfect reception on each channel.

The sharp, clear performance of the Walsco *Star* has made it the only indoor antenna that can, in most cases, be compared with a good *outdoor* installation. It was designed specifically for outstanding VHF and UHF reception in metropolitan and suburban areas. List price is \$12.95. The Walsco *Starlet* (without tuning control), for use in strong signal areas, lists for \$10.95. Available at jobbers everywhere in 3 smart, decorator colors.

---

Walsco Electronics Corporation, 3602 Crenshaw Blvd.,  
Los Angeles 16, California.

---

\*Patent Applied For

# PUT YOURSELF IN THE *High-Paying* TELEVISION PICTURE .....

R  
Radio  
T  
Television  
T  
Training  
A  
Association

Today, when demand for trained men is higher than ever before, pay is higher than ever before, you can train AT HOME in your SPARE TIME to become a Television Technician.



E. C. Lane, B.S., M.A.  
President, Radio-Television Training Association. Executive Director, Pierce School of Radio & Television.

## PREPARE FOR A BRIGHTER FUTURE AS A TV TECHNICIAN

You can hold down a full-time job and still train AT HOME by the same successful methods I used to help hundreds of men—many with no more than grammar school training—master television!

## NO EXPERIENCE NEEDED... I'LL TRAIN YOU AT HOME IN YOUR SPARE TIME

# VETERANS!

My School fully approved to train veterans under new Korean G.I. Bill. Write discharge date on coupon.

**GOOD  
SPARE TIME  
EARNINGS**

Almost from the very start you can earn extra money while learning by repairing radio-TV sets for friends and neighbors. Many of my students earn up to \$25 a week... pay for their entire training from spare time earnings... start their own profitable service business.

**EXPERT FM-TV  
TECHNICIAN  
TRAINING**

My FM-TV Technician Course can save you months of training if you have previous Armed Forces or civilian radio experience! Train at home with kits of parts, plus equipment to build BIG SCREEN TV RECEIVER. ALL FURNISHED AT NO EXTRA COST!

**NEW!  
PRACTICAL TV  
CAMERAMAN &  
STUDIO COURSE**

(For men with previous radio & TV training)  
I train you at home for an exciting big pay job as the man behind the TV camera. Work with TV stars in the TV studios or "on location" at remote pick-ups! Available if you want it... one-week course of practical work on TV studio equipment at Pierce School of Radio & TV, our associate resident school in New York City.

**OPTIONAL:  
2 WEEKS TRAINING  
IN NEW YORK CITY  
AT NO EXTRA COST**

You get two weeks, 50 hours, of intensive laboratory work on modern electronic equipment at our associate school in New York City — Pierce School of Radio and Television. And I give you this AT NO EXTRA COST whatsoever, after you finish your home study training in the Radio-FM-TV Technician Course and FM-TV Technician Course. However, your home study course is complete even without this two-week laboratory session. It is only one of the many Extras available to you from RTTA if you want it.



C-W Telephone Transmitter



RF Signal Generator



Super-Het Radio Receiver



Public Address System



Combination Voltmeter-Ammeter-Ohmmeter

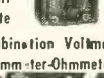

21" TV

### ENOUGH EQUIPMENT TO SET UP YOUR OWN HOME LABORATORY

As part of your training, I give you all the equipment you need to prepare for BETTER PAY TV job. You build and keep a professional GIANT SCREEN TV RECEIVER complete with big picture tube (designed and engineered to take any size up to 21-inch) . . . also a Super-Het Radio Receiver, RF Signal Generator, Combination Voltmeter-Ammeter-Ohmmeter, C-W Telephone Transmitter, Public Address System, AC-DC Power Supply. Everything supplied, including all tubes.

### FREE FCC COACHING COURSE

Qualifies you for Higher Pay! Given to all my students AT NO EXTRA COST after TV Theory and Practice is completed. Helps you qualify for the TOP JOBS in Radio-TV that demand an FCC License! Full training and preparation at home for your FCC License.

### MY 4 FREE AIDS SHOW YOU HOW AND WHERE TO GET A BETTER PAY JOB IN TELEVISION.

See for yourself how my simple, practical methods can make success as easy for you as they have for my hundreds of graduates.

## MAIL THIS COUPON TODAY!

*No salesman will call!*

Mr. Leonard C. Lane, President  
RADIO-TELEVISION TRAINING ASSOCIATION Dept. R-2  
52 East 19th Street, New York 3, N. Y.

Dear Mr. Lane: Mail me your NEW FREE BOOK, FREE SAMPLE LESSON, and FREE aids that will show me how I can make BIG MONEY IN TELEVISION. I understand I am under no obligation and no salesman will call.

(PLEASE PRINT PLAINLY)

Name \_\_\_\_\_ Age \_\_\_\_\_

Address \_\_\_\_\_

City \_\_\_\_\_ Zone \_\_\_\_\_ State \_\_\_\_\_

I AM INTERESTED IN:

- Radio-FM-TV Technician Course  
 FM-TV Technician Course  
 TV Cameraman & Studio Technician Course

**VETERANS!**

Write discharge date

**Radio Television Training Association**

52 EAST 19th STREET • NEW YORK 3, N. Y.

Licensed by the State of New York • Approved for Veteran Training

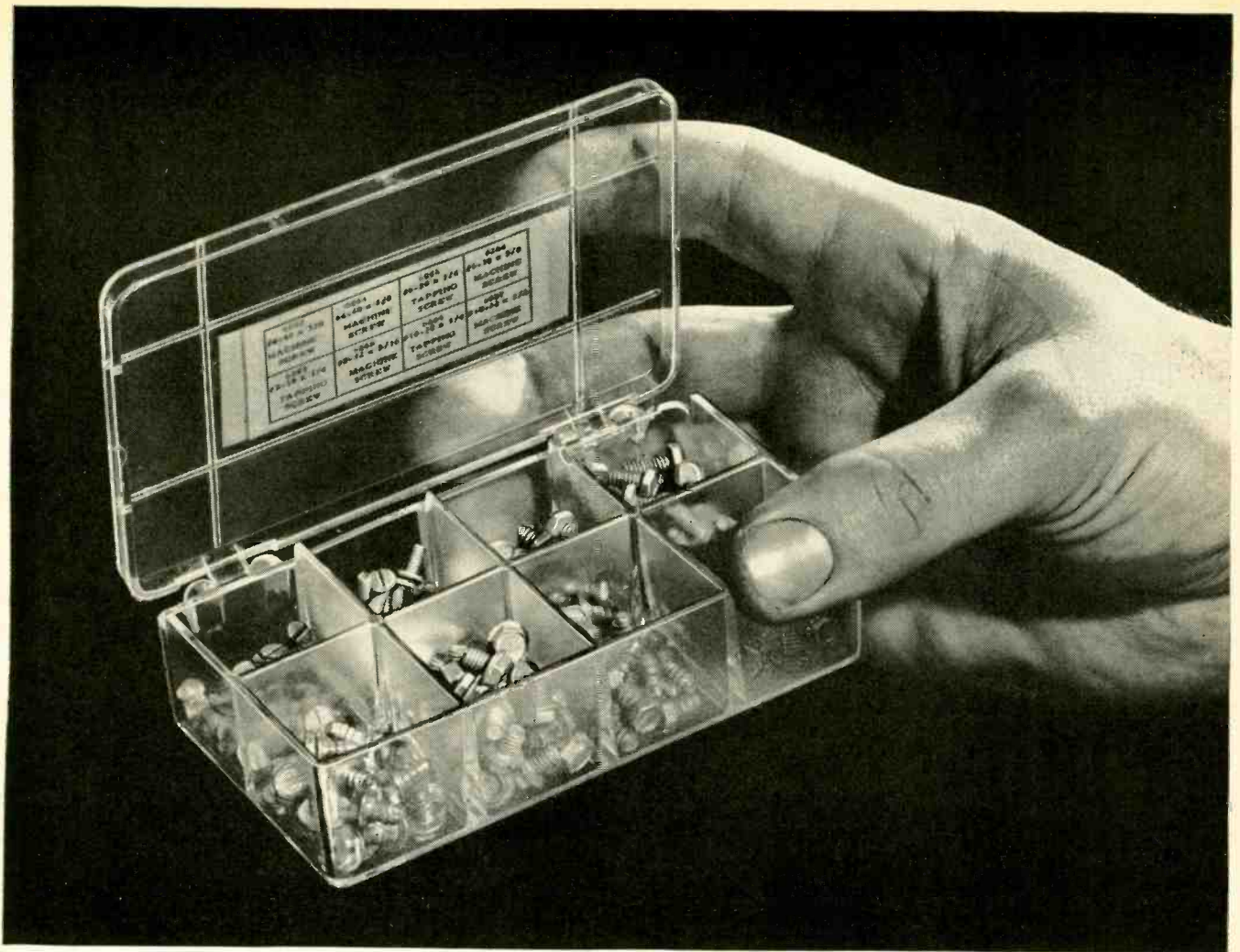

Now...Delco offers **POCKET-SIZE** kits that keep replacement hardware at your fingertips

**A GREAT NEW  
CONVENIENCE  
FOR AUTO RADIO  
TECHNICIANS!**

*For quicker, easier servicing* of Delco auto radios, a large assortment of replacement hardware—from tuner bearings to case screws—is now available in *four* clear polystyrene kits.

*There's no more fumbling* in a dark drawer when you need a hardware replacement part. You can see it immediately in these transparent kits. And each part fits your repair need exactly.

*A handy chart attached* to the inside cover of the box shows the contents of each of the eight compartments—a convenience when ordering re-fills for the compartments in plastic bags.

*You can obtain these* convenient pocket-size kits through your UMS Delco Electronics Parts Distributor today.

A GENERAL MOTORS PRODUCT   A UNITED MOTORS LINE

DISTRIBUTED BY ELECTRONICS DISTRIBUTORS EVERYWHERE



**DELCO RADIO**

DIVISION OF GENERAL MOTORS, KOKOMO, INDIANA

# Home Study Courses in TELEVISION SERVICING offered by RCA INSTITUTES



Study Television Servicing—from the very source of the latest, up-to-the-minute TV and Color TV developments. Train under the direction of men who are experts in this field. Take advantage of this opportunity to place yourself on the road to success in television. RCA Institutes, Inc. (A Service of Radio Corporation of America), thoroughly trains you in the "why" as well as the "how" of servicing television receivers.

## FIRST HOME STUDY COURSE IN COLOR TV SERVICING

Now you can train yourself to take advantage of the big future in Color TV. RCA Institutes Home Study Course covers all phases of Color TV Servicing. It is a practical down-to-earth course in basic color theory as well as how-to-do-it servicing techniques.

This color television course was planned and developed through the combined efforts of instructors of RCA Institutes, engineers of RCA Laboratories, and training specialists of RCA Service Company. You get the benefit of years of RCA research and development in color television.

Because of its highly specialized nature, this course is offered only to those already experienced in radio-television servicing. Color TV Servicing will open the door to the big opportunity you've always hoped for. Find out how easy it is to cash in on Color TV. *Mail coupon today.*

### SEND FOR FREE BOOKLET

Mail coupon in envelope or paste on postal card. Check course you are interested in. We will send you a booklet that gives you complete information. No salesman will call.



**RCA INSTITUTES, INC.**  
A SERVICE OF RADIO CORPORATION OF AMERICA  
350 WEST FOURTH STREET, NEW YORK 14, N.Y.



## HOME STUDY COURSE IN BLACK-AND-WHITE TV SERVICING

Thousands of men in the radio-electronics industry have successfully trained themselves as qualified specialists for a good job or a business of their own—servicing television receivers. You can do this too.

This RCA Institutes TV Servicing course gives you up-to-the-minute training and information on the very latest developments in black-and-white television.

As you study at home, in your spare time, you progress rapidly. Hundreds of pictures and diagrams, easy-to-understand lessons help you to quickly become a qualified TV serviceman.

There are ample opportunities in TV, for radio servicemen who have expert training. Mail coupon today. Start on the road to success in TV Servicing.

### MAIL COUPON NOW

RCA INSTITUTES, INC.  
Home Study Dept. RE-2-55  
350 West Fourth Street, New York 14, N. Y.

Without obligation on my part, please send me copy of booklet on:

- Home Study Course in TELEVISION SERVICING.  
 Home Study Course in COLOR TV SERVICING.

Name \_\_\_\_\_ (please print)

Address \_\_\_\_\_

City \_\_\_\_\_ Zone \_\_\_\_\_ State \_\_\_\_\_

the fabulous VHF-UHF antenna that actually sells itself with performance!

CHAMPION RAINBOW\*

What do America's servicemen think of Channel Master's RAINBOW antenna? Here are their very words†:

"The RAINBOW brings metropolitan reception to isolated areas."

"Gets more stations in this fringe area than any other antenna made."

"Just what our customers have been waiting for -- a powerful, sturdy, economical antenna."

†Just a few of the many letters of praise we receive daily.

LOOK at the RAINBOW'S unique design, so deceptively simple, yet so unbelievably efficient. LOOK at its advanced features: New Spacing Formula, new Triple-Section High Band elements, new full-efficiency Intermix Design, and the brilliant triple-power TRI-POLE! LOOK at its remarkable Yagi performance on every channel, its sharp single lobe. LOOK at its rugged, durable 100% aluminum construction, reinforced at all stress points. LOOK at its trigger-fast "Snap-Lock" Action, Channel Master's fabulous preassembly that snaps open, locks open, without hardware or tightening.

With every installation, Channel Master's RAINBOW again proves itself the most powerful TV antenna yet developed by modern science. Buy for bay, it out-performs every all-channel antenna on the market today!

Get In On This High-Powered Advertising Deal

Your Channel Master distributor offers you a hard-hitting promotion program which includes TV spot films, newspaper mat ads, radio ads, full-color display material, and consumer literature. Advertise and install America's best known, most wanted antenna.

Here's how the RAINBOW out-performs the famous Champion:

		CHANNEL												
		2	3	4	5	6	7	8	9	10	11	12	13	
Gain Over 1-Bay Champion	1-Bay RAINBOW	0	0	0	+1	+2	+3	+2.5	+1	+5	+5	+1.5	+2.5	
	DB	DB	DB	DB	DB	DB	DB	DB	DB	DB	DB	DB	DB	
1-Bay SUPER RAINBOW	1-Bay SUPER RAINBOW	+1	+1	+1.5	+2.5	+3.5	+3.5	+3	+2	+1.5	+2	+3.5	+4.5	
	DB	DB	DB	DB	DB	DB	DB	DB	DB	DB	DB	DB	DB	

		CHANNEL												
		2	3	4	5	6	7	8	9	10	11	12	13	
Gain Over Stacked Champion	Stacked RAINBOW	+1.5	+2	+1.5	+1.5	+2	+5	+5	+0	+0	+1	+1.5	+1.5	
	DB	DB	DB	DB	DB	DB	DB	DB	DB	DB	DB	DB	DB	
Stacked SUPER RAINBOW	Stacked SUPER RAINBOW	+2	+2.5	+3	+3	+4	+5	+1	+1	+2	+2	+2.5	+3.5	
	DB	DB	DB	DB	DB	DB	DB	DB	DB	DB	DB	DB	DB	

don't kid me!  
NOTHING outperforms CHANNEL MASTER

There's a RAINBOW model for every area . . . for every purse!

For fringe and super-fringe areas:

Super RAINBOW model no. 331, \$37<sup>50</sup> list  
stacked Super RAINBOW model no. 331-2, \$75<sup>70</sup> list

For suburban and near-fringe areas:

Champion RAINBOW model no. 330, \$23<sup>60</sup> list  
stacked Champion RAINBOW model no. 330-2, \$48<sup>60</sup> list

For economy installations:  
(featuring butted tubing)

Challenger RAINBOW model no. 332, \$18<sup>06</sup> list  
stacked Challenger RAINBOW model no. 332-2, \$37<sup>50</sup> list

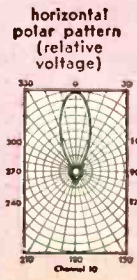
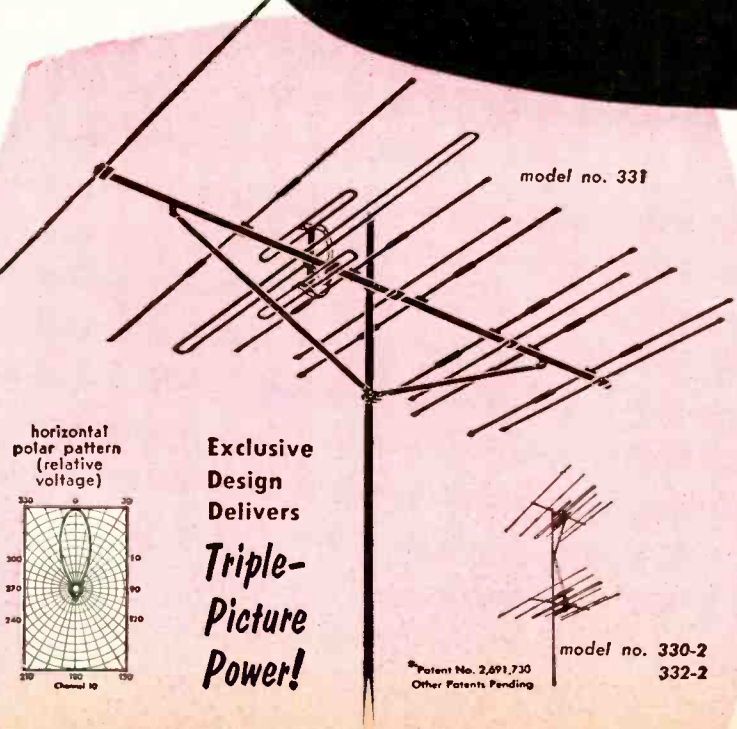

Exclusive Design Delivers Triple-Picture Power!

Patent No. 2,691,730  
Other Patents Pending

model no. 330-2  
332-2



a major step forward  
in installation procedures —

**CHANNEL  
MASTER'S**

# SELECTENNA

coupling system

the great Channel Master development  
that permits *unlimited antenna combinations*  
with only *one* transmission line to the set!

the **NEW WAY**, the **BEST WAY**,  
the only **AUTOMATIC WAY** to get  
all-channel, all-direction reception . . .

● **Without rotators!**

Selectenna means: no extra control unit on the set; no moving parts to get out of order; antennas are always in perfect orientation.

● **Without switches!**

Selectenna means: no manual switches to bother with; better performance because couplers have less insertion loss than switches.

● **Without multiple lead-in wires!**

Selectenna means: neater, more professional installations, because no complicated wiring enters the home. Only one lead connects to the set.

This modern way to obtain multi-directional reception — with its individual band-pass filter networks — offers the consumer great convenience advantages possible in no other system. There's never been anything like it! The Selectenna System is rapidly replacing all older methods. Use it on your next "multi-direction" installation!

**FREE TECHNICAL  
ADVISORY SERVICE**

Our engineers will tell you the correct hook-up for your area. Merely list the channel you expect to receive, as well as the different antennas you would like to hook up. No charge or obligation.

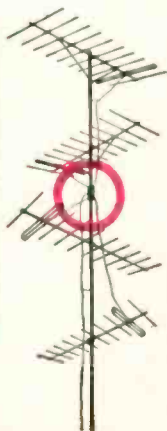

Simple as:

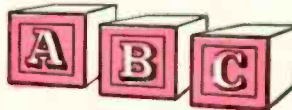

Simply select your  
channel on the set...  
the right signal is  
always there!

list price:  
**\$5.42**  
each

Including mounting  
hardware and  
connecting wire.

Couplers snap together. This particular interlocked stack consists of four Antenna Couplers and one Hi-Lo Coupler, for joining two High Band and two Low Band antennas.



**CHANNEL MASTER CORP.** ELLENVILLE, N. Y.  
The World's Largest Manufacturer of Television Antennas and Accessories.

Copyright 1954, Channel Master Corp.

# The Only TV Tower

## ALPRODCO'S POP-UP TOWERS

**THE ANSWER! YOU BET!** For the first time since TV started, we have a tower that solves all the problems! It comes in a package! It is pre-assembled! One man can erect it easily! Install antenna and rotator on the ground! Raise and lower it in seconds! It is guaranteed! And look at the low, low cost. Yes, **POP-UP** is the answer!

**POP-UP's CONSTRUCTION:** It is a beautiful combination of Alprodco's famous aluminum and steel towers. The lower section is Alprodco's triangular hot-dip galvanized steel and the top section is Aircraft Aluminum joined at the "elbow" with a strong A-frame. You get the whole "Ball-o-wax" including 1. hinged base, 2. ground anchors, 3. Aluminum and steel towers, 4. winch, 5. cable, 6. A-frame, 7. guy-brackets, 8. top-trim, 9. mast kit, **and** 10. a 9 foot telescoping aluminum mast.

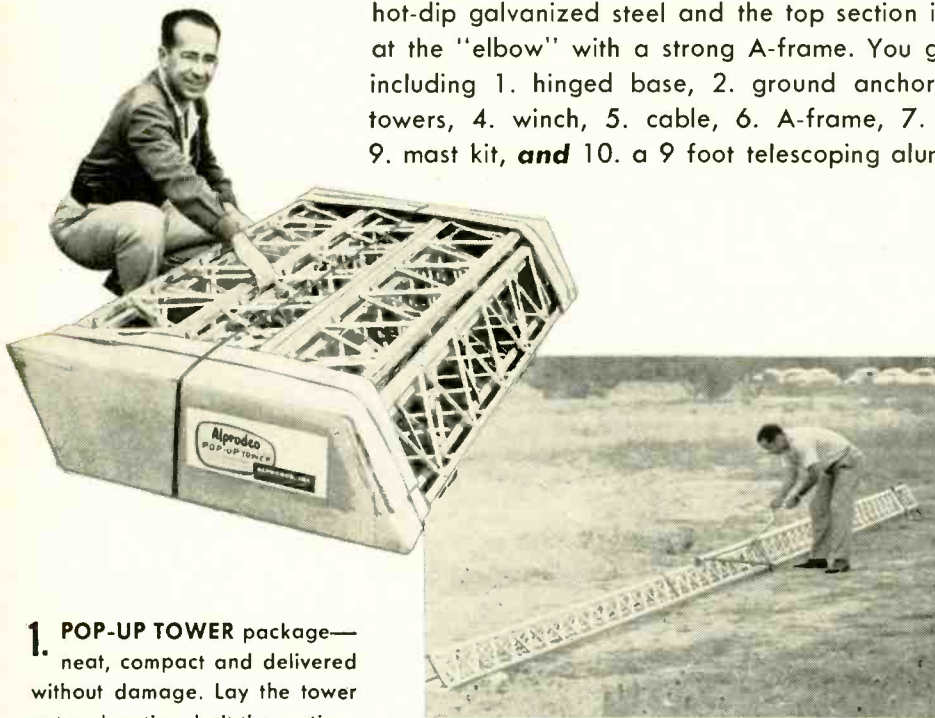

**1. POP-UP TOWER** package—neat, compact and delivered without damage. Lay the tower out on location, bolt the sections together and it's ready to POP-UP.

**2. ASSEMBLED:** Use temporary guys at right angle to the raising position and **POP-UP** can be pushed up by one man. The top aluminum tower serves as a "reverse" boom.

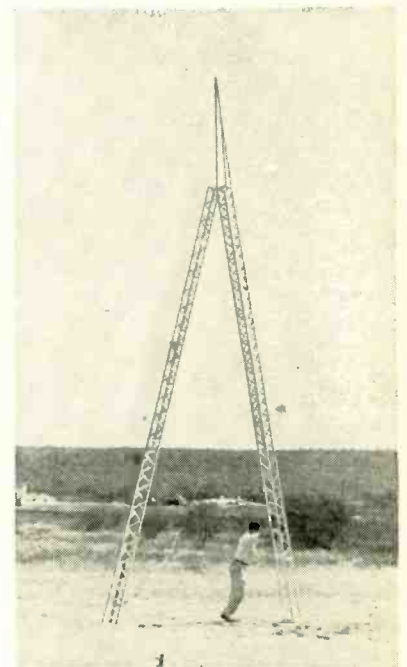

**3. PUSH POP-UP** up. Pick the tower up at the "A"-frame "Elbow" and work back on the top half as the tower jack-knives up. While the tower is in this position, secure the third guy and then plumb the lower tower.

WORLD'S LARGEST PRODUCER  
OF ALUMINUM TV, AM  
AND FM TOWERS

**ALPRODCO, INC.**  
ELECTRONICS DIVISION

TOWERS • ANTENNAS

MINERAL WELLS, TEXAS

# One Man Can Erect!

**PRE-ASSEMBLED POP-UP TOWERS** are delivered with all parts assembled. Bolt the sections together and it's ready to POP-UP.

**SAVES STORAGE SPACE.** The aluminum tower is nested inside the lower steel tower and requires less than half the usual storage space.

**COMPLETE INSTRUCTIONS** with each tower. Simple, easy to follow instructions guide correct **ASSEMBLY, ERECTION,** guying, installing antenna, lead wire and any make rotator.

Alprodco **PAYS COST OF SHIPPING** right to your door. No hidden costs when you get 5 or more **POP-UP** Towers.

**GUARANTEED** to withstand up to 90 mile wind and storm load when guyed according to factory recommendations.

**POP-UP'S DEALER PRICE:** 49 ft.—\$53.25; 61 ft.—\$64.45; 73 ft.—\$75.65. Full freight paid on 5 or more towers assorted. (The demand for this new tower has swamped our production department—so please allow as much lead time as possible on delivery.)

6. POP-UP is UP. Fasten the top guys and walk away from the easiest tower job you've had yet! And boy, isn't she a B-E-A-U-T-Y? Let winds and storm blow... no worries when you use Alprodco's POP-UP Tower.

HEIGHT  
**61 feet**

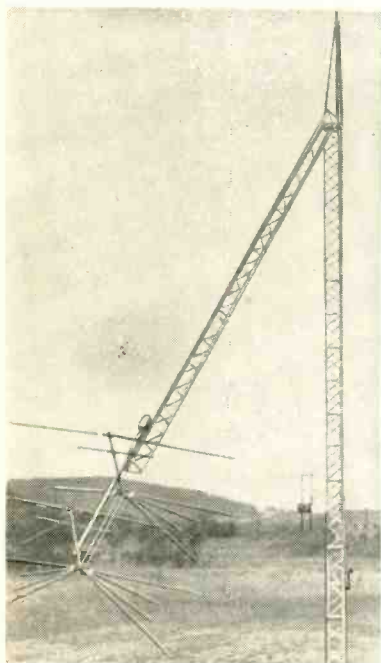

4. Attach an **ALPRODCO ROTATOR** if available, and an **ALPRODCO ANTENNA**, and it's all ready to go up. Pull the antenna away from the tower base to get winch leverage and crank.

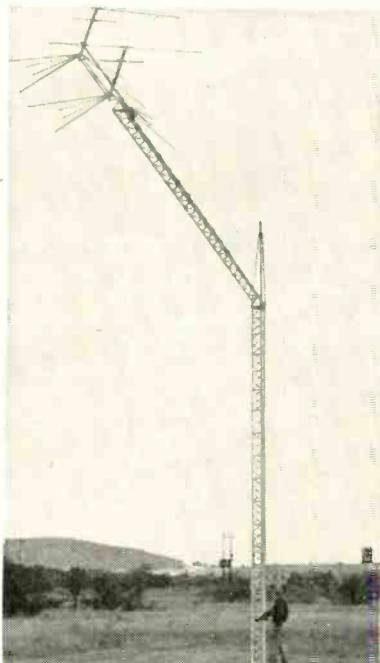

5. **JUST TURN THE CRANK** and up she goes! Honest now—have you ever seen such a sweet deal! The Answer! You bet it's the answer! **POP-UP** is the service man's dream!

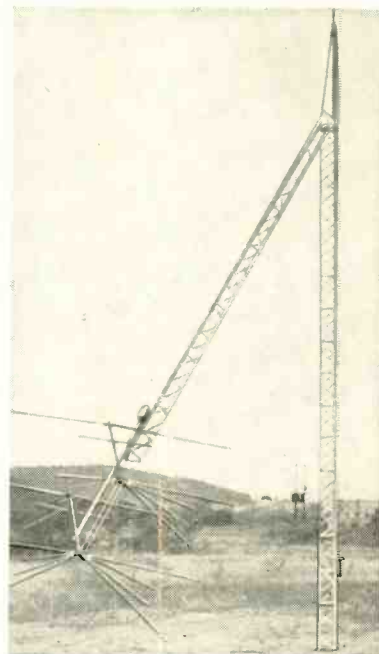

7. **REPAIRS?** If you haven't used an Alprodco Antenna and rotator, most likely there are repairs to be made soon. So—in 10 seconds you can lower the antenna to a handy working position. All done? Up she goes!

ROTATORS • SLIP-UP MASTS

KEMPTON, INDIANA • DUBLIN, GEORGIA

**FREE 1955  
EICO CATALOG!**  
Tells you how to **SAVE 50%** on  
your test equipment costs!

**EICO**  
THE LARGEST MANUFACTURER OF ITS KIND IN THE WORLD

**KITS  
INSTRUMENTS**

THE INDUSTRY'S MOST COMPLETE LINE OF KITS & INSTRUMENTS  
1/3 MILLION EICO INSTRUMENTS IN USE THE WORLD OVER -  
SAVE 50% - BUILD 'EM IN ONE EVENING... THEY LAST A LIFETIME

the Exclusive **EICO** Make-Good  
**GUARANTEE**

Each EICO Kit and Instrument is doubly guaranteed by EICO and your  
jobber in certain only selected quality components. EICO guarantees to  
replace any component which might become defective in normal use if  
returned to the factory within 90 days of purchase.  
EICO guarantees all Kits, assembled according to EICO's simplified  
instructions will operate as specified therein.  
EICO guarantees service and calibration of every EICO Kit and Instru-  
ment at the nominal charge as stated in the instructions.

**ELECTRONIC INSTRUMENT CO., INC.**  
Test Equipment Manufacturers  
84 WITHERS STREET, BROOKLYN 11, N. Y.

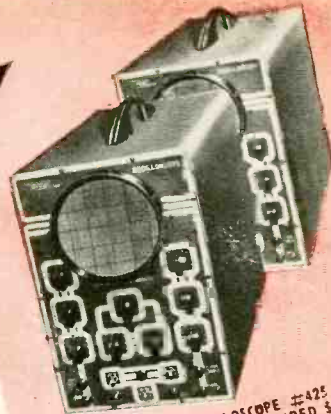

5" PUSH-PULL OSCILLOSCOPE #425  
KIT \$44.95 WIRED \$79.95  
NEW! #470 7" PUSH-PULL OSCILLOSCOPE  
KIT \$79.95 WIRED \$129.50

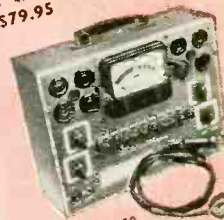

CRA . . . \$4.50  
TUBE TESTER #275  
KIT \$34.95 WIRED \$49.95



20,000 Ohms/Volt  
MULTIMETER #565  
KIT \$24.95  
WIRED \$29.95



1,000 Ohms/Volt  
MULTIMETER #536  
KIT \$12.90  
WIRED \$14.90



NEW! #232 PEAK-TO-PEAK  
VTVM with DUAL-PURPOSE  
AC/DC UNI-PROBE (pat. pend.)  
KIT \$29.95 WIRED \$49.95

NEW! #249 DELUXE  
PEAK-TO-PEAK VTVM with 7 1/2"  
METER & UNI-PROBE (pat. pend.)  
KIT \$39.95 WIRED \$59.95



VACUUM TUBE VOLTMETER #221  
KIT \$25.95 WIRED \$39.95  
DELUXE VTVM (with 7 1/2" METER) #214  
KIT \$34.95 WIRED \$54.95



R-C BRIDGE & R-C-L  
COMPARATOR #950B  
KIT \$19.95 WIRED \$29.95

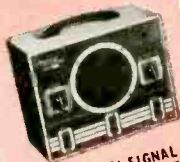

MULTI-SIGNAL  
TRACER #145  
KIT \$19.95  
WIRED \$28.95

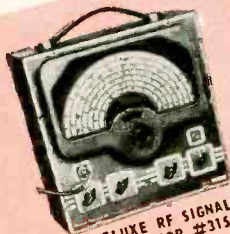

DELUXE RF SIGNAL  
GENERATOR #315  
KIT \$39.95 WIRED \$59.95

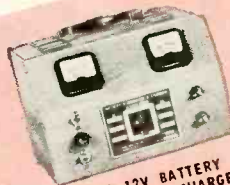

6V & 12V BATTERY  
ELIMINATOR & CHARGER  
#1050  
KIT \$29.95 WIRED \$38.95



NEW! #244 FLYBACK  
TRANSFORMER & YOKE  
TESTER  
KIT \$23.95  
WIRED \$34.95



RF SIGNAL GENERATOR #320  
KIT \$19.95 WIRED \$29.95



TV/FM SWEEP GENERATOR #360  
KIT \$34.95 WIRED \$49.95

5MC-4.5MC CRYSTAL  
\$3.95 ea.

A PROBE FOR EVERY PURPOSE

**EICO**

See the famous EICO line at your jobber today  
SEND FOR FREE CATALOG **C-2**  
**ELECTRONIC INSTRUMENT CO., Inc.**  
84 Withers Street • Brooklyn 11, N. Y.  
Prices 5% higher on West Coast

## TEC-TELEDUCATION

... U.S. Technical Graduates are Decreasing Alarminglly ...

It is no longer news that the Soviet Union is rapidly overtaking the United States in technical education. I have called attention to this very serious state of affairs in an article recently.\* Many stories in the press continue to sound the alarm at an ever-increasing tempo, with an overtone of despair and frustration.† Reading these, it would appear that there is no remedy in sight, because of fundamental shortcomings in our educational setup for training technicians.

We are told over and over that due to our traditional underpaying of teachers we cannot hope now to reverse quickly the trend of teacher-instructor defection. We cannot hold the thousands who abandon their poorly paid jobs to take more lucrative positions in industry or elsewhere.

New instructors—even if we finally see the light and pay them attractive salaries—cannot be recruited overnight. *It takes years to develop a good teacher or educator.* Not all the money in the world can undo the harm already perpetrated by our past *laissez-faire*.

The security of our country is based on technology and science. *These are, in fact, our national lifeblood.* Yet since 1950 the number of our technical graduates and scientists has decreased constantly. Within a few short years—if we don't reverse the trend—we will be running far behind the Soviet Union.

Today the United States, with 160 million inhabitants, has a scant 700,000 engineer-scientists. The Soviet Union, with a population of 213 millions, has almost 600,000. While our yearly number of technical graduates is rapidly decreasing, the Russians are *increasing* theirs as rapidly.

By the end of this year, **THE SOVIETS WILL HAVE SURPASSED US BY FAR.**

What the effect of this will be on our economy, our war potential and our very survival can be readily imagined. What is the answer?

Since 1950, I have been advocating *mass* education via television.‡ This was spearheaded by an editorial article I wrote for RADIO-ELECTRONICS, September, 1951, entitled "Teleducation." The Board of Education of New York City evinced interest in the idea; but so far it has not been adopted, evidently due to lack of funds.

The idea in its simplest terms can be described as follows: Instead of more—and often mediocre—teachers and instructors, we need fewer but *outstanding* ones, men who are the very best in the land. *These educators will teach millions of pupil-students at the same time by television, from one Central Teletorium* which could be located say in New York, Chicago, Washington or anywhere else. Classrooms all over the country would be interconnected by a closed-circuit wire or microwave relay system to the Central Teletorium.

*Because of the magnitude of such a national universal*

\*RADIO-ELECTRONICS, February, 1954, "Wanted: Technicians."  
†NEW YORK TIMES, Nov. 7, 1954, "Russia Is Overtaking U. S. in Training of Technicians."

‡See article in NEWSPEEK, December, 1950, "Few Teachers Reach Many Via TV."

*educational undertaking, it would of necessity have to be a Federally built one. The Government would not operate such a system, but finance it through the states.*

While the fundamental idea of teleducation is simple in concept, I can visualize endless ramifications. For a better understanding of its scope, I will enumerate here only a few of its aspects.

Emanating from a single Central Teletorium, a number of teaching programs can be broadcast over the closed circuits. Thus one set of teachers can teach grade schools. Another group will teach higher grades. A third can teach science for the lower grades. For high school purposes, there will be specially selected and more diversified science programs, such as, the fundamentals of mechanics, chemistry, electricity-electronics, astronomy, etc.

The local schools all will have large projection type TV screens, so no pupil will have to strain his eyes to see the distant lecturer. Loudspeakers placed around the classroom will reproduce the voice of the teleteacher loudly and clearly.

*Teleducation will not displace present teachers—it will supplement and augment them.* Thus, the teleducation programs can be broadcast into the classrooms *every other hour.* The hours in between are left open for the local teacher for individual instruction, blackboard work, supervision during tests, etc. It will be seen from this that the system can be made as flexible as required.

Time difference between remote points of the country and the Central Teletorium is no problem. The programs can be repeated to remote towns via film or tape, as we do today in commercial TV.

Most important, however, for the future of our country is the aspect of technology in teleducation.

Just as we have a national closed-circuit TV network for grade and high schools, there will be a similar one for colleges and universities, covering the entire country. In principle, it will be similar. The faculties of the various colleges and universities will remain as they are, but they will be *augmented and amplified* by scientific and technological giants of the world from the Central Teletorium.

**No single university could possibly afford a constant stream of our country's and the world's greatest scientists, which can now be summoned either in person or by remote control and connected into the national Tec-Teleducation university hookup. How foolish we once were, our children will say in the future, to allow our great scientists to talk only to a few dozen or perhaps a few hundred pupils when the great man could lecture to 500,000 at the same time! And what student would wish to be absent when the latest Nobel-prize scientist or the Einstein of his day speaks?**

Fortunately for America, we have in our hands today the technical means of making teleducation a reality in the immediate future. We need not wait for a new development to make it possible—*all the necessary elements are here now.* All we have to do is bring the new system into being. We do not have to be outclassed and outdistanced by any other country in the world.

—H.C.

# NEW COLOR BAR and WHITE DOT GENERATORS

*Circuit layout and operation of two popular color TV test instruments*

By ROBERT F. SCOTT  
TECHNICAL EDITOR

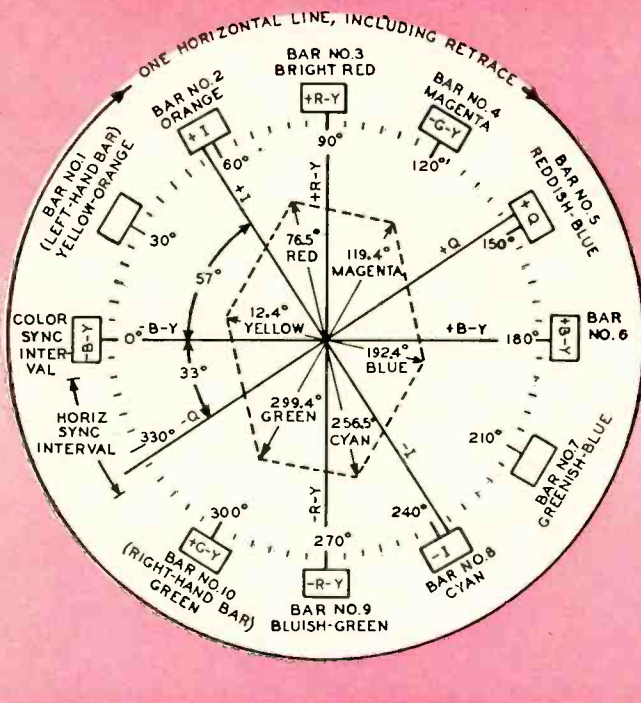

Fig. 1—Color-vector diagram showing phase relationships of color signals produced by the WR-61A. Shaded area shows phase angles and relative amplitudes.

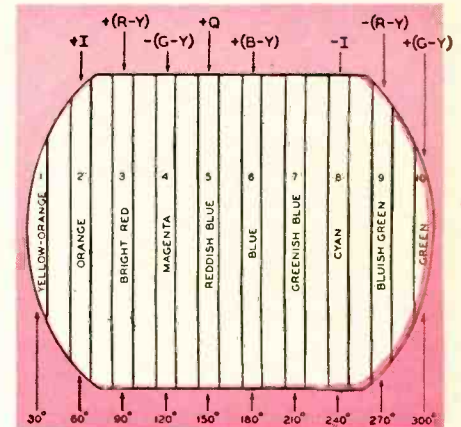

Fig. 2—Pattern shows order of color bars, their phase angles and axis relationship.

THE color bar and white dot generators are two new types of test equipment essential to rapid and efficient servicing and installation of color TV receivers. This article discusses the theory of operation and use of the new RCA WR-61A color bar generator and the Hickok model 650 video generator as modified for producing white dots for checking and adjusting convergence in color TV sets.

The RCA model WR-61A (see photo) produces 10 vertical color bars on a color TV receiver by shifting the frequency of the color-burst (subcarrier) oscillator by 15,750 cycles so that for each horizontal line there is a frequency difference of one cycle between the subcarrier and color-reference oscillator in the receiver. This shift of 360°—one cycle equals 360°—produces a continuous spectrum of vertical bars across the TV receiver's screen. Fig. 1 shows the phase relationships of the I, Q, R - Y, B - Y and G - Y axes. Note that the I and Q axes are separated from the B - Y and R - Y axes by only 30° instead of 33° as specified by NTSC standards. This slight phase difference can be counteracted by adjusting the hue control—also called color-phase control—in the TV receiver.

Since the WR-61A produces 12 bars spaced 30° apart, the color-burst oscillator must be keyed at 12 times the horizontal rate (12 × 15,750) or 189 kc. Only 10 bars appear on the screen

of the receiver because the eleventh occurs during the horizontal retrace and the twelfth during the color-sync period. This can be seen by comparing Figs. 1 and 2. The bar immediately following the horizontal sync pulse (Fig. 1) serves as the color-sync burst in the receiver.

### Circuit of the WR-61A

The diagram of the WR-61A is shown in Fig. 3. The subcarrier oscillator V3-b is a triode crystal-controlled type operating on 3,563,795 cycles (3.563795 mc). The bar oscillator is a Pierce crystal type using the control and screen grids of V1-a and operating on 189 kc. A part of the signal is tapped off the screen and synchronizes the 15,750-cycle horizontal sync multivibrator (V6).

In early models of the WR-61A the horizontal hold control permits the horizontal sync multivibrator frequency to be varied from below 15,750 cycles to above 31,500 cycles. In later models the hold control restricts the variable range to a narrow band around 15,750 cycles. The output of the multivibrator is tapped off the plate of V6-b and fed to the paralleled grids of clamp tube V2-a and horizontal sync shaper V2-b. The latter shapes the signal to have a duration of about 5 microseconds. V2-a eliminates the twelfth bar that occurs during the color sync period.

The 189-kc signal from the grid of

V1-a goes to the input of bar shaper V1-b. Burst and bar width are determined by the preset adjustment of the variable resistor in the grid circuit. Signals from the burst, horizontal sync and subcarrier oscillators are fed simultaneously to the grid of the subcarrier keyer (V3-a). The circuit operates so its output consists of a series of 8-cycle blocks of 3.56-mc signal. These subcarrier blocks are applied to one control grid of mixer V4 across the SUBCARRIER AMPLITUDE control. The horizontal sync pulse from the sync shaper and a 60-cycle voltage from one side of the heater string are fed to the grid and cathode, respectively, of V4-b.

The SUBCARRIER AMPLITUDE control sets the amplitude of the subcarrier burst. In normal color transmission, the amplitudes of the color sync burst and the horizontal sync pulse are equal. If the amplitude of the burst is attenuated by a frequency-selective narrow-band antenna, improper receiver alignment, multipath reception that causes frequency-selective signal cancellation, or other defects or maladjustments, the color hold circuits in the receiver become unstable or lose sync completely. This control enables the technician to check quickly color sync circuits in the receiver and determine whether color sync instability is caused by a defect in the receiver or some outside trouble.

The subcarrier level control in the

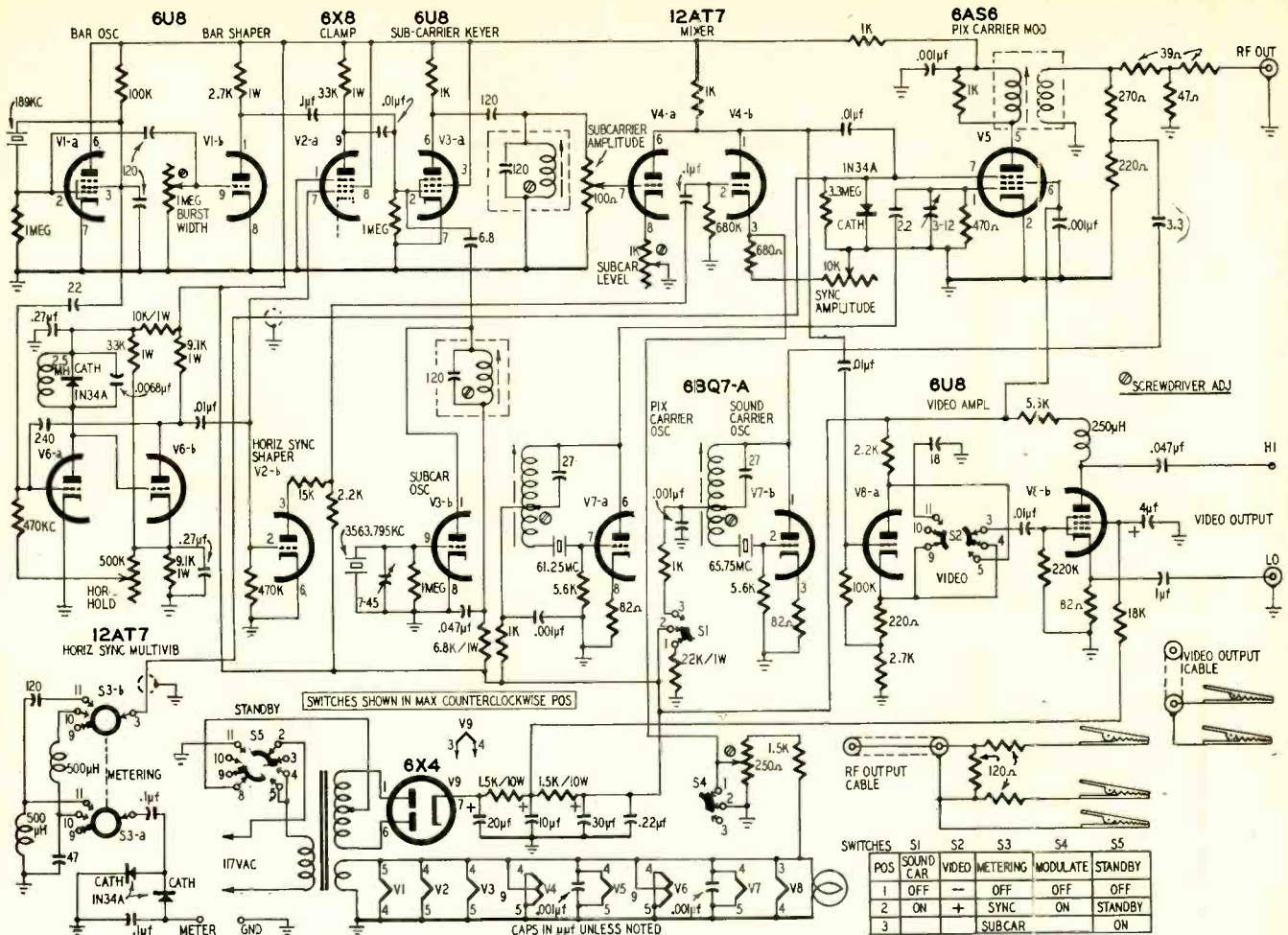

Fig. 3—Complete schematic diagram of the RCA WR-61A color bar generator.

cathode circuit of V4-a sets the maximum amplitudes of the subcarrier burst and color bar signals. It is normally adjusted for 1.2 volts on the suppressor of the 6AS6 modulator.

The SYNC AMPLITUDE control in the cathode of V4-b varies the amplitude of the horizontal sync pulses and controls the brightness of the color pattern. When the 60-CYCLE MOD control (S4) is closed, a 60-cycle voltage modulates the color bar signals by shifting their axes with respect to the sync tips. The modulation produces light and dark areas in the color bars. In a normal receiver the hue remains the same in light and dark areas. A variation in hue indicates amplitude distortion in the receiver.

The composite color video signal appears across the 1,000-ohm mixer plate load resistor. This signal is applied to a 6U8 video amplifier (V8) with its triode and pentode sections connected in cascade. This stage is provided with high- and low-impedance output circuits for signal tracing in receiver circuits following the video detector. If the receiver does not operate properly when a composite r.f. picture signal is fed into the tuner, the video may be fed to the video amplifier's input to determine whether the fault is before or after the video detector. The high-impedance output delivers 8 volts peak-to-peak across

4,700 ohms and the low-impedance output 0.25 volt peak-to-peak across 75 ohms.

A circuit-reversing switch between the halves of the 6U8 permits the technician to select either negative or positive video polarity. The position of the switch indicates polarity at the high-impedance video output terminal. A signal of opposite polarity is available at the low-impedance terminal.

The composite color video signal from the mixer and the 61.25-mc (channel 3) picture carrier are fed to the suppressor and control grids, respectively, of the 6AS6 modulator. The carrier is modulated by the video signal and is applied to the r.f. output terminal. The output impedance is 300 ohms and the signal level at least .01 volt peak-to-peak.

A crystal-controlled unmodulated sound carrier (65.75 mc produced by V7-b) is fed to the output network. The frequency of the color burst oscillator is selected so the beat (approximately 900 kc) between the subcarrier and 4.5-mc sound i.f. does not cancel as it does in color telecasts. This beat appears in the color bars so it can be used for critical adjustment of the receiver's fine tuning control and in checking the sound i.f. attenuation circuits. The beat can be recognized by turning the sound carrier on and off while watching the sound bars.

The output of the WR-61A contains

a luminance signal for checking color registration. This signal appears as a thin dark vertical line on the left and a thin light line on the right of each color bar. If registration is off, some or all of the color bars will be shifted into or beyond the luminance lines. This condition may be caused by improper alignment of r.f. or i.f. amplifiers, demodulator output or band-pass filters or a defective delay line.

A built-in metering circuit using a pair of 1N34-A's and meter terminals are provided so an external v.t.v.m. can be used to measure and adjust the amplitudes of the subcarrier and sync pulses. The METERING switch permits meter connection to sync or subcarrier circuits.

### Hickok 650 video generator

Hickok model 650 is a combination bar and dot generator producing stable patterns of 15 horizontal and 20 vertical bars or a series of 300 dots arranged in 15 equally spaced horizontal rows. Its output signal is available as a composite video signal and as video-modulated r.f. on channels 2 through 13. The early 650 produces black patterns on a white background for monochrome receiver servicing. When servicing or installing color TV receivers with trigun tubes, the adjustment of the various controls affecting convergence is made easier by using a

# TEST INSTRUMENTS

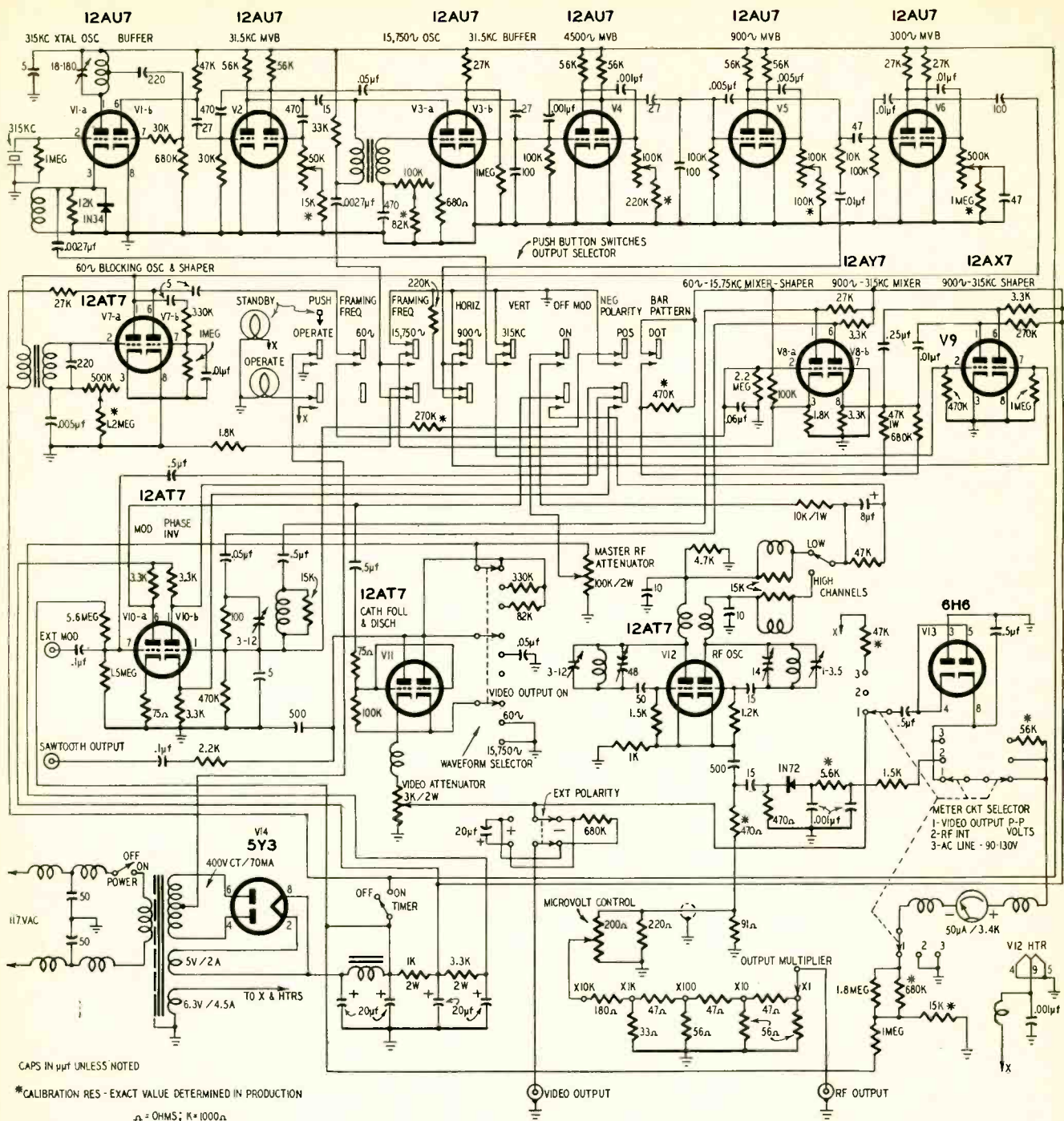

Fig. 4—Above is the complete schematic diagram of the Hickok model 650 video generator described in this article.

white dot signal such as is provided by the recently developed 650-C or an earlier model with a video phase inverting color adapter added.

### Circuit operation

The heart of the 650 (Fig. 4) is the 315-kc crystal-controlled oscillator, V1-a. The germanium diode in the cathode circuit of the oscillator is a pulse-shaping device. It rectifies the unsymmetrical signal appearing at the cathode and shapes the positive half for later use as a sync pulse. A portion of the oscillator output is fed from the plate circuit to input of buffer V1-b where it is further shaped and am-

plified. V1-b feeds a multivibrator frequency divider with a stepdown of 10 to provide a 31.5-kc signal. The output of this circuit takes two paths. One leads to frequency-halving blocking oscillator V3-a. The other path feeds the signal through buffer V3-b to a chain of frequency dividers (V4, V5, V6 and V7-a) that reduces the frequency in steps of 7, 5, 3 and 5 to produce timing signals of 4,500, 900, 300 and 60 cycles.

When the HORIZ and VERT buttons of the OUTPUT SELECTOR switch are pressed, the 900-cycle and 315-kc signals are fed from the 900-cycle multivibrator and 315-kc master timing oscillator to

the control grids of shaper V9. After shaping, the 900-cycle and 315-kc signals are mixed in the cathode circuit of V8-b, a grounded-grid amplifier.

The 60- and 15,750-cycle signals are fed into the grid and cathode, respectively, of V8-a. A video signal consisting of 60- and 15,750-cycle sync and 900-cycle and 315-kc blanking pulses are fed through isolation and shaping networks to the grid of phase inverter V10-b. This stage is coupled through the POLARITY section of the OUTPUT SELECTOR to the grid of modulator V10-a that modulates the section of r.f. oscillator V12 selected by the CHANNELS switch.



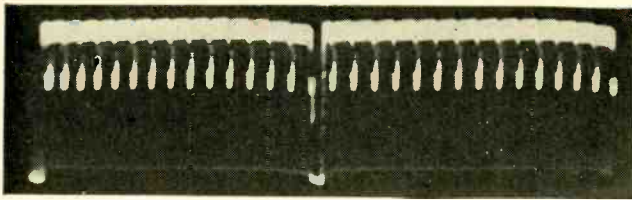

Fig. 5—Composite video signal when generator is producing a cross-bar pattern.

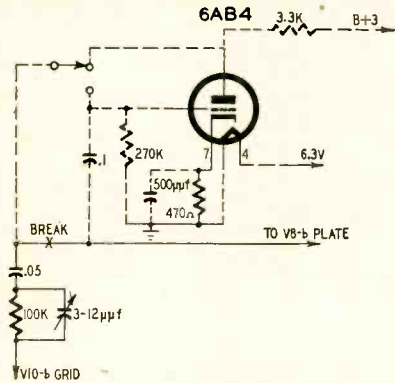

Fig. 6—Color adaptor in Hickok 650-C.

The r.f. signal appears across the cathode resistor common to both sections of oscillator V12 and is applied to the RF OUTPUT connector through fine and coarse attenuators. A metering circuit is provided for adjusting the oscillator signal level so the output corresponds to the calibrations on the fine (MICROVOLT CONTROL) and coarse (OUTPUT MULTIPLIER) attenuators. The oscillator B plus voltage is adjusted with the MASTER RF ATTENUATOR so the output is approximately 10,000 microvolts with the fine and coarse attenuators set for maximum output. The r.f. metering circuit consists of a 1N72 germanium diode, an R-C filter and a 50- $\mu$ a d.c. meter.

The coarse attenuator is a five-stage ladder type with output impedance constant at approximately 5 ohms except on the  $\times 10,000$  range where it varies from 50 to 0 ohms, depending on the setting of the fine attenuator.

When the PATTERN section of the OUTPUT SELECTOR is open, V8-b is supplied with a normal value of cathode bias from a B plus voltage divider consisting of a 470,000-ohm resistor, 47,000- and 680,000-ohm resistors in parallel and the 3,300-ohm cathode resistor. Thus V8-b conducts continuously and the 900-cycle and 315-kc signals

modulate the r.f. oscillator to produce a cross-bar pattern.

Closing the PATTERN switch shorts out the 470,000-ohm resistor increasing the bias on V8-b so it operates near cutoff and conducts only on the negative peaks of the signals applied to its cathode. Now the output signal consists of chains of 20 sharp pulses recurring at intervals to produce 15 horizontal lines of dots on the screen of the receiver.

Normally the horizontal bars and dots cover three and a half to five scanning lines, depending on the receiver under test. Fig. 5 shows the composite video signal developed when the generator is producing a cross-bar pattern. The wide pulses in the center and at the extreme right are 60-cycle vertical sync signals. The dim lines of equal amplitude are the 15,750-cycle horizontal sync signals. The lower-amplitude heavy pulses between the vertical sync pulses have a frequency of 900 cycles and are used to produce the horizontal bars. The 315-kc signals for producing the vertical bars are of equal amplitude but are not visible in the photograph.

The r.f. oscillators can also be modulated by an external signal applied to the EXT MOD connector when the 3.5-kc and 60-, 900- and 15,750-cycle sections of the OUTPUT SELECTOR are open. Modulation level is determined by the master r.f. level control.

**Video signal output circuit**

The output of modulator V10-a is applied to the input of cathode follower V11. The output is taken off the VIDEO ATTENUATOR in the cathode circuit when the WAVEFORM SELECTOR is set to VIDEO OUTPUT ON. This signal is used for servicing and signal-tracing in amplifier circuits following the video detector.

The output of V11 is also fed to V13 connected as a peak-to-peak rectifier and then applied to the meter. Output is variable from 0 to 30 volts.

The EXTERNAL POLARITY selector is used to polarize correctly the 20- $\mu$ f electrolytic coupling capacitor for proper operation when the cathode follower is connected directly to a load that has a d.c. potential with respect to ground. When the video output jack is connected to a load that is positive with respect to ground, the switch must be placed in the PLUS position so the positive terminal of the electrolytic connects to the load. When the generator feeds a circuit such as the video amplifier grid that may be at a high negative potential, the switch must be placed in the NEGATIVE position. The 680,000-ohm resistor across the switch discharges the capacitor to remove the possibility of shock to the operator and damage to external circuits to which the 650 is connected.

When the WAVEFORM SELECTOR is set for 60- and 15,750-cycle sawtooth output and the corresponding section of the OUTPUT SELECTOR is closed, the cathode of V11 is grounded and a resistor and discharge capacitor are inserted in the plate circuit. With a sine wave applied to its grid, V11 acts as discharge tube, developing a sawtooth voltage in its plate circuit. These voltages can be used for signal tracing and substitution in the deflection circuits of TV receivers.

**The color adaptor**

Fig. 6 shows the circuit that is included in the 650-C to provide white dots on a black background by inverting the phase of the 900-cycle and 315-kc signals before they are applied to the input of V10-b. The 6AB4 and components shown in dashed lines are included in the color adaptor.

A conversion kit—called the 60-C—may be ordered from Hickok for converting 650 generators to 650-C's. It contains the 6AB4, mounting bracket, socket, terminal strip and all other mechanical and electrical components necessary for the conversion as well as full instructions and diagrams. The mechanical operations are minor. The .06- $\mu$ f shaping capacitor in the grid circuit of V8-a must be relocated to make room for mounting the adapter bracket. Two small holes are drilled for self-tapping screws used to mount the adapter bracket. A half-inch hole is drilled in the top of the case for operating the rotary switch used for the changeover from black to white dots. This switch has a slotted shaft adjusted with a screwdriver through the hole in the cabinet. A snap-in plug closes the hole against dust and other foreign bodies. The switch is wired so it must be turned clockwise for black dots or bars on a white background and counterclockwise for white dots or bars.

If white dots or bars of greater intensity are needed, reduce the resistance in the grid circuit of the 315-kc section of shaper V9 by connecting a 100,000-ohm, 1/2-watt resistor from pin 2 to ground as described in the Hickok notes.

END



The RCA WR-61A color bar generator.



The Hickok 650 video generator.

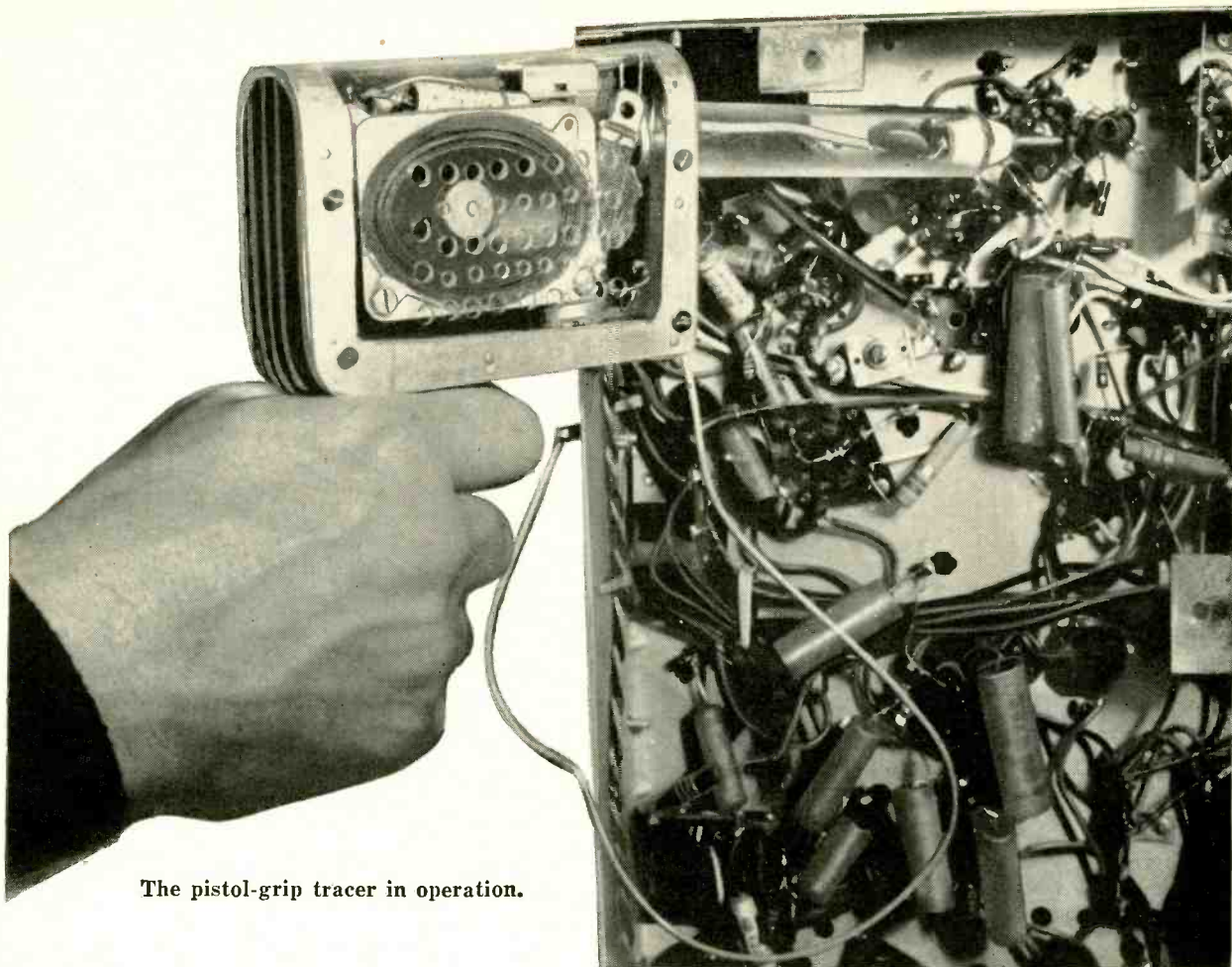

The pistol-grip tracer in operation.

## PISTOL-GRIP SIGNAL TRACER

*This small and compact transistorized instrument features unique design, yet is easy to construct*

By HOMER L. DAVIDSON

**T**HIS little transistorized signal tracer resembles the pistol type soldering iron used by many experimenters and service technicians. It is compact and has only one outside lead—an alligator grounding clip. The nozzle or pointer of the tracer is touched to the circuit being tested; the signal is rectified and amplified, then reproduced through a 2-inch speaker.

A .001- $\mu$ f disc type capacitor couples the incoming signal to the amplifier. A 1N34 crystal rectifies any r.f. signal picked up and feeds it to a volume control. This control is used to reduce signal strength when necessary. It is a standard type but a midget unit could have been used. Had that been done, the d.p.s.t. switch could have been placed on the control instead of at the top of the unit.

A midget electrolytic capacitor cou-

ples the incoming signal to transistor V1. Both transistors used in this signal tracer are CK722's. They are mounted in hearing-aid tube sockets that were lying around, although regular sockets can be used. Be careful when wiring the leads because heat from a soldering iron can easily damage transistors. A good trick is to let long-nose pliers absorb the heat. This also applies to the 1N34.

Resistor R1 is a base return and develops bias for this stage. Since transistor characteristics vary, R2 should be chosen for the value that provides maximum volume within the applied current limits. To find the correct value, use a 500,000-ohm potentiometer in place of R1 and vary it for maximum signal. At the same time, connect a milliammeter in series—the current should not rise higher than 5 ma. The audio amplifier stage is

transformer-coupled to the output stage. This little transformer is a Stancor UM-113: primary impedance 20,000 ohms, secondary impedance 1,000 ohms. It was designed primarily for transistor amplifying stages. A standard interstage transformer could be used if the signal tracer is constructed on a chassis where space is not limited. A 10- $\mu$ f electrolytic capacitor couples the signal to the base of V2. The base-return resistor R2 was measured before being placed in the circuit as R1 was. A small output transformer steps down the amplified signal and feeds it into a 2-inch speaker.

**Wiring the unit**

When wiring the signal tracer be sure the transistors are properly connected—and be sure neither one draws more than 5 ma. The wiring is not critical but all leads and components must be closely spaced with the leads as short as possible. There isn't any separate chassis, the two transistor sockets being soldered to the speaker frame. Pins 3, 4, and 5 of the hearing

aid sockets are soldered together. A heavy piece of brass wire is soldered to both sockets and then anchored to the 2-inch speaker frame. Also, the positive lug on the small 22.5-volt hearing aid battery is soldered directly to the 1-inch bolt fastened directly to the speaker frame.

The transistor sockets are soldered directly together. When plugging the CK722 transistors into their sockets, be sure both red dots or pins are plugged in properly. A d.p.s.t. push type switch is mounted on top.

Construction of the gun holder is easy. Get a few scraps of three-ply wood and draw a gun on each piece. Place the other piece between these handleless pieces and glue and nail them together. After the assembly dries, round the edges, carve and sand, giving it the appearance of a pistol. The middle section of the pistol is not sawed or cut out until the plastic is formed around it.

A small piece of Lucite is used as a cover for the pistol signal tracer. It is

fitted around the pistol assembly while heat is applied from a gas flame. Be sure to hold the plastic away from the flame. Then the plastic can be formed around the gun assembly and held there until it sets. The speaker holes can be drilled before or after the plastic is bent. All protruding corners are then cut and rounded off to fit snugly around the wooden assembly.

At this point the center of the gun assembly is sawed out. Only a narrow border is left and the plastic piece is screwed to it. A  $\frac{3}{8}$ -inch hole is drilled into the bottom for the volume control, which resembles a trigger. A 1-inch hole is then drilled for the pistol barrel. The barrel consists of a 1-inch piece of round plastic tubing with a plastic bottle cap and 2-inch bolt fastened into the end as the test probe. To save mounting space the small coupling capacitor and the 1N34 can be mounted in the plastic tube.

The results obtained from the small transistor signal tracer were surprising. Troubles were easily located in small radios, TV sets and amplifiers. END

**Parts for signal tracer**

- 1—33,000, 1—220,000 ohms, resistors; 1—1 megohm, potentiometer; 1—.001  $\mu$ f ceramic disc capacitor; 2—10  $\mu$ f, 25 volts, electrolytic capacitor (small as possible); 1—interstage transformer, primary impedance 20,000 ohms, secondary impedance 1,000 ohms (Stancor UM-113 or equivalent); 1—output transformer, primary impedance 2,000 ohms, secondary 3.2 ohms (Stancor A-3332 or equivalent); 2—hearing-aid or transistor sockets; 2—CK722 transistors; 1—sheet of plastic; 3—pieces of 3-ply plywood; 1—2-inch speaker; 1—d.p.s.t. switch (see text); 1—1N34; 1—alligator clip; 1—plastic tubing; 1—22.5-volt hearing-aid battery.

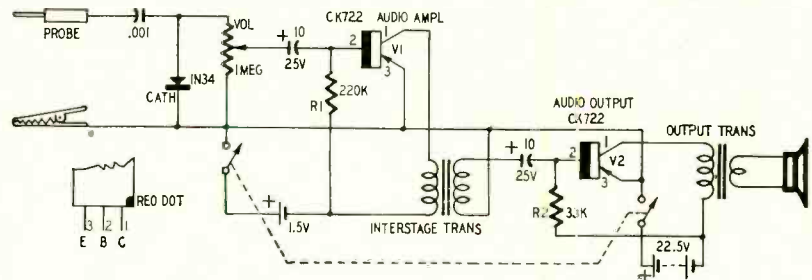

Schematic pistol-grip signal tracer.

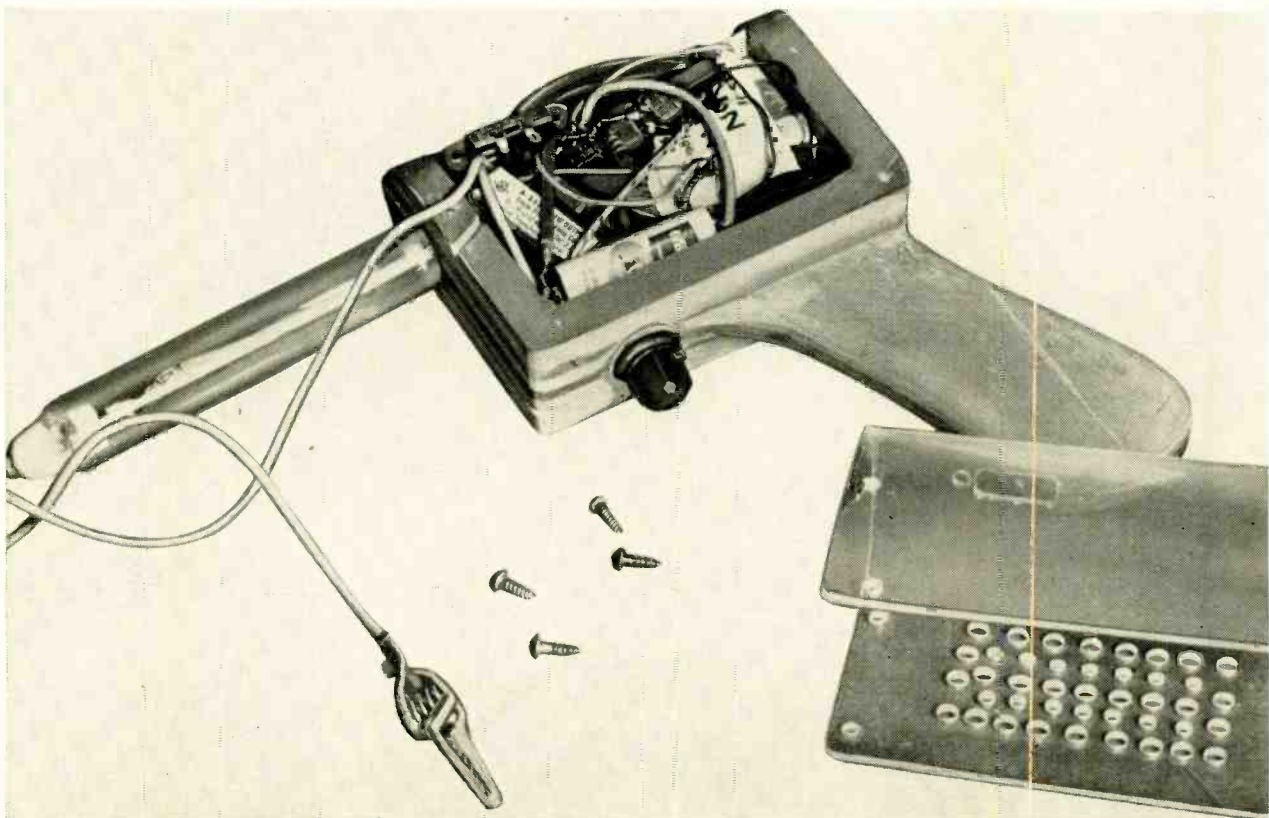

Assembly of the signal tracer—unit is compact; completed plastic cover at right.

# DIODE WATTMETER

By RONALD L. IVES

**A**UDIO-frequency wattmeters, for use at medium and high power levels, are difficult to obtain commercially, and few of them have been made for use in custom-built and commercial installations. The wattmeter described in this article (Fig. 1) is extremely well suited for use in amateur modulators to indicate the a.f. output and in better-quality amplifiers and public-address systems where human ability to judge power output seems to vary inversely with the tone quality.

This a.f. wattmeter can be used with any standard line and is based on the formula  $W = I^2 R$  or  $W = \frac{E^2}{R}$ . The line resistance (or impedance)  $R$  is a constant, so wattage varies with the voltage across the line.

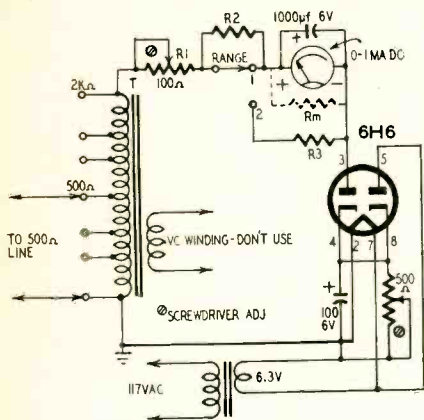

Fig. 1—Diode wattmeter schematic.

When the a.f. voltage is rectified, and the wattage computed from the measured voltage and the line impedance, a wattmeter scale (Fig. 2) can be made. Any rectifier may be used within a limited frequency range. For the great range of a.f. signals normally used, a diode such as one half of a 6H6 which has constant characteristics from below 80 microamperes to above 8 milliamperes will be most satisfactory.

Unlike dry rectifiers, such as selenium or germanium units, thermionic diodes have an appreciable contact potential which will interfere with wattmeter zeroing unless it is "bucked out." This is done by rectifying the heater voltage in the other half of the 6H6 and injecting it into the meter circuit through the common cathode resistor, which is adjusted until the meter zeros with no signal. Once adjusted, the zero setting holds for approximately the life of the tube.

The zero setting remains constant only as long as the circuit resistance is not changed. Thus, a second wattage range, if desired, must be so designed that the

total resistance remains the same. Likewise, the damping of the meter circuit will be a constant only so long as the resistance in shunt with the 1,000- $\mu$ f damping capacitor also remains constant.

Resistor  $R_1$  is set so that the meter reads full scale at 10 milliwatts. To produce a 100-mw range while keeping the total circuit resistance constant and also maintaining the damping R-C as high as possible, a resistor is inserted in series with the meter and a shunt placed across the pair. Values for these resistors were arrived at as follows:

To keep circuit resistance constant, the network consisting of  $R_3$  in parallel with  $R_2$  and  $R_m$  (the meter resistance, 52 ohms in this case) must be equal to  $R_m$ . Also, at 100 mw, current through the meter must be the same as at 10 mw (1 ma in this case). Voltage across the meter and its resistors will be increased

$$\text{by } 3.16, \text{ since } W = \frac{E^2}{R} \text{ and } 10W =$$

$$\frac{(\sqrt{10} E)^2}{R} = \frac{(3.16 E)^2}{R}$$

Thus, the sum of  $R_2$  and  $R_m$  must be 3.16  $R_m$ , and  $R_2$  will be 2.16  $R_m$  (110 ohms in this case). The value of  $R_3$  can be determined by the usual parallel-resistance rules, giving a value of 72 ohms. Currents in the two arms of the circuit should be in the ratio of 1 (meter), to 2.16 (shunt), and checking by Ohm's law show that they are.

Effect of the shunt and series resistors on the time constant of the meter circuit is not great and can be computed by Kirchoff's law, using  $R_m$  as one arm of the parallel circuit and  $R_3$  plus  $R_2$  as the other. The resistance across the damping capacitor is now 40.5 ohms, and the time constant (with a 1,000- $\mu$ f capacitor) has been reduced from .052 to .040 second. A 300- $\mu$ f capacitor may be added, by use of another arm on the range switch, if desired.

Because a 6H6 diode can carry 8 ma steadily, a third wattage range, 1 watt, can be added. The resistance values will be, with a 52-ohm meter,  $R_2 = 468$  ohms,  $R_3 = 57.8$  ohms,  $R-C = .047$  second.

Measurement of meter resistance may be difficult, as an ordinary ohmmeter will usually produce a badly slammed pointer or a burned-out moving coil. The best procedure is to connect the meter, a variable high resistance and a small battery in series. Adjust the resistor until the meter reads full scale and note the resistance value (disconnect the meter and measure the resistance with an ohmmeter). Then adjust the resistor again until the meter reads exactly half scale. Measure the new resistance value

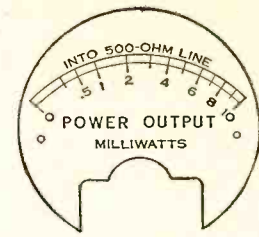

Fig. 2—Calibrated wattmeter scale.

(with meter out of circuit). This second resistance value minus twice the first is the meter resistance.

Because the average thermionic diode, such as a 6H6, has a high resistance, a voltage stepup is necessary to obtain a full-scale reading at low power levels. This is most simply done by connecting the diode between ground and a high-impedance tap of a small matching transformer or autotransformer, such as a Stancor A-7947, Thordarson TS-

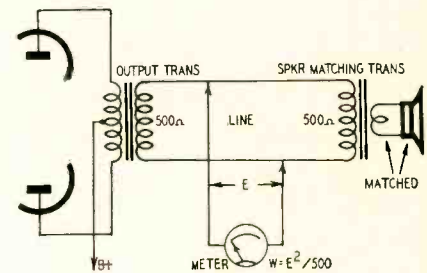

Fig. 3—Meter hookup for 500 ohms.

24-S66, UTC S-12 or an equivalent transformer. A similar effect can be obtained, at higher cost, with a more sensitive instrument, such as a 0-100 microammeter (which will also require different resistance and capacitance values).

The wattmeter is calibrated directly. Measured voltages are applied across the line with the speaker (or other load) connected. A convenient place to insert these voltages is across the 500-ohm winding, values then being in accord with the table.

This will give correct wattage values with a 1-ma instrument at the frequency of the inserted voltage only if the load is connected to the correct tap. If the matching transformer has a good frequency characteristic, values will be accurate at all audible frequencies. If its characteristic looks like a profile of

### Wattmeter Calibration

Mw	E	Mw	E	Mw	E	Scale
0.25	0.353	2.5	1.13	25	3.53	0.157
0.5	0.500	5	1.57	50	5.00	0.224
1	0.707	10	2.24	100	7.07	0.316
2	1.00	20	3.16	200	10.0	0.446
3	1.22	30	3.83	300	12.2	0.544
4	1.41	40	4.45	400	14.1	0.630
5	1.57	50	4.96	500	15.7	0.700
6	1.73	60	5.46	600	17.3	0.774
7	1.87	70	5.91	700	18.7	0.835
8	2.00	80	6.32	800	20.0	0.895
9	2.12	90	6.70	900	21.2	0.95
10	2.24	100	7.07	1000	22.4	1.0

the Rocky Mountains, accuracy of power indications will vary accordingly with frequency. In the table, the scale column gives the reading of the original instrument scale (0-1 ma) corresponding to the wattage in the first column. With in the power ranges involved, the higher scales may be read in the same fashion, adding zeros for the higher ranges. For ease and rapidity of reading, it is usually advisable to make up a new instrument scale.

If a more sensitive meter movement is used or higher powers are involved, separate calibrations may be needed for each range, as a 6H6 has a nearly straight characteristic only between .08 and 8 ma.

Tests of this type of wattmeter indicate that it will work very well in a.f. service for an indefinite period, holding calibration and zero satisfactorily. The first model constructed is still in service, with all the original components, after 1,400 hours of operation (more than the rated tube life). It has needed no adjustment.

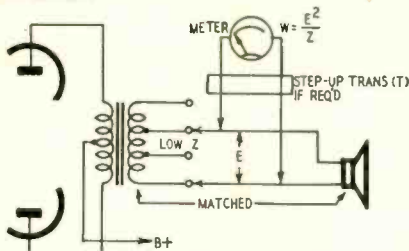

Fig. 4—Connections for low-impedance output. Recalibrate the meter.

Choice and arrangement of components are apparently not at all critical. Standard components (of the better grades) can be used throughout with a reasonable margin of safety allowed. All resistors were rated at 2 watts and all capacitors at 6 volts. With a space requirement of less than 100 cubic inches (without crowding) this wattmeter can be built into any convenient chassis or can be wholly contained within a small utility case.

**Connecting the meter**

Fig. 3 shows how the meter is connected across a 500-ohm audio line. The 500-ohm taps on transformer T (Fig. 1) connect across the line. Calibrations are correct only when the speaker or other load is connected and properly matched to the line.

Corrections are needed when the amplifier's output impedance is other than 500 ohms. If the impedance is lower than 500 ohms, correct corresponding taps of T across the load as in Fig. 4. If the output transformer has taps at 500 ohms and some higher impedance, you may connect the meter directly across the higher impedance tap without using transformer T. In any event, the meter must be calibrated in terms of load impedance and voltage across it. Use a v.t.v.m. or calibrated scope to measure the voltage across the load. Ordinary a.c. voltmeters have too low an impedance and their accuracy varies with frequency. END

# TRANSISTOR

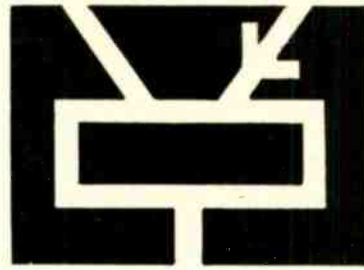

# VOLTMETER DESIGN PROBLEMS

By I. QUEEN

FIG. 1 is the basic circuit of a transistor voltmeter. Such instruments have been described before by this author and Rufus Turner among others. R1 is the multiplier resistor, R2 the input resistor and R3 controls the reverse current through the meter. When this current equals cutoff, the meter rests at zero.

There are a few difficulties, however. The meter not only reads in proportion to signal (base) current, but also varies with every change in resistance between base and emitter. When R2 is very small, collector cutoff (zero input) current may be a few microamps. It may jump to over 200  $\mu$ a if the resistance is large.

There are two ways to reduce this error. First, you can choose a transistor with very low cutoff current. One CK722 tried showed only 5  $\mu$ a with the input terminals open. The current fell to 3  $\mu$ a with the terminals shorted. This variation is so small it can be ignored. A second way is to use a meter with a high full-scale reading, for example 1 ma. (See "Transistor Microammeter" in the June, 1953, issue.) Unfortunately, such a meter cannot make very sensitive measurements.

Now how about actual values for R1, R2 and R3? Those shown in Fig. 2 proved suitable for a voltmeter using a 100- $\mu$ a d.c. meter and a type 2N34 high-gain transistor.

As already stated, R2 controls the cutoff current. If it is too low, it reduces the gain. If too high, the cutoff current will be considerable, and ambient temperature will have too great an effect. A resistance of about 100,000 ohms was found suitable. It reduced the cutoff current to about 110  $\mu$ a at 70°. In practice, R2 is an 82,000-ohm resistor and a 50,000-ohm potentiometer in series. The gain can be varied about 5% with this arrangement, and the potentiometer is used as a calibration control.

R1 is determined by experiment. An 8.2-megohm resistor provided nearly full-scale deflection with 10 volts input. The deflection was then set to exactly full scale with the calibration control. (Note that this instrument has an input resistance of more than 800,000 ohms

per volt!) For a 1-volt scale the multiplier is 820,000 ohms, and for a 100-volt scale R1 is of course 82 megohms. Multipliers should be hand-picked for high accuracy but need not be precision types.

**Temperature effects**

If transistor cutoff did not vary with temperature, R3 would be no problem at all. It would simply have to pass a

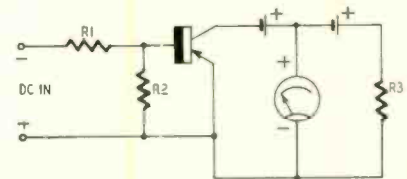

Fig. 1—The basic voltmeter.

current equal to the cutoff current of the transistor. But temperature does affect transistors. A rise of 20°F may almost double the cutoff current, so R3 must be variable over a wide range to compensate for operation at different temperatures. The arrangement in Fig. 2 is made up of a 3,300-ohm fixed unit, a 10,000-ohm potentiometer and an 8,200-ohm resistor that can be

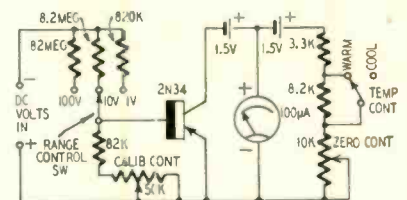

Fig. 2—Sensitive transistor voltmeter in three ranges.

switched in and out. This has enough leeway to cover wide temperature variations. The switch is opened or closed to compensate for wide temperature difference, and is calibrated with a "warm" and a "cool" position.

Fortunately the ambient temperature error is usually very small. Measurements were made on a hot summer day, with the sun falling directly on the instrument, then after chilling in a refrigerator. The "hot" reading was only about 5% lower than the "cool" measurement. END

# NEW CHROMATIC AMPLIFIER



The high-gain wide-band Chromatic Amplifier.

*Here is a highly  
useful "tool"  
for checking low-gain  
circuits in  
color receivers*

By ROBERT G. MIDDLETON\*

**T**HE new Simpson model 406 Chromatic Amplifier simplifies various tests in low-gain chroma circuits of color TV receivers. It is also useful in certain other tests in conjunction with a low-gain wide-band scope.

The Chromatic Amplifier does not have to be used in all color receiver circuit checks. When the circuit under test provides some gain, rather than loss, the amplifier becomes superfluous; for example, tests of the red, blue and green video amplifiers do not require signal boost. However, tests of the Y channel or the matrix elements require amplification to obtain full-screen deflection (unless a very substantial input signal or a very high-gain scope is used). The circuit diagram of the amplifier (Fig. 1) appears somewhat elementary, but the experienced operator will perceive that there is more here than meets the eye. An amplifier of this type operates from 8 kc to 4.5 mc. The plate circuits require compensation to maintain a flat response over this wide range and to develop a desirable gain figure. The arrangement shown in Fig.

1 develops a gain of approximately 50.

Because the plate circuit is compensated, it acts as a low-pass filter which will operate properly only when working into the proper load—the input impedance of the demodulator probe. Any other load value will alter the frequency response of the amplifier. Hence it should be used only to drive the probe, and the probe used should have characteristics equivalent to the Simpson peak-to-peak high-frequency probe (Fig. 2). Otherwise, a flat response will not be obtained from the amplifier.

### Using the amplifier

Fig. 3 shows the three possible arrangements for an amplifier when used to boost the signal into or out of a circuit under test or out of a probe to obtain full-screen deflection on a low-gain scope or for testing a very low-gain circuit. Fig. 3-a is satisfactory from the standpoint of operating stability, but is more costly because the amplifier must work into a different circuit impedance for each test. Circuit impedances may vary from that of a 500-ohm contrast control to the grid circuit of the chroma amplifier. The

shunt capacitance values in such circuits vary considerably. Hence, if this method is used, a second tube is required in the amplifier so that a very low output impedance (such as 75 ohms) can be obtained. However, the use of an extra tube should be avoided if another method will prove more practical.

The second arrangement (Fig. 3-b) offers a very attractive feature in that the amplifier may now work into a constant load impedance, the input impedance of the probe. If the specified probe is used with the amplifier, a pentode-triode will develop the desired gain with response flat within  $\pm \frac{1}{2}$  db over the range of 8 kc to 4.5 mc in all tests.

Placing the amplifier between probe and scope might make it possible to use a relatively narrow-band amplifier, requiring one less section in the tube envelope. This arrangement (Fig. 3-c), however, is not practical for service work. Although the amplifier need not have a frequency response above 50 kc for the intended purpose, the low-frequency response of the amplifier must be extended to 20 cycles because a demodulated signal is now being amplified. With a low-frequency response of

\*Field Engineer, Simpson Electric Co.

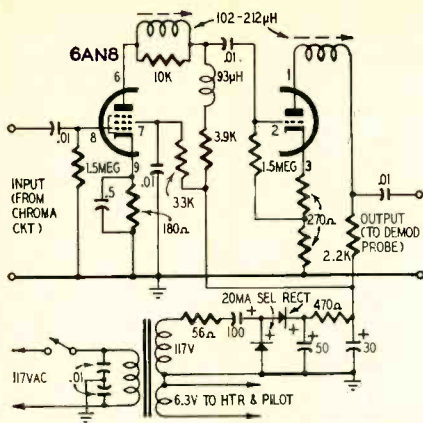

Fig. 1—Diagram of the Chromatic Amplifier. Unit operates from 8 kc to 4.5 mc.

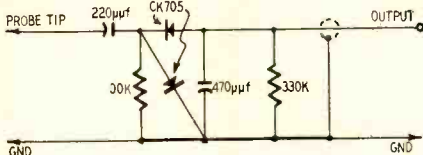

Fig. 2—Simpson high-frequency probe.

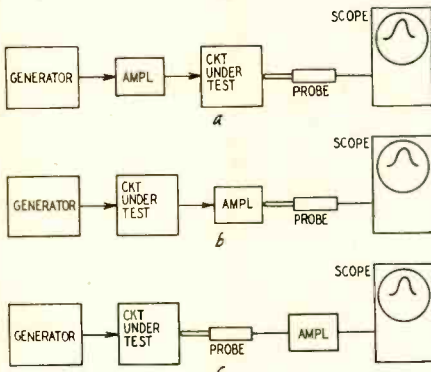

Fig. 3—Possible amplifier arrangements

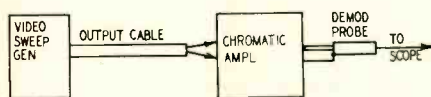

Fig. 4—Checking generator output.

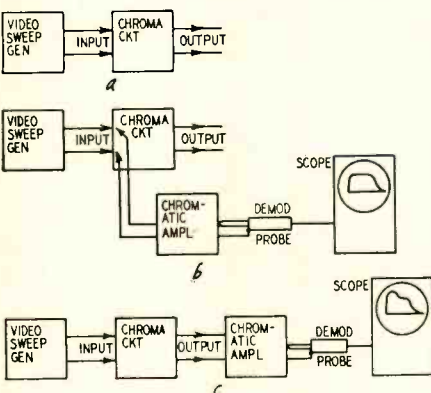

Fig. 5—Checking chroma circuit input.

this type, "bounce" becomes a severe problem since any small variation of line voltage, such as is caused by snapping a light switch on or off, causes the pattern to bounce off-screen. The difficulty can be avoided by operating the receiver under test from an automatic

line-voltage regulating transformer. Service shops do not commonly have this type of transformer available for bench work, so the arrangement shown in Fig. 3-b represents the most economical method for the service bench.

The amplifier does not respond to changes in source impedance, thus the input voltage from the circuit under test may be obtained from a low-impedance source such as the cathode of a phase-splitter tube or from a high-impedance one such as the grid of a picture tube, without disturbing the amplifier response. However, the input capacitance of the amplifier is important to the circuit under test since unsuitable test leads may shunt so much capacitance across a high-impedance TV circuit that its operation is disturbed and a distorted response curve obtained.

A shielded input cable has much more capacitance than does a pair of open test leads, but it is effective in minimizing the possibility of stray-field pickup such as flyback pulses. Whenever a shielded cable is to be used in a high-impedance circuit, the possibility of circuit loading must be kept in mind. It is better to "kill" the horizontal sweep section of the receiver and use a pair of open test leads rather than take the chance of disturbing the normal operation of a high-impedance circuit with a shielded cable. Fortunately the majority of signal takeoff points in a color TV chassis can be obtained at low-impedance circuit points.

The amplifier pentode (Fig. 1) is series-shunt-peaked, and the triode is series-peaked, with negative feedback in the cathode circuit. The triode grid leak is connected to the midpoint of the feedback resistor to obtain the proper operating point. The series peaking coil of the pentode is damped to flatten out the frequency response and avoid excessive high-frequency peaking. However, the series peaking coil of the triode section is undamped because of the lower plate resistance of the triode.

The series peaking coils have adjustable cores to permit equalizing of the frequency response in case the 6AN8 is replaced. They also compensate for slight tolerances in the factory wiring. By slight stagger-peaking for a 4-mc rise, the over-all frequency response is flat within  $\pm 1/2$  db to 4.5 mc. This figure meets or exceeds that of any service instrument which has come to my attention.

Flat response below 8 kc is unnecessary because the output capability of video sweep generators or the Chromatic Probe (see January, 1955, issue) does not extend below this figure. In fact, the demodulating capability of most service probes extends down to only 50 kc.

Amplifier filtering

An important function of the am-

plifier, which may not be immediately recognized, is its filter action. By making the test shown in Fig. 4, the technician can determine whether the output from his video sweep generator is sufficiently flat. The pattern obtained on the scope screen should be an essentially flat line if the generator output voltage is uniform. Otherwise, the generator output will have to be corrected, as a distorted response curve will result if the generator lacks a flat output.

Fig. 5 shows the steps to be followed in checking the flatness of the sweep input to a chroma circuit. The sweep generator signal is applied to the input of the chroma circuit under test (Fig. 5-a). The Chromatic Amplifier is also connected to the input of the chroma circuit under test (Fig. 5-b), and the output from the amplifier is applied to a peak-to-peak demodulator probe that feeds the scope. The scope trace should be a straight horizontal line. Finally, the Chromatic Amplifier is connected to the output of the chroma circuit under test (Fig. 5-c) to obtain the circuit's frequency response.

The amplifier serves primarily as a low-pass filter, removing all frequencies except the video-frequency signal used in making the chroma circuit check. This is done because a video sweep generator must operate on a beat-frequency principle to cover the wide frequency range required (50 kc to 4.5 mc). All beat-frequency generators develop a sum as well as a difference frequency and feed-through frequencies. A few generators have a low-pass filter in the output circuit, but the majority do not. Hence, the filter function must be provided by the technician if he is to obtain a valid flatness check.

It is sometimes assumed that if one of the signals in the output of a sweep generator is flat, all must be flat, or vice versa. But this is not true. It is possible for the sum frequency and the feed-through frequencies to be flat, and for the difference frequency to show distortion such as a low-frequency droppoff. Thus only the type of test shown in Fig. 4 (or an equivalent filtering arrangement) will provide the technician with the information he seeks. The exact procedure to be followed is shown in Fig. 5.

The present trend is toward the use of wide-band scopes that provide full gain at the color subcarrier frequency, and of course the gain of such scopes is relatively low. When such a scope is used for alignment work, the Chromatic Amplifier will be required for a greater number of tests. Some wide-band scopes, however, provide a dual-band arrangement, so that the input circuit can be converted by switching for high-gain narrow-band response. In such case, alignment checks can be made in the high-gain position of the switch, and the Chromatic Amplifier will be called upon less often to boost the test signal. END

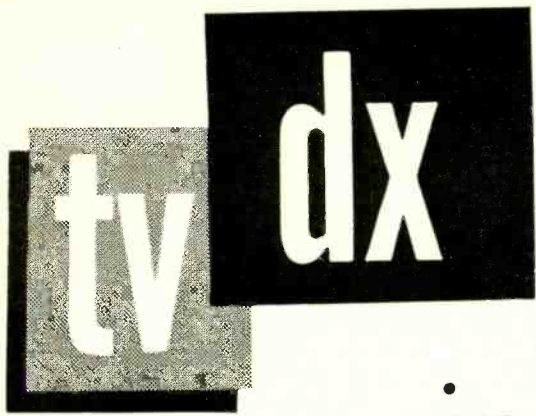

*What's what and who's who  
in long distance TV reception*

# in 1954

By E. P. TILTON, W1HDQ\*

**T**HOUGH this is the fourth yearly summary of TV dx observations, most casual television viewers are still unaware that TV signals can on occasion be received over distances of 1,000 miles or more. Even when they encounter their first dx, a typical reaction may be "So what? It's the same program I get on the local channel!" And many a proud dx-er, calling in a neighbor to witness one of his prize catches, has been rebuffed with "Lots of snow on it, isn't there?" But to a growing army of enthusiasts the logging of TV dx is a fascinating, if sometimes exasperating, hobby.

The TV dx-er is a reincarnation of the radio dx bug of a generation ago. He carries on in the same tradition; no hour is too late or too early for his brand of fishing, if it will add a new call to his reception log. He watches the vagaries of nature, until he can predict with a fair degree of accuracy when "conditions" will be just right. Program content means nothing; he lives only for the moment when call letters are flashed on the screen or announced by voice. (And he'll tell you that this is done all too haphazardly to suit his requirements!)

The true dx-er keeps an accurate log, and this is important. As in many other fields of scientific endeavor, the amateur TV dx observer is in a position to make real contributions to our knowledge of v.h.f. wave propagation. It is with this thought in mind that RADIO-ELECTRONICS has encouraged the careful observation and detailed reporting of TV dx reception. Reports are gone over for information of general interest and then made available for study by individuals or agencies interested in v.h.f. propagation. (See "The Effect of Sporadic E on TV Reception" in the June, 1953, issue.)

The January issues of this magazine for the past three years have carried

detailed analyses of these reports, together with explanations of the various forms of dx likely to be encountered. Readers who want to know more about the nature of TV dx are urged to read these articles. Otherwise some of the terms that follow may seem so much Greek.

## 1954 in review

We need only stack the 1954 reports alongside those for previous years to see that there was a marked upturn in TV dx this year. There was also an increase in the number of reporters, and in the skill of the old hands. Anyone not experienced in this hobby might think it impossible to log 64 different stations in a lifetime, but one of our observers identified that many *in a single day!* At least eight have logged more than 100 stations and one fellow, who has been at it for 5 years, is up to 202.

The major season for sporadic-E dx was longer in 1954. Where heretofore there has been little doing before late April, a fair number of openings were caught in March. The dx season lasted well through August, and there were more openings in all the other "off months" than in previous years. It would be too repetitious to sort out the 1954 reports by station and date, as we have done previously, but spot checks of the more complete and accurate logs show that, except for the longer summer season, dx followed closely the well-established geographical and seasonal patterns.

The 1954 file runs to several thousand individual observations from nearly every state of the Union and from Yellowknife, Northwest Territory, to Buenos Aires, Argentina. TV stations of 10 countries were identified. As before, stations in the lower latitudes were reported most often, with the Cubans well up toward the top of the list. All forms of dx were reported most often by observers in the Gulf

states, with the Great Lakes region and the coastal states, east and west, following close behind.

## Some rare dx

With an ever greater number of stations on the air, and with programming now running to full-day proportions, the chance of catching extreme dx would seem to be diminishing. Even so, several South American stations have been logged by our keener observers. PRF-3, Sao Paulo, Brazil, takes the prize among the South Americans. This station has been reported several times before, but never so often or widely as in 1954. If you can recognize the difference between Spanish and Portuguese when you hear it spoken, watch any Latin-American reception closely. This aid enabled G. P. Obero, Richmond, Va., to dig out PRF-3 on May 17, at 7:30 pm, E.S.T., and May 20, at 7:05 pm.

Bob Seybold, Dunkirk, N. Y., also caught PRF-3 on May 17 and again on June 17. Ronn deNeuf, Ithaca, N. Y., picked it up on May 20, also around 7:30 pm, E.S.T. Fred L. Hall, Wichita, Kans., saw it on July 18. Harry Nelson, Winchester, Va., saw PRF-3 back on Sept. 10, 1952, but had not reported it previously. What is probably a world TV dx record was the achievement of Bob Cooper, who reports 16 minutes of PRG-3, Rio de Janeiro, Brazil, July 22, beginning at 11:47 P.S.T. A distance of more than 6,600 miles, it is approached (to our knowledge) only by the South African reception of the BBC, back in the high sunspot years of 1946-48. And that, of course, was under highly unusual atmospheric conditions.

These South American reports are of special interest to hams who work the amateur 50-mc band, as sporadic-E communication between North and South America has been practically nonexistent. It would appear that with proper coordination of effort, some very

\*V.h.f. Editor, QST.



nice amateur dx might be possible on 50 mc at times other than during the high sunspot years.

We continue to get scattered high-band TV dx reports that also have no counterpart in amateur communications experience, Ernest J. Smith, Bennettsville, S. C., reports reception of KGGM, Albuquerque, N. M., on channel 13, but gives no details. This is about 1,200 miles, a distance that has been equaled by hams on 144 mc, but never approached on 220 mc, which is just outside the high edge of channel 13. Tommy Larkins, Clarkville, Tenn., reports WATV-13, Newark, N. J., at 11:30 pm, Dec. 29, 1953. This is some 750 miles, at a season when high-band dx is a rarity. Reception of high-band stuff from Havana and Galveston, Tex., is reported by Dorsey Akers of Charleston, W. Va.

High-band dx of a tropospheric nature is common in the warmer months, with September and October perhaps the best. Albert Brant, Salem, Ore. logged KFMB-8, San Diego, about 950 miles, in October. The advantage held by the Gulf states in regard to tropospheric dx is shown in the logs of Weems and Betterworth of State College, Miss.; Blalock, Tallahassee, Fla.; Sherman, Sinton, Tex.; Doss, Dallas; Walker, Daytona Beach; Bondurant, Tampa; Hopwood, Miami, Fla., and many others. These observers find it not uncommon for channels 7 to 13 to be open across the Gulf, at distances up to 750 miles or so, even in January and February. The reports of a score of Gulf states observers indicate that the period of Feb. 25 to 27, for instance, was equal to almost anything that the summer had to offer.

The Southerners don't have it all, however. L. A. Canning, Halifax, N. S., found signals from New York to Washington, D. C., on all channels the night of April 20. He got WATV-13 and saw a picture from WPXI-11 for the first time. These are in the New York area, more than 500 miles away. Canning is one of the very few observers who have definitely identified auroral propagation in TV reception. On Sept. 30, he found broad mushy signals coming from 5 degrees west of north. Both audio and horizontal sync were badly garbled on signals picked up on channels 2, 3, 4, 5 and 10. Indications were that they were New York and Philadelphia stations, from what little audio could be copied. He lists a new Canadian station for dx-ers to shoot for: CJCB-4, Sydney, N. S.

Another far-north station, as yet unreported in the States, is KFIA-2, Anchorage, Alaska. This was logged on Aug. 28 and 29 by Glick, of Yellowknife, Northwest Territory.

The Southern record is held by Middleton of Sanford, Fla., who logged LVD, Buenos Aires, on July 8, 1953, between 5 and 6:15 pm E.S.T. Another interesting Latin American report, possibly a case of mistaken identity:

"HGLO" reported by Aldridge, Winston-Salem, N. C. According to international prefix assignments, this would be in Colombia, but we have not heard of it from other observers.

YVKA, Caracas, Venezuela, was picked up by Akers, Charleston, W. Va., on both channels 2 and 5, at 5:12 and 6:18 pm E.S.T. on May 13, and on channel 5 June 11 and 15. A channel 2 station with the call CR5J was intercepted along with YVKA on May 13. Anyone know more of this one? In the international prefix table this sequence is reserved for Portuguese colonies.

Some u.h.f. dx, too

When u.h.f. stations first came on the air, 50 miles was considered good dx for channels 14 to 83. As we gain more experience with it, u.h.f. is turning up stuff almost equal to the best observed on 7 to 13. Seybold, Dunkirk, N. Y., has 10 u.h.f. stations more than 200 miles distant, with WEEK-43, Peoria, Ill., 480 miles, and WWOR-14, Worcester, Mass., 350 miles, as his best west and east. Reception up to nearly 400 miles was fairly common during the fall tropospheric bending periods. Bob uses stacked corner reflector antennas 70 feet above ground for his u.h.f. reception.

Four stacked bowties and a hilltop location help Louis Matullo, Washington, Pa., in pulling in plenty of u.h.f. dx, including just about every u.h.f. station out to Waterloo and Ft. Wayne, Ind. Lou keeps perhaps the most complete record of weather and reception conditions of any dx-er we know of, and he's watching the TV channels night and day, whether he is at work (as a TV service technician) or at home.

Burst reception

Several observers report occasional bursts of short duration, when conditions do not appear to be favorable for dx. A lot remains to be learned about this sort of thing, but we know of at least two natural phenomena that can be responsible. Ionized trails formed by the passing of meteors through the E region of the ionosphere are known to reflect frequencies up to at least 150 mc, possibly higher. Such bursts are usually of so short duration that they are useless for normal reception. Occasionally they may hold on for long enough to permit identification. They have been known to last for nearly 2 minutes, probably because of the overlapping of several individual bursts. They may bring in flash signals from distances up to 1,200 miles or more.

Lightning flashes, too, have been shown to develop sufficient ionization to reflect v.h.f. waves. The reflecting region is lower, in this case, so the distance over which its effect is noticeable is shorter. Usually lightning effects show up as sudden enhancement of the strength of a signal you're already seeing, whereas the meteor burst is usually a flash of signal from beyond even the best tropospheric range.

Bursts have been reported by Matullo; Ross, River John, N. S.; Erickson, Havre, Mont.; Chadwick, Wilcox, Sask., and DeGeer, Tulsa, Okla. We welcome more observations of this nature, particularly in high-band or u.h.f. reception.

What it takes to receive dx

Many correspondents ask for details of equipment used by outstanding dx-ers. No doubt these readers feel that the more successful observers must have some magic formula to account for their superior results. A good high antenna, a clear quiet location far from sources of man-made noise, nearness to large bodies of water—these are all helpful factors. But we think the red-hot TV dx enthusiast's real secret weapon is perseverance. Knowledge of the most likely times for dx (we've covered this information several times in the past, and RADIO-ELECTRONICS carries quarterly forecasts) and familiarity with the correlation between weather variations and dx propagation are important aids, but it takes time and patience to run up impressive totals.

At least one fellow we know went to some trouble to get a good antenna, too. Grant Ross, Marathon, Ont., was more than 300 miles from the nearest TV station, Green Bay, Wis. To get a better shot in that direction, he erected a large rhombic array on a 300-foot hill and ran an 1,800-foot transmission line down into the valley. This enabled him to get excellent signals from WBAY-2 at least 40% of the time. Poor or useless reception prevails only 20% of the time. The rhombic also serves him well whenever dx is coming through.

Over fifty TV dx club

Listed below are the records of some of the outstanding observers. This information was taken only from reports where totals were compiled by the correspondent himself. We know that it passes up much excellent work done by others. If you'd like to have your record in this section the next time it is published, please include your totals when you report.

NAME	LOCATION	TOTAL U.H.F. DX	BEST
Dorsey W. Akers	Charleston, W. Va.	202	1,200*
Robert Seybold	Dunkirk, N. Y.	163	19 4,900
Bedford Brown, Jr.	Hot Springs, Ark.	162	
Fred Von Gunten	Berne, Ind.	154†	
Louis Matullo	Washington, Pa.	146	
Russell Ashworth	New Bedford, Mass.	121	22
Robert Weems, Jr.	State College, Miss.	102	
Art Collins	Buffalo, N. Y.	100	
Roger Anderson	Madison, S. D.	99	26
Bob Cooper	Lafayette, Calif.	92	6,600
F. E. DeGroat	Salamanca, N. Y.	90	
Douglas Bryan	Otzy, Tex.	86	
Ronn deNeuf	Ithaca, N. Y.	83	12
Ernest J. Smith	Bennettsville, S. C.	83	2,300
Alton Caldwell	Brookton, Mass.	81	4
Paul Mitschler	Marysville, Kan.	81	
Toby Chambers	Miami, Fla.	76	1
Joe Foyer	Westville, Ill.	72	15
Mrs. Wm. Callan	Allioma, Pa.	72	
Kenneth C. Bush	Buffalo, N. Y.	71	
James M. Homan	Broxi, Miss.	70	
Ross Brown	Tupperville, Ont.	66	
Tommy Larkins	Clarkville, Tenn.	66	
Danny Startzman	Bennington, Kan.	64	
R. A. Wilson	Detroit Lakes, Minn.	62	
Carl F. Lupton	Shelbyville, Ill.	61	
Harry Wieskamp	Holland, Mich.	58	14
Kenneth M. Neal	Henlin, Tex.	55	
M. W. DeGeer	Tulsa, Okla.	55	
Karl Kleintop	Bowmantown, Pa.	52	8
Richard Gleitz	York, Pa.	52	11
W. C. Sherman	Sinton, Tex.	50	

\* High band—CMBF-7 and KGUL-II  
† 126 photographed.

# COLOR TV CIRCUITS

## Part IX—The Lawrence strip type tube; its operation and circuitry

By KEN KLEIDON\* and PHIL STEINBERG\*

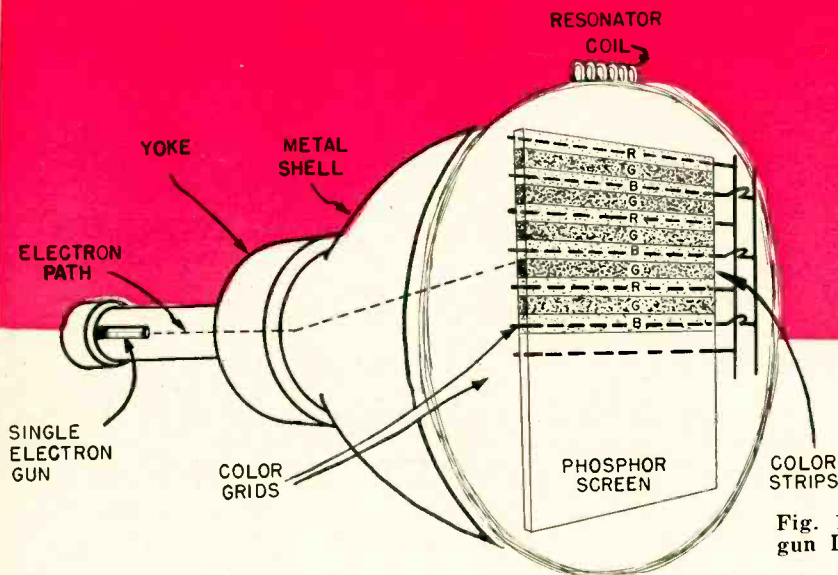

Fig. 1—The single-gun Lawrence tube.

**A**LTHOUGH the three-gun dot type color picture tube is predominant at present in commercial color receiver production, many feel that the Lawrence strip type tube will eventually be used for a lower-cost, mass-produced color set. The disadvantages of the strip type color tube, which discouraged its early use, were excessive 3.58-mc radiation, poor vertical resolution especially on single color fields and limited production facilities. According to the tube licensor, the first two disadvantages have been remedied and production facilities will soon be improved.

The Lawrence tube has, according to the manufacturer, a number of distinct advantages over the three-gun tube, including:

#### Advantages to consumer:

1. Larger color pictures
2. More brilliant picture because tube makes maximum use of electron stream
3. Stable color pictures because of simplicity of receiver circuits
4. Better and sharper black-and-white pictures
5. Simpler controls

#### Advantages to receiver manufacturer:

1. Smaller cabinet—tube is shorter due to its wide deflection angle
2. Standard deflection and focus components
3. Low raster scanning power
4. Simple low-cost circuitry
5. No high-voltage regulation required

6. No purity or convergence components
7. Quick circuit alignment
8. No mu-metal shield needed to shield tube from stray magnetic fields

#### Advantages to tube manufacturer:

1. Lower scrap rate and easier manufacturing because design allows greater tolerances than other type color tubes
2. Manufacturing techniques parallel those for black-and-white tubes
3. Less expensive and fewer component parts
4. Lower manufacturing cost for larger color pictures
5. Greater profit margins

Because of these advantages, the Lawrence type color tube is worthy of serious consideration by the television technician.

#### The single-gun tube

The Lawrence tube differs greatly from the three-gun dot type color tube in that it contains only one electron gun and the face of the tube is composed of phosphor strips rather than dots. Also, a grid structure is located directly behind the phosphor strips in place of the shadow mask. Fig. 1 illustrates the Lawrence tube and its major components. The single gun serves as the electron source to excite the red, blue and green phosphor strips. These are arranged in the sequence, from top to bottom, of red, green, blue, green, red, green, blue, green, red, etc. There are an equal number of red and blue strips and twice as many green strips

as there are blue and red strips. The width of the strips is shown out of proportion in the illustration for the purpose of clarity—there are hundreds of horizontal phosphor strips on the tube face.

Located directly behind the phosphor screen is a grid structure composed of two sections in the same plane, termed color grids. One section of the color grid has a grid wire positioned directly behind each red phosphor strip and the other a grid wire positioned directly behind each blue phosphor strip. Connections to the two color grids are provided by terminals at the top of the tube. A resonator coil is connected to these, and with the internal capacitance presented by the color grids, will resonate at a frequency of 3.58 mc. Its function is to modulate vertically at a sinusoidal rate each horizontal scanning line. This resonator coil is driven by a power amplifier and is shielded to prevent radiation of the 3.58-mc signal.

The deflection yoke is almost identical to the type used for a conventional black-and-white receiver and, since no yoke purity adjustment is required as with a three-gun tube, its adjustment or positioning is not as critical. The high-voltage requirement is about 18 kv, unregulated, and is applied to the phosphor screen. A potential of 5 kv is applied to the color grids.

Fig. 2 shows a side view of the color grids and the phosphor screen for three different conditions. Since the color grids for the blue phosphor strips are connected to one end of the resonator

\*Raytheon Manufacturing Company, Television and Radio Division.

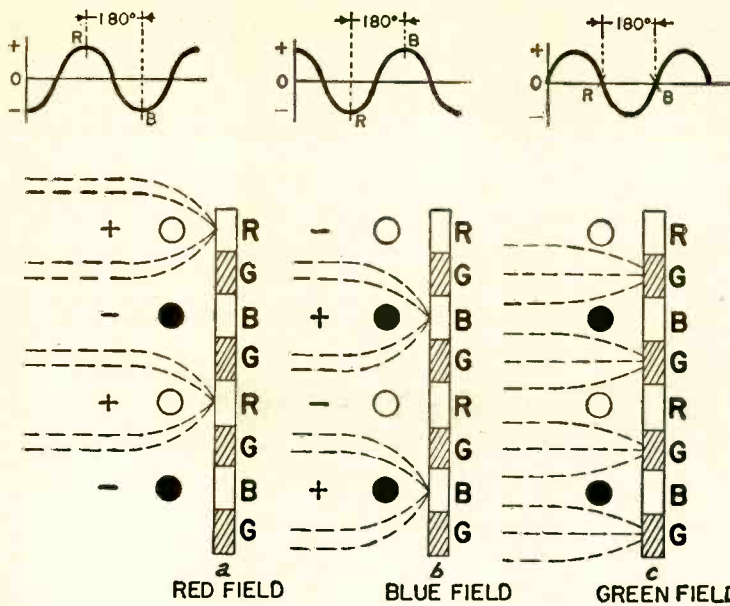

Fig. 2—Side view of grids and screen of a post-deflection focus tube.

coil, and the red grids are connected to the other, the grids are 180° out of phase. Fig. 2-a illustrates a resonator-coil polarity condition when the red grids are positive due to the resonator sine-wave phase and the blue grids are negative, since the grids are 180° out of phase. For this polarity, the electrons strike only the red phosphor strips. The combination of electrostatic fields caused by the color-grid polarities and the focusing action due to the 13-kv difference in potential between the color grids and phosphor screen prevent electrons from striking the green or blue strips.

Fig. 2-b shows the opposite condition—the blue grids are positive, the red grids negative. Thus, the electrons will strike only the blue phosphor strips.

When the grids are at the same potential (Fig. 2-c), the electrons strike only the green phosphor strips. The focusing action which takes place due to the 13-kv difference in potential between the color grids and phosphor screen prevents the electrons from striking the red or blue strips.

Fig. 3 shows the effect of the resonator coil on the path of the electron beam during a portion of one horizontal scanning line. The horizontal deflection voltage applied to the yoke moves the electrons from left to right across the face to the picture tube, as in any monochrome picture tube. However, at the same time, a sinusoidal deflection voltage is applied to both sets of color grids by the resonator coil as described previously. This deflects the path of the electron beam in a sine-wave displacement and the electron beam scans three strips in the following sequence: green, red, green, blue, green, red, etc. As with a monochrome picture tube, vertical deflection voltage is applied to the yoke at the same

time so that the electron beam will move down to scan the next lower set of strips for the next horizontal scan period.

The last step necessary to produce a color picture on the Lawrence strip type tube is to control the electron beam so that, when the beam is striking the red phosphor strip, the red video signal will be modulating the electron beam, and the same for blue and green. To separate the three primary colors in the receiver the picture tube is gated. By gating, we mean that only green video information is allowed to modulate the electron beam while it is crossing the green strip, only blue video information is allowed to modulate the electron beam while it is crossing the blue strip and similarly for the red video information.

Fig. 3 also shows the time intervals required for gating the green, red and

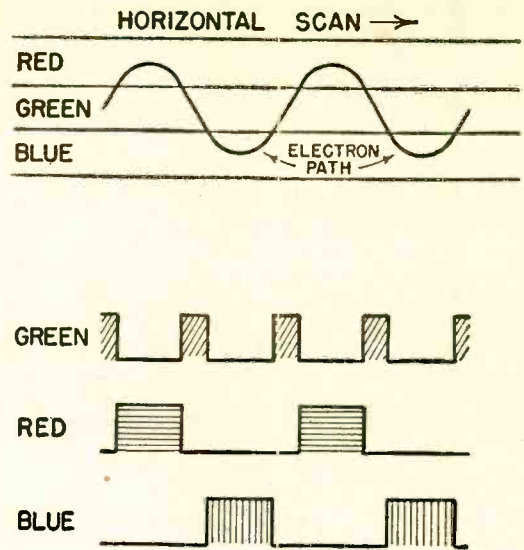

Fig. 3—Path of the electron beam due to action of the resonator coil. Also shown is the color gate time intervals.

blue signals for proper modulation of the electron beam. The gating process in the receiver is controlled by the same type of 3.58-mc color oscillator, synchronized by the color burst signal, as in the three-gun-tube color receiver.

Single-gun circuitry

A block diagram of the circuitry for a Lawrence tube color receiver (Fig. 4) shows that most of the color circuitry is similar to that for a three-gun color picture tube. The first and second video amplifiers, bandpass amplifier, demodulators, color oscillator and control, and the matrix circuits are nearly identical for both three-gun and single-gun circuitry. Red, green and blue video signals are obtained from the matrix, as for the three-gun tube, and are applied to their respective gate circuits and then to the Chromatron cathode. Differences do exist between

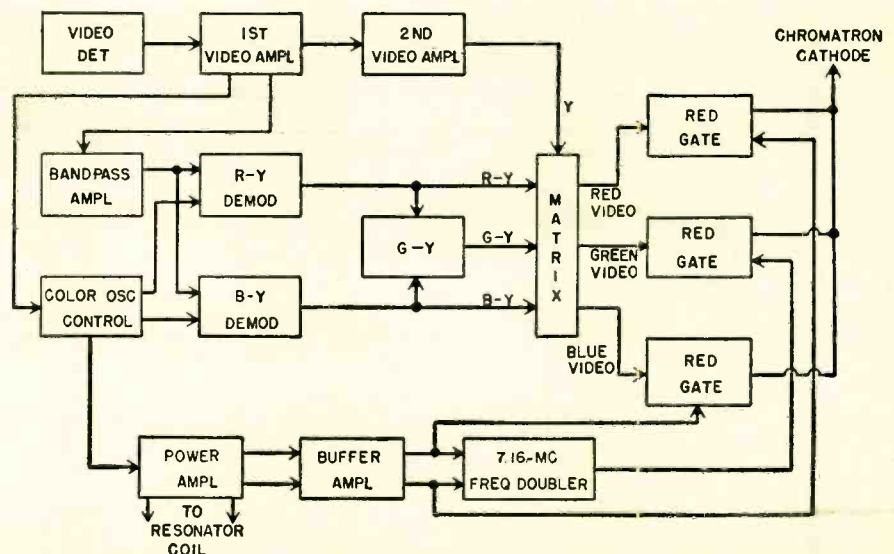

Fig. 4—Block diagram shows the circuits for a Lawrence tube color receiver.

## TELEVISION

the 3.58-mc color oscillator output circuit of the three-gun and single-gun tubes. In the single-gun Lawrence circuitry an additional oscillator signal, at the second harmonic of 3.58-mc (7.16-mc), is coupled to the green gating circuit.

A gating circuit is nothing more than an amplifier with a video signal coupled to its control grid and a gating signal applied to its screen grid. The gating signal is the oscillator signal and the stage is designed to allow the amplifier to conduct only on the positive peaks of the 3.58-mc (7.16-mc for green gate) sine-wave oscillator signal applied to the screen grid.

Referring to Fig. 3 again, the gat-

ing time intervals are shown for the red, blue and green gating circuits. This shows that the red gate will conduct or allow the red video information to pass to the color picture tube only during the time period shaded with horizontal lines, which corresponds to the time that the electron beam is exciting the red phosphor strip.

An action that is similar to this occurs for the blue gate, the only difference being that since the electron beam, traveling according to a sine wave, passes the blue strip 180° after passing the red strip, the blue gating signal must be 180° out of phase with the red gating signal. The blue gate conducts or allows the blue video information to

pass to the color picture tube only during the time period shaded with vertical lines.

Since the red and blue gating time intervals occur once for every cycle of the 3.58-mc sine-wave electron-beam deflection, the frequency of the gate action must also be 3.58-mc. The green gate, however, must operate twice for every cycle of the electron-beam sine-wave deflection. Therefore, the green gate signal must be twice the frequency of the red or blue gating signal ( $2 \times 3.58\text{-mc} = 7.16\text{-mc}$ ). Also, the green gating signal must be 90° out of phase with the red screen gating signal as the electron beam passes the green strip 90° after it passes the red strip. For proper phase relationships, the screen gating signals are obtained from the same 3.58-mc power amplifier which drives the resonator coil.

Fig. 3 also shows that the width of the green gating interval is half that of the red and blue gating intervals, which are equal. Since the green gating interval occurs twice as often as the red and blue and is only half as wide, all three phosphor strips will receive equal electron-beam excitation.

The action of the gating circuit is such that for a single color field, red for example, the blue and green gating circuits prevent blue and green video signals from reaching the cathode of the picture tube. When the gate circuits are closed, they bias the picture tube beyond cut off during the gating intervals and no electrons are emitted from the cathode during the time the sinusoidal electron beam strikes the blue and green phosphor strips. The red gate allows excitation of only red phosphor strips and results in a red field.

Variations of the circuit shown in Fig. 4 are possible in the same manner as for a three-gun picture tube. For example, gated R - Y, B - Y and G - Y color-difference signals can be applied to the cathode of the color picture tube while the Y signal can be applied to the control grid. For a black-and-white picture with this arrangement, the outputs from the three gating circuits are equivalent to bias voltages for the electron gun, sufficiently high so that only the Y signal controls the electron beam. The Y signal as described in a previous article is equivalent to the black-and-white portion of the composite color video signal. If the amplitude of the sinusoidal deflection voltage is adjusted properly, the red, blue and green phosphor strips will be excited equally and result in a monochrome picture.

The next and final article will consist of a summary of the previous articles and practical color service information. TO BE CONTINUED

*Note:* More detailed information on Lawrence tube circuitry will be presented in a forthcoming book, *Color TV Circuitry* by the authors of this series of articles and available through the publishers of RADIO-ELECTRONICS magazine some time in 1955.

## Viewer Injured as TV Receiver Implodes



A housewife suffered superficial cuts on her arms and legs as the result of a violent implosion of the picture tube in her television receiver (see photo). Mrs. Bonnie Patlon of Harbor Hill, Fla., was watching television in her living room. At 9:30 in the evening she heard a frying sound. As she continued to watch, the picture flashed bright, accompanied by "a loud popping noise that sounded like a light bulb exploding."

Mrs. Patlon started for the television receiver to turn off the power, but as she passed in front of it, the blast occurred. She was thrown back into a chair as glass showered across the 12-foot room and out onto an adjoining porch. The entire picture tube and safety glass was blown into the room.

The local police chief reported he could find no reason for the implosion. Just why the police chief was sent for was not explained.

# TELEVISION . . .

*it's a cinch*

By E. AISBERG

*Fifteenth conversation, first part:*

*Separating the sync signal,*

*why, where and how; diode and*

*pentode separators*

WILL—Now I'm sure I know it all!

KEN—Your usual modest self, I see! But just what prompted that remark?

WILL—What I mean is—now I know the televiser from end to end—from first r.f. to last v.f. And besides that, I haven't forgotten the time bases. So, I know all the circuitry of . . .

KEN—Don't get excited, Will! You've still plenty to learn! For example, how are you going to go about synchronizing those time bases?

WILL—Now that you mention it, I remember that the vertical and horizontal sweep circuits are synchronized by the sync pulses we studied a long time ago. But where's the problem? If you just apply the composite video signal to the sweep oscillators . . .

KEN— . . . you'd get into plenty of trouble! The mixture of video signals with the horizontal and vertical sync pulses would keep triggering the sweep circuits at the wrong times! When you figure your time in microseconds, everything has to be neat and clean. Each sweep oscillator has to receive its own sync pulses, free from any other signal whatever. Those sweep circuits can often be started into action by the least fluctuation of the voltage on the grid of the tube that triggers them.

WILL—I see what you're coming to: you have to separate the sync from the picture signals. Because I remember when you first drew a block diagram of a televiser, you had a block marked "sync separator."

KEN—I hope, then, that you'll have no trouble figuring out how such a circuit would work?

WILL—I suppose we'll have to have some kind of electronic switch that applies the signals to the right sweep circuit at the right time. For example, at the end of each line, the voltage is applied to the horizontal sweep, and . . .

KEN—No, Will. First of all, how would you synchronize your electronic switch? Can't you see another way of capturing the pulses from the video signal—a method based on some fundamental difference between the two sorts of signals?

WILL—Well, the main difference is in their amplitudes . . .

KEN—You're on the right track. Keep going!

WILL—The sync pulses occupy the top 25% of the composite video signal. Voltages below that represent the video image, ranging from black to white. So all you have to do

From the original "La Télévision? . . . Mais c'est très simple!" Translated from the French by Fred Shunaman. All North American rights reserved. No extract may be printed without the permission of RADIO-ELECTRONICS and the author.

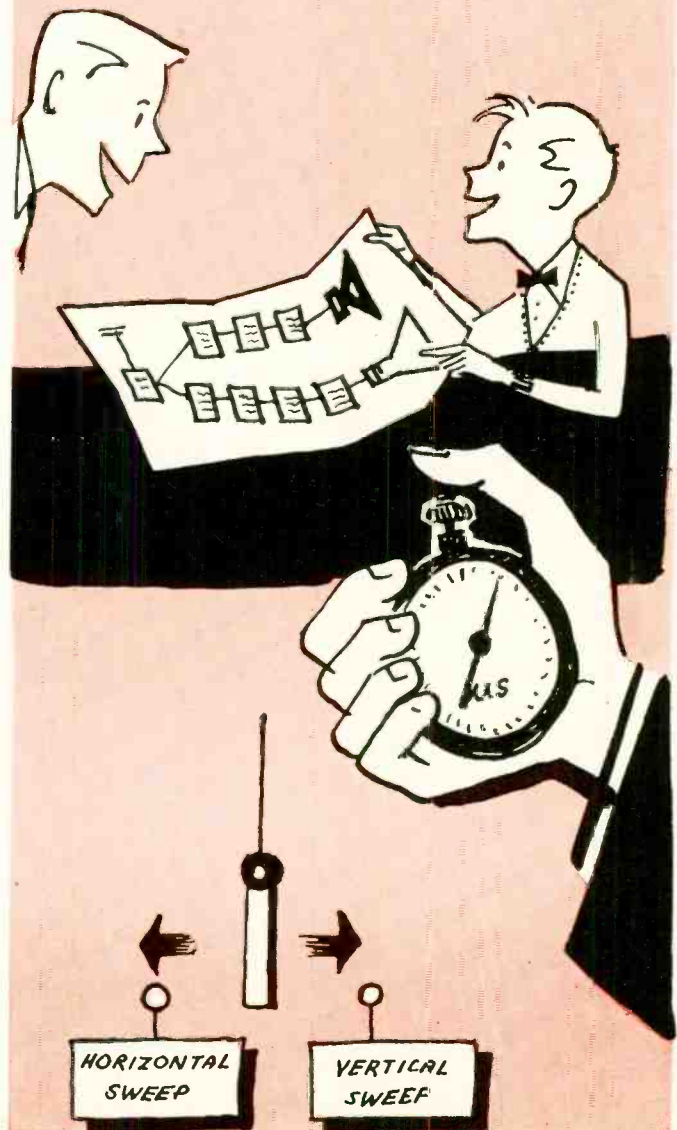

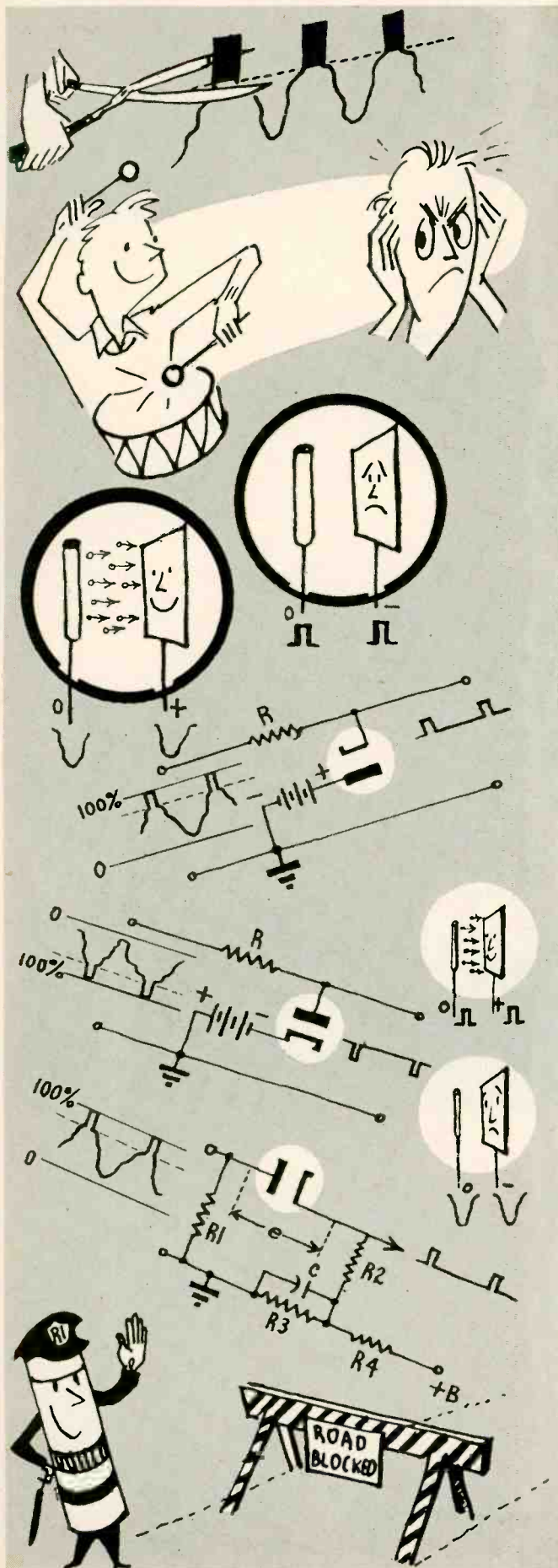

is cut off the top 25% and you then have only the pulses.  
 KEN—Excellent, Will! Only instead of cutting, it's called clipping.

WILL—But just how can you clip the top off a wave?

The limits of patience

KEN—It's easy. Just apply the signal to a tube that will function perfectly up to a given point, but absolutely refuses to pass that limit.

WILL—H'mm, something like my Uncle Jack. He never did like much racket, so I was always a little worried when I was practicing as a Boy Scout bugler. He never said a word; but the day I started to train for a drummer, he blew his top! But what kind of tube acts like that?

KEN—You use pentodes, generally. But a triode could be made to work, and in many setups a simple diode does the job—fairly well at that.

WILL—And where do you put this separator?

KEN—Theoretically, you could separate the sync signal before the detector, for the signal would be detected while you were clipping it. But it's an unreliable way in practice. So it's usually put at the output of the video amplifier, or at least after the first video stage.

WILL—And of course the signal can be either positive or negative, according to whether you apply it to the grid or cathode of the separator.

KEN—You can have either polarity of signal, though there are several circuit tricks that are better than applying an input signal to the cathode.

WILL—Now suppose we have a positive signal, so the first 75% of the voltage is below the sync level. How is a diode going to clip off the top 25%?

KEN—There's more than one way to do it. The easiest is to use a diode biased so that its cathode is more negative than the plate at all voltages below the point where you intend to begin clipping. You shunt your diode across a source of composite video signal. The diode short-circuits all voltages up to that which makes the cathode more positive than the plate. So the sync signals, which are more positive, stop the diode conducting and pass on to the output.

WILL—I can see that the diode should be biased so the plate is a little more positive than the highest video signal voltage—a little above the black or pedestal level, whatever you like to call it. Then you are sure to short all the picture signals through the tube. But what's this resistance R in your hookup?

KEN—It keeps the diode from shorting the stage that supplies the signal. You are getting your signal from some point in the video circuits and you can't permit your sync separator to affect the signal going to the picture tube. The picture tube has to get all the picture signal without distortion, and also the sync signal to black out the return trace.

WILL—Of course—I just didn't think of it . . . But now can you draw me a circuit for negative-going signals?

KEN—Certainly. We just turn the diode around and make the cathode more negative than the plate again. If you have the right bias, it remains more negative through the range of picture signals so the diode shorts them out. But the sync pulses drive the plate more negative than the cathode, conduction stops and the sync signal passes through. And that's how a shunt type separator works.

WILL—You give me the idea there must be a series type separator as well.

KEN—There is. One circuit is like this. The cathode is connected into a voltage divider (R3, R4) that makes it a little more positive than the plate. If the bias is right, only sync pulses can pass through the tube. You take the output pulses off R2, and C passes any alternating component.

WILL—What's R1 for?

KEN—It's just to give you a closed diode circuit—makes it possible to connect to your signal supply source through a capacitor. It may have other uses, as you'll see later.

WILL—I think I see how this works. If the bias voltage is about the same as the video signal at the black level, no picture signals can get through. But when the sync pulses raise the voltage higher, the plate is more positive than

the cathode, the circuit conducts and the pulses go through.

KEN—Good reasoning, Will. And the output of the circuit—the voltages across R2—consists of nothing but a series of positive pulses.

WILL—Would this work for negative pulses?

KEN—Well, if you need to make a positive signal out of a negative one, you can always use a triode as a phase inverter. But this circuit will work with negative signals, if you reverse the diode like this. Your cathode is now more positive than the plate except when the very negative pulses come through. They drive it more negative and the pulses are passed.

WILL—One thing I don't like about these circuits—the batteries you keep throwing in. This is an all-electric age—can't you make them all work with voltage dividers to bias your diode elements?

KEN—I just used the batteries to simplify the drawing. They wouldn't be used in a television receiver. Take a look at this circuit. You apply the positive-going composite video signal through C1. Each pulse attracts electrons from the cathode, which have to flow back through R1. That biases the diode so the plate is more negative than the cathode. By choosing the right values for C1, R1 and R2, you can adjust the bias so that the tube begins to conduct just at the black level. The sync pulses then appear as voltage pulses across R2. The great feature of this circuit is that it is self-adjusting to different signal strengths. If you get your components adjusted so the diode just triggers at the right level on a medium-strength signal, stronger signals will increase the bias and weaker ones decrease it, because of the change in current through R1. So both weak and strong signals will clip at the right point.

**With three grids or more**

WILL—The bias batteries would never do that. One good thing about the diode—it doesn't change the polarity of the pulses. And the circuits are simple. I wonder why anyone would want to use pentodes?

KEN—Simplicity doesn't always mean perfection! Our diode separators are weak in many ways. The separation is imperfect, for the high-frequency picture signals—those that represent very rapid variations of intensity—work their way into the sweep circuit time bases through the interelectrode capacitance of the diode. That can give you sync trouble. Another thing—a diode doesn't give out with more signal than you put into it, and never quite all of that. So, it's only natural to take advantage of the pentode because it amplifies. Besides, its grid-anode capacitance is very small, so little or no high-frequency picture signal can get through.

WILL—But how do you limit the patience of a pentode?

KEN—Its patience—actually, its plate current—can be limited at either end. We can make our tube blow its top at the least provocation or we can push it so far it will give up and tolerate anything. Take a look at this grid-voltage-plate-current characteristic curve. Right down here—in the negative-voltage region—you have a bend. And again—near zero volts—there's another very sharp bend followed by a long level stretch.

WILL—So that any increase of grid voltage from that point won't affect the plate current?

KEN—Exactly, and that applies to any reduction of grid voltage beyond the lower—or plate cutoff—bend. Since the plate current reaches zero at that point, it has to stay at zero if the grid goes more negative.

WILL—I'm beginning to see just how you could use those two limits of patience. But that curve doesn't look too standard to me. Just how do you model that kind of a grid-voltage-plate-current characteristic?

KEN—By applying the right voltages to the screen and plate. The idea is to prevent the plate from receiving more than a certain amount of current, however wide you may open that electron valve we call the grid. So you put a very low voltage on the plate and a higher one on the screen. Or you can tackle the problem from the opposite direction and put normal voltage on the plate but very low voltage on the screen.

TO BE CONTINUED

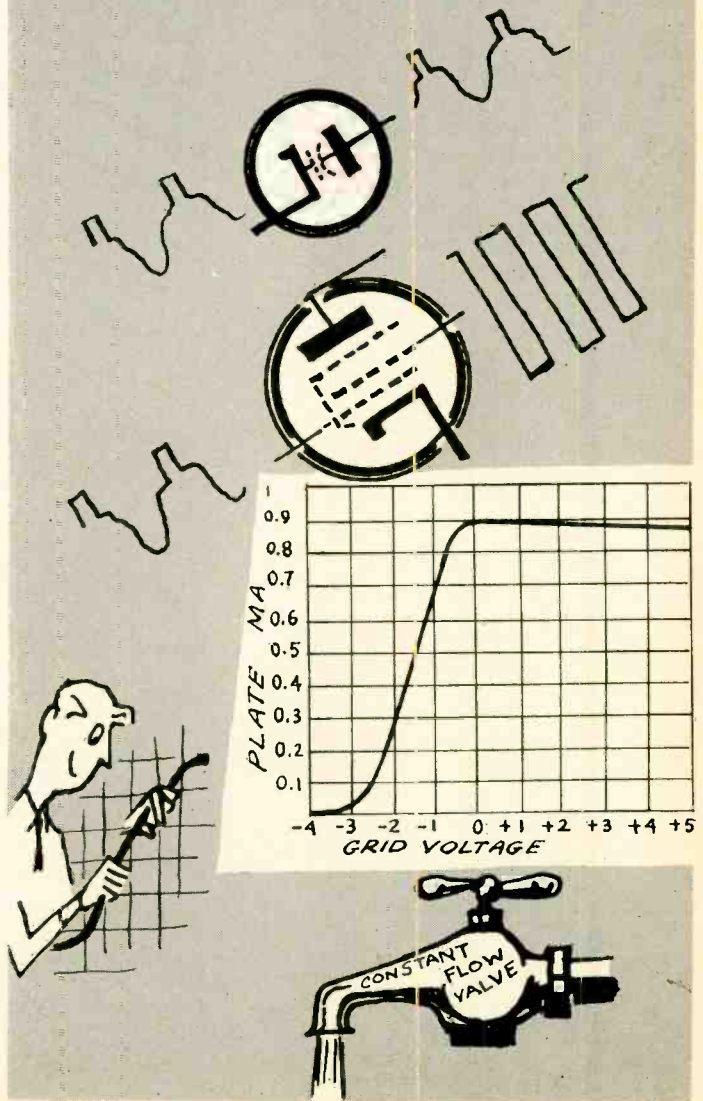
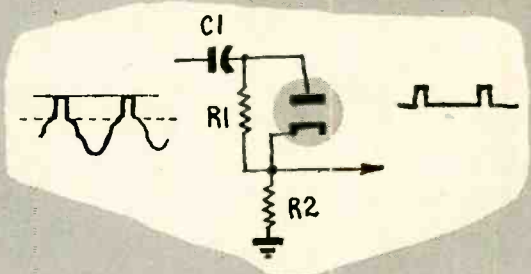
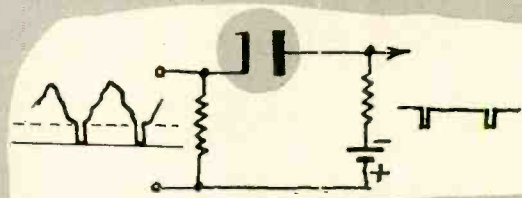

# TED TACKLES TOUGH TV PROBLEMS

By WALLACE WANER



Fig. 1—Negative picture on screen.



Fig. 2—Vertical picture bounce.

WHEN I hired Ted a few months ago, he was green from a local television school. His only practical experience had been a few minor repairs on his own receiver or those of his relatives, plus what little lab work he got at school. The kid's sharp though and when he learns new things, he doesn't forget them.

Our Main Street shop is small and our personnel consists only of Ted, our outside man Jim, and myself. On occasion I help Ted with the bench work, but the business end of the organization doesn't allow me too much time to tinker. So Ted is on his own for the most part and calls me in consultation only when he gets a sticker.

We service a variety of sets, so we often run across unusual or freak troubles, and I have standing orders with Ted to call me before he tackles any toughie.

## Case of the negative pix

Only a few weeks ago Ted called me while I was sitting at my desk absorbed in a modern scientific treatise.

"Say, boss," he remarked casually, "I think I got one that would interest you."

Ted was at that age where he considered any show of emotion as immature. The more he acted like Jack Webb, the more excited he really was. Reluctantly I laid aside the summary of the latest Kinsey report and followed him into the workshop. The receiver was an RCA 7T143. A negative picture appeared on the screen and (while I wasn't unduly impressed) I got my camera and took a picture (Fig. 1) so Ted wouldn't be disappointed.

"What's the unusual angle?" I asked him. "It just looks like a bad a.g.c. system and picture overload."

"No, sir," Ted replied. "It isn't a

bad picture tube either, nor is the alignment off!"

"O.K.," I told him. "I'll tackle it and see what I can come up with."

Ted shrugged ever so casually. "That's not necessary. I've found the trouble. It's a bad first video amplifier tube."

"Oh, I see," I said hastily. I didn't want him to hog the spotlight exclusively. You got to bring these kids along slowly, even if they're talented, otherwise they'll get a swelled head. I took my time lighting a cigarette to give myself a better chance to review mentally some of my theoretical knowledge of the composite video signal. After the first slow exhale, I felt sure I had the right answer.

"With a dead tube," I pointed out, "capacitance still exists between the tube elements and the signal can still be transferred across it even with an open heater. This is particularly true of triode tubes in a strong signal area. The dead stage will not give a phase reversal of the signal as a live stage would. Therefore, the signal arrives at the picture tube with incorrect polarity for proper whites and blacks. Result, a negative picture!"

"It sounds logical," Ted said. "Anyway, I put in a new tube before you came in and it did result in a positive picture."

I smiled. "Did you put this old tube back just so I could take a picture, or were you trying to stump me on a rough one?"

"Oh no," he assured me. "I really wanted to know the theory behind the symptom, but you don't always give out with explanations unless I trick you into it. I heard you mention once that this was a television repair shop and not a training school."

I shrugged and walked away.

## Case of the vertical bounce

Only a few days later Ted again called me to the workshop. I hated to be interrupted because I was trying to solve a perplexing business problem while resting my eyes on a Marilyn Monroe calendar. Reluctantly I tore myself away from my problem and followed Ted.

The set was a Westinghouse model H-746-K21 which had the nicest picture bounce (Fig. 2) you ever saw. Since movement cannot be photographed in a still picture, you will have to visualize the appearance. The picture jiggled up and down like a 5-year-old who has waited too long.

I watched the screen in silence for a few minutes trying to figure what in blue blazes could cause this. I stalled for time with my cigarette lighting routine but still didn't come up with an answer. So I hedged for time by asking Ted if he had made any preliminary checks.

"Yes, sir," he replied. "I've checked all tubes, voltages, and component parts. Everything in the vertical section and in the associated circuits seems to be in order."

"So what did you find is causing it?" I asked, trying to make it sound as though I knew but just wanted to know if he knew.

Ted shook his head. "I haven't been able to find the trouble this time and I thought you would help out."

Well, to make a long story longer, I rechecked everything Ted had checked and could find nothing wrong. After a couple of hours my usually serene disposition was beginning to fray slightly at the edges so I shut the set off and went to the receiver service notes to find out whether the manufacturer had any hints for this trouble.

For the first five minutes I couldn't



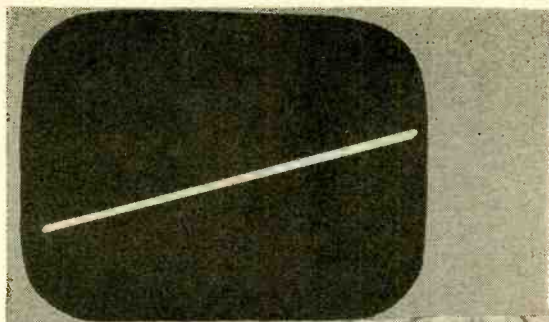

Fig. 3—Unusual diagonal pattern.

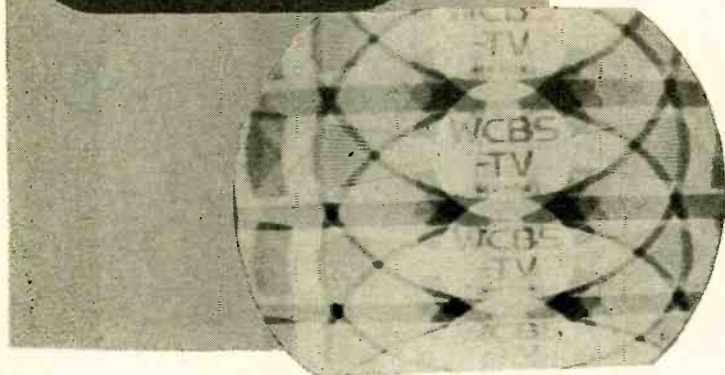

Fig. 4—Multiple vertical pattern.

the final analysis rely on your knowledge of circuit theory and your practical experience!"

### Case of the multiple image

The fourth trouble happened during the time I was trying to memorize the figures 3.5795. (No, you're wrong—it's the exact frequency by which the color-burst frequency is separated from the carrier in color television.) I wanted to have this number at my mental fingertips so I could work it into a conversation with Ted sometime and impress him.

This time the picture resembled that shown in Fig. 4, and the set was a Du Mont RA-117A.

"This one really has me stumped," Ted said to me. "The original trouble was vertical roll. I found a bad 390,000-ohm resistor in series with the hold control pot and replaced it with a new one. Now the picture has the multiple image you see, yet voltages, tubes, and all the other parts check O.K."

"But, Ted," I objected, "you know that the trouble must be in the vertical oscillator circuit, so everything can't be all right."

"Well," Ted replied, "if there is something wrong in that stage, it sure has got away from me. I checked everything several times and everything is exactly like the schematic."

"In that case," I told him, "the only thing that could be wrong is that you replaced the 390,000-ohm resistor in the hold circuit with one of incorrect value. That would upset the R-C constant and reduce the vertical oscillator frequency."

Ted shook his head. "No, that couldn't be it. See, the color code says orange, white, yellow for 390,000. The resistor is plainly marked in these colors."

I didn't even look closely at the resistor, because I'm partially color blind. I pulled over a v.t.v.m. and clipped the leads to the resistor scale. "Here's your trouble," I announced, "your 390,000-ohm resistor reads well over a megohm."

Ted muttered something like "I'll be darned," only stronger. "Hereafter I'll test every new part I put into a set."

With that I walked back to my office, sat down at my desk and again opened my little black book. Gloomily I paged through it and noted where I had checked off each blonde. With a sigh of resignation I picked up the phone and called Brenda, my favorite *brunette*.

"Honey," I said, "how about a date tonight with me and my new red convertible?"

"I'd love to," she crooned, "but you may not like me anymore. I have just had a conversion job done on my hair and I'm now a decided blonde!"

I hung up and sank back in my chair with a happy sigh. A wonderful business, this television repair game!! END

concentrate, but I solved that problem by turning the calendar to the wall. After that it didn't take me long to get to the solution, and I must admit that I dropped my becoming dignity a trifle as I ran into the shop brandishing the service notes in my left fist.

The notes specified that a jumpy picture may result if the white a.g.c. lead that ties from the 12AT7 sync amplifier and sync control tube is not dressed away from the 6BK5 audio output tube socket. This helped to emphasize to us how the signals of one circuit can interfere with the operation of another by capacitive coupling when critical wires are dressed too closely to each other!

### Case of the oblique line

The third odd trouble happened in a Philco model 52-T2100. This time Ted interrupted me while I was critically analyzing three new wrinkles which had appeared in my face. I was wondering whether this was the reason I hadn't been able to date any blondes in the last three days to help me show off my new red convertible. (And it doesn't make sense to date a brunette for a red convertible!)

When I got into the shop Ted showed me the receiver. The screen was dark—the only thing visible being a diagonal white line as shown in Fig. 3.

"What do you think of that?" Ted chortled. This was a little out of character for dead-pan Ted, but it is hard to gloat in a monotone.

I always like my employes to be happy so I fed his obvious glee at being able to show me such a peculiar symptom by saying: "That really is something. I've seen a horizontal line when the vertical sweep collapsed and I have also seen a vertical line when the horizontal sweep failed in a receiver with an r.f. high-voltage power supply. I

must admit, however, that I've never seen a diagonal line."

"What do you think it is, boss?" Ted asked. "I just turned it on and haven't even opened the back."

"Well, it couldn't be any shorted turns in the yoke, because that would produce a keystone pattern," I hedged, thinking aloud in this fashion while desperately hoping to arrive at a solution. "At the same time it would seem that we have neither vertical nor horizontal deflection, yet the bar indicates that there must still be some sort of deflection!"

I didn't want Ted to think I was losing my touch in trouble-shooting. It was bad enough that I felt I was losing out in acquiring the necessary accessories to go with red convertibles. Suddenly a thought struck me.

"You know, kid, there really is only one solution when you think of it. The vertical sweep has failed in this receiver and the yoke is tilted."

"But, boss, the yokes are bolted pretty tightly and can't move by themselves. I am sure the customer didn't loosen the brackets because he said the set hadn't been touched."

I smiled patronizingly. No matter how bright these young fellows are, they can't compete with years of experience in this business.

"Ted," I said learnedly, "don't you believe them. They all say that even when they bring the set in with all the parts loose in a basket. Let's take the back off and see what is what."

Three minutes later Ted stared at the tilted yoke in speechless surprise. Since he was duly impressed, I couldn't help driving home the object lesson.

"My boy," I said. (There is no better way to feel superior than to start off by saying "my boy.") "Let this be a lesson to you. Always listen carefully to what the customer has to say but in

# U.H.F. INSTALLATION TECHNIQUES

By HAROLD DAVIS

**W**HEN the first u.h.f. station went on the air in Portland, Ore., over two years ago, TV personnel from all over flocked to the West Coast to see this new system the FCC had devised for making television available to every nook and corner. What they found was a highly elusive and not too strong signal that often skipped over large areas and bounced off buildings and obstacles.

Since then technicians have made thousands of u.h.f. installations. Installing antennas for the u.h.f. channels is now a simple routine job.

Unlike v.h.f., u.h.f. fringe areas are where you find them. For instance, in St. Petersburg, Fla., there is a fringe area in the southern part of the city and in Jackson, Miss., there is one within sight of the tower. The man who goes into these areas and makes an ordinary installation will get nothing but trouble. Technicians don't have to be told where these bad spots are; they have only to look around at other installations to tell what the condition is. When you start seeing 20-foot-and-higher masts loaded with stacked Yagis, that's it.

To make a good ordinary installation in areas where the signal strength is normal only requires following a few simple rules.

A normal u.h.f. installation in most cities consists of anything from a bowtie to a 12-element Yagi mounted on a 5- or 10-foot mast on a housetop.

The type of antenna is unimportant from the u.h.f. standpoint. However, because most viewers now have or will have v.h.f. available, combination v.h.f.-u.h.f. antennas are highly desirable. The most popular of these is the stacked-V. This antenna costs less than most other types, permitting the all-important low-cost installation. It may be stacked to provide increased signal strength in weak areas and, being not too directional, it will receive signals well from the sides and back.

### The transmission line

Having selected the antenna, we must now select our lead-in and standoffs. In strong signal areas lead-in is no problem except in coastal areas. I have made hundreds of successful installations with flat lead-in. However, when

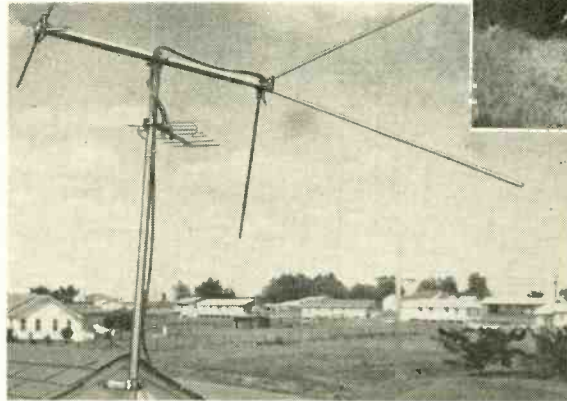

Conical and Yagi mounted on common mast.

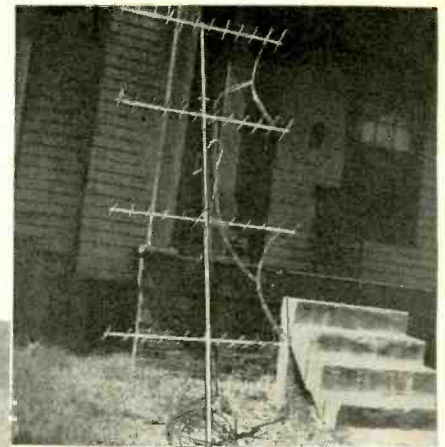

Stacked Yagis ready for installation.

the going gets rough, don't take chances! Use a good grade of oval, making sure the top is looped with the end down to prevent rain from collecting. In coastal areas seal the line to keep out the salt atmosphere. Then coat all connections with a good preservative.

Run the lead-in through standoffs that do not have a metal ring passing around the lead-in. Many a good u.h.f. signal is lost between the antenna and set because of this ring. Crooks and turns, particularly foldbacks, must be kept at a minimum, which makes selecting a spot for the antenna highly important.

The antenna should be located so that there is a short, direct lead to the set, requiring only two or three well placed standoffs. Never tape a lead-in to anything. To splice (Fig. 1), tape only the insulation with plastic tape. Leave the ends of the wires sticking out, twist and solder them, and then coat with a preservative.

Lightning arresters must be watched as a source of trouble. Underwriters Laboratories accept either a grounded mast or a lightning arrester. The grounded mast is preferable where city ordinances permit it. Finally, the u.h.f.

lead-in must not terminate in loops lying behind the set.

In fringe areas, either local or out of town, the procedure changes somewhat—locating the antenna becomes the most important factor. The signal is usually there; it is just a matter of finding it. The area must be searched both vertically and horizontally. The only intelligent way to do this is with a field-strength meter.

When probing for a signal, first try all spots where the antenna can be conveniently mounted. There is no use finding a good signal at a spot where the antenna cannot be placed.

In probing, avoid reflected signals because they are unstable, have poor quality and at times will disappear completely. Engineers at u.h.f. stations are constantly working to improve their patterns, and with the electrically tilted antennas and other devices the field can change. Reflected signals can be recognized by rotating the antenna. The reflected signal will come from a different direction than the direct one.

Contrary to what has been said many times, I have never been able to gather direct evidence that trees deflect u.h.f. signals. The only way to tell for sure

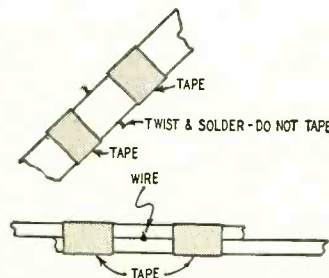

Fig. 1—Splicing transmission line.

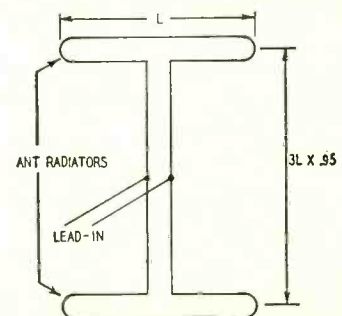

Fig. 2—Computing antenna spacing.



Probing for maximum signal strength.

would be to chop the trees down, since moving the antenna may have accomplished the desired result whether the trees have been there or not. In fact, I have seen good u.h.f. reception with the antenna directly facing a solid brick wall between it and the station.

**Stacking antennas**

If it is impossible to find a good signal, take the best you can find and see what can be done with it. If the signal contains only a slight trace of snow, changing to a higher-gain type antenna may do the trick. If using a stacked-V, change to a 12-element Yagi; and in most cases you should stack two of them. The gain of an antenna expressed in db looks good on paper, but those of us who climb house tops for a living know that it takes a bit of doing to undo a little snow.

In stacking u.h.f. Yagis, the best dis-

tance between them was found to be different from v.h.f. After painstaking trial and error, it was found that for frequencies below channel 40, the best distance is 5% less than 3 halfwaves. You don't have to delve into intricate mathematics to find this distance. Simply consider the driven element as a halfwave (Fig. 2); multiply it by 3 and subtract 5%. For channels above 40, use slightly greater distances—subtract 2-4%. For 60 to 80, use 3 halfwaves.

Consider a 4-bay Yagi for channel 25. The bays are spaced 31.5 inches or slightly less than 3 half-wavelengths apart and are connected together in pairs as shown with open-wire line cut to fit. The length of the transmission line connecting the top pair of bays to the bottom pair is not important as long as the lead-in connects to the exact center. We make it just long enough to permit anchoring to a standoff insulator on the mast. This usually runs around 72 inches for a channel-25 antenna.

The difference between local and distant fringes in u.h.f. is that, locally, the signal is around somewhere if you can find it. In distant fringe areas, which start as near as 15 miles out, the signal starts decreasing in field strength.

Here, the "dos and don'ts" become still more important. Every db available must be carefully preserved. Everything said before must now be taken with emphasis. In addition, height now becomes the most important factor. In areas where the station has been operating for some time, the best practical height probably is already established. If all the other antennas are mounted on a 40-foot mast, you are wasting time if you start by trying a 20-foot unit.

In fringe areas the horizontal positioning of the antenna is not so critical, but any terrain advantage is highly desirable. Towns 50 and 100 feet higher than others get better u.h.f. reception even with lower antennas.

Deep fringe areas are found about 40 miles out. Here it is almost impossible to get an absolutely snow-free picture, but one nearly snow-free may be had with a good installation. For the deep fringe area use Yagis stacked four

deep. The 5%-less-than-3-halfwaves distance is used between each antenna, and here again we vary from the v.h.f. hookup. For better reception the best hookup is shown in Fig. 3. The top two antennas are connected together, as are the bottom two. Open-wire transmission line connects the pairs together and the lead-in is in turn connected to the center of this. The connecting open-wire line may be sufficiently long to permit anchoring it to a standoff against the mast. Solder all connections. Use a minimum amount of standoffs, and they should now be placed with a field-strength meter. In fact, take the meter up on the house so that you can watch the result of everything that is done to the line.

After finishing on the housetop, move the meter to the porch or window and continue to watch every move to see that no signal is lost. Do not use any type of crossover network—there is loss in all of them. Use a field-strength meter to check the signal at the set. In case of poor reception, the meter will isolate the trouble either in the set or the antenna installation.

As with everything else, there are tricks that can be done with u.h.f. To remove a small trace of snow, it is often quicker and cheaper to stick another bowtie or other type u.h.f. antenna on the mast than to fool around trying to locate the trouble. The second antenna (Fig. 4) can be connected to the present one, even to a v.h.f. antenna, with a piece of lead-in whose length is a quarterwave of the lowest channel v.h.f. station being received.

Many sets have separate u.h.f. and v.h.f. antenna inputs. In strong signal areas both these inputs may be connected to a single antenna by installing the lead-in on the v.h.f. posts and connecting it to the u.h.f. input with a piece of lead-in whose length is a quarter-wave of the lowest channel v.h.f. station to be received (Fig. 5). Sometimes this may have to be changed to the weakest v.h.f. station.

The v.h.f. input is a high impedance to the u.h.f. signal and will affect it very little. The low impedance of the u.h.f. input at the end of the quarter-wave stub does not affect the v.h.f. signal. In fact, in some cases, it actually improves it as does a quarterwave stub. This should not be done in fringe areas, and the direct connecting of antennas and input posts very often introduces ghosts. In such cases, run separate lines and use a mechanical switch. END

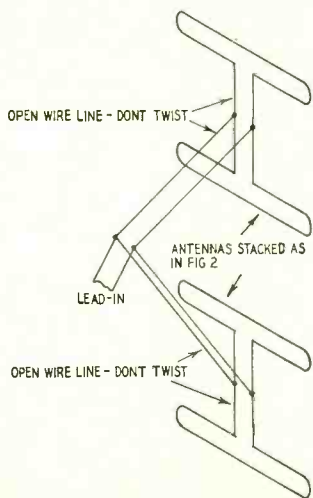

Fig. 3—Connecting stacked antennas.

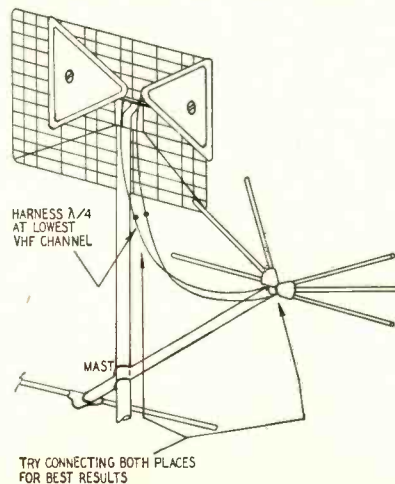

Fig. 4—Connecting a second antenna.

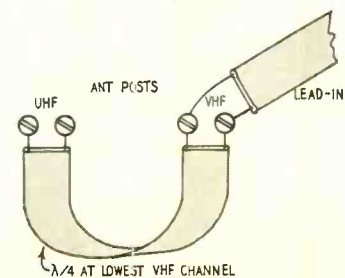

Fig. 5—Using single u.h.f.-v.h.f. lead-in.

# *the* teledoctor

*TV-electronics can solve a serious problem of our modern life*

By HUGO GERNSBACK



**P**ROJECTION of the senses over a distance began early in the animal world. The cries uttered by alarmed prehistoric reptiles, saurians or birds were transmitted over a distance to warn others. A highly developed and sensitized olfactory sense brought the smell of an enemy creature to the nostrils of early mammals who could then flee promptly, thus avoiding destruction. The sense of sight, too, became sharply developed in many animals and especially birds which could then observe potential enemies—or their own prey—often from a point many miles away.

Modern man, with new scientific techniques, has greatly improved the projection of some of his senses, not only over a few, but over hundreds and thousands of miles. By telephone, we can hear and speak to distant friends around the world. Via television, we can see across continents.

As I have pointed out in earlier articles, it will be possible in the future to smell and taste half-way around the

globe—and further.\* But science does not stop with this. There is the far more important conception of the *projection of the self at a distance*. This means nothing less than the possibility now dawning for man to be in two places at the same time.

I will give here but one example of this revolutionary concept, which, incidentally, is NOT in the future—it can be realized today, with the technical means available now.

The average medical doctor today is overworked and short-lived. There are never enough doctors anywhere for the world's constantly multiplying population. Many patients die because the doctor cannot reach them in time, particularly at night and in remote or isolated regions.

Furthermore, the doctor wastes a terrific amount of time visiting patients in person—he can see only a few during a day. With increasing traffic congestion, many doctors refuse to make personal calls—except in emergencies.

\*See "Television." *Forecast* 1952, page 22.

Even then they arrive often too late. Much of this dilemma will be archaic in the near future, thanks to the *Teledoctor*.†

I imagine this innovation as follows: Incorporated as an integral part into a combination television camera and receiver is a set of *mechanical hands*. The latter are now routinely manufactured by General Electric and other manufacturers. These incredibly sensitive hands are primarily used in atomic plants where scientists handle dangerous, "hot" atomic substances from a distance, without personally exposing themselves to danger. With these *telehands*, the scientist can do almost anything at a distance—writing, weighing, pouring liquids, unscrewing covers of "hot" containers—yes, even diapering a baby, miles away, including putting on the safety pins. *The sense of touch has been projected over a distance!* The action, of course, is watched via television.

†See also article on the same subject: "The Radio Teledactyl!" by H. Gernsback, *Science & Invention* magazine, February, 1925, page 978.

The teledoctor of the near future now becomes an actual projection of the doctor. In front of his television transmitter-receiver is a panel with a number of instruments which indicate blood pressure, pulse, respiration and other data routinely required in most examinations of patients.

Now let us see how you, the patient of tomorrow, "visit" your doctor, 15 miles away. Suppose you come down with a fever. You or your wife make a call to the local druggist, who is the agent for the teledoctor corporation which stocks the special TV transmitter-receiver equipped with its telehands.

These instruments are never sold, only rented to the sick, say for \$3.50 a day. They are used only for closed-circuit work. The rubber-wheeled mechanism is delivered quickly to your home and rolled in front of the bed. Located in the drawer of the cabinet, right under the TV set, you will find a thermometer, blood-pressure appliance, sterile bandages, prescription blanks, fever chart (with instructions), tongue depressors, adhesive tapes and other items routinely found in every doctor's black bag. A cord with a telephone plug attached to the teledoctor instrument is now plugged into a special jack on your telephone. Future telephones will be provided with this facility. The TV signals and telehand electronic signals, etc., will all travel

over the closed circuit telephone lines. §

Next you dial your physician's telephone number. He or his nurse takes the call. You give your name and state that your teledoctor instrument is plugged in and ready. The doctor now plugs his own set into the telephone and in a few seconds two-way communication is established. The doctor by electronic telecontrol moves your instrument into the best position, raising or lowering your set, which has a swivel mechanism for that purpose.

The color camera is now trained on you and the doctor looks you over. He listens to your heart—not with a stethoscope, but with the back of his right telehand. This has a sensitive microphone which the doctor places over your heart. He hears your heartbeat, now strongly amplified, over his loudspeaker.

He next takes your blood pressure, looks into your throat or examines any part of you. If he wants to inject you with penicillin or other medication, he will ask you to place a prescription blank into a holder arranged for this purpose. He picks up a special pencil from the drawer and writes out a prescription, then signs it. You are to get this from your drugstore as soon as

§*Technical note.* At the present state of the art, it is not possible to transmit a 525-line TV signal over existing telephone lines. A good picture of 250-350 lines, however, can be phone-transmitted today. Such a picture would give sufficient definition for the proper operation of the teledoctor.

feasible. When you have received it, you call the doctor once more. He places the special injection cartridge, now on the market called *Busher*, into his telehand and presses it against your skin. By spring action, the medication is shot into the arm quickly.

The doctor then gives you whatever other instructions are required and promises to "visit" you again early in the evening. When you are well again, phone your druggist who will call for the teledoctor instrument.

It should be noted that, short of a serious operation, the doctor of the future will be able to do almost anything by teledoctoring that he can do in person. He can remove your bandages after an operation, bandage you, remove stitches post-operationally, swab wounds, all at a distance.

In the more distant future, he will even be able to perform emergency long-distance operations, provided a nurse or nurses can be secured to assist him.

Soon, your doctor will be able to see far more patients with infinitely greater efficiency. He will not only save untold lives, and generate better health for his patients, but his own life will be made far easier and he will himself live longer and so serve suffering humanity far better than was ever possible before.

END

NOTICE: Reproduction rights to this article have been acquired by *The American Weekly*, and it may not be reprinted.

Patient and distant doctor are connected by telephone and closed circuit TV as illustrated on this and facing page. Doctor can treat ten times as many patients via teledoctoring as in person.



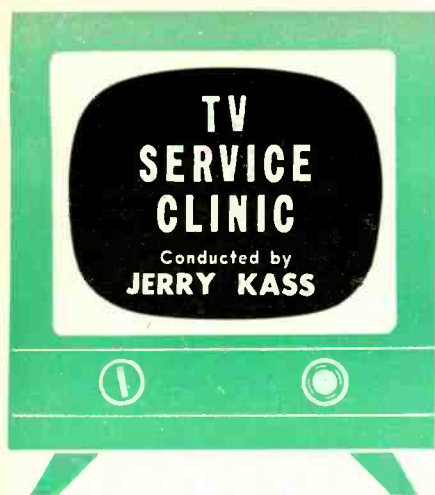

TELEVISION broadcasting stations transmit a series of synchronizing pulses together with the video information to control the receivers' scanning generators and form an intelligible image. In the receiver these timing pulses are removed from the composite video signal and used to synchronize vertical and horizontal sweep generators with those of the broadcast station. Appropriately, the circuit that performs this function is called the sync separator.

The sync separator does not separate the horizontal and vertical pulses from each other—this is done by integrating and differentiating networks. The prime function of the sync separator is to separate—as thoroughly as possible—the sync pulses from the video signal.

The separation process begins with the feeding of a portion of the composite video signal, taken from any point between the video detector output and the grid or cathode of the picture tube, into a "clipper" circuit. Since it is generally advantageous to work with as large a signal as possible, it is common to find the plate circuit of the final video amplifier as the point of "sync takeoff." In addition, the video amplifier increases the signal-to-noise ratio.

With the sync pulses transmitted at a constant amplitude and occupying the upper 25% of the composite video signal—the blacker-than-black region—they can be easily removed by amplitude discrimination. For maximum sync strength it would be ideal if the clipping were done exactly at the 75% level. But for practicality clipping usually takes place at a slightly higher level to avoid the possibility of components changing in value and lowering the clipping level, allowing portions of the video to pass through the separator and hamper proper synchronization.

There are several methods of separating the synchronizing pulses from the picture, however the principle is always the same. The circuit is biased so that no plate current will flow until the signal exceeds its blanking level. Usually the clipper stage develops a

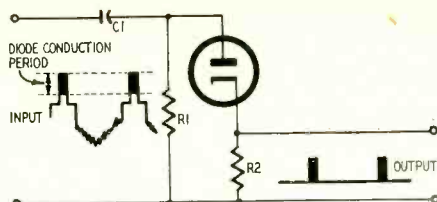

Fig. 1—A simple diode sync clipper.

negative bias and the signal applied to the circuit is of such polarity that the sync pulses represent the most positive portion of the signal, hence current will flow only during the sync pulses. Since the picture information is below the blanking level, it will not appear in the clipper output signal. The clipper can be a diode, triode or pentode type.

#### Diode clipper

Fig. 1 is a diode clipper, with C1-R1 forming a grid-leak type network. Their values are such as to maintain a high negative bias voltage between plate and cathode. When the composite video signal is applied, the plate draws current and C1 charges to the peak value of the input signal. As the signal falls to a lower value, C1 discharges slowly through R1, creating the negative bias voltage. The bias voltage keeps the tube cut off until the signal becomes sufficiently positive to overcome it. This will occur only when the signal rises above the blanking level.

A weakness of the diode clipper is its inability to separate completely the sync pulses from the picture information. As a result it must usually be followed by one or more clipper-amplifiers and shaping circuits.

Since this circuit passes both vertical and horizontal sync pulses, a defect will usually produce both vertical and horizontal instability.

The first check of over-all sync instability should be replacement of the diode. Follow this by measuring R1. If R1 is open, no sync pulses will appear across R2 (an oscilloscope across R2 may show extremely small pulses). If R1 becomes very much less than its normal value, C1 discharges quickly to a lower than normal level between sync pulses. This lowers the bias voltage and allows a portion of the video signal to pass through along with the sync pulses, causing unstable synchronization. An oscilloscope across R2 under these circumstances will show considerable video information in the output signal.

If R1 increases in value, the negative bias developed will be larger and the sync output smaller. When this occurs, the horizontal and vertical hold controls will become very critical because the small sync pulses will not be able to "hold" the horizontal and vertical oscillators. Thus if R1 becomes too large, a scope across R2 will show smaller than normal pulses. An open, leaky or shorted C1 will prevent proper separation and cause poor sync stability.

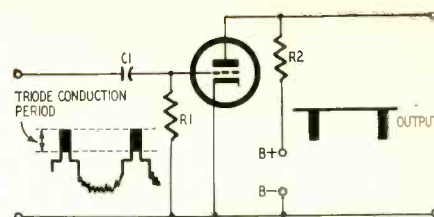

Fig. 2—A triode sync clipper amplifies and inverts polarity of signal.

Being the output load resistor, R2 open will prevent the passage of any sync signal. If under this condition a scope is placed across this resistor, a deceiving situation can arise—the internal resistance of the scope becomes R2 and may restore normal operation of the TV set. To prevent this, make this check with a 0.5- $\mu$ f capacitor in series with one of the scope leads.

Should R2 decrease in value, the sync output will also be decreased. If it increases appreciably (more than 10%) in value, C1 will not charge to its proper value. This lowers the bias voltage and permits video signals to pass through. In addition, the sync pulses in the output will be larger than normal, causing the picture to tear on strong signals.

#### Triode clipper

Fig. 2 is typical of a triode circuit used for sync separation. Since a triode can perform the same function as a diode while having the additional advantage of amplification, it has proven a more popular circuit.

The plate voltage in this circuit is usually extremely low (15 to 40 volts), permitting plate current to be cut off with very little grid bias. See Fig. 3. This circuit is very similar to that of Fig. 1, with the grid and cathode performing the same function as the plate and cathode of Fig. 1. When the grid becomes positive, C1 charges to the peak value of the input signal. The time constant R1-C1 is again very long compared to the time between sync pulses. As a result, very little of the charge on C1 will leak off before another pulse arrives to recharge it to its peak value. This establishes a steady bias on the tube so that only about the upper 20% of the input signal will be passed (leaving a 5% safety margin and preventing the black signals from riding through). Since the plate voltage on the tube is so very low, plate current will be cut off shortly after the input signal falls below the peak value of the sync pulses.

With only the tips of the sync pulses drawing grid current, the pulses in the plate circuit are clamped to the same level. Thus, in effect, we have d.c. restoration. This circuit can operate only with the sync pulses representing the most positive portion of the input signal.

The triode has the advantage of greater output than the diode clipper. Still higher output can be had with a pentode. The trend in modern receivers is toward pentodes because they pro-





The author working on the 120-relay computer referred to in this article.

# How a Computer Works

*These simple basic circuits make it easier to understand how the more complex instruments operate*

By DAVID B. MUMFORD

**T**HIS is the story of a miniature relay computer designed and built by the author. It is the last in a series of progressively more complex computers starting from one containing 20 relays and ending with 120. Up to 1,500 feet of wire as well as a mechanical tape reader of our own design went into the largest model.

First, I shall describe the original computer in the series used as one section of the last and most powerful one. It performed the single operation of addition. It required you to give it numbers in binary notation (see box) and gave its answers likewise in binary. Since only two symbols are used in binary, 0 and 1, this system adapts itself readily to 2-position switches or relays, each position corresponding to a symbol. Furthermore, this system has a very simple addition table.

Next I will show how the original circuit can be modified to economize relays—a necessity when numbers of several digits are to be added. No constructional data on the 120-relay machine will be given—the diagram is too large and complex to print in a magazine article. What will be described is exactly how a simple circuit works and how it can be built into progressively more complicated circuits to handle bigger numbers, with a quick view of the final computer.

This—it is hoped—will interest the technician who would like to know how

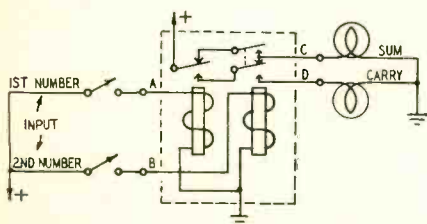

Fig. 1—The simplest addition circuit.

these circuits work but does not want to build one. It will also be helpful to the would-be computer constructor, who can use the information (and will need a great deal of additional study) to build a sizable machine of his own.

### A simple adding circuit

Consider first the problem of adding 1-digit numbers or the first (smallest or right-hand) digit of larger numbers. The addition table page gives us the answers for the four input combinations:  $0 + 0$ ,  $1 + 0$ ,  $0 + 1$ ,  $1 + 1$ . The circuit of Fig. 1 gives the correct answers when traced: 0, 1, 1, 0 + carry 1 to next digit. If either the first or second numbers are 1, the sum 1 appears (top lamp lights). If both are 1, the result is a 2-digit number 10. The top lamp goes out indicating zero and bottom one lights, indicating a carry to the second digit, and giving the sum, 10 (2 in decimal notation).

To add larger numbers, these elementary circuits are combined. To add 2-digit numbers, for instance, an identical circuit adds the second digits of the

numbers and a third circuit adds the carry from the first digit to this result. The sums from the first and the second digits form the first and second digits of the sum, respectively, while the carry from the second digit forms the third digit of the sum. Rectifiers are added between circuits to prevent improper interaction. A 3-unit circuit is shown in Fig. 2.

Suppose the two figures 11 and 11 (3 and 3 in decimal notation) are to be added. The first digit (the unit, or smaller number) is entered at input A of unit I. The lower contact of relay Z1 is closed, lighting lamp 1. The second digit, entered at input 1, is entered at input A of unit II (the 2's unit). It closes the lower contact of relay Y1 and lights lamp 2 through the lower contact of X1.

The second 11 is entered at input 2. Its first digit goes to input B of unit I, drawing down both armatures of relay Z2. Since the armature of Z1 is down, drawing down Z2's upper armature has no effect; but the lower armature is drawn away from its upper contact, and

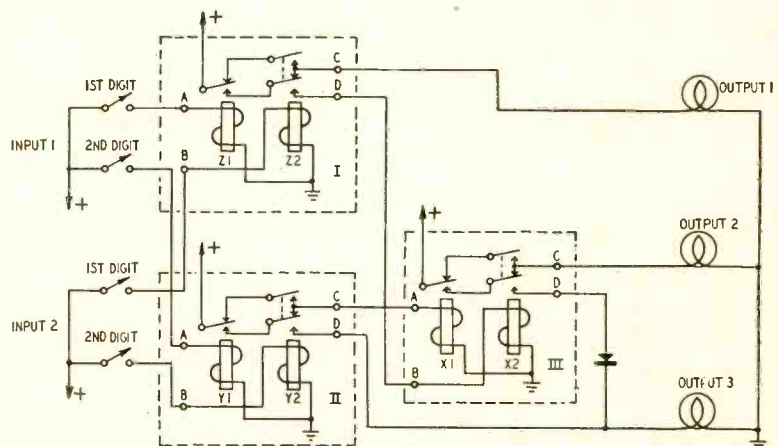

Fig. 2—Two-digit numbers can be added with this three-unit circuit.



lamp 1 goes out. Current flows through output D and through relay X2. Both armatures of X2 are drawn down, and lamp 2 extinguished as the lower armature of X2 is disconnected from C and connected to D. Lamp 3 lights.

The second digit enters at B of unit II, drawing down both armatures of Y2. The lower armature breaks the contact through output C, releasing the armature of X1. This permits current to flow through the C output of unit 3, again lighting lamp 2. The sum is then 110.

The reader may find it easier to follow the problem by drawing Fig. 2 on tracing paper, then drawing and erasing the armatures to indicate the correct positions as each digit is entered.

**Techniques of design**

Although these circuits are comparatively easy to trace, to verify that they give the correct answer, you may wonder how they are designed. Unfortunately there is no simple answer. Trial and error are useful in many cases and familiarize one with the results of simple combinations. Some authors attempt to systematize these basic circuits as well as some others for common uses<sup>1</sup> while others feel that the technique of Boolean algebra solves many problems.<sup>2</sup> However, some simplifications and original circuits are very difficult to discover by either of these methods, leaving the success of the final circuit to the ingenuity and inspiration of the designer.

The development and modification of the circuit given above to add larger binary numbers are a good example of the evolution of a relay circuit. In its original form, it employs two relays for the first digit and four more for each successive digit. Ultimately we can reduce it to only two relays for each digit. The first simplification is to eliminate the first relay of the second block in each digit (unit III in Fig. 2, for example). But the function of that relay was to keep one circuit closed when there was power on the lead A which closes it, and another when there was not power. Therefore, if we eliminate the relay, it becomes necessary to have a second lead (A' in Fig. 3) which has power when and only when A has no power. These two leads will take the place of the wires coming from the contacts of the eliminated relay. The result may be verified by tracing as with Fig. 2.

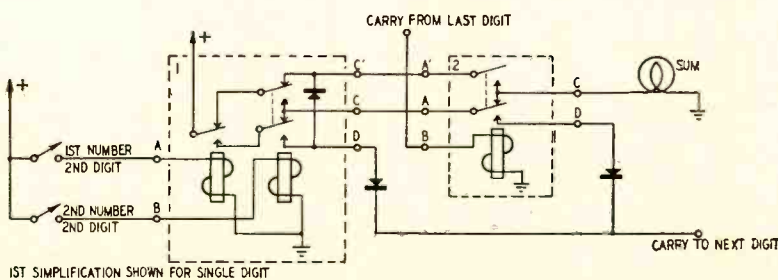

Fig. 3—This simplification eliminates one relay in the second block.

A second simplification eliminates the second relay of the second block in each digit. However, the carry from the digit before closes this relay. So just as we needed the A' lead above, we now need a second lead from the preceding digit which will supply power when and only when there is no carry. Therefore, we must also add a circuit to provide this so-called no-carry lead for the next digit. When the contacts of the resulting circuit are combined, the result may be seen in Fig. 4, which is best verified by tracing.

**Programmed computers**

If all large computers had to be designed with this type of direct circuit, giving you the answer with no further instruction from the operator, their power would be strictly limited by the ingenuity of the designer and the number of operations he could build into a circuit. Large computers use a second type of circuit, called "sequential" because they accomplish their result in a series of steps, as opposed to the "combinational" circuits described above. In these circuits, a simple computer of the combinational type is retained to perform each of the steps, which consist of simple operations.

Memories must be added to store intermediate results between operations. A common set of wires called a "bus," connected to each memory and to the input and output of the computing unit within the enlarged calculator, transfers numbers within the whole framework of the computer.

To control this transfer of numbers as well as the operation being performed by the computing unit, a continuous set of instructions called "programming" is fed the computer through the control unit. The actual numbers to be operated with are given to the computer separately, so that this programming will be fixed for a particular sequence of operations—such as involved in solving a quadratic equation, for example.

**The 120-relay equipment**

It was on this plan that the main computer illustrated in the photograph was designed. Six-digit binary numbers were taken as the base in which all computations were performed: the memories stored six-digit numbers, the bus carried six-digit numbers, the computing unit operated on six-digit numbers. Rather than breaking the

working of the machine down into steps of one operation each, it was further broken into cycles. In each cycle, a number may be taken from one section (e.g. memory, input, output, computing unit or instructions) of the computer and put in another. Thus a step would consist of several cycles which would: 1, put the numbers to be operated on in the computing unit; 2, put the code for the correct operation to be performed in the

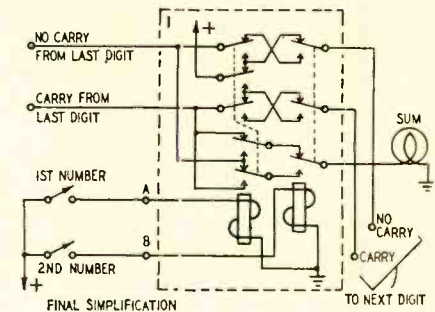

Fig. 4—Another relay is eliminated.

computing unit from the instructions; 3, take the answer from the computing unit to a memory. The actual computation within the unit is performed automatically once the numbers are at hand. A rough block diagram is given in Fig. 5.

Paper tape was used for the programming, giving the necessary instructions for each cycle in three entries. The first entry determines the section of the computer which is to receive the number. The second determines the section containing the number to be sent and actually connects these through the bus, thus transferring the number. The last entry is provided in case the number to be sent is not in the computer, in which case it will be automatically sent if put on the instructions in this entry. Actually there is another means of putting a new number in the computer: if it is stopped in the middle of the cycle by a special code, a number may be manually connected to the bus with switches as in the simple unit described in Fig. 1.

**Memory circuits**

The memory (Fig. 6) is the simplest of the individual units within the computer and illustrates the principles for transferring numbers. The actual process of remembering is accomplished by what is called a "holding" circuit. When the relay is temporarily closed by voltage from the bus, a path from the relay

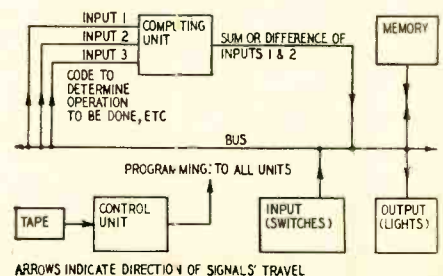

Fig. 5—An elementary block diagram of a programmed type of computer.

## ELECTRONICS

coil through the relay contacts to the voltage source is completed, thus permanently connecting the relay coil to the voltage unless this path should be broken elsewhere. This path—called a hold lead—controls the operation of the memory. When it has voltage on it, the relays remember; when it does not, they forget. In a single memory (that is,

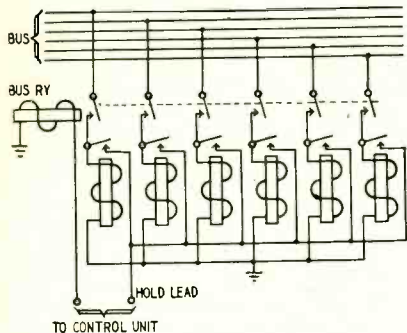

Fig. 6—Circuit of relay memory.

for six relays in the computer illustrated), the hold leads are generally connected together and are disconnected only when another number is to be put in the memory. A single relay is used in this computer to connect the relays of a memory to the corresponding wires of the bus, both for sending and receiving a number.

The computing unit is very similar

### BINARY NOTATION

This system writes numbers to the base 2 rather than 10. It uses two symbols (0 and 1) rather than 10 symbols (0, 1, 2, 3, 4, 5, 6, 7, 8, 9). Thus a number expressed in decimals as:

$$45 = 4 \times 10^1 + 5 \times 10^0$$

is expressed in binary as:

$$101101 = 1 \times 2^5 + 0 \times 2^4 + 1 \times 2^3 + 1 \times 2^2 + 0 \times 2^1 + 1 \times 2^0$$

In both cases, the number is made up from the coefficients of the terms. Similarly

$$1, 2, 3, 4, 5, 6, 7, 8, 9, 10 \dots$$

is expressed in binary as:

$$1, 10, 11, 100, 101, 110, 111, 1000, 1001, 1010, \dots$$

Rather than a complicated addition table, in binary we have:

$$\begin{aligned} 0 + 0 &= 0 \\ 0 + 1 &= 1 \\ 1 + 0 &= 1 \\ 1 + 1 &= 10 \end{aligned}$$

(or 0 with a carry of 1 to next digit)

A larger addition is carried out just as in decimal notation: The first and smallest digits are added first, then the second digits plus the carry from the first, etc. For example:

$$\begin{array}{r} 101 = 5 \\ 111 = 7 \\ \hline 1100 = 12 \end{array}$$

to the simple combinational computer discussed above. Two sets of relays working as memories replace switches for storing input numbers. Lights on the output are replaced by a relay connecting the answer wires directly to the bus. This computing unit will perform three operations instead of one: addition, subtraction and selection. The purpose of the selection circuit is to select one of two numbers, depending on whether a third is 0 or 1. This is an important function in larger computers.

We have studied in this article the detail design of one type of circuit—the addition circuit—and some of the general principles that apply to the design of larger calculators. Some of these same ideas can be applied, moreover, to the construction of checker playing machines, mechanical turtles, automatic oil refineries, and immense telephone exchanges. Below is a short bibliography for those of our readers who would like to delve farther into this far-reaching field: END

### References

<sup>1</sup>Keister, Alistair and Washburn, *The Design of Switching Circuits*, New York: D. Van Nostrand Co.

<sup>2</sup>Berkeley, *RADIO-ELECTRONICS*, October, 1950, through October, 1951; also December, 1951, and February, 1952.

<sup>3</sup>*Scientific American*, Automatic Control issue, September, 1952.

## NOVEL HIGH-VOLTAGE SUPPLY

MANY instruments for detecting and measuring nuclear radiation require high-voltage low-current power supplies to provide a polarizing voltage for the ion chambers or G-M tubes. This voltage is usually obtained from miniature high-voltage batteries used directly or in combination with capacitors charged in parallel and discharged in series, from an r.f. type supply using a high-frequency oscillator and rectifier, or from a vibrator supply. (For details on these types of high-voltage supplies, see "Counters for Prospectors" in the October, 1949, issue.)

A new miniature electrostatic type high-voltage low-current supply has been developed by S. R. Gilford, S. Saito, and J. L. Herson of the National Bureau of Standards. This generator is simpler to construct, is potentially less expensive, has fewer components, and does not require special batteries that may be hard to obtain.

The electrostatic supply consists basically of a stator of two field plate conductors and a rotor with a number of pairs of conducting sectors. (See photo A. The rotor is on the left and the stator on the right. These parts are fabricated by printed-circuit techniques using copper foil laminated phenolic etched to produce the desired patterns.)

The rotor is driven at speeds up to 6,000 r.p.m. by a lever-operated reciprocating drive system. Several sets of

brushes transfer the electrical charge to the storage capacitors. The NBS generator with its reciprocating drive system is shown in photo B.

The problem of establishing a constant output polarity was solved by using a small external bias voltage to precharge the storage capacitor. This voltage is obtained from a supply used with the electronic equipment. END

The NBS electrostatic generator can charge an .02- $\mu$ f capacitor to 2,000 volts in about 15 seconds. In a survey instrument requiring a current of  $10^{-12}$  to  $10^{-14}$  amperes, the storage capacitor needs to be recharged only occasionally to make up for a leakage loss of about 100 volts. This charge can be restored with a single operation of the instrument's driving lever. END

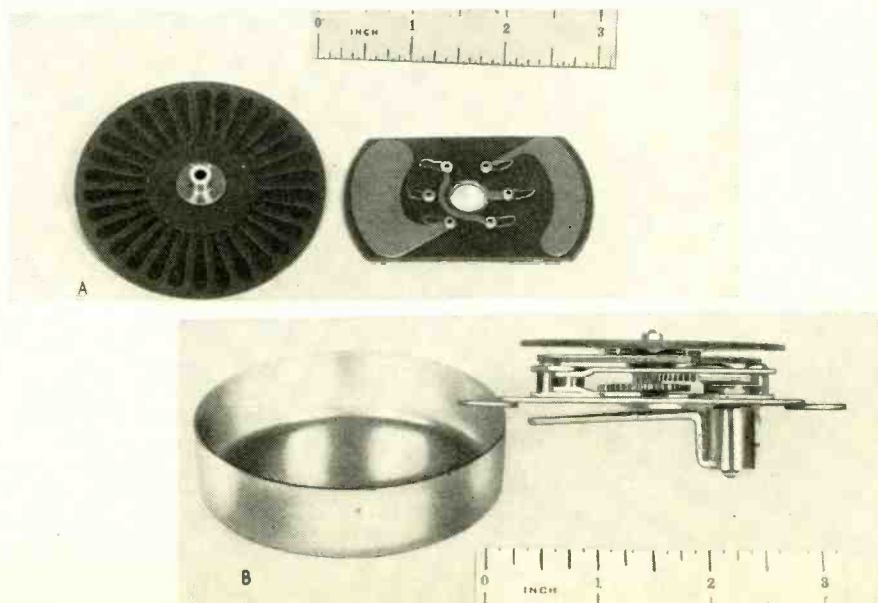

# Phototransistors and Photoelectrets

Interesting developments  
in solid-state materials

By EDWARD D. PADGETT

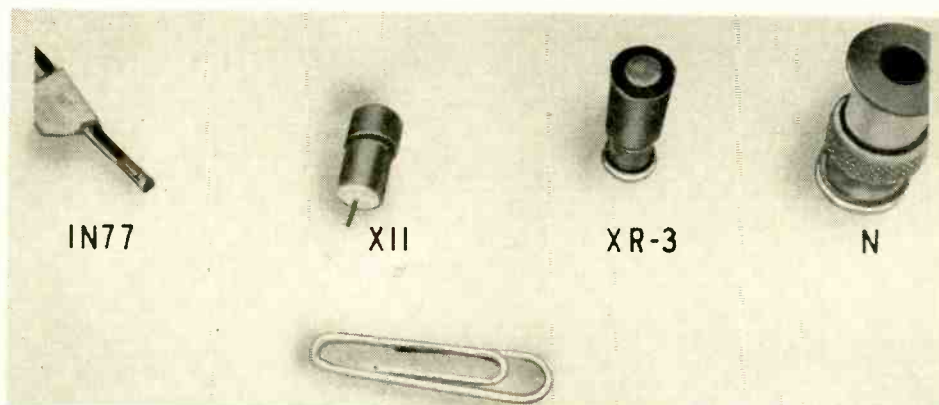

Left, smallest photodiode commercially available. Photo also shows experimental "wide-area junction photocells."

THE phototransistor and photoelectret are electronic devices of unusual interest. Due to a saturation characteristic, they are useful as electronic switches which can be triggered on and off by a light beam. Other potential uses are as the light-sensitive element in photoelectric recording equipment, talk switches in communications equipment, pulse generators and TV projection apparatus, and, in many cases, as auxiliary elements for phototubes in computers and industrial electronic equipment.

Phototransistors (RADIO-ELECTRONICS, November, 1954, page 96) are photocells of semiconducting materials of relatively low resistivity. Although much information is available about phototransistors, very little is known about the photoelectret. According to the literature, a photoelectret is a dielectric material of relatively high resistivity that can be polarized by light. For reference, the resistivities of various semiconductors and dielectrics are shown in the table. Photoelectrets will be discussed later.

## The phototransistor

It is very easy to change the electronic nature of semiconductors. A phototransistor works as it does because light energy, absorbed by the semiconductor, changes the conductivity of the material. Phototransistors are said to be photoconductive. The importance of this photoconductive effect is

shown in Fig. 1. When a light beam is absorbed by a crystal, the energy in the beam is spent in raising electrons from an almost filled to an almost empty energy band. In other words, the absorption of light produces free electrons and positive holes in the semiconductor. The liberation and movement of these charges cause the photocurrent of a phototransistor. Electrons ejected from the surface of the crystal by the light beam do not contribute to the photocurrent.

A simplified sketch of a phototransistor is shown in Fig. 2. The collector is a catswhisker of 10-mil phosphor

bronze wire, pressed against a thin germanium pellet about .005 inch thick. The incoming light energy injects holes into the semiconductor. The collector is biased negatively so that the positive holes will flow in the right direction. The photocurrent is read with a 1-ma meter. When no light falls on the germanium, the meter will read a small "dark current," due to the normal conductivity of the material. Germanium pellets from burned out or obsolete transistors can be recovered and used to make experimental photocells.

However, phototransistors are available commercially. Most of them use doped germanium as the semiconductor. The devices are called phototransistors, germanium photocells or germanium photodiodes by their manufacturers. In the point-contact type, the photosensitive pellet and pointed collector electrode are mounted in a coaxial housing (or imbedded in a plastic cylinder) of very small size. The junction type is also called the "wide-area junction

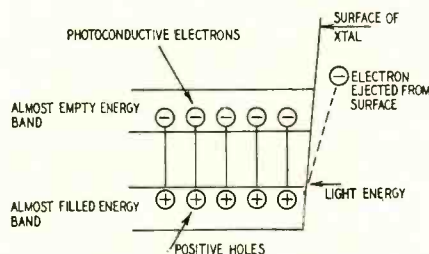

Fig. 1—The photoconductive effect.

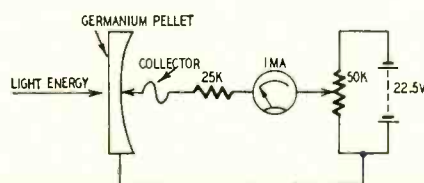

Fig. 2—Experimental phototransistor.

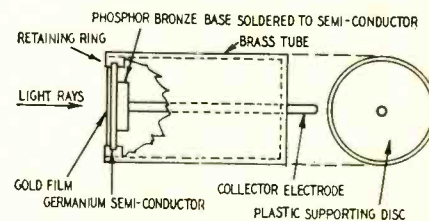
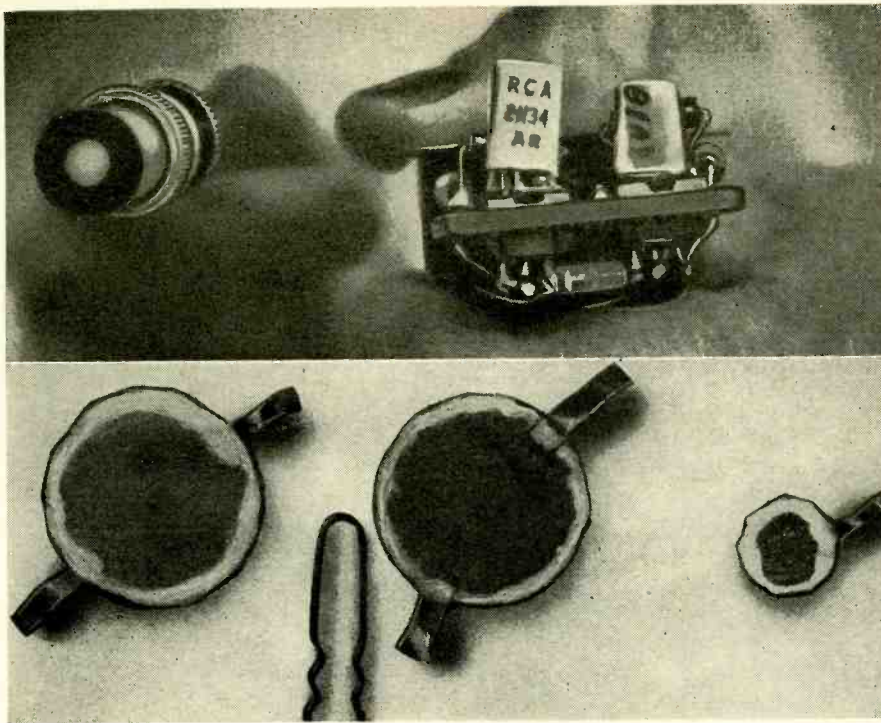

Fig. 3—Diagram of the coaxial gold-on-germanium junction photocell.



Junction transistor amplifier—unit is used with junction photocells.

Typical experimental photoelectrets.

photocell" or the "gold-on-germanium junction photocell." It consists of a thin circular piece of semiconductor (about 0.25 to 0.5 inch in diameter), mounted in the end of a brass tube (see Fig. 3). A thin film of gold is evaporated onto the large surface of the germanium. The gold diffuses into the semiconductor and forms a p-n junction. An important advantage of this design is that it gives the cell a photovoltaic property. That is, the light energy that strikes the junction is converted into a voltage (about 20 to 40 millivolts as measured between collector and brass case). It means that the gold-on-germanium junction photocell requires no biasing voltage or power supply for its operation. Because of its photovoltaic property, small size and good signal-to-noise ratio, the device can be mounted anywhere, the output signal amplified with a suitable amplifier, and used in photoelectric and industrial electronic applications.

Junction photocells are low-impedance devices. Their output impedance varies from about 500 to 1,000 ohms, depending on design. The input impedance of a grounded-emitter, junction transistor stage is about 600 ohms. For

most practical purposes this slight impedance mismatch is not important. As a matter of fact, if the brass case is grounded, the collector of a junction photocell can be capacitance-coupled to the base of the transistor. Here the phototransistor is used as a current generator; the signal current is injected into the base of the junction transistor through a capacitor. The circuit diagram of a two-stage junction transistor amplifier suitable for such purposes is shown in Fig. 4. Best results will be obtained if the first stage is a high-alpha 2N34 unit. The 68,000- and 100,000-ohm resistors between collector and base provide bias and stabilization. R-C coupling is used throughout. Large paper capacitors are used since this is a low-frequency amplifier.

The collector resistors are shown as 50,000-ohm potentiometers to allow for optimum adjustment of the load of each transistor. A single 22.5-volt hearing-aid battery is an adequate power supply. The output of the last stage (either a 2N34 or a hermetically sealed 2N38 junction transistor) may be capacitance-coupled to a peak-reading v.t.v.m. or oscilloscope for analysis

of the output signal. For convenience, the light source is shown as a 2-watt 120-volt lamp. The blades of a rotating electric fan, placed in front of the lamp, "chop" the light into pulses.

Since gold-on-germanium photocells require no external biasing voltage, a great amount of research is going on to determine if other semiconductors possess the photovoltaic property. Work on semiconducting intermetallic compounds at Battelle Memorial Institute is being sponsored by the Bradley Mining Co., San Francisco, Calif. At the April, 1953, meeting of the Electrochemical Society in New York City R. K. Willardson, A. C. Beers and A. E. Middleton of Battelle described the photoelectric properties of a semiconducting intermetallic known as antimony aluminum (other intermetallics, like antimony indium and antimony sulphur, possess semiconducting prop-

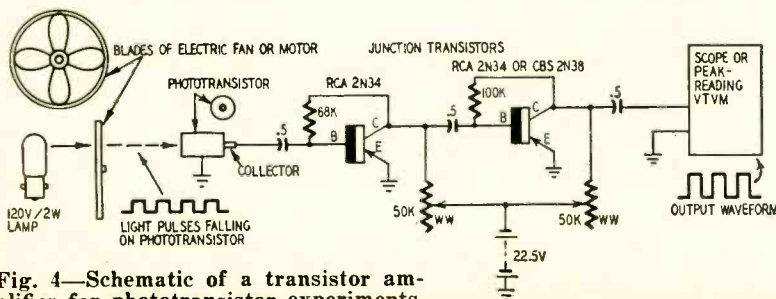

Fig. 4—Schematic of a transistor amplifier for phototransistor experiments.

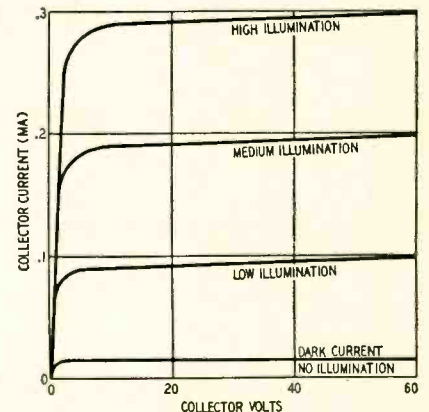

Fig. 5—The photoelectric properties of an intermetallic p-n junction.

erties). The photoelectric properties of an intermetallic p-n junction are shown in Fig. 5. The saturation characteristic is useful in various applications, as already mentioned. Hence, transistors and photocells made from semiconductors other than germanium and silicon should be available in the near future, especially so since the intermetallics are more economical than germanium or silicon.

**The photoelectret**

Our industrial economy is demanding the development of new or improved photoconducting materials. It is interesting to note that in spite of important progress in transistors and solid-state materials, no one has become interested in the ideas and experiments of G. Nadjakoff, a physicist at the University of Sofia. Nor has anyone tried to verify his experiments. According to Nadjakoff, a photoelectret consists of a dielectric material that can be "polarized" and "depolarized" by light energy.<sup>1</sup> His graphs and descriptions suggest that he uses the word *polarized*

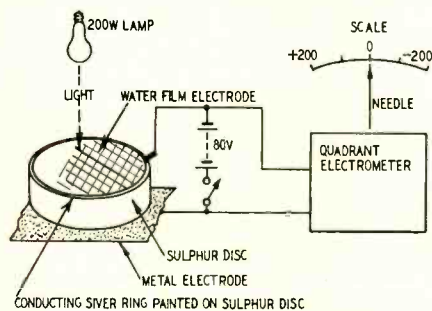

Fig. 6—Sulphur-disc photoelectret.

to mean "charged," and *depolarized* to mean "discharged." He does not use these words to describe the physical condition of some of the grain or boundary-oriented substances (such as antimony sulphur) that are being used in photoelectric experiments at the present time.

The Balkan scientist used pure sulphur as the dielectric material for his photoelectrets. The molten material (melting point about 114.5° C) was allowed to solidify in the form of small discs—approximately 1.7 millimeters

thick and 10 square centimeters in area. As shown in Fig. 6, one surface of a sulphur disc was attached to a metal electrode. The electrode on the other surface consisted of a transparent film of water<sup>2</sup> and a conducting ring.

Nadjakoff applied 80 volts to the electrodes on the disc. The electric field strength through the disc would be 470 volts per centimeter. When the water-film electrode was illuminated with a 200-watt lamp, he noticed that a strong photocurrent was produced. This polarizing (or charging) current increased from a very small dark value to a maximum of between 200 and 250 units as read on the calibrated scale of an electrometer (a device for measuring the presence of electric charge). The sequence of events is summarized in Fig. 7, which shows the charge-discharge characteristics of a photoelectret.

Four minutes after the electric field was applied to the disc, the water film was illuminated with the electric lamp. The light energy triggered the photocurrent into its highest or saturation value. After reaching saturation, the current then decreased slowly with time. Eleven minutes later the lamp was turned off, leaving the electret in darkness, and the current dropped to its original low value. Then the electric field was removed from the electrodes and left off for the rest of the test. These events placed the photoelectret in its polarized state. After 19 minutes, the sulphur disc was illuminated again. A strong depolarizing (or discharge) current appeared, which was

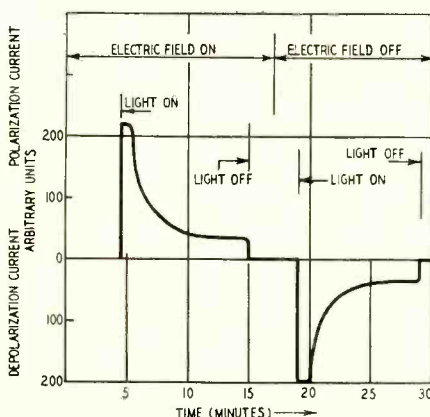

Fig. 7—Charge-discharge characteristic of the sulphur-disc photoelectret.

opposite in direction to the polarizing current. This current likewise reached a saturation value (between 200 and 250 units on the electrometer scale) and then decreased slowly with time. The light was turned off after 29 minutes and the current dropped to its original low value. This was the end of the depolarization.

Nadjakoff demonstrated that the polarization of his photoelectrets had a certain amount of permanence. The results are shown in Fig. 8. He plotted the photodepolarization current as a function of time immediately after

photopolarization. After the data were taken, the disc was polarized again; the electric field was removed, the elec-

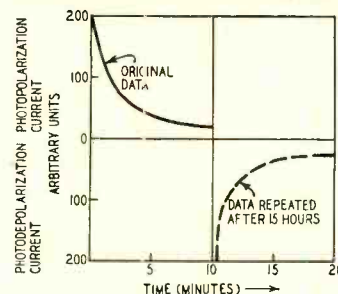

Fig. 8—Polarization permanence.

trodes were short-circuited and the disc was placed in darkness for 15 hours. Then the photodepolarization measurements were repeated. The data (dashes) so closely followed his original curve that he concluded that as long as the polarized dielectric was kept in darkness a condition of permanent polarization remained.

I have attempted to verify some of Nadjakoff's experiments. The results are summarized in the table. Since conductivity of monoclinic sulphur is about three times that of rhombic sulphur, it is believed that Nadjakoff made photoelectrets from it. (The ordinary wax type electret has no photoelectric properties.) If the radiation that falls on the photoelectret is too intense, the current does not return to its original value immediately (as shown in Fig. 7). In other words, this type of photoelectret can be oversaturated. The photodepolarization curve is complicated, difficult to interpret and to reproduce. Several authorities have suggested that Nadjakoff's original photodepolarization effect may have been due to boundary or semiconducting properties of the water-film electrode, rather than a property of the dielectric. If so, then Nadjakoff probably was the first man to make a phototransistor.

To investigate this situation further, photoelectrets were made from other substances and other film materials. Pieces of modified germanium, antimony sulphur and ceramic materials such as titanium and germanium oxide were used. Films of Aquadag (colloidal graphite), gold and indium were used instead of the water-film electrode. A barium titanate photoelectret (or modified antimony sulphur) with an Aquadag electrode would generate usable signals across the output terminals when an electric lamp or hot soldering iron was held near the surface. Further tests showed that the germanium device was not a photoelectret. Since the germanium used was not a dielectric, this device turned out to be our old friend, the junction photocell, discussed earlier in this article. END

**References**

- <sup>1</sup> G. Nadjakoff, in *Physik Zeitschrift*, Vol. 39, pages 226-227, 1938
- <sup>2</sup> W. Conrad Roentgen, in *Ann. d. Phys.*, Vol. 64, page 1, 1921.

**RESISTIVITY OF VARIOUS SEMICONDUCTORS AND DIELECTRICS**

MATERIAL	RESISTIVITY (Ohms per cc)
<b>Semiconductor</b>	
Doped antimony-aluminum	0.01 to 35
Doped silicon	0.01 to 40
Doped germanium	1.0 to 60
<b>Dielectric</b>	
Ivory	$2 \times 10^8$
Halowax 1001	$2 \times 10^{13}$
Ordinary glass	$9 \times 10^{13}$
Carnauba wax	$6 \times 10^{14}$ (30°C)
Sulphur	$8 \times 10^{15}$ to $10^{17}$
Rosin	$5 \times 10^{16}$

The resistivity of copper is  $1.7 \times 10^{-6}$  ohms per cc.

New

COVER FEATURE

# ELECTRONIC PIANO

BENJAMIN F. MIESSNER

Benjamin Franklin Miessner has devoted most of his life to audio engineering, particularly to the development of electronic musical instruments. His patents have been the basis of organs by Everett, Minshall and Wurlitzer, and pianos by Hardman & Peck, Story & Clark (Storytone) and Ansley.

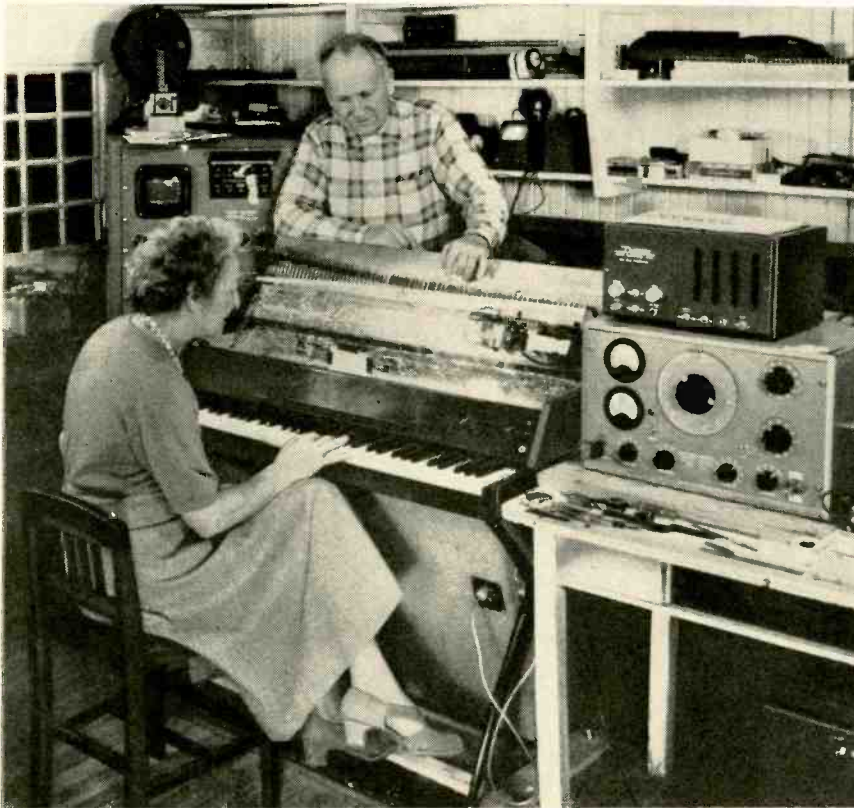

Author with Mrs. Miessner at the electronic piano.

Before founding his laboratory in 1930, Miessner had made important contributions to the art of electronic sound recording and reproduction as chief engineer of Brunswick-Balke-Collender, and at an even earlier date invented the first noise-canceling microphone for airplane use.

Other developments and inventions of Miessner include work on guided missiles with John Hays Hammond before World War I, at which time he invented and built the ancestor of our present-day electronic "turtles" and "squirrels," an "Electric Dog" which would follow a light. He also developed a one-control radio receiver before 1920, and produced (for Garod Radio Co.) some of the first a.c. receivers.

**H**UNDREDS of millions of dollars' worth of electronic organs have been sold since their introduction in 1935.

Electronic guitars have been produced in great numbers since the early 1930's, and today no popular orchestra is complete without one. The electronic "steel" guitar has made possible tremendous advances in artistic performance.

Electronic carillons have supplanted cast bells and have made feasible a great many installations where the cost of cast bells would have been prohibitive.

In spite of all these electronic advances in music, the piano has been technically static for at least 50 years; the industry as a whole has never welcomed new tone-production methods. Yet the piano was at one time a well-nigh universal instrument, found in almost every home that could afford one. When (in 1930) I set up my first laboratory, exclusively for the application of electronics to musical instruments, my very first developments were directed toward the piano in an effort to simplify the age-old tone-production methods and to provide a variety of tonal types. Though I already had a 25-year background of training and experience in radio and electro-acoustics, another 25 years of almost constant research and development were to be necessary to produce my greatest achievement, the stringless electronic piano that is the subject of this article.

## Early experiments

The very first vibrators used in those early days were reeds. Then tuning forks, rods and bars were tried. But their output lacked the great complexity and overtone richness of piano tones.

Hammer-struck strings were next used. Much more realistic, they yet lacked essential details of tonal perfection. Such nuisances as periodic retuning were still unsolved.

Conventional pianos were then tried, with the soundboard cut away to minimize direct acoustic tone, and magnetic, electrostatic and other types of string vibration pickups. Their performance, though interesting, was not suitable because the tones did not subside fast enough for clearness in rapid passages. The effect was such as is heard on conventional pianos when too much sustaining pedal is used.

I went back to reeds again in my recently developed electronic piano. They are simple, rugged and can hold their tuning for decades.

## Problems with reeds

Reeds have been successful only when maintained in continuous vibration, as in reed organs, accordions or orchestral reed instruments. They have never been found useful in true musical instruments of the percussion family. Their overtones are few and completely in-harmonious with one another. This may come as a surprise to the electronic

technician who is used to thinking of overtones and harmonics as synonymous. Yet the frequency of the second partial (overtone) is 6.267 times the fundamental; that of the third, 17.548; the fourth, 34.387, and the fifth a little more than 56 times the fundamental.

A reed fixed at one end and free at the other has only one nodal point—the fixed end—when vibrating at its fundamental. It has an additional node for each partial generated. For the second partial, the node is at 0.2261 of the length from the free end; for the third partial, the nodes are at 0.1321 and 0.4999 the length from the free end.

However, reeds do offer great and tempting advantages. They are simple, rugged, and can hold their tuning over many years. The trick is to make a "silk purse" out of this traditional "sow's ear" of the musical field.

The path of research in the effort to solve the problems of using the musicaly lowly, hammer-struck free reed as a producer of truly beautiful tones was a long one, covering 25 years and staked out by more than 40 issued and pending patents. The solution comprises several tricky steps:

1. Striking the reeds at their third-partial nodal points to eliminate this discordant component of the reed vibration.

2. Placing the pickups at the second partial's nodal point and thus eliminating this partial, also badly discordant. This leaves only the fundamental vibration to be translated by the pickups.

3. Designing and adjusting the pickups so they themselves—with their connected circuitry—develop a complete series of precisely in-tune overtone (harmonic) currents. These can be completely characteristic of piano tones and can produce better tone quality than conventional pianos.

4. Further control of the harmonic content of the complex tone currents by formant circuitry to realize some of the characteristic effects of soundboards in string pianos, to produce pianistic tones throughout the entire pitch range.

### Some piano characteristics

The suggestion that an electronic instrument can improve the tone quality of the piano may shock some who are used to thinking of the piano as a standard instrument, to be imitated rather than surpassed. Yet the piano is far from being a perfect instrument, for the following reasons, among others:

Tensioned-string piano tones are imperfect because their overtones become musically sharper as their harmonic number increases, so they are not strictly in tune with one another. This is due to inherent stiffness in the strings, which should have no stiffness other than that due to tension.

Further imperfections are caused by a series of jingling, inharmonic overtones set up by longitudinal vibrations in the strings, especially noticeable in the lower registers and at a frequency about four octaves above the normal

transverse vibration pitch of the string.

The piano soundboard tends to cut off at about 100 vibrations per second—roughly two octaves above the lowest string's fundamental vibration.

The soundboard does not vibrate in the same direction over its whole surface; various areas vibrate in phase opposition and cancel one another. The soundboard also "amplifies" the string vibrations unevenly, so the tone quality shifts rather abruptly in many instruments from one note to another.

The right-hand end of the soundboard responds best to frequencies of about 500 per second, so the tones at the top of the scale (between about 3,000 and 4,000 vibrations per second) are very fleeting and contain more hammer noises than musical tones.

The piano has certain mechanical weaknesses as well, including the fan-

tastically complicated hammer action, worthy of Rube Goldberg at his best. There is also the necessity of keeping over 200 strings under from 160 to 180 pounds of precisely adjusted tension. This necessitates massive iron plate and woodwork buttresses to hold in check the aggregate crumpling force of over 20 tons. In spite of this pianos require frequent retuning.

### The new reed piano

The new stringless piano uses small steel reeds 0.25 inch wide and .032 inch thick, struck by key-actuated hammers and stopped by very simple dampers. This key action has about one-tenth as many parts as a conventional piano action, yet performs better. The principle of the dashpot is substituted for the complex friction-damping mechanism invented by Christofori in 1709 and

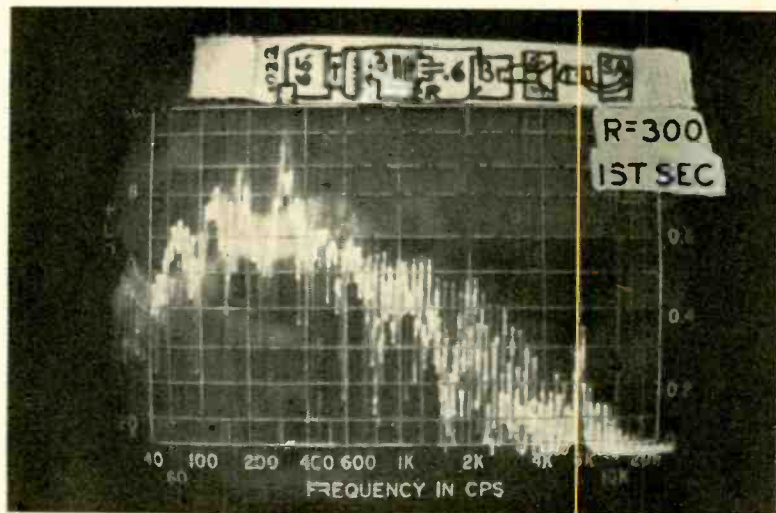
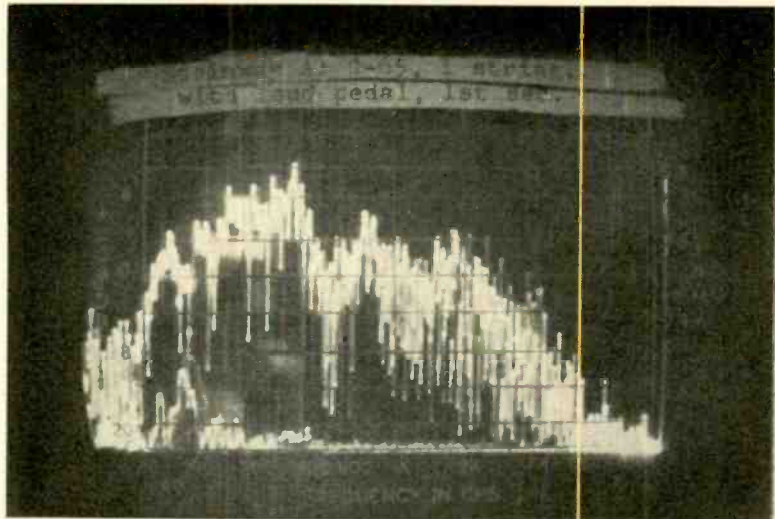

Above is the output of a Steinway model A grand and, below, that of the new Miessner electronic piano. The photos show the first five partials in closely agreeing amplitude ratios, followed by higher-frequency partials up to nearly 20,000 cycles. This can be compared with the similar tone shown in Fig. 4.

## AUDIO—HIGH FIDELITY

improved and complicated greatly since.

Machined brass pickups (Fig. 1) are positioned near the free ends of the reeds. They act as stators of variable capacitors of which the reeds are the moving plates. The changes in capacitance caused by reed vibration are used to vary the frequency of an oscillator, producing a frequency-modulated signal which is detected by a discriminator.

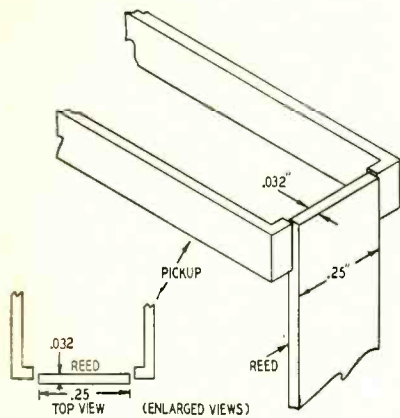

Fig. 1—Positioning of pickup and reed.

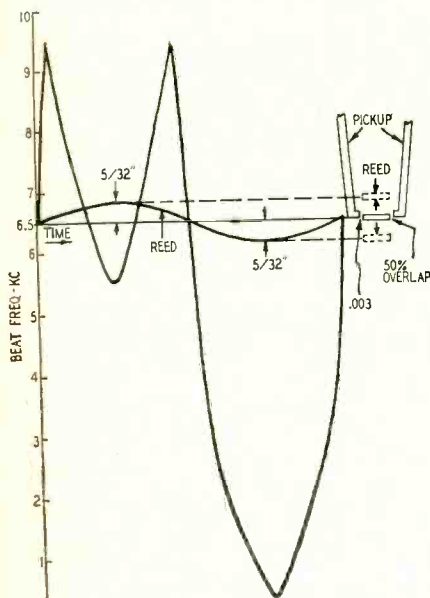

Fig. 2—End view of reed, with diagram of its excursion and voltage generated.

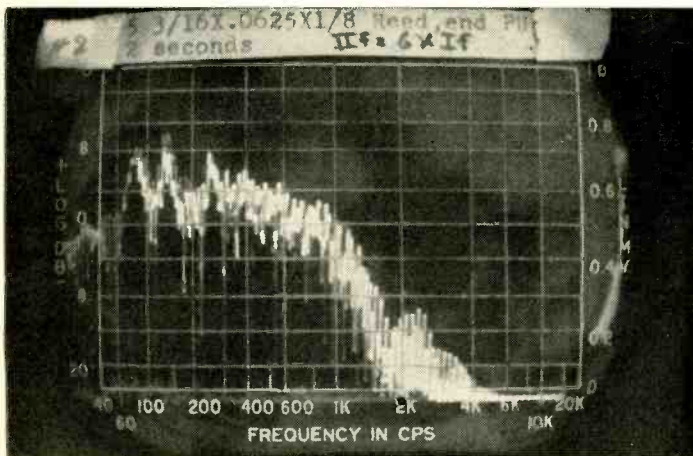

Fig. 3—Waveform produced by the reed and fed into tone-forming circuits.

The oscillator, discriminator and an audio stage form a preamplifier contained in the piano itself. Its output produces loud tones in a headset, making it possible for a student to practice on a (to others) silent piano. For room-level output, the piano may be plugged into an amplifier or even the home radio, TV or phonograph system.

The pickups are the same thickness as the reed and are so adjusted that they overlap the reed's edge about one-half its thickness. The output tone quality may be adjusted by varying the amount of this overlap. If pickup and reed are set flush with no overlap (maximum capacitance), the output will be double the reed frequency. The half-way overlap gives exact frequency reproduction.

If the pickup is moved farther away from the normal half-lap position, the fundamental's strength relative to the higher partials will increase. Moving it still farther away increases the damping rate, since the low-amplitude vibrations—as these decrease to minute values—will not be picked up. The tone quality can also be changed by changing the shape of the pickup.

The pickups are so constructed that each has two faces, one positioned at each edge of its reed. This neutralizes any effects that might be caused by sidewise motion or vibration. The normal capacitance between reed and pickup is about  $4 \mu\text{mf}$ . This increases to a maximum of  $8 \mu\text{mf}$  as the reed moves to a position opposite the pickup faces, then decreases rapidly as the reed moves on past the pickup faces and toward maximum deflection. As the reed moves back toward its normal rest position, capacitance again increases rapidly, then falls to a very low value as the reed swings in the opposite direction. The asymmetrical variation in capacitance thus produced generates a wave rich in harmonics.

At lower reed amplitudes the pickup acts more like a variable-area pickup and the output contains only the fundamental and a few partials. This is very important, since piano tones change similarly in tone quality with amplitude.

The actual capacitance changes are very small. The total capacitance of reeds to pickups in a 73-note reed piano is only  $280 \mu\text{mf}$  with all reeds in the rest position. Coupled as the frequency-determining element of an L-C circuit for a 5-mc oscillator, the vibration of a single reed modulates the oscillator up to more than 10,000 cycles.

The curve marked "Reed" in Fig. 2 is the sinusoidal vibration of partial 1 (the fundamental frequency) of the reed at an amplitude of  $5/32$  inch (average) on each side of its normal position. The pickup faces next to the reed edges are  $1/32$  inch wide and  $1/2$  inch long (along the reed edges). The air gaps are about  $.003$  inch long, but adjustable by bending the pickup arms, for "voicing" the amplitude of the output tone.

The other curve shows the frequency modulation of the oscillator as the reed is moved up to  $5/32$ -inch deflection, back down to  $5/32$ -inch downward deflection and back up again to its normal position in completing one cycle of vibration.

This frequency-modulation curve was obtained by beating the FM oscillator of the preamplifier with a fixed-frequency r.f. oscillator and measuring the resulting a.f. beat-note frequency. The actual frequency modulation of the FM oscillator is 3,000 cycles above and 7,000 cycles below its norm of 5 mc, or 10,000 cycles over-all at the  $5/32$ -inch reed vibration amplitude. This amounts to 0.2% modulation.

The effect of this sharply peaked change of pickup capacitance within a cycle of reed vibration is to set up, in the preamplifier circuit, a long series of both even- and odd-numbered precisely harmonic a.f. partials having a fundamental frequency the same as partial 1 of the reed. A sonic spectrogram of this output tone is shown in Fig. 3.

When modified by a suitable a.f. tone-forming circuit, this spectrum is changed to that shown in Fig. 4, which is a very fine piano tone of 65 cycles.

### The preamplifier

The oscillator just referred to—a 6BA7—is the first tube of the three-tube preamplifier contained in the piano (Fig. 5). The 6BA7's output goes to a 6AL5 hooked up as an FM discriminator. The audio signal thus detected is amplified by a 6AG5. The preamplifier output may be further amplified with ordinary amplifiers as previously stated, but ideally is applied to the input of a special amplifier.

This amplifier contains broadband L-C formant circuits to stimulate the tonal effects of the piano soundboard, which cuts off rather sharply around 100 cycles at the low end.

Because of the low-frequency cutoff it is both desirable and economical to use an amplifier and speaker system with limited low-frequency response—one which starts to cut off at about 100 cycles. The high-frequency characteristics must be very good, however, and



**It's New! 3 Years in Development  
-NOW READY FOR YOU!**

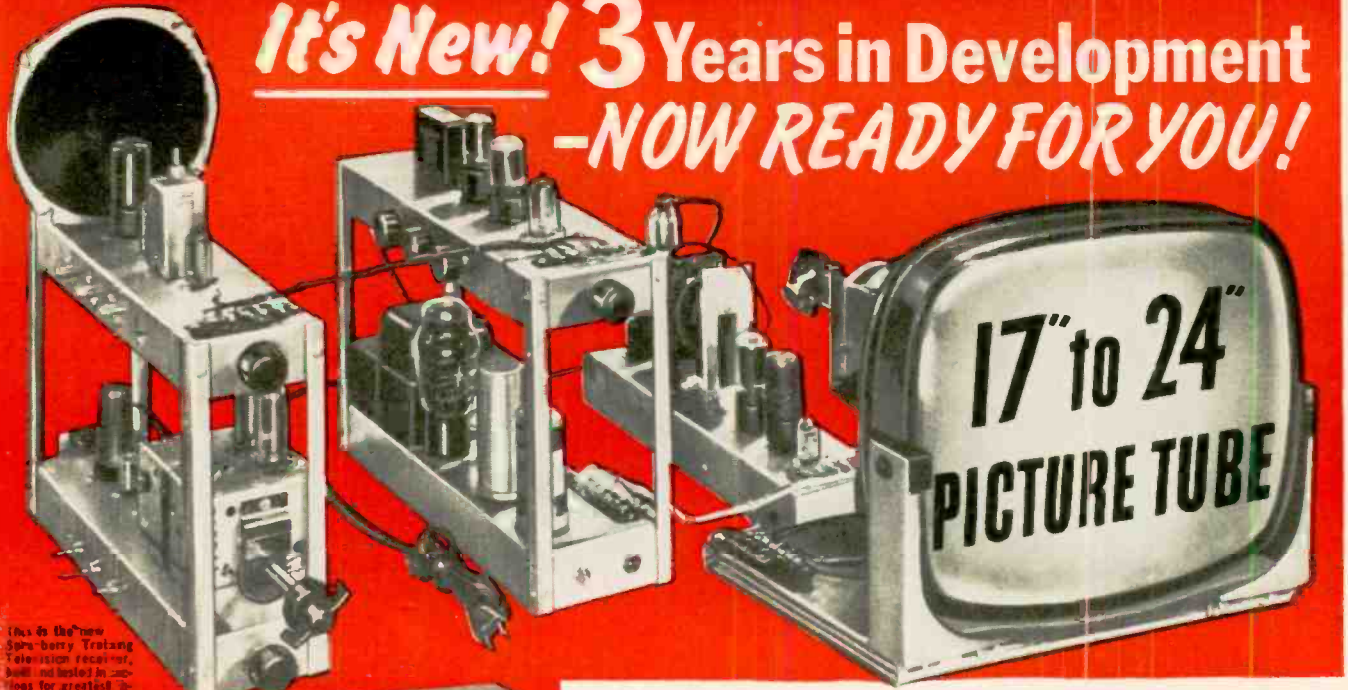

This is the new Sprayberry Training Television receiver, built and tested in Chicago for greatest instruction value.

**17" to 24"  
PICTURE TUBE**



These photos show only a small part of the training equipment I send my students.

You build the new Sprayberry Test Set in range Volt-Ohm-Millio meter (addings plus set it meter and condenser and resistors substitution correct).

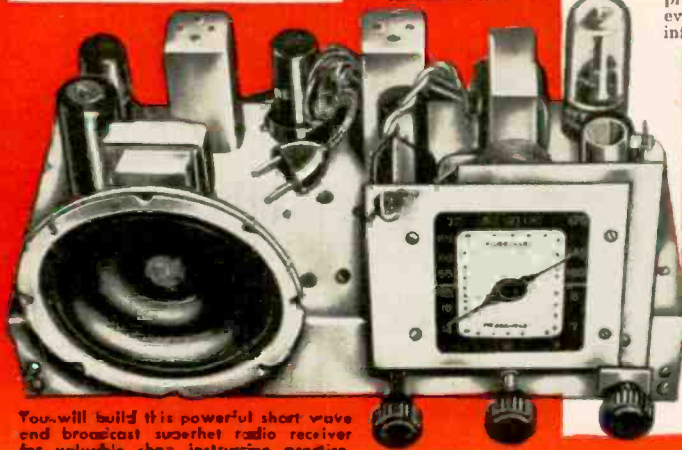

You will build this powerful short wave and broadcast superhet radio receiver for valuable shop instruction practice.

**New Equipment! New Lessons! Enlarged Course!**  
**SPRAYBERRY PRACTICAL TRAINING IN**  
**RADIO-TELEVISION**  
**3 NO OBLIGATION TRAINING PLANS**



Frank L. Sprayberry  
President, Sprayberry  
Academy of Radio

**You have NO MONTHLY PAYMENT CONTRACT to sign  
... pay for this outstanding training as you learn!**

The complete facts are so big and so important to any man seeking training in Radio-Television that I urge you to mail the coupon below at once for my big all-new 56 page FREE CATALOG and FREE Sample Lesson. Get the full story of this remarkable new and up-to-the-second Training Plan. You'll read about my 3 NO OBLIGATION PLANS or "packaged unit" instruction for both beginners and the experienced man. You'll learn how I can now prepare you in as little as 10 MONTHS to take your place in this fast moving big money industry as a Trained Radio-Television Technician. You'll see that you take no risk in enrolling for my Training because you DO NOT SIGN A BINDING TIME PAYMENT CONTRACT. I have been training successful Radio-TV technicians for 22 years . . . I can prepare you, too, to get into your own profitable Service Shop or a good paying job, even if you have no knowledge of Radio-Television. Mail the coupon . . . I rush full information FREE and without obligation. (No salesman will call.)

**NEWEST DEVELOPMENTS**

Your training covers U H F, Color Television, FM, Oscilloscope Servicing, High Fidelity Sound and Transistors.

**PRACTICE AND TRAIN AT HOME WITH 25 NEW KITS OF EQUIPMENT**

You get valuable practical experience in construction, testing and shop practice. You build a powerful 2 band superhet radio, the all-new 18 range Sprayberry multimeter, the new Sprayberry Training Television receiver, signal generator, signal tracer and many other projects. All equipment is yours to use and keep . . . and you have practically everything needed to set up a Radio-Television Service Shop.

All your training is IN YOUR HOME in spare hours. Keep on with your present job and income while learning. I help you earn extra spare time money while you learn. If you expect to be in the armed forces later, there is no better preparation than practical Sprayberry Radio-Television training. Rush coupon below for all the facts—FREE!

**SPRAYBERRY ACADEMY OF RADIO**  
111 NORTH CANAL STREET, DEPT. 20-U, CHICAGO 6, ILLINOIS



**FREE CATALOG AND SAMPLE LESSON**

Rush coupon for my catalog "How to Make Money in Radio-Television". PLUS an actual sample Sprayberry Lesson without obligation—ALL FREE. Mail coupon NOW!

SPRAYBERRY ACADEMY OF RADIO MAIL THIS COUPON FOR FREE  
Dept. 20-U, 111 N. Canal St., Chicago 6 Ill. FACTS AND SAMPLE LESSON

Please rush all information on your ALL-NEW Radio-Television Training Plan. I understand this does not obligate me and that no salesman will call upon me. Include New Catalog and Sample Lesson FREE.

Name \_\_\_\_\_ Age \_\_\_\_\_  
Address \_\_\_\_\_  
City \_\_\_\_\_ Zone \_\_\_\_\_ State \_\_\_\_\_



NEW 1955

# Heathkit

## Engineering Features

### New PRINTED CIRCUITS

One of the many tremendous improvements in the new 1955 Heathkits is the use of an etched metal process printed circuit board. Printed circuits will be used in Heathkits whenever they will affect construction simplification, performance stabilization, and lend themselves to instrument design. Now for the first time a kit instrument company offers the advantages of modern printed circuit instrument construction technique. For the first time consideration has been given toward reducing the kit assembly time. Also this is the first time that printed circuit boards have been hand soldered on a volume basis. Offered only by Heathkit, the pioneer and leader in kit instrument design.

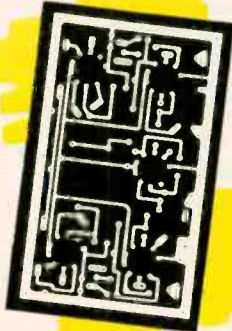

### New PEAK-TO-PEAK VTVM CIRCUIT

New 6AL5 full wave rectifier in AC input circuit permits full scale peak-to-peak measurements. Seven ranges — upper limits 4000 volts peak-to-peak. Just the thing you TV servicemen have needed in making TV circuit voltage checks. Precision resistor voltage divider limits AC RMS level to 150 volts. Prevents overloading the rectifier—extends upper limit AC RMS ranges to 1500 volts—further protects meter and circuitry against AC flash-over or arcing. Another definite example of continuing Heathkit design leadership in the kit instrument field.

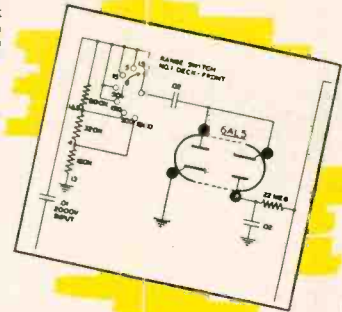

### New HIGH READABILITY PANELS

New 1955 Heathkits feature complete panel redesign. Sharp white lettering applied to the beautiful charcoal gray panels, provide a new high in readability. Lettering is easy-to-read open style and panel calibrations are vividly clear against the pleasing soft gray background. New knobs of exclusive Heathkit design.



### New 3" UTILITY SCOPE

The new 3" Scope is a "natural" for the well rounded line of Heathkit instruments. Small in size, 11 3/4" deep, 6 1/2" wide, 9 1/2" high, yet big in performance. Just think of the value. An Oscilloscope for \$29.50. Brilliant intensity, sharp focusing, wide positioning range. An ideal portable Scope for the TV serviceman—a second shop scope—modulation monitor for you hams (deflection plate terminals in rear of cabinet). Performance to spare for all general scope applications. See specifications on following page.



### New STYLING New COLOR

New styling and coloring is responsible for tremendous improvement in Heathkit appearance. The new instrument panel color combination is high definition white lettering in a soft charcoal gray panel. Cabinet color is a lighter leather gray. The satin gold baked enamel cabinet for the WA-P2 Pre-amplifier is further indicative of the modern pacesetter trend in Heathkit styling.



### New SCOPE SWEEP CIRCUIT 10 CYCLES — 500 KC

New 1955 Heathkit Model 0-10 Scope features a new wide frequency range sweep generator covering 10 cycles to 500,000 cycles. This coverage is available in five virtually decade sweep ranges and is five times greater than the sweep frequency range usually available. Excellent retrace time characteristics, actually less than 20% at 500 KC. Use of the free running Heath circuit provides a larger margin of stability and a new high in Heathkit Scope performance.

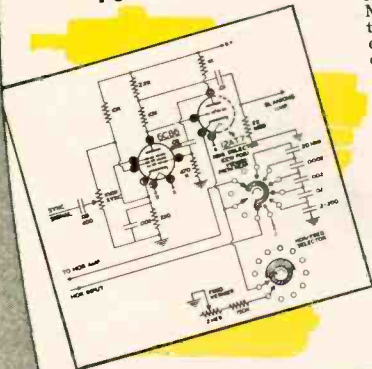

### Continuing PROGRESS FUTURE LINE EXPANSION

The outstanding improvements featured in the 1955 Heathkit line are representative of the progress characterized by the Heath Company operation. Long range planning will provide a continuing succession of new kit releases to further expand the Heathkit line which already represents the world's greatest selection of electronic kits. The innovations in the 1955 line, are representative of additional new models scheduled for release for the coming years.



SEE THE INSTRUMENTS  
ON THE FOLLOWING PAGES

**HEATH COMPANY • • Benton Harbor 20, Mich.**

# Heathkit ELECTRONIC SWITCH KIT

The basic function of the Heathkit Electronic Switch Kit is to permit simultaneous oscilloscope observation of two separate traces which can be either separated or superimposed for individual study. This is accomplished through the use of two individually controlled inputs working through amplifier, multi-vibrator, and blocking stages. The output of the Electronic Switch is connected directly to the vertical input of the Oscilloscope. A typical example of usefulness would be simultaneous observation of a signal or waveform as it appears at both the input and output stages of an amplifier.

## APPLICATIONS

An Electronic Switch has many applications to increase the over-all operating versatility of your oscilloscope. It can be used to check amplifier distortion—audio crossover networks—phase inverter circuits—to measure phase shift—special waveform study, etc. The instrument can also be conveniently used as a square wave generator over the range of switching frequencies, often providing the necessary wave form response information without incurring the expense of an additional instrument. Ownership of this instrument will reveal many entirely new fields of oscilloscope application and will quickly justify the modest cost of the Electronic Switch Kit.

Tube complement:  
2-6SN7, 2-6SN7,  
1-6X4.

Continuously variable  
switching rates in three  
ranges from less than 10  
CPS to over 2000 CPS.

Individual input  
gain controls, po-  
sition control,  
coarse frequency  
control, and fine  
frequency control.

Transformer operated for  
safety when used in con-  
junction with other equip-  
ment.



MODEL S-2

**\$23.50**

Shpg. Wt.  
8 lbs.

# Heathkit VOLTAGE CALIBRATOR KIT



MODEL VC-2

**\$11.50**

Shpg. Wt. 4 lbs.

Another useful oscilloscope accessory particularly in circuit development work and in TV and radio service work. The Voltage Calibrator provides a convenient method for making peak-to-peak voltage measurements with an oscilloscope, by establishing a relationship on a comparison basis between the amplitude of an unknown wave shape and a known output of the voltage calibrator. Peak-to-peak voltage values are read directly from a calibrated panel scale without recourse to involved calculations.

## FEATURES:

To off-set line voltage supply irregularities, the instrument features a voltage regulator tube. A convenient "signal" position on the panel switch by-passes the calibrator completely and the signal is applied through the oscilloscope vertical input, thereby eliminating the necessity for constantly transferring test leads.

## RANGES:

With the Heathkit Voltage Calibrator it is possible to measure all types of complex waveforms within a voltage range of .01 to 100 volts peak-to-peak. Build this instrument in a few hours and enjoy the added benefits offered only through combination use of test equipment.

# Heathkit LOW CAPACITY PROBE KIT



No. 342

**\$3.50**

Shpg. Wt. 1 lb.

An oscilloscope accessory, the 342 Low Capacity Probe permits observation of complex TV waveforms without distortion. An adjustable trimmer provides proper matching to any conventional scope input circuit. Excellent for high frequency, high impedance, or broad bandwidth circuits. The attenuation ratio can be varied to meet individual requirements.

# Heathkit SCOPE DEMODULATOR PROBE KIT



No. 337-C

**\$3.50**

Shpg. Wt. 1 lb.

Extend the usefulness of your oscilloscope by observing modulation envelopes of RF or IF carriers found in TV and radio receivers. The Heathkit Demodulator Probe will be helpful in alignment work, as a gain analyzer and a signal tracer. Easy construction with the new modern printed circuit board. Voltage limits are 30 volts RMS and 500 volts D.C.

# HEATH company

BENTON HARBOR 20,  
MICHIGAN

## AUDIO-HIGH FIDELITY

# HIGH- FIDELITY DICTIONARY

*A compilation of commonly  
used audio terminology*

By ED BUKSTEIN\*

**H**IGH fidelity is a hobby that claims an ever-growing following and represents a considerable portion of the electronics industry in this country. The public, having learned the meaning and pleasure of high fidelity, is no longer content with the 100-5,000-cycle response once considered satisfactory. The technician called upon to install or repair a high-fidelity system finds the customer entirely capable of intelligent discussion of sound reproduction.

For personal satisfaction and business reasons, the technician should acquaint himself with the techniques of high-fidelity sound reproduction. The following definitions indicate the extent of the subject, and the areas in which further study would be advisable.

## Acoustical labyrinth enclosure

A loudspeaker enclosure in which partitions are used to increase the length of the air path of the rear radiation of the loudspeaker (Fig. 1).

\*Northwestern Television and Electronics Institute, Minneapolis, Minn.

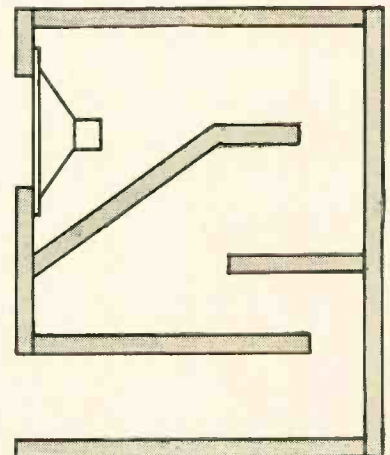

Fig. 1—Acoustical labyrinth enclosure.

# NEW *Heathkit* 5" PUSH-PULL OSCILLOSCOPE KIT FOR COLOR TV

**BRAND NEW DESIGN:** The new Heathkit Model O-10 Oscilloscope would be something special at any price, but is almost unbelievable at \$69.50. Completely re-designed scope has broadband amplifiers for color TV work and offers brilliant overall performance. Vertical frequency response within 5 db from 5 cps to 5 mc. Even more astounding, the response is down less than 1 1/2 db at 3.58 mc. the color TV sync burst frequency. It is essential that scopes for color work have these broadband characteristics.

**PRINTED CIRCUITS:** Two printed circuit boards used in this fine instrument to insure stable, consistent performance. Problems solved by pre-engineering of boards, and their use guarantees completed unit that will have same characteristics as lab development model. Printed circuits simplify construction and save labor.

**NEW SWEEP CIRCUIT:** Sweep circuit operates with exceptionally good linearity from 20 cps to over 500,000 cps. 5 times the usual range for scopes in this price range. An entirely new circuit introduced for the first time in any Heathkit.

First color television service Oscilloscope with necessary high sensitivity and full 5 megacycle bandwidth.

New printed circuit construction, all components mounted on high insulation surface resulting in uniform, low circuit capacities.

New type wide frequency range Heath sweep generator, 10 cycles to 500,000

New 5U1 CR tube



New cabinet styling and color harmony—charcoal gray panel with high readability white lettering.

**MODEL O-10**  
**\$69<sup>50</sup>**  
3hp-g. Wt. 27 lbs.

**FEATURES:** Other outstanding characteristics of this professional oscilloscope are: Built-in 1V peak-to-peak reference for calibration of plastic CRT face-plate; 5" 5U1 CRT; push-pull hor. and vert. deflection amplifiers; hor. trace width expandable to 3 times diameter of CR tube to allow inspection of any small portion of the signal; deflection sensitivity, .025 volts per inch; wiring harness pre-formed and cabled to save construction time and insure professional appearance and operation. Incorporates efficient retrace blanking. Frequency compensated step attenuator at the vertical input. Entire tube face useable. No fold-over on vertical over-load. Performance obtainable only in much more expensive laboratory models.

Uses 5U1, 6AB4, 6B07, 12BH7, 6CB6, 12AT7, 2-12AU7, 6X4, 1V2, and 6C4. Quality components used throughout so that outstanding performance characteristics may be maintained for years to come. Plastic molded condensers are used in all coupling and by-pass applications. The "new-look" in Heathkit styling produces professional appearance in keeping with the professional performance of this instrument.

Simplified, standardized construction technique of vertical and horizontal amplifier construction made possible through the use of a single printed circuit board.

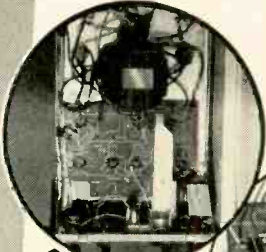

Clean, open, under-chassis construction and wiring. Possible only through use of pre-cabled wiring harness, and simplified printed circuit boards.

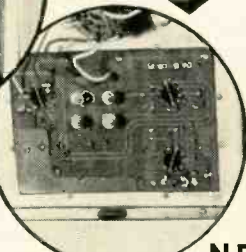

## NEW *Heathkit* 3" PRINTED CIRCUIT OSCILLOSCOPE KIT

**MODEL OL-1**  
**\$29<sup>50</sup>** Shpg. Wt. 15 lbs.



3GP1 CR TUBE

New compact utility Scope—light-weight—portable for service work.

Deflection plate terminals—ideal for ham transmitter modulation monitoring.

New easy-to-build printed circuit board with high insulation factor.

New Heathkit instrument styling—charcoal gray panel with high readability white lettering.

New Heath twin triode sweep generator 15-100,000 cycle sweep.

**EXCEPTIONAL VALUE:** The brand new Model OL-1 Utility Oscilloscope is designed especially for portable applications so that outside servicemen or persons performing field tests can have the advantages of a scope available. Then too, it is ideal for home workshop, the ham-shack, or as an "extra" scope for the service shop. It is compact, light in weight, and surprisingly versatile in operation. An outstanding instrument for the price.

Front panel controls are "bench-tested" for ease of operation and convenience. Printed circuit board used for constant circuit performance. Assembly time cut in half!

**SPECIFICATIONS:** Vertical amplifiers feature frequency response within 1 db from 10 cps to 100 kc, and within 5 db from 5 cps to 500 kc. Vertical sensitivity .2 volts per inch at 1 kc, with input impedance of 12 mmfd shunting 10 megohms.

Horizontal response within 1 db from 10 cps to 200 kc, and within 5 db from 5 cps to 500 kc. Hor. sensitivity .25 volts per inch at 1 kc, input impedance of 15 mmfd shunting 10 megohms. Sweep generator covers 10 cps to 100,000 cps with stable positive lock-in circuit. Cathode follower input in both vert. and hor. amplifiers; push-pull vertical and horizontal deflection amplifiers; 3" CRT; electronic positioning controls for wide range of vertical and horizontal spot deflection; provision for internal and external sync; 60 cycle line sweep. New modern color styling and unusual performance make this instrument an outstanding value.

## NEW *Heathkit* 5" PRINTED CIRCUIT OSCILLOSCOPE KIT

**MODEL OM-1**  
**\$39<sup>50</sup>** Shpg. Wt. 24 lbs.

5BP1 CR TUBE



**VERSATILE INSTRUMENT:** The new Model OM-1 general purpose Oscilloscope represents an outstanding dollar value in reliable test equipment. Full 5 inch CRT. Printed circuit boards for ease of assembly, constant circuit characteristics, and rugged component mounting. Includes all the design features necessary for servicemen, students, experimenters, radio amateurs, etc. Frequency response of amplifiers flat within 1 db from 10 cps to 100 kc, and down only 7 db from 10 cps to 500 kc. Sweep generator range from 20 cps to 100,000 cps. Also features new Heathkit color styling with charcoal gray panel and high definition white lettering for readability even under subdued lighting conditions.

**DESIGN FEATURES:** A full-size, versatile oscilloscope at a price you can afford. Other features are: adjustable spot shape control; RF connections to deflection plates; direct coupled centering controls; external and internal sweep and sync; 60 cycle line sync; built in 1 volt peak-to-peak panel terminal reference voltage; professional appearance of cabinet, panel, and knob styling.

**HEATH company**  
BENTON HARBOR 20,  
MICHIGAN

# Heathkit MULTIMETER KIT

The new Heathkit Multimeter is a "must" to complete the instrument lineup of any well equipped service shop. Here is an instrument packed with every desirable service feature, many of which are not found in other Multimeters. All of the measurement ranges you need or want. High sensitivity 20,000 ohms per volt DC; 5,000 ohms per volt AC.

### ★ ADVANTAGES

Complete portability through freedom from AC line power operation—provides service ranges of direct current measurements from 150 microamps up to 15 amperes—can be safely operated in RF fields without impairing accuracy of measurement.

### ★ RANGES

Full scale AC and DC voltage ranges are 0-1.5, 5, 50, 150, 500, 1500 and 5,000 volts. Direct current ranges are 150 microamps, 15, 150 and 500 milliamperes and 15 amperes. Resistances are measured from .2 ohms to 20 megohms in 3 ranges and db range from -10 to +65 db.

### ★ CONSTRUCTION

The Heathkit MM-1 features a unique resistor ring switch mounting assembly procedure. With this method of assembly the precision resistors are wired to the rings and range switch before actual mounting of the switch to the instrument panel. This procedure affords the advantage of simpler construction yet complete accessibility of precision resistors in event replacement is ever required. Ohmmeter batteries were selected for convenience of replacement and only standard commercially available types are used. Batteries consist of 1 type C flashlight cell and 4 Penlite cells. All batteries and necessary test leads are furnished with the kit.

20,000 ohms per volt sensitivity DC; 5,000 ohms per volt AC.

Polarity reversal switch eliminates transferring of test leads.

All 1% precision multiplier resistors—sensitive to 30 Simpson meter.

Total of 35 meter ranges on two color scale.

New modern cabinet styling—attractive appearance.

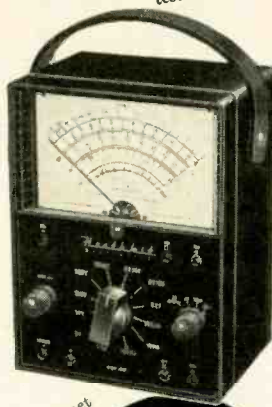

MODEL MM-1

**\$26.50**

Shpg. Wt. 6 lbs

## Heathkit HANDITESTER KIT



MODEL M-1

**\$14.50**

Shpg. Wt. 3 lbs.

The Heathkit Model M-1 Handitester readily fulfills major requirements for a compact, portable volt-ohm milliammeter. The small size of the smooth gleaming molded bakelite case permits the instrument to be tucked into your coat pocket, toolbox or glove compartment of your car. Always the "Handitester" for those simple repair jobs.

### RANGES:

Despite its compact size, the Handitester is packed with every desirable feature required in an instrument of this type. AC or DC voltage ranges, full scale, 10, 30, 300, 1,000 and 5,000 volts. 2 convenient ohmmeter ranges 0-3,000 ohms and 0-300,000 ohms. 2 DC milliammeter ranges 0-10 milliamperes and 0-100 milliamperes.

### CONSTRUCTION

The instrument uses a 400 microampere meter movement which is shunted with resistors to provide a uniform 1 milliamper load in both AC and DC ranges. This design allows the use of but 1 set of 1% precision divider resistors on both AC and DC and provides a simplicity of switching. A small hearing aid type ohms adjust control provides the necessary zero adjust function on the ohmmeter range. The AC rectifier circuit uses a high quality Bradley rectifier and a dual half wave hookup. Necessary test leads and battery are included in the price of this popular kit.

## Heathkit RESISTANCE SUBSTITUTION BOX KIT

MODEL RS-1

**\$5.50**

36 standard RTMA 1 watt resistor values between 15 ohms and 10 megohms with an accuracy of 10% are at your fingertips in the Model RS-1 Resistance Substitution Box kit. This sturdy and attractive accessory will easily prove its worth many times over as a time saving device. Order several today.

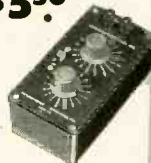

Shpg. Wt. 2 lbs.

## Heathkit CONDENSER SUBSTITUTION BOX KIT

MODEL CS-1

**\$5.50**

18 standard RTMA values are available from .0001 mfd to .22 mfd. An 18 position switch set in the panel of an attractive bakelite case allows quick changes without touching the test leads. Invest a few minutes of your time now and save hours of work later on.



Shpg. Wt. 2 lbs.

# HEATH company

BENTON HARBOR 20,  
MICHIGAN

## AUDIO—HIGH FIDELITY

### Amplitude distortion

The result of nonlinearity of an amplifier with respect to signal amplitude. This results from driving a tube beyond the linear portion of its characteristic so that, for example, a two-fold increase of input-signal amplitude will not double the amplitude of the output. Since this type of distortion introduces harmonics not present in the input, it is also known as *harmonic distortion*.

### Attenuator

Attenuation is the opposite of amplification, and an attenuator is therefore a component or network designed to reduce the amplitude of a signal applied to it. In its simplest form this would be a potentiometer, but a more elaborate network of resistances is often used to provide also impedance matching.

### Audio range

The range of frequencies to which the human ear will respond. This range varies with individuals, age, state of health, etc. and is approximately 16 to 16,000 cycles.

### Baffle

A structure, usually wooden, used to lengthen the air path of the rear radiation of a loudspeaker. In its simplest form, the baffle is a flat piece of wood with an opening for the loudspeaker. By increasing the air-path length of rear radiation, it reduces the cancellation of sound waves by out-of-phase components of front and rear radiation. Because, the dimensions of a flat baffle adequate for low-frequency response are excessively large, this type is not commonly used.

### Bass boost

The characteristic of a circuit that results in increased gain at lower frequencies. Bass-boost circuits are generally designed to increase the low-frequency gain at a rate of 6 db per octave.

### Bass-reflex enclosure

A loudspeaker enclosure consisting

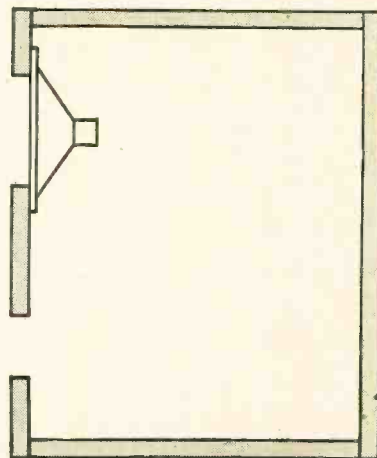

Fig. 2—Basic bass-reflex enclosure.

# NEW *Heathkit* VACUUM TUBE VOLTMETER KIT PRINTED CIRCUIT DESIGN

Another outstanding example of continuing Heath Company pioneering and leadership in the kit instrument field. A new printed circuit VTVM. New peak-to-peak circuit—new styling and new panel design. A prewired, prefabricated printed circuit board eliminates chassis wiring, cuts assembly time in half, assures duplication of Engineering pilot model specifications, and virtually eliminates possibility of construction error.

### CIRCUIT:

A 6AL5 tube operated as a full wave AC input rectifier permits seven peak-to-peak voltage ranges with upper limits of 4000 volts P-P. Just the ticket for you TV servicemen. Voltage divider in the 6AL5 input circuit limits applied AC input to a safe level. This circuitry and the isolation of the meter in the cathode of the 12AU7 bridge circuit affords a high degree of protection to the sensitive 200 microampere meter.

### RANGES:

Seven voltage ranges. 1.5, 5, 15, 50, 150, 500 and 1,500 volts DC and AC RMS. Peak-to-peak ranges 4, 14, 40, 140, 400, 1400, 4000. Ohmmeter ranges X1, X10, X100, X1000, X10K, X100K, X1 meg. Additional features are a db scale, a center scale zero position, and a polarity reversal switch.

### IMPORTANT FEATURES:

High impedance 11 megohm input—transformer operated—1% precision resistors, 6AL5 and 12AU7 tube—selenium power rectifier—individual AC and DC calibrations—smoother improved zero adjust control action—new panel styling and color—new placement of pilot light—new positive contact battery mounting—new knobs—test leads included.

The new V-7 also sets the pace as a kit instrument style leader. Smart, good-looking charcoal gray panel and soft leather gray cabinet. High readability panel with sharply contrasting white calibrations. The pleasing, eye catching, modern styling is in harmonious balance with the outstanding circuit design improvements. Easily the best buy in kit instruments.

*New* charcoal gray baked enamel panel with high readability, white lettering, soft leather gray cabinet, subdued pilot light indicator.

*New* printed circuit board for faster, easier construction—exact duplication of Lab development model.



*New* easy-to-read open panel layout. Off-on switch now incorporated in the selector switch.

MODEL V-7

**\$24<sup>50</sup>**

Shpg. Wt. 7 lbs.

*New* peak-to-peak meter scale—new color harmony—new knobs.

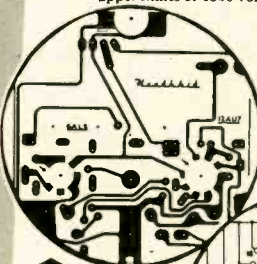

Full wave rectifier in AC input circuit. Read peak-to-peak and RMS volts with upper limit of 4000 P-P and 1500 volts RMS. Voltage divider input circuit.

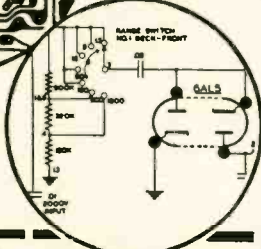

The first kit instrument to offer a labor-saving, error-free printed circuit board. Your instrument an exact wiring replica of Engineering development model.

## *Heathkit* AC VACUUM TUBE VOLTMETER KIT MODEL AV-2

**\$29<sup>50</sup>**

Shpg. Wt. 5 lbs.

Extreme sensitivity has been emphasized in the design of the Heathkit AC VTVM. Ten full scale RMS ranges are .01, .03, .1, .3, 1, 3, 10, 30, 100, and 300 volts. Frequency response is substantially flat from 10 cycles per second to 50 KC with input impedance of 1 megohm at 1 KC. Will accurately measure as low as 1 millivolt at high impedance. Total db range is -52 db to +52 db. An excellent kit for measuring the output of phono cartridges and the gain of amplifier stages. Use it also to check power supply ripple, as a sensitive null detector, and for compiling frequency response data. Features one knob operation, 200 microampere Simpson meter and precision resistors.

ing the output of phono cartridges and the gain of amplifier stages. Use it also to check power supply ripple, as a sensitive null detector, and for compiling frequency response data. Features one knob operation, 200 microampere Simpson meter and precision resistors.

## *Heathkit* AUDIO WATTMETER KIT

Read audio power output directly without using external load resistors with the new Heathkit Audio Wattmeter. Built-in non-inductive load resistors provide impedances of 4, 8, 16, and 600 ohms. Flat response from 10 CPS to 250 KC. Full scale power ranges are 0-5 MW, 0-50 MW, 0-500 MW, 0-5 W and 0-50 W. Model AW-1 will operate continuously at 25 watts and has a duty cycle of 3 minutes at 50 watts. Total db range in five positions is -50 db to +48 db, using the standard 1 milliwatt 600 ohms.

MODEL AW-1

**\$29<sup>50</sup>**

Shpg. Wt. 6 lbs.



## *Heathkit* 30,000 VOLTS DC PROBE KIT

Measure up to 30,000 volts DC with the Heathkit VTVM and the 336 high voltage Probe. Precision resistor provides multiplication factor of 100. Can be used with any 11 megohm input VTVM. Housed in a Polystyrene two color sleek plastic probe body for safety of operation.

No. 336

**\$450**

Shpg. Wt. 1 lb.



## *Heathkit* PEAK-TO-PEAK PROBE KIT



No. 338-C

**\$5<sup>50</sup>**

Shpg. Wt. 2 lbs.

Peak-to-peak values not exceeding 80 volts at a LC level of not more than 600 volts, can now be read directly by using 338-C Probe with previous model Heathkit VTVM's or any VTVM with 11 megohm input resistance. Probe construction features a modern printed circuit board for easy assembly. Frequency range 5 KC to 5 MC.

## *Heathkit* RF PROBE KIT

The Heathkit RF Probe will permit the measurement of RF voltages up to 250 MC with an accuracy of ±10%. The limits are 30 volts AC and a DC level of 500 volts. Designed for any 11 megohm input VTVM. Modern styling, Polystyrene aluminum housing, Polystyrene insulation, and printed circuit board for easy assembly.



No. 309-C

**\$3<sup>50</sup>** Shpg. Wt. 1 lb.

**HEATH company**  
BENTON HARBOR 20,  
MICHIGAN

# Heathkit 6-12 VOLT BATTERY ELIMINATOR KIT

Here is the new 12 volt Heathkit Battery Eliminator so necessary for modern up-to-date operation of your Service Shop. Furnishes either 6 or 12 volt output which can be selected at the flick of a panel switch. Use the BE-4 to service all of the new 12 volt car radios in addition to the conventional 6 volt models.

### RANGES:

This new Battery Eliminator provides two continuously variable output voltage ranges. 0-6 volts D.C. at 10 amperes continuously or 15 amperes maximum intermittent and 0-12 volts D.C. at 5 amperes continuously or 7.5 amperes maximum intermittent. The output voltage is clean and well filtered, as the circuit uses two 10,000 mfd condensers.

The continuously variable voltage output feature is of definite aid in determining the starting point of vibrators, the voltage operating range of oscillator circuits, etc.

### OTHER USES:

The controllable low voltage DC supply has many other applications besides primary use in car radio service work. Can be nicely used as a battery charger, or low voltage DC supply for electric trains. Has applications in high gain audio work requiring clean DC filament supply. Can be used for low power electro-plating or as a power supply for battery powered intercommunication systems.

Automatic overload relay—self resetting—fuse protected.

New 18 plate split type, heavy duty rectifier unit.



Continuously variable output voltage, either 6 or 12 volt operation.

Constant ammeter and voltmeter monitoring.

MODEL BE-4

**\$31<sup>50</sup>**

Shpg. Wt. 17 lbs.

## Heathkit VIBRATOR TESTER KIT



MODEL VT-1

**\$14<sup>50</sup>**

Shpg. Wt. 6 lbs.

This time-saving device will quickly pay for itself in your auto radio service shop. 6 volt vibrators can be checked instantly on the Good—Bad type meter scale. Operation requires only a variable DC voltage from 4 to 6 volts at 4 amperes. Model BE-4 Battery Eliminator is recommended for this application.

Five test sockets provide for the testing of hundreds of interrupter and self-rectifier types. Proper starting voltage is determined easily and accurately. Over-all quality is then unmistakably indicated on the panel mounted meter.

## Heathkit IMPEDANCE BRIDGE KIT



MODEL IB-2

**\$59<sup>50</sup>**

Shpg. Wt. 12 lbs.

The new Heathkit Impedance Bridge features built-in adjustable phase shift oscillator and amplifier. This instrument actually represents four instruments in one compact unit. The Wheatstone bridge for resistance measurements, the Capacity Comparison bridge for capacity measurements, Maxwell bridge for low Q, and Hay bridge for high Q measurements.

### DESIGN:

Panel provisions for external generator use. A new two section CRL dial, provides ten separate "units." Ten separate units switch settings and fractions of units are read on a continuously variable calibrated control. A special minimum capacity shielded and balanced impedance matching transformer between the generator and bridge circuit is automatically switched to provide correct load operation of the generator circuit. The instrument uses 1/2% precision resistors and condensers in all measurements circuits.

## Heathkit VARIABLE VOLTAGE ISOLATION TRANSFORMER KIT

Variable output voltage between 90 and 130 volts AC. Rated at 100 volt—amperes continuously and 200 volt—amperes intermittently. The principle function of the Heathkit Isolation Transformer is to isolate the circuit being tested from line interference being caused by motors, appliances, etc. It works backward too by isolating such devices from the line. Many other uses, especially with AC—DC type circuits. Do not confuse the Heathkit Isolation Transformer with the hazardous auto transformer type line voltage boosters.



MODEL IT-1

**\$16<sup>50</sup>**

Shpg. Wt. 10 lbs.

**HEATH** company  
BENTON HARBOR 20,  
MICHIGAN

## AUDIO—HIGH FIDELITY

of a closed-back box having an opening in addition to the one behind which the speaker is mounted. The additional opening, known as a port, is generally located directly beneath the loudspeaker. The internal volume of the enclosure and the size of the port are such that the sound waves emitted from the port and from the speaker opening are in phase at the low frequencies, thereby improving the low-frequency response (Fig. 2).

### Binaural

A sound-reproducing system for duplicating the realism of the original sound by providing a separate signal for each ear. The sound is picked up by two microphones spaced a short distance apart to represent the two ears of the listener. The signals are amplified separately and ultimately applied to a pair of headphones, one signal to each unit. Because of the inconvenience of headphones, loudspeakers are often substituted. This, however, is no longer a *pure* binaural system since sound from the "left-ear" loudspeaker can reach the right ear of the listener and vice versa.

### Cabinet resonance

The acoustical resonance of the loudspeaker enclosure. The frequency of resonance is determined by the internal volume of the enclosure and gives rise to a booming effect sometimes known as one-note bass. Although it is sometimes possible to use cabinet resonance to compensate or fill in a low spot in the frequency response of the loudspeaker, it is generally desirable to minimize such resonance.

### Capacitive pickup

A pickup element containing two metal plates, one stationary and the other actuated by the stylus. As the stylus rides in the groove, its movements are coupled to the movable metal plate. In this way, the plate spacing and capacitance vary in accordance with the modulation of the groove.

### Capacitive loudspeaker

A type of loudspeaker consisting of two closely spaced metal plates, one rigid and the other thin and flexible. The audio signal is applied to these plates in series with a steady d.c. potential known as the polarizing voltage. As the flexible plate becomes alternately positive and negative it is alternately attracted and repelled by the fixed plate. The flexible plate corresponds to the cone of a conventional loudspeaker, and its vibration sets up sound waves. The capacitor loudspeaker is also known as an *electrostatic loudspeaker* since it operates on the principle of electrostatic attraction and repulsion.

### Cartridge

In a pickup, the unit which converts the motion of the stylus into a corresponding electrical signal. (See Cera-



# NEW *Heathkit* TV ALIGNMENT GENERATOR KIT

Here is the most radically improved Sweep Generator in the history of the TV service industry. The basic design follows latest high frequency techniques which result in a combination of performance features not found in any other sweep generator.

### SWEEP:

Sweep action is obtained electronically through the use of a newly developed controllable inductor, thereby eliminating all moving parts with their resultant hum, vibration, fatigue, etc. Frequency coverage entirely on fundamentals, is continuous from 4 MC to 220 MC at an output level well over a measurable .1 volt.

Triple marker system, 4.5 MC crystal controlled marker—continuously variable marker—provisions for external marker.

### MARKER:

The same instrument incorporates a triple marker system with a crystal controlled reference. A variable marker provides accurate coverage from 19 to 60 MC on fundamentals, and 57 to 180 MC on calibrated harmonics. A separate fixed crystal controlled 4.5 MC marker can be used for checking IF, band-pass, calibration, reference, etc. Provisions are also made for external marker use. A 4.5 MC crystal is supplied with the kit.

### POWER SUPPLY:

The transformer operated Power Supply features voltage regulation for stable oscillator operation. Three sets of shielded cables are furnished with the kit. Sweep range is completely and smoothly controllable from zero up to a maximum of 50 MC, depending upon base frequency.

Here is a TV Sweep Generator that truly no serviceman can afford to be without for rapid, accurate, TV alignment work.

Controllable inductor sweep oscillator with output entirely on fundamentals.

Triple marker system 4.5 MC crystal controlled—5 sets of cables included.

Electronically operated, smooth continuously variable, sweep circuit. No vibration, hum or noise.

Frequency coverage: 4 MC—220 MC continuous including FM spectrum. RF output well over .1 volt.



MODEL TS-3

**\$44.50**

Shpg. Wt. 18 lbs.

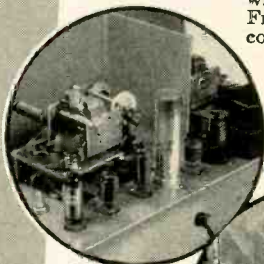

Automatic amplitude control circuit—constant output voltage regulated power supply.



## NEW *Heathkit* SIGNAL GENERATOR KIT

MODEL SG-8

**\$19.50** Shpg. Wt. 8 lbs.

The new Heathkit service type Signal Generator, Model SG-8 incorporates many design features not usually found in this instrument price range. Frequency coverage

is from 160 KC to 110 MC in five ranges, all on fundamentals, with useful calibrated harmonics up to 220 MC. The RF output level is well in excess of 100,000 microvolts throughout the frequency range. The oscillator circuit consists of a twin triode tube, one-half used as a Colpitts oscillator, and the other half as a cathode follower output which acts as a buffer between the oscillator and external load, thereby eliminating oscillator frequency shift usually caused by external loading.

All coils are factory wound and adjusted, thereby completely eliminating the need for individual calibration and the use of additional calibrating equipment. The stable, low impedance output, features step and variable attenuation for complete control of RF level. A separate 6C4 triode acts as a 400 cycle sine wave oscillator, and a panel mounted switching system permits choice of either external or internal modulation.

## *Heathkit* LABORATORY GENERATOR KIT

The new Heathkit Laboratory type Signal Generator definitely establishes a new performance standard for a kit instrument. An outstanding feature involves the use of a panel mounted 200 microampere meter calibrated both in microvolts and percent modulation, thereby providing a definite reference level for using the Signal Generator in design work, gain measurements, selectivity, frequency response checks.

### DESIGN:

Additional design features are copper plated shield enclosure for oscillator and buffer stages resulting in effective double shielding. Fibre panel control shaft extensions in RF carrying circuits, thorough AC line filtering, careful shielding of the attenuator network, voltage regulated B plus supply, selenium rectifier, etc.

### RANGES:

Frequency coverage from 150 KC to 30 MC all on fundamentals in five separate ranges. Output voltage .1 volt with provisions for metered external or internal modulation. Output impedance termination 50 ohms. Transformer operated power supply.

Investigate the many dollar stretching features offered by the LG-1 before investing in any generator for Laboratory or Service work.



MODEL LG-1

**\$39.50**

Shpg. Wt. 16 lbs.

## NEW *Heathkit* BAR GENERATOR KIT



MODEL  
BG-1

**\$14.50** Shpg. Wt. 4 lbs.

The Heathkit BG-1 produces a series of horizontal or vertical bars on a TV screen. Since these bars are equally spaced, they will quickly indicate picture linearity of the receiver under test without waiting for transmitted test patterns. Panel switch provides "standby—horizontal and vertical position." The oscillator unit uses a 12AT7 twin triode for the RF oscillator and video carrier frequencies. A neon relaxation oscillator provides low frequency for vertical linearity tests. The instrument will also provide an indication of horizontal and vertical sync circuit stability as well as overall picture size. Operation is simple and merely requires connection to the TV receiver antenna terminal. Transformer operated for safety.

**HEATH company**  
BENTON HARBOR 20,  
MICHIGAN

# Heathkit VISUAL-AURAL SIGNAL-TRACER KIT

The new Heathkit Visual-Aural Signal Tracer features a special high gain RF input channel used in conjunction with a newly designed wide frequency range demodulator probe. High RF sensitivity permits signal tracing from the receiver antenna input. Separate low gain channel and probe available for audio circuit exploration. Both input channels are constantly monitored by an electron ray beam indicator so that visual as well as aural indications may be obtained.

## NOISE LOCATOR:

A decidedly unusual feature is a noise locator circuit used in conjunction with the audio probe. With this system, a DC potential is applied to a suspected circuit component and the action of the voltage in the component can be seen as well as heard. Invaluable for ferreting out noisy or intermittent condensers, noisy resistors, controls, IF and power transformers, etc.

## WATTMETER:

Built-in calibrated wattmeter circuit will prove useful for quick preliminary check of total wattage consumption of equipment under test. Separate panel terminals provide external use of the speaker or output transformer for substitution purposes. Saves valuable service time by eliminating the necessity for speaker removal on every service job. The same panel terminals also provide easy access to a well filtered B plus supply for external use. Don't overlook the many interesting service possibilities provided through the use of this instrument, and let the Signal Tracer work for you by saving time and money.

Substitution test speaker—utility amplifier.

Noise locator circuit—calibrated wattmeter.



RF and audio probes supplied along with necessary test leads.

Visual and aural signal tracing.

MODEL T-3

**\$23.50**

Shpg. Wt. 9 lbs.

## Heathkit CONDENSER CHECKER KIT



MODEL C-3

**\$19.50** Shpg. Wt. 7 lbs.

Here is a handy test instrument for any Service Shop. Unknown values of capacity and resistance are quickly determined on the direct-reading condenser checker dial. Capacity is measured in four ranges from .001 mfd to 1000 mfd. Resistance in the range from 100 ohms to 5 megohms.

DC polarizing voltages of 25, 150, 250, 350, and 450 volts are available for leakage tests on all types of condensers. For electrolytics, a power factor control is provided to balance out inherent leakage and to indicate directly the power factor of a condenser under test. Proper balancing of the AC bridge is reflected in the degree of closure of an electron beam indicator tube.

Model C-3 uses a transformer operated power supply, spring return leakage test switch, and a convenient combination of panel scales for all readings. Test leads are furnished in addition to precision components for calibrating purposes. Quick and easy to operate, the Heathkit Condenser Checker will save valuable time and increase your Shop efficiency.

## Heathkit "Q" METER KIT



MODEL QM-1

**\$44.50**

Shpg. Wt. 14 lbs.

The Heathkit QM-1 represents the first practical popular priced Q meter available within the price range of schools, laboratories, TV service men, and experimenters. This instrument will enable the operator to simulate conditions encountered in practical circuits and to measure the performance of coils or condensers at the operating frequencies actually encountered. All indications of value are read directly on the 4 1/2" 50 microampere Simpson calibrated meter scale. Measures Q of condensers, RF resistance, and the distributed capacity of coils. Oscillator section supplies RF frequencies 150 KC to 18 MC in four ranges. Calibrate capacity with range of 40 MMF to 450 MMF with vernier of  $\pm 3$  MMF. Investigate the many services this instrument can perform for you.

## Heathkit

## AUDIO OSCILLATOR KIT



MODEL AO-1

**\$24.50**

Shpg. Wt. 10 lbs.

The Heathkit Audio Oscillator will produce both sine and square waves within the frequency range from 20 CPS to 20 KC in three ranges. Thermistor controlled linearity results in a variation of no more than  $\pm 1$  db in a 10 volt (no load) variable output level. There will be less than .6% distortion from 100 CPS throughout the audible range. Low impedance 600 ohm output. Precision 1% resistors, used in the range multiplier circuits to provide accurate calibration.

# HEATH company

BENTON HARBOR 20,  
MICHIGAN

## AUDIO—HIGH FIDELITY

mic, Crystal, Dynamic, Strain and Variable-reluctance pickup.)

### Ceramic pickup

A pickup cartridge using the piezoelectric properties of a ceramic material such as barium titanate. The stylus movement applies a twisting motion to the ceramic element which translates this motion to a corresponding voltage variation. Ceramic pickups are practically unaffected by temperature and humidity.

### Chip

The thread of material cut out of a disc by the stylus during recording.

### Coaxial loudspeaker

Two loudspeakers mounted on the same longitudinal axis, usually one within the other. One of these speakers is smaller and is designed to reproduce the higher audio frequencies.

### Compression

A type of nonlinearity intentionally introduced into a recording. The high-amplitude portions of the signal are reduced prior to recording and the low-amplitude portions are increased. This technique prevents high-amplitude signals from causing the stylus to cut into adjacent grooves, and prevents the signal-to-noise ratio from becoming excessively small during low-amplitude portions of the signal. (Not generally used in present-day high-fidelity recording.) The playback amplifier must be so designed that its gain will vary directly with the amplitude of the signal, or the loudness range will be smaller than that of the sound recorded (loud sounds will be quieter than they should be and quiet sounds louder). This type of compensation is known as volume expansion.

### Cone resonance

The increased response of a loudspeaker at the natural frequency of vibration of its cone. This frequency is determined by such factors as cone size, shape, suspension, etc. and produces a peak in the response curve of the loudspeaker. In some cases this peak can be used to fill in a hole or low spot in the response of associated equipment.

### Conical horn

A loudspeaker horn whose flare or taper is such that its cross-sectional area increases as the square of the distance from the throat.

### Constant-amplitude recording

A disc recording technique in which, for equal signal voltages, the lateral

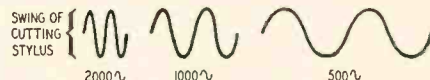

Fig. 3—Constant-amplitude recording.

movement of the cutting stylus will be equal for all recorded frequencies (Fig. 3).

TO BE CONTINUED

# Heathkit TUBE CHECKER KIT

The Heathkit TC-2 Tube Checker was primarily designed for the convenience of radio and TV servicemen and will check the operating quality of tubes commonly encountered in this type of work. Test set-up procedure is simplified, rapid, and flexible. Panel sockets accommodate 4, 5, 6, and 7 pin tubes, octal and loctal, 7 and 9 pin miniatures, 5 pin Hytron, and a blank socket for new tubes. Built-in neon short indicator, individual 3-position lever switch for each tube element, spring return test switch, 14 filament voltage ranges, and line-set control to compensate for supply voltage variations, all represent features of the TC-2.

Illuminated for easy reading and quick identification of chart

Simplified construction—new harness type wiring—closer tolerance resistors.

Smart, professional appearance—available in counter or portable models.

Three color Good—7-BAD 4 1/2" plastic cased meter.

Improved smooth running roll chart mechanical action.



**MODEL TC-2**  
**\$29.50**  
Shpg. Wt. 12 lbs.

## Heathkit PORTABLE TUBE CHECKER KIT

The portable model is supplied with a strikingly attractive two-tone cabinet finished in rich maroon proxylin impregnated fabric covering with a contrasting gray on the inside of the detachable cover.

**MODEL TC-2P**  
**\$34.50**  
Shpg. Wt. 15 lbs.



Results of tube tests are read directly from the large 4 1/2" Simpson 3-color meter. Checks emission, shorted elements, open elements, and continuity. Wiring procedure has been simplified through the use of multi-wired color coded cable providing a harness type installation between tube sockets and lever switches. This procedure insures standard assembly and imparts a "factory built" appearance to the instrument. New Construction Manual furnishes detailed information regarding tube set-up procedure for testing of new or unlisted tube types. No delay necessary for release of factory data.

## Heathkit REGULATED POWER SUPPLY KIT



**MODEL PS-2**  
**\$33.50** Shpg. Wt. 15 lbs.

Here is a source of regulated D.C. voltage for circuit development work. Power supply voltage and current drain to the circuit under test are constantly monitored by the 4 1/2" panel mounted meter. Separate 6.3 volt at 4 ampere A.C. filament source available. The regulated and variable output voltage will be constant over wide load variations, and hum ripple will not exceed .012% at 250 volts under a 50 MA load. Completely isolated circuit, standby switch, and other desirable features, make the Model PS-2 extremely useful in a wide variety of applications.

## Heathkit TV PICTURE TUBE TEST ADAPTER

The Heathkit TV Picture Tube Test Adapter used with the Heathkit Tube Checker Kit, will quickly check picture tubes for emission, shorts, etc. and determine tube quality. Consists of standard 12-pin TV tube socket, four feet of cable, octal socket connector, and data sheet.



**No. 355**  
**\$4.50** Shpg. Wt. 1 lb.

## Heathkit DECADE RESISTANCE KIT



**MODEL DR-1**  
**\$19.50**  
Shpg. Wt. 4 lbs.

Twenty 1% resistors are decoded in 1 ohm steps to provide any value between 1 ohm and 99,999 ohms. Sturdy ceramic switches with silver plated contacts insure reliable service. Use the Decade Resistance in bridge circuits, meter multipliers, calibrations, or any application requiring a wide range of precision resistance values.

## Heathkit AUDIO GENERATOR KIT

Here is an Audio Generator with features generally found only in the most expensive instruments. Sine wave coverage from 20 cycles to 1 Megacycle—response flat  $\pm 1$  db from 20 cycles to 400 Kc—continuously variable and step attenuated output. Because the output voltage is relatively constant over wide frequency ranges, the AG-8 is ideal for running frequency response curves in audio circuits. Once set by means of the attenuator, this voltage may be relied upon for accuracy within  $\pm 1$  db. Instrument features low impedance 600 ohm output circuit and distortion less than .4 of 1% from 100 CPS through audible range.



**MODEL AG-8**  
**\$29.50**  
Shpg. Wt. 11 lbs.

## Heathkit DECADE CONDENSER KIT

The Heathkit Decade Condenser provides a ready source of capacity values from 100 mmf to .111 mfd inclusive in capacity steps of 100 mmf. Silver plated contacts on husky ceramic switches, assure positive contact for each switch position. Precision silver mica condensers  $\pm 1\%$  accuracy for close tolerance accurate work.

**MODEL EC-1**  
**\$16.50**  
Shpg. Wt. 3 lbs.



**HEATH company**  
BENTON HARBOR 20,  
MICHIGAN

# NEW *Heathkit* HIGH FIDELITY PREAMPLIFIER KIT

Here is the exciting new Heathkit Preamplifier with all of the features you Audiophiles have asked for and at a down-to-earth price level. Beautiful satin gold baked enamel finish, striking control knobs and arrangement, attractive custom appearance and entirely functional design.

### DESIGN:

Uses three twin triode tubes in a shock mounted chassis, 2-12AX7 and 1-12AU7. Features tube shielding, plastic sealed color coded capacitors, smooth acting controls, good filtering, excellent decoupling, low hum and noise level, and all aluminum cabinet. Special balancing control for absolute minimum hum level. Cathode follower, low impedance output circuit for complete installation flexibility.

### SPECIFICATIONS:

Provides five switch selected inputs, 3 high level, and two low level, each with individual level controls—4 position LP, RIAA, AES, and early 78 equalization switch—4 position roll-off switch, 8, 12, 16 with one flat position. Separate tone controls, bass 18 db boost and 12 db cut at 50 CPS, treble 15 db boost, and 20 db cut at 15,000 CPS. Power re-

Equalization for LP, RIAA, AES, and early 78.

Separate bass and treble tone controls—special hum



Cathode follower low impedance output circuit.

Beautiful, modern appearance, blends with any interior or color scheme.

Five switch selected inputs with individual level controls.

quirements from Heathkit Williamson Type Amplifier power supply 6.3 volts AC at 1 ampere, and 300 volts DC at 10 MA. Over-all dimensions 12 3/8" wide x 5 1/2" deep x 3 3/8" high.

### APPLICATION:

The new Heathkit WA-P2 Preamplifier has been designed to operate with any of the Heathkit Williamson Type Amplifiers and is directly interchangeable with the previous Model WA-P1 Preamplifier unit. Order your kit today and enjoy completely smooth control over the operation of your Hi-Fi system. Obtain the exact tonal balance of bass and treble with the precise degree of equalization you want. Note that the design of the WA-P2 accommodates the newly established RIAA curve.

MODEL WA-P2

**\$19<sup>75</sup>**

Shpg. Wt. 7 lbs.

## HAM EQUIPMENT

Single knob band switching—pre-wound coils.



Crystal or VFO excitation—metered operation.

52 Ohm coaxial output—built-in power supply.

MODEL AT-1

**\$29<sup>50</sup>**

Shpg. Wt. 16 lbs.

filter, good shielding and a 52 ohm coaxial output. The 425 volt, 100 milliampere power supply and 5U4 rectifier are more than adequate for the 6AG7 oscillator multiplier and 6L6 amplifier doubler.

*Heathkit*

AMATEUR

### TRANSMITTER KIT

The Heathkit AT-1 Transmitter has established a high reputation and has been enthusiastically accepted by hundreds of experienced operators as well as beginners. Power input up to 35 watts for the novice and suitable as a standby exciter for your higher powered rig later on.

Model AT-1 can be crystal or VFO excited and operates on 80, 40, 20, 15, 11 and 10 meters. The pre-wound coils with the oscillator and amplifier are switched simultaneously by the rugged band switch. Meter switch allows a reading of the final grid and plate current on the panel mounted meter. Modulator input and VFO power sockets are provided as well as a key jack for CW operation. Other features include a crystal socket, standby switch, key click filter, AC line filter, good shielding and a 52 ohm coaxial output. The 425 volt, 100 milliampere power supply and 5U4 rectifier are more than adequate for the 6AG7 oscillator multiplier and 6L6 amplifier doubler.

Brand NEW

### HEATHKIT VFO KIT

The new Heathkit VFO is the perfect companion to the Heathkit Model AT-1 Transmitter and it has sufficient output to drive any multi-stage transmitter of modern design. Good mechanical and electrical design insures operating stability. Coils are wound on stable, heavy duty, ceramic forms using Litz or double cellulose wire coated with Polystyrene cement and baked for humidity protection. Variable capacitor of differential type construction, especially designed for maximum handsread. Kit is furnished with a carefully precalibrated scale which provides well over two feet of scale length. Smooth acting vernier reduction drive and illuminated dial provides easy tuning and zero beating.

Power requirements 6.3 volts AC at .45 amperes, and 250 volts DC at 15 mls. Just plug it into the power receptacle provided on the rear of the AT-1 Transmitter. Seven band coverage 160 through 10 meters with 10 volt average RF output. Uses 6AU6 electron coupled Clapp oscillator and OA2 voltage regulator.

Copper plated chassis—aluminum cabinet—easy to build.



Smooth acting illuminated and precalibrated dial.

Seven band coverage 160 through 10 meters at 10 volt RF output.

6AU6 electron coupled Clapp oscillator and OA2 voltage regulator.

MODEL VF-1

**\$19<sup>50</sup>**

Shpg. Wt. 7 lbs.

*Heathkit*

### GRID DIP METER KIT

The invaluable instrument for Hams, servicemen and experimenters. Useful in TV service work, for alignment of traps, filters, 1F stages, peaking compensation networks, etc. Locates spurious oscillation, provides a relative indication of power in transmitter stages. Use it for neutralization, locating parasites, correcting TVI, measuring CL and Q of components, and determining RF circuit resonant frequencies. The variable meter sensitivity control, headphone jack, 500 microampere Simpson meter, continuous frequency coverage from 2 MC to 250 MC. Prewound coil kit and rack included.

### LOW FREQUENCY COILS:

Low frequency range extended to 355 KC by the use of two additional coils. Complete with dial correlation curves. Set 341-A for GD-1B and set 341 for GD-1A. Shpg. wt. 1 lb. Price \$3.00



MODEL GD-1B

**\$19<sup>50</sup>**

Shpg. Wt. 4 lbs.

*Heathkit* ANTENNA

### IMPEDANCE METER KIT

MODEL AM-1

**\$14<sup>50</sup>**

Shpg. Wt. 2 lbs.

Determine antenna resonance and resistance, transmission line surge impedance, and receiver input impedance. Works with one-half and one-quarter wave lines, half wave and folded dipoles, harmonic mobile and beam antennas. Resistance type SWR bridge—100 microampere meter—frequency range 0-150 MC—impedance range 0-600 ohms.



MODEL AC-1

**\$14<sup>50</sup>**

Shpg. Wt. 4 lbs.

*Heathkit*

### ANTENNA COUPLER KIT

For the Heathkit AT-1 Transmitter or any comparable Amateur Transmitter. Will handle power up to 75 watts at its 52 ohm coaxial input. Matches a wide range of antenna impedances with its L type tuning network and neon indicator. A tapped inductance provides coarse adjustment and a transmitting type variable condenser sets it "right on the nose." Will operate on the 10 through 80 meter bands.

**HEATH** company

BENTON HARBOR 20,  
MICHIGAN

*New* **LOW PRICED**  
**HEATHKIT SINGLE UNIT**  
 Williamson Type *High Fidelity*  
**AMPLIFIER KIT**

Here is the newest Heathkit Hi-Fi Amplifier at the lowest price ever quoted for a complete Williamson Type Amplifier circuit. The W-4 Model has been designed for single chassis construction, and only for the new Chicago Transformer Company Model BO-13 "super range" high fidelity output transformer. This transformer, a new development in the Hi-Fi field, is being offered at substantial saving over transformers of comparable quality. It is outstanding in performance and on the basis of our tests, we find it equal in every respect to transformers used in the W-2 and W-3 Heathkit series.

**LOW PRICES:**

Through utilization of a single chassis with resultant economy obtained through elimination of duplicate sheet metal fabrication, connecting cables, plugs, sockets, and a new Chicago "super range" output transformer, a 20% price reduction has been made possible without sacrificing kit quality.

**COMPONENTS:**

The new Heathkit W-4 uses the same heavy duty power transformer and choke. It has all of the features of previous models including individual jacks and a wire wound control to balance the output tubes—plastic high quality capacitors and the exact circuitry previously utilized in Williamson Type Amplifiers. Intermodulation distortion and harmonic distortion are both at the same low level as in the W-2 and W-3 models.

**CONSTRUCTION:**

Here is the opportunity for even the economy minded Hi-Fi enthusiast to enjoy all of the advantages offered through Hi-Fi reproduction of fine recorded music. Simplified step-by-step Construction Manual completely eliminates necessity of electronic knowledge or special equipment. Assemble this Amplifier in a few pleasant hours.

Rugged, heavy duty, single chassis construction.

Output Impedances 4, 8, and 16 ohms.

Standard brand components used, no sacrifice of quality.



Lowest price high quality Williamson Type Amplifier ever offered.

Send for free booklet "High Fidelity Especially For You."

**COMBINATIONS AVAILABLE**

W-4M with Chicago "super-range" transformer only. Single chassis main amplifier and power supply. Shipping weight 28 lbs. Express only **\$39.75**

COMBINATION W-4 with Chicago "super-range" transformer only includes single chassis main amplifier and power supply with WA-P2 preamplifier kit. Shpg. wt. 35 lbs. Express only **\$59.50**

**NEW Heathkit 20 WATT**  
**High Fidelity AMPLIFIER KIT**

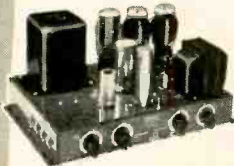

MODEL A-9B

**\$35<sup>50</sup>**

Shpg. Wt. 24 lbs.

In keeping with the progressive policy of the Heath Company, further improvement has been made in the already famous Heathkit High Fidelity 20 Watt Amplifier. Additional reserve power has been obtained by using a heavier power transformer. A new output transformer designed and manufactured especially for the Heath Company, now provides output impedances of 4, 8, 16 and 500 ohms. The harmonic distortion level will not exceed 1% at the rated output.

**FEATURES:**

Outstanding features of the Heathkit 20 watt Amplifier include frequency response of  $\pm 1$  db from 20 CPS to 20 KC. Separate (boost and cut) bass and treble tone controls. Four switch selected input jacks and a special hum balancing control. Flexibility is emphasized in the input circuits and proper equalization for all input devices is incorporated.

**TUBE LINEUP:**

12AX7 magnetic preamplifier and first audio amplifier. 12AU7 two stage amplifier with tone controls. 12AU7 voltage amplifier and phase splitter. Two 6L6 push-pull beam power output and 5U4G rectifier. The Heathkit Model A-9B is excellent for custom installation and is designed for outstanding service at a very reasonable cost.

**Heathkit SIX WATT**  
**AMPLIFIER KIT**



MODEL A-7B

**\$15<sup>50</sup>**

Shpg. Wt. 10 lbs.

An outstanding value, this economically priced 5 watt Amplifier is capable of performance expected only in much more expensive units. Only 2 or 3 watts output will ever be used in normal home applications and Model A-7B will be more than adequate for this purpose.

**SPECIFICATIONS:**

Two switch selected inputs are available for crystal and ceramic phono pickups, tuner, TV audio, tape recorder, and carbon type microphone. Model A-7B features separate bass and treble tone controls, push-pull balanced output stages, output impedances of 4, 8, and 15 ohms, and extremely wide frequency range  $\pm 1\frac{1}{2}$  db from 20 CPS to 20 KC. Not just a souped up AC-DC job. Full wave rectification, transformer operated power supply and good filtering, result in exceptionally low hum level.

**MODEL A-7C**

Provides a preamplifier stage and proper compensation for the variable reluctance cartridge and low level microphone. \$17.50

**Heathkit**  
**WILLIAMSON TYPE**  
**AMPLIFIER KIT**

Here is the famous kit form Williamson Type *high fidelity* Amplifier that has deservedly earned highest praise from every strata of Hi-Fi music lovers. Virtually distortionless, clean musical reproduction, full range frequency response, and more than adequate power reserve.

**OUTPUT TRANSFORMERS:**

This outstanding Williamson Type Hi-Fidelity Amplifier is supplied with the famous Aerosound TO-300 output transformer. This quality transformer features the popular "ultra-linear" output circuit for clean maximum power level. Separate chassis for amplifier and power supply.

**SPECIFICATIONS:**

Frequency response within 1 db from 10 cycles to 100,000 cycles. Harmonic distortion at 5 watt output less than .5% between 20 cycles and 20,000 cycles. IM distortion at 5 watts equivalent output .5% using 60 and 3,000 cycles. Output impedances of 4, 8, or 16 ohms. Overall dimensions for each unit 7" high x 5 $\frac{1}{2}$ " wide x 11 $\frac{1}{2}$ " long.

**CONSTRUCTION MANUAL:**

This fine kit is supplied with a completely detailed step-by-step Construction Manual and the only effort required is the assembly and wiring of the pre-engineered kit. Even the complete novice can successfully construct this Amplifier and have fun building it.

**COMBINATIONS AVAILABLE:**

W-3 Amplifier Kit (Includes Main Amplifier with Aerosound Output Transformer, Power Supply and WA-P2 Preamplifier.) Shipping weight 37 lbs. Shipped express only **\$69.50**

W-3M Amplifier Kit (Includes Main Amplifier with Aerosound Output Transformer and Power Supply.) Shipping weight 29 lbs. Express only **\$49.75**



**HEATH company**  
 BENTON HARBOR 20,  
 MICHIGAN



# FOR GOLDEN EARS ONLY

*The G-E Golden Treasure cartridge;  
RCA LC-1A and SL-12 loud-  
speakers; new records review*

By MONITOR

**W**HEN introduced just after the war, the General Electric cartridge created a revolution. It is still the workhorse of high-fidelity, and deserves its popularity. So far as I can determine there is no difference between the Golden Treasure and the cheaper standard cartridge. It comes equipped with one or two diamond instead of sapphire needles. The needle mount is the new double-twist type with six damping elements.

Fig. 1 shows the response curve of the cartridge with the 1-mil needle to the Cook series 10LP test record with a 100,000-ohm load into a preamplifier flat within 1 db from 20 to 20,000 cycles.

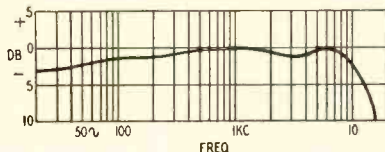

Fig. 1—Response of the G-E cartridge.

As the curve shows, the maximum departure is -2.5 db at 10,000 cycles and +3 db at 20 cycles and within 1.5 db between 100 and 9,000 cycles. Some of the departure is due to the test record and some to the preamp. I have obtained a similar slope beyond 10 kc with every G-E cartridge I have ever used.

Now this is very good indeed, particularly the absence of any peaks, and the slope beyond 10 kc is not as serious for most uses as it might appear. It takes a very sharp ear to discern the difference between the G-E with its slope and the Ferranti with its flat response to 20,000 cycles, and the difference is revealed not so much in direct loss of highs as in better definition and transient response. Part of the loss can be compensated for by placing a series resistance of about 500,000 ohms in the output of the preamp and shunting this resistance with a capacitor of between 50 and 500  $\mu\text{f}$ . The capacitor should be chosen by trial and error to produce the flattest curve beyond 10 kc without producing a peak or rising

slope below 10 kc. By careful choice, it is possible to obtain a considerable improvement beyond 10 kc in this way. This method does produce reduced output below 10 kc but usually this loss is not important.

Hum pickup is sometimes a problem with the G-E cartridge as it is with all high-impedance low-level cartridges. The Baton pickup arm minimizes this. It has a twisted-pair cable running through the tube of the arm to the base, producing shielding with low capacitance. If a shielded lead is run from the base to the preamp and is well oriented, over-all hum is low enough to be completely tolerable.

In any case, the G-E cartridge produces excellent quality and, purely from a listening point of view, is pretty hard to beat when all things, including price, are considered.

### RCA LC-1A and SL-12 loudspeakers

Dr. H. F. Olson of RCA has designed a series of interesting loudspeakers culminating in the LC-1A and the inexpensive SL series. The LC-1A (see photo) has found considerable use in broadcasting and recording studios as a monitor, but its high price has limited its use in home systems and relatively few audiophiles have had an opportunity to hear it. I was, therefore, very pleased when RCA made one available to me for testing.

In designing this series of speakers Dr. Olson has been less concerned with obtaining an extreme bandwidth than reducing distortion, producing a smooth response curve and obtaining a wide and more or less uniform angle of dispersion throughout the frequency range covered. The curves of Figs. 2, 3, 4, supplied by RCA with the speaker, indicate the degree to which these ideals have been approximated. I have no accurate way of checking them, but my tests, by instruments and ears, give me no reason to doubt or question them.

The response curve is unusually smooth for a loudspeaker, particularly in that it is remarkably free of steep peaks or dips. The distortion at any

normal home listening level is well under 2% down to 60 cycles. The directional characteristics are extremely uniform to 7,000 cycles; above that the loss at wide angles off center is very slight.

The response at the high end falls off steeply beyond around 13,000 cycles and cuts off at around 17,000. The resonance in free space of the speaker I tested was around 45 cycles. In the Karlson enclosure the speaker produced a response with a very large component of fundamental down to 20 cycles. In a wall type infinite baffle the response was smooth to 35 cycles and sloped severely below that, cutting off at around 30 cycles.

Personal taste, prejudice and preference play a larger part in judging loudspeakers than any other portion of a hi-fi system. Moreover, loudspeakers are musical instruments in effect and almost all have a distinctive personal

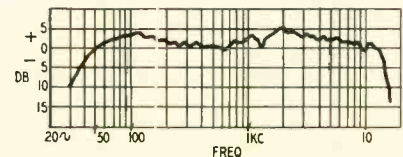

Fig. 2—Response of the LC-1A speaker.

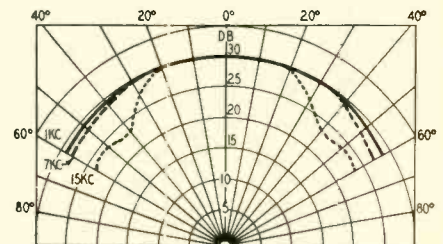

Fig. 3—LC-1A directional response.

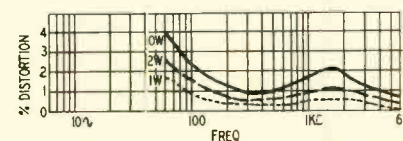

Fig. 4—LC-1A harmonic distortion.

## AUDIO—HIGH FIDELITY



The LC-1A duo-cone hi-fi loudspeaker.



SL-12 extended-range 12-inch speaker.

character and color. There is plenty of room for differences of opinion in judging them and it is dangerous to make categorical statements. Keeping all this in mind, I liked the sound produced by the LC-1A very much indeed. It was very clean, very smooth and personally I thought the balance between highs and lows and mid-range very fine, although it is possible that people accustomed to exaggerated highs or a higher proportion of distortion in the high end may think it is somewhat lacking in high-highs.

It also seemed to me that the LC-1A added less of its own character to the over-all sound than most speakers, and that it reproduced the most subtle differences between various amplifiers, pickups and recordings more clearly than most speakers. Some, no doubt, will like it more or less than others, but I think there is no doubt it is a great speaker and deserves its reputation.

The characteristics are the result of some very novel design features. The LC-1A is a duo-cone speaker. Both cones are independent and the crossover is electrical. A real novelty is that the bass voice coil is used as the inductance in the crossover network. This requires a bigger and heavier voice coil than usual but the increased mass does not appear, to my ears, to have any significant effect on the audible performance. The transient response is very fine at all frequencies.

Another novelty is the use of a foam-rubber ring as a damping element on the outer edge of the cone. "This," to quote the specifications, "prevents reflections from the outer cone housing from combining with directly radiated sound to produce dips and peaks in the response." The smooth response curve appears to testify to its effectiveness.

Even more novel and certainly the most striking thing about this speaker are the "acoustic domes" cemented to the cone. Their purpose is to break up the symmetry of the cone at higher

frequencies, minimize resonance and force the cone to act as a single stiff piston at low frequencies. Again, the smooth response seems to testify to the effectiveness of this novelty. Butterfly dispersing vanes are used on the high-frequency cone to obtain a wide angle of distribution, minimizing the hole-in-the-wall effect of sharply directive tweeters.

The LC-1A is supposed to be somewhat less efficient than comparable speakers of other makes. But I did not notice any difference and I found that the speaker will deliver all the volume any household can stand with less than 1 watt of electrical input and normal living room volume on less than 50 milliwatts. A commendable feature is that the LC-1A can be serviced, adjusted and repaired by a competent technician according to simple instructions which accompany the speaker.

The inexpensive SL-12 (see photo) which I was also able to test resembles the LC-1A only in the use of the foam-rubber damping ring. It is a single-cone radiator of conventional design. The speaker had a resonance of about 75 cycles. In the Karlson enclosure it produced excellent response down to around 35 cycles; in the infinite baffle, there was a severe slope below 50 cycles. To my ears the response seemed to slope upward at the high end, and cutoff occurred somewhere between 14,000 and 16,000 cycles. The reproduction is not in the same class as that of the LC-1A, but I found it excellent and entirely pleasing. The transient response was very good and, though as I have noted the high-highs seemed somewhat pre-emphasized as compared with the LC-1A, I found the response at normal listening levels smooth and the distortion commendably low. It offers a lot of quality and fidelity for its price.

### New records

**TCHAIKOVSKY: *Symphony No. 5***

Stokowski and His Orchestra

RCA Victor LM 1780

**RICHARD STRAUSS: *Don Quixote***

Munch and Boston Symphony

RCA Victor LM 1781

Of these two discs, the Strauss is by far the more spectacular principally because the music offers more opportunity for hi-fi effects. Though the high-highs are not as magnificent as in some competing discs, they are very sharp and clean except in the crescendos where some distortion is audible. The balance between highs and lows seems quite natural. The solo cello passages are extremely good and the pizzicato measures are most natural. The definition is very fine and the over-all sound is stunning. The record would, therefore, make an excellent showoff or demonstration selection.

The Tchaikovsky at first sounds dull in contrast but this is because the music itself is more mellow and offers few openings for the high-highs to sparkle. The most encouraging thing to me was the quality of the bass on the first side.

The record has a fine rich sound which will be impressive to the layman who does not reject a record simply because it lacks spectacular highs. I can recommend it for demonstration and showoff in such cases. There is an amusing example of miking effects in the Third Movement when some kind of woodwind blows its nose right into one's face. The double basses on side A are notable in spots, particularly in the pizzicato passages. The highs are very clean and without any harsh sounds, though there are very few high-highs to demonstrate.

**MOZART: *Adagio and Rondo for Glass Harmonica* (K617)**

*Concerto for Flute and Harp* (K299)

*Audante for Flute and Orchestra* (K315)

Pro Musica Chamber Orchestra of Vienna  
Vox PL 8550

For years I have been looking for a record capable of offering a conclusive test for the masking effects of rumble, hum and other noises. This is very important because the dynamic range of a playback system is principally limited, not by its ability to reproduce the peaks, but its ability to reproduce perfectly the softest pianissimo passages. There are all sorts of records with very pianissimo passages, but they don't offer a clear and conclusive test. Here at last in the *Adagio and Rondo* is the perfect record for this purpose.

This was written originally for Ben Franklin's glass harmonica but since none are now in existence it is played here by the celeste. The celeste is an instrument of very low power output and high noise level—that is, the volume of the musical tones is so soft that the noises produced by the keys, hammers, fingers, etc., are clearly audible at close range. These noises are faithfully reproduced on this record even in the softest passages. The test, therefore, is very simple and foolproof: at the volume level normal for average listening in a specific room, all the noises should be completely audible without straining the ears or shoving the head into the speakers. With the best of today's turntables, pickups, pre-amps, etc., they will be; but any significant hum, rumble, hiss or scratch will mask the noises seriously. Aside from this specific quality, this is a wonderful disc for demonstrating the high end. The tones of the celeste are beautifully clear and clean, and the music is so lovely that it is likely to produce a favorable reaction in all listeners.

**Soft Light Music: *The Club Orchestra***  
Vox VX 580 (10 inch)

Here is a recording of popular music nearly on a par in hi-fi quality with symphonic works. The music is typical supper music. It involves strings, electronic organ, guitar, harp and percussives. The high-highs of the brushed cymbals are nicely prominent, the bass good though not sensational, the balance excellent. There is enough room res-



## AUDIO—HIGH FIDELITY

onance to produce an intimate effect of presence. There are only slight touches of distortion in the peaks. The record should make any system sound good to those who prefer popular music.

**Echoes of Broadway: George Feyer,**  
piano with rhythm accompaniment  
Vox VX 650 (10-inch)

Though not as varied in the quality of the sound as *Soft Light Music*, this will also make a good showoff record. Nor are the high-highs as prominent, but the piano is excellent. Again a slight touch of distortion on the peaks, but far superior to the average pops.

**Millstein Recital: Improvisations on**  
and excerpts from violin works of  
Pergolesi, Schumann, Brahms, Suk,  
Bloch and Paganini.

Nathan Millstein with piano accompaniment.  
Capitol 8259

The violin can sound more spectacularly natural and present on a fine system than any other instrument. This recording is exceptional in this respect and offers, in addition, some really remarkable fiddling by one of the great virtuosi of the day. On the best systems Millstein will appear to be in the same room. The tone and subtle coloration of the violin, as well as the very wide range of tone coloring of which it is capable in fine hands, are very well recorded. The odd harmonics are the dominant ones in the violin and the rather rough, biting quality which this imparts to the violin comes through with great naturalness. The definition is excellent and the violinists and critics who listen to this will clearly appreciate the wizardry of Millstein's playing for the simple reason that even the most complex effects are clearly audible.

**HARL MacDONALD: Suite from Childhood**

**ANDRE CAPLET: The Red Mask of Death**

Anne Mason Stockton, harp, and Concert Arts Orchestra  
Capitol 8255

Pleasant and, in portions, brilliant music for showoff, particularly on the MacDonald side which is based on familiar childhood tunes. Both sides present a very fine recording of the harp, full of nice transients. The pianissimo passages are good for checking hum and rumble.

**BARTOK: Piano Concerto No. 3**

**PROKOFIEFF: Piano Concerto No. 3**  
Leonard Pennario and St. Louis Symphony  
Capitol 8253

The music will interest the most advanced listeners most; but portions of this are notable for hi-fi quality. The opening of the Bartok, for example, has some excellent double bass. The piano tone is fine and very individual in its dryness. Occasional bursts of triangles and sharply muted brasses establish high-frequency response. The polyphonic writing provides good measures for definition. Over-all sound is very impressive and the recording is very clean. END

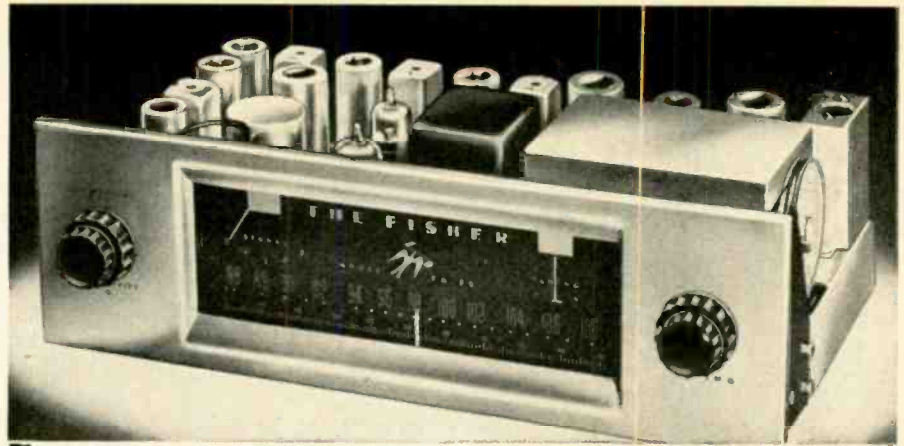

# It's New! It's Terrific!

## THE FISHER FM TUNER

MODEL FM-80

NEVER before in the history of Frequency Modulation has there been a tuner to match the remarkable, new FISHER FM-80. Equipped with TWO meters, it will outperform any existing FM tuner, *regardless of price!* The FM-80 combines extreme sensitivity, flexibility, and micro-accurate tuning. It has an unusually *compact*, beautifully designed chassis. Like its renowned companions, the FISHER FM-AM Tuners, Models 50-R and 70-RT, we predict the FM-80 will be widely imitated, but never equalled. Be sure; buy THE FISHER. **Only \$139.50**

### Outstanding Features of THE FISHER FM-80

- TWO meters; one to indicate sensitivity, one to indicate center-of-channel for micro-accurate tuning. • Armstrong system, with two JF stages, dual limiters and a cascade RF stage. • Full limiting even on signals as weak as one microvolt. • Dual antenna inputs: 72 ohms and 300 ohms balanced. • Sensitivity: 1½ microvolts for 20 db of quieting on 72-ohm antenna input; 3 microvolts for 20 db of quieting on 300-ohm antenna input. • Chassis *completely* shielded and shock-mounted, with full shielding of tuning condenser to eliminate microphonics, and noise from otherwise accumulated dust. • Three controls — Variable AFC/Line-Switch, Sensitivity, and Station Selector PLUS an exclusive Output Level Control. • Two bridged outputs; low-impedance, cathode-follower type, permitting output leads up to 200 feet. • 11 tubes. • Dipole antenna supplied. Beautiful, brushed-brass front panel. • Self-powered. • WGT: 15 pounds. • SIZE: 12¾" wide, 4" high, 8½" deep including control knobs.

*Price Slightly Higher West of the Rockies*

WRITE TODAY FOR COMPLETE SPECIFICATIONS

FISHER RADIO CORP. • 21-29 44th DRIVE • L. I. CITY 1, N. Y.

# One modern picture tube overshadows all others!

## THE SYLVANIA

# "Silver Screen 85"

**Acclaimed by service industry**—Dealers and servicemen everywhere acclaim the "Silver-Screen 85." Sylvania's revolutionary "Silver-Screen 85" is the *one* modern picture tube that overshadows all others.

**Super-performance plus**—Only Sylvania's "Silver-Screen 85" combines these three outstanding design advances: (1) Silver-activated screen (2) Super-aluminized reflector, and (3) Precision-focus electron gun. Together, they achieve a picture, so clear, so sharp, that only professional motion pictures can duplicate it.

**Overwhelming consumer reaction**—Already, TV set owners across the nation are asking for the Sylvania "Silver-Screen 85" by name. And the demand is pyramiding.



The "Silver-Screen 85" story is reaching millions of TV homes each week through Sylvania's top-rated TV show, "Beat the Clock."

**Silent salesmen work for TV service**—Thousands of the "Silver-Screen 85" consumer booklets are being read by TV set owners who have written to request them. An even greater number are requesting them

from progressive dealers and servicemen who display the Sylvania service sign. This is Sylvania's way of including you in its national advertising program. Leave a copy of the booklet on each new service call and experience the magic of national advertising right in your own business!



**Good way to build "good will"**—You can build customer confidence and repeat business by stocking and selling Sylvania's great "Silver-Screen 85" picture tube. You're assured of customer satisfaction because your customers are pre-sold on the "Silver-Screen 85." And Sylvania puts the name on the face for your double protection. "Silver-Screen 85" customers stay happy too, because they get better-than-ever performance from their old TV sets.

**A built-in profit bonus**—Every "Silver-Screen 85" you install means extra profit because you offer the finest performance money can buy. And there's a full line of "Silver-Screen 85" types in the most popular sizes. Start cashing in on America's demand for television's most modern picture tube. You just can't miss!

SYLVANIA ELECTRIC PRODUCTS INC.  
1740 Broadway, New York 19, N. Y.

In Canada: Sylvania Electric (Canada) Ltd.  
University Tower Bldg., St. Catherine Street  
Montreal, P. Q.

LIGHTING • RADIO • ELECTRONICS  
TELEVISION • ATOMIC ENERGY

A complete package of promotion aids for your use, including window display and streamers, postal cards, bill inserts, radio spot announcements, and TV films.



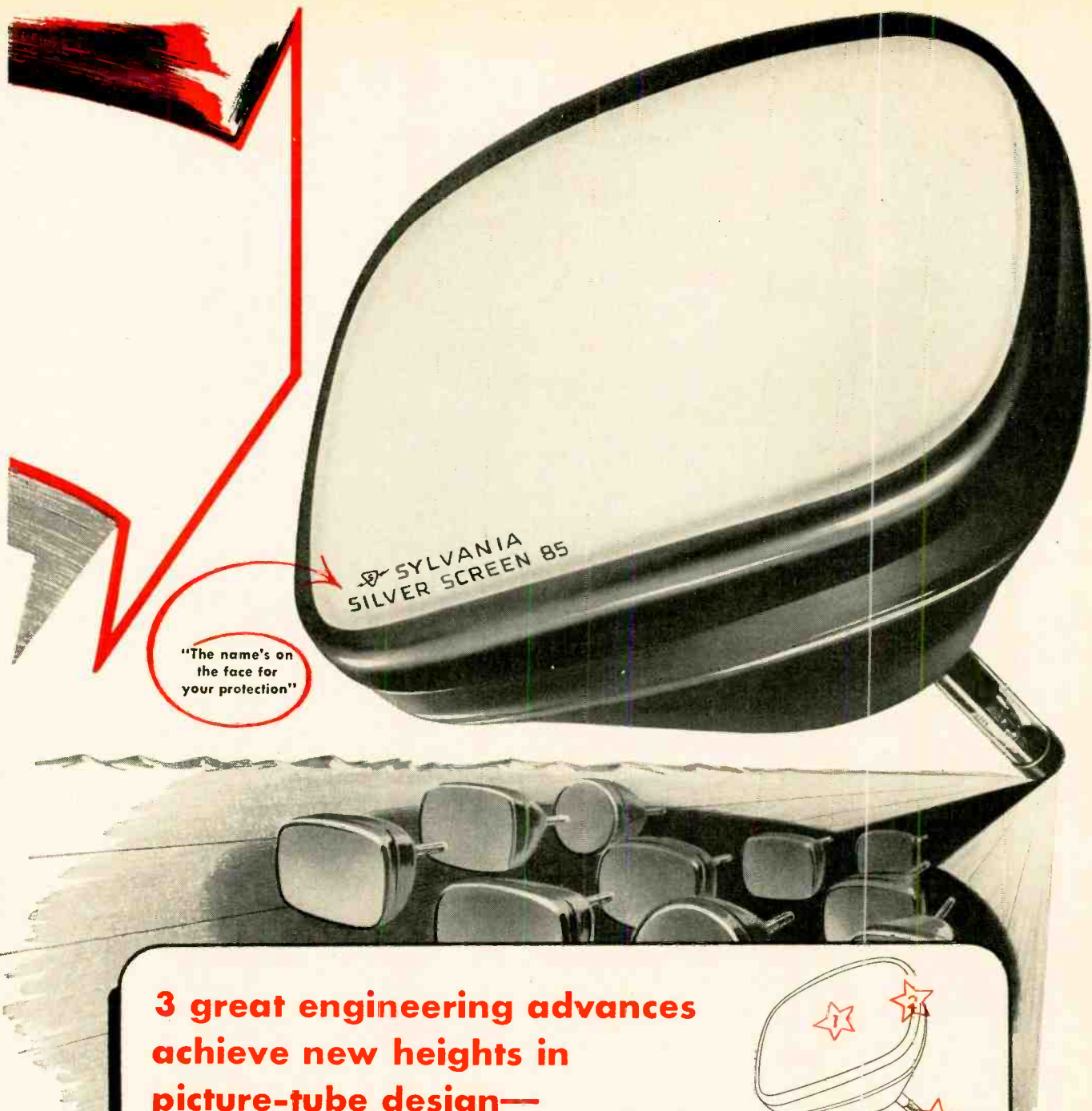

SYLVANIA  
SILVER SCREEN 85

"The name's on  
the face for  
your protection"

**3 great engineering advances  
achieve new heights in  
picture-tube design—**



**1 Silver activated  
screen**

—light-giving atoms of silver are added to Sylvania's special screen phosphors to produce a new level of picture contrast.



**2 The super-aluminized  
reflector**

—a microscopic film of aluminum behind the silver activated screen captures the extra brightness and makes it useful. Greater depth and contrast result.



**3 Precision-focus  
electron gun**

—the powerful electron beam in the "Silver-Screen 85" energizes the entire screen in pin-point detail to produce a new degree of all-over sharpness and clearness.

**Keep your eye on**

**SYLVANIA** 

**...fastest growing name in sight**



# 4 INPUT AMPLIFIER

*Low-distortion 16-watt amplifier features simple mixing system and monitored output*

By ALBERT STRATMOEN

ANYONE interested in constructing audio equipment will find this amplifier easy to build. It requires few shielded leads and a minimum of stages because of the mixing system used. Distortion is low, due partly to the inverter used and to the stabilizing of the output tubes' screen voltage. Also included are features that will appeal to professionals, such as a built-in output meter, headphone jack with volume control and plenty of output terminals.

For each input channel (see diagram) there is only one stage, a 6J7, whose gain is controlled by adjusting the cathode voltage. The plates of all four input tubes are connected together and the mixed output is fed to the second stage, a 6SJ7, through a volume control used as the master gain control. The 6SN7 phase inverter is conventional except for its adjustable feature and drives the 6L6 output tubes, delivering 16 watts in the voice coil at 0.7% distortion. A type 79 is used as a voltage stabilizer, controlling the screen voltage of the 6L6's and, to a

lesser degree, their cathode voltage. The 79 and 6Y7-G are not common types today but I used them because their high plate dissipation and amplification factors are ideally suited to the application. Other twin triodes such as the 6N7 and 6J6 are unsatisfactory in this particular amplifier circuit.

The most popular tubes for low-level audio work are probably 6J7's, usually operated with fixed bias. They are sharp cutoff tubes; but if the screen voltage is allowed to rise with increasing cathode voltage, they act like remote cutoff types. If only a series resistor were used, there would be almost no gain variation but in this circuit R3 permits it to rise only moderately. The change in bias is obtained from R2, some additional voltage being obtained from the plate supply through R4. The bias is prevented by R1 from becoming too low at maximum gain setting. Linear wirewound controls are used and the attenuation is more rapid at low settings, the rate of change becoming progressively less toward maximum gain. The scales for these controls are those furnished with Daven LA350 attenuators and are linear, so they are only approximately correct. Tapered carbon controls, such as IRC F taper, would provide a much more linear

attenuation.

Due to a peculiarity of pentode tubes (plate current is practically independent of the plate voltage), it is possible to use a common plate resistor, R5. The settings of the gain controls of all four input tubes affect the plate voltage, causing it to vary widely. This would cause serious interaction if the tubes were triodes, but with pentodes it is very slight. It could be eliminated entirely by using separate resistors and blocking capacitors for each channel. Because the plate resistance of pentodes

### Parts for four-input amplifier

- Resistors:** 1—560, 1—820, 4—1,000, 2—1,200, 1—10,000, 1—20,000, 2—47,000, 3—100,000, 2—150,000, 1—390,000, 1—470,000, 4—560,000, 4—1 megohm, 4—2.2 megohms, 1/2 watt; 1—120,000, 1 watt; 1—250, 1—5,000, 10 watts.
- Potentiometers:** 1—200, wirewound; 4—10,000, F taper; 2—10,000, wirewound; 1—150,000; 1—500,000, audio taper; 1—1 megohm, carbon.
- Capacitors:** 1—.002  $\mu$ f, 2—.004  $\mu$ f, 1—.01  $\mu$ f, 1—.05  $\mu$ f, 1—.1  $\mu$ f, 2—0.25  $\mu$ f, 600 volts, paper; 5—0.5  $\mu$ f, 400 volts, paper; 1—10  $\mu$ f, 1—20  $\mu$ f, 1—40  $\mu$ f, 1—125  $\mu$ f, 450 volts, electrolytic; 4—50  $\mu$ f, 25 volts, electrolytic; 1—100  $\mu$ f, 50 volts, electrolytic.
- Miscellaneous:** 4—6J7, 1—6SJ7, 1—6SN7-GT, 2—6L6-G, 1—5Z3, 1—79, tubes; 8—octal sockets; 1—4-prong socket; 1—6-prong socket; 4—grid shields; 4—small grid clips; 1—large grid clip; 1—power transformer, 700 volts c.t. @ 110 ma, 6.3 volts @ 4.5 amp, 5 volts @ 3 amp; 1—filter choke, 8 h @ 150 ma; 1—meter, 1 ma d.c.; 1—output transformer, primary 9,000 ohms c.t., secondary 4, 8, 16 ohms, potted (Acrosound TO-280); 1—2 feet of shielded grid wire; 1—IN34; 1—single-pole 3-position switch; 1—s.p.s.t. switch; 1—phone jack; 4—input jacks; 1—4-terminal barrier strip; 1—chassis

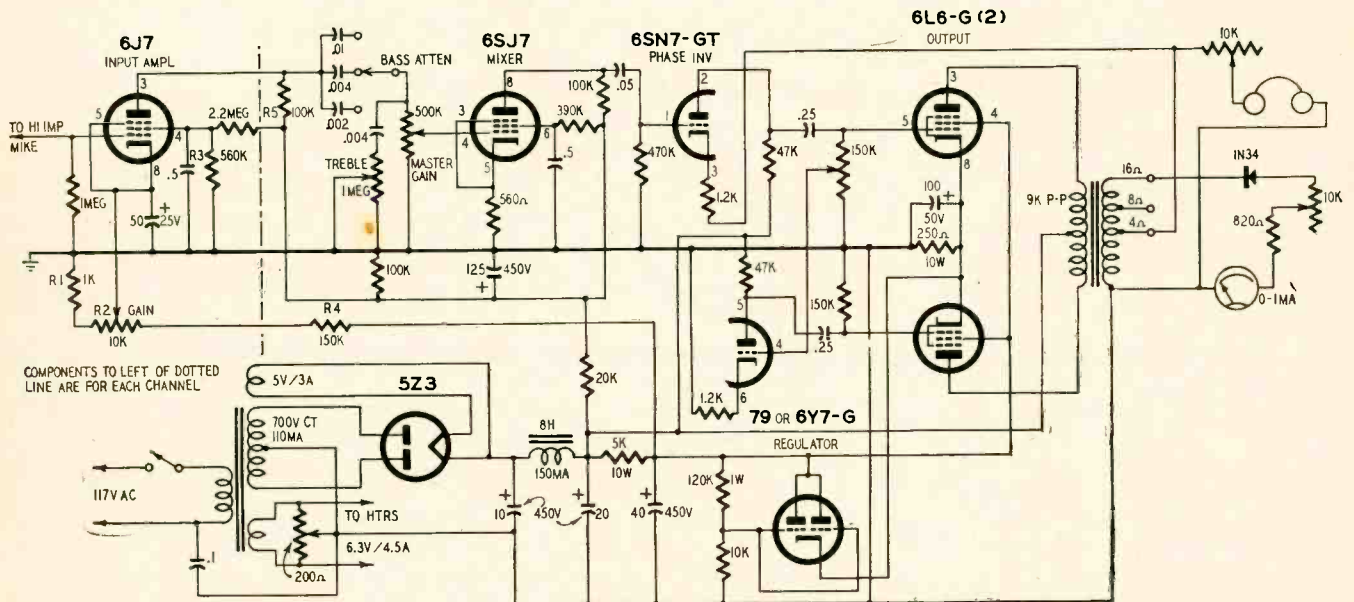

Schematic of four-input PA system. Diagram shows one of four identical input circuits.

is much greater than the recommended load resistance, one tube will not act as a load on another, and so the gain remains independent on the number of channels used.

The over-all sensitivity can be varied by changing the value of the common plate resistor. Using a 100,000-ohm resistor an input voltage of 4 mv drives the amplifier to full output—16 volts across a 16-ohm load. Increasing the resistance increases the sensitivity and vice versa. But it should not be made too low as the gain controls would lose their effectiveness. It is not necessary to make any changes in the cathode or screen circuits when changing sensitivity by this method.

This system of gain control lends itself to remote operation, and could be used in home music amplifiers. For best fidelity the gain variations in the first stage should be minimized, using the master control to set the approximate level. A 20-db range is permissible if the signal level is less than 15 mv. Large signals cause rectification at low gain settings and therefore harmonic distortion. If these suggestions are followed, the maximum increase in harmonic distortion will be about 0.25%.

The phase-inverter circuit used has been the target for a lot of adverse criticism, chiefly because it is not self-balancing. The balance depends on feeding just the right voltage to the second tube, and that depends on the ratio of the resistors in the grid circuit of the following stage. But even such circuits as the phase splitter do not insure perfect balance where it counts—in the plate circuit of the output tubes. Mismatched tubes or an imperfectly balanced output transformer would produce harmonic distortion. By making the inverted voltage variable, the disadvantage of this circuit becomes an advantage.

A low-distortion oscillator and a distortion meter are needed to adjust the inverter. These were scarce articles a few years ago, but since the FCC now requires yearly proof-of-performance tests by broadcast stations they have become plentiful. Radio engineers being a kindly lot, probably the local station will permit you to use its equipment. If not, set the resistance for about 17,000 ohms to ground and you will not be far off. A frequency of about 200 cycles is best as the balance changes with frequency and this value gives the best compromise. The distortion goes down to about 0.4% at the balance frequency but increases as the frequency is changed.

Top—Front view of the amplifier. Type 82 rectifier has been replaced by a 5Z3. Center—Rear view showing all major components. Two toggle switches and octal and Jones connectors are for dynamotor operation and are not discussed or shown in diagram.

Bottom—An underchassis view. Oil-filled capacitors on chassis coverplate parallel others to form some of the capacitance values specified on the schematic.

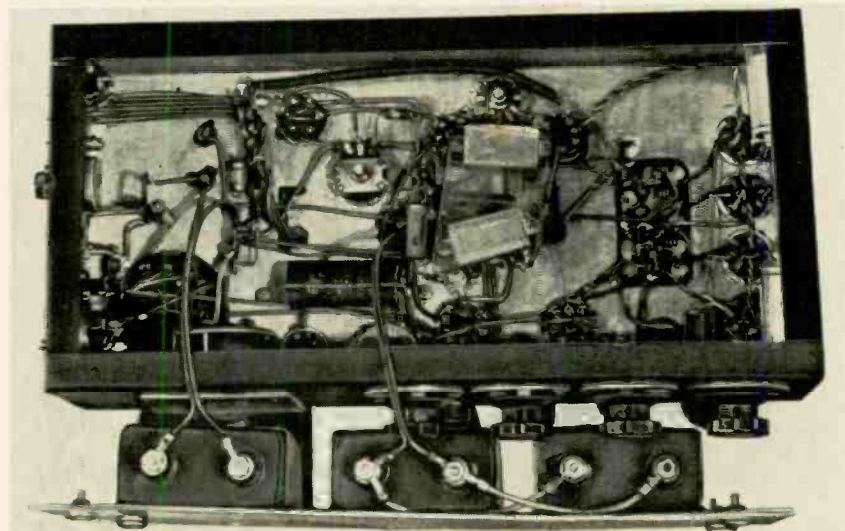
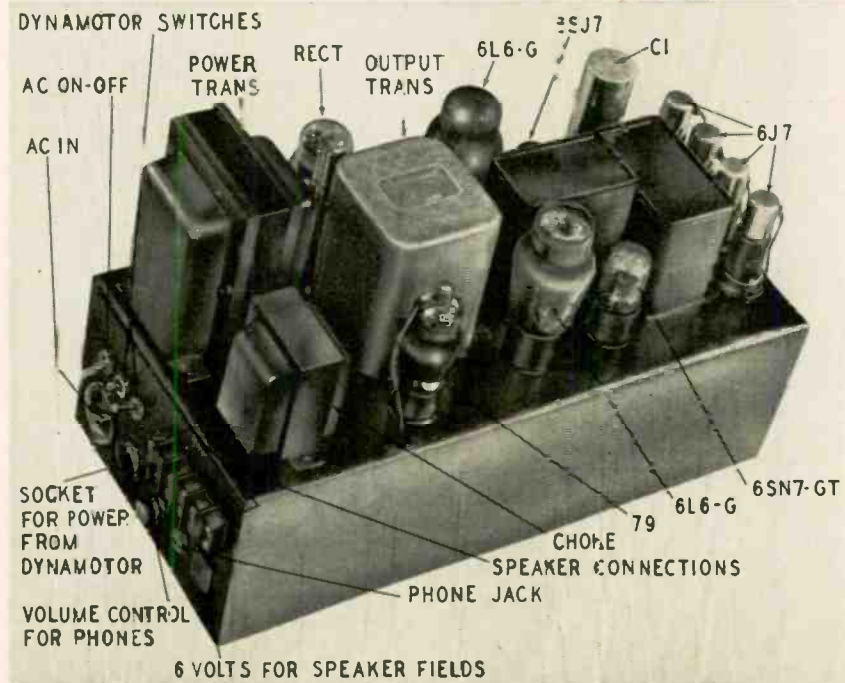

## AUDIO—HIGH FIDELITY

The type 79 stabilizer tube takes the place of two voltage-regulator tubes but has the disadvantage that it requires heater current. It cuts off at high signal levels though, so it is more economical as far as d.c. power is concerned. It is operated at about zero bias and draws 10 milliamperes at no signal. As the signal is increased the screen current of the 6L6's increases, resulting in lower screen voltage. This increases the bias on the 79 and its plate current falls, thus tending to keep the screen voltage constant. At the same time the cathode voltage of the 6L6's rises due to an increase in plate current. This also increases the bias on the 79 and thus stabilizes the screen voltage.

Because the increase in screen current comes from the plate current of the 79, the current through the cathode resistor is more nearly constant so some cathode voltage stabilization results too. The cutoff occurs at about 18 watts output; above this level no further regulation is possible. The effect of the stabilizer tube is to increase both gain and fidelity.

It is common practice to connect the chassis to both sides of the a.c. line through capacitors. This places the chassis midway between line voltage and ground. Less hum results if only one capacitor is used and the a.c. plug is inserted the way that causes the least hum.

The tone controls provide attenuation of either highs or lows or both. The bass attenuation is obtained by decreasing the size of the blocking capacitors. This method does not give continuous control but does produce a desirable attenuation curve. The smallest capacitor is for use with speakers having a high cutoff frequency or for setups where a high-pitched output helps to overcome noise. It is best to reduce the master gain when changing the bass response, otherwise a definite thud will be heard. (Resistors of several megohms from each of the switch contacts to chassis will minimize this condition.—*Editor*) To use the amplifier for high-quality music a fourth tap should be added with an .05- $\mu$ f capacitor. This will extend the response to much lower frequencies.

The potentiometer across the heater supply balances out hum. It should be adjusted with one channel and the master gain on full. If 6SJ7's are used, this adjustment is very necessary as these are inferior to 6J7's both as to hum and microphonics. It is necessary to use shields over the grid caps, especially if the amplifier is not shielded.

The output meter enables the operator to maintain a constant level. Thus the scale used isn't very important. The meter shown in the photo has two scales, one linear and the other calibrated in db. The db calibration is useful on a sound truck in areas having ordinances specifying the maximum audio level. Of course, the sound level would also depend on the efficiency of

Slender, modern dynamic at a fraction of the price you expect

ANOTHER TURNER

MICROPHONE VALUE

### TURNER MODEL 57 DYNAMIC

FOR BROADCAST, TV, PA  
Response: 50 - 13000 c.p.s.  
Level: -55 db

Impedance: wired for quick selection of either high or low.  
Cable: 20 ft. 3-conductor shielded with Cannon XL-4 quick-disconnect plug.

Case: black-satin finish. Can't reflect light.

Mounting: hinged coupler swings mike in 60° arc. Standard 3/8" - 27 thread.

Sharp, clear, clean-cut reproduction of voice and music. Quickly converts from desk to floor stand or hand use.

LIST PRICE: \$57.00  
Model BL-6 Shockmounted matching desk stand: \$7.50



THE  
**TURNER**  
COMPANY

933 17th St. NE, Cedar Rapids, Iowa

Canada: Canadian Marconi Co., Toronto, Ont. & Branches

Export: Ad Aurema, Inc., 89 Broad St., New York 4, N. Y.

## AUDELS TV-RADIO SERVICE LIBRARY

HERE IS LATE INFORMATION IN A HANDY FORM FOR RADIO AND TELEVISION REPAIRMEN, SERVICEMEN AND STUDENTS

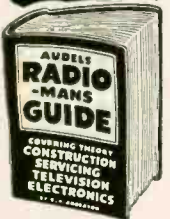

2 VOLS. 6 COMPLETE \$1 A. PAY ONLY 1 MO.

AUDELS T.V.-RADIO SERVICE LIBRARY—Highly Endorsed—1001 Facts—Over 1552 Pages—625 Illustrations, Diagrams of Parts. Presents Important Subjects of Modern Radio, Television, Industrial Electronics, F.M., Public Address Systems, Auto, Marine & Aircraft Radio, Phonograph Pick-Ups, etc.

### IT PAYS TO KNOW!

The Basic Principles—Construction—Installation—Operation—Repairs—Trouble Shooting. Shows How to get Sharp, Clear T.V. Pictures. Install Aerials—How to Test. Explains Color Systems, Methods of Conversion, Terms, etc. Includes Ultra High Frequency (U.H.F.)—Valuable for Quick Ready Reference & Home Study. Tells How to Solve T.V. & Radio Troubles—Answers Your Questions.

Get this Information for Yourself. 7 DAY TEST—ASK TO SEE IT!

### MAIL ORDER

AUDEL Publishers, 49 W. 23 St., N.Y. 10, N.Y.  
Mail AUDELS T.V. RADIO SERVICE LIBRARY 2 Vols. \$6 on 7 days free trial. If O. K. I will remit \$1 in 7 days and \$1 monthly until \$6 is paid. Otherwise I will return them.

Name \_\_\_\_\_  
Address \_\_\_\_\_  
Occupation \_\_\_\_\_  
Employed by \_\_\_\_\_ RE

## CLEAR TV PICTURE PERMANENT INSTALLATION—

WITH A



Permanent, one-man tower erection—fewer guy wires—no special tools. Offer better reception at lowest cost—eliminate mounting troubles and service calls.

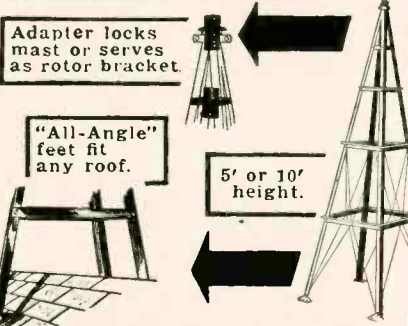

WRITE FOR FREE FOLDER TODAY!  
**WINPOWER**  
NEWTON, IOWA

## AUDIO—HIGH FIDELITY

the speakers. The meter is mounted on the inside of the chassis and a piece of plexiglas on the outside protects the glass.

Because oil capacitors are used, the chassis size (8 x 17 x 5 inches) is rather large. It is constructed of 20-gauge galvanized iron. Two oil capacitors were soldered on before it was painted. Because paint often does not adhere well to galvanized iron, other constructors may prefer using electrolytic capacitors and a smaller, standard-size chassis. The oil-capacitor block, obtained from a type C1 Autopilot amplifier, is very convenient to mount resistors on and reduces congestion around the front end of the chassis. The extra-large decoupling capacitor C1 costs only about a dollar more than a 40- $\mu$ f unit and greatly reduces hum. If you want to extend the low-frequency response, this capacitor will help prevent motorboating at extremely low frequencies. The Acrosound transformer seems to have a healthy output down to 2 or 3 cycles and it takes a large capacitor to be effective at that frequency.

The headphone circuit is intended for 500-ohm war-surplus phones. If high-impedance phones are used, it may be necessary to use a higher resistance control and to obtain the voltage from the 16-ohm tap.

Performance of the amplifier is good although the power output is a little low, perhaps because the output transformer is designed for fidelity rather than efficiency. Up to 16 watts the distortion does not exceed 0.7% from 50 to 7,500 cycles. At 20 watts, distortion is 5% or more; a relatively low percentage.

With all gain controls at minimum, the noise level is 70 db below 16 watts. With the master gain on full but all channels off, the level is 60 db down. With one channel wide open, it is 50 db. This is definitely audible but not annoying: it is a rushing sound originating in the grid resistor of the first stage. Any low-resistance input source, such as a dynamic microphone or a magnetic cartridge, would reduce this noise by shorting out the grid resistor. If a crystal pickup is used, it could be connected to the top of the master gain control. A more satisfactory method would be to use a voltage divider to cut its output to 6 or 8 millivolts and use it on one of the microphone channels.

Feedback howl is one of the sound man's greatest problems. The most important factor causing this is a peak in the response from microphone to room acoustics. A high-fidelity amplifier with a lot of feedback from the speaker voice coils will not only be peak-free itself but will correct the speakers, reducing their peaks. This will permit a higher usable sound output. Good-quality cardioid type microphones and careful speaker placement will complete a satisfactory sound installation. END

FEBRUARY, 1955

**OUTSTANDING for HIGH FIDELITY!**

BUY DIRECT  
AND SAVE

'PRE-FAB'

**COLLINS** TUNERS  
and  
RECEIVERS

AUDIO PRODUCTS CO.

NOW!  
with AFC

Collins Audio Products Co. is a member  
affiliated with Collins Radio Co.

Each Collins Tuner Kit is complete with punched chassis, tubes, power transformer, power supply components, hardware, dial assembly, tuning eye, knobs, wire, etc., as well as the completed sub-assemblies: FM tuning units, AM tuning units, IF amplifiers, etc., where applicable. All sub-assemblies wired and aligned at the factory make Collins Pre-Fab Kits easy to assemble even without technical knowledge. The end result is a fine, high quality, high fidelity instrument at often less than half the cost—because you helped make it and bought it direct from the factory.

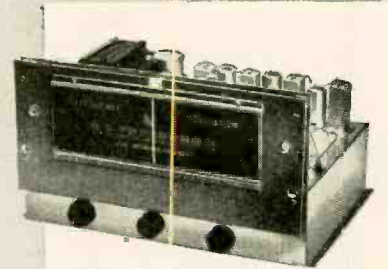

FM Tuner Kit

**\$55**

with AFC \$58.50

The FM-11 tuner is available in kit form with the IF Amplifier mounted in the chassis, wired and tested by us. You mount the completed RF Tuning Unit and power supply, then after some simple wiring, it's all set to operate. 11 tubes: 6J6 RF amp, 6AG5 converter, 6C4 oscillator, 6BA6 1st IF, (2) 6AU6 2nd and 3rd IF, (2) 6AU6 limiters, 6AL5 discriminator, 6AL7-GT double tuning eye, 5Y3-GT rectifier. Sensitivity 6 to 10 microvolts, less than 1/2 of 1% distortion, 20 to 20,000 cycle response with 2DB variation. Chassis dimensions: 12 1/2" wide, 8" deep, 7" high. Illustrated manual supplied. Shipping weight 14 lbs.

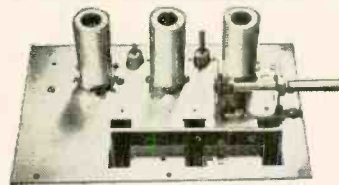

FMF-3 Tuning Unit

**\$1525**

with AFC \$18.75

The best for FM. The most sensitive and most selective type of "front end" on the market. 6 to 10 microvolts sensitivity. Image ratio 500 to 1. 6J6 tuned RF stage, 6AG5 converter, 6C4 oscillator. Permeability tuned, stable and drift-free. Chassis plate measures 6 1/2" x 4 1/2". In combination with the IF-6 amplifier, the highest order of sensitivity on FM can be attained. Tubes included as well as schematic and instructions. Draws 30 ma. Shipping weight FMF-3: 2 1/2 lbs. Dial available @ \$3.85.

IF-6 Amplifier

6 Tubes, Shipping Wgt. 3 lbs.

**\$1975**

### FOR USERS OF COLLINS TUNERS:

Receive \$5.00 credit toward the new FMF-3A front end! Mail us your old front end with \$13.75 and we will send you the new, improved FMF-3A with AFC, or, remit the full amount of \$18.75 and when we receive your old unit in return a check will be mailed you for \$5.00.

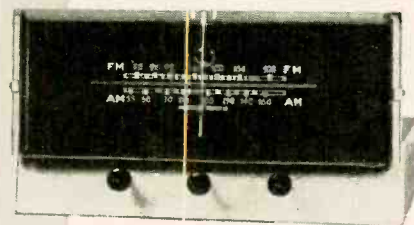

FM/AM Tuner Kit

**\$7750**

with AFC \$81.00

The original 15 tube deluxe FM/AM pre-fab kit redesigned on a smaller chassis. The tuner now measures 14" wide by 12" deep by 7 1/2" high. This attractive new front and dial assembly opens up new applications where space is at a premium. Kit includes everything necessary to put it into operation—punched chassis, tubes, wired and aligned components, power supply, hardware, etc. Kit comprises FMF-3 tuning unit, IF-6 amplifier, AM-4 AM tuning unit, magic eye assembly and complete instructions. All tubes included. Shipping weight 19 lbs.



AM-4 Tuning Unit

**\$2450**

Tops in AM superhet performance! A 3-gang tuning condenser gives 3 tuned stages with high sensitivity and selectivity. Assembly is completely wired, tested and aligned ready for immediate use. Frequency coverage 540 KC to 1650 KC at a sensitivity of 5 microvolts. Tubes 6BA6 RF amplifier; 6BE6 converter; 6BA6 IF amplifier and 6AT6 detector. Draws 30 ma @ 220 volts. Mounts on a chassis plate measuring 4" x 7 3/8". Shipping weight 2 1/2 lbs. Dial available at \$3.85.

MAIL  
COUPON  
TODAY

To: Collins Audio Products Co. Int. RE-2  
P.O. Box 366, Westfield, N. J.  
Tel. Westfield 2-4390

FM Tuner Kit  FM/AM Tuner Kit  FMF 3 Tuning Unit  
 with AFC  with AFC  with AFC

IF-6 Amplifier  AM-4 Tuning Unit

NAME.....

ADDRESS.....

CITY.....STATE.....

Amount for Kit \$..... See weights, add shipping cost \$.....

Total amount enclosed \$..... Check  Money Order

**WHEN YOU THINK OF TUNERS, THINK OF COLLINS AUDIO PRODUCTS**

Engineering

## WRITERS

**ENGINEERS, E. E. or PHYSICS GRADUATES, for preparation of technical manuals...**

HUGHES RESEARCH AND DEVELOPMENT LABORATORIES' expanding program for production of radar, electronic digital computers, guided missiles and other military advanced electronic systems and devices requires the following:

**1 ELECTRICAL ENGINEERING AND PHYSICS GRADUATES** to prepare operating, servicing and overhauling instructions for complex electronic equipment. Those with previous maintenance experience on military equipment preferred. Writers will participate in a three-month program in our technical training school to become familiar with the latest Hughes equipment prior to writing assignments.

**2 ENGINEERS EXPERIENCED** in the writing and preparation of maintenance manuals for electronic equipment or guided missiles. These specialists will work step-by-step with the people designing, developing and manufacturing the products involved. Experience in the writing of engineering reports is of value.

### HOW TO APPLY

Write full details of your qualifications to

## HUGHES

Research and Development Laboratories

SCIENTIFIC AND ENGINEERING STAFF

Culver City, Los Angeles County California

Assurance is required that relocation of the applicant will not cause disruption of an urgent military project.

## AUDIO—HIGH FIDELITY

# ELECTROSTATIC TWEETER

By MARVIN HOBBS\*

THE new low-voltage electrostatic speakers now used in some sets (see "New Electrostatic Speakers" in the October 1954 issue) are usually connected to the plate of one of the output tubes through a high-pass dividing network. This connection is impractical for home audio enthusiasts who may wish to add one or more electrostatic tweeters to their existing system. There is the danger of positive feedback resulting from coupling between the amplifier input and the tweeter and its coupling network. Too, there is a considerable variation in the d.c. voltage available at the plates of output tubes in popular equipment. A further disadvantage is that the speaker does not receive full

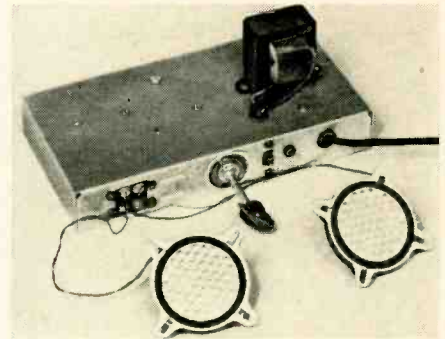

Fig. 2—The 702 using dual tweeters.

the tweeter is taken from the secondary of the amplifier's output transformer. A step-up transformer in the tweeter package matches a 4-, 8- or 16-ohm input and develops the maximum drive of about 60 volts r.m.s. in the range of 7 to 20 kc. Polarizing voltage—about 250 d.c.—is supplied by a small power transformer and rectifier. Fig. 2 shows the chassis of the model 702, using dual electrostatic tweeters.

The electrostatic tweeters are flat with an area of approximately 8.5 square inches each. They may be used with any amplifier delivering up to 10 watts. The response of the tweeters is flat within 3 db from 7,000 to 20,000 cycles.

The single- and dual-tweeter packages are supplied with matching transformer and crossover network. Both are available with and without polarizing supply and cabinet. The speaker in the 701 is tilted from the vertical in its cabinet to increase high-frequency distribution when placed atop a low-frequency enclosure of medium height. In the 702 the tweeters are also set at slight angles to the front to increase the horizontal spread. END

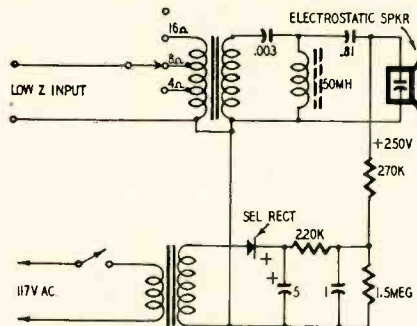

Fig. 1—Schematic of the A.R.F. 701.

benefit of the even-harmonic cancellation characteristic of the push-pull output circuit.

To minimize these effects in adapting electrostatic tweeters to existing equipment, A.R.F. Products has introduced the series 701 and 702 electrostatic tweeters with built-in power supply and low-impedance input. Fig. 1 shows the circuit of the 701, a single-tweeter unit, with crossover around 6 kc. Audio for

\*Consulting Engineer, A.R.F. Products

## CONSTANT-TRACKING PLAYBACK ARM

A new and revolutionary playback tone arm resembling an overhead drive recording lathe is a recent development of Kral Products, of Philadelphia, Pa. Called the *Trans Linear*, the new arm continually follows the tracking angle of the recorder, thereby eliminating tracking distortion on playback.

Available in 12- and 16-inch models, the arm is easily installed on any turntable. Height, stylus pressure and leveling adjustments are simple. Standard cartridges like the Fairchild, G-E and Pickering are simply slipped into place and clamped with a thumb lock. A calibrated indexing strip may be fastened to the front of the housing to simplify pin-point positioning of the stylus in any band or groove on the record. Accidental damage to the record

or stylus in the play and off positions is prevented by a safety lock. The arm swings to one side for easy record placement and removal.

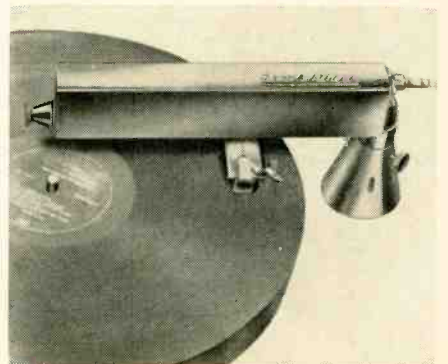



# GILDING

# THE

# GOLDEN EARS

*Improving the performance  
of the Junior and Milady's  
Golden Ear amplifiers*

By JOSEPH MARSHALL

ANY design is capable of improvement and Golden Ear amplifiers are no exceptions. The original articles in RADIO-ELECTRONICS produced an unusually large number of letters with comments and reports from readers who either had constructed a Golden Ear amplifier or were doing so. A few letters reported happy results, and some suggested improvements or modifications. Inspired by this interest I have been doing a great deal more work with and made several improvements in the circuit. Some of these were included in "Milady's Golden Ear" (April, 1954) and others will be found in a new laboratory model which I hope to describe in this magazine shortly. Meanwhile, it seemed appropriate to report on the improvements and how they can be applied to existing Golden Ears.

## Outer Feedback Loop

Several correspondents noted that there was a limit to the improvement in reducing distortion which could be obtained by increasing feedback in the outer loop. In most cases applying 14 db or a little more in the outer loop, in addition to the 14 db in the inner loop, produced a reduction in distortion. But in some instances, an increase beyond 14 db did not produce any further improvement and sometimes even increased distortion. There are two reasons for this and two cures.

In the original design the outer loop applied feedback from the voice coil

of the output transformer to one of the cathodes of the input pair of cathode followers. This places the feedback resistor and the voice coil in shunt with the cathode resistor and, therefore, reduces the net or effective cathode resistance. This produces unbalance. The unbalance can be corrected by the balance control. However, the size of the feedback resistor decreases as feedback is increased. If the resistor is too small, the cathode resistance of the input tube is reduced to the point that the tube is underbiased. This is not likely to occur with the Junior version (November, 1953) which takes feedback from a 500-ohm tap and therefore uses a high value of feedback resistor. But when a 16- or 8-ohm tap is used, the feedback resistor may be as low as 10,000 ohms and even less; and this does throw the input stage out of its normal bias range.

There is a very simple solution. Feedback can be applied to the grid of the bottom tube—the off-grid—through a voltage divider as indicated in Figs. 1, 2. This way the feedback network has no influence whatever on the static values of the input stages. The voltage fed back must be *in phase* with the signal, rather than out of phase as is the case with normal types of feedback. The feedback action here is obtained through the fact that the inverter is a differential amplifier. When in-phase signals of the same frequency are fed into both grids, the weaker subtracts from the stronger; if both are equal, they cancel each other out completely.

When an amplifier is wired, there is a 50-50 chance that the voltage from the top end of the voice coil will be in phase. If it is, feedback will be negative. This will be evidenced by lower volume or output level. If the applied signal is out of phase, you will get positive feedback, evidenced by a rise in volume or, more probably, motor-boating. When this occurs, the phase must be reversed. The easiest way to do this is to reverse the input grids. Phase can also be reversed by reversing the primary leads on the output transformer but it is usually simpler to reverse the input grids.

The values specified in the diagrams were suggested by Dave Hafner of Acrosound—who first applied this scheme after mutual discussion—and work very well. There is no reason to suppose, however, that other values wouldn't work as well. To determine the optimum value of feedback resistor the following is recommended:

Connect temporarily a potentiometer of around 10,000 ohms (for 8- or 16-ohm voice coils) or 25,000 ohms maximum for 500-ohm voice coils as a feedback control. Apply a resistive load or, if you must use a speaker load, disconnect the tweeters. Adjust the potentiometer downward until the amplifier breaks into parasitic oscillation. This condition can be determined by hooking up the a.c. probe of a v.t.v.m. across the voice coil. Adjust any signal input to produce say a 1-volt reading on the v.t.v.m. Now reduce the value of the potentiometer resistance. The





# STAR-HELIX

RAINBOW ANTENNA

A STAR IS BORN









## THE NEWEST STAR IN THE JFD RAINBOW ANTENNA GALAXY

It's out of this world! . . . A radical new departure in all-channel black and white or color performance—featuring the JFD Hi-Plex folded dipole system—the greatest antenna advance since the origin of the Inline Yagi.

MODEL		LIST
<b>SX711</b>	Single	<b>\$25.50</b>
<b>SX711S*</b>	Stacked	<b>\$52.50</b>

\*Complete with Hi-Gain Stacking Transformers

-  **SUN** From JFD, the fountainhead of Antenna development
-  **MOON** As sensitive in signal attraction as the *Moon*
-  **VENUS** As beautiful as *Venus*
-  **MERCURY** As quick to install as *Mercury*
-  **SATURN** As spectacular as *Saturn*
-  **JUPITER** As outstanding as *Jupiter*
-  **MARS** As powerful as *Mars*

Look to JFD for Engineering Leadership!



THE MOST OUTSTANDING ANTENNA ADVANCE SINCE THE ORIGIN OF THE INLINE YAGI!



# STAR-HELIX

## RAINBOW ANTENNA



NOW—2 GREAT JFD HELIX RAINBOW ARRAYS TO CHOOSE FROM:

1. Jet-Helix featuring the new JFD Flat Plane Helical-Conical Concept.
2. Star-Helix featuring the new JFD Inline Helical-Yagi Concept.

TOMORROW'S COLOR ANTENNA — TODAY!

A giant in black and white performance. Flat microwave type helical section composed of individual non-linear additive collectors, each tuned separately for highest gain and sharpest directivity on one high band channel.

Revolutionary new Hi-Plex folded dipole design transforms low band collector into 3 half wave length antennas that develop highest in-phase current on high band. Result: sustained high signal magnitude on all low and high band channels — plus sharp forward unidirectional response.

A giant in color performance! Possesses consistently flat gain across the spectrum, uniformly high signal to noise ratio, narrow beam width, and close 300 ohm impedance match essential for fidelity color reception.

Special matching Booster Transformer permits close stacking for maximum high band response and electrical wide stacking for optimum low band response.

Inline designed for physically streamlined appearance. Maximum eye-appeal. Minimum wind resistance.

Completely preassembled. Just flip elements into place. New "Hi-Tension" aluminum brackets lock elements permanently in place. No tools. No screws.

Built for permanence — constructed of matchless aluminum by ALCOA.

300 ohm impedance for 100% signal transfer.

Highest Front-to-Back Ratio ever in Broad Band design

Chan.	DB	Rel. Volt.
2	17.	7:1
3	22.	12.5:1
4	21.	11.5:1
5	20.	10:1
6	20.	10:1
7	10.5	3.5:1

Chan.	DB	Rel. Volt.
8	18.	8:1
9	19.	9:1
10	25.	18:1
11	22.	12.5:1
12	25.	18:1
13	13.	4.5:1

HERE'S HOW THE JFD HI-PLEX SYSTEM WORKS!

### ON LOW BAND



Current Distribution (Channels 2-6)

Full sized low band half wave folded dipole develops maximum in-phase current across its length on low band channels 2 to 6. Entire dipole length acts as effective capturing device because it operates totally on fundamental frequency unimpeded by additional radiating devices used in other broad band systems to raise high band gain.

### ON HIGH BAND



Current Distribution (Channels 7-13) Without Helix

When operating on high band frequencies, JFD Hi-Plex phasers transform each low-band collector extremity into separate high band dipoles. These electrically isolated elements function as independent collectors operating on their fundamental frequency, each developing maximum in-phase current on channels 7 to 13. Out-of-phase voltage of center section of folded dipole is minimized and isolated from other high band dipoles by blocking action of two anterior high band phasing elements.

### ON BOTH LOW AND HIGH BANDS



Current Distribution resulting from connection of Helix (channels 7-13)

Special phasing harness feeds channel 7 to 13 energy produced by flat plane helix into Hi-Plex collector in same phase and magnitude of other 2 high band dipoles. Result in in-phase additive operation of 3 half-wave antennas balanced for increased high band gain and unlimited signal strength on low band channels — Plus 300 ohm impedance to assure 100% energy transfer.

COMPARE THE PERFORMANCE OF THE STAR HELIX WITH ANY VHF ANTENNA YOU ARE NOW USING!

ANTENNA	CHANNELS												
	2	3	4	5	6	7	8	9	10	11	12	13	
"STAR-HELIX" SX711	4.75	5.	6.25	7.25	7.	14.5	14.	13.25	13.5	13.75	13.75	14.5	
"STAR-HELIX" SX711S	8.	8.5	9.	10.5	10.5	17.5	17.	15.75	16.	16.	16.	17.5	
"DODD" Screen Type REFLECTOR	4.75	4.5	7.2	7.1	7.	11.	11.2	11.8	11.5	11.1	12.1	12.	
"SUPER DODD" Screen Type REFLECTOR	6.3	6.8	8.8	7.8	7.5	9.5	11.2	11.8	12.	11.1	12.1	12.	
Broad Band Yagi with Phasing Stubs	4.3	5.7	4.5	7.1	9.	13.	14.	13.5	14.	13.	14.	15.	
Inline Yagi with Phasing Stubs	5.2	5.5	6.	8.	8.	11.5	9.5	10.	9.	11.	11.5	11.8	
Inline Yagi with Triple Dipole	5.25	6.25	7.	7.5	7.75	10.5	10.25	8.75	9.5	10.25	11.	11.75	
Super Inline Yagi with Triple Dipole	6.75	7.	9.2	9.	10.	11.5	12.2	12.8	13.5	13.1	14.6	15.5	

65.6% S/N Figure of Merit\*

\*The S/N Figure of Merit sums up the major individual characteristics of an antenna in one concise value. Write for S/N Figure of Merit engineering folder No. 315 for complete details.

Gain Represents That Over 1/2 Wave Reference Folded Dipole

Up to 18 db on High Band\*

\*Tested in strict accordance with RETMA antenna measuring standards

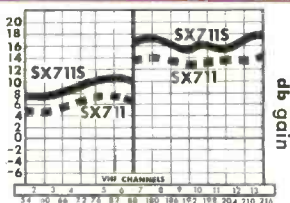

Up to 11 db on Low Band\*

Horizontal Pattern (Relative Voltage) Channel 2-6

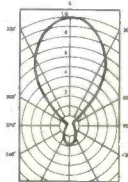

Today's Fastest Installing Broad Band Antenna! As Easy to Handle as Power Steering. The Slowest Part Is Opening the carton! Remarkable new JFD Hi-Tension Aluminum Bracket Design Cuts Installation Time 250%. No tools or labor necessary. No screws or hardware to tighten. Just flip elements into place.

INTERNATIONAL DIVISION  
15 Moore Street, New York 4, U. S. A.



MANUFACTURING CO., INC. Brooklyn 4, New York

## AUDIO—HIGH FIDELITY

mended. The gain is so much higher that the input signal may well have to be cut to one-half or less. This might produce too much boosting of highs or lows with the Junior Compentrol. The Senior Compentrol allows adjustment of both level and compensation.

If you now have an amplifier using pentode-connected 6V6's, 6K6's or 6L6's, or an output transformer which does not have taps for Ultra-Linear operation, the circuit is easily modified. The only change is that of providing proper screen voltage. Since in most cases the screens can operate with the same voltages as the plates, connecting the screens to the center tap of the transformer primary will be O.K. Otherwise the circuit remains unchanged.

### Extending high-frequency response

In Milady's Golden Ear and other versions using Acrosound output transformers flat to about 100 kc and having resonant peaks between 120 and 200 kc, the amount of feedback possible in the outer loop is limited by the phase shift in the ultrasonic region; after a certain point the amplifier bursts into oscillation. Moreover, even when outright and continuous oscillation does not occur, the transient response suffers. A 20-kc square wave may have very steep sides but the top, instead of being flat, may be extremely unstable (Fig. 3-a). The cure for this is to reduce the phase shift at the high end so that even at the resonant frequency it is less than 180°. A common way is to build a phase-shift network into the feedback loop by shunting the feedback resistor with a suitable capacitor, as indicated in the feedback loop of Fig. 2.

The exact value of this capacitor will vary with the circumstances and the transformer. With most Acrosound transformers a combination of R-C having a constant of 10 microseconds will do the job. This will be achieved if the resistance of the feedback resistor in *ohms* and the capacitance in *microfarads* produce the product 1. For example, a 4,700-ohm resistor will need a capacitor of about .0002  $\mu\text{f}$ ; a 4,000-ohm resistor, .00025  $\mu\text{f}$ , and a 3,000-ohm resistor, .00033  $\mu\text{f}$ .

A more exact correction can be obtained with the help of a scope and a 10-kc or 20-kc square wave. The scope will show, not a flat top, but one with a great deal of wiggle. Try various capacitances across the feedback resistor and choose the one which produces the flattest top and the least wiggle.

This measure is not always fully effective, especially if a large amount of feedback is desired. The Golden Ear circuit however produces a unique opportunity for a further improvement by precompensating the phase shift at the high end. All that is necessary is a small capacitance from cathode to cathode of the driver stage. Here is how it works:

## Defies Weather!..

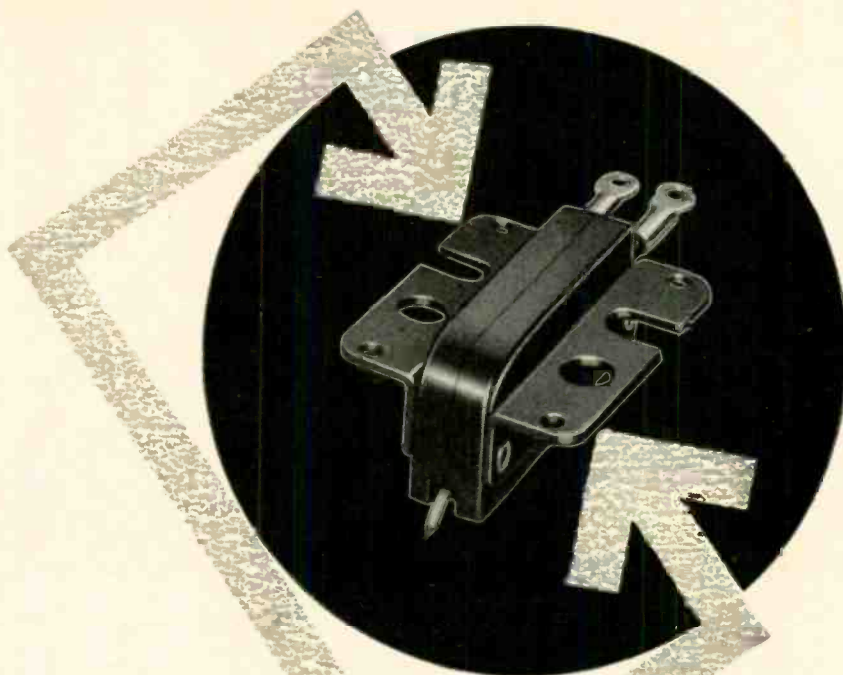

### MODEL GX *ceramic*

WEBSTER ELECTRIC  
**Featheride**<sup>®</sup>

REPLACEMENT CARTRIDGE  
for 33 $\frac{1}{3}$  and 45 rpm use

• Here is WEBSTER ELECTRIC's answer to the wide demand for a high quality, small-sized, durable *ceramic* replacement cartridge. The new Model GX defies any weather and climate—its ceramic construction enables it to withstand extremes of temperature and humidity.

It is designed especially for fast on-the-spot replacement in any standard RMA  $\frac{1}{2}$ " mounting, such as the Columbia 33 $\frac{1}{3}$ —also in all RCA 45 record players ( $\frac{1}{2}$ " to  $\frac{5}{8}$ " mounting).

Stock and sell this new *ceramic* member of the famous Featheride family for added sales and profits. Write today for full information.

#### DATA ON THE MODEL GX

**TYPE** • Ceramic cartridge with single 1-mil osmium needle for 33 $\frac{1}{3}$  and 45 rpm use. Also available with 2-mil needle for 3-speed players  
**OUTPUT** • Develops 0.6 volt at 33 $\frac{1}{3}$  rpm  
...0.8 volt at 45 rpm  
**TRACKING PRESSURE**  
7.0 gr.  
**CUTOFF FREQUENCY**  
10,000 C.P.S.  
**NET WEIGHT** • 5.0 gr.

WEBSTER  ELECTRIC  
RACINE WISCONSIN

"Where Quality is a Responsibility and Fair Dealing an Obligation"  
WEBSTER ELECTRIC COMPANY, RACINE, WISCONSIN - EST. 1909

THE TAPE THAT MIRRORS THE ORIGINAL SOUND



- ▶ Frequency Range: 20-20,000 cps.
- ▶ Lowest noise level • Uniform sensitivity
- ▶ Minimum amplitude variation • Less distortion

600 feet on plastic reel..... net \$2.10  
 1200 feet on plastic reel..... net 3.30  
 2400 feet on plastic reel..... net 7.71

At All Leading Sound Dealers

THE  
**FINEST TAPE**  
 YOUR RECORDER  
 CAN USE

**ORRADIO INDUSTRIES, INC.**  
 OPELIKA, ALABAMA  
 Export Division: Morhan Exporting Corp., New York  
 In Canada: Atlas Radio Corp., Ltd., Toronto



**AUDIO—HIGH FIDELITY**

The capacitor shunts the feedback loop and therefore limits the feedback. But the shunt varies with frequency. At low frequencies the reactance is so high that it has little or no shunting effect; but at very high frequencies the reactance may be so low that the feedback loop is completely shorted out and gain at these frequencies is increased by up to 20 db. By choosing the right value it is possible to taper the feedback beyond, let us say, 50 kc, thus increasing gain beyond this point rapidly. The increase in gain slows the phase shift so that whereas previously it may have been 180° at 150 kc, it may now be much less—enough less to prevent positive feedback.

Here, too, the best way of proportioning this compensation is with a scope and a 20-kc square wave, choosing the capacitor which either eliminates ringing entirely or minimizes it most completely. I have not yet determined optimum values, but a value of around 100  $\mu\text{f}$  appears to be a good average for Golden Ears using the Acrosound T-300 transformer and between 16 and 20 db of feedback in the outer loop. Fig. 3-b shows the improvement produced by the combination of these two means in the revised circuit of Milady (Fig. 2), with 20 db feedback in the outer loop in addition to the 14 db in the inner loop.

**Adjusting balance**

In my experiments I discovered a most effective method of adjusting amplifier balance precisely. It involves the use of an IM analyzer or meter. Adjust the balance roughly by the usual means. Set up the IM analyzer and take an IM reading at about 1 watt. Now adjust the balance control carefully on both sides of the rough balance position for minimum reading on the IM meter. You will find the IM falls as the balance control is moved to one end or the other. However, if you switch to the *carrier set* position of the analyzer, you will see that the output has fallen. The correct minimum is somewhere near mid-rotation and will provide a distinct improvement in IM with no decrease—or even with an increase—in output.

This method can produce an almost perfect balance and can reduce distortion to one-half, one-third or even less.

The IM meter can also be used the same way for adjusting the bias of the 12AX7 driver in Milady's Golden Ear or others using the same front end. This time, however, take an IM reading close to maximum output and then adjust bias for minimum IM.

**Modifying Williamson kits**

Several correspondents have pointed out that Williamson type kits are available at prices 50% or less than the cost of parts for Milady and have asked if such kits could be modified. The answer is yes and usually very easily. Aside from the fact that a couple of

LEARN

**Television-Radio  
 Electricity**

**REFRIGERATION-ELECTRONICS**  
 IN THE GREAT SHOPS OF **COYNE**

**TRAIN QUICKLY! OLDEST, BEST  
 EQUIPPED SCHOOL of ITS KIND in U.S.**

Come to the Great Shops of Coyne in Chicago. Get practical training in opportunity fields—TELEVISION-RADIO—ELECTRICITY—ELECTRONICS—vital in Defense Program. Prepare now for a better job in Industry or better service rating.

**Approved for Veterans**

Finance Plan—Enroll now, pay most of tuition later. If you need part-time work to help out with living expenses while at Coyne, we'll help you get it. Special tuition plan for men of Draft Age.

**FREE BOOK** Clip coupon for Big Free Illustrated Book. No salesman will call. Act NOW.

B. W. Cooke, President

**COYNE** [SCHOOL]

A TECHNICAL TRADE INSTITUTE CHARTERED NOT FOR PROFIT Established 1899 500 S. Paulina, Chicago

**ELECTRICITY ★ TELEVISION  
 RADIO ★ REFRIGERATION ★ ELECTRONICS**

B. W. COOKE, Pres.  
 COYNE School  
 500 S. Paulina St., Chicago 12, Ill. Dept. 25-81H

Send FREE BOOK and full details on:  
 TELEVISION-RADIO  ELECTRICITY

NAME.....  
 ADDRESS.....  
 CITY..... STATE.....

**STAN-BURN  
 E-D-A-R-K-E**

**\* CATHODE RAY TUBE SPECIALS \***  
 ONE YEAR GUARANTEE \*

G.E.		STAN-BURN	
* 10BP4A	\$14.95	* 10BP4	\$10.20
* 10FP4A	21.10	* 12LP4	11.90
* 12LP4A	18.75	* 12LP4A	13.95
* 12QP4A	18.75	* 12QP4	11.90
* 12QP4A B1014	21.00	* 12JP4	11.90
* Dumont	28.75	* 12UP4A	14.50
* 14CP4	24.50	* 14CP4	15.60
* Dumont	23.75	* 16DP4	17.50
* 16AP4A	30.95	* 16DP4 or A	17.50
* 16DP4A (N.U.)	25.25	* 16GP4 or A	17.50
* 16GP4 or B	31.25	* 16FP4	17.50
* 16KP4/16RP4	24.20	* 16WP4	17.50
* 16KP4A (Aluminum)	28.35	* 16AP4	17.50
* 16JP4A (N.U.)	25.25	* 16AP4A	23.00
* 16LP4A	28.50	* 16EP4	19.00
* 16WP4A	26.50	* 16EP4A	23.50
* 16GP4B	31.25	* 16GP4 or A	21.00
* 17BP4A	34.50	* 17CP4	18.50
* 17BP4B	39.75	* 17CP4A	24.50
* 17CP4	34.00	* 17QP4B	22.60
* 17CP4B (Aluminum)	38.50	* 19FP4	23.00
* 19AP4A	41.50	* 19FP4A	24.00
* 20CP4	30.00	* 19AP4	23.90
* 20LP4	37.50	* 19AP4A	24.90
* 21AP4	42.00	* 20CP4	23.95
* 21EP4	32.80	* 21EP4	25.50
* 21EP4A	37.35	* 21AP4	26.50
* 24AP4	78.50	* 24AP4	49.00

**\* PRICES SUBJECT TO  
 CHANGE WITHOUT NOTICE \***

AUTHORIZED DISTRIBUTORS for: General Electric, Kenrad, Tung-Sol, National Union, De Wald, Regal, Automatic and General Motors.

**AUTOMATIC CUSTOM-BUILT RADIOS** for Plymouth, Ford, Chevrolet and many others, always in stock. We carry a complete stock of **HI-FIDELITY** and **SOUND EQUIPMENT**. Send us your requests. We also carry a complete line of popular makes of Radio tubes at 50-10% discount. Also many other special purpose and transmitting types, and all electronic parts and equipment at lowest prices. Send us a list of your requirements for prompt quotations. Terms: 20% with order, balance COD. All prices FOB NEW YORK Warehouse. Minimum order \$5.00. Write for our latest price list and Hi-Fi Catalog to Dept. RE-2.

**STAN-BURN** RADIO and ELECTRONICS CO.  
 1697 BROADWAY • NEW YORK 19, N.Y.

P. R. MALLORY & CO. INC.  
**MALLORY**  
APPROVED PRECISION PRODUCTS

P. R. MALLORY & CO. INC.  
**MALLORY**  
APPROVED PRECISION PRODUCTS

P. R. MALLORY & CO. INC.  
**MALLORY**  
APPROVED PRECISION PRODUCTS

## On electrolytics— FP means MALLORY!

Look for the two names—Mallory and FP—on the electrolytic capacitors you buy. They're your assurance of getting the genuine FP design, offering an exclusive combination of Mallory-developed features.

Famous for long life on the shelf and in service, they have true fabricated plate anodes . . . have been built for years to operate dependably at 85° C (185° F).

FP's handle high ripple currents. They're ideal for voltage doubler applications and for selenium rectifier circuits. Their twist prong mounting cuts installation time to seconds.

Don't accept substitutes. Always specify Mallory FP Capacitors to be sure of premium performance at no extra price.

### BE SURE TO USE . . .



*Mallory Plasvacs*® . . . plastic tubular replacements with permanently secured leads . . . won't short out or open prematurely.



*Subminiature Silverlytic*\* Capacitors . . . only  $\frac{3}{8}$ " long and  $\frac{1}{16}$ " in diameter . . . idea for transistors and other miniature low-voltage circuits.

\*Trademark

P. R. MALLORY & CO. INC.  
**MALLORY**  
APPROVED PRECISION PRODUCTS

P. R. MALLORY & CO. INC.  
**MALLORY**  
CAPACITORS • CONTROLS • VIBRATORS • SWITCHES • RESISTORS  
RECTIFIERS • POWER SUPPLIES • FILTERS • MERCURY BATTERIES  
**APPROVED PRECISION PRODUCTS**  
P. R. MALLORY & CO. INC. INDIANAPOLIS 6, INDIANA

P. R. MALLORY & CO. INC.  
**MALLORY**  
APPROVED PRECISION PRODUCTS

P. R. MALLORY & CO. INC.  
**MALLORY**  
APPROVED PRECISION PRODUCTS

P. R. MALLORY & CO. INC.  
**MALLORY**  
APPROVED PRECISION PRODUCTS

**OUR BUSINESS  
IS BUILT  
ON GOOD  
"CONNECTIONS"**

UNDI  
MINNE.  
NEW ENL  
FEDERAL T,  
THE PACIFIC  
HUGHES AIRCR  
WESTERN ELECT  
DOUGLAS AIRCRAFT  
CONSOLIDATED VULT.  
ELECTRIC BOAT CO. •  
ILLINOIS BELL TELEPHONE CO. • ...  
STEWART WARNER CORP. • TELETYPE CO  
MONSANTO CHEMICAL CO. • NESCO  
SERVEL INC. • FRUEHAUF TRAI  
NEW YORK CENTRAL R. R. CO.  
AMERICAN TELEPHONE & T  
EASTMAN KODAK COMPANY

ATORIES • LEAR, INC  
DE NEMOURS & CO  
WESTINGHOUSE EL  
DUMONT CORP. • C  
LOCKHEED AIRCRA  
AMERICAN AVIATIO  
H CO. • KAISER A  
ED TELEPHONE CO  
GAS & ELECTRIC CO  
BRASS & COPPER CO  
AL HARVESTER CO. • THE PULL  
RP. • HOTPOIN  
FREE SEV  
NORT  
NES  
CO  
-LIT

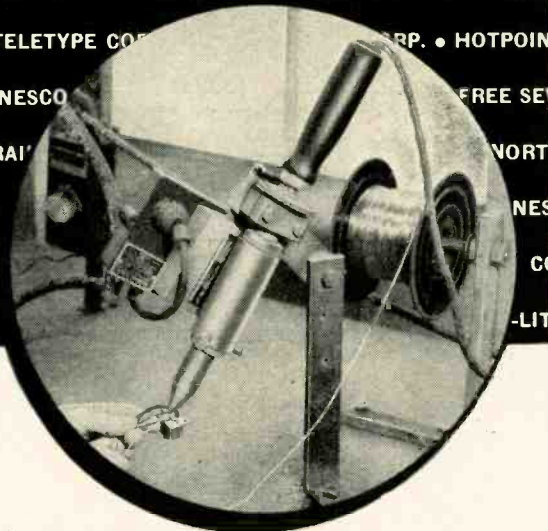

## American Beauty ELECTRIC SOLDERING IRONS

are making "connections where they count" on the finest radio, TV, electronic, telephone and aviation equipment.

Since 1894—American Beauty Electric Soldering Irons have been the standard for dependability, durability and efficiency.

They are made in many sizes to fit all requirements, but in only one quality—the best!

*[[ We also manufacture and stock a wide variety of soldering iron tips in special shapes and sizes. Tell us your requirements. ]]*

Write for Descriptive Literature

**AMERICAN ELECTRICAL HEATER COMPANY**

**DETROIT 2, MICHIGAN**



144-H

## AUDIO—HIGH FIDELITY

tubes, some resistors and capacitors may have to be bought, the main problem is to find space and provide holes for two more tubes. The two-chassis versions of the Williamson kit have an additional hole on each chassis to take interconnecting plugs. These holes can be used for tube sockets and the interconnecting cable run through grommet-lined holes easily drilled. Single-chassis models will usually require punching another socket hole. If you use a miniature tube (it is all right to use a 12AX7 in combination with a 6SN7), the hole is small and can be made very easily with a  $\frac{5}{8}$ - or  $\frac{3}{4}$ -inch drill.

Some Williamson kits use the triode instead of the Ultra-Linear circuitry in the output stage and the transformers provided will not have taps for Ultra-Linear use. The only modification necessary is to reduce the feedback resistors in both loops to two-thirds the value for Ultra-Linear operation. Triodes have only about two-thirds the gain of Ultra-Linear pentodes and to get the same feedback factor more voltage has to be fed back.

There are also several Williamson 6V6 kits—Heathkit A-7B, Knight, etc.—which can be converted into Junior Golden Ears. The models which include a phono-preamp will provide enough holes for tube sockets.

### Equalizer for hi-fi ceramic pickups

Several readers have asked if there is any simple way of modifying the input of Junior to permit the use of hi-fi ceramic phono cartridges like the Sonotone and Electro-Voice Ultra-Linear. I offer two possibilities which will provide good equalization of the new RIAA curve and adequate results on other curves. The first is very simple and is included in the input of Fig. 1. It consists of a switch and a 1.5-megohm potentiometer so that the input resistance in the phono channel is 2 megohms, but only 500,000 ohms in the other channel.

The second equalizer (Fig. 4) provides exact and variable equalization, but requires an additional tube. With the volume control about two-thirds on, the equalization complements the RIAA curve beautifully. As the control is turned lower, you get more bass and less treble; and as it is turned further up, you get more treble and less bass. Actually the curve remains fairly flat no matter what the position of the control. It is merely revolved around a pivot at around 1,000 cycles to provide varying slopes. The circuit has very little net gain when the control is less than two-thirds full on. The control could be placed on the panel to provide continuous equalization control to suit the record or taste. If a switch is provided as indicated, the circuit will give loudness control of bass when the tuner is used, as in the Golden Ear Control Unit from which the circuit was developed. The circuit can be used with any amplifier or control unit. END





**G-C RADIO-TV SERVICE CEMENT**  
Repair speaker cones, voice coils, etc. Waterproof.  
No. 34-2 2 oz. tube List \$0.60



**G-C BAKELITE CEMENT**  
Cement broken cabinets, knobs, panels, all plastics.  
No. 32-2 2 oz. bottle List \$0.65



**G-C FABRIC & GRILLE CLOTH CEMENT**  
Cement cloth to metal, plastic or wood. Fast-drying.  
No. 22-2 2 oz. bottle List \$0.65



**G-C ACRYLIC CEMENT**  
Cement Lucite, Plexiglas, other acrylics. Fast-drying.  
No. 40-2 2 oz. bottle List \$0.65



**G-C TELEVISION TUBE KOAT**  
Recoat scratched or peeling picture tubes. Fast-drying.  
No. 49-2 2 oz. bottle List \$0.95



**G-C RED-X TV CORONA DOPE**  
Prevents TV high voltage corona shorts. Fast-drying.  
No. 50-2 2 oz. bottle List \$1.20



**G-C KOLLOID ACRYLIC SPRAY**  
For UHF-VHF TV and other high frequencies.  
No. 8665 12 oz. can List \$1.79



**G-C LIQUIDOPE**  
Coil dope for all-wave coil windings. Fast-drying.  
No. 36-2 2 oz. bottle List \$0.65



**G-C PORCELAIN PATCH STICK**  
For scratches on refrigerators, sinks, etc. Easy to use.  
No. 908 List \$0.50



**G-C SHELLAC STICK KIT**  
Kit of 10 assorted colors; for all woods. Easy to use.  
No. 925 List \$2.25



**G-C TV ROLL-AROUND**  
Fits all console TV sets, ball-bearing, easy to move.  
No. 8957 List \$9.95



**G-C No. 71-42-STRAND BRONZE CABLE**  
Twisted phosphor bronze cable for dials; .040" dia.  
No. 71-25 25 ft. spool List \$1.65



**G-C DIAL CABLE TOOL**  
Handy for replacing cables or dial springs.  
No. 5096 List \$0.85



**G-C TV-RADIO KNOB FELTS**  
Brown felt washers to prevent scratches. Envelope of 50.  
No. 1065-E List \$0.45



**G-C TV-RADIO KNOB SET SCREWS**  
Assorted lengths, slotted, cup point.  
No. 1060 50 assorted List \$1.10



**G-C TV-RADIO KNOB PULLER**  
Saves time, protects the cabinet.  
No. 1063 List \$0.50



**G-C PHONO NEEDLE SET SCREWS**  
Assorted replacements for all cartridges.  
No. 1052-E 7 assorted List \$0.45



**G-C FIBEROID FISH PAPER**  
For many electrical uses around the shop.  
.010"-240 sq. in. roll.  
No. 560 List \$0.55



**G-C DIAL POINTER KIT**  
Kit of 10 assorted dial pointers.  
No. 6810 List \$3.25

**G-C MINI-MAX STRIP**  
For connecting 67½ volt "B" batteries.  
No. 8115 List \$0.30



**G-C PLASTIC TUBING KIT**  
Kit of assorted Genflex colors and sizes.  
No. 535 25 ft. assorted List \$1.00



**G-C TV LINE PROTECTIVE TUBING**  
Protects 300-ohm flat line from damage.  
No. 825 Box of 8 ft. List \$1.10



**G-C BASEBOARD CLIPS**  
Handy to run wire safely around room.  
No. 8345-E List \$0.45

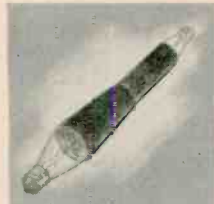

**G-C PILOT LAMP INSTALLER**  
Handy rubber tool for all small lamps.  
No. 7935 List \$0.65



**G-C PICK-UP TOOL**  
Reaches into difficult places easily.  
No. 5089 List \$1.65



**G-C THIN TYPE TEST LEADS**  
Slim handles and test prods, 50" wire.  
No. 8465 List \$2.10



**G-C ALLIGATOR & WRENCH ALIGNING TOOL**  
Combination alligator and ¼" hex wrench.  
No. 5012 List \$0.55



**G-C LONGNOSE CLAMPPLIERS**  
Jaws closed unless handles are squeezed. Straight nose.  
No. 5192 List \$1.00



**G-C SPEEDEX SOLDER IRON TIPS**  
High heat, turn-down tip; fits ⅜" irons.  
No. 8741 List \$1.00



**G-C TWEEZER KIT**  
Handy set of 3 tweezers for service work. Leatherette case.  
No. 7950 List \$3.55

Ask For These



# RADIO-TV SERVICE AIDS

at Your Jobber



ASK YOUR JOBBER  
FOR THE **G-C**  
SPECIALS OF THE MONTH

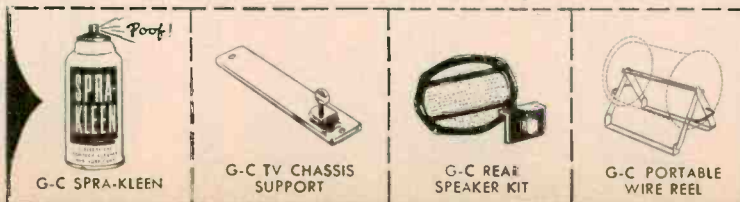

G-C SPRA-KLEEN

G-C TV CHASSIS SUPPORT

G-C REAR SPEAKER KIT

G-C PORTABLE WIRE REEL

FREE!  
Your Copy of the big illustrated G-C Catalog. Send postcard today!

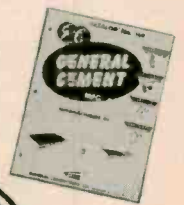

**GENERAL CEMENT MFG. CO.**

910 Taylor Avenue • Rockford, Illinois

# DEPENDABLE

# PERFORMANCE

with **AMPHENOL**

# TWIN-LEAD

Twin-leads can look alike to the casual glance. It is difficult to distinguish between materials and impossible to evaluate electrical characteristics without conducting extensive laboratory tests under simulated weathering conditions.

If you do not have the facilities required to conduct such tests the only way to protect your business and to provide dependable twin-lead installations for your customers is to use twin-leads manufactured by reputable manufacturers.

Using AMPHENOL Twin-Lead gives you this protection — for AMPHENOL guarantees every foot of Twin-Lead sold to be free from defects and maintains the strict quality controls necessary to insure this guarantee!

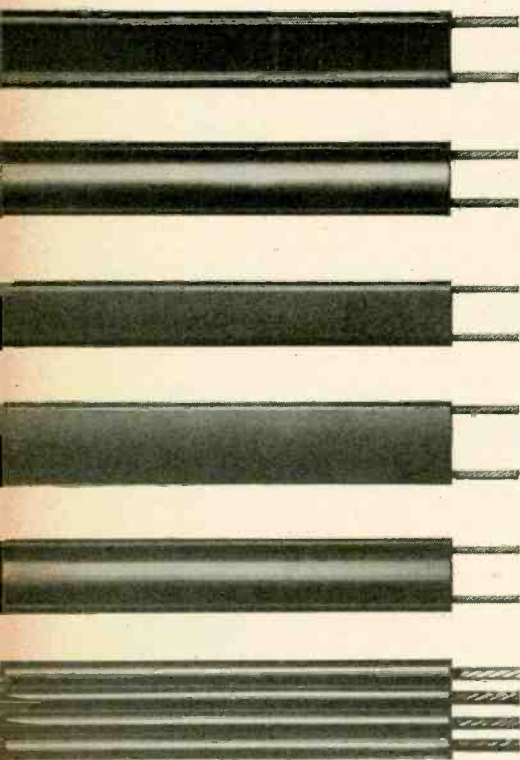

14-056 Standard Flat Twin-Lead

14-271 AIR-CORE Tubular Twin-Lead\*

14-100 New CENTURY Twin-Lead

14-185 New HEAVY DUTY Twin-Lead

14-076 Deluxe AIR-CORE Tubular Twin-Lead\*

14-298 Four Conductor Rotator Cable

\*U.S. Pat. 2,543,696



Send for your copy



Vest Pocket Guide to Transmitting and Receiving Twin-Leads

AMERICAN PHENOLIC CORPORATION  
1830 S. 54th Ave., Chicago 50, Ill.

In Canada: AMPHENOL CANADA LIMITED Toronto

## RADIO

### ROTATABLE LOOP ANTENNA FOR BROADCAST RECEPTION

A ROOF-TOP rotatable loop antenna greatly improves broadcast reception in outlying areas where induction interference is a problem. It eliminates or minimizes co-channel interference when so rotated that the unwanted station is in the null of its response pattern. The loop shown in the photo and diagram can be rotated to eliminate either of two co-channel stations of equal strength when they are separated by 30° or more. When a good line filter is used at the a.c. input to the receiver, the antenna system is completely noise-free, even with a brush type motor operating on the same circuit.

Because tuning a remote loop antenna for maximum signal pickup is awkward, a novel system was used. The antenna actually consists of three separate loops (L1, L3 and L5 in the diagram) that are closely coupled and tuned to different frequencies for broad-band performance.

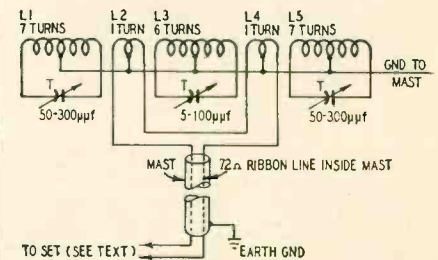

The antenna is wound with No. 20 enameled wire forming two 7-turn outside windings (L1 and L5) and a 6-turn center winding (L3). Pickup loops L2 and L4 have one turn each and are wound between L3 and the two outer windings. All coils are center-tapped. L1, L3 and L5 are tuned by small trimmer capacitors. Response is good across the band when the coils are tuned to my favorite stations on 690, 860 and 1560 kc.

The windings form the sides of a square with 6-foot diagonals. The frame is made from one 8- and one 6-foot length of 1 3/4 x 1-inch pine. The end pieces are 1/4-inch birch plywood notched every 1/2 inch to hold the wire in place.

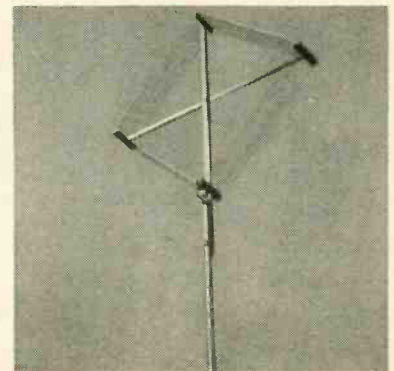

View of the rotatable loop antenna.

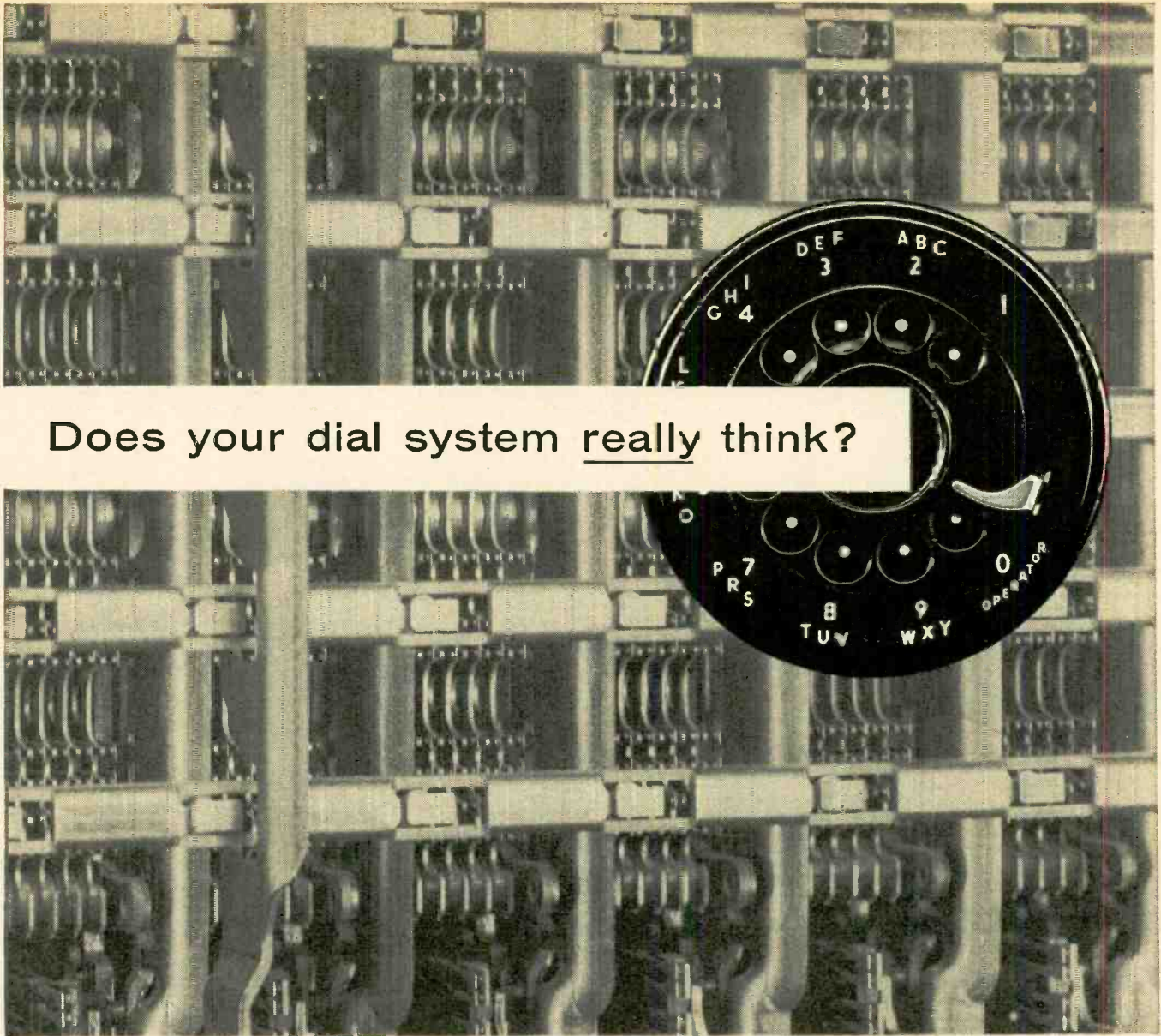

Does your dial system really think?

Part of the control equipment of a modern dial system—dial telephony's equivalent of a brain. It goes into action the instant you dial a call, selecting the telephone you want to reach and directing the switches that set up the connection . . . just as the brain directs the muscular actions of the body.

**T**his question can't be answered until we learn more about the nature of thought. But dial telephone systems *do* simulate many of the processes of the human brain. For example, when a number is dialed, Bell's newest switching system—

**COUNTS** the dial pulses

**REMEMBERS** them

**DECIDES ON** the best route to a nearby town or across the nation

**TESTS** to see if the route is clear

**SELECTS** an alternate if the first route is busy

**REPORTS** difficulties in circuits, if any

Today's automatic switching reflects the creative thinking of many scientists and engineers at Bell Telephone Laboratories. Each year your dial telephone is able to do more for you. And this is but one phase of the continuing effort to keep your Bell telephone service the world's best.

**BELL TELEPHONE LABORATORIES**

IMPROVING TELEPHONE SERVICE FOR AMERICA PROVIDES CAREERS FOR CREATIVE MEN IN SCIENTIFIC AND TECHNICAL FIELDS



The  
Record  
Changer

with

JPF\*  
Collaro

RC-54 3 Speeds  
Fully Automatic



\* Get the whole story

ROCKBAR CORPORATION, Dept. RB-16  
215 East 37th Street, New York 16, N.Y.

Tell me about JPF and the Collaro RC-54

Name.....

ADDRESS.....

City..... Zone..... State.....

RADIO

Several coats of varnish provide insulation and weatherproofing.

The three trimmers are in an i.f. can mounted close to the bottom of the loop. The loop should be tuned and the i.f. can be weatherproofed with hard-setting wax before the antenna is erected on the roof.

The extra 2 feet on the longer piece of the framework permits clamping the antenna to the 1 1/4-inch TV mast used to support it. The centers of all windings are connected to the mast, which is grounded for lightning protection. The 1 1/4-inch metal mast is fastened to the eaves with strapping and sits in a socket drilled in a 2 x 4 nailed to the window sill. It can be turned manually from the window, or an antenna rotator motor could be used. Rotating the loop through 180° is sufficient.

Couple the transmission line to the radio through a primary of about 25 turns of fine wire in place of the ordinary primary. The new coil is wound either on the same form as the secondary or on one that will slip over it.

A Faraday shield gives a sharper null but greatly decreases the signal input so it is not recommended for weak-signal areas. The lead-in is brought down inside the mast to provide shielding. It may be necessary to slip a grounded shielded braid over the 72-ohm line from the mast base to the receiver if the run is long. The first r.f. stage of the receiver should be well shielded to prevent stray pickup. The signal output from a loop antenna is lower than from a long-wire type so a sensitive receiver is required for good performance.—John A. Dewar

INVENTIONS NEEDED

The National Inventors Council, in cooperation with the armed forces, has published a list of technical problems confronting the military services. The list is published with the hope that the publicity given to these problems will lead to satisfactory solutions or suggestions that can be developed into solutions. Included in the list are a group of subjects—not strictly problems—where general technological advances are desirable. This list is issued periodically and can be obtained free of charge from: National Inventors Council, U. S. Department of Commerce, Washington 25, D. C.

The following are subjects pertaining to the electronic field extracted from the list:

- Long-life batteries
- High-power microwave oscillator
- High-frequency recorder
- Coaxial r.f. switch
- Semiconductor material
- Rugged portable ammeter
- Magnetostriction units
- Miniature batteries
- Miniature radio equipment construction
- Electronic telegraph printer
- High-quality synthetic quartz crystals
- High-power electron tubes
- Radiation measuring equipment
- Method of heating dry batteries
- High-voltage power supplies
- Memory circuits
- Homing navigation system
- Ultra-lightweight antenna masts
- Converting heat into electrical energy
- Converting light into electrical energy
- Improved electrolytes

AIREX'S NEW AUTO-FOCUS  
1955 CHANNELOC 630FA4

Up to 200 Miles Reception • Hi Gain  
Cascade Tuner • 4 Microvolt Sensitivity  
The Perfect Chassis for Fringe Areas  
New Exclusive Advancements

- Picture always in focus • Hi & Low Sync Amplifier • Channeloc-Locks picture & sound together
- Drift free operation • Automatic Freq. Control • Gated A.G.C. • Fringe Area Control • Full 4 MC. Picture Bandwidth • Phono connection & Switch
- Efficient Retrace Blanking • Automatic Brightness Control • Full Focus Cosine Yoke • Fused HV Power Supply • Molded Plastic Condensers • 6CB6 Tubes in Video I.F. • Handles up to 24" Rnd
- Improved Sync System • Auto former fly back
- Improved Video amplification • Heavy Duty Power Transformer • Improved Horizontal Sweep • Full range 12" Loudspeaker
- 4 Microvolt Sensitivity
- Ready for UHF Stations
- Size 22" x 20" x 24"
- With 21" Tube Mounted.

\$149<sup>95</sup>

Less CR Tube & Brackets  
12" Hi-Fi Speaker  
Tube Mtg. Brackets—\$6.50

Detailed Service Manual & Schematic—\$1.00

Combination Saving

FA-4 Chassis \$224<sup>95</sup>  
21" Tube  
Mah. Cons. Cabinet.

TV Picture Tubes

Standard Brands. Aluminized. New. Gtar. 1 year.  
• 21" Tube .....\$34.95  
• 24" Tube Rect.....\$59.95  
• 27" Tube Rect.....\$74.95

PLASTIC MASKS

20" and 21".....\$ 7.95  
24".....\$14.95  
27".....\$17.95

Send for Cabinet & Hi-Fi Parts Catalog

630-9 TV CHASSIS FOR 24" & 27" TUBES

- Channeloc-Picture & sound locked together • No drift • Reception up to 200 miles • 90 degree deflection—22 KV high voltage power supply • For 24" & 27" rect. tubes • Phono connection & switch on chassis • Adaptable for color • RMA guarantee.

\$179<sup>95</sup> With 12" TUBE MTG. Hi-Fi RCA BRACKETS Speaker \$9.95

RECORD CHANGER SAVINGS

- VM 1955 Model with turnover titone dual sapphire cartridge.....\$26.50
- Webster-Chicago, 1121 type series with turn-over crystal cart..... 26.95
- Webster-Chicago, 1121 type series with G.E. RPX 050 Reluctance cart..... 32.50
- Garrard, RC 80 with 2 plug-in heads..... 42.75
- Garrard, RC 90 with 2 plug-in heads..... 59.95
- 45 RPM spindle for Garrard..... 3.37
- G.E. RPX050 dual sapphire Reluctance cart. 6.49

All merchandise is brand new, fact, fresh & guar. Mail & phone orders filled on receipt of certified check or MO of 20% of items as a deposit. Balance COD FOB fact. N. Y. Prices & specifications subject to change without notice.

AIREX RADIO CORP.

171 Washington St., N. Y. 7 CO 7-5218

INSIST ON  
THE GENUINE

NEW INCA

QUICKIE #2

the 10 WAY WRENCH

WITH 1,001 USES!



ONLY 98¢ Slightly higher W. of Miss.

Small head for hard-to-reach places... Fits all hex nuts & bolts from 1/4" to 1/2", plus 1/4" sq. Finest made, rugged, alloy construction, hard chrome finish.

4" x 1" overall

AT YOUR JOBBER  
if he cannot supply, write to

J. E. S. CO.

111-47 Lefferts Blvd.

S. Ozone Park 20, L. I., N. Y.

WATCH FOR OUR MARCH ISSUE

ON SALE FEB. 24

*The Complete Line*

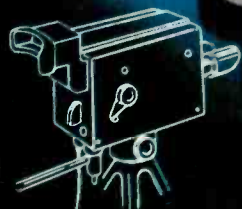

*Aptitude-Tested*  
**ELECTRONIC**  
**WIRES**  
and  
**CABLES**

Belden makes a complete line of Aptitude-Tested electronic wires and cables. You can select the right wire for every application, because all performance values are shown. See your Belden Catalog.

**Belden Manufacturing Company**  
Chicago, Illinois



**Belden**

**WIREMAKER  
FOR INDUSTRY**

# Protect your

# TRANSISTORS

By HAROLD REED\*

I WAS quite proud when I got my first transistor. None of my associates could claim ownership to one of these intriguing devices and I proudly related what I knew of its characteristics and applications, emphasizing its minute size, low voltage and current drain requirements and how simply it could be applied in different electronic circuits.

In my first experiment everything seemed to go well. A more elaborate circuit arrangement was tried and then I experienced that sinking feeling in the abdomen and almost lost my pride and joy. Something got crossed up, possibly due to my long association with electron tubes (not too helpful when working with transistors). The experimental circuit did not behave as expected and when, accidentally, the transistor came into physical contact with the hand, it was found to be about as hot as the 35-watt soldering iron used in wiring the circuit. The battery supply was hastily disconnected!

Transistors are easily ruined, but this little fellow must have been exceptionally rugged. It withstood the extremely high current flow and to this day still performs as well as later additions to my increasing collection.

This experience is similar to that known to experimenters in the "good old days" when triode vacuum tubes were selling at prices equivalent to the transistors of today and the B plus side of the power supply sneaked into the 6-volt filament circuit.

I resolved to attempt to eliminate all possible conditions that might prove disastrous to transistors when used in untried experimental circuits. It was decided to have complete variable control over all battery potentials applied to transistors. This is especially desirable if battery voltages are near or above maximum rating of the transistor. This condition was satisfied by the setup shown in Fig. 1-a. A varia-

tion using two controls, providing individual adjustment of the positive and negative potentials of the battery is shown in Fig. 1-b.

The small 4 x 2 1/4-inch bakelite panel (Fig. 2) on which is mounted the on-off switch, variable control, fuse holder and terminals, is equipped with two small angle brackets, slotted at one end so they may be slipped under the battery binding posts. The supply leads from the battery have spade lugs that also slip under the battery posts. Thus, with the 5308 Burgess battery, used in this instance, the supply potential is variable from 0 to 22.5 or 45 volts. When the battery is run down, the panel and lugs may be slipped onto a new battery of the same type. Also, polarity of the output terminals of the panel can be reversed simply by slipping the slotted brackets and lead lugs under the battery binding posts from the opposite side of the battery. The small fuse in the circuit is of the instrument protection type. Available in many different sizes, it should be chosen according to the maximum current rating of the transistors in the circuit.

The current drain on the battery, limited by the 250,000-ohm control at 22.5 volts, will be about 90 microamperes; at 45 volts, 180 microamperes. Actual measured currents are a little under these Ohm's-law figures. A heavy-duty battery of the type shown is usually not required for transistor applications. I used it because this type is kept on hand for remote broadcast amplifiers and, when replaced, its capacity is still adequate for most experimental work. This same idea, of course, is applicable to any type battery available and even lower current drain can be obtained with a higher resistance control. With a 500,000-ohm potentiometer across 45 volts, the current drain will be around 90 microamperes; while using the 22.5-volt tap, the current will be under 45 microamperes. If the transistor circuit being tested is to be developed into a per-

manent device, after the correct operating potentials are established, small batteries with voltages near the correct values may then be substituted for the test battery.

In dealing with untried transistor circuits, particularly when working near maximum rated values, it is unwise to obtain these values instantaneously. Approach them gradually.

I considered it necessary to know all operating values of the circuit, not just the current flowing through a single path in the transistor. A vacuum-tube voltmeter should be used to check battery voltages; d.c. voltmeters of at least 1,000 ohms per volt can be used if the voltage drop due to loading can be tolerated. When working close to the maximum voltage rating, be careful that this rating is not exceeded when the load of the voltmeter is removed from the circuit. Low-range milliammeters or microammeters are inserted in the three current paths of the transistor to give constant indication of the operating conditions with changes in component parts of the circuit and adjustments.

The layout used in developing a transistor audio amplifier (see photo) is a typical haywire breadboard setup. Nevertheless, the transistors are protected.

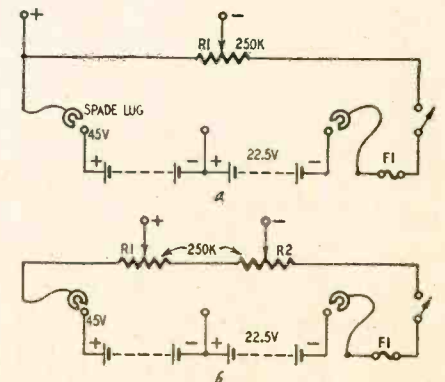

Fig. 1—Circuits for obtaining variable battery voltages for transistors.

\*Chief engineer, station WOL, Washington, D.C.



Fig. 2—Front and rear views of voltage control unit shown in Fig. 1-a.



Radio technicians and experimenters are aware of the devastating effect of extremely high temperatures to germanium diodes because they have been widely used. Transistors are similarly affected. Heat from the soldering iron must be dissipated so it is not carried into the transistor via the leads. If the transistor is being wired into a circuit permanently, each lead may be gripped between the iron and transistor by a pair of long-nose pliers to reduce heat transmission. Where transistors are to be used repeatedly in experimental circuits, the mountings shown in Fig. 3 may prove helpful.

To the left is shown a Raytheon CK722 transistor with its 2 x .016-inch leads and a miniature socket (Cinch Nos. 14148 or 14273 may be used). Even with a socket a small soldering iron should be used quickly. Two methods used to protect the CK722 in numerous experimental circuits are shown at the right of the picture. One way is to use the full length of the leads, threading them down through and under a narrow strip of insulating material, then up through the opposite end, fanning the ends for soldering into any circuit, and applying cellulose cement to obtain rigidity. This also prevents breakage of the leads where they enter the transistor. Should they break at the end of the insulating strip, additional leads can be soldered on without damage to the transistor. The other mounting shown is a square of bakelite with three relatively large soldering terminals. The transistor leads were cut to suitable size, covered with spaghetti tubing and soldered to the terminals. The bakelite square is always mounted so that the terminals are above the transistor leads to minimize heat transfer to the transistor.

When soldering the transistor leads into a circuit, *observe battery polarity*. Incorrect polarity can easily damage a transistor permanently.

After that almost fatal experience with my first transistor, the procedures described were put into effect. Since then many tried and untried transistor circuits have been investigated with no transistor tragedies. **END**

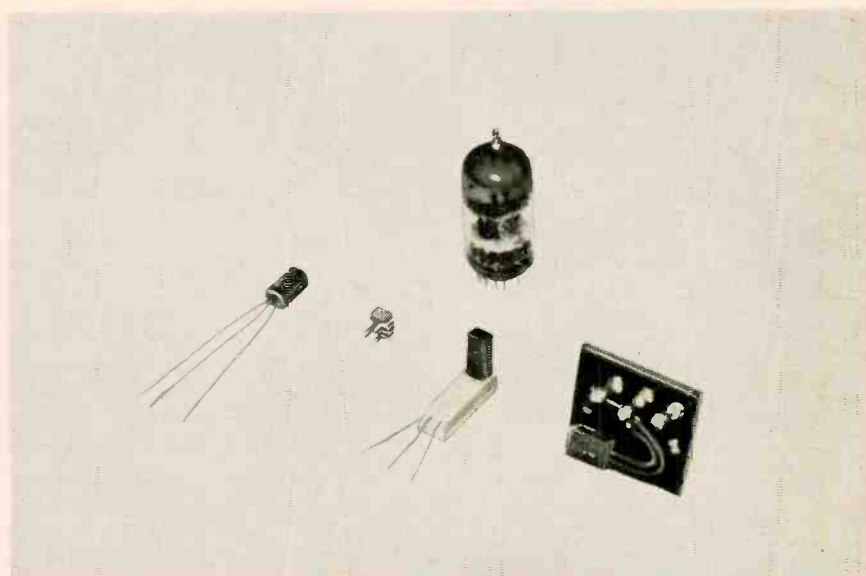
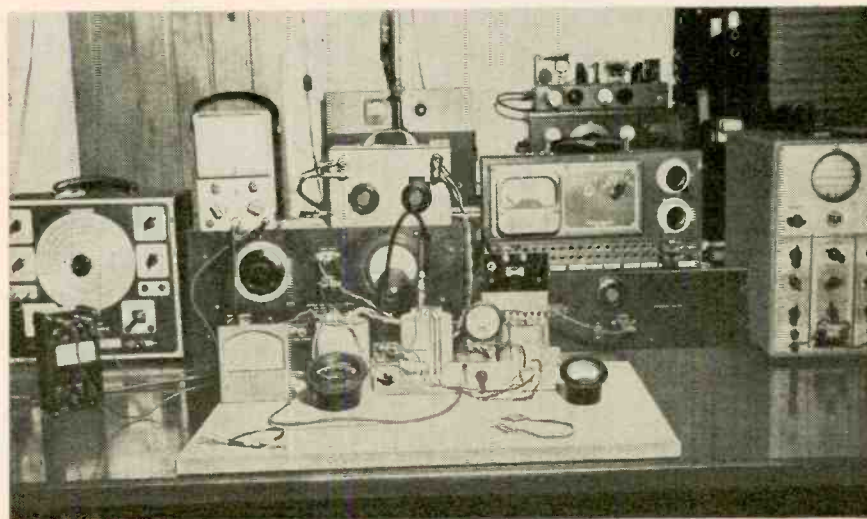

Fig. 3—Photo shows (left to right) a CK722 transistor, Cinch socket and two methods of mounting transistors. Miniature tube shows relative sizes.



Layout used for transistor experiments. Haywire-looking—but saves transistor.

**BUY DIRECT...  
SAVE MONEY!**

**HI-FI and  
Binaural units...  
wired or kits!**

**New** Imperial V—  
12-tube AM-FM  
Tuner Kit

- Band width — 200 kc • Tuned RF stage • Tuning Range 88-108 mc • Sensitivity 5-10 u/v, 20-30 db • Iron core tuned I.F. disc. trans. • 6CB6 RF amplifier • 6AB4 mixer • 6AB4 oscillator • 6AU6 1st I.F. amplifier • 6AU6 2nd I.F. amplifier • 6AU6 1st limiter • 6AU6 2nd limiter • 6AL5 detector • 6C4 cathode follower output • AM tuning range 530-1650 kc • 6BA6 RF amplifier • 6BE6 converter • 6BA6 1st I.F. amplifier • 1N34 or 1N60 crystal diode detector • Tuned RF stage • Chassis dimensions: 9 3/4" long, 5" high, 8" W.

Complete kit of parts including tubes, \$37.50 pictorial and schematic diagrams

Frequency Response (FM) 20 — 20,000 CPS ± .5 DB  
Frequency Response (AM) 20 — 7,500 CPS ± 3 DB

**New** V-9 FM  
Receiver Kit

- Self-contained AC Power Supply
- 3 section variable condenser • Tuning range 88-108 mc • Band width 200 kc • Sensitivity 10 microvolts 20 db • Tuned RF stage • Iron core tuned I.F.—disc. trans. • 6CB6 R.F. amplifier • 6AB4 mixer • 6AB4 oscillator (temp. compensated) • 6AU6 1st I.F. amplifier • 6AU6 2nd I.F. amplifier • 6AU6 1st limiter • 6AU6 2nd limiter • 6AL5 detector • 6C4 cathode follower output • #65 selenium rectifier • Dimensions 9 3/4" x 5" x 5 7/8"

Complete kit of parts including AC power supply, tubes, pictorial and schematic diagrams \$29.50

Frequency response 20—20,000 CPS ± .5 DB  
Wired & Tested extra... \$5.00

**New** V-5 AM  
Receiver Kit

- Self-contained AC power supply
- Tuning range 530-1650 kc • 6BA6 RF Amplifier • 6BE6 converter • 6BA6 1st I.F. amplifier • 6AL5 detector • 6C4 cathode follower output • #65 selenium rectifier • 3 section variable cond. • Tuned RF stage • Sensitivity 5 microvolts • Iron core tuned coils throughout • Dimensions 9 3/4" x 5" x 5 7/8"

Complete kit of parts, including AC power supply, tubes, pictorial and schematic diagrams \$24.50

Frequency Response 20—7,500 CPS ± 3 db  
Wired & Tested extra \$4.25

**FREE CATALOG OFFER!**

Write Dept. RE-E today for free complete Approved catalog!

ORDER DIRECT FROM

**APPROVED**  
ELECTRONIC INSTRUMENT CORP.

928 BROADWAY NEW YORK 10, N. Y.

**RADIO**

**HI-FI FM**  
*for your car*

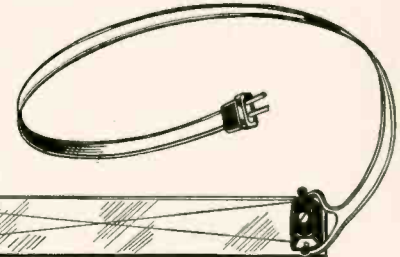
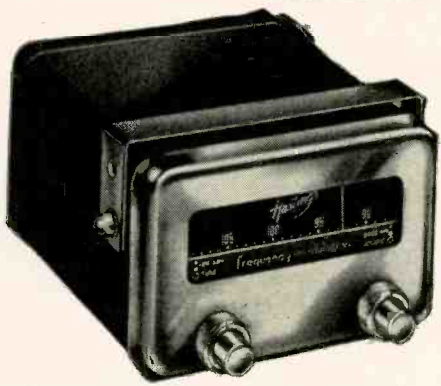

Above, Hastings FM car receiver. Below, compact antenna assembly.

FOR years the average American motorist has listened to his favorite music, sportcasts, plays and news on an AM auto radio while roaming the highways and byways. Leaky power lines, atmospheric disturbances and un-suppressed ignition systems in other cars often interfere with his reception. His enjoyment of the program material suffers by conscious or unconscious comparison with the interference-free reproduction on his FM receiver at home.

A line of FM broadcast receivers and tuners for automobile installations (introduced by Hastings Products, Inc., of Boston, Mass.) may well bring auto reception up to the home quality level. Four different models are made. The CT-6 and CT-12 (conversion types) are tuners using the power supply and audio amplifier circuits of the automo-

bile's 6- or 12-volt AM radio receiver.

The PS-6 and PS-12 are complete FM broadcast receivers operating from 6- and 12-volt d.c. supplies. They consist of a tuner chassis, a separate power supply and audio chassis and a high-fidelity 8-inch PM speaker for rear deck mounting. The audio output circuit uses push-pull 6AQ5's (or 12AQ5's in the 12-volt model) and a 12AT7 phase inverter in a high-fidelity circuit. Response is said to be flat within 1.5 db from 20 to 20,000 cycles. Total distortion is less than 0.5% at normal listening levels and less than 2% at full output. Inverse feedback voltage is tapped off the secondary of the output transformer and fed to the phase inverter.

The tuners and receivers cover from 87 to 109 mc. An r.f. amplifier, three i.f. amplifiers, a pair of crystal diode

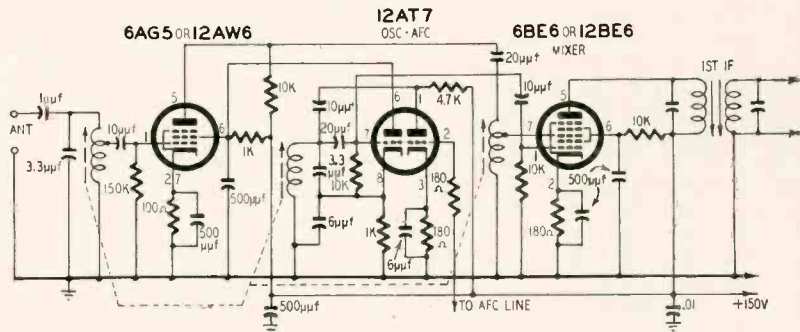

Fig. 1—The r.f. and a.f. circuits in the Hastings FM automobile radios.

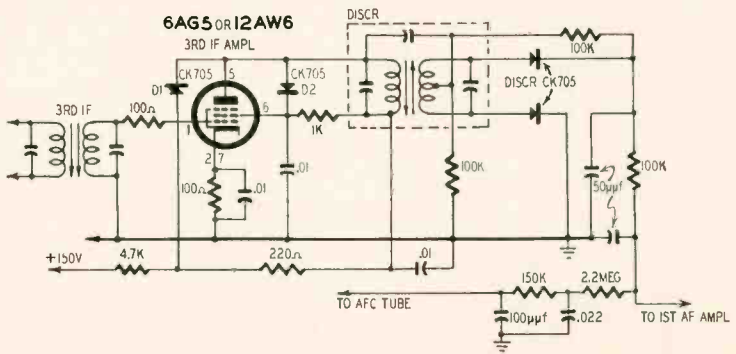

Fig. 2—Four germanium diodes replace tubes to reduce drain on the battery.



## RADIO

limiters and a Foster-Seeley discriminator provide 2 microvolts sensitivity with full limiting at 5 microvolts input. Automatic frequency control minimizes drift and simplifies tuning. The i.f. bandwidth is 200 kc with adjacent-channel response 60 db down. The discriminator feeds a 12AT7 2-stage voltage amplifier and bass-boost tone-control stage through a standard de-emphasis network.

The tuners and tuner chassis of the receivers are identical. They are unusually compact, considering the number of tubes and the circuitry. The cases, designed for suspension under the dashboard, are 6½ inches wide, 4 inches high and 9¾ inches deep, including control knobs and a power plug in the rear. The PA-6 and PA-12 amplifier-power units measure 7 x 6 x 5¾ inches and are mounted on the firewall behind the dashboard.

### Circuit features

Fig. 1 is the diagram of the front end used in the sets. The tube lineup depends on the battery voltage. Models for cars with 6-volt batteries use a 6AG5 r.f. amplifier, 12AT7 oscillator and a.f.c., and a 6BE6 mixer. The 12-volt models use a 12AW6 r.f. amplifier and 12BE6 mixer. A reactance-modulator type a.f.c. circuit shunts the oscillator tank circuit. A d.c. control voltage from the discriminator varies the effective reactance of the a.f.c. tube to hold the oscillator on frequency. The amount of control is carefully engineered to minimize drift without permitting a strong signal to capture the receiver and make it impossible to tune in a weak station on an adjacent channel.

The mixer feeds a conventional 3-stage 10.7-mc i.f. amplifier using 6AG5's or 12AW6's, depending on the heater voltage. A pair of germanium diodes (Fig. 2) are used as limiters. D1 is a dynamic limiter and D2 is a positive peak clipper. The diodes are biased by an R-C network that provides a variable threshold extending down to the level of the weakest signals. This combination provides efficient quieting and suppression of interchannel noise.

The audio detector is a Foster-Seeley discriminator using a pair of germanium diodes. The d.c. component of the discriminator output is filtered and used to vary the reactance of the a.f.c. tube. The a.f. output of the discriminator goes to the 2-stage 12AT7 voltage amplifier and bass-boost tone-control circuit, then to the audio circuit of the AM receiver or the high-fidelity amplifier in the deluxe installations. The latter type can be supplied with an Altec 400-B, University 308, Electro-Voice SP8B or equivalent 8-inch speaker with escutcheon plate and grille cloth for mounting on the rear deck.

A special nondirectional antenna for use with these receivers and tuners consists of a tuned circuit imbedded in a thin transparent plastic strip that is fastened on the side of the car's windshield.

END

# FULL VIEW FULL VALUE

WITH A

## HYCON OSCILLOSCOPE MODEL 617

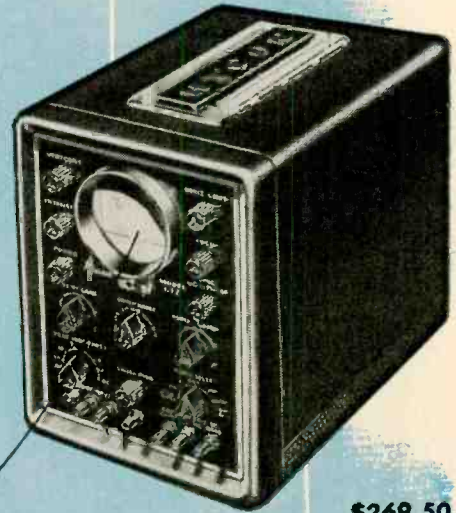

\$269.50

SHARP UNDISTORTED TRACE EDGE TO EDGE

You get *more* for your scope dollar in a Model 617 Oscilloscope, because Hycon's special flat face 3-inch tube eliminates fringe distortion. You pay for a 3-inch scope—you get 3 inches of sharp, usable trace.

And this precision scope meets all requirements for color TV servicing. So before you buy any scope, compare it to the Model 617 feature by feature.

For full view—full value you'll buy Hycon... setting the standards "where accuracy counts."

- 4.5 MC BANDPASS WITHIN  $\pm 1$  DB (VERTICAL AMPLIFIER)
- HIGH DEFLECTION SENSITIVITY (.01 V/RMS PER INCH)
- INTERNAL CALIBRATING VOLTAGES
- EDGE LIGHTED BEZEL
- STURDY, LIGHTWEIGHT CONSTRUCTION



See Hycon's line of matched, bench-stacking test instruments at your Electronic Parts Jobber's.



Service facilities in your area.

# Hycon Mfg. Company

2961 EAST COLORADO STREET PASADENA 8, CALIFORNIA

"Where Accuracy Counts"

# FIX ANY TV or

**This professional SERVICE TRAINING IS THE KIND THAT REALLY "PAYS OFF"!**

Let these two up-to-the-minute Ghirardi books make it easy for you to handle ALL types of AM, FM and Television receiver service by the very best and latest methods! Learn to handle jobs faster, better . . . and with less testing! Whether you're a service beginner or an experienced technician you'll find the speedy, professional methods that are so clearly explained can give BOTH your service efficiency and your earnings a big boost!

Almost 1500 pages and over 800 big, clear pictures and diagrams explain EVERY troubleshooting and repair operation so simply it's next to impossible to go wrong. Each book contains up-to-date data on the latest methods and equipment.

indicated. Better yet, you can save \$1.25 by buying both together! Send no money. Practice from these great books for 10 full days FREE.

Mail coupon today to Rinehart & Co., Inc., Dept. RE-25, 232 Madison Ave., New York 16, N. Y.

Books are sold separately at prices

**SAVE \$1.25!**

Make your service library complete! Have the needed data at your fingertips WHEN YOU NEED IT!

If broken into "lessons" and sent to you as a "course," you'd regard this new Ghirardi training as a bargain at \$100 OR MORE! Instead you buy BOTH big books at the bargain price of only \$12.00 (you save \$1.25!)



A. A. Ghirardi More servicemen have trained from Ghirardi books than any other books or courses of their kind!

## Radio & Television Receiver

### 1 Circuitry & Operation

by Ghirardi & Johnson  
669 pages, 417 clear illustrations, \$6.50

It's lots easier to repair ANY radio or television set when you know all about its circuits and just why and how each one works! You locate troubles in much less time and with less testing. You repair them faster, better—more profitably!

That's why *Radio & Television Receiver CIRCUITRY AND OPERATION* is invaluable to servicemen who want to be well equipped to handle today's complicated receivers! First it gives a complete understanding of basic circuits and their variations. It teaches

you to recognize each one quickly. Then it shows how to eliminate useless testing and guesswork in making repairs.

Throughout, this book gives you the kind of above-average training that takes the "headaches" out of servicing—the kind that fits you for the better-paid jobs. Covers all basic circuits used in modern TV and radio as well as phono pick-up and record players.

Sold separately for \$6.50—or see big MONEY-SAVING COMBINATION OFFER IN COUPON.

## Radio & Television Receiver

### 2 Troubleshooting & Repair

by Ghirardi & Johnson  
822 pages, 417 clear illustrations, \$6.75

Backed by the how-to-do-it methods and procedures so clearly explained in this big book, you can breeze through television and radio service jobs easier and faster than you may have thought possible!

Throughout its 822 pages, *Radio & Television TROUBLE-SHOOTING AND REPAIR* is an amazingly complete, how-to-do-it guide to professional service methods . . . the kind that help you handle jobs lots faster and make more money doing it!

For beginners, this big book is an easily understood course in locating troubles fast and repairing them right. For experienced servicemen, it is a quick way to "brush up" on

specific jobs; to develop better methods and shortcuts; or to find fast answers to tough service problems.

Modern troubleshooting is clearly explained—from quick "static" tests to dynamic signal tracing and all the rest. Special hard-to-fix troubles are fully covered. Step-by-step charts demonstrate exactly what to do on different operations. A big, television section includes everything you need to know for fast, accurate work on any TV receiver model or make.

Sold separately for \$6.75. Save money by ordering the SPECIAL COMBINATION offer. Send coupon today. Practice 10 days FREE!

## SAVE MONEY ON INSTRUMENTS!



**BASIC ELECTRONIC TEST INSTRUMENTS**  
254 pages, 171 illus., Price \$4.00

Work better with fewer instruments—get more work out of your old ones

Here, at last, is an instrument book especially for servicemen, amateurs and experimenters!

Basic Electronic Test Instruments helps you work better and faster with fewer instruments; shows how to increase the usefulness of old instruments; how to choose the right instrument for each job; how to understand instrument readings and put them to practical use; how to avoid buying unnecessary instruments . . . and lots more.

Over 60 instruments from the old standbys to the very latest ones are fully described and explained. Work-saving shortcuts are outlined.

Included are complete details on simple meters for current and voltage; ohmmeters and V-O-M's, V-T voltmeters; power meters; impedance meters; capacitor checkers; inductance checkers; special-purpose bridges; oscilloscopes; R-F test oscillators; signal generators; audio test oscillators; R-F and A-F measuring devices; signal tracers; tube testers and many others.

This handy book is a complete training course in the latest instruments including grid-dip oscillators, TV sweep and marker generators; TV linearity pattern generators, square wave generators, distortion meters, etc. Dozens of time-saving "tricks" help you put old instruments to new uses.

Check Basic Electronic Test Instruments in coupon for 10-day FREE trial.

## BE AN EXPERT ON MAGNETIC RECORDING!



**MAGNETIC RECORDING**  
by S. J. Begun  
242 pages, 146 illustrations  
Price \$5.00

This how-to-do-it book makes it easy to specialize in one of the fastest-growing electronic fields

There's a real future for men who specialize in the fast-growing field of magnetic recording in any of its many branches!

From high fidelity sound to broadcasting, to sound movies, industrial communications, secret communications (speech scrambling), amateur radio, industrial sound and noise measurements and many others, magnetic recording is now an important factor. This book, *Magnetic Recording*, by one of the nation's acknowledged experts, clearly explains all details of the art.

### A COMPLETE GUIDE TO RECORDING METHODS AND EQUIPMENT

First you get a clear understanding of every phase of wire and tape recording . . . from basic acoustic and magnetic theories to components, equipment and circuits in present day use. Subjects include Acoustic Factors; Magnetism; Magnetic Recording Theory and Practice; System Components; Magnetic Recording Equipment; Recording Applications; Instrumentation and Measurements; The Magnetic Phonograph, and many more. Read it 10 full days at our risk. Order *Magnetic Recording* in coupon.

## SHORT CUT TO TELEVISION REPAIRS



**PIX-O-FIX TV TROUBLE FINDER GUIDES**  
Only \$2.00 for the two

No. 1 No. 2 Eliminate useless testing . . . Fix sets twice as fast!

Just turn the dial of the handy, pocket-size Ghirardi & Middleton PIX-O-FIX TV Trouble Finder Guide. When the picture in the PIX-O-FIX window matches the screen image on the television set you're repairing . . . presto! . . . you've got your clue.

PIX-O-FIX then shows the causes of the trouble. Next it indicates the exact receiver section in which the trouble has probably happened. Then it gives step by step repair instructions.

The two PIX-O-FIX units No. 1 and No. 2 cover 47 different television troubles . . . just about anything you're likely to be called on to fix. No. 1 identifies 21 of the most common troubles and gives 192 causes and 253 remedies for them. No. 2 covers 23 more advanced troubles not included in No. 1. Together, they are a comprehensive guide to quick "picture analysis" servicing of any TV set . . . AND THE PRICE IS ONLY \$2.00 for the two. Money refunded if you are not more than satisfied. Specify PIX-O-FIX in coupon.

USE COUPON FOR 10-day Free Trial!

# RADIO EVER MADE

**FAST!  
EASY!  
R-I-G-H-T!**

## Cash in on HIGH FIDELITY SERVICE and CUSTOM-BUILDING!



**HIGH FIDELITY TECHNIQUES**  
By John H. Newitt  
Staff, Mass. Inst. of Technology  
494 pages, 203 illus.  
Price \$7.50

Get better results from "Hi-Fi" by having all the facts and latest ideas at your fingertips!

This big, brand new book by one of the nation's experts, brings you the complete "low down" on modern sound reproduction methods and equipment. It shows how to get better results at lower cost; how to build your own; how to service hi-fi equipment; discusses all details of components; compares different methods—**AND IS CRAMMED FULL OF HOW-TO-DO-IT TIPS AND IDEAS.**

### ANSWERS YOUR HI-FI QUESTIONS

... Helps you get top-notch results!

Here are just a few of the many subjects: How to get the right hi-fi equipment for your needs; Hi-fi versus P.A. type speakers; Loud-speaker construction and performance; Adjusting bass-reflex cabinets; Controlling distortion; Getting rid of "hangover"; The best reproducer enclosure; Selecting a woofer-tweeter; Sound-proofing materials; All about output transformers; Special hi-fi circuits; Ways to suppress noise; Negative feedback and how to use it; Amplifier construction hints; Minimizing tuner distortion; Avoiding chatter; Limiter-discriminator vs. ratio detector FM circuits; All about re-ords and record players; Avoiding record wear; Tips for custom builders; Bass-reflex calculations and design charts; Acoustical horn design data and equalizers; pick-up resonance and how to avoid it; a novel horn system . . . and literally dozens of other subjects.

Order High Fidelity Techniques in coupon today for 10-day FREE trial!

## GET MORE WORK out of YOUR OSCILLOSCOPE!



Oscilloscopes are "gold mines" for servicemen who learn to use them fully—and here is a book that **REALLY SHOWS YOU HOW.**

In clear, easily understood terms, *Modern Oscilloscopes and Their Uses* explains when, where and how to use the oscilloscope . . . how to interpret patterns . . . how to use your scope to handle all sorts of jobs easier, faster and better.

No complicated theory! This book gets right down to "brass tacks" in showing how oscilloscopes operate. Then you see exactly how to use them in lab work and on all types of AM, FM and television service . . . from locating troubles to handling tough alignment jobs easier and in lots less time.

### MODERN OSCILLOSCOPES AND THEIR USES

By J. H. Ruitter, Jr., of Allen B. Du Mont Laboratories, Inc.  
326 pages, 370 illus.  
Price \$6.00

### A complete guide to the HANDIEST INSTRUMENT OF THEM ALL!

Each operation is made as simple as A-B-C. You learn where and how to use the scope on specific jobs; how to make connections; how to adjust circuit components, how to set the controls . . . and HOW TO ANALYZE PATTERNS. 370 illustrations including dozens of pattern photos make things doubly clear.

Practice from it 10 days FREE. Order Modern Oscilloscopes in coupon.

## DON'T THROW OLD RADIOS AWAY!



Let this big Handbook show you **EXACTLY HOW TO FIX THEM** fast and r-i-g-h-t

There's a "secret" to fixing old radios fast and profitably . . . and Ghirardi's big 744-page, manual-size **RADIO TROUBLE-SHOOTER'S HANDBOOK** is it!

By **A. A. GHIRARDI**

Covers every model made by 202 mfrs. from 1925 to 1942

Airline  
Apex  
Arvin  
Atwater Kent  
Belmont  
Bosch  
Brunswick  
Clarion  
Crosley  
Emerson  
Fada  
G-E  
Kolster  
Majestic  
Motorola  
Philco  
Pilot  
RCA  
Silvertone  
Sparton  
Stromberg

No other guide like it! Gives common trouble symptoms and remedies for over 1,800 models of old home receivers, auto radios and record changers. Contains tube and component data, charts, circuits, etc. available from no other source.

Even beginners can repair old sets that dealers say should be thrown away because service data is lacking. Just look up the model you want to fix. Four times out of 5, this giant Handbook leads you right to the trouble . . . shows exactly how to fix it. No useless testing. No guesswork. You repair sets in a jiffy that would otherwise go to the junk pile.

There are over 400 pages of troubleshooting and service case histories. In addition, you get over 300 pages of helpful I-F transformer data; superhet realignment data and alignment peaks; handy troubleshooting reminder charts; auto radio gear ratios; complete data and characteristics on old tube types and components; tube substitution data . . . and dozens of other invaluable service tips and ideas. Price only \$6.50.

and over a hundred more!

Specify **RADIO TROUBLE-SHOOTER'S HANDBOOK** in coupon for 10-day FREE trial.

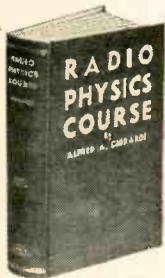

**RADIO PHYSICS COURSE**  
by Ghirardi  
972 pages, 508 illus.  
856 self-test questions  
Price only \$6.50

## Here's How to BREAK INTO RADIO-ELECTRONICS!

More people now in Radio-Television-Electronics got their basic training from this book than any other of its type!

"The most complete training course in radio fundamentals ever offered!" . . . that's what the experts say about Ghirardi's world-famous **RADIO PHYSICS COURSE** book. More widely used in World War II military training and for home study than any other basic text.

**RADIO PHYSICS COURSE** is the oldest text of its kind on the market—and still a "best seller" because it is so complete, clear and easy to understand, even without any previous radio training. You can buy newer and far more costly training—but you can't buy better training at anywhere near the price. Ask the men who know!

Starts right at the beginning with Basic Electricity. Then it takes you step by step through the entire field from circuits showing basic functions to the final applications of these circuits in radio-electronic equipment.

Study from it for 10 full days. Specify **RADIO PHYSICS COURSE** in coupon.

**Send No Money!  
TRY ANY BOOK  
TO FULL DAYS FREE!**

Dept. RE-25, Rinehart & Company, Inc.  
232 Madison Ave., New York 16, N. Y.

Check here for **MONEY-SAVING COMBINATION OFFER . . .**

. . . on Ghirardi's Radio & TV Receiver **CIRCUITRY AND OPERATION**, and Radio & TV Receiver **TROUBLESHOOTING AND REPAIR**. Price only \$12.00 for the two books plus postage. (Regular price \$13.25 . . . you save \$1.25). Payable at rate of \$3 after 10 days and \$3 a month for three months until \$12 has been paid. If not satisfactory, return books in 10 days and owe nothing.

Check here to order **INDIVIDUAL BOOKS**

- |   |   |
|---|---|
| <input type="checkbox"/> Radio & TV Receiver <b>CIRCUITRY &amp; OPERATION</b> . . . . . \$6.50    | <input type="checkbox"/> <b>PIX-O-FIX TROUBLE-FINDER GUIDES</b> (Nos. 1 and 2) . . . . . \$2.00 |
| <input type="checkbox"/> Radio & TV Receiver <b>TROUBLESHOOTING &amp; REPAIR</b> . . . . . \$6.75 | <input type="checkbox"/> <b>HIGH FIDELITY TECHNIQUES</b> . . . . . \$7.50                       |
| <input type="checkbox"/> <b>BASIC ELECTRONIC TEST INSTRUMENTS</b> . . . . . \$4.00                | <input type="checkbox"/> <b>MODERN OSCILLOSCOPES AND THEIR USES</b> . . . . . \$6.00            |
| <input type="checkbox"/> <b>MAGNETIC RECORDING</b> . . . . . \$5.00                               | <input type="checkbox"/> <b>RADIO TROUBLESHOOTER'S HANDBOOK</b> . . . . . \$6.50                |
|   | <input type="checkbox"/> <b>RADIO PHYSICS COURSE</b> . . . . . \$6.50                           |

If cash is sent with order, we pay postage—same 10 day return privilege. Otherwise, postage is extra.

To order **OUTSIDE U.S.A.**—Special combination offer, \$13.00 for both books. For all other books, add 50c each to above prices for handling through customs, etc. Sold for cash only. Any book may be returned in 10 days and money will be refunded.

Name

Address

City, Zone, State

# professional tube testers by EMC

featuring...

**Lowest Prices**  
**Precision Construction**  
**Widest Instrument Choice**  
**Advance-designs**



## EMC MODEL 204

### Tube - Battery - Ohm Capacity Tester

Easy, direct readings for all tubes from .75 to 117 filament volts • Flexible four-position lever-type switches positively protect against obsolescence • Large, 4½" three-color, "reject-good" scale meter • Checks batteries under rated load • Uses emission test • Checks continuity, shorts, opens and leakages • Line voltage control for variations from 105 to 135V • Checks resistance to 4 meg. ohms, capacity to 1 mfd., leakage to 1 meg. ohm • Easy-to-use roll chart • Handsome, hand-rubbed oak carrying case with removable cover.

MODEL 204P  
(ill.) \$55.90  
MODEL 204C  
(counter case)  
\$54.90  
MODEL 207  
204 Tester with  
extra large  
7½" meter  
for counter use.  
\$65.90



## EMC MODEL 205 Emission Tube Tester

Standard emission method accurately checks all tubes (with filament volts between .75 to 117V.) • Individual sockets • Compensates for line variations between 105-135V • Flexible four-position lever-type switches positively protect against obsolescence • Checks continuity, shorts, opens and leakages • Large, clear, 4½" three-color, "reject-good" scale meter • Handsome, hand-rubbed oak carrying case with removable cover • Easy-to-use roll chart.

MODEL 205P  
(ill.) \$47.50  
MODEL 205C  
(counter case)  
\$46.50



## EMC MODEL 206 Mutual Conductance Tube Tester

4½" three-color meter with calibrated micromho and "reject-good" scale checks mutual conductance and gas content • Plate current sufficient to check emission and mutual conductance • Flexible four-position lever-type switches positively protect against obsolescence • Easy, direct, readings for all tube types • Individual sockets • Instrument fuse replaced from panel front • Easy-to-use roll chart • Handsome, hand-rubbed oak carrying case with removable cover

MODEL 206P  
(ill.) \$83.50  
MODEL 206C  
(counter case)  
\$79.50



*New*

## EMC MODEL 208 Portable Tube Tester

Requires no supplementary equipment • Completely tests all tube types for quality, shorts, leakages, filament continuity and opens between any two tube elements • Adjustable line voltage visually assures accurate quality testing • Space saving, portable case, 5½" x 6¾" x 2¾", fits serviceman's "caddy case" • Individual sockets • Matches Hi-Fi tubes • Comes with detailed instruction book and tube listings.

MODEL 208  
(ill.) \$24.90  
MODEL 208P  
(Oak carrying  
case) \$27.90  
MODEL CRA (pic  
-ture tube adap-  
-ter for 204, 205  
208) \$4.50  
ICTA for 206)  
\$9.95

Free...  
write Dept  
RE-2 for your  
copy of complete  
catalog TODAY!

# EMC

**ELECTRONIC MEASUREMENTS CORP.**  
280 LAFAYETTE STREET NEW YORK 12, N. Y.  
EXPORT DEPT.— 136 LIBERTY ST. N. Y.

# new Devices



**TV BROADBAND AMPLIFIER**, *Blonder-Tongue model M1A*, has low-noise cascode circuits delivering more than 37-db gain on all v.h.f. channels. Four tubes operate on high band and three tubes on low. Maximum



output 1.25 volts r.m.s. on each band. Response flat over both v.h.f. bands with less than 0.75-db variation over any 6-mc range. Flatness assures optimum results for color TV, permits use of a greater number of amplifiers in cascade for long-line systems. — **Blonder-Tongue Laboratories, Inc.**, 526 North Ave., Westfield, N. J.

**HI-FI 50-WATT POWER AMPLIFIER**, *Fairchild 260*, intermodulation distortion under 0.5% at 42 watts, low harmonic distortion and high signal-to-noise ratio. Frequency response flat 20-20,000 cycles, power gain 42 db. Has 7¼ x 12 x 7-inch chassis, features self-contained balance control and adjustable bias supply. Permits adjust-



ment for minimum distortion, proper phase inversion and dynamic balance of output tubes to be made aurally without any test equipment. Good stability under varying load conditions — important where three-way or multiple speaker installations are used. — **Fairchild Recording Equipment Co.**, 154th St. and 7th Ave., Whitestone, N.Y.

**MULTI-OUTLET SYSTEM**, *Jerrold*, feeds 20 or more receivers with signal strength increased and signal-to-noise ratio maintained. Reception at each receiver, on all channels, is best antenna can provide. Has type ABD-1 distribution amplifier which amplifies signal from an-

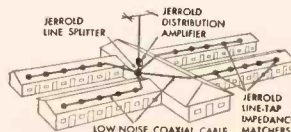

tenna by 25 db. The 115-volt-operated amplifier, mounted in doors, contains five-tube cascode circuit with noise level of 6 db.

The 72-ohm output of ABD-1 amplifier feeds passive *splitter*, used, if needed, to divide signal equally two or four ways for distribution to various parts of building. *Splitter* uses no tubes; cannot be overloaded by any signal. Noise-free coax cable from room to room distributes high-gain signal to each receiver. Cables can be tapped conveniently by using line-tap impedance matcher for each receiver. Line tap matches receiver's 300-ohm antenna input; completely isolates each receiver against oscillator interaction. — **Jerrold Electronics Corp.**, 26th and Dickinson Sts., Philadelphia 46, Pa.

**HI-FI AMPLIFIER** and preamplifier (remote controlled) *Newcomb Classic 2500-R* features *Audi-Balance* which enables the user to find out by simply pressing a button if amplifier is operating at minimum distor-



tion. Less than .01% distortion up to 10 watts, less than 0.2% at 20 watts; 10-100,000-cycle response, within 0.1 db from 10-30,000 cycles; dual-range tone controls; bass range -16 db to +23 db; treble range -25 db to +23 db; d.c.-operated preamplifier. — **Newcomb Audio Products Co.**, 6824 Lexington Ave., Hollywood 38, Calif.

**HI-FI AUDIO AMPLIFIER**, *PILOTONE AA-420*, Williamson type with push-pull 5881's for 15-watt output combined with preamplifier. Six tubes plus rectifier. Dual equalization switches provide five positions of treble rolloff and five of bass turnover. Loudness control with individual level setting controls for three inputs.

Frequency response ±1.0 db, 15 to 20,000 cycles at rated output. Total harmonic distortion



**NEW DEVICES**

less than 1%. Intermodulation distortion less than 2% at rated output. Hum and noise level 80 db below rated output.—**Pilot Radio Corp.**, 37-06 36th St., Long Island City, N. Y.

**TENNA-ROTOR, Alliance K-22**, consists of a rotator and a control unit in a plastic case. Rotator unit mounted on antenna mast; control box placed on or



adjacent to receiver. Unit's speed approximately 2 r.p.m. Die-cast housing of rotator unit has been strengthened and magnetic brake added to prevent drifting.—**Alliance Manufacturing Co.**, Alliance, Ohio.

**LIGHTNING ARRESTER, JFD AT130**, for v.h.f. and u.h.f. utilizes new material with less capacitance and less inductance which results in no line loading on u.h.f. Case of AT130 is weatherproof plastic. Patented sawtooth washers provide permanent and positive electrical contact without requiring stripping of lead-in wires. AT130 can be used with 300-ohm v.h.f. or u.h.f. flat or tubular transmission or open wire.—**JFD Manufacturing Co.**, 6101 16th Ave.,

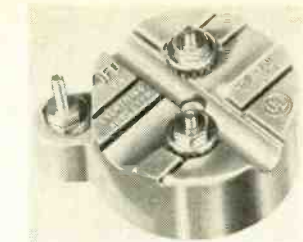

Brooklyn 4, N. Y.

**ALL-CHANNEL V.H.F. ANTENNA, Kay-Townes' Rear Guard**, uses no reflectors or screens. Front-to-back ratios of better than 25-1 (some chan-

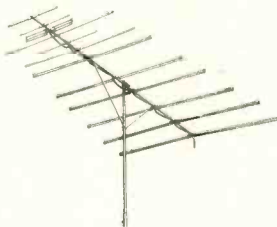

nels up to 100-1) with narrow forward lobe of 35° with a forward gain of 8 db or better, obtained electronically by a phasing system using seven folded dipoles.—**Kay-Townes Antenna Co.**, 1511 Dean Ave., Rome, Ga.

**TWIN-LIGHT CONTROL UNIT** for *Leader Superrotor* antenna rotator features two arrows on dial face, pointing left and right, that light up automatically when the antenna is ro-

tated. By observing relative brilliance of arrows, user can determine direction of antenna rotation. A de luxe unit with a NESW directional scale on dial face also being offered.—**Leader Electronics Corp.**, 2925 E. 55th St., Cleveland 27, Ohio.

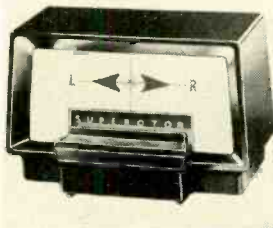

**VEST POCKET BEAM, Mosley**, two-element unit, has loading coils at element centers which permit rotary beam performance on 40-meter band. Supporting boom is 14½ feet long and element lengths approximately 33½ feet. Weatherproof link winding on radiator coil designed to match 50-ohm coaxial feed line. Tests indicate standing-wave ratios as low as 1.07/1. Front-to-back ratios in the order of 19 db. Beam is pre-tuned to 7210 kc.—**Mosley Electronics Inc.**, 8622 St. Charles Rock Road, St. Louis, Mo.

directional pattern in horizontal and vertical planes at all frequencies. *Model 201*, single-bay unit, can be elaborated into two-bay structure, *Model 202*, by addition of stacking transformer.—**Telrex Inc.**, Asbury Park, N. J.

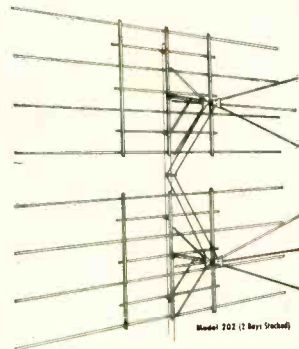

**TV ANTENNAS, Telco Mity-V and Bonnie-V.** *Mity-V* an adjustable u.h.f.-v.h.f. unit for close-in reception areas. Twin elements are adjustable 60° to 90° for best performance.



*Bonnie-V*, a streamlined antenna strictly for local reception areas.—**Television Hardware Manufacturing Co.**, Division of General Cement Mfg. Co., 919 Taylor Ave., Rockford, Ill. (Cont'd. on page 114)

Just Out

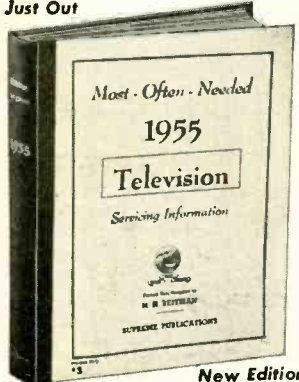

New Edition Covers all important 1955 Sets

# New SUPREME 1955 TV Manual

## AMAZING BARGAIN

The new 1955 TV manual is the scoop of the year. Covers all important sets of all makes in one giant volume. Your price for this mammoth manual is only \$3. This super-value defies all competition. Other volumes at only \$3 and \$2 each. Each manual has a whole year of service material. Includes all data needed for quicker TV repairs. Practically tells you how to find each fault and make the repair. More pages, more diagrams, more service data per dollar of cost. Get the best for less. Get SUPREME.

## TELEVISION SERVICING COURSE

Let this new course help you in TV servicing. Amazing bargain, complete, only \$3, full price for all lessons. Giant in size, mammoth in scope, topics just like a \$200.00 correspondence course. Lessons on picture faults, circuits, adjustments, short-cuts, UHF, alignment facts, hints, antenna problems, trouble-shooting, test equipment, picture analysis. Special, only **\$3**

## RADIO DIAGRAMS

Here is your complete source of all needed RADIO diagrams and service data. Covers everything from most recent radios to pre-war old-timers; home radios, auto sets, combinations, changers, and portables. Sensational values. Still sold at pre-Korean prices. Only \$2 for most volumes. Every Radio manual contains large schematics, all needed alignment facts, parts lists, voltage values, trimmers, dial stringing, and helpful service hints. All volumes are large in size, 8½x11 inches, about 192 pages. See coupon at right for a complete list of these low-priced manuals.

## COVERS ALL POPULAR SETS

*Supreme TV manuals* have all needed service material on every popular TV set of every important manufacturer. Here is helpful, practical, factory-prepared data that will really make TV servicing and adjustment easy for you. Benefit and save with these amazing values in service manuals. These giant TV manuals have complete circuits, alignment facts, test patterns, response curves, service hints, all recommended changes, voltage charts, waveforms, and many double-page diagram blueprints. Here is your TV service material to help you do more expert work quicker; and priced at only \$3 and \$2 per manual covering a full year of material. Be ready to repair any model by having in your shop all nine TV volumes listed in coupon below. Or try the new 1955 TV manual to see what an amazing bargain you get for only \$3. Send trial coupon for prompt shipment, or ask your jobber.



The repair of any television set is really simple with *Supreme TV service manuals*. Every set is covered in a practical manner that will simplify trouble-shooting and repair. This is the help you need to find the highest faults in a jiffy. Each \$3 TV volume covers a whole year of service material. *New Television Servicing Course* will aid you in learning TV. Be wise, buy *Supreme Manuals* only once each year instead of spending dollars every week for not needed data.

## NO-RISK TRIAL ORDER COUPON

**SUPREME PUBLICATIONS, 1760 Balsam, Highland Park, ILL.**

### Radio Diagram Manuals

Most Often Needed Series (See full description at left.)

- 1954 Radio Manual, \$2.50
- 1953 Diagrams
- 1952 Radio
- 1951 Diagrams
- 1950 Manual
- 1949 Radio
- 1948
- 1947
- 1946
- 1942
- 1941
- 1940
- 1939
- 1926-1938 Manual, \$2.50
- Master INDEX only 25c

EACH AT ONLY **\$2** EACH

Rush today Radio manuals checked  at left and TV manuals below. Satisfaction guaranteed.

- New 1955 Television Manual, \$3.
- 1954 TV, \$3.
- 1953 TV Manual, \$3.
- UHF Manual, \$1.50
- 1952 Television Manual, \$3.
- 1951 TV, \$3.
- 1950 Television Manual, \$3.
- 1949 TV, \$3.
- 1948 TV, \$3.
- 1947 TV & FM, only \$2.
- Television Servicing Course, complete, only \$3.

- I am enclosing \$..... Send postpaid.
- Send C.O.D. I am enclosing \$..... deposit.

Name: ..... Address: .....

**Supreme Publications**  
Sold by All Leading Parts Jobbers

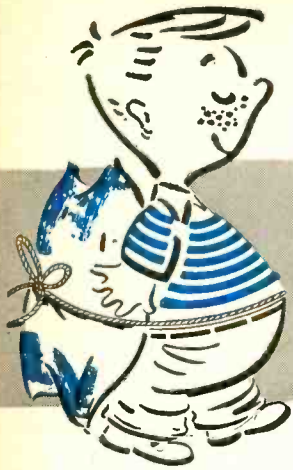

# Now!

# KAY-TOWNES

brings you complete

# Protection from the Rear

# Plus

## Quick Rig!

THE *first*  
SNAP-OUT

ANTENNA WITH THE  
EXCLUSIVE  DOUBLE LOCK  
FEATURE!

Boom also folds to take less room in storage and for ease of installation. Sure-grip mast clamp holds in gale-force winds... will not slip or crush.



Exclusive with KAY-TOWNES Elements will not droop, sag or fold up on a Kay-Townes Antenna... they're nested and double locked in position to stay in position.



Patents applied for

New features that make the K-T "REAR-GUARD" America's most advanced TV Antenna!

- ★ Completely Preassembled, it's mechanically safe!
- ★ It snaps in place to stay in place! Elements are double locked in position! A K-T Exclusive!
- ★ No bolts or nuts to tighten on elements!

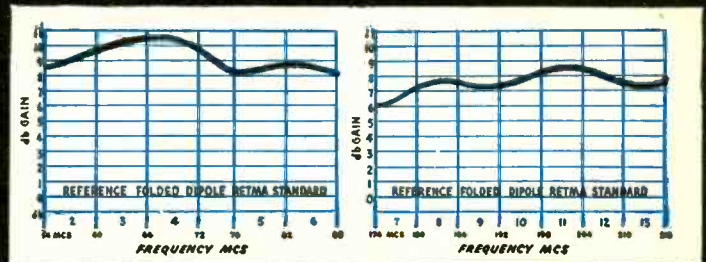

Front to back ratio is better than 25/1 forward lobe 30° or better standing wave ratio 1.2:1 average.

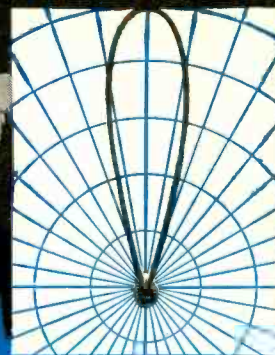

CHANNEL 2 THROUGH 13  
RADIATION CURVE  
REPRESENTING ALL  
VHF CHANNELS

Over 20 to 1 gain on ALL Channels

## For Quality...

Manufactured and distributed in Canada by Delhi Metal Products, Ltd. Delhi, Ontario

# REAR GUARD

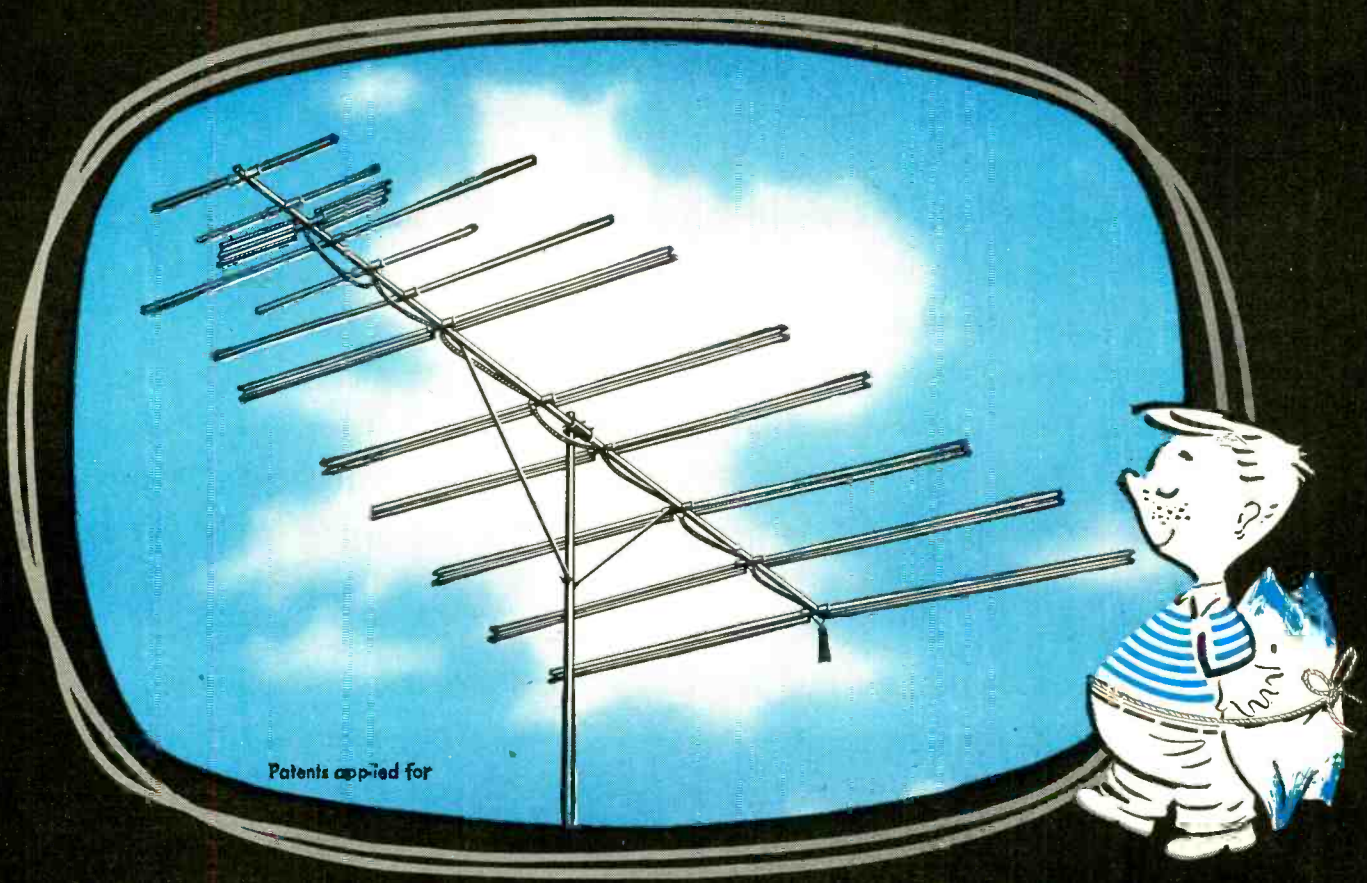

## THE ANTENNA DESIGNED TO REJECT UNWANTED SIGNALS FROM REAR AND SIDES!

In areas where many local stations or stations from near-by cities interfere with reception, ordinary antennas cannot filter out unwanted signals from sides and rear ... BUT the KAY-TOWNES REAR-GUARD, with a front to back ratio far in excess of 20 to 1, is designed for this particular job ... to give quality reception even in problem areas.

Add to the REAR-GUARD'S pin point selectivity such exclusive K-T features as double locked and nested elements that cannot droop or sag, Sure-Grip Mast Clamp that holds in gale-force winds without slipping or crushing, extra rigid construction and wood dowel pins and crimped ends that relieve metal fatigue due to vibration ... they all add up to America's most wanted TV Antenna.

... for Performance look to KAY-TOWNES!

The First Name in TV Antennas

# KAY-TOWNES

## ANTENNA COMPANY

### BOX 593B, ROME, GEORGIA

Use the K-T Line  
of television  
accessories

**NEW DEVICES**

**FRINGE-AREA ANTENNA**, Welco Sabre Senior, has high gain on all v.h.f. channels. *Miracle Phase* isolates and minimizes interaction and loading

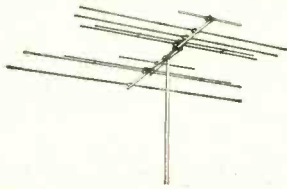

of phased elements. Coupling of working elements makes it possible to feed received signal to set for clear pictures in fringe areas.—Welco Manufacturing Co., Burlington, Iowa.

**U.H.F. CONVERTER**, Alliance model UC-2, has coaxial tuner for smooth operation. Low-noise amplification assures good reception in any area.—The Alliance Manufacturing Co., Alliance, Ohio.



**VOLTMETER KIT**, Franklin model FV-1, includes tubes, assembly material, test leads and detailed assembly manual. Fast measurements with greater accuracy on 1.5-volt low scale—more than 2½-inch scale length

per volt. A.c.-d.c. ranges: 0, 1.5, 5, 15, 50, 150, 500, 1,500 volts (1,000-volt maximum on a.c.). Ohmmeter range from ×1 to ×100,000 ohms and ×1 megohm. Measures 0.1 ohm to 1,000 megohms.—Franklin Electronics, King St., Franklin Park, Ill.

**NEW KIT, General Cement Glo-Bar Filament Resistor Kit**, comprises two washer type thermistors suitable for replacement on any well known brand of TV receiver (such as Motorola, General Electric, etc.) using series-tube heater string.—General Cement Manufacturing Co., 919 Taylor Ave., Rockford, Ill.

**PORTABLE OSCILLOSCOPE KIT**, Heath model OL-1 employs 3-inch cathode-ray tube to perform all utility scope functions. Has push-pull deflection amplifiers. Sweep operation up to

100,000 cycles.—Heath Co., Benton Harbor 20, Mich.



**NEW KITS**, Tech-Master amplifier kit TM-15A and preamplifier-equalizer kit TM-15P. Amplifier kit based on Williamson circuit with modifications—has been increased in output from 15 to 20 watts. Distortion less than 0.25% at normal listening levels, with good transient characteristics.

Preamplifier kit has four input channels, selector switch for FM, AM or TV tuner; crystal or reluctance style pickup; tape recorder or other signal sources; contains a cathode-follower output stage.



Both units complete with all components, step-by-step in-

(Continued)

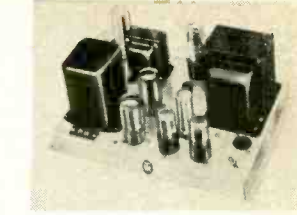

structions and premounted tube sockets, and terminal strips.—Tech-Master Corp., 75 Front St., Brooklyn 1, N. Y.

**PORTABLE KIT**, Xcelite No. 77 contains seven nut drivers 3/16 to 3/8 inch with different colored handles to identify size.—Xcelite, Inc., Orchard Park, N. Y.



**LOUDSPEAKER SUPPORT STAND**, Atlas model SS-2, has been redesigned to accommodate U-brackets of all makes and types of loudspeaker projectors. Top bracket adapter permits attachment or removal of a projector without unscrewing top adapter or using any tools. Base stability is adequate for support of cluster of speakers even under adverse wind conditions. Supports several hundred pounds, has height extension of 5 to 10 feet and weighs 20 lb.—Atlas Sound Corp., 1451 39th St., Brooklyn 18, N. Y.

**FREE ALLIED'S SPECIAL 64-PAGE HI-FI CATALOG**

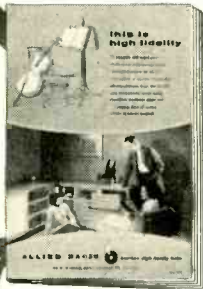

Your guide to an easy understanding of Hi-Fi—plus the world's largest selection of Hi-Fi systems and components

send for it

This 64-page book shows you how to select a Hi-Fi music system at lowest cost. Tells you what to look for in each unit and shows many handsome, practical installation ideas. Offers you the world's largest selection of complete systems and individual units from which to make your money-saving choice. To understand Hi-Fi, to own the best for less, you'll want this free book. Write for it today.

**ALLIED RADIO**

America's Hi-Fi Center

ALLIED RADIO CORP., Dept. C-25  
100 N. Western Ave., Chicago 80, Ill.

Send FREE High Fidelity Catalog

Name.....  
Address.....  
City..... Zone..... State.....

**NEW! All Channel SUPER POWERFUL VHF-UHF TV RECEPTION IN ALL DIRECTIONS**

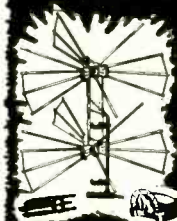

Only \$23.50

Model AX-524

**ROCKET DIRECTRONIC MOTORLESS TV ANTENNA**  
360° ELECTRONICALLY SWITCHED BEAM

In the fringe or ultra-fringe, the NEW 1955 Motorless Directronic will out-perform any ordinary antennas. This sensational new 360° UHF-VHF TV antenna offers "around the compass" reception WITHOUT Rotors. Provides superb ghost-free picture clarity. Model AX-524 "Service-man's Array" contains Hi-Pac Molded Insulator of Extreme tensile strength, 24 Insulative aluminum elements, including 6 Multi-purpose Reflector-directors, 1 set matched tie rods, Universal Mast Clamps, 6-position Beam Selector Switch, 75' Low-loss UHF-VHF Tubular TRX Cable.

**Super UHF RECEPTION HI-GAIN YAGI**

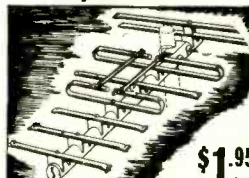

\$1.95 ea.

Provides guaranteed sensational UHF fringe reception. Amazing sensitivity provides up to 30 db gain, using 2, 4, or 6 bay stacked arrays. Ghosts, interference minimized or eliminated. Each serviceman's array provides 4 directors, 2 ea. folded dipoles, 2 reflectors. And our low price insures a low cost installation. Select the model required in your area.

Model	Covering
F-7A	Channels 14-48
F-7B	Channels 27-62
F-7C	Channels 47-83
Matched stacking bars \$0.30 pr.	



**UHF CORNER REFLECTOR**

ONLY \$2.99 EACH IN LOTS OF 6

SINGLE LOTS \$3.50 EACH

This hi-gain UHF Corner Reflector can only be offered you at this low price for a short time. 8 to 11 db gain across UHF band. Order Model F-6. ALL PRICES F.O.B. CLEVELAND, OHIO Do not remit more than complete purchase price. Pay shipping charges on receipt of goods. 25% deposit on all C.O.D. orders, please. Money-back guarantee. Prices Subject to Change Without Notice

**Our Greatest BARGAIN**

2-Bay 16-ELEMENT CONICAL ARRAY with Hi-Band Adapters Sturdy 3/8" Elements

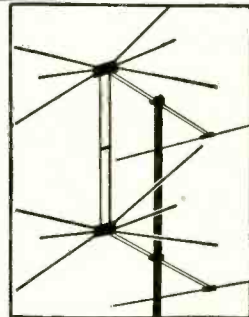

\$4.99 IN LOTS OF THREE

SINGLE LOTS \$5.30

Never before has National Electronics had a BARGAIN like this. We made a special purchase in order to get these sensational prices. And this array has everything. This conical 2-bay 16-element array provides ultra-fine fringe reception. Includes sixteen 3/8 inch airplane type aluminum elements, including hi-band adapters for greater gain on the high channels and is complete with one pair of stacking bars to each array. These are packed in cartons of three 16-element arrays per carton, with tie rods at \$14.95 per carton. When purchased in single 16-element arrays, separately boxed—your cost is.....\$ 5.30 each  
3 Two-Bay Arrays per carton without Tie Rods.....\$13.50 carton  
4 Bay Ultra-Fringe Stacking Assembly for Above—Model 4B.....\$1.95 set

**FAMOUS ROCKET ZOOM-UP TOWERS**

Sturdy • Reliable • Easiest Installation Economize with Rocket Zoom-up Towers. Offers quickest, easiest way to make an installation up to 50'. Each section telescopes inside the other—to erect, simply slide out each section in its turn—insert bolt thru section below—tighten to keep mast from turning. Each tower complete with guy rings, bolts, and mounting base suitable for peak or flat roof. Handsome and sturdy. Rocket Zoom-ups offer you economy and long life. Order by size.

20'	\$ 9.95	30'	\$15.95
40'	19.95	50'	29.95
(Deduct 10% discount in lots of 3)			

**National Electronics**  
OF CLEVELAND  
**THE HOUSE OF TV VALUES**

6608 Euclid Ave., Dept. E-2, Cleveland 3, Ohio



NEW DEVICES

(Continued)

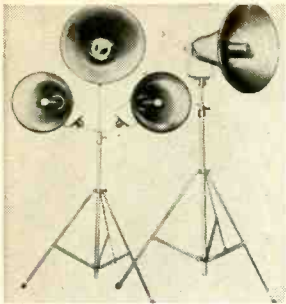

**SPEAKER ENCLOSURE, Klipsch Rebel 3, G & H Wood,** has been added to their line which already includes Rebel 4 and 5. Stems in design from the

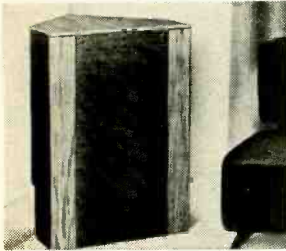

Klipschorn. Maximum performance per cubic foot possible through use of the same principles of mirror images produced by walls in a room corner as in Klipschorn.—G & H Wood Products, 75 North 11th St., Brooklyn 11, N. Y.

**ADAPHONE INSTRUMENT, Fenton,** permits listening to radio and TV without disturbing others by using earpiece set in the unit. A 5-ohm load replaces



speech coil when loudspeaker is switched off. Provides hearing aid for hard-of-hearing listener or a silent listener for night owls. Has a 15-foot extension cord. Additional earpiece set or an earphone embedded in a 12 x 9 x 2½-inch foam-rubber pillow also available.—Fenton Co., 15 Moore St., New York 4, N. Y.

**ENCLOSURE, nonresonant, for use with the Hartley 215 loud speaker.** Has two-stage acoustic filter and measures 18 x 18 x 16

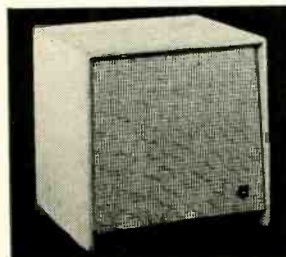

All specifications given on these pages are from manufacturer's data.

inches in unfinished gumwood, sanded ready for staining or painting.—H. A. Hartley Co. Inc., 521 E. 162nd St., New York, N. Y.

**INDUSTRIAL METERS, Phaostron,** incorporate most ruggedized features demanded by military under specification MIL-M-10304. Sturdy, metal-



cased, with easy-to-read front zero adjustments. Available in 2½- and 3½-inch round or square bezels. A.c. and d.c. models. Phaostron Co., 151 Pasadena Ave., South Pasadena, Calif.

**49 PANEL METERS, Simpson,** have four ranges in microammeters d.c.: 25-0-25, 50-0-50, 100-0-100, 500-0-500; three ranges in ammeters d.c.: 0-75, 0-100, 0-150.—Simpson Electric Co., 5200 W. Kinzie St., Chicago 44, Ill.

**TAPE RECORDER, Symphotone model 212,** two-speed record-playback mechanism records at 3¼ and 7½ i.p.s. with twin-track recording head. Frequency response 40 to 13,000 cycles at 7½ i.p.s. One control selects fast, forward, standard forward, fast rewind and stop. Other controls select playing speed,

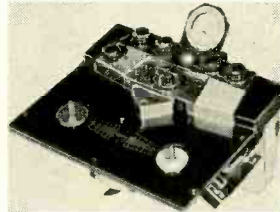

record-playback, volume, on and off and speaker cutout. Two inputs available—high-impedance jack for microphone and high-impedance input on terminal strip for phono or radio tuner.—Webster Electric Co., 1900 Clark St., Racine, Wis.

**REPLACEMENT CARTRIDGE, Turner** universal phonograph pickup, can be used to replace 95% of all 78-r.p.m. pickups in use. Available in two models, AU and A. Model AU has an externally mounted capacitor for low-voltage (2.0 volts or lower

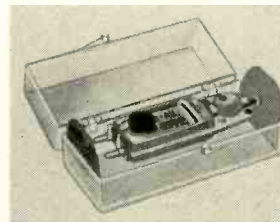

output) replacements. The capacitor may be slipped off for high-voltage replacements. Model A, same cartridge as AU, but furnished without the external capacitor.—The Turner Co., 933 17th St. N. E., Cedar Rapids, Iowa. END

# BUILD 15 RADIOS

ONLY

## AT HOME \$19.95

Complete

With the New Improved 1955 Progressive Radio "EDU-KIT"

NOW INCLUDES  
HIGH FIDELITY,  
SIGNAL TRACER, and  
CODE OSCILLATOR



- ATTRACTIVELY GIFT PACKED
- FREE SOLDERING IRON
- NO ADDITIONAL PARTS NEEDED
- EXCELLENT BACKGROUND FOR TV
- 10 DAY MONEY-BACK GUARANTEE
- SCHOOL INQUIRIES INVITED
- ABSOLUTELY NO KNOWLEDGE OF RADIO NECESSARY

### WHAT THE PROGRESSIVE RADIO "EDU-KIT" OFFERS YOU

The Progressive Radio "Edu-Kit" offers you a home study course at a rock bottom price. Our Kit is designed to train Radio Technicians, with the basic facts of Radio Theory and Construction practice expressed simply and clearly. You will gain a knowledge of basic Radio Principles involved in Radio Reception, Radio Transmission and Audio Amplification. You will learn how to identify Radio Symbols and Diagrams; how to build radios, using regular radio circuit schematics; how to mount various radio parts; how to wire and solder in a professional manner. You will learn how to operate Receivers, Transmitters, and Audio Amplifiers. You will learn how to service and trouble-shoot radios. You will learn code. You will receive training for F.C.C. license. You will learn High Fidelity. In brief, you will receive a practical basic education in Radio, worth many times the small price you pay.

### THE KIT FOR EVERYONE

The Progressive Radio "Edu-Kit" was specifically prepared for any person who has a desire to learn Radio. The Kit has been used successfully by young and old in all parts of the world. It is not necessary that you have even the slightest background in science or radio. The Progressive Radio "Edu-Kit" is used by many Radio Schools and Clubs in this country and abroad. It is used for training and rehabilitation of Armed Forces Personnel and Veterans throughout the world. The Progressive Radio "Edu-Kit" requires no instructor. All instructions are included. All parts are individually boxed, and identified by name, illustration and diagram. Every step involved in building these sets is carefully explained. You cannot make a mistake.

### PROGRESSIVE TEACHING METHOD

The Progressive Radio "Edu-Kit" comes complete with instructions. These instructions are arranged in a clear, simple and progressive manner. The theory of Radio Transmission, Radio Reception, Audio Amplification and servicing by Signal Tracing is clearly explained. Every part is identified by photograph and diagram. You will learn the function and theory of every part used. Therefore you will build radios, perform jobs, and conduct experiments to illustrate the principles which you learn. These radios are designed in a modern manner, according to the best principles of present-day educational practice. You begin by building a simple radio. The next set that you build is slightly more advanced. Gradually, in a progressive manner, you will find yourself constructing still more advanced multi-tube radio sets, and doing work like a Professional Radio Technician. Altogether you will build fifteen radios, including Receivers, Transmitters, Amplifiers, Code Oscillator and Signal Tracer. These sets operate on 105-125 V. AC/DC. An Adaptor for 210-250 V. AC/DC operation is available.

### THE PROGRESSIVE RADIO "EDU-KIT" IS COMPLETE

You will receive every part necessary to build 15 different radio sets. Our kits contain tubes, tube sockets, chassis, variable condensers, electrolytic condensers, mica condensers, paper condensers, resistors, line cords, selenium rectifiers, tie strips, coils, hardware, tubing, etc. Every part that you need is included. These parts are individually packaged, so that you can easily identify every item. A soldering iron is included, as well as an Electrical and Radio Tester. Complete, easy-to-follow instructions are provided. In addition, the "Edu-Kit" now contains lessons for servicing with the Progressive Signal Tracer, F.C.C. instructions, quizzes, high fidelity instructions. The "Edu-Kit" is a complete radio course, down to the smallest detail.

### TROUBLE-SHOOTING LESSONS

Trouble-shooting and servicing are included. You will be taught to recognize and repair troubles. You will build and learn to operate a professional Signal Tracer. You receive an Electrical and Radio Tester, and learn to use it for radio repairs. While you are learning in this practical way, you will be able to do many a repair job for your neighbors and friends, and charge fees which will far exceed the cost of the "Edu-Kit". Here is your opportunity to learn radio quickly and easily, and have others pay for it. Our Consultation Service will help you with any technical problems which you may have.

### FREE EXTRAS

- ELECTRICAL & RADIO TESTER ● ELECTRIC SOLDERING IRON ● TV BOOK ● RADIO TROUBLE-SHOOTING GUIDE ● CONSULTATION SERVICE ● QUIZZES ● F.C.C. TRAINING
- Progressive "Edu-Kits" Inc., 497 Union Ave., Dept. RE-101, Brooklyn 11, N.Y.

MAIL TODAY—Order shipped same day received.

10-Day Money-Back Guarantee. Include ALL FREE EXTRAS

- Send "Edu-Kit" Postpaid. I enclose full payment of \$19.95 (U.S.A. only).
- Send "Edu-Kit" Postpaid. I enclose full payment of \$20.95 (Outside U.S.A.).
- 210-250 V. Adaptor for "Edu-Kit"—\$2.50.
- Send "Edu-Kit" C.O.D. I will pay \$19.95 plus postage (U.S.A. only).
- I wish additional information describing "Edu-Kit". No Obligation.
- Send me FREE Radio-TV Servicing Literature. No Obligation.

Name.....  
Address.....

### PROGRESSIVE "EDU-KITS" INC.

497 UNION AVE., Dept. RE-101, Brooklyn 11, N.Y.

# C-D's CUB BEST-BAR NONE

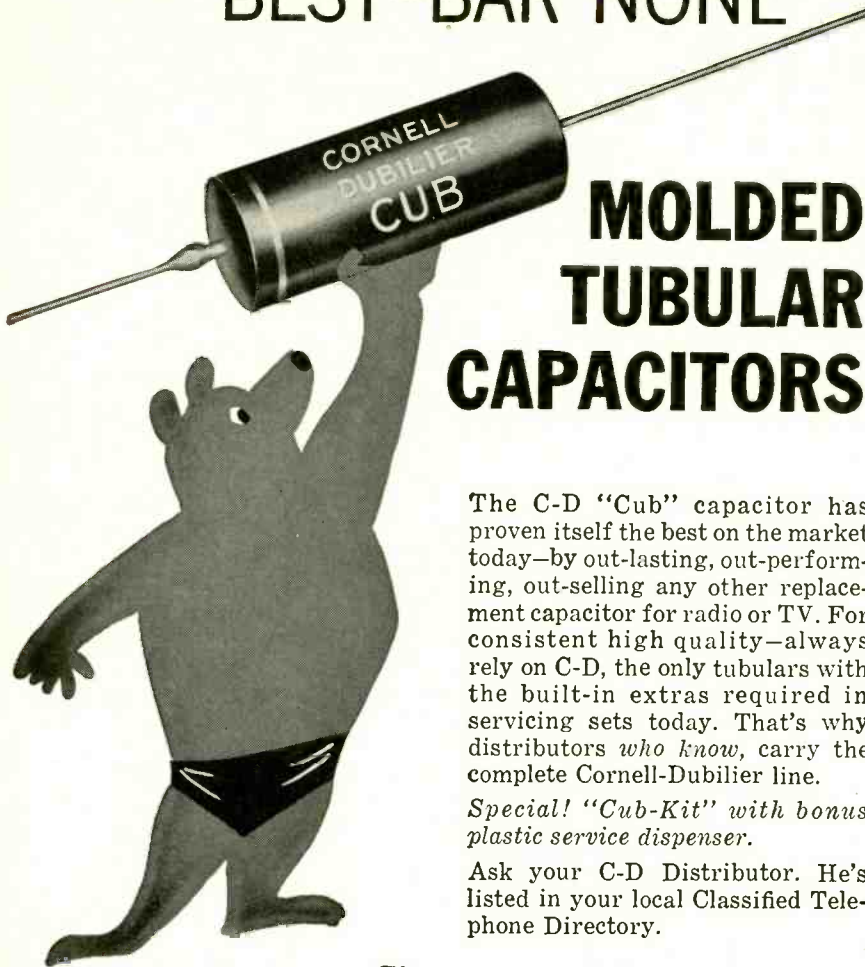

## MOLDED TUBULAR CAPACITORS

The C-D "Cub" capacitor has proven itself the best on the market today—by out-lasting, out-performing, out-selling any other replacement capacitor for radio or TV. For consistent high quality—always rely on C-D, the only tubulars with the built-in extras required in servicing sets today. That's why distributors *who know*, carry the complete Cornell-Dubilier line.

*Special! "Cub-Kit" with bonus plastic service dispenser.*

Ask your C-D Distributor. He's listed in your local Classified Telephone Directory.

*There are more C-D capacitors in use today than any other make*



### CONSISTENTLY DEPENDABLE CORNELL-DUBILIER CAPACITORS

PLANTS IN SOUTH PLAINFIELD, N. J.; NEW BEDFORD, WORCESTER AND CAMBRIDGE, MASS.; PROVIDENCE AND HOPE VALLEY, R. I.; INDIANAPOLIS, IND.; SANFORD AND FUGUAY SPRINGS, N. C.; SUBSIDIARY: THE RADIART CORPORATION CLEVELAND, O.



#### NATESA MAKES LIST

To encourage the practice of distributor selling to service technicians only, the National Alliance of Television and Electronic Service Associations has planned a list of bona fide radio-TV service firms, Frank Moch, NATESA president, reports.

The list will contain names of all genuine service businesses, whether members of NATESA affiliates or not, Mr. Moch explained, adding that he hoped it might be used one day by distributors as the sole guide to genuine service shop owners. Jobbers will be urged to restrict dealer discounts to that list, possibly offering other and smaller discounts to some other types of customers.

A Chicago list, in preparation by TISA, is expected to be ready shortly.

#### NEW YORK LICENSING

Arguments for and against a bill to license New York City TV and radio repair were heard at a City Council hearing Nov. 30 last. The bill (see Radio Month), a local law sponsored by Councilmen Cunningham, Kranis and Issacs, was passed by the Council in 1951 but was later declared ineffective for technical (legal) reasons.

Among those favoring the proposed local law were representatives of a local organization, the Associated Radio and Television Servicemen of New York (City) (ARTSNY); the District Attorney of Brooklyn, Edward S. Silver, and representatives of a number of out-of-town and even out-of-state groups. The representatives of Philadelphia groups stated that their interest in the subject was due to the influence that passing of a service bill in New York City would have on the rest of the country.

Leading opponent of the bill was Glen McDaniel, president of the Radio-Electronic-Television Manufacturers Association and a representative of the Commerce and Industry Association of New York. Two small radio-TV service associations, one an alumni group of the local RETMA training program and the other a TV service group from Staten Island, also opposed the bill, while another, an appliance and TV-radio servicing organization, favored it. In all 12 voices were heard in favor of the proposition and 8 opposed.

Opposition was based on governmental interference in private industry, possibility of political angles and



### SUBMINIATURE POCKET TESTER

A true subminiature tester which affords the serviceman with eight 'test instruments' in one, compactly mounted in a sturdy metal case.

- Low Voltage (1000V. AC, DC)
- High Voltage (50KV)
- AGC Voltage Substitution
- Signal Tracer
- Audio Oscillator
- Continuity Tester
- Condenser Tester
- Visual Output Meter

See your dealer or write . . .

# EBY

SALES CO. of N. Y.  
130 E. Lafayette St., N. Y. C. 13

free on request.  
EBY is at all leading dealers.



alleged greater cost to the customer due to limiting of the number of technicians through licensing. Advocates cited the possibility of controlling the unethical service technician without the difficult expedient of issuing complaints and resorting to a court of law, the advantage to the customer of knowing that his repairman is qualified and an increase in prestige to the service trade in general. District Attorney Silver was especially explicit on the weaknesses of legal redress, pointing out that few set owners would swear out a complaint and take the necessary time to testify in court, preferring to pocket their losses rather than incur the larger ones inevitable in the effort to bring fraudulent operators to justice.

**UTAH ON LICENSES**

License proposals would be put before the State Legislature of Utah during the 1955 session, the assistant Salt Lake City attorney reported recently. This, he stated in a report to the city commission, appeared to be the best answer to the problems of radio-TV servicing.

The report was the result of a meeting with a committee of service technicians and the local BBB.

**TISA-ILLINOIS ELECTS**

The Television Installation Service Association, Chicago, Ill., has unanimously re-elected Frank J. Moch (Aide Service Corp.) president. Walt Krzak (Television Engineers, Inc.) was named first vice president, Russ Havill (Havill's TV) second vice president, Larry Corlew (Electronic Engineers, Inc.) secretary, George Hingson (Courtesy TV Service) treasurer and Mel Brown (B & M Radio and TV Service) sergeant at arms.

President Moch outlined accomplishments of 1954 and proposed certain changes for 1955. These included creation of a third vice presidency, whose incumbent would act as coordinator of membership drives, and making the NATESA delegate and alternate elective offices.



New TISA officials, left to right: Larry Corlew, Russ Havill, Mel Brown, Frank Moch, Walt Krzak, Geo. Hingson.

**\$2.7 BILLION SERVICE FEE**

Installation and maintenance of TV and radio equipment for the home is now a major contribution to the total industry income, RCA Executive Vice President Charles M. Odorizzi told a Cleveland meeting recently.

(Continued on page 120)

**The DYNAMŪ Story**  
**IS TOLD BY OUR CUSTOMERS**

B  
R  
E  
A  
K  
T  
H  
E  
S  
O  
U  
N  
D  
B  
A  
R  
R  
I  
E  
R  
F  
O  
R  
T  
A  
P  
E

"... DYNAMŪ head produced significantly less hum and tape hiss..."

"... For the first time my tapes sound as good as my best records through my Hi Fi System..."

"... Could extend useful frequency response 15 kc or more..."

"... No audible distortion such as may be discerned during peaks of a phonograph recording..."

"... No noise is detectable except with ear right against the speaker..."

"... A phonograph record transferred to tape and played back is indistinguishable from the original..."

"... It was a 'cinch' to convert my tape recorder with your well illustrated folders..."

"... Can't tell the difference at 7.5" with DYNAMŪ and 15" with my professional recorder..."

**DYNAMŪ DATA**

● DIRECT magnetronic drive as in finest professional studio equipments.

● 1½/10,000 of an inch gap formed of pure electrolytic copper for highest efficiency and long life. The finest and narrowest gap ever available on any head.

● RECORD and REPRODUCE gaps a straight line from end to end within 2 wave lengths of light for exact reproduction quality from one recorder to another with lowest intermodulation distortion.

● Distortion—typical head: 100 cycles— .6% at 15db below tape saturation. 800 cycles— .35% as above.

**STANDARD GUARANTEE ON MATERIALS AND WORKMANSHIP**  
**Illustrated Step-By-Step Instructions Furnished**

**"DO IT YOURSELF"**  
Or Factory Authorized Installation

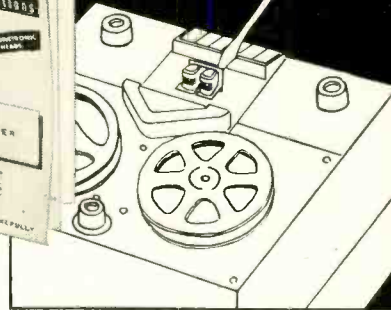
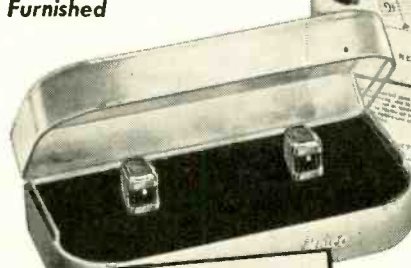

**The Great Names in HI FI Distribution Have DYNAMŪ for you**  
**Ask your Favorite Dealer**

**DYNAMŪ CONVERSION KITS**  
**FOR YOUR PENTRON • REVERE**  
**RCA • WILCOX GAY • KNIGHT**  
**CONCERTONE • OTHERS**

**DYNAMŪ MAGNETRONICS CORPORATION, Div. of the**  
Maico Bldg., Minneapolis, Minn.





Measures 6 1/4" x 9 1/2" x 4 1/2"

Superior's new  
Model 670-A

# SUPER METER

A COMBINATION VOLT-OHM MILLIAMMETER PLUS  
CAPACITY REACTANCE INDUCTANCE AND DECIBEL MEASUREMENTS

**SPECIFICATIONS:**

D.C. VOLTS: 0 to 7.5/15/75/150/750/1,500/7,500 Volts  
A.C. VOLTS: 0 to 15/30/150/300/1,500/3,000 Volts  
OUTPUT VOLTS: 0 to 15/30/150/300/1,500/3,000 Volts  
D.C. CURRENT: 0 to 1.5/15/150 Ma. 0 to 1.5/15 Amperes  
RESISTANCE: 0 to 1,000/100,000 Ohms to 10 Megohms  
CAPACITY: .001 to 1 Mfd. 1 to 50 Mfd. (Good-Bad scale for checking quality of electrolytic condensers.)  
REACTANCE: 50 to 2,500 Ohms 2,500 Ohms to 2.5 Megohms  
INDUCTANCE: .15 to 7 Henries 7 to 7,000 Henries  
DECIBELS: -6 to +18 +14 to +38 +34 to +58

**ADDED FEATURE:**

Built-in ISOLATION TRANSFORMER  
reduces possibility of burning out  
meter through misuse.

The Model 670-A comes housed, in a rugged crackle-finished steel cabinet complete with test leads and operating instructions.

**\$2840**  
NET



Superior's new  
Model TV-11

# TUBE TESTER

**SPECIFICATIONS:**

- ★ Tests all tubes including 4, 5, 6, 7, Octal, Lock-in, Peanut, Bantam, Hearing Aid, Thyatron Miniatures, Sub-miniatures, Novals, Sub-minars, Proximity fuse types, etc.
- ★ Uses the new self-cleaning Lever Action Switches for individual element testing. Because all elements are numbered according to pin-number in the RMA base numbering system, the user can instantly identify which element is under test. Tubes having tapped filaments and tubes with filaments terminating in more than one pin are truly tested with the Model TV-11 as any of the pins may be placed in the neutral position when necessary.
- ★ The Model TV-11 does not use any combination type sockets. Instead individual sockets are used for each type of tube. Thus it is impossible

to damage a tube by inserting it in the wrong socket.

- ★ Free-moving built-in roll chart provides complete data for all tubes.
- ★ Newly designed Line Voltage Control compensates for variation of any Line Voltage between 105 Volts and 130 Volts.
- ★ NOISE TEST: Phono-jack on front panel for plugging in either phones or external amplifier will detect microphonic tubes or noise due to faulty elements and loose internal connections.

The model TV-11 operates on 105-130 Volt 60 Cycles A.C. Comes housed in a beautiful hand-rubbed oak cabinet complete with portable cover.

**EXTRA SERVICE**—The Model TV-11 may be used as an extremely sensitive Condenser Leakage Checker. A relaxation

type oscillator incorporated in this model will detect leakages even when the frequency is one per minute.

**\$4750**  
NET



SUPERIOR'S NEW MODEL TV-40

# C.R.T. TUBE TESTER

A complete picture tube tester  
★ for little more than the price of a "make-shift" adapter!!

★ Tests all magnetically deflected tubes . . . in the set . . . out of the set . . . in the carton!!

The Model TV-40 is absolutely complete! Self-contained, including built-in power supply, it tests picture tubes in the only practical way to efficiently test such tubes: that is by the use of a separate instrument which is designed exclusively to test the ever increasing number of picture tubes!

**EASY TO USE:**

Simply insert line cord into any 110 volt A.C. outlet, then attach tester socket to tube base (Ion Trap Need Not Be on Tube). Throw switch up for quality test . . . read direct on Good-Bad scale. Throw switch down for all leakage tests.

**SPECIFICATIONS:**

- Tests ALL magnetically deflected picture tubes from 7 inch to 30 inch types.
- Tests for quality by the well established emission method. All readings on "Good-Bad" scale.
- Tests for inter-element shorts and leakages up to 5 megohms.
- Tests for open elements.

Model TV-40 C.R.T. Tube Tester comes absolutely complete—nothing else to buy. Housed in round cornered, molded bakelite case. Only.....

**\$1585**  
NET

**SHIPPED ON APPROVAL  
NO MONEY WITH ORDER — NO C.O.D.**

Try any of the above instruments for 10 days before you buy. If completely satisfied then send down payment and pay balance as indicated on coupon. No Interest or Finance Charges Added! If not completely satisfied return unit to us, no explanation necessary.

MOSS ELECTRONIC DISTRIBUTING CO., INC.  
Dept. D-97, 3849 Tenth Ave., New York 34, N.Y.

Please send me the units checked. I agree to pay down payment within 10 days and to pay the monthly balance as shown. It is understood there will be no finance, interest or any other charges, provided I send my monthly payments when due. It is further understood that should I fail to make payment when due, the full unpaid balance shall become immediately due and payable.

Model 670-A.....Total Price \$28.40  
\$7.40 within 10 days. Balance \$3.50  
monthly for 6 months.

Model TV-11.....Total Price \$47.50  
\$11.50 within 10 days. Balance \$6.00  
monthly for 6 months.

Model TV-40.....Total Price \$15.85  
\$3.85 within 10 days. Balance \$4.00  
monthly for 3 months.

Name .....

Address .....

City..... Zone..... State.....

The Model  
TV-50

# GENOMETER

A versatile all-inclusive GENERATOR which provides ALL the outputs for servicing:

**A. M. Radio    F. M. Radio    Amplifiers    Black and White TV    Color TV**



## 7 Signal Generators in One!

- ✓ R. F. Signal Generator for A.M.
- ✓ R. F. Signal Generator for F.M.
- ✓ Audio Frequency Generator
- ✓ Bar Generator
- ✓ Cross Hatch Generator
- ✓ Color Dot Pattern Generator
- ✓ Marker Generator

### SPECIFICATIONS:

#### R. F. SIGNAL GENERATOR:

The Model TV-50 Genometer provides complete coverage for A.M. and F.M. alignment. Generates Radio Frequencies from 100 Kilocycles to 60 Megacycles on fundamentals and from 60 Megacycles to 180 Megacycles on powerful harmonics. Accuracy and stability are assured by use of permeability trimmed Hi-Q coils. R.F. is available separately, modulated by the fixed 400 cycle sine-wave audio or modulated by the variable 300 cycle to 20,000 cycle variable audio. Provision has also been made for injection of any external modulating source.

#### VARIABLE AUDIO FREQUENCY GENERATOR:

In addition to a fixed 400 cycle sine-wave audio, the Model TV-50 Genometer provides a variable 300 cycle to 20,000 cycle peaked wave audio signal. This service is used for checking distortion in amplifiers, measuring amplifier gain, trouble shooting hearing aids, etc.

#### BAR GENERATOR:

This feature of the Model TV-50 Genometer will permit you to throw an actual Bar Pattern on any TV Receiver Screen. Pattern will consist of 4 to 16 horizontal bars or 7 to 20 vertical bars. A Bar Generator is acknowledged to provide the quickest and most efficient way of adjusting TV linearity controls. The Model TV-50 employs a recently improved Bar Generator circuit which assures stable never-shifting vertical and horizontal bars.

#### CROSS HATCH GENERATOR:

The Model TV-50 Genometer will project a cross-hatch pattern on any TV picture tube. The pattern will consist of non-shifting, horizontal and vertical lines interlaced to provide a stable cross-hatch effect. This service is used primarily for correct ion trap positioning and for adjustment of linearity.

#### DOT PATTERN GENERATOR (For Color TV)

Although you will be able to use most of your regular standard equipment for servicing Color TV, the one addition which is a "must" is a Dot Pattern Generator. The Dot Pattern projected on any color TV Receiver tube by the Model TV-50 will enable you to adjust for proper color convergence. When all controls and circuits are in proper alignment, the resulting pattern will consist of a sharp white dot pattern on a black background. One or more circuit or control deviations will result in a dot pattern out of convergence, with the blue, red and green dots in overlapping dot patterns.

#### MARKER GENERATOR:

The Model TV-50 includes all the most frequently needed marker points. Because of the ever-changing and ever-increasing number of such points required, we decided against using crystal holders. We instead adjust each marker point against precise laboratory standards. The following markers are provided: 189 Kc., 262.5 Kc., 456 Kc., 600 Kc., 1000 Kc., 1400 Kc., 1600 Kc., 2000 Kc., 2500 Kc., 3579 Kc., 4.5 Mc., 5 Mc., 10.7 Mc. (3579 Kc. is the color burst frequency.)

The Model TV-50 comes absolutely complete with shielded leads and operating instructions. Only .....

**\$47<sup>50</sup>**  
NET

**SHIPPED ON APPROVAL**  
**NO MONEY WITH ORDER — NO C.O.D.**

Try it for 10 days before you buy. If completely satisfied then send \$11.50 and pay balance at rate of \$6.00 per month for 6 months. No Interest or Finance Charges Added! If not completely satisfied return unit to us, no explanation necessary.

MOSS ELECTRONIC DISTRIBUTING CO., INC.  
Dept. D-97, 3849 Tenth Ave., New York 34, N.Y.

Please rush one Model TV-50. I agree to pay \$11.50 within 10 days and to pay \$6.00 per month thereafter. It is understood there will be no finance, interest or any other charges, provided I send my monthly payments when due. It is further understood that should I fail to make payment when due, the full unpaid balance shall become immediately due and payable.

Name .....

Address .....

City ..... Zone ..... State .....

# BE YOUR OWN AUDIO ENGINEER

MODEL 80  
MODEL 8112  
MODEL 8115

## CABINART



**H I F I**

EQUIPMENT  
CABINET

SPEAKER  
CABINET

Model 80 has lift lid, removable panels. Bass reflex tuned for 12" or 15" speakers. Overall dimensions: 33 1/2" H, 23" W, 16" D. M80 tuner section, inside: 20" H, 21 3/4" W, 15 1/2" D. M8112, M8115 baffle volume: 6 cubic feet. 5/8" white pine

80	equipment cabinet kit	\$27.00
8112	12" speaker cabinet kit	18.00
8115	15" speaker cabinet kit	18.00

# K I T S

ACOUSTICALLY ENGINEERED — ASSEMBLED WITH ONLY A SCREWDRIVER!

FEATURING  
THE KLIPSCH-DESIGNED

## Rebel\* 4 KITS

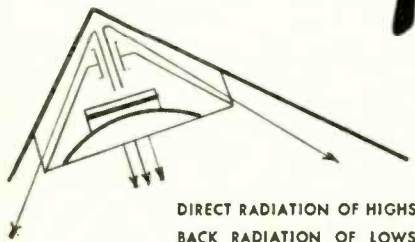

DIRECT RADIATION OF HIGHS  
BACK RADIATION OF LOWS

REBEL enclosure development entails a cavity and slot port, to form a resonant chamber, and a horn coupled to the slot. The slot is loaded by the horn; the proportioning of slot, cavity and horn provide bass response below 100 cycles which corresponds in efficiency to the front-of-cone direct radiator response above this critical 100-cycle point. There are two ways one might consider the function of this horn. One is a bass reflex with a horn acting as a resistive load on the port. System resonances are damped by useful radiation resistance while the horn does not cost anything. It is already formed by the room corner. Again, if a full horn were added below the 100-cycle point bass response would be boomy and unnatural. But, in the Rebel enclosures, the cavity-port combination acts as an acoustic low pass filter. And its design is such that low-end response will compare with response higher in the sound scale.

MODEL K-12  
MODEL K-15  
K. 12 36.00  
K. 15 42.00

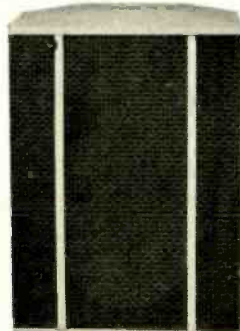

ready-to-finish birch

All kits precision-cut to size, baffles pre-cut for 12" or 15" speakers, Kits include Saron plastic acoustical cloth, glue, sandpaper, plastic wood, hardware, assembly instructions and finishing instructions. Write for complete catalogs and nearest Cabinart kit dealer.

Model 61, Model 63  
corner horn



12" speaker — \$19.95  
15" speaker — \$23.95

all prices slightly higher west and south

\* Trade Mark

KITFORMS BY

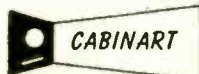

75 North 11th Street  
Brooklyn, N. Y.

### TECHNICIANS' NEWS (Continued)

In 1953, Mr. Odorizzi stated, the industry employed nearly 100,000 service technicians, the income from home service alone was \$1.4 billions and by the end of 1957 will increase to approximately \$2.7 billions. As the use of electronic apparatus increases with automation and application of electronic controls to industry, plus the spread of television service, the importance of service will increase accordingly. "Service," he said, "therefore has become an important facet of the nation's business structure."

### N. H. GROUP ELECTS

The New Hampshire Radio and Television Association, meeting at the New Hampshire Technical Institute, Manchester, N. H., has re-elected Harvey O'Dowd of Goffstown as president for the 1955 term. Other officers elected were Paul Frost, Concord, first vice president; George Bennett, Manchester, second vice president; Ernest Tetrault, Manchester, treasurer; Emile R. Gelinis, Manchester, executive secretary, and Warren Davis, Hampton, secretary.

### MINTSE MOVES

A meeting was held in Minneapolis on Dec. 9, 1954, "to organize an association to improve service (radio and TV) to the public." The meeting was sponsored by the Minnesota Television Service Engineers and the Minnesota State Department of Business Development as well as the State Bureau of Labor. The Minnesota Television Service Engineers is a group formed by members of existing service associations for the purpose of launching the state-wide organization.

The meeting was addressed by State Gov. C. Elmer Anderson, Commissioner Clark of the Department of Business Development and others. Howard Sams, slated to speak, could not reach the meeting, but sent a telegram of encouragement, as did District Attorney Silver of Brooklyn, N. Y. A heavy storm the night before and slippery roads reduced attendance, but representatives from 18 Minnesota communities were present as well as visitors from two Wisconsin localities. Since the idea of MINTSE was new to many, it was decided to postpone action for 90 days, during which time an informational campaign would be carried out. Then a meeting of representatives would be held to formulate proposals which would be submitted for final action to a large meeting in the late spring.

Of the approximately 15 persons heard from during the meeting, only one opposed the idea of the new state-wide association. Matters of detail were of course held in abeyance, but the consensus was that the organization would follow generally the industry standards set up by NATESA—grading service personnel from engineer to apprentice. END

# radio-electronic Circuits

## SSB RECEIVING ADAPTER

Many amateurs and SWL's use the receiver's b.f.o. to reinsert the carrier of SSB (single-sideband, suppressed-carrier) transmissions so the signals are readable. Since reinserted carrier must be within 50 cycles of the correct frequency for reasonably distortion-free reception, the receiver's high-frequency and beat-frequency oscillators must be highly stable. Frequency drift with temperature or voltage changes greatly increases distortion and makes frequent

retuning necessary for good readability.

Reception of SSB signals is easier and readability is greater when the receiver is fitted with an SSB adapter. The usual SSB adapter (commonly called a signal slicer) converts the conventional communications receiver to a double superhet with a very selective 50-kc i.f. system. The second i.f. is sharp enough to permit the operator to select either one of the sidebands present in the receiver's normal i.f. selectivity

curve and completely reject the other. The adapter is equally useful in receiving AM, PM, NBFM, and CW signals.

Most SSB adapters that have been described in the past have used complex filters or phase-shift networks that are difficult for the average constructor to obtain or duplicate. This difficulty has been eliminated by the introduction of the new type S-15000 single-sideband filter produced by Burrell & Co. of Yonkers, N. Y. The diagram in Fig. 1 shows the circuit of a signal slicer designed around this filter.

A length of coaxial cable couples the plate of the last i.f. amplifier in the receiver to the grid of mixer V1 through a 10- $\mu$ f capacitor. V2 is a Pierce oscillator, with crystals Y1 and Y2 selected by switch S1. The frequencies of the crystals depend on the i.f. of the receiver. One is 50 kc below and the other 50 kc above the i.f. Surplus FT-241 type crystals marked with the frequency of the 54th harmonic are suitable. The higher-frequency crystal is used for receiving the lower sideband when the receiver's high-frequency oscillator is above the signal frequency.

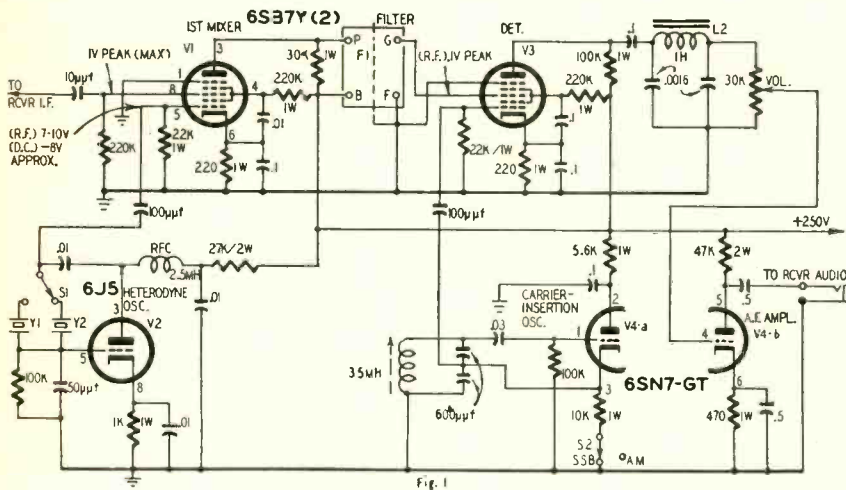

Fig. 1

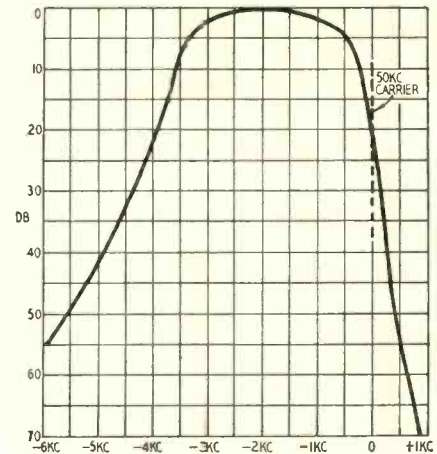

Fig. 2

Burton Browne Advertising



LIST PRICE \$19.95

# PLAY YOUR TRUMP



## Regency

...with high volume low-cost conversion using Regency RC-53 all channel UHF converter—the lowest price converter available which provides conversion to all UHF channels from a wide selection of VHF channels. Designed as a primary area converter, tests prove excellent performance in 80% of UHF locations.

Regency, world's leading manufacturer of TV accessories including VHF boosters, FM boosters, voltage boosters, UHF converters, remote TV control, high pass filters and a complete line of high fidelity equipment.

REGENCY DIVISION, L.D.E.A., INC.,

INDIANAPOLIS 26, INDIANA

# Announcing the NEW SANGAMO Type 36

## PLUG-IN TUBULAR PAPER CAPACITOR



## Your answer to those calls for a PRINTED CIRCUIT REPLACEMENT CAPACITOR

Perhaps you've already had calls for printed circuit replacement capacitors. Now you can offer your customers the first mass produced capacitors for printed circuit chassis. Remember, the new Type 36 plug-in tubular is an exact replacement for most of today's new printed circuit chassis. To stock up now, see your Sangamo jobber or write direct.



**MOISTURE-  
RESISTANT  
END FILL**



**BAKELITE  
MOLDED CASE**



**LEADS ARE CUT  
AND PROPERLY  
SPACED TO FIT**

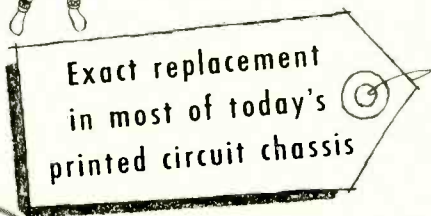

*Those who know*



*choose Sangamo*

**SANGAMO ELECTRIC COMPANY** MARION, ILLINOIS

The 30,000-ohm plate-load resistor for V1 provides the proper input impedance for the S-15000 filter. (Because the input impedance is not too critical, a standard 33,000-ohm unit can be used at this point.) The filter is designed to pass the 50-ke carrier and frequencies 2,500 cycles below it. The selectivity curve is shown in Fig. 2.

A 50-ke signal of about 0.1 volt peak appears on the grid of V3. This tube is used as a heterodyne detector (converter or mixer) for SSB signals and as a plate detector for AM and NBFM signals. Closing S2 for SSB reception completes the cathode circuit of V4-a, the 50-ke carrier-insertion oscillator. The oscillator circuit is a Colpitts, tuned by a variable-inductance 35-mh r.f. choke. The oscillator must be tuned to exactly 50 kc by checking it against an accurate frequency meter such as the BC-221.

The output of the detector (V3) passes through a low-pass filter (L2 and the two .0016- $\mu$ f capacitors) that eliminates the 50-ke component in the output. L2 may be a Burnell type S-1676 toroid or a 1-henry air-wound choke. The filter is terminated by the 30,000-ohm volume control in the grid circuit of a.f. amplifier V4-b.

### Parts for SSB adapter

**Resistors:** 1—33,000, 2—100,000, 1—220,000 ohms, 1/2 watt; 2—220, 1—470, 1—1,000, 1—5,600, 1—10,000, 2—22,000, 1—30,000, 1—100,000, 2—220,000 ohms, 1 watt; 1—27,000, 1—47,000 ohms, 2 watts.

**Capacitors:** (Paper) 1—.03, 5—.01, 2—.05  $\mu$ f, 600 volts; (mica) 1—10, 1—50, 2—100, 2—600  $\mu$ f; 2—.0016  $\mu$ f, 500 volts; (disc ceramic) 4—.01  $\mu$ f, 600 volts.

**Miscellaneous:** 1—2.5-mh r.f. choke, 1—35-mh adjustable r.f. choke, 1—1-henry toroid or air-core inductor; 1—s.p.d.t. wafer switch, 1—s.p.s.t. toggle switch; 1—Burnell S-15000 filter; 2—FT-241 type low-frequency crystals (see text); 2—6S87Y, 1—6J5, 1—6SN7-GT tube. Chassis, hardware, hookup wire.

Additional details on this receiving adapter and a circuit and details on the construction of a SSB generator for amateur transmitters are given in a 17-page booklet, *Single Sideband for the Amateur*, available from Burnell & Co., 45 Warburton Ave., Yonkers 2, N. Y.

### TRANSISTOR OSCILLATOR

Experimenters and laboratory workers have adapted the transistor for many uses but until now its commercial applications have been limited almost entirely to hearing aids (and receivers, recently). General Radio Co. has just

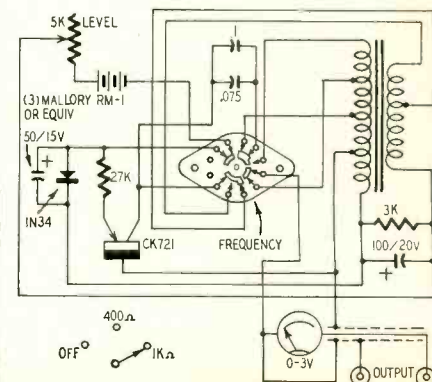



entered the field of transistorized test instruments with the development of the model 1307-A audio oscillator shown in the photo and diagram.

The pocket-size instrument (6 x 3 1/2 x 2 1/2 inches) delivers 400- and 1,000-cycle signals at up to 2 volts across a 600-ohm load for checking continuity of audio systems, setting operating levels, preliminary calibration of audio equipment, and many other applications where these standard test frequencies are used. The output cable terminates in a type 274-MB double plug.

The circuit is a Hartley oscillator using a CK721 transistor. Instead of the usual tapped coil, its coil is wound in two parts to simplify the application of proper operating voltages. The coils are connected in series for oscillatory currents by the 100-μf capacitor. The emitter, corresponding to the cathode of a vacuum tube, connects to the junction of the two coils. The ends of the coils are connected between collector and base (plate and grid in a vacuum tube). The circuit is tuned by the 1- and .075-μf capacitors in parallel across the entire coil. For 1-kc operation, the inductance of the coil is reduced by tapping down from the ends.

The 27,000-ohm resistor in the emitter circuit provides degeneration needed to improve the output waveform. The output voltage, taken from a tap on the coil, is measured by a 3-volt rectifier type a.c. meter across the output terminals. The level is adjusted by varying the resistor in series with the battery. The germanium diode sets the operating bias on the base and provides more reliable operation under different battery voltages, temperatures, and transistors. Further details appeared in the August, 1954, issue of *The General Radio Experimenter*. END

**Radio Thirty-Five Years Ago**  
In Gernsback Publications

**HUGO GERNSBACK**  
Founder

Modern Electrics	1908
Wireless Association of America	1908
Electrical Experimenter	1913
Radio News	1919
Science & Invention	1920
Television	1927
Radio-Craft	1929
Short-Wave Craft	1930
Television News	1931

Some of the larger libraries still have copies of **ELECTRICAL EXPERIMENTER** on file for interested readers.

**In February, 1921 Science and Invention (formerly Electrical Experimenter)**

- Hall Jet Relay for Recording Radio Signals, by Prof. Ralph D. Doner
- Grand Opera by Radio, by Nellie Gardner
- Messages at 100 Words per Minute by Radio
- Stock Brokers Find Radio Useful
- New Loud Speaking Telephone
- Radio Weather Report

**Flyweight Magnemite\***



**Electric-Motor  
Battery-Operated  
Portable Tape Recorder**

The ideal recorder for newspaper reporting, recording lectures, telephone monitoring, field reports, traveling secretary, on-the-spot interviews, reference recording, customer interviews, salesmen reports and secret recording.

Combines for the first time, ease and efficiency of operation with maximum reduction of weight. Performs anywhere, producing professional results under adverse conditions. Fully shielded, fly-ball governor-controlled electric motor assures constant speed and freedom from hash. Weather-tight, satin-finished, aluminum alloy case gives complete protection to recorder.

Electrically rewinds a reel of tape in less than two minutes. Immediate playback through earphones or external amplifier. 6 Single speed and 3 two-speed models available. Speeds range from 1 1/4 ips. to 15 ips. Recorders weigh only 8 lbs. with batteries and measure 5 1/2" x 9" x 12".

Write for complete technical specifications and direct factory prices to Dept. RE.

**New VU Magnemite\***

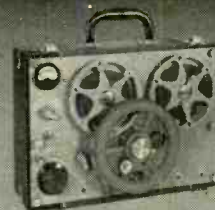

**Spring-Motor  
Battery-Operated  
Portable Tape Recorder**

Now you can consistently make professional recordings under the most grueling field conditions. Tapes will faultlessly play back on all professional and home recorders. Ruggedly designed for maximum dependability and top-notch efficiency. Combines unlimited versatility of performance with extreme simplicity of operation. Choice of fourteen models available for every conceivable application.

Incorporates a multi-purpose VU monitoring meter for precise setting of recording level without earphone monitoring. Meter also accurately indicates condition of "A" and "B" batteries. Five single speeds as well as two, three and 4-speed models available. Units weigh only 19 lbs. with batteries and measure 6 1/2" x 9 1/2" x 14 1/4". Higher speed models meet NARTB standards. All recorders are guaranteed for One Full Year.

**AMPLIFIER CORP. of AMERICA 398 Broadway, New York 13, N.Y.**

\*T. M. REG. U. S. PAT. OFF.

**Picture Tube Booster**  
**SCOOP!**  
**95¢**

New Life for Old Picture Tubes!

Plug in and picture tube gets brighter. Automatic, no wiring. Full socket, 6 leads. For electrostatic or electromagnetic, parallel circuits. Order Vu-Brite C 401. Lots of 6 or more...90c ea.

**Full Range Recording**  
**TAPE**  
**\$1.95** per Reel  
1200 ft. reel  
Plastic base

Reproduces full range sound with flawless fidelity. Guaranteed top quality at rock-bottom prices. Lots of 6 or more only \$1.79 ea.

**LOWEST PRICES EVER!**  
**Alnico V PM Speakers!**  
Your Choice  
4 inch Square (1 1/2" deep)  
5 inch Round (1 3/4" deep)  
**98¢**

**SNYDER BROAD BAND YAGIS**

- Higher Gain Than Conventional Yagis
- For Fringe or Ultra-Fringe

Produces sharp, bright pictures. Hi tensil 3/8" aluminum elements; 7 on low band, 9 on high band. Complete with Universal U Clamps.

RB 2-6 for Chls. 2 thru 6 **\$9.95**  
RB 7-13 for Chls. 7 thru 13 **\$4.95**

Write for FREE FYI Bulletin 212

**WHOLESALE**  
**RADIO PARTS CO., Inc.**  
311 W. Baltimore St. • Baltimore 1, Md.

*"We're in luck, Boss  
A JENSEN NEEDLE"*

## LEARN basic electricity THE EASY "PICTURE BOOK" WAY!

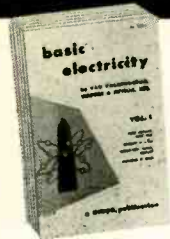

**Just Released:**  
The fabulous new  
**ILLUSTRATED**  
Training Course  
**now** used by  
the U. S. Navy!

### You Learn by Pictures

Over 25,000 Navy trainees have already learned Basic Electricity this easy, "Picture Book" way! Now, for the first time, YOU can master the basics of Electricity with this same "Learn-by-Pictures" training course! Over 900 simple, easy-to-understand drawings explain every section—these "teaching" pictures actually make up more than half the entire course! No other Basic Electricity course in America uses this revolutionary illustrative technique! You learn Basic Electricity faster and easier than you'd ever dream possible!

### A Complete Idea on Every Page

Here's how this easy, illustrated course works: every page covers the complete idea! There's at least one big illustration on that same page to explain it! What's more, an imaginary instructor stands figuratively at your elbow, doing "demonstrations" that make it even easier for you to understand. Then, at the end of every section, you'll find review pages that highlight the important topics you've just covered. You build a thorough, step-by-step knowledge at your own pace — as fast or as slow as you yourself want to go!

### Everyday English — A Course Anyone Can Understand

Sponsored by the Navy to turn out trained technicians in record time, this modern course presents Basic Electricity in a simple way that everyone can grasp — regardless of previous education! Every phase is down to earth English — with hundreds of easy-to-understand illustrations to help you!

### 5 Complete Volumes

Volumes 1 and 2 of this outstanding illustrated course cover DC components and circuits; Volumes 3 and 4 cover AC components and circuits; Volume 5 covers AC and DC motors and machinery.

### Home Study Without Correspondence

This course is so different, so complete — there's no need for the usual letter writing, test taking, question and answer correspondence! You learn at home — at your own pace!

### 10 Day Examination — Money Back Guarantee

Send today for this exciting new Basic Electricity training course — you risk nothing! When you receive the 5 volumes, examine them in your own home for 10 full days. If, at the end of that time, you're not completely satisfied, simply return the books to us and we'll gladly refund your full purchase price! Total cost for the 5-volume course is only \$9.00! In Canada, prices approximately 5% higher.

## ORDER TODAY!

"Basic Electricity" is sold by most parts jobs and book stores. If YOUR dealer doesn't have these books, mail this coupon to us!

**JOHN F. RIDER PUBLISHER, INC.**  
480 Canal Street, N.Y.C.

Please RUSH me.....sets of "Basic Electricity" @ \$9.00 per set. I understand that I may return the books within 10 days and receive a complete refund of my full purchase price.

Name .....

Address .....

City & State .....

# Question Box



## G.D.O. MODIFICATION

The grid-dip oscillator described in the June, 1954, issue works swell. Can you show how I can add a 6C4 as a separate oscillator with a switch for disabling the circuit so it can be used as an absorption wavemeter?—R. F., Truro, Nova Scotia

Here is the diagram. In it the 6E5 is used as a vacuum-tube voltmeter to measure the voltage on the grid of the 6C4 oscillator. When the switch is

closed, the 6C4 oscillates. Opening the switch removes the oscillator plate voltage. The grid-cathode circuit of the 6C4 acts as a diode rectifier with the grid resistor as the load. The 6E5 indicates this voltage when the unit is used as a wavemeter. Try different values for the grid resistor and use the value giving highest sensitivity.

The phone jack permits the instrument to be used as a diode monitor or as an oscillating (regenerative) detector.

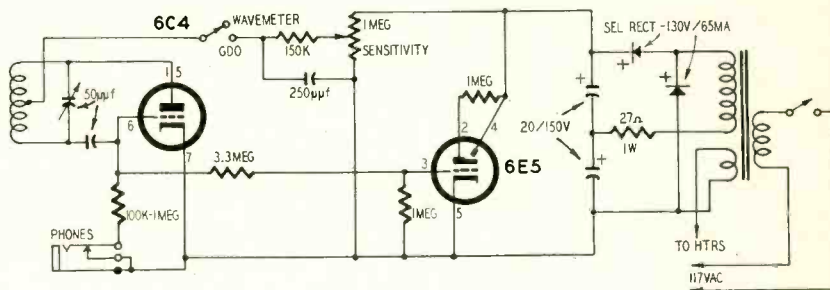

## YAGI ANTENNA QUERY

I am having trouble matching a 10-element home-made Yagi antenna to a 300-ohm transmission line, using 1/4- and 1-inch tubing in a 2-conductor folded dipole. Please tell me what spacing to use between the dipole conductors when the antenna resistance is 20, 15, 10 and 5 ohms.—G. A., Uniontown, Pa.

The impedance-transformation nomograms in *The Radio Amateur's Handbook* and *Sylvania News* show that the conductors you have selected are not practical for the stepup ratios you desire. Your conductors have a diameter ratio of 4 to 1 so the center-to-center spacing is 0.775 inch for an antenna resistance of 10 ohms, 0.85 inch for 15 ohms and 1.075 inches for a 20-ohm antenna. Subtract the sum of the conductor radii from the spacings indicated and you will see that they will be difficult to attain.

The best bet is to increase the ratio

of the conductor diameters to at least 7. Higher ratios increase the conductor spacing and make it easier to attain and hold. If you substitute No. 8 aluminum ground wire (approximately 0.13-inch diameter) for the smaller conductor, the ratio is 7:7 and the spacings are 0.865, 1.105 and 1.43 inches for antennas of 10, 15 and 20 ohms, respectively.

You can obtain the same results by increasing the diameter of the larger conductor to 2 inches. The center-to-center spacings are 7, 9 and 12 times the diameter of the smaller conductor for impedance stepups of 30, 20 and 15 times, respectively.

The nomograms do not provide for impedance stepups higher than 30 so for a 5-ohm antenna you can use dipole conductors to step up the impedance to 150 ohms and then use a quarter-wave-length transformer to double the resulting impedance to match a 300-ohm lead-in.

## A.F.C. FOR FM TUNER

The November, 1954, issue carried an article describing how a.f.c. can be added to FM tuners. The reactance tube for this circuit is a 6K4—a subminiature type that is expensive and difficult to locate. Please show how I can substitute a more common and less expensive tube.—J. L. J., Highland Falls, N. Y.

The 6K4 was listed in more than one 1954 parts catalog, but appears to have been dropped in 1955 issues. The diagrams at a and b show typical reactance-tube circuits using a 6J6 and a 6AB4 or half of a 12AT7. In some sets a small amount of fixed bias is applied to the cathode of the circuit at b through a

# HOT as the new **veeDxer**

THE ALL CHANNEL (vhf) ANTENNA THAT **BEATS 'EM ALL**

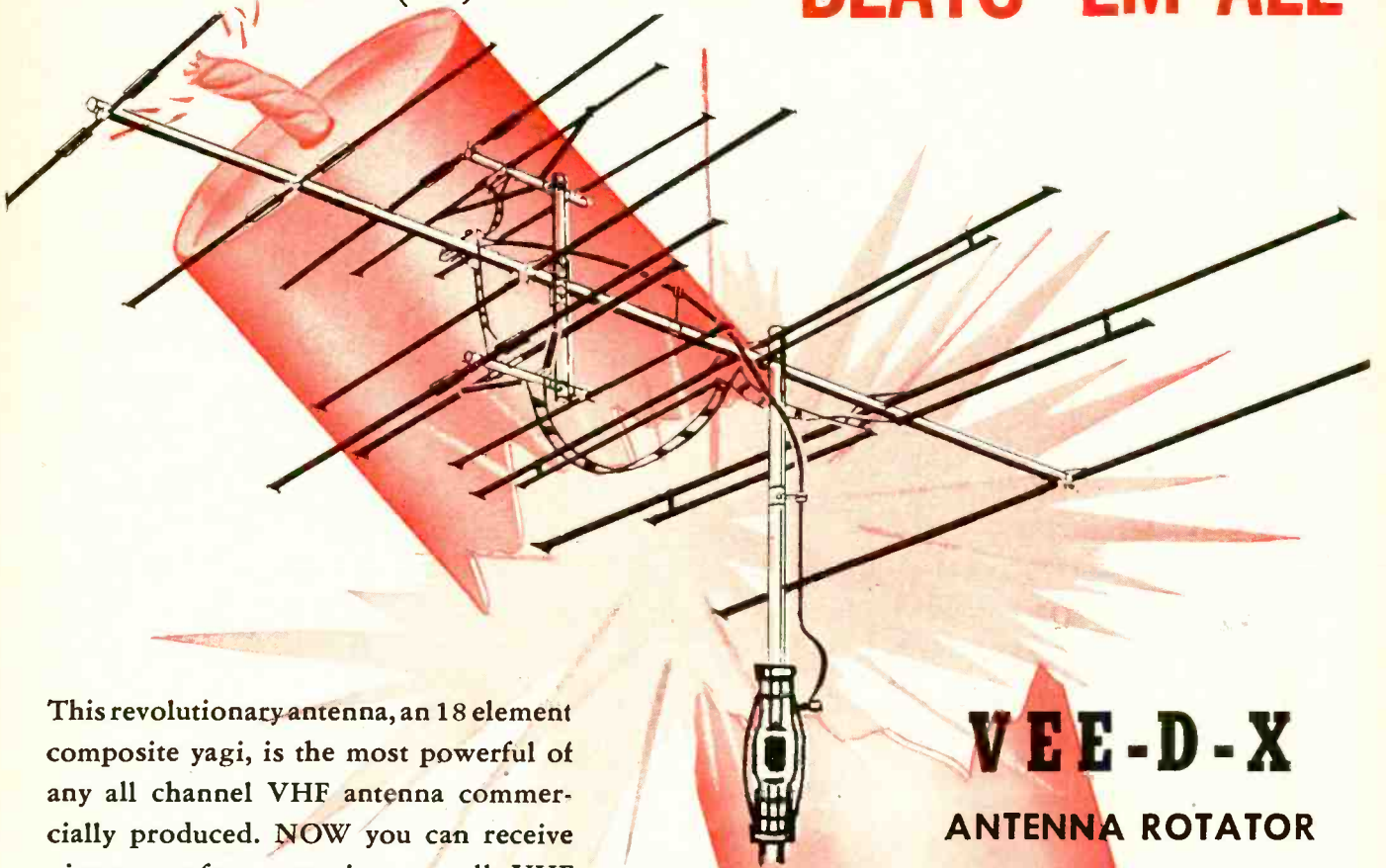

This revolutionary antenna, an 18 element composite yagi, is the most powerful of any all channel VHF antenna commercially produced. NOW you can receive picture perfect reception on all VHF channels comparable to a single channel 10 element yagi. When all others have failed, install a super power VEE-D-Xer for the finest reception.

## VEE-D-X

### ANTENNA ROTATOR

Team together the new VEE-D-X Rotator with the new VEE-D-Xer antenna for matchless reception of ALL VHF channels on the air, in all directions NOW and in the future.



## HIGHEST GAIN

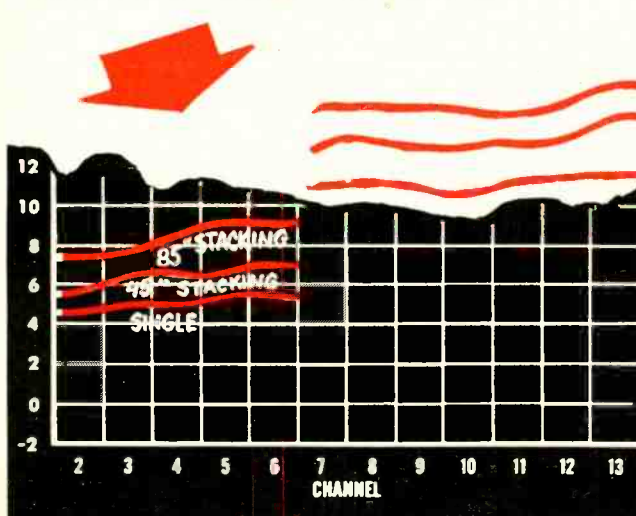

WRITE TODAY for information on the VEE-D-Xer and the new VEE-D-X Rotator.

**LaPointe** ELECTRONICS INC.  
ROCKVILLE, CONN. PE-1

Please send me specification sheets on:

Vee-D-Xer  Rotator

NAME.....

ADDRESS.....

CITY..... ZONE..... STATE.....

# THE American IDEA

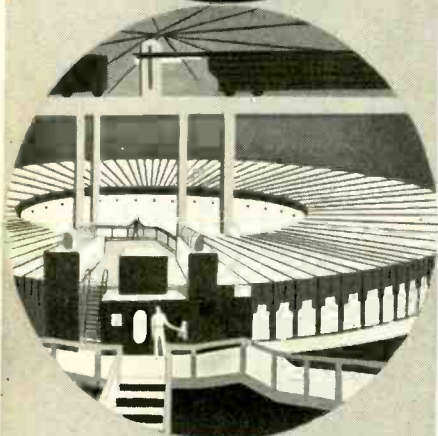

"To find and follow the better way"... Gigantic offspring of the cyclotron, the Bevatron—world's greatest magnet—can send masses of protons hurtling around its 135'-diameter race track at almost the speed of light. "Idea", to penetrate deep into the atomic nucleus, where lie secrets of matter and energy.

With us, the "American Idea" is, by directed effort and applied know-how, to continue to lead in bringing you electronic products of the highest quality.



Complete line of "Full Vision" Microphones  
D33 Broadcast  
D-22 Public Address

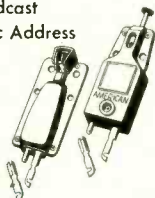

Replacement Phonograph Cartridges

INSIST ON AMERICAN FOR QUALITY  
Send for FREE Catalog 47



American microphone co.

370 South Fair Oaks Ave. • Pasadena, 1, Calif.

## QUESTION BOX

(Continued)

27,000-ohm resistor from the 130-volt B plus line as shown by the dashed lines.

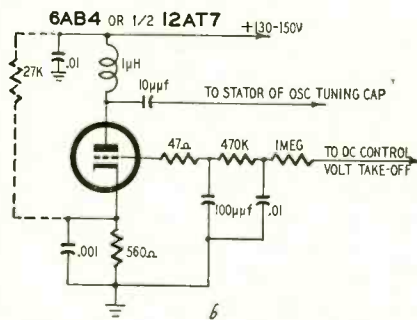
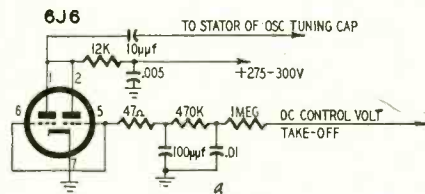

## HI-FI CRYSTAL TUNER

While thumbing through back issues of RADIO-ELECTRONICS I came across an ad describing the Miller bandpass t.r.f. AM tuner kit. The description sounds so interesting I'd like to construct one of these tuners if you will print the circuit.—J. J. M., St. John's, Newfoundland

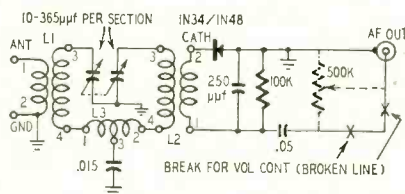

This unit was designed for high-quality reception of local broadcast stations. The double-tuned bandpass circuit uses negative mutual coupling to provide adequate selectivity. Bandwidth is approximately 25 kc at 2-db points when measured at 900 kc.

The crystal diode develops between .05 and 0.5 volt on stations within a radius of 20-25 miles when used with a good outside antenna 75-100 feet long. L1 and L2 are Miller 242-A antenna coils and L3 is a type EL-55 negative mutual coupling coil. A volume control can be connected as shown by the dashed lines. Break circuit at X when installing volume control.

END

Response to our query on continuing the Question Box has swamped our staff with questions. If you don't get your answer in a month or so, don't worry—we'll get to it in time. Incidentally, the Question Box will continue.

See  
the New  
LA-75  
Arrester



List \$1.35

Make installations the easiest, fastest ever.

Slip any standard lead-in under its new twin-lead grip, tighten wing nut—the job is done. Another Radion first. Ask your distributor now.

**Radion**

The Radion Corp., Dept. G.  
1130 W. Wisconsin Ave., Chicago 14, Ill.

## TELEVISION

Big demand for graduates

**B.S. DEGREE IN 27 MONTHS** in radio including TV engineering—VHF, UHF, AM and FM. Students use over \$100,000 worth of equipment including 2 large commercial type transmitters in new TV lab. Intense specialized course includes strong basis in mathematics, science and advanced design in radio and TV.

Hundreds of young men each year are earning engineering degrees in this recognized institution. Start any quarter. Many earn a major part of expense in this industrial center. Low tuition. Competent instruction. Thorough, intense, practical program. Also **B.S. DEGREE IN 27 MO.** in Aeronautical, Chemical, Civil, Electrical and Mechanical Engineering. G.I. Gov't approved. Enter March, June, Sept., Dec. Free catalog. **ENROLL NOW.**

**INDIANA TECHNICAL COLLEGE**  
1725 E. Washington Blvd., Fort Wayne 2, Indiana

## OSCIL-O-PEN

Extremely convenient test oscillator for all radio servicing; alignment • Small as a pen • Self powered • Range from 700 cycles audio to over 600 megacycles u.h.f. • Output from zero to 125 v. • Low in cost • Used by Signal Corps. • Write for information.

**GENERAL TEST EQUIPMENT**  
38 Argyle Ave. Buffalo 9, N. Y.

**\$3.00**

## FOR CARTOON IDEAS

RADIO-ELECTRONICS prints several radio cartoons every month. Readers are invited to contribute humorous radio ideas which can be used in cartoon form. It is not necessary that you draw a sketch, unless you wish.

Address

**RADIO-CARTOONS,**  
**RADIO-ELECTRONICS**  
25 West Broadway, New York 7, N.Y.

# WE ARE SHARING the success of our products WITH YOU

as a CUSTOMER'S DIVIDEND in the most SENSATIONAL PRICE SLASHING EVER!



Build your own  
**SUPER DE LUXE**  
31-TUBE  
#630 TV CHASSIS

#630 SUPER DE LUXE 31-TUBE TV KIT  
Engineered in strict adherence to the genuine RCA #630 plus added features . . . OPERATES 16" to 24" PICTURE TUBES . . . CASCODE TUNER . . . COSINE YOKE . . . LARGER POWER TRANSFORMER . . . KEYED AGC . . . 12" SPEAKER . . . CONDENSERS and RESISTORS at rated capacities and tolerances. You receive a COMPLETE SET OF PARTS AND TUBES. Everything needed is included, (less CRT and wire.) You will enjoy building it with "LIFE-SIZE" easy to follow step-by-step ASSEMBLING INSTRUCTIONS" included with each KIT.

slashed to **\$99.99**

## #630 SUPER TV CHASSIS

LICENSED UNDER RCA PATENTS  
**COMPLETE READY TO PLUG IN AND PLAY—**  
Similar in characteristics and features to the TV KIT above • Manufactured especially for us by nationally known manufacturers • No efforts or expense have been spared in workmanship or materials, to make this #630 SUPER DE LUXE TV CHASSIS the best obtainable for fringe areas, clarity and all-around performance. Customers report reception better than 200 miles. Each set is factory aligned and air-tested • All parts carry the RMA three month guarantee • Our mass volume of business on this CHASSIS (numbering thousands of pleased customers) now makes it possible for us to reduce the price. (less CRT.)

slashed to **\$142.27**

We Also Sell The **TECH-MASTER**  
Complete Line of  
#630 TV CHASSIS. Catalog mailed on request.

Modernize a #630 or any TV Set

## STANDARD CASCODE TUNER

For better all around performance  
Complete with tubes and Brooks CASCODE MANUAL with step-by-step instructions and all extra parts needed. **\$17.97**

## UNIVERSAL PICTURE TUBE MOUNTING BRACKETS

Fits All 12 1/2" to 21" picture tubes  
Complete — including band that holds picture tube

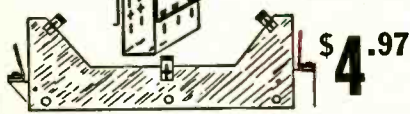

**\$4.97**

## PULSE KEYED AGC KIT

Finest, most accurate and the easiest Kit to install in a #630 or in any other make TV receiver. Improves performance, and insures a steady picture on all channels.

COMPLETE SET OF PARTS **\$2.99**  
Including 6AU6 tube & Instructions

## CUSTOM-BUILT AUTO RADIOS

Known Mfr. . . . . Licensed by RCA  
6-TUBE SUPER (B-Tube Performance) installs easily in 15 minutes. Appearance and tone quality equal to expensive radios supplied by car manufacturers.

**FORD · CHEVROLET · PLYMOUTH**  
**DODGE · STUDEBAKER · HUDSON**

1949 to 1955 Inclusive List Price \$59.95  
For Most Make Cars **\$41.97**

Any Model complete ready to install Your Price

## CUSTOM-BUILT CABINETS #630 AND ALL OTHER TV SETS

The VOGUE

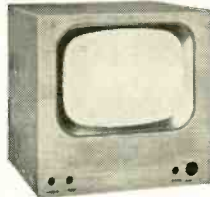

H-25", W-26", D-22"

**\$35.91**

The FUTURAMIC



H-37", W-28", D-24 1/4"

**\$79.34**

From Factory to You

4 LEADING STYLES in genuine mahogany or walnut (blond 10% extra)  
• Ready drilled for any #630 TV chassis and cutout for any 16", 17", 19", 20" or 21" picture tube at no extras in price • Also supplied with undrilled knob panel for any other TV set • EVERYTHING NECESSARY for an easy perfect chassis and CRT assembly is included • Each cabinet is delivered complete as pictured with mask, safety glass, mounting brackets, backboard, backcup, hardware and assembling instructions • Each cabinet is shipped in an air cushioned carton from FACTORY to YOU!

The MAYFAIR



H-40", W-26", D-25"

**\$88.70**

The MANHATTAN



H-41", W-25", D-23"

**\$53.43**

## NATIONALLY KNOWN BRAND PICTURE TUBES

BRAND NEW in Factory Sealed Cartons—With a Full Year Guarantee

17" #17BP4A **\$26.66** | 21" #21EP4B Aluminized **\$39.21** | 24" #24CP4A Aluminized **\$59.99** | 27" #27EP4A Aluminized **\$74.31**

## #630 Parts in COMPLETE SETS

TV WIRE & SOLDER KIT, for any Set. . . . . \$ .98  
630-KIT, screws, nuts, rivets, washers, etc. . . . . 1.69  
TERMINAL STRIP KIT, set of 30 . . . . . .69  
VIDEO AND I.F. KIT, 19 items. . . . . 4.99  
VARIABLE CONTROL KIT, 9 controls . . . . . 3.97  
CARBON RESISTOR KIT, 107 resistors . . . . . 4.98  
WIREWOUND RESISTOR KIT, 4 resistors. . . . . 1.76  
BRACKET AND SHIELD KIT, 18 items. . . . . 6.44  
ELECTROLYTIC CONDENSER KIT, 6 cond. . . . . 4.96  
TUBULAR CONDENSER KIT, 38 Condensers. . . . . 3.63  
CERAMIC CONDENSER KIT, 28 condensers. . . . . 1.98  
MICA CONDENSER KIT, 11 condensers. . . . . .97  
COMPLETE SOCKET KIT, 25 sockets. . . . . 1.57  
COMPLETE SET OF TUBES, 29 tubes. . . . . 24.64

## PARTS For #630 TV SETS

PUNCHED CHASSIS PAN, cadmium plated \$3.96  
ESCUTCHEON PLATE, for tuner. . . . . .38  
COMPLETE SET OF KNOBS, incl. decals. . . . . .99  
POWER TRANSFORMER, 295ma. 201T6. . . . . 9.16  
VERTICAL OUTPUT TRANS. 204T2. . . . . 2.24  
VERTICAL BLOCKING TRANS. 208T2. . . . . .98  
HORIZONTAL OUTPUT TRANS. 211T1. . . . . 1.62  
HORIZONTAL OUTPUT TRANS. 211T5. . . . . 2.97  
FOCUS COIL, 247 ohms, 202D1. . . . . 1.64  
FOCUS COIL, 470 ohms, 202D2. . . . . 2.93  
DEFLECTION YOKE, 60° 201D1. . . . . 1.14  
DEFLECTION YOKE, Cosine 70° 206D1. . . . . 3.45  
SOUND DISCRIMINATOR TRANS. 203K1. . . . . .94  
1st PIX I.F. TRANSFORMER, 202K2. . . . . .88  
2nd PIX I.F. TRANSFORMER, 202K3. . . . . .88  
1st or 2nd SOUND I.F. TRANS. 201K1. . . . . .69  
HORIZONTAL DISCRIM. TRANS. 208T8. . . . . .98  
FILTER CHOKE, 62 ohms. . . . . 1.15  
CATHODE TRAP COIL, 202K4. . . . . .88  
WIDTH CONTROL COIL, keyed AGC. . . . . .52  
ION TRAP BEAM BENDER, double 203D3. . . . . .65  
ION TRAP BEAM BENDER, single 203D1. . . . . .52  
HI VOLTAGE CAGE ASSEMBLY, complete. . . . . 2.66  
VOLTAGE DIVIDER SHIELD & COVER " " 1.12  
HV RECTIFIER, SOCKET ASSEMBLY, single .59  
HV RECTIFIER, SOCKET ASSEMBLY, double .98

Brooks LIFE-SIZE TV INSTRUCTIONS, for building any #630 TV Receiver. . . . . **\$1.25** Postpaid

HINTS FOR BETTER PERFORMANCE on your #630 TV receiver. . . . . **50c** Postpaid

Brooks CASCODE MANUAL, how to install Cascode Tuner in any make TV Set. . . . . **25c** Postpaid

**100 ASSORTED TUBULAR CONDENSERS**  
All Are Standard Brands & Desirable Sizes **\$3.69**  
\$15.00 Value Only

**100— ASSORTED 1/2 WATT RESISTORS \$2.88**

**15 — Asst. Radio Electrolytic CONDENSERS \$3.49**

**15 — Assorted TV Electrolytic CONDENSERS \$4.97**

**100— ASSORTED MICA CONDENSERS \$3.72**

**100— ASSORTED CERAMIC CONDENSERS \$3.72**

**100— ASSORTED 1 WATT RESISTORS \$4.62**

**100— ASSORTED SOCKETS \$2.79**  
Octal, Lactal & Miniature

**100— ASSORTED KNOBS \$2.84**  
SCREW & PUSH-ON

**10 — VOLUME CONTROLS \$2.63**  
ASSORTED, WITH SWITCH 1/4, 1/2, 1, 2 meg. and others

**BROOKS RADIO & TV CORP., 84 Vesey St., Dept. A, New York 7, N. Y.** TELEPHONE Cortland 7-2359

Just what the TV Doctor ordered...

# R STANCOR

## EXACT REPLACEMENT FLYBACKS

Whether the "patient" is a Crosley, a Muntz, an RCA, or any other brand, you can be sure of a prompt recovery when the prescription reads "STANCOR"



**R** Patient: *Muntz*

Stancor A-8242

New Exact Replacement Flyback for Muntz TO-0028 and TO-0029

List Price.....\$9.00

**R** Patient: *Crosley Super V, Hallicrafters*

Stancor A-8241

New Exact Replacement Flyback for Crosley 157820 and Hallicrafters 550251

List Price.....\$8.10

**R** Patient: *RCA*

Stancor A-8244

New Exact Replacement Flyback for RCA 78201 and RCA 78810. Used in 67 models and chassis.

List Price.....\$10.00

FREE—HIGH FIDELITY, Ultra-Linear Amplifier. Bulletin 479 describing performance and construction of the 24 watt Stancor-Williamson Amplifier, using Stancor Ultra-Linear Output Transformer A-8072 (\$15.00 net). Available from your distributor.



## CHICAGO STANDARD TRANSFORMER CORPORATION

3592 ELSTON AVENUE • CHICAGO 18, ILLINOIS

EXPORT SALES: Roburn Agencies, Inc. • 431 Greenwich Street • New York 13, N. Y.

Stancor transformers are listed in Photo-fact Folders, Counter-facts, Radio's Master, and File-O-Matic.

## new Tubes & Transistors



6CB5, 6BK4, 6BL4

The first of a new line of receiving tubes designed for use with the RCA 21-inch color receiver has been announced by that company. The new tube types (see photo) are designed to have operating characteristics that match the circuit requirements of the

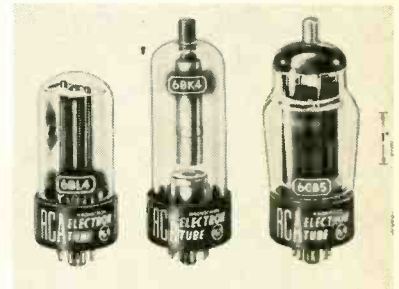

RCA 21-inch picture tube, the 21AXP22.

The 6CB5 is a high-perveance, beam-power tube designed especially for use as a horizontal deflection amplifier. Its maximum plate dissipation is 23 watts, maximum grid-2 input 3.6 watts, maximum peak positive-pulse plate voltage rating 6,800, and maximum negative-pulse voltage rating 1,500.

The 6BK4 is a sharp-cutoff beam triode designed for regulating the high-voltage supply. It has a maximum d.c. plate voltage rating of 25,000, maximum d.c. plate current rating of 1.5 ma, and maximum plate dissipation rating of 25 watts.

The 6BL4 is a half-wave vacuum-tube rectifier designed for use as a damper diode. Rated to withstand a maximum peak inverse plate voltage of 4,500, it can supply maximum peak plate current of 1,200 ma and maximum d.c. plate current of 200 ma. When the heater is operated negative with respect to the cathode, negative peak pulses between the heater and cathode of as much as 4,500, including a d.c. component of up to 900 volts, may be used.

7AU7

Another release by RCA is the 7AU7, a medium-mu twin triode of the nine-pin miniature type. It is intended for use as a vertical deflection oscillator and horizontal deflection oscillator in TV receivers having a single 600-ma series-connected heater string. Except for changes in the heater design, the 7AU7 is like the 12AU7.

This tube may also be use as an audio mixer, phase inverter, multi-

## Another Fabulous YAGI VALUE!!



Now only

**\$6.95** ea.

Reg. \$34.50

\$6.50 ea. — lots of 3

You've never seen an antenna value as sensational as this Delco Ultra Sensitive Broadband Yagi. Will receive Channels 2 to 6 with Razor Sharp clarity at distances of 125 miles or more. Excellent front-to-back ratio helps to prevent "ghosting." Extremely simple to assemble. Complete with mounting hardware and instructions. Shpg. wt 12 lbs.

Stock No. 99-B-BD56

## Delco Aluminum 5 Element BROADBAND Yagis

Covers Channels 2 to 6

CONCORD RADIO 54 Vesey St., N. Y. 7.  
Dept. C2 20% deposit with C.O.D. MINIMUM ORDER \$5.00

Please send NEW 1955 CONCORD Catalog!

NAME \_\_\_\_\_

ADDRESS \_\_\_\_\_

CITY \_\_\_\_\_ ZONE \_\_\_\_\_ STATE \_\_\_\_\_

CONCORD RADIO • 54 VESEY ST. • NEW YORK 7, N. Y. • Digby 9-1132

## EDLIE for TOP VALUES

Newest & Best "Fix-It-Yourself" Aid  
Larrel's E-Z TV REPAIR GUIDE

The Only **FIX-IT-YOURSELF** Guide  
Made expressly for **YOUR TV Set!**

Now you can save costly TV repairs with this new, simplified method which includes all necessary data for just YOUR set. No confusing, unimportant information applicable to hundreds of other makes. Simplifies detection of faulty tubes in your TV receiver quickly, accurately.

It's a terrific idea—It's a terrific guide! Order today and have your set back in only perfect condition at once. Be sure to send us make and model of your TV when **50¢** ordering.

### New CODE KEYS, J-38

Brand new! Signal Corp., U.S. Army, black bakelite base, 3" x 4 1/4", brass jumper, strip, & binding posts. Circuit closing switch. Completely adjustable. **79¢**  
Special

### Save! HIGH PASS FILTER

Input impedance: 600 ohms; output impedance 5,000 ohms. 300 cycles cut off frequency at 3,500 cycles attenuates at 2 db.; at 120 cycles attenuates at 20 db.; at 60 cycles attenuates at 45 db. 2" x 3 1/2" x 2". Original cost: \$2.00. **\$1.35**  
Reduced to

### Save! LOW PASS FILTER

At 3,500 cy. attenuates at less than 0.2 db.; at 8,000 cy. attenuates at greater than 60.0 db.; at 6,000 cy. attenuates at greater than 50.0 db. Input impedance: 5,000 ohms. Original cost: \$1.50. **\$1.45**  
Reduced to

### SAVINGS ON KITS

#### INSULATED RESISTOR KIT



100 INSULATED RESISTORS. RMA code marked all 1/2 watt varying in ohms from 1 ohm to 10 megohms and tolerance of 5%, 10% & 20% of standard makes. RMA color code chart included FREE. Special. **95¢**

#### DeLuxe Insulated Resistor Kit

Includes: 15-2 watt, 35-1 watt and 50-1/2 watt values up to 20 megs. Housed in a transparent plastic box, 4 3/8" x 2 3/8" x 1". 4-compartments. Reduced to **\$2.25**

#### FLEXIBLE W. W. PIGTAIL RESISTOR KIT

100 Resistors of asst. ohmages and wattage **\$1.65**

#### CANDOHM W. W. metal clad

25 Resistors of asst. ohmages and wattage **95¢**

#### WIRE WOUND RESISTOR KIT

25 Wire Wound Resistors up to 50-1/2 ohms. 5, 10, 20, 30, 40, and 100 watt resistors **\$1.95**

#### PRECISION CARBOFILM RESISTOR KIT

1% tolerance in ohmages from 5 to 2.2 megohm. \$2.50 value **\$2.45**



#### Terrific Buy! PRECISION WIRE WOUND RESISTOR KIT

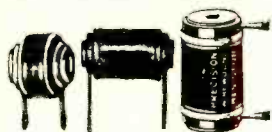

20 Precision W.W. resistors. 1% tolerance. 20 different ohmages ranging up to 1/2 megohm, 1/2 & 1 watt. \$2.50 value **\$2.45**

#### Disc Condenser Kit

50 Disc condensers—.001, .0015, 2X0015, 2X004, 0047, .005, .01, 2X01, & 0000 10/2KV mfd. of equal amounts. **\$1.95**  
Now!

#### CERAMIC CONDENSER KIT

50 Tubular ceramic (solid and hollow) ranging in capacity from 1 to 4700 mfd. **\$1.75**  
Special!

Write today for FREE Catalog. All mdse, shipped F.O.B. New York City, prices subject to change without notice. Include 20% deposit with C.O.D.'s.

## EDLIE ELECTRONICS

154 Greenwich St. New York 6, N.Y.  
DI. 9-3143

## NEW TUBES

(Continued)

vibrator, sync separator and amplifier, and resistance-coupled amplifier.

The design features of the 7AU7 include a strengthened mount structure to minimize microphonic effects, a terminal for each cathode and a mid-tapped heater which will permit operation from either a 7-volt or a 3.5-volt supply.

### 2N76

GE has announced development of a new, low-cost (suggested list price, \$7.95), fused-junction transistor, the 2N76. The transistor (see photo) was



designed to cover a broad specification range. Designers and hobbyists interested in developing and experimenting with transistor circuits now have available a stable, relatively inexpensive component. The unit is hermetically sealed.

The 2N76 was developed for use in audio and ultrasonic-frequency stages. It has a maximum cutoff frequency at 2.5 mc, with a design center at 1 mc. The alpha design center of the transistor is 0.95. Maximum ratings are: collector voltage, -20; collector current, -10 ma; emitter current, 10 ma. The 2N76 is capable of dissipating 50 milliwatts at an ambient temperature of 77° F.

### Silicon power rectifier

The Transistron Electronic Co., Melrose, Mass., has announced development of experimental silicon power rectifiers. Dr. Bakalar, company president, said that theoretically these units should have infinite life as they do not exhibit a continuous aging effect as do selenium rectifiers. And because of their extremely low losses, operating efficiencies of as high as 98% are possible.

Silicon rectifiers are capable of

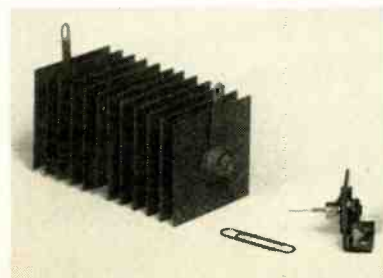

# 655XC

# HICKOK

## TELEVISION

### color bar generator



MODEL  
655XC

This generator produces a standard 100% fully saturated NTSC color bar pattern on color TV sets. Regardless of future color television receiver design this color bar generator will be compatible.

Produces same type of signal that is transmitted over the air. All literature and alignment data is published around this standard NTSC signal. The Model 655XC provides signal for complete color alignment. When alignment is made with this type of signal, operator is sure that proper program colors will be displayed on the TV receiver.

The color bars appear on the TV screen in the following order from left to right: green, yellow, red, magenta, white, cyan, blue and black. OUTPUT. . . EITHER R F. or VIDEO

Write for . . .

complete technical literature.

THE HICKOK ELECTRICAL INSTRUMENT CO.  
10531 Dupont Ave. • Cleveland 8, Ohio



# CAP-CHECK!

the only precision instrument that checks condensers WHILE IN THE CIRCUIT!

WITH CARRYING STRAP AND TEST LEADS COMPLETELY WIRED AND TESTED.

- Checks condensers in the circuit and eliminates the time consuming need of unsoldering and resoldering.
- The only direct reading microfarad meter.
- Convenient jacks for using CAP-CHECK with frequencies from audio generator or RF generator.
- Large easy-to-read dial. A flip of the switch instantly gives the condition of the capacitor without removing it from the circuit.
- Eliminates the need for carrying multiple units. Has built in voltmeter, an ohmmeter, plus the capacity meter — All using one master function selector switch.
- Uses a 4½" precision microammeter.
- Engineered and precision made to give dependable and accurate service.
- Each instrument backed by written registered warranty and conforms to standard RTMA guarantee.

AC only \$44.95

CAP-CHECK gives High Performance at Low Low Cost!!

See your local jobber or write for full information.



**Instruments for Service Inc.**

96 SOUTH GRAND AVENUE, BALDWIN, LONG ISLAND, N. Y.

## OPPORTUNITY ADLETS

Rates—45c per word (including name, address and initials). Minimum ad 10 words. Cash must accompany all ads except those placed by accredited agencies. Discount, 10% for 12 consecutive issues. Misleading or objectionable ads not accepted. Copy for April issue must reach us before Feb. 15, 1955.

Radio-Electronics

25 W. Broadway, New York 7, N. Y.

SPEAKER REPAIRS ON ALL MAKES. 8" & 12" HI-FI speakers for sale. Amprite Speaker Service, 70 Vesey St., New York 7, N. Y.

"Buy Surplus Radio, Electronic Equipment direct from Government. List \$1.00. Box 213AK, East Htfd 8, Conn."

SPEAKER RECONING: Guaranteed workmanship. C&M Recone Co., 255 Tloqa St., Trenton 9, N. J.

RADIO DIAGRAMS \$1.00. Television \$2.00. Give make model. Diagram Service, 672-RE, Hartford 1, Conn.

TELEVISION JOBS—Names and addresses of companies to contact. \$1.00 Fitzgerald, Dept. A-23, 3038 West Wellington Avenue, Chicago 18, Illinois.

TUBES, TV, RADIO, TRANSMITTING, AND SPECIAL PURPOSE TYPES BOUGHT, SOLD AND EXCHANGED. Send details to B. N. Gensler W2LNI, 136 Liberty, N. Y. 6, N. Y.

RECORDING FANS! SWAP TAPES EVERYWHERE. DETAILS FREE. BOX 1404-W, San Francisco 1.

TEST EQUIPMENT REPAIRED—New modern lab equipped to handle all makes and types of meters and testers. Free estimates. Catalogue available. General Electronic Dist. Co., 100 Park Place, N. Y. 7, N. Y.

TOP DOLLAR paid for ART-13s, dynamometers, parts racks and all other component parts. Write: Harjo Sales Company, 4109 Burbank Blvd., Burbank, Calif.

ALL MAKES OF ELECTRICAL INSTRUMENTS AND TESTING equipment repaired. Write for free catalogue on new and used instruments at a savings. Hazelton Instrument Co., 128 Liberty Street, New York, N. Y.

WANTED: AN/APR-4, other "APR." "TS.", "IE.", ARC-1, ARC-3, ART-13, IC-349, etc. Microwave Equipment. Everything Surplus. Special tubes, Tec Manuals, Lab Quality Equipment, Meters, Fast Action, Fair Treatment. Top Dollar! Littell, Fairhills Box 26, Dayton 9, Ohio.

BUY WHOLESALE—25,000 Items—Catalog 25c. Matthews, 1472-P4, Broadway, NYC 36.

SPEAKER RECONING: 25 years experience. Michigan Speaker Reconing Service, 930 Metropolis, Marine City, Michigan.

ALUMINUM TUBING. Angle and Channel. Plain and Perforated Sheet. Willard Radcliff, Fostoria, Ohio.

Power Transformers Rebuilt: all makes, Victor R32—\$12.95. Red Arrow Radio, 924 Metropolis, Marine City, Michigan.

25-50% DISCOUNT, guaranteed. Factory Fresh LP records: 68¢ and up; pre-recorded tapes. Send 20¢ for catalogue. SOUTHWEST RECORDS, 4710 Caroline, Houston 4, Texas.

TELEVISIONS, WORKINGS, \$30 UP. W4API, 1420 South Randolph, Arlington 4, Virginia.

INCREDIBLE! ONE TUBE radio receives television, FM broadcast, CAP and amateurs. Special tube and diagram only \$2.00. Wired assembly \$2.00. Springfield Enterprises, Box 54-F2, Springfield Gardens 13, New York.

REFERENCE HANDBOOK OF ENGINEERING MATHEMATICS \$1.00 cash, ppd. Dept. 2T Box 7794, University Station, Austin, Texas.

TV FM ANTENNAS, ALL TYPES INCLUDING UHF. Mounts, accessories. Lowest prices. Wholesale Supply Co., Lunenburg 2, Mass.

## PHOTOGRAPHS

RADIO-ELECTRONICS can use good photographs of service benches, service shops, high-fidelity audio layouts, and any other interesting and original radio-electronic devices.

We will pay \$6.00 each for good professional photos or equivalent, suitable for reproduction.

Full information on subject photographed will increase their acceptability.

The Editor, RADIO-ELECTRONICS

21 West Broadway, New York 7, N. Y.

## NEW TUBES

(Continued)

operating efficiently between an extremely wide range of temperatures (150° C to -60° C) and possess large power-handling ability. They can be extremely compact (see photo).

## 6570

RCA has announced a vacuum phototube for use in industrial applications critical as to microphonics and sensitivity. The 6570 phototube is particularly useful in beverage-inspection and ampule-inspection equipment.

The 6570 is extremely sensitive to red and near-infrared energy, making it especially suitable for use with an incandescent light source. The tube has a maximum anode-supply voltage rating of 500, a maximum average cathode-current rating of 5 microamperes, and an average luminous sensitivity of 30 microamperes per lumen.

## USN-0A2WA, USN-0B2WA

Heralded as the new VR tubes without "pips" (sudden discrete voltage shifts), CBS-Hytron has announced the USN-0A2WA and the USN-0B2WA.

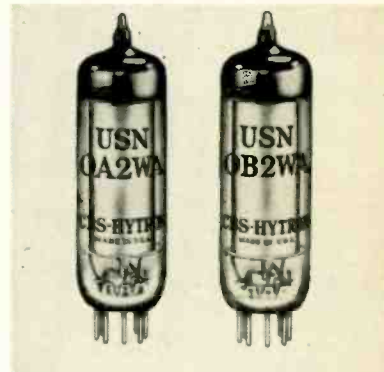

These tubes are of the seven-pin miniature type.

The gaseous VR tubes are designed to provide reliable, stable operation as voltage regulators and, under specific conditions, as voltage-reference tubes. They provide flat, smooth voltage-current characteristics between 5 and 30 ma of tube current and are interchangeable with the 0A2 and 0B2. **END**

## COLOR TV

By JULIA R. SEITZ

The purple cow is not a myth  
Pink elephants parade  
And blue bananas by the bunch  
Are garishly displayed.

You doubt my word? You think me daft?

I swear I'm no deceiver.  
The proof I'll show you any day  
On my TV receiver.



# Patents



## TV RECORDING

Patent No. 2,688,693  
 Harold E. Haynes, Haddonfield, N. J.  
 (Assigned to Radio Corp. of America)

TV programs are recorded on movie film for filing and rebroadcasting. The usual method is to make a negative and then make prints for distribution. Time and expense could be saved by scanning a negative image and photographing directly on positive film. This circuit converts a conventional video voltage so that it corresponds to a negative image.

A negative film is one whose light transmission is inversely proportional to its exposure. For example, if its exposure were increased three times, it would transmit only

one-third the light. The diagram shows a circuit whose output voltage varies inversely as the input. Therefore if a conventional video signal is fed in, the output will correspond to a negative.

The double-triode multivibrator is followed by a differentiating network and diode D1. Negative pulses flow through the diode, while the positive ones block the tube. Thus C charges periodically and discharges (through R) when the diode blocks. The pentode is a sharp-cutoff tube that conducts only when C is almost completely discharged. In such a circuit, cutoff time varies

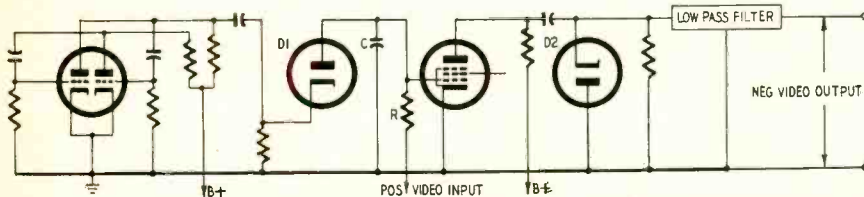

inversely with the amplitude of the input signal. Thus the tube's output voltage (which is proportional to the cutoff time) also varies inversely with the input voltage.

The output of the pentode is controlled by d.c. restorer D2 and an averaging (low-pass filter) network.

## AUDIENCE REACTION

Patent No. 2,688,873  
 Harold Burris-Meyer, Madison, N. J.  
 (Assigned to Control, Inc., Jersey City, N. J.)

Psychologists know that the mental state of a person is reflected in his physical attitude and movements. For example, a bored viewer may become fidgety and restless while watching a film or listening to a speech but an interested one leans forward in his seat. This invention measures the movements and positions of a sitting person without his becoming aware of it.

Strain gauges are placed beneath the seat of the person to be tested. In one system four such

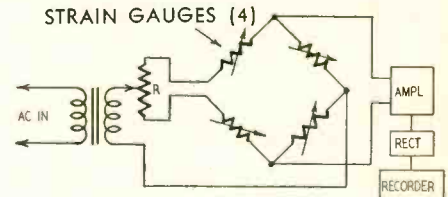

gauges are used. Two of them measure changes in the vertical stress (right and left). The others detect changes fore and aft. Each gauge is made of a grid of wire imbedded in a plastic sheet. Its resistance varies when the sheet is bent, stretched or otherwise deformed.

The gauges are used as arms of a bridge network, fed by an a.c. source. The bridge is initially balanced by R. Resistance changes cause unbalance, indicated by the recorder.

The output of the strain gauges is fed to an amplifier to raise the signal level.

Get This Valuable Book

Just for Examining COYNE'S New 6-Volume Set

# FREE



# "Applied Practical Radio-Television"

Yes, you get this big, new 1954 book, "150 Radio-Television Picture Patterns and Diagrams Explained", absolutely FREE! Just off the press! Gives complete 11x22" Schematic Diagrams on leading models Radio and Television Sets. Easy-to-read, large 8½x11" pages, with full instructions on how to read and use the diagrams. A "must" in every Radio and Television service-man's repair kit. You get this valuable book as a FREE Gift for asking to see Coyne's great new 6-book set, "Applied Practical Radio-Television"!

ON 7 DAY FREE TRIAL!



**At Last! Money-Making "Know-How" on Transistors, Color TV and Servicing**

Coyne's great new 6-volume set gives you all the answers to servicing problems—quickly! For basic "know-how" that is easy to understand, you'll find everything you want in volumes 1 to 5 which contain over 5000 practical facts and data. They cover every step from principles to installing, servicing, trouble-shooting and aligning all types of radio and TV sets. So up-to-date it includes COLOR TV and UHF, adapters, converters. Also covers latest data on TRANSISTORS.

**Extra! 802-Page Television Cyclopeda Included**

And then, for speedy on-the-job use, you get volume 6—the famous Coyne TELEVISION CYCLOPEDIA. It answers today's television problems on servicing, alignment, installation and others. In easy-to-find ABC order, cross indexed. Use this 6 volume TV-RADIO LIBRARY free for 7 days; get the valuable Servicing Book ABSOLUTELY FREE!

**SEND NO MONEY!** Just mail coupon for 6-volume set on 7 days free trial. We'll include book of 150 TV-Radio Patterns & Diagrams. If you keep the set, pay \$2 in 7 days and \$2 per month until \$22.50 plus postage is paid. (Cash price \$20.95). Or you can return the library at our expense in 7 days and owe nothing. **YOU BE THE JUDGE.** Either way, the book of TV-Radio Patterns is yours FREE to keep! Offer is limited. Act NOW!

**FREE BOOK—FREE TRIAL COUPON!**

Educational Book Publishing Division  
**COYNE ELECTRICAL SCHOOL, Dept. 25-T1**  
 500 S. Paulina St., Chicago 12, Ill.

YES! Send 6-volume "Applied Practical Radio-Television" for 7 days FREE TRIAL per your offer. Include TV-Radio Patterns & Diagram Book FREE.

Name ..... Age.....

Address .....

City ..... Zone ..... State.....

Where Employed.....

( ) Check here if you want library sent COD. You pay postman \$20.95 plus COD postage on delivery. 7-day money-back guarantee.

Educational Book Publishing Division  
**COYNE ELECTRICAL SCHOOL**  
 500 S. Paulina St., Dept. 25-T1, Chicago 12, Ill.

For QUALITY - PERFORMANCE - DEPENDABILITY

# Rad-Tel Tubes Guaranteed 1 FULL YEAR



70% to 90% OFF

- Same Day Service
- All Tubes Individually Boxed
- 300 Types Always in Stock

Type	Price	Type	Price	Type	Price	Type	Price
024M	.65	6AH6	.73	6CD6	1.11	12AT6	.41
1A7GT	.47	6AK5	.55	6H6GT	.41	12AT7	.72
1AX2	.62	6AK6	.59	6J5GT	.43	12AU6	.46
1B3GT	.73	6AL5	.42	6J6	.52	12AU7	.60
1E7	.29	6AM8	.78	6K6GT	.45	12AV6	.39
1H4	.30	6AQ5	.50	6L6	.84	12AV7	.73
1H5GT	.49	6AQ6	.37	6S4	.48	12AX7	.63
1LA6	.69	6AQ7	.70	6SA7GT	.55	12BA6	.49
1LH4	.69	6AR5	.45	6SK7GT	.53	12BE6	.51
1LN5	.59	6AS5	.50	6SL7GT	.48	12BH7	.63
1N5GT	.67	6AS6	1.49	6SN7GT	.59	12BY7	.65
1R5	.62	6AT	.41	6SQ7GT	.46	12SA7GT	.65
1S5	.51	6AU4GT	.68	6T4	.99	12SK7GT	.63
1T4	.58	6AU5GT	.82	6T8	.80	12SL7GT	.57
1U4	.57	6AU6	.46	6U8	.78	12SN7GT	.52
1U5	.50	6AV5GT	.83	6V6GT	.50	12SQ7GT	.56
1X2A	.63	6AV6	.40	6W4GT	.47	12V6GT	.46
3AU6	.46	6AX4GT	.65	6W6GT	.57	12X4	.38
3BC5	.54	6BA6	.49	6X4	.37	14A7	.63
3BN6	.74	6BC5	.54	6X5GT	.37	14B6	.63
3CB6	.54	6BE6	.51	6X8	.75	14R7	.79
3Q4	.48	6BG6G	1.25	7A7	.69	19T8	.69
3Q5GT	.69	6BH6	.53	7A8	.68	25AV5GT	.83
3S4	.58	6BJ6	.49	7B7	.49	25BQ6GT	.98
3V4	.58	6BK7	.80	7C5	.69	25L6GT	.51
5J6	.64	6BL7GT	.83	7C6	.59	35B5	.52
5T4	.79	6BN6	.74	7F7	.79	35C5	.51
5U4G	.55	6BQ6GT	.98	7H7	.59	35L6GT	.51
5U8	.75	6BQ7	.90	7N7	.69	35W4	.47
5V4	.71	6BZ7	.90	7Q7	.66	35Y4	.54
5Y3GT	.37	6C4	.40	7Y4	.69	35Z3	.59
6A8	.62	6CB6	.54	12AL5	.37	35Z5GT	.47
6AB4	.44					50A5	.55
6AC7M	.86					50B5	.52
6AF4	.90					50C5	.51
6AG5	.56					50L6GT	.61
6AG7M	.99					80	.43
6AH4	.57					117Z3	.37

**Selenium Rectifiers Mfg. by FEDERAL**



66 DC-Ma.	.59	250 DC-Ma.	1.39
75 DC-Ma.	.69	300 DC-Ma.	1.49
100 DC-Ma.	.79	350 DC-Ma.	1.59
150 DC-Ma.	.84	400 DC-Ma.	1.69
200 DC-Ma.	1.25	500 DC-Ma.	1.79

## COMPLETE TUBE LIST OF OVER 300 TYPES IN STOCK!

**TERMS:** A 25% deposit must accompany all orders—balance C.O.D. All shipments F.O.B. Irvington warehouse. **ORDERS UNDER \$10—\$1.00 HANDLING CHARGE.** . . . Subject to prior sale.

**PLEASE:** Send full remittance . . . allow for postage and save C.O.D. charges! We refund all unused money! Dept. RE2. Phone: Essex 5-2947.

# Rad-Tel TUBE CO.

*'Integrity Is Our Chief Asset'*

115 COIT ST., IRVINGTON II, N. J.

## FACTORY REPAIRS

ON ALL MAKES AND TYPES OF TEST EQUIPMENT

Send units via parcel post—will quote after inspection.

Write for NEW FREE Catalogue

GENERAL ELECTRONIC DIST. CO.

100 PARK PLACE, NEW YORK 7, N. Y.

## BRAND NEW PARTS

Not enough of each to list individually

1. TUBES, 20 assorted, \$5.99.
2. CONDENSERS—item zed, Identified Ceramic, 2 ea. 30 sizes \$3.98, Silver Mica, 2 ea. 20 sizes \$2.98.
3. Assorted, 5 lbs. minimum: WIREWOUND RESISTORS, 80¢ per lb.; TRANSMITTING CONDENSERS oil, bakelite 90¢ per lb.

Shipped prepaid USA with 50¢ handling charge.

R & M TV, 284 Morris Ave., Eliz., N. J.

RADIO-ELECTRONICS is paying good rates on acceptance for original and unusual articles on audio, television, FM and AM servicing, as well as articles on industrial electronic equipment and applications. Send for a copy of our Authors' Guide, Address:

## THE EDITOR RADIO-ELECTRONICS

25 West Broadway  
New York 7, N. Y.

PATENTS

(Continued)

## MECHANICAL RECTIFIER

Patent No. 2,673,947

Jerrold B. Winther, Kenosha, Wis.

(Assigned to Eaton Mfg. Co., Cleveland, Ohio)

Mechanical rectifiers handle greater power than other types. This rotating device, for example, delivers more than 100 volts at 2 amps. Fig. 1 shows the rectifier as a switch, controlled by a motor. The switch is closed during most of the positive half-wave (polarity is as shown in Fig. 1). It is opened during the negative half-cycle.

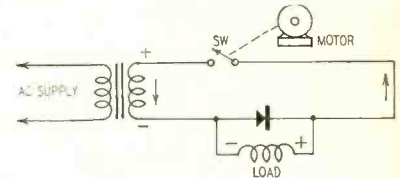

The transformer primary is connected to a 220-volt a.c. line. The switch closes near the peak of the positive half-wave. Electron flow is in the direction of the arrows. It feeds the load, which may be a motor field, for example. The selenium diode is blocked during this time. As the voltage wave tapers off to zero, the conductivity of the switch increases to maintain uniform output.

Just before the voltage polarity reverses, the switch opens. Due to the high inductance of the load, the current is maintained through the load in the same direction. Normally this inductive effect would cause sparking across the open switch contacts. It is eliminated here by the selenium diode which conducts the induced current through the load.

Mechanical details of the switch are shown in Fig. 2. Two brush contacts touch a conducting surface (shaded in Fig. 2) on a rotating cylinder. As it rotates, the conducting surface

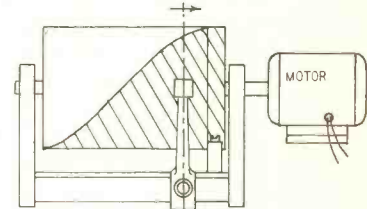

Fig. 2

increases from zero to maximum. This compensates for the drop in voltage as the a.c. wave falls off from its peak value. At the end of the positive half-wave the conducting path is broken.

One of the contacts is mounted on a sliding member so it can be adjusted. Its position controls the phasing of the switch relative to the positive half-wave. END



# Technotes



## HOFFMAN 301-302 CHASSIS

In some areas a buzz problem has been encountered due to modulation at the transmitter. This has been cured by shifting the sound take-off point from the plate of the 6AH6 video amplifier to the junction of L205 and C212 immediately after the video detector, as shown in the diagram. Note also that the values of R212 and R213 have been interchanged.

In areas where greater horizontal and vertical sync stability is needed add a .005- $\mu$ f, 500-volt capacitor across the horizontal hold control and change the value of C602 (the capacitor between ground and the junction of the 47,000- and 10,000-ohm resistors between the blue lead on the vertical output trans-

former and pin 1 of the 12AU7 sync separator) from .001  $\mu$ f to a .0047- $\mu$ f, 400-volt unit.

To increase the range of the vertical hold control, add a 680,000-ohm,  $\frac{1}{2}$ -watt resistor between the center tap and the ungrounded side of the control. Also, add a 470,000-ohm,  $\frac{1}{2}$ -watt resistor from the ungrounded side of the vertical hold control to the blue lead of the blocking oscillator transformer.

The changes described have been made in later production runs of these chassis.

If feedback occurs on channel 7, re-address the speaker leads away from the antenna lead-in.—*Hoffman Service Bulletin*

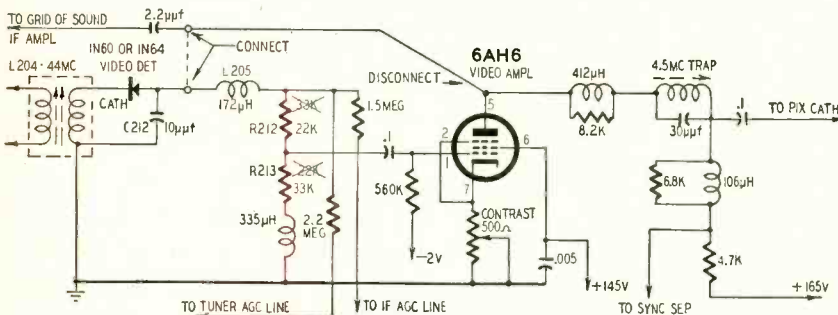

## ZENITH G510

After a few weeks of operation the 35W4 rectifier in these models burns out. The heater string on these sets starts at the pilot light tap. This causes excess voltage to be applied to the

heater string, reducing the normal life of the tubes. Connecting the line to pin 4 instead of 6 reduces the heater voltage and will result in longer tube life.—*Wayne Miller*

## WESTINGHOUSE 600T16

In this set, lack of horizontal deflection can be assumed to be caused by a defective yoke. However, before replacing the yoke, replace the 0.1- $\mu$ f capacitor between ground and the junction of the width control and the hori-

zontal output choke. It is good practice also to replace the 0.1- $\mu$ f capacitor between the deflection amplifier plates and the horizontal yoke winding. Position of this capacitor can be seen in the partial schematic.—*Wilbur Hantz* END

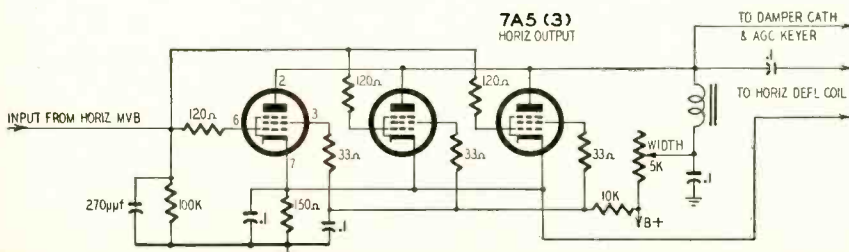

## THE NEW PRECISION MODEL 120

GIVES YOU WHAT YOU WANTED IN A HIGH SENSITIVITY MULTI-RANGE TEST SET

20,000 OHMS PER VOLT D.C.  
5,000 OHMS PER VOLT A.C.

The '120' gives you . . .

- ✓ MORE RANGES
- ✓ AN EXTRA-LOW RESISTANCE RANGE
- ✓ AN EXTRA-LOW VOLTAGE RANGE
- ✓ AN EXTENDED LOW CURRENT RANGE
- ✓ A LARGER METER SCALE FACE
- ✓ SIMPLE, POSITIVE RANGE SELECTION
- ✓ POSITIVE CONTACT JACKS and PLUGS

### Compare These Wide Spread Ranges and Special Features:

- ★ 8 DC VOLTAGE RANGES: 20,000 ohms per volt.
- ★ 8 AC VOLTAGE RANGES: 5,000 ohms per volt. 0-1.2-3-12-60-300-600-1200-6000 volts.
- ★ 8 AC OUTPUT RANGES: same as AC volt ranges. Built-in 600 volt blocking capacitor.
- ★ 7 DC CURRENT RANGES: 0-60-300 Microamperes. 0-1.2-12-120-600 Ma. 0-12 Amperes.
- ★ 5 RESISTANCE RANGES: self-contained. 0-200-2000-200,000 ohms. 0-2-20 megohms.
- ★ 8 DECIBEL RANGES: -20 DB to +77DB. 0 DB = 1 Milliwatt, 600 ohms.
- ★ EXTRA LARGE  $\frac{5}{16}$ " RUGGED 'FACE' METER: 40 microamperes sensitivity, 2% accuracy.
- ★ 1% MULTIPLIERS and SHUNTS: Wire-wound and deposited film types.
- ★ TWO JACKS SERVE ALL STANDARD RANGES: Separately identified and isolated jacks provide for extra high ranges.
- ★ "TRANSIT" SAFETY POSITION on range selector protects meter during transport and storage.
- ★ CUSTOM-MOLDED PHENOLIC CASE and PANEL: Compact, laboratory styled instrument.

MODEL 120 . . . complete with internal ohmmeter batteries, banana-plug test leads and detailed operating manual. Overall case dimensions.  $5\frac{3}{8} \times 7 \times 3\frac{1}{8}$ " Net Price \$39.95

**PRECISION Apparatus Co. Inc.**

70-31 84th Street, Glendale 27, L. I., N. Y.

Export Division: 458 Broadway, New York 13, U.S.A. • Cables—Morhanex  
In Canada: Atlas Radio Corp. Ltd. 560 King Street W. Toronto 28

**OXFORD Speakers**  
*Guarantee Quality Sound*

Better sound from OXFORD SPEAKERS complete line from 2' to 15'... for all replacement needs... **ORDER TODAY!**

**OXFORD ELECTRIC CORPORATION**  
 3918 South Michigan Avenue - Chicago 15, Illinois  
 EXPORT—ROBURN AGENCIES, NEW YORK CITY IN CANADA—ATLAS RADIO CORP. LTD., TORONTO

**Important Notice to SUBSCRIBERS**

If you're moving, please don't forget to send us your address as it appears on the copy of the magazine, including the numbers shown beside your name, as well as your new address. If possible, send us your address label which is pasted on the upper left hand corner of the back cover.

If we receive this information before the 20th of the month, you will continue getting the magazine without interruption.

Your cooperation will be most helpful and greatly appreciated.

Please send your new address to:

Circulation Department  
 RADIO-ELECTRONICS  
 25 W. Broadway, New York 7, N. Y.

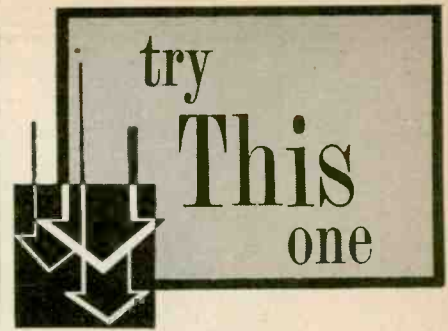

**SIMPLE PHONO CONNECTION**

Frequently radio technicians are called in to add a phono connection to a radio or TV set. Conventional adaptations require the installation of a phono-radio switch. However, when the set owner does not want an extra control knob or is afraid that drilling the mounting hole will mar the set, you can

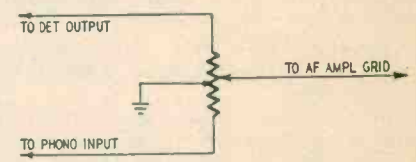

use a simple trick that will prove satisfactory.

Replace the present volume control with a center-tapped type having twice the resistance of the original. Wire the arm, tap and counterclockwise end of the new control to the leads removed from the arm, ground and hot end, respectively, of the old control. Connect the phono input jack or terminal to the remaining contact on the control.

The revised circuit appears as in the diagram. The center position of the control produces zero volume. Turning the knob clockwise brings up the radio volume and turning it counterclockwise from center brings in the phonograph. —J. Sareda

**NOVEL PI NETWORK**

Pi networks are widely used as antenna couplers and as final tank circuits to minimize harmonic radiation and to simplify matching the rig to single-wire and unbalanced antennas. Separate plug-in coils or expensive variable inductors are used when the rig is operated on several bands.

The diagram shows how I modified a standard center-tapped tank coil to cover the 80-, 40- and 20-meter bands. L1 and L2 are halves of an 80-meter coil with the link removed. We removed three turns from L2 to hit 40 meters. L3, used alone for 20 meters, is a 10-turn section of B & W type 3015 Mini-inductor (1 inch in diameter, 16 turns per inch). This coil is supported by its leads and is positioned alongside the larger

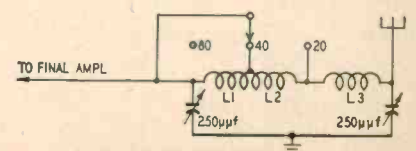

coil and about 1/4 inch from it. One lead is soldered to the base pin connected to the 20-meter terminal on the switch and the other goes to one of the pins formerly used for the link winding. The switch is a transmitting type with ceramic insulation.

With this arrangement the 3-band coil can be removed from its socket whenever necessary. We are not able to detect any loss of efficiency when using this tapped coil in place of separate plug in coils for each band.—I. Queen, W2OUX

**TV SWEEP OSCILLATORS**

A broadcast receiver can be used to determine whether the vertical and horizontal oscillators are functioning in a defective TV receiver. Tune the broadcast receiver to a vacant spot on the dial between about 1490 and 1550 kc. Turn the volume up full. Rotate the horizontal hold control through its range. If the circuit is oscillating, you will hear the horizontal oscillator as it changes frequency. If a picture carrier is coming in and sync pulses are reaching the a.f.c. tube, you will hear a high pitched whistle as the oscillator is brought into sync and a steady hum when it locks in.

When the vertical oscillator is functioning, it produces a buzz that changes frequency as the vertical hold control is rotated. A small battery-operated portable receiver is handy for making these tests on home calls.—John Mayo

**USING PLASTIC SPRAYS**

Exposure to air causes oxidation that decreases the holding power of friction and electricians' rubber tapes and causes them to peel, fray and crumble. When using these tapes for a more or less permanent connection, try spraying the completed wrap with plastic spray. This prevents oxidation and protects against moisture penetration.—Charles Erwin Cohn

**SOLDERING LUGS**

It is a good idea to put a lock washer under a soldering lug before fastening it down with a screw or a nut. This makes it easier to position the lug because the washer keeps it from turning as the screw or nut is tightened.—J. Sareda

**SHAFT COUPLING HINT**

I have found standard shaft couplings a source of irritation and costly call-backs because the setscrews often loosen with ordinary use. I licked the problem with a stick of ferrule cement available at any fishing tackle shop.

Remove the setscrews from the coupling and melt some of the cement into the tapped holes. Heat the coupling to make the cement flow. Replace the screws and screw in tight while the coupling is still hot. When the coupling cools, the screws are locked tight and cannot shift. They cannot be removed without first warming the coupling.—Alan M. Palmer

END

**OHMITE® REPLACEMENTS**

**WON'T boomerang into call backs**



**NEW OHMITE FUSE RESISTOR**

**FOR REPLACEMENT IN ALL TELEVISION RECEIVERS**

The FR-7.5 Fuse Resistor is provided with 1 1/2" tinned wire leads for easy installation directly in the circuit. Can also be soldered to the plug-in terminal strip which is provided.



**7.5 OHMS**



**Little Devil® COMPOSITION RESISTORS**

Tiny, yes . . . but what dependability, ruggedness, and stability! Rated at 70C rather than 40C. Completely sealed and insulated by molded plastic, they meet all MIL-R-11A requirements. Little Devils are available in 1/2, 1, and 2-watt sizes in all standard RETMA values.

**BROWN DEVIL® AND DIVIDOHM® RESISTORS**

Brown Devil fixed resistors and Dividohm adjustable resistors are favorite vitreous-enamelled units! Resistance wire is welded to terminals. Brown Devils are available in 5, 10, and 20-watt sizes; Dividohm and fixed resistors in 10 to 200 watts.

**TYPE AB NOISE-FREE POTENTIOMETERS**

Because the resistance material in these units is solid-molded—not sprayed or painted on—continued use has practically no effect on the resistance. Often, the noise-level decreases with use. They give exceptionally long service. Rated at 2-watts.

Be Right with  
**OHMITE®**  
DEPENDABLE RESISTANCE UNITS

GET THEM FROM YOUR ELECTRONIC PARTS DISTRIBUTOR

Write for Stock Catalog No. 24



OHMITE MANUFACTURING CO.  
3646 Howard St., Skokie, Ill.  
(Suburb of Chicago)

# NEW STOCK OF FIRST QUALITY TELTRON TUBES GUARANTEED! . . . LOWEST PRICES EVER!

All tubes individually boxed . . . unconditionally guaranteed for one year!

**GIFT OFFER!**  
One 6BG6G tube  
will be shipped  
FREE with any  
order accompany-  
ing this ad.

## FREE Bonus Offer!



Model 625K

- Illum. gear-driven "Speed Rollchart"
- New lever-action switches for individual testing of every element
- Tests all conventional and TV tubes

May be bought outright from Teltron for \$34.95

This Eico Tube Tester is yours FREE when you buy \$199 worth of tubes or more within 60 days at Teltron.

Type	Price	Type	Price	Type	Price
1A7GT	.53	6BE6	.46	7N7	.49
1H5GT	.51	6BF5	.48	12AL5	.43
1L4	.51	6BF6	.48	12AT6	.37
1L6	.51	6BG6G	1.18	12AT7	.71
1LC6	.49	6BK5	.75	12AU6	.43
1N5GT	.51	6BJ6	.51	12AV6	.42
1T4	.51	6BH6	.51	12AV7	.73
1U5	.43	6BK7	.78	12AX4GT	.60
2A3	.35	6BL7GT	.78	12AX7	.61
2A7	.35	6BN6	.90	12AZ7	.65
3Q4	.53	6BQ7	.85	12B4	.72
3Q5GT	.61	6BY5G	.60	12BA7	.58
3S4	.48	6BZ7	.95	12BY7	.65
3V4	.48	6C4	.41	12BZ7	.63
5U4G	.43	6CB6	.51	12SL7GT	.60
5V4G	.49	6CO6G	1.63	12SN7GT	.56
5Y3GT	.30	6CU6	.95	19BG6G	1.48
5Y4G	.40	6F6	.42	19T8	.71
5Z3	.42	6F5GT	.44	25BQ6GT	.82
6A8	.40	6H6	.50	25CU6	1.09
6AC7	.65	6J5GT	.49	25L6GT	.41
6K7	.40	6K6GT	.39	25Z5	.55
6AB4	.43	6L6	.78	25Z6GT	.36
6AF4	1.02	6Q7	.40	35A5	.48
6AG5	.52	6S4	.41	35B5	.48
6AH4GT	.65	6S8GT	.65	35C5	.48
6AK5	.96	6SA7GT	.45	35L6GT	.41
6AQ5	.48	6SK7GT	.45	35W4	.33
6AR5	.48	6SL7GT	.60	35Y4	.42
6AT6	.37	6SN7	.60	35Z5GT	.33
6AU5GT	.60	6SQ7GT	.38	50A5	.49
6AV5GT	.60	6T8	.71	50B5	.48
6AV6	.37	6V3	.80	50C5	.48
6AX4GT	.60	6V6GT	.48	50L6GT	.50
6AX5GT	.60	6W6GT	.53	TYPE 80	.40
6BA6	.56	6X4	.37	117L7GT	1.20
6BA7	.58	6X5GT	.38	117Z3	.33
6BC5	.48	6X8	.80	117Z6GT	.65
		7F8	.49		

**FREE** \$7.20 list value Bonus Box of three 6SN7 tubes and 25 assorted resistors with each order of \$25 or more.

### SAME DAY SERVICE

48 Hour Postal Delivery To West Coast

TERMS: Save all freight and postage charges. All orders accompanied by full remittance will be shipped POSTAGE PAID anywhere in the continental U.S.A.

25% deposit required on C.O.D.'s. Minimum order \$10.00. Open accounts to rated firms only.

Send for Free complete tube listing and monthly specials! Get on our mailing list.

### SPECIALS!—Till MAR. 1

Type	Price	Type	Price
1B3GT	.58	6W4GT	.35
1U4	.42	12AU7	.50
1X2	.58	12BA6	.39
6AL5	.32	12BE6	.39
6AU6	.35	12BH7	.55
6BQ6GT	.75	12SA7	.40
6J6	.52	12SK7	.40
6SN7GT	.48	12SQ7	.35
6U8	.69	35L6GT	.38

## TELTRON ELECTRIC COMPANY

428 Harrison Ave.,

Harrison, N. J.

Dept. RE-2

Phone HUmboldt 4-9848

1440 pgs.

Fully catalogs  
Radio-TV-  
Electronic  
parts &  
equipment:  
Tubes,  
Trans-  
mitters,  
Test Equip-  
ment, Comm.  
Receivers,  
Transformers,  
Capacitors,  
Antennas,  
Resistors,  
Coils & Relays,  
Recording &  
PA Systems,  
Hardware,  
Tools, etc., etc.  
OFFICIAL BUYING  
GUIDE OF THE  
INDUSTRY

## 1440 page MASTER

for everything in Electronics

Make rapid selections from one industry-wide MASTER CATALOG complete with SPECIFICATIONS, ILLUSTRATIONS, DESCRIPTIONS, DIAGRAMS, PRICES on thousands of Radio-TV-Electronic parts and equipment.

### NEW! 1955 BUYING GUIDE

List \$6.50

As low as **\$1.95** • Over 85,000 • Fully indexed items • 8½" x 11" • Over 8,500 illus. • Weighs 6 lbs.

From leading parts distributors or write to:

UNITED CATALOG PUBLISHERS, INC.  
110 Lafayette Street, New York 13, N. Y.

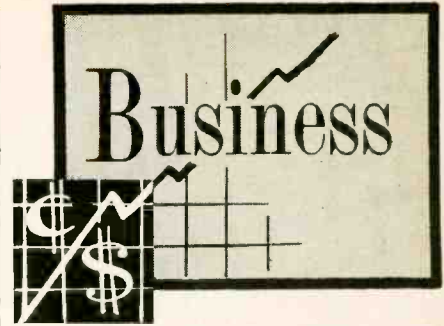
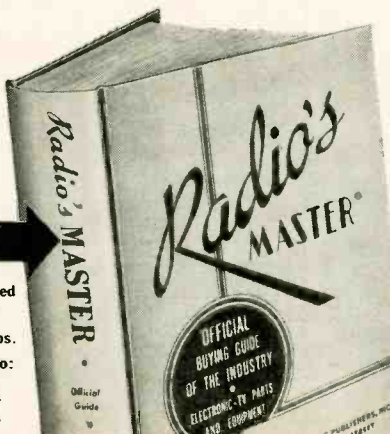

### Merchandising and Promotion

Jensen Industries, Forest Park, Ill., is now merchandising its phono needles in white leatherette-covered boxes. The



company is shipping assortments of ten diamond needles in a metal strong box which the dealer may keep for storage or as a cash box.

ORRadio Industries, Opelika, Ala., is under way on the largest consumer advertising campaign in its history on its line of Irish Brand magnetic sound recording tape. The company is also holding a special promotion during the months of January and February during which six 1,200-foot reels of home recording tape are offered for the price of five.

Simpson Electric Co., Chicago, is continuing its series of color and black-and-white TV service meetings. Demonstrations were recently held in California and Arizona.



Cornish Wire Co., New York City, designed a series of counter display cartons for its products.

JFD Manufacturing Co., Brooklyn, N. Y., which celebrates its 25th anni-

### 6 VOLT BATTERY SOLDERING IRON AND WELDER

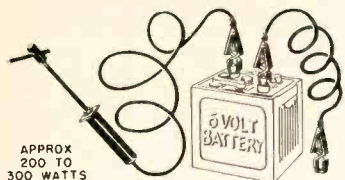

APPROX  
200 TO  
300 WATTS

U.S. Army release. Brand New—Never Used. Fully Guaranteed. This soldering iron can be used to solder or weld when connected to any six-volt storage battery. Uses approximately 200 to 300 watts. The high intensity arc created between the metal to be soldered and the carbon electrode (carbons supplied free with iron) can be used to heat tin or aluminum solder. Suitable also for light brazing and spot welding. Arc can be used for melting metals, cutting holes and soldering seams in chassis. Also useful for analyzing metals and minerals.

Battery soldering iron outfit includes 2 carbons, 3 heavy duty spring clips, 2 pieces 5 ft. heavy duty wire cable. (Battery not included.) Ideal for use where current is not available. Ship wt. 4 lbs. **\$1.95**  
ITEM NO. 126  
UNUSUAL BUY (Shp. Chgs. 40c)

### POWERFUL ALL PURPOSE MOTOR



Sturdy shaded pole A.C. induction motor. 15 watts, 3000 rpm. 3/2"x1 3/4"; 4 mounting studs; 3/8" shaft, 3/16" diameter; 110-120 volts, 50-60 cycles. A.C. only. When geared down, this unit can operate on 18" turntable with a 200 lb. dead weight. Use it for fans, displays, timers and other purposes. Ship wt. 2 lbs. **\$2.45**  
ITEM NO. 147  
UNUSUAL BUY (Shp. Chgs. 35c)

### WATT HOUR METER

Leading makes—reconditioned. Ideal for trailer parks. 100-110 volts, 60 cycles, 2-wire A.C. 5 amp. Heavy metal case 8 1/2" x 6 1/4" x 5". Easy to install. Ship wt. 14 lbs.



ITEM NO. 33 **\$4.50**  
NOW ONLY (Shp. Chgs. 81.25)

### WESTERN ELECTRIC BREAST MIKE



Lightweight 1 lb. carbon microphone. Aircraft type. Breastplate mounting, adjustable 2-way swivel. Easily fastened straps. For home broadcasts, communications etc. Complete with 6 foot cord, hard rubber plug. Sherardized plate, non-rusting finish. Ship wt. 2 lbs. **\$1.98**  
ITEM NO. 152  
NEW LOW PRICE (Shp. Chgs. 32c)

### AMAZING BLACK LIGHT



250-watt ultra-violet light source. Makes fluorescent articles glow in the dark. Fits any lamp socket. For experimenting, entertaining, unusual lighting effects. Ship wt. 2 lbs. **\$2.45**  
ITEM NO. 87  
A SAVING AT (Shp. Chgs. 35c)

### 250 POWER TELESCOPE LENS KIT

Make your own high powered 6 ft. telescope! Kit contains 2" diam., 75" focal length, ground and polished objective lens and necessary eye pieces. Magnifies 50x to 250x. Full instructions. Ship wt. 1 lb. **\$2.95**  
ITEM NO. 123  
YOU SAVE AT (Shp. Chgs. 10c)

HUDSON SPECIALTIES CO.  
25 West Broadway, Dept. RE-2-55  
New York 7, N. Y.

I am enclosing full remittance for items circled below. (Be sure to include shipping charges.)  
OR, my deposit of \$... Ship balance C.O.D.  
MINIMUM C.O.D. ORDER \$5.00.  
C.O.D. ORDERS ACCEPTED ONLY WITH 20% DEPOSIT  
INCLUDE SHIPPING CHARGES.

Circle Items Wanted  
87 147 33 152 126 123

Name .....  
Please Print Clearly

Address .....

City ..... Zone ..... State .....

BUSINESS

(Continued)

versary this month, is planning a year-long advertising and promotion program to celebrate the event.

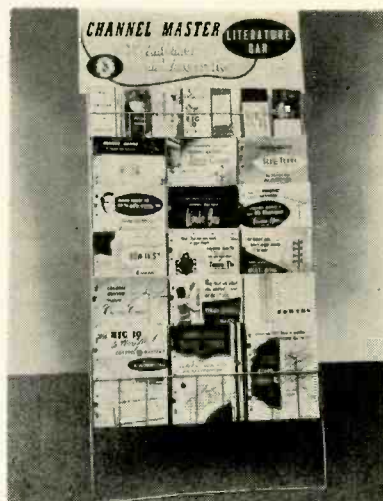

Channel Master Corp., Ellenville, N. Y., designed a literature display rack for its distributors. It will accommodate 22 different pieces of literature.

Electrovox Co., Inc., East Orange, N. J., created a new package for its Walco replacement needles.

General Electric, Syracuse, N. Y., is now packaging its replacement germanium diodes in plastic envelopes mounted on colorful counter display cards. The company also designed a counter shadow-box dealer aid for its TV receiving tube line.

CBC Electronics Co., Philadelphia, is merchandising its high-fidelity interconnecting cables on a rotating display merchandiser.

### Calendar of Events

Audio Fair, Los Angeles, February 11-13, Alexandria Hotel, Los Angeles.

National Conference on Transistor Circuits, February 17 and 18, Irvine Auditorium, University of Pennsylvania, Philadelphia, Pa.

1955 Joint Western Computer Conference and Exhibit, March 1-3, Statler Hotel, Los Angeles.

1955 IRE Show, March 21-24, Kingsbridge Armory, Bronx, N. Y.

Fourth Regional Seminar for Parts Distributors, April 1-2, Paxton Hotel, Omaha, Neb.

Ninth Annual Spring Technical Conference of the Cincinnati Section of the IRE, April 15-16, Engineering Society of Cincinnati Building, Cincinnati, Ohio.

1955 High-Fidelity Show, September 30-October 2, Palmer House, Chicago.

### Production and Sales

RETMA reported production of 5,654,791 TV sets and 8,040,230 radios for the first ten months of 1954 as against 6,204,803 and 11,201,656 for the 1953 period. The association noted that average weekly production of TV sets for October, 1954, was at the highest level on record. Retail sale of TV sets for the first nine months of 1954 reached 4,645,063 compared to 4,300,360 for the 1953 period. Radio sales for the 1954 period were 4,032,704 as against 4,526,186 for the 1953 period.

## NEW! EICO FLYBACK & YOKE TESTER KIT



MODEL  
944

Checks all flybacks & yokes instantly—in or out of set!

- Detects even 1 shorted turn!
- Exclusive separate calibration for air & iron-core flybacks for accurate testing of all types.
- Tests continuity of coils, speakers, switches, etc.
- Large 4 1/2" meter, 3 colored scales.
- Complete with easy instructions.
- Compact, rugged, smartly styled.

See it at your jobber today. Write for FREE Catalog CF-2 describing EICO's 38 Kits and 42 Wired Instruments. Prices 5% higher on West Coast.

EICO ELECTRONIC INSTRUMENT CO., Inc.  
84 Withers Street, Brooklyn, N. Y.  
© 54



HERE IS AN UNBEATABLE VALUE!

5 WATT AC AMPLIFIER  
Complete, ready to play

Yes, a top quality AC Amplifier, fully equipped with two inputs — one for Reluctance or Microphone — the other for Crystal Pickup... for the unbelievable price of \$17.99. And the unit is supplied with all parts, including tubes. Amplifier uses three tubes — 1-6X5; 1-6V6; 1-6SL7. 117 Volts, 50-60 cycles, two controls — volume and bass compensation control that lessens needle noise.

Complete with tubes, only **17<sup>99</sup>**  
Order while they last. No more after they're gone.

New catalog FREE. Write Dept. RE-2

STEVE-EL Electronics Corp.  
61 Reade St. New York 7, N. Y.

# GREATEST TUBE BUYS

EVERY TUBE GUARANTEED A FULL YEAR

Branded—Bulk Packed in Original Mfr's. Nested Cartons or Individually Boxed  
**JOBS! DISTRIBUTORS! We have a Wonderful Deal For You. Write—Wire—Phone!**

0A2	5.87	1U4	.46	GAT6	.36	6N7	.95	7F7	.64	12SF5	.48	35Z3	.40
0A3 VR75	.57	1U5	.40	6AU6	.40	6Q7	.49	7F8	.90	12SF7GT	.68	35Z5GT	.59
0A4G	.60	1X2	.55	6AV5GT	.79	6R7	.49	7G7	.80	12SG7	.70	36	.35
0B2	.74	2A3	.90	6AV6	.36	6S4	.39	7K7	.80	12SL7GT	.49	39-44	.35
0B3 VR90	.90	2A5	.49	6AX4GT	.57	6S7G	.55	7L7	.77	12SJ7	.55	42	.40
0C3 VR105	.95	2A6	.49	6B7	.93	6SA7	.40	7N7	.57	12SK7GT	.49	43	.40
0D3 VR150	.85	2A7	.60	6B8G	.29	6SC7	.75	7Q7	.57	12SN7GT	.50	45Z3	.40
0Z4	.59	2B7	.62	6BA6	.38	6SD7GT	.38	7R7	.59	12SQ7GT	.53	46	.45
1A4P	.35	2X2	.39	6BA7	.55	6SF5GT	.45	7S7	.83	12SW7GT	.50	47	.85
1A5GT	.40	2X2A	1.14	6BC5	.49	6SF7	.58	7V7	.80	12T7	.49	49	.38
1A7GT	.45	3A4	.44	6BE6	.37	6SG7	.40	7W7	.85	12T7	.49	50L6GT	.61
1AB5	.38	3A5	.90	6BF5	.69	6SH7	.60	7X6	.57	14A4	.65	50X6	.62
1B3GT	.67	3ABGT	.59	6BG6G	1.15	6SH7GT	.50	7Y4	.40	14A5	.65	50Y6GT	.57
1C5GT	.40	3B7	.39	6BH6	.45	6S7	.54	7Z4	.45	14B	.40	56	.47
1C7G	.37	3D6	.38	6BJ6	.41	6SK7	.39	12AG	.49	14AF7	.59	56	.53
1D7GT	.75	3LFA	.71	6BK7	.89	6SL7GT	.49	12A7	.98	14B6	.45	57	.56
1E7GT	.35	3Q4	.48	6BL7GT	.65	6SN7GT	.48	12B7GT	.84	14B8	.63	70L7GT	1.00
1F5G	.44	3S4	.46	6BQ6GT	.75	6SR7	.45	12AT6	.35	14C7	.65	71A	.52
1H4G	.40	3V4	.50	6BQ7	.86	6ST7	.48	12AT7	.65	14E6	.65	76	.77
1H5GT	.38	5T4	1.25	6C4	.35	6T8	.57	12AUG	.36	14E7	.80	77	.53
1J6G	.59	5U4G	.49	6C5	.39	6U7G	.45	12AU7	.59	14F7	.65	78	.43
1L4	.45	5V4G	.76	6U8	.48	6V8	.48	12AV7	.64	14H7	.57	82	.67
1L6	.45	5V6G	.38	6C8G	.85	6V6	.48	12AX7	.55	14H7	.67	83	.77
1LA4	.59	5Z3	.33	6C8E	.42	6W4GT	.41	12AX4GT	.55	14N7	.67	83	.77
1LA6	.75	6A5	.45	6DD6G	1.05	6X4	.35	12AY7	.72	19	.45	85	.57
1LB4	.77	6A7	.80	6D8	.95	6X5	.35	12BA6	.47	19B6G	1.15	89Y	.29
1LC5	.59	6A8	.65	6D8G	.95	6X5	.35	12BA7	.59	19B7	.75	117L7GT	1.17
1LC6	.75	6AB4	.42	6E5	.76	6X8	.70	12B7	.44	12F4	.40	117Z3	.38
1LD5	.49	6AB7	.71	6F6	.45	7A4	.45	12BD6	.46	22	.75	117Z3	.38
1LE3	.75	6AC5GT	.95	6F7	.90	7A5	.55	12BE6	.45	25AV5GT	.80	117Z4GT	.73
1LG5	.75	6AC7	.68	6F8G	.69	7A6	.65	12BH7	.65	25B5GT	.75	117Z6GT	.70
1LH4	.49	6AF6	.89	6C6G	.63	7A7	.65	12C8	.44	25L6GT	.40	2051	.93
1LH5	.55	6AF6G	.75	6H6	.49	7AD7	.90	12F5GT	.35	25W4GT	.45	803	2.95
1N5GT	.61	6AG5	.47	6J5	.38	7AG7	.55	12H6	.45	25Z5	.60	807	1.45
1P5GT	.56	6AG7	.90	6J6	.50	7AH7	.65	12J6GT	.62	25Z6GT	.45	814	3.50
1Q5GT	.55	6AH6	.98	6J7	.49	7B4	.44	12J7GT	.57	26	.42	832A	5.95
1R4	.81	6AK5	.59	6J8G	.90	7B5	.55	12K7	.53	27	.37	866A	1.45
1R5	.47	6A5	.35	6K6GT	.39	7B6	.55	12K8	.58	32L7GT	.95		
1S4	.55	6AQ5	.39	6K7G	.38	7C4	.55	12Q7G	.57	35C5	.37		
1S5	.40	6AQ6	.36	6K8G	.64	7C7	.65	12S8GT	.60	35L6GT	.45		
1SA6	.48	6AQ7GT	.58	6L6G	.75	7E5	.62	12S7GT	.62	35W4	.59		
1T4	.46	6AS5	.62	6L6GA	.99	7E6	.40	12S7	.68	35Y4	.44		

Our Tubes are of Excellent Quality Because—

1. We've specialized in selling vacuum tubes exclusively for many years.
2. All tubes offered herein are obtained from Receiver Manufacturers' surplus, various gov't. agencies and other surplus sources. Most of these tubes are brand new and the balance is removed from gov't. and other equipment. **WE UNCONDITIONALLY GUARANTEE EVERY TUBE YOU BUY.**
3. Our modern, completely equipped laboratories check every tube received. You are invited to see this special equipment in operation. Even though our inventories include almost every tube type made over the past 20 years—in quantities of more than a million assorted types—it is impossible to list every type. You are, therefore, urged to include any additional types required in your order. Minimum Order: \$10.00. Terms: 25% with order, balance C.O.D. Please include postage. All prices subject to change without notice.

## TRANSAMERICA ELECTRONICS CORP.

115 LIBERTY ST., NEW YORK 6, NEW YORK

### BETTER UHF RECEPTION WITH THE "TARGET" CORNER REFLECTOR

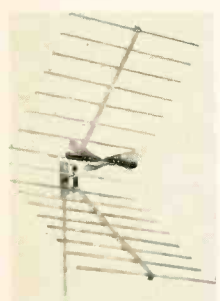

Model CR123

All-aluminum hurricane construction. High quality antenna for top performance in fringe area.

**ONLY \$10<sup>50</sup>** list

Also manufacturers of the famous "Target 88"m, the best all-channel fringe area antenna made, and conical and Yogi-style antennas.

### FIRST TO USE FIBREGLAS INSULATORS

Write for information on open territories, advertising allowances and discounts.

## S & A ELECTRONICS

1025 Nevada Avenue Toledo 5, Ohio

### CASH IN ON COLOR!

Exclusive Details on RCA 21" Color Set Revealed For First Time In

## ELEMENTS OF TV SERVICING

By Abraham Marcus (co-author of famous "Elements of Radio" which has sold over 1,000,000 copies!) and Samuel E. Gendler.

Gives New Money-Making Tips, Time-Saving Methods of TV Repair & Servicing. Covers in Detail all Phases of Black-& White and Color Installations!

In 544 pages—packed with diagrams, tables, charts, circuitry—this clearly-written book wraps up the whole subject of TV servicing so that anyone can make money in it! You see how to rig an antenna quickly... how to cure picture troubles fast... valuable service hints... how to trouble-shoot... how to get and keep customers... tips for profitable bench servicing... and many more. **COLOR CHAPTERS ALONE ARE WORTH MANY TIMES PRICE OF BOOK:** Color TV theory... color transmission... components of color receiver explained... comparison of color and B & W systems... blueprint of color picture tubes.

**USE 10 DAYS FREE!** Coupon below brings you "Elements of TV Servicing" on FREE trial for 10 days, without obligation. But you must mail now! Offer Limited!

Prentice-Hall, Inc., Dept. M-RE-255  
 Englewood Cliffs, N. J.

Send me for 10 DAYS' FREE TRIAL "Elements of TV Servicing." I will return it in 10 days and pay nothing—or keep it and send \$7.35 (plus small postage).

Name.....

Address.....

City..... Zone..... State.....

**SAVE!** Send \$7.35 with coupon, we'll pay postage and handling! Same return privilege.

BUSINESS

(Continued)

RETMA announced that manufacturers had sold 6,476,566 cathode-ray tubes worth \$134,922,387 during the first nine months of 1954 compared with 7,552,862 tubes valued at \$179,133,671 for the 1953 period. Receiving tubes sold during the period totaled 266,050,907 compared with 347,152,450 for the 1953 period.

### New Plants and Expansions

Raytheon Manufacturing Co., Waltham, Mass., is constructing a large electronics engineering and research laboratory in Wayland, Mass.

Shure Bros., Chicago, manufacturer of acoustic devices, announced plans to begin construction on a new 80,000-square-foot plant in Evanston, Ill., which it hopes to finish by spring, 1956.

Sprague Electric Co., North Adams, Mass., has begun construction of a 13,000-square-foot building in Venice, Calif., to house all its Southern California operations. It is expected to be completed by spring.

Precision Apparatus Co. and its meter manufacturing subsidiary, Pace Electrical Instrument Co., are now located in a new plant in Glendale, L. I., N. Y.

Davis Electronics, Burbank, Calif., purchased the Vaaro Electronics Engineering Co. which it will operate as a division.

Daystrom Inc., Elizabeth, N. J., which owns about half the capital stock of Weston Electrical Instrument Corp., purchased the assets of the American Gyro Corp., Santa Monica, Calif., which it will operate as a subsidiary.

Motorola Inc., Chicago, purchased the car radio tuner manufacturing facilities of Lee J. Drennan, Inc., Arcade, N. Y.

James B. Lansing Sound Inc., Los Angeles, added a 10,000-square-foot cabinet plant adjacent to its main office. The company also opened a warehouse in Atlanta, Ga.

Aerovox Corp., New Bedford, Mass., acquired the outstanding stock of Henry L. Crowley & Co., West Orange, N. J., manufacturer of powder-irons and steatite products.

General Electric, Syracuse, N. Y., plans to enter complete engineering and manufacturing of germanium rectifiers and diodes in its Clyde, N. Y., plant, transferring engineering design and development of rectifiers and diodes from its Syracuse headquarters.

Kay Lab, San Diego, Calif., electronics firm, plans to begin construction of a new building as the first step in its expansion program.

### Show Notes

RADIO-ELECTRONICS will exhibit at the Audio Fair, Los Angeles, in February. M. Harvey Gernsback, Editorial Director of the magazine, will be present. **END**



# Now

a complete, practical, how-to-do-it book on radio control!

## RADIO-CONTROL HANDBOOK—

Gernsback Library Book No. 53

By Howard G. McEntee, W2SI.  
The book radio control fans—beginners and experts alike—have been waiting for.

192 Pages. 175 Illustrations.  
**\$2.25**



Here's a book that skips theory and gets right down to the business of putting radio-control systems together so they will operate your model planes, boats, trucks, etc.

**Emphasizes the Practical**  
RADIO-CONTROL HANDBOOK concentrates on construction details of a number of practical radio-control units which will actually work and work well. It also covers the hitherto neglected field of trouble shooting radio-control systems. Whether or not you know radio, this is a book for anyone and everyone interested in R/C. For the first time, it combines

the necessary practical information on radio with detailed instructions on mechanical construction of control units.

### Written by an authority on Radio Control

Howard G. McEntee's experience in radio goes back some 25 years. And he has been hailed as a leader in the model field for just as long. Probably no man living knows more about the practical application of electronics in model control, than the author. Certainly no one writes about it better. Here's a book slated to become a classic on model control by radio. Be the first in your area to profit from the ideas it gives you.

### CONTENTS OF RADIO-CONTROL HANDBOOK

- Complex Control Systems
- Motor and Auxiliary Controls
- Single-Tube Receivers
- Multi-Tube Receivers
- Simple Transmitters
- Complex Transmitters
- Keying the Transmitter
- Installation of Parts
- Adjustments
- Test Instruments
- Complete Control Systems

## Other Gernsback Library Books you'll want to read



- The Oscilloscope—No. 52. \$2.25.
- Transistors—Theory and Practice—No. 51. \$2.00.
- TV Repair Techniques—No. 50. \$1.50.
- Radio & TV Test Instruments—No. 49. \$1.50.
- High-Fidelity—Design, Construction, Measurements—No. 48. \$1.50.
- Radio & TV Hints—No. 47. \$1.00.
- Television Technotes—No. 46. \$1.50.
- Radio Tube Fundamentals—No. 45. \$1.00.
- Basic Radio Course—No. 44. \$2.25.
- High-Fidelity Techniques—No. 42. \$1.00.
- Public-Address Guide—No. 41. 75c
- Practical Disc Recording—No. 39. 75c.

From the publishers of  
**RADIO-ELECTRONICS**

**MODEL CONTROL BY RADIO—No. 43** By Edward L. Safford. 112 Pages. 114 Illustrations. \$1.00

### Some of the contents

Here's the perfect companion volume to Radio-Control Handbook! It covers theory as well as construction details for control units and complete systems for the beginner and more advanced fans. The author is a guided missiles instructor and winner of many awards in model-airplane meets.

Basic concepts • Methods of coding • Radio transmission • Wired transmission • Receivers • Decoders • Relays • Power control circuits • Servomotors • Transmitter construction • Construction of receivers, coders and decoders • Complete control systems • Trouble shooting • Receiver adjustment • Transmitter hints.

For a complete library on model control  
—order both books today.

See your distributor—or mail this coupon

**GERNSBACK PUBLICATIONS, INC., Dept. 25**  
25 West Broadway  
New York 7, N.Y.

Enclosed is my remittance of \$.....

Please send me the following books postpaid.

- 53 Radio-Control Handbook \$2.25.  
 43 Model Control by Radio \$1.00.

- 39  41  42  44  45  46  
 47  48  49  50  51  52

Name .....

(Please print clearly)

Street .....

City ..... Zone ..... State.....

# TRANSVISION

## 27" Wired CHASSIS for CUSTOM BUILDING

27 TUBES, including CRT with or without REMOTE CONTROL



## CHASSIS and CRT—\$239

In Kit Form . . . \$199

plus 10% Tax  
This De Luxe Transvision Chassis is ideal for fringe area, UHF-VHF reception . . . Has supersensitivity and stability. . . Keylet AGC . . . 27 tubes, including CRT and 3 rectifier tubes. Available with Remote Control and dual sound system for \$69 additional.

### CRT TESTER-REACTIVATOR

\$19.95

- Completely checks picture tubes for emission and shorts.
- Reactivates many tubes in which emission has fallen off from either use or standing in a carton.



### CRT SPARKER

\$19.95

Eliminates Electrical Leakage by the application of 15,000 volts of RF

Also—CRT TESTER-REACTIVATOR-SPARKER; 3 instruments in one for only \$34.95 net.

10 DAY TRIAL: Try these Transvision TESTERS for 10 days. Then, if you are not 100% satisfied, you may return them. Your purchase price, less 10% (our cost of handling and repacking) will be promptly refunded.

**TRANSVISION, INC.**  
NEW ROCHELLE, N.Y.

TRANSVISION, INC., New Rochelle, N. Y., Dept. RE-2

( ) Send .....  
( ) Enclosed find \$..... deposit. Balance C.O.D.  
I accept your 10 Day Trial terms.

Name .....

Address .....

City ..... State.....

My Jobber is.....  
**JOBBER INQUIRIES INVITED.**

**IT'S BIGGER AND BETTER THAN EVER!**

**B-A's NEW 1955  
FREE CATALOG**

**164 BIG PAGES  
LOADED WITH SAVINGS  
AND NEW ITEMS IN  
RADIO, TV, ELECTRONICS**



**INCLUDES 23 PAGES  
OF AMAZING  
BARGAINS, NOT FOUND  
IN ANY OTHER CATALOG**

**BURSTEIN-APPLEBEE CO.**

BURSTEIN-APPLEBEE CO. Dept. S,  
1012-14 McGee St., Kansas City 6, Mo.

Send Free B-A Catalog No. 551.

Name.....

Address.....

City.....

State.....



**SEND FOR IT TODAY!**



Need a Tube Tester?  
**FOLLOW THE  
LEADER...**

Buy **EICO**

© 1955

**TUBE TESTER #625  
KIT \$34.95 Wired \$49.95**



More Servicemen buy EICO TUBETESTERS — in KIT and wired form — than any others sold through distributors. Why? Because EICO gives you the MOST value at LOW-EST cost.

- Test all conventional & TV tubes and pilot lights.
- 10 individual lever-type element switches.
- Illuminated anti-backlash rollochart kept up-to-date by EICO's Engineering Dept.
- 4½" meter, 3-color "Good-Bad" scale.
- Line-adjust control. Blank socket for new tubes. Protective overload bulb.

In stock at your local jobber. Write for free Catalog. CT-2 Prices 5% higher on West Coast.

**ELECTRONIC INSTRUMENT CO., INC.**  
84 Withers Street • Brooklyn 11, N. Y.



**FREE:** Important Technical Manual for Community and Master TV Systems

FIELD STRENGTH METER, operates both on Battery and AC... \$89.

Write today to:

**TRANSVISION, INC. NEW ROCHELLE, N. Y.**



**People**

Robert G. Marchisio was promoted to vice president of CBS-Hytron, Danvers, Mass. He joined the company in 1951 as assistant to C. F. Strohmeyer, then vice president.



Adm. J. J. (Joeko) Clark joined Radio Receptor Co., of Brooklyn, N. Y., as a vice president. He was commander of the Seventh Fleet during the Korean war.

Daniel F. Shea, Jr. joined Halliercrafters, Chicago, as engineering liaison executive of the Government contract division. He came to the company from Hazeltine.



Richards W. Cotton, who has joined National Co., Malden, Mass., as assistant to the president, served in a similar capacity with Philco.

Everett E. Leedom was named advertising manager of Electro-Voice, Inc., Buchanan, Mich., and George R. Riley was appointed assistant manager of the Distributor Sales Division. Leedom was formerly with Acme Steel and Riley was a sales engineer with Electro-Voice. The company also announced the appointment of Cullen Macpherson as assistant manager of the Reproducing Components Division and Lloyd W. Loring as sales engineer. Macpherson was formerly a research assistant at the University of Minnesota, and Loring sales manager of Audio House, Inc. Lawrence L. LeKashman, vice president



**E. Leedom**



**G. Riley**

value unsurpassed  
**arkay KITS**

world's finest radio, phono, TV, and test kits

**10 watt hi-fi amplifier kit**



arkay kit model A-12: Top quality kit for home and industry with built-in pre-amp. for magnetic pickup, built-in equalizer networks, true bass and treble boost circuit controls and push-pull output with inverse feedback. Freq. resp.: 20-20,000 cps.,  $\pm 1$  db; hum:—70 db; slow rated output, 5 tubes, 70 watts. Includes input selector switch front panel and elaborate instruction book. Com-**\$22.95** plete with tubes.

**HI-FI baffle**

(knockdown form) for 12" speaker  
Arkay kit model B-12: Cabinet replica of a very expensive sound chamber, and constructed of sturdy, specially treated lumber; acoustically balanced. Front baffle plate of 1/4" thick sound absorbent material; reduces echo and eliminates cabinet resonance. Extended bass response possible. For use also (without legs) inside bar, credenza. Includes attractive grill cloth. Comes completely knocked down, easy assembling. Instructions anyone can follow. **\$9.95**



**hi-fi ac/dc amplifier kit**

arkay kit model A-5: A high-fidelity AC/DC amplifier kit featuring a new, improved push-pull output circuit plus a specially designed output transformer utilizing 2 speakers for the new 3d-dimensional qualities of audio reproduction. New engineering developments give you hi-fi at the lowest possible price. Kit is complete, except for speakers. **\$9.95**



**hi-fi amplifier with built-in pre-amp**

arkay kit model FL-10: A striking new design with physical dimensions and style for use on a shelf or corner without elaborate or expensive enclosures. Specifications: same as model A-12.



**\$27.95**

**3-way portable radio kit**



arkay kit model 3W10-P: A smartly styled portable radio kit that operates on AC/DC or self contained batteries. Has 4 tubes and selenium rectifier with a fine quality Alnico V speaker, built-in loop antenna and hi-gain coils. Includes pictorial and schematic diagrams that are easy to follow. Color-ful plastic cabinet. **\$18.95**

**ac/dc radio kit**

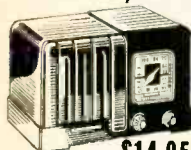

**\$14.95**

arkay kit model S-5E: New, 5-tube superhet. kit designed for radio students and hobbyists. Includes new 3D color instruction book. 550-1600 kc, complete with glistening walnut bakelite cabinet.

Write today for new catalog including complete arkay line of radio, TV, phonograph, amplifier and test equipment kits. Prices F.O.B. N.Y.

the world's finest kits

**arkay** RADIO KITS, INC.  
120 Cedar Street  
BEekman 3-6686 New York 6, N. Y.

PEOPLE

(Continued)

of sales for Electro-Voice, said the appointments were part of an expansion of the company's Sales Division. Irving P. Wolfe joined Walsco Electronics Corp., Los Angeles, as Eastern sales manager. He was formerly with Chief Electronics.

Frank G. Mullins, Jr. joined Fairchild Recording Equipment Co., Whitestone, N. Y., as manager of engineering and as special counsel.

Robert J. Marshall was promoted from chief engineer to head of the recently established New Product Development group. Mullins was formerly with Westinghouse.



F. Mullins, Jr.



R. Marshall

Obituaries

Richard A. Graver, vice president and director of marketing for Hallcrafters Co., Chicago, died suddenly of a heart attack while in New York for a business conference. He was 58 years old.

George B. Flood, former treasurer of Sprague Electric Co., North Adams, Mass., passed away at the age of 74 after a long illness.

Albert Brand, secretary-treasurer of Radio Merchandise Sales, New York City, died suddenly in Mount Vernon, N. Y., at the age of 46.

Leo R. Mead, technical assistant to the chief engineer of Hallcrafters, Chicago, died suddenly at the age of 51.

Personnel Notes

... Gen. Walter Bedell Smith, elected to the Board of Directors of RCA, served as Under Secretary of State from February, 1953, to October, 1954. He is vice chairman of the Board of Directors of American Machine and Foundry Co. RCA also announced the appointment of Maj. Gen. William L. Richardson, U.S.A.F. (Ret.), to the new post of manager, Defense Projects Coordination, Engineering Products Division. General Richardson retired from military service last July.

... Carl E. Mosley, president and treasurer of Mosley Electronics, St. Louis, Mo., was appointed general manager of the company. George E. Mobus, advertising manager, assumes additional responsibilities as sales manager. Jewel Hawkins will act as purchasing agent and production manager. Mrs. Janet E. Lloyd is now assistant secretary.

**LEARN COLOR UHF, MONOCHROME TELEVISION**



**Edward M. Noll**

nationally known TV consultant, teacher and writer

**MAKES IT EASY**

in the new revised edition of his famous **TELEVISION for RADIOMEN**

**Complete course in one volume**

All in one book—at much less cost than the average course of lessons—you'll get THOROUGH, practical training for the best jobs in TV. You'll know the fundamentals of both transmission and receiving; the practical techniques of installation, alignment, adjustment, trouble-shooting; the latest improvements, transistor circuits, UHF, color.

You'll UNDERSTAND TV; be able to handle service work expertly, efficiently; be well qualified for the hundreds of high-paid technical openings in TV today.

**Easy to learn**

Each step in theory is explained in clear non-mathematical terms and is applied to circuit set-up and operation so you see exactly how to use theory in practical work. Many schematics and how-to-do-it examples help you learn both theory and practical techniques easily and thoroughly. Study questions insure your understanding.

**Prepares you fully for work on color TV, UHF**

You'll learn each detail of the NTSC color system; the function of each circuit, the special installation and adjustment techniques, the service problems and how to handle them. You'll know the principles and all practical details of the intercarrier I-F system, the best antenna installations for UHF.

*There is no better, more up-to-date, or more thorough book on television fundamentals.*

**HERE is your ticket to the best TV technical jobs today!**



**STUDY IT FREE for ten days Use this coupon**

THE MACMILLAN CO., 60 Fifth Avenue, New York 11, N. Y.

RE-6

Please send me a copy of Noll's *Television for Radiomen, Revised*. I will either remit the full price of \$10.00 plus a few cents delivery charge, or return the book in ten days. (SAVE: Send check or money order and we pay delivery charge.)

Signed .....

Address .....

This offer good only within continental limits of U.S.A.

# ELECTRICAL ENGINEERS

or

# PHYSICS GRADUATES

with experience in

## RADAR or ELECTRONICS

or those desiring to enter these areas...

*The time was never more opportune than now  
for becoming associated with the field of advanced electronics.*

*Because of military emphasis this is the most  
rapidly growing and promising sphere of endeavor for the young  
electrical engineer or physicist.*

Since 1948 Hughes Research and Development Laboratories have been engaged in an expanding program for design, development and manufacture of highly complex radar fire control systems for fighter and interceptor aircraft. This requires Hughes technical advisors in the field to serve companies and military agencies employing the equipment.

As one of these field engineers you will become familiar with the entire systems in-

cluded, including the most advanced electronic computers. With this advantage you will be ideally situated to broaden your experience and learning more quickly for future application to advanced electronics activity in either the military or the commercial field.

Positions are available in the continental United States for married and single men under 35 years of age. Overseas assignments are open to single men only.

Scientific  
and  
Engineering  
Staff

## HUGHES

RESEARCH  
AND  
DEVELOPMENT  
LABORATORIES

Culver City,  
Los Angeles  
County,  
California



Hughes Field Engineer H. Heaton Barker (right) discusses operation of fire control system with Royal Canadian Air Force technicians. Avro Canada CF-100 shown at right.

Relocation of applicant must not cause disruption of an urgent military project.



PEOPLE

(Continued)

... Charles A. Hansen, widely known sales executive, established his own manufacturers' rep firm in Los Angeles, Calif. He was formerly distributor sales manager of Gramer Halldorson Transformer Co., where he inaugurated the company's distributor sales organization, according to James M. Blackledge, president.

... L. Arthur Hoyt was appointed advertising manager of Allen B. Du Mont Laboratories' Cathode-Ray Tube Division, Clifton, N. J. He has been with the company since 1952 as technical writer, copywriter and editor of a house organ. Du Mont also announced the appointment of Robert E. Kessler as manager of its Communication Products Division. He was formerly assistant manager of the division.

... Lieut. Gen. Lewis A. Pick, former Chief of Engineers of the United States Army, was elected a director of OR-Radio Industries, Opelika, Ala.

... E. Gordon Burlingham is the new sales service manager of CBS-Hytron, Danvers, Mass. He was formerly a sales service manager of another company in the electronics field.

... Jack Whiteside was promoted to general manager of Simpson Electric Co., Chicago, Ill. He was formerly assistant general manager. Larry Patterson, former purchasing agent, was named director of material. Al Arbeiter, former assistant chief meter engineer, was named chief meter engineer and Bill Coon, former chief engineer, is now director of engineering.

... George E. Bottjer, chief pilot and manager of flight test for Raytheon Manufacturing Co., Waltham, Mass., was appointed to the Naval Aviation Advisory Committee. The company also announced that Leslie E. Woods, its director of industrial relations and personnel, was appointed a member of the Massachusetts Council for Employment of the Aging, for a 3-year term.

... John H. Skehan was named Southwestern sales representative for Syl- vania Electric, with headquarters in Dallas, Tex. He was formerly with the General Engineering Department in Emporium, Pa.

... George Mena and Robert Burns were appointed district managers of the Southeast and East Central districts, respectively, of Belden Manufacturing Co., Chicago, Ill. Mena, who was formerly in the Atlanta-Richmond territory, succeeds Burns.

... Richard M. Thompson was appointed district sales manager for General Electric Tube Department distributor sales with headquarters in Schenectady, N. Y. He will cover New York State, exclusive of the New York City and Poughkeepsie areas. He was formerly a member of the distributor sales headquarters staff. END

# technical Literature

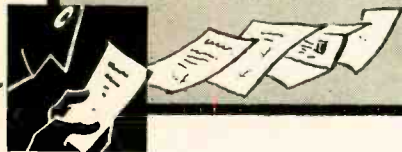

## CRYSTAL DIODES

CBS-Hytron's *Reference Guide for Crystal Diodes* lists 185 types of diodes and gives all basic data concerning them, with 18 dimensional diagrams.

CBS-Hytron, a Division of Columbia Broadcasting System, Inc., Danvers, Mass.

## TEST EQUIPMENT

RCP's 8-page brochure describes and illustrates their test equipment: the a.c.-d.c. multitester, portable tube tester, wide-range signal generator, v.t.v.m., Midgetscope, Signalizer and Servishop as well as others.

Radio City Products Co., Inc., Easton, Pa.

## VOLTAGE STABILIZERS

A 16-page *Catalog No. 4-260* describes voltage stabilizers and their performance. Applications for voltage stabiliz-

ers are also discussed in the catalog. Raytheon Manufacturing Co., Dept. 6120-PR, Waltham 54, Mass.

## INSTRUMENT TYPE SWITCHES

No. 17-SC, an 8-page catalog, gives data on instrument type switches and includes a simplified system for use in ordering items. Complete descriptions are given for CES rotary, shorting and nonshorting types, 1, 2 and 3 to 4 poles per deck.

Cinema Engineering Co., Division of Aerovox, Burbank, Calif.

## SPEAKER ENCLOSURES

A 32-page booklet, *The Karlson Enclosure*, opens with the basic problem of what speaker baffle to use and describes the discovery of the Karlson principle. Data on the various applications best suited for the Karlson and

a discussion of recommended loudspeakers.

Karlson Associates, Inc., 1483 Coney Island Ave., Brooklyn 30, N. Y.

## BROADBAND AMPLIFIER

RCA's folder 3R2468 describes the new MI 5185 broadband amplifier, listing the amplifier's features and what it does. It outlines advantages of multiple distribution systems.

Radio Corp. of America, Engineering Products Division, Building 15-1, Camden, N. J.

## ALLIGATOR CLIPS

Mueller's circular describes and illustrates the numerous applications in compact equipment of insulated alligator test clips. Shows how lip action of slotted insulator permits clip to bite terminal without exposing metal clip.

Mueller Electric Co., 1567 E. 31st St., Cleveland 14, Ohio.

## AUDIO RECORDING SERVICES

A 12-page *Bulletin C* for 1954-55 describes the complete range of tape and disc recording services offered by Dubbings' audio laboratory for broadcast stations, sound studios, businesses, record companies, prerecorded tape firms and hi-fi enthusiasts. It covers the various types of Dubbings in use.

Dubbings Sales Corp., 41-10 45th St., Long Island City 4, N. Y.

## HI-FI CATALOG

A 12-page *Altec* catalog provides

**COYNE offers LOW COST TELEVISION RADIO-ELECTRONICS**  
Training in Spare Time AT HOME



The future is YOURS in TV-RADIO!

A fabulous field—good pay—fascinating work—a prosperous future! Good jobs galore, or independence in your own business!

Coyne brings you the first *truly lower cost*, MODERN—QUALITY Television Home Training; training designed to meet Coyne standards. Not an old Radio Course with Television "tacked on". Here is MODERN TELEVISION TRAINING including working knowledge of Radio. Includes **UHF AND COLOR TV**. No Radio background or previous experience needed. Personal guidance by Coyne Staff. **Practical Job Guides** to show you how to do actual servicing jobs—**make money early in course.**

With Coyne Television Home Training you pay only for your training, **No Costly "Put together kits"**.

**COYNE ELECTRICAL SCHOOL**

A TECHNICAL TRADE INSTITUTE OPERATED NOT FOR PROFIT

500 S. Paulina Street, Chicago 12, Dept. 25-TR4

B. W. COOKE, President



Coyne—the Institution behind this training... the largest, oldest, best equipped residential school of its kind. Established 1899. Send coupon for details.

## MAIL COUPON FOR FREE DETAILS

including information about easy Payment Plan.

**No obligation, no salesman will call.**



### COYNE ELECTRICAL SCHOOL

Television Home Training Div.

500 S. Paulina St., Chicago 12, Ill., Dept. 25-TR4

Send Free Picture Folder and details on Television Home Training. This does not obligate me and no salesman will call.

Name \_\_\_\_\_

Address \_\_\_\_\_

City \_\_\_\_\_ State \_\_\_\_\_

Check here if interested in Resident School Training in Chicago.

**TOP QUALITY TUBES ONE YEAR GUARANTEE** **BELOW MFRS' PRICES!**

**MORE THAN A MILLION tubes on hand! We list here only a few of the more important television and radio types. Order all types you need, whether on this list or not—all ship promptly from our huge stocks—at LOWEST COMPETITIVE PRICES! All our tubes are lab-tested, fully guaranteed FOR ONE YEAR, and individually boxed in our colorful cartons.**

Type	Price	Type	Price	Type	Price	Type	Price	Type	Price
OB2	.79	6AC7	.72	6BQ6	.95	6W4GT	.39	12A6	.59
OZ4	.54	6AF4	.89	6BQ7A	.72	6W6	.56	12AL5	.49
1A7	.53	6AF6	.75	6BZ7	.92	6X4	.39	12AT6	.35
1AX2	.69	6AG5	.56	6C4	.41	6X5GT	.29	12AT7	.68
1B3	.69	6AG7	.95	6CB6	.57	6X8	.79	12AU6	.45
1L4	.49	6AH6	.89	6CD6	.99	7A4	.54	12AU7	.53
1LA4	.59	6AJ5	.89	6CF6	.64	7A5	.59	12AV6	.44
1L6	.79	6AK5	.79	6CS6	.51	7A6	.69	12AV7	.72
1LCS	.59	6AL5	.41	6F6	.45	7A7	.69	12AX4GT	.68
1LN5	.57	6AL7	.89	6H6	.32	7A8	.59	12AX7	.63
1P5GT	.56	6AM8	.69	6J5	.40	7B4	.44	12BA6	.49
1QS7	.57	6AN8	.79	6J6	.59	7B5	.59	12BE6	.39
1R5	.58	6AQ5	.39	6S4	.49	7B6	.59	12BH7	.59
1S4	.58	6AR5	.45	6SA7	.54	7C4	.58	12BY7	.69
1S5	.45	6AS5	.48	6SB7Y	.89	7C5	.49	12BZ7	.65
1T4	.55	6AT6	.41	6SC7	.79	7C7	.65	12SA7GT	.64
1U4	.39	6AU6	.46	6SG7GT	.49	7E5	.59	12SC7	.69
1U5	.48	6AV6	.34	6SH7	.60	7F8	.95	12SF5	.49
1X2A	.59	6AX4GT	.59	6S17	.50	7H7	.59	12SG7	.75
2X2	.39	6BA5	.39	6SK7	.49	7L7	.59	12SH7	.75
3A4	.44	6BC5	.39	6SL7GT	.59	7R7	.65	12SJ7	.59
3A5	.90	6BD6	.49	6SN7GT	.59	7S7	.85	12SK7	.44
3C4	.55	6BE6	.39	6SQ7	.45	7W7	.85	12L7GT	.57
354	.56	6BC6	1.24	6T4	.95	7X7	.70	12SN7GT	.58
3V4	.58	6B16	.48	6T8	.79	7Y4	.44	12SQ7GT	.56
5J4G	.55	6B16	.49	6U8	.79	7Z4	.49	12SR7	.49
5Y3GT	.39	6BK5	.69	6V6GT	.41	1OY	.69	14A4	.69
5Z3	.44	6BK7A	.96						
6AB4	.51	6BL7GT	.89						
6AC5GT	.99	6BN6	.79						

**FREE OFFER!**  
7 Assorted tubes. List value approx. \$23.00. FREE with every order for \$25.00 or more!

**EXPORT INQUIRIES INVITED!**  
New Complete Listing—Send For Free Copy!

**ELECTRON TUBE WHOLESALERS, INC.**  
140 DUANE STREET • NEW YORK 13, N. Y. • Phone: Barclay 7-7616

Type	Price	Type	Price	Type	Price
58	.58	14A5	.59	25AV5GT	.84
70L7GT	1.00	14AF7	.59	25B6GT	.89
71A	.54	14F8	.59	25L6GT	.89
75	.49	14H7	.59	35B5	.49
76	.43	14N7	.69	35C5	.48
77	.55	14Y4	.69	35L6GT	.37
78	.45	19BG6	1.35	35W4	.43
81	1.11	25AV5GT	.84	35Y4	.45
84	.54	25B6GT	.89	50A5	.54
85	.59	25L6GT	.89	50B5	.49
89/Y	.29	35B5	.49	50C5	.49
117P7GT	.98	35C5	.48	50L6GT	.61
117Z3	.38	35L6GT	.37	50X6	.64
807	.99	35W4	.43	50Y6GT	.59
2051	.95	35Y4	.45		
9001	1.49	9006	.68		
9002	.98				
9003	1.48				
9004	.97				
9006	.68				

**CATHODE RAY**  
5BP1 3.98  
5BP4 5.95  
5CP1 5.95  
7BP7 7.45  
12DP7 19.50  
Minimum order \$10. Please include 25% deposit with order. Prices subject to change without notice. All prices F.O.B. our warehouse, N.Y.C. WRITE FOR TYPES NOT LISTED

When answering advertisements please mention **RADIO-ELECTRONICS**

**!!! CHECK EVERY ITEM !!!**  
Whopping Values for Everyone!!  
**G. E. METER HOUSING & GLASS**  
25 $\frac{1}{2}$ " I.D., 1-5/16" behind panel. All bakelite.  
Type DO-71 3 1/2" O.D. each \$1.49  
Type "A" 3" O.D. each .98

**A. C. MOTOR SPECIALS . . .**  
All 115V, 60 cycle, 30 RPM. . . dbie. 1/4" shaft.  
Overall: 5"x2 1/2"x1 1/4" (shpg. wt. 2 lbs) 2.49  
1/10 H.P. (Oster #KS-687) 1725 RPM, 2.8 amps. Shaft 1" x 3/8" O.D. Fully enclosed, 7" L. x 4 1/2" O.D. (shpg. 14 lbs) 7.95  
**HEAVY DUTY RECORDING MOTOR**  
(RM-4 type) 4 pole, silent operating. IDEAL FOR TAPE, WIRE, or DISC. 5/16" shaft. Overall: 3 3/8" x 4 1/2" x 3 1/2" deep. Less mtg. plate assembly. 4.95  
1/40 H.P. (Robins & Myers) 1650 RPM. 5/16" shaft. 3 1/4" O.D. x 1 1/2" L. With starting capacitor (shpg. wt. 3 lbs) 4.95

**SAVE ON GUARANTEED TUBES**  
70% to 90% OFF Individually Boxed.  
#6B8, 6K7, 24, 26, 27, 41, 42, 55 or 89. ea. 29c  
#1A7, 1H4, 1H5, 6AG, 6C4, 6C5, 6P6, 6SA7, 6SK7, 6V3, 6SD7, 6SR5, 6U7, 6V5, 6V4, 6X5, 7A4, 7Y4, 7Z4, 25Z6, 32, 34, 39/44, 76, 78 or 80 39c  
#1J6, 2A5, 2A6, 6A8, 6A15, 6B1, 6C1, 6D6, 6S17, 6SN7, 6SQ7, 7A7, 7AG7, 7B6, 7B8, 7C5, 7C7, 7C6, 12A6, 12Q7, 12SN7, 35, 45, 71A or 77 49c  
#1L6, 1LCS, 1L6C, 1LH4, 6A3, 6AC7, 6E5, 6J8, 6L6, 7G7, 7Q7 or 47 69c  
#OC3, OD3, 5T4, 6AG7 or 1680 89c

**STOP!! LOOK!! PROFIT!!**

The "JUMBO RADIO ELECTRONICS PARTS KIT" is BIGGER & BETTER THAN EVER!  
FULL LBS. of SWITCHES, CONTROLS, WIRE, SOCKETS, PHOTOFACTS, SPEAKER REPLACEMENT PARTS, RESISTORS, CONDENSERS, PLUGS, DZENS OF OTHER ITEMS (shpg. wt. 20 lbs.) \$3.95



**CRYSTAL DIODES . . .**  
IN21 ea. 69c-10/ \$5.95  
IN21B ea. 98c-12/ \$10.00  
IN21B ea. \$1.49-6/ \$7.50  
"DIRECT FACTORY SPEAKER REPAIRS SINCE 1927"  
Min. Order \$3.00. 20% deposit req. on all C.O.D.'s. Full remittance with foreign orders. Please add sufficient postage—excess refunded.  
**LEOTONE RADIO CORP.**  
67 Day Street  
New York 7, N. Y.

**SAVE MONEY.. MAKE MONEY..**  
**LEARN TV**  
the practical way..  
17", 21" and 27"  
**ASSEMBLE A TRANSVISION TV KIT**  
Pay as You Wire \$39 Down Payment

WE WILL HELP YOU to start learning TV the practical way—by assembling a TRANSVISION TV KIT in EASY STAGES. For only \$39 you get PACKAGE #1 (standard first pkg. for all of our kits). This package gives you the BASIC CHASSIS and over 450 TV COMPONENTS with complete Instructions, Drawings, Photos, and Service Booklet. When ready, you order the next stage (pkg. #2), etc. Low prices make your complete kit a terrific buy.



**FREE CATALOG**  
Shows 6 Great TV Kits:  
EXCLUSIVE: Only Transvision TV Kits are adaptable to UHF. Ideal for FRINGE AREAS. No Previous Technical Knowledge required. Write now!  
**TRANSVISION**  
THE OLDEST NAME IN TV KITS

NEW ROCHELLE, N. Y.  
Educational Director  
TRANSVISION, INC., NEW ROCHELLE, N. Y. Dept. RE-2  
 I'm enclosing \$\_\_\_\_\_ deposit. Send standard kit PACKAGE #1, with all Instruction Material. Balance C.O.D.  
 Send FREE copy of your new TV Kit Catalog.  
Name \_\_\_\_\_  
Address \_\_\_\_\_  
City \_\_\_\_\_ State \_\_\_\_\_

**TECHNICAL LITERATURE (Continued)**  
detailed information on more than 20 high-fidelity products. Among them are AM-FM tuners, preamplifiers, amplifiers, speakers, speaker systems, horns, networks and cabinets.

*Altec Lansing Corp., 8356 Santa Monica Blvd., Beverly Hills, Calif.; or 161 6th Ave., New York 13, N. Y.*

**HI-FI UNITS**  
*Sightmaster's* 16-page catalog on high-fidelity units includes: diamond needles, hi-fi amplifier, baffle board, cabinets, record changer, speaker accessories, speaker enclosures, AM-FM tuner, TV chassis, etc.

*Sightmaster Corp., New Rochelle, N. Y.*

**HEATHKITS**  
*Heath's* 1955 catalog features seven new kits and describes more than 55 kits, including test instruments, amateur equipment, high-fidelity audio equipment, etc. The 48-page catalog contains technical specifications and schematics.

*Heath Co., Benton Harbor 20, Mich.*

Any or all of these catalogs, bulletins, or periodicals are available to you on request direct to the manufacturers, whose addresses are listed at the end of each item. Use your letterhead—do not use postcards. To facilitate identification, mention the issue and page of RADIO-ELECTRONICS on which the item appears. UNLESS OTHERWISE STATED, ALL ITEMS ARE GRATIS. ALL LITERATURE OFFERS ARE VOID AFTER SIX MONTHS.

**TV ACCESSORIES**  
An 8-page catalog, *Mosley TV Antenna Accessories*, gives data on roof and wall insulators, TV conduit, antenna switches, couplers, sockets, etc.  
*Mosley Electronics, Inc., 8622 St. Charles Rock Rd., St. Louis, Mo.*

**COIL REPLACEMENT GUIDE**  
*TV Technician's Coil Replacement Guide 155* cross-references all set manufacturers' coil numbers with Miller replacement numbers. Among the things listed in this 20-page guide are radio replacement coils, TV components and TV replacement components.  
*J. W. Miller Co., 5917 S. Main St., Los Angeles 3, Calif.*

**TV BULLETIN**  
A 4-page bulletin describes the book *Most-Often-Needed 1955 Television Servicing Information* and other books.  
*Supreme Publications, 1760 Balsam Rd., Highland Park, Ill.*

**NEEDLE CATALOG**  
Fidelitone, Jensen, Permo, Miller, Recoton, Walco and Duotone brands are cross-referenced to cartridges and cartridge-needle numbers in a 12-page catalog.  
*Permo, Inc., 6415 Ravenswood Ave., Chicago 26, Ill.*

**CAPACITORS**  
Dual-capacitor units, electrolytic capacitors, small-base oil-paper capacitors, etc., are described and illustrated in a 24-page catalog.  
*Pyramid Electric Co., 1445 Hudson Blvd., N. Bergen, N. J.* END

# RADIO SCHOOL DIRECTORY

## GET INTO ELECTRONICS

You can enter this uncrowded, interesting field. Defense expansion, new developments demand trained specialists. Study all phases radio & electronics theory and practice: TV, FM; broadcasting; servicing; aviation, marine, police radio. 18-month course. Graduates in demand by major companies. H.S. or equivalent required. Begin Jan., March, June, Sept. Campus life. Write for catalog.

**VALPARAISO TECHNICAL INSTITUTE**  
Dept. C Valparaiso, Ind.



## Get Your F.C.C. LICENSE Quickly!

Correspondence or residence preparation for F.C.C. examinations. Results guaranteed. An FCC commercial operator license means greater opportunities and higher pay. We are specialists in preparing you, in a MINIMUM OF TIME, to pass FCC examinations for all classes of licenses. Beginners get 2nd class license in 5 weeks and 1st class in 3 additional weeks. Write for free booklet.

### GRANTHAM School of Electronics

Dept. 101 E. 6064 Hollywood Blvd., Hollywood 28, Calif.



## TV REPAIRMEN EARN TOP MONEY!

IN JUST 12 MONTHS, COMPLETE TV SERVICE TRAINING, INCLUDING COLOR TV. Streamlined course gives you all essentials for a good job as service technician. Graduates in great demand; jobs are plentiful in this growing field. Other electronic courses in radio operation and maintenance. Day or evening classes. Opportunity for employment in local industry. Approved for Korean veterans.

Write for Catalog 111 Today

**INDIANAPOLIS ELECTRONIC SCHOOL**  
312 E. Washington, Indianapolis 4, Ind.

## RADIO ENGINEERING DEGREE IN 27 MONTHS

Intensive, specialized course including strong basis in mathematics and electrical engineering, advanced radio theory and design, television. Modern lab. Low tuition. Self-help opportunities. Also B.S. degree in 27 months in Aeronautical, Chemical, Civil, Electrical, and Mechanical Engineering. G.I. Gov't approved. Enter March, June, September, December. Catalog.

### INDIANA TECHNICAL COLLEGE

1525 E. Washington Blvd., Fort Wayne 2, Indiana

## CODE SENDING RECEIVING SPEED

Be a "key" man. Learn how to send and receive messages in code by telegraph and radio. Commerce needs thousands of men for jobs. Good pay, adventure, interesting work. Learn at home quickly through famous Candler System. Qualify for Amateur or Commercial License. Write for FREE BOOK.

**CANDLER SYSTEM CO.**  
Dept. 3B, Box 928, Denver 1, Colo., U.S.A.

## RCA INSTITUTES, INC.

A service of Radio Corporation of America  
350 West 4th St., New York 14, N. Y.

**OFFERS COURSES IN ALL TECHNICAL PHASES OF RADIO, TELEVISION, ELECTRONICS**  
Approved for Veterans  
Write Dept. RE-55 for Catalog

## ENJOY 3 COLOR TELEVISION FILTER SCREEN NOW

Changes dull eye-straining black and white pictures into beautiful color tones. Seconds to attach. No tools used. Helps eliminate glare and snow in fringe areas. Order direct. Send \$1 for screen size up to 16". \$1.25 size 17". \$1.50 size 20". \$2 size 21". \$2.50 size 24". \$3 size 27". We pay postage except on C.O.D. orders. Satisfaction guaranteed. Inquiries from dealers also welcomed.

**Zingo Products, Johnstown 13, New York**

## MORE JOBS

than graduates

Demand for our engineering graduates exceeds supply. **Effective placement.** Study in this world-famed college established 1884. Quarters start March, June, September, January.

### Bach. Sc. degree in 27 months

Complete Radio Eng. courses . . . TV, UHF and FM. Also Mech., Civil, Elec., Chem., Aero. and Adm. Eng.; Bus. Adm., Acct. Small classes. Well-equipped labs. Modest costs. Prep. courses. Write **Jean McCarthy, Director of Admissions,** for Catalog and Campus View Book.



## TRI-STATE COLLEGE

2425 College Avenue, Angola, Indiana

## TELEVISION

PREPARE FOR A GOOD JOB!

BROADCAST ENGINEER  
ELECTRONICS  
RADIO SERVICING

### Television Servicing

(Approved for Veterans)

SEND FOR FREE LITERATURE  
**BALTIMORE TECHNICAL INSTITUTE**  
1425 EUTAW PLACE, BALTIMORE 17, MD.

## RADIO-TV ELECTRONICS



CREI graduates in big demand. ECPD-Accredited Technical Institute Curricula. New classes start monthly. Free placement service for grads. Courses: Radio Engineering, Broadcast or TV Engineering; TV, FM, AM Servicing; resident studies leading to "Associate in Applied Science" degree. Write for free catalog. Approved for vets.

### CAPITOL RADIO ENGINEERING INSTITUTE

Dept. RE, 3224—16th St., N.W., Washington 10, D. C.

## EARN MORE MONEY— BE A PROFESSIONAL TELEVISION SERVICE TECHNICIAN

GET DOWN-TO-EARTH PRACTICAL TV TRAINING WITH WTI EXPERTS FOR THE TOP PAYING \$5,000-\$10,000 PER YEAR JOBS.

UHF—COLOR—VHF

Master the latest, up-to-the-minute TV and Color TV developments QUICKLY.

SEND FOR FREE BOOK TODAY!

WESTERN TV offers real experience on live equipment in our BIG SHOPS AND LABORATORIES in the shortest practical time under expert instructors. Graduates are in big demand because they have the "field experience" necessary for immediate "bench" or supervisory positions. You learn every phase of Radio and TV servicing (AM, FM, VHF, UHF). WTI men win fast promotion . . . can demand better pay . . . develop highly profitable businesses of their own with the latest and most PRACTICAL PERSONALIZED TRAINING BEHIND THEM. You concentrate all your time on being a PROFESSIONAL TV SERVICE TECHNICIAN — non-essential math and engineering theory omitted. YOU CAN EARN WHILE YOU LEARN. Special Finance Plan. APPROVED FOR VETERANS. Find out how you can get into the TOP PAY GROUP — Send for this fact-packed book NOW!

### WESTERN TELEVISION INSTITUTE

America's Leading Television Servicing School

Western Television Institute Dept. E-2-55  
341 W. 18th St., Los Angeles 15, Calif.  
Without obligation, please send FREE fully illustrated booklet. (No salesman will call.)

NAME \_\_\_\_\_ AGE \_\_\_\_\_  
ADDRESS \_\_\_\_\_  
CITY \_\_\_\_\_ ZONE \_\_\_\_\_ STATE \_\_\_\_\_

Become an

# ELECTRICAL ENGINEER



## Major in Electronics or Power BS Degree in 36 months

Prepare now for a career as an electrical engineer or engineering technician — and take advantage of the many opportunities in these expanding fields.

You can save a year by optional year 'round study. Previous military, academic, or practical training may be evaluated for advanced credit.

## Enter Radio and Television — courses 12 to 18 months

You can be a radio technician in 12 months. In an additional 6-months you can become a radio-television technician with Associate in Applied Science degree. Color television instruction is included in this program.

These technician courses may form the first third of the program leading to a degree in Electrical Engineering. Twenty-one subjects in electronics, electronic engineering and electronic design are included in these courses.

Courses also offered: radio-television service (12 mos.); electrical service (6 mos.); general preparatory (3 mos.).

Terms — April, July, September, January

Faculty of specialists. 50,000 former students—annual enrollment from 48 states, 23 foreign countries. Non-profit institution. 52nd year. Courses approved for veterans. Residence courses only.

MS-6A

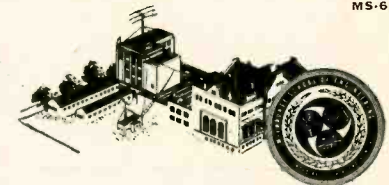

## MILWAUKEE SCHOOL OF ENGINEERING

MILWAUKEE SCHOOL OF ENGINEERING  
Dept. RE-255, 1025 N. Milwaukee Street  
Milwaukee 1, Wisconsin

Send FREE illustrated booklets  
 Career in Electrical Engineering.  
 Career in Radio-Television.

I am interested in \_\_\_\_\_ (name of course)

Name \_\_\_\_\_ Age \_\_\_\_\_

Address \_\_\_\_\_

City \_\_\_\_\_ Zone \_\_\_\_\_ State \_\_\_\_\_

If veteran, indicate date of discharge \_\_\_\_\_

\$

\$



# MEN WHO GET AHEAD IN ELECTRONICS

read every issue of

## RADIO-ELECTRONICS

FOR AUTHORITATIVE UP-TO-DATE INFORMATION ON EVERY NEW DEVELOPMENT IN COLOR TV . . . AUDIO . . . HIGH FIDELITY . . . U.H.F. . . . ELECTRONICS . . . RADIO . . . SERVICING

**Don't miss...**

these interesting and practical features coming in the issues just ahead:



- **WHAT—NO HIGH VOLTAGE?**  
Service techniques used in trouble-shooting high-voltage problems.
- **A 14-INCH PORTABLE TV**  
Discussion of interesting circuits in a recent Emerson model.
- **MAGNETIC TAPE RECORDER AIDS INDUSTRY**  
The tape recorder that can be used to do some things which are now being done by more expensive control units.
- **EMPLOYMENT IN ELECTRONICS**  
Where the jobs are—what they require—and, roughly, what they pay.
- **THREE-CHANNEL MIXER-EQUALIZER**  
A useful piece of equipment for the audio enthusiast, PA man and broadcast engineer.

Clip and mail today

**SEND ME RADIO-ELECTRONICS**

Please check:

3 YEARS—36 Big Issues—ONLY \$8.00  
SAVES YOU \$5.05 over the single copy price!

2 YEARS—24 Big Issues—ONLY \$6.00  
SAVES YOU \$2.70 over the single copy price!

1 YEAR—12 Big Issues—ONLY \$3.50  
SAVES YOU 85c over the single copy price!

NAME (Please Print Clearly) \_\_\_\_\_

STREET ADDRESS \_\_\_\_\_

CITY \_\_\_\_\_ ZONE \_\_\_\_\_ STATE \_\_\_\_\_

I enclose \$.....

Bill Me

MAIL TO:  
RADIO-ELECTRONICS  
25 West Broadway  
New York 7, N. Y.

**GIVE THIS COUPON**

to your local magazine agent or mail today to:

**RADIO-ELECTRONICS**  
25 W. Broadway  
New York 7, N.Y.

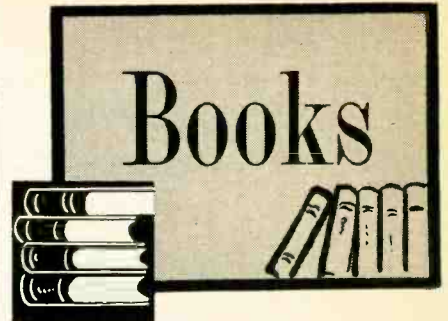

**ELECTRONICS FOR EVERYONE**, by Monroe Upton. The Devin-Adair Co., 23 E. 26th St., New York, N. Y. 5 1/4 x 8 1/2 inches, 370 pages. \$6.

Here is a thoroughly absorbing book on the evolution of electronics. Partly biographical, partly historic and completely fascinating, Monroe Upton strikes an unusual level of presentation. *Electronics for Everyone* is a quasi-technical story, one that the novice will marvel at and the engineer will read with complete satisfaction.

Starting in ancient Greece with Thales and the discovery of amber's electrical properties and ending with Zworykin and television, the scientific achievements of titans like Faraday, Volta, Tesla, Ohm, Edison and Ampere are woven into a "human" story.

No mathematics beyond simple arithmetic is used. Every technical expression is introduced only after the necessary groundwork for understanding it is laid—there are no abstract terms.

Typical chapter titles are: Georg Ohm Writes a Law; The Marvelous Magnets of Henry; de Forest's Magic Lamp, and Superhet by Armstrong. The experiments and inventions of the famous and lesser knowns are explained.—JK

**AUDIO AMPLIFIERS AND ASSOCIATED EQUIPMENT (Volume 5)**. Compiled and published by Howard W. Sams & Co., Indianapolis 5, Ind. Pages not numbered. \$3.95.

Fifth of a series, this volume is a compilation of Photofact folders giving complete servicing information and technical details on audio amplifiers, preamplifiers and tuners produced in 1953 and 1954. The service technician will quickly realize the value of the voltage and resistance tables and the photos showing the location of all parts down to the smallest resistor and capacitor. The audio fan and circuit fanatic can study and compare equalizers and tone controls using R-C and L-C networks or various versions of the Williamson, Ultra-Linear and other amplifiers.

**LINEAR TRANSIENT ANALYSIS (Volume 1—Lumped-Parameter Two-Terminal Networks)**, by Ernst Weber. John Wiley & Sons, New York. 348 pages, \$7.50.

A comprehensive work giving equal emphasis to all the classical and operational methods of transient analysis. Each fundamental method is illustrated by mathematical examples.

## EASY TO LEARN CODE

It is easy to learn or increase speed with an Instructograph Code Teacher. Affords the quickest and most practical method yet developed. For beginners or advanced students. Available tapes from beginner's alphabet to typical messages on all subjects. Speed range 5 to 40 WPM. Always ready—no QRM.



**ENDORSED BY THOUSANDS!**

The Instructograph Code Teacher literally takes the place of an operator-instructor and enables anyone to learn and master code without further assistance. Thousands of successful operators have "acquired the code" with the Instructograph System. Write today for convenient rental and purchase plans.

**INSTRUCTOGRAPH COMPANY**  
4701 Sheridan Rd., Dept. RC, Chicago 40, Ill.

**RADIO CONTROLLED Garage Door Operating Mechanism \$24.50**  
Write for Information  
**P. E. HAWKINS CO.**  
631 Prospect Kansas City 24, Mo.

**FREE!** REQUEST PORTFOLIO 200 TO EVERY TV SERVICEMAN

GET IT TODAY! TV accessories and parts catalogs, literature, data sheets, etc. Yours for the asking!

**Vidaire ELECTRONICS MFG. CORP.**  
Main Office & Plant  
576 WEST MERRICK ROAD LYNBROOK, N. Y.



**NEW! ATLAS CJ-30  
COBRA-JECTOR**  
INDESTRUCTIBLE FIBER-GLASS  
ALL WEATHER  
WIDE ANGLE DISPERSION

List \$40.00  
**NET \$24.00**  
Complete  
with Driver.



Weatherproof  
Line Matching  
Transformer  
as shown,  
Net \$5.10.

New versatile all-purpose projector—excellent for paging & talk-back, intercom, marine, and industrial voice & music systems. Penetrating articulation assures wide angle intelligible coverage even under adverse sound conditions. "ALNICO-V-PLUS" magnetic assembly. Double-sealed against all weather. Omni-directional mounting bracket. Quick, easy installation. An amazing "power package"—Specify the CJ-30 for the "tough" jobs!

Input Power (continuous).....15 watts  
Input Impedance.....8 ohms  
Response.....250-9000 cps  
Dispersion.....120° x 60°  
Dimensions:.....Opening, 14" x 6"  
Overall Length, 14"



WRITE FOR COMPLETE CATALOG  
**ATLAS SOUND CORP.**  
1443—39 St., Bklyn. 18, N. Y.  
In Canada:  
Atlas Radio Corp., Ltd., Toronto, Ont.

**MAKE MORE MONEY!**

Greater ability means more pay. An FCC Commercial Operator License is recognized as proof of technical ability and is required for many high-paying jobs in radio, television, and industrial electronics. Add theoretical knowledge and an FCC license to your practical experience, and make more money.

THE GRANTHAM RADIO LICENSE COURSE IS DESIGNED TO PREPARE YOU, IN A MINIMUM OF TIME, TO PASS

**F.C.C. LICENSE EXAMINATIONS**

Our license training is available by CORRESPONDENCE or in RESIDENCE. Either way, you are completely prepared. In every detail, to obtain the particular class of FCC license you want. Our training includes constant practice with FCC type tests.

**Our Guarantee:**  
**You Will Get Your License**

Read details in our FREE BOOKLET.

**MAIL COUPON FOR FREE BOOKLET**

Grantham School of Electronics  
Dept. 101-RA  
6064 Hollywood Blvd.  
Hollywood 28, Calif.

Send me your FREE booklet, telling how I can get my commercial FCC operator license quickly and what job opportunities are available to licensed technicians.

NAME \_\_\_\_\_  
ADDRESS \_\_\_\_\_  
CITY \_\_\_\_\_ STATE \_\_\_\_\_

BOOKS

(Continued)

INTRODUCTION TO ULTRA-HIGH-FREQUENCY RADIO ENGINEERING, by Stephen A. Knight. Pitman Publishing Corp., New York. 256 pages, \$4.50.

A guide to the theory, applications and techniques of u.h.f. radio, written for students, engineers and other interested readers wishing to obtain a working knowledge of u.h.f. without mathematical theory and unnecessary details. A good middle-of-the-road text filling the gap between purely engineering texts and books prepared for the radio beginner. Covers such subjects as waveguides, antennas, resonant cavities, propagation and special u.h.f. tubes.

**MOST-OFTEN-NEEDED 1955 TELEVISION SERVICING INFORMATION** (Volume TV-9). Compiled by M. N. Beitman. Supreme Publications, Highland Park, Ill. 192 pages, \$3.

Contains schematic diagrams, drawings, photographs, waveforms, voltage and resistance tables, alignment points and frequencies and other pertinent servicing information on approximately 600 television receiver models and chassis of 26 brands. All information is as supplied by the set manufacturer.

**AUDELS HOME APPLIANCE SERVICE GUIDE**, by Edwin P. Anderson. Theo. Audel & Co., New York. 842 pages, \$4.

Beginning with a 124-page section on electrical fundamentals, appliance testers and house wiring, the author then devotes the remaining 27 of 34 chapters to detailed servicing information including wiring diagrams and disassembly instructions on almost every type of electrical and electrically controlled appliance used in the home. The only appliances conspicuously excluded are shavers, sewing machines and water pumps. The usefulness of the book would be even greater if the author had included a chapter or two on eliminating the radio interference frequently caused by motors and thermostatic controls. END

**CORRECTION**

There is an error in the review of M. N. Beitman's book *Most-Often-Needed 1954 Radio Diagrams and Servicing Information* on page 153 of the November, 1954, issue. The review should read as follows: "This is the latest addition in the continued series of volumes of diagrams and service data on modern home, auto and portable radios.

"The volume consists of reprints of data and diagrams on approximately 560 models made by 32 receiver manufacturers."

The last paragraph of this review as it was published is actually the second and concluding paragraph in the review of the NBS publication in the same column.



**Trav-Electric CONVERTERS**

provide  
*House Current*

*Anywhere*

—from battery in car, truck, boat. At the beach —picnic grounds—at cabin—on trips—anywhere! Easy! No installation! Just plug Trav-Electric into cigar lighter on dash.

- Trav-Electric Operates:
- Tape Recorders
  - Electric Shavers
  - Radios
  - Soldering Irons
  - Dictating Machines
  - Small Electric Drills
  - Portable Phonographs
  - Etc. etc. etc.

**6 Models 10 to 100 Watts**  
—a size for every need.

**"Midget"**

Model 6-11160  
10-15 Watts  
About as small as a pack of cigarettes.  
**\$11.95 LIST**



PORTABLE PHONOGRAPH



DICTATING MACHINE



ELECTRIC SHAVER

**"JUNIOR"**

Model 6-110  
115 Cycle  
30-40 Watts  
**\$12.95 LIST**

**"SENIOR"**

Model 6-1160  
Size 2 1/2" x 2 1/2" x 4 1/2"  
35-40 Watts  
**\$15.95 LIST**

**"MASTER"**

Model 6-51160  
40-50 Watts  
Size 4" x 5" x 6"  
**\$27.50 LIST**

**"SUPER"**

Model 6-71160  
(Shown at top of ad)  
60-75 Watts  
Size 4" x 5" x 6"  
**\$37.95 LIST**

—and now, the **"CHIEF"**  
NEW—JUST OUT—Model 6-81160—75-100 Watts—automatic on-off switch—  
**\$49.95 LIST**

See your Electronic, Hardware, or Automotive Jobber or Dealer

**Terado Company**

Designers and Mfrs. of Electronic Equipment  
1057 Raymond Ave., ST. PAUL 14, MINN.  
In Canada Write: Atlas Radio Corp., Ltd.  
560 King St. West, Toronto 28, Ont.  
Export Sales Division: Scheel International, Inc.  
4237 N. Lincoln Ave., Chicago 18, Ill. U.S.A.  
Cable Address—Harsheel

# NOW- STEP AHEAD FASTER! AS AN INDUSTRIAL ELECTRONICS TECHNICIAN

Turn your experience into a big, new, better-paying career!

Day by day industrial plants are adding more electronic devices—for sorting, counting, checking, almost any control job you can name. Cash in on industry's great need for men who can keep these devices in top working order. Make more money, feel more secure, doing work that is second nature to you. With what you already know about electronics you have a long head start in a field just beginning to boom. GET INTO IT RIGHT NOW with the help of

## PRACTICAL INDUSTRIAL ELECTRONICS LIBRARY

4 Volumes \$22.50  
1390 pages EASY  
1050 illus. TERMS



Here's the practical kind of information these 4 volumes give you:

- How to keep the plant's electronic equipment performing as it should
- How to locate and correct tube and circuit troubles quickly and easily
- How to install, service, and maintain even brand new equipment without being stumped by new circuits

No long sessions on math or theory! Instead you get: Clear explanations of how tubes and tube-operated circuits work in motor controls, welding controls, heat controls, etc. A complete manual that covers all maintenance procedures. A handbook of 433 industrial electronic circuits with each fully described. Troubleshooting charts, tested working methods, step-by-step directions—everything you need to start right now is here.

Contains  
Chute's Electronics in Industry  
Miller's Maintenance Manual of Electronic Control  
Markus & Zeluff's Handbook of Industrial Electronics Circuits  
Henney & Fahnestack's Electron Tubes in Industry

Shows facts such as:  
How to operate the vacuum-tube voltmeter  
How to correct ignitor misfire  
How to maintain light sources for photoelectric control  
How to protect circuits of welding machines  
How tubes serve in conveyor synchronization, color measurement, etc. and hundreds more

## FREE TRIAL—EASY TERMS

McGraw-Hill Book Co., Dept. RE-2, 327 W. 41 St., NYC 36

Send me the Practical Industrial Electronics Library for 10 days' examination on approval. In 10 days I will send \$2.50, then \$4.00 a month until \$22.50 is paid. (A saving of \$3.50 under the regular price of \$26.00.) Otherwise I will return books postpaid. (Print)

Name .....

Address .....

City .....

Zone .....

State .....

Employed by .....

This offer applies in U.S. only. RE-2

## ADVERTISING INDEX

Radio-Electronics does not assume responsibility for any errors appearing in the index below.

Airex Corp.	102
Alproco, Inc.	28, 29
Alliance Mfg. Co.	Inside Front Cover
Allied Radio Corp.	13, 114
American Electrical Heater Mfg. Co.	98
American Microphone Co.	100
American Phenolic Corp.	100
Amplifier Corporation of America	123
Approved Electronic Instrument Corp.	106
Arky Radio Kits, Inc.	141
Atlas Sound Corp.	147
Audel Publishers.	88
Barry Electronics Corp.	148
Belden Mfg. Co.	103
Bell Telephone Labs.	101
Brooks, Radio & TV Corp.	127
Burstein Applebee Co.	140
CBS Hytron (Div. of Columbia Broadcasting System)	14
Cannon Electric Co.	16
Capitol Radio Engineering Institute	17
Channel Master Corp.	26, 27
Chicago Standard Transformer Corp.	128
Cisin, H. G.	16
Cleveland Institute of Radio-Electronics	129
Collins Audio Products Co.	89
Concord Radio	128
Cornell-Dubilier Electric Corp.	10, 106
Coyne Electrical & TV Radio School	96, 131, 143
DeCray, Frank W.	140
Delco Radio (Div. of General Motors Corp.)	24
DeVry Technical Institute	117
Dynamu Magnetronics Corp.	117
EBY Sales Co.	116
Edlio Electronics, Inc.	129
Electro-Voice, Inc.	6
Electron Tube Wholesalers, Inc.	144
Electronic Instrument Co. (EICO)	30, 137, 140
Electronic Measurements Corp.	110
Fisher Radio Corp.	83
G&H Wood Products Co.	120
General Cement Mfg. Co.	99
General Industries Co.	12
General Electronic Distributing Co.	132
General Test Equipment	147
Grantham School of Electronics	147
Hawkins Co., P. E.	146
Heath Co.	69-80
Hickok Electrical Instrument Co.	129
Hudson Specialties Co.	137
Hughes Research & Development Labs.	90, 122
Mycon Mfg. Co.	107
Indiana Technical College	126
Instructograph Co.	146
Instruments For Service, Inc.	130
JFD Mfg. Co., Inc.	93, 94
J.E.S. Co.	102
Jensen Industries	123
Kay-Townes Antenna Corp.	112, 113
Lafayette Radio Corp.	149
La Pointe Electronics	125
Leotone Radio Corp.	144
MacMillan Co., The	141
Mallory & Co., Inc., P. R.	97
McGraw-Hill Book Co.	148
Moss Electronic Distributing Co.	118, 119
National Electronics of Cleveland	114
National Radio Institute	3, 19, 20
National Schools	5
Ohmite Mfg. Co.	135
Opportunity Adlets	130
Or-Radio Industries, Inc.	96
Oxford Electric Co.	134
Phaestron Co.	21
Precision Apparatus Co., Inc.	12, 133
Prentice Hall, Inc.	138
Progressive "Edu-Kits", Inc.	115
R&M TV, Inc.	132
RCA Institutes, Inc.	25
RCA Tube Div. (Radio Corp. of America)	Back Cover
Rad-Tel Tube Co.	132
Radiart Corp.	10
Radio Television Training Association	23
Radion Corporation	18, 126
Raytheon Mfg. Co.	11
Regency Division (I.D.E.A.)	121
Riverson, Inc., John F.	124
Rinehart & Co., Inc.	108, 109
Rockbar Corp.	102
S & A Electronics	138
Sams & Co., Inc., Howard W.	18
Sansone Electric Co.	122
Sprayberry Academy of Radio	67
Stan-Burn Radio & Electronics	96
Steve-El Electric Corp.	111
Supreme Publications	111
Sylvania Electric Products, Inc.	84, 85
Tab	150
Teltron Electric Co.	136
Teraco Co.	147
Transvision, Inc.	139, 140
Transamerica Electronics	138
Trio Mfg. Co.	15
Triplett Electrical Instrument Co.	Inside Back Cover
Tung-Sol Electric Co.	8
Turner Co.	88
United Catalog Publishers	136
Vidaire Electronics Mfg. Corp.	146
Walco Electronics Corp.	22
Webster Electric Corp.	95
Wholesale Radio Parts Co.	123
Winpower Mfg. Co.	88
Zingo Products	145

## RADIO SCHOOL DIRECTORY PAGE 145

Baltimore Technical Institute	
Candler System Co.	
Capitol Radio Engineering Institute	
Grantham School of Electronics	
Indiana Technical College	
Indianapolis Electronic School	
Milwaukee School of Engineering	
RCA Institutes, Inc.	
Tri-State College	
Valparaiso Technical Institute	
Western Television Institute	
Radio Television Training Association	23
Radion Corporation	18, 126
Raytheon Mfg. Co.	11
Regency Division (I.D.E.A.)	121
Riverson, Inc., John F.	124
Rinehart & Co., Inc.	108, 109
Rockbar Corp.	102
S & A Electronics	138
Sams & Co., Inc., Howard W.	18
Sansone Electric Co.	122
Sprayberry Academy of Radio	67
Stan-Burn Radio & Electronics	96
Steve-El Electric Corp.	111
Supreme Publications	111
Sylvania Electric Products, Inc.	84, 85
Tab	150
Teltron Electric Co.	136
Teraco Co.	147
Transvision, Inc.	139, 140
Transamerica Electronics	138
Trio Mfg. Co.	15
Triplett Electrical Instrument Co.	Inside Back Cover
Tung-Sol Electric Co.	8
Turner Co.	88
United Catalog Publishers	136
Vidaire Electronics Mfg. Corp.	146
Walco Electronics Corp.	22
Webster Electric Corp.	95
Wholesale Radio Parts Co.	123
Winpower Mfg. Co.	88
Zingo Products	145

## STANDARD BRAND TUBES

- Individually boxed ● Only 1st quality. ● Latest Dating—
- No private label, electrical or mechanical rejects.
- No rebrands or rewashed "bargains."
- Write for Free 1955 New Air-Mail Handy-Order Blank.
- Lists ALL Popular TV & Radio Types.
- Makes Mail-Order a Pleasure.
- All Tube Orders Over \$25.00 (with full remittance) POSTPAID

### SPECIAL-PURPOSE TUBES

Write for our complete listing on XMTG, Industrial, Special-Purpose and Crystal Diodes. We stock over 2,000 types at excellent prices.

Type	Price	Type	Price	Type	Price
024	.50	6BD6	.75	717	1.35
1A5GT	.80	6BE6	.70	7K7	1.20
1A7GT	1.00	6BF5	.85	7L7	1.15
1B3GT	.85	6BF6	.70	7N7	.95
1H5GT	.75	6BGG	1.80	7Q7	1.00
1L4	.85	6BH6	.80	7R7	1.30
1L6	1.00	6BL7	.70	7S7	1.25
1LA4	1.00	6BK5	.90	7V7	1.30
1LA6	1.00	6BK7A	1.10	7W7	1.30
1LB4	1.00	6BL7GT	1.15	7X6	.85
1C5	1.00	6BN6	1.15	7X7	1.00
1LD5	1.00	6BQ6GT	1.20	7Y4	.70
1LE3	1.00	6C7A	1.20	7Z4	.70
1L65	1.00	6BX7GT	.55	12A15	.50
1LN5	.95	6BY5G	1.30	12AT6	.50
1N5GT	.90	6BZ7	1.25	12AT7	1.00
1Q5GT	1.15	6C4	.50	12AU6	.60
1R4	1.00	6CB6	.70	12A07	.80
1R5	.70	6CD6G	1.75	12AV6	.55
1S1	.90	6CF6	1.00	12AV7	.95
1S5	.70	6CL6	1.00	12AW6	.85
1T4	.70	6CM6	.90	12AX1GT	.85
1T5GT	1.05	6C6	.70	12AX7	.80
1U4	.70	6C6U	1.70	12AY7	1.75
1U5	.65	6E5	1.00	12AZ7	.90
1V	.95	6F3	.90	12B4	.90
1V2	.95	6F6M	1.80	12B6	.65
1X2B	.65	6F6G	.80	12BA7	.95
2D21	1.00	6H6	.50	12BE6	.70
2X2	.50	6I4	1.95	12BH7	.95
3A4	.55	6I5	.50	12BY7	.95
3A5	.90	6I6	.75	12BZ7	1.00
3FL4	1.15	6I7	.95	12C6T	.70
3Q4	1.00	6K6GT	.60	12K7GT	.90
3Q5	1.00	6K7M	.80	12K8GT	1.10
3S4	.85	6K8	1.20	12Q7GT	.80
3V4	.75	6L6G	1.15	12SA7GT	.65
5AW4	1.35	6L6GA	1.30	12SG7	.90
5R4GY	1.55	6L6M	1.50	12SH7	.95
5U4G	.55	6L7G	1.25	12SK7GT	.65
5V4G	.90	6N7	1.15	12SK7GT	.65
5W4GT	.70	6Q7M	.95	12SL7GT	1.00
5X4G	.80	6Q7G	.80	12SN7GT	.80
5Y3GT	.45	6Q7GT	.80	12SQ7GT	.60
5Y4G	.65	6S4	.60	14A4	1.00
5Z3	.80	6S8	1.10	14A5	1.50
5Z4	1.25	6SA7GT	.65	14A7	.35
6A8M	1.00	6SC7	.75	14I7	1.35
6A8GT	1.05	6SF5	.75	14N7	1.00
6A81	.65	6SG7	.70	14Q7	.95
6A87	1.35	6SH7	.80	14R7	1.30
6A9	1.00	6SI7M	.70	14S7	1.25
6A95GT	1.15	6SK7GT	.65	14W7	1.35
6A97	1.10	6SL7GT	.80	19B6G6	2.00
6A97G	1.45	6SN7GT	.75	19T8	1.20
6A98	1.30	6SQ7GT	.60	25AV5	1.20
6AF6	1.20	6S87	.85	25BQ6GT	1.30
6AG5	.75	6T4	1.30	25L6GT	.65
6AG7	1.20	6T8	1.25	25W4GT	.70
6AH1GT	.85	6U5	.90	25Z5	.70
6AH6	.90	6U8	1.00	25Z6GT	.65
6A15	1.75	6V3A	1.30	35A5	.70
6AK5	.75	6V6GT	.65	35B5	.65
6AK6	.80	6V6M	1.30	35C5	.70
6AL5	.60	6W4GT	.60	35L6GT	.65
6AL7	1.50	6W6GT	.80	35W4GT	.45
6AM8	1.25	6X4	.50	35Z5GT	.45
6AN4	1.50	6X8	.95	50A5	.70
6AN5	3.50	6Y8	.95	50B5	.70
6AN8	1.20	6Y6G	1.00	50C5	.70
6AQ5	.70	7A4	.80	50L6GT	.65
6AQ6	.55	7A5	.95	50P5	.90
6AQ7	1.20	7A6	.85	70L7	1.55
6AR5	.65	7A7	.80	80	.60
6AR6	2.75	7A8	.85	83	1.15
6AS5	.75	7B4	.80	117L7GT	2.50
6AS6	2.50	7B5	.70	117N7GT	1.95
6AS7G	3.75	7B6	.75	117P7GT	1.95
6AT6	.55	7B7	.80	117Z3	.70
6AU4GT	.95	7C4	1.25	17724GT	1.15
6AU5GT	1.10	7C5	.80	117Z6GT	1.00
6AU6	.60	7C6	.70	211	.65
6AV5GT	1.05	7C7	.85	803	1.90
6AV6	.55	7E8	1.10	838	1.90
6AX1GT	.80	7E7	1.20	872-A	2.75
6AX5GT	.75	7F7	.90	5642	1.00
6BA6	.65	7F8	1.20	5654	1.75
6BA7	.90	7G7	1.15	6096	1.85
6BD5	.70	7H7	.75	8008	4.40
6BD5	1.40	7H7	.75	And Others	

TWO-COLORED TUBE CARTONS, with new Safety Preventions Tube Breakage. This Super-Gloss Red and Black Carton is the Most Distinctive Box Available Today! Minimum: 100 any one size. Quantity prices on request. Boxes F.O.B. N.Y., N.Y. SIZE Miniature (6AU6, 6AL5, etc.) \$ .01 GT (6SN7, 6W4, etc.) .0125 LARGE GT (1B3, 6BQ6GT, etc.) .015 LARGE G (5U4G, 6BGGG, etc.) .02

Terms: 25% with order, balance C.O.D. All merchandise guaranteed. F.O.B., N.Y.C. New phone and address Phone: Walker 5-7000.

**BARRY** ELECTRONICS CORP.  
512 Broadway N.Y. 12, N.Y.

# LAFAYETTE'S SPECTACULAR MULTITESTER VALUES



## HIGH SENSITIVITY AC-DC MULTITESTER 20,000 ohms per Volt

The new Lafayette High Sensitivity Multitester is a complete instrument (not a kit). Here is an instrument packed with every desirable feature found only in instruments costing twice as much. One of the most sensitive multitesters ever offered. 20,000 ohms per volt DC; 8,000 ohms AC, having a high sensitivity 45 microamps meter. Full scale AC-DC voltage ranges are 0-10V, 0-50V, 0-250V, 0-500V, 0-1,000V; DC current ranges 50 microamps, 2.5 ma, 25 ma, 250 ma. Resistance: 0-5K ohms, 0-50K ohms, 0-500K and 0-5 megohms. Decibel range: -20 +5 db; +5 +22 db (0 db - 0.775V - 600 ohms). Extreme versatility and accuracy. 1% precision resistors; 3/4" meter; beautiful plastic front, with metal bottom for ruggedness. Size: 3 3/4" x 5 3/4" x 2 1/2". Complete with batteries and leads. Shpg. Wt. 4 lbs.

RW-30G ..... NET **19.95**  
In lots of 3 **19.25**

**19.95**

## NEW POCKET AC-DC VOM MULTITESTER 1,000 ohms per Volt

This instrument is one of the best buys that Lafayette has ever offered in a Wide Range AC-DC MULTITESTER. An ideal portable unit that meets the need for a compact, yet rugged test instrument. Has ease of operation usually found only in MORE EXPENSIVE INSTRUMENTS. Has 1000 ohms/volt sensitivity on both AC or DC. Uses full 3" rectangular meter with large easy to read scale. Uses 1% precision resistors, jeweled D'Arsonval microamp meter movement. Ranges: AC-DC and output volts 0-5, 0-25, 0-250, 0-1000V; DC current 0-1, 0-10, 0-100, MA; Resistance 0-10K and 0-100K ohms. In handsome sturdy bakelite case. Size: 4 3/4" x 3 1/4" x 1 3/4". Supplied Complete with test leads and batteries. A Must for every serviceman, shop, Laboratory or experimenter—and at Lafayette's Price you can afford to own one. Shpg. Wt. 2 1/2 lbs.

MODEL RW-27C—Complete In Lots of 3 **9.45**  
Single, ea. **9.95**



**9.95**

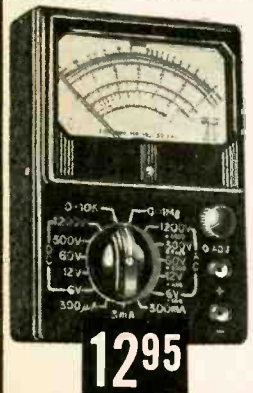

## SENSITIVE AND ACCURATE AC-DC MULTITESTER 2000 OHMS PER VOLT ON BOTH DC AND AC

An unusual buy in a very accurate and sensitive VOM. Features single selector switch for all ranges. Has 3% precision 110 microamp meter, 2000 ohms per volt on both AC and DC, 21 full scale ranges, consisting of AC-DC Voltage Ranges: 0-6; 0-12; 0-60; 0-300; 0-1200 Volts; DC Current Ranges: 0-300 ua; 0-3 MA; 0-300 MA; Resistance Ranges: 0-20 K ohms; 0-2 Megohms; Decibels: 0 db +8 db; +20 db; +34 db; +46 db (0 db - 0.775V).

Extreme versatility and accuracy. 1% precision resistors; beautiful plastic front with metal bottom for ruggedness and shielding. Size 3 3/4" x 5 1/4" x 1 1/2". Shpg. Wt. 3 lbs.

MODEL RW-360 Complete  
In lots of 3 **12.45**  
Singly, ea. **12.95**

**12.95**

## NEW! SLOPING PANEL MULTITESTER 2,000 Ohm per Volt Sensitivity on both DC and AC

- High Sensitivity 3/4", 160 Microamp Meter Insures Accuracy
- 25 Full Scale Ranges
- Sloping Panel for Easy Reading
- 4 Resistance Ranges on Two Separate Scales
- 5 Output Ranges to Measure AC with DC present
- Convenient Pocket SIZE 3 3/4" x 5 3/4" x 2-2/5"

This unusual Multitester is a complete instrument (not a kit) with high quality and sensitive 160 microamp meter. Features extreme versatility, accuracy and ruggedness. In an attractive bakelite front panel, with metal bottom for ruggedness and shielding. Single switch selects all ranges; 1% precision resistors used throughout. An outstanding instrument, for the professional, serviceman or Laboratory. FULL SCALE RANGES: DC Volts: 0-10; 0-50; 0-250; 0-500; 0-1000; AC Volts: 0-10; 0-50; 0-250; 0-500; 0-1000; Output Volts: 0-10; 0-50; 0-250; 0-500; 0-1000; DC Current: 0-500 microamps; 0-2.5 MA; 0-25 MA; 0-250 MA; Resistance: 0-1K; 0-10K; 0-100K; 0-1 Meg; Decibels: +22 and +50 db (0 db - 0.775V - 600 ohm). COMPLETE with test leads and BATTERIES shpg. wt. 4 lbs.

RW-29Y...NET **14.95** ..... In lots of 3, ea. **14.25**

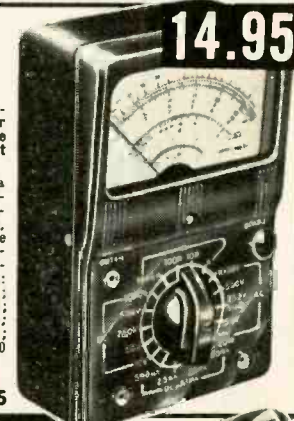

**14.95**

## Collaro THE WORLD'S FINEST 3 SPEED AUTOMATIC RECORD CHANGER

SPECIAL **29.50** LIST PRICE **54.50**

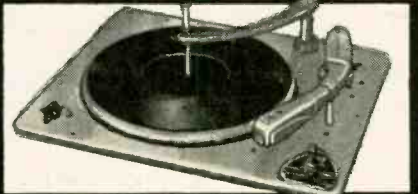

Lafayette scores again with an almost unbelievable price on the Collaro 3-speed Automatic record changer. We made a spectacular buy and we are passing the savings on to you. Here's the finest changer made. Manufactured in England—with a world-wide reputation. It plays all sizes and all speeds automatically. It's packed with quality features that the Hi-Fidelity enthusiast will appreciate: Jant-proof ball bearing mounted tone arm; automatic shut-off after last record; powerful fan cooled hum-shielded 4-pole motor with self-aligning oilite bearings; automatic muting switch; weighted ball-bearing mounted constant speed turntable; rubber drive couplings—and more! Base size 14 3/4" x 12 1/4". Depth below base 2 1/4". Shpg. Wt. 19 lbs. Available either less cartridge with plug-in shell or with famous turnover Ceramic or G.E. Triple-Play cartridge.

COLLARO Model 3/531 changer ..... Net **29.50**  
COLLARO Model 3/531 with Turnover Ceramic cartridge ..... Net **33.50**  
COLLARO Model 3/531 with G.E. Triple Play RPX-050 cartridge installed ..... Net **34.50**  
45 RPM SPINDLE  
Slips in place of regular spindle, eliminating use of center inserts on 45 RPM records.  
GSA Spindle ..... Net **3.23**

## High Output Dynamic Microphone Worth Many Times Its Price

At Last! A Hi-Fi Dynamic Mike for tape recorders, etc.—at a price you'd expect to pay for a good crystal mike! Lafayette went abroad to obtain a high quality DYNAMIC MICROPHONE at a price that is 70% less than any comparable dynamic microphone on the market today. Exceptionally fine for public address, recording and other general purpose use. Substantially flat response, 60-10,000 cps, assures faithful reproduction of speech and music. Impedance 40,000 ohms ±15% at 1000 cps. Output Level -55 db. Die cast metal case finished in light grey and fine chromium. Compact and light weight. Net Wt. 1 lb. Head at fixed tilt of 15°, equipped with 6 ft. well shielded low-loss special vinyl-jacketed cord. Standard 3/8"-27 thread. Dimensions 1-23/32" high, 2" wide, 3/8" deep. Shpg. Wt. 3 lbs.

PA-19...Singly, ea. **14.95**... In lots of 3 **14.45**



**14.95**

## RCA 807 TUBES

QUANTITY LIMITED BRAND NEW JAN. SPECS. STOCK NO. SP-70 **1.29**

CROSLY UHF FRONT END

- Mallory 3 Gang Inductometer
- 6AF4 — 6BZ7 and 1N72
- Parts Alone Worth Twice the Price

UHF front end covers all channels 14 through 82, using the famous Mallory continuous tuning inductor. Original replacement for Crosley part 15169B-1-1 used in Crosley series UH chassis 393 and 394. Ideal for building UHF converters, etc. Output feeds into channel 5 I.F. Concentric shaft includes fine tuning. Built-in antenna switch operates off tuning shaft. Comes complete with 1N72 diode, 6BZ7 and shock mounted 6AP4 tubes. Size: 8 x 5 x 3 1/2". Shpg. Wt. 5 lbs. Quantity limited.

TL-25 ..... Lots of 3, ea. **4.45**  
Singly, ea. **4.95**

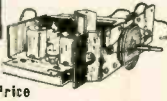

## CARDWELL UHF CONVERTER SALE!

List **42.50**  
Net **13.95** ea. Lots of 3  
Singly **14.45** ea.

Outstanding Value! The Cardwell ES-1 UHF converter covers the entire UHF spectrum—channels 14-83. Has 6AF4 oscillator, 6CB6 IF amplifier and 1N72 crystal diode. Features printed circuit oscillator, high overall gain (3 to 4 times), high sensitivity, constant L/C ratio tuner, 25-1 gear drive. Has AC cord and plug, 3-pos. switch for UHF, VHF and OFF. Handsome wood cabinet 8 1/2 x 6 1/2 x 3 1/2" with easy reading dial. Shpg. Wt. 4 1/2 lbs.

Lots of 3 each ..... **13.95**  
CARDWELL ES-1 Converter—Singly each ..... **14.45**



## RADIART TV BOOSTER

QUANTITY LIMITED

List **29.95**  
ea. in **6.45** lots of 3  
Singly, ea. **6.95**

A special purchase enables Lafayette to offer Radiart Model TVB-1 at a fraction of their original cost. High signal-to-noise ratio greatly minimizes ghosts, snow and interference. Wide Band Amplification insures sharp pictures, free from smear. Attractive styled polished Mahogany cabinet. For 115 Volts, 60 cycles. Shpg. Wt. 4 lbs.

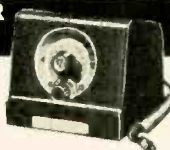

BINOCULARS NEVER BEFORE AT THIS PRICE

## IMPORTED DIRECT

Prism-Coated Lenses

- All-Metal Construction
- Individual Focus
- Leather Case & Straps

F-105, 8 x 30 with case ..... NET **19.95**  
F-15, 7 x 35 with case ..... NET **22.50**  
F-103, 7 x 50 with case ..... NET **24.95**  
F-104, 12 x 50 with case ..... NET **32.50**

with order, Add 10% Fed. Tax



## TIMER-SWITCH SALE

Automatically turns on radios, television sets, toasters, coffeemakers, etc.—at any pre-set time within 12 hour period; also times 15 min. Built-in single pole switch handles up to 15 amps, 115 volt. Requires 3/4" diameter round hole. Depth behind dial face 2 1/4". Shpg. Wt. 1 1/2 lbs. MS-62, for 110V/60 Cy AC

**3.95**



Lafayette Radio

DEPT. J.B.

NEW YORK, N.Y. 100 Sixth Ave.  
BRONX, N.Y. 542 E. Fordham Rd.  
NEWARK, N.J. 24 Central Ave.  
PLAINFIELD, N.J. 139 West 2nd St.  
BOSTON, MASS. 110 Federal St.

Include postage with order.  
Write for FREE Bargain Packed Catalog!



# TRAVELING LIGHT

**BUT WITH A COMPLETE**

pocket-sized

**LABORATORY**

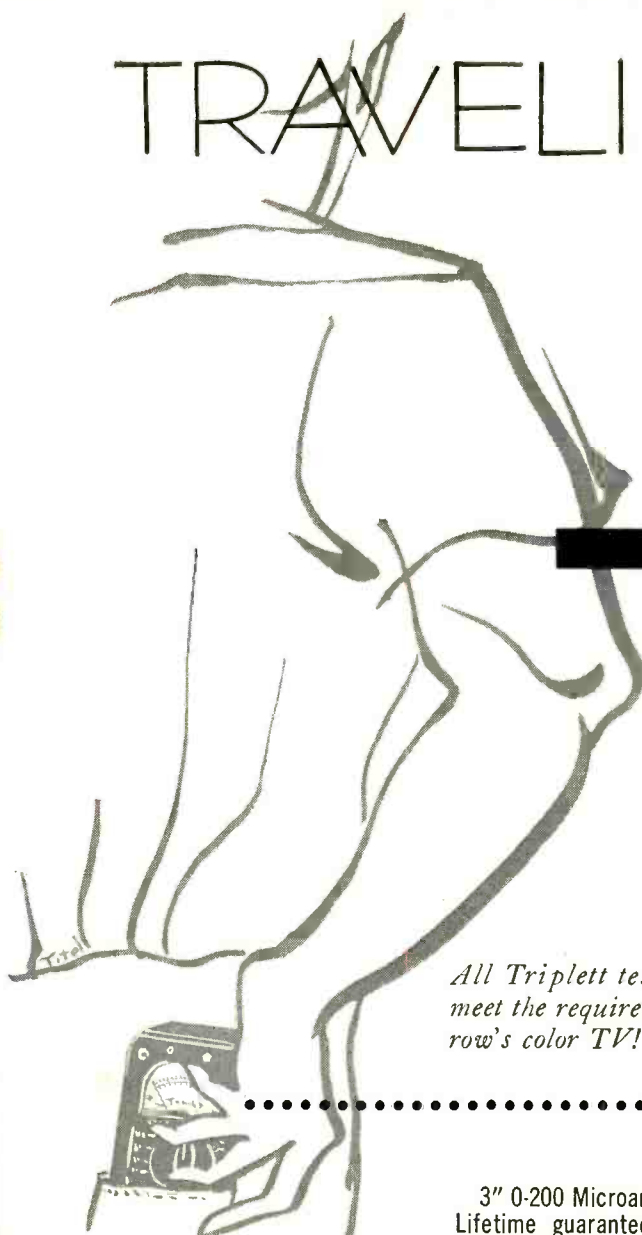

**ON HAND** for his service needs in the Triplet

Model 666R pocket size VOM

**TRAVELING LIGHT,** too, on expense

Model 666R is only \$26.50 dealer net

*All Triplet test instruments meet the requirements of tomorrow's color TV!*

3" 0-200 Microammeter, RED • DOT Lifetime guaranteed. Red and black dial markings on white. Easy to read scale.

Pre-calibrated rectifier unit. Batteries—self-contained, snap-in types, easily replaced.

- RANGES**  
**D.C. VOLTS:** 0-10-50-250-1000-5000, at 1000 Ohms/Volt.  
**A.C. VOLTS:** 0-10-50-250-1000-5000, at 1000 Ohms/Volt.  
**D.C. MA:** 0-10-100, at 250 M.V.  
**D.C. AMP.:** 0-1, at 250 M.V.  
**OHMS:** 0-3000-300,000 (20-2000 center scale).  
**MEG OHMS:** 0-3 (20,000 Ohms center scale).

(Compensated Ohmmeter circuit.)  
Also available—Model 666-HH Pocket V O M, Dealer Net \$24.50.

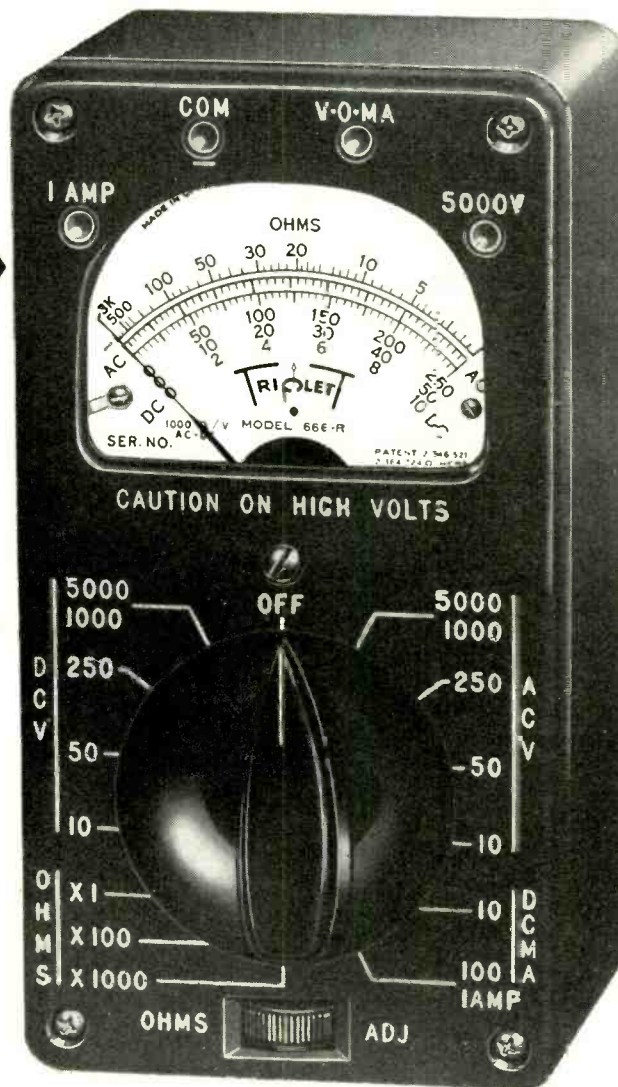

Dim.: 3 1/16 x 5 7/8 x 2 9/16

Enclosed selector switch of molded construction keeps dirt out. Retains contact alignment permanently. A Triplet design representing the culmination of a quarter-century of switch making experience. Unit construction—All resistors, shunts, rectifier and batteries housed in a molded base integral with the switch. Eliminates chance for shorts. Direct connections. No cabling.

Precision film or wire-wound resistors, mounted in their own separate compartment—assures greater accuracy. Four connectors at top of case, controls, knobs and instrument are all flush mounted with the panel.

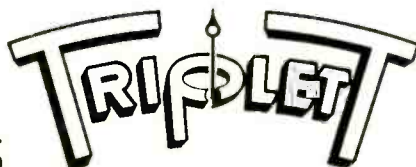

**TRIPLET ELECTRICAL INSTRUMENT CO.**  
Bluffton, Ohio

Millions of TV Owners  
 Who Read **LIFE** will read about you . . .  
 Their Television Serviceman . . . on March 7th

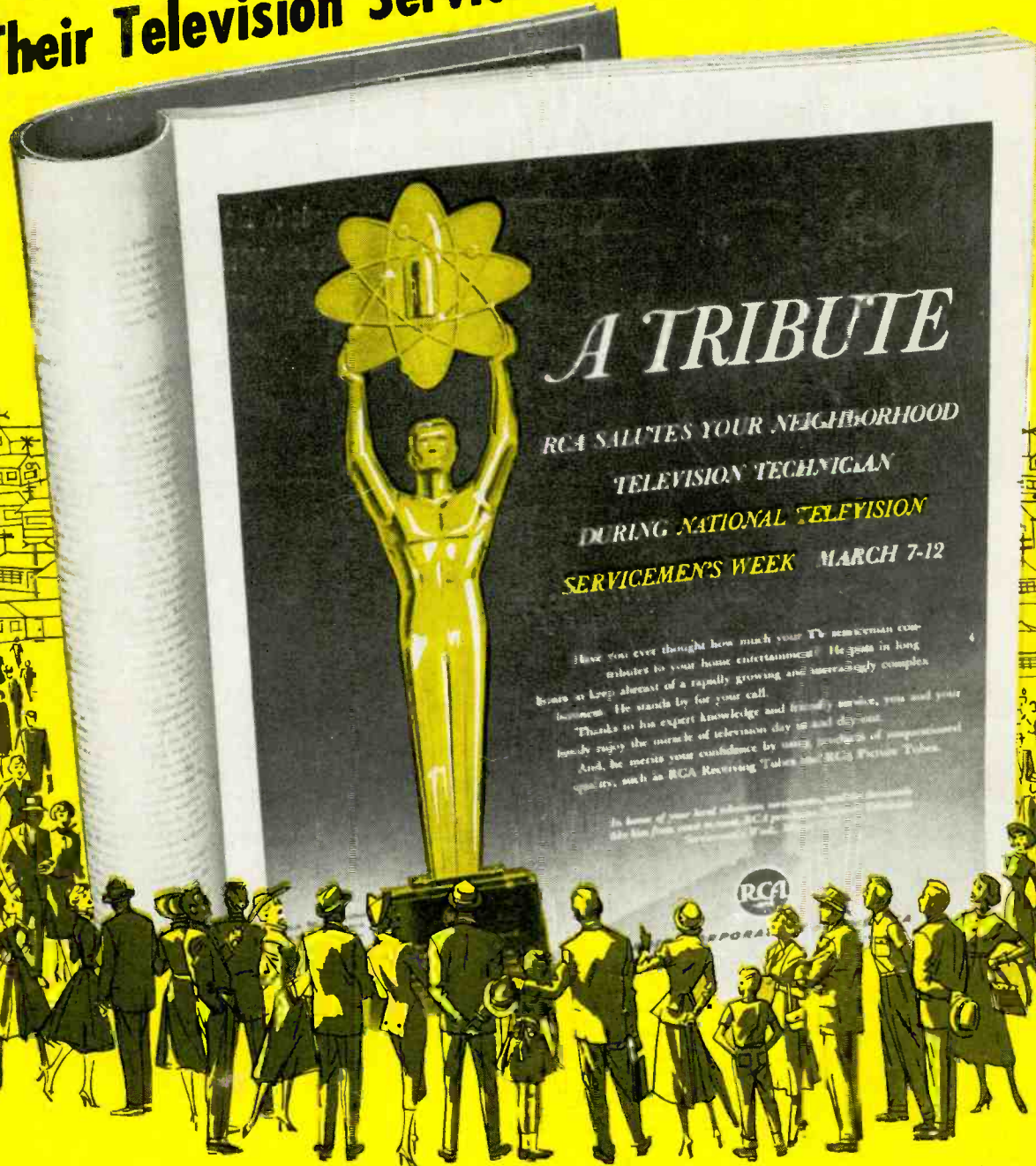

In the March 7th issue of LIFE magazine, readers all over America will see a special advertisement, sponsored by the RCA Tube Division, paying tribute to local television servicemen and dealers everywhere. This will mark the opening of the consumer phase of National Television Servicemen's Week—a perfect opportunity for you to tell your story to your community.

**SEE your RCA Tube Distributor NOW**

. . . for details about NATIONAL TELEVISION SERVICEMEN'S WEEK (March 7-12). Be ready to take full advantage of this big event planned by RCA—exclusively for **YOU!**



**RADIO CORPORATION  
 of AMERICA**

**ELECTRON TUBES HARRISON, N.J.**