

**8th ANNUAL TELEVISION NUMBER**

JANUARY 1955

# RADIO — ELECTRONICS

TELEVISION • SERVICING • HIGH FIDELITY

HUGO GERMSBACK, Editor

*In this issue:*

**Special**

**Full-Color**

**Feature:**

**Servicing**

**Color TV**

**Receivers**

**What's Happening  
To U.H.F.?**

**19-Inch Receiver  
Color Circuitry**

**50¢**

U. S. and  
CANADA



**Unitized Printed-Circuit TV Receiver**

(See page 4)

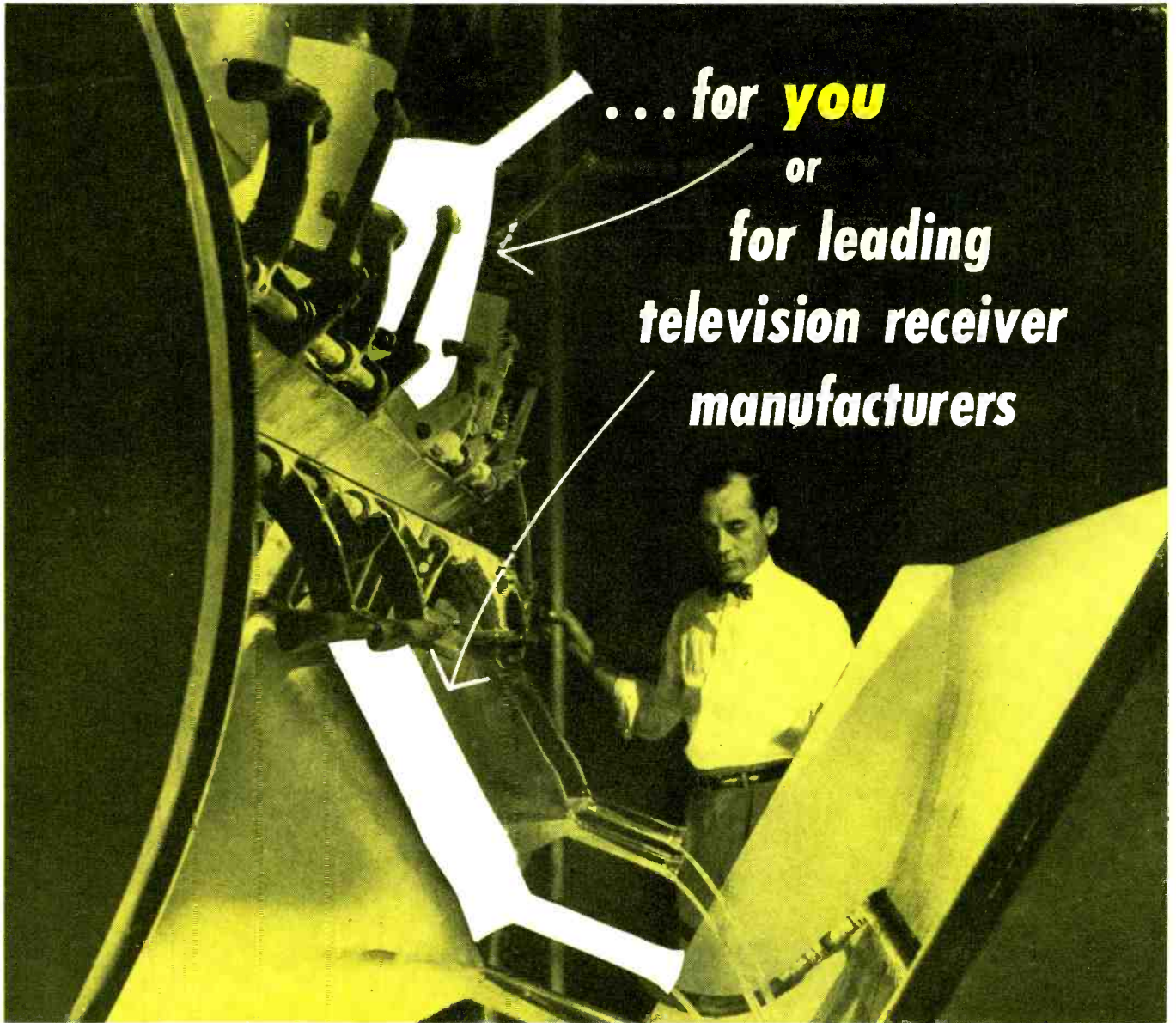

... for **you**  
or  
for leading  
television receiver  
manufacturers

**At Du Mont there is only one**

*Standard of Quality...*



\*Trade Mark

All Du Mont picture tubes are built to the highest standards of quality – whether for leading TV receiver manufacturers as initial equipment, or for the individual serviceman. The same careful assembly, processing and inspection is done on *every* picture tube bearing the Du Mont name.

Do as leading TV receiver manufacturers do – choose Du Mont initial quality picture tubes for new set performance.

CATHODE-RAY TUBE DIVISION  
ALLEN B. DU MONT LABORATORIES, INC.  
CLIFTON, N. J.

# now you can own

a 3-Dimension

Relief Map of the World

Molded in Plastic—Four Colors

for only \$15.00

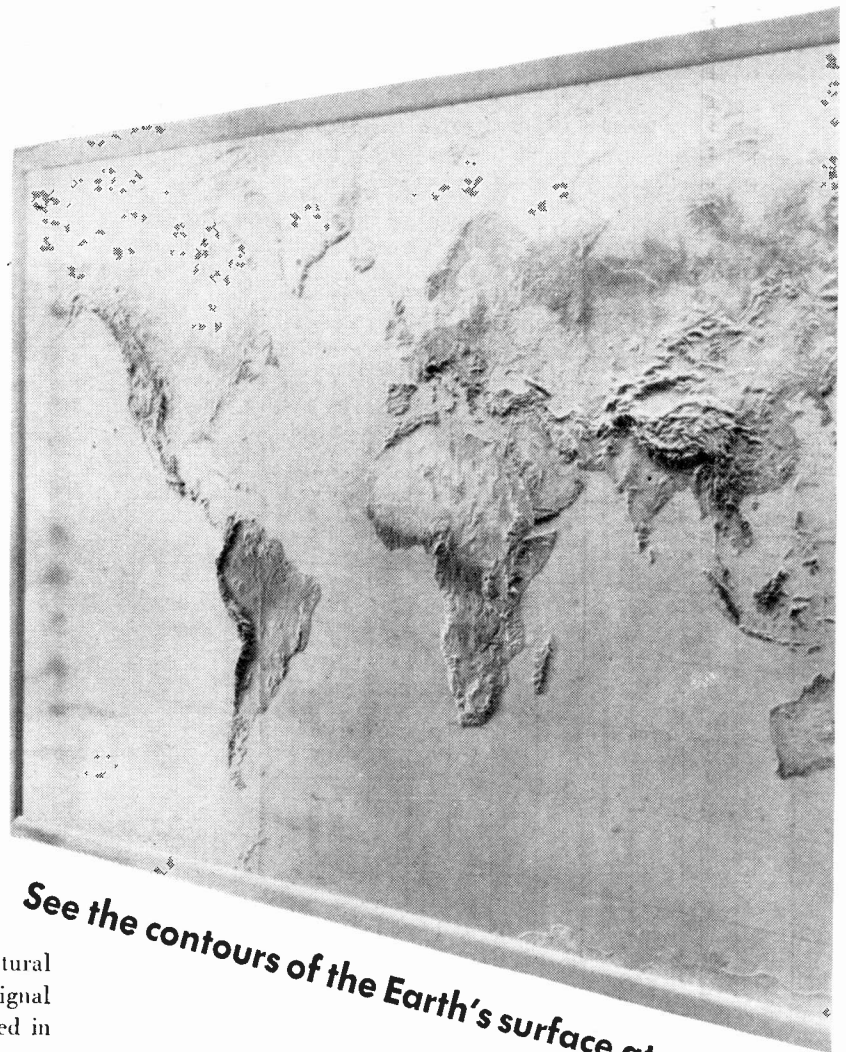

*See the contours of the Earth's surface at a glance.*

The mountains, valleys, and other natural characteristics of the Earth, affecting signal transmission and reception, are modeled in exact scale at their proper height above sea level.

Shows 150 countries and political entities, cities, seaports, airports, rail centers, almost 1,000 features.

This useful and decorative map is molded in sturdy, washable plastic with a self-frame, ready for hanging, and measures 21"x34¼".

Send the coupon today. Be first in town to own this revolutionary new map for only \$15.00.

**An entirely new, third dimension,  
relief map of the World,  
molded in washable plastic,  
to conform with the earth's contours.**



## LEGEND



Easy-to-read symbols that tell you at a glance the major seaports, airports, rail centers and important trading areas.

At least 150 countries and political entities are clearly shown, together with population.

DUN & BRADSTREET'S  
INTERNATIONAL MARKETS  
99 Church Street, New York, N. Y.

Please send me \_\_\_\_\_ copies of the molded plastic world map at \$15.00 each. You may bill me.

Print Your Name \_\_\_\_\_

Address \_\_\_\_\_

City \_\_\_\_\_

Zone \_\_\_\_\_

State \_\_\_\_\_

# RADIO - ELECTRONICS

Formerly RADIO CRAFT • Incorporating SHORT WAVE CRAFT • TELEVISION NEWS • RADIO & TELEVISION\*

Hugo Gernsback  
Editor and Publisher  
M. Harvey Gernsback,  
Editorial Director  
Fred Shunaman  
Managing Editor  
Robert F. Scott  
W2PWG, Technical Editor  
Jerome Kass  
Associate Editor  
I. Queen  
Editorial Associate  
Matthew Mandl  
Television Consultant  
Angie Pascale  
Editorial Production  
Wm. Lyon McLaughlin  
Tech. Illustration Director  
Sol Ehrlich  
Art Director

Lee Robinson  
General Manager  
John J. Lamson  
Sales Manager  
G. Aliquo  
Circulation Manager  
Adam J. Smith  
Director, Newsstand Sales  
Robert Fallath  
Promotion Manager  
Seymour Schwartz  
Advertising Production

## GERNSBACK PUBLICATIONS, INC.

Executive, Editorial and Advertising Offices, 25 West Broadway, New York 7, N. Y. Telephone REctor 2-8630.

Hugo Gernsback  
Chairman of the Board  
M. Harvey Gernsback  
President  
G. Aliquo  
Secretary

ON THE COVER (See page 64) The service technician shows how the units of the new Walsco printed-circuit TV receiver can be removed and replaced to make servicing speedier and cheaper. *Color original by Habershaw Studios*



## CONTENTS

### SPECIAL FULL-COLOR FEATURE:

Color Servicing.....by W. W. Cook and C. E. Lasswell 53

Editorial (Page 33)  
Universal TV Receiver.....by Hugo Gernsback 33

### Television (Pages 34-76)

What's Happening to U.H.F.?.....by David Lachenbruch 34

Color Circuitry in a 19" Receiver.....by Robert F. Scott 37

Miniature TV Antennas..... 39

Convergence in 3-Gun C-R Tubes.....by Leonard Lieberman 40

TV DX (January-March)..... 42

The Waves of Wireless (Poem).....by Lee de Forest 42

Transistorized Portable Receiver.....by G. B. Herzog and R. D. Lohman 43

Television and Electronics.....by Brig. Gen. David Sarnoff 46

Picture-Tube Replacement Guide.....by E. W. Scott 49

Joe Doaks—TV Repairman.....by Henry Farad 50

Color Servicing.....by W. W. Cook and C. E. Lasswell 53

What's the Dope on Color TV?..... 57

Top TV Reception in Isolated Areas.....by Edward M. Noll 58

Color TV Antenna Techniques.....by Ira Kamen 60

Television Underwater.....by Ralph W. Hallows 62

Printed-Circuit TV Chassis (Cover Story)..... 64

Color TV Circuits, Part VIII—Circuit tracing an experimental color TV receiver.....by Ken Kleidon and Phil Steinberg 65

Television—it's a Cinch (Fourteenth conversation, second half—Down with capacitors! direct coupling; restoring the d.c. components; the useful diode).....by E. Aisberg 68

New British Keyed A.G.C. Circuits..... 70

Machines Make TV Sets..... 71

Simple Graphical Solution for TV and FM Propagation Problems.....by C. F. Rockey 72

TV Service Clinic.....by Jerry Kass 74

TV Station List as of November 15, 1954..... 76

Test Instruments for TV (Pages 77-104)

Chromatic Probe.....by Robert G. Middleton 77

Rainbow Generator.....by Winston H. Starks 79

Versatile Wide-Band 5" Oscilloscope.....by Hugh Herring 83

Low-Frequency Sweep Generator Adapter.....by Richard Graham 99

Audio—High Fidelity (Pages 106-134)

The Missing Link in Speaker Operation, Part II—Obtaining variable damping factors.....by D. J. Tomcik 106

Servicing High-Fidelity Equipment, Part XI—AM and FM tuner distortion; de-emphasis and pre-emphasis; noise.....by Joseph Marshall 115

For Golden Ears Only—the Ampex 600 tape recorder; Karlson enclosure; Dubbing D-500 level indicator and test records; good recordings.....by Monitor 119

The Wurlitzer Electronic Organ, Part II—Tone coloring, the vibrato circuit.....By Richard H. Dorf 128

Electronics (Pages 136-138)

Light-Sensitive Neon-Tube Circuits.....by Joseph Braunbeck 136

DEPARTMENTS

Books .....182

Business .....170

Correspondence .....14

New Devices .....146

New Tubes and Transistors.....153

Patents .....161

People .....176

Question Box .....168

The Radio Month .....10

Radio-Electronic Circuits.....166

Technical Literature .....178

Technicians' News .....142

Technotes .....158

Try This One.....164

MEMBER Audit Bureau of Circulation

Average Paid Circulation over 180,000

Vol. XXVI, No. 1

RADIO-ELECTRONICS, January 1955, Vol. XXVI, No. 1. Published monthly at Mt. Morris, Illinois, by Gernsback Publications, Inc. Entered as Second Class matter June 23, 1954, at the Post Office at Mt. Morris, Ill. Copyright 1954 by Gernsback Publications, Inc. Text and illustrations must not be reproduced without permission of copyright owners. SUBSCRIPTIONS: Address correspondence to Radio-Electronics, Subscription Dept., 404 N. Wesley Ave., Mt. Morris, Ill., or 25 West Broadway, New York 7, N. Y. When ordering a change please furnish an address stencil impression from a recent wrapper. Allow one month for change of address. SUBSCRIPTION RATES: In U. S. and Canada, and in U. S. possessions, \$3.50 for one year; \$6.00 for two years; \$8.00 for three years; single copies 35c. All other foreign countries \$4.50 a year; \$8.00 for two years; \$11.00 for three years. BRANCH ADVERTISING OFFICES: Chicago: 7522 North Sheridan Road, Tel. Rogers Park 4-8000. Los Angeles: Ralph W. Harker and Associates, 1127 Wilshire Boulevard, Tel. MADison 6-1271. San Francisco: Ralph W. Harker and Associates, 582 Market St., Tel. GARfield 1-2481. FOREIGN AGENTS: Great Britain: Atlas Publishing and Distributing Co., Ltd., London E.C. 4. Australia: McGill's Agency, Melbourne. France: Brentano's, Paris 2e. Belgium: Agence et Messageries de la Presse, Brussels. Holland: Tricetron, Heemstede. Greece: International Book & News Agency, Athens. So. Africa: Central News Agency Ltd., Johannesburg; Capetown, Durban, Natal. Universal Book Agency, Johannesburg. Middle East: Steimatzky Middle East Agency, Jerusalem. India: Broadway News Centre, Dadar, Bombay #14. Pakistan: Paradise Book Stall, Karachi 3. POSTMASTER: If undeliverable send form 3573 to: RADIO-ELECTRONICS, 25 West Broadway, New York 7, N. Y. \*Trademark registered U.S. Patent Office.



## National Schools brings you a new dimension in training for **TELEVISION-RADIO-ELECTRONICS**

### YOU CAN LEARN BY HOME STUDY, IF—

- you are ambitious to increase your earning power.
- you want to broaden your knowledge and skill.
- you choose the school with the most complete training and service.

### 50 Years of Successful Training

National Schools has been training men for success since 1905. Our graduates are located around the globe, in good-paying jobs in servicing, installation and manufacturing... in public and private industry, or in their own businesses. All this experience and background are your assurance of success.

**What This New Dimension in Home Study Means to You**  
As a National Schools student, with Shop Method Home Training, you master *all phases* of the industry—TV, Radio, Electronics—theory and practice. You learn *HOW* and *WHY*, in one complete course at one low tuition.

Because National Schools' world headquarters are in Los Angeles—"capital city" of TV-Radio-Electronics—our staff is in close touch with industry. Our lessons and manuals are constantly revised to keep you up-to-the-minute on latest developments. We show you how to make spare time earnings as you learn, and we give you free placement assistance upon graduation. National Schools is approved for G. I. Training. Both Resident and Home Study courses are offered. If you are of draft age, our training helps you achieve specialized ratings and higher pay grades.

This *new dimension* enables us to train you as you should be trained at home, regardless of your age or previous education.

### Your Course Includes Valuable Units

We send you important equipment, including a commercial, pro-

fessional Multitester... plus parts to build Receivers, Oscillators, Signal Generator, Continuity Checker, other units, and Short Wave and Standard Broadcast Superhet Receiver.

### Mail Coupon for Complete Information

Get these two free books about this new dimension in Home Training. A comprehensive, illustrated fact-book and a sample National Schools lesson. No obligation, so mail coupon today.

**NATIONAL SCHOOLS**  
TECHNICAL TRADE TRAINING SINCE 1905  
Los Angeles 37, Calif. • Chicago: 323 W. Polk St.  
In Canada: 811 W. Hastings St., Vancouver, B.C.

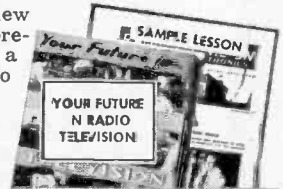

### MAIL NOW TO OFFICE NEAREST YOU!

(mail in envelope or paste on postal card)

### NATIONAL SCHOOLS, Dept. RG-15

4000 S. FIGUEROA STREET LOS ANGELES 37, CALIF., OR 323 W. POLK STREET CHICAGO 7, ILL.

Rush FREE BOOK, "Your Future in Radio-TV-Electronics," and FREE LESSON. No obligation, no salesman will call.

NAME \_\_\_\_\_ BIRTHDAY \_\_\_\_\_ 19 \_\_\_\_\_

ADDRESS \_\_\_\_\_

CITY \_\_\_\_\_ ZONE \_\_\_\_\_ STATE \_\_\_\_\_

Check if interested ONLY in Resident Training at Los Angeles.

VETERANS: Give date of discharge \_\_\_\_\_

# You can build a reputation on Tung-Sol® Quality

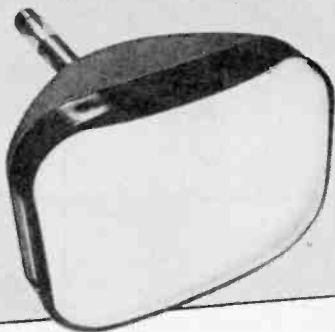

**TUNG-SOL** makes  
All-Glass Sealed Beam Lamps,  
Miniature Lamps,  
Signal Flashers,  
Picture Tubes, Radio, TV,  
Special Purpose Electron Tubes,  
Semiconductor Products.

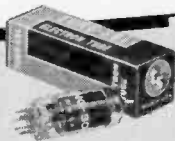

**TUNG-SOL ELECTRIC INC.**  
Newark 4, New Jersey

Sales Offices: Atlanta, Chicago, Columbus, Culver City (Los Angeles), Dallas, Denver, Detroit, Newark, Seattle

## the Radio month



**SOUNDORAMA**, a new idea in high-fidelity demonstrations took place during a concert of the National Symphony Orchestra in Constitution Hall, Washington, D. C., Nov. 13. The 90-man orchestra, under Conductor Howard Mitchell, played a selection which was simultaneously tape-recorded. As soon as the orchestra completed its performance, the recorded version was played back over an assembly of ten 50-watt amplifiers and ten three-way loud-speaker systems mounted on the stage

with the orchestra so that the audience of 4,000 could compare the original with modern high-fidelity reproduction. Standard high-fidelity components made for home use were employed in the demonstration.

The program was produced by Station WGMS, Washington, with the cooperation of Fisher Radio Corp., Jensen Manufacturing Co., and Berlant Associates to show how high-quality sound reproduction has progressed in recent years.



Principals in Soundorama concert. Left to right: B. Berlant, Berlant Associates; H. Mitchell, conductor; A. Fisher, Fisher Radio Corp.; K. Kramer, Jensen Mfg. Co.

**UNDERWATER TELEVISION** played a major role in the recovery of the recently wrecked jet airliner *Comet 1* near Elba. The British Government, investigating similar wrecks, assigned a ship of the Royal Navy to search for and recover as much of the airliner as possible.

Using special television cameras (see *Television Underwater*, page 62), the

area of the crash was probed and the remnants of the plane discovered. Guided by the television cameras, thousands of pieces of the plane were brought to the surface—in all, 70% of the recoverable weight. Some pieces were no bigger than a matchbox. Study of the recovered fragments indicated that metal fatigue had probably caused the crash.

**EUROPE TV REPORT** was given by E. A. Marx, director of the International Division of Du Mont Labs, upon his return from a fact-finding survey of the television situation in Europe. While stating that foreign TV does not compare in picture quality with that in the U.S., he singled out Italy and Germany as having set the pace in TV progress.

Marx stated that Italy has a chain of nine TV stations that runs from near

the Swiss border south to Rome, with plans under way to extend this network as far as Naples and to Sicily in the near future. Germany is rapidly expanding her television network with the continuous building of television stations. The Federal German Republic may soon have 28 TV stations.

Eurovision, the European television network which covers the Continent, has a bright future, in the opinion of

(Continued on page 10)

RADIO-ELECTRONICS

*Here, I am confident,  
is the finest Home  
training of its kind  
in Television, Radio,  
and Electronics.  
W. C. DeVry*



You get laboratory type **PRACTICAL EXPERIENCE** from your own **HOME LABORATORY**. Work over 300 projects.



You build and keep a **5-INCH OSCILLOSCOPE** and jewel bearing **MULTI-METER** Helps you **EARN** while learning.



Wonderfully effective, exclusive **HOME MOVIES** help you grasp important points faster, easier, better.

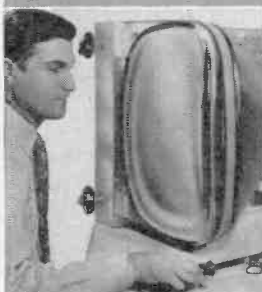

You may also build and keep a **21 INCH TV SET**. D.T.I. offers another home training without the TV set.



*"One of America's Foremost Television Training Centers"*

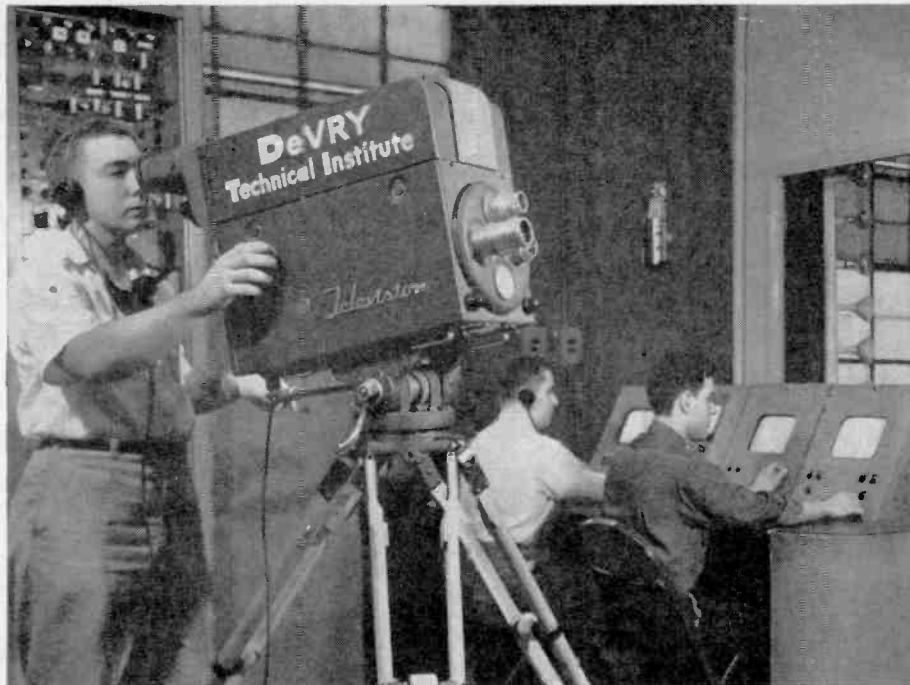

## Here is one of the most effective ways to OPEN THE DOOR to opportunity in TELEVISION - ELECTRONICS

Your future is the most important thing in your life! Give it every advantage you can. Find out about the wonderfully promising years facing YOU in America's great, billion dollar field of Television-Electronics . . . once you are properly trained.

And you can now get the very training industry wants, either by attending D.T.I.'s wonderfully equipped Chicago laboratories—one of the nation's finest—or by getting laboratory type training in your spare time at home.

Remember—you receive more than just home training from D.T.I. You get training that has profited from the knowledge and experience gained in preparing thousands of men in D.T.I.'s Chicago laboratories.

You get training that includes all of the wonderful features shown to the left. You learn-by-reading from lessons . . . you learn-by-seeing from D.T.I.'s exclusive, remarkably effective visual training MOVIES . . . you learn-by-doing from many shipments of electronic parts.

### EMPLOYMENT SERVICE

And upon completing either the Home Program or Chicago Laboratory Training, you get the SAME EFFECTIVE EMPLOYMENT SERVICE that has already helped thousands of men to a real job or their own profitable business in Television-Radio-Electronics.

Little wonder so many men express amazement at the results secured through D.T.I. There's NOTHING ELSE like it! See for yourself. Mail coupon today for the fascinating story about D.T.I. There's no obligation. The time to act about your future is . . . NOW!

The **DeVry Technical Institute**



4141 Belmont Avenue Chicago 41 Illinois

Affiliated with DeForest's Training, Inc.



Here, and above, are typical views in D.T.I.'s great Chicago training center—attended by many students from the United States, Canada and the Hawaiian Islands. These men come here to benefit from one of the finest, practical laboratory trainings, of its kind—not only in Television and Radio—but also in Industrial Electronics, Nuclear Instrumentation, and other highly promising branches of today's great, billion dollar Electronics field.



**DeVry Technical Institute**  
4141 Belmont Ave., Chicago 41, Ill., Dept. RE-I-L

I would like late facts about the many opportunities in Television-Radio-Electronics, and how D.T.I. can prepare me for my start in this billion dollar field.

Name \_\_\_\_\_ Age \_\_\_\_\_

Street \_\_\_\_\_ Apt. \_\_\_\_\_

City \_\_\_\_\_ Zone \_\_\_\_\_ State \_\_\_\_\_

*DTI's training is available in Canada*

# Depend on the COMPLETE line of ROHN

"SUPERIOR DESIGN" towers and accessories

for **LARGER PROFITS** **MORE SATISFACTION** **GREATER EASE IN HANDLING**

3 added towers to solve ALL your needs

also



## no. 6 tower

"All-Purpose" tower.

Fulfills 75% of your general tower needs—is structurally as sturdy—yet costs less than the well-known Rohn No. 10 Tower. Ideal for home and industrial installations, communication requirements... eliminates stocking many different tower models. Self-supporting to 50 ft. or guyed to 120 ft. Easy to climb for fast, efficient servicing. Utilizes "Magic Triangle" which insures far greater strength and stability. Permanent hot-dipped galvanized coating. Dependability—a feature customers demand—is assured with the Rohn No. 6 Tower... designed to "stand up" for years to the rigors of weather and climatic conditions.

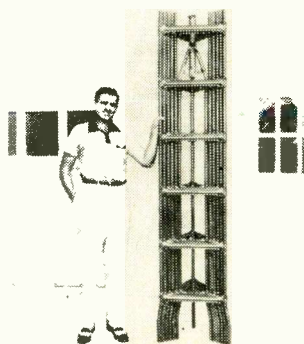

## Package Tower

"Space Saver"—cuts storage space 300% or more!

Popular PT-48 has almost 50' of sturdy tower within a compact 8' x 20" package! "Magic Triangle" design is adapted to a pyramid shape using a wide 19" base with progressively decreasing size upward. Decreases your overhead—easy to transport and assemble—cuts shipping costs. Galvanized throughout. Available in heights of 24, 32, 40, 48, 50 and 64 feet!



## no. 30 tower

Heights up to 200' or more when guyed  
Self-supporting up to 60'

Sturdy communication or TV tower that "stands up" to all the stresses of weather and climatic conditions... will withstand heavy wind and ice loading. Heavy gauge tubular steel, electrically welded throughout. Weather resistant, non-corrosive double coating provides durable finish. All sections in 10' lengths. Only 2-4 manhours required for installing 50' tower!

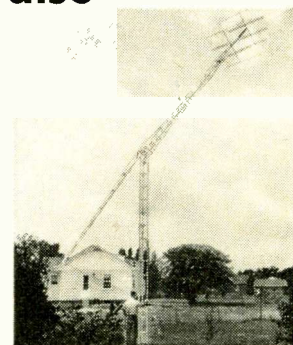

## ROHN Fold-over tower

For experimenters, TV service departments and retailers. Use this kit with regular Rohn tower sections. Simple and easy to use.

## ROHN Telescoping Masts

Heavy-duty hot-dipped galvanized steel tubing and rigid joints give extraordinary strength. Quick installation... mast attached to base—antenna fixed, then mast hoisted quickly to desired height. Utilizes special clamp and guy ring arrangement. Flanged interior section; crimped exterior section gives mast stability that can't be beat. Complete with guy rings and necessary erection parts. In 20, 30, 40 and 50 ft. sizes. Bases and ground mounts available.

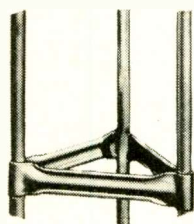

Both Towers Feature

### THE ROHN MAGIC TRIANGLE

For structural superiority, famed wrap-around "magic triangle" design is featured in these all-steel towers. Towers have full 2 1/2" wide corrugated cross-bracing welded to tubular steel legs. The exclusive design assures dependable strength and permanence.

and a complete line of ROHN accessories—all galvanized



### PEAK ROOF MOUNT

Heavy duty for quick, secure mounting of tower to top of peak roof. Flanges hinged, fastened to roof with 2 lag screws in each flange.

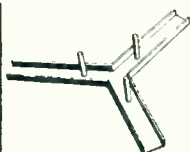

### FLAT ROOF MOUNT

For all types flat surfaces. 3-1" solid steel projections permit first section of tower to be mounted directly on roof mount by inserting usual 3/8" bolts.

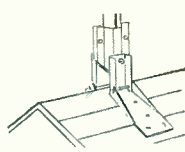

### MAST BASES

Complete line of telescoping mast bases for every requirement, accommodating masts from 1"-2 1/4" diameter. Also available—drive-in mast bases.

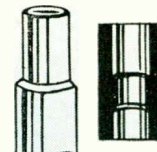

### MAST 'N' TV TUBING

Heavy-duty, hot-dipped galvanized steel tubing. Machined to perfection. Extra sturdy joints slotted for full, perfect coupling.

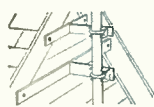

### PEAK and WALL MOUNTS

For mounting of mast or pole to roof or wall. Heavy-duty steel. Variable sizes. Models for most every need.

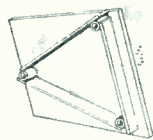

### DRIVE-IN BASE

Set on top of ground... 3-4" drive rods driven through base into ground. First tower section secured to rods with single bolt in each leg. Instant erection.



### SERVICE TABLE

Perfect answer for television servicing, display and storage. Truly one of the finest of its kind in economy price range.

### ALSO AVAILABLE

Rotator posts for mounting rotator to tower; House Brackets; Guying Brackets; UHF Side Arm Mounts; Mounts for Additional Antennae on a Tower; Erection Fixtures; Guy Rings; Installation Accessories; and dozens of other items!

For complete catalog and prices, see your authorized Rohn Representative or Distributor; or write or wire direct.

Designed and Manufactured Exclusively by **ROHN Manufacturing Company**

Dept. RE 116 Limestone, Bellevue Peoria, Illinois

RADIO-ELECTRONICS



LONG-PLAYING 33 $\frac{1}{3}$  R. P. M. HIGH-FIDELITY

# 8 MASTERPIECES \$1<sup>00</sup>

COMPLETE TO THE LAST NOTE!  
NOT \$1<sup>00</sup> EACH — — But \$1<sup>00</sup> FOR ALL EIGHT!



Long  
Playing

## NO STRINGS ATTACHED!

Without any obligation to ever buy another record from us—now or later—you can now obtain all the advantages of trial membership.

NOW YOU can get a real start on a complete record collection for only a dollar. Yes. You get ALL EIGHT of these great masterpieces—complete to the last note—for only \$1.00. Just imagine—NOT \$1 each, but \$1 for ALL EIGHT!

Of course, this price bears no relation to the value of the recordings. Even for TWENTY times that amount, you could not buy these masterpieces in recordings of equal quality.

### Why We Make This Amazing Offer

Actually we were FORCED to make this "give-away" offer . . . for two reasons: (1) Only by putting our recordings in your hands can we convince you how extraordinary their tonal quality is. Performed by internationally-renowned orchestras, conductors, and soloists. Custom-pressed on the purest vinyl plastic. Reproduced with a fidelity of tone which encompasses the entire range of human hearing . . . 50 to 15,000 cycles!

(2) We want to show you how our new trial membership plan works. As a trial member, you are not obligated to buy any other recordings from us—now or later! You do, however, have the right to try—free of charge—any of the Society's monthly selections which interest you. You receive prior notice of these. You pay nothing in advance. And you are not obligated to keep those you try . . . even after you have played them and read the interesting music notes which accompany each selection. You pay only for those which—after having tried them—you decide you really want to own. And for these, you pay only the low member's price of \$1.50 per long-playing disc, embodying on the average about 40 minutes of music by the great masters. A saving of about 2/3 off the usual retail price!

### There Shall Be Music In Your Home

Think how much beauty and serenity these recordings will add to your life—at a trifling cost. Think how they will set your family apart as one interested in the better things of life. Think what a cultural advantage your children will gain by having great music as an everyday inspiration.

### Mail Coupon Now

Of course, we cannot keep "handing out" such magnificent long-playing recordings indefinitely. Once our membership rolls are filled—and they are limited by our production capacity—the offer will have to be withdrawn. So avoid disappointment. Rush coupon with a dollar today.

The Musical Masterpiece Society, Inc.  
Dept. 521, 43 West 61st Street  
New York 23, N. Y.

### Internationally Acclaimed!

"The recording is of such perfection it seems to bring the artists into your living room"

—Glorious Sounds, Amsterdam, Holland.

"The discs can be recommended without reservation to record lovers"

—The Action, Zurich, Switzerland.

"Excellent series of records"

—The Saturday Review, New York

"The beautiful reproduction is a great merit of the Society"

—The Evening Post, Frankfurt, W. Germany.

"Uncommonly fine, even for these days of technical advancement"

—Los Angeles Examiner, Calif.

## SCHUBERT

Symphony No. 8 (The "Unfinished"),  
Zurich Tonhalle Orch., Otto Ackermann, Conducting

## BEETHOVEN

The Ruins of Athens (March and Choir),  
Netherlands Philharmonic Choir and Orch.,  
Walter Goehr, Conducting

## BRAHMS

Academic Festival Overture,  
Utrecht Symphony, Paul Hupperts, Conducting

## MOZART

Piano Concerto in E Flat, K 107  
Artur Balsam, piano, Winterthur Symphony Orch.,  
Otto Ackermann, Conducting

## BACH

Tocatta and Fugue in D Minor,  
Alexander Schreiner at the Organ of the Tabernacle  
Salt Lake City

## WAGNER

Die Meistersinger, Prelude, Act 1  
Zurich Tonhalle Orch., Otto Ackermann, Conducting

## DUKAS

Sorcerer's Apprentice  
Utrecht Symphony, Paul Hupperts, Conducting

## MOUSSORGSKY

Night on Bald Mountain  
Netherlands Philharmonic, Walter Goehr, Conducting

The Musical Masterpiece Society, Inc.  
Dept. 521, 43 W. 61st St., New York 23, N. Y.

### ALL EIGHT FOR \$1.00

BRAHMS  
Academic Festival Overture

WAGNER  
Die Meistersinger, Prelude,  
Act 1

SCHUBERT  
Symphony No. 8

MOZART  
Piano Concerto in E Flat

DUKAS  
Sorcerer's Apprentice

MOUSSORGSKY  
Night on Bald Mountain

BEETHOVEN  
"Ruins of Athens"  
(march, choir)

BACH  
Tocatta and Fugue in D Minor

I enclose \$1.00 as complete payment; please send me the recordings of the eight great masterpieces listed above. Also enroll me as a Trial Member.  
I am not obligated to buy any other recordings from the Society. I may receive an advance description of future monthly selections. I may try any of these—free of charge—without paying a penny in advance. I may reject any recording before or after I receive it. And I may cancel my trial membership at any time.  
In the future, for each selection I decide to keep—I will pay special member's price of only \$1.50 plus few cents shipping charges . . . a saving of 2/3 off the usual retail price!

Name.....

Address.....Zone.....State.....

City.....

IN CANADA address: 686 Bathurst St., Toronto 4, Ont. 521

## Engineering

# WRITERS

**ENGINEERS, E. E. or PHYSICS GRADUATES, for preparation of technical manuals...**

HUGHES RESEARCH AND DEVELOPMENT LABORATORIES' expanding program for production of radar, electronic digital computers, guided missiles and other military advanced electronic systems and devices requires the following:

**1 ELECTRICAL ENGINEERING AND PHYSICS GRADUATES** to prepare operating, servicing and overhauling instructions for complex electronic equipment. Those with previous maintenance experience on military equipment preferred. Writers will participate in a three-month program in our technical training school to become familiar with the latest Hughes equipment prior to writing assignments.

**2 ENGINEERS EXPERIENCED** in the writing and preparation of maintenance manuals for electronic equipment or guided missiles. These specialists will work step-by-step with the people designing, developing and manufacturing the products involved. Experience in the writing of engineering reports is of value.

### HOW TO APPLY

Write full details of your qualifications to

## HUGHES

Research and Development Laboratories

SCIENTIFIC AND ENGINEERING STAFF  
Culver City, Los Angeles County  
California

Assurance is required that relocation of the applicant will not cause disruption of an urgent military project.

## THE RADIO MONTH

Mr. Marx. He said that telecasts of international football (soccer) games have caused a sensation. Under this setup, when such programs are broadcast, TV interpreters in each individual country take over and act as announcers.

**FIRST CONTEMPT PROSECUTION** in the Government's get-tough policy against illegal r.f. heat-generating equipment was enforced against a plastics manufacturer in New York City. The violator was sentenced to a 30-day jail term because he failed to heed warnings that his equipment was interfering with a confidential military radio channel. Assistant U. S. Attorney Robert Sweet said that this, being the first, was a test case.

According to Arthur Batcheller, FCC engineer, under FCC regulations such industrial devices must be kept within frequency channels centering on 13.56, 27.12, 40.68 and 2,450 mc.

**ELECTRONIC IRONY** and shades of Frankenstein fell upon Sir Robert Watson-Watt recently. The noted radar pioneer was fined \$12.50 by Kingston, Ontario, authorities, for speeding. The police had clocked Sir Robert's car—with radar!

**THEATER COLOR** TV projection system was demonstrated recently at the 76th semiannual convention of the Society of Motion Picture and Television Engineers held in Los Angeles. The new system projects color pictures 15 by 20 feet with—according to RCA—good resolution and brightness. The highlight brightness is approximately 5 foot-lamberts on an embossed aluminized screen. The system can also be used for monochrome projection.

**TWO BILLION DOLLARS'** worth of television service annually may be expected in this country before 1959, stated Harold J. Schulman, CBS-Columbia service director, at a recent radio-TV technicians' meeting in Atlanta, Ga. The prediction was based on the estimate that there would be more than 44,000,000 black-and-white and 18,000,000 color receivers in use by 1959.

Not only the increased number of receivers, but their greater complexity, will increase the amount of service work. Color receivers, Mr. Schulman believes, will require an average of six calls per year, as compared to two for monochrome sets.

The talk was the main event of the Atlanta Radio and Television Association's regular monthly meeting. W. A. Steed, president of the association, introduced Mr. Schulman to the meeting, held at Jackson Electronic Supply Co.

**ULTRASONICS** are being used to reduce pain and relax muscle spasm in arthritis patients and help arthritic cripples to walk.

(Continued)

At a meeting of the American Institute of Ultrasonics in Medicine, Capt. Edward P. Reese of the Army and Navy Hospital, Hot Springs, Ark., said he was "quite disinterested and pessimistic" when asked to start a study of ultrasonic treatment of arthritis because so many drugs, hormones and other treatments for arthritis had proved disappointing after first being hailed enthusiastically. But after a short experience with ultrasonics, he thinks that it "may prove to be one of the greatest advancements in the treatment of arthritis."

(Further reference to ultrasonics in medicine can be found in "IRE Shows Electronic Progress," in the June, 1954, issue of RADIO-ELECTRONICS.)

**RADIO PIONEERS**, at a recent dinner meeting in New York City, presented citations to Raymond A. Heising "for a noteworthy radio career of 44 years and his invention of the system of modulation used in almost every standard broadcasting station in the world" and Lloyd Espenschied "for his brilliant 45-year radio career which included pioneering development of systems of voice communication and the coaxial cable." Dr. Heising and Mr. Espenschied were engineers with Bell Labs for many years before they retired.

**SUBWAY TRAIN** communications have been demonstrated successfully in a station-to-moving-train hookup. New York City's vast rapid-transit system may soon adopt this communication system wherein existing signal cables and the third, or power, rail are used to transmit frequency modulated carrier waves.

In the test, a dispatcher at New York's Times Square station spoke to a representative of the Union Switch and Signal Division of the Westinghouse Air Brake Co., installer of the apparatus, who was aboard the train. Those hearing the demonstration were impressed by the clearness of sound, lack of static and continuous operation, even while the train was crossing switches.

**SURPLUS RADAR** equipment might save coastal cities thousands of dollars—as well as many lives—by spotting approaching hurricanes, according to I. R. Tannehill of the United States Weather Bureau. He pointed out that some Midwestern cities now have their own radar equipment for tornado searching.

A used radar can be converted to a storm spotter for about \$10,000, said Mr. Tannehill. It would cost about \$200,000 to buy a new one. While they would not supersede the regular Weather Bureau service, since they could not detect a storm more than about 200 miles away, they could tell exactly where it was and where it was headed, once it came within range of the radar.

END

Let me send you FREE  
the entire story

Just fill out the coupon and mail it. I will send you, free of charge, a copy of "How to Pass FCC License Exams," plus a sample FCC-type Exam, and the amazing new booklet, "Money-Making FCC License Information."



CARL E. SMITH, E.E.  
President

I can train you to pass your FCC License Exams in a minimum of time if you've had any practical radio experience — amateur, Army, Navy, radio servicing, or other. My time-proven plan can help put you, too, on the road to success.

# How to Pass FCC

COMMERCIAL  
Radio Operator

# License Exams

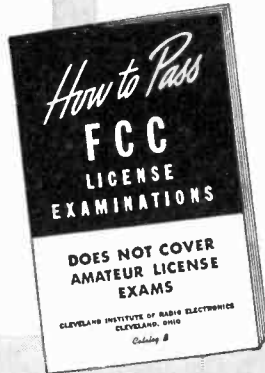

FREE

Tells where to apply and take FCC examinations, location of examining office, scope of knowledge required, approved way to prepare for FCC examinations, positive method of checking your knowledge before taking the examination.

GET YOUR FCC TICKET IN A MINIMUM OF TIME

## Get this Amazing Booklet FREE



TELLS HOW

### HERE IS YOUR GUARANTEE

If you fail to pass your Commercial License exam after completing our course, we guarantee to continue your training without additional cost of any kind, until you successfully obtain your Commercial license, provided you first sit for this examination within 90 days after completing our course.

WE GUARANTEE

TO TRAIN AND COACH YOU AT HOME IN SPARE TIME UNTIL YOU GET

YOUR FCC LICENSE

If you have had any practical experience—Amateur, Army, Navv, radio repair, or experimenting

Employers make

TELLS HOW

### JOB OFFERS Like These to Our Graduates Every Month

Letter from nationally-known Airlines:

"Radio Operators and Radio Mechanics are needed for our company. Periodic wage increase with opportunity for advancement. Both positions include many company benefits such as paid vacations, free flight mileage allowance and group insurance."

These are just a few examples of the job offers that come to our office periodically. Some licensed radiomen filled each of these jobs . . . it might have been you!

Letter from nationally-known manufacturer:

"We have a very great need at the present time for radio-electronics technicians and would appreciate any helpful suggestions that you may be able to offer."

### HERE'S PROOF FCC LICENSES Are OFTEN SECURED IN A FEW HOURS OF STUDY WITH OUR COACHING at HOME in SPARE TIME

Name and Address	License	Time
Harry G. Frame, Box 429, Charleston, W. Va.	2nd Class	13 Weeks
Charles Ellis, Box 449, Charles City, Iowa	1st Class	28 Weeks
Omar Bibbs, 1320 E. 27th St., Kansas City, Mo.	1st Class	34 Weeks
Kenneth Rue, Dresser, Wisconsin	2nd Class	20 Weeks
B. L. Jordan, Seattle, Washington	1st Class	20 Weeks

TELLS HOW

### Our Amazingly Effective JOB-FINDING SERVICE

Helps CIRE Students Get Better Jobs

Here are a few recent examples of Job-Finding results

**GETS FIVE JOB-OFFERS FROM BROADCAST STATIONS**  
"Your 'Chief Engineer's Bulletin' is a grand way of obtaining employment for your graduates who have obtained their 1st class license. Since my name has been on the list I have received calls or letters from five stations in the southern states, and am now employed as Transmitting Engineer at WMMT."  
Elmer Powell, Box 274, Sparta, Tenn.

**GETS CIVIL SERVICE JOB**  
"I have obtained a position at Wright-Patterson Air Force Base, Dayton, Ohio, as Junior Electronic Equipment Repairman. The Employment Application you prepared for me had a lot to do with my landing this desirable position."  
Charles E. Loomis, 4516 Genesee Ave., Dayton 6, Ohio.

OURS IS THE ONLY HOME STUDY COURSE WHICH SUPPLIES FCC-TYPE EXAMINATIONS WITH ALL LES-SONS AND FINAL TESTS.

**GETS AIRLINES JOB**  
"Due to your Job-Finding Service, I have been getting many offers from all over the country, and have taken a job with Capital Airlines in Chicago, as Radio Mechanic."  
Harry Clare, 4537 S. Drexel Blvd., Chicago, Ill.

Your FCC ticket is recognized by most employers in the electronic field as proof of your technical ability.

Get All 3 FREE

MAIL COUPON NOW

CLEVELAND INSTITUTE OF RADIO ELECTRONICS

Desk RE-72

4900 Euclid Bldg., Cleveland 3, Ohio  
(Address to Desk No. to avoid delay)

I want to know how I can get my FCC ticket in a minimum of time. Send me your FREE booklet, "How to Pass FCC License Examinations" (does not cover exams for Amateur License), as well as a Sample FCC-type exam and the amazing new booklet, "Money-Making FCC License Information." Be sure to tell me about your Television Engineering Course. Special tuition rates to members of the U. S. Armed Forces

NAME \_\_\_\_\_

ADDRESS \_\_\_\_\_

CITY \_\_\_\_\_ ZONE \_\_\_\_\_ STATE \_\_\_\_\_

FOR PROMPT RESULTS SEND AIR MAIL

CLEVELAND INSTITUTE OF RADIO ELECTRONICS

CARL E. SMITH, E. E., Consulting Engineer, President  
Desk RE-72 — 4900 Euclid Bldg., Cleveland 3, Ohio

NEW  
MERIT FLYBACKS  
GIVE YOU

# exact replacement FOR 1,252 tv set models

MANUFACTURED BY

HVO-15  
PHILCO



HVO-21  
PHILCO



HVO-24  
ADMIRAL



The only transformer line designed exclusively for service—Merit since 1947 has made available to you a complete line of exact replacement transformers.

Merit's 3 plants are geared to supply your TV transformer needs when you need them—on the spot for black and white and color with exact or universal replacement flybacks.

**CROSLEY**  
**Admiral**



**Firestone**  
**SYLVANIA**

**hallicrafters**



**RCA**

**PHILCO**

**Emerson**

**MUNTZ**



**SILVERTONE**

**Motorola**

# MERIT

**MERIT COIL & TRANSFORMER CO.**

4427 N. Clark Street • Chicago 40, Illinois

Ask your jobber, or write for, your copy of Merit 1955 Replacement Guide #407 listing up-to-date replacement components for all models and chassis of TV receivers.

# HIGH-FIDELITY MUSIC-APPRECIATION RECORDS

TO HELP YOU UNDERSTAND MUSIC BETTER AND ENJOY IT MORE



**ON ONE SIDE** there is a full performance of a great musical work, featuring orchestras and soloists of recognized distinction in this country and abroad. You listen to this performance first, or afterward, as you desire, and then . . .



**ON THE OTHER SIDE** is an illuminating analysis of the music, with the themes and other main features of the work played separately with running explanatory comment, so that you can learn *what to listen for*.

## A NEW IDEA OF THE BOOK-OF-THE-MONTH CLUB

**A**LL TOO FREQUENTLY, most of us are aware, we do not listen to good music with due understanding and appreciation. There is no doubt about the reason: we are not properly primed about *what to listen for*. MUSIC-APPRECIATION RECORDS meet this need—for a fuller understanding of music—better than any means ever devised. After hearing several of these records, all the music you listen to is transformed, because you learn in general what to listen for. This highly enjoyable form of self-education can be as thorough as the Music-Appreciation courses given in any university.

**YOU SUBSCRIBE BUT TAKE ONLY THE RECORDS YOU WANT . . .** A new MUSIC-APPRECIATION RECORD will be issued—for subscribers only—every month. Ultimately

all the great masterpieces of music will be included. The announcement about each forthcoming record will be written by Deems Taylor. After reading this descriptive essay (presented in a form that can be kept for long use) you may take the record or not, as you decide at the time. *You are not obligated as a subscriber to take any specified number of records.* And, of course, you may stop the subscription at your pleasure—at any time!

**TWO TYPES OF RECORDS AT A RELATIVELY LOW COST . . .** All MUSIC-APPRECIATION RECORDS will be high-fidelity, long-playing records of the highest quality—33 $\frac{1}{3}$  R.P.M. on Vinylite. They will be of two kinds: first, a so-called Standard Record—a *twelve-inch* disc—which will present the performance on one side, the analysis

on the other. This will be sold at \$3.60, to subscribers only. The other will be an Analysis-Only Record—a *ten-inch* disc—priced at \$2.40. The latter will be made available each month for any subscriber who may already have a satisfactory long-playing record of the work being presented. (A small charge will be added to the prices above to cover postage and handling.)

**TRY A ONE-MONTH SUBSCRIPTION — NO OBLIGATION TO CONTINUE . . .** Why not make a simple trial, to see if these records are as pleasurable and as enlightening as you may anticipate? The first record, BEETHOVEN'S FIFTH SYMPHONY, will be sent to you at once—at *no charge*. You may end the subscription immediately after hearing this record, or you may cancel any time thereafter.

*As a demonstration*  
**WILL YOU ACCEPT  
WITHOUT CHARGE**



## Beethoven's Fifth Symphony

A NEW HIGH-FIDELITY RECORDING BY THE LONDON SYMPHONY ORCHESTRA

Norman Del Mar, *Conductor*

Analysis by Thomas Scherman

**Y**OU HAVE HEARD this great work countless times—what have you heard in it? And what may you have failed to hear? This demonstration will show you what you may have been missing in listening to great music.

PLEASE RETURN ONLY IF YOU HAVE A RECORD PLAYER WHICH CAN PLAY 33 $\frac{1}{3}$  R.P.M. LONG-PLAYING RECORDS

MUSIC-APPRECIATION RECORDS

R39-1

c/o Book-of-the-Month Club, Inc.  
345 Hudson Street, New York 14, N. Y.

Please send me at once the first MUSIC-APPRECIATION RECORD, Beethoven's Fifth Symphony, without charge, and enter my name in a Trial Subscription to MUSIC-APPRECIATION RECORDS, under the conditions stated above. It is understood that, as a subscriber, I am not obligated to buy any specified number of records, but may take only those I want. Also, I may cancel this subscription after hearing the first record, or any time thereafter at my pleasure, but the introductory record is free in any case.

Mr. }  
Mrs. } ..... (Please Print)  
Miss }  
Address .....  
City..... Zone..... State.....

MAR 1

for **ALL METERS**  
**ALL RANGES**



Complete with plug-in resistors for any range, any meter

Make safe, accurate high-voltage measurements with any voltmeter, multi-meter, or VTVM having sensitivities of 10,000 ohms-per-volt or more.

The new Boland & Boyce Universal High-Voltage Probe can be used with different instruments for dozens of ranges . . . and it is safe and easy to use in the bargain. Complete with 4 plug-in precision resistors and instructions for matching virtually any meter . . . any range—10KV, 30KV, 60KV, and intermediate ranges. Clear, high-dielectric handle shows resistors in use. Includes shielded cable with Amphenol connectors. B&B MODEL 702 HV PROBE—\$12.95 net.

### TEST C-R TUBES & CIRCUITS under receiver's own power

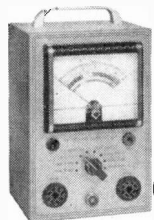

Measure both TV picture tube or receiver performance in one all-inclusive test! Two cabled leads of B&B C-R Tube Tester connect between tube and receiver.

8-position switch tests: grid-cathode, heater-cathode, and grid-screen leakage; grid cathode voltages; receiver screen and video output voltages; beam current at HV anode; grid control of beam; effect of brightness and contrast controls; and much more.

Instantly isolates tube or receiver faults. Separate plug-in power supply available for in-carton tube testing. Prices include 2 cabled leads and instruction manual, KIT—\$29.95. FACTORY WIRED & TESTED—\$39.95. Sold by leading distributors.

### New! B&B Model 704 BIAS BOX

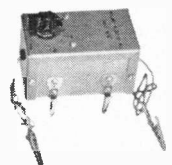

An exact, steady source of d-c bias voltage, 0 to 17 volts. A "must" for radio and TV realignment. Clips and grounds to chassis apron; connects to nearest 6.3-V heater voltage terminal. Kit only \$6.95. Assembled, wired and tested, \$9.95.

Write for brochure describing B&B products.

**BOLAND & BOYCE, Inc.**  
Dept RE-15, 236 Washington Avenue  
Belleville 9, N. J.

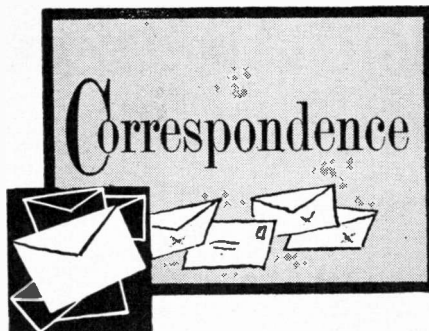

### IS IT THAT TOUGH?

Dear Editor:

I was very much interested in C. F. Mahler Jr.'s article on "Tough U.H.F. Installations" appearing in the October issue.

Since the beginning of u.h.f. I have been amused by the fantastic stories that have come out of Portland, Ore. I have made hundreds of u.h.f. installations in seven states and have yet to install an antenna in a man's front yard, on a fence post, outhouse or 7½ inches off the ground.

Having been indoctrinated by the Portland stories, I once installed a bowtie on the eaves of a house. Some time later a new occupant moved in. Passing the house one day, I was mortified to find a u.h.f. antenna sitting squarely on the roof where it should have been in the first place.

Mr. Mahler's statement concerning the uselessness of a field-strength meter gives me a clue as to why there are so many unorthodox installations out there. I have found this instrument extremely useful in u.h.f. work—especially in determining the practicality of stacked arrays. The meter will indicate whether or not you have something to work with.

HAROLD DAVIS

Jackson, Miss.

### JUST A FEW GRIPES

Dear Editor:

I have been a service technician for 25 years. During that time I have accumulated a few things I would like to get off my chest. Though I read many trade publications, I am writing to RADIO-ELECTRONICS because I consider Mr. Gernsback one of the leaders in the radio and television fields and a man who has done a great deal for the betterment of the service technician.

I have read numerous articles on servicing, especially servicing in the home, written by so-called experts. I think a few weeks' work in the field, servicing in the average customer's home, will alter their opinions.

When making repairs in the home, what customer will pay you for your years of experience and ability in trouble shooting and rapid diagnosis, when the defective component costs 18 cents? It is logical that in practically all cases where more than tubes are involved in a defect, the set has to be pulled for shop repair. And I am not even considering the strong possi-

(Continued on page 18)

now you can really  
**understand**  
**COLOR TV!**

get the new SAMS book

**"Fundamentals of Color Television"**  
by  
**BOYCE**

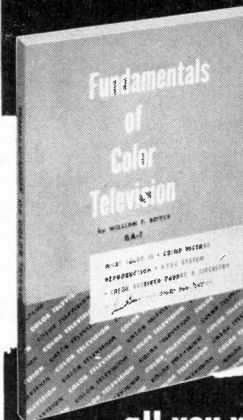

written so  
you can  
**UNDERSTAND IT**  
ONLY  
**\$2.00**

all you want to know  
in five great chapters:

**CHAPT. 1: "What You Need to Know About Color."**

A simple description of color, its relationship to the eye, its application in Color TV; explains terms: hue, saturation, mixtures, purity, chromatic, achromatic, luminosity, etc.

**CHAPT. 2: "Color Picture Reproduction."** Covers physical aspect of color reproduction in the picture tube; tube structures and exact physical functioning in all major color tube types.

**CHAPT. 3: "Principles of NTSC Color System."** Complete description of Color TV signal; compatibility requirements; integration of color and sound; methods of transmission and reception.

**CHAPT. 4: "Color Receivers."** Covers theory of operation of various receiver systems using any of the color picture tubes, in block diagram analysis form.

**CHAPT. 5: "Circuit Analysis of Color Receivers."** Covers every circuit in detail; gives practical information on special components associated with color; all text supported by photos, block diagrams and schematics.

Prepare for Color TV with the help of this complete, easy-to-understand up-to-date book. 224 pages. 5½ x 8½".

ORDER BA-1 **\$2.00**  
Only

**ORDER TODAY**

**HOWARD W. SAMS & CO., INC.**

Order from your Parts Jobber today, or write to Howard W. Sams & Co., Inc., 2205 East 46th St., Indianapolis 5, Ind.

My (check) (money order) for \$..... enclosed. Send.....copy(ies) of "Fundamentals of Color Television" (BA-1, \$2.00)

Name.....

Address.....

City.....Zone....State....  
(outside U.S.A. priced slightly higher)

# FREE

## 1955 ALLIED 308-PAGE CATALOG

the only COMPLETE catalog  
for everything in TV, Radio  
and Industrial Electronics

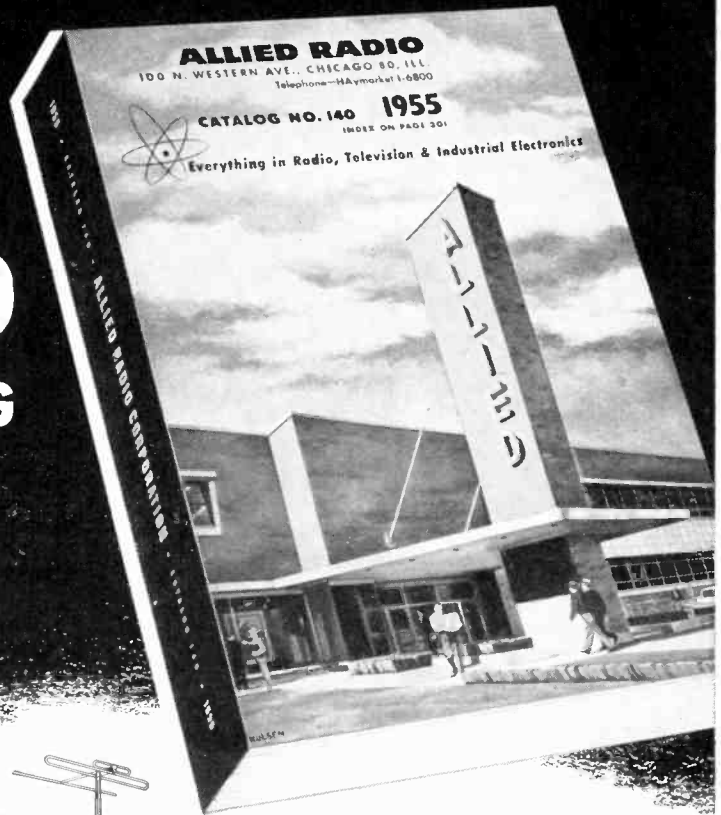

### World's largest Stocks

- All TV and Radio Parts
- All Electron Tube Types
- Test and Lab Instruments
- High Fidelity Equipment
- Custom TV Chassis
- AM, FM Receiving Equipment
- Recorders and Supplies
- P.A. Systems, Accessories
- Amateur Station Gear
- Builders' Kits, Supplies
- Equipment for Industry



ultra-modern facilities for the

**FASTEST SERVICE IN ELECTRONIC SUPPLY**

### SEND FOR IT TODAY!

Get ALLIED'S 1955 Catalog—308 pages packed with the world's largest selection of quality electronic equipment at lowest, money-saving prices. Select from the latest in High Fidelity systems and components; custom TV chassis, TV antennas and accessories; AM and FM receiving equipment; P. A. systems and accessories; recorders and supplies; Amateur receivers, transmitters and station gear; specialized industrial electronic equipment; test instruments; builders' kits; huge listings of parts, tubes, tools, books—the world's *most complete* stocks of quality equipment. ALLIED gives you *every* buying advantage: fastest shipment, expert personal help, lowest prices, assured satisfaction. Get the big 1955 ALLIED Catalog. Keep it handy. Send for your FREE copy today.

### IT'S VALUE PACKED... SAVE ON EVERYTHING IN ELECTRONICS

### SEND FOR THE LEADING ELECTRONIC SUPPLY GUIDE

FREE



### ALLIED RADIO world's largest Electronic Supply House

#### EASY-PAY TERMS

Use ALLIED'S liberal Easy Payment Plan—only 10% down, 12 months to pay—no carrying charges if you pay in 60 days. Available on Hi-Fi and P.A. units, recorders, TV chassis, test instruments, Amateur gear, etc.

#### HI-FI SPECIALISTS

To keep up with the latest and best in High Fidelity, look to ALLIED. Count on us for all the latest releases and largest stocks of Hi-Fi equipment. We specialize, too, in TV supply, and are foremost in the field of Builders' Kits.

ALLIED RADIO CORP., Dept. 2-A-5  
100 N. Western Ave., Chicago 80, Illinois

Send FREE 308-Page 1955 ALLIED Catalog.

Name \_\_\_\_\_

Address \_\_\_\_\_

City \_\_\_\_\_ Zone \_\_\_\_\_ State \_\_\_\_\_

**"Everywhere! Even in the most extreme fringe areas, the sensational Winegard Interceptors are providing clear, enjoyable TV pictures."**

Wilmington, Del.  
 "First shipment of Interceptors and Pixies enthusiastically acclaimed by our dealers. Advertising claims well founded. Pixie will outperform a stacked conical . . . oftentimes at a much lower height. Interceptor better than anything we have run up against including large colinear arrays."  
**DELAWARE ELECTRONICS SUPPLY CO.**

Reports like these from across the nation are pouring in, testifying to the exceptional performance of our antennas

**A great new antenna that gives you both**

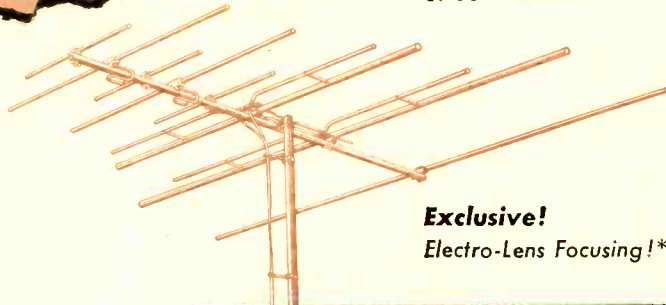

**Exclusive!**  
 Electro-Lens Focusing!\*

1. Complete all-channel VHF coverage—
2. Brilliant yagi performance—  
 Yes, the extraordinary high gain of a yagi . . . The pin-point directivity of a yagi . . . Not on just one channel—not on just one band—but clear across the whole VHF spectrum.

**The Interceptor is designed for both black and white and color**

The same Interceptor that gives you those sharp, clear black and white pictures today will give you the truest, brightest color pictures imaginable in the future.

**NOTE**—The Interceptor has been received so enthusiastically . . . all over the country . . . that the Winegard Company, even with around the clock production in its brand new plant, can't seem to make *Interceptors* fast enough. Twice this season production has been actually doubled over what was originally planned, and still we are experiencing difficulty in keeping up with this tremendous demand. So, get your order in now—and avoid disappointment on delivery.

List price U.S.A. . . . Interceptor . . . per bay . . . **\$24<sup>95</sup>**  
 (Stacking bars available)

**AND NOW up to 22% more gain! Super 'Ceptor**  
 (Super Interceptor)

A NEW, more powerful version of our famous Winegard Interceptor—Now—makes it possible to have multi-element yagi performance on all channels in the most extreme fringe areas.

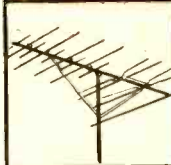

The Super 'Ceptor possesses all of the wonderful features of the Interceptor, but with much increased sensitivity . . . up to 22% more gain over the standard Interceptor model.

**Features of the Interceptor and Super 'Ceptor**

- Excellent 300 ohm impedance match over the entire VHF range.
- Extremely narrow yagi type forward lobes, with no side lobes and negligible rear lobes.
- Single lead . . . no switching . . . no interaction between the high channel elements and the low band elements.

**The New Winegard Super 'Ceptor**  
 (Super Interceptor)  
 With Electro-Lens Focusing!\*

Gives you—multi-element yagi performance, not on one channel . . . not on one band . . . but on every single channel in the whole VHF spectrum!

List price U.S.A. . . . Super 'Ceptor . . . per bay **\$34<sup>95</sup>**  
 (Stacking bars available)

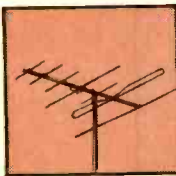

**IMP**—Model L-7 for channels 7-13. On the high VHF band, the IMP functions as two high gain yagi—operating side by side in perfect phase, to give gain and directivity far in excess of more conventional 7-13 broad band designs.

**Imp Features:**

- Exceptionally high gain on channels 7-13.
- Full wave driven elements.
- Full wave reflector elements.
- Electro-Lens Focusing.\*

**Note**—the IMP makes the perfect all-channel attic antenna for *all* channels in primary areas.

List price U.S.A. . . . Imp . . . per bay . . . **\$12<sup>95</sup>**  
 (Stacking bars available)

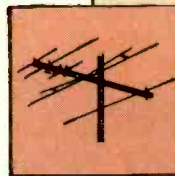

**THE PIXIE**

Top all channel performance—at a low price—featuring unique improved conical type driven element—for high gain and uni-lobe directivity.

List price U.S.A. . . . PIXIE . . . per bay **\$14<sup>95</sup>**  
 (Stacking bars available)

\*PATENT PENDING

See your jobber or write us for additional information about the Interceptor and other Winegard antennas



**WINEGARD COMPANY**

3000 SCOTTEN BOULEVARD, BURLINGTON, IOWA

Winegard—America's most wanted line of TV antennas—designed to make installations quicker—easier—and more profitable



*Don't improvise...*



# RTV-ize!

**FOR FAST, SURE, ECONOMICAL CONTROL REPLACEMENTS**

As easy as using the 'phone book. As sure as if you looked up the original specs of that chassis. All because Clarostat engineers, responsible for the majority of TV controls in use, have compiled the replacement data available to you in the **Clarostat TV Control Replacement Manual** and the **Supplementary Sheets**.

Listings are by set-manufacturer's model and chassis, part number, Clarostat catalog number, function and description. Cross references, too.



← **New 275-page Second Edition.**

**Supplementary sheets available from your distributor.** →



← **RTV replacements available when Standard types won't do.**

→ **Standard types, especially field-assembled "Pick-A-Shaft" and "Ad-a-Switch" controls.**



The 275-page **Clarostat TV Control Replacement Manual** (2nd Edition) and **Supplementary Sheets** to this Manual provide you with our latest TV control-replacement data. Ask your distributor for the **Manual** and **Supplementary Sheets**.

\* Trade Mark



## CONTROLS AND RESISTORS

CLAROSTAT MFG. CO., INC., DOVER, NEW HAMPSHIRE  
In Canada: Canadian Marconi Co., Ltd., Toronto, Ontario

# WHOA, Mr. Serviceman!

## DON'T JUST REPLACE— MODERNIZE

with wide-range, high-compliance

# SONOTONE

## TITONE CERAMIC CARTRIDGES



Always install a Sonotone, the original ceramic cartridge—your customers will love you for it. It will start them on the road to high-fidelity—and additional new business for you!

**Write for free Sonotone manual today!**

New Sonotone Phonograph Modernization Manual includes an up-to-date cross reference and phonograph model index, fully explains how to use Sonotone Ceramic Cartridges. Send coupon below for your free copy, now!

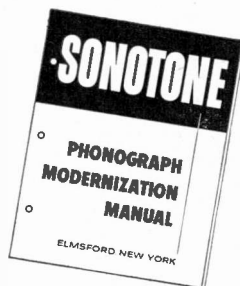

ELECTRONIC APPLICATIONS DIVISION

### SONOTONE CORPORATION

Elmsford, New York

SONOTONE CORPORATION  
Elmsford, N.Y.

Dept. E

Please send me a free copy of the Sonotone Phonograph Modernization Manual

Name \_\_\_\_\_

Address \_\_\_\_\_

City \_\_\_\_\_ State \_\_\_\_\_

CORRESPONDENCE (Continued)

bility of not having that particular part on hand when it is needed, especially parts like sound traps and peaking coils.

Many authors insist that technicians should carry a scope, v.t.v.m. and all types of generators into the home, plus a C-R tube tester. This is ridiculous. Don't get me wrong, I have this equipment—and I value it highly. But the prime function of a sweep generator is for alignment, and the average set seldom needs alignment when it comes in for repairs. Only when some amateur has tampered with it is alignment necessary.

As for C-R tube testers, having serviced thousands of sets I can definitely state that any experienced TV technician can tell whether a picture tube is defective. Money spent for a C-R tube tester could better be spent for a finer scope or v.t.v.m.

I want to register also a complaint against most manufacturers of radio and TV sets, from the standpoint of accessibility of components. And I am including the most recent 1955 models.

Why don't TV manufacturers use some of their engineering talent to make sets more serviceable? Replacing a picture tube in some Philco receivers is a major operation. Don't they realize that the recommendations of technicians to customers will depend upon how easy it is to service a set?

And why don't manufacturers make picture tubes removable from the front? Sometimes a picture can be improved considerably by cleaning the face of the tube. But technicians hesitate because it is a lot of work in most sets. Serviceability is a very important factor to the customer, too. He foots the bills, and tough servicing means larger labor bills.

I dread the thought of servicing color receivers. As far as cooperation with the service technician is concerned, TV manufacturers still haven't rounded first base on black-and-white.

How about more practical articles on servicing? With 25 years behind me, I am still learning new tricks every day.

ANTON FELDMAN

New York, N. Y.

#### COLOR-CODED CLIPS

Dear Editor:

I noticed an article by Charles Cohn on improvised color coding for alligator test clips in the Try This One column, page 121 of the October, 1954, issue, and wish to *exclaim* that clip insulators in five code colors are being made by our client, Mueller Electric Co.

Long ago Scott Mueller told me that they were developing coded insulators, despite the absence of a ready market, simply because they felt responsible for providing what is still a convenience, in advance of the real need. As you know, Mueller Electric Co. is a major producer of clips and insulators.

NOBLE D. CARLSON

PDA ADVERTISING AGENCY  
Cleveland, Ohio



These



# SERIES STRING TUBES HAVE 300% GREATER RELIABILITY

High voltage surges due to inequalities of heater warmup time previously have limited the most effective use of "series connections" of tube heaters in TV receivers. The new Raytheon "Series String" Tubes — now used by many leading set manufacturers — virtually eliminate heater burnouts, permitting the use of this type of circuitry which results in lighter, more compact receivers.

Raytheon helped set manufacturers solve this warmup problem, by designing a new line of "Series String" Tubes which feature tightened controls on heater warmup, identical current value and a heater stability so improved that heater burnouts from warmup surges are rare. By narrowing the tolerances on heater wire to one-third of the former specifications and improving heater coating techniques this has been achieved. This important advance plus Raytheon's thorough knowledge of every aspect of tube construction guarantees the superior quality of Raytheon "Series String" Tubes.

<p><b>RAYTHEON 3AL5</b> is a heater-cathode type double diode of miniature construction. Its principal application is as a diode detector, automatic volume control rectifier, or as a low current power rectifier.</p>	<p><b>RAYTHEON 3AU6</b> is a heater-cathode type, sharp cutoff pentode of miniature construction designed for service as a high-frequency amplifier in radio and television receivers.</p>	<p><b>RAYTHEON 3BC5</b> is a heater-cathode type, sharp cutoff pentode, of miniature construction. Used as an RF amplifier and as a high-frequency, intermediate amplifier.</p>	<p><b>RAYTHEON 3BN6</b> is a 7-pin miniature, heater-cathode type, sharp cutoff pentode. Designed to perform the combined functions of limiting and frequency discrimination in FM and TV receivers.</p>	<p><b>RAYTHEON 3CB6</b> is a heater-cathode type sharp cutoff pentode of miniature construction designed for use as an intermediate frequency amplifier, operating at frequencies in the order of 40 megacycles, or as an RF amplifier in VHF Television Tuners.</p>
<p><b>RAYTHEON 5AM8</b> is a diode pentode of miniature construction designed for use as a video detector and IF amplifier in television receivers.</p>	<p><b>RAYTHEON 5AN8</b> is a medium-mu triode and a sharp cutoff pentode of miniature construction designed to perform combined functions of a video detector or IF amplifier and sync separator.</p>	<p><b>RAYTHEON 5J6</b> is a heater-cathode type, double triode of miniature construction designed for mixer applications.</p>	<p><b>RAYTHEON 5U8</b> is a heater-cathode type triode-pentode of miniature construction designed for use as an oscillator mixer.</p>	<p><b>RAYTHEON 6S4A</b> is a heater-cathode type medium-mu, high-perveance triode of miniature construction for use as a vertical deflection amplifier in TV receivers.</p>
<p><b>RAYTHEON 6SN7GTB</b> is a dual triode designed for use as a combined vertical oscillator and vertical deflection amplifier in television receivers.</p>	<p><b>RAYTHEON 7AU7</b> is a heater-cathode type double triode of miniature construction designed for use as a resistance coupled voltage amplifier, phase inverter, horizontal deflection oscillator or vertical deflection oscillator-amplifier in television receivers.</p>	<p><b>RAYTHEON 12AX4GT</b> is a heater-cathode type diode designed for use in horizontal frequency damper service in television receivers.</p>	<p><b>RAYTHEON 12BH7A</b> is a heater-cathode type medium-mu double triode of miniature construction designed for use as a vertical deflection amplifier in television receivers employing "Series String" heater designs.</p>	<p><b>RAYTHEON 12BK5</b> is a miniature beam power pentode designed for use as a power output tube in radio and TV receivers.</p>
<p><b>RAYTHEON 12BY7A</b> is a heater-cathode type pentode of miniature construction designed for use as a video amplifier.</p>	<p><b>RAYTHEON 12L6GT</b> is a heater-cathode type beam pentode power amplifier. Generally used as an output tube in ac-dc receivers.</p>	<p><b>RAYTHEON 12W6GT</b> is a heater-cathode type beam pentode designed for service as a vertical deflection amplifier in TV receivers having a relatively low B supply voltage.</p>	<p>Ask your Raytheon Tube Distributor about these and other new Raytheon "Series String" Tubes.</p>	



## RAYTHEON MANUFACTURING COMPANY

Receiving and Cathode Ray Tube Operations  
Newton, Mass., Chicago, Ill., Atlanta, Ga., Los Angeles, Calif.

RAYTHEON MAKES ALL THESE:

RECEIVERS AND PHOTODIODES - RELAYED COMMUNICATIONS AND REMOTE TUBES - SEMICONDUCTOR DIODES AND TRANSISTORS - VACUUM TUBES - MICRORAY TUBES

*Excellence in Electronics*

# Your Best Buy...

## for Black-and-White...and COLOR TV



**RCA WR-89A**  
Crystal-Calibrated  
Marker Generator



**RCA WR-59C**  
Television Sweep Generator

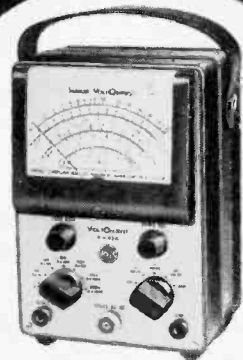

**RCA WV-97A**  
Senior VoltOhmyst®

In color receivers, all of the color information is contained in the region from about 2 Mc to 4.1 Mc on the over-all rf-if response curve, as shown in Fig. 1. Any loss of gain in this region will weaken the color signals. If the loss is appreciable, it may result in such effects as poor color sync, poor color "fit" (incorrect registration of color and brightness information on the kinescope), or cross-talk or color contamination between I and Q channels.

The rf-if amplifiers must be aligned correctly to provide flat response for modulating frequencies up to 4.1 Mc. The RCA WR-59C Sweep Generator and WR-89A Marker Generator provide the flatness of sweep output and crystal accuracy essential for aligning color circuits.

In color receivers, there are a number of video-frequency sections, including the video amplifier, the bandpass amplifier, the demodulator channels (see Figures 2, 3, 4), and the green, red, and blue matrix networks—including the adders and output stages. A flat video sweep extending down to 50 Kc is a necessity in checking or aligning the tunable bandpass filter and the I and Q filters. Late model RCA WR-59C Sweep Generators provide a flat video sweep extending down to 50 Kc. They also cover all rf and if ranges required for both color and black-and-white receivers.

Get full details today from your RCA Distributor.

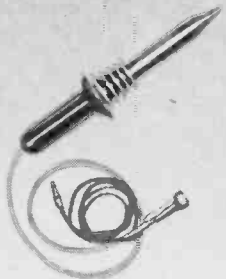
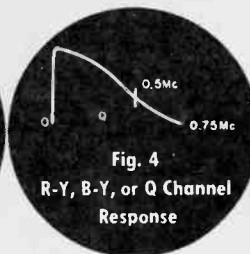
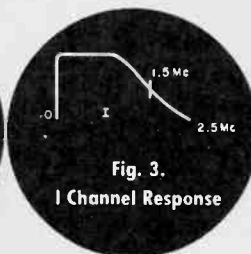
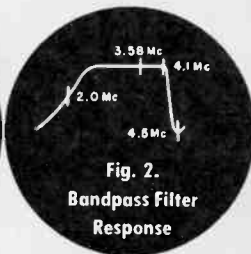
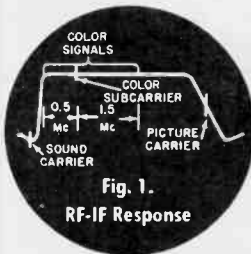

**REMEMBER** that the high voltage (up to 30,000 volts and more) must be set to the specified value before adjusting purity and convergence. The RCA Volt-Ohmysts can be used with the RCA High Voltage Probe (WG-289 and WG-206 Multiplier Resistor) to measure dc voltages up to 50,000 volts.



Now off the press—RCA's new enlarged, 2nd edition of "Practical Color Television for the Service Industry." Price: \$2.00—from your RCA distributor.



**RADIO CORPORATION of AMERICA**  
TEST EQUIPMENT  
HARRISON, N.J.



L. C. Lane, B.S., M.A.  
President, Radio-Television  
Training Association.  
Executive Director, Pierce  
School of Radio & Television.

Study AT HOME in your SPARE TIME  
to be a TELEVISION TECHNICIAN

**VETERANS!**  
**NON-VETERANS!**

# YOU LEARN MORE because I GIVE YOU MORE!



Super-Het  
Radio Receiver

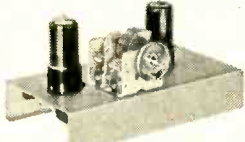

C-W Telephone Transmitter



Public Address System



Combination Voltmeter-  
Ammeter-Ohmmeter



21<sup>in.</sup>



RF Signal  
Generator

## LEARN BY DOING

Every one of my students gets enough equipment to set up his own home laboratory. You learn to be a television technician by actually doing what a TV technician must do on the job. With the equipment I send you, you build and keep a professional GIANT SCREEN TV RECEIVER complete with big picture tube (takes any size up to 21-inch) . . . also a Super-Het Radio Receiver, AF-RF Signal Generator, Combination Voltmeter-Ammeter-Ohmmeter, C-W Telephone Transmitter, Public Address System, AC-DC Power Supply. Everything supplied, including all tubes. No experience is necessary . . . My practical, easy-to-understand lessons have brought success to hundreds of men, many with no more than a grammar school education.

## CHOOSE FROM 3 COMPLETE COURSES

My Courses cover all phases of radio, FM and television.

### 1. Radio, FM and Television Technician Course

(No Previous Experience Necessary)

You learn by practicing with the professional equipment I send you. Many of my graduates now hold down good paying technician jobs with such firms as RCA, NBC-TV, CBS-TV, DUMONT TV and numerous other TV studios and plants.

### 2. FM-TV Technician Course

(Previous Training or Experience in Radio Required)

You can save months of time if you have previous Armed Forces or civilian radio experience! Train at home with kits of parts, plus equipment to build BIG SCREEN TV RECEIVER. ALL FURNISHED AT NO EXTRA COST!

### EXTRA TRAINING IN NEW YORK CITY AT NO EXTRA COST!

After you finish your home study training in Course 1 or 2 you get two weeks, 50 hours, of intensive Laboratory work on modern electronic equipment at our associate school in New York City, Pierce School of Radio & Television. THIS EXTRA TRAINING IS YOURS AT NO EXTRA COST WHATSOEVER. My courses are complete without this extra training, however. It is just an added opportunity for review and practice.

### 3. TV Cameraman and Studio Technician Course

(Advanced Training for Men with Radio or TV Training or Experience)

I train you at home for an exciting high pay job as the man behind the TV camera. Work with TV stars in TV studios or "on location" at remote pick-ups!

An optional 30 hour one-week course of practical work on TV studio equipment at Pierce School is offered upon completion of Course 3.

## EARN WHILE YOU LEARN

Almost from the very start you can earn extra money while learning by repairing Radio-TV sets for friends and neighbors. Many of my students earn up to \$25 a week . . . pay for their entire training from spare time earnings. . . start their own profitable service business.

## FREE FCC COACHING COURSE!

Important for BETTER PAY JOBS requiring FCC License. You get this training AT NO EXTRA COST. Top TV jobs go to FCC-licensed technicians.

## VETERANS!

My School fully approved to train veterans under new Korean G.I. Bill. Available only to Veterans who begin training within three years of discharge date.

**YOU GET ALL FOUR FREE**

MAIL THIS COUPON TODAY!  
NO SALESMAN WILL CALL!



Mr. Leonard C. Lane, President  
RADIO-TELEVISION TRAINING ASSOCIATION  
52 East 19th Street, New York 3, N. Y. Dept. R-1

Dear Mr. Lane: Mail me your NEW FREE BOOK, FREE SAMPLE LESSON, and FREE aids that will show me how I can make BIG MONEY IN TELEVISION. I understand I am under no obligation and no salesman will call.

(PLEASE PRINT PLAINLY)

Name \_\_\_\_\_ Age \_\_\_\_\_

Address \_\_\_\_\_

City \_\_\_\_\_ Zone \_\_\_\_\_ State \_\_\_\_\_

I AM INTERESTED IN:

- Radio-FM-TV Technician Course
  - FM-TV Technician Course
  - TV Cameraman & Studio Technician Course
- VETERANS!**  
Write Discharge Date \_\_\_\_\_

# Radio Television Training Association

52 EAST 19th STREET • NEW YORK 3, N. Y.

Licensed by the State of New York • Approved for Veteran Training

*the most complete line...*

*a model for every application*

# C·D·R ROTORS

*C·D·R Rotors have*  
**AXS 679\***

*\*The highest grade premium die cast aluminum... so rugged and durable that it is used for aircraft landing gear.*

**PRE-SOLD**  
for you to MILLIONS  
through spot announce-  
ments on television.



**CORNELL-DUBILIER**  
SOUTH PLAINFIELD, N.J.



**THE RADIART CORP.**  
CLEVELAND 13, OHIO



*Prepare now for  
the great opportunity  
field of...*

*You Can Quickly  
be doing interesting  
profitable work  
like this!*

# TELEVISION

## RADIO-ELECTRONICS

*In spare time  
at home!*

A fascinating field! A great future! A good job or independence in a business of your own! TV is growing by leaps and bounds—1227 new communities, 1845 new stations have been given the "go-ahead". Trained men are worth their weight in gold!

### MODERN TRAINING BY COYNE RIGHT IN YOUR OWN HOME

Here is modern, up-to-the-minute Home Training in Television and Radio designed to meet the standards that have made the Coyne School famous for many years. You get personal supervision by members of Coyne instruction staff—men who know TELEVISION AND RADIO AND KNOW HOW

B. W. COOKE, President

**COYNE**  
SCHOOL

A TECHNICAL TRADE INSTITUTE  
CHARTERED NOT FOR PROFIT  
Established 1899

500 S. Paulina Dept. 15-HR4, Chicago 12,

TELEVISION ★ RADIO ★ ELECTRICITY ★ REFRIGERATION ★ ELECTRONICS

TO TEACH IT—men who have helped train thousands of men and young men, Service men and Veterans.

### LEARN TO EARN IN SPARE TIME

COYNE offers a most practical, down-to-earth Home Television Training. Simple, easy to follow step-by-step instructions, fully illustrated. So practical, you can quickly be earning money in Television and Radio and keep your present job while training.

Let us show you that this is not only the newest, most up-to-the-minute Training in Television-Radio-Electronics—but also it costs you much less than you'd expect to pay. Send coupon today for details including Easy Payment Plan.

B. W. COOKE, President  
COYNE SCHOOL  
500 S. Paulina St., Chicago 12  
Dept. 15-HR4

Send details of your offer on training checked below. This does not obligate me and no salesman will call. I am interested in:

- Television-Radio Home Training
- Electricity in Coyne Shops
- Television-Radio in Coyne Shops

Name .....

Address .....

City ..... State .....

YOU CAN ALSO TRAIN FOR  
**TELEVISION-RADIO** OF **ELECTRICITY**  
IN THE GREAT SHOPS  
OF **COYNE** AT CHICAGO



Coyne, of course, also offers practical resident training in the Coyne Training Shops here in Chicago in the fields of TELEVISION-RADIO and ELECTRICITY. If you prefer to get information about our resident courses in either or both of these fields, then check on the coupon accordingly and mail it to us. Our fully illustrated 48 page Guide To Careers in Television-Radio and Electricity and complete details about our resident training will be sent you by return mail. No cost or obligation to you, of course, and no salesman will call on you.

### MAIL COUPON FOR INFORMATION

Fill in and mail coupon TODAY. Paste it on a postcard if you wish. Complete details will come by return mail. No cost —no obligation and no salesman will call.



the KEY to your problem

**phastron** the NEW LOOK in **"555" metal-cased MULTIMETERS**



**POCKET SIZE WITH A 4 7/8" LENGTH SCALE**

**WE LEAVE IT TO YOU**

**WOULD YOU BUY A PLASTIC-CASED WRIST WATCH . . .**

if you could buy the finest movement in a magnetically shielded metal case?

Phastron, world famous manufacturer of ENVIRONMENT FREE PRECISION AIRCRAFT EQUIPMENT for Military and Industrial uses introduces a new concept in Multimeters. This magnetically shielded, metal-cased "555" compares with plastic-cased multimeters as a fine watch in a precious metal case would compare with a plastic wrist watch.

The shielded, shatterproof and anti-magnetic case insures continued accuracy and integrity of this instrument for years to come.

Phastron "555" Multimeter incorporates more ranges, including AC current, greater visibility, simplified and functional controls and the greatest value offered to date.

See the Phastron "555", note its many outstanding features, its beautiful satin chrome case, its compactness and light weight, and you will know why

**"YOU CANNOT BUY BETTER"**

**\$39.95** at your **PARTS DISTRIBUTOR**

Manufactured by PHAOSTRON COMPANY • 151 Pasadena Avenue • South Pasadena, Calif., U.S.A.

the KEYS to your problems

- phastron** AC CURRENT RANGES
- phastron** ANTI-MAGNETIC . . . DOUBLY SHIELDED
- phastron** LARGE SCALES . . . COLOR CODED
- phastron** SIMPLICITY . . . ONLY 2 JACKS
- phastron** ACCURACY . . . 3% DC, 4% AC
- phastron** GREATER RANGES . . . 3 TO 1 STEPS
- phastron** FASTER & FUNCTIONALLY EASIER to use and read



# I Will Train You at Home

## For Good Pay Jobs, Success in

# RADIO-TELEVISION



J. E. SMITH  
President  
National Radio  
Institute  
Washington, D. C.  
40 years of success  
training men at  
home in spare time.



### Practice Broadcasting with Equipment I Send

As part of my Communications Course I send you kits of parts to build the low-power Broadcasting Transmitter shown at the left. You use it to get practical experience putting a station "on the air," performing procedures demanded of Broadcasting Station Operators. An FCC Commercial Operator's License can be your ticket to a better job and a bright future; my Communications Course gives you the training you need to get your license. Mail card below and see in my book other valuable equipment you build.



### Practice Servicing with Equipment I Send

Nothing takes the place of PRACTICAL EXPERIENCE. That's why NRI training is based on LEARNING BY DOING. You use parts I furnish to build many circuits common to Radio and Television. With my Servicing Course you build a modern Radio (shown at right). You build a Multitester which you use to help fix sets while training. Many students make \$10, \$15 a week extra fixing sets in spare time starting a few months after enrolling. All equipment is yours to keep. Card below will bring book showing other equipment you build.

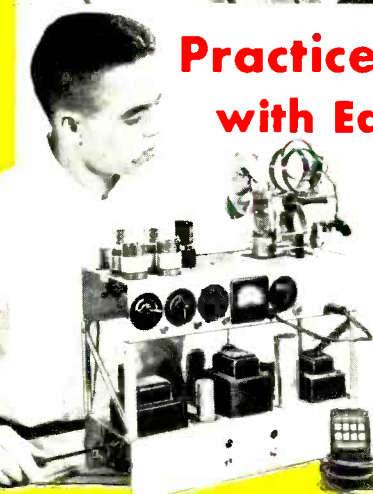

### Television is Growing Fast Making New Jobs, Prosperity

More than 25 million homes now have Television sets and thousands more are being sold every week. Well trained men are needed to make, install, service TV sets. About 200 television stations on the air with hundreds more being built. Think of the good job opportunities here for qualified technicians, operators, etc. If you're looking for opportunity get started now learning Radio-Television at home in spare time. Cut out and mail postage free card. J. E. Smith, President, National Radio Institute, Washington, D. C. OUR 40TH YEAR.

AVAILABLE TO  
**VETERANS**  
UNDER G.I. BILL

Good Jobs, Good Pay, Success  
in Radio-TV! SEE OTHER SIDE

CUT OUT AND MAIL THIS CARD NOW

Sample Lesson & 64-Page Book  
**Both FREE**

This card entitles you to Actual Lesson on Servicing, shows how you learn Radio-Television at home. You'll also receive my 64-Page Book, "How to Be a Success in Radio-Television." Mail card now!

**NO STAMP NEEDED! WE PAY POSTAGE**

Mr. J. E. SMITH, President,  
National Radio Institute, Washington 9, D. C.

Mail me Lesson and Book, "How to Be a Success in Radio-Television." (No Salesman will call. Please write plainly.)

NAME ..... AGE .....

ADDRESS .....

CITY ..... ZONE ... STATE .....

**VETS** write in date  
of discharge .....

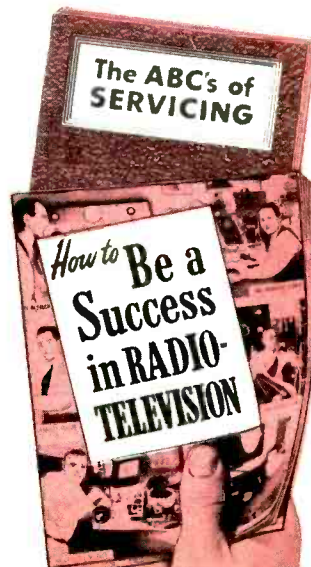

# Train at Home to Jump Your Pay as a RADIO-TV Technician



J. E. Smith, President  
National Radio Institute

The men whose messages are published below were not born successful. Not so long ago they were doing exactly as you are now... reading my ad! They decided they should KNOW MORE... so they could EARN MORE... so they acted! Mail card below now.

## Get a Better Job—Be Ready for a Brighter Future in America's Fast Growing Industry

Training PLUS opportunity is the PERFECT COMBINATION for job security, good pay, advancement. When times are good, the trained man makes the BETTER PAY, GETS PROMOTED. When jobs are scarce, the trained man enjoys GREATER SECURITY. NRI training can help assure you and your family more of the better things of life.

Radio-Television is today's opportunity field. Even without Television, Radio is bigger than ever before. Over 3,000 Radio Broadcasting Stations on the air; more than 115 million home and Automobile Radios are in use. Then add Television. Television Broadcast Stations extend from coast to coast now with over 25 million Television sets already in use. There are channels for 1,800 more Television Stations. Use of

Aviation and Police Radio, Micro-Wave Relay, Two-way Radio communication for buses, taxis, trucks, etc. is expanding. New uses for Radio-Television principles coming in Industry, Government, Communications and Homes.

### My Training is Up-to-Date You Learn by Practicing

Get the benefit of my 40 years experience training men. My well-illustrated lessons give you the basic principles you must have to assure continued success. Skillfully developed kits of parts I furnish "bring to life" the principles you learn from my lessons. Read more about equipment you get on other side of this page.

Naturally, my training includes Television. I have, over the years, added more and more Television information to my courses. The equipment I furnish students gives experience on circuits common to BOTH Radio and Television.

### Find Out About the Tested Way to Better Pay

Read at the right how just a few of my students made out who acted to get the better things of life. Read how NRI students earn \$10, \$15 a week extra fixing Radios in spare time starting soon after enrolling. Read how my graduates start their own businesses. Then take the next step—mail card below.

You take absolutely no risk. I even pay postage. I want to put an Actual Lesson in your hands to prove NRI home training is practical, thorough. I want you to see my 64-page book, "How to Be a Success in Radio-Television" because it tells you about my 40 years of training men and important facts about present and future Radio-Television job opportunities. You can take NRI training for as little as \$5 a month. Many graduates make more than the total cost of my training in two weeks. Mailing postage free card can be an important step in making your future successful. J. E. Smith, President, National Radio Institute, Washington 9, D. C. OUR 40TH YEAR.

## I TRAINED THESE MEN



Consultant on Antenna Systems

"I resigned as Chief Engineer. Now I am on my own as consultant on private and commercial antenna systems." R. J. Bailey, Weston, W. Va.



\$10 a Week In Spare Time

"Before finishing, I earned as much as \$10 a week in Radio servicing in my spare time. I recommend NRI." S. J. Petruff, Miami, Fla.



Control Operator, Station WEAN

"I received my license and worked on ships. Now with WEAN as control operator, NRI course is complete." R. Arnold, Rumford, R. I.



Has Own Radio-Television Shop

"Doing Radio and Television servicing full time. Have my own shop. I owe my success to NRI." Curtis Stath, Fort Madison, Iowa.



Radio-Television Service Chief

"Am chief Radio and Television serviceman for large repair shop. Pay very good, working conditions pleasant." P. G. Brogan, Louisville, Ky.



Got First Job Thru NRI

"My first job was with KDLR. Now Chief Emer. of Radio Equipment for Police and Fire Dept." T. Noutou, Hamilton, Ohio.

Start Soon to Make \$10 to \$15 a Week Extra Fixing Sets



Keep your job while training. Many NRI students make \$10, \$15 and more a week extra fixing neighbors' Radios in spare time, starting a few months after enrolling. I start sending you special booklets that show you how to fix sets, the day you enroll. The multimeter you build with parts I furnish helps discover and correct troubles.

SEE OTHER SIDE

## My Training Leads to Jobs Like These

- |   |  |   |
|---|--|---|
| <b>BROADCASTING</b><br>Chief Technician<br>Chief Operator<br>Power Monitor<br>Recording Operator<br>Remote Control Operator | Service Manager<br>Tester<br>Serviceman<br>Research Assistant  | <b>AVIATION RADIO</b><br>Plane Radio Operator<br>Transmitter Technician<br>Receiver Technician<br>Airport Transmitter Operator                                |
| <b>SERVICING</b><br>Home and Auto Radios<br>P.A. Systems<br>Television Receivers<br>Electronic Controls<br>FM Radios        | <b>SHIP AND HARBOR RADIO</b><br>Chief Operator<br>Assistant Operator<br>Radiotelephone Operator  | <b>TELEVISION</b><br>Pick-Up Operator<br>Voice Transmitter Operator<br>Television Technician<br>Remote Control Operator<br>Service and Maintenance Technician |
| <b>IN RADIO PLANTS</b><br>Design Assistant<br>Transmitter Design Technician   | <b>GOVERNMENT RADIO</b><br>Operator in Army, Navy, Marine Corps, Coast Guard<br>Forestry Service<br>Dispatcher<br>Airways Radio Operator | <b>POLICE RADIO</b><br>Transmitter Operator<br>Receiver Serviceman  |

FIRST CLASS  
Permit No. 20-R  
(Sec. 34.9, P.L. & R.)  
Washington, D.C.

BUSINESS REPLY CARD

No Postage Stamp Necessary If Mailed In The United States

POSTAGE WILL BE PAID BY  
NATIONAL RADIO INSTITUTE

16th and U Sts., N.W.

Washington 9, D. C.

J K L M N

CUT OUT—MAIL  
Postage Free CARD



SAMPLE LESSON  
and 64-PAGE BOOK

Both FREE

## Have Your Own Business

Many NRI trained men start their own successful Radio-Television sales and service business with capital earned in spare time. Joe Travers, a graduate of mine, in Asbury Park, N. J., writes: "I've come a long way in Radio and Television since graduating. Have my own business on Main Street."





Weston Model 981  
Proportional Mutual Conductance Tubechecker

# FILTERED D-C POTENTIALS

for accurate  
 $G_m$   
measurements

## OUTSTANDING FEATURES:

**$G_m$  MEASUREMENTS**— $G_m$  measurements are made more accurately by using filtered d-c plate, screen grid and control grid potentials. A precision voltage divider network and selector switch allows a proportionate value of signal voltage to be chosen for testing tubes having transconductances up to 30,000 micromhos. Signal voltages of 5.2, 2.6, 1.3, and 0.65 volts peak-to-peak having a frequency of 5000 cycles are provided.

**GRID BIAS, SCREEN GRID AND PLATE VOLTAGE:** Filtered d-c potentials of 90, 130, and 220 volts are available for plate and screen potentials. A variable filtered d-c voltage in two ranges of 0-5 and 0-20 volts are used to obtain better resolution of Grid Bias settings. *Far greater accuracy is obtainable with filtered d-c potentials than previously possible in portable tubecheckers.*

**METER MEASUREMENT OF HIGH LEAKAGE RESISTANCE**—Since tube leakage as high as several megohms can cause poor performance in TV Receivers, this tubechecker is designed to provide an accurate meter measurement of leakage resistance as high as 5 megohms between tube elements, thus being particularly useful for TV servicing and TV line production assembly.

**TWIN SECTION TUBES**—Three toggle switches make it possible to rapidly check and compare the respective sections of twin section tubes at only one setting of the selector switches.

**WESTON** 980 LINE  
TEST EQUIPMENT

THE  
**980**  
LINE

PROPORTIONAL  
MUTUAL  
CONDUCTANCE  
**TUBECHICKER**

SEND COUPON TODAY FOR  
COMPLETE DESCRIPTION AND PRICES

Weston Electrical Instrument Corporation  
614 Frellinghuysen Avenue  
Newark 5, New Jersey

Please send literature on the new 981 Tubechecker.

NAME \_\_\_\_\_

ADDRESS \_\_\_\_\_

RE

AKRO-MILS

# FREE SWING BIN

## NEWEST ASTRON SPECIAL OFFER includes complete BLUE-POINT® capacitor stock!

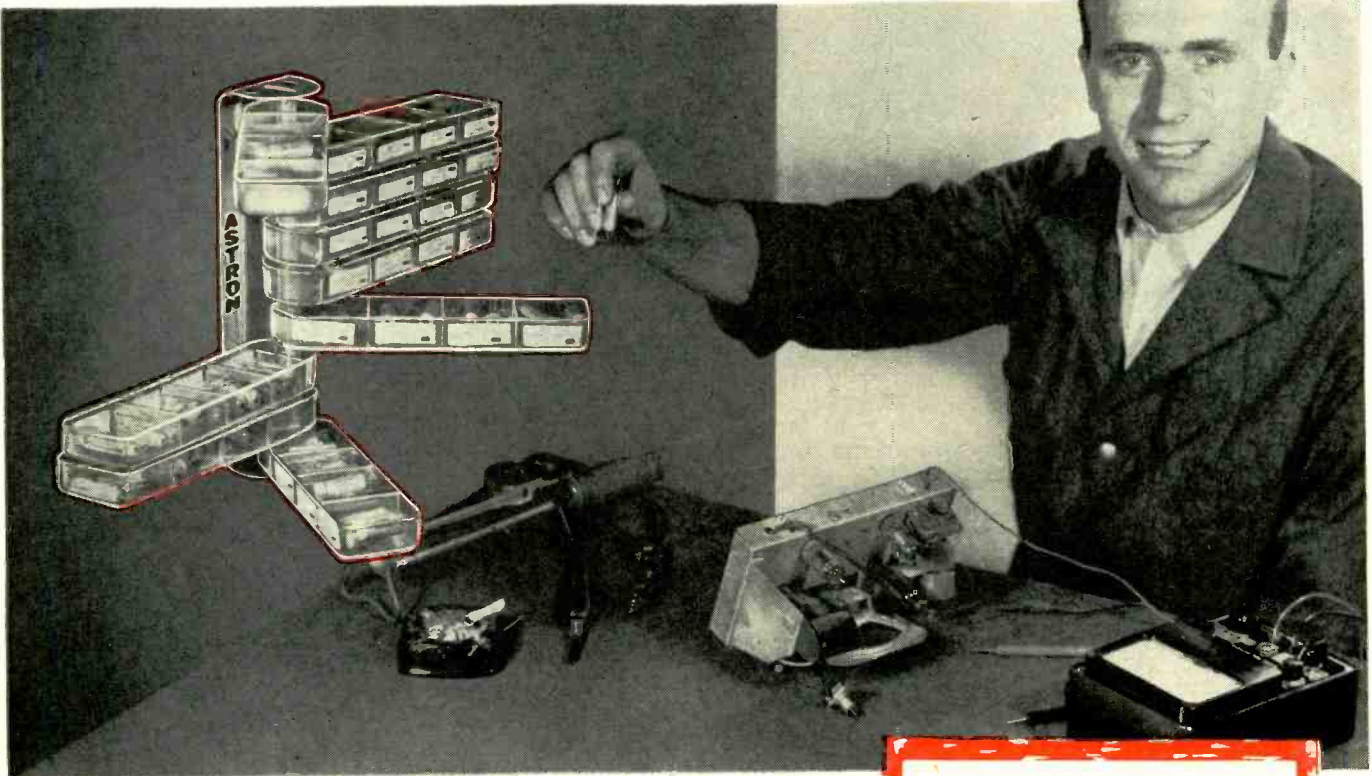

New ASTRON introductory offer is giving service technicians a complete assortment — 166 units — 36 different popular values — of fabulous BLUE-POINT plastic tubulars at 55% off list *plus* free "Swing Bin" for better servicing. Individual "Swing Bins" swing out. Keep entire capacitor stock in easy reach... off the bench for more work space. Visual stock control.

Fabulous BLUE-POINTS are newest, most dependable molded plastic capacitors made. New solid thermosetting impregnant for high capacitance stability • continuous 85°C operation WITHOUT DERATING • bonded shell and seal impervious to heat and moisture • low power factor • high insulation resistance • individual tests — all add up to guaranteed performance of ASTRON BLUE-POINTS.

Get in on this sensational offer today. Jobber stocks are limited. Be sure — get yours now!

Available nationally through authorized distributors.

**ASTRON**  
CORPORATION  
255 GRANT AVENUE EAST NEWARK, N. J.



DEALERS — This special offer available from local distributors or write to ASTRON for full details.

Export Division: Rocke International Corp., 13 East 40th St., N. Y., N. Y. In Canada: Charles W. Pointon, 6 Alcino Ave., Toronto 10, Ontario

*How you save*

\$6470	BLUE-POINTS
+ 522	Swing Bin
\$6992	Total
-3997	Savings
only \$29 <sup>95</sup>	
your deal price	
55% off list	
PLUS	
FREE SWING BIN	

# Home Study Courses in TELEVISION SERVICING offered by RCA INSTITUTES



Study Television Servicing—from the very source of the latest, up-to-the-minute TV and Color TV developments. Train under the direction of men who are experts in this field. Take advantage of this opportunity to place yourself on the road to success in television. RCA Institutes, Inc. (A Service of Radio Corporation of America), thoroughly trains you in the "why" as well as the "how" of servicing television receivers.

## FIRST HOME STUDY COURSE IN COLOR TV SERVICING

Now you can train yourself to take advantage of the big future in Color TV. RCA Institutes Home Study Course covers all phases of Color TV Servicing. It is a practical down-to-earth course in basic color theory as well as how-to-do-it servicing techniques.

This color television course was planned and developed through the combined efforts of instructors of RCA Institutes, engineers of RCA Laboratories, and training specialists of RCA Service Company. You get the benefit of years of RCA research and development in color television.

Because of its highly specialized nature, this course is offered only to those already experienced in radio-television servicing. Color TV Servicing will open the door to the big opportunity you've always hoped for. Find out how easy it is to cash in on Color TV. *Mail coupon today.*

### SEND FOR FREE BOOKLET

Mail coupon in envelope or paste on postal card. Check course you are interested in. We will send you a booklet that gives you complete information. No salesman will call.



**RCA INSTITUTES, INC.**  
A SERVICE OF RADIO CORPORATION OF AMERICA  
350 WEST FOURTH STREET, NEW YORK 14, N.Y.

## HOME STUDY COURSE IN BLACK-AND-WHITE TV SERVICING

Thousands of men in the radio-electronics industry have successfully trained themselves as qualified specialists for a good job or a business of their own—servicing television receivers. You can do this too.

This RCA Institutes TV Servicing course gives you up-to-the-minute training and information on the very latest developments in black-and-white television.

As you study at home, in your spare time, you progress rapidly. Hundreds of pictures and diagrams, easy-to-understand lessons help you to quickly become a qualified TV serviceman.

There are ample opportunities in TV, for radio servicemen who have expert training. Mail coupon today. Start on the road to success in TV Servicing.

### MAIL COUPON NOW

RCA INSTITUTES, INC.  
Home Study Dept. RE-1-55  
350 West Fourth Street, New York 14, N. Y.

Without obligation on my part, please send me copy of booklet on:

Home Study Course in Television Servicing  
 Home Study Course in Color TV Servicing

Name \_\_\_\_\_ (please print)

Address \_\_\_\_\_

City \_\_\_\_\_ Zone \_\_\_\_\_ State \_\_\_\_\_

# FREE 1955 EICO CATALOG!

Tells you how to SAVE 50% on  
your test equipment costs!

## EICO

THE LARGEST MANUFACTURER OF ITS KIND IN THE WORLD

### KITS INSTRUMENTS

THE INDUSTRY'S MOST COMPLETE LINE OF KITS & INSTRUMENTS  
1/3 MILLION EICO INSTRUMENTS IN USE THE WORLD OVER -  
SAVE 50% - BUILD 'EM IN ONE EVENING... THEY LAST A LIFETIME

the Exclusive **EICO** Make-Good  
**GUARANTEE**

Each EICO Kit and Instrument is double guaranteed by EICO and your  
pioneer. In addition, only selected quality components. EICO guarantees to  
replace any component which might become defective in normal use if  
returned to the factory within 90 days of purchase.  
EICO guarantees all Kits assembled according to EICO's simplified  
instructions will operate as specified therein.  
EICO guarantees service and calibration of every EICO Kit and Instru-  
ment at the nominal charge as stated in the instructions.

**ELECTRONIC INSTRUMENT CO., INC.**  
Test Equipment Manufacturers  
84 WITHERS STREET, BROOKLYN 11, N. Y.

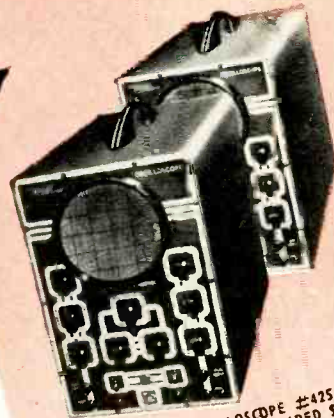

5" PUSH-PULL OSCILLOSCOPE #425  
KIT \$44.95 WIRED \$79.95  
NEW! #470 7" PUSH-PULL OSCILLOSCOPE  
KIT \$79.95 WIRED \$129.50



CRA... \$4.50  
TUBE TESTER #435  
KIT \$34.95 WIRED \$49.95



20,000 Ohms/Volt  
MULTIMETER #565  
KIT \$24.95  
WIRED \$29.95



1,000 Ohms/Volt  
MULTIMETER #536  
KIT \$12.90  
WIRED \$14.90



NEW! #232 PEAK-TO-PEAK  
VTVM with DUAL-PURPOSE  
AC/DC UNI-PROBE (pat. pend.)  
KIT \$29.95 WIRED \$49.95

NEW! #249 DELUXE  
PEAK-TO-PEAK VTVM with 7 1/2"  
METER & UNI-PROBE (pat. pend.)  
KIT \$39.95 WIRED \$59.95



VACUUM TUBE VOLTMETER #221  
KIT \$25.95 WIRED \$39.95  
DELUXE VTVM (with 7 1/2"  
METER) #214  
KIT \$34.95 WIRED \$54.95



R-C BRIDGE & R-C-L  
COMPARATOR #950B  
KIT \$19.95 WIRED \$29.95



MULTI-SIGNAL  
TRACER #145  
KIT \$19.95  
WIRED \$28.95

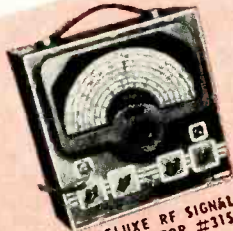

DELUXE RF SIGNAL  
GENERATOR #315  
KIT \$39.95 WIRED \$59.95

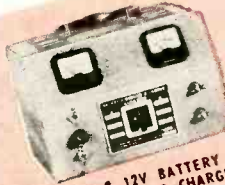

6V & 12V BATTERY  
ELIMINATOR & CHARGER  
#1050  
KIT \$29.95 WIRED \$38.95



NEW! #900 FLYBACK  
TRANSFORMER & YOKE  
TESTER  
KIT \$23.95  
WIRED \$34.95

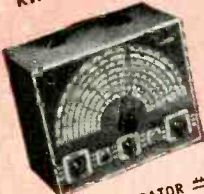

RF SIGNAL GENERATOR #320  
KIT \$19.95 WIRED \$29.95

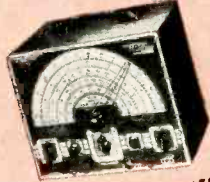

TV/FM SWEEP GENERATOR #360  
KIT \$34.95 WIRED \$49.95

SMC-4 SMC CRYSTAL  
\$3.95 ea.



A PROBE FOR EVERY PURPOSE

## EICO

See the famous EICO line at your jobber today  
SEND FOR FREE CATALOG C-1  
**ELECTRONIC INSTRUMENT CO., Inc.**  
84 Withers Street • Brooklyn 11, N. Y.  
Prices 5% higher on West Coast

## UNIVERSAL TV RECEIVER

*... Television, like progress, evolves continuously ...*

THE technical world never stands still. As new know-how, new inventions, new facts and new techniques evolve they are seized on immediately to improve present-day devices of every kind, whether pens, automobiles, floor mops, radios, corkscrews or television sets. Nothing is ever perfected; improvements, like evolution, never stop.

This has been ever true in the radioelectronic industry, famous for rapid changes. No sooner has the latest model been announced than its designers have already scrapped it in their minds and have moved on to next year's designs. This trend is even more common in television where the leading manufacturers bring out new and more modern designs throughout the year.

It follows that the television receiver of the future will bear little resemblance to present-day models. This becomes even more apparent when we reflect that television has been with us only a comparatively short time—eight years. It is still in its swaddling clothes.

For that reason, we should not be overly surprised at the radical and perhaps fundamental changes that lie ahead for the new art. And as television is intimately fused with its parent, electronics—the latter itself of recent origin—anything is possible in the future. Here are a few ideas on television as your children will know it.

- The televiser of the future will certainly require no outdoor antenna, except in very special cases (fringe areas, etc.).

- Your receiver will be stereoscopic, i.e., the picture will have depth—it will be *three-dimensional*.

- Your TV set will not have a huge picture tube and most probably it will not be a cathode-ray tube at all. Consequently, there will be no dimensional scanning which makes for today's long electronic scanning beams. There will be millions of special spots, self-glowing in three colors when excited electronically in their proper lineal sequence. They probably will be "steered" by atomic autotransistors or like devices.

- The resulting picture will be so brilliant that it can be viewed in bright sunlight. *The size of your TV set will be only as large as its screen.* Thus a 21-inch set will measure about 23 by 16 inches, but *it will be only 2 or 3 inches thick.* The receiver can be placed on a table or hung on the wall like a picture.

*Its glass, plastic or other special faceplate will also be the loudspeaker.* This speaker will be for the bass or low notes. The high notes will have a special speaker incorporated in the frame which surrounds the entire receiver.

- The TV set hanging on the wall, when not turned on, will appear as a beautiful painting, water color or drawing. This picture part disappears the instant the set is put in operation. Thus, instead of a cumbersome-appearing big receiver using a large floor area as

do present sets, the future TV set becomes an esthetic picture on the wall.\* It will weigh less than 25 pounds, making it easy to service.

- All controls of the future TV set will be pushbutton-operated. Almost invisible, these buttons will be set in the lower part of the frame of the set. Each receiver will have a plug-in cord for remote control operation and a small disc that fits the hand will have its own buttons for tuning, volume, off-on switch, etc.

- Other more elaborate models will be almost wholly automatic. They will turn themselves on and off at certain specified times, for certain programs only, switching to other programs automatically. You will be able to turn the set on or off from any part of the room merely by blowing a tiny supersonic whistle that humans cannot hear. The whistle is similar to the special dog whistles now on the market.

- Merely pushing an extra button on the side of your receiver will change it from broadcast to closed circuit. *It also becomes a transmitter now.* Lenses for viewing and a microphone for listening will be built into the top of the television set frame. Similar TV sets located in various rooms in your home (or office) *automatically become intercommunicating.* Hence you can carry on conversations as well as see other persons in various rooms as desired. Note: Those desiring full privacy simply do not press the special closed-circuit button of their set. They are thus excluded from intercommunication.

- This does not end the versatility of the future TV set. *It can be connected to your telephone* by throwing a special switch on the phone. You can now talk and see people across the continent and they (at least their faces) will appear life size on your receiver.

- If you are a subscriber to the drama, the opera, the concert hall, your TV set will bring you *live* the latest Broadway show or whatever entertainment you desire—for a price of course—over the switched-on closed circuit.

- If you are afraid of burglars, you can become a member of a special safety service supervision company. They will monitor your home 24 hours a day via your TV set. They will watch your home whether you are in or out or on a trip. It would be difficult for burglars or intruders not to be seen. Cutting wires or darkening the supervised rooms will be disastrous for the robbers—it will instantly bring the police on the run.

Lack of space precludes the listing of numerous other uses of the future universal TV set. But one conclusion is certain—*the television set can easily become the most important and valued possession of the future household.*

\*First described by the author in RADIO-ELECTRONICS, January, 1954, page 33.

# What's happening to U.H.F.

*Is u.h.f. a foredoomed failure  
or the salvation of television?*

*Here is an impartial estimate.*

By DAVID LACHENBRUCH\*

**W**HEN the first u.h.f. television station went on the air a little over two years ago, it was hailed as opening a new era in television. Only by utilizing the ultra-high-frequency spectrum, said the Federal Communications Commission, would it be possible to have a nation-wide TV system with a full choice of channels for viewers everywhere.

In April, 1952, when the FCC ended its 3½-year freeze on construction of new TV stations, it outlined an engineering plan which envisioned a maximum of 2,051 stations in the United States—of which 1,445 were to be in the u.h.f. band.

In the mad rush to get stations on the air after the FCC's thaw, too little thought was given to the tremendous handicaps under which u.h.f. stations were starting out. But it wasn't long until the dawn,

Some 350 new TV stations have gone on the air since freeze-end (in addition to the 108 pre-freeze v.h.f. outlets). These included about 150 in the u.h.f. band—of which more than two dozen have already died, for reasons both economic and technical. Nowadays very few new u.h.f. stations are going on the air. The picture is summed up in Fig. 1.

Note that in 1953, when u.h.f. transmitters first became readily available, u.h.f. growth paralleled v.h.f. During the first nine months of that year 81 u.h.f. and 75 v.h.f. stations went on the air. During the same period of 1954, only 22 new u.h.f. stations began telecasting, as opposed to 57 v.h.f.—but in the meantime 21 u.h.f. stations went out of business. Today there are fewer u.h.f. stations on the air than there were on New Year's Day, 1954. The pattern is graphically illustrated in Figs. 2 and 3.

Nevertheless, in many communities, u.h.f. is now rendering a highly successful service—but only in the areas where

u.h.f. is TV and not a "second-class service."

### U.h.f.'s dark clouds

U.h.f. started out under two great difficulties, both due to the tremendous headstart of v.h.f.: lack of receiver circulation, and lack of technical development. When u.h.f. was thrust upon the scene, there were no tried-and-proven transmitters, receivers, antennas or test equipment. There had been virtually no practical experience with the propagation of the u.h.f. TV signal, as compared with v.h.f. We could only accept the word of the leading engineers and manufacturers—and the FCC—that equipment and techniques would develop rapidly.

In setting rules for u.h.f. stations, FCC engineers took an "educated guess" and permitted maximum power of 1 megawatt for u.h.f. stations, on the assumption that it would give coverage equivalent to top-powered v.h.f. stations with effective radiated power (ERP) of 100 kw (on channels 2-6) and 316 kw (channels 7-13). But a megawatt of power was just a prediction—no one had developed and tested a system that could yield more than one-fiftieth of that.

When the first u.h.f. stations went on the air in late 1952 and early 1953, the most powerful available transmitters were rated at 1 kilowatt—capable of radiating the equivalent of about 20 kw through high-gain transmitting antennas. At the same time, v.h.f. stations were boosting their power output to the maximums of 100 and 316 kw!

Propagation, particularly at low power, turned out to be extremely tricky—not at all like v.h.f. In some locations, even close to stations, it seemed impossible to find any signal at all. Receiving antennas were insensitive. Much of the signal was lost in the lead-in. Receivers were insensitive and noisy. As to most of the early con-

verters—the less said about them the better.

Perhaps the most surprising thing is that u.h.f. didn't roll over and die then and there. But u.h.f. stations were an immediate success in a few areas, mostly places which previously had had

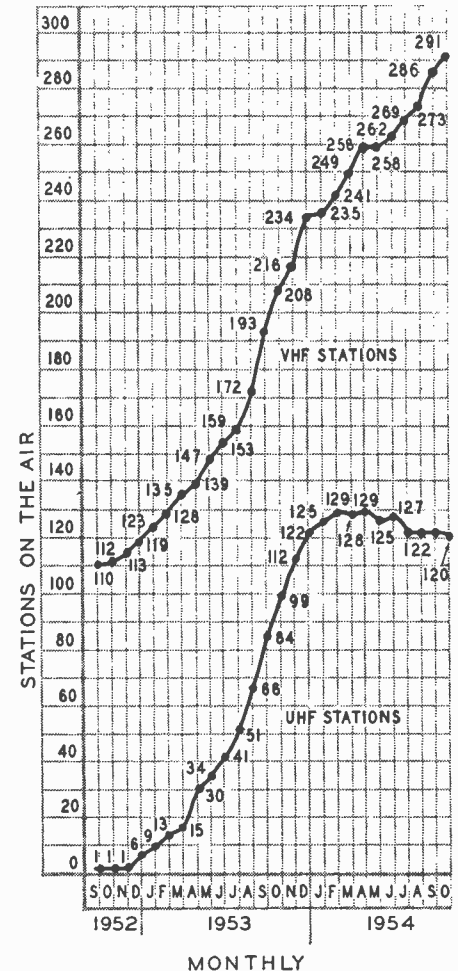

Fig. 1—Total TV stations on the air, September 1952 through October 1954.

\*Associate editor, *Television Digest with Electronics Reports.*



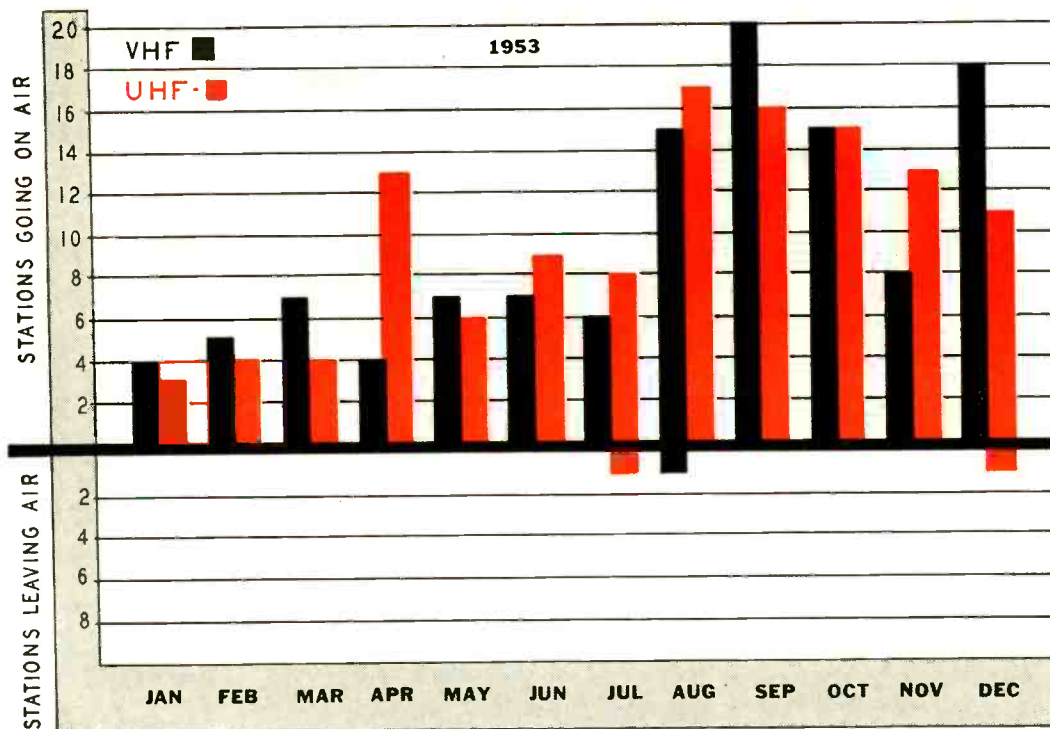

Fig. 2—1953 was a year of boom for both v.h.f. and u.h.f.

very poor fringe TV or none. Conversion problems in such locations were nonexistent or negligible, and the public was willing to go to considerable expense to pick up a good signal. Where there were already established v.h.f. outlets, it was far harder to persuade the public to spend money on converters, new antennas and special installations to pick up the additional TV signal.

**Technical outlook improved**

Technical strides in the past two years haven't materially changed the basic pattern of u.h.f., but they have considerably improved the outlook in many sections of the country. On the transmitting end, 12-kw transmitters as well as directional and higher-gain antennas became available by mid-1953. As 1954 ended, two companies (RCA and G-E) were completing the world's first 1,000,000-watt u.h.f. TV installations!

At the receiving end, high-gain antennas now reach out for elusive u.h.f. signals. Low-loss transmission line does a far more effective job of carrying the signal to the set, even in wet weather. U.h.f. tuners have improved to the point where some now equal their v.h.f. counterparts in sensitivity and noise level.

But even as these technical developments were in progress, concern for the future of u.h.f. became so serious that a Congressional investigation was instituted last spring.

A Senate subcommittee under Sen. Charles E. Potter, Republican of Michigan, held hearings and accumulated 1,177 pages of testimony and exhibits. It heard charges that FCC's policy of "intermixing" v.h.f. and u.h.f. stations

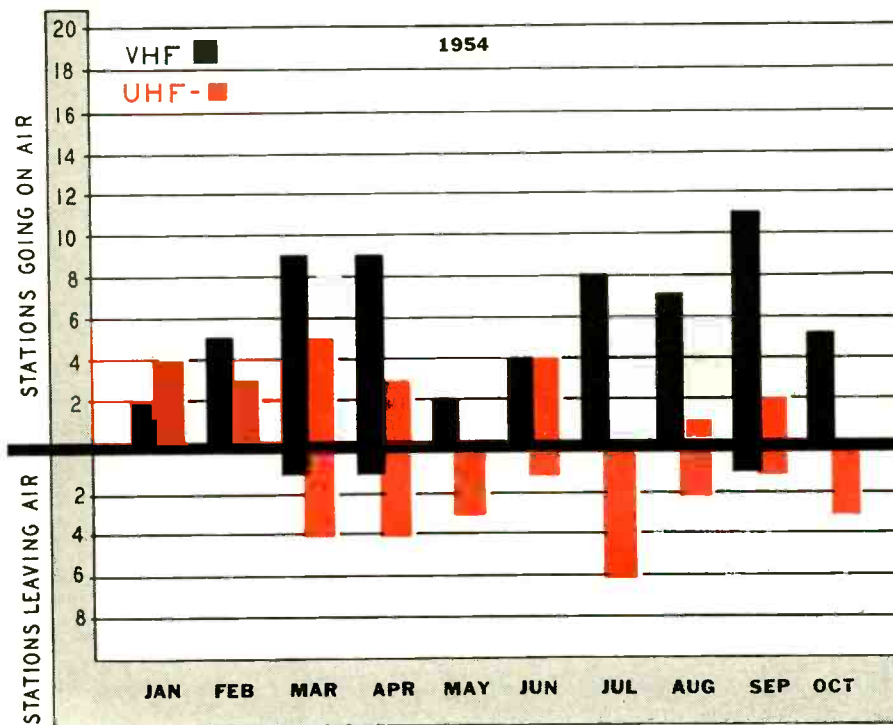

Fig. 3—1954 saw increases, but u.h.f. barely held its own.

in the same markets was a mistake, that v.h.f. station powers and heights were too great, that the networks were at fault for not making better programs available to more u.h.f. stations, that the equipment makers were at fault and even that the u.h.f. stations were at fault for going on the air in the first place. No concrete action came out of the hearings. They did create an awareness of the troubles facing u.h.f.—and may set the wheels rolling toward action to help preserve u.h.f. TV as a nationwide medium.

**Power and programs**

Scanning u.h.f.'s two-year history, one fact becomes strikingly evident. Regardless of equipment problems and technical shortcomings, the communities where u.h.f. has been successful are those where the viewer can see the top TV program on his u.h.f. set. Thus even a 20-kw station with good network programs has far more chance of gaining conversions—and viewers—than the most powerful station showing ancient cowboy movies all day.

In areas with little or no v.h.f. serv-

## TELEVISION

ice, u.h.f. set sales almost invariably are good. The trouble spots are the places where v.h.f. and u.h.f. rub elbows, and in these locations the v.h.f. station has all the advantages.

Because it can claim bigger audiences and wider coverage, v.h.f. can get the top network programs and attract the big national advertisers. U.h.f. station operators complain of inability to obtain national advertising because of "blind prejudice against u.h.f." by advertising agencies and advertisers themselves—even to the point where some agencies and sponsors refuse to buy time on u.h.f. stations in communities where there is no v.h.f.

As u.h.f. stations have shown they can deliver the goods, this attitude has broken down to some extent, and some aggressive u.h.f. stations now boast a lineup of national advertisers that would turn many a v.h.f. operator green with envy. But in the face of local v.h.f. competition, it is still true that most u.h.f. stations have to take the leavings program-wise, and often cannot stir up any large scale desire on the part of the public to buy converters or combination v.h.f.-u.h.f. receivers. In these areas the plight of u.h.f. is most serious.

This is not to imply that u.h.f. is doomed to failure in all communities where there are also v.h.f. stations. Norfolk and Milwaukee are two examples—and there are quite a few others—of communities where u.h.f. stations, backed by good network programs, sound equipment and solid relationships with dealers and service technicians, have gained sizeable audiences, even in competition with well-established and well-heeled local pre-freeze v.h.f. stations.

But the Norfolks and Milwaukees are still the exceptions. Despite undeniable progress in u.h.f. technology, conversion has been disappointing in most mixed v.h.f.-u.h.f. markets. Demand for u.h.f.-equipped sets has dipped: In November, 1953, some 35% of all TV sets produced were equipped with built-in u.h.f. tuners; by August, 1954, the percentage had dropped to 14%. In view of the scanty demand, some receiver manufacturers are beginning to wonder if it is worth while to continue producing u.h.f.-equipped sets.

The current u.h.f. pessimism is found at all levels of the trade from manufacturer to retailer. In many u.h.f. areas, it's difficult to buy some of the leading-brand TV sets equipped with u.h.f. tuners. Promotion of u.h.f. by manufacturers, distributors and retailers has dipped to a new low.

You can't blame the dealer. He probably was stung when the u.h.f. station first went on the air, because he misjudged demand and stocked too many u.h.f. sets and converters. In today's market, the stripped-down set often is the leader, and the consumer shops on a price basis. U.h.f. tuners add \$20-\$50 to the cost of the set. And the dealer knows, too, that he will reap a harvest of ill-will every time a u.h.f. station

dies. Millions of dollars worth of converters, tuners and installations are made useless overnight—and the consumer often blames the dealer as much as he blames the station.

### Will color help?

There is a widely held belief that color TV will be the savior of u.h.f. This belief—based on the assumption that all color sets will be equipped with u.h.f. tuners—doesn't stand up under analysis. The industry's most optimistic prediction of color-set production is 300,000 receivers in 1955, 1,780,000 in 1956, 3,000,000 in 1957—insignificant figures when compared to the 30-odd million TV sets already in use (of which about 10% can now receive u.h.f.).

And who says all color sets will be u.h.f.-equipped? Manufacturers today are under terrific pressure to get the price of color sets down to a figure the mass market can afford. They are ready to leave u.h.f. tuners out if the demand isn't there, and pass the savings along to the public. Who can blame them?

### A boost from FCC

Two recent actions by the FCC could provide a substantial assist in putting u.h.f. across on a nation-wide basis.

The commission recently amended its rules to permit any corporation or individual to own seven TV stations, provided at least two of them are u.h.f. Previous limit was five, with no distinction between v.h.f. and u.h.f. The significance of the new ruling is this: The big networks are anxious to expand their holdings of stations and they must go into u.h.f. if they wish to hold the full limit. With their resources in programming and promotion, the networks could give u.h.f. a healthy shot in the arm by building or acquiring u.h.f. stations of their own. The big networks are already in the process of acquiring u.h.f. stations in accordance with the new rule.

Three of the four TV networks—CBS, Du Mont and NBC (RCA)—are also in the TV set manufacturing business. When these companies engage in the business of u.h.f. broadcasting—when they "own a share of u.h.f."—it's logical to assume they'll intensify their efforts in developing, manufacturing, merchandising and promoting u.h.f. receiving gear.

The second important FCC action is the recently instituted "satellite" policy. The commission says it will encourage low-cost u.h.f. stations by permitting them to rebroadcast signals of other stations without local programming. Such "repeater" stations could be used in a variety of ways—to help fill in "shadows" or "holes" in u.h.f. station coverage, to extend coverage areas of u.h.f. stations or to pipe good programs carried by big-city stations into small-city areas where no TV service exists now. Existing u.h.f. stations could convert to satellite operation, thereby eliminating costs of maintaining local studios and big staffs during the period

when it's so important to build up u.h.f. conversion. For some stations, this economy could mean the difference between staying on the air or giving up the ghost.

While the satellite policy could materially help u.h.f., it also has its dangers—depending upon how the FCC chooses to administer it. Some u.h.f. operators argue that if the commission automatically approves all satellite applications, the big and wealthy v.h.f. stations can build u.h.f. satellites of their own and choke out independent local u.h.f. operations, turning u.h.f. into "another FM." The FCC insists it will approve satellite applications on a "case-to-case basis," its sole criterion in each case being "aid to u.h.f."

The two main proposals advanced by suffering u.h.f. station operators to relieve ultra-high troubles are: 1. "Deintermixture"—that is, reassigning virtually the entire TV spectrum, so that some cities have v.h.f. channels only, other u.h.f. only and none both. 2. Putting all stations in the u.h.f. band. Neither proposal has the slightest chance.

Barring such radical panaceas, the best prognosis for the immediate future is that u.h.f. will continue to struggle along about as it has in the past few months. A few more stations probably will go off the air. Extremely few new u.h.f. stations will go on the air in the next year or so.

It is unlikely that u.h.f. will die out and disappear. There are too many communities where it is successfully providing a needed TV service. But u.h.f. can hardly become a real *nation-wide* service if it is destined to succeed only in those areas where it has little or no direct competition from v.h.f. TV stations.

The real future of u.h.f. as a nation-wide service depends on its ability to compete on equal, or nearly equal, terms with v.h.f. This, in turn, is dependent primarily on these basic conditions:

1. High-power, high-quality transmitting equipment which can give u.h.f. stations a coverage area roughly equivalent to the highest-powered v.h.f. stations.

2. Availability of good v.h.f.-u.h.f. combination receivers at the same price as—or very little more than—v.h.f.-only sets.

3. The continued expansion of the American economy to the point where it is able to support a greater number of competing TV stations in more communities.

Given these three conditions—which can come about only in the relatively far future—u.h.f.'s real nation-wide expansion should come in a slow and orderly fashion in contrast to the get-on-the-air fever of 1952-53.

Short-range, the u.h.f. picture is not a glowing one, though it does have some bright spots. Long-range, given the proper encouragement, the future of u.h.f. can be as bright as the future of TV itself.

END

# COLOR CIRCUITRY

in a

# 19"

# RECEIVER

*Circuit tracing the new 19-inch color chassis*

By ROBERT F. SCOTT  
TECHNICAL EDITOR

**T**HE average color TV receiver is a monster employing from 37 to 45 tubes plus the picture tube, two or more germanium diodes and frequently at least two selenium rectifiers.

A notable change is seen in the new Motorola 19-inch tricolor receivers, the simplest I've seen thus far. The models 19CK1, 19CK2 and 19CT1 twin-chassis sets (chassis TS-902 and RP-902) have only 30 tubes (including the three-gun picture tube) 3 germanium diodes, 3 selenium rectifiers and a diode type high-voltage regulator—a considerable reduction in components.

Circuitwise, the new Motorola is essentially a conventional black-and-white receiver with color circuits added. (See block diagram in Fig. 1.) Shaded circuits are those designed especially for color.

Tracing the circuit from the antenna to speaker and video detector output we have to look hard to find an unfamiliar circuit. The antenna feeds a 6BZ7 cascode r.f. amplifier and a 6U8 mixer-oscillator. Following this is a three-stage 40-mc i.f. circuit feeding separate video and sound detectors—

even this is not new, G-E used it a couple of years ago in one of their first intercarrier receivers.

Fig. 2 shows the circuits immediately following the third composite i.f. amplifier. This stage feeds the video and sound detectors, used separately to prevent cross-modulation and to provide optimum performance in the video detector circuit. The composite video signal applied to the sound detector is rectified to develop the 4.5-mc sound i.f. signal as in conventional monochrome intercarrier television receivers.

The output of the video detector is fed to the first video and sync amplifier, the triode section of a 6AN8. Portions

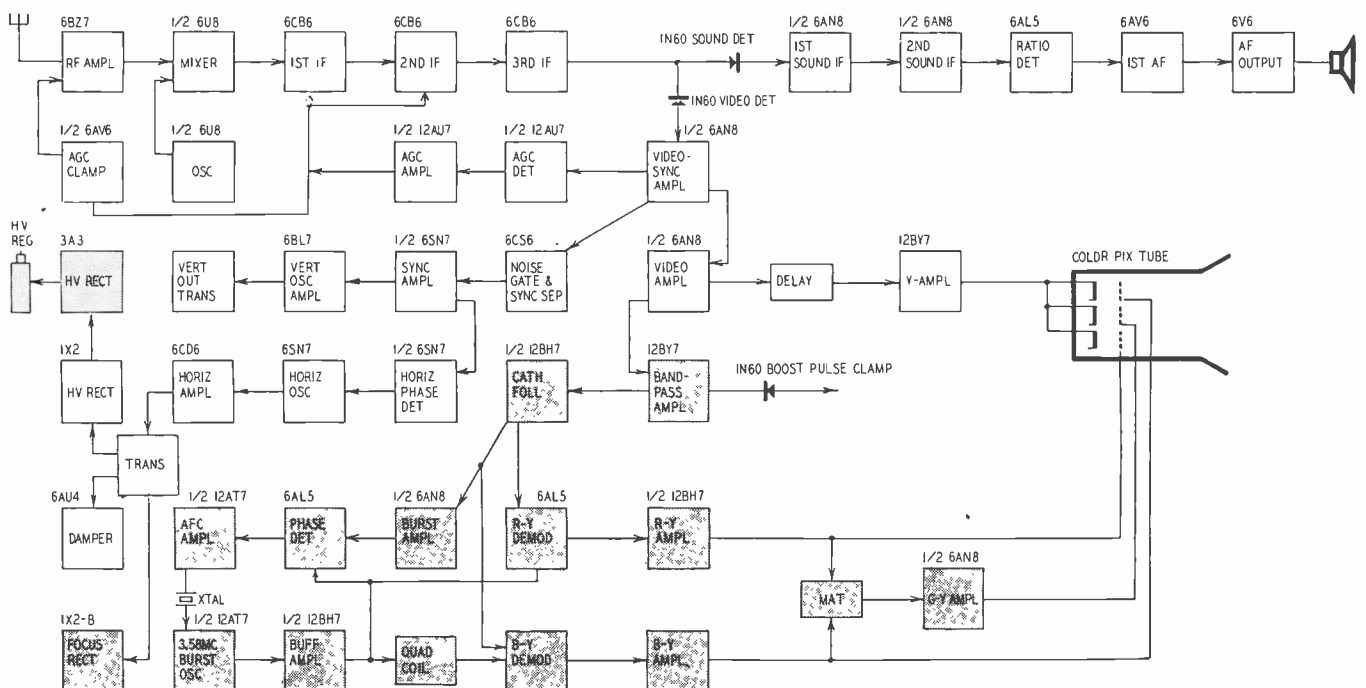

Fig. 1—Block diagram of the Motorola chassis TS-902 showing tube functions and the distribution of signal flow.

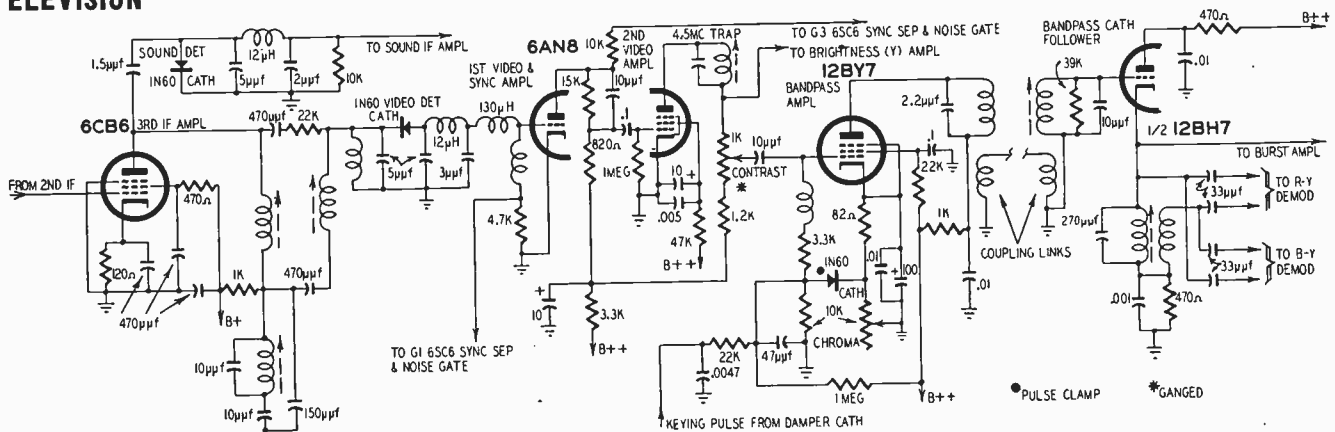

Fig. 2—The video circuits and sound detector following third i.f. amplifier.

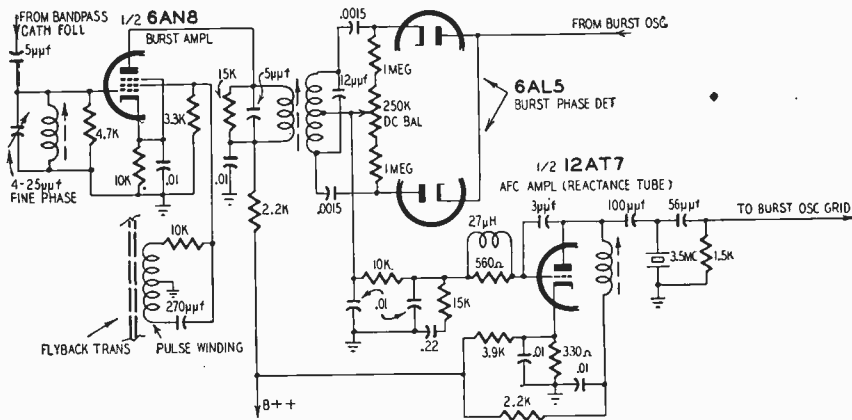

Fig. 3—Schematic of the burst amplifier, phase detector and reactance circuits.

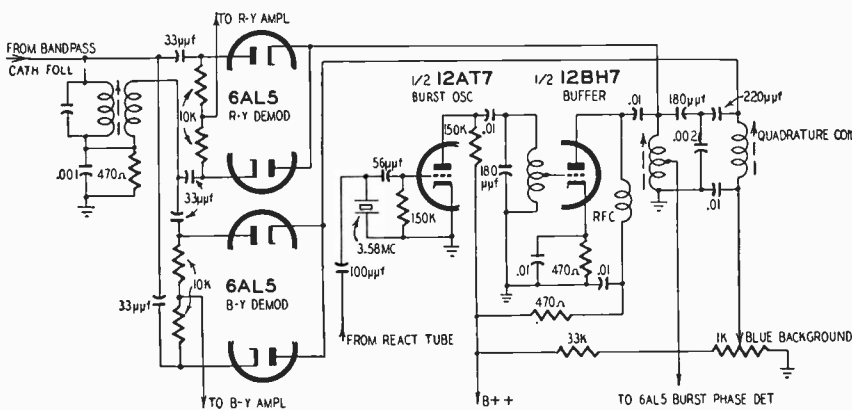

Fig. 4—Schematic of the demodulators, oscillator and quadrature circuits.

of the composite video signal are taken from the grid and plate circuits and used in a noise-immunity sync separator circuit. The second video amplifier raises the signal to the level required by the bandpass amplifier and the Y (brightness) amplifier in Fig. 5.

The bandpass amplifier is a narrow-band video amplifier tuned to pass the 3.58-mc color burst and the chroma sidebands that contain information for reproducing the correct color saturation and hue on the screen. The 4.5-mc sound trap in the plate circuit of the video amplifier prevents the 3.58- and 4.5-mc signals from beating and pro-

ducing a 920-kc beat pattern in the picture.

The output of the chroma or band pass amplifier is link-coupled to the 12BH7 bandpass cathode follower that drives the burst amplifier (Fig. 3) and the R-Y and B-Y demodulators (Fig. 4).

**Color oscillator control**

The color TV receiver—with few exceptions—uses a 3.58-mc oscillator that must exactly synchronize in phase and frequency with the subcarrier oscillator at the transmitter. An 8- or 9-cycle burst of 3.58-mc signal is trans-

mitted after each horizontal sync pulse. It is used in the receiver to maintain color sync.

The signal from the output of the bandpass cathode follower in Fig. 2 is fed into the grid of the burst amplifier in Fig. 3. The 3.58-mc burst is separated from the rest of the video signal appearing on the grid by gating the tube so it conducts only during the period that the burst is being transmitted.

The burst amplifier operates in some respects like an a.g.c. keyer tube. There is no B plus supply for the screen of the 6AN8. Instead of being supplied with a constant d.c. voltage, the screen is coupled through a resistor and capacitor to the opposite ends of a center-tapped winding on the flyback transformer. Lack of screen voltage holds the tube cut off until it is driven into conduction by a positive pulse from the flyback transformer. Horizontal blanking and flyback pulses occur simultaneously so the burst amplifier conducts just long enough to amplify the 8 or 9 cycles of 3.58-mc color sync signal.

The output of the 6AN8 is transformer-coupled to a 6AL5 phase detector similar to the horizontal a.f.c. detectors used in many monochrome TV receivers. The phase of the incoming burst is compared to the phase of the signal developed by the 3.58-mc crystal oscillator in Fig. 4. The phase relationship of the two signals is used to control the oscillator frequency.

If the two signals are out of sync, the phase detector develops a positive or negative voltage—depending on the direction of the error—and applies it to the grid of the a.f.c. amplifier. The a.f.c. amplifier is a reactance modulator connected across the oscillator tank (crystal) circuit. The d.c. voltage on the modulator grid varies the effective reactance in the oscillator circuit and holds the oscillator in exact sync with the burst signal. The phase detector output is zero when the signals are locked in. The d.c. balance control in the detector circuit compensates for circuit unbalance caused by differences in tube and component characteristics.

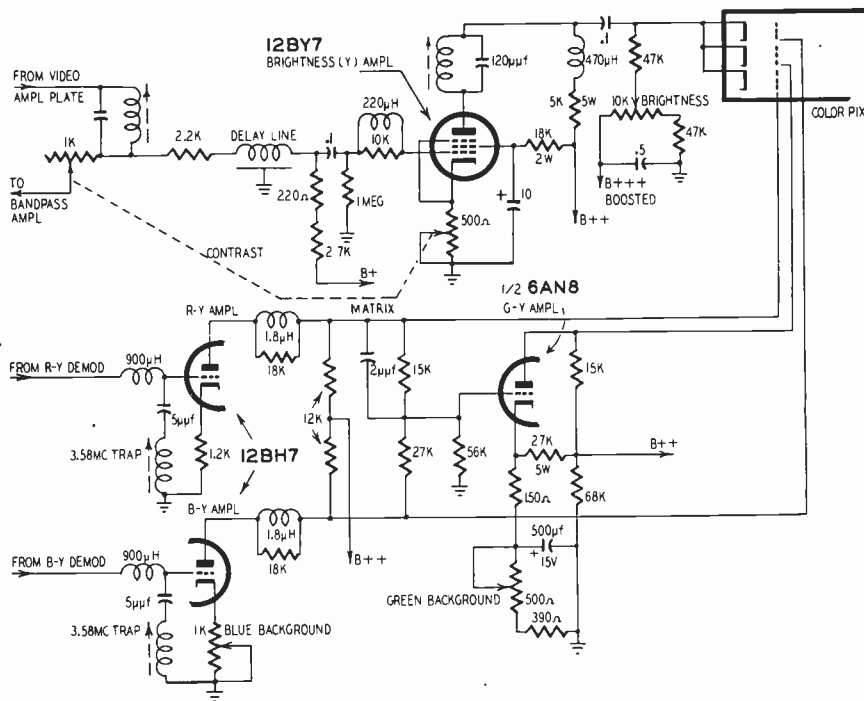

Fig. 5—Schematic of the red, green and blue circuits feeding the picture tube.

**R — Y and B — Y demodulators**

The R — Y and B — Y signals are transmitted as sidebands of the 3.58-mc signal generated and then suppressed at the transmitter. These signals are recovered in their original forms by taking them from the output of the bandpass cathode follower and combining them with the locally generated 3.58-mc signal in balanced mod-

ulators. The signals from the cathode follower and oscillator buffer are polarized and phased to reproduce exactly the original signals at the output of the diode type balanced modulators).

The outputs of the demodulators are fed to the R — Y and B — Y amplifiers (Fig. 5). The oscillator signal is eliminated by the action of the demodulators

and by the traps in the amplifier grid circuits.

The outputs of the R — Y (red) and B — Y (blue) amplifiers are fed to their respective grids on the picture tube and to the grid of the G — Y amplifier through a voltage-divider network (matrix) to reproduce the proper signal on the green grid of the color tube.

The red phosphor is the least sensitive of the three, so it requires the greatest amount of voltage excitation. For this reason the R — Y amplifier is operated at full gain while the amplification of the green and blue amplifiers is controlled by background controls in the cathode circuits.

**The Y amplifier**

The R — Y and B — Y signals are unavoidably delayed as they pass through the bandpass amplifier—the phase of a signal is always delayed when it passes through a low-pass or narrow-band circuit—so the Y signal from the video amplifier is passed through a delay line which delays it the same amount as the R — Y and B — Y signals are delayed in the band-pass amplifier. The Y amplifier drives the cathode of the picture tube. Over-all brightness is controlled by a potentiometer common to the three cathodes. Contrast is controlled by two ganged potentiometers—one in the brightness-amplifier grid circuit and the other in the cathode return of the Y amplifier.

The plates of the R — Y, B — Y, and G — Y amplifiers are direct-coupled to the control grids of the color guns. END

## MINIATURE TV ANTENNAS

**D**URING the past year a number of so-called miniature TV antennas have been advertised as devices that will outperform, and eliminate the need for, conventional indoor and outdoor antennas.

Because of these and other questionable claims, the National Better Business Bureau had three of these devices tested by an independent laboratory. These antennas consisted of about 8 feet of copper wire with a connecting lug at one end and a plastic box, disc or capacitor at the other. (See photos on page 8 of the May 1954 issue.)

Each of the miniature antennas was tested for performance in comparison with a conventional indoor V or "rabbit ears" antenna, and with an outdoor dipole roof antenna.

The laboratory reported that its tests did not support unqualified claims that the devices eliminate snow or ghosts, reduce static or provide clearer, sharper pictures than either indoor V or outdoor dipole antennas.

The units tested showed an increase in snow over both indoor and outdoor conventional antennas. None of the

devices tested was particularly effective in eliminating ghosts, and none reduced static interference.

The laboratory found, in conclusion, that none of the units tested was any more useful or effective as a TV antenna than an equal length of plain stranded copper wire. Testing with and without the end attachment showed that in no case was the end attachment of any use or value in improving reception. Although the miniature antennas tested picked up TV signals, they neither outperformed nor performed as well as either the roof antenna or the indoor V antennas used in the tests.

As a result, the NBBB has recommended to advertisers of these devices that claims made for the performances of their products be limited to the provable facts. One manufacturer of "miniature antennas" has gone so far as to enclose his unit in a transparent case (see photo) with a pretentious

array of resistors and coils mounted around a rotary switch. While not tested by the BBB, members of the RADIO-ELECTRONICS staff tried it out at two locations and found its performance not essentially different from that of the simpler antenna units described above. END

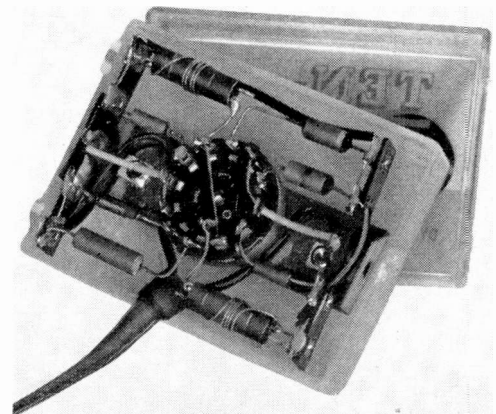

# CONVERGENCE in 3-GUN C-R TUBES

*Problems involved in the positioning of electron-gun beams*

By LEONARD LIEBERMAN

CONVERGENCE and focusing difficulties in color had their monochrome equivalent when black-and-white tubes grew in size from 10 to 21 and 24 inches. In most 10- and 12-inch tubes, the deflection arc of the beam was 50° to 54°. With this beam sweep, it was simple to design a deflection and focusing system that kept

the beam in relatively good focus across the tube.

As shown in Fig. 1-a, with the short distance to go, it is possible to sweep 26° from the center of the flat plane of glass with very little defocusing. With an increase in the size of the screen this deflection angle is still possible (Fig. 1-b) except that the bell of the tube becomes unmanageably large. To reduce the tube length, the deflection arc had to be increased to 70°, or 35° either side of center.

Fig. 2 shows what occurred to the focusing at the sides of the sweep when the deflection arc was increased. Old-timers will recall the many readjustments that were necessary. If the picture was well focused at the center, it was defocused at the edges. Many a bald or gray spot can be attributed to the early 15- and 16-inch rectangular tubes.

The component makers soon came up with a solution. Since the 70° yokes similar to the yokes with a uniform 52° field could cause such trouble, perhaps a nonuniform field might correct it. Thus was born the 70° cosine yoke. In this yoke, using a specially designed flared edge, the magnetic field across the neck of the tube was so deformed at its edges that as the beam was deflected to the sides of the tube, its focal length was increased. This resulted in a beam that maintained a relatively good focus from side to side.

This problem—to a greater extent—exists in the three-gun shadow-mask tube. To understand it, a brief review of the tube's construction will be helpful. The three color guns are mounted parallel to each other and to the neck

of the tube. They lie 120° apart, around the axis of the neck.

The guns face a screen containing approximately 300,000 holes, accurately spaced. These holes are so arranged that when the three beams pass through, they strike a triad of phosphor dots. If the beams are properly adjusted, each beam strikes a dot of the same color as the information fed to its input grid.

### Focusing

Now the problem of a curved deflection arc and a flat screen enters. First, assuming the mask were not there, none of the beams would enter the bell of the tube from the axial center of the neck. The deflection-yoke field must be different for each of the beams the moment the sweep passes the center of the screen. Second, even though the distance between the guns, at the neck, is small, by the time the beams reach the end of the sweep, there is a sizable variation in the focusing point of each (Fig. 3). This effect becomes a problem because each of the beams must pass through the same hole.

It is not possible to make all of the corrections with a properly designed yoke as in monochrome. This is due to the first complication mentioned. Because the three beams are not in the center of the neck but toward the outer edge, only a uniform field would affect them in the same way.

In the three-gun tube, this problem breaks down into four parts:

1. To bend all the beams so as to make them coincide at the center of the tube.
2. To control the three beams so that

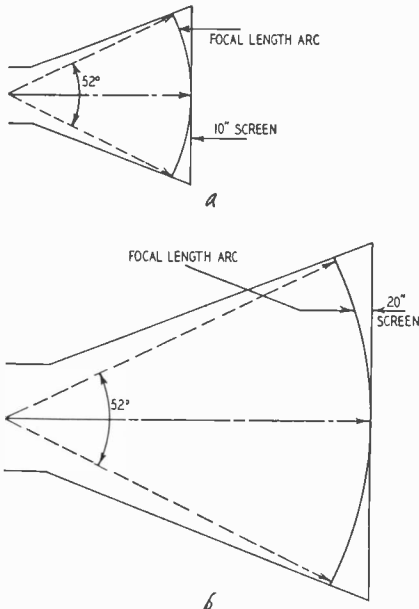

Fig. 1—Narrow-angle deflection tubes.

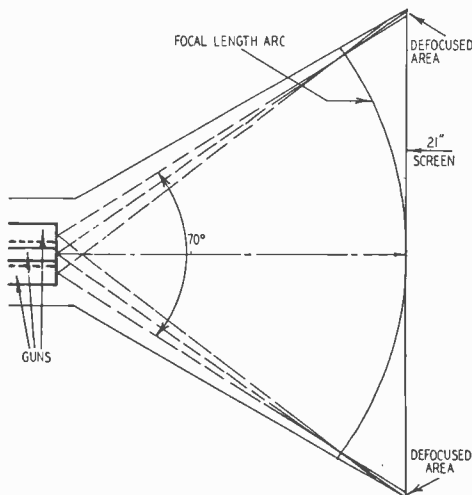

Fig. 2—Wide angle creates defocusing.

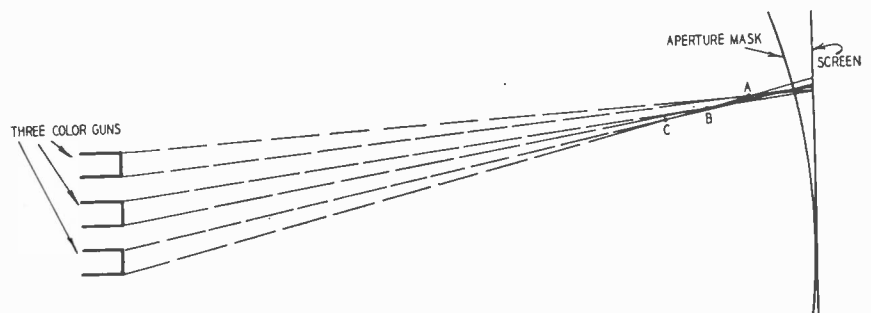
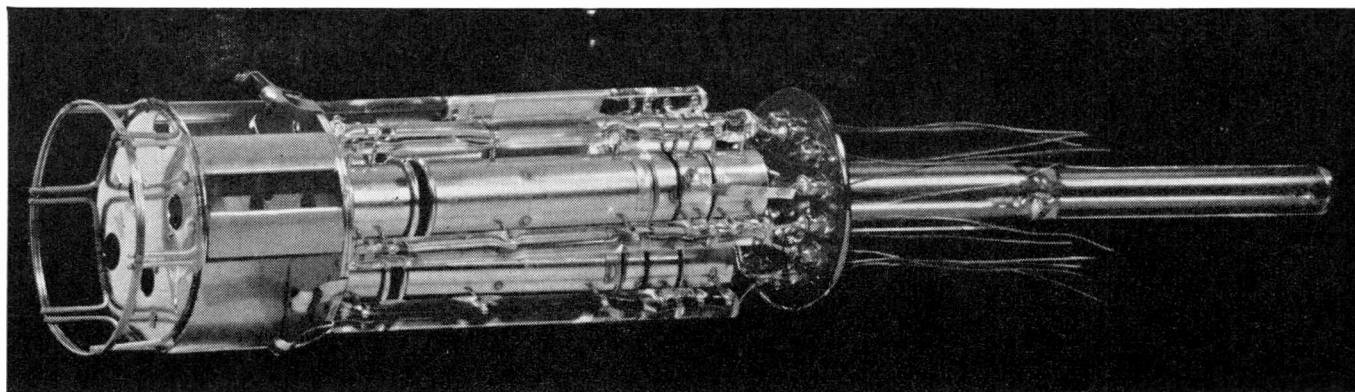

Fig. 3—Each beam focus at different point (a,b,c)—path lengths differ.



CBS-Colortron 205 electron-gun assembly.

- they focus individually when they coincide at the center of the tube.
3. To cause the three beams to coincide at the holes at the sides.
  4. To cause the individual beams to change their focal lengths in such a manner that they are in focus at the sides of the tube.

**Obtaining proper convergence**

The first two problems are met by static methods—the voltages and currents in the operation are constant. Static focusing requires accurate placement of the three guns 120° from each other in the neck of the tube and an electrostatic focusing grid in each gun.

The voltage on an additional electrostatic grid common to all guns is varied

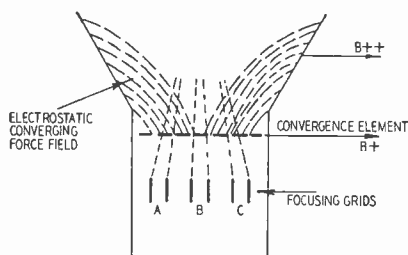

Fig. 4—Effect of convergence grid.

for static convergence.

These grids act as electrostatic lenses. The lenses function through the electrostatic fields between the various grids because of the different voltages on these grids and the second anode. The focusing action is similar to that in an electrostatically focused monochrome tube. In the color tube the focusing lenses are created between the focusing element and the common convergence grid. If we consider the three beams entering the convergence

field as part of one large beam, then the convergence grid can be looked at as a large focusing grid bringing the three separate beams together at a common point. This “focusing” of the three beams is called convergence. Fig. 4 shows the effect of this grid.

The third and fourth problems are handled by an a.c. voltage impressed on the focusing and convergence grids. This voltage is impressed on the focusing grid to maintain a constant voltage relationship between it and the convergence grid. The voltage waveform is parabolic, and causes the convergence field pattern to change. The change is such that the focusing effect on the three beams compensates for the variations in the distance each beam travels. To help this effect, the holes in the mask are not uniformly distant from each other but spread slightly.

This waveform is developed from circuits like those shown in Fig. 5 (from the RCA color set). Sawtooth voltages are taken off the cathodes of the horizontal and vertical output amplifiers. The horizontal pulse is shaped into a parabola by the .0047- $\mu$ f capacitor and L113. The vertical pulse is shaped by feedback network C197-R238-R239.

The amplified output of this tube is applied to transformers in parallel. The combined output of these transformers (Fig. 6) is applied through C193 to the convergence grid. A portion of this parabolic waveform is applied to the focus grid.

A d.c. voltage is also applied to the convergence grid. This d.c. convergence voltage is tapped off the regulated second-anode voltage. In this way, the voltage relationship between the second-anode and the convergence grid is kept constant. The d.c. voltage from

focusing is taken from a separate focusing rectifier (Fig. 7). In this particular circuit, the rectifier taps off the high-voltage transformer. The retrace pulse is rectified and the a.c. filtered out by C206, R247, R248 and C207. The d.c. applied to the focusing grids is taken off through the arm of the focus-control potentiometer. Another way to improve convergence toward the tube edges is to use a curved mask and faceplate, as in the CBS-Hytron Colortron.

**Larger tubes**

The 19-inch and bigger tubes have no convergence grid. They use external

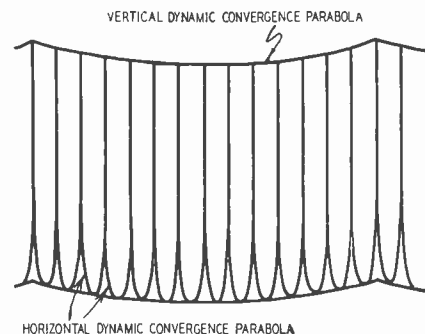

Fig. 6—Output waveform of Fig. 5.

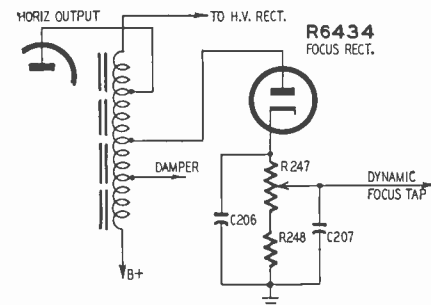

Fig. 7—RCA focus rectifier circuit.

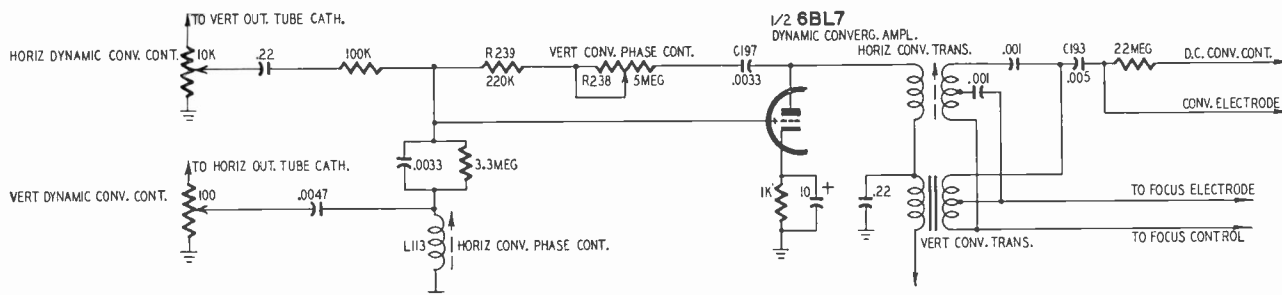

Fig. 5—Schematic of the RCA tricolor dynamic convergence circuits.

## TELEVISION

convergence coils, as described in the article beginning on page 66 of last month's issue.

DuMont has developed a 19-inch tube with 60° sweep and reduced over-all length, using a curved mask and faceplate and special gun design.

The gun is shorter and narrower than those used hitherto. The center axes of the three guns are brought 30% closer together and a higher convergence voltage is used. It is claimed that the focal length of the three-beam convergence is thus increased. This increased focal length, the reduction of the distance each beam travels, and the curved mask and plate enable the beams to be converged at the ends of the 60° of sweep.

The effects of beam interaction, due to the closeness of the three beams to each other, are overcome by precision holes in the aperture mask and the high degree of accuracy achieved by photographically printed phosphors.

The CBS Colortron 205 (see New Tubes — RADIO-ELECTRONICS, September) is another wide-angle deflection color tube. The 19-inch 62° deflection tube provides proper convergence by tilting the three beam sources toward the common tube axis. RCA's new 21-inch tube—on which no detailed information was obtainable at the time this article was written—has the curved mask and faceplate to improve focusing toward the edges of the tube.

### Adjusting convergence circuits

The dot generator is a very useful tool for setting up the convergence system: it enables the service technician to produce a series of dots on the screen.

Turn the d.c. convergence control until the dot pattern in the center of the raster is in the color design:



Increase the d.c. voltage and adjust the beam-positioning magnets until a single white dot replaces the above triad in the center portion of the screen. The focus control may have to be touched up since the convergence and focusing voltages interact.

The dynamic convergence controls (horizontal and vertical) also are interdependent. Adjust the vertical dynamic control until the dots at the top and bottom of the raster show only slight color fringing at the sides. The d.c. convergence control is then adjusted until the dots in the center of the screen are all white from the top of the raster to the bottom.

The horizontal dynamic control is then set so that the dots at the side are either all white or show a slight color fringing. In the event of fringing some slight readjustment of the d.c. convergence control may be needed. If it is not possible to bring the dots in evenly on both top and bottom or from side to side, it may be necessary to adjust the vertical-convergence phase control in the first case or the horizontal-convergence phase control in the second case. END

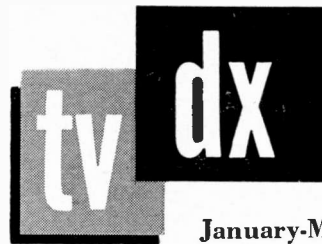

January-March

**T**HOUSANDS of individual reports sent in by observers in all parts of the United States and Canada, as well as a few from South and Central America, are now being studied in preparation for the publication of the usual yearly summary of TV dx. Ordinarily this would have been available for the January issue, as in the past, but your TV dx editor has been on an extended trip through the Far West and the work of analyzing the reports has been delayed thereby.

Now that the reports are all in there is no doubt about it: the summer TV dx season of 1954 was the best on record. With this in mind, TV dx-ers are looking forward to a good winter

season, too. That there is a winter dx season may come as a surprise to some, though the more experienced observers look forward to it each Christmas time. It will have gotten under way before this appears in print and will run through about the middle or latter part of January.

February and March will not amount to very much dx-wise. They are the lowest dx months of the year, although there is always the possibility of occasional scattered openings. Tropospheric propagation will be generally poor over most of the first quarter, though the latter part of March will see an increase in receiving range in the more southerly parts of the country. END

## THE WAVES OF WIRELESS

By LEE DE FOREST

With the swift speed of light we travel  
From ten thousand centers to envelop the earth  
In a woven web of intangible nothingness.  
No mighty storms harass us, we penetrate all atmospheres,  
Scouring the tallest mountain, leaping the broadest valleys;  
Refracted by knifelike edges, we can skim  
Into unbelievable canyons, where theory forbids us entrance.  
Continuous or modulated, in bursts or shaded impulses,  
In lower, high or ultra-high frequencies.

We bear abroad the broadcast messages.  
(These often are unworthy of our lofty lineage,  
Ill suited to be winged so far and generously.)  
At certain hours we bear abroad world news,  
Of earthquakes, floods, war and consummate disasters:  
Or messages from man's weak rulers to yet weaker men.  
Though our origin dates from the primordial lightning flash  
But recently did Maxwell predict, and Hertz show how  
Mere Man could generate and frame us to his purposes.  
These uses were well worthy of us ether waves.  
Gladly we sped across the seven seas,  
And mounted to high ionospheres, the meteor's dust,  
O'er wider realms to spread our silent signals.

Marconi harnessed us with Morse's dots and dashes,  
Fessenden and de Forest learned to form us into spoken words,  
With music to enrich our wings to gladden all mankind.  
(Perchance to tell some listening being in some infinite Remote  
That Earth has now evolved some voices like the angels')  
More recently a clan of scientists has artfully conspired  
To frame us into pictures, etheric, yet widely visible at last,  
To bring new wonders, synthetic sights, to millions of mankind.  
Strange fingers reach aloft from countless house-tops  
Silently groping for us through the silent night.  
To snare some infinitesimal fraction of our wasting watts  
And lead them downwardly before the family hearths  
There to emblazon on a magic screen  
The vision of some spectacle scanned countless miles away.

We are the Waves of Wireless  
Destined to a nobler mission than we yet have found,  
When Man will learn to trust to us  
Only the best he knows, his grandest music, and his finest songs,  
His sterling sermons, and most worthy plans,  
His visions of most comely womankind, and earth's most noble scenery  
And all the themes that frame man's Godlike destiny;  
Leading at last Humanity to a Future worthy of us Messengers—  
We Wireless Waves.



*Transistorized***PORTABLE RECEIVER**

By G. B. HERZOG\* and R. D. LOHMAN\*

**T**HIS article reports on a pioneering attempt to build a television receiver in which transistors were used for all the functions performed by vacuum tubes, other than the picture tube (5FP4). The preliminary result is a single-channel receiver consuming only 13 watts of input power. Of this, 3.6 watts, or more than 25% of the total, is consumed by the 5FP4 filament. The entire receiver is about the size of a portable typewriter case. Complete with batteries it weighs only 27 pounds. As a completely portable set it gives good results in the New York area. This receiver was built in late 1952, and transistors developed since may allow some circuit simplification.

The set was built to receive signals from channel 4, the NBC station in New York. The built-in loop antenna is therefore tuned to 67.25 mc. Operating without an r.f. stage, the incoming signal is heterodyned with the local oscillator output in a balanced diode mixer (Fig. 1). The oscillator uses a 2N33 high-frequency point-contact type transistor operating in a base feedback type circuit. The frequency of the oscillator was chosen to produce an 8-mc picture i.f. Following the mixer are six stages comprising the i.f. amplifier.

All six stages are essentially the same and use point-contact transistors in grounded-base circuits (Fig. 2). A coil wound on a ferrite torroid smaller than a dime provides the inductance for the collector tank circuit of each stage. Variable capacitors allow these to be stagger-tuned to give the bandwidth required for intercarrier sound. Impedance matching is obtained by a tap on the inductance. Good power transfer between the high collector impedance and the low input impedance of the following emitter is thus obtained. The transistors are biased at 1-ma emitter current obtained from penlite cells.

Two point-contact transistor second detectors provide optimum paths for the sync and video components of the signal (Figs. 3, 4). The emitters of these detectors are unbiased and act as diode rectifiers. The rectified signal is internally coupled and amplified by transistor action to the collector circuit. The video amplifier (Fig. 3) uses both a junction and a point-contact transistor. The base-input junction transistor presents a reasonably high input impedance to the second detector and at the same time stabilizes the point-contact transistor to the extent that high-frequency

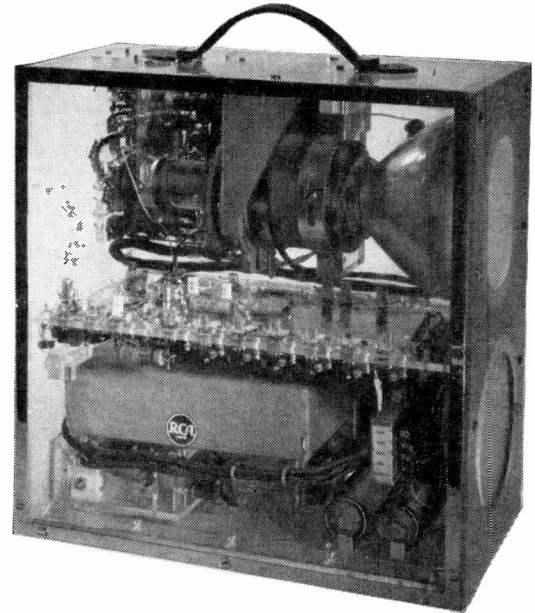
*A stage-by-stage**analysis of an**experimental**TV set*

quency positive feedback can be applied in its base circuit.

The 4.5-mc intercarrier sound signal is taken from a trap located in the video second-detector output circuit. Three sound i.f. stages plus a ratio detector provide the necessary gain for the sound channel. An audio amplifier consisting of one preamplifier stage and a complementary symmetry output stage (Fig. 5) drive a 5-inch speaker. This output stage uses the complementary nature of p-n-p and n-p-n transistors to provide push-pull amplification without a phase inverter. Many novel applications of this circuit have been published.<sup>1, 2, 3</sup>

The signal obtained from the sync second detector (Fig. 4) is coupled to a junction transistor which acts as a sync separator. The sync signal is positive and causes the emitter junction of the p-n-p transistor to conduct on

the sync tips. The charge deposited on the coupling capacitor by this conduction keeps the transistor cut off between sync pulses. The pulses themselves are internally coupled to the collector and after amplification are fed to the horizontal a.f.c. circuit and the vertical integrator. The vertical pulse from the printed-circuit integrator is amplified and then used to trigger the vertical oscillator (Fig. 6). This oscillator uses the negative-resistance region of a point-contact resistor to provide free-running oscillations with a sawtooth waveform. The sawtooth is then amplified and applied to a complementary symmetry output stage. This type output stage allows direct coupling to the yoke without the presence of decentering current.

**Horizontal deflection**

The horizontal scanning circuits use

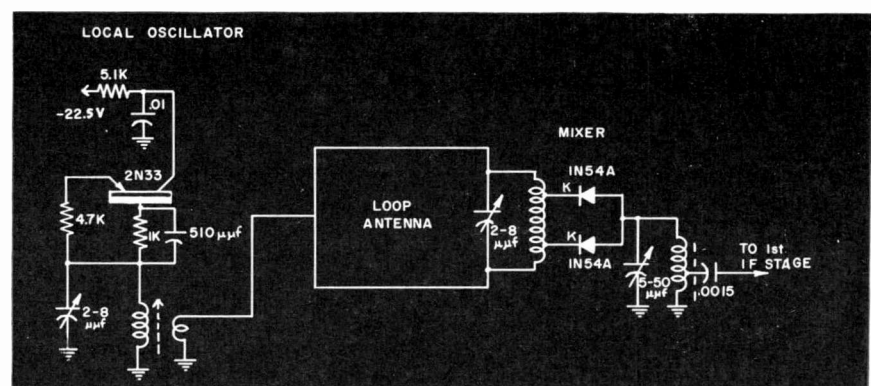
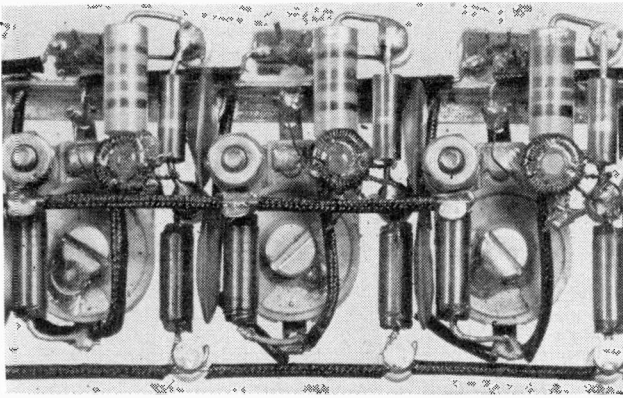

Fig. 1—Local oscillator-mixed circuits. Transistor and two diodes are used.

\*RCA Laboratories Division, David Sarnoff Research Center.



Close-up of section of the i.f. strip. Note the small size of the torroids. The trimmers are 8-50  $\mu\text{f}$ .

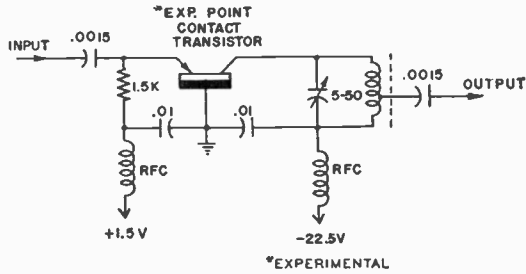

Fig. 2—A typical transistor i.f. amplifier stage. Six are used in the set.

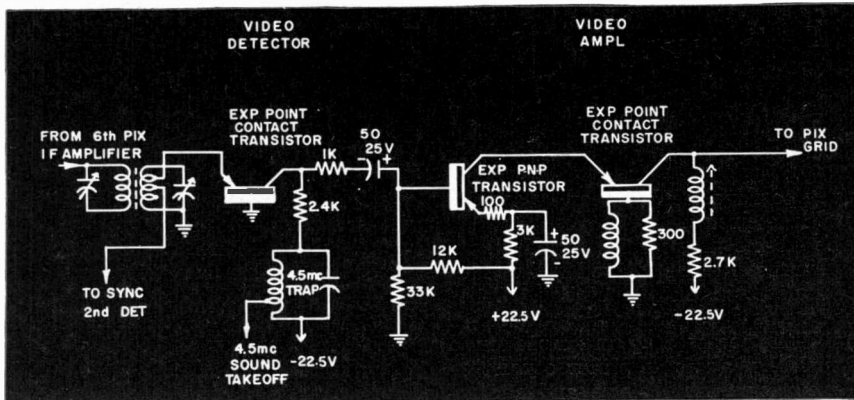

Fig. 3—The video detector and grounded-emitter-grounded-base amplifier.

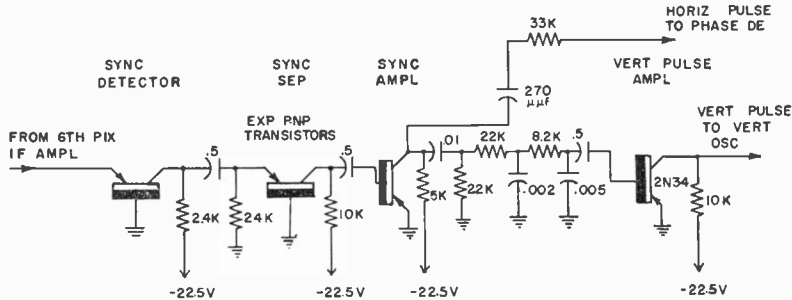

Fig. 4—The sync separator and amplifier section, which uses four transistors.

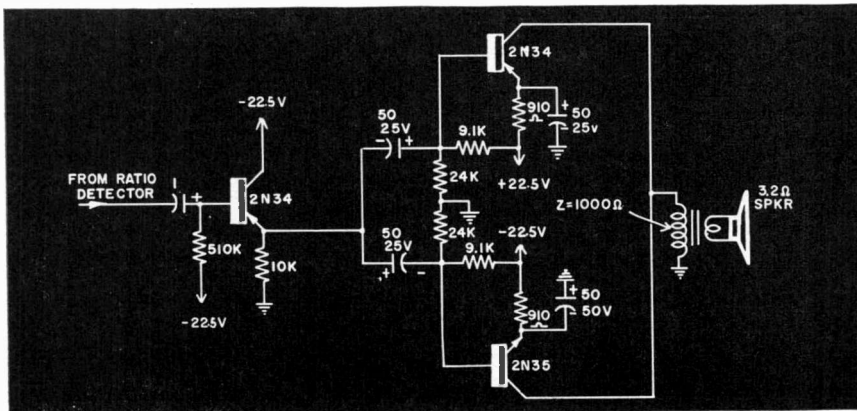

Fig. 5—The audio amplifier and complementary symmetry audio output stage.

a.f.c. (Fig. 7). These circuits make use of the symmetrical characteristics of individual junction transistors.

Unlike vacuum tubes, where one of the elements must be heated to give off electrons, transistors require only the application of the proper potentials for current flow. Thus in an alloy p-n-p junction transistor, either junction may emit holes and the other collect them. Proper design can make the two junctions exactly alike, and both can act either as emitter or collector. This property may be used to make an extremely simple phase detector. The horizontal a.f.c. circuit compares the horizontal sync pulse to the scanning sawtooth. If they are not phased properly, a correction signal is produced. No push-pull signals or transformers are required.

A sawtooth signal is taken from the horizontal deflection yoke. This may be obtained from a small resistor in series with the yoke, thus giving a voltage proportional to the current, or it can be obtained from an R-C circuit across the yoke. The sawtooth voltage which appears across the capacitor of the integrator is capacitively coupled to the phase-detector transistor so that it appears between the two junctions. If one junction is grounded, the other will go equally positive and negative with respect to ground since the sawtooth loses its d.c. component in the coupling capacitor. As long as the transistor does not conduct, there is no d.c. potential on the ungrounded junction and the filter circuit from this point to the horizontal oscillator frequency-control device will not pass any correcting signal.

When the amplified sync pulses are applied to the base of the phase-detector transistor, the transistor will conduct for the duration of the sync pulse. The direction of current flow through the transistor when it conducts is determined by the instantaneous voltage on the junctions. If the horizontal oscillator is running at exactly the correct frequency and phase, the voltage on the ungrounded junction will go from positive to negative in the sweep return portion of the sawtooth. The transistor will therefore briefly conduct current in one direction and then the other.

If the phase is correct, the currents will be equal and no unbalanced charge will be left at the end of the sync pulse conduction period. If the oscillator begins to run too slow, the sync pulse will occur while the sawtooth voltage on the ungrounded junction is positive and this junction will act as the emitter, positive current flowing to ground and leaving the coupling capacitor with an incremental charge. This charge causes to appear on the ungrounded junction a negative potential which is passed through a filter to the oscillator frequency control device. If the oscillator runs too fast, the output is positive.

#### Horizontal oscillator

This circuit consists of a pulse generator using the negative-resistance ef-

fect found in a point-contact transistor. Its operation is similar to that of the vertical oscillator. The component values are different, however, to give the proper frequency and pulse output rather than sawtooth. The rate at which this oscillator runs is determined by the R-C time constant associated with the .015- $\mu$ f capacitor between the emitter and collector of the transistor. As long as there is a sufficient amount of charging current flowing through the emitter resistor, the transistor is kept nonconductive. When the current falls below a critical value, the potential at the emitter permits conduction which is regenerative.

If the effective resistance of the charging circuit is changed, the rate of oscillation will change. The effective resistance of the emitter resistor can be changed by shunting it with a transistor. This transistor has a certain quiescent bias causing a pre-fixed amount of current to flow. The variable resistor in series with the oscillator emitter is adjusted to nearly the correct frequency as is normally done with the horizontal hold control on TV sets. The phase detector then provides an output which is applied to the base of the transistor, shunting the oscillator emitter resistor. The control signal changes the conduction of this transistor, changing the frequency of the oscillator. If the oscillator is running too slow, a negative output will be obtained from the phase detector. When this negative signal is applied to the p-n-p transistor shunting the oscillator emitter resistor, its conduction will increase, thus allowing the charging capacitor to charge more rapidly and the oscillator to increase its frequency.

The output pulses of the oscillator are amplified by a complementary symmetry pulse amplifier and then applied to a "totem pole" power amplifier (Fig. 8). This is a regenerative type pulser which switches the bases of the output transistors from a large negative bias present during forward trace to a large positive bias which cuts the output transistors off during retrace. The output transistors are directly connected to the horizontal yoke and act like a switch which connects the yoke to a battery on forward trace and open-circuits the yoke to cause retrace.

The pulses which occur across the yoke are used to drive a 2-stage class-B amplifier (Fig. 9). The final stage works into a stepup transformer tuned to the horizontal line frequency. The secondary voltage is rectified by a selenium rectifier and provides 2,000 volts for the second anode of the picture tube.

The most important difference in a set which might be built today would be the absence of almost all the point-contact transistors. END

**References**

- <sup>1</sup> G. B. Herzog, "A Transistorized Ukulele," *RADIO-ELECTRONICS*, February, 1952.
- <sup>2</sup> G. C. Sziklai, "Symmetrical Properties of Transistors and Their Applications," *Proc. of the IRE*, June, 1953.
- <sup>3</sup> R. D. Lohman, "Complementary Transistor Circuits," *Electronics*, September, 1953.

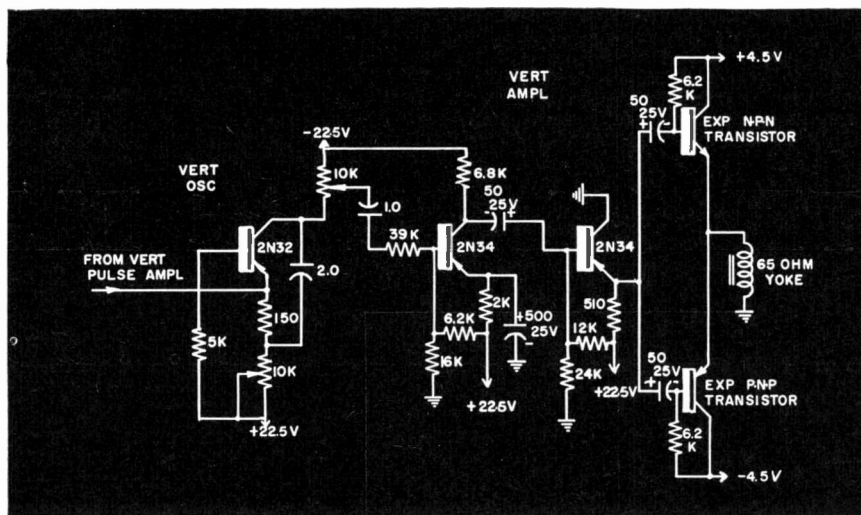

Fig. 6—The five-transistor vertical deflection circuit is rather elaborate.

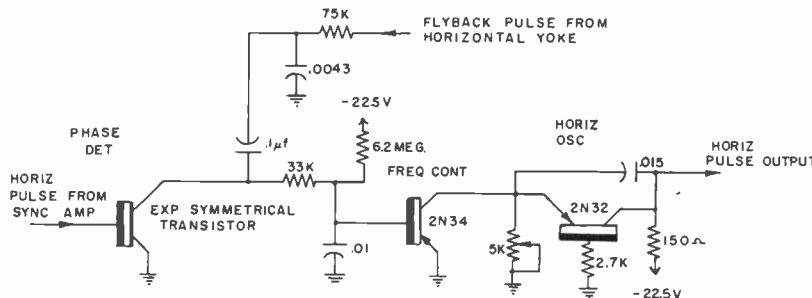

Fig. 7—The horizontal a.f.c. system depends on a symmetrical transistor.

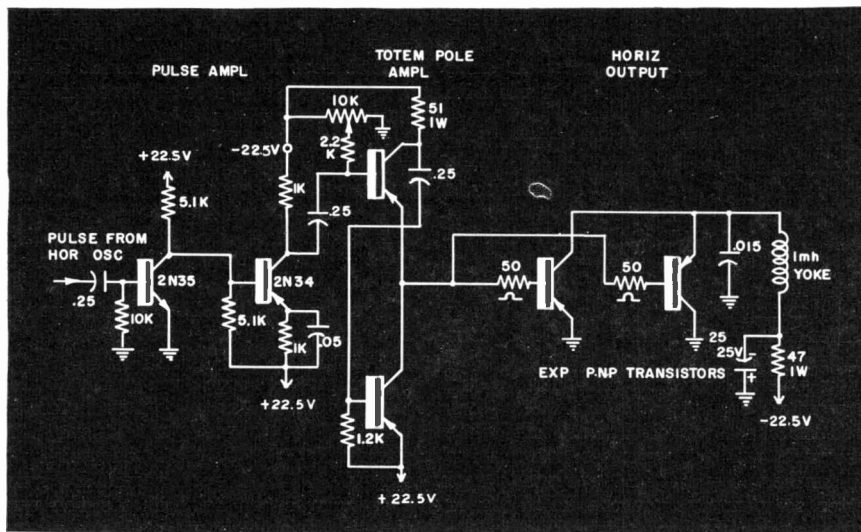

Fig. 8—The horizontal deflection system—another ingenious use of transistors.

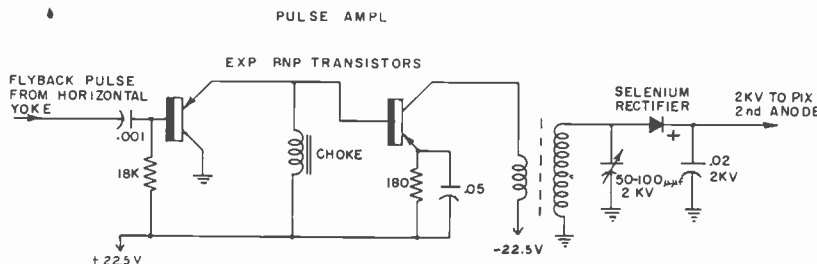

Fig. 9—Even the high-voltage supply in this receiver has been transistorized.

# TELEVISION and ELECTRONICS



By

BRIG. GEN. DAVID SAROFF\*

... a look into the future

TELEVISION has made it possible for man to see what goes on elsewhere without having to go there bodily—a great boon to mankind. And it is a great field of endeavor for all of us to be engaged in, especially for the younger men who are now entering the new field of color television with its promising future.

The developments and the promise of color television are so great that there is room for everyone. If we look back ten years from now—perhaps even five years from now—upon the color structure as it exists today, we will not recognize it. The progress that will be made from here on will be of such tremendous dimensions that I believe almost everything used in color TV today will be obsolete. This is nothing to worry about, for our industry has lived on obsolescence. But obsolescence does not mean stagnation. It means replacement by better equipment and better service. That is the hallmark of radio and television, whether it be black-and-white or color. Progress comes through pioneering effort and leadership. And it is here that we meet the human element.

Now, as to color equipment: RCA recently demonstrated a 21-inch color tube and a simplified color receiver that will operate with that tube (see photos). The new set will use only a few more tubes than an ordinary 21-inch black-and-white receiver. The simplification of the circuit and the perfection of the 21-inch color tube will

mark, I think, the beginning of practical color equipment for quantity production. The tube is not a revolutionary new invention. It is still a shadow-mask tube, based on the principles we developed in the earlier type of that tube. But it does mark a significant advance.

Color tubes are hard to make. They have very narrow tolerances and it is no secret to those engaged in the business that as many as three or four tubes sometimes have had to be rejected before one good one, could be selected. We think we have reasonably licked that problem with our new 21-inch color tube.

Our main effort has been to produce a color tube which will be steady, will not fringe at the edges, will cover the entire face of the tube with uniform color, will be of adequate brightness and will be of sufficient strength mechanically to be shipped safely. It should be a tube that will be simple to manufacture so that, as the quantity produced is increased, the price at which it is sold can be reduced. In other words, a color tube that lends itself to mass production in the same way that the present 21-inch black-and-white tube does.

These requirements called for new practical inventions—for new methods of mounting and a new type of mask. They called for a number of things that would not alter the quality of the color when the temperature affected the position of the mask, and so on. Those are the things upon which we have concentrated our attention and our efforts, the problems that we believe

we have now finally solved.

Of course, we will not see sales of color sets in any such quantities as the sales of black-and-white sets until there is a nation-wide service of color broadcasting, and until the price to the consumer is within reach of the masses.

Finally, I would like to say a word about possible future developments.

On the 45th anniversary of my association with radio, I suggested to the research men in our Princeton Laboratories that they invent three "presents" for me by the time my 50th anniversary arrives in 1956.

All my suggestions sounded "impossible." But those of us who are unhampered by too much knowledge of the obstacles have more confidence in the scientists than the scientists sometimes have in themselves. Personally I have always proceeded on the theory that whatever the mind of man can imagine, the mind of man can ultimately produce.

In any case, I asked them, first, for a magnetic tape recorder for television programs; second, for an electronic air conditioner and, third, for a true amplifier of light. Amazingly, there is reason to believe that I shall receive all three of these within the time I specified.

The magnetic TV tape recorder has already been produced and functions in color as well as in black-and-white. It records and reproduces sight as readily as magnetic tape does sound. Its applications for the future are many. To cite just one example, the

\*Chairman of the board, Radio Corp. of America.

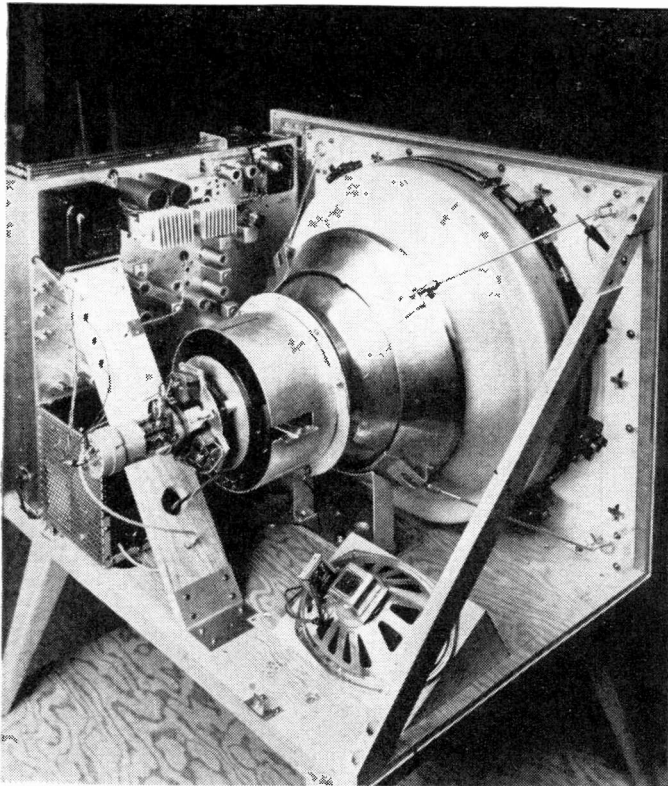

Rear view of the 21-inch RCA color television receiver.

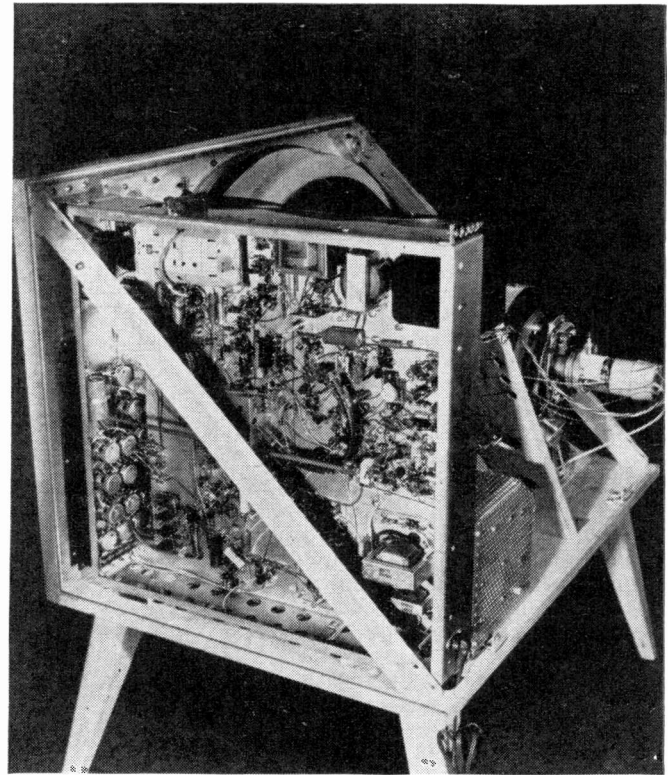

Simplified circuitry. (See block diagram on page 55.)

television camera can be used to make telemovies in the home. You will be able to make a tape recording—in color—of Willie eating his porridge, just as you can now record his first prattlings—and you can see it on your own television set.

As for the electronic air conditioner, I can say that encouraging progress is being made and that a laboratory model is under way.

### Amplifying light

What are the potentials for practical use of such a revolutionary development as the light amplifier? It is not possible to foresee all of them before a new invention reaches the stage of practical application. Often, as we know from experience, the most significant uses are not immediately apparent.

When Faraday produced an electric current, neither he nor his generation could visualize the spectacular future he had unlocked. Neither did Marconi dream of broadcasting and television when he succeeded in sending the first faint wireless signal through the air. I am convinced that electronic amplification and conversion of light will enrich life for all of us.

A first benefit from this research will be bigger and brighter television pictures in the home. I believe that the TV tube of today will eventually be eliminated. It will be displaced by a thin, flat screen like a picture on the wall. Or it may be in an easel-like frame that will sit on your living room table and—being portable—can be moved to any other part of the room or house. If desired, the same program

could be received on a number of screens in different rooms.

The pictures will be controlled from a television box no bigger than a jewel case or cigar box. No cabinet will be required. The television box will contain all the controls—tuning, volume, brightness, station selector—and a knob will enable you to make the image larger or smaller, and in black-and-white or in color, to suit your eye and your mood.

Television, however, is only one of the avenues through which electronic light will flow into daily life. Right down the line it will provide substitutes for present types of light used for illumination.

In other areas, the electronic light amplifier may be expected to lead to devices which will make vision possible in darkness. These will add greatly to the safety of our transportation on land, at sea and in the air. The perils of night driving, too, are likely to be reduced and perhaps abolished by such electronic devices providing far-reaching light without glare.

In short, the sky is the limit in imagining the future of electronic light. The one certainty is that, like other major scientific innovations in the past, it will open roads to improvements on existing products and processes and will give birth to entirely new instruments, appliances and services.

### Transistors

These devices are making progress, and tubeless receiving sets are not far away. There is no change in the prediction previously made that transistors will one day replace all tubes

but the picture tube in television and all tubes in radio sets. The only delay, again, is the delay incident to learning how to produce these transistors in large quantities and at a price that will make them competitive with tubes. Progress in this direction is being steadily made. I shouldn't be surprised if within the next year or two a considerable number of transistors will be used in radio sets.

In recent months, much has been heard of personal and pocket-size radios. They are certainly coming. One day I hope to see the real pocket-size personal radio operating from an atomic battery so there will be no need to worry about battery replacements for at least 20 years. Portable TV sets, that will be truly portable, will also be here one of these days.

In the atomic and electronic age in which we now live, changes are taking place at such a rapid rate that it takes more than our past experience to adjust to them and to appreciate and fully comprehend them. But after all is said and done, the efforts in which we are engaged are stimulating because they are for the purpose of entertaining and informing and educating people and not for destroying them. They are intended to serve the constructive purposes of advancing civilization, increasing happiness and making life more meaningful.

I hope that as progressive changes take place in technology, the mind of man, too, may adjust itself to a more ethical, a more constructive, a more peaceful concept in dealing with the problems that today beset a troubled world.

END

# PICTURE-TUBE REPLACEMENT GUIDE

By E. W. SCOTT

**T**HIS tabulation is designed to show at a glance those characteristics of magnetically deflected TV picture tubes that are important to the technician who has to consider replacing a tube with a more modern type or a larger size. Tubes are listed in groups according to size, shape, construction, method of focusing and deflection angle. Generally, any tube in a specific group or panel is a replacement for those above it in the same group since overall dimensions often determine whether or not the replacement will fit into the cabinet without alterations. RETMA specifications give dimensions with plus and minus tolerances. Data sheets issued by various manufacturers may show slight differences in dimensions but all will be found to be within RETMA tolerances.

Deflection angles are important when replacing one type tube with another. Round tubes up to about 15 inches in diameter generally have deflection angles ranging from 50 to 56°. Since all may use identical horizontal output transformers and deflection yokes they are listed simply as 50° types.

The tabulation lists the horizontal deflection angle for round tubes and the diagonal deflection angle for rectangular types. Thus, a round tube with a 66° deflection angle and a 70° rectangular type may use identical output transformers and yokes.

Original specifications on a specific tube type may call for a double-field ion-trap magnet, yet recently released data sheets may specify a single-field

type. This is because some manufacturers may use a different or improved gun structure that permits the use of the more common single-field beam bender. Some makes of tubes of a given type work satisfactorily with either double- or single-field magnets while others require a specific type for satisfactory operation.

Tubes with aluminized (metal-backed) screens have greater apparent brightness. Those having aluminized screens in the basic type are marked with an asterisk immediately following the type number. When metal-backed screens are available in an improved version carrying a letter suffix, a dagger is used and you should refer to the table

of suffixes to determine the proper type to use.

### KEY TO PICTURE TUBE SUFFIXES

Suffix A: indicates GRAY faceplate on 10BP4, 10MP4, 12LP4, 12QP4, 12UP4, 12VP4, 16AP4, 16DP4, 16HP4, 16JP4, 16LP4, 16MP4, 16SP4, 16WP4, 17BP4, 17FP4, 19AP4, 19DP4, 20CP4, 20DP4, 20HP4, 21EP4, 21FP4, 21KP4, 21ZP4 and 22AP4; GRAY ALUMINIZED faceplate on 10FP4, 12KP4, 12ZP4, 16KP4, 17ATP4, 17LP4, 17QP4, 21ACP4, 21ALP4, 21AMP4, 21ANP4, 21AQP4, 21ARP4, 21AUP4, 21AVP4, 21WPP4, 21XP4, 21YP4, 24AP4, 24CP4, 24DP4 and 24VP4; GRAY-FROSTED on 14BP4 and 17HP4 and CLEAR on 16EP4 and 16GP4.  
 Suffix B: indicates GRAY faceplate on a 16EP4; FROSTED on a 24AP4; GRAY-FROSTED on 12UP4, 16GP4, 19AP4, and 20HP4 and GRAY-ALUMINIZED on 17BP4, 17HP4, 20CP4, 20DP4, 21EP4 and 21ZP4.  
 Suffix C: indicates a CLEAR-ALUMINIZED screen on 10BP4, FROSTED on 16GP4, GRAY-FROSTED on 17BP4 and 20CP4; and GRAY-ALUMINIZED on 12LP4, 19AP4, 20DP4, 20HP4 and 21FP4.  
 Suffix D: indicates a GRAY-ALUMINIZED screen on 10BP4, 20CP4 and 20HP4 and FROSTED on 19AP4.

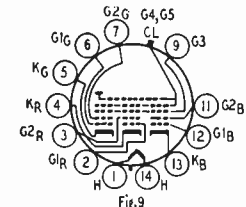
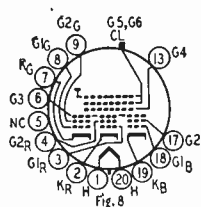
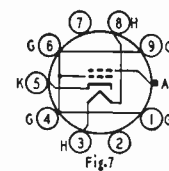
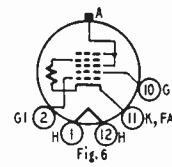
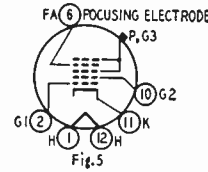
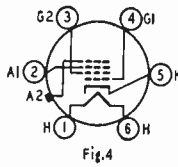
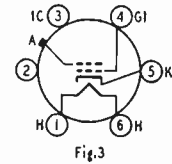
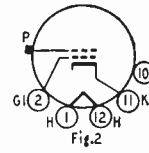
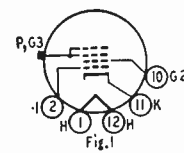

Tube Type	Bulb Diameter or Diagonal (inches)	Over-all length (inches)	Ion Trap Type	Base Diagram Fig. No.	Anode Connector	Notes
<b>10-inch glass round, 50°</b>						
10BP4†	10 1/2	17 5/8	Double	1	Cavity	
10EP4	10 1/2	17 5/8	Double	1	Ball	
10FP4*	10 1/2	17 5/8	None	1	Cavity	
10MP4	10 1/2	17	Double	2	Cavity	
10CP4	10 1/2	16 5/8	None	1	Ball	
<b>10-inch glass round, 50°, electrostatic focus</b>						
10DP4*	10 1/2	17 5/8	None	5	Cavity	o
<b>12 1/2-inch glass round, 50°</b>						
12LP4†	12 7/16	18 3/4	Double	1	Cavity	
12TP4	12 7/16	18 3/4	Double	1	Cavity	a
12VP4	12 7/16	18	Single	2	Cavity	
12WP4*	12 7/16	17 3/4	Single	7	Special	
12KP4*	12 7/16	17 5/8	None	1	Cavity	
12ZP4*	12 7/16	17 5/8	Single	1	Cavity	
12QP4	12 7/16	17 1/2	Single	1	Ball	
12UP4	12 7/16	18 5/8	Double	1	Cone	a, l
12JP4	12 3/16	17 1/2	None	1	Ball	d
12RP4	12 3/16	17 1/2	Single	1	Ball	d
12CP4	12 1/16	18 5/8	None	3	Cavity	a, b, c
<b>12 1/2-inch glass round, 40°, electrostatic focus</b>						
12AP4	12 3/16	25 3/8	None	4	Cap	a, c

Tube Type	Bulb Diameter or Diagonal (inches)	Over-all length (inches)	Ion Trap Type	Base Diagram Fig. No.	Anode Connector	Notes
<b>14-inch glass rectangular, 65°</b>						
14FP4	13 13/16	16 1/2	Single	1	Cavity	a
14BP4	13 11/16	16 13/16	Double	1	Cavity	
14EP4	13 11/16	16 13/16	Double	1	Cavity	
14CP4	13 11/16	16 3/4	Single	1	Cavity	
14DP4	13 11/16	16 3/4	Double	1	Cavity	a
14HP4	13 11/16	16 3/4	Single	5	Cavity	
14GP4	13 11/16	17 3/16	Single	5	Cavity	
<b>15-inch glass round, 50°</b>						
15CP4	15 3/4	21 7/8	Double	1	Cavity	a
<b>15-inch glass round, 52°</b>						
15EP4	15 1/10	22 4/10	Single	1	Cap	
<b>15-inch glass round, 57°</b>						
15AP4	15 3/4	20 7/8	None	1	Ball	a
15DP4	15 3/4	20 7/8	Single	1	Ball	a
<b>16-inch glass round, 50-60°</b>						
16MP4	16 1/8	21 3/4	Double	1	Cavity	
16FP4	16 1/8	21 1/4	Single	1	Ball	a
16JP4	16 1/8	20 3/4	Double	1	Cavity	
16LP4	15 7/8	22 1/4	Double	1	Cavity	f, g

Tube Type	Bulb Diameter or Diagonal (Inches)	Over-all length (inches)	Ion Trap Type	Base Diagram Fig. No.	Anode Connector	Notes
16HP4	15 <sup>7</sup> / <sub>8</sub>	21 <sup>1</sup> / <sub>4</sub>	Double	1	Cavity	f
16DP4	15 <sup>7</sup> / <sub>8</sub>	20 <sup>3</sup> / <sub>4</sub>	Double	1	Cavity	a
16CP4	15 <sup>7</sup> / <sub>8</sub>	21 <sup>1</sup> / <sub>2</sub>	Double	1	Cavity	a, f, g
<b>16-inch glass rectangular, 65°, electrostatic focus</b>						
16AEP4	17 <sup>1</sup> / <sub>8</sub>	19 <sup>1</sup> / <sub>8</sub>	Single	5	Cavity	
<b>16-inch glass rectangular, 70°</b>						
16UP4	17 <sup>1</sup> / <sub>8</sub>	18 <sup>1</sup> / <sub>8</sub>	Single	1	Cavity	a
16TP4	16 5/16	18 <sup>1</sup> / <sub>8</sub>	Single	1	Cavity	
16QP4	16 <sup>1</sup> / <sub>8</sub>	19 <sup>1</sup> / <sub>8</sub>	Double	1	Cavity	a, e
16KP4†	16 <sup>1</sup> / <sub>8</sub>	18 <sup>3</sup> / <sub>4</sub>	Single	1	Cavity	
16RP4	16 <sup>1</sup> / <sub>8</sub>	18 <sup>3</sup> / <sub>4</sub>	Single	1	Cavity	
16XP4	16 <sup>1</sup> / <sub>8</sub>	18 <sup>3</sup> / <sub>4</sub>	Double	1	Cavity	a
16ABP4	16 <sup>1</sup> / <sub>8</sub>	18 <sup>3</sup> / <sub>4</sub>	Single	1	Cavity	t
<b>16-inch glass round, 70°</b>						
16ZP4	15 <sup>7</sup> / <sub>8</sub>	22 <sup>1</sup> / <sub>4</sub>	Double	1	Cavity	h
16WP4	15 <sup>7</sup> / <sub>8</sub>	17 <sup>3</sup> / <sub>4</sub>	Double	1	Cavity	a, h, q
16SP4	15 <sup>7</sup> / <sub>8</sub>	17 5/16	Single	1	Cavity	h
16VP4	15 <sup>7</sup> / <sub>8</sub>	17 5/16	Single	1	Cavity	h
16VP4	15 <sup>7</sup> / <sub>8</sub>	17 3/16	Single	1	Cavity	a
<b>16-inch metal round, 53°</b>						
16AP4	15 <sup>7</sup> / <sub>8</sub>	22 5/16	Double	1	Cone	a
<b>16-inch metal round, 60°</b>						
16EP4	15 <sup>7</sup> / <sub>8</sub>	19 <sup>3</sup> / <sub>8</sub>	Double	1	Cone	a
<b>16-inch metal round, 70°</b>						
16GP4	15 <sup>7</sup> / <sub>8</sub>	17 11/16	Single	1	Cone	a, i
<b>16-inch glass round, 60°</b>						
16ACP4	15 <sup>7</sup> / <sub>8</sub>	20 <sup>7</sup> / <sub>8</sub>	Single	6	Cavity	
<b>17-inch glass rectangular, 70°</b>						
17BP4†	16 <sup>3</sup> / <sub>4</sub>	19 <sup>5</sup> / <sub>8</sub>	Single	1	Cavity	i, q
17AP4	16 <sup>3</sup> / <sub>4</sub>	18 <sup>5</sup> / <sub>8</sub>	Single	1	Cavity	
17JP4	16 <sup>3</sup> / <sub>4</sub>	19 9/16	Single	1	Cavity	
17QP4†	16 <sup>3</sup> / <sub>4</sub>	19 9/16	Single	1	Cavity	k
17UP4	16 <sup>3</sup> / <sub>4</sub>	19 9/16	Single	1	Cavity	k
17YP4	16 <sup>3</sup> / <sub>4</sub>	19 9/16	Single	1	Cavity	k
<b>17-inch glass rectangular, 70°, electrostatic focus</b>						
17FP4	16 <sup>3</sup> / <sub>4</sub>	19 <sup>5</sup> / <sub>8</sub>	Single	5	Cavity	o
17HP4†	16 <sup>3</sup> / <sub>4</sub>	19 9/16	Single	5	Cavity	n
17LP4†	16 <sup>3</sup> / <sub>4</sub>	19 9/16	Single	5	Cavity	k, n
17RP4	16 <sup>3</sup> / <sub>4</sub>	19 <sup>3</sup> / <sub>4</sub>	Single	5	Cavity	n
17VP4	16 <sup>3</sup> / <sub>4</sub>	19 9/16	Single	5	Cavity	k, n
17KP4	16 <sup>3</sup> / <sub>4</sub>	19 <sup>5</sup> / <sub>8</sub>	Single	6	Cavity	p
17SP4	16 <sup>3</sup> / <sub>4</sub>	19 3/16	Single	6	Cavity	k, p'
<b>17-inch metal rectangular, 70°</b>						
17CP4	17	19	Single	1	Cone	a
<b>17-inch metal rectangular, 70°, electrostatic focus</b>						
17GP4	17	18 1/16	Single	5	Cone	a, o
17TP4	16 13/16	19 5/16	Single	5	Cone	a, n
<b>17-inch glass rectangular, 90°, electrostatic focus</b>						
17ATP4†	16 <sup>5</sup> / <sub>8</sub>	16 <sup>1</sup> / <sub>4</sub>	Single	5	Cavity	
17AVP4	16 <sup>5</sup> / <sub>8</sub>	15 <sup>5</sup> / <sub>8</sub>	Single	5	Cavity	
<b>19-inch glass round, 66°</b>						
19FP4	18 <sup>7</sup> / <sub>8</sub>	22	Double	1	Cavity	a
19DP4	18 <sup>7</sup> / <sub>8</sub>	21 <sup>1</sup> / <sub>2</sub>	Double	1	Cavity	e
19GP4	18 <sup>7</sup> / <sub>8</sub>	21 <sup>1</sup> / <sub>4</sub>	Single	1	Cavity	a
<b>19-inch metal round, 66°</b>						
19AP4†	18 <sup>3</sup> / <sub>4</sub>	22	Single	1	Cone	a
<b>19-inch glass rectangular, 70°</b>						
19JP4	18 <sup>5</sup> / <sub>8</sub>	21 3/16	Single	1	Cavity	a
19QP4	18 <sup>5</sup> / <sub>8</sub>	21 <sup>1</sup> / <sub>8</sub>	Single	5	Cavity	n
19EP4	17 <sup>1</sup> / <sub>8</sub>	21 <sup>1</sup> / <sub>2</sub>	Double	1	Cavity	
<b>20-inch glass round, 54°</b>						
20BP4	20 <sup>3</sup> / <sub>8</sub>	28 <sup>3</sup> / <sub>4</sub>	None	1	Cap	a
<b>20-inch glass rectangular, 70°</b>						
20CP4†	20 7/32	21 13/16	Single	1	Cavity	a, n, r
20DP4†	20 3/32	21 <sup>1</sup> / <sub>8</sub>	Single	1	Cavity	s
<b>20-inch glass rectangular 70°, electrostatic focus</b>						
20MP4	20 9/32	22 <sup>1</sup> / <sub>8</sub>	Single	5	Cavity	n
20HP4†	20 7/32	22 <sup>1</sup> / <sub>8</sub>	Single	5	Cavity	e
20LP4	20 7/32	22 <sup>1</sup> / <sub>8</sub>	Single	5	Cavity	a, l, n, r
20FP4	20 3/32	22 <sup>1</sup> / <sub>8</sub>	Single	5	Cavity	n
20GP4	20 3/32	22 <sup>1</sup> / <sub>8</sub>	Single	5	Cavity	a, l, s
20JP4	20 7/32	22 <sup>1</sup> / <sub>8</sub>	Single	6	Cavity	p
<b>21-inch metal rectangular, 70°</b>						
21DP4	22 <sup>5</sup> / <sub>8</sub>	21	Single	5	Cone	a, o
21GP4	22 <sup>5</sup> / <sub>8</sub>	21	Single	6	Cone	a, p
21MP4	21	22 <sup>5</sup> / <sub>8</sub>	Single	5	Cone	
21AP4	20 <sup>3</sup> / <sub>4</sub>	22 <sup>5</sup> / <sub>8</sub>	Single	1	Cone	
<b>21-inch metal rectangular, 70°</b>						
21DP4	22 <sup>5</sup> / <sub>8</sub>	21	Single	5	Cone	a, o
21GP4	22 <sup>5</sup> / <sub>8</sub>	21	Single	6	Cone	a, p
21MP4	21	22 <sup>5</sup> / <sub>8</sub>	Single	5	Cone	a, n
21AP4	20 <sup>3</sup> / <sub>4</sub>	22 <sup>5</sup> / <sub>8</sub>	Single	1	Cone	d

Tube Type	Bulb Diameter or Diagonal (inches)	Over-all length (inches)	Ion Trap Type	Base Diagram Fig. No.	Anode Connector	Notes
<b>21-inch glass rectangular, 70°</b>						
21JP4	21 11/32	23 <sup>1</sup> / <sub>2</sub>	Internal	1	Cavity	
21KP4	21 11/32	23 <sup>3</sup> / <sub>8</sub>	Single	6	Cavity	a, k, l, p
21AWP4*	21 11/32	23 <sup>3</sup> / <sub>8</sub>	Single	1	Cavity	
21EP4†	21 11/32	23 <sup>3</sup> / <sub>8</sub>	Single	1	Cavity	a, q
21ARP4†	21 7/32	23 1/32	Internal	1	Cavity	
21ZP4†	21 7/32	23 <sup>3</sup> / <sub>8</sub>	Single	1	Cavity	
21WP4†	20 <sup>5</sup> / <sub>8</sub>	22 <sup>5</sup> / <sub>8</sub>	Single	1	Cavity	
<b>21-inch glass rectangular, 70°, electrostatic focus</b>						
21AUP4	21 <sup>1</sup> / <sub>2</sub>	23 13/32	Single	5	Cavity	
21AVP4	21 <sup>1</sup> / <sub>2</sub>	23 13/32	Single	5	Cavity	
21YP4†	21 <sup>3</sup> / <sub>8</sub>	23 <sup>3</sup> / <sub>8</sub>	Single	5	Cavity	
21AFP4	21 11/32	23	Single	5	Cavity	a
21FP4†	21 11/32	23 <sup>3</sup> / <sub>8</sub>	Single	5	Cavity	m, s
21XP4†	20 <sup>5</sup> / <sub>8</sub>	22 <sup>1</sup> / <sub>4</sub>	Single	6	Cavity	
<b>21-inch glass rectangular, 90°</b>						
21ACP4†	21 9/16	20 <sup>3</sup> / <sub>8</sub>	Single	1	Cavity	
21AMP4†	21 9/16	20 <sup>3</sup> / <sub>8</sub>	Single	1	Cavity	
21ANP4†	21 9/16	20	Single	5	Cavity	a, n
21ALP4†	21 9/16	20 7/16	Single	5	Cavity	n
21ATP4	21 9/16	20 <sup>3</sup> / <sub>8</sub>	Single	5	Cavity	n
21AQP4†	21 9/16	20	Single	1	Cavity	a
<b>22-inch metal round, 70°</b>						
22AP4	24 <sup>1</sup> / <sub>8</sub>	22 <sup>7</sup> / <sub>8</sub>	Single	1	Cone	a
<b>24-inch metal round, 70°</b>						
24AP4†	24 <sup>1</sup> / <sub>8</sub>	24 7/16	Single	1	Cone	a
24BP4	24 <sup>1</sup> / <sub>8</sub>	24 7/16	Single	5	Cone	a
<b>24-inch glass rectangular, 90°</b>						
24CP4†	24	21 <sup>1</sup> / <sub>8</sub>	Single	1	Cavity	a
24VP4†	24	21 <sup>1</sup> / <sub>8</sub>	Single	1	Cavity	
24XP4	24	21 <sup>1</sup> / <sub>8</sub>	Single	1	Cavity	a
24DP4†	24	21 <sup>1</sup> / <sub>8</sub>	Single	5	Cavity	n
24QP4	24	21 <sup>1</sup> / <sub>8</sub>	Single	1	Cavity	
24TP4*	24	21 <sup>1</sup> / <sub>8</sub>	Single	1	Cavity	
<b>27-inch metal rectangular, 90°</b>						
27AP4	26 <sup>7</sup> / <sub>8</sub>	21 <sup>7</sup> / <sub>8</sub>	Single	1	Cone	n
27MP4*	26 <sup>7</sup> / <sub>8</sub>	22 3/16	Single	1	Cone	
<b>27-inch glass rectangular, 90°</b>						
27EP4*	27	23 3/32	Single	1	Cavity	a
27GP4	27	23 7/16	Single	1	Cavity	a
27LP4*	27	24 23/64	Single	1	Cavity	
27NP4	27	23 <sup>3</sup> / <sub>8</sub>	Single	1	Cavity	
27RP4*	27	23 <sup>3</sup> / <sub>8</sub>	Single	1	Cavity	
27SP4*	27	23 <sup>3</sup> / <sub>8</sub>	Single	5	Cavity	n
<b>30-inch metal round, 90°</b>						
30BP4	30 <sup>1</sup> / <sub>8</sub>	23 9/16	Single	1	Cavity	a, n

COLOR TUBES

<b>15-inch glass round, 45°, electrostatic focus</b>						
15GP22(RCA)	14 <sup>5</sup> / <sub>8</sub>	26 <sup>1</sup> / <sub>8</sub>		8	Metal flange	
15HP22(CBS)	14 <sup>5</sup> / <sub>8</sub>	26 <sup>1</sup> / <sub>8</sub>		8	Metal flange	
<b>19-inch glass rectangular, 62°, electrostatic focus</b>						
19VP22(CBS)	19 <sup>1</sup> / <sub>2</sub>	26 7/16		9	Metal flange	
<b>21-inch metal round, 70°, electrostatic focus</b>						
21AXP22(RCA)	20 11/16	25 5/16		9	Metal flange	

Footnotes to C-R Tube List

- \*Aluminized
- †Aluminized version listed in key to picture-tube suffixes
- a—Tube has no exterior conductive coating. Add 500-μmf, high-voltage filter capacitor when using tube as replacement for type having exterior coating. When this type is replaced by tube having outside coating, ground the coating to the chassis.
- b—Triode type tube; has no No. 2 grid. For circuitry, refer to diagrams of sets using triode and tetrode types. Alter receiver circuits where necessary to suit tube being used for replacement.
- c—This tube has 2.5-volt, 2.1-amp heater; all others have 6.3-volt, 600-ma heaters.
- d—Faceplate curvature has 20-inch radius; all others in this group have 40-inch radius.
- e—Requires JETEC-RETMA type 106 focus coil; others in this group use type 109 focus coil.
- f—Faceplate curvature has 56-inch radius; others in this group have 27-inch radius.
- g—Deflection angle 50°. Deflection angle for other tubes in this group 60°
- h—Radius of faceplate curvature is 56 inches.
- i—Radius of faceplate curvature is 40 inches; all others in this group have 27-inch radius.
- j—17BP4-A and B have outside conductive coatings; 17BP4 has not.
- k—Cylindrical face.
- l—Tube with suffix A has external conductive coating.
- m—Experimental type—first run.
- n—Tube has low-voltage electrostatic-focus electrode.
- o—Tube has high-voltage electrostatic-focus electrode.
- p—Self-focus tube.
- q—Types with letter suffix have outer conductive coating.
- r—Suffixes A and D have outer conductive coating.
- s—Suffixes A and C have outer conductive coating.
- t—Has curved mask and faceplate.

## JOE DOAKS

## TV REPAIRMAN

*Getting started in TV—or—  
an aspirin a day*

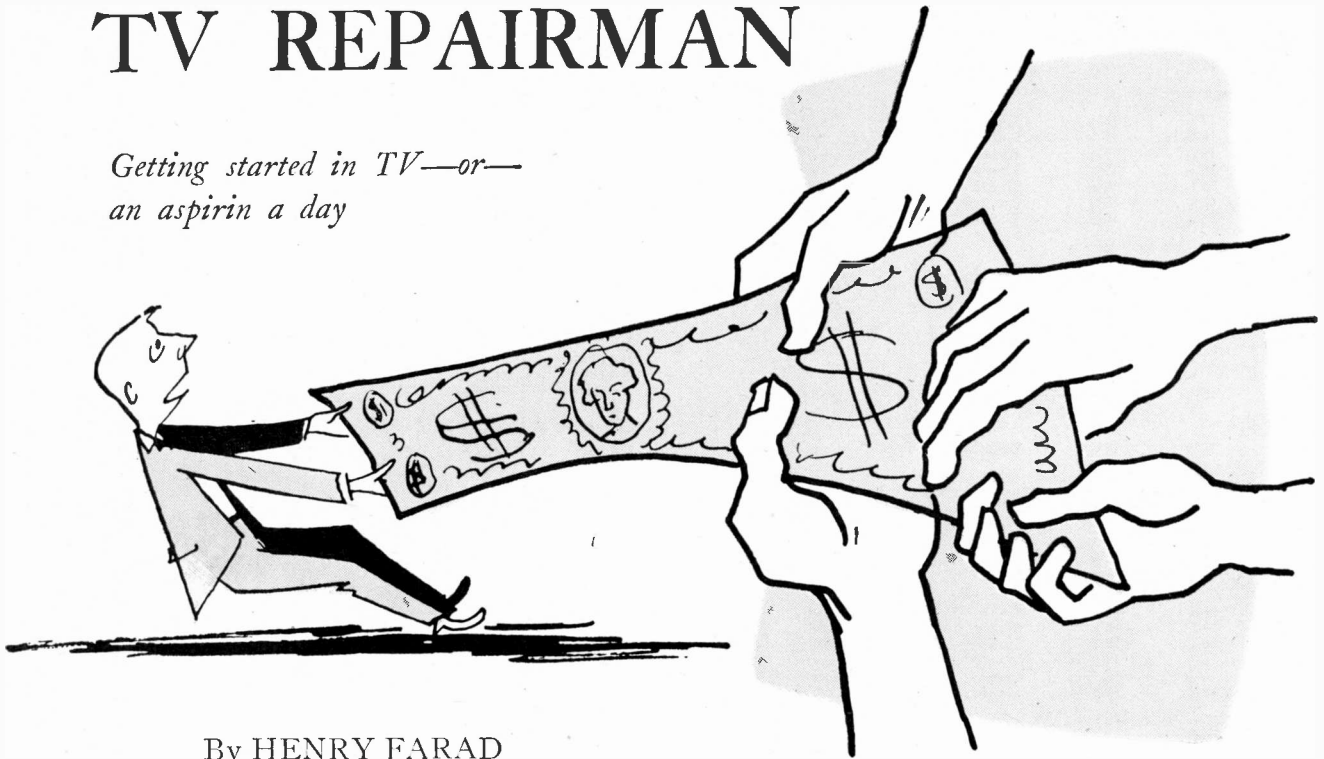

By HENRY FARAD

**T**HIS tale of Joe Doaks, TV repairman, is really the composite story of several individuals. I was only one of them. No single person could ever have got into as much trouble as did Joe.

Joe's story should be required reading for every TV student and experimenter who may sometimes engage in neighborhood TV repairing. Avoiding just one of the numerous deadfalls into which he blundered can well repay the time spent in reading and considering well this story.

Mastering any vocation or occupation is a double-barreled business. Learning what *to do* is only part of it; learning what *not to do* is every bit as important. (To cite one simple example, the student pilot who has *not* been taught to avoid cross-wind landings is always a poor insurance risk.) TV repairing is no exception.

Joe escaped a jail sentence once by the skin of his teeth. Twice did he barely save himself from being fined; on a third occasion he didn't escape. Sometimes innocently, sometimes willfully, he shattered certain state laws and various municipal ordinances; he lost an incredible amount of time battling petty bureaucrats. A lot of his early profits vanished down various rat holes (not counting the money he spent for aspirin). All because Joe started a part-time TV repair business without realizing there are certain things you *don't do*.

There's money to be made in part-time TV repairing—sizable chunks of it, too. Before you start, however, you should be aware of the numerous things you should not do *and avoid doing them!* Otherwise you'll find yourself being shot at from every point of the compass.

#### How to start wrong

Joe had been studying TV in his spare time for quite a spell. He'd collected some test equipment and learned pretty well how to use it. Inevitably, the idea of picking up a little spare-time money occurred to him. Thus, Joe put a small sign on his front porch and inserted a small advertisement in the classified section of a local paper. That seemed sensible enough. Only it wasn't.

Joe's third customer wasn't a customer. Instead, he was an agent of the Planning Commission; he was there to advise Joe he'd laid himself open to a fine and jail sentence, because Joe had established a "commercial enterprise" in an "interim zone," and unless he forthwith suspended operations he would have the well-known book thrown at him. Joe's sign came down; his newspaper ad was canceled. Ordinance 3885, subsection k, prescribes fines up to \$50 per day for "zoning violations"!

Sure, after going through channels, Joe finally got permission to put his sign back! After he'd filled out several pages of forms and submitted an "exact map of premises"; and after being

grilled by the Planning Commission in dread session, with a tape recorder ominously grinding away on the secretary's desk; and after a lapse of nine weeks, during which time doing any business was strictly verboten.

Get the idea? Before ever you make the slightest noise about your part-time business, find out what sort of zone you're in, if any. Displaying signs may be impossible if you're in an iron-clad residential neighborhood. Doing busi-







ness at all may be prohibited. In any event, bear in mind that boards, bureaus, and commissions normally move at a snail's pace, which means that if a permit is needed you may be two or three months getting it. Time yourself accordingly.

If you take Joe's advice, you won't hang out any sign at all—not at the start, anyway. You'll also limit your advertising to word-of-mouth and very modest classified insertions. The reasons will be shortly elucidated, as the man said, but first let me relate another of Joe's blunders—that of giving himself a company name: Joe Doaks TV Service. This little mistake cost him \$50, after the local gendarmerie had instructed him to “properly execute a Certificate of Individual Doing Business Under an Assumed Name, pursuant to Article XVI, Section 5, paragraph J . . .” Or else! It's a state law, understand, with penalties provided. . .

You can buy an Assumed Name form for a dime at any large stationery store. (There's another form for A Partnership Doing Business, etc., so be sure you get the right one. You need two, to be exact.) Fill out the blank spaces, get one notarized and have it recorded at your county courthouse. Thus far it's pretty cheap and easy, but in my state (California) it isn't legal until it's printed in full a prescribed number of times in a “newspaper of general circulation.” That can really cost you, as it did Joe.

Hence, do business under your own name. If your card or advertising reads plain “Joe Doaks” with “TV Repairs” on another line, nobody can touch you. But make it “Joe Doaks TV Service” and you're instantly \$50 downhill—not exactly peanuts for a small operator just getting started.

A sign on your front porch—to cite another objection—will likely result in your electric light bill being doubled! In case you didn't know, the presence of

that sign automatically changes your rate from domestic to commercial. It's the law. In Joe's case, it jumped his bill almost exactly 100%. Again, not peanuts for a small dealer.

As a suave but unyielding character from the power company informed Joe, it was all the same difference whether he repaired one TV set a month, or a thousand—the minute he hung that sign out front, he was a dead duck. Joe had the option, of course, of having a second electric meter installed and then splitting up his house wiring so that all TV activities were on a separate meter. In that case the remainder of the house would keep the domestic schedule. Of course the alteration would involve a slight charge of around \$100 for labor, material, permits, etc., associated with hanging two meters on the house and reshuffling the wiring.

The power company let Joe have it with one barrel; the telephone company gave him the other. Joe lost his domestic telephone rate and went on commercial. That's right, it just about doubled the bill. Squawking got him



nothing. As a frigid female at the telephone business office explained it, the fact that Joe's business then amounted to a paltry six or eight repair jobs a month was immaterial. Laws regulating public utility rates provided for no exceptions. The law . . .

“I see,” Joe broke in, “another double-or-nothing program.” Joe could tell she didn't think it was funny. Neither did he, for that matter.

Understandably enough, Joe was getting a bit gun-shy by this time. In what other direction, he wondered, was his neck stuck out—and how far? That's when he suddenly recalled he possessed no Municipal Business License. . .

Skidding into City Hall shortly afterward, he narrowly evaded a 100% penalty for “late declaration” only by crawfishing with an agility which surprised even him.

Anyway, don't forget to shell out that \$10 or \$25 or whatever the bite may be for a license to do business in your locality. Then there is also the municipal business tax and city sales tax.

## Know what you're doing!

Bookkeeping is one of today's major headaches for the man operating a small business, which promptly brings up another don't. *Don't* ever start even the smallest, pip-squeak TV business without first being sure your bookkeeping is going to be attended to competently and promptly. Otherwise you're sure to lose a lot of hard cash, one way or another, and you'll never know for sure whether you're winning or losing. Quarterly sales-tax reports; Federal income tax; state income tax; social security payments—the right answers can come from a correct set of books, nowhere else.

Sure, you can approximate or guess at your sales tax—you can guess at nearly anything! But every so often unfortunately, the man from the State Tax Department is going to drop around and demand to see your books. The Federal boys might even want to look at them some time. If you don't have any books, or if you've “lost” them, or if they don't look right, you're apt to get slugged—but good—right in the wallet. The law says you must keep books. No matter how small you are, you keep books or else.

Oddly enough, inadequate bookkeeping often results in the small operator's Federal and state income taxes running considerably higher than they should. Absence of adequate bookkeeping appears to go hand in hand with the great majority of failures among small businessmen. And even the small operator with a good accounting system is pretty sure to overpay on income tax unless he hires a tax specialist to figure his returns.

Bookkeeping is important enough to harp on just a bit longer. If no one in the family is competent to handle the job you must hunt up someone who handles a number of small sets of books and engage him or her. The cost, incidentally, will be surprisingly low, and weeks can go by without your saying half a dozen words with your bookkeeper, or using even five minutes of your own time. The trick lies in methodically supplying him with complete information of what's going on, and the painless automatic method of doing so is by using those ready-printed sales books sold by stationery stores. The 5 x 8-inch size is about right. They come in books of fifty, in triplicate, consecutively numbered.

My system gives the customer the white, original copy, duly marked paid, except in those infrequent cases where he gets credit. The yellow duplicate copies are filed daily on a hook fastened permanently in one place. Money paid out for anything is written up in the same book, except that the white original is used as a file copy, the yellow duplicate being destroyed. This shows at a glance whether any particular file copy represents charge or credit. The nondetachable triplicate copies act as a backstop in case a file copy goes astray as happens once in a while.



This same sales book comes in particularly handy whenever you may be obliged to give someone credit, even temporarily. Credit is dynamite in radio and TV repairing, but sometimes there's no help for it. In such a case, asking the customer to sign his tag in the sales book is normal and to be expected, and gives you a dandy lever if he happens to turn out to be a dead-beat. Yank him into Small Claims Court with his signature on the sales slip, and you win in a walk. Go into court with nothing but the assertion that he owes you money and even an amateur dead-beat may get the best of you.

This is a complicated age. These United States have become top-heavy almost beyond belief with laws, regulations, ordinances, codes, restriction, prohibitions, and keep-off-the-grass signs. Moreover, our legal codes presume that every citizen knows *all* about *every* law; ignorance is no excuse. Which is how Joe came within inches of doing 10 days in the county jail. Luck was with him, however; he got off with a fine and a warning. What had he done? He had put up a 50-foot mast and TV antenna and installed a distribution system in a motel out in a nearby fringe area.

Joe had investigated every angle well in advance of making a bid on the job. The motel was outside any incorporated area; no licenses or permits were required; no ordinance existed affecting use or structural height. The motel owner told him to go ahead and Joe wrapped the whole thing up one week-end and collected his money. Everyone was happy.

Two weeks later he found himself in court one morning, pleading guilty to a charge of contracting without state license, on information filed by the State Contract Licensing Authority. The law again... In Joe's state it's illegal to quote a flat price on any construction or installation work unless you possess a contractor's license. Transactions less than \$100 are exempt, but Joe's bid had been more than that.

Pleading guilty was his only out. He was nailed cold, and hiring a lawyer would have cost him not less than \$50 and probably \$100.

It was during this hearing, while the judge probed for details, that Joe discovered he'd also broken a few other assorted laws. For one thing, he was not registered—as required by law—with the Federal Department of Employment, and he had had occasionally hired a high-school student next door to help him put up a TV mast. Furthermore, he'd made no deductions from his helper's wages for state unemployment insurance, for social security payments, nor had he made any employer's contribution to his helper's social security account. (When he eventually made good on all these charges out of his own pocket, he was fined for being late in getting the money to the various collectors.) Because the student was under 18 years of age, Joe had shattered another law by not securing a Minor's Working Permit for the boy, even though it was all a strictly hit-or-miss, part-time deal for both parties. He had also failed to carry workmen's compensation insurance or equivalent for his employee.

Outside all the foregoing, Joe was pretty much in the clear, except that he had never carried any property damage insurance, which means that if some customer had filed a civil suit against him, claiming Joe had damaged a roof while erecting a mast, poor old Joe would have found himself in still another kettle of hot water. It's a complicated age!

It's been said there aren't half enough competent electronic technicians in the U.S., but it's my guess there aren't one-quarter enough. The way it looks from here, the supply of really competent men is not going to overtake demand for decades, if ever. The actual number of openings and opportunities, incidentally, is considerably more than meets the eye; a definitely measurable percentage of today's talent consists of ignoramuses and incompetents who fold up like three-dollar accordions when better informed competition makes its appearance.

Unfortunately, in some localities established radio and TV operators do not brook any competition from "tinkerers and side-liners." In localities where this spirit exists, the boys often go to considerable lengths in making things as tough and unpleasant as possible for the part-time operator—hence it's al-

ways prudent to make only a minimum of noise until one has gotten a good toe-hold in his business.

Trying to strong-arm electronic wholesalers into refusing to sell to anyone but "legitimate dealers" is one weapon sometimes employed. Local legislation aimed directly at small fry is another. The first-mentioned device is loaded with dynamite, as the participants are well aware; its success depends entirely on how easily the opposition can be bluffed. "Conspiring to Engage in Restraint of Trade" is a Federal rap which has laid low more than one monopolist in the past; merely threatening to file a charge can be relied upon to end any monkey business.

Making money from part-time TV repairing isn't as easy as you might believe. The money's there, sure—Joe can show you in his books net profits up to \$50 a week from part-time work. But you have to play it right to win. You have to be prepared for rubber checks, callbacks, occasional repair jobs of the "stinker" variety, dead-beats, policy adjustments, inventory problems—you'll run into these and other headaches. And after you've run the obstacle course to the bitter end, Federal and state tax collectors have their hand stuck out for more than 20 cents of every dollar in your net-profit column.

Despite everything, however, TV maintenance and repair is a satisfying occupation or business, whichever you make it. Largely, I think, because it's sufficiently complicated to never become boring; largely because something new happens every week.

Most important, part-time servicing serves as a stepping stone to bigger and better things. It is during this time that the beginner serves his real apprenticeship. He learns the importance of systematic inventory control, bookkeeping and servicing techniques. Even more important, he learns the value of building a good reputation. With comparatively little money to play with, the beginner will do limited advertising, depending greatly upon word of mouth from satisfied customers.

In cutting through the labyrinth of bureaucratic red tape, the part-time technician broadens his knowledge of running a business, enabling him to squeeze additional net income from his gross receipts. Rules and regulations are made for a reason, although the reason is not always clear. Stay with them and you will be on the right track.

END



# COLOR

## SERVICING

*Techniques and instruments for shooting trouble in the color receiver, together with bar patterns to show just how many troubles look*

By W. W. COOK\* and  
C. E. LASSWELL\*

**L**ARGE-SCREEN color television will give the average television mechanic an opportunity to expand greatly his service business. By using already well known techniques of black-and-white servicing, plus a few new pieces of color test equipment, the service technician will find the transition from black-and-white no insurmountable obstacle.

The color television receiver contains all the circuits of a black-and-white set. The same service techniques are employed to service the r.f. tuner, picture and sound i.f. amplifier, sync, a.g.c. horizontal and vertical deflection and video circuits as in black-and-white receivers. However, the requirements for some of these circuits are more rigid. For example, picture i.f.'s must be aligned with greater care to amplify the color information without distortion. Fortunately, the test equipment used for black-and-white r.f. and i.f. alignment will suffice for color.

Since color reception depends more than black-and-white upon proper adjustment of the customer controls, the service technician will have to be sure the customer understands their importance. For example, a misadjusted fine tuning control may present a black-and-white picture with very slight apparent loss of fine detail. It might result in complete loss of color on a color program. Even a slight misadjustment of the fine tuning could result in improper color edging as illustrated in Fig. 1. Comparing this with Fig. 2, the normal bar pattern, shows that edges of the color bars have been shifted to an improper hue due to the loss of the upper chrominance sidebands. Faulty picture i.f. alignment with cutoff ranging between 3.6 and 4.0 mc would also result in this same improper color edging.

New color test equipment has been developed which will facilitate servicing color circuits. One of these new instruments, which is available on the market today, is the color bar generator, designed to provide a thorough check on the operation and adjustment of color receivers. The 300-ohm lead from its output is connected to the antenna terminals with the receiver tuned to the channel specified in the operating instructions. With the receiver properly adjusted, the bar pattern pictured in Fig. 2 appears on the picture tube. Reading from left to right, the ten bars represent chrominance signals as indicated below:

$$\begin{array}{ccccccccc} (G-Y)+90^\circ & +I & +(R-Y) & +(G-Y) & +O \\ + (R-Y) & (G-Y)-90^\circ & -I & -(R-Y) & -(G-Y) \end{array}$$

The color bar generator is necessary for checking the demodulators and matrix. For proper color, the phase of the 3.58-mc carrier signal must be adjusted for the correct waveform at the output of the demodulators. For I and Q demodulation the second and eighth bars should show maximum response at the plate of the I demodulator. When demodulation recovers R-Y and B-Y directly, the third

\*RCA Service Co., Inc., Camden, N. J.

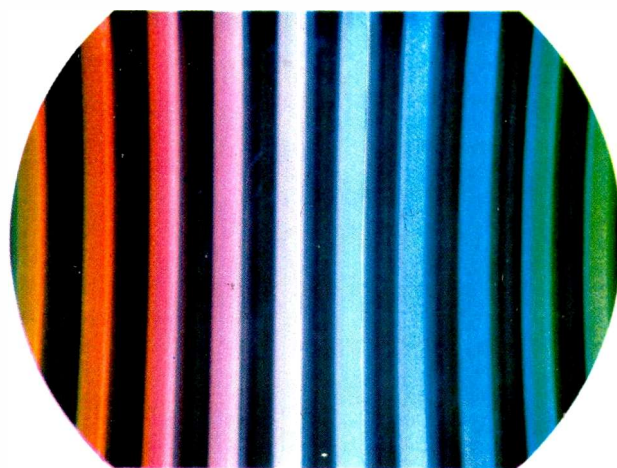

Fig. 1—Color bar pattern with fine tuning misadjusted.

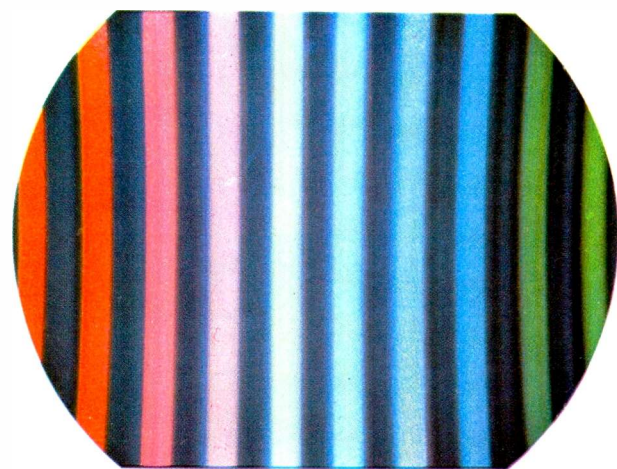

Fig. 2—This is the normal and correct color bar pattern.

and ninth bars should be maximum and the sixth bar should be zero at the plate of the R-Y demodulator. Another check which can be made with the color bar generator is the matrixing of the color difference signals and the Y signal. With an oscilloscope connected to the grids of the kinescope, an accurate check of the color signal ratios can be made. Once the correct oscilloscope pattern is obtained, overall correct operation of the color circuits is assured.

## TELEVISION

trol and burst take-off transformer are adjustable to provide the proper 3.58-mc carrier phase to the chroma demodulators. The phase detector provides a bias voltage which, in conjunction with a reactance tube, controls the phase of the 3.58-mc carrier oscillator. A portion of the negative voltage developed by the phase detector when burst is present is applied to the grid of the color killer. If the burst signal is lost due to failure of the burst gate or

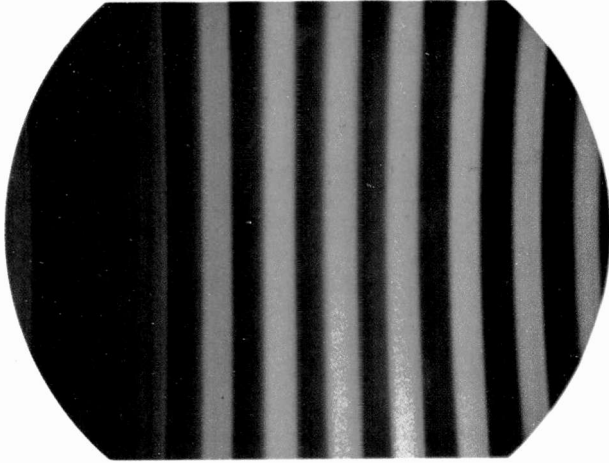

Fig. 7—Color bar pattern with red information missing.

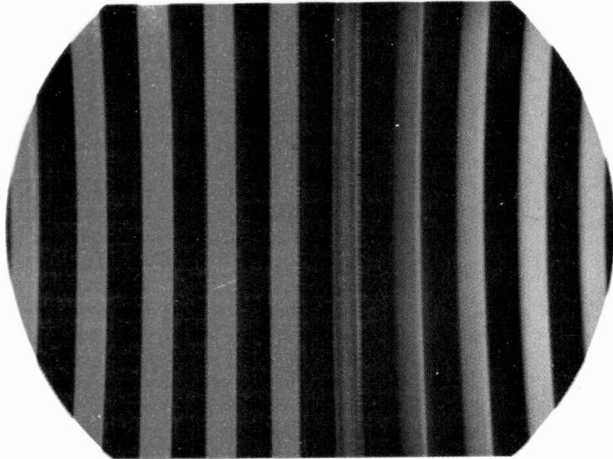

Fig. 8—The blue has been lost in this color bar pattern.

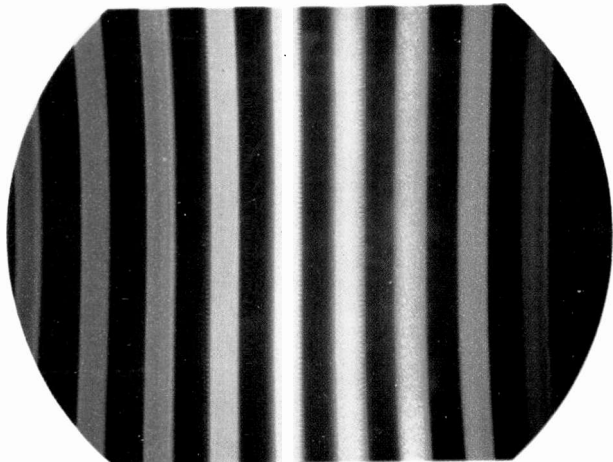

Fig. 9—Same as Figs. 7 and 8, but with green missing.

phase detector, the color killer will conduct, biasing off the chroma amplifier and thus "killing" the color reproduction. Misadjustment of the hue control or burst take-off transformer will result in improper color rendition by making the phase of the controlling 3.58-mc burst incorrect. If the range of the hue control is insufficient, the burst take-off transformer must be adjusted. An example of incorrect hue is pictured in Fig. 5.

Bias produced by the phase detector controls the conduction of the reactance tube, which in turn maintains the 3.58-mc carrier oscillator in synchronization with the burst signal. Loss of bias from the phase detector or failure of the reactance tube allows the oscillator to run freely. This condition is similar to loss of horizontal or vertical scanning sync. An illustration of this condition is shown in Fig. 6. Complete failure of the oscilloscope will result in loss of color.

The output of the chroma amplifier is fed to the chroma demodulators. Here the chroma signals are mixed with the 3.58-mc oscillator carrier. The output of the demodulator provides the necessary R-Y, B-Y and G-Y color-difference signals. Failure of one of the chroma demodulators or an open coupling capacitor in the R-Y, B-Y or G-Y lead to the kinescope would result in two color reproduction of color pictures. Figs. 7, 8 and 9, respectively, illustrate bar patterns in which red, blue and green signals are missing.

When trouble is indicated in the color circuits of the receiver, it is usually necessary to trace the 3.58-mc carrier or chrominance signal, using a wideband oscilloscope. Frequencies of 3.58 mc cannot be seen with ordinary oscilloscopes. A wideband oscilloscope with a frequency response flat to 4.5 mc and a direct sensitivity of 0.1 volt peak-to-peak is desirable for this type of work. Starting at the chroma detector, burst and chrominance signals can be traced to the output of the chroma amplifiers, quickly isolating the source of trouble. A wideband oscilloscope is also useful in tracing the burst signal through the burst gate to the phase detector and checking the gate pulses applied to the color killer and burst gate for proper waveshape.

To summarize, the three most common visual presentations resulting from component failures are outlined below. A logical sequence for isolating the defect is given under each condition:

### Pix and sound O.K.—no color

Check the following, using color bar generator:

1. Fine tuning and chroma controls.
2. Tubes in color circuits.
3. The 3.58-mc crystal (if used).
4. D.c. bias on chroma amplifier.
  - a. If high, check burst amplifier and phase detector circuits.
  - b. If burst input to the burst amplifier is low, check r.f. and i.f. alignments.
5. Bias on grid of the 3.58-mc oscillator.
  - a. If zero, oscillator is inoperative.
6. Waveforms at the plates of the demodulators.
  - a. If normal, trace signal to kinescope grid to isolate trouble.

### Pix and sound O.K.—no color sync

Check the following, using color bar generator:

1. Phase detector.
2. Reactance tube.
3. 3.58-mc oscillator.
4. Bias at grid of reactance tube.
  - a. If high, ground grid of reactance tube. If color then rolls slowly through the picture, the trouble lies in the phase detector circuit. If color remains badly out of sync, the trouble lies in the reactance tube or oscillator circuits.

### Pix and sound O.K.—improper color

Check the following, using the color bar generator:

1. Hue control for proper operation and range.
2. Demodulation and phase inverter tubes.
3. With an oscilloscope, check the waveforms at the plates of the demodulators and at grids of kinescope. **END**

# What's the dope on COLOR TV?

**M**ORE than a few of us have gotten a little behind on it, but color TV has kept right on going ahead—in giant steps. And at each step it has left some thousands of sets built according to the then best standards. All these sets will have to be serviced. So the technician will have to understand, not only the “perfected” receiver (if one is ever built), but also all the evolutionary forms. It is time to catch up!

What—roughly—do we have to know? And where is the dope? The following is an attempt at a brief outline and guide. The references in parentheses are to issues of RADIO-ELECTRONICS. For further dope on any point, read the articles referred to.

We hear of two main types of circuitry: the I-Q and the R-Y, B-Y types. These refer to the way the colors are put together in the receiver. The complete television picture is taken with three color cameras—red, green and blue. The output from these is separated and the black-and-white, luminance or Y signal transmitted on a regular 4-mc channel. The color signal from which the Y has been removed (-Y) is transmitted on a *subcarrier* centered at the 3.58-mc point of the 4-mc band.

The R-Y, B-Y system (September, 1954, page 60) is the simplest. The color signal is detected by two *demodulators*, R-Y and B-Y. The G-Y signal is supplied by subtraction from the two others (what isn't blue or red is green). This is done by a simple mixing (matrixing) system (September, 1954, page 61). The R-Y and the B-Y are passed along to the red and blue guns and the correct proportions of -(R-Y) and -(B-Y) to the green gun. The correct amount of Y signal must now be added to each of these -Y signals to restore the original R, B and G signals which produce the picture.

The I-Q system (May, 1954, page 40; October, 1954, page 42) is more complex but supplies more color detail. It goes up to about 1500 kc as opposed to 600 kc with the simpler system. (Fine detail is supplied by the black-and-white signal in both systems, as the eye is insensitive to color in fine detail.) The terms I and Q refer to “colors” which do not represent the output of two of the cameras but a mixture of all three. This calls for a more complex matrixing system, since some of the output of both the I and Q demodulator (as well as Y signal) is required for each of the three primary colors.

A third system—just emerging—is the R-Y, B-Y, G-Y circuitry used in the new RCA 28-tube

*What does R-Y Mean to you? Or Q-X? What is a Chromatron? Phasatron? Trichromoscope? Burst amplifier? Q-De-modulator? Breezeaway? Phase corrector? If the answer to all the above is a confused look, this article may help you.*



receivers and shown in the block diagram on page 55 of this issue.

Tubes are a simpler problem, but one which has its ramifications. Which type, 1-gun or 3-gun? And how about size? The answers are still fairly easy. The 3-gun type is the only one now in common use, *though most authorities act as if they expect the tube of the future to be a 1-gun type.* Best known of color picture tubes is the 15GP22, RCA's original flat-mask color tube (June, 1950, page 27; July, 1954, page 30). Although now considered obsolete, thousands of sets have been made with that tube. They have been or will be sold, given away or otherwise disposed of, so the service technician is sure to run into them.

The shadow mask has a faceplate covered with hundreds of thousands of red, blue and green dots, and a perforated mask behind it to assure that the electron beam will fall on the dots. An improved 15-inch version with a *curved* faceplate and mask was made by CBS-Hytron (December, 1953, page 103; July, 1954, page 30). Its advantage is that all parts of the screen are more nearly at the same distance from the guns, simplifying the problems of focusing and convergence over all parts of the screen (January, 1955, page 40).

The 19-inch tube, 19VP22, (November, 1954, page 110; December, 1954, page 66; brief description September, 1954, page 124) is another curved mask and faceplate tube, now being used in a number of sets. RCA's new 21-inch tube will follow the same general lines, with an improved means of avoiding color contamination by the earth's magnetic field.

The 1-gun, Lawrence or post-deflection tube has strips instead of dots of colored phosphors on the faceplate (July, 1954, page 30; article scheduled

for February, 1955). A wire grid deflects the beam up or down or permits it to go straight through, under the influence of the red, blue or green signals, respectively. At the time of writing, no color receivers have been placed on sale using this tube, although several manufacturers are experimenting with it.

How about the present black-and-white receivers? Is there any chance of converting them for color? The answer is: at present, no. Turning an ordinary set into a color receiver demands extensive rebuilding in the black-and-white portion as well as adding all the video circuits. It would probably be more expensive than buying a new color receiver. A few short-cuts have been tried (notably an attempt to break the signal down to a field-sequential type; see April, 1954, page 8) but so far without appreciable success. It is possible—though not probable—that it may in the future be possible to buy some kind of kit to convert a monochrome set into color.

But the future holds too many things to permit much guessing. For instance, the price of color sets may drop to a level comparable with that of good monochrome receivers, making conversions impractical. Or totally new types of TV receivers may appear. General Sarnoff suggests (page 46) that the TV set of the future may be a flat screen in a picture frame. Fantastic as the concept may seem, such frames now exist and can already be used for simple scope and radar displays. Several companies are working on “picture tubes” which may be even less like our present device than the flat screen. The bulky cathode-ray tubes may soon be pushed into a place in history with the perforated spinning disc of the late '20's. END

# TOP TV RECEPTION IN

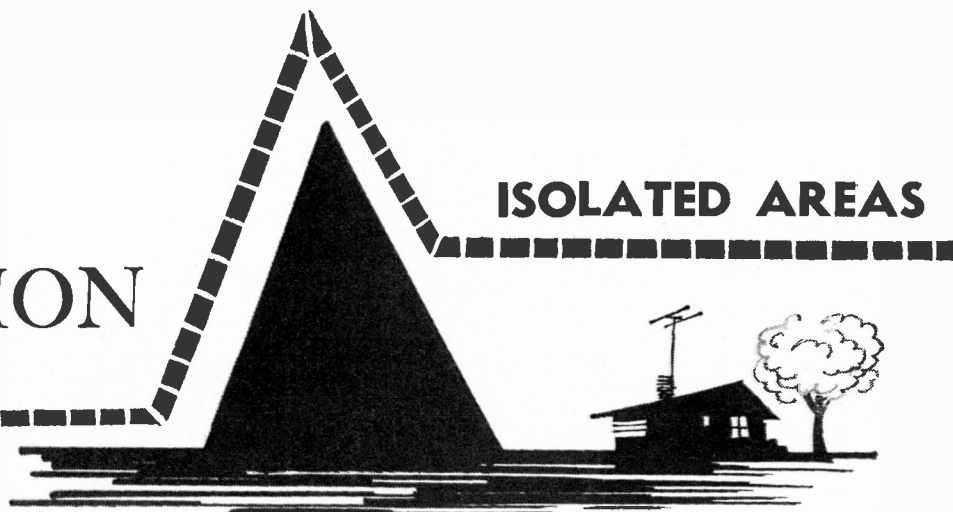

ISOLATED AREAS

*Organizing and planning a community TV system*

By EDWARD M. NOLL

THIS country is dotted with small and large towns that either do not have any television service or get very poor pictures (despite high antenna installation costs). Many of these towns are located in valleys near ridges or mountaintops suitable for the installation of a community antenna system. Still others on flatter terrain would obtain improved signals with the erection of a single, but very high, receiving antenna tower and a community distribution system.

A well-planned antenna distribution system is often the answer to improved picture quality and stability. Such a system can be installed by a local service organization or other technical personnel. It can be financed by a local service organization or an association of local service technicians, dealers, amateurs or other interested persons. If you live in such a community read this article with careful consideration.

Such an installation can be a low-cost nonprofit community project with each interested person (every subscriber) contributing to the installation and annual upkeep. Among the subscribers there probably will be enough public-spirited men of various trades to make the installation a community project. If not, a service organization can be hired to handle the job. An example of such a community project has been completed at Moccasin, Calif. Moccasin is located in a small mountain-surrounded valley some 120 miles from San Francisco. At present the community antenna system (nonprofit) has 25 subscribers with a potential of only 50. Each subscriber pays a small installation charge and a small yearly assessment. No existing community antenna system provides any better pictures at such low subscriber costs. Here is a plan that should spread from isolated village to isolated village across the country.

The initial experimental work was

undertaken by Harold Barnard, a local radio amateur and now president of the community antenna association. He has reason to be proud of their system. The afternoon I visited him he showed me three beautiful pictures from the three San Francisco stations—actually, poorer and less stable pictures are common 25 to 35 miles from the transmitters. A setup such as Moccasin's could be used to great advantage in many communities much nearer to stations.

### Planning a system

If you are a technical man and have dreams for better television in your community, there are a number of steps you can take to start the ball roll-

ing. Given a sufficient shove it will carry itself through the community.

The first action to be taken is to investigate signal-strength possibilities at various likely sites. Take a close friend or two (fellow technicians) and measure the field strength on the higher ridges and mountains in the vicinity. A simple service type field-intensity meter and a few standard antennas are adequate for initial checks. The meter must be battery-operated or run off a converter attached to your car battery.

When the best site is chosen, erect a good antenna and make arrangements to check the picture on a small television receiver and to demonstrate the possi-

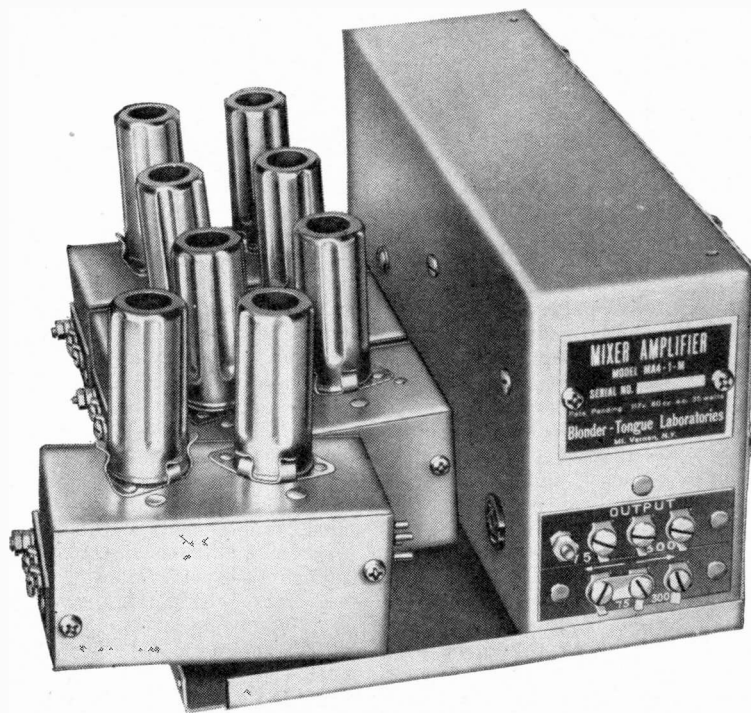

Blonder-Tongue channel-strip amplifiers.

bilities to a few carefully chosen townspeople. Another plan is to attach one amplifier at the antenna and a second one half-way down the hill (temporarily they could be two good-quality boosters), running a temporary but low-loss line down the mountain to the nearest interested subscriber. The advantages of the idea can thus be shown to a number of influential people in the town, using just a single channel.

Next, begin to plan the route of the distribution system and to assemble initial and approximate cost figures. Check with local power and light or telephone companies about attaching lines to existing poles and resultant rental charges. Most local public utilities will rent pole space to carry transmission lines. In other instances small poles can be set up by the installer along the cable path to the community to be served. In many smaller installations cables can be run from house to house with the various houses supplying the a.c. power for the amplifiers. This is an inexpensive method and permits location of all amplifiers indoors. Outside amplifiers must be mounted in waterproof housings.

Organize your material, outlining advantages, method of distribution and installation, and costs. Finally, present the plan at local meetings and gain support for the project.

#### Typical small system

The general plan of the system installed at Moccasin is shown in the diagram. The limited equipment required for a small installation—plus a cooperative community spirit—can result in first-class television at low cost.

The antenna site chosen is on the mountaintop nearest the town although there is a still higher peak a short distance away. However, a limited economy and fewer cable problems governed the choice of the nearer peak.

Individual single Yagis are used for channels 4 and 5, and a stacked Yagi for channel 7. The antennas supply

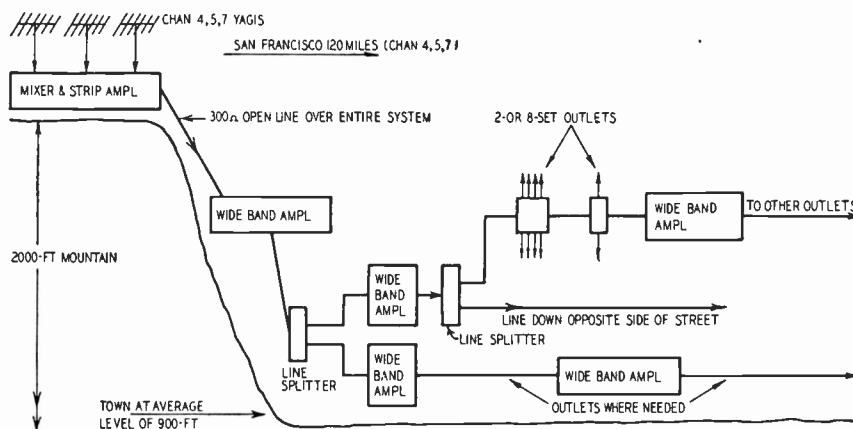

Diagram shows the general plan of a small antenna distribution system.

signal to the individual channel strips of a Blonder-Tongue master mixer-amplifier. The entire system uses Blonder-Tongue equipment except for a small Astatic booster that connects between the transmission line and the channel 7 strip. It boosts the channel 7 signal before application to the mixer-amplifier, equalizing the three signals.

The output of the mixer-amplifier feeds the transmission line that runs some 1,000 feet down the mountainside. An all-channel amplifier is inserted halfway down the hill to compensate for line attenuation. Open-wire line is used throughout the system because of its low loss (reducing required amplification).

It is true that open-wire line has a greater radiation and there is more opportunity for signal stealing. This happened once in this small town but the "poacher" finally succumbed to ribbing and pressure and became a subscriber. Line equalizers are positioned at various points along the system to compensate for the fact that signal attenuation is a function of frequency, with channel 7 attenuated more than 4 and 5 and channel 5 more than 4. Thus signals are held at approximately a constant level throughout the system.

At the bottom of the hill the signals feed into a line splitter that divides the system into two paths. It does so without causing mismatch and resultant smear or line reflections on the picture. Wide-band amplifiers are inserted in each path to restore proper levels once again. One primary line feeds signals to the far end of town. Additional wide-band amplifiers are equipped because of its greater length. Tapoffs are made along the line to feed signals to receivers in the various houses.

The second-primary line splits into two secondary lines after the first wide-band amplifier. One secondary line runs down one side of the street while the second runs down the opposite side. All receiver dropoffs are made through outlet amplifiers. Either two- or eight-outlet distribution amplifiers are used, according to the number of receivers to be fed at a given location. The distribution units have no gain but make certain each receiver is fed the same amount of signal at no loss and with no interaction. Thus the tuning of one receiver will not affect the performance of other receivers along the line. The isolation offered by these outlet units permits a very stable and consistent distribution system. END

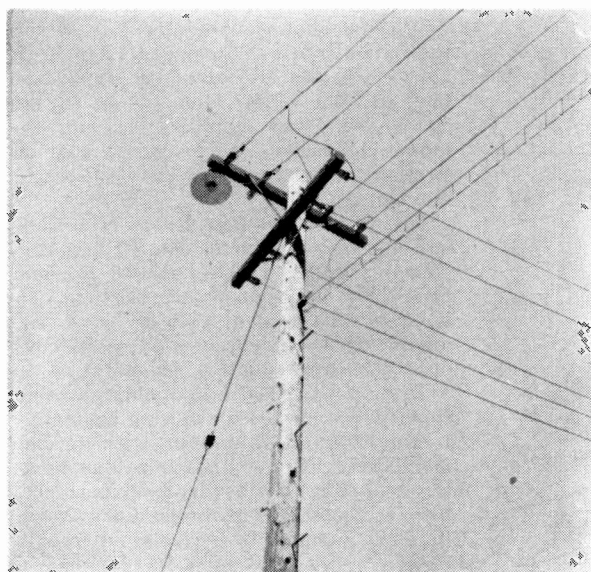

← Open-wire line (lowest line on pole) distributes the signal around town.

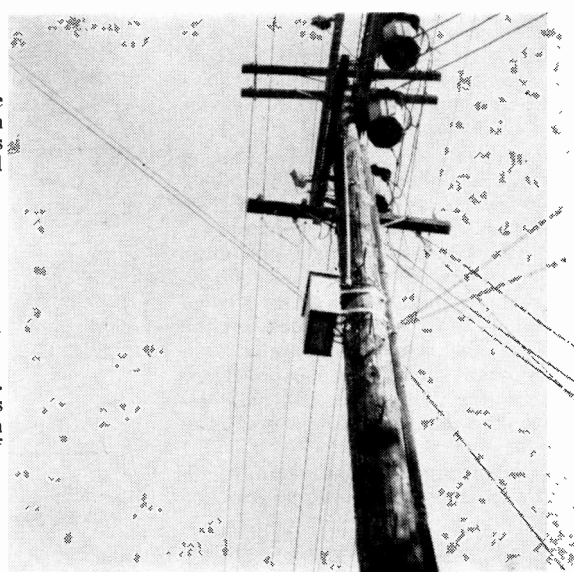

→ Two-set distribution outlet. Amplifier is mounted in weatherproof housing.

# COLOR TV ANTENNA TECHNIQUES

*Black-and-white TV antennas may require modification for best color reception*

By IRA KAMEN\*

**A**LL TV antennas designed for black-and-white reception will work on color TV, if the transmission frequencies are the same. How well they will perform on color depends on the answers to the following questions:

1. Does the antenna suck out the color TV subcarriers? (The amateur term *suck out* refers to the antiresonant action of the antenna on some frequencies—the antenna acting as a trap and attenuating the TV signals before they are available for transfer to the lead-in.)

2. Is the antenna subject to FM pickup?

3. Can the antenna be oriented to attenuate or eliminate ghosts?

To answer these questions, I conducted numerous tests and consulted with antenna engineers of RCA Service Co. and CBS Columbia.

The answer to the first question ("Does the antenna suck out the color TV carrier?") uncovered a surprise culprit—the very popular conical antenna with six front dipole elements. Perhaps several million of these antennas have been installed. Tests revealed that some of these conicals suck out the color TV subcarrier on channel 4, a very important channel in most sections of the country. This suck out may deteriorate the channel 4 picture seriously.

This defect in the majority of 6-element dipole conicals was overlooked

by antenna engineers during their original development work because the frequencies assigned to present color subcarriers were unknown. Therefore, the subcarrier frequencies now used were not a check point in examining the characteristics of the conical antenna. However, the conical, a dependable performer in v.h.f. monochrome reception, can and will maintain its position in the color TV field when it is properly adjusted. So don't put the axe to all conicals yet! They can be corrected by several easily made field modifications. Three modifications can be made to eliminate the channel 4 suck out of the color subcarrier.

### Antenna modifications

Fig. 1-a shows the ends of both 3-element sections shorted together with

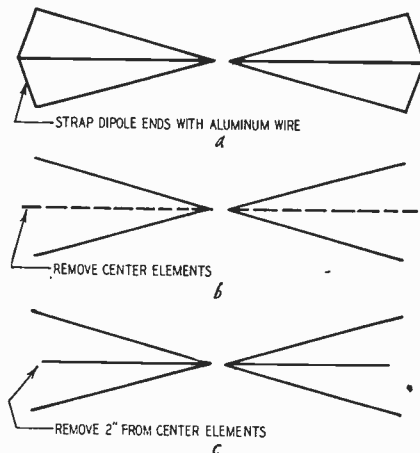

Fig. 1—Modifications for color TV.

aluminum tie wire. This modification, in addition to improving color TV performance on channel 4, provides on some conicals a gain on channels 7 through 13. This bonus depends on the length of the conical elements and their forward angle.

Fig. 1-b shows the center element removed. The center element of the conical is used to provide more surface area, and in many conical types this increase in surface area provides an average gain of less than 1 db over the complete TV band. Thus in primary areas where the station power has been increased to a great extent the technician can remove the center element without reducing receiver performance.

Fig. 1-c shows the center element of the conical reduced in length (2 inches) so the outside elements are 48 inches long and the center elements 46 inches in length. This modification can be made in the field, using a heavy pair of snippers for cutting and heavy pliers to close the ends.

Fig. 2 shows a new commercial conical known as the *Colorcon*, with center elements reduced in length to prevent color TV subcarrier attenuation. To identify this conical and its color TV modification, the center element is covered with a conductive red paint.

From a practical standpoint no table could be assembled containing all manufactured conical antennas with recommendations for modification. The service technician will, from experience, have to choose one of the methods shown in Fig. 1 when the problem presents itself.

\*Vice president, Brach Division, General Bronze Corp.



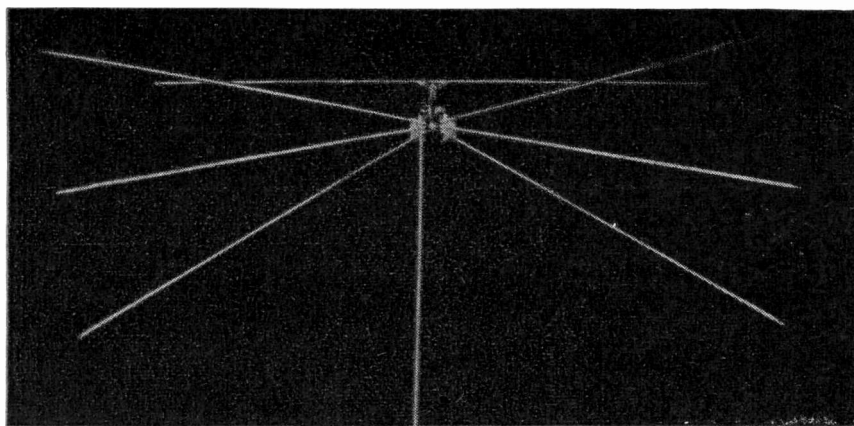

Fig. 2—The Colorcon conical antenna—center elements are reduced in length.

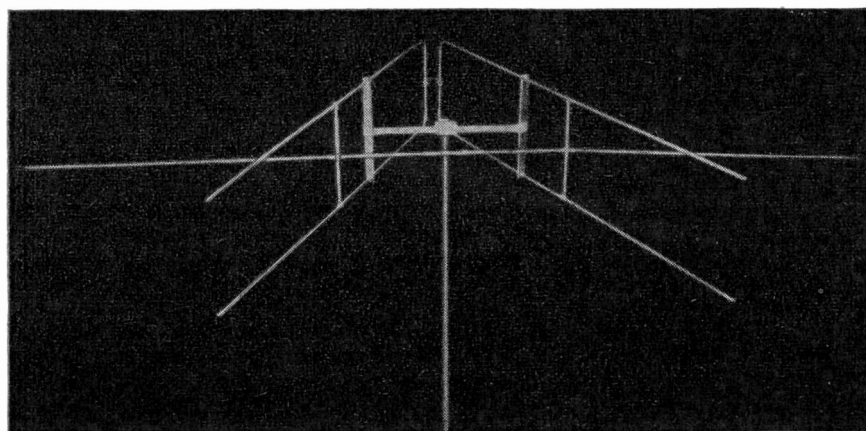

Fig. 3—The Delta V Beam color TV antenna. The CBS model has a reflector.

### FM interference

The answer to the second question ("Is the antenna subject to FM pickup?") is important in those areas where FM broadcasting is a major entertainment factor. New York City, Chicago, Los Angeles, Boston and several other urban areas may require serious attention to this problem. Color TV is more sensitive to FM interference than black-and-white transmission due to the presence of the color carrier and susceptibility to beat frequencies. This means that it would be more desirable in some areas to have an antenna which discriminates against FM signals.

Some basic antenna designs are adjusted to attenuate FM pickup. However, the majority of TV antennas on the market are designed to receive FM. In many cases FM pickup efficiency was considered highly desirable since front ends such as the Du Mont *Inputuner* tune through the FM band.

CBS-Columbia in introducing its new v.h.f.-u.h.f. Delta V Beam type antenna with reflector (similar to that shown in Fig. 3) has designed an antenna that greatly attenuates FM pickup. Above 88 mc its pattern breaks up into a multilobed configuration having unfavorable FM signal acceptance in every direction. (See "U.H.F. and V.H.F. Antenna" in the December, 1954, issue.) For identification this antenna is manufactured with colored elements.

Should an FM filter not be handy

when FM interference appears on the color TV picture, take a 30-inch piece of standard 300-ohm ribbon line and place it across the antenna terminals of the color TV receiver. Start cutting the stub  $\frac{1}{2}$  inch at a time until the FM interference disappears.

Stub adjustments should be made in the location where the stub is to be installed. Surroundings may have a considerable influence on its length. It is better to lie on the floor underneath or behind the color TV receiver to cut the stub, rather than to push the receiver away from its installed position for a more comfortable adjustment which may not be satisfactory when the receiver is returned to its normal position.

Once in a while in strong signal areas an FM stub may degrade the picture on the high-frequency channels. Should this occur, the stub may be connected to the TV receiver through a high-frequency antiparallel transfer switch. This will remove the stub from the antenna circuit when the receiver is tuned to the high-frequency channels.

### Attenuating ghosts

The final question ("Can the antenna be oriented to attenuate or eliminate ghosts?") requires a review of some of the differences in definition between black-and-white and color TV pictures. Consider the same number of lines on a

picture of a baseball game. In monochrome we see a white player running against a gray background. In color TV we see the same player running against a green grass background. Obviously with the same number of lines on color TV there is a much greater apparent definition. In fact, it may be said that the average viewer watching a color picture on the old CBS 405-line low-definition system, would find it of greater apparent definition than viewing the same picture on the standard high-definition black-and-white screen with its greater number of lines.

This, of course, means that reflections on color TV will have a greater marring effect on the picture than they have on black-and-white.

Experiments have shown that viewing color TV pictures that contain color ghosts cause optical and mental annoyances that never existed with black-and-white. Clearing these objectionable ghosts may require antennas with highly directional frontal lobes. Antennas with rotators should become more popular with color TV.

Many times the solution will be to replace the existing antenna with a new high front-to-back ratio type. This recommendation by the technician may create a problem since the consumer may complain ghosts never bothered him on his black-and-white set.

Padding the ghost into the background, multiple antennas and ghost phasing between indoor and outdoor antennas will be some of the practices service technicians can try to satisfy their customers' requests for clear color TV pictures.

A padding circuit that will drop the level of the reflected signal into the background is shown in Fig. 4. By de-

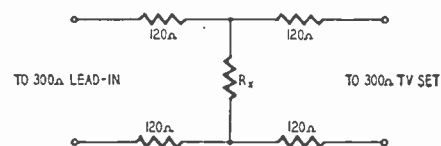

Fig. 4—Adjustable padding network.

creasing the value of  $R_x$  the signal level can be reduced slowly until the reflection disappears. Where the reflected signal approximates the strength of the original one, padding will not be possible.

In many areas it is possible to install an indoor antenna and parallel it at the antenna terminals with the outdoor antenna. The indoor antenna can then be used to pick up signals which either reinforce the original transmission or cancel out the reflected signals. This can usually be done only on one or two channels. The indoor antenna may have to be connected through a switching arrangement.

The ghost problem in urban areas on color TV will increase activity in the field of multiple-antenna systems. An individual antenna designed and adjusted for each television channel will assure the residents of multiple dwellings of good color TV reception. END

# TELEVISION UNDERWATER

By RALPH W. HALLOWS

*A new and fascinating application of the television camera*

THE development of submarine television is going rapidly ahead in Britain these days. Housed in a leakproof casing designed to withstand enormous pressures and provided with a special lens system, the TV camera has already proved itself an invaluable tool for the wreck salvager, the harbor engineer, the ship repairer, the naval architect, the designer of defenses against coastal erosion, the marine biologist and the oceanographer.

Underwater television might have been born in any maritime country, had the incentive occurred. It so happened that such an incentive was given to Britain by the tragic loss of the submarine *Affray* on April 16, 1951. Not one of those aboard her was saved and the only means of discovering the cause of the disaster was to locate and examine the wreck. Believing that television might possibly be of some use, the Admiralty had the Marconi Company make a camera that would work in 250 feet of water. In less than 5 weeks the complete apparatus was designed, manufactured, and installed in the salvage vessel *Reclaim*.

A wreck, believed to be that of the *Affray*, had been located by sweepers in 280 feet of water in a region particularly difficult for divers because of

the strong currents and heavy seas prevailing there. The salvage ship steamed to the spot. The camera was lowered and slowly moved from point to point about the wreck. Detail after detail was clearly seen. Then came the moment when perhaps the most dramatic television image ever seen appeared on the screen (Fig. 1), the *Affray's* nameplate, plain to read.

As the examination of the wreck went on submarine television proved its value again and again. With its help, for example, a diver can be sent straight to the place where he is wanted. The diver's descent is always guided by a shot rope (a cable with a heavy weight at its end). Without TV it is impossible to know whether or not the shot rope is in the right place until the diver reaches the bottom. He cannot move more than a foot or two from the rope when wearing armored deep-water dress; if its position is wrong, the diver must be brought up and the entire process repeated. But raising a diver from deep water to the surface is so slow a process that often only a single dive can be made during each tide—and there is no certainty that the shot rope will be properly placed at the next attempt.

With TV there is no element of

chance and no waste of time or of the diver's energy. He does not go down until the rope is seen on the receiver screen to be in the right position; he can be shown, too, just what he is wanted to examine. The best of divers can work for no more than a few minutes in very deep water; the TV camera stays on the job for hours on end. Unlike the diver, it can be moved as required. During the work on the wreck of the *Affray* the range of diver's vision was no more than 5 feet. Owing to the sensitivity of the image orthicon, the TV camera "saw" clearly through 15 feet of dim water. The diver can make no records, other than reports by telephone, of what he finds.

## Equipment

Fig. 2 shows the latest TV equipment for salvage work developed by Marconi in cooperation with Siebe Gorman. Capable of working down to at least 500 feet, it is lowered on a nonspin cable, to which the multicore electric cable is attached. The tubular frame carries the lights and the camera itself. The latter has a trunnion mounting and can be moved from the surface through 90° vertically; any "take" from straight ahead to straight down can thus be made. The lights, also controlled from



Fig. 1—Scene from 280 feet beneath the sea as seen on screen of TV monitor.

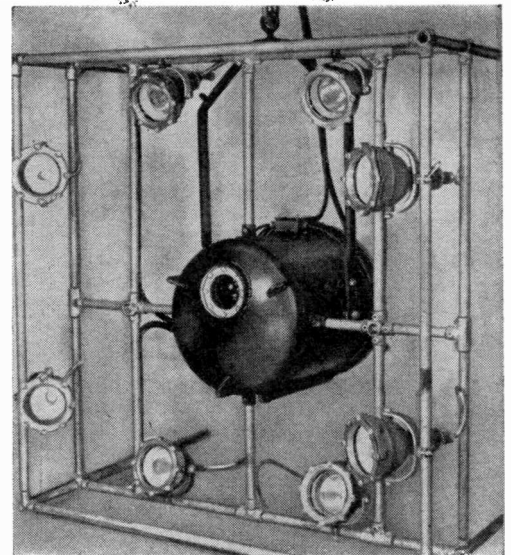

Fig. 2—Marconi underwater TV camera in a Siebe Gorman pressure case.

the surface, are ordinary 200-watt tungsten lamps. These have so far been found to give the best lighting, down to about 700-800 feet. Though the pressures at such depths are in the order of 20-25 atmospheres (300-375 pounds per square inch), unprotected lamp bulbs are not crushed, as it might be expected they would be. Direct contact with the water keeps the bulbs cool and they can therefore be made smaller and of thicker glass if necessary. Mercury arc lamps can be used at depths of thousands of feet.

All remote controls of the camera, as well as the main viewing C-R tube, are mounted in a compact monitor unit (Fig. 3). The unit allows the focus, the iris diaphragm and the lighting to be adjusted, no matter at what depth the camera is working. If a turret lens is used, it is also remotely controlled. Indicating dials at the monitor include an inclinometer, showing the vertical angle of the camera, a compass showing the bearing on which it is pointing, a humidity meter, giving warning of excessive moisture in the armored case containing the camera, and a tell-tale showing whether or not the heater is maintaining the proper temperature for the image orthicon to work most efficiently.

A recent refinement is the addition of a vision radio link with a normal range of over 30 miles. This enables experts ashore to be consulted when any specially difficult salvage problem arises.

#### Other applications

Underwater TV equipment of this kind is fast becoming standard gear on salvage vessels. It is also of great value to engineers in charge of docks and defenses against the sea. Turbidity of the water is the main difficulty here; but one means of overcoming this is already being developed. This consists of fixing to the front of the camera

casing a funnel-shaped closed tube filled with clear water.

An engineer can sit in his office ashore with a plan of the harbor he is inspecting before him. A vessel carrying TV gear and a radio link is directed to point after point by the engineer, who is able to conduct a minute inspection by watching his receiving screen and making permanent photographic records of anything requiring minute study. Such inspections have become routine in the clear waters of the Mediterranean Sea.

For some time the Scottish Marine Biological Association has been making successful use of submarine TV in its 75-foot research vessel *Calanus*. A smaller and lighter camera for this kind of work has been developed by E.M.I., using the emitron tube, the British counterpart of the image orthicon. Many different kinds of images are needed, ranging from whole shoals of fish or large areas of the sea-bed to detailed close-ups of individual small creatures. The camera is therefore fitted with a 6-lens turret.

Dr. H. Barnes, in charge of this research, reports excellent results and predicts a big future for underwater TV in this field. It can be used, for example, to examine oyster and clam beds as well as to study the enemies of the shellfish and their methods. Dr. Barnes found that with the help of TV he could easily and quickly carry out fish counts in selected areas. Again, there can be no doubt that TV will enable us to learn far more than we now know of the habits and food of different fishes, of their seasonal movements, of their spawning grounds and of the conditions which work for and against the rapid growth of newly hatched fish. How clearly fish can be seen at considerable depths may be gathered from Fig. 4, which shows herring at 240 feet.

So far as I know, television has not yet been applied to the actual catching

of fish, though it has been used with success for discovering just how trawls and nets behave when in action. This is likely to lead to improvements in this kind of gear and probably in fixed traps such as crab and lobster pots. Television, too, may revolutionize such industries as pearling and sponge-fishing.

And what of the location of shoals of fish? The fishing fleets of tomorrow may well include scouting vessels equipped with underwater cameras. Trawls and nets will not be shot until the fish have been found. Sea fishing will then be a certainty, with no waste of time, energy or fuel.

Since the seas cover three-quarters of the world's surface, oceanography is a vastly bigger job than geography. Fig. 5 shows the TV camera developed by the Pye Company for the Admiralty and now in service in the ocean survey ship *Discovery II*. Though it is regularly used down to depths of 1,000 feet, the casing has over-all dimensions of only some 3 x 2 feet and weighs no more than 7 hundredweight. The camera points downward and the feet at the bottom of the case prevent damage to the window.

This camera is proving most valuable for examination of the sea-bed and its inhabitants down to the depths mentioned. Other cameras for much greater depths are now being developed. The housing of the camera and the illumination of its field of view present no great problems; but means have still to be found of making great lengths of multicore cable in one piece and of handling such cables satisfactorily at sea.

It seemed, not so long ago, that there was little of the world left to be explored. Now submarine television is offering a huge new field for exploration and discovery by giving man the power of seeing and of photographing what lies under the deep water of the oceans.

END

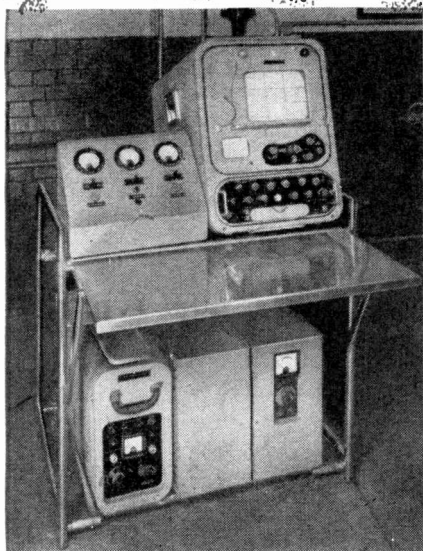

Fig. 3—Monitor and control panel.



Fig. 4—TV view of fish at 240 feet.

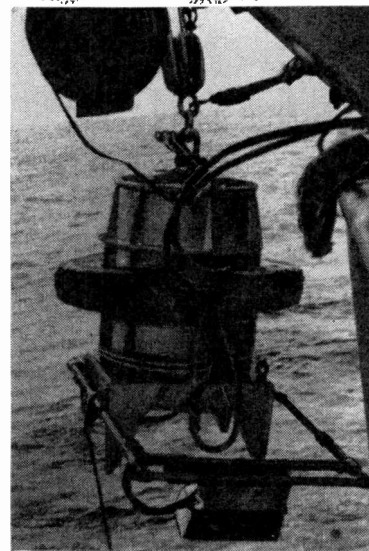
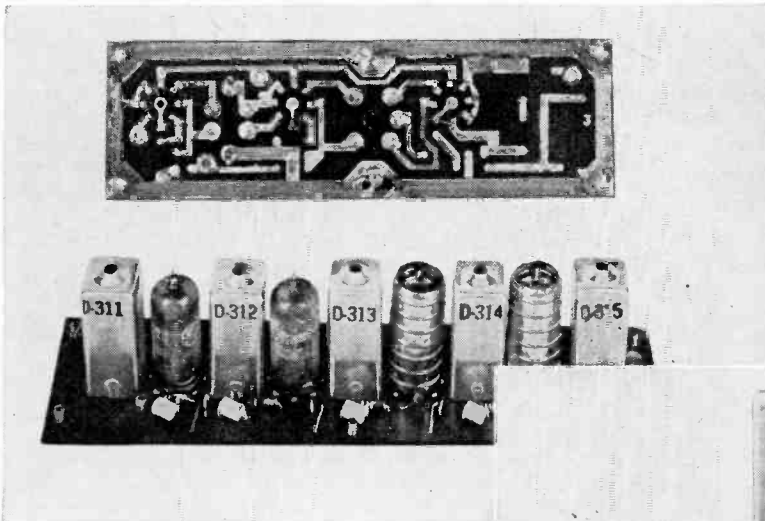

Fig. 5—Deep-water TV camera.

# PRINTED-CIRCUIT TV CHASSIS

Containing nine printed-circuit units mounted on plastic strips, the Walsco PC-9 (shown on cover) represents a considerable departure from conventional TV circuitry. It is the first complete printed-circuit chassis. Dip soldering has reduced the usual 2,900 hand-soldered connections of a conventional TV receiver to only 56. Each circuit strip simply plugs into a vertically mounted chassis. Thus the repairman can replace complete units instead of troubleshooting them. The set includes remote-control tuning.



Above—top and bottom views of the video i.f. amplifier strip, containing four 6CB6's.

Below, the chassis with all printed-circuit strips in place. Mounted on the tuner is the remote-control mechanism.

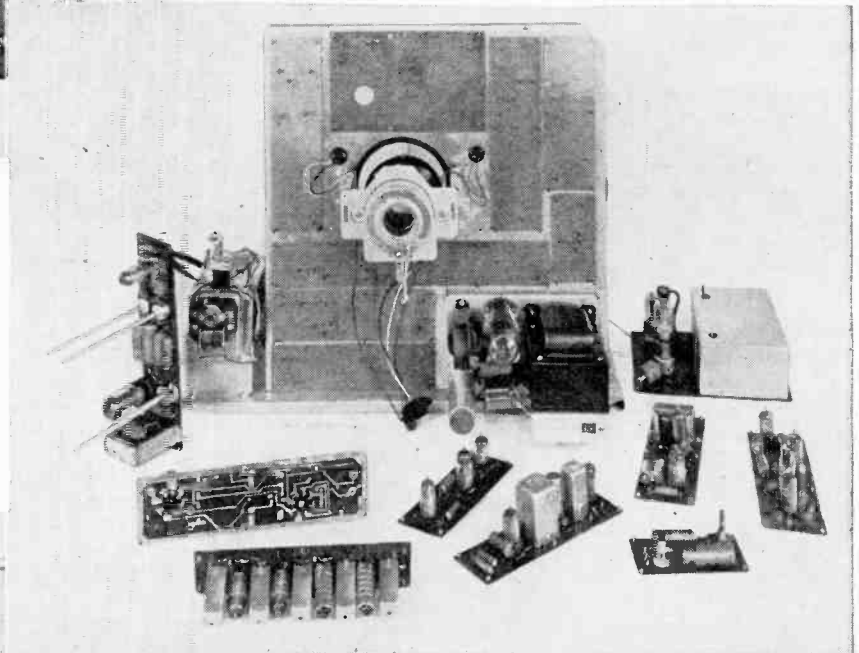
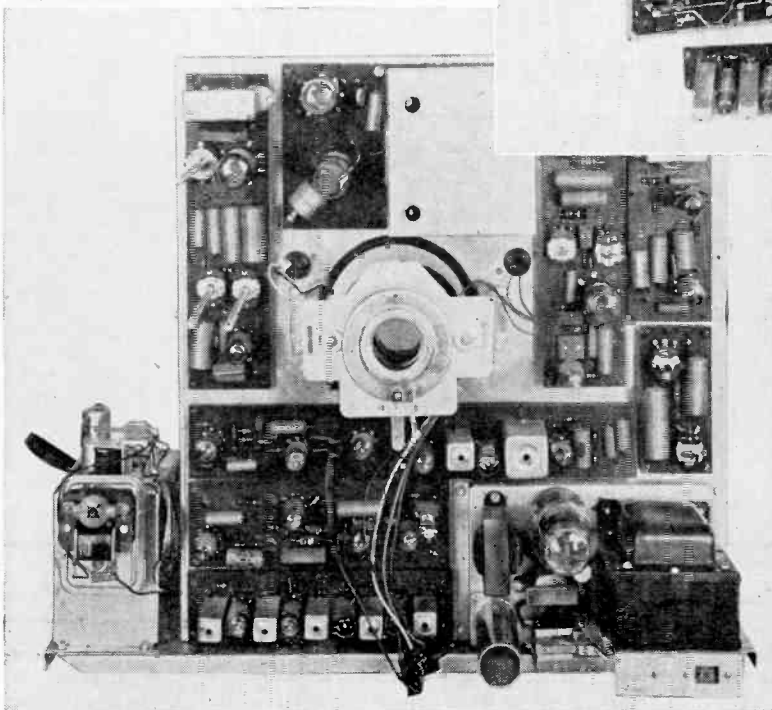

Above—the chassis with all nine printed-circuit strips removed. Only the conventionally wired tuner and low-voltage power supply are "permanently" mounted.

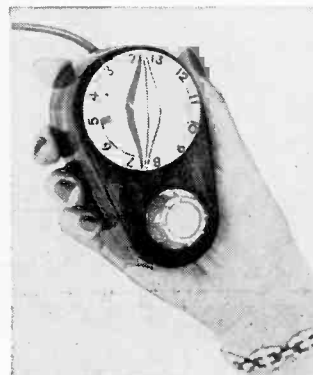

Left—the head of the remote-control unit. It contains a volume and on-off knob and a channel dial. The control and 20 feet of cable are standard equipment with this chassis.





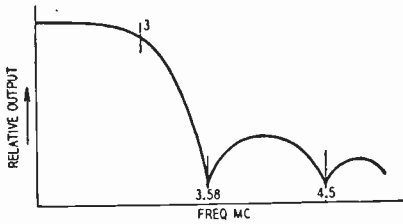

Fig. 4—The Y channel video response.

to pass. The over-all video sweep response has a 6-db peak at 4.1 mc to compensate for the rolloff at the corresponding (41.67-mc) i.f. The purpose is to secure over-all flat response of the 3.58-mc color subcarrier and its sidebands to  $\pm 600$  kc. The bandpass amplifier video response is shown in Fig. 5. Since this is a color-difference type of receiver, the response does not extend as far in the lower frequency direction as that required for an I-Q type of receiver where sidebands extend to about 1.3 mc below the color subcarrier. The chrominance signal from the cathode of the second bandpass amplifier is then applied to the R - Y and B - Y demodulators.

Returning again to the first video amplifier, the 3.58-mc burst signal is removed from the plate by the 3.58-mc burst takeoff coil. The burst signal is fed to the grid of the gated burst amplifier. This circuit is gated—allowed to conduct only during the narrow burst interval—by a pulse derived from a winding on the high-voltage transformer. The burst-amplifier grid circuit, consisting of a CK706 diode, .01 and .0022- $\mu$ f capacitors and 22,000- and 18,000-ohm resistors, delays the pulse so the burst amplifier will be gated at the proper time. It also clamps the pulse to zero volt so that during the sweep time the input to the burst amplifier will be a negative voltage sufficient to hold the tube cut off. It shapes the pulse to give sharp rise and decay times.

After amplification by the burst amplifier, the 3.58-mc burst signal is applied to the color phase detector through the center-tapped transformer. The frequency of the burst is compared to the input to the phase detector from the oscillator (taken from the quadrature transformer primary). Any frequency difference creates a d.c. voltage at the transformer center tap which is applied through a low-pass filter to the grid of the reactance tube and appears as a varying capacitance across the crystal oscillator. The effect of this action is to maintain the color oscillator at exactly the correct phase and frequency. The 3.58-mc signal from the color oscillator cathode is coupled to the grid of the buffer amplifier which drives the quadrature transformer in

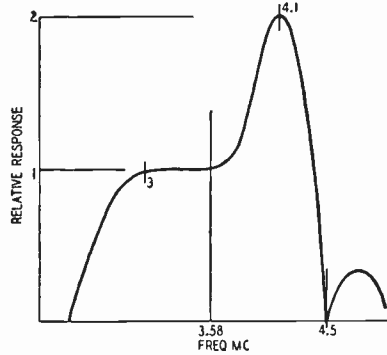

Fig. 5—Chrominance bandpass response.

its plate circuit. The output from the primary is coupled to the suppressor grid of the R - Y demodulator while the secondary output,  $90^\circ$  out of phase with the primary, is coupled to the B - Y demodulator suppressor grid.

The demodulator outputs are applied to the matrix amplifiers after passing through identical 0-600-kc low-pass filters.

The R - Y output appearing at the plate of the matrix amplifier is applied through an 8- $\mu$ f coupling capacitor to the grid of the 6AH6 red amplifier. Since the red signal is equal to (R - Y) + Y, the Y signal is applied from the output of the third video amplifier through a 1,500-ohm 1-watt resistor to the grid of the red amplifier. The blue signal is developed similarly at the grid of the blue amplifier. To obtain green, the equation  $G = 1.7Y - 0.5R - 0.17B$  is used and the proper proportions of red and blue are obtained by passing these signals from the grids of the red and blue amplifiers through 10,000- and 30,000-ohm resistors, respectively, and developing the mixture across the matrix gain control. By varying this control, the proper amounts of the red and blue voltages are obtained to mix with 1.7Y applied to the plate of the matrix amplifier from the third video amplifier. The green signal is then applied to the grid

of the 6AH6 green amplifier.

D.c. restorers are used to set proper color backgrounds for the video signals applied to the red, blue and green control grids, pins 8, 3 and 18 of the color picture tube. The green and blue brightness controls vary the respective color grid voltage levels, while the master brightness control varies all three grids simultaneously.

Vertical flyback voltage is applied to the 12AU7 convergence amplifier (pin 2) across the vertical convergence amplitude control which varies the amplitude of this voltage. The vertical parabola developed across the 1- $\mu$ f grid capacitor is then applied to pin 7, which also receives horizontal sweep voltage from the cathode at the 6CD6 high-voltage drive tube. A horizontal convergence control is used to vary the amplitude of this voltage. The vertical parabola and the horizontal sweep voltages are then amplified simultaneously and applied to the primary of the convergence transformer. The horizontal sweep voltage is then changed to a horizontal parabola by the inductance of the convergence transformer. The dynamic convergence voltages are applied to the convergence electrode (pin 13) and the focus electrode (pin 6) of the color picture tube. Convergence and d.c. focus voltages are obtained from the convergence and focus controls.

The high-voltage supply is not regulated in this receiver because of the design which uses a 25CD6 horizontal output tube (in the monochrome chassis) for horizontal deflection, while the 6CD6 is used only to develop the high voltage. With this arrangement, operation is comparable to that of a regulated receiver. A separate 1X2-A is used to develop focus high voltage.

Two low-voltage power supplies are used: one, on the monochrome chassis, supplies all monochrome type circuits; the other, on the color chassis, supplies the color circuits, the fifth i.f. stage and cathode follower. TO BE CONTINUED

## COMMUNITY ANTENNA USES BIG HORN

This horn is no doubt one of the world's largest television receiving antennas. It is 60 feet long and the dimensions of the mouth opening are 22 x 26 feet. It is used by the Muscle Shoals TV Cable Co. to pick up signals from channels 6 and 13 in Birmingham and transmit the programs to subscribers in Florence, Tusculumbia, and Sheffield, Ala. The horn is designed to have a peak sensitivity on channel 13 and to cut off immediately below channel 6.

The photograph was supplied to us through the courtesy of Jerrold Electronics Corp., who designed and installed the horn.

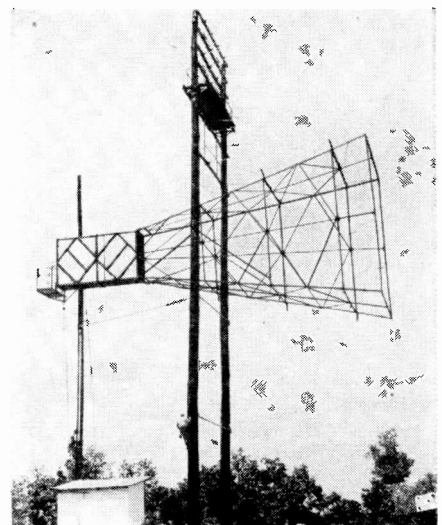

◀ Schematic of the complete color chassis. The various voltages are applied to this chassis from the monochrome unit.

# TELEVISION . . . it's a cinch

From the original "La Télévision? . . . Mais c'est très simple!" Translated from the French by Fred Shunaman. All North American rights reserved. No extract may be printed without the permission of RADIO-ELECTRONICS and the author.

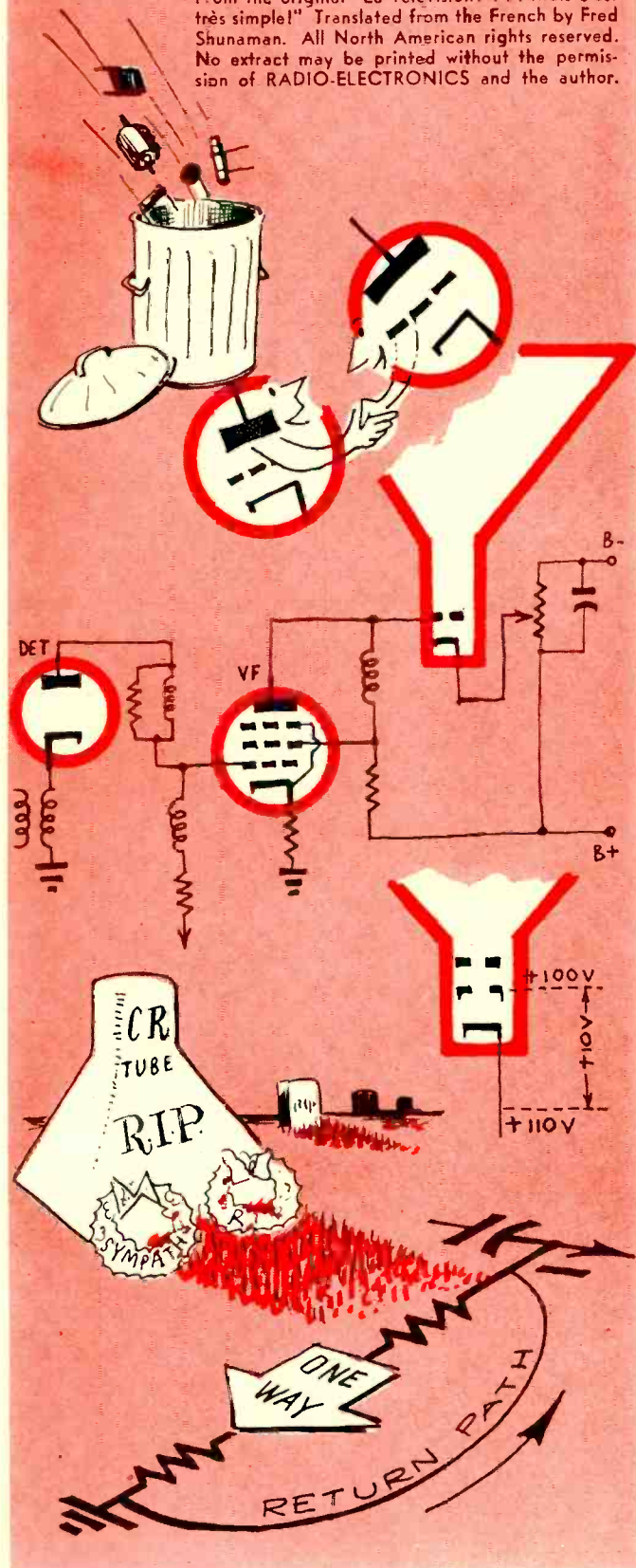

*Fourteenth conversation, second half: Down with capacitors! direct coupling; restoring the d.c. component; the useful diode*

By E. AISBERG

WILL—I don't dig it! Then all capacitors—and even parasitic capacitances, I suppose—are practically fatal to a good picture. Suppose we throw them all out?

KEN—You're joking, I hope! But that's just what has been done—quite seriously—in "direct-coupling" hookups. Nothing prevents you from getting rid of the capacitor between the detector output and amplifier grid. Eliminating the capacitor between the video-amplifier plate and the picture tube's grid is a little harder. Without that capacitor, the grid finds itself at the high positive voltage of the video-amplifier plate circuit.

WILL—So of course that can't be done. We know that the picture-tube control grid has to be more negative than its cathode, just the same as the grid of a little receiving triode.

KEN—That's right. Yet there is a way of keeping the cathode at a higher voltage than the control grid. Take a look at this. All we have to do is tap it in on a bleeder across the low-voltage power supply. Use a potentiometer. Now we have this circuit, and you can see that we can put more or less B plus voltage on the grid by varying the pot. And it acts as the brightness control, too!

WILL—Wonderful! With no capacitors to make trouble, everything should be smooth scanning. I never thought the solution would be so easy!

KEN—Don't worry—it isn't! In fact, things get a little less simple—the circuit has its own defects and troubles. For one thing, you take a chance on the life of the picture.

WILL—I can't see any connection!

KEN—Suppose that—for one of the many reasons that make a picture tube conk out—the video tube goes dead. As soon as it stops drawing current, its plate voltage goes up because there's no longer a drop across its plate resistor. The voltage on the picture grid is now likely to go up almost as high as the cathode voltage.

WILL—I see what would happen. The voltage on the control grid could go up to the low-voltage B plus. And the control grid—tapped to its bleeder—would be likely to be very little more positive. So the current goes way up, and before long the tube is ready for the garbage can! So I suppose pix-tube manufacturers might like the circuit, if no one else! Is there any way around that problem?

KEN—There are complex direct-coupling circuits that safeguard the picture tube as well as eliminate some other defects of direct coupling. But there are other—and simpler—methods that work by bringing the video-frequency voltages back into place after they go through the coupling capacitor.

### A simple restoration

WILL—Let's hear about them—at least, if they're better than the improved direct-coupling circuits.

KEN—I take it that you've noticed that all our troubles with coupling capacitors come from the passage of electrons in both directions through R. It's the voltage drops these two-way currents produce that give us the alternately positive and negative voltages.

WILL—I suppose if we could bring our electrons back to the right-hand capacitor plate without having them go through a resistor, we could cut out the positive alternations. But I don't see any way of doing that.

KEN—But there is a way, and it's not complicated. All



you have to do is shunt R with a diode that has its cathode connected to ground.

WILL—Why couldn't I have thought of that! Now the electrons driven out of the right-hand plate can't get to ground except through the resistor, because they make the diode plate negative. But on the way back they simply go through the diode. Its resistance is so low in that direction that the voltage across it (and R) is very small.

KEN—You make it sound very simple. In actual fact, the electrons that charge up capacitor C don't flow through R instantaneously. The job of the diode is to feed the right-hand plate of C enough electrons to keep the v.f. signal always negative, so even the whitest whites don't approach zero voltage. So now the right-hand plate of C is varying in one direction from ground potential, instead of fluctuating around it as an average voltage.

WILL—Do electrons go through the diode on every scanning line?

KEN—Not necessarily. If the voltages on succeeding lines have practically the same form—or more exactly, if they put the same number of electrons into movement—the diode can just charge up the capacitor and sit back. But if more electrons are put into circulation, the diode has to pass a large enough number to keep the charge up. And if the charges become weaker, the excess electrons flow out through R. So the restorer . . .

WILL—Is that what it's called?

KEN—Pardon me—I overlooked the introductions. The official title is d.c. restorer. And sometimes it's called a clamping tube, because it "clamps" the circuit to a given d.c. voltage.

WILL—And what is this d.c. we're restoring?

KEN—Well, it's a little bit abstract. The one-polarity voltage (either entirely positive or negative) we get after detection can be considered as the sum of two voltages. One of them is an alternating voltage of the form we find after the signal goes through a capacitor; the other a direct voltage (d.c. voltage, if you must!) with the right polarity and enough amplitude to put the alternating voltage entirely within the positive or negative region.

WILL—I suppose this voltage will be just equal to the one I drew in dots on the graph to divide the surface of the v.f. signal curve from our white triangle into two equal parts? (See the December installment.—*Editor*)

KEN—Once more you're right, Will.

WILL—You've drawn your figure for negative polarity. Can you show what happens in the positive case?

KEN—Nothing easier. If you have positive-going signals, just turn your diode around—connect the plate to the ground and the cathode at the junction of C and R.

**Diode here, diode there**

WILL—Just where along the road do you have to put back this d.c. component? I suppose the best thing would be to put it at the output of the last stage, at the coupling to the grid or cathode of the picture tube?

KEN—That's probably the best place to put it. Of course you have to take your sync voltages off first, but that's usual. You can also use several restorer diodes—one after the

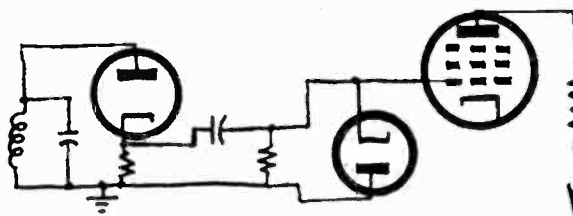

detector, one after the first v.f. stage, and so on. . .

WILL—You don't happen to own a piece of a tube factory that specializes in diodes, by any chance?

KEN—Not at all, worse luck! But do you remember the little triangle you drew, and the signals from it? Can't you see that—with no diode—the a.c. signal area was noticeably greater than that occupied by the signals from

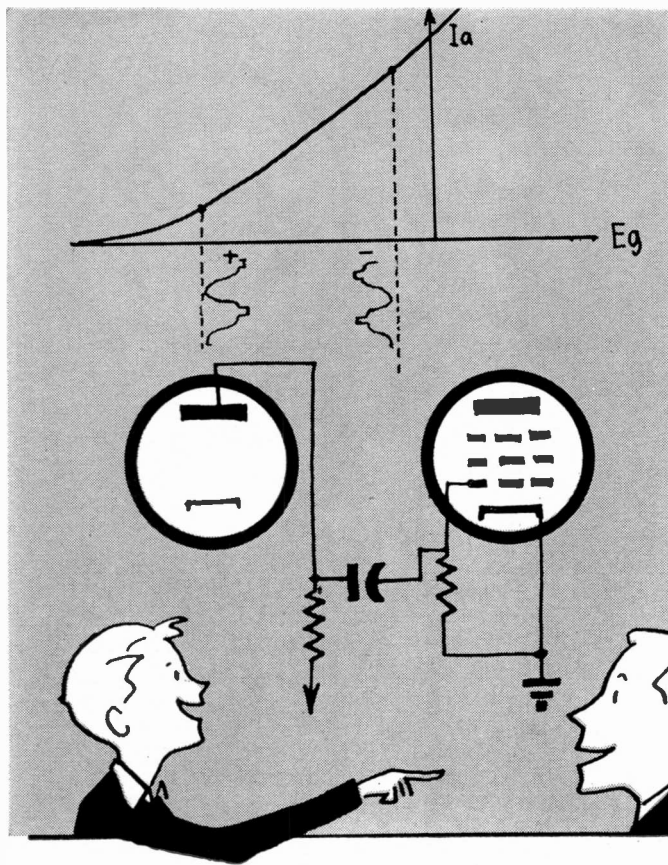

the detector, which (also because of a diode) were all of the same polarity?

WILL—But why should we worry if the signals stretch out a little further along the voltage scale?

KEN—Just because video amplifiers already have very unfavorable conditions to work under—as you learned not long ago—and there's no object in overloading their grids if we can help it. But video signal variations are usually pretty small, so we can dispense with our flock of diodes. Some sets dispense with d.c. restoration altogether, and let brightness values vary. Blacks come out sort of grayish, but it's cheaper, and the viewers don't seem to mind.

WILL—I wonder how you should bias video-amplifier tubes to amplify these unsymmetrical "unipolar" signals?

KEN—An excellent question! There would certainly be very little sense in using "the center of the linear portion of the tube's characteristic curve" as your operating point. If you have negative-polarity signals, the operating point can be less than 1 volt negative. And if they're positive-going, the operating point should be at the extreme negative end of the linear part of the tube's curve.

WILL—To sum up, if I take the concrete case of a receiver with one video amplifier and with negative-going signals applied to the picture tube's control grid, one diode—across the pix-tube grid resistor—should be enough?

KEN—More than enough, Will. If your signals are negative, the cathode-grid space of the picture tube can replace your diode. 'Way back in the days when we analyzed the grid-leak detector, you knew that the grid of a tube can—and does at times—act as the anode of a diode. In this case it's so connected with respect to the grid resistor and the signal polarity as to become its own d.c. restorer.

WILL—And I've just been accusing you of being an agent for diode manufacturers . . . !

TO BE CONTINUED

## NEW BRITISH KEYED A.G.C. CIRCUITS

WHEN the new 147-216-mc British TV band opened recently, set manufacturers immediately turned to superhet circuits to replace the much more common t.r.f. type used in the 41-68-mc band. A review of new British TV developments in *Wireless World* describes two novel keyed a.g.c. circuits.

The circuit in Fig. 1, used in *Ultra* receivers, is keyed at the *vertical sweep frequency* rather than the horizontal as is conventional here. Positive-going pulses developed during the vertical retrace period are applied to the cathode of diode V1 through an RC network (R1, C1, R2 and C2) so it is cut off during a part of the vertical flyback period. Amplifier V2 is normally biased to cutoff. A positive-going composite video signal is applied to the grid of V2 through a voltage divider consisting of R3 and the internal resistance of V1. During the vertical sweep interval, V1 conducts heavily and appears as a very low resistance so the video signal on the grid of V2 is greatly attenuated by the drop across R3. During this period the video signal is too weak to drive V2 to conduction.

When the vertical flyback pulse cuts off V1, its resistance increases to many times R3 so almost the full amplitude of the video signal reaches the grid of V2 and drives it to conduction. The vertical blanking pulses that occur during the retrace interval produce negative-going pulses at the plate of V2. These pulses pass through diode V3

and develop a negative charge on the upper plate of C4. This voltage is used for a.g.c. A variable delay bias for V3 is adjusted with the contrast control. A minimum negative bias for the controlled stages is obtained by connecting the a.g.c. line to the grid of the horizontal output tube through R4.

Fig. 2 shows the basic circuit of another unusual keyed a.g.c. system. It is used in the Murphy model V240A. Composite video is fed to the grid of V1 and positive-going horizontal flyback pulses are fed to the plate. V1 acts as a grid-controlled rectifier for the pulses on the plate. The resistor between plate and cathode is the load.

Current through the tube is controlled by the amplitude of the sync pulses that occur simultaneously with the flyback pulses on the plate. The operating point is set by the potentiometer in the cathode return.

The average d.c. voltage at the plate of V1 is applied to the grid of V2 through R1. The keying pulses are applied to the grid through a capacitive voltage divider (C2 and C3) that lowers their amplitude. The amplifier conducts only when the sum of the d.c. and keying pulse voltages exceeds the cutoff bias on the cathode. The pulses are rectified by the diode, filtered and then used as a.g.c. voltage.

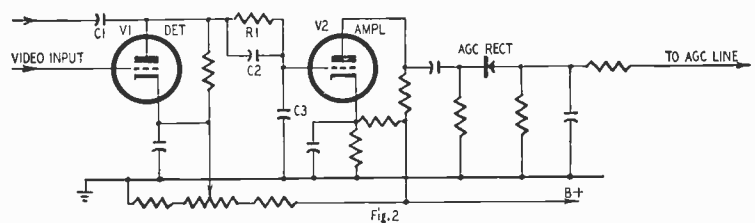
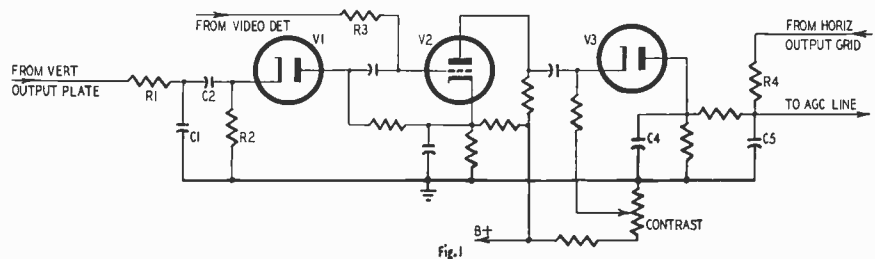

# MACHINES MAKE TV SETS



*(All photos courtesy Admiral Corporation)*

The 30-foot line of automatic machines in the photo above assembles half the new Admiral vertical chassis. Comparison between new and old units in left foreground.

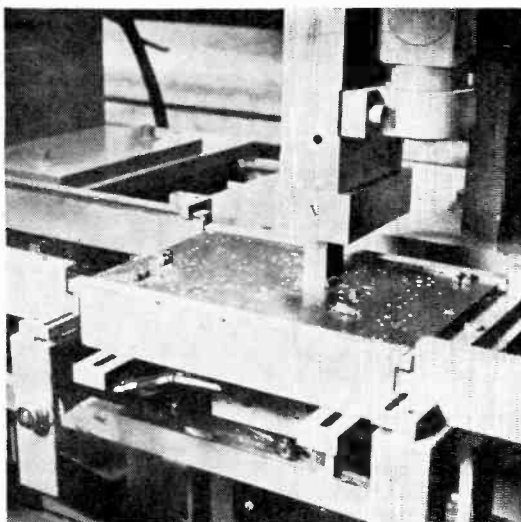

The machine at left inserts wire jumpers that connect the circuits on a printed-circuit board.

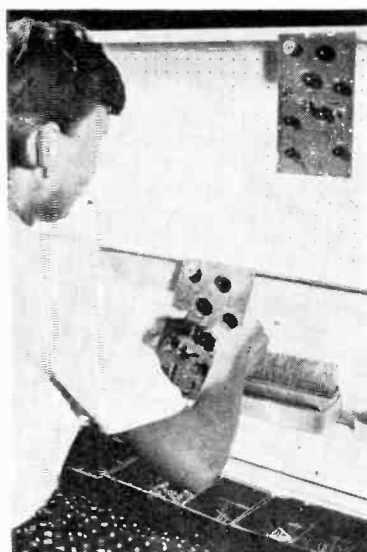

Left - Personnel is not displaced: the line has so increased output that more girls have been hired to complete the final hand assembly. Right - All connections on one side of the board are soldered in a single dip operation.

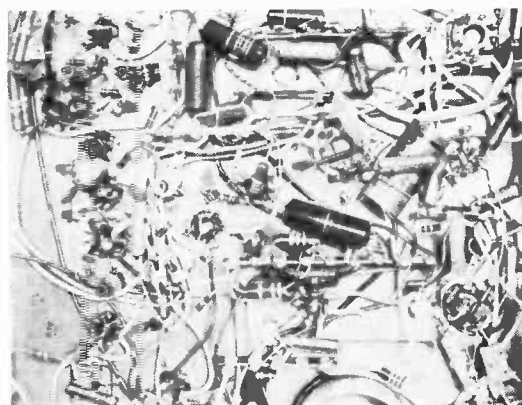

Left - "Before" printed wiring. An old-style TV underchassis. Right - "After" printed wiring. Greatly simplified layout has no dangling parts or leads.

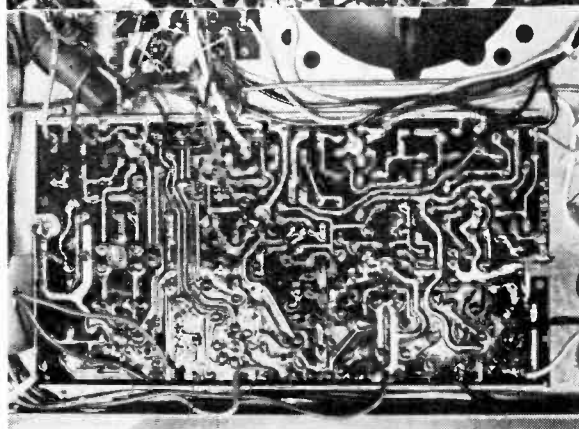

# SIMPLE GRAPHICAL SOLUTION FOR



## PROPAGATION PROBLEMS

By C. F. ROCKEY

**T**HREE common problems in wave propagation which face the practicing service technician are:

How much signal can one expect to receive from a TV transmitter?

What must be the minimum height of a receiver antenna above ground to produce satisfactory pictures?

When is a high-gain array or booster necessary?

These, and many similar u.h.f. or v.h.f. wave propagation problems may be easily solved by the method outlined here. All that is required is a pencil and a straightedge. No mathematics of any sort is needed.

Certain pertinent information is required. This, in general, will be:

1. The effective radiated power of the station involved.

2. The heights of the transmitting and receiving antennas above average ground (in feet).

3. The airline distance to the transmitter (in miles).

If this information is not known to the service technician, it may be obtained from Log and Call books, or from the TV station itself.

The calculations are performed with the nomograph (Fig. 1). All the pertinent information is marked off on scales A, B, C, D, or E. In addition, two blank "intermediate lines," I and II, are used.

To illustrate the use of the nomograph, let us solve a problem of the type first stated, in which we are to find the received signal strength. Setting the problem up, we have:

Effective radiated power (ERP) of transmitter 30 kilowatts.

Height of receiving antenna above ground 10 feet.

Height of transmitting antenna above ground 300 feet.

Distance between transmitter and receiver 10 miles

Find received power.

1. Place one end of a straightedge at the proper value of effective radiated power, on scale A (30 kw).

2. Set the straightedge so that it passes through the proper receiving antenna height, on scale B (10 feet).

3. With the straightedge now bridging the proper points on scales A and B, mark the point of intersection of the straightedge with line I (point X on the nomograph).

4. Now place the straightedge so that it bridges between point X on line I and the proper height of the transmitting antenna, on scale C (300 feet).

5. Carefully mark the intersection of the straightedge with line II (point Y on the nomograph).

6. Then find the proper transmitter-receiver distance (10 miles) on scale D, and bridge this point and point Y. Allow the straightedge to project beyond scale D to scale E. The point of intersection on scale E indicates the expected received power, in micro-microwatts (approximately  $7 \times 10^3$ , or 7,000 micro-microwatts).

Actually, it takes less time to run through a calculation than it did to read the above instructions. Practice will increase proficiency.

The system operates just as well with any one of the aforementioned quantities as the unknown as long as all of

*TV field strength in any area can be quickly estimated using known constants and two simple nomograms*

the other quantities are known. For instance, if the transmitter ERP, height of transmitter antenna, distance, and received power are known, the minimum height of receiving antenna can be determined, by "working backward," so to speak. A few minutes of practice will reveal the various possibilities.

By obtaining the received signal strength in power units, instead of the more common voltage units (microvolt per meter), we eliminate the frequency factor from the equation and increase the usefulness of the system. However, since many receivers are rated in terms of voltage sensitivity, a conversion chart is provided in Fig. 2. This chart enables us to transmit received signal power in micro-microwatts, into microvolts across a 300-ohm receiver input, or into decibels below 1 watt. The latter is most convenient where multi-element receiving antenna arrays are employed. In this case, we merely translate micro-microwatts into decibels, add to this figure the gain of the array expressed as decibels relative to half-wave dipole, then re-enter the table to find microvolts.

A final word as to the limitations and the accuracy of this method. There is no valid method of predicting signal strength in mountainous country, or in the heart of a steel-towered city. Likewise, the variable nature of the atmosphere itself plays hob with the finest calculations. But under the conditions in which the average TV or radio service technician finds himself, this method compares well with any now in use. END

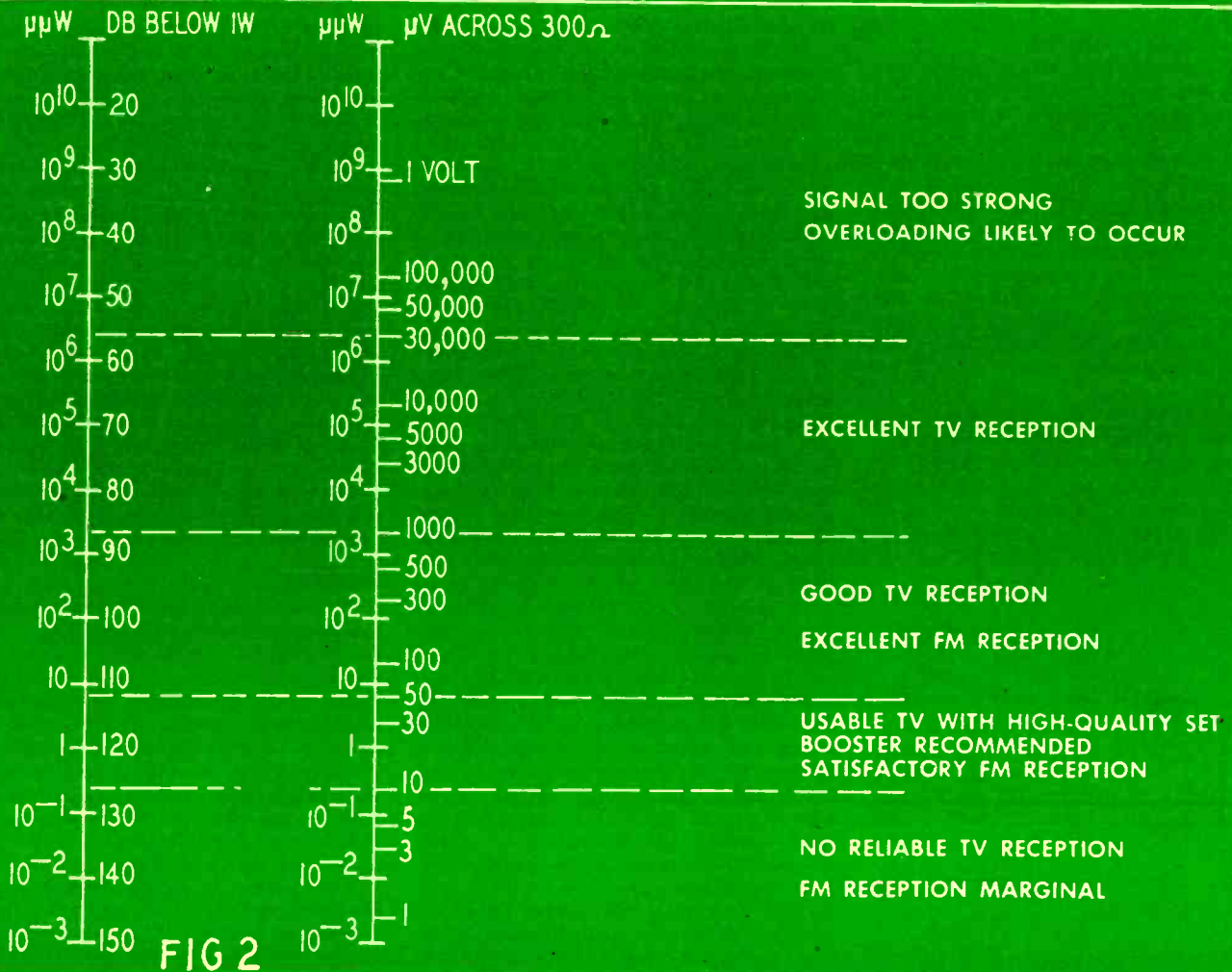
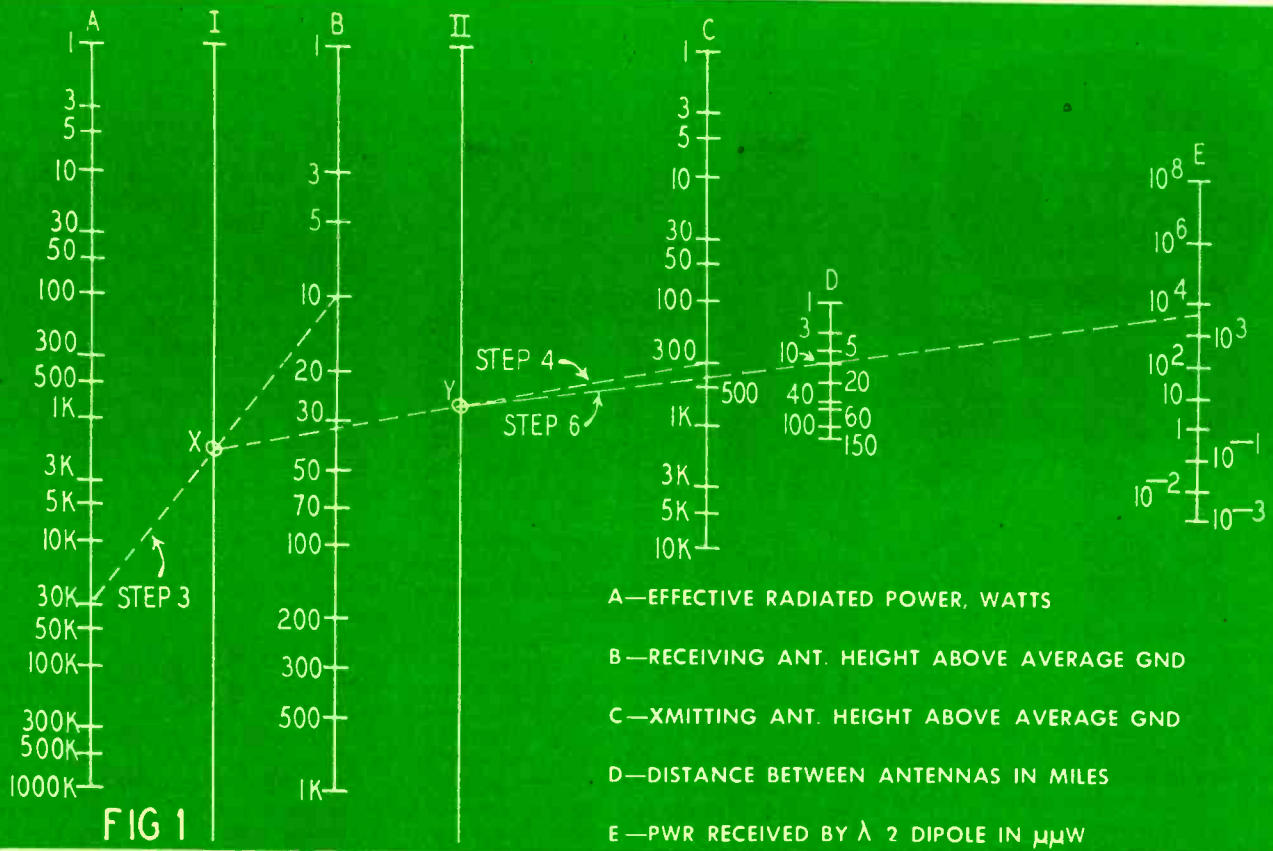

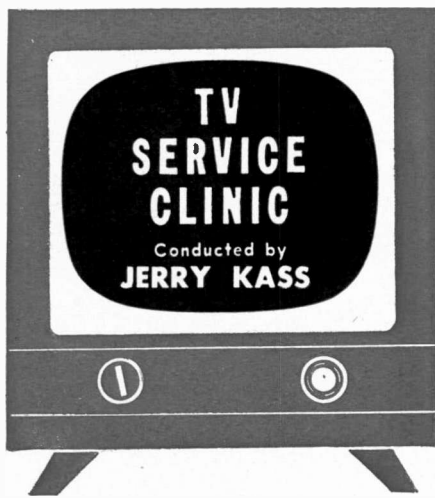

**U**NQUESTIONABLY the high-voltage rectifier is by far the most dramatic circuit in the television receiver. While the many other circuits are hard at work dissecting the numerous components of the composite video signal and rearranging them to form an intelligible image, it remains for the high-voltage rectifier to provide the finishing touch—that of furnishing second-anode voltage to give brilliance to the picture. At the same time, this circuit is a continuous source of a potentially lethal voltage that forces the service technician to be constantly on his guard.

The generation of second-anode voltage is the work of many circuits (Fig. 1), originating with the horizontal oscillator. Failure or below-par operation of any of these can decrease the second-anode voltage, with a resultant loss of picture or lack of brightness. While loss or lack of brightness can be caused by a defective picture tube or abnormal operation of any of the many circuits feeding the tube, we shall assume that, unless otherwise mentioned, all adjustments and voltages except the output of the high-voltage power supply are normal.

When little or no brightness exists, the most obvious step is to measure the voltage between the picture-tube anode

cap and ground. Voltage measurements should be made with a high-impedance meter such as a v.t.v.m. and a high-voltage probe, and should be made both with and without the high voltage applied to the picture tube. If the no-load voltage is normal, it does not necessarily indicate a defective picture tube. However, it should put the technician on guard to check for excessive second-anode current flow either through leakage on the surface of the picture tube, across the rubber high-voltage cap, or due to a defect in the picture tube. Lack of a picture does not necessarily mean the complete absence of high voltage. There can be several thousand volts on the second anode, and still not be enough for a picture.

Many service technicians, either because they do not have a high-voltage probe or simply to make a fast check, will place the high-voltage lead near the chassis and observe the arc. Though much has been said against this practice, if it is done properly, no harm will result. Doing it properly consists of drawing as long an arc as possible—of momentary duration. Excessive arcing of this type will overload and possibly ruin the high-voltage rectifier tube, flyback transformer and high-voltage filter resistor. If the circuit does not include this resistor, one of 500,000 ohms to 1 megohm should be inserted in series with the high-voltage lead when drawing a high-voltage arc.

If the second-anode voltage is low or missing, measure the high voltage at the filament of the high-voltage rectifier tube V2. If the voltage is normal here, the indication is an open or defective high-voltage filter resistor R2. This is very common. The resistor overheats and its charred particles form an extremely high resistance, causing a large voltage drop across it. The overall effect is to reduce the high-voltage output, causing an effect known as blooming.

The next test point is at the plate of the high-voltage rectifier tube. Here again, for practical purposes, a measurement can be made by drawing an arc, using a screwdriver having a well-insulated handle. With the metal blade placed near the plate cap of V2 you should be able to draw a strong (about ½ inch) a.c. high-voltage arc. This check should be made both with the cap on and with it off (especially if, with the cap on, no arc can be drawn).

If the a.c. voltage on the rectifier plate is normal, the trouble lies somewhere between this point and R2. Replace the high-voltage rectifier tube. If this does not restore normal operation, check the filament circuit of V2 for continuity. If the current-limiting resistor R1 in the filament circuit shows any signs of overheating, replace it. This resistor is subjected to sharp bursts of current and often deteriorates.

If you suspect that the rectifier tube is not receiving its proper filament voltage, disconnect the filament winding, replace it with a 1.5-volt dry cell

and observe operation under these conditions. The cell is at a high d.c. potential and must be insulated accordingly.

A final check of this circuit is to replace the high-voltage filter capacitor. Low a.c. voltage on the plate of V2 is often caused by a defective filter capacitor. If the capacitor is shorted, there will be no high-voltage output; if it is open, very little.

If the a.c. pulse voltage on the high-voltage rectifier tube is low or nonexistent, check the voltage on the plate of the horizontal output tube V1. Here again, under normal conditions, an arc can be drawn. Should this be the case, the possibility exists of a defective horizontal output transformer (shorted or open turns, or even a defective core).

If there is no pulse voltage at the plate of the horizontal output tube or if this voltage is low, all deflection components will have to be checked since their operation determines the voltage on the plate of V1. A good start is to measure the boost voltage. If this is low, check the horizontal output tube and damper V3 (by replacement). If this does not help, check the operation of the horizontal output circuit. Most important, measure the grid drive.

If the drive voltage is normal, check if the bias voltage developed is O.K. If a scope is available, check the waveform of the drive voltage—excessive curvature can reduce the high-voltage output. Should these and other measurements indicate the output stage is operating normally, it will then be necessary to return to the deflection circuit for further checks.

Obviously a short circuit in or across the flyback secondary or the horizontal deflection coils reduces the inductive kick fed to the horizontal output tube. A common trouble-maker is a shorted width coil and balancing capacitor. Check also for an open circuit in the horizontal deflection coils. And, by all means, inspect the sweep-circuit fuse.

Should there be insufficient grid drive, the next step is to check the horizontal oscillator. Measure the oscillator grid bias. If there is no negative bias, or if it is very low, the origin of the trouble has been found and the oscillator circuit must be serviced and restored to proper operation.

### Blooming

This is a condition where the picture expands both horizontally and vertically far beyond its normal size. It is usually accompanied by low brightness and poor focus. This is caused by insufficient high voltage, usually the result of low emission of the high-voltage rectifier.

Occasionally blooming occurs when the brightness control is advanced. This causes excessive second-anode current with a resulting large voltage drop across R2 and a decrease in the high-voltage output. Low second-anode voltage will not always cause blooming. When the defect is in the horizontal sweep, deflection or damper circuits, a

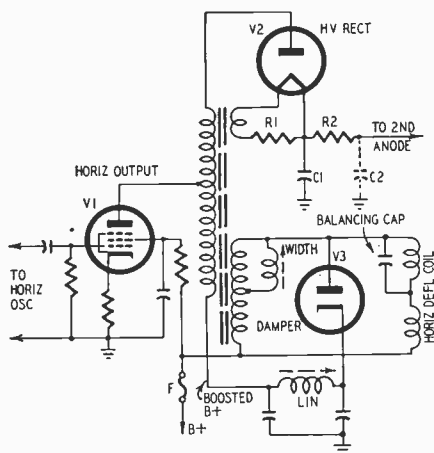

Fig. 1—A typical flyback circuit.

reduction in sweep voltage accompanies a reduction of high voltage, with the net effect being poor brightness, normal width and some vertical stretch (depending upon the boost voltage and whether it is used at the plate of the vertical output tube).

### Barkhausen oscillations

Last month we discussed the cause and effect of this condition; this month we will concern ourselves with its elimination.

Since certain tubes have a greater tendency than others toward these oscillations, the first step is to replace the output tube. If this does not help, passing a magnetic field through the tube will often greatly reduce the intensity of the oscillations and sometimes change their frequency to a point where the tuner will be relatively insensitive to them. This test can be made rapidly by placing an ion-trap magnet of the spring type around V1 and adjusting it for the elimination of the oscillations.

In some cases Barkhausen oscillations can be eliminated by reducing the grid drive to V1. In others, varying the width control is effective, especially when it is the type that varies the spacing of the air gap in the core of the flyback transformer.

In persistent cases, insert small carbon resistors in the control- and screen-grid circuits of the output stage. They should be no larger than a few hundred ohms, so as not to interfere with normal circuit voltage distribution, and should be directly connected to the tube socket.

### Arcing and corona

While these terms are often used interchangeably, each has characteristics of its own. Arcing bears a sharp sparking or cracking noise as the high voltage breaks down insulation. This will usually cause disappearance of the raster or intermittent brightness. In most cases arcing can be spotted without too much difficulty by examination of the high-voltage circuitry.

Corona can be recognized by a characteristic frying or sizzling and the odor of ozone. In most cases the only effect on the picture is dimness with an occasional snowlike appearance. The most common cause of this phenomenon is sharp or jagged edges. It is particularly annoying because it is so often difficult—sometimes impossible—to track down because it is virtually invisible. Another cause of corona is closeness of a high-voltage lead to the chassis or some component near chassis potential.

Where arcing occurs, it can be corrected by redressing the faulty wiring away from other leads and ground connections (including the high-voltage cage). Where wire insulation has broken down, either replace wire or re-dress it and apply anti-corona lacquer.

Frequently arcing occurs between the rubber cap at the end of the second-anode lead and the Aquadag coating

on the picture tube or between the anode button and the coating. Where impurities in the rubber cap are causing arcing across the cap, the entire second-anode lead should be replaced. Where the arcing is taking place across the tube, the area between the coating and the anode button should be cleaned with acetone or some similar solvent.

In corona troubles, round off all sharp edges with solder, straighten all kinks in wires, use conductive cement in cases of poor r.f. grounding and apply corona dope in particularly troublesome spots. In humid weather there is often corona leakage across dusty or greasy components such as C1 and R2—wipe these surfaces clean.

### Distorted sound

*In an Admiral chassis 20V1 the sound becomes distorted a short time after alignment despite the great care I have taken in aligning the tuner, i.f. amplifier and audio i.f. circuits. I can usually clear the trouble by alignment of the ratio detector but within a week the trouble returns. Suspecting the r.f. oscillator, I have changed almost every part in that circuit but still cannot stop what appears to be drift. I would appreciate any help that you can offer.*—M. R., Miami, Fla.

You are correct in suspecting drift, and from your description the distorted sound is the result of misalignment of the ratio detector transformer as a result of frequency drift. You can put an end to this trouble by connecting a 20- $\mu$ f N750 temperature coefficient ceramic capacitor in parallel with the 180- $\mu$ f capacitor connected across the secondary of the ratio detector transformer. Then, realign the transformer.

### Poor resolution

*I have an RCA receiver model 21D328 badly lacking in detail. This trouble appears on all channels. Checking with service notes and inspecting the horizontal and vertical wedges of my test pattern, the loss of detail appears both horizontally and vertically. The lack of detail came on so slowly over a long period of time that I didn't realize it until it became very bad.*—A. M., New York, N. Y.

Your first check should be the operation of the focus control. Not only should you adjust for best focus, but the focus control should be able to move through the point of best focus. If optimum focus occurs at either end of the control range, check all components and voltages in the focus circuit. If the focus control is operating properly, check the video amplifier tube and the crystal video detector.

Measure the resistance of all peaking coils—a defective unit can cause severe loss of picture detail. One other common cause of this trouble is misalignment of the r.f. and i.f. circuits.

### Vertical linearity

*An Air King model 700 came in with a great deal of stretching at the top*

*of the picture and compression at the bottom. Everything else in the picture was perfect, including vertical synchronization. I have had this set on the bench for a week and can honestly say that I have checked every component and voltage even remotely associated with the vertical oscillator and amplifier. This one has really got me stumped.*—L. B. R., Boston, Mass.

Apparently this trouble was very common in this chassis for the manufacturer made several production-line changes to correct it in later models. To improve the linearity of the vertical sweep, make the following changes:

Fixed cathode resistor R49 in the vertical output tube (Fig. 2) was changed from 330 to 1,000 ohms.

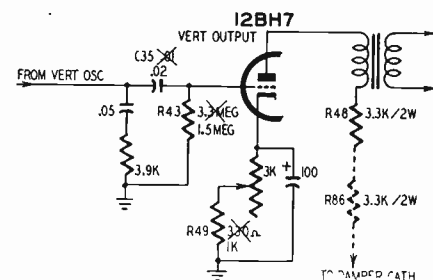

Fig. 2—Vertical output circuit of the Air King model 700 TV receiver.

Grid resistor R43 of the vertical output tube was changed from 3.3 to 1.5 megohms.

A 3,300-ohm 2-watt resistor (R86) was added in series with the low end of the primary winding of the vertical output transformer.

Coupling capacitor C35 to the vertical output tube was changed from .01  $\mu$ f to .02  $\mu$ f, 600 volts.

### Poor vertical sync

*There is a continuous barrelling that cannot be stopped by the vertical hold control. The set is a practically brand-new Bendix, chassis T14-15. The horizontal sync is perfect, so I checked the vertical oscillator and output circuits for defective components but have been unable to come up with the answer.*—G. R., Waco, Tex.

It isn't always safe to assume that good horizontal sync action means proper sync clipper action. Often a defective component will pass the horizontal pulses at 15,750 cycles and seriously attenuate the lower-frequency 60-cycle pulses.

However, you will do well to start by replacing the sync clipper and vertical oscillator tube and the vertical output tube. If this does not help, use your oscilloscope and check the waveform at both ends of the capacitor that couples the output of the video amplifier to the input of the sync limiter and noise gate. If the waveform appears normal on both sides of this capacitor, check it at the control grid and cathode of the sync clipper. If the waveform still appears normal, check all components in the integrating network.

END

# TV Station List as of November 15, 1954

(Canadian list next month)

<b>Alabama</b>		<b>WTVH-TV</b>	Peoria	19	<b>KXLF-TV</b>	Butte	6	<b>WENS</b>	Pittsburgh	16
<b>WABT</b>	Birmingham	<b>WVGM-TV</b>	Quincy	10	<b>KFFB-TV</b>	Great Falls	5	<b>WQED</b>	Pittsburgh	12
<b>WBRC-TV</b>	Birmingham	<b>WREX-TV</b>	Rockford	13	<b>KGVO-TV</b>	Missoula	13	<b>WEU-TV</b>	Reading	33
<b>WMSL-TV</b>	Decatur	<b>WTV0</b>	Rockford	39	<b>Nebraska</b>			<b>WHUM-TV</b>	Reading	61
<b>WALA-TV</b>	Mobile	<b>WHBF-TV</b>	Rock Island	4	<b>KOLN-TV</b>	Lincoln	12	<b>WARM-TV</b>	Scranton	16
<b>WCOV-TV</b>	Montgomery	<b>WICS</b>	Springfield	20	<b>KUON-TV</b>	Lincoln	12	<b>WGBI-TV</b>	Scranton	22
<b>WSFA-TV</b>	Montgomery	<b>Indiana</b>			<b>KMTV</b>	Omaha	6	<b>WTVU</b>	Scranton	73
<b>Alaska</b>		<b>Bloomington</b>	Bloomington	10	<b>WOW-TV</b>	Omaha	3	<b>WBRE-TV</b>	Wilkes-Barre	28
<b>KFIA</b>	Anchorage	<b>Elkhart</b>	Elkhart	52	<b>Nevada</b>			<b>WILK-TV</b>	Wilkes-Barre	34
<b>KTVB</b>	Anchorage	<b>Evansville</b>	Evansville	62	<b>KHOL-TV</b>	Las Vegas	8	<b>WNOW-TV</b>	York	49
<b>Arizona</b>		<b>Fort Wayne</b>	Fort Wayne	33	<b>KLAS-TV</b>	Reno	8	<b>WSBA-TV</b>	York	43
<b>KTYL-TV</b>	Mesa (Phoenix)	<b>Indianapolis</b>	Indianapolis	6	<b>KZTV</b>			<b>Puerto Rico</b>		
<b>KDOL-TV</b>	Phoenix	<b>Indianapolis</b>	Indianapolis	8	<b>New Hampshire</b>			<b>WAPA-TV</b>	San Juan	4
<b>KPHO-TV</b>	Phoenix	<b>Lafayette</b>	Lafayette	59	<b>WMUR-TV</b>	Manchester	9	<b>WKAQ-TV</b>	San Juan	2
<b>KOPO-TV</b>	Tucson	<b>Muncie</b>	Muncie	49	<b>New Jersey</b>			<b>Rhode Island</b>		
<b>KVOA-TV</b>	Tucson	<b>South Bend</b>	South Bend	34	<b>WRTV</b>	Asbury Park	58	<b>WJAR-TV</b>	Providence	10
<b>KIVA</b>	Yuma	<b>Terre Haute</b>	Terre Haute	10	<b>WATV</b>	Newark	13	<b>WNET</b>	Providence	16
<b>Arkansas</b>		<b>Waterloo-Ft. Wayne</b>	Waterloo-Ft. Wayne	15	<b>New Mexico</b>			<b>South Carolina</b>		
<b>KFSA-TV</b>	Fort Smith	<b>Iowa</b>			<b>KGGM-TV</b>	Albuquerque	13	<b>WAIM-TV</b>	Anderson	40
<b>KARK-TV</b>	Little Rock	<b>WOI-TV</b>	Ames	5	<b>KOAT-TV</b>	Albuquerque	7	<b>WCSC-TV</b>	Charleston	5
<b>KATV</b>	Pine Bluff	<b>KCRI-TV</b>	Cedar Rapids	9	<b>KOB-TV</b>	Albuquerque	4	<b>WUSN-TV</b>	Charleston	2
<b>California</b>		<b>WMT-TV</b>	Cedar Rapids	2	<b>KWSB-TV</b>	Roswell	8	<b>WCOS-TV</b>	Columbia	25
<b>KAFY-TV</b>	Bakersfield	<b>KGT-TV</b>	Davenport	17	<b>New York</b>			<b>WNBC-TV</b>	Columbia	10
<b>KERO-TV</b>	Bakersfield	<b>WHB-TV</b>	Des Moines	13	<b>WROU-TV</b>	Albany	41	<b>WBTV</b>	Florence	8
<b>KHSL-TV</b>	Chicago	<b>KQT-TV</b>	Fort Dodge	21	<b>WBEN-TV</b>	Binghamton	12	<b>WFBC-TV</b>	Greenville	4
<b>KIEM-TV</b>	Eureka	<b>KGLO-TV</b>	Mason City	3	<b>WBUF-TV</b>	Buffalo	17	<b>WGVL</b>	Greenville	23
<b>KJED</b>	Fresno	<b>KTVI</b>	Sioux City	4	<b>WGR-TV</b>	Buffalo	2	<b>South Dakota</b>		
<b>KKEA-TV</b>	Los Angeles	<b>KVTV</b>	Sioux City	9	<b>WCY-TV</b>	Buffalo	7	<b>KELO-TV</b>	Sioux Falls	11
<b>KHJ-TV</b>	Los Angeles	<b>KWWL-TV</b>	Waterloo	7	<b>WABC-TV</b>	Carthage-Watertown	2	<b>Tennessee</b>		
<b>KLAC-TV</b>	Los Angeles	<b>Kansas</b>			<b>WABD</b>	Elmira	24	<b>WDF-TV</b>	Chattanooga	12
<b>KNBH</b>	Los Angeles	<b>KCKT</b>	Great Bend	2	<b>WABD</b>	New York	7	<b>WJHL-TV</b>	Chattanooga	11
<b>KNXT</b>	Los Angeles	<b>KTVH</b>	Hutchinson	12	<b>WCBS-TV</b>	New York	5	<b>WROL-TV</b>	Knoxville	6
<b>KTLA</b>	Los Angeles	<b>KOAM-TV</b>	Pittsburg	7	<b>WCBS-TV</b>	New York	2	<b>WTSK</b>	Knoxville	26
<b>KTTV</b>	Los Angeles	<b>WTBW-TV</b>	Topeka	10	<b>WOR-TV</b>	New York	9	<b>WHBQ-TV</b>	Memphis	13
<b>KMBY-TV</b>	Los Angeles	<b>WKA-TV</b>	Wichita	16	<b>WRCB-TV</b>	New York	11	<b>WMCT</b>	Memphis	5
<b>KCCC-TV</b>	Monterey	<b>KEDD-TV</b>	Wichita	16	<b>WRCA-TV</b>	New York	66	<b>WLAC-TV</b>	Nashville	5
<b>KSBW-TV</b>	Sacramento	<b>Kentucky</b>			<b>WKNY-TV</b>	Kingston	6	<b>WSIX-TV</b>	Nashville	8
<b>KFMB-TV</b>	Salinas	<b>WEHT</b>	Henderson	50	<b>WHAM-TV</b>	Rochester	6	<b>WSM-TV</b>	Nashville	4
<b>KFSD-TV</b>	San Diego	<b>WAVE-TV</b>	Louisville	3	<b>WHAM-TV</b>	Rochester	10	<b>Texas</b>		
<b>KGO-TV</b>	San Diego	<b>WHAS-TV</b>	Louisville	11	<b>WHET-TV</b>	Rochester	10	<b>KRBC-TV</b>	Abilene	9
<b>KPIX</b>	San Francisco	<b>Louisiana</b>			<b>WRGB</b>	Schenectady	6	<b>KFDA-TV</b>	Amarillo	10
<b>KQED</b>	San Francisco	<b>KALB-TV</b>	Alexandria	5	<b>WTRI</b>	Schenectady	35	<b>KGNV-TV</b>	Amariillo	4
<b>KRON-TV</b>	San Francisco	<b>WAFB-TV</b>	Baton Rouge	28	<b>WHEN</b>	Syracuse	8	<b>KGBT-TV</b>	Austin	7
<b>KSAN-TV</b>	San Francisco	<b>KPLC-TV</b>	Lake Charles	7	<b>WSYR-TV</b>	Syracuse	13	<b>KBMT</b>	Beaumont	31
<b>KVEG-TV</b>	San Francisco	<b>KTAG-TV</b>	Lake Charles	25	<b>WKTV</b>	Utica	13	<b>KVDD-TV</b>	Corpus Christi	22
<b>KEYT</b>	San Luis Obispo	<b>KNOE-TV</b>	Monroe	8	<b>North Carolina</b>			<b>KRLD-TV</b>	Dallas	4
<b>KOVR</b>	Santa Barbara	<b>WDSU-TV</b>	New Orleans	6	<b>WISE-TV</b>	Asheville	62	<b>WFAA-TV</b>	Dallas	8
<b>KTVU</b>	Stockton	<b>WJMR-TV</b>	New Orleans	61	<b>WLOS-TV</b>	Asheville	13	<b>KROD-TV</b>	El Paso	4
<b>KCOK-TV</b>	Stockton	<b>KSIA</b>	New Orleans	12	<b>WAYS-TV</b>	Charlotte	36	<b>KTSM</b>	El Paso	9
<b>Colorado</b>		<b>Maine</b>			<b>WBTV</b>	Charlotte	3	<b>WBAP-TV</b>	Fort Worth	5
<b>KKTU</b>	Colorado Springs	<b>WABI-TV</b>	Bangor	5	<b>WTVD</b>	Durham	11	<b>KGBT-TV</b>	Galveston	11
<b>KRDO-TV</b>	Colorado Springs	<b>WTWO</b>	Bangor	5	<b>WFMY-TV</b>	Greensboro	2	<b>KPRC-TV</b>	Harlingen	4
<b>KBTU</b>	Denver	<b>WLAM-TV</b>	Lewiston	17	<b>WFMY-TV</b>	Greensboro	9	<b>KUHT</b>	Houston	2
<b>KFEL-TV</b>	Denver	<b>WMTV</b>	Lewiston	8	<b>WFMD-TV</b>	Raleigh	28	<b>KUHT</b>	Houston	8
<b>KLZ-TV</b>	Denver	<b>WCSH-TV</b>	Portland Spring	6	<b>WISV-TV</b>	Wilmington	6	<b>KUHT</b>	Houston	8
<b>KFXJ-TV</b>	Denver	<b>WGAN-TV</b>	Portland	3	<b>WTOB-TV</b>	Winston-Salem	12	<b>KUHT</b>	Houston	8
<b>KCSJ-TV</b>	Grand Junction	<b>WPMT</b>	Portland	53	<b>North Dakota</b>			<b>KTVB</b>	Longview	32
<b>Connecticut</b>		<b>Maryland</b>			<b>KFYR-TV</b>	Bismarck	5	<b>KDBU-TV</b>	Lubbock	13
<b>WICC-TV</b>	Bridgeport	<b>WMAR-TV</b>	Baltimore	2	<b>KJIB-TV</b>	Minot	13	<b>KID-TV</b>	Midland	2
<b>WGTH-TV</b>	Hartford	<b>WAAM</b>	Baltimore	13	<b>KXJB-TV</b>	Valley City	4	<b>KITXL-TV</b>	San Angelo	8
<b>WKNB-TV</b>	New Britain	<b>WBAL-TV</b>	Baltimore	11	<b>Ohio</b>			<b>KGBS-TV</b>	San Antonio	5
<b>WNHC-TV</b>	New Haven	<b>WBOW-TV</b>	Salisbury	16	<b>WAKR-TV</b>	Akron	49	<b>WQAI-TV</b>	San Antonio	4
<b>WATR-TV</b>	Waterbury	<b>Massachusetts</b>			<b>WACA-TV</b>	Ashtabula	15	<b>WCEN-TV</b>	Temple	6
<b>Delaware</b>		<b>Adams-Pittsfield</b>	Adams-Pittsfield	74	<b>WCET-TV</b>	Cincinnati	7	<b>KCMC-TV</b>	Texarkana	6
<b>WDEL-TV</b>	Wilmington	<b>Boston</b>	Boston	4	<b>WCPC-TV</b>	Cincinnati	9	<b>KLTU</b>	Tyler-Longview	34
<b>District of Columbia</b>		<b>Boston</b>	Boston	7	<b>WKRC-TV</b>	Cincinnati	12	<b>KANG-TV</b>	Waco	5
<b>WMAL-TV</b>	Washington	<b>Cambridge</b>	Cambridge	56	<b>WLWT</b>	Cincinnati	5	<b>KRGV-TV</b>	Weslaco	5
<b>WNBW</b>	Washington	<b>Holyoke</b>	Holyoke	61	<b>WEWS</b>	Cleveland	5	<b>KFDX-TV</b>	Wichita Falls	3
<b>WTOP-TV</b>	Washington	<b>Springfield</b>	Springfield	61	<b>WNBK</b>	Cleveland	4	<b>KWFT-TV</b>	Wichita Falls	6
<b>WTTG</b>	Washington	<b>Worcester</b>	Worcester	14	<b>WXEL</b>	Cleveland	9	<b>Utah</b>		
<b>Florida</b>		<b>Michigan</b>			<b>WBNS-TV</b>	Columbus	10	<b>KBYL-TV</b>	Salt Lake City	4
<b>WFTL-TV</b>	Fort Lauderdale	<b>Ann Arbor</b>	Ann Arbor	20	<b>WTVN</b>	Columbus	6	<b>KSL-TV</b>	Salt Lake City	5
<b>WTVT</b>	Fort Lauderdale	<b>Bay City-Saginaw</b>	Bay City-Saginaw	5	<b>WHIO-TV</b>	Dayton	7	<b>KUTV</b>	Salt Lake City	2
<b>WINK-TV</b>	Fort Myers	<b>Cadillac</b>	Cadillac	13	<b>WLWD</b>	Dayton	2	<b>Virginia</b>		
<b>WJHP-TV</b>	Jacksonville	<b>Detroit</b>	Detroit	2	<b>WLOK-TV</b>	Lima	73	<b>WBTM-TV</b>	Danville	24
<b>WMBR-TV</b>	Jacksonville	<b>Detroit</b>	Detroit	4	<b>WSTV-TV</b>	Steubenville	13	<b>WVEC-TV</b>	Hampton-Norfolk	15
<b>WTVJ</b>	Miami	<b>East Lansing</b>	East Lansing	60	<b>WSPJ-TV</b>	Toledo	13	<b>WSVA-TV</b>	Harrisonburg	3
<b>WDBO-TV</b>	Orlando	<b>Grand Rapids</b>	Grand Rapids	8	<b>WFMI-TV</b>	Youngstown	27	<b>WVLA-TV</b>	Lynchburg	13
<b>WJNO-TV</b>	Palm Beach	<b>Kalamazoo</b>	Kalamazoo	53	<b>WVBN-TV</b>	Youngstown	27	<b>WACH-TV</b>	Newport News-Norfolk	33
<b>WJDM</b>	Panama City	<b>Lansing</b>	Lansing	53	<b>WHIZ-TV</b>	Zanesville	50	<b>WTR-TV</b>	Norfolk	4
<b>WSUM-TV</b>	St. Petersburg	<b>Lansing</b>	Lansing	6	<b>Oklahoma</b>			<b>WVTR</b>	Richmond	6
<b>WIRK-TV</b>	W. Palm Beach	<b>Saginaw</b>	Saginaw	57	<b>KTEN</b>	Ada	10	<b>WVLS-TV</b>	Roanoke	10
<b>Georgia</b>		<b>Traverse City</b>	Traverse City	7	<b>KGEV-TV</b>	Ada	5	<b>Washington</b>		
<b>WALB-TV</b>	Albany	<b>Minnesota</b>			<b>KSWO-TV</b>	Lawton	7	<b>Bellingham</b>	Bellingham	12
<b>WAGA-TV</b>	Atlanta	<b>KMKT</b>	Austin	6	<b>KTVX</b>	Muskogee	8	<b>KING-TV</b>	Seattle	5
<b>WLVA</b>	Atlanta	<b>Duluth-Superior</b>	Duluth-Superior	3	<b>KLPR-TV</b>	Muskogee	8	<b>KOMO-TV</b>	Seattle	4
<b>WQXI-TV</b>	Atlanta	<b>Duluth-Superior</b>	Duluth-Superior	6	<b>KTPV</b>	Oklahoma City	19	<b>KXLY-TV</b>	Spokane	4
<b>WSB-TV</b>	Atlanta	<b>Minneapolis-St. Paul</b>	Minneapolis-St. Paul	5	<b>KTVQ</b>	Oklahoma City	25	<b>KHQT-TV</b>	Spokane	6
<b>WFB-TV</b>	Augusta	<b>Minneapolis</b>	Minneapolis	4	<b>KWTV</b>	Oklahoma City	9	<b>KREM-TV</b>	Spokane	2
<b>WRDQ-TV</b>	Augusta	<b>Minneapolis</b>	Minneapolis	11	<b>WKY-TV</b>	Oklahoma City	4	<b>KMO-TV</b>	Tacoma	13
<b>WRDK-TV</b>	Augusta	<b>Minneapolis</b>	Minneapolis	10	<b>KCEB</b>	Tulsa	23	<b>KTNT-TV</b>	Tacoma	11
<b>WRBL-TV</b>	Columbus	<b>Rochester</b>	Rochester	10	<b>KOTV</b>	Tulsa	6	<b>KIMA-TV</b>	Yakima	29
<b>WREB-TV</b>	Columbus	<b>St. Paul</b>	St. Paul	11	<b>KV00-TV</b>	Tulsa	2	<b>West Virginia</b>		
<b>WETV</b>	Macon	<b>Mississippi</b>			<b>Oregon</b>			<b>WCHS-TV</b>	Charleston	8
<b>WMAZ-TV</b>	Macon	<b>WJTV</b>	Jackson	25	<b>KVAL-TV</b>	Eugene	13	<b>WKNA-TV</b>	Charleston	49
<b>WR0M-TV</b>	Rome	<b>WLBTV</b>	Jackson	3	<b>KBES-TV</b>	Medford	5	<b>WJPB-TV</b>	Fairmont	35
<b>WTOC-TV</b>	Savannah	<b>WLSL-TV</b>	Jackson	12	<b>KOIN-TV</b>	Portland	6	<b>WSAZ-TV</b>	Huntington	15
<b>Hawaii</b>		<b>WTKO-TV</b>	Meridian	11	<b>KPTV</b>	Portland	27	<b>WTAP</b>	Parkersburg	15
<b>KGMB-TV</b>	Honolulu	<b>Missouri</b>			<b>Pennsylvania</b>			<b>WTRF-TV</b>	Wheeling	7
<b>KONA</b>	Honolulu	<b>Cape Girardeau</b>	Cape Girardeau	12	<b>Altoona</b>	Altoona	51	<b>Wisconsin</b>		
<b>KULA-TV</b>	Honolulu	<b>Columbia</b>	Columbia	8	<b>Bethlehem</b>	Bethlehem	57	<b>WEAU-TV</b>	Eau Claire	13
<b>Idaho</b>		<b>Hannibal</b>	Hannibal	7	<b>WLEV-TV</b>	Bethlehem	57	<b>WBAY-TV</b>	Green Bay	8
<b>KIDD-TV</b>	Boise	<b>Joplin</b>	Joplin	12	<b>WGLV</b>	Easton	12	<b>WBWT</b>	La Crosse	8
<b>KID-TV</b>	Idaho Falls	<b>Kansas City</b>	Kansas City	5	<b>WCU</b>	Erie	35	<b>WKOW-TV</b>	Madison	21
<b>KBOI</b>	Meridian	<b>Kansas City</b>	Kansas City	9	<b>WSEE</b>	Harrisburg	35	<b>WMTV</b>	Madison	27
<b>Illinois</b>		<b>Kansas City</b>	Kansas City	4	<b>WCEB-TV</b>	Harrisburg	25	<b>WMBV-TV</b>	Marinett	11
<b>WBLS-TV</b>	Bloomington	<b>Sedalia</b>	Sedalia	10	<b>WHP-TV</b>	Harrisburg	55	<b>WCAN-TV</b>	Milwaukee	25
<b>WCIA</b>	Chicago	<b>Springfield</b>	Springfield	3	<b>WTPA</b>	Harrisburg	71	<b>WKY-TV</b>	Milwaukee	19
<b>WBBM-TV</b>	Chicago	<b>St. Joseph</b>	St. Joseph	2	<b>WARD-TV</b>	Johnstown	56	<b>WOKY-TV</b>	Milwaukee	4
<b>WBKB</b>	Chicago	<b>St. Louis</b>	St. Louis	9	<b>WJAC-TV</b>	Johnstown	8	<b>WTMJ-TV</b>	Milwaukee	12
<b>WGN-TV</b>	Chicago	<b>St. Louis</b>	St. Louis	5	<b>WGL-TV</b>	Lancaster	6			



# CHROMATIC PROBE

By ROBERT G. MIDDLETON\*

*Converts sweep and marker generators for color TV testing*

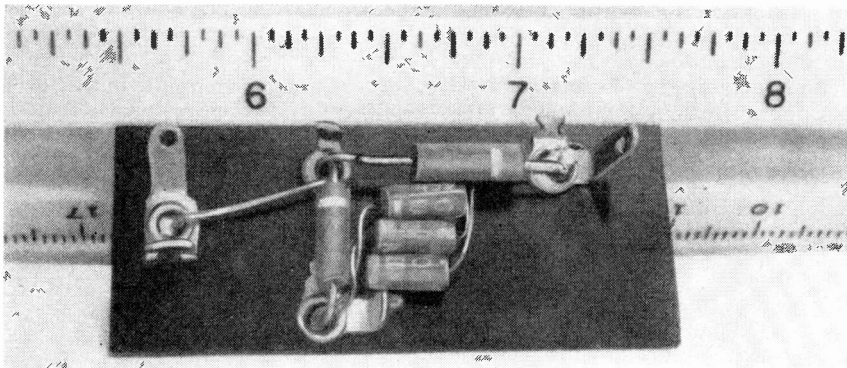

Fig. 1—Internal layout of Chromatic Probe.

**T**HE Simpson Chromatic Probe (Fig. 1) converts r.f. and i.f. sweep and signal generators for the video sweep requirements of color TV receiver circuits. The probe was de-

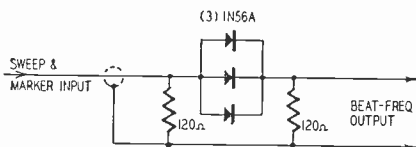

Fig. 2—Diagram of Chromatic Probe.

signed for use with specific equipment, but with slight modifications it can be used with most sweep and marker generators. Details of the modifications are explained at a later point in the article.

Fig. 2 shows the circuit arrangement of the Chromatic Probe. It is essentially a nonlinear mixing device, which generates an upper and a lower sideband when two different frequencies are applied to its input.

The lower sideband is a difference-

\*Field Engineer, Simpson Electric Co.

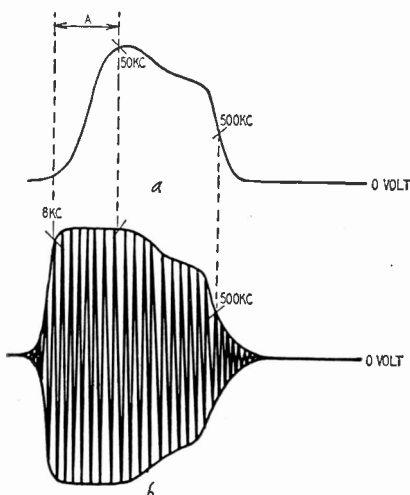

Fig. 3—Response curves: a, using demodulator probe; b, using low-capacitance probe. "A" is area of low-frequency attenuation.

frequency sweep, for testing the video-frequency circuits of a color TV receiver. To understand how the probe operates, consider a typical operating condition in which a 160-mc center-frequency signal from a sweep generator is swept over a 5-mc band, from 157.5 to 162.5 mc, and in which a 157.5-mc signal from a marker generator is mixed with the swept signal. The signals are applied to the input of the Chromatic Probe. The probe modulates these signals and generates an upper and a lower sideband. The lower sideband sweeps from 0 to 5 mc and is the signal that interests the color TV technician. It is the signal output used to sweep-check the Y amplifier, I, Q, chroma amplifier and chrominance circuits.

The Chromatic Probe uses three 1N56A crystal diodes connected in parallel. The reason is that the output impedance of the probe is approximately 100 ohms, and maximum operating efficiency is obtained with a low-impedance modulator. When three crystal diodes are connected in parallel, the internal impedance of the equivalent generator is reduced to one-third, with a corresponding increase in sideband output voltage.

The question may be asked why the output impedance is maintained at 100 ohms instead of perhaps 5,000 ohms, which would be suitable for use with a single modulating crystal. A low-impedance output is used because the impedance of color TV receiver circuits often contains a large capacitive component which attenuates the higher-frequency output from the Chromatic Probe, unless the output impedance is a low value, such as 100 ohms.

The cable of the probe is terminated principally by the first 120-ohm resistor, but also in part by the internal impedance of the paralleled crystal diodes and the output load resistor. The output network terminates the cable in its own characteristic impedance, so that standing waves are avoided. Such waves are

undesirable because it is difficult to maintain flatness of swept output when the standing-wave ratio varies greatly from unity.

The probe is operated with an r.f. instead of an i.f. input. Although it can be operated at i.f., the output is often not as uniform as when operated at r.f. The reason for this departure from flatness is that i.f. sweep generators commonly operate on the beat principle, while r.f. generators do so on the pure fundamental output from the swept oscillator. The beat principle creates in the output from the generator additional frequencies other than that indicated on the tuning dial. Ordinarily, this does not matter since the tuned circuits of the receiver under test will reject the additional frequencies.

But consider the situation when the Chromatic Probe is used in the output circuit of a sweep generator: containing no tuned circuits, it responds to all applied frequencies. When operated on an i.f. beat band, it is possible for the additional frequencies in the generator output to cross-beat through the probe so as to produce a distorted output. Although this does not necessarily occur, it is a distinct possibility at certain points in the i.f. ranges. Thus, it is best to restrict the operation of the probe to input voltages from the r.f. bands of the generator, so that the operator may be certain of a flat difference-frequency sweep-signal output from it.

This difference-frequency output from the probe provides excellent signals for checking the chroma circuits in color TV receivers.

### Frequency characteristics

The probe provides flat sweep output from 8 kc through 4.5 mc. This low-frequency limit is remarkable and far exceeds the ability of common demodulator probes to handle the low-frequency sweep. Accordingly, a demodulator probe must be avoided, and the output from the circuit under test must be applied to the scope via a low-capacitance probe.

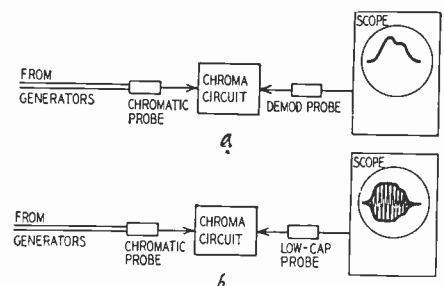

Fig. 4—Chromatic Probe test setups.

## TEST INSTRUMENTS FOR TV

If an ordinary demodulator probe is used to provide a signal to the vertical input circuit of the scope, the response curve will "pinch off" at frequencies below 50 kc, because of the inability of such a probe completely to rectify and filter frequencies below 50 kc.

If a low-capacitance probe is used to provide a signal to the vertical input circuit of the scope, low-frequency attenuation is eliminated. However, the technician usually finds the "modulated carrier wave" type of display somewhat more difficult to interpret than the conventional response curve. The difference between these two is shown in Fig. 3.

Output is not obtained from the Chromatic Probe at frequencies below 8 kc because any two generators will eventually lock when tuned near the same frequency. The point at which locking occurs depends upon the amount of coupling between them.

The two general test setups used with the probe are shown in Fig. 4. Complete low-frequency information is not obtained in *a*, because of the limitations in demodulator-probe response. Complete high-frequency information may not be obtained in *b* unless the vertical amplifier of the scope has a flat response equal at least to the bandwidth of the chroma circuit under test. Since few service scopes have a flat response out to 4.5 mc, the technician will usually have to make both tests to obtain complete information.

When the scope being used does not have as good a frequency response as the circuit under test, the result is distortion and attenuation of the curve at the high-frequency end in *b*. But if the scope has full frequency response, either test is equally useful to determine the high-frequency response.

It may not be necessary to use a low-

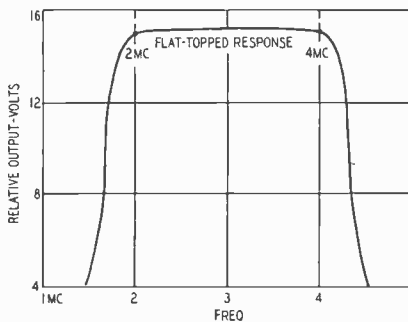

Fig. 5-a—Ideal bandpass response.

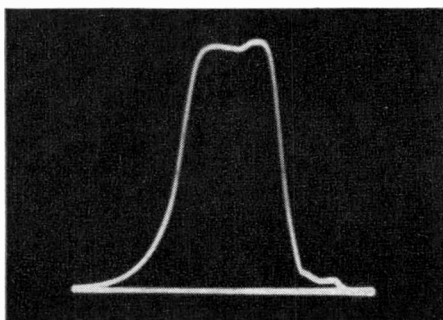

Fig. 5-b—Curve using Chromatic Probe.

capacitance probe, if the scope is applied across a low-impedance circuit point; but the probe is essential if the scope is applied across a medium- or high-frequency circuit point. Omission of the low-capacitance probe in such case will cause substantial high-frequency attenuation.

Certain precautions are sometimes required in applying the Chromatic Probe at the input of the circuit under test. If a d.c. voltage component is present, a blocking capacitor must be used in series with the probe output to avoid drain-off of the d.c. voltage and possible damage to both probe and circuit.

### Modifications

The probe will not work unless *both* sweep and CW output are applied. Since many generating units provide separate sweep and marker CW outputs, it is necessary to make a suitable mixing arrangement before the probe can be used. One practical solution is to remove the connector provided with the probe and substitute a Y connector to handle the output cables from the sweep and marker generators. Upon occasion, standing waves may cause trouble, but in most cases it is possible to select suitable generator frequencies to minimize the loss of flatness.

The generator frequencies should also be pure fundamentals (not harmonic or beat frequencies) or unusably low and distorted outputs will probably

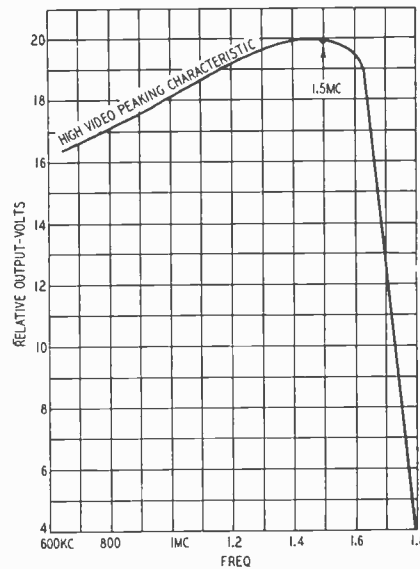

Fig. 6-a—I synchronous detector curve.

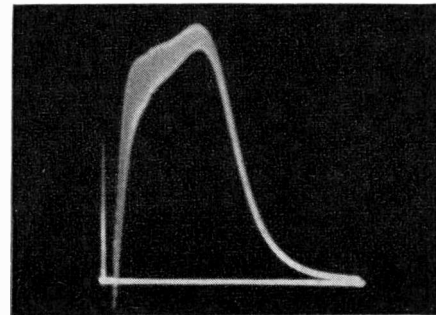

Fig. 6-b—Response obtained with probe.

plague the technician. This point requires careful consideration, since the marker generator may not operate on pure fundamentals above 60 mc, and delivers only harmonic output, while the sweep generator may not deliver pure fundamental output below 75 mc.

### Color applications

There are many circuits in a color TV receiver that require video-frequency

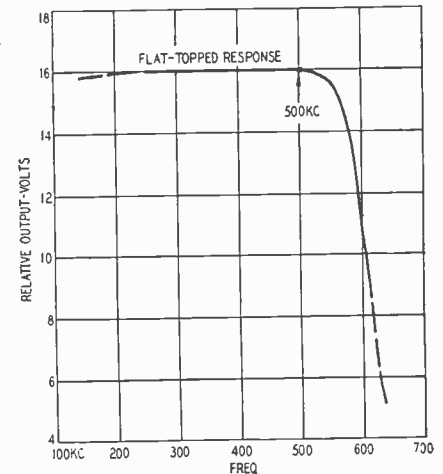

Fig. 7-a—Q synchronous detector curve.

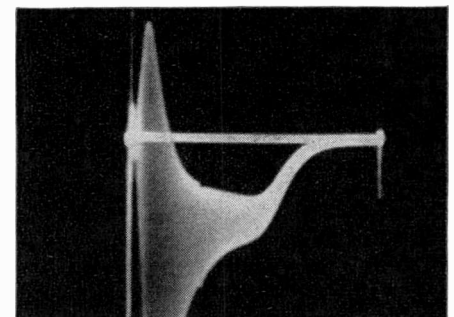

Fig. 7-b—Curve obtained with probe.

amplification, as compared with the usual single amplifier in a monochrome chassis. Fig. 5-a shows the ideal response of a bandpass amplifier, as found in the output circuit of the chrominance amplifier. For comparison, Fig. 5-b shows an actual response curve obtained with the Chromatic Probe.

Fig. 6-a shows the ideal response for the I-channel synchronous detector; *b* shows the response obtained with the probe. The fuzz is caused by incomplete rectification and filtering of the peak-to-peak high-frequency probe, which also attenuates the extreme low-frequency response.

The frequency response of a Q synchronous detector output circuit is shown in Fig. 7-a; *b* shows the response obtained with the probe. The large amount of unrectified and unfiltered fuzz is due to the use in the test of a different type of demodulator probe that uses a relatively small value of filter resistance in its output circuit. It is apparent that the appearance of the video display is greatly dependent upon probe characteristics.

END

# RAINBOW GENERATOR



*Simplified  
color pattern  
generator  
for speedier  
color TV  
servicing*

By WINSTON H. STARKS\*

**N**EW instruments and techniques are required to service color television receivers. Laboratory research and practical testing of color TV in the field have proved that color servicing need not be any more complicated than monochrome receiver servicing when the technician can mentally isolate the trouble to a given circuit by using his knowledge of symptoms. The model 150 Win-Tronix Rainbow Generator, shown in the photo, was developed to make possible the use of new and simplified methods for servicing of color television receivers.

The Rainbow Generator is a new kind of color pattern generator. The front panel controls of the generator are a CHANNEL dial for selection of channels 2 through 6, a RAINBOWS dial for selection of from one to eight rainbows or color spectra, a FUNCTION switch for

selection of either CHROMA (3.58 mc) or LUMINANCE (60-cycle square-wave) modulation, and a POWER switch. A 300-ohm connector at the rear of the unit supplies the r.f. output signal.

### Circuit analysis

The diagram of the generator is shown in Fig. 1. One section of a 12AT7 serves as an r.f. oscillator, with grid circuit tuning from channels 2 through 6. The remaining section is used as a chroma oscillator and modulator. A stable grid-tuned circuit is used to minimize drift of the 3.58-mc chroma oscillator. The tuning of the grid circuit (C1 and L1) produces the effect of phase modulation. When it is tuned to 3.579545 mc (standard chroma sub-carrier frequency), the RAINBOWS dial will be set on 0 and CAL, the phase modulation effect will be zero, and no colors will be produced. When the grid circuit

is tuned to 3.579545 mc minus the horizontal scanning frequency (3.579545 mc - 15.734 kc = 3.563811 mc), the color pattern of Fig. 2 will be produced on a properly aligned color receiver. The colors in the pattern, viewed from left to right, are as follows:

- I—123°, an orange-red
- Red—103.5° (primary color)
- R - Y—90°, dull red
- Magenta—60.7°, reddish-purple (secondary color)
- Q—33°, purple-blue
- B - Y—0°, dull blue
- Blue—346.9° (primary color)
- Cyan—285.5°, greenish-blue (secondary color)
- Green—240.7°, (primary color)
- Yellow—166.9° (secondary color, occurs during retrace time).

These colors are all produced simultaneously by the generator. Each color occurs at a definite point on the color

\*Winston Electronics Inc.

## TEST INSTRUMENTS FOR TV

kinescope and the oscilloscope waveforms. This permits accurate location of these colors by graphic means and make it possible to test and align the phase controls of the color receiver.

This pattern consists of all colors of the NTSC system, blending from one to the other as in a rainbow, with each appearing at definite locations and phases. The principle by which these colors are produced is called *linear phase sweep*. This new concept of color pattern generation simplifies methods for test and alignment of color television receivers. The FUNCTION switch allows the chroma oscillator to operate when in the CHROMA position. Placing this switch in the LUMINANCE position connects the heater voltage to the chroma oscillator grid. This kills the oscillator and makes the tube operate as a sinewave clipper, producing a 60-cycle square-wave modulation for the luminance reference signal. The power supply consists of a halfwave transformer, a selenium rectifier and a long time constant R-C filter.

### Linear phase sweep

The NTSC color standards provide that all the hues of the color TV system may be produced by a 3.579545-mc subcarrier having a phase change from 0 to 360°. Therefore, if a 3.579545-mc oscillator has a phase change or sweep from 0 to 360°, all hues will be produced on the TV receiver screen.

In the case of the Rainbow Generator, linear phase sweep of 0 to 360° occurs during the time of one horizontal line from the left edge of the picture to the right edge. One method of generating phase sweep is to provide a fixed-frequency oscillator with a sawtooth phase modulator; however, it is difficult to produce a linear phase sweep in this manner. The generator uses a much simpler method which actually provides a perfectly linear relative phase sweep. A phase change of from 0 to 360° represents a shift of one cycle since there are 360° in a cycle. Also, the phase change during one cycle is linear because of the uniform nature of a cycle.

One rainbow pattern is produced when the 3.58-mc chroma signal is made to slip or lose one cycle during the time of one horizontal line. This produces a 360° change in the phase of the 3.58-mc signal. To slip or lose one cycle during each horizontal line means that the chroma subcarrier must run at a frequency 15.734 kc lower than the standard 3.579545 mc, or at a frequency of 3.563811 mc. The burst phase of 180° occurs off the left edge of the picture during burst sampling time. Since the burst gate of the color receiver samples during retrace before each horizontal scan, we call this *burst phase*. The phase-detector circuits see only a phase change of 360° during the horizontal sweep time because they do not respond to a frequency modulation or a frequency change. If the chroma oscillator of the Rainbow Generator runs at twice

the horizontal line frequency lower than 3.579545 mc, two rainbows will be produced on the color kinescope, and so on. Fig. 3 shows three rainbows.

The importance of linear phase sweep to the service technician and the engineer is apparent when we realize that phase and matrix adjustments are simplified. This method of testing and alignment produces simple sine-wave curves showing the entire phase response at the outputs of the demodulators and the matrix networks. It is interesting to note the similarity of linear phase sweep, which permits simultaneous viewing of all phases in the form of a *phase response curve*, and the conventional frequency sweep, which permits viewing of i.f. and r.f. response curves.

### Servicing color TV

The Rainbow Generator makes possible color TV servicing in the home as well as in the shop. It provides a useful color pattern for making quick overall performance checks of the color receiver. Here are some of its applications:

1. Using the color pattern presented on the color kinescope simplifies trouble diagnosis and location in the customer's home and aids in locating defective tubes in the chroma circuit by providing a monitor signal for "tube tapping" and tube replacement methods. Tubes are responsible for an overwhelming percentage of all chroma-circuit failures.

2. The chroma signal is useful for checking the performance of new color TV receivers when they are unpacked and when they are being installed in the purchasers' homes.

3. Dealers may use the generator to check the operating condition of their color receivers before the beginning of a scheduled color telecast.

4. The generator may be adjusted to produce several rainbows (see Fig. 3) for showroom demonstrations of color TV sets.

### Trouble-shooting chroma circuits

Fig. 4 shows 11 patterns that may be used for rapid alignment of troubles in the chroma circuits of a color TV receiver. Compare these with Fig. 2, obtained with the master phase control correctly adjusted. The troubles most likely to produce the patterns in Fig. 4 are:

- a. Improper adjustment of the master phase control.
- b. Color hold control and generator locked in on 3.58 mc.
- c. Chroma circuits overloaded.
- d. Weave in pattern indicates excessive hum in the horizontal or 3.58-mc circuits.
- e. Red missing or weak indicates trouble in the red matrix, amplifier or gun of the C-R tube.
- f. Blue weak or missing indicates trouble in the blue matrix, amplifier or gun.
- g. Green weak or missing indicates trouble in the green matrix, amplifier or gun.
- h. An R - Y color pattern that indicates defect or failure of B - Y demodulator.
- i. Pattern produced by B - Y demodulator alone. The R - Y demodulator is defective.
- j. Reddish-orange and light-blue bars produced by I demodulator alone. The Q demodulator is defective.

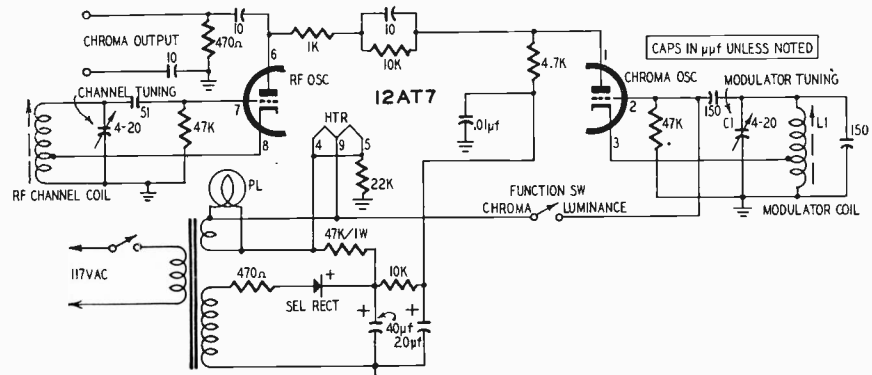

Fig. 1—This simple circuit supplies a complete bar pattern for color TV service.

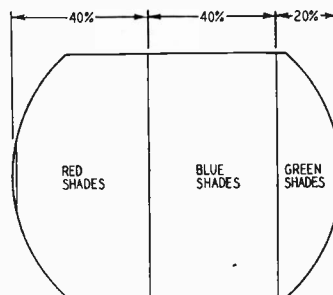

Fig. 2—The complete color bar pattern.

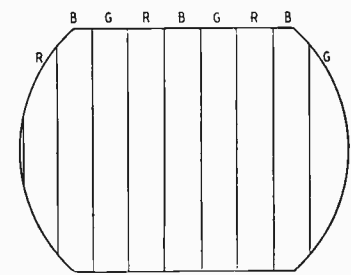

Fig. 3—Pattern at thrice line frequency.

k. Purple-blue with green bars at the sides produced by Q demodulator alone. This indicates a defective I demodulator.

The patterns at h, i, j and k may be produced for verification of diagnosis or for demonstration by pulling the corresponding demodulator tube

**Color subcarrier alignment**

The 3.58-mc subcarrier circuit can be aligned simply with the Rainbow Generator and a scope capable of displaying a usable signal at 3.58 mc. Connect the generator to the receiver's antenna posts and set the RAINBOWS dial to CAL. Connect the scope to a point following the trap or circuit to be adjusted. Ad-

just the variable element as described in the receiver manufacturer's instructions.

The circuits requiring adjustment at 3.58 mc are the coils in the burst amplifier, keyer and phase detector, keyer and phase detector, color reference oscillator and reactance tube and 3.58-mc traps. (In some cases, the normally variable element may be fixed or omitted, depending on the design of the receiver.)

**Demodulator and matrix alignment**

The linear phase sweep produced by the model 150 generator is ideally suited for fast alignment of demodulator-phase

controls. These controls consist of the master phase (I or R - Y demodulator phase) and the quadrature phase (Q or B - Y demodulator phase). The phase adjustments may be made in the home by observing the color pattern and location of colors on the kinescope screen. In the shop or laboratory the adjustments would normally be made by observing demodulator output curves on an oscilloscope.

All matrix adjustments of either I-Q or R - Y B - Y systems may be made by using the chroma signal to set phase and the luminance signal to adjust for the correct luminance to chroma ratios on the C-R grids. END

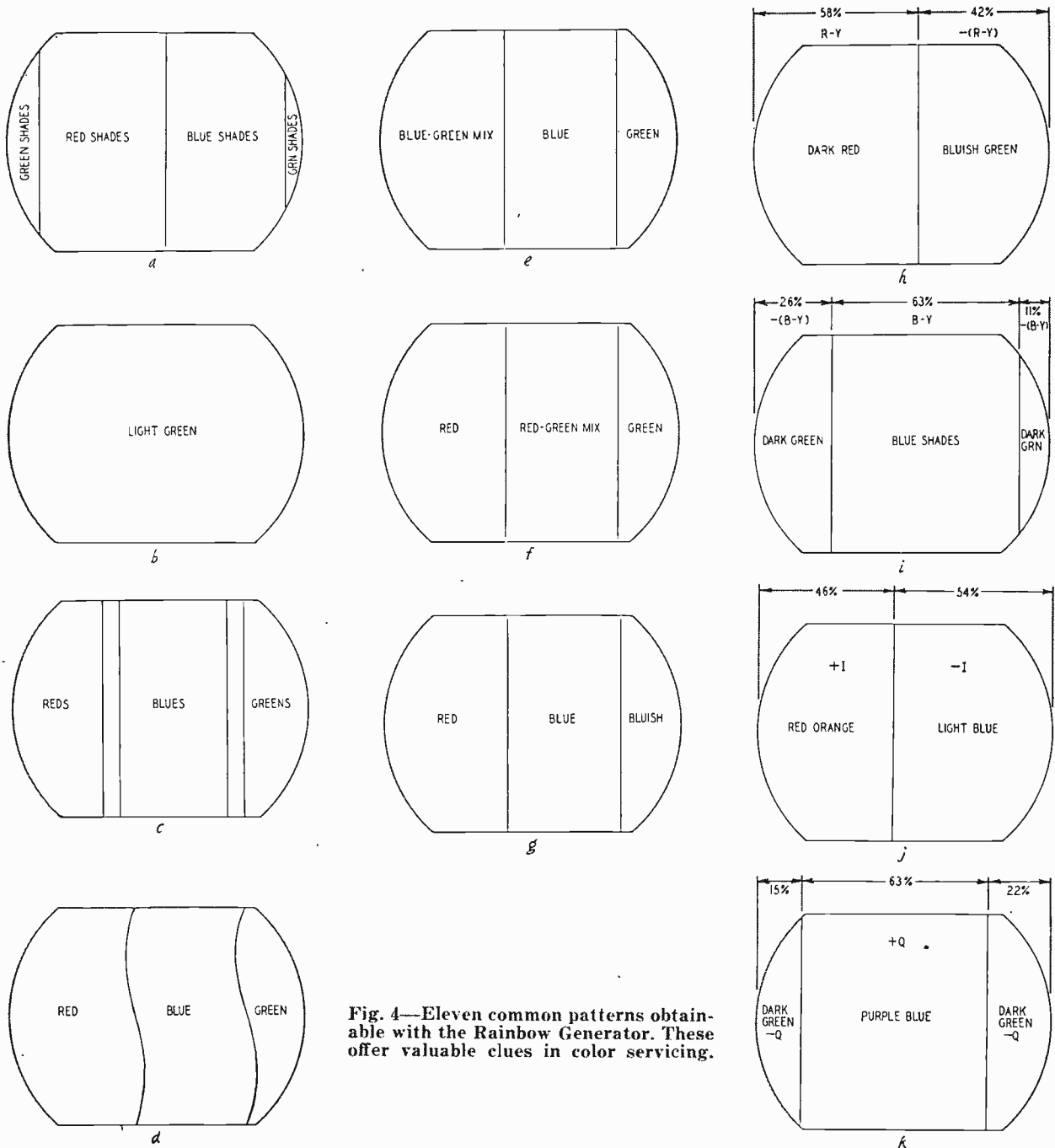

Fig. 4—Eleven common patterns obtainable with the Rainbow Generator. These offer valuable clues in color servicing.

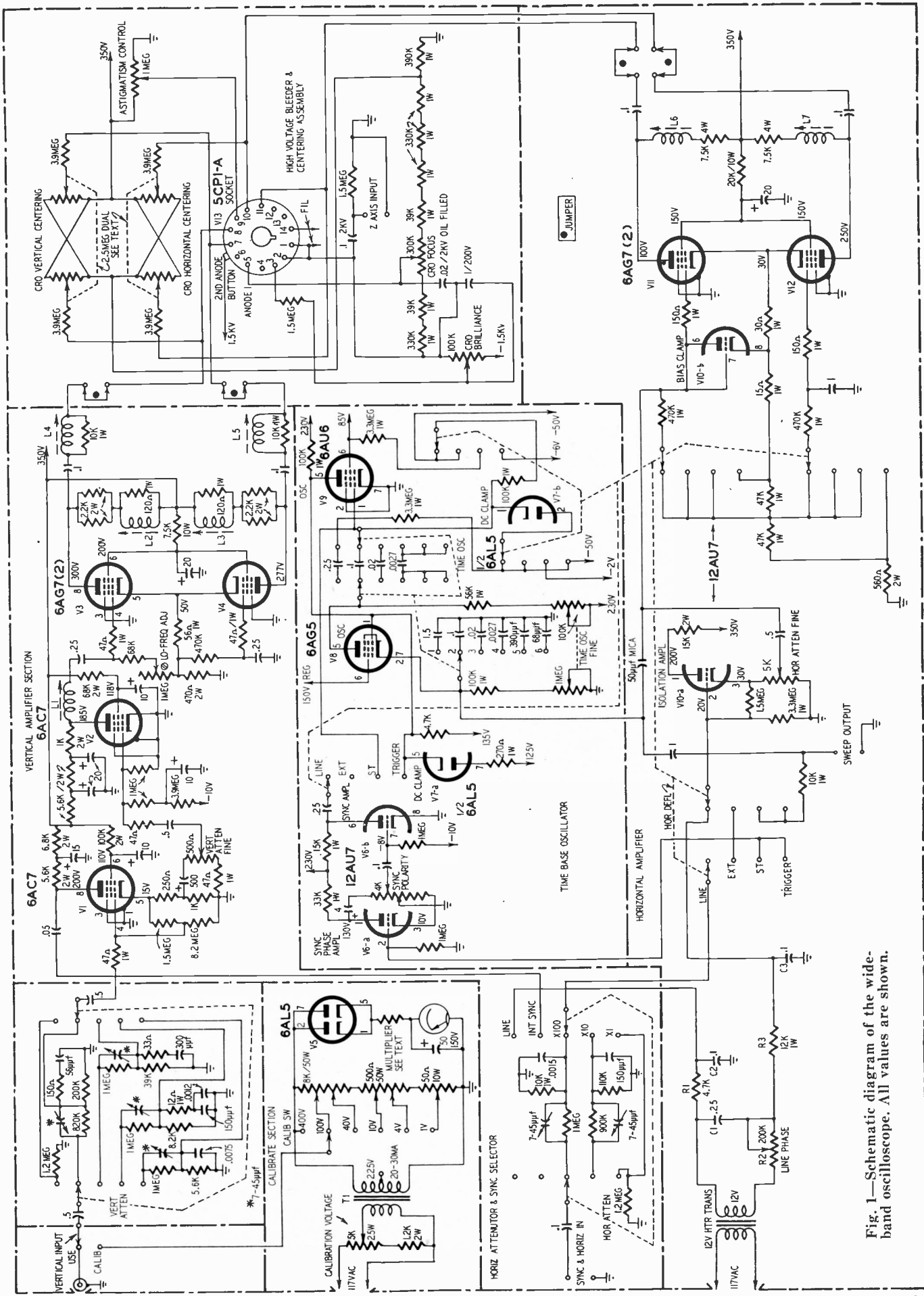
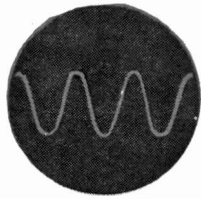

Fig. 1—Schematic diagram of the wide-band oscilloscope. All values are shown.

# VERSATILE WIDE-BAND

# 5"



# SCILLOSCOPE

By HUGH HERRING

*The frequency range  
of this instrument  
makes it a natural  
in color TV service*

USED to the better types of laboratory equipment for many years in conjunction with my work, I have had unhappily to make do with the cheaper scopes and various makeshifts—a serious compromise at best—whenever the need for such instruments has arisen in my home laboratory. The rising importance of pulse work and color television makes a wide-band scope increasingly essential to the serious experimenter, ham and service technician. With the above in mind and with a wary eye on prices of equivalent equipment, I arrived at the alternative of either doing without the necessary oscilloscope or designing one that would outperform all but the most expensive and would hold its own with these.

After considerable thought I decided on the following specifications:

1. Tube diameter at least 5 inches.
2. Vertical response to at least 5 mc and usable to 8 or 10 mc.
3. High vertical sensitivity. At least ½-inch deflection with .01-volt input.
4. Excellent low-frequency response and minimum phase shift.
5. Triggered sweep for viewing random phenomena.
6. Horizontal amplifier flat to at least 500 kc.
7. Compact, simple, trouble-free circuitry. No trick circuits.
8. Inexpensive as compared to an equivalent commercial piece.
9. All functions controllable from the front panel with a minimum number and complexity of controls.
10. Unit construction for simplicity in wiring and versatility in changing units, for ease of servicing and any possible future redesign or modification.
11. An accurate, quick, easy-to-read, built-in peak-to-peak voltage calibrator.
12. Professional appearance.

The scope to be described is the result of 11 months of experimentation and rebuilding. Although nothing new or radically different is claimed or assumed, the over-all passband and extreme linearity of the finished instrument make it a "must" project for every serious ham, experimenter and service technician. The price of a commercial equivalent is well above \$600. The following is a summary of the electrical specifications of the completed oscilloscope:

#### VERTICAL AMPLIFIER:

Frequency response:  
 ± ¼ db to 5 mc  
 - 2½ db at 6.5 mc  
 - 5 db at 7 mc  
 80% down at 11.5 mc  
 Usable to 12 mc

Sensitivity: 2.5-inch deflection with 0.5 volt peak-to-peak input

Square-wave response:

1. No measurable tilt or overshoot from 20 cycles to 9 kc
2. Rise time less than 1.25 microseconds up to 110 kc

Impedance: (Input) Direct, without input cable measures 1.2 megohms in parallel with 38 μμf

Maximum input voltage: Not to exceed 600 volts peak to peak.

#### HORIZONTAL AMPLIFIER:

Frequency response: Flat to within 5% to 1.3 mc

No special tools are needed to build this unit, but a scope is useful for checking the functions of the various units as they are completed. Also, if the full capabilities of the instrument are to be realized, a sweep generator and an oscilloscope must be used to adjust the peaking coils and trimmer capacitors in the horizontal and vertical attenuators.

For ease of construction and future versatility the scope was designed and

built from separate units on small metal subchassis cut from 1/16-inch aluminum sheet. Upon completion of each sub-assembly it was checked out both physically and for proper electrical functioning before installation on the main chassis.

The circuitry of the completed oscilloscope (Fig. 1) is rather simple, and no wiring difficulties should arise if the unit construction is closely followed. Because fundamental circuits are used throughout, the instrument is not at all touchy in operation. Also, by sticking to tried and proven circuitry, long and trouble-free operational life may be expected.

#### Sync and horizontal sweep

The Potter oscillator is used as a sweep generator because it is much more flexible and is capable of synchronizing with a much higher frequency with more reliability and linearity than the more conventional gas tube. The sweep will run recurrently or triggered, as desired. The frequency of the sweep generator (time-base oscillator) is controlled by a 6-position (TIME OSC) range switch and a continuously variable TIME OSC FINE control. The oscillator can be stabilized by positive sync pulses from an outside source connected to the SYNC AND HORIZ IN terminals on the front panel. Beginning with range 1, the approximate frequency ranges are: 22-150, 150-600, 600-2,500 cycles, 2.5-17, 17-60 and 60-225 kc.

Synchronizing voltages are amplified before being applied to the sweep oscillator to insure more stable operation. The sync circuit uses a 12AU7. One section, the sync amplifier, gives the desired gain for triggering purposes, while the other half (sync phase amplifier) gives a change in polarity by connection to the plate and the cathode through a specially constructed potentiometer. Two operating levels are set by use of two clamp circuits. One clamp

# TEST INSTRUMENTS FOR TV

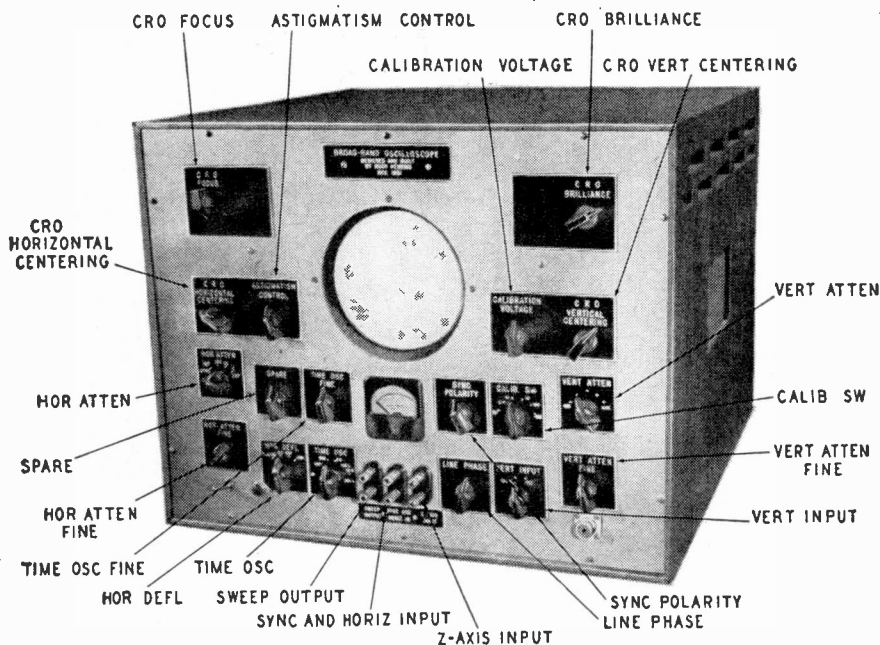

Front view of the wide-band scope. Note screened vents on side of wooden cabinet.

diode prevents the voltage on the grid of the 6AG5 from swinging much below 130, while in the sawtooth position the other clamp diode prevents the grid voltage from swinging much below -2.

The horizontal amplifier is a 3-tube circuit. Half of a 12AU7 is a simple cathode-follower isolation amplifier that drives two 6AG7 tubes in push-pull. The other half is a diode-connected bias clamp that keeps the output 6AG7's operating over the linear part of their curves.

The horizontal attenuator and sync selector switching arrangement is exactly what the name implies. In positions 100, 10 and 1 the horizontal input is attenuated (and also frequency-compensated) by 100, 10 and 1. In the internal position, the synchronizing pulse or voltage is obtained from the first section of the vertical amplifier. In the LINE position a 60-cycle voltage is selected and its phase controlled by the built-in phase-shifting network consisting of R1, R2, R3 and C1, C2, C3.

Horizontal attenuation is controlled by a step attenuator and a potentiometer in the cathode leg of the isolation amplifier.

The sweep output terminals on the front panel are another important feature of this instrument. With the sweep oscillator set for triggered or

recurrent sweep, the sweep voltage is also available at the terminals for triggering or synchronizing external auxiliary equipment.

## Vertical deflection circuit

The vertical amplifier circuit is a 3-stage affair with push-pull output. The input stage is a 6AC7 cathode follower feeding a series-peaked 6AC7 driver for the push-pull 6AG7's.

The vertical attenuator is in two sections. The fine control is a potentiometer between the 6AC7 amplifiers. A frequency-compensated step attenuator is in the input circuit. The switch marked CALIBRATE-USE at the vertical input terminal is for comparing the voltage under observation with the self-contained calibrating voltage.

The accuracy of the calibrating source can be better than that obtained with 1% resistors if you take care in its calibration. The calibrating voltage is obtained from T1, any small transformer delivering approximately 225 volts at 20 to 30 ma. The voltage divider uses adjustable wirewound power resistors. Large wattages are used because their physical size makes minute adjustments easier. Take care in the adjustment and the accuracy will be better than 1% and as good as the calibrating source used.

The power supply is fully conventional and self-explanatory. No problems should be encountered in its construction. (Continued on page 86)

## Parts for oscilloscope (Fig. 1)

**Resistors:** (Composition) 1-33, 1-250, 1-1,200, 1-5,600, 1-8,200, 1-39,000, 1-68,000, 1-110,000, 1-200,000, 1-470,000, 1-820,000, 1-900,000 ohms; 7-1, 1-1.2, 1-1.5, 5-3.9, 1-8.2 megohms, 1/2 watt; 1-12, 1-15, 1-30, 5-47, 1-56, 2-120, 3-150, 1-270, 1-1,000, 4-10,000, 1-12,000, 1-15,000, 1-33,000, 3-39,000, 2-47,000, 1-56,000, 3-100,000, 4-330,000, 1-390,000, 2-470,000 ohms; 3-1.5, 3-3.3 megohms, 1 watt; 1-470, 1-560, 1-1,000, 1-1,200, 4-2,200, 3-5,600, 1-6,800, 1-15,000, 1-68,000, 1-100,000 ohms, 2 watts. (Wirewound) 2-7,500 ohms, 5 watts, noninductive; 1-50 ohms, adjustable, 1-7,500, 1-20,000 ohms, 10 watts; 1-500, 1-8,000 ohms, adjustable, 50 watts. (Potentiometers) 1-500, 1-4,000, 1-5,000, 1-100,000, 1-200,000, 1-300,000 ohms; 2-1 megohm; 2-dual 2.5 megohms, 1-dual 100,000 ohms and 1 megohm, composition; 1-5,000 ohms, 25 watts (Ohmite type H or equivalent).

**Capacitors:** (Mica) 1-56, 1-68, 2-150, 1-300, 1-390  $\mu$ f; 1-.0012, 1-.0015, 2-.0027, 1-.0075  $\mu$ f, 500 volts. (Paper) 1-.05, 7-0.1, 4-0.25, 2-0.5,

2-1.0  $\mu$ f, 600 volts, tubular; 2-.02, 2-0.1, 1-0.25, 3-0.5, 1-4.0  $\mu$ f, 400 volts, tubular where available; 1-0.1  $\mu$ f, 200 volts, tubular, 1-1.0  $\mu$ f, 200 volts, bathub. (Oil-filled paper) 1-.02, 1-0.1  $\mu$ f, 2,000 volts. (Ceramic trimmers) 6-7-45  $\mu$ f. (Electrolytic) 3-20  $\mu$ f, 450 volts; 2-10, 1-15, 1-20  $\mu$ f, 350 volts; 1-50  $\mu$ f, 150 volts; 1-10, 1-500  $\mu$ f, 50 volts.

**Switches (Rotary):** 1-s.p.s.t.; 2-2 gangs, 2 circuits, 5 positions; 1-1 gang, 1 circuit, 11 positions, adjustable stop; 1-4 gangs, 8 circuits, 5 positions, adjustable stop; 1-3 gangs, 3 circuits, 11 positions, adjustable stop. (Toggle) 1-s.p.s.t.

**Sockets:** 6-octal; 4-miniature, 7 pins; 2-miniature, 9 pins; 1-medium-shell 12-pin diptal.

**Tubes:** 2-12AU7, 2-6AL5, 1-6AU6, 4-6AG7, 2-6AC7, 1-6AG5, 1-5CP1-A.

**Transformers:** 1-power transformer, 225-250 volts c.t. @ 20-30 ma; 1-filament transformer, 12 volts @ 600 ma or more.

**Miscellaneous:** Automobile ignition wire, 600-volt-test rubber-covered wire, hookup wire, assorted tie posts, terminal strips, Micarta or fiberboard for terminal boards, terminals or small brass screws and bolts for terminal boards; 1-chassis 17 x 13 x 3 inches, 1-chassis 17 x 6 x 3 inches, aluminum for panel and subchassis, knobs, shield for SC1P1.

## Parts for power supply (Fig. 2)

**Resistors:** 1-270, 1-1,500, 1-4,700, 1-5,300, 1-33,000, 1-47,000, 1-68,000, 2-470,000 ohms, 1 watt; 1-850, 1-2,200, 1-33,000 ohms, 2 watts; 1-5,000 ohms, 5 watts; 1-1,500, 2-2,000 ohms, 10 watts.

**Capacitors:** (Electrolytic) 2-40, 1-10  $\mu$ f, 450 volts; 2-10  $\mu$ f, 350 volts; 1-10, 2-15  $\mu$ f, 250 volts. (Oil-filled paper) 2-0.2  $\mu$ f.

**Miscellaneous:** 1-power transformer, 750 volts c.t. @ 250 ma, 6.3 volts @ 6 amps, 5 volts @ 3 amps (Stancor P-8171 or equivalent); 1-high-voltage transformer, 1,300-1,500 volts @ 5 ma, 6.3 volts @ 1 amp, 2.5 volts @ 2 amps, 1-filter choke, 6 henries, 275 ma; 1-5U4-G, 1-6AL5, 1-2X2-A, 1-0D3 or VR150; 2-octal sockets; 1-4-prong high-voltage socket for 2X2-A, 1-7-pin miniature socket; 1-pilot lamp with jeweled assembly.

## Peaking-coil data

L1-25 turns No. 32 enameled wire close-wound on CTC L53 form.  
L2 and L3-38 turns No. 36 enameled wire close-wound on XR-50 form.  
L4 and L5-46 turns No. 36 enameled wire close-wound on XR-50 form.  
L6 and L7-67 turns No. 36 enameled wire close-wound on XR-50 form.

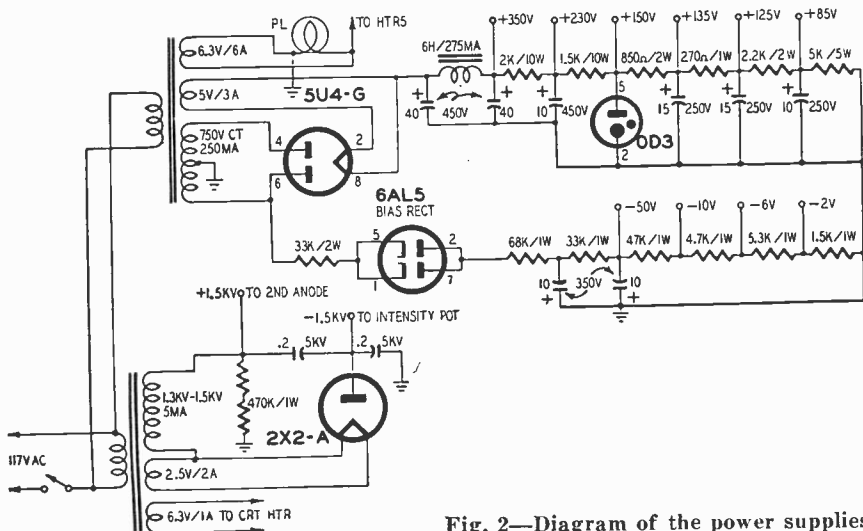

Fig. 2—Diagram of the power supplies.



**It's New! 3 Years in Development  
-NOW READY FOR YOU!**



This is the new Sprayberry Training Tube Tester Receiver, built and tested in sections for greatest instruction value.

**17" to 24"  
PICTURE TUBE**

**New Equipment! New Lessons! Enlarged Course!  
SPRAYBERRY PRACTICAL TRAINING IN**

# **RADIO-TELEVISION**

**3 NO OBLIGATION TRAINING PLANS**

**You have NO MONTHLY PAYMENT CONTRACT to sign  
... pay for this outstanding training as you learn!**



Frank L. Sprayberry  
President, Sprayberry  
Academy of Radio

The complete facts are so big and so important to any man seeking training in Radio-Television that I urge you to mail the coupon below at once for my big all-new 56 page FREE CATALOG and FREE Sample Lesson. Get the full story of this remarkable new and up-to-the-second Training Plan. You'll read about my 3 NO OBLIGATION PLANS or "packaged unit" instruction for both beginners and the experienced man. You'll learn how I can now prepare you in as little as 10 MONTHS to take your place in this fast moving big money industry as a Trained Radio-Television Technician. You'll see that you take no risk in enrolling for my Training because you DO NOT SIGN A BINDING TIME PAYMENT CONTRACT. I have been training successful Radio-TV technicians for 22 years... I can prepare you, too, to get into your own profitable Service Shop or a good paying job, even if you have no knowledge of Radio-Television. Mail the coupon... I rush full information FREE and without obligation. (No salesman will call.)



You build the new Sprayberry Test... 18 range Volt-Ohm-Millimeter readings plus output meter and condenser var and resistor substituting selector.

These photos show only a small part of the training equipment I send my students.

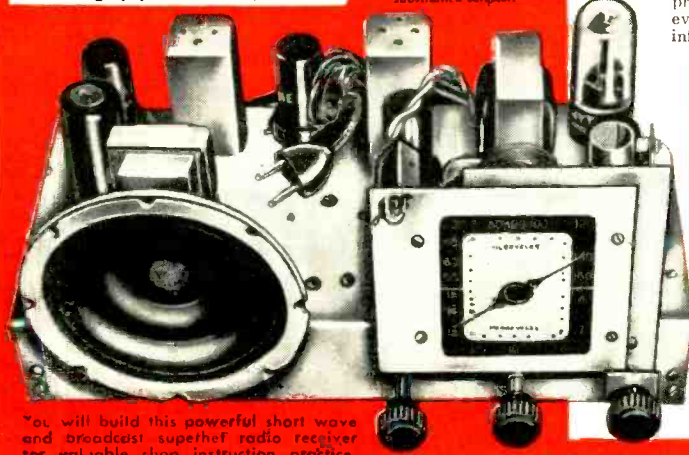

You will build this powerful short wave and broadcast superhet radio receiver for valuable shop instruction practice.

**NEWEST DEVELOPMENTS**  
Your training covers U H F, Color Television, F M, Oscilloscope Servicing, High Fidelity Sound and Transistors.

**PRACTICE AND TRAIN AT HOME WITH 25 NEW KITS OF EQUIPMENT**

You get valuable practical experience in construction, testing and shop practice. You build a powerful 2 band superhet radio, the all-new 18 range Sprayberry multimeter, the new Sprayberry Training Television receiver, signal generator, signal tracer and many other projects. All equipment is yours to use and keep... and you have practically everything needed to set up a Radio-Television Service Shop.

All your training is IN YOUR HOME in spare hours. Keep on with your present job and income while learning. I help you earn extra spare time money while you learn. If you expect to be in the armed forces later, there is no better preparation than practical Sprayberry Radio-Television training. Rush coupon below for all the facts—FREE!

**SPRAYBERRY ACADEMY OF RADIO**  
111 NORTH CANAL STREET, DEPT. 20-T, CHICAGO 6, ILLINOIS

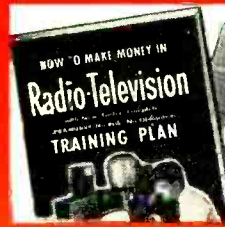

## **FREE CATALOG AND SAMPLE LESSON**

Rush coupon for my catalog "How to Make Money in Radio-Television". PLUS an actual sample Sprayberry Lesson without obligation—ALL FREE. Mail coupon NOW!

**SPRAYBERRY ACADEMY OF RADIO MAIL THIS COUPON FOR FREE CATALOG AND SAMPLE LESSON**  
Dept. 20-T, 111 N. Canal St., Chicago 6, Ill.

Please rush all information on your ALL-NEW Radio-Television Training Plan. I understand this does not obligate me and that no salesman will call upon me. Include New Catalog and Sample Lesson FREE.

Name \_\_\_\_\_ Age \_\_\_\_\_  
Address \_\_\_\_\_  
City \_\_\_\_\_ Zone \_\_\_\_\_ State \_\_\_\_\_

## TEST INSTRUMENTS FOR TV

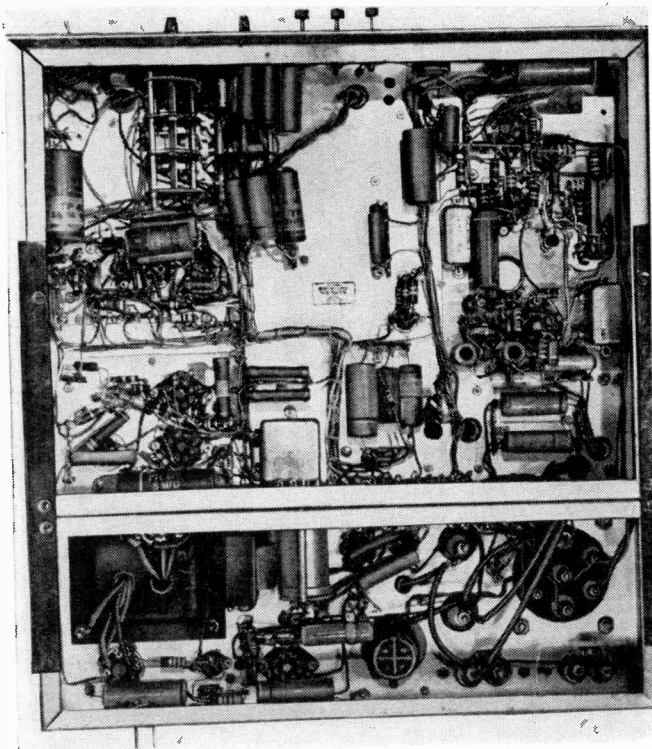

Under-chassis view of the scope. Note the short leads, cabling and generous use of tie points. Photo at right shows layout of chassis and positions of major parts.

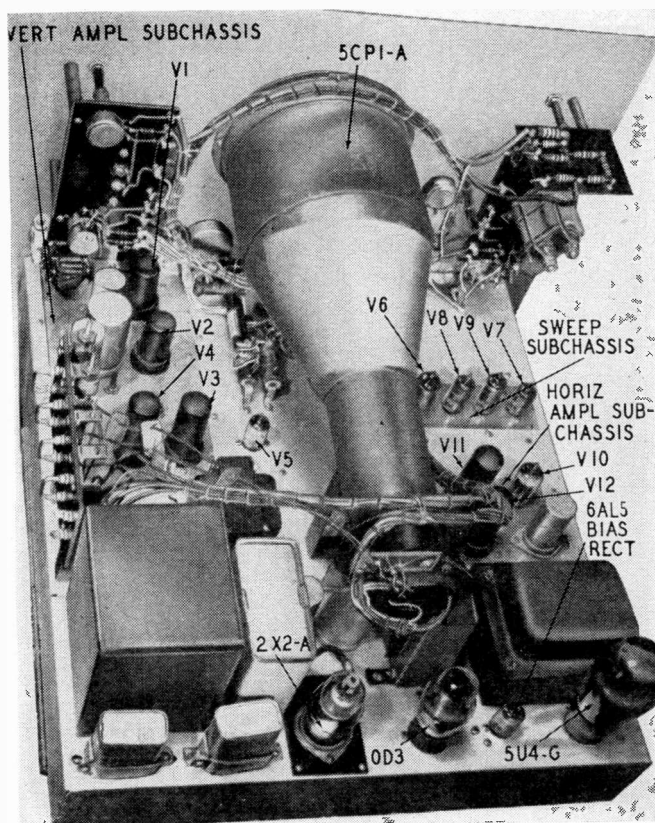

The schematic is broken by section lines into individual units. By building and following the unit construction method, the wiring and interconnecting cabling is much easier to see at a glance. Also, any trouble shooting can be done before final installation. The instrument is actually made up of two main chassis that are bolted together at the completion of the wiring sequences. The two power supplies, the high-voltage and low-voltage and bias supplies, are built on a 17 x 6 x 3-inch aluminum chassis. The high-voltage transformer (Fig. 2) was obtained on the surplus market, but any commercial equivalent will do as well.

It might do well to mention parts substitutions at this point. Parts substitutions are permissible, the only critical components being in the vertical amplifier and the frequency-determining capacitors in the sweep frequency sections. Of course, voltage and current ratings must be observed and adhered to and adequate insulation insured as the high potentials used for the second anode of the cathode-ray tube are extremely DANGEROUS.

The main chassis is aluminum and measures 17 x 13 x 3 inches. Three 1-inch or larger holes are punched in each chassis in such a manner that they will line up when the two are bolted together. These holes are provided for the purpose of assuring adequate insulation for the high-voltage, 117-volt a.c. and the filament wiring, which must pass from one unit to the other. Before the

units are bolted together the various rectangular cutouts are laid out and sawed out to size so that they will accommodate the various subassemblies when they are complete. One word of caution at this point! First build up and check the complete power-supply chassis and see that its circuits are functioning correctly. By doing this, the proper operating voltages may be easily obtained for checking the various subassemblies as they are completed.

The vertical amplifier is built as compactly as is feasible, as are all of the subassemblies. This gives more room on the main chassis for interconnecting wiring, ease of servicing and any future changes or alterations. The vertical amplifier is built on a 1/16-inch aluminum sheet measuring 5½ x 9½ inches. The layout can be clearly seen from the photographs (the left side of the top-view photo and right side of the under-chassis view) and should be followed as accurately as possible so as to approximate closely the distributed capacitances of the parts and wiring. This is of paramount importance if the pass-band of the original unit is to be obtained with the information and instructions given. Any radical departure from the layout of parts and lead dress will very likely cause undue trouble in obtaining a flat response at 6 or 7 mc. After completion of the wiring short out the peaking coils temporarily and check the unit for proper functioning.

The sweep circuit should be built next. The small subchassis is 4 x 6

inches. Direct, rigid leads must be used. Be generous in using tie points and terminals. This makes for ease of wiring, less underchassis confusion and more rigid construction. When the oscillator is finished, check its waveform with a scope.

Next, build the horizontal amplifier on a 4 x 7 inch chassis using rigid and direct leads. When completed and operating correctly, it can be laid aside until the rest of the subassemblies are completed.

The horizontal and vertical attenuator switching assemblies and the coarse frequency control are next. All of the components are wired directly onto the switches themselves. This method of construction can be seen clearly in the top-view photo. There is nothing complicated in this phase of the work and no trouble will be experienced even by an inexperienced builder.

The next step in construction is making the terminal boards and assemblies for holding the focus, centering, intensity and astigmatism controls. These boards, made from either bakelite or fiberboard, also hold the high-voltage bleeder and voltage-divider networks. I used ¼-inch thick Micarta boards. Two of these are 3 x 6 inches, one is 3 x 5 inches and one is 3 inches square. The smallest holds the high-voltage resistance-divider network. The terminal boards are mounted on the front panel with 2½-inch brass spacers. The brilliance, focus, horizontal and vertical centering and astigmatism control po-

NEW 1955

# Heathkit

## Engineering Features

### New PRINTED CIRCUITS

One of the many tremendous improvements in the new 1955 Heathkits is the use of an etched metal process printed circuit board. Printed circuits will be used in Heathkits whenever they will affect construction simplification, performance stabilization, and lend themselves to instrument design. Now for the first time a kit instrument company offers the advantages of modern printed circuit instrument construction technique. For the first time consideration has been given toward reducing the kit assembly time. Also this is the first time that printed circuit boards have been hand soldered on a volume basis. Offered only by Heathkit, the pioneer and leader in kit instrument design.

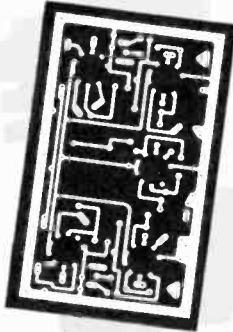

### New PEAK-TO-PEAK VTVM CIRCUIT

New 6AL5 full wave rectifier in AC input circuit permits full scale peak-to-peak measurements. Seven ranges — upper limits 4000 volts — peak-to-peak. Just the thing you TV servicemen have needed in making TV circuit voltage checks. Precision resistor voltage divider limits AC RMS level to 150 volts. Prevents overloading the rectifier — extends upper limit AC RMS ranges to 1500 volts — further protects meter and circuitry against AC flash-over or arcing. Another definite example of continuing Heathkit design leadership in the kit instrument field.

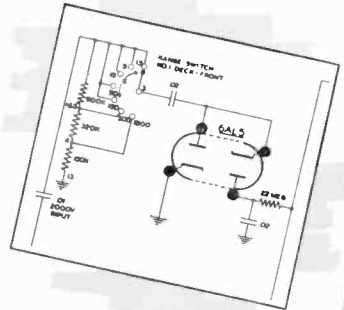

### New HIGH READABILITY PANELS

New 1955 Heathkits feature complete panel redesign. Sharp white lettering applied to the beautiful charcoal gray panels, provide a new high in readability. Lettering is easy-to-read open style and panel calibrations are vividly clear against the pleasing soft gray background. New knobs of exclusive Heathkit design.



### New 3" UTILITY SCOPE

The new 3" Scope is a "natural" for the well rounded line of Heathkit instruments. Small in size, 11 3/4" deep, 6 1/2" wide, 9 1/2" high, yet big in performance. Just think of the value. An Oscilloscope for \$29.50. Brilliant intensity, sharp focusing, wide positioning range. An ideal portable Scope for the TV serviceman — a second shop scope — modulation monitor for you hams (deflection plate terminals in rear of cabinet). Performance to spare for all general scope applications. See specifications on following page.



### New STYLING New COLOR

New styling and coloring is responsible for tremendous improvement in Heathkit appearance. The new instrument panel color combination is high definition white lettering in a soft charcoal gray panel. Cabinet color is a lighter feather gray. The satin gold baked enamel cabinet for the WA-P2 Pre-amplifier is further indicative of the modern pre-setting trend in Heathkit styling.



### New SCOPE SWEEP CIRCUIT 10 CYCLES — 500 KC

New 1955 Heathkit Model 0-10 Scope features a new wide frequency range sweep generator covering 10 cycles to 500,000 cycles. This coverage is available in five virtually decade sweep ranges and is five times greater than the sweep frequency range usually available. Excellent retrace time characteristics, actually less than 20% at 500 KC. Use of the free running Heath circuit provides a larger margin of stability and a new high in Heathkit Scope performance.

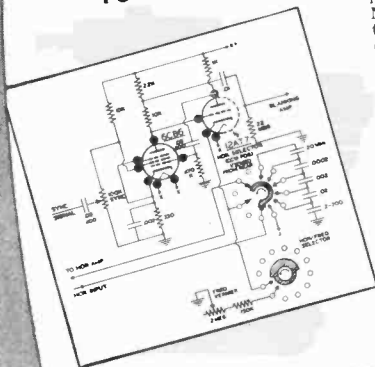

### Continuing PROGRESS FUTURE LINE EXPANSION

The outstanding improvements featured in the 1955 Heathkit line are representative of the progress characteristic of the Heath Company operation. Long range planning will provide a continuing succession of new kit releases to further expand the Heathkit line which already represents the world's greatest selection of electronic kits. The innovations in the 1955 line, are representative of additional new models scheduled for release for the coming years.



SEE THE INSTRUMENTS ON THE FOLLOWING PAGES

**HEATH COMPANY • • Benton Harbor 20, Mich.**

# Heathkit ELECTRONIC SWITCH KIT

The basic function of the Heathkit Electronic Switch Kit is to permit simultaneous oscilloscope observation of two separate traces which can be either separated or superimposed for individual study. This is accomplished through the use of two individually controlled inputs working through amplifier, multi-vibrator, and blocking stages. The output of the Electronic Switch is connected directly to the vertical input of the Oscilloscope. A typical example of usefulness would be simultaneous observation of a signal or waveform as it appears at both the input and output stages of an amplifier.

## APPLICATIONS

An Electronic Switch has many applications to increase the over-all operating versatility of your oscilloscope. It can be used to check amplifier distortion—audio crossover networks—phase inverter circuits—to measure phase shift—special waveform study, etc. The instrument can also be conveniently used as a square wave generator over the range of switching frequencies, often providing the necessary wave form response information without incurring the expense of an additional instrument. Ownership of this instrument will reveal many entirely new fields of oscilloscope application and will quickly justify the modest cost of the Electronic Switch Kit.

Tube complement:  
2—6X4  
1—6X5

Continuously variable  
switching rates in three  
ranges from less than 10  
CPS to over 2000 CPS.

Individual input  
gain controls, po-  
sition control,  
coarse frequency  
control, and fine  
frequency control.

Transformer operated for  
safety when used in con-  
junction with other equip-

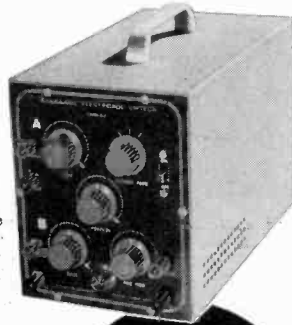

MODEL S-2

**\$23<sup>50</sup>**

Shpg. Wt.  
8 lbs.

# Heathkit VOLTAGE CALIBRATOR KIT



MODEL VC-2

**\$11<sup>50</sup>**

Shpg. Wt. 4 lbs.

Another useful oscilloscope accessory particularly in circuit development work and in TV and radio service work. The Voltage Calibrator provides a convenient method for making peak-to-peak voltage measurements with an oscilloscope, by establishing a relationship on a comparison basis between the amplitude of an unknown wave shape and a known output of the voltage calibrator. Peak-to-peak voltage values are read directly from a calibrated panel scale without recourse to involved calculations.

## FEATURES:

To off-set line voltage supply irregularities, the instrument features a voltage regulator tube. A convenient "signal" position on the panel switch by-passes the calibrator completely and the signal is applied through the oscilloscope vertical input, thereby eliminating the necessity for constantly transferring test leads.

## RANGES:

With the Heathkit Voltage Calibrator it is possible to measure all types of complex waveforms within a voltage range of .01 to 100 volts peak-to-peak. Build this instrument in a few hours and enjoy the added benefits offered only through combination use of test equipment.

# Heathkit LOW CAPACITY PROBE KIT



No. 342

**\$3<sup>50</sup>**

Shpg. Wt. 1 lb.

An oscilloscope accessory, the 342 Low Capacity Probe permits observation of complex TV waveforms without distortion. An adjustable trimmer provides proper matching to any conventional scope input circuit. Excellent for high frequency, high impedance, or broad bandwidth circuits. The attenuation ratio can be varied to meet individual requirements.

# Heathkit SCOPE DEMODULATOR PROBE KIT



No. 337-C

**\$3<sup>50</sup>**

Shpg. Wt. 1 lb.

Extend the usefulness of your oscilloscope by observing modulation envelopes of RF or IF carriers found in TV and radio receivers. The Heathkit Demodulator Probe will be helpful in alignment work, as a gain analyzer and a signal tracer. Easy construction with the new modern printed circuit board. Voltage limits are 30 volts RMS and 500 volts D.C.

# HEATH company

BENTON HARBOR 20,  
MICHIGAN

## TEST INSTRUMENTS FOR TV

tentiometers are on the 3 x 6-inch boards with an eye toward ease of wiring and panel symmetry. The rest of the components are mounted around the controls. I used regular commercial terminals riveted to the boards for mounting the various components. However, you can use small 4-40 brass screws and nuts as terminals and solder to these. Again the need for rigid and neat workmanship cannot be over-emphasized, as the insulation value has to be very good due to the 2,600 volts present on and around the terminal boards and the voltage-divider network.

At this point it is safe to assume that all of the individual subassemblies are checked and functioning properly. The extra work of hooking up each individual assembly to the power supply and checking it may seem unnecessary; however, the time spent in checking and removing any faults which may be present will save a great amount of time and unnecessary work in tracking down the faulty section after the completed scope is assembled. Also this method allows the builder to become familiar with the functioning of the individual circuitry and thus enables him to better understand and use the finished product.

The 3 x 5-inch terminal board as seen in the left side of the top-view photo is for direct connection to the deflection plates. The deflection plate leads are brought to connectors in the top row and the peaking coils to corresponding connectors in the bottom row. In normal use wire jumpers, as shown in the photo, connect the amplifiers to their respective deflection plates. The jumpers are removed for direct connection to the plates. The terminal board is secured to the chassis with two brass brackets or angles as shown.

The SYNC POLARITY control should now be made up. This potentiometer differs from the conventional in that its midpoint is grounded. No commercial equivalent could be found so one was made from a Mallory 2-watt wire-wound potentiometer. After prying off the back, the center was found with an ohmmeter, and a drop or two of solder was flowed in, making contact with the center of the resistance wire and the metal case. This automatically grounds the resistance to the case which in turn is grounded when the control is installed on the metal front panel.

The front panel is made from 3/16- or 1/4-inch aluminum or dural stock measuring 14 x 19 inches. All mounting holes were laid out and then drilled to size. The large circular opening for the 5CP1-A scope tube was scribed with dividers and cut out with a fine-tooth wood-cutting blade in a jig saw.

When the panel was drilled and cut, it was sanded with medium-fine paper and then four coats of clear lacquer were sprayed on. This method of finishing gave a deep luxurious brushed-satin effect, which has held up quite well despite hard wear.

The high-voltage, centering and focus components and subassemblies are now

# NEW *Heathkit* 5" PUSH-PULL OSCILLOSCOPE KIT FOR COLOR TV

**BRAND NEW DESIGN:** The new Heathkit Model O-10 Oscilloscope would be something special at any price, but is almost unbelievable at \$69.50. Completely re-designed scope has broadband amplifiers for color TV work and offers brilliant overall performance. Vertical frequency response within 5 db from 5 cps to 5 mc. Even more astounding, the response is down less than 1 1/2 db at 3.58 mc, the color TV sync burst frequency. It is essential that scopes for color work have these broadband characteristics.

**PRINTED CIRCUITS:** Two printed circuit boards used in this fine instrument to insure stable, consistent performance. Problems solved by pre-engineering of boards, and their use guarantees completed unit that will have same characteristics as lab development model. Printed circuits simplify construction and save labor.

**NEW SWEEP CIRCUIT:** Sweep circuit operates with exceptionally good linearity from 20 cps to over 500,000 cps. 5 times the usual range for scopes in this price range. An entirely new circuit introduced for the first time in any Heathkit.

**FEATURES:** Other outstanding characteristics of this professional oscilloscope are: Built-in 1V peak-to-peak reference for calibration of plastic CRT face-plate; 5" 5UP1 CRT; push-pull hor. and vert. deflection amplifiers; hor. trace width expandable to 3 times diameter of CR tube to allow inspection of any small portion of the signal; deflection sensitivity, .025 volts per inch; wiring harness pre-formed and cabled to save construction time and insure professional appearance and operation. Incorporates efficient retrace blanking. Frequency compensated step attenuator at the vertical input. Entire tube face useable. No foldover on vertical over-load. Performance obtainable only in much more expensive laboratory models.

Uses 5UP1, 6AB4, 6BO7, 12BH7, 6CB6, 12AT7, 2-12AU7, 6X4, 1V2, and 6C4. Quality components used throughout so that outstanding performance characteristics may be maintained for years to come. Plastic molded condensers are used in all coupling and by-pass applications. The "new-look" in Heathkit styling produces professional appearance in keeping with the professional performance of this instrument.

First color television service Oscilloscope with necessary high sensitivity and full 5 megacycle bandwidth.

New printed circuit construction. All components mounted on high insulating surface resulting in uniformly low circuit capacities.

New type wide frequency range Heath sweep generator, 10 cycles to 500,000

New electronic positioning controls for instantaneous, definite positioning without bounce or overshoot.

New 5UP1 CR tube



New cabinet styling and color harmony—charcoal gray panel with high readability white lettering.

MODEL O-10

**\$69<sup>50</sup>**

Shpg. Wt. 27 lbs.

Simplified, standardized construction technique of vertical and horizontal amplifier construction made possible through the use of a single printed circuit board.

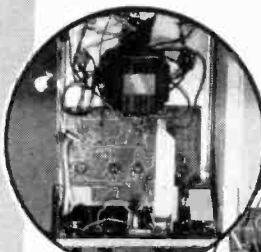

Clean, open, under chassis construction and wiring. Possible only through use of pre-cabled wiring harness, and simplified printed circuit boards.

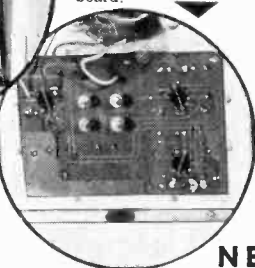

## NEW *Heathkit* 3" PRINTED CIRCUIT OSCILLOSCOPE KIT

MODEL OL-1

**\$29<sup>50</sup>** Shpg. Wt. 15 lbs.

New easy-to-build printed circuit board with high insulation factor.

New Heathkit instrument styling—charcoal gray panel with high readability white lettering.

New Heath twin triode sweep generator 15-100,000 cycle sweep.



3GP1 CR TUBE

New compact utility Scope—light-weight—portable for service work.

Deflection plate terminals—ideal for ham transmitter modulation monitoring.

**EXCEPTIONAL VALUE:** The brand new Model OL-1 Utility Oscilloscope is designed especially for portable applications so that outside servicemen or persons performing field tests can have the advantages of a scope available. Then too, it is ideal for home workshop, the ham-shack, or as an "extra" scope for the service shop. It is compact, light in weight, and surprisingly versatile in operation. An outstanding instrument for the price.

Front panel controls are "bench-tested" for ease of operation and convenience. Printed circuit board used for constant circuit performance. Assembly time cut in half!

**SPECIFICATIONS:** Vertical amplifiers feature frequency response within 1 db from 10 cps to 100 kc, and within 5 db from 5 cps to 500 kc. Vertical sensitivity .2 volts per inch at 1 kc, with input impedance of 12 mmfd shunting 10 megohms.

Horizontal response within 1 db from 10 cps to 200 kc, and within 5 db from 5 cps to 500 kc. Hor. sensitivity .25 volts per inch at 1 kc, input impedance of 15 mmfd shunting 10 megohms. Sweep generator covers 10 cps to 100,000 cps with stable positive lock-in circuit. Cathode follower input in both vert. and hor. amplifiers; push-pull vertical and horizontal deflection amplifiers; 3" CRT; electronic positioning controls for wide range of vertical and horizontal spot deflection; provision for internal and external sync; 60 cycle line sweep. New modern color styling and unusual performance make this instrument an outstanding value.

## NEW *Heathkit* 5" PRINTED CIRCUIT OSCILLOSCOPE KIT

MODEL OM-1

**\$39<sup>50</sup>** Shpg. Wt. 24 lbs.

**VERSATILE INSTRUMENT:** The new Model OM-1 general purpose Oscilloscope represents an outstanding dollar value in reliable test equipment. Full 5 inch CRT. Printed circuit boards for ease of assembly, constant circuit characteristics, and rugged component mounting. Includes all the design features necessary for servicemen, students, experimenters, radio amateurs, etc. Frequency response of amplifiers flat within 1 db from 10 cps to 100 kc, and down only 7 db from 10 cps to 500 kc. Sweep generator range from 20 cps to 100,000 cps. Also features new Heathkit color styling with charcoal gray panel and high definition white lettering for readability even under subdued lighting conditions.

**DESIGN FEATURES:** A full-size, versatile oscilloscope at a price you can afford. Other features are: adjustable spot shape control; RF connections to deflection plates; direct coupled centering controls; external and internal sweep and sync; 60 cycle line sync; built in 1 volt peak-to-peak panel terminal reference voltage; professional appearance of cabinet, panel, and knob styling.

5BP1 CR TUBE



**HEATH** company

BENTON HARBOR 20,  
MICHIGAN

# Heathkit MULTIMETER KIT

The new Heathkit Multimeter is a "must" to complete the instrument lineup of any well equipped service shop. Here is an instrument packed with every desirable service feature, many of which are not found in other Multimeters. All of the measurement ranges you need or want. High sensitivity 20,000 ohms per volt DC; 5,000 ohms per volt AC.

## ★ ADVANTAGES

Complete portability through freedom from AC line power operation—provides service ranges of direct current measurements from 150 microamps up to 15 amperes—can be safely operated in RF fields without impairing accuracy of measurement.

## ★ RANGES

Full scale AC and DC voltage ranges are 0-1.5, 5, 50, 150, 500, 1500 and 5,000 volts. Direct current ranges are 150 microamps, 15, 150 and 500 milliamperes and 15 amperes. Resistances are measured from .2 ohms to 20 megohms in 3 ranges and db range from -10 to +65 db.

## ★ CONSTRUCTION

The Heathkit MM-1 features a unique resistor ring switch mounting assembly procedure. With this method of assembly the precision resistors are wired to the rings and range switch before actual mounting of the switch to the instrument panel. This procedure affords the advantage of simpler construction yet complete accessibility of precision resistors in event replacement is ever required. Ohmmeter batteries were selected for convenience of replacement and only standard commercially available types are used. Batteries consist of 1 type C flashlight cell and 4 Penlite cells. All batteries and necessary test leads are furnished with the kit.

20,000 ohms per volt sensitivity DC; 5,000 ohms per volt AC.

Polarity reversal switch eliminates transferring of test leads.

All 1% precision multiplier resistors—sensitive 50 microamp 4 1/2 Simpson meter.

Total of 35 meter ranges on two color scale.

New modern cabinet styling—attractive appearance.



MODEL MM-1

**\$26.50**

Shpg. Wt. 6 lbs.

## Heathkit HANDITESTER KIT



MODEL M-1

**\$14.50**

Shpg. Wt. 3 lbs.

The Heathkit Model M-1 Handitester readily fulfills major requirements for a compact, portable volt-ohm milliammeter. The small size of the smooth gleaming molded bakelite case permits the instrument to be tucked into your coat pocket, toolbox or glove compartment of your car. Always the "Handitester" for those simple repair jobs.

### RANGES:

Despite its compact size, the Handitester is packed with every desirable feature required in an instrument of this type. AC or DC voltage ranges, full scale, 10, 30, 300, 1,000 and 5,000 volts. 2 convenient ohmmeter ranges 0-3,000 ohms and 0-300,000 ohms. 2 DC milliammeter ranges 0-10 milliamperes and 0-100 milliamperes.

### CONSTRUCTION

The instrument uses a 400 microampere meter movement which is shunted with resistors to provide a uniform 1 milliamper load in both AC and DC ranges. This design allows the use of but 1 set of 1% precision divider resistors on both AC and DC and provides a simplicity of switching. A small hearing aid type ohms adjust control provides the necessary zero adjust function on the ohmmeter range. The AC rectifier circuit uses a high quality Bradley rectifier and a dual half wave hookup. Necessary test leads and battery are included in the price of this popular kit.

## Heathkit RESISTANCE SUBSTITUTION BOX KIT

MODEL RS-1

**\$5.50**



Shpg. Wt. 2 lbs.

36 standard RTMA 1 watt resistor values between 15 ohms and 10 megohms with an accuracy of 10% are at your fingertips in the Model RS-1 Resistance Substitution Box kit. This sturdy and attractive accessory will easily prove its worth many times over as a time saving device. Order several today.

## Heathkit CONDENSER SUBSTITUTION BOX KIT

MODEL CS-1



**\$5.50**

Shpg. Wt. 2 lbs.

18 standard RTMA values are available from .0001 mfd to .22 mfd. An 18 position switch set in the panel of an attractive bakelite case allows quick changes without touching the test leads. Invest a few minutes of your time now and save hours of work later on.

# HEATH company

BENTON HARBOR 20,  
MICHIGAN

## TEST INSTRUMENTS FOR TV

bolted to the panel with countersunk-head 6-32 screws. The various potentiometers and switch assemblies are next bolted in place on the panel and then the panel is fastened to the main chassis using the control-shaft bushings and nuts to hold it in place. The cathode-ray tube shield is next centered and bolted in place.

The interconnecting wiring harness is then made up and laced in place for the centering, focus, brilliance and other circuits. Use only high-grade wire of adequate insulation value. I used ignition cable for the high-voltage wiring and 600-volt-test, rubber-covered wire for all the rest of the interconnecting wiring and cabling. This may seem unnecessary, but as everything is bunched and cabled together this tends to prevent trouble later on when the insulation dries out from heat and age. After the interconnecting harness is wired in and all is in place, check and see if the controls for the brightness, focus, centering and astigmatism are functioning. However, be sure not to let the spot remain too long in one place on the screen because it will burn and deface it. When it is certain that this part of the unit is operating normally, make up and wire in harnesses for connecting the remaining subassemblies and the power supplies. If each unit has been previously checked and is in good order, little or no trouble should be encountered during this phase of the work. When all of the interconnecting wiring has been completed, check carefully for any errors in wiring, and then turn on the scope so all of its functions can be checked. Watch for any overheating of components.

The individual name and function plates should next be made up. The plates in the photos were made by engraving on sheets of Lamicoid. This gave a professional appearance such as is seen only on the more expensive custom-built equipment. However, several alternate methods are available to the reader who may not have access to an engraver. There are several types of decals on the market which when used correctly and with care make a very commendable appearance. Or the name plates may simply be lettered in ink and drawn on plain white Bristol board.

### Calibration and adjustment

First we shall take up the sweeping of the amplifiers. As mentioned earlier, to obtain maximum bandpass a sweep generator and an oscilloscope are necessary. A radio technician's sweep generator is satisfactory and any type of scope will do so long as it will pass 60 cycles. Take off from all peaking coils the shorting connections which were tacked in for the initial check.

Connect the scope to the output of the vertical amplifier stage to be aligned and the sweep generator directly to the input of the amplifier—not through the stepped attenuator—and adjust the peaking-coil slugs carefully for the desired waveform. Typical response pat-

# NEW *Heathkit* VACUUM TUBE VOLTMETER KIT PRINTED CIRCUIT DESIGN

Another outstanding example of continuing Heath Company pioneering and leadership in the kit instrument field. A new **printed circuit** VTVM. New peak-to-peak circuit—new styling and new panel design. A prewired, prefabricated printed circuit board eliminates chassis wiring, cuts assembly time in half, assures duplication of Engineering pilot model specifications, and virtually eliminates possibility of construction error.

### CIRCUIT:

A 6AL5 tube operated as a full wave AC input rectifier permits seven peak-to-peak voltage ranges with upper limits of 4000 volts P-P. Just the ticket for you TV servicemen. Voltage divider in the 6AL5 input circuit limits applied AC input to a safe level. This circuitry and the isolation of the meter in the cathode of the 12AU7 bridge circuit affords a high degree of protection to the sensitive 200 microampere meter.

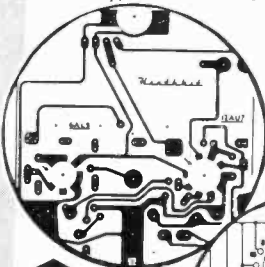

Full wave rectifier in AC input circuit. Read peak-to-peak and RMS volts with upper limit of 4000 P-P and 1500 volts RMS. Voltage divider input circuit.

The first kit instrument to offer a labor-saving, error-free printed circuit board. Your instrument an exact wiring replica of Engineering development model.

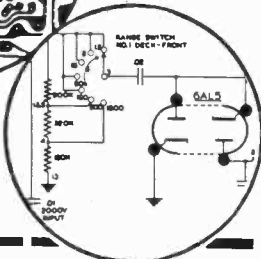

### RANGES:

Seven voltage ranges, 1.5, 5, 15, 50, 150, 500 and 1,500 volts DC and AC RMS. Peak-to-peak ranges 4, 14, 40, 140, 400, 1400, 4000. Ohmmeter ranges X1, X10, X100, X1000, X10K, X100K, X1 meg. Additional features are a db scale, a center scale zero position, and a polarity reversal switch.

### IMPORTANT FEATURES:

High impedance 11 megohm input—transformer operated—1% precision resistors, 6AL5 and 12AU7 tube—selenium power rectifier—individual AC and DC calibrations—smoother improved zero adjust control action—new panel styling and color—new placement of pilot light—new positive contact battery mounting—new knobs—test leads included.  
The new V-7 also sets the pace as a kit instrument style leader. Smart, good-looking charcoal gray panel and soft leather gray cabinet. High readability panel with sharply contrasting white calibrations. The pleasing, eye etching, modern styling is in harmonious balance with the outstanding circuit design improvements. Easily the best buy in kit instruments.

*New* charcoal gray baked enamel panel with high readability, white lettering, soft leather gray cabinet, subdued pilot light indicator.

*New* printed circuit board for faster, easier construction—exact duplication of Lab development model.



*New* easy-to-read open panel layout. Off-on switch now incorporated in the selector switch.

MODEL V-7

**\$24.50**

Shpg. Wt. 7 lbs.

*New* peak-to-peak meter scale—new color harmony—new knobs.

## *Heathkit* AC VACUUM TUBE VOLTMETER KIT MODEL AV-2

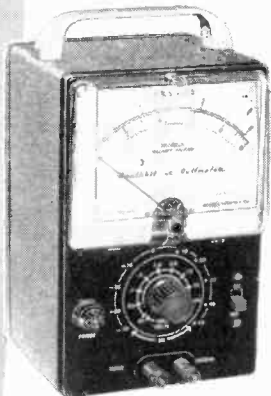

**\$29.50**

Shpg. Wt. 5 lbs.

Extreme sensitivity has been emphasized in the design of the Heathkit AC VTVM. Ten full scale RMS ranges are .01, .03, .1, .3, 1, 3, 10, 30, 100, and 300 volts. Frequency response is substantially flat from 10 cycles per second to 50 KC with input impedance of 1 megohm at 1 KC. Will accurately measure as low as 1 millivolt at high impedance. Total db range is -52 db to +52 db. An excellent kit for measuring

the output of phono cartridges and the gain of amplifier stages. Use it also to check power supply ripple, as a sensitive null detector, and for compiling frequency response data. Features one knob operation, 200 microampere Simpson meter and precision resistors.

## *Heathkit* AUDIO WATTMETER KIT

Read audio power output directly without using external load resistors with the new Heathkit Audio Wattmeter. Built-in non-inductive load resistors provide impedances of 4, 8, 16, and 600 ohms. Flat response from 10 CPS to 250 KC. Full scale power ranges are 0-5 MW, 0-50 MW, 0-500 MW, 0-5 W and 0-50 W. Model AW-1 will operate continuously at 25 watts and has a duty cycle of 3 minutes at 50 watts. Total db range in five positions is -50 db to +48 db, using the standard 1 milliwatt 600 ohms.



MODEL AW-1

**\$29.50**

Shpg. Wt. 6 lbs.

## *Heathkit* 30,000 VOLTS DC PROBE KIT

Measure up to 30,000 volts DC with the Heathkit VTVM and the 336 high voltage Probe. Precision resistor provides multiplication factor of 100. Can be used with any 11 megohm input VTVM. Housed in a Polystyrene two color sleek plastic probe body for safety of operation.



No. 336  
**\$4.50**

Shpg. Wt. 1 lb.

## *Heathkit* PEAK-TO-PEAK PROBE KIT



No. 338-C

**\$5.50**

Shpg. Wt. 2 lbs.

Peak-to-peak values not exceeding 80 volts at a DC level of not more than 600 volts, can now be read directly by using 338-C Probe with previous model Heathkit VTVM's or any VTVM with 11 megohm input resistance. Probe construction features a modern printed circuit board for easy assembly. Frequency range 5 KC to 5 MC.

## *Heathkit* RF PROBE KIT

The Heathkit RF Probe will permit the measurement of RF voltages up to 250 MC with an accuracy of ±10%. The limits are 30 volts AC and a DC level of 500 volts. Designed for any 11 megohm input VTVM. Modern styling, Polystyrene aluminum housing, Polystyrene insulation, and printed circuit board for easy assembly.



No. 309-C

**\$3.50** Shpg. Wt. 1 lb.

**HEATH** company  
BENTON HARBOR 20,  
MICHIGAN

# Heathkit 6-12 VOLT BATTERY ELIMINATOR KIT

Here is the new 12 volt Heathkit Battery Eliminator so necessary for modern up-to-date operation of your Service Shop. Furnishes either 6 or 12 volt output which can be selected at the flick of a panel switch. Use the BE-4 to service all of the new 12 volt car radios in addition to the conventional 6 volt models.

### RANGES:

This new Battery Eliminator provides two continuously variable output voltage ranges. 0-6 volts D.C. at 10 amperes continuously or 15 amperes maximum intermittent and 0-12 volts D.C. at 5 amperes continuously or 7.5 amperes maximum intermittent. The output voltage is clean and well filtered, as the circuit uses two 10,000 mfd condensers.

The continuously variable voltage output feature is of definite aid in determining the starting point of vibrators, the voltage operating range of oscillator circuits, etc.

### OTHER USES:

The controllable low voltage DC supply has many other applications besides primary use in car radio service work. Can be nicely used as a battery charger, or low voltage DC supply for electric trains. Has applications in high gain audio work requiring clean DC filament supply. Can be used for low power electro-plating or as a power supply for battery powered intercommunication systems.

Automatic overload relay—self resetting—fuse protected.

New 18 plate split liner unit.



Continuously variable output voltage, either 6 or 12 volt operation.

Constant ammeter and voltmeter monitoring.

MODEL BE-4

**\$31.50**

Shpg. Wt. 17 lbs.

## Heathkit VIBRATOR TESTER KIT

MODEL VT-1

**\$14.50**

Shpg. Wt. 6 lbs.



This time-saving device will quickly pay for itself in your auto radio service shop. 6 volt vibrators can be checked instantly on the Good-Bad type meter scale. Operation requires only a variable DC voltage from 4 to 6 volts at 4 amperes. Model BE-4 Battery Eliminator is recommended for this application.

Five test sockets provide for the testing of hundreds of interrupter and self-rectifier types. Proper starting voltage is determined easily and accurately. Over-all quality is then unmistakably indicated on the panel mounted meter.

## Heathkit VARIABLE VOLTAGE ISOLATION TRANSFORMER KIT

Variable output voltage between 90 and 130 volts AC. Rated at 100 volt-amperes continuously and 200 volt-amperes intermittently. The principle function of the Heathkit Isolation Transformer is to isolate the circuit being tested from line interference being caused by motors, appliances, etc. It works backward too by isolating such devices from the line.

Many other uses, especially with AC-DC type circuits. Do not confuse the Heathkit Isolation Transformer with the hazardous auto transformer type line voltage boosters.

MODEL IT-1

**\$16.50**

Shpg. Wt. 10 lbs.



## Heathkit IMPEDANCE BRIDGE KIT

MODEL IB-2

**\$59.50**

Shpg. Wt. 12 lbs.



The new Heathkit Impedance Bridge features built-in adjustable phase shift oscillator and amplifier. This instrument actually represents four instruments in one compact unit. The Wheatstone bridge for resistance measurements, the Capacity Comparison bridge for capacity measurements, Maxwell bridge for low Q, and Hay bridge for high Q measurements.

### DESIGN:

Panel provisions for external generator use. A new two section CRL dial, provides ten separate "units." Ten separate units switch settings and fractions of units are read on a continuously variable calibrated control. A special minimum capacity shielded and balanced impedance matching transformer between the generator and bridge circuit is automatically switched to provide correct load operation of the generator circuit. The instrument uses 1/2% precision resistors and condensers in all measurements circuits.

**HEATH company**  
BENTON HARBOR 20,  
MICHIGAN

## TEST INSTRUMENTS FOR TV

terns are shown in Fig. 3. Be careful to keep the generator output low so the amplifier is not overloaded. If the waveforms in Fig. 3 are not closely approximated, you will have to either increase or decrease the number of turns on the coils to compensate for differences in stray and distributed capacitances. Make adjustments by experimenting.

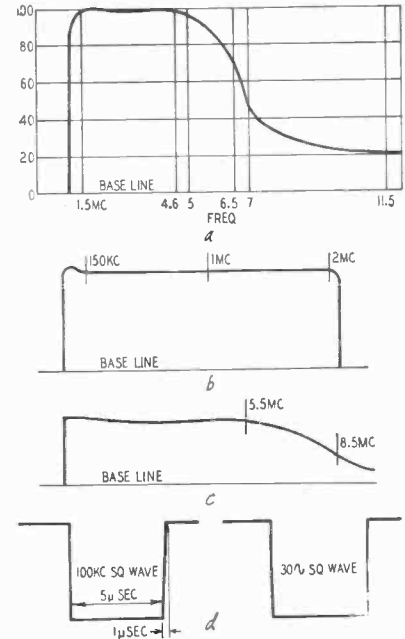

Fig. 3—Curve at a is desired response of the vertical amplifier measured at the deflection plates of the C-R tube. Sweep trace b shows low-frequency responses at the vertical plates of the 5CP1-A. Response at plate of compensated 6AC7 is shown at c. Square waves at d, like the trace at b, show low-frequency response at vertical plates of C-R tube. Patterns traced from RCA scope.

When the parts layout differs greatly from the original, it may be necessary to change the values of the three resistors in the plate circuits of the 6AG7's in the vertical amplifier and alter the lead dress for the desired response. Remember that stage gain decreases as resistance values are lowered.

This method is used also to align the horizontal amplifier stage. No trouble should be anticipated in this stage as the 500-kc response is fairly easy to obtain at this point.

### Attenuator adjustments

The preferred method of adjusting the vertical and horizontal stepped attenuators is to inject a square wave of approximately 12 or 15 kc at the vertical input, using the shortest, most direct leads possible. Set the attenuator to the first compensated position and adjust the trimmer for a flat-topped square wave as viewed on the face of the scope tube. When the wave has been made as flat as possible, turn the attenuator to successive positions and repeat the procedure.

The low-frequency response of the amplifier can now be further improved by inserting a 20- or 30-cycle square



# NEW *Heathkit* TV ALIGNMENT GENERATOR KIT

Here is the most radically improved Sweep Generator in the history of the TV service industry. The basic design follows latest high frequency techniques which result in a combination of performance features not found in any other sweep generator.

#### SWEEP:

Sweep action is obtained electronically through the use of a newly developed controllable inductor, thereby eliminating all moving parts with their resultant hum, vibration, fatigue, etc. Frequency coverage entirely on fundamentals, is continuous from 4 MC to 220 MC at an output level well over a measurable .1 volt.

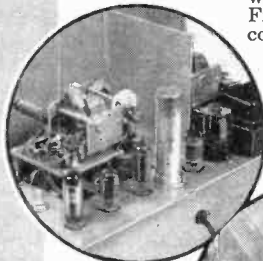

Triple marker system, 4.5 MC crystal controlled marker—continuously variable marker—provisions for external marker.

Automatic amplitude control circuit—constant output voltage regulated power supply.

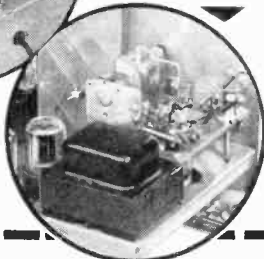

#### MARKER:

The same instrument incorporates a triple marker system with a crystal controlled reference. A variable marker provides accurate coverage from 19 to 60 MC on fundamentals, and 57 to 180 MC on calibrated harmonics. A separate fixed crystal controlled 4.5 MC marker can be used for checking IF, band-pass, calibration, reference, etc. Provisions are also made for external marker use. A 4.5 MC crystal is supplied with the kit.

#### POWER SUPPLY:

The transformer operated Power Supply features voltage regulation for stable oscillator operation. Three sets of shielded cables are furnished with the kit. Sweep range is completely and smoothly controllable from zero up to a maximum of 50 MC, depending upon base frequency.

Here is a TV Sweep Generator that truly no serviceman can afford to be without for rapid, accurate, TV alignment work.

Controllable inductor sweep oscillator with output entirely on fundamentals.

Triple marker system 4.5 MC crystal controlled—3 sets of low loss, low capacity shielded cables included.

Electronically operated, smoothly continuously variable, sweep circuit. No vibration, hum or noise.

Frequency coverage: 4 MC—220 MC continuous including FM spectrum. RF output well over .1 volt.

MODEL TS-3

**\$44<sup>50</sup>**

Shpg. Wt. 18 lbs.

# NEW *Heathkit* SIGNAL GENERATOR KIT



MODEL SG-8

**\$19<sup>50</sup>** Shpg. Wt. 8 lbs.

The new Heathkit service type Signal Generator, Model SG-8 incorporates many design features not usually found in this instrument price range. Frequency coverage is from 160 KC to 110 MC in five ranges, all on fundamentals, with useful calibrated harmonics up to 220 MC. The RF output level is well in excess of 100,000 microvolts throughout the frequency range. The oscillator circuit consists of a twin triode tube, one-half used as a Colpitts oscillator, and the other half as a cathode follower output which acts as a buffer between the oscillator and external load, thereby eliminating oscillator frequency shift usually caused by external loading.

All coils are factory wound and adjusted, thereby completely eliminating the need for individual calibration and the use of additional calibrating equipment. The stable, low impedance output, features step and variable attenuation for complete control of RF level. A separate 6C4 triode acts as a 400 cycle sine wave oscillator, and a panel mounted switching system permits choice of either external or internal modulation.

# *Heathkit* LABORATORY GENERATOR KIT



MODEL LG-1

**\$39<sup>50</sup>**

Shpg. Wt. 16 lbs.

The new Heathkit Laboratory type Signal Generator definitely establishes a new performance standard for a kit instrument. An outstanding feature involves the use of a panel mounted 200 microampere meter calibrated both in microvolts and percent modulation, thereby providing a definite reference level for using the Signal Generator in design work, gain measurements, selectivity, frequency response checks.

#### DESIGN:

Additional design features are copper plated shield enclosure for oscillator and buffer stages resulting in effective double shielding. Fibre panel control shaft extensions in RF carrying circuits, thorough AC line filtering, careful shielding of the attenuator network, voltage regulated B plus supply, selenium rectifier, etc.

#### RANGES:

Frequency coverage from 150 KC to 30 MC all on fundamentals in five separate ranges. Output voltage .1 volt with provisions for metered external or internal modulation. Output impedance termination 50 ohms. Transformer operated power supply.

Investigate the many dollar stretching features offered by the LG-1 before investing in any generator for Laboratory or Service work.

# NEW *Heathkit* BAR GENERATOR KIT



MODEL  
BG-1

**\$14<sup>50</sup>** Shpg. Wt. 4 lbs.

The Heathkit BG-1 produces a series of horizontal or vertical bars on a TV screen. Since these bars are equally spaced, they will quickly indicate picture linearity of the receiver under test without waiting for transmitted test patterns. Panel switch provides "standby—horizontal and vertical position." The oscillator unit uses a 12AT7 twin triode for the RF oscillator and video carrier frequencies. A neon relaxation oscillator provides low frequency for vertical linearity tests. The instrument will also provide an indication of horizontal and vertical sync circuit stability as well as overall picture size. Operation is simple and merely requires connection to the TV receiver antenna terminal. Transformer operated for safety.

# HEATH company

BENTON HARBOR 20,  
MICHIGAN

# Heathkit VISUAL-AURAL SIGNAL-TRACER KIT

The new Heathkit Visual-Aural Signal Tracer features a special high gain RF input channel used in conjunction with a newly designed wide frequency range demodulator probe. High RF sensitivity permits signal tracing from the receiver antenna input. Separate low gain channel and probe available for audio circuit exploration. Both input channels are constantly monitored by an electron ray beam indicator so that visual as well as aural indications may be obtained.

## NOISE LOCATOR:

A decidedly unusual feature is a noise locator circuit used in conjunction with the audio probe. With this system, a DC potential is applied to a suspected circuit component and the action of the voltage in the component can be seen as well as heard. Invaluable for ferreting out noisy or intermittent condensers, noisy resistors, controls, IF and power transformers, etc.

## WATTMETER:

Built-in calibrated wattmeter circuit will prove useful for quick preliminary check of total wattage consumption of equipment under test. Separate panel terminals provide external use of the speaker or output transformer for substitution purposes. Saves valuable service time by eliminating the necessity for speaker removal on every service job. The same panel terminals also provide easy access to a well filtered B plus supply for external use. Don't overlook the many interesting service possibilities provided through the use of this instrument, and let the Signal Tracer work for you by saving time and money.

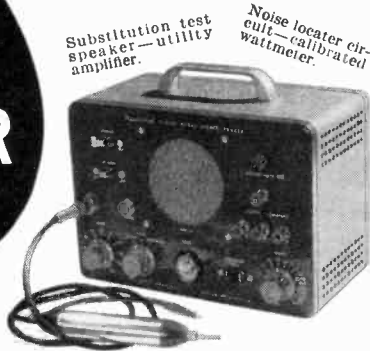

Substitution test speaker—utility amplifier.

Noise locator circuit—calibrated wattmeter.

RF and audio probes supplied along with necessary test leads.

Visual and aural signal tracing.

MODEL T-3

**\$235.00**

Shpg. Wt. 9 lbs.

# Heathkit CONDENSER CHECKER KIT

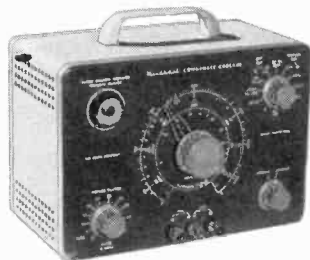

MODEL C-3

**\$19.50** Shpg. Wt. 7 lbs.

Here is a handy test instrument for any Service Shop. Unknown values of capacity and resistance are quickly determined on the direct reading condenser checker dial. Capacity is measured in four ranges from .001 mfd to 1000 mfd. Resistance in the range from 100 ohms to 5 megohms.

DC polarizing voltages of 25, 150, 250, 350, and 450 volts are available for leakage tests on all types of condensers. For electrolytics, a power factor control is provided to balance out inherent leakage and to indicate directly the power factor of a condenser under test. Proper balancing of the AC bridge is reflected in the degree of closure of an electron beam indicator tube.

Model C-3 uses a transformer operated power supply, spring return leakage test switch, and a convenient combination of panel scales for all readings. Test leads are furnished in addition to precision components for calibrating purposes. Quick and easy to operate, the Heathkit Condenser Checker will save valuable time and increase your Shop efficiency.

# Heathkit "Q" METER KIT



MODEL QM-1

**\$44.50**

Shpg. Wt. 14 lbs.

The Heathkit QM-1 represents the first practical popular priced Q meter available within the price range of schools, laboratories, TV service men, and experimenters. This instrument will enable the operator to simulate conditions encountered in practical circuits and to measure the performance of coils or condensers at the operating frequencies actually encountered. All indications of value are read directly on the 4 1/2" 50 microampere Simpson calibrated meter scale. Measures Q of condensers, RF resistance, and the distributed capacity of coils. Oscillator section supplies RF frequencies 150 KC to 18 MC in four ranges. Calibrate capacity with range of 40 MMF to 450 MMF with vernier of ±3 MMF. Investigate the many services this instrument can perform for you.

# Heathkit AUDIO OSCILLATOR KIT



MODEL AO-1

**\$24.50**

Shpg. Wt. 10 lbs.

The Heathkit Audio Oscillator will produce both sine and square waves within the frequency range from 20 CPS to 20 KC in three ranges. Thermistor controlled linearity results in a variation of no more than ±1 db in a 10 volt (no load) variable output level. There will be less than .6% distortion from 100 CPS throughout the audible range. Low impedance 600 ohm output. Precision 1% resistors, used in the range multiplier circuits to provide accurate calibration.

# TEST INSTRUMENTS FOR TV

wave into the vertical input jack of the amplifier and adjusting the 1-megohm potentiometer in the vertical-output grid circuit for the best flat-topped waveform. Increasing the resistance seems to improve the low-frequency response.

## Voltage calibrator

Adjusting the internal calibration voltage source is the final step. The first part of this operation is to calibrate the meter for peak-to-peak voltage readings. Adjust the multiplier resistor in series with the meter for full-scale deflection of the particular meter used with an applied voltage of 400 peak to peak. The meter recommended is a 0-5-ma d.c. type but any meter up to 10 or 12 ma can be used. The multiplier resistor was made by winding No. 40 enameled wire on a 1-megohm 2-watt resistor until the desired full-scale deflection was obtained. If an accurate multimeter with an a.c. range is available, the correct voltages can also be set up with only a small amount of calculation. Set each voltage divider tap for the scale desired, making sure that the indicating meter reads full scale each time. If the a.c. voltmeter method is used to set the taps, you must multiply the reading obtained on the meter by 2.82 to convert from r.m.s. value to peak to peak values.

The meter is calibrated directly for 400 and for 100 volts peak-to-peak. These scales are used for 40-, 10-, 4-, and 1-volt peak-to-peak full-scale readings.

## The final operation

Construction or selection of the cabinet is the last step toward completion of this scope. A metal cabinet for the instrument could easily be fabricated from aluminum or other sheet metal, or a sheet-metal shop would probably do the job for a reasonable fee. The rest of my equipment is in wooden laboratory-type cabinets, so a mahogany cabinet was constructed, coated with clear lacquer, and then lined with copper screening for shielding. Adequate shielding is important in any cabinet other than an all-metal type.

When you are finished, you will possess an instrument worth well in excess of \$600. With it you can measure and observe pulses of regular or random repetition rates. Transient voltages of extremely high speeds in the neighborhood of 1 and 2 microseconds with frequency components up to 5 and 6 mc can be clearly seen and measured. Steep-fronted leading edges of pulses such as encountered in radar or Ioran equipment stand out boldly and are faithfully reproduced. One glance at television horizontal sync and video pulses on this instrument as compared to any of the cheaper scopes currently available will show up the startling difference immediately. Many other applications will become apparent with experience in the use and versatility of this instrument.

END

**HEATH company**  
BENTON HARBOR 20,  
MICHIGAN

# Heathkit TUBE CHECKER KIT

The Heathkit TC-2 Tube Checker was primarily designed for the convenience of radio and TV servicemen and will check the operating quality of tubes commonly encountered in this type of work. Test set-up procedure is simplified, rapid, and flexible. Panel sockets accommodate 4, 5, 6, and 7 pin tubes, octal and loctal, 7 and 9 pin miniatures, 5 pin Hytron, and a blank socket for new tubes. Built-in neon short indicator, individual 3-position lever switch for each tube element, spring return test switch, 14 filament voltage ranges, and line-set control to compensate for supply voltage variations, all represent features of the TC-2.

Illuminated for easy reading and quick identification of chart

Improved smooth running roll chart mechanical action.

Simplified construction—new harness type wiring—closer tolerance resistors.

Smart, professional appearance—a valuable in counter or portable models.

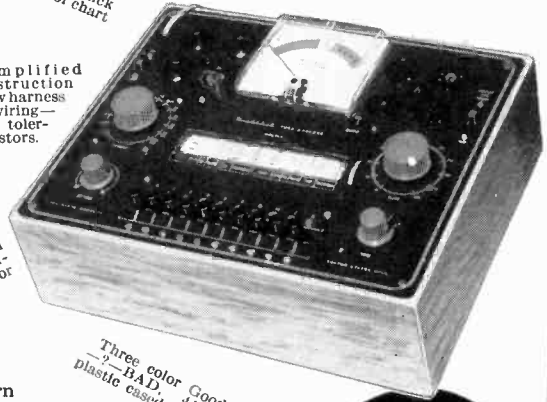

Three color Good-BAD plastic cased meter.

## Heathkit PORTABLE TUBE CHECKER KIT

The portable model is supplied with a strikingly attractive two-tone cabinet finished in rich maroon proxylin impregnated fabric covering with a contrasting gray on the inside of the detachable cover.

MODEL TC-2P  
**\$34.50**  
Shpg. Wt.  
15 lbs.



Results of tube tests are read directly from the large 4½" Simpson 3-color meter. Checks emission, shorted elements, open elements, and continuity. Wiring procedure has been simplified through the use of multi-wired color coded cable providing a harness type installation between tube sockets and lever switches. This procedure insures standard assembly and imparts a "factory built" appearance to the instrument. New Construction Manual furnishes detailed information regarding tube set-up procedure for testing of new or unlisted tube types. No delay necessary for release of factory data.

MODEL TC-2  
**\$29.50**  
Shpg. Wt.  
12 lbs.

## Heathkit REGULATED POWER SUPPLY KIT



MODEL PS-2  
**\$33.50** Shpg. Wt.  
15 lbs.

Here is a source of regulated D.C. voltage for circuit development work. Power supply voltage and current drain to the circuit under test are constantly monitored by the 4½" panel mounted meter. Separate 6.3 volt at 4 ampere A.C. filament source available. The regulated and variable output voltage will be constant over wide load variations, and hum ripple will not exceed .012% at 250 volts under a 50 MA load. Completely isolated circuit, standby switch, and other desirable features, make the Model PS-2 extremely useful in a wide variety of applications.

## Heathkit TV PICTURE TUBE TEST ADAPTER

The Heathkit TV Picture Tube Test Adapter used with the Heathkit Tube Checker Kit, will quickly check picture tubes for emission, shorts, etc. and determine tube quality. Consists of standard 12-pin TV tube socket, four feet of cable, octal socket connector, and data sheet.



No. 355  
**\$4.50** Shpg. Wt.  
1 lb.

## Heathkit DECADE RESISTANCE KIT



MODEL DR-1  
**\$19.50**  
Shpg. Wt.  
4 lbs.

Twenty 1% resistors are decaded in 1 ohm steps to provide any value between 1 ohm and 99,999 ohms. Sturdy ceramic switches with silver plated contacts insure reliable service. Use the Decade Resistance in bridge circuits, meter multipliers, calibrations, or any application requiring a wide range of precision resistance values.

## Heathkit AUDIO GENERATOR KIT

Here is an Audio Generator with features generally found only in the most expensive instruments. Sine wave coverage from 20 cycles to 1 Megacycle—response flat ±1 db from 20 cycles to 400 Kc—continuously variable and step attenuated output. Because the output voltage is relatively constant over wide frequency ranges, the AG-8 is ideal for running frequency response curves in audio circuits. Once set by means of the attenuator, this voltage may be relied upon for accuracy within ±1 db. Instrument features low impedance 600 ohm output circuit and distortion less than .4 of 1% from 100 CPS through audible range.



MODEL AG-8  
**\$29.50**  
Shpg. Wt. 11 lbs.

## Heathkit DECADE CONDENSER KIT

The Heathkit Decade Condenser provides a ready source of capacity values from 100 mmf to .111 mfd inclusive in capacity steps of 100 mmf. Silver plated contacts on husky ceramic switches, assure positive contact for each switch position. Precision silver mica condensers ±1% accuracy for close tolerance accurate work.

MODEL DC-1  
**\$16.50**  
Shpg. Wt.  
3 lbs.



**HEATH** company  
BENTON HARBOR 20,  
MICHIGAN

# NEW *Heathkit* HIGH FIDELITY PREAMPLIFIER KIT

Here is the exciting new Heathkit Preamplifier with all of the features you Audiophiles have asked for and at a down-to-earth price level. Beautiful satin gold baked enamel finish, striking control knobs and arrangement, attractive custom appearance and entirely functional design.

#### DESIGN:

Uses three twin triode tubes in a shock mounted chassis, 2-12AX7 and 1-12AU7. Features tube shielding, plastic sealed color coded capacitors, smooth acting controls, good filtering, excellent decoupling, low hum and noise level, and all aluminum cabinet. Special balancing control for absolute minimum hum level. Cathode follower, low impedance output circuit for complete installation flexibility.

#### SPECIFICATIONS:

Provides five switch selected inputs, 3 high level, and two low level, each with individual level controls—4 position LP, RIAA, AES, and early 78 equalization switch—4 position roll-off switch, 8, 12, 16 with one flat position. Separate tone controls, bass 18 db boost and 12 db cut at 50 CPS, treble 15 db boost, and 20 db cut at 15,000 CPS. Power re-

Equalization for LP, RIAA, AES, and early 78.

Separate bass and treble tone controls—special hum control.



Cathode follower low impedance output circuit.

Beautiful, modern appearance, blends with any interior or color scheme.

Five switch selected inputs with individual level controls.

Requirements from Heathkit Williamson Type Amplifier power supply 6.3 volts AC at 1 ampere, and 300 volts DC at 10 MA. Over-all dimensions 12 $\frac{1}{2}$ " wide x 5 $\frac{1}{2}$ " deep x 3 $\frac{3}{8}$ " high.

#### APPLICATION:

The new Heathkit WA-P2 Preamplifier has been designed to operate with any of the Heathkit Williamson Type Amplifiers and is directly interchangeable with the previous Model WA-P1 Preamplifier unit. Order your kit today and enjoy completely smooth control over the operation of your Hi-Fi system. Obtain the exact tonal balance of bass and treble with the precise degree of equalization you want. Note that the design of the WA-P2 accommodates the newly established RIAA curve.

MODEL WA-P2

**\$19.75**

Shpg. Wt. 7 lbs.

## HAM EQUIPMENT

Single knob band switching—prewound coils.



Crystal or VFO excitation—metered operation.

52 Ohm coaxial output—built-in power supply.

MODEL AT-1

**\$29.50**

Shpg. Wt. 16 lbs.

filter, good shielding and a 52 ohm coaxial output. The 425 volt, 100 milliamperere power supply and 5U4 rectifier are more than adequate for the 6AG7 oscillator multiplier and 6L6 amplifier doubler.

*Heathkit*

AMATEUR

### TRANSMITTER KIT

The Heathkit AT-1 Transmitter has established a high reputation and has been enthusiastically accepted by hundreds of experienced operators as well as beginners. Power input up to 35 watts for the novice and suitable as a standby exciter for your higher powered rig later on.

Model AT-1 can be crystal or VFO excited and operates on 80, 40, 20, 15, 11 and 10 meters. The prewound coils with the oscillator and amplifier are switched simultaneously by the rugged band switch. Meter switch allows a reading of the final grid and plate current on the panel mounted meter. Modulator input and VFO power sockets are provided as well as a key jack for CW operation. Other features include a crystal socket, standby switch, key click filter, AC line

filter, good shielding and a 52 ohm coaxial output. The 425 volt, 100 milliamperere power supply and 5U4 rectifier are more than adequate for the 6AG7 oscillator multiplier and 6L6 amplifier doubler.

Brand NEW

Smooth acting illuminated and precalibrated dial.

### HEATHKIT VFO KIT

The new Heathkit VFO is the perfect companion to the Heathkit Model AT-1 Transmitter and it has sufficient output to drive any multi-stage transmitter of modern design. Good mechanical and electrical design insures operating stability. Coils are wound on stable, heavy duty, ceramic forms using Litz or double cellulose wire coated with Polystyrene cement and baked for humidity protection. Variable capacitor of differential type construction, especially designed for maximum bandspread. Kit is furnished with a carefully precalibrated scale which provides well over two feet of scale length. Smooth acting vernier reduction drive and illuminated dial provides easy tuning and zero beating.

Power requirements 6.3 volts AC at .45 amperes, and 250 volts DC at 15 mls. Just plug it into the power receptacle provided on the rear of the AT-1 Transmitter. Seven band coverage 160 through 10 meters with 10 volt average RF output. Uses 6AU6 electron coupled Clapp oscillator and OA2 voltage regulator.

Copper plated chassis—aluminum cabinet—easy to build.



Seven band coverage 160 through 10 meters at 10 volt RF output.

6AU6 electron coupled Clapp oscillator and OA2 voltage regulator.

MODEL VF-1

**\$19.50**

Shpg. Wt. 7 lbs.

*Heathkit*

### GRID DIP METER KIT

The invaluable instrument for Hams, servicemen and experimenters. Useful in TV service work, for alignment of traps, filters, IF stages, peaking compensation networks, etc. Locates spurious oscillation, provides a relative indication of power in transmitter stages. Use it for neutralization, locating parasitics, correcting TVI, measuring CL and Q of components, and determining RF circuit resonant frequencies. The variable meter sensitivity control, headphone jack, 500 microampere Simpson meter, continuous frequency coverage from 2 MC to 250 MC. Prewound coil kit and rack included.

#### LOW FREQUENCY COILS:

Low frequency range extended to 355 KC by the use of two additional coils. Complete with dial correlation curves. Set 341-A for GD-1B and set 341 for GD-1A. Shpg. wt. 1 lb. Price \$3.00



MODEL GD-1B

**\$19.50**

Shpg. Wt. 4 lbs.

*Heathkit* ANTENNA

### IMPEDANCE METER KIT

MODEL AM-1

**\$14.50**

Shpg. Wt. 2 lbs.

Determine antenna resonance and resistance, transmission line surge impedance, and receiver input impedance. Works with one-half and one-quarter wave lines, half wave and folded dipoles, harmonic mobile and beam antennas. Resistance type SWR bridge—100 microampere meter—frequency range 0-150 MC—impedance range 0-600 ohms.



MODEL AC-1

**\$14.50**

Shpg. Wt. 4 lbs.

*Heathkit*

### ANTENNA COUPLER KIT

For the Heathkit AT-1 Transmitter or any comparable Amateur Transmitter. Will handle power up to 75 watts at its 52 ohm coaxial input. Matches a wide range of antenna impedances with its L type tuning network and neon indicator. A tapped inductance provides coarse adjustment and a transmitting type variable condenser sets it "right on the nose." Will operate on the 10 through 80 meter bands.

**HEATH** company

BENTON HARBOR 20,  
MICHIGAN

# New LOW PRICED HEATHKIT SINGLE UNIT Williamson Type *High Fidelity* AMPLIFIER KIT

Here is the newest Heathkit Hi-Fi Amplifier at the lowest price ever quoted for a complete Williamson Type Amplifier circuit. The W-4 Model has been designed for single chassis construction, and only for the new Chicago Transformer Company Model BO-13 "super range" high fidelity output transformer. This transformer, a new development in the Hi-Fi field, is being offered at substantial saving over transformers of comparable quality. It is outstanding in performance and on the basis of our tests, we find it equal in every respect to transformers used in the W-2 and W-3 Heathkit series.

#### LOW PRICES:

Through utilization of a single chassis with resultant economy obtained through elimination of duplicate sheet metal fabrication, connecting cables, plugs, sockets, and a new Chicago "super range" output transformer, a 20% price reduction has been made possible without sacrificing kit quality.

#### COMPONENTS:

The new Heathkit W-4 uses the same heavy duty power transformer and choke. It has all of the features of previous models including individual jacks and a wire wound control to balance the output tubes—plastic high quality capacitors and the exact circuitry previously utilized in Williamson Type Amplifiers. Intermodulation distortion and harmonic distortion are both at the same low level as in the W-2 and W-3 models.

#### CONSTRUCTION:

Here is the opportunity for even the economy minded Hi-Fi enthusiast to enjoy all of the advantages offered through Hi-Fi reproduction of fine recorded music. Simplified step-by-step Construction Manual completely eliminates necessity of electronic knowledge or special equipment. Assemble this Amplifier in a few pleasant hours.

Rugged, heavy duty,  
single chassis con-  
struction.

Output impedances  
4, 8, and 16 ohms.

Standard  
brand com-  
ponents used,  
no sacrifice of  
quality.

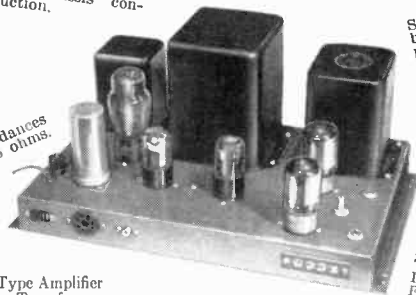

Lowest price high quality  
Williamson Type Amplifier  
ever offered.

Send for  
free booklet  
"High  
Fidelity  
Especially  
For You."

#### COMBINATIONS AVAILABLE

W-4M with Chicago "super-range" transformer only. Single chassis main amplifier and power supply. Shipping **\$39.75** weight 28 lbs. Express only

COMBINATION W-4 with Chicago "super-range" transformer only includes single chassis main amplifier and power supply with WA-P2 preamplifier **\$59.50** kit. Shpg. wt. 35 lbs. Express only

## NEW *Heathkit* 20 WATT High Fidelity AMPLIFIER KIT

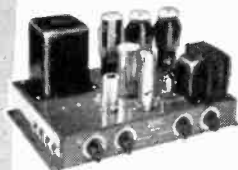

MODEL A-9B

**\$35<sup>50</sup>**

Shpg. Wt. 24 lbs.

In keeping with the progressive policy of the Heath Company, further improvement has been made in the already famous Heathkit High Fidelity 20 Watt Amplifier. Additional reserve power has been obtained by using a heavier power transformer. A new output transformer designed and manufactured especially for the Heath Company, now provides output impedances of 4, 8, 16 and 500 ohms. The harmonic distortion level will not exceed 1% at the rated output.

#### FEATURES:

Outstanding features of the Heathkit 20 watt Amplifier include frequency response of  $\pm 1$  db from 20 CPS to 20 KC. Separate (boost and cut) bass and treble tone controls. Four switch selected input jacks and a special hum balancing control. Flexibility is emphasized in the in-

put circuits and proper equalization for all input devices is incorporated.

#### TUBE LINEUP:

12AX7 magnetic preamplifier and first audio amplifier. 12AU7 two stage amplifier with tone controls. 12AU7 voltage amplifier and phase splitter. Two 6L6 push-pull beam power output and 5U4G rectifier.

The Heathkit Model A-9B is excellent for custom installation and is designed for outstanding service at a very reasonable cost.

## *Heathkit* SIX WATT AMPLIFIER KIT



MODEL A-7B

**\$15<sup>50</sup>**

Shpg. Wt. 10 lbs.

An outstanding value, this economically priced 5 watt Amplifier is capable of performance expected only in much more expensive units. Only 2 or 3 watts output will ever be used in normal home applications and Model A-7B will be more than adequate for this purpose.

#### SPECIFICATIONS:

Two switch selected inputs are available for crystal and ceramic phono pickups, tuner, TV audio, tape recorder, and carbon type microphone. Model A-7B features separate bass and treble tone controls, push-pull balanced output stages, output im-

pedances of 4, 8, and 15 ohms, and extremely wide frequency range  $\pm 1\frac{1}{2}$  db from 20 CPS to 20 KC. Not just a souped up AC-DC job. Full wave rectification, transformer operated power supply and good filtering, result in exceptionally low hum level.

#### MODEL A-7C

Provides a preamplifier stage and proper compensation for the variable reluctance cartridge and low level microphone. **\$17.50**

## *Heathkit* WILLIAMSON TYPE AMPLIFIER KIT

Here is the famous kit form Williamson Type *high fidelity* Amplifier that has deservedly earned highest praise from every strata of Hi-Fi music lovers. Virtually distortionless, clean musical reproduction, full range frequency response, and more than adequate power reserve.

#### OUTPUT TRANSFORMERS:

This outstanding Williamson Type Hi-Fidelity Amplifier is supplied with the famous Acrosound TO-300 output transformer. This quality transformer features the popular "ultra-linear" output circuit for clean maximum power level. Separate chassis for amplifier and power supply.

#### SPECIFICATIONS:

Frequency response within 1 db from 10 cycles to 100,000 cycles. Harmonic distortion at 5 watt output less than .5% between 20 cycles and 20,000 cycles. 1M distortion at 5 watts equivalent output .5% using 60 and 3,000 cycles. Output impedances of 4, 8, or 16 ohms. Overall dimensions for each unit 7" high x 5 $\frac{1}{2}$ " wide x 11 $\frac{1}{2}$ " long.

#### CONSTRUCTION MANUAL:

This fine kit is supplied with a completely detailed step-by-step Construction Manual and the only effort required is the assembly and wiring of the pre-engineered kit. Even the complete novice can successfully construct this Amplifier and have fun building it.

#### COMBINATIONS AVAILABLE:

W-3 Amplifier Kit (Includes Main Amplifier with Acrosound Output Transformer, Power Supply and WA-P2 Preamplifier.) Shipping weight 37 lbs. Shipped express only **\$69.50**

W-3M Amplifier Kit (Includes Main Amplifier with Acrosound Output Transformer and Power Supply.) Shipping **\$49.75** weight 29 lbs. Express only



**HEATH** company  
BENTON HARBOR 20,  
MICHIGAN



# LOW-FREQUENCY SWEEP GENERATOR ADAPTER

*Sweep frequencies—audio to video—provided by this simple instrument*

By RICHARD GRAHAM



**S**WEEP generators have enjoyed a tremendous growth in popularity. With the wide-band frequency responses common in FM and TV such an instrument is necessary for proper alignment. Most sweep generators today are designed with only these applications in mind—the lowest output frequency is usually about 4 mc. But a sweep generator's usefulness can be extended considerably for numerous low-frequency applications of interest to both ham and experimenter. The low-frequency sweep generator adapter does just that—it extends the frequency range of the sweep generator from 4 mc down to a few cycles. This new added range includes all the commonly used audio, radio and video frequencies. Thus the device can be used to align the i.f. amplifiers of communications

receivers for exact bandpass. Likewise the response curve of any selective i.f. strip can be obtained, be it at 50, 175, 455 or 1600 kc. The color subcarrier channels of a color TV set contain low-frequency components that necessitate use of a sweep generator with a comparatively low-frequency range. (See RCA's *Practical Color Television*, revised edition, page 68.)

The sweep adapter can also be used for a variety of audio-frequency applications such as determining response and cutoff frequencies of an audio

filter, response curves of equalizer amplifiers for magnetic phono cartridges, etc. The characteristics of various bass and treble controls can be quickly investigated. Similarly, the response of video amplifiers up to 4 mc can be visually observed. These are but a few of the more obvious applications of this device.

The basic operation of the sweep adapter is to take the swept frequency out of the sweep generator and beat it against a stable fixed-frequency oscillator set at approximately 6 mc

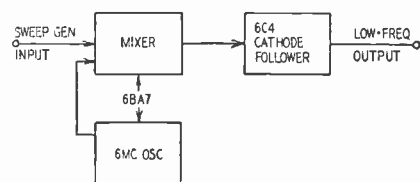

Fig. 1—Block diagram of sweep adapter.

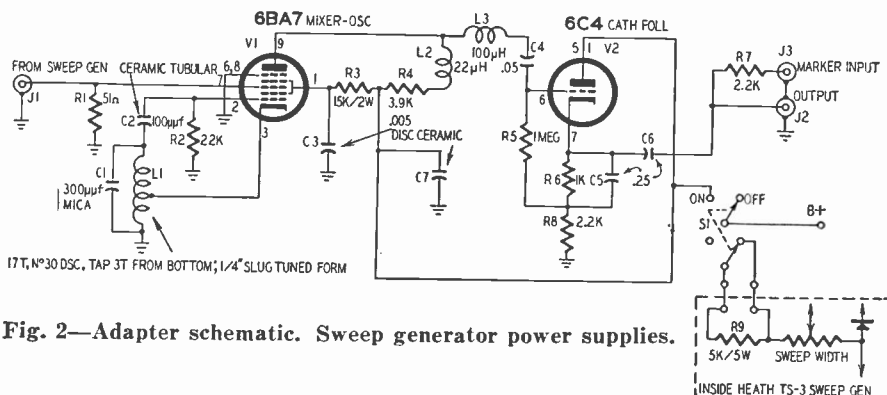
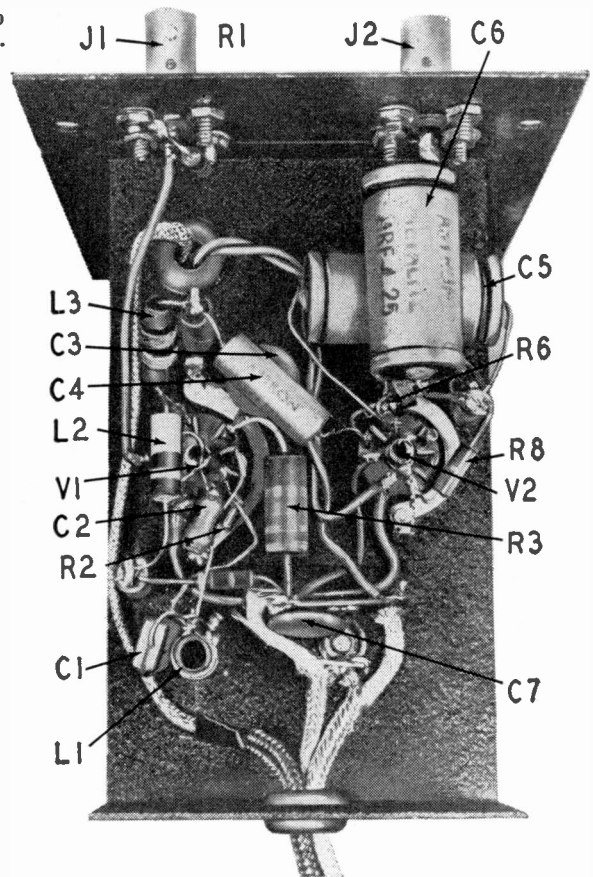
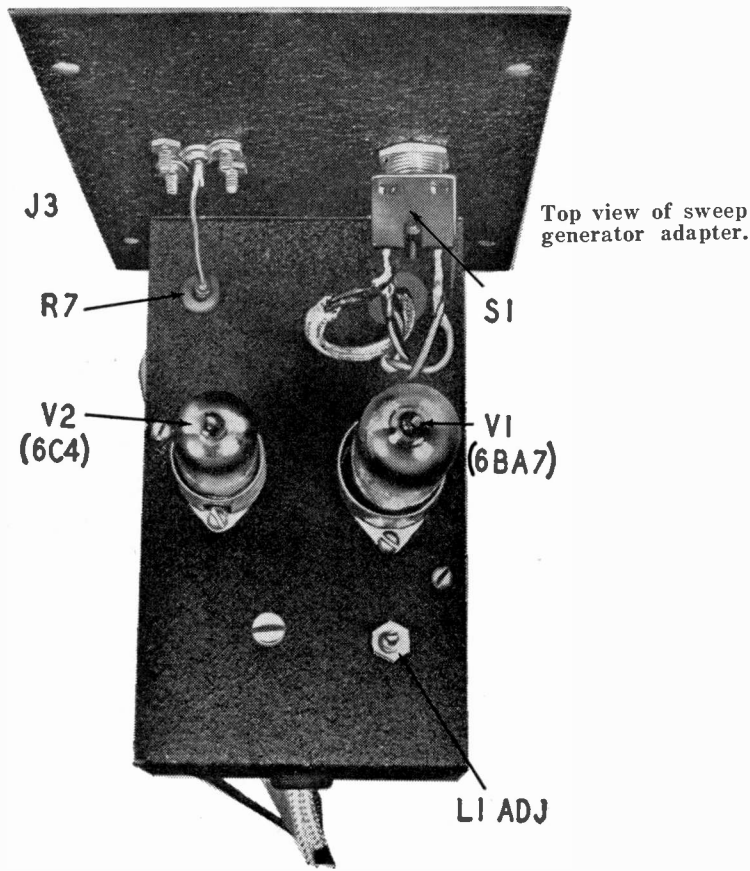

Fig. 2—Adapter schematic. Sweep generator power supplies.

# TEST INSTRUMENTS FOR TV



(Fig. 1). For example, if the sweep generator is set at a center frequency of 6.455 mc and mixed with a fixed 6.0-mc signal, the output will consist of the sum and difference of these frequencies as well as the two original signals. However, all the frequencies in the plate circuit of the mixer will be attenuated except the difference frequency, 455 kc. Since the sweep generator is sweeping about 6.455 mc, the output will vary about a center frequency of 455 kc.

Similarly, if the sweep generator were sweeping from 6 to 10 mc and this were mixed with a fixed oscillator at 6 mc, the output from the adapter would be sweeping over the 0- to 4-mc range. Thus the device can sweep the range from audio to video frequencies simply by adjusting the sweep generator center

frequency and the sweep-frequency deviation control.

### The circuit

The schematic of the adapter is shown in Fig. 2. The mixer and oscillator are combined in one 6BA7. The sweep generator output is fed to the control grid of the 6BA7. Coil L1 and

capacitor C1 form the resonant circuit of a Hartley oscillator operating at approximately 6 mc. The exact frequency is not too important just so long as it provides a stable fixed frequency. The only requirement is that the fixed oscillator be higher in frequency than the highest frequency out of the adapter. For example, if the adapter is used for video sweeping up to 4 mc and if the beat oscillator in the adapter is set at 4 mc, then a pip appears on the response waveform on the scope at 4 mc. Therefore, 6 mc was arbitrarily chosen for the fixed oscillator frequency.

The 6-mc oscillator frequency may have to be varied with sweep generators of different manufacture if any video applications are intended. This particular sweep adapter was used with a Heath TS-3 sweep generator, which is capable of extremely large sweep deviation. At 6 mc the sweep deviation is approximately 12 mc, i.e., the frequency of the output can vary from 6 to 18 mc in one sweep at maximum

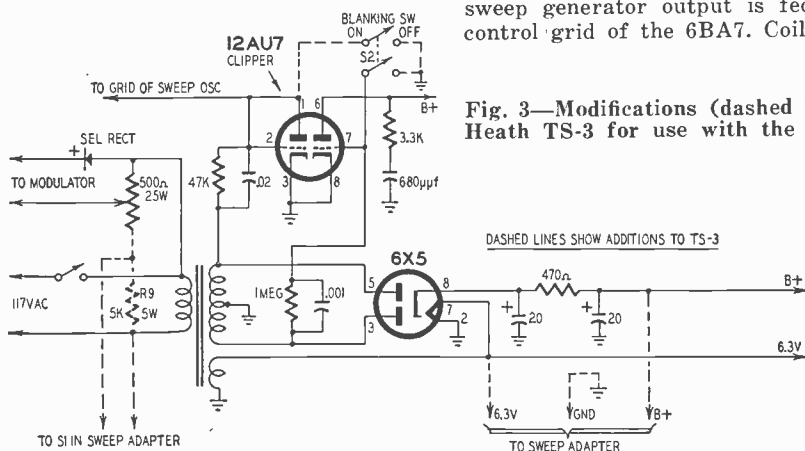
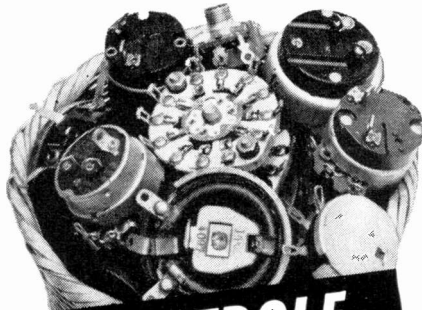

Fig. 3—Modifications (dashed lines) in Heath TS-3 for use with the adapter.





**QUIETROLE**  
Reg. U. S. Pat. Off.  
The ORIGINAL  
NON-INFLAMMABLE  
NON-CONDUCTIVE  
LUBRICANT CLEANER



CONTROLS & SWITCHES like new by the BASKETFUL for only a few PENNIES . . . that's what QUIETROLE can do for you, and only QUIETROLE will give that long lasting smooth, quiet operation . . . even new controls last longer and operate quieter when treated with QUIETROLE . . . the original and most reliable product of its kind.

THE CHOICE OF BETTER SERVICEMEN "EVERYWHERE"  
Supplied in 2, 4, and 8 oz. sizes. Ask for it at your distributor.

manufactured by



**QUIETROLE**  
COMPANY  
Spartanburg, South Carolina

**WAIT!**  
DON'T BUY ANY  
SOLDERING IRON  
UNTIL YOU SEE

THE **ESICO**  
*New* **LUGER**  
SOLDERING IRON

Makes all other irons  
obsolete!

*The shape of  
soldering irons to come!*

UNVEILING EARLY IN 1955

**ESICO**

ELECTRIC SOLDERING IRON CO.  
DEPT. E DEEP RIVER, CONN.

## TEST INSTRUMENTS FOR TV

deviation. If the sweep generator available does not have at least a 4-mc deviation starting at 6 mc, some higher oscillator frequency must be chosen.

The 6BA7 stage is not only a mixer and oscillator, but a video amplifier as well. The output circuit of the 6BA7 is shunt- and series-compensated for frequencies up to 5 mc. The output of this stage is fed into a conventional 6C4 cathode follower stage.

A marker signal from an external signal generator can be injected into the cathode of the cathode follower through isolating resistor R7. This is a convenient method of identifying frequencies on response curves. The marker is not effective when the adapter is used for audio purposes because a marker pip on a response curve is actually the audio beat frequency produced by the marker signal generator and the sweep generator. The zero beat frequency is the center of the marker pip. Thus the marker would take up the whole response curve of an audio amplifier. Likewise for extremely sharp i.f. responses, the marker will appear on all sides of the response at once. However, it does serve as a rough marker even here.

Since the sweep adapter requires only 15 ma at 250 volts d.c. and 6.3 volts a.c. at 0.45 amp, the power was taken from the sweep generator.

Two minor modifications of the Heath TS-3 sweep generator were necessary. They may or may not be needed on other sweep generators. The blanking of the sweep generator during the return trace had to be removed. This was necessary because the blanking method used frequency-modulated the sweep-generator oscillator even when the deviation control was set to zero. This condition is normal for this instrument since the generator is primarily designed for wide-band applications. Blanking can be easily removed by adding a switch as shown in Fig. 3.

If the adapter is used with other sweep generators, the constructor can easily determine if it is necessary to remove the blanking by hooking up the adapter and sweeping through an i.f. or other narrow-band amplifier strip. If the scope shows some sort of pattern even when the deviation control is set to zero, chances are the blanking method used in the generator is frequency-modulating the oscillator. Many sweep generators have a switch to remove blanking.

Another modification—more of an operating convenience than a necessity and helpful when working with narrow-band i.f. amplifiers—is a means of reducing the maximum sweep width. This is done by adding 5,000-ohm resistor R9 in series with the width control in the Heath sweep generator. Resistor R9 can be made variable and placed on the panel of the sweep adapter. This will provide a coarse sweep-width control while the one on the sweep generator will act as a fine control. In this case R9 was simply a

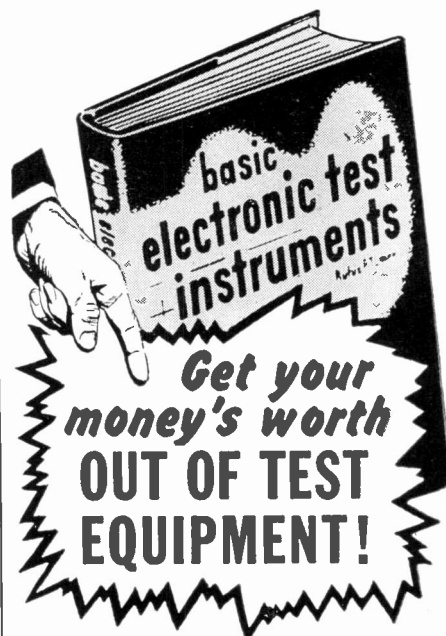

Get your  
money's worth  
**OUT OF TEST  
EQUIPMENT!**

**WORK BETTER, FASTER WITH  
FEWER INSTRUMENTS!**

Test instruments are plenty expensive these days . . . and that's not all!

No sooner do you buy one new instrument than another type comes along that is said to be even better and more useful.

You soon realize you've got to draw the line somewhere!

The answer is to really learn about instruments . . . to KNOW exactly what each type CAN and CANNOT do. Actually, you can do first class work with only a comparatively few basic instruments . . . and you can save hundreds of dollars by learning to use old instruments more fully.

Remember! *It isn't so much the instruments you use . . . it's the instrument "KNOW HOW" that counts!* And that's where this famous book can be worth its weight in gold to experienced radio-TV men and beginners alike!

**GET MORE WORK OUT OF  
YOUR OLD INSTRUMENTS**

BASIC ELECTRONIC TEST INSTRUMENTS by Rufus Turner covers instruments and test equipment from a practical, on-the-job standpoint. No useless theory! In 255 pages and with more than 170 illustrations it shows you how to select the right instruments and how to use them on all kinds of jobs.

It shows how to modernize old types and use them in new ways. It helps you avoid buying unnecessary instruments; teaches you work-saving testing short cuts; shows how to evaluate instrument readings fast and accurately.

Over 60 types . . . from the latest TV sweep, marker and linearity pattern generators to grid-dip oscillators, special purpose bridges and all the old standbys from V-O-M's signal generators to oscilloscopes and dozens more . . . are fully covered in a way you can easily understand.

Written especially for servicemen, students, amateurs and experimenters, BASIC ELECTRONIC TEST INSTRUMENTS is the only book of its kind. It saves you money . . . helps you earn more money . . . by helping you work better, faster and more accurately! Price only \$4.00 (\$4.50 outside U.S.A.)

**10-DAY FREE TRIAL**

- Dept. RE-15 Rinehart & Co., Inc.
- 232 Madison Ave., New York 16, N. Y.
- Send Turner's 255-page BASIC ELECTRONIC TEST INSTRUMENTS book for 10-day FREE EXAMINATION. If I decide to keep book, I will then remit \$4.00 plus a few cents postage. Otherwise, I will return book post-paid promptly and owe you nothing.
- Name .....
- Address .....
- City, Zone, State .....
- OUTSIDE U.S.A. — Price \$4.50 cash only. Money back if book is returned in 10 days.

STYLED FOR SALES



# Roto King

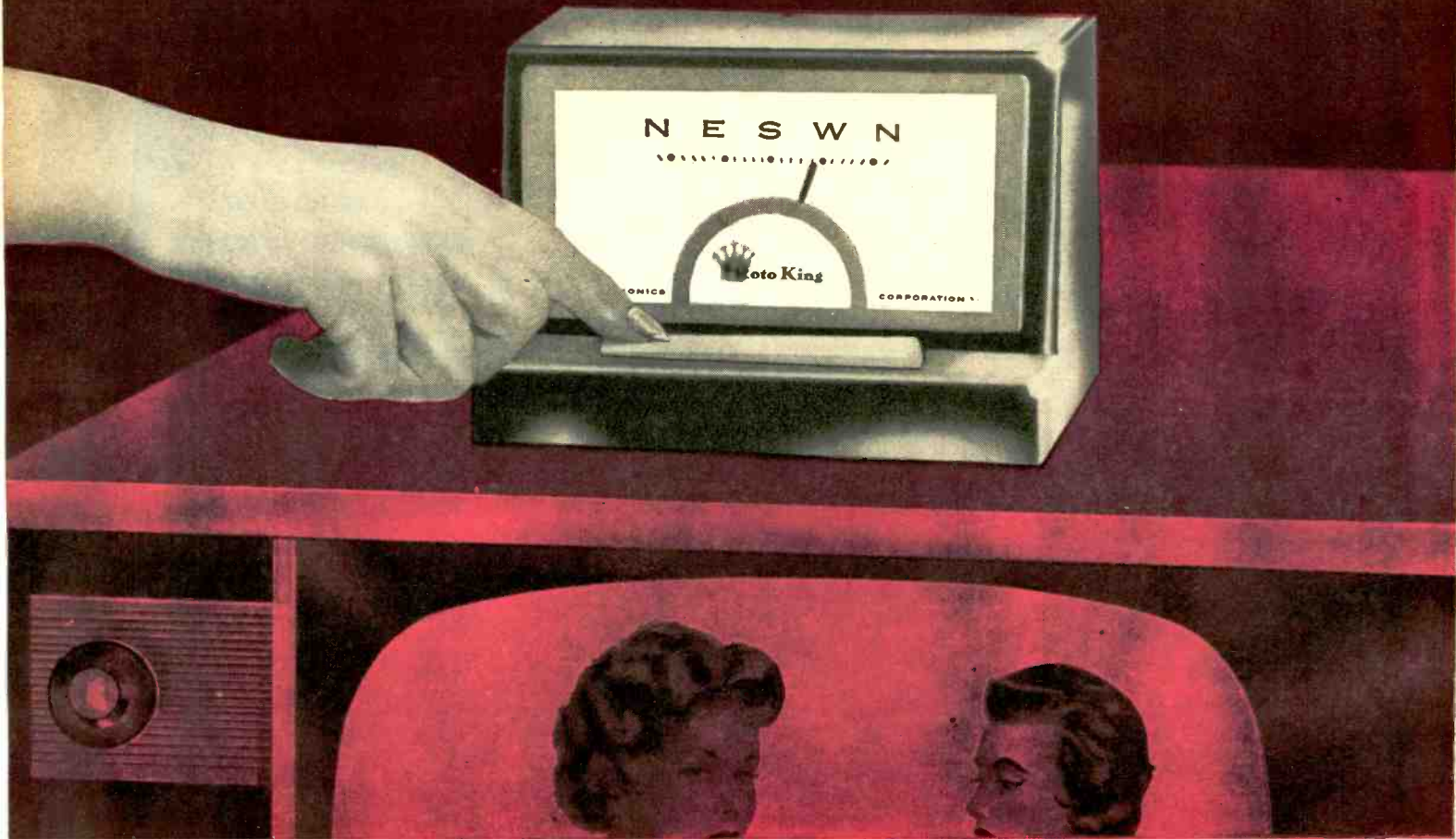

## ENGINEERED FOR SALES

### SMARTLY STYLED CONSOLE WITH PIANO TUNING

The striking control console is designed for beauty of design as well as ease of operation. Actuates the rotator with the slightest touch. Available in mahogany or ivory cabinet.



### STOP WATCH TUNING ACCURACY

Pinpoint control system is unsurpassed in consistent accuracy of indication. Stops antenna instantly within 1/2 degree of desired position. No drift or ambiguity.



### POWERFUL INLINE DESIGN

Supports direct deadweight load of largest stacked array. Resists downthrust and bending moment. Built-in thrust bearings. No extra parts to buy. No breakable offset bearings.

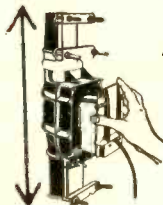

### REPLACEABLE FACTORY SEALED CARTRIDGE UNIT

Sealed power drive unit eliminates the former need of dismantling the antenna when servicing. Simply loosen 3 screws to remove the sealed unit.

### BALANCED POWER

Close tolerance 3200:1 reverted gear drive (within .002 in. tolerance) efficiently transmits 100% of developed power. No inherently weak worm gears.

Write for 8-page Roto-King engineering brochure No. 288.

### 390 DEGREE ROTATION

390 degrees—the broadest traverse range now in use—speeds and simplifies station selection beyond standard 360 degree revolution.

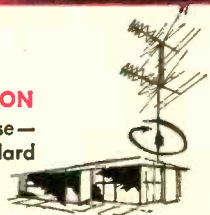

### COLORFUL "CARRY-ALL" CARTON

Safely protects Roto-King en-route...eases on-the-job carrying of units...comes in handy in the shop or around the home. A JFD merchandising extra at no extra cost.

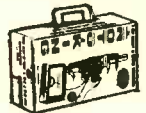

### AUTOMATIC VOLTAGE COMPENSATION

Advanced circuitry achieves automatic voltage compensation for stability and exactness of indication despite line voltage fluctuations.

ROTO-KING IS LIKE A DIRECT LINE TO EVERY TV STATION IN YOUR AREA.



Model	List
<b>RT100-M</b>	<b>\$44.95</b>
<i>Mahogany</i>	
<b>RT100-IV</b>	<b>\$44.95</b>
<i>Ivory</i>	



Look to JFD for Engineering Leadership!

**MANUFACTURING CO., INC.**

6101 16th AVENUE, BROOKLYN 4, N. Y.  
INTERNATIONAL DIVISION: 15 Moore Street, New York 4, U.S.A.



# JET-HELIX<sup>®</sup>

## "The RAINBOW Antenna"

a radical new flat plane helical concept  
for VHF-UHF black and white  
or COLOR reception

### Compare

its revolutionary microwave helix design that delivers highest signal magnitude on all channels with the least amplified noise—the same helical configuration used in amateur and commercial reception where the ultimate in high gain and sharp directivity is vital.

### Compare

its preassembled jet-action construction with sensational new "Hi-Tension" aluminum element brackets that slash assembly time to seconds. You don't even need a screw driver because there is no hardware to tighten. It's automatic!

### Compare

its tremendous consumer advertising support that presells your customers! newspaper ad mats, direct mail, displays, streamers, radio and television, movie commercials, national publicity.

### Compare

its top-notch front-to-back (up to 23 db) and front-to-side (up to 20 db) ratios that reject co-channel and adjacent channel interference!

### Compare

its matchless Alcoa aluminum construction!



### Compare

the Jet Helix by any standards known and you will agree with thousands of dealers—the JET HELIX is the "hottest" antenna in the industry, both in performance and sales!

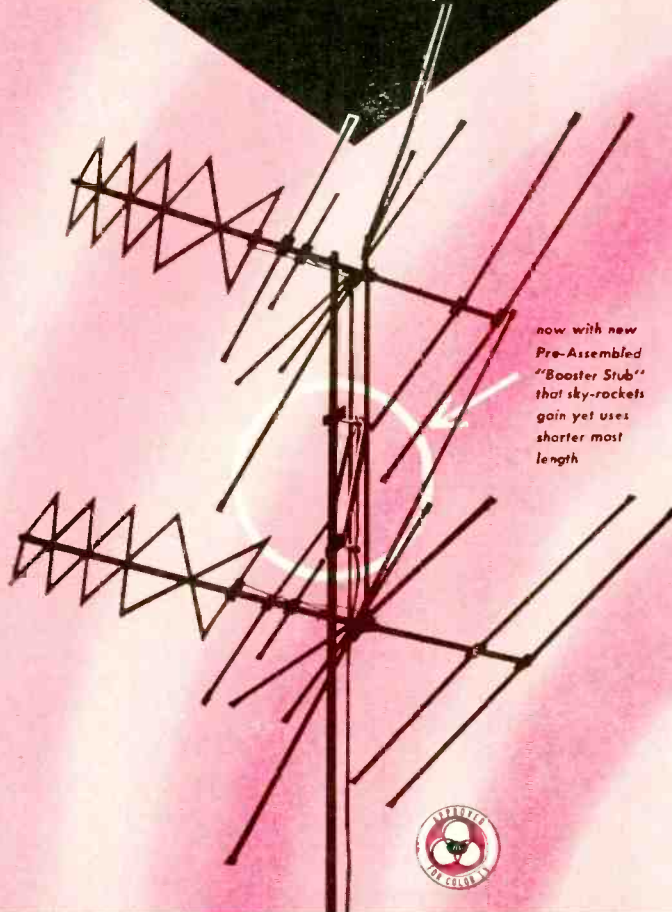

now with new  
Pre-Assembled  
"Booster Stub"  
that sky-rockets  
gain yet uses  
shorter mast  
length



## INCREDIBLE MICROWAVE HELICAL DESIGN!

ANTENNA	2	3	4	5	CHANNELS				10	11	12	13
					6	7	8	9				
"JET-HELIX" JET9135	8.3	8.6	9.	9.5	9.4	15.2	15.8	15.5	15.	14.8	15.1	15.3
"JET-HELIX" JET9135-5	9.2	10.5	11.1	10.5	9.8	13.5	14.4	14.8	15.2	15.5	15.5	15.
"SUPERJET" JET2135	5.8	8.3	9.5	8.3	8.5	10.5	11.2	12.	13.5	13.8	13.6	12.9
"SUPER POWERJET" JET2135-5	7.5	9.5	11.2	10.5	9.3	11.3	12.2	12.8	13.2	13.3	14.2	14.
"DODO" Screen Type REFLECTOR	4.75	4.5	7.2	7.1	7.	11.	11.2	11.8	11.5	11.1	12.1	12.
"SUPER DODO" Screen Type REFLECTOR	5.3	6.8	8.8	7.3	7.5	9.5	11.2	11.8	12.	11.1	12.1	12.
Broad Band Yagi with Phasing Stubs	4.3	5.7	4.5	7.1	9.	13.	14.	13.5	14.	13.	14.	15.
Inline Yagi with Phasing Stubs	5.2	5.5	6.	8.	8.	11.5	9.5	10.	9.	11.	11.5	11.8
Inline Yagi with Triple Dipole	6.25	6.5	8.7	8.5	9.	11.5	11.7	11.8	11.5	11.1	13.1	13.5
Super-Inline Yagi with Triple Dipole	6.75	7	10.2	10.3	11.	11.5	12.2	12.8	13.5	13.1	14.6	15.5

### SKY-ROCKETS GAIN!

### COMPARE THE DIFFERENCE!

For your "pot of gold" follow the  
JFD RAINBOW Antenna!

Compare its S/N Figure of Merit!  
JFD JET-HELIX—57.85%\*

Model	Bays	List
JET 913	SINGLE	25.50
JET 913S	STACKED	52.50
JET 913S-5	HALF WAVE STACKED	55.00

The Signal-to-Noise Figure of Merit sums up the major individual characteristics of an antenna in one concise value for gain and accurate comparison. Note the S/N Figure of Merit analysis for detail.

gain represents that over 1/2 wave reference folded dipole

Horizontal Pattern

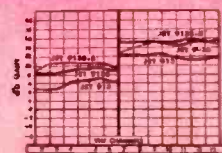

WHERE  
ACCURACY  
COUNTS

# Hycon

QUALITY  
ELECTRONIC  
INSTRUMENTS  
FOR TV  
TESTING

Buy right...know you're right with Hycon—setting new standards in quality test instruments. In addition to the three basic instruments shown, the Hycon line includes a combination volt-ohm-meter and tube tester, sweep generator, bar and dot generator, and color bar generator. All instruments meet color TV requirements. Write the factory or contact your local electronic parts jobber for additional product information.



MODEL 614 VTVM

Accuracy at unprecedented low cost sums up this rugged, serviceable instrument. Hycon plus features include 21 ranges (28 with p-p scales), large 6½" meter, 3% accuracy (DC and ohms), AC frequency response to 250 MC (with accessory crystal probe). And test probes stow inside case, ready to use.

This is the widely heralded new Hycon Digital VTVM—featuring 1% accuracy (DC and ohms), 1 millivolt sensitivity, illuminated decimal point and polarity sign, 12 ranges (AC, DC, ohms). AC frequency response to 250 MC with auxiliary probes. Direct reading, no interpolation.



MODEL 615 VTVM

Designed specifically for color TV and laboratory requirements, the Hycon Model 617 features 4.5 MC vertical band-pass, flat within  $\pm 1$  db; high deflection sensitivity (.01 v./rms per inch); and a special flat face 3" CRT for more usable trace. Sharp undistorted trace edge to edge.



3" OSCILLOSCOPE  
MODEL 617

ALL INSTRUMENTS  
IN MATCHING,  
BENCH-STACKING CASES

## Hycon Mfg. Company

2961 East Colorado Street  
Pasadena 8, California

ELECTRONIC EQUIPMENT  
PHOTO RECONNAISSANCE EQUIPMENT  
AERIAL SURVEY • ORDNANCE PRODUCTS

## TEST INSTRUMENTS FOR TV

fixed resistor placed in the sweep generator for convenience.

### Construction details

The unit is housed in a 4 x 5 x 6-inch steel box with a built-in chassis. The power leads connecting the sweep generator with the adapter should be shielded to prevent stray radiation. A 5-prong socket was mounted on the rear of the sweep generator so that the sweep adapter can be removed if desired.

After the unit is completed it is necessary only to adjust coil L1 to set the unit into operation. This is done by placing the antenna of a receiver tuned to 6 mc near L1 and adjusting the coil for maximum indication in the receiver. Another method is to couple a grid-dip meter to L1 and adjust the slug in L1 for a dip at 6 mc. Either method is satisfactory since the exact frequency is not too important.

### Parts for sweep adapter

**Resistors:** 1—51, 1—1,000, 2—2,200, 1—3,900, 1—22,000, 1—1 megohm, ½ watt; 1—15,000, 2 watts; 1—5,000, 5 watts (R9, see text).

**Capacitors:** 1—100  $\mu$ f, ceramic tubular; 1—300  $\mu$ f, mica; 2—.005  $\mu$ f, ceramic disc; 1—.05  $\mu$ f, 400 volts, paper; 2—0.25  $\mu$ f, 200 volts, paper.

**Miscellaneous:** 1—6BA7, 1—6C4, tubes; 1—coil (L1), 17 turns, No. 30 d.s.c., tap 3 turns from bottom, ¼-inch diameter slug-tuned form; 1—coil (L2), 22  $\mu$ h, 1—coil (L3), 100  $\mu$ h; 1—d.p.s.t. switch (blanking switch, see text); 1—d.p.d.t. switch; 1—cabinet and chassis; 2—tube sockets; 3—connectors for input, output and marker cables.

The operation of the sweep generator with the sweep adapter is exactly the same as it was when the sweep generator was used by itself at higher frequencies. However, more care in operating the sweep generator is required. Since the blanking has been removed, double responses will appear on the scope which must be matched up by the phasing control on the sweep generator.

Image responses will appear if the sweep width is set too high and the frequency of the generator too low. For example, if the sweep generator is set to sweep from 5 to 7 mc and the adapter output is sweeping through a 455-kc i.f. amplifier, two responses will appear on the scope. One response will be the image of the other (Fig. 4). If

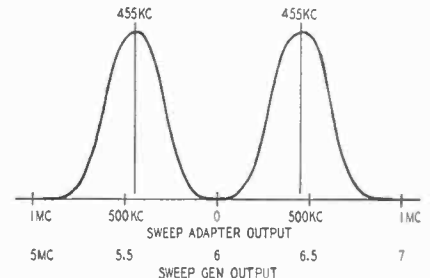

Fig. 4—Dual traces caused by too low a frequency and too much sweep.

the generator, like the TS-3, sweeps in one direction from the dial setting, this is only a matter of making sure the sweep dial is always set at some point above 6 mc. If this is done only one response will appear. END

# Introducing the Masterline<sup>★</sup> SERIES

## For BETTER, MORE POWERFUL MASTER TV SYSTEMS

Blonder-Tongue research and development have had one objective in mind: to enable local TV technicians to plan, install and maintain master TV systems of any size. As a result, the B-T program has succeeded in producing economical, easy-to-install, and easy-to-maintain equipment. A noteworthy example is the B-T 'Add-A-Unit' System with its complement of broadband amplifiers, distribution amplifiers and accessories.

Now comes our greatest achievement in this field . . . the MASTERLINE Series. Three units are now ready—more will follow—with the result that the TV technician will now be equipped, better than ever, to undertake any task involving TV signal distribution.



### MASTERLINE AMPLIFIER

A more powerful, cascade, all-channel VHF Amplifier with variable gain control for equalizing high and low bands. When used with AGC unit (Model MAGC) maintains non-varying output signal.

**Model MLA**

#### Features:

- Gain: 37db 170x)
- Impedance: 75 ohms input and output.
- Flat response.
- Input and output coax connectors.
- Self-contained power supply.
- Hammettone metal chassis with easily removable cover plate.
- Weight—6½ lbs. Dimensions—9 x 6 x 5".
- UL-approved.

**\$119<sup>50</sup>**  
List Price



### MASTERLINE AUTOMATIC GAIN CONTROL Model MAGC

A plug-in AGC unit designed for use with the MLA amplifier. Maintains constant output level, yet permits independent regulation of each band.

#### Features:

- Separate high and low band gain settings.
- Acts as positive protection against overload.
- Impedance: 75 ohms, input and output.
- Input and output coax connectors.
- Obtains power from MLA.
- Hammettone metal chassis and cover.
- Weight—3 lbs. Dimensions—6 x 4 x 5".
- UL-approved.

**\$59<sup>50</sup>**  
List Price



### MASTERLINE MIXER-SEPARATOR

**Model MMS**

A complete network unit employing no tubes and requiring no power. As a Mixer the MMS permits up to 12 VHF Yagis, each to be individually equalized, mixed and fed into one output line. As a Separator the MMS divides the output of a single line or broadband antenna into separate channels with an output (up to 12) provided for each channel. Each channel can then be individually attenuated, filtered or otherwise equalized.

#### Features:

- Has 12 tuned VHF channel terminals (input or output)—requires no adjustment.
- Impedance: 75 ohms input and output.
- Employs at least 4 resonant circuits for each channel.
- Low mixing loss—1 to 3db.
- Supplied with channel attenuator plugs—0 to 24db.
- Has strain-relief clamp bars for cables.
- Housed in Lead-coated chassis and mast mounting bracket with Aluminum weather-proof cover.
- Weight—4 lbs. Dimensions—12 x 6½ x 4".

**\$59<sup>50</sup>**  
List Price

Manufacturers of TV Amplifiers, Boosters, Converters, Accessories, and Originators of the B-T 'Add-A-Unit' Master TV System.



For complete specification data and operating instructions, write Dept. ZA-3

**BLONDER-TONGUE LABORATORIES, INC.**

WESTFIELD, NEW JERSEY

*the missing link in*

# SPEAKER OPERATION

*Part II—Obtaining variable damping factors in amplifiers; determining critical damping factors*

By D. J. TOMCIK\*

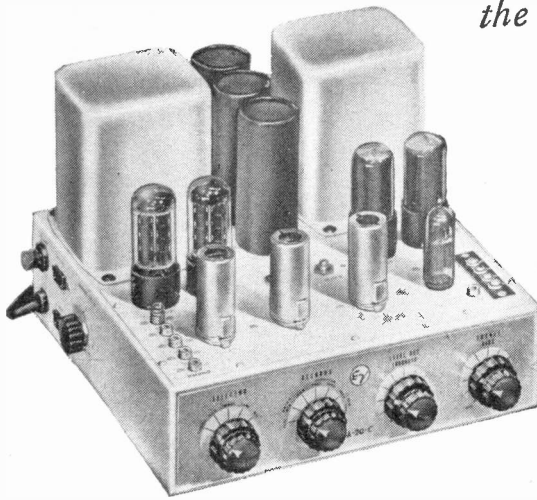

The Electro-Voice Circlotron amplifier. The unit uses variable damping-factor control.

**P**ART I of this article (December, 1954) discussed the effects of various damping factors on the operation of cone type speakers, particularly in the region of cone resonance. It was determined that a given speaker performs best only when critically damped. The matched reproducing system therefore requires the speaker as well as the amplifier be terminated in their proper loads. The amplifier is matched over the greater portion of the frequency spectrum by proper design, so the speaker should be matched to its desired load by proper amplifier design.

As was shown, the proper speaker load for critical damping is the numerical difference between the critical damping resistance (CDR) and the d.c. resistance of the voice coil. This value should be equal to the amplifier internal impedance. Of course, the speaker can be critically damped by using an amplifier of very low internal impedance and putting a fixed resistor in series with the speaker. However, this method results in a power loss in the resistor which may be much greater than that supplied to the speaker. The correct and efficient method of matching is by controlling the amplifier internal impedance, which does not absorb power. (The amplifier nominal impedance should not be confused with amplifier internal impedance. The nominal impedance, 4, 8 or 16 ohms, is what the amplifier should work into whereas the amplifier internal impedance refers to regulation, as explained later in this article. The two values are seldom the same.)

### Damping factor

To simplify matters and eliminate the variable of nominal impedance, the term *amplifier damping factor* is often used. The damping factor is equal to the nominal impedance divided by the internal resistance of the amplifier. For example, an amplifier whose internal resistance on the 16-ohm tap is 8 ohms has a damping factor of 2.

For a given speaker there is one

value of internal resistance and consequently one value of damping factor which results in critical damping. This value can be called the *critical damping factor* (CDF).

To visualize the damping-factor concept better, consider the amplifier output terminals a voltage source with zero impedance in series with a resistor equal in value to the internal impedance. Fig. 1 shows this arrangement with the proper amplifier load. The amplifier may be push-pull, cathode follower, or any other type, since the equivalent output circuit for all can be considered to be the same as that in Fig. 1. To measure damping factor of any amplifier it is necessary only to measure the output voltage under no-load and rated-load conditions. The formula for damping factor then becomes:

$$DF = \frac{E_{r1}}{E_{n1} - E_{r1}}$$

where  $E_{r1}$  = rated-load voltage and  $E_{n1}$  = no-load voltage.

From this formula we see that the damping factor is also a measure of the output regulation — how far the



Fig. 1—Equivalent output circuit.



Fig. 2—Schematic diagram of the equivalent plate circuit of the output stage.

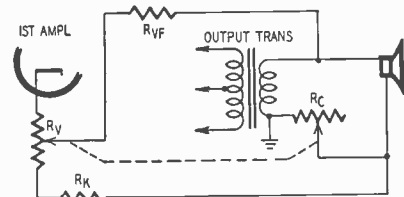

Fig. 3—Circuit using variable feedback.

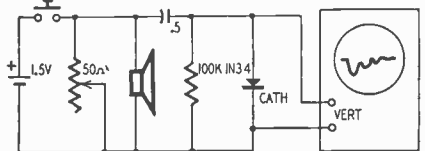

Fig. 4—Circuit for determining CDF.

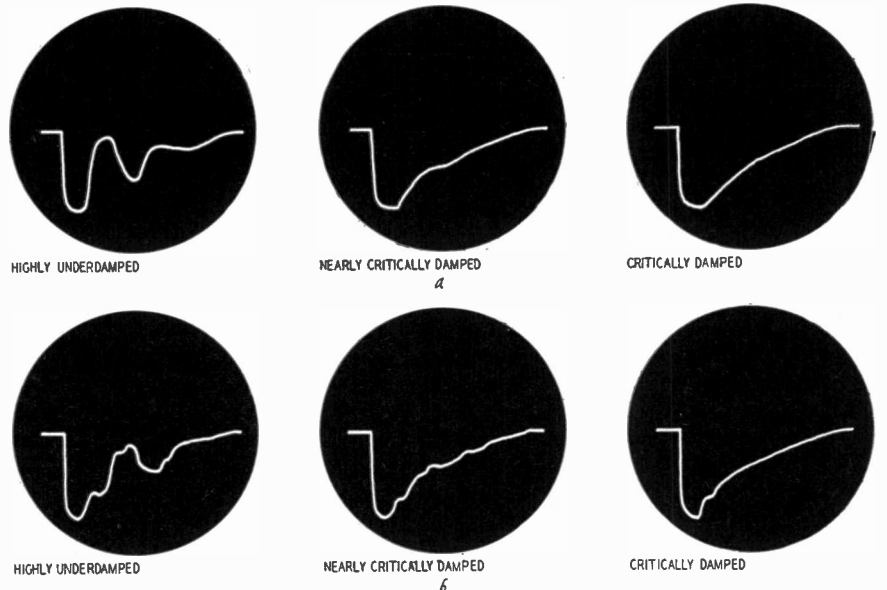

Fig. 5—Oscilloscope traces; a, three conditions with speaker in an infinite-baffle enclosure; b, same conditions with speaker in large reflex enclosure.

\*Chief Electronics Engineer, Electro-Voice, Inc.

# Pickering Audio Components...

**SYNONYMOUS WITH HIGHEST QUALITY**

*Design... Manufacture... Performance*

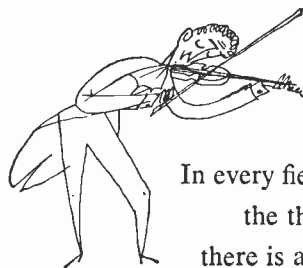
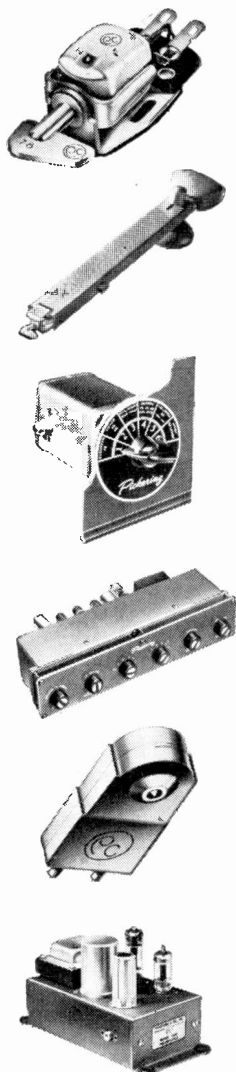

In every field of endeavor . . . manufacturing,  
the theatre, concert or contest . . .  
there is always one standout.

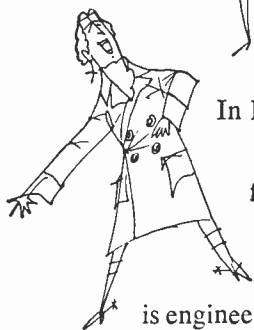

In HI-FI equipment the standout is Pickering . . .  
pioneer in this field, responsible  
for the development and introduction of outstanding  
components for highest quality performance;  
every product bearing the Pickering name

is engineered to conquer the challenge of  
optimum performance . . . in their manufacture  
the most stringent quality controls are  
exercised to assure and maintain the "Ne Plus Ultra"  
reputation for products featured by the  emblem.



It's with good reason that professionals use  
Pickering Audio Components . . . they know  
the values built into Pickering equipment.  
**INVESTIGATE** and you too will use Pickering  
components for your HI-FI system. . . .  
You'll thrill to new listening experiences . . .  
you'll have the same high quality performance  
as leading FM/AM good music stations, network  
and recording studios . . . **REMEMBER**, leading  
record companies use Pickering Components  
for quality control.

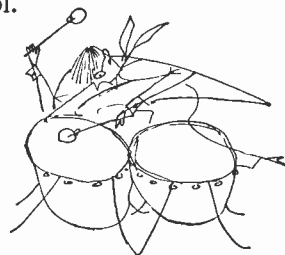
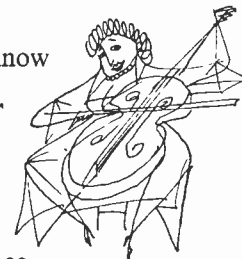

**PICKERING and company incorporated •**

**Oceanside, L. I., New York**

PICKERING PROFESSIONAL AUDIO EQUIPMENT

*"For those who can hear the difference"*

. . . Demonstrated and sold by Leading Radio Parts Distributors everywhere.

For the one nearest you and for detailed literature; write Dept. P-6.

# ELECTRICAL ENGINEERS

or

# PHYSICS GRADUATES

with experience in

## RADAR or ELECTRONICS

or those desiring to enter these areas...

*The time was never more opportune than now  
for becoming associated with the field of advanced electronics.  
Because of military emphasis this is the most  
rapidly growing and promising sphere of endeavor for the young  
electrical engineer or physicist.*

Since 1948 Hughes Research and Development Laboratories have been engaged in an expanding program for design, development and manufacture of highly complex radar fire control systems for fighter and interceptor aircraft. This requires Hughes technical advisors in the field to serve companies and military agencies employing the equipment.

As one of these field engineers you will become familiar with the entire systems in-

involved, including the most advanced electronic computers. With this advantage you will be ideally situated to broaden your experience and learning more quickly for future application to advanced electronics activity in either the military or the commercial field.

Positions are available in the continental United States for married and single men under 35 years of age. Overseas assignments are open to single men only.



Hughes Field Engineer H. Heaton Barker (right) discusses operation of fire control system with Royal Canadian Air Force technicians. Avro Canada CF-100 shown at right.

Relocation of applicant must not cause disruption of an urgent military project.



Scientific  
and  
Engineering  
Staff

## HUGHES

RESEARCH  
AND  
DEVELOPMENT  
LABORATORIES

Culver City,  
Los Angeles  
County,  
California

## AUDIO—HIGH FIDELITY

output varies from a constant-voltage source with changes in load. Amplifiers with high damping factors act more like *constant-voltage* sources than those with lower damping factors. Conversely, amplifiers with low damping factors act more like *constant-current* sources than those with higher damping factors. Hence a means is provided to vary the damping factor simply by controlling the regulation. This is easily done by using feedback in the circuit to obtain more or less constant-voltage or constant-current amplifiers. But, first, what damping factor requirements are necessary in a really good high-fidelity amplifier?

We have seen in Part I that all speakers classed as high-fidelity units require positive values of amplifier resistance for critical damping. Only inefficient speakers in the very low price range require *negative* resistances. It is possible to obtain negative-resistance characteristics from an amplifier by using *positive* feedback. But since the speaker that requires this type of damping is mediocre at best, and since positive feedback may result in instability and increased distortion, negative-resistance amplifiers are unnecessary in the present state of the reproducing art.

The highest practical damping factor is approximately 10 to 15. Since the d.c. coil resistance of a speaker generally makes up more than 75% of the total nominal impedance, amplifier damping factors greater than 10 or so have no appreciable effect on speaker damping. For example, a 16-ohm speaker with a 12-ohm d.c. coil will have a total series resistance of 13.6 ohms with a damping factor of 10, and a total series resistance of 12.4 ohms with a damping factor of 40. The difference in frequency response is not noticeable to the ear and hardly measurable.

The lowest damping factors found in today's high-fidelity speakers range around 0.3 or 0.4. A good low limit for amplifier design would be 0.1 or 160 ohms on the 16-ohm tap.

We have now established the limits to be between 0.1 and 15 to cover amply the range in modern-day speakers. The damping control should be calibrated directly in damping factor or internal resistance to simplify adjustment to a given speaker.

### Other considerations

A good high-fidelity amplifier should also have a constant sensitivity with rated load applied, as the damping factor is varied. This results in a constant negative feedback which maintains the distortion and hum figures at constant low levels. In addition, the damping-factor control system should not be frequency-discriminating. Frequency discrimination will affect sensitivity more at some frequencies than at others and produce an undesirable tone-control action in the system.

An effect which might be noticed



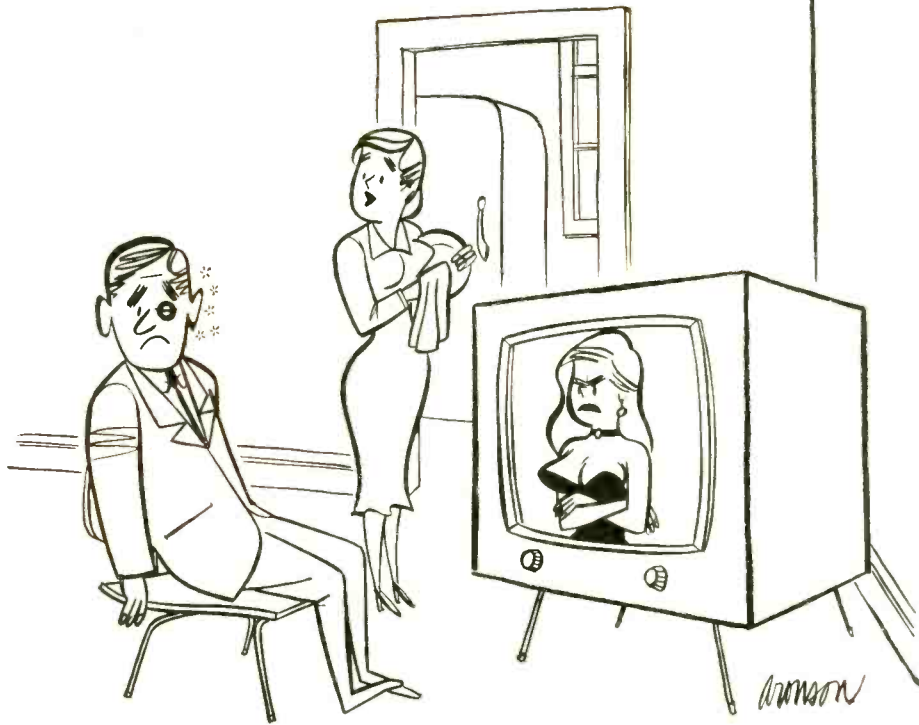

NEVER THOUGHT WE COULD GET PICTURES WITH SO MUCH PUNCH 'TIL WE HAD THOSE SPRAGUE CAPACITORS PUT IN.

## Don't Be Vague... Insist on SPRAGUE

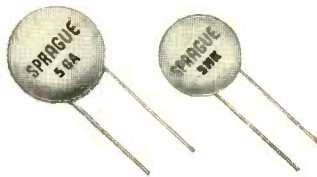

### Insist on Sprague CERAMICS

Tiny, tough, dependable . . . in every application . . . whether discs, plates, buttons, or door knobs. And there's a Sprague ceramic capacitor to meet every service need. You give your customers dependable service, guard yourself against costly call-backs, when you use only Sprague Ceramic capacitors.



### Insist on Sprague TWIST-LOK<sup>☆</sup> 'LYTICS

Sprague TVL's fill the top performance bill in the toughest TV circuits. High temperatures, surge voltages, ripple currents won't faze them. Like all Sprague capacitors, Twist-Lok 'Lytics are your first line of defense against expensive call-backs.

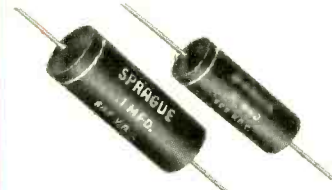

### Insist on Sprague BLACK BEAUTY<sup>®</sup> TELECAPS<sup>®</sup>

The most imitated capacitor Sprague ever introduced. But you get Sprague *performance* only when you insist on Sprague Telecaps. Hundreds of millions are in use today as first choice of quality conscious manufacturers and servicemen. It's the *premium* molded tubular *at no extra cost*.

Accept no substitutes. There is a Sprague Distributor in every sales area in the United States. Write for the name of your nearest source of supply today.

☆ Trademark

# SPRAGUE

Get your copy of Sprague's latest radio and TV service catalog C-610. Write Sprague Products Company\*, 81 Marshall St., North Adams, Mass.

\*Distributors' Division of Sprague Electric Company

**WORLD'S LARGEST  
CAPACITOR MANUFACTURER**

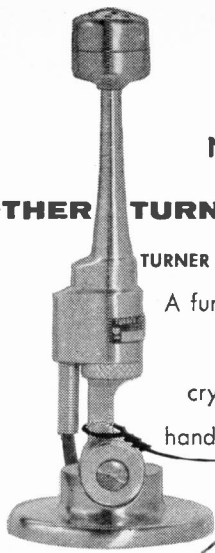

NOW better performance than ever

## ANOTHER TURNER MICROPHONE VALUE

TURNER MODEL 80 CRYSTAL—The level is now only -54db.

A further improvement in this always outstanding performer. The Turner 80 is a powerful miniature crystal mike so tiny you can hide it in the palm of your hand. A really big performer within its frequency range.

### TURNER MODEL 80 SPECIFICATIONS

Response: 80—7,000 c.p.s.  
 Level: -54 db.  
 Case: die-cast zinc alloy. Satin chrome finish.  
 Crystal: bimorph moisture sealed. Blast and mechanical shock proofed.  
 Cable: 7 ft. attached single conductor, shielded.  
 LIST PRICE: **\$15.95**  
 Matching C-4 stand as shown here: **\$5.75**

### THE TURNER COMPANY

933 17th St., NE, Cedar Rapids, Ia.  
 Canada: Canadian Marconi Co., Toronto, Ont., & Branches  
 Export: Ad. Auriema, Inc., 89 Broad St., New York 4, N.Y.

**FRANKLIN**  
 Announces New  
**VACUUM TUBE  
 VOLTMETER  
 KIT**



Engineered by Electronic Craftsmen with over 30 Years Experience

Quality parts—Finest on the market.  
 Recessed handle — Sinks into case to permit stacking.  
 Large 4½" meter—Easier to read than others.  
 Etched panel—Smooth etched rubproof panel keeps wording legible.  
 Low price — In spite of better grade parts, Model FV-1 sells for bargain price.  
 Equal to, or better than competitive makes!  
 Fast measurements with greater accuracy on 1½ volt low scale give more than 2½-inch scale length per volt. AC-DC ranges 0-1.5-5-15-50-150-500-1500 volts (1000 volt max. on AC). Ohmmeter range from X1 to X100K and X1 meg. Measures .1 ohm to 1000 megohms. Many other features.

Kit includes tubes, assembly material, test leads, manual for assembly. (Wired—\$35.50)

**MAIL ORDER for MODEL FV-1 TODAY!**

**FRANKLIN ELECTRONICS**  
 Free Bulletin! King St., Franklin Park, Ill.

Enclosed find  check,  money order.  Ship C.O.D. C.O.D. postage. Money back guarantee.

Name \_\_\_\_\_  
 Address \_\_\_\_\_  
 City \_\_\_\_\_ Zone \_\_\_\_\_ State \_\_\_\_\_

## PUT THE HIGH IN HIGH FIDELITY!

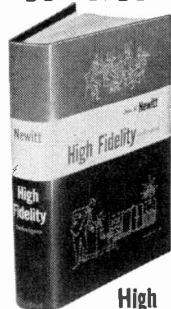

### High Fidelity Techniques A COMPLETE GUIDE

by John H. Newitt

The book that says goodbye to guesswork in choosing, building and servicing hi-fi equipment.

512 pages  
 203 pictures  
 Price \$7.50

Whether you specialize in high fidelity service, custom building or simply want to build a top-notch outfit for yourself, this big 512-page book will guide you every step of the way.

Helps you get better results at less cost. Shows what to do . . . what mistakes to avoid. Gives you a full understanding of the many different methods, circuits, designs, equipment, components and other subjects that are debated whenever hi-fi fans get together.

Written by one of the nation's leading experts, High Fidelity Techniques is complete, authentic and easy to understand. From beginning to end, it is chock full of how-to-do-it tips, service hints, custom-building ideas and data, charts and diagrams of the most helpful sort.

### 10-DAY FREE EXAMINATION!

Dept. RE-15, RINEHART & CO., INC.  
 232 Madison Ave., New York 16, N.Y.

Send HIGH FIDELITY TECHNIQUES for 10-day FREE EXAMINATION. If I like book, I will then promptly send \$7.50 (plus a few cents postage) in full payment. Otherwise, I will return book postpaid and owe you nothing!

Name \_\_\_\_\_

Address \_\_\_\_\_

City, Zone, State \_\_\_\_\_

OUTSIDE U.S.A.—Price \$8.00 cash with order only.  
 Money back if book is returned in 10 days.

## AUDIO—HIGH FIDELITY

in a nonfrequency-discriminating system is that of high-frequency accentuation at low damping-factor values where a single wide-range speaker is used. This high-frequency boost is caused by the speaker inductive reactance becoming appreciable and affecting the gain of the amplifier at high frequencies. The effect is not present in multiple-speaker systems since the reproducing components are designed to present the nominal impedance over their working range of frequencies and are then cut off by the crossover network above their range. However, in a single-speaker system, the several decibels of treble boost are not serious and probably complement the high-end speaker roll-off due to the single-cone operation. In any event, if desired, the treble control can nullify this effect.

### Amplifier design

With the requirements mentioned, we can proceed to design the output circuit of the amplifier, remembering the criterion that negative voltage feedback lowers the internal resistance while negative current feedback raises the resistance. We will probably want to settle on some minimum value of negative feedback to take care of the frequency response, distortion and hum. This usually falls between 15 and 20 db of loop feedback. It may turn out that we will need more than this minimum value, depending on the circuit and particular constants used.

The circuit is first considered without loop feedback so as to determine the starting-point damping factor. The equivalent circuit shown in Fig. 2 applies to all types of circuits as long as  $r_p$  is considered the effective plate resistance and  $R_L$  the load impedance referred to the primary of the output transformer. For example, the damping factor for push-pull 6V6's pentode-connected, with  $r_p = 64,000$  ohms and  $R_L = 8,000$  ohms, is

$$DF = \frac{8,000}{64,000} = 0.125$$

without loop feedback. To obtain the high damping factor of 10, negative voltage feedback is used around the loop until that value is obtained, say 18 db. Then if 9-db of negative current feedback is added while 9 db of negative voltage feedback is removed, the total negative feedback remains at 18 db; but the damping factor is now 0.125 as with no feedback. However, the sensitivity, frequency response, distortion and hum remain constant. This amplifier covers approximately the desired range of damping factors while the set requirements are maintained. The design procedure is applicable to all types of amplifiers, the only difference being in the initial value of damping factor with no loop feedback. The value of  $r_p$  will vary greatly with the type of circuit. A cathode-follower output stage results in a very low value of  $r_p$ , approximately equal to the reciprocal of the transconductance. Generally, pen-

## AUDIO—HIGH FIDELITY

todes in push-pull have high values. Triodes fall in between pentodes and cathode followers. The ultra-linear circuit is a combination midway between pentode and triode operation. The Electro-Voice Wiggin's Circlotron circuit using two 6V6's in a bridge arrangement results in  $r_p$  equal to 2,000 ohms and  $R_L$  equal also to 2,000 ohms. Under these conditions, no loop feedback or equal voltage and current feedback results in a damping factor of 1. Overall negative voltage feedback increases the damping factor to values greater than 1, and over-all negative current feedback to values less than 1.

Fig. 3 shows an arrangement in which the current and voltage feedback can be varied in any amount while the total feedback remains a constant. Resistor  $R_v$  permits maximum desired current feedback when it is fully in the circuit. The value of  $R_v$  is such that the total required voltage feedback is obtained when the slider of  $R_v$  is at the cathode position. The ratio of  $R_v$  to  $R_k$  is chosen so that the voltage feedback is equal in value to the maximum current feedback when the movable arm of  $R_v$  is at the  $R_k$  end. The two potentiometers are ganged in such a way that an increase in voltage feedback causes a decrease in current feedback.

### Determination of CDF

With the Fig. 3 circuit arrangement it is possible to obtain various damping factors by the turn of a knob. It is now necessary only to determine the CDF of the speaker to be used and then adjust the amplifier damping factor to that value.

The Electro-Voice line of high-fidelity speakers includes the CDF value in their specifications. For those who would like to determine the CDF of their present speaker system, the equipment needed includes an oscilloscope, a calibrated variable resistance of about 50 ohms maximum, a flashlight battery, a momentary pushbutton switch, a 0.5- $\mu$ f capacitor, a type 1N34 germanium diode and a 100,000-ohm resistor. The components are arranged as in Fig. 4. Carefully observe the polarity of the flashlight cell and the 1N34. Mount the speaker under test in its permanent enclosure since the baffle has some influence on the CDF value. The amount of coupling between speaker cone and enclosure is not very great. The cabinet resonances will not be appreciably affected by changing damping on the speaker, but the enclosure does contribute to the effective mass and stiffness of the speaker, which directly affects the value of CDF.

The circuit of Fig. 4 operates as follows. When the switch is closed, the speaker cone is displaced due to the current flowing through the voice coil. The switch is then opened and the cone returns to rest position. The voltage it generates in so doing is observed on the oscilloscope. The external resistance shunting the speaker is ad-

# Smart Servicemen

## Are Modernizing Current TV Sets

And...

*Making  
dollars*



By Using

## Conversion Chassis CC-1

And...

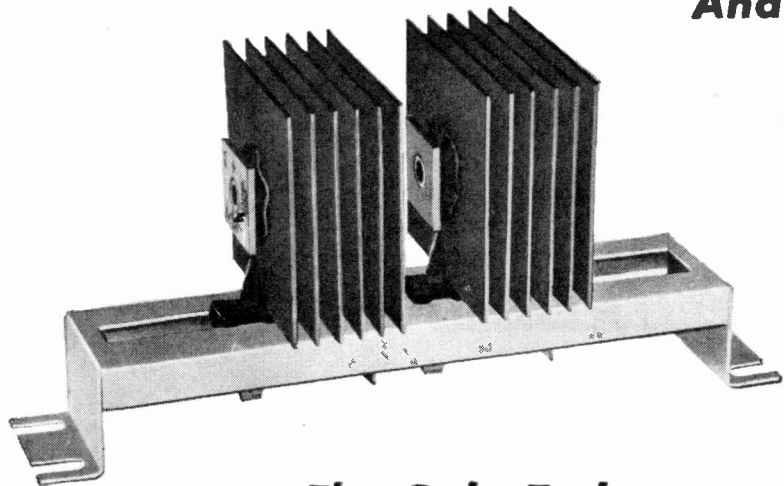

**...The Only Truly  
Universal Plug-In\* Replacement  
Rectifier That Can Also Be  
Bolted And Soldered**

\* PATENT APPLIED FOR

Get a copy of the latest Selenium Rectifier Replacement Guide from your distributor

**Sarkes  
Tarzian, INC.**

RECTIFIER DIVISION

415 N. COLLEGE, DEPT. RE-1, BLOOMINGTON, IND.

In Canada: 700 Weston Rd., Toronto 9, Tel. Murray 7535  
Export: Ad. Auriema, Inc., New York City

your customers want the  
**BEST! . . . the "ORIGINAL"**

**MOSLEY**

**Wall**

**Thru**

To Get The ORIGINAL,  
Ask For It By Name!

TAKES ALL  
POPULAR LINES!  
RUBBER GROMMET  
SEALS OUT  
MOISTURE!

POLYSTYRENE  
THRU-OUT! FULL  
1/8" THICK WALL  
- BEST FOR UHF,  
VHF, COLOR

CONVENIENT  
LOW LOSS SOCKET  
MAY BE INSTALLED  
ON INSIDE PLATE

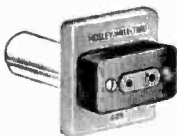

Cat. No. 625  
MOSLEY WALL-THRU,  
in brown or ivory.  
List Price \$1.95

Cat. No. 625-PK  
WALL-THRU, with  
Universal TV Socket  
& mating Plug.  
List Price \$3.00

Write for free copy of MOSLEY Condensed Catalog, Form D-1. Tells - How To Make More Installation Profits!

**Mosley**  
Electronics, Inc.  
8622 ST. CHARLES ROCK ROAD  
ST. LOUIS 14, MISSOURI

**A Word Of Caution!**

Because there are numerous imitations, similar in appearance to the popular Wall-Thru, the TV installer is cautioned to ask for the Original MOSLEY Wall-Thru - by name!

For Quality, Value, Practical Design - insist upon the MOSLEY Wall-Thru . . . Another PREMIUM QUALITY MOSLEY Accessory for Better, More Profitable TV Installations!

**AUDIO—HIGH FIDELITY**

justed so that the scope trace indicates critical damping. This value of resistance is then equal to the necessary amplifier resistance to critically damp the cone. Thus the CDF is determined. The capacitor and 100,000-ohm resistor act as a filter to stabilize the scope trace when the switch is repeatedly opened and closed. If they weren't included, the trace would bob up and down on the screen, making observation almost impossible.

This effect is due to the slow charge and discharge of the input capacitor of the oscilloscope. The 1N34 diode shorts out the positive voltage surge when the switch is closed so that only the motion of the cone on opening the switch is analyzed on the scope.

In performing the test, start with the variable resistance high so the speaker is underdamped. Decrease resistance slowly until critical damping is obtained. In so doing, the point where the second and succeeding cycles just barely disappear is more easily seen. Approaching critical damping from the overdamped state is more difficult to observe. The switch should be continuously operated several times a second and the horizontal sweep adjusted to a low sweep rate.

The curves in Fig. 5-a show the traces obtained for a speaker in an infinite baffle for the underdamped and critically damped states. Notice the absence of any second cycle when critically damped. In Fig. 5-b, the speaker was mounted in a very large bass-reflex box. Notice how the enclosure resonance remains even after the speaker is critically damped. In small bass-reflex enclosures, the resonant frequency of the port is close to the cone resonance and does not show distinctly on the curve. In this case, the patterns appear as in Fig. 5-a. The point of critical damping is reached when the second full cycle is just barely eliminated in all cases. The wave form for a slightly overdamped condition looks the same as that for the critical damping, the only difference being an amplitude decrease in the overdamped wave.

**Conclusion**

The CDF of any speaker can now be obtained and the amplifier matched to give optimum performance. Errors of  $\pm 50\%$  in CDF do not appreciably change the performance of the speaker, so it is unnecessary to determine the needed amplifier resistance down to the last ohm. In fact, the point at which critical damping occurs will be rather broad when the above procedure is followed.

However, great mismatch can result in a very appreciable loss of bass power—as much as eight or nine times. It is therefore worth the time and effort to determine the CDF and match the speaker-amplifier combination. You will have the satisfaction of knowing that the components are performing at their best and in this way providing more listening pleasure. END

**NEW!** **Electro**  
ELECTRONIC EQUIPMENT  
completely assembled  
**6 and 12 VOLT  
DC POWER SUPPLY**



Model  
D-612  
**ONLY  
\$3995**

at a comparable KIT PRICE

0 to 8, 0 to 16v. completely variable; 0 to 10 amps. at 12v. continuous. Operates all auto radios. For relays, low voltage devices, battery charging, etc. Less than 5% ripple over rated ranges. Withstands high voltages.

**MODEL "B" FILTERED DC  
POWER SUPPLY**

For testing, servicing, operating low power 2-way mobile auto radios. 1 Model "B" delivers 6v. at 20 amps. 2 Model "B's" in parallel deliver 6v. at 40 amps. \$49.80

**MODEL "S" Converts Battery Radios  
to AC All-Electric**

Assures hum-free reception from any 1 1/2v., 4 to 6-tube battery radio using 115-volt, 50-60 cycle source. Fits battery space. Guaranteed three years. \$11.10 See Your Parts Distributor or Write for Bulletin

**ELECTRO PRODUCTS LABORATORIES**  
4501-Ra N. Ravenswood Ave., Chicago 40, Ill.  
Canada: Atlas Radio Corp., Ltd., Toronto

**AUDEL'S TV-RADIO  
SERVICE LIBRARY**

HERE IS LATE INFORMATION IN A  
HANDY FORM FOR RADIO AND TELEVISION  
REPAIRMEN, SERVICEMEN AND STUDENTS

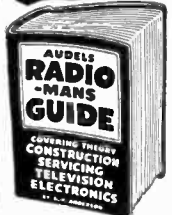

2 VOLS. 6 COMPLETE \$1 A  
PAY ONLY 1 MO.

**AUDEL'S T.V.-RADIO  
SERVICE LIBRARY**—  
Highly Endorsed—1001  
Facts—Over 1552 Pages—  
625 Illustrations, Diagrams  
of Parts. Presents Important  
Subjects of Modern  
Radio, Television, Industrial  
Electronics, F.M., Public  
Address Systems, Auto,  
Marine & Aircraft Radio,  
Phonograph Pick-Ups, etc.

**IT PAYS TO KNOW!**

The Basic Principles—  
Construction—Installation—  
Operation—Repairs—  
Trouble Shooting. Shows  
How to get Sharp, Clear  
T.V. Pictures, Install Aerials—  
How to Test. Explains  
Color Systems, Methods of  
Conversion, Terms, etc. In-  
cludes Ultra High Fre-  
quency (U.H.F.)—Valu-  
able for Quick Ready Ref-  
erence & Home Study. Tells How to Solve T.V.  
& Radio Troubles—Answers Your Questions.

Get this Information for Yourself!  
**7 DAY TEST—ASK TO SEE IT!**

**MAIL ORDER**

**AUDEL Publishers, 49 W. 23 St., N.Y. 10, N.Y.**  
Mail AUDEL'S T.V. RADIO SERVICE LIBRARY 2 Vols. \$6 on 7  
days free trial. If O. K. I will remit \$1 in 7 days and \$1 monthly  
until \$6 is paid. Otherwise I will return them.

Name \_\_\_\_\_  
Address \_\_\_\_\_  
Occupation \_\_\_\_\_  
Employed by \_\_\_\_\_ RE

# CREI prepares you quickly for success in

*The future is in your hands!*

The signs are plain as to the future of the trained men in the electronics industry. It is a tremendous industry, and—at the *present time* there are more jobs than there are trained men to fill them. But—when there's a choice between a trained and untrained applicant, the trained man will get the job. Your biggest problem is to decide on—and begin the best possible training program.

## CREI Home Study . . . The Quick Way to Get There.



Since 1927, CREI has given thousands of ambitious young men the technical knowledge that leads to more money and security. The time-tested CREI procedure can help *you*, too—if you really want to be helped. CREI lessons are prepared by experts in easy-to-understand form. There is a course of instruction geared to the field in which you want to specialize. You study at *your* convenience, at *your* rate of speed. Your CREI instructors guide you carefully through the material, and grade your written work personally (not by machine).

## Industry Recognizes CREI Training.

CREI courses are prepared, and taught with an eye to the needs and demands of industry, so your CREI diploma can open many doors for you. Countless CREI graduates now enjoy important, good-paying positions with America's most important companies. Many famous organizations have arranged CREI group training for their radio-electronics-television personnel. To name a few: All America Cables and Radio, Inc.; Canadian Aviation Electronics, Ltd.; Canadian Broadcasting Corporation; Columbia Broadcasting System; Canadian Marconi Company; Hoffman Radio Corporation; Machlett Laboratories; Glenn L. Martin Company; Magnavox Company; Pan American Airways, Atlantic Division; Radio Corporation of America, RCA Victor Division; Technical Appliance Corporation; Trans-Canada Air Lines; United Air Lines. Their choice for training of their own personnel is a good cue for *your* choice of a school.



*Benefits Felt  
Right Away.*

Almost immediately, you feel the benefits of CREI training. Your employer, when informed of your step toward advancement (only at your request), is certain to take new interest in you and in your future. What you learn in CREI Home Study can start helping you do a better job immediately.



## CAPITOL RADIO ENGINEERING INSTITUTE

Accredited Technical Curricula • Founded in 1927  
3224 16th Street, N.W. Washington 10, D. C.

### MAIL THIS POSTAGE-FREE POSTCARD TODAY

#### CAPITOL RADIO ENGINEERING INSTITUTE

Dept. 111-B, 3224 16th St., N.W., Washington 10, D. C.

Please send me your course outline and FREE Illustrated Booklet "Your Future in the New World of Electronics" . . . describing opportunities and CREI home study courses in Practical Electronics Engineering.

CHECK  
FIELD OF  
GREATEST  
INTEREST

- Practical Radio Engineering
- Broadcast Radio Engineering (AM, FM, TV)
- Practical Television Engineering
- Aeronautical Electronics Engineering
- TV, FM & Advanced AM Servicing

Name.....

Street.....

City..... Zone..... State.....

CHECK:  Residence School  Veteran.

- BROADCASTING
- TELEVISION
- MANUFACTURING
- COMMUNICATIONS
- SERVICING
- AERONAUTICAL ELECTRONICS

## CREI also offers Resident Instruction

at the same high technical level—day or night, in Washington, D. C. New classes start once a month. If this instruction meets your requirements, check the coupon for Residence School catalog.

### INFORMATION FOR VETERANS

If you were discharged after June 27, 1950—let the new G. I. Bill of Rights help you obtain resident instruction. Check the coupon for full information.

## Get this fact-packed booklet today. It's free.

Called "Your Future in the New World of Electronics," this free illustrated booklet gives you the latest picture of the growth and future of the gigantic electronics world. It includes a complete outline of the courses CREI offers (except Television and FM Servicing) together with all the facts you need to judge and compare. Take 2 minutes to send for this booklet right now. We'll promptly send your copy. The rest—your future—is up to you.

See Our Ad On The Next Page

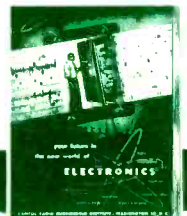

To help us answer your request intelligently, please give the following information:

EMPLOYED BY.....

TYPE OF PRESENT WORK.....

SCHOOL BACKGROUND.....

ELECTRONICS EXPERIENCE.....

IN WHAT BRANCH OF ELECTRONICS MOST INTERESTED?

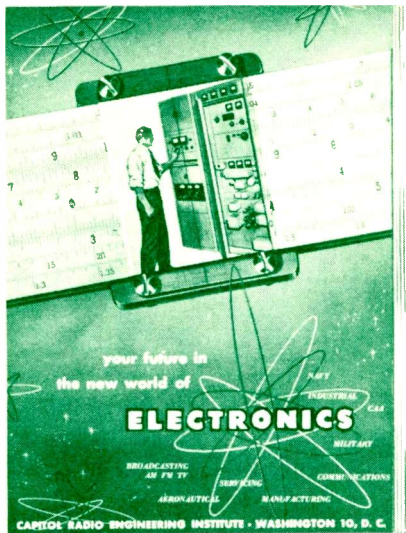

*The data that Launched  
Thousands of Careers  
is yours FREE to show*

## HOW YOU CAN BE SUCCESSFUL IN RADIO-TV-ELECTRONICS

*Send for Your Booklet Today!*

YOU CAN PLOD ALONG for years, getting a paltry increase now and then, enjoying little security, finding your work dull and drab.

Then something happens. Things look up. You become more confident. Your earnings rise. You feel more important.

"Luck," some may say.

"Contacts," others may suggest.

But in your heart, you will know the answer: "Training." And it all may have started the moment you filled out a coupon requesting a copy of a free booklet named "Your Future in the New World of Electronics." From this data you get knowledge of where you stand in Electronics. Tremendous expansion leaves this gigantic industry pleading for trained men. Top manufacturers sold billions of dollars worth of electronic merchandise in 1953. By 1960, the radio-electronics industry should do no less than 10 billion dollars per year, not counting military orders.

Today there are over 97,000 radio-equipped police cars; an even larger number of taxis are radio equipped (at least 87,000); 32,000 civilian planes have radio; 35,000

American ships have radio.

Today there are over 120,000,000 radios in use. There are 28,000,000 TV sets and 381 TV stations in operation. Color TV is coming into its own. Countless positions must be filled—in development, research, design, production, testing and inspection, manufacture, broadcasting, telecasting and servicing. To fill these posts, trained men are needed—men who somewhere along the line take time to improve their knowledge, their skills. Men who, today, perhaps, take two minutes to send for a booklet.

"Your Future in the New World of Electronics" shows you how CREI Home Study leads the way to greater earnings through the inviting opportunities described above.

However, CREI does not promise you a "snap." With an accredited technical school such as this, you must *study* to convert your ambition into technical knowledge you can sell in the fabulous Electronics market.

Since its founding in 1927, CREI has provided thousands of professional radio men with technical educations. During World War

II CREI trained thousands for the Armed Services. Leading firms choose CREI courses for group training in electronics, at company expense, among them United Air Lines, Canadian Broadcasting Corporation, Trans-Canada Airlines, Sears, Roebuck and Co., Bendix Products Division, All-American Cables and Radio, Inc., and RCA Victor Division.

CREI courses are prepared by recognized experts, in a practical, easily understood manner. You get the benefit of time-tested materials, under the personal supervision of a CREI Staff Instructor, who *knows* and *teaches* you what industry wants. This is accomplished on your own time, during hours selected by you, and controlled by your own will power. This complete training is the reason that graduates find their CREI diplomas keys-to-success in Radio, TV and Electronics. CREI alumni hold top positions in America's leading firms. At your service is the CREI Placement Bureau, which finds positions for advanced students and graduates. Although CREI does not guarantee jobs, requests for personnel far exceed current supply.

Now is the time of decision for you. Luck will not propel you forward unless it finds you trained. Contacts won't budge you an inch unless you have the skill to back them up. The answer is: Technical Training . . . and willingness to learn. Together they will bring you increased earnings in this new Age the Electronics. Fill out the postage-free reply card and mail it now. We'll promptly send you your free copy of "Your Future in the New World of Electronics." The rest—your future—is up to you.

1st Class

Permit No. 288-R

Sec. 34.9 P.L.R.

Washington, D. C.

### BUSINESS REPLY CARD

No Postage Stamp Necessary If Mailed In United States

3¢ Postage Will Be Paid By

**CAPITOL RADIO ENGINEERING INSTITUTE**

**3224 16th Street, N.W.**

**Washington 10, D. C.**

MAIL THIS  
**POSTAGE-FREE**  
POSTCARD TODAY

## SERVICING

## HIGH-FIDELITY

## EQUIPMENT

## Part XI—AM and FM tuner distortion; de-emphasis and pre-emphasis; noise

By JOSEPH MARSHALL

THE servicing of high-fidelity tuners differs very little from the servicing of ordinary radio and TV receivers. Two factors, however, demand special consideration and care—noise and distortion.

Distortion in both AM and FM tuners must be kept to a minimum. The better the high-fidelity amplifiers and speakers following the tuners, the more audible and annoying the distortion. Indeed, in the best systems, the total distortion at the output is likely to consist very largely of the distortion present in the output of the tuner.

Almost all radio programs are heavily limited. And while limiting amplifiers are much better today than formerly, heavy limiting is usually obtained at the price of some distortion. Moreover, though the signal radiated by most stations may meet FCC standards as to distortion *as transmitted*, it will considerably exceed FCC standards as received because the high average modulation level drives the detectors into the high-distortion region of their operating curves. This will produce at least 1% harmonic distortion (or about 4% IM) on even the best programs from the best stations on the best tuners. Clearly then, it is highly essential to minimize the distortion produced by the tuner as completely as possible.

In AM tuners distortion is largely caused by the detector. Most tuners use diode detectors. To hold down the distortion the diode load is kept very high either by using grid-leak biasing (Fig.

1) in the following audio stage or by using a cathode follower after the diode (Fig. 2). In the first case, the diode load looks into a grid resistor of 3 to 10 megohms; in the second case, the grid resistor may be 1 megohm or less but the effective input resistance is multiplied up to 10 times by the current feedback of the follower. In either case, the diode should be capable of handling high modulation percentages with acceptably low distortion.

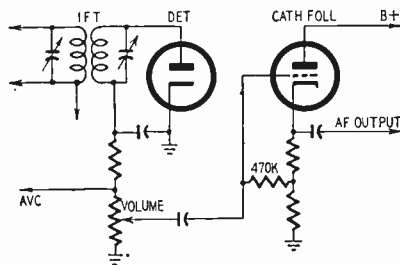

Fig. 2—Detector feeds cathode follower.

If the distortion is high, check the diode detector and its associated amplifier. There is a simple check for diode loading. Feed an audio signal into the end of the diode load which goes to the following stage. Measure the output of the following audio amplifier as you sweep the signal from 200 to 20 cycles. If the input resistance of the audio stage is as high as it should be to maintain a high diode load (and keep distortion low), the response at very low frequencies should be very flat—even if the coupling capacitor is small. You should get not more than a 3-db drop at 20 cycles with any coupling capacitor larger than .001  $\mu$ f if the following stage uses either a 10-megohm grid resistor or is a cathode follower. In fact, in a hi-fi tuner the response should be within 1 db. If the drop is greater than this, it is a pretty safe assumption that the diode will be too heavily loaded to keep distortion down to a safe minimum.

This may be the fault of the design; if so, there is nothing you can do about it short of redesigning the audio end

of the tuner. But if the audio stage is either grid-leak biased or uses a cathode follower, it is more likely to be a tube or component fault. The low-frequency response could be improved by increasing the size of the coupling capacitor but this will not help the loading; indeed it will load the diode more heavily at very low frequencies.

A few AM tuners use the infinite-impedance or cathode-follower detector (Fig. 3). This detector is capable of handling high percentages of modulation with low distortion. For lowest distortion the cathode load is sometimes critical. If such a receiver develops high distortion, check the values of the cathode resistor (or resistors) and the r.f. bypass capacitor for leakage or shorts.

## Distortion in FM tuners

Excessive distortion in FM tuners is principally the result of misalignment of the i.f. amplifier and detector. For lowest distortion the i.f. bandwidth should be not less than 150 kc at the -6-db point and preferably from 180 to 240 kc. The curve should also be as symmetrical as possible. The discriminator curve should be very straight and the straight portion should be at least 200 and preferably 240 kc long. Therefore, when lowest distortion is called for, careful alignment with a scope, sweep generator and accurate markers is absolutely essential.

Regeneration can produce serious distortion in FM tuners. It always shows itself as a badly shaped trace on the

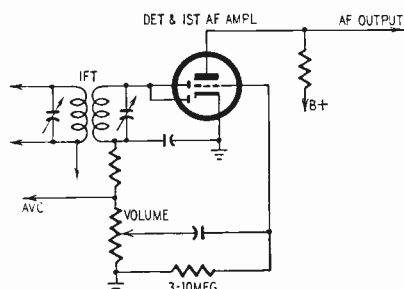

Fig. 1—Diode detector feeding an audio amplifier using grid-leak biasing.

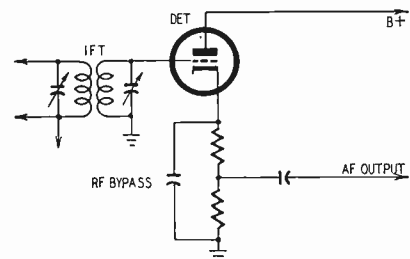

Fig. 3—Infinite-impedance detector.

## AUDIO—HIGH FIDELITY

scope in visual alignment. If extreme peaking of coils misshapes the curve, look for regeneration. Cure it if you can; if you cannot, back off the trimmer on the offending stage to produce the most symmetrical and smoothest curve possible.

A most annoying type of distortion can occur in FM tuners on remote or weak signals when the signal arrives by multiple paths, producing phase distortion which is reduced not much, if any, by the limiters. This type of distortion must be treated the same way as multiple-path ghosts in TV—by using a directional antenna and orienting it to eliminate all but one receiving path.

Excessive limiting at the broadcast station can produce similar phase distortion which also is reduced not much, if any, by the limiters. The audible effects of these two types of phase distortion fall into the 10,000- to 15,000-cycle range principally and can be very annoying. Nothing, of course, can be done if the distortion is in the signal itself. However, antenna orientation will tell you whether it is due to multiple-path reception or to limiting.

Another problem sometimes arises when extremely sensitive tuners are used on strong local stations—distortion may be produced by overdriving one or more stages, especially the converter. Theoretically, an overdriven i.f. or r.f. stage should become a sort of limiter and the distortion produced should be minimized by the limiting action. However, some of the distortion is phase or FM distortion and is not affected by the limiting action. This type of distortion can be diagnosed by reducing the input either with an attenuator pad or by using a very poor antenna—a 4- or 5-foot length of wire perhaps.

Another possible cause of increased distortion may be found in the de-emphasis network following the detector. Under present standards FM broadcasting calls for a treble boost of 13.7 db at 10,000 cycles achieved by a 75-microsecond network. The receiver should have a complementary de-emphasis network of 75 microseconds or a slope of 13.7 db at 10,000 cycles.

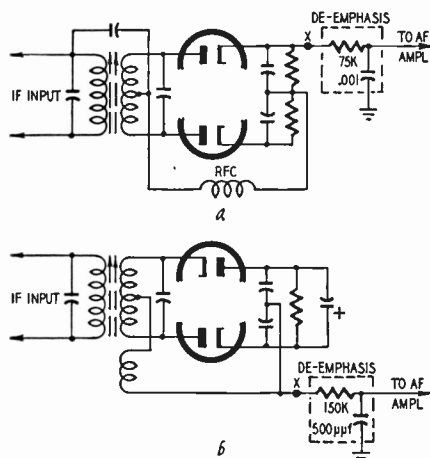

Fig. 4—De-emphasis networks in the: *a*, Foster-Seeley; *b*, ratio detector circuits.

The pre-emphasis in the station has a tendency to accentuate distortion as well as treble tone. If the receiver does not provide complete or accurate de-emphasis, the result is higher audible distortion, as well as a shrill treble. Unfortunately, some tuners do not provide complete de-emphasis and others actually produce a treble boost of up to 10 db at 10,000 cycles, with a corresponding increase in audible distortion. Sometimes, too, a failure of components may shift the de-emphasis slope.

Fig. 4 shows typical de-emphasis networks for the Foster-Seeley circuit *a* and the ratio detector *b*. The network consists of a series resistor and a shunt capacitor. Individual values are not important and may vary. The important thing is that the time constant should be 75 microseconds. There is some range of tolerance and in practice a product of between 60 and 85 microseconds may be acceptable; the lower value produces a boost of about 2 db at 10,000 cycles, and the latter a slope of about the same value.

You can also check the slope with an audio generator and meter. Apply the generator output to point X and measure the tuner output. Check the difference in reading between 1,000 and 10,000 cycles. It should be between 13 and 14 db down at 10,000 cycles.

If the distortion seems high on all stations and the treble is also shrill, check the de-emphasis in the same manner. The resistor may be off-value or the capacitor open or leaky. If the time constant is not close to 75 microseconds, the simplest correction can be obtained by replacing the resistor with one whose resistance yields the required time constant (or produces the 14-db slope at 10 kc) with the capacitor already in the circuit. The series resistance produces a loss of gain and should not be too high; values up to 150,000 ohms will usually be all right if the following grid resistor is 500,000 ohms or larger.

The technician should be careful not to blame signal distortion on the receiver. Record programs are especially likely to contain considerable distortion because of improper or careless equalization of the pickup, a worn needle or records which have been played too long and improperly stored. Before you tear up a tuner be sure the distortion is not in the signal. Tuner distortion will be fairly constant from station to station and with live or recorded material; signal distortion will vary from station to station and record to record.

### Receiver noise

Aside from hum, a familiar problem to the service technician, the noises in hi-fi tuners take the form of inter-channel interference on AM and incomplete noise suppression on FM.

High-fidelity reception of AM stations faces a difficult obstacle. For good treble response the bandwidth should be wide. Unfortunately, a wide bandwidth increases the interference from adjacent-channel stations. The problem is more

serious in high fidelity because if the following amplifier and speakers have a flat response to 15 or 20 kc the interference is considerably more audible than in the ordinary radio.

Designers try to minimize the problem by using a wide bandwidth in the i.f. section but following it with some sort of low-pass or band-rejection filter in the audio section to cut off the interfering noise. Another solution lies in making the bandwidth just narrow enough to attenuate the interference to a level low enough to minimize annoyance.

When faced with this problem, see if the tuner uses a "whistle" filter. Such filters, whether of the low-pass or band-rejection type, can usually be easily recognized on a diagram or in circuit tracing: They require one or more inductances in the audio channel and often a complicated network of resistors and capacitors. They usually follow the detector and precede the first audio amplifier. The simplest way to test the operation of such a filter is to feed an audio signal ahead of the network and measure the output of the stage following the network or the tuner output. Sweep the signal from 5,000 to 15,000 cycles. You should get very severe attenuation (20 db or more) in the region between 7,500 and 11,000 cycles. If you do not, check the components of the network for opens, shorts and serious off-values.

Careful alignment of the r.f. and i.f. channels is very important in hi-fi AM tuners, whether or not they use a whistle filter. Visual alignment is highly recommended. If the tuner uses a whistle filter, align the tuner for the flattest top on the response curve up to 10 kc on each side of center frequency. This will provide the flattest audio response.

If the tuner has no whistle filter, careful alignment is even more important. Again visual alignment is very helpful, but in this case it pays to listen as well as look. Make the top of the response curve as flat as you can. But the sides should be as steep as possible and the attenuation at 10 kc each side of center should be at least 20 db. A combination of listening (for lowest interference when tuned to a station) and scope observation (for flattest top when using a sweep oscillator) should produce the best possible compromise.

If your regular (not sweep) r.f. oscillator or generator permits the injection of an external a.f., an effective hi-fi alignment procedure is as follows: 1. Put the Clarkstan sweep-frequency record on a turntable. 2. Equalize it with the preamp to produce the flattest and straightest trace as observed on a scope. 3. Inject the equalized a.f. sweep into the signal generator and adjust gain for modulation of around 30%. 4. Inject modulated r.f. into the tuner. 5. Observe the trace at the output of tuner. 6. Align tuner to produce, first, as complete attenuation as possible at 10 kc; second, the flattest trace from 50 to 7,500 cycles.



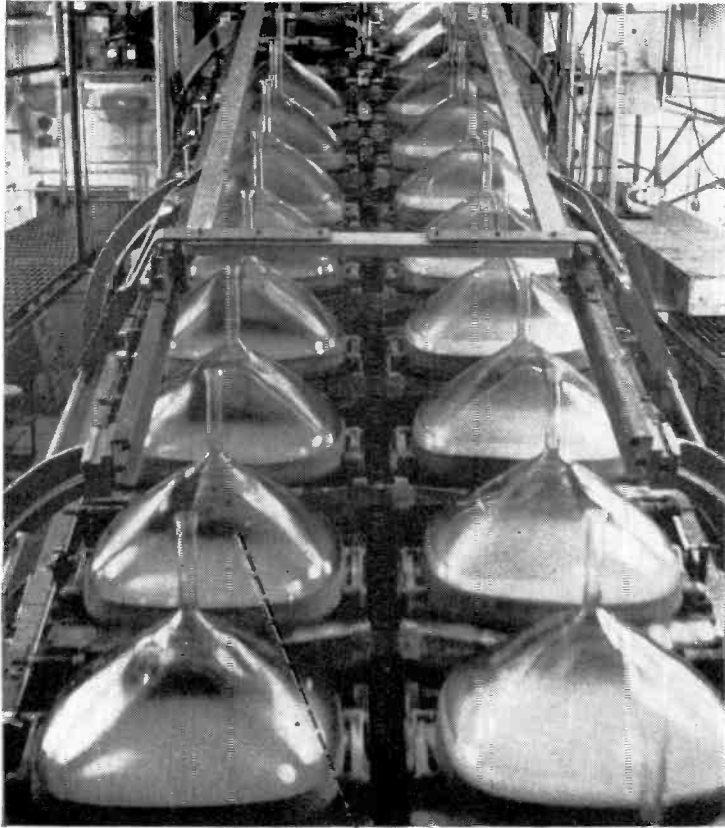

## **From ZERO to CAPACITY PRODUCTION IN THREE MONTHS!**

The same "advanced-engineering" that produced the CBS-Colortron and the Mirror-Back picture tube also engineered and built this modern CBS-Hytron plant at Kalamazoo, Michigan. The same drive typical of CBS-Hytron activity brought this complex industrial operation up to capacity production just three short months after first shipments began. For the ability to keep pace with your demands . . . for premium quality in TV picture tubes, look to the fastest-growing, most modern and forward-thinking company in the industry — CBS-Hytron.



**CBS-HYTRON**

Main Office: Danvers, Massachusetts

*A Division of Columbia Broadcasting System, Inc.*

**A member of the CBS family: CBS Radio • CBS Television • Columbia Records • CBS Laboratories • CBS-Columbia • CBS International • and CBS-Hytron**



**beyond  
a shadow  
of a doubt**  
the most versatile 78 rpm  
crystal phono cartridge  
of them all!



**THIS DUAL-WEIGHT, DUAL-VOLT PICKUP CARTRIDGE  
REPLACES 149 DIFFERENT MODELS OF 78-RPM CARTRIDGES!**

The W78 Dual-Weight, Dual-Volt Phono Cartridge replaces 149 different steel and aluminum case cartridges currently found in 78 rpm equipment!

This versatility shows beyond a shadow of a doubt that the W78 is the most useful crystal phono cartridge ever designed for 78 rpm cartridge replacement business!

Actual sales to servicemen prove that the versatile W78 cartridge is a replacement sensation—prove indeed that the W78 fills a great need—for here in one cartridge model is the answer to servicemen's inventory problems for 78 rpm cartridges!

MODEL NO.	TYPE	LIST PRICE	OUTPUT LEVEL	MIN. NEEDLE FORCE	RESPONSE TO	NET WT.	SHURE NEEDLE NO.
W78	Crystal	5.55	4.0V or 2.0V	1 oz.	6,000 c.p.s.	Dual Weight 25 grams or 12 grams	None

*Dual-Weight Cartridge. Has weight slug secured by shrink-on band. With lead weight, net weight of cartridge is 25 grams. If 12 gram weight is desired, the shrink-on band can be cut off and the lead weight removed. In addition Model W78 has capacitor, furnished as accessory. Without capacitor output is 4.0 volts; with capacitor output is 2.0 volts.*

See your Shure Distributor or write the factory for Replacement Chart which lists the 149 crystal phono cartridges replaced by Model W78

**SHURE** *The Mark of Quality*

SHURE BROTHERS, INC. • 225 WEST HURON STREET • CHICAGO 10, ILLINOIS

## AUDIO—HIGH FIDELITY

Interchannel interference noise is often made worse by better-than-needed sensitivity. Try reducing antenna pick-up by shortening the antenna or using merely the built-in antenna.

### FM Noise

Noise in FM tuners is principally the result of incomplete limiting. It is well, however, to check the possibility that the noise is due to the audio end. This is especially so in tuners which also contain control units and preamps; the audio gain may be very high and any tube or resistor noise may be annoying. The check is very simple. If the tuner has an input selector switch, turn it from FM to another channel, preferably a high-level channel. If the noise is still there, the fault is in the audio end. Or you can remove the FM detector tube. If the noise continues, it is in the audio end; if it is greatly or entirely reduced, it is in the tuner portion.

Incomplete quieting is almost always the result of insufficient sensitivity, although there is a possibility of trouble in the limiter stage or stages or the detector. If noise suppression is not complete even on the strongest stations, it is well to check the limiter and detector stages for faulty tubes or components. If replacements are necessary, be sure to use exactly the values specified. Limiters are designed with time constants which are very important; the constants can be maintained only by the original design values.

Assuming that incomplete quieting has developed with time and is not the fault of design, the trouble can always be corrected by replacing tubes and realigning.

In fringe areas, however, incomplete quieting may be the result of a combination of weak signals and poor receiver sensitivity. If restoring the tuner to peak sensitivity by changing tubes and realignment does not produce complete quieting, things still may not be entirely hopeless. Provide the tuner with a greater input signal. This can be achieved by using an antenna of higher gain and matching it and its lead-in to the receiver to produce maximum signal transfer. The techniques are the same as those used in improving TV reception. If the noise occurs on only one favored station, it may be eliminated by re-orienting the antenna.

A booster may solve the problem also. It is hard to tell without actually trying a booster whether the improvement will be sufficient. But there is a useful rule of thumb: If the desired station signal is fairly uniform and constant but quieting not complete, the chances are 10 to 1 that the booster will do the job. However, if the station can be received only occasionally and is deep in the noise most of the time, the chances for improvement are poorer. If the receiver has a sensitivity of 5 microvolts or better, the chances of improvement are very small; but if the receiver sensitivity is less than 5 microvolts, the chances are good. TO BE CONTINUED

# FOR GOLDEN EARS ONLY

*The Ampex 600 tape recorder;  
Karlson enclosure; Dubbing  
D-500 level indicator and test  
records; good recordings*

**By MONITOR**

WAS not surprised to ascertain from my tests that the new Ampex 600 tape recorder not only meets the specifications claimed for it (see the table), but thoroughly lives up to the enviably high standards set by its older and bigger brothers in performance, quality and workmanship. I was surprised, however, to find that despite its smallness and simplicity, the 600 is

extremely versatile, easy to use and, above all, just about as foolproof as a tape recorder could be.

The 600 is a single-speed job (7½ inches per second) and comes with single-track heads. The claimed response is attainable at a level 20 db below 0 VU. At higher levels the response slopes more severely in the treble because of tape saturation. This is true of all low-speed recorders because of the great amount of treble boost necessary to compensate for the low speed and tape characteristics. Fig. 1 shows the response curves I obtained at several levels with good, but not top quality, tape. At the -20-db level the high-frequency response is within 1 db to 12 kc and down only 4 db at 15 kc—also only 12 db down at 17.5 kc. There is a 3-db bass boost between 50 and 1,000 cycles, and a mere 2-db slope below 50 cycles all the way to 20 cycles.

At the -10-db level (which would represent average musical peaks) the high-frequency response is down only 2 db at 10 kc, 6 db at 12 kc and 20 db at 15 kc while the bass is within ±2 db all the way down to 20 cycles. At the 0-db level, which represents maximum peaks, the bass is flat to 50 cycles and slopes to -4 db at 20 cycles; the treble

slopes severely, being down 9 db at 10 kc and 20 db at 12 kc. In actual practice, the effective curve would be that of curves *b* or *c* for the bass and of *a* for the treble. This is because the

**TABLE I. AMPEX 600 SPECIFICATIONS**

- TAPE SPEED:** 7½ inches per second.
- FREQUENCY RESPONSE:** 40 to 15,000 cycles per second; ± 2 db 50 to 10,000 c.p.s.; down no more than 4 db at 15,000 c.p.s.
- SIGNAL-TO-NOISE RATIO:** Over 55 db below peak recording level at 3% total harmonic distortion.
- FLUTTER AND WOW:** Under 0.25%.
- PLAYING TIME:** 32 minutes with 7-inch, 1,200-foot reel.
- REWIND TIME:** 90 seconds for full 1,200-foot reel.
- PLAYBACK TIMING ACCURACY:** ± 3.6 seconds in a 30-minute recording.
- RECORD INPUTS:** Microphone: any high-impedance microphone. (Low-Impedance Conversion Kit, Catalog No. 9359 available at extra cost.) Line: 0.5 volt required for program level.
- PLAYBACK OUTPUT POWER:** 1.25 volts into 10,000-ohm load at program level.
- REQUIREMENTS:** 117 volts, 60 cycles; 0.52 ampere, 61 watts.
- DIMENSIONS (INCHES):** Transport top area: 9 5/16 x 12½; electronic top area: 6½ x 12¼; depth below top plate: 5; height above top plate: 1½.
- WEIGHT:** Less than 28 pounds, in portable carrying case.

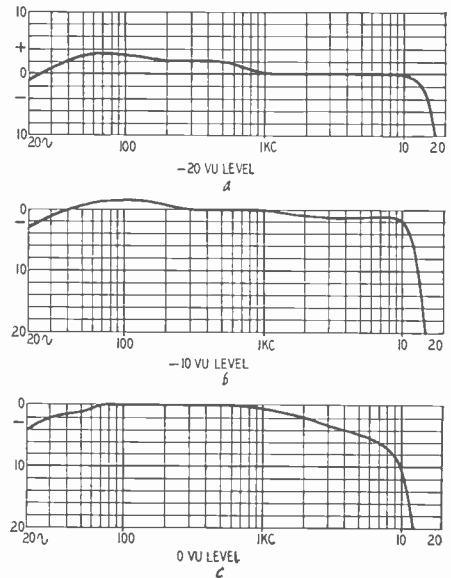
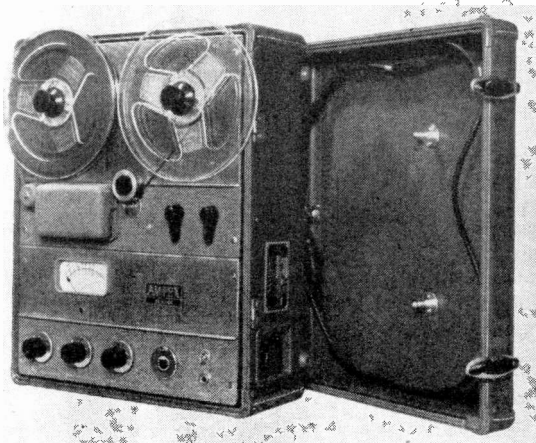
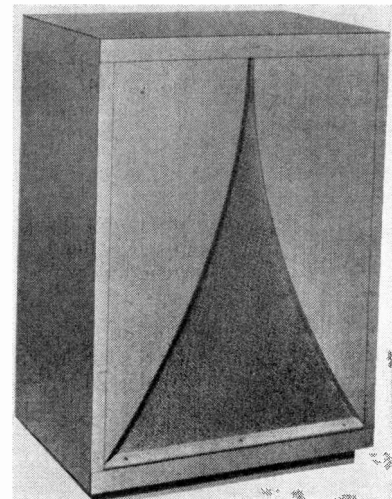

Fig. 1—Response curves of Ampex 600.



The new Ampex model 600 tape recorder.



The Karlson 15 B speaker enclosure.

# Let's Talk Ceramic Capacitors...

and the most  
complete standard  
stock line...

## ERIE

TEMPERATURE COMPENSATING  
TUBULAR CERAMICONS

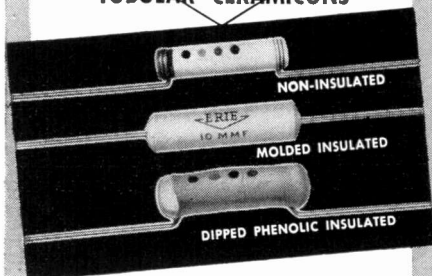

- Three Temperature Coefficients: NPO, N330, N750: Close tolerance on all temperature coefficients.
- Non-insulated, Molded insulated, Dipped Phenolic Insulated.
- Wide range of capacity values, close tolerance on all capacity values.
- Provide commercial equivalents of many often used JAN types.

One purpose of the three temperature coefficients is to provide the means of combining in parallel, various combinations of NPO and N330; and NPO and N750 to obtain intermediate temperature coefficients. Formulae for computing these values as well as a simple nomograph for quick computations will be afforded in service information.

The range of capacity values is the most complete offered as standard stock by any ceramic capacitor manufacturer. Servicemen and engineers... your distributor has these capacitors to meet your requirements for TV replacements, laboratory work, and prototype development.

Write for complete list of capacity values available JAN equivalent table, and nomograph.

ERIE components are stocked at leading electronic distributors everywhere.

**ELECTRONICS DISTRIBUTOR DIVISION  
ERIE RESISTOR CORPORATION**

Main Offices: ERIE, PA.

Factories: ERIE, PA. • LONDON, ENGLAND  
TRENTON, ONTARIO

## AUDIO—HIGH FIDELITY

amplitude of frequencies above 5,000 cycles is a good 20 db down from that of the region between 70 and 1,000 cycles in which the peak powers of music occur. Incidentally, the response is just as flat and free of peaks or dips as the curves; continuous sweeps revealed no departure from the smoothness of the spot frequency curves. The specified noise level applies to the line-input channel and my measurements confirmed it.

The listening quality of the recordings is superb. There was a scarcely perceptible difference between the sound of the tapes dubbed from such demanding records as the Spectratone *Musical Gadgetry* and Cook *Fiesta Flamenca* and the original records themselves when a Ferranti pickup was used. This difference could be eliminated by some judicious treble boosting of the playback amplifier. There was no difference when the G-E pickup was used.

Two input channels are provided, one for high-impedance mike and one for a line. The two channels can be mixed with individual volume controls, without switching. Either the input to the recording head or the output of the recorded tape itself can be monitored both with headsets (or amplifier) or with a meter. A monitor switch permits instant comparison of the input with the tape output while recording. It is even possible to produce an "echo chamber" effect when using the mike à la Les Paul by the simple expedient of feeding back a portion of the recorded output to the line input. The only equipment needed is a short length of cable with a phone plug at one end and a phono plug at the other.

The 600 can very conveniently be tied into any hi-fi system so that off-the-air or off-the-record recordings can be made at a moment's notice. The assembly could be removed from the case and mounted in a cabinet, or vice versa, in not much over 10 minutes so the recorder could be used for both studio and portable use.

The extremely simple mechanical section is of superb quality. A single synchronous motor is used very effectively. Editing is very rapid and simple, although for such fine touches as eliminating a final "s" from a word, the fact that the tape rides rather deep in the head assembly makes it rather difficult to mark precisely. Routine maintenance is reduced to a minimum; periodic cleaning of heads and idler and lubrication every 500 hours covers it. The service manual (available for \$1.75 extra) is very complete and specific.

The electronic portion, the diagram of which is printed in the Operator's Guide supplied with the equipment, is quite elaborate despite the small size. Here there are precise adjustments for all necessary factors—recording and playback equalization, recording, playback and monitoring level, biasing, noise balancing, etc. All these adjustments are through controls on the chassis—well out of sight and removed

## REPEAT SALE BY POPULAR DEMAND

WORLD-FAMOUS HI-FI 3-SPEED  
AUTOMATIC PHONO  
3 SPEAKERS

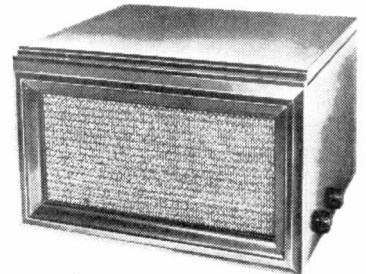

Deluxe 3-speed automatic record player with speaker cross over network for true high-fidelity. 4 tube amplifier scientifically designed to reproduce from 20 to 20,000 cycles. Automatic shut-off for amplifier when last record has played. Beautiful mahogany cabinet with luxurious woven grill. Dimensions: 17 7/8" x 15 7/8" x 11". Weight 30 lbs.

Nationally  
Advertised  
for \$139.95

CLOSE OUT  
PRICE!

**\$72<sup>50</sup>**

Write Dept. RE-1 for FREE catalog.

**STEVE-EL Electronics Corp.**  
61 Reade St. New York 7, N. Y.

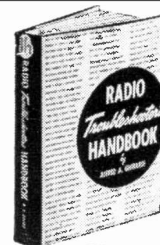

## DON'T THROW OLD RADIOS AWAY!

Here's the data you need  
to fix them FAST and r-i-g-h-t!

Just look up the how-to-do-it data on that old radio you want to fix!

Four times out of 5, this giant, 3 1/2-pound, 714-page Ghirardi RADIO TROUBLESHOOTER'S HANDBOOK gives exactly the information you need to fix it in a jiffy. Tells what is likely to be causing the trouble... shows how to fix it. No useless testing. No wasted time. Handbook covers practically every radio receiver model made by 202 manufacturers between 1925 and 1942. Using it, even beginners can easily fix old sets which might otherwise be thrown away because service information is lacking. With a few simple repairs, most of these old sets can be made to operate perfectly for years to come.

**THE ONLY GUIDE OF ITS KIND!**

**Cuts service time in half!**

Included are common trouble symptoms and their remedies for over 4,800 models of home and auto radios and record changers, Airline, Apex, Arvin, Atwater Kent, Belmont, Bosch, Brunswick, Clarion, Crosley, Emerson, Peda, G-E, Kolster, Majestic, Motorola, Philco, Pilot, RCA, Silverstone, Sparton, Stromberg and dozens more. Gives how-to-do-it data on SPECIFIC jobs—NOT general theory. Includes hundreds of pages of invaluable tube and component data, service short cuts, etc.

**TRY IT 10 DAYS... at our risk!**

Dept. RE-15, RINEHART & CO., Inc.  
232 Madison Ave., New York 16, N. Y.  
Send Ghirardi's RADIO TROUBLESHOOTER'S HANDBOOK for 10-day free examination. If I decide to keep book, I will then remit the full price of only \$6.50 plus a few cents postage. Otherwise, I will return book postpaid and owe you nothing.

NAME.....

ADDRESS.....

CITY, ZONE, STATE.....

Outside U.S.A.—Price \$7.00, cash only. Same return privilege

# Not a single channel antenna! Not another all-channel antenna!



A radically new—radically different, original Winegard design idea . . . that for the first time permits channel peaking on any combination of channels you can think of. This means—it is now possible for you to have an antenna that is actually *tailored to your area*—that will deliver *peak gain* on the channels you are able to receive in your area.

But! A brand new type of antenna . . . an antenna that gives you . . . for the first time . . . peaked performance on the stations in your area!

**It's the New**  
**WINEGARD**  
*Combo*

## WHAT IS THE COMBINATION NEEDED IN YOUR AREA?

CODE LETTER	CHANNEL	CODE NO.	CHANNEL
A	2	1	7
B	3	2	8
C	4	3	9
D	5	4	10
E	6	5	11
		6	12
		7	13

\*PATENT PENDING

Only the Combo gives you such extreme flexibility—

- Can be used as a single channel antenna.
- Can be used as an all-channel antenna.
- Can be used as a combination yagi peaked to the channels in your area.
- Can be used as a stacked array—(stacking bars available for stacking 2 and 4 bays.)
- Can be used as a large screen array ("Full size" reflector screens available for such use.)

### Features—

- Peaked to the channels in your area.
- Electro-lens Focusing.\*
- Light—compact—low wind resistance.
- Adaptable to any reception requirement—from close in to the most distant fringe areas.
- Quality—all weather construction—to withstand high winds and ice loading.

Note: Due to limited space on this page, it is not possible to explain in great detail all the technical operating details, applications, etc. . . . of this amazing new antenna. So, for those who want all the facts, see your nearest jobber . . . or write directly to the Winegard factory.

(P.S. Send us the combination of channels that you receive in your area.)

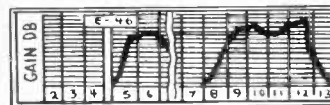
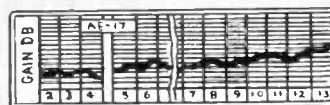

See your jobber or write us for additional information about the Combo



# WINEGARD COMPANY

3000 SCOTTEN BOULEVARD, BURLINGTON, IOWA

Winegard—America's most wanted line of TV antennas—designed to make installations quicker—easier—and more profitable

# precise says: Ask ANY Engineer or Serviceman, "WHAT'S THE TOUGHEST TEST OF ALL?"

YOUR test . . . the way the equipment works in actual use . . . under actual conditions. PRECISE test equipment has passed that test countless times . . . every instrument fully proven. That is why YOU and thousands like you have made PRECISE the fastest growing line of test instruments in America today!

Remember, too, PRECISE uses no surplus. See the complete line of PRECISE quality instruments at your jobber now—and save!

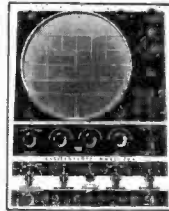

EXCLUSIVE PRECISE 8 1/2" OSCILLOSCOPE  
#308K . . . . . kit form \$129.50  
#308W . . . . . factory wired \$229.50

PRECISE 7" OSCILLOSCOPE  
#300K . . . . . kit form \$94.95  
#300W . . . . . factory wired \$199.50

precise ★ precise ★



EXCLUSIVE PRECISE VOLT. REG. V.T.V.M.  
#9071K . . . . . kit form \$35.95  
#9071W . . . . . factory wired \$49.95

precise ★ precise ★ precise

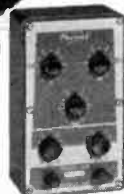

PRECISE RESISTANCE  
DECADE BOX  
#468K . . . . . kit form \$18.95  
#468W . . . . . factory wired \$24.95  
PRECISE CAPACITY DECADE BOX  
#478K . . . . . kit form \$18.95  
#478W . . . . . factory wired \$24.95



NEW PRECISE VOLTAGE REG. POWER SUPPLY  
#760K . . . . . kit form \$39.95  
#760W . . . . . factory wired \$59.95

precise ★ precise ★ precise ★ precise ★ precise



PRECISE HIGH VOLTAGE PROBE  
#999 . . . . . wired only \$6.98  
PRECISE RF PROBE  
#912 . . . . . wired only \$4.25  
PRECISE CAPACITY ATTENUATOR PROBE  
#960 . . . . . wired only \$3.95



PRECISE RF-AF-TV & MARKER GENERATOR  
#630K . . . . . kit form \$33.95  
#630KA . . . . . pre-assembled head \$38.95  
#630W . . . . . factory wired \$53.95



NEW PRECISE Em. & MUT. COND. TUBE TESTER  
#111K . . . . . kit form \$69.95  
#111W . . . . . factory wired \$139.95

★ precise ★ precise ★ precise ★ precise ★ pr



PRECISE UNIV. AF SINE, SQ. & PULSE GEN.  
#635K . . . . . kit form \$33.50  
#635W . . . . . factory wired \$52.50



PRECISE RF SIGNAL GENERATOR  
#610K . . . . . kit form \$23.95  
#610KA . . . . . pre-assembled head \$28.95  
#610W . . . . . factory wired \$39.95



NEW PRECISE VACUUM TUBE VOLTMETER  
#909K . . . . . kit form \$25.98  
#909W . . . . . factory wired \$37.50

precise ★ precise

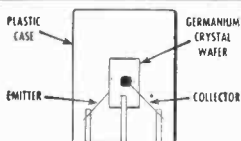

PRECISE NEW T1 TRANSISTOR KIT

PRECISE offers a simple and direct approach to the understanding of transistors. The instruction book covers the physics and practical applications in simple and non-mathematical terms. Two transistors, one germanium diode, transformer, electrolytics, coils, resistors, condensers, chassis, etc. are supplied.  
Model T1 . . . . . kit only \$17.95

## precise

DEVELOPMENT CORP.  
OCEANSIDE, NEW YORK

Prices slightly higher in the West. Prices and specifications subject to change without notice.

SEND FOR NEWEST PRECISE CATALOG—DEPT. MB-3

## AUDIO—HIGH FIDELITY

from any possibility of accidental disturbance.

In short, the Ampex 600 can not only stand up with the very finest and most expensive studio type recorders as to high-fidelity quality but is capable of fine results even in unskilled hands.

### The Karlson enclosure

The biggest and toughest obstacle to complete fidelity in most hi-fi systems is the inability of the speaker system to reproduce the lowest octave and a half—from 16 to 40 cycles—of the musical spectrum. Many expedients—some quite heroic—have been worked out for extending speaker response downward to include this last octave. Lately we have had many efforts to do the job with relatively small enclosures. A novel and successful one is the Karlson which, though only 34 x 24 x 15 inches in outside dimensions, claims and (to cut the suspense) *can* in fact deliver a response down to 16 cycles with a suitable loudspeaker.

The Karlson could be called a wide-band resonator. It employs an air column as a resonant element. Air columns, however, though very efficient (as the pipes of a pipe organ can prove) have some bothersome properties. They are resonant when their length equals a quarter wavelength, but at higher frequencies they behave in a way very comparable to the behavior of a transmission line—or particularly a stub. Thus a column open at one end produces a strong fundamental and odd harmonics; but the reflection from the open end at frequencies for which the column is a half wavelength, or a multiple of a half-wave, is out of phase and results in cancellation—exactly as in a shorted stub. The over-all response curve is as in *a* of Fig. 2.

Mr. Karlson says that if the column is given a lip or slot at the open end, the peaks are broadened, as in *b*. If the slot is continued for more than two-thirds the column length and given an exponential shape, the result is a flat wideband response as in *c*.

Readers who examine the Karlson enclosure will be hard pressed to see any resemblance to a column or pipe, and it is the harder to recognize since Mr. Karlson has also employed the

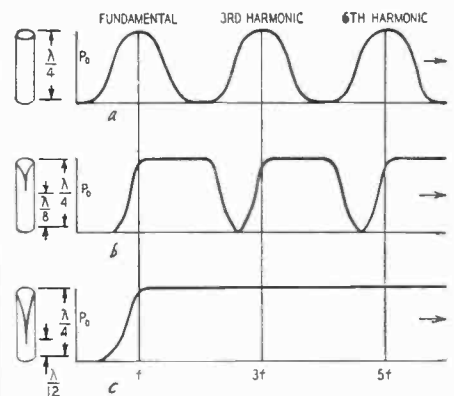

Fig. 2—Action of notched organ pipe.

# distance smashers!

## Telrex

**SUPER-  
PERFORMANCE  
4-BAY**

# "CONICAL-V-BEAMS"®

- THE FINEST FRINGE AREA ANTENNA EVER PRODUCED
- UNEQUALLED FOR DISTANCES UP TO 200 MILES
- "HURRICANE-BUILT"  
—WEIGHT APP. 16 LBS.

The famous Telrex Model 8X-TV, undisputed distance champion for over 6 years. The accepted standard in fringe area installations... if the Model 8X-TV does not provide a usable signal, reception is either impossible or impractical. Built of weather-proven components throughout to withstand severest weather conditions.

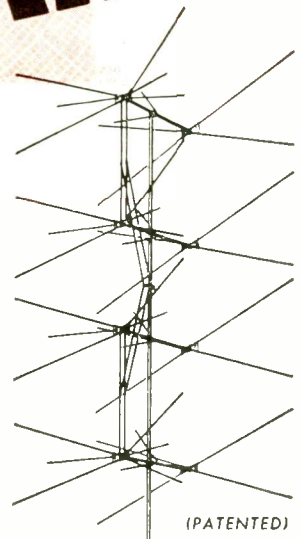

**MODEL 8X-TV**

Telrex guaranteed to outperform any antenna or combination of cut-to-frequency antenna. Also available in 2-BAY stacked array, Model 4X-TV.

## NEW VHF "KING PIN" BEST FOR B & W OR COLOR TV!

The new Telrex "KING PIN" — utilizing the Patented "Conical-V-Beam" theory to perfection — provides excellent performance on both VHF and UHF. "Conical-V-Beam" dipoles afford best and most uniform match to 300 or 200 ohm line across entire band. Write for catalogs and prices today!

- Maximum Gain
- Maximum F/B Ratio
- Minimum Spurious Lobes
- No Phase Shift
- Pre-assembled
- Installs Quickly

**TELEREX HAS THE ANSWER TO ANTENNA PROBLEMS  
OVER 100 MODELS FOR EVERY TYPE INSTALLATION**

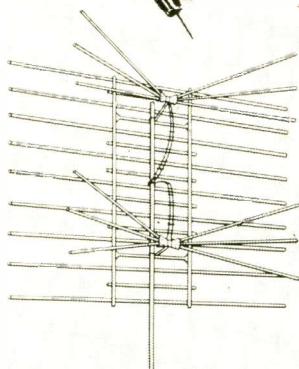

• "CONICAL-V-BEAMS" are produced under U. S. Patent No. 23,346, Canadian Patent No. 500,436 and British Patent No. 691,485. Other patents pending.



AMERICA'S  
OUTSTANDING  
TELEVISION  
BEAM

**ASBURY PARK 9  
NEW JERSEY**

for happy satisfied customers

**DON'T JUST MAKE A REPLACEMENT  
...MAKE AN IMPROVEMENT**

with a  
**QUAM**  
*Adjust-a-Cone*<sup>®</sup>  
**SPEAKER**

Ask for **QUAM**  
the quality line,  
for all your  
speaker needs.

**FREE** The  
QUAM catalog  
listing over 100  
exact replacement  
speakers.

The performance of a set can be no better than the performance of its loudspeaker—and QUAM speakers will make any set sound better—because of their patented design, heavier magnetic structures, and because a QUAM replacement speaker is an exact replacement—designed to do a specific job.

That's why servicemen all over the country have named QUAM their preferred brand of replacement speaker, by a wide margin (Brand Name Surveys, April, 1954).

**QUAM-NICHOLS COMPANY**

236 East Marquette Road • Chicago 37, Illinois

**OVER 97,000 TECHNICIANS HAVE LEARNED  
HOW TO GET THE MOST OUT OF  
BASIC TEST EQUIPMENT** for AM  
FM-TV

**'Servicing by Signal Substitution'**

A BEST SELLER FOR OVER 13 YEARS!  
(NEW, UP-TO-DATE, 14th EDITION)

The Modern, Simplified, Dynamic Approach to  
all Receiver Adjustment & Alignment Problems

- ★ Nothing complicated to learn
- ★ No extra equipment to purchase
- ★ Universal . . . non-obsolete
- ★ Employs only Basic Test Instruments

Ask for "S.S.S." at your local Radio  
Parts jobber or remit 40¢ in small  
stamps or coin directly to factory.



**ONLY 40¢**

103 pages.  
Invaluable  
information  
that will help  
you redouble  
the value of  
your basic test  
equipment.

**PRECISION APPARATUS COMPANY, INC.**  
70-31 84th STREET, GLENDALE 27, L. I., N. Y.

**AUDIO—HIGH FIDELITY**

reflex principle to increase efficiency further. The result is an enclosure of quite complicated structure but one which does a spectacular job on the bass.

I have had a Karlson on test for a couple of months and have tried it with speakers in just about every price range. Whether or not, as Karlson claims, it beats a 30-foot horn I could not determine, having no desire to build a 30-foot horn. But certainly it can put out an amazing bass, completely out of proportion to its size and far beyond the design capacity of the speaker used.

The degree to which the last octave is covered will depend, of course, on the speaker—the lower its resonance, the flatter the response below 40 cycles. Every speaker seems to deliver from a half to a full octave more range than one would imagine from the speaker specifications. The RCA LC-1A and the older 515S2 both have resonance in free air of between 45 and 50 cycles. Both, in the Karlson enclosure, give a response down to 20 cycles which contains a large and dominant component of fundamental. In an infinite baffle both cut off severely below 30 cycles.

Actually, what surprised me most was, not the performance with fine speakers, but what it did with inexpensive ones. For instance, I stuck a prewar Cinaudagraph of the PA type in it and the result was a startling bass. The medium-priced SL-12 (RCA) produced an exceptional over-all frequency response and a very smooth one. This suggests that those who can, or must, let their systems improve with time, might consider purchasing a Karlson enclosure in kit form for use initially with an inexpensive speaker.

A fine characteristic, not shared by all speaker systems, is that it delivers excellent bass response at very low levels. Aside from the tremendous bass response, it has a very individual character easily and readily recognizable. First, the slot spreads the point source so that the orchestra fills the room more, so to speak, instead of seeming to be in the next room and audible through a small hole in the wall. This is all to the good.

However, there is another effect which some will like more than others. It is what Mr. Karlson describes as "controlled ring time." Rather difficult to describe in words, it is definitely not cavity resonance nor really hangover. It might be called "built-in reverberation." In most rooms and to most ears, the result is a rather spectacularly improved feeling of presence.

The speaker, not at all critical as to placement, can be put anywhere in a room. The bass response is not dependent on use in a corner. I suppose it could be put in a corner though I shudder to think what the resultant bass would do to the listener's ears.

**D-500 level indicator, test records**

Almost every audiophile who isn't a complete technical dub occasionally wants to measure the response of his



## AUDIO—HIGH FIDELITY

system and thereby to ascertain its performance and condition. And there are many excellent test records available which would make this possible—provided he has some kind of output indicator. And there's the rub, for an output meter or wattmeter or a.c. voltmeter is seldom a part of the well-furnished modern home, even the hi-fi household. Therefore, in offering its D-500 level indicator at the modest price of \$3.95 the Dubbings Co. is filling a real need. The question is: How well does it fill the need? I'll summarize right at the start by saying that it does a good job of it. It is simple enough to be useful to anybody bright enough to understand what a level indicator is and why one is necessary, and with reasonable care should offer no trouble in use.

The D-500 is a very simple gadget indeed. It consists of three battery type pilot bulbs in a plastic case, hooked up so that the bulbs light up progressively as the input voltage increases. The bulbs and circuit have been chosen so that the bulbs light up at levels 3 db apart. There are two flexible leads with alligator clips to connect the gadget to the loudspeaker or amplifier terminals.

To use it one adjusts the amplifier gain with a reference signal so that the middle bulb just begins to glow. Variations in level will now be indicated by variations in the light output of the three bulbs. A 1-db drop will cause the middle bulb to go out completely; a 3-db drop will also extinguish the end bulb; a 3-db rise will cause the third bulb to begin glowing and a 5-db rise will cause it to light with full brilliance. The total safe range is around 8 or 9 db—enough for most hi-fi measurements.

Considerable care is necessary to avoid bulb burnouts since even the transients produced by a switch click or the setting down of the pickup may be high enough to blow them out. However, if you follow the instructions carefully and exactly, and exercise elementary judgment, you should have no trouble. I didn't. Despite the fact that I put in several hours of use on my test gadget, I didn't burn out a single bulb. I found I could discern differences in level as small as a half decibel, as compared with a perfectly linear wattmeter.

There are many excellent test records on the market, but Dubbings has managed to find and fill a couple of blanks which have long bothered many of us. The D-100 offers a frequency run from 30–1,200 cycles, an unmodulated band for testing rumble and hum; a 3,000-cycle band for checking wow and flutter, and, finally, a unique series of five bands for testing pickup tracking and compliance. The two sides are identical and, if you save one, the record can last for a considerable number of years.

The two records and the level indicator together provide just about all



A. A. Ghirardi

J. R. Johnson

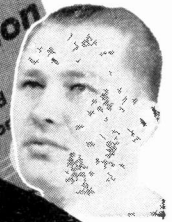

# ...here's how to LEARN SERVICING R-I-G-H-T!

Complete training in modern professional methods . . . only \$12 . . . 3 months to pay!

## FIX ANY RADIO OR TV SET EVER MADE...easier...better...faster

### Radio & TV Receiver TROUBLESHOOTING AND REPAIR

by Ghirardi & Johnson

822 pages, 417 illustrations  
Price \$6.75

(See special offer in coupon)

This big, 822-page book brings you the kind of PROFESSIONAL training that helps you handle the toughest radio-television-electronic service jobs as slick and as accurately as you now do the easy ones!

For service beginners, Radio & Television Receiver TROUBLE-SHOOTING AND REPAIR is a complete, easily understood professional training course. For experienced servicemen, it is the ideal way to "brush up" on specific jobs; to develop better troubleshooting methods and shortcuts; and to find quick answers to puzzling service problems.

Step by step, it takes you through each service procedure . . . from locating troubles quicker and with less testing to repairing them faster and better.

You learn to deal with any kind of trouble in any kind of receiver. No guesswork. No aimless testing.

Here are just a few of the subjects covered: Components and Their Troubles; Basic Troubleshooting Methods; "Static" and "Dynamic" Testing; Practical Troubleshooting Tips and Ideas; AC/DC, 3-way Portable and Battery-set Problems; Servicing Communications Receivers; A Complete Guide to Television Service; AM, FM and TV Realignment Made Easy; Resistor, Capacitor, Inductor and Transformer Problems; Servicing Tuning, Selector and Switching Mechanisms; Loudspeakers; Servicing Recorders and Record-playing Equipment . . . and dozens more. Use coupon. Read it for 10 days at our risk.

## LEARN BASIC CIRCUITS...and watch service "headaches" disappear!

### Radio & TV Receiver CIRCUITRY AND OPERATION

by Ghirardi & Johnson

669 pages, 417 illustrations  
Price \$6.50

(see special offer!)

It's amazing how much easier you can repair radio and television sets and even industrial electronic equipment when you know all about their circuits. You locate troubles in a jiffy because you know what to look for and where to look. You handle jobs lots faster, better . . . and more profitably.

Radio & Television Receiver CIRCUITRY AND OPERATION gives you a complete understanding of basic circuits as well as their varieties. It teaches you to recognize them . . . to understand their peculiarities . . . to

know their likely "troublespots" . . . and how to eliminate guesswork and useless testing.

Throughout, this new book brings you the kind of above-average professional training that fits you for the bigger, better-pay jobs. Covers all circuits used in modern television and radio receivers, amplifiers, phono pick-ups, record players, etc.

Price only \$6.50 . . . or see money-saving combination offer in coupon. 10-day FREE examination.

# Save \$1.25!

Make your training library complete. Have ALL the latest data at your fingertips. Get both these books at only \$12.00 for the two . . . YOU SAVE \$1.25.

## FREE EXAMINATION . . . easy terms!

Dept. RE-15, RINEHART & CO., INC.  
232 Madison Ave., New York 16, N.Y.

Send books indicated for FREE EXAMINATION. In 10 days, I will either remit price indicated plus a few cents postage or return books postpaid and owe you nothing.

Radio & TV CIRCUITRY AND OPERATION (Price \$6.50)  Radio & TV TROUBLE-SHOOTING AND REPAIR (Price \$6.75)

COMBINATION OFFER . . . Both books only \$12.00 (Regular price separately \$13.25 . . . you save \$1.25)

(Combination offer is payable at rate of \$3 (plus postage) after 10 days if you decide to keep books, and \$3 a month thereafter until \$12 has been paid.)

Name .....

Address .....

City, Zone, State .....

OUTSIDE U.S.A. . . . \$7.25 for TROUBLESHOOTING AND REPAIR; \$7.00 for CIRCUITRY AND OPERATION; \$13.00 for both books; Cash with order, but money refunded if you return books in 10 days.

# PROGRESSIVE SPEAKER EXPANSION

a new approach to personalized listening . . .

by *University*

A modest budget need no longer limit the quality and caliber of your hi-fi aspirations. University offers, for the first time in audio history, a tremendous selection of uniquely designed speaker and network components so brilliantly conceived and executed that it is now possible to develop your loudspeaker system in successive, relatively inexpensive stages . . . until what you have meets your listening requirements.

Progressive Speaker Expansion by University makes it possible for you to buy a speaker today in terms of the system you want tomorrow! You are thus able to devote your present budget primarily in the initial selection of quality amplifying and program source equipment which cannot be economically altered or substituted at a later date. P-S-E makes your speaker choice an easy one. Depending upon your goal and space limitations, there are numerous University speaker systems that can be started at minimum cost with immediate listening satisfaction.

start planning today . . .  
the *University* way!

- Buy good amplifier and program source equipment which will do justice to your eventual University speaker system . . . and start with one of the versatile top quality speakers or combinations recommended in the P-S-E chart.
- Build up to a deluxe speaker system with University components so designed that speaker and network can be easily integrated for better and better sound reproduction—without fear of obsolescence.
- Own a P-S-E speaker system which meets hi-fi quality standards from the very beginning—and reach the highest standard of all—YOUR OWN.

Do it with University P-S-E! Only University products can meet such flexibility of application and demanding performance requirements.

## University Loudspeakers

80 SOUTH KENSICO AVENUE, WHITE PLAINS, NEW YORK

★ For the complete illustrated Progressive Speaker Expansion charts, write Desk No. 41, University Loudspeakers Inc., White Plains, New York.

## Support the March of Dimes

### We're Proud!

to have been closely associated with the TELEVISION & RADIO INDUSTRY . . .

during the past 8 years and have marveled at its spectacular progress

In the future as in the past we will continue supplying the Service Men and the Electronic Industry with only the very highest quality merchandise and equipment.

As an added service we will send you upon request absolutely free our monthly publication of the "Almo Broadcaster."

**Almo RADIO CO.**  
509 Arch St. Phila., Pa.

BRANCH STORES  
Norristown, Pa., Camden, N. J., Atlantic City, N.J., Wilmington, Del., Salisbury, Md.

### ENJOY 3 COLOR TELEVISION FILTER SCREEN NOW

Changes dull eye-straining black and white pictures into beautiful color tones. Seconds to attach. No tools used. Helps eliminate glare and snow in fringe areas. Order direct. Send \$1 for screen size up to 16". \$1.25 size 17". \$1.50 size 20". \$2 size 21". \$2.50 size 24". \$3 size 27". We pay postage except on C.O.D. orders. Satisfaction guaranteed. Inquiries from dealers also welcomed.

Zingo Products, Johnstown 13, New York

RADIO CONTROLLED  
Garage Door  
Operating Mechanism \$24.50  
Write for Information

P. E. HAWKINS CO.

631 Prospect

Kansas City 24, Mo.

## AUDIO—HIGH FIDELITY

the material you need to check your phono system. For instance, if the response begins to fall off above 7,000 cycles, it's a pretty safe bet the needle is worn.

### Good recordings

*Fiesta Flamenca* Cook 1027  
*Masterpieces from the Theatre*  
New Orchestral Society of Boston Cook 2064  
*Organ in Symphony Hall*  
Reginald Fort Cook 1055

These releases testify that the more the rest of the industry improves the more Cook seems to stay at the head of the parade. *Fiesta Flamenca* is a typical Cook *tour-de-force*, a superb record in sound of the Spanish equivalent of a jazz jam session. From a hi-fi point of view it stands by itself and is one of the greatest recordings ever made by anyone. If it's transients you want—and everybody seems to want them—here is a gold mine. In fact it contains little but transients. Except for a guitar, an occasional burst of castanets and some sporadic singing, the music (and it is music) consists almost entirely of heel clicks and taps, hand clapping and vocal ejaculations. I doubt that a TV set is faced with more demanding waveforms than some presented in this recording.

*Masterpieces of the Theatre*, which includes an excerpt from Bizet's *Carmen*, Rossini's overture from *La Gazza Ladra*, Mendelssohn's *Midsummer Night's Dream* and von Weber's *Euryanthe*, is a horse of a different color.

Most notable is the extreme dynamic range, the almost unprecedented lack of distortion in the peaks and the excellent definition even in the highest crescendos. Even in the biggest peaks—and some of them are in excess of 20 db above the average level—the separate instruments stand out cleanly and distinctly, instead of merging into a vague boom or roar.

But this record has to be played loud—at least 500 milliwatts for the peaks, which, I assure you, is enough to bring the cops—unless you live by your lonesome. At lower levels it falls nearly as flat as a fried cold-storage egg.

*Organ in Symphony Hall* is one of those rare records which tells you, not how good your system is, but how far short of perfection it still is. This is quite possibly the best recording of the pedal range of an organ and includes the whole bass spectrum down to and including 16 cycles.

*Americana for Solo Winds and String Orchestra*  
Eastman Rochester Symphony, Howard Hansen conducting.  
Mercury MG 0003

The notable points about this record are: The music is pleasantly soothing, an excellent balm for nerves tautened by too much listening at high levels to the more modern, bombastic and dissonant music of most good demonstration records. It features the oboe, flute, clarinet, trumpet and English horn in solo works, reproducing them with great naturalness. In several passages the solo instrument plays against a heavy bass: these offer an excellent opportunity to test system intermodulation—and your ear's ability to recognize it. Fully up to Mercury's recent high standards.

*Musical Gadgetry Vol. 1* Spectratone AH-1002

If you remember those wonderful saloons and beer gardens of the pre-Prohibition days, this extraordinary recording will take you back so you can almost taste that mild beer and smell the savory free lunch. And, if you can't remember but have wondered what stimulated people to cry into their beers before the juke box was invented, this will answer your question vividly. This disc records with remarkable fidelity some of the tremendously complicated mechanical music-makers of the era before World War I, including several large saloon type music boxes, a variety of mechanical pianos and xylophones, and finally a hurdy-gurdy and a street piano and even a carousel band organ.

Aside from its capacity for evoking nostalgia, the record offers some very interesting hi-fi material. The jacket says that microscopic inspection reveals that the record covers the range from 20–25,000 cycles. The complete fidelity with which, not only the music, but the various incidental noises are reproduced is indirect evidence of this.

END

# Simpson

MODEL

# 260

MULTI-TESTER

**outsells all others combined!**

More technicians are using the Model 260 than any other high-sensitivity VOM. Over half a million Model 260's have been sold to date! 20,000 Ohms per volt. You'll find it wherever quick, accurate, electrical checks are needed. It's so handy, so dependable, so sensibly priced. Ask your jobber to show you the Simpson Model 260. Only **\$38.95**, including Adjust-A-Vue Handle. Carrying cases from **\$6.75**.

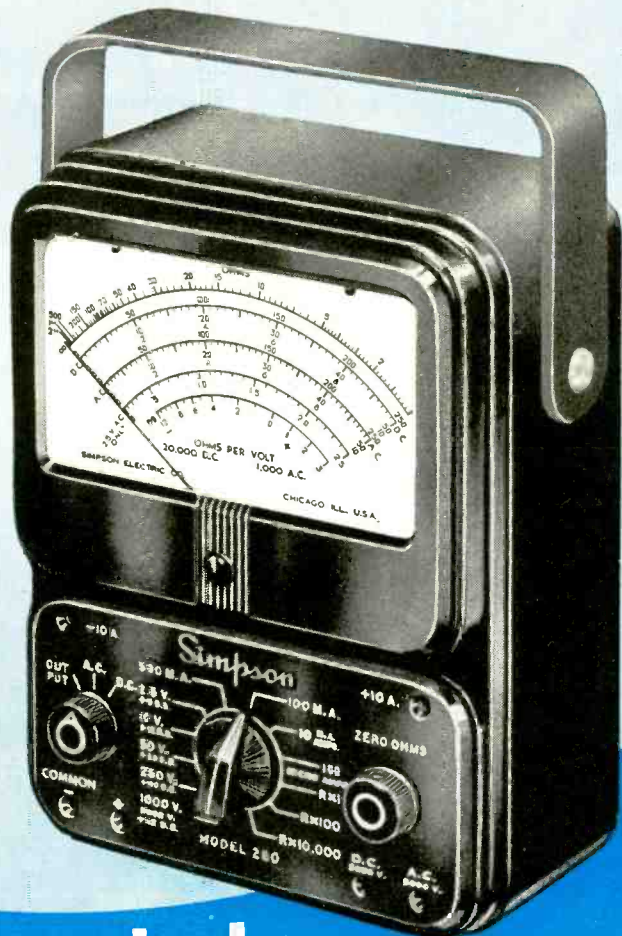

## world's most popular!

MODEL

# 262

**the new vom with a 7" meter**

20,000 Ohms per volt DC. 5,000 Ohms per volt AC. 33 RANGES

DC VOLTAGE: 0-1.6, 0-8, 0-40, 0-160, 0-400, 0-1600, 0-4000 volts

(20,000 ohms per volt sensitivity)

AC VOLTAGE: 0-3, 0-8, 0-40, 0-160, 0-800 volts (5,000 ohms per

volt sensitivity)

AF OUTPUT VOLTAGE: 0-3, 0-8, 0-40, 0-160 volts (0.1 microfarad

internal series capacitor)

VOLUME LEVEL IN DECIBELS: -12 to +45.5 DB in 4 ranges.

Zero DB Power Level, .001 watt in 600 ohms.

DC RESISTANCE: 0-500 ohms (4.5 ohms center); 0-5,000 ohms (45 ohms center);

0-50,000 ohms (450 ohms center); 0-500,000 ohms (4,500 ohms center);

0-5 megohms (45,000 ohms center); 0-50 megohms (450,000 ohms center)

DC CURRENT: 0-80, 0-160 microamperes, 0-1.6, 0-16, 0-160 milliamperes,

0-1.6, 0-16 amperes (267 millivolts maximum drop)

MODEL 262 complete with 2 test leads with removable

alligator clips, 4,000 v. DC multiplier

Dealer's Net Price, including Adjust-A-Vue

Handle. . . **\$59.50** Carrying Case. . . **\$9.95**

Accessory High Voltage Probe

for 16,000 volts DC. . . **\$11.50**,

40,000 volts DC. . . **\$12.50**

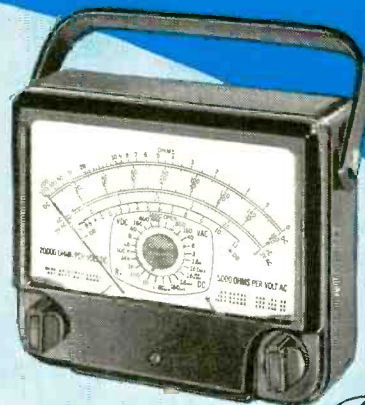

*Deluxe!*

SEE THEM AT YOUR JOBBER, OR WRITE . . .

## Simpson ELECTRIC COMPANY

WORLD'S LARGEST MANUFACTURER OF ELECTRONIC TEST EQUIPMENT

5203 W. Kinzie St., Chicago 44, Illinois, Phone: ESTbrook 9-1121

In Canada: Bach-Simpson, Ltd., London, Ontario

# the WURLITZER ELECTRONIC ORGAN

By RICHARD H. DORF\*

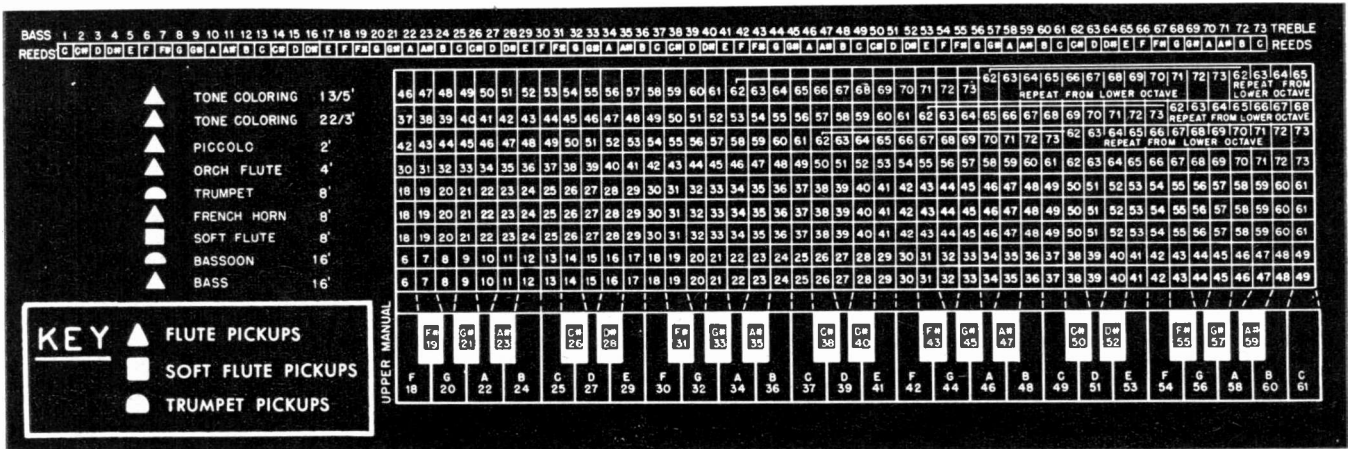

Fig. 1—Upper manual of the Wurlitzer organ. Key indicates type of pickup.

THE available variety of tone colors for both manuals of the Wurlitzer organ is obtained by mixing stops, since actually there are only two varieties of color, flute and trumpet. This scheme could be diagrammed only on a page at least several times the size of this, so only the upper manual is shown (Fig. 1).

The upper manual is equivalent to the swell on a usual organ. The keys are shown in pictorial form, numbered from F18 to C61. C25 corresponds to middle C, 261.7 cycles. The reed chart above the upper-manual chart shows the 73 reeds and their notes, ranging from bass to treble.

Let us see what happens when we play the upper manual with the SOFT FLUTE 8' stop pulled. Start by pressing middle C (key 25) and find it on the manual in Fig. 1. Note that a horizontal column of figures extends to the right from the SOFT FLUTE 8' marking on the chart. Follow the line of boxes upward from key 25 until it intersects the SOFT FLUTE 8' line; you will find a box with the number 25. This indicates that when C25 is pressed with the SOFT FLUTE 8' stop pulled, a pickup on reed No. 25 is energized.

Next we must know which pickup on

that reed is energized. Note that to the left of the SOFT FLUTE 8' marking is a square. According to the key at the bottom of the chart, all pickups for this stop are the soft flute pickups—tone screw immediately over the reed, with greater distance (and therefore less effect) than the other similar screw on the reed which is for normal flute tone.

Thus, from Fig. 1 we know that under these circumstances we will get only a soft flute tone from the organ, at the pitch of middle C.

Leaving the SOFT FLUTE 8' tab in the on position, we also pull the FRENCH HORN 8' tab. Again following the boxes up from key 25 to the FRENCH HORN 8' line, we find the number 25, indicating the same reed. But at the left of the FRENCH HORN 8' title is a triangle, which, after reference to the key at bottom, shows that a normal flute pickup screw has been energized. Now both screws on reed 25 are energized.

### Tone coloring

We can make the tone quality more interesting by adding to the former two stops the one called TONE COLORING 2 2/3'. Following the boxes upward from the TONE COLORING 2 2/3' intersection, we find the number 44. Referring to the reed chart, we see that we have energized a

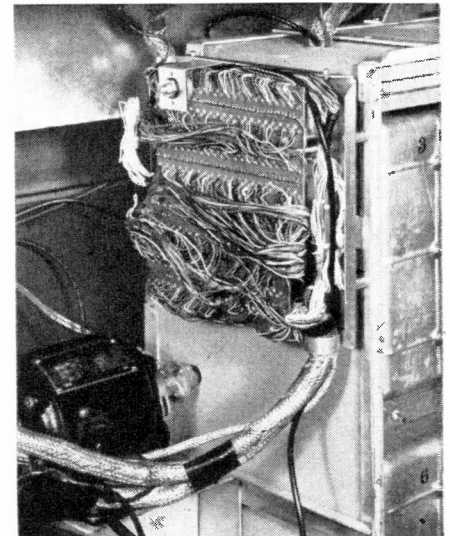

Fig. 2—Connection board on reed chamber.

normal flute pickup (triangle to left of TONE COLORING 2 2/3' designation) on a reed supplying a note G 1.5 octaves above our C25. This is approximately the third harmonic of our middle C (key 25).

Let us add a fourth stop, TONE COLORING 1-3/5'. By the same process we find that we have added the normal flute pickup on reed 53, the E about 2.25 octaves above middle C, approximately

\*Author: Electronic Musical Instruments. Radio Magazines, Inc.

the fifth harmonic of middle C (key 25).

Thus we can see that pulling TONE COLORING 2 2/3' adds the third harmonic to any notes played at 8' pitch and pulling TONE COLORING 1-3/5' adds the fifth harmonic. This is carried on as far as possible until the TONE COLORING stops run out of reeds after which octaves are repeated, giving subthird and subfifths. This scheme is simply a harmonic synthesis system somewhat similar in principle to the more complex Hammond system.

The TONE COLORING stops which take care of only fifth and third harmonics are not the only parts of the harmonic synthesis system. The second harmonic, an octave above the 8' note, is handled by the ORCHESTRAL FLUTE 4' stop. When we play middle C with that stop pulled, we energize the flute pickup on reed 37, which is C an octave above middle C. The fourth harmonic is supplied by the PICCOLO 2' stop, which energizes reed 49, two octaves above middle C. Thus the system gives us control over the fundamental, second, third, fourth and fifth harmonics. There is also a BASS 16' stop which gives the subfundamental, one octave below the key struck. Naturally, these stops can be manipulated in many ways to give different tone colors.

The upper manual also has two trumpet-tone stops which have no relation to the harmonic synthesis system, though they work the same way. The first is the TRUMPET 8' stop. Assuming we have struck middle C (key 25), with the TRUMPET 8' stop pulled, we find that we have energized a pickup on reed 25. From the semicircle opposite the stop name and the key below we see that it is the trumpet pickup—the strip of metal close to the end of the reed—which is energized. The second trumpet stop is the BASSOON 16', which energizes the trumpet pickup on the reed one octave below the key struck. Though the trumpet stops are not related to the harmonic synthesis scheme they can, of course, be added to any combination of flute stops to produce still more combinations.

The lower manual operates in the same way, except that there is no fifth harmonic, but a sixth instead, plus an eighth. The lineup is as follows:

- Subfundamental—BASS 16'
- Fundamental—HORN 8'
- Second Harmonic—FLUTE 4'
- Third Harmonic—TONE COLORING 2 2/3'
- Fourth Harmonic—PICCOLO 2'
- Fifth Harmonic—none
- Sixth Harmonic—TONE COLORING 1 1/3'
- Eighth Harmonic—FIFE 1'

In addition, the lower manual has a TENOR TRUMPET 8' which uses the trumpet pickups and an ACCOMPANIMENT 8' which uses the soft flute pickups.

The keys of the lower manual energize many of the same pickups as those of the upper manual and do not add anything. Thus if key 25 on the upper manual is pushed with the TRUMPET 8' stop pulled, pushing key 25 on the lower

manual with the TENOR TRUMPET 8' stop pulled will simply energize the same pickup, but will produce no additional sound.

The pedals have no selection of stops, with a single tone quality obtained by making each one energize a separate pedal pickup screw on the lowest 13 reeds. An additional time-constant network is used at each pedal contact to make the pedal tones speak and decay

more slowly than those of the manuals.

Fig. 2 shows the connection board on the reed chamber to which all the keying leads go. This board, on its inner side, contains all the 165 printed-circuit time-constant filters. Each keyed pickup has 160 volts d.c. on it. The first eight notes of the trumpet pickups have only 50 volts, obtained by using special dropping resistors at the bass-end entrances of the corresponding stop rods

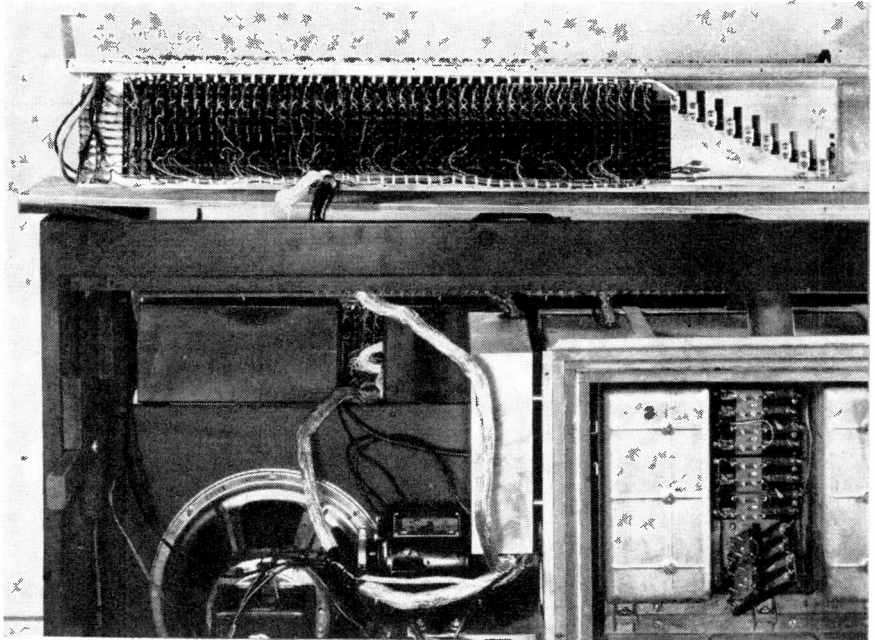

Fig. 3—The upper-manual key action. Loudspeaker is mounted beneath manuals.

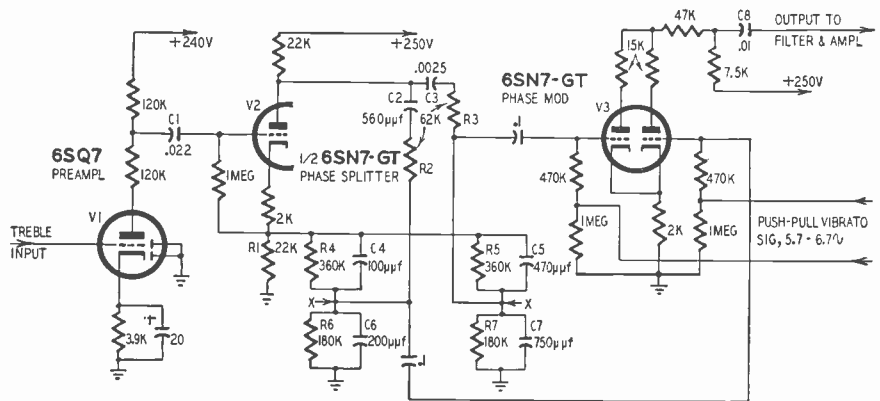

Fig. 4—Schematic of the vibrato circuit—less low-frequency oscillator.

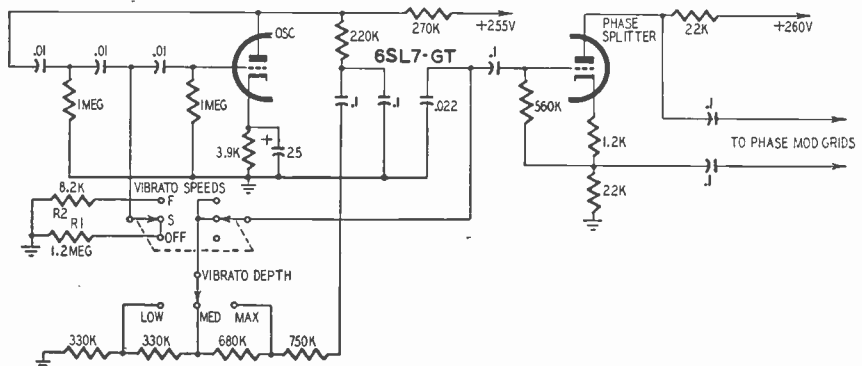

Fig. 5—Vibrato phase-shift oscillator. Primary control is the speed switch.

IT'S BIGGER AND BETTER THAN EVER!

B-A's NEW 1955

# FREE CATALOG

**164 BIG PAGES**  
**LOADED WITH SAVINGS**  
**AND NEW ITEMS IN**  
**RADIO, TV, ELECTRONICS**



INCLUDES 23 PAGES  
 OF AMAZING  
 BARGAINS, NOT FOUND  
 IN ANY OTHER CATALOG

**BURSTEIN-APPLEBEE CO.**

BURSTEIN-APPLEBEE CO. Dept. 5,  
 1012-14 McGee St., Kansas City 6, Mo.

Send Free B-A Catalog No. 551.

Name.....

Address.....

City.....

State.....



**SEND FOR IT TODAY!**

## SHOOT TV TROUBLE FAST!

**With H. G. Cisin's Copyrighted RAPID "TV TROUBLE SHOOTING METHOD"**

Without experience or knowledge, this guaranteed new method of servicing TV sets enables you to DIAGNOSE TV troubles rapidly as an expert. **NO THEORY—NO MATH**—you can locate all faults in record-breaking time, regardless of make or model. "TV TROUBLE SHOOTING METHOD" is the most valuable aid to TV servicing ever written. Be a TV Trouble Diagnostician, increase your present earnings. Open your own Profitable Business or get a high-paying skilled job.

It's all in this book . . .

Nothing more to Pay—Nothing else to Buy

Alphabetically listed there are 85 picture troubles, over 58 raster and 17 sound troubles and by this unique copyrighted method you know EXACTLY WHERE the trouble is; plus step-by-step instructions, including 69 RAPID CHECKS, enabling you to find the faulty part.

**13 IMPORTANT PRELIMINARY CHECKS NEED NO INSTRUMENTS!** Of the 69 Rapid Checks, **OVER 65 ALSO REQUIRE NO INSTRUMENTS!** Rapid checks include emergency checks for distorted pictures, defective tubes including PIX tube, plus 57 others. **ALL EXPLAINED IN SIMPLE LANGUAGE. PERFORMED WITHOUT INSTRUMENTS MANY CHECKS USE THE PICTURE TUBE AS A GUIDE.** H. G. Cisin, the author, is the inventor of the AC/DC midjet radio. He licenses RCA, AT&T, etc. He has also trained thousands of technicians now owning their own prosperous TV service organizations or holding highly paid TV positions. His years of experience are embodied in this remarkable new TV TROUBLE SHOOTING METHOD.

Guaranteed, Money Back in 5 Days if Not Satisfied!

If you use coupon below you will receive, **ABSOLUTELY FREE**, a copy of H. G. Cisin's new book "Trouble Shooting Pix Guide incl. TV Terms Explained," which sells for \$1. **ACT NOW** and get both books postpaid at the cost of only one.

**\$1** Post-paid

**RUSH COUPON NOW!**

H. G. CISIN, CONSULTING ENGINEER,  
 Amagansett, N.Y. (Dept. E-17)

Enclosed find \$1. Rush both books.

Name.....

Address.....

City.....

Zone.....

State.....

## STAN-BURN EDARKE

**\* CATHODE RAY TUBE SPECIALS \***  
 ONE YEAR GUARANTEE

G. E.		STAN-BURN	
* 10BP4A	\$14.95	10BP4	\$10.20
* 10FP4A	21.10	12LP4	11.90
* 12KP4A	24.45	12LP4A	13.95
* 12CP4	18.75	12CP4	11.90
* 12QP4A/B1014		12JP4	11.90
Dumont	21.00	12UP4A	14.50
* 12UP4B	28.75	14CP4	17.50
14CP4	24.50	15DP4	17.50
* 15DP4/B1014		16KP4	17.50
Dumont	23.75	16CP4 or A	17.50
* 16AP4	30.95	16JP4	17.50
* 16DP4A (N.U.)	25.25	16CP4 or A	17.50
16GP4 or B	31.25	16FP4	17.50
* 16KP4/16RP4	24.20	16WP4	17.50
16KP4A	28.35	16AP4	17.50
(Aluminum)	25.25	16AP4A	23.00
* 16JP4A (N.U.)	28.25	16CP4	19.00
16LP4A	28.50	16EP4A	23.50
* 16WP4A	26.50	16GP4 or A	21.00
16GP4B	31.25	17BP4	18.50
* 17BP4A	24.25	17CP4A	24.50
17BP4B	30.35	17GP4B	22.60
17CP4	34.00	19FP4	23.00
* 17CP4B		19FP4A	24.00
(Aluminum)	38.50	19AP4	23.90
19AP4A	41.50	19AP4A	24.90
* 20CP4	30.00	20CP4	23.95
20LP4	37.50	21EP4	25.50
* 21AP4	42.00	21AP4	26.50
21EP4A	32.80	24AP4	49.00
* 21EP4A	37.35		
24AP4	78.50		

**\* PRICES SUBJECT TO CHANGE WITHOUT NOTICE \***

**\* AUTHORIZED DISTRIBUTORS for: General Electric, Kenrad, Tung-Sol, National Union, De Waid, Regal, Automatic and General Motors. \***

**\* AUTOMATIC CUSTOM-BUILT RADIOS for Plymouth, Ford, Chevrolet and many others, always in stock. \* We carry a complete stock of HI-FIDELITY and SOUND EQUIPMENT. Send us your requests. We also carry a complete line of popular makes of Radio tubes at 50/10% discount. Also many other special purpose and transmitting types, and all electronic parts and equipment at lowest prices. Send us a list of your requirements for prompt quotations. Terms: 20% with order. Balance C.O.D. All prices FOB. NEW YORK Warehouse. Minimum order \$5.00. Write for our latest price list and Hi-Fi Catalog to Dept. RE-1**

**STAN-BURN RADIO and ELECTRONICS CO.**  
 1697 BROADWAY • NEW YORK 19, N.Y.

## AUDIO—HIGH FIDELITY

and splitting the nichrome wires. Fig. 3 shows the rear of the console with the upper-manual key action raised and brought into sight. Note the 12-inch speaker secured to the board beneath the manuals in front.

### The Wurlitzer vibrato

The vibrato circuit may well be called exciting by many people who have sought a practical way to introduce genuine vibrato—frequency shift—into systems where the original tone source must remain at a constant frequency. The amplifier system of the organ is not particularly notable, with the exception that one of the stages is used for gating. It normally has cutoff bias which is removed through a time-constant circuit by a series of paralleled contacts under the keys whenever any key is pressed. This eliminates noise of any kind in the absence of a signal.

The heart of the vibrato circuit (aside from the low-frequency oscillator) is shown in Fig. 4. The treble input from the reed pickups containing frequencies between 138.6 and 4,186 cycles is fed to the grid of a 6SQ7 (V1) preamplifier in a standard cathode-biased circuit. (The bass signal is fed through a fairly similar stage directly through the main amplifier system without vibrato.) From the plate circuit of the 6SQ7 signals go through C1 to the grid of V2, half of a 6SN7-GT.

A phase splitter of the "long-tailed" type, V2 provides two signals: one from the cathode circuit, across R1; the other from the plate, the two signals 180° apart in phase. At the plate the signal is divided into two parts, one part passing through C2-R2 and the other through C3-R3. The cathode signal is also divided in two paths, one passing through R4-C4 and the other through R5-C5. The plate and cathode signals in each leg are then combined, one through C6-R6 and the other through C7-R7.

The entire purpose of these six legs is to act as a phase-shift network, producing two signal outputs which have a constant phase difference of about 90°. The two outputs appear at the points marked X. Their phase relationship to the original V2 input signal changes, of course, with changes in frequency. But they maintain a difference between themselves of about 90° from about 500 to 15,000 cycles. We can call these signals quadrature voltages, for the vibrato of the Wurlitzer 44 is a phase-modulation system.

The two quadrature voltages are fed to the grids of V3 through blocking capacitors. The two signals are mixed at the plate of V3 and the mixed output is again a single signal taken from C8.

Vibrato-frequency voltage at either 5.7 or 6.7 cycles is obtained from a low-frequency oscillator and phase inverter; it appears in push-pull on the grids of V3. It causes the two triodes to conduct singly. When the phase of the low-frequency signal makes the left grid positive and the right negative, the left

(Continued on page 134)

P. R. MALLORY & CO. INC.  
**MALLORY**

APPROVED PRECISION PRODUCTS

P. R. MALLORY & CO. INC.  
**MALLORY**

APPROVED PRECISION PRODUCTS

P. R. MALLORY & CO. INC.  
**MALLORY**

APPROVED PRECISION PRODUCTS

# You've made them the leader FOR 25 YEARS

Ever since Mallory introduced the first commercial vibrators 25 years ago, they have consistently led the field. They have led . . . and are still leading . . . not only in quality but also in acceptance by service men and manufacturers alike.

**Service men prefer them.** Surveys show that 5 out of 6 service men use Mallory vibrators for replacement work.

**Set manufacturers prefer them.** More Mallory vibrators are used as original equipment than all other makes combined.

**Now better than ever.** New standards of quiet operation are set by the latest Mallory vibrator. A floating mounting for the internal mechanism cushions out hum . . . makes these the quietest vibrators ever.

**See your distributor today.** Ask him about the special Mallory Vibrator Deal—6 vibrators that cover 75% of your replacement jobs. And get a copy of the latest Mallory Vibrator Guide.



### ON AUTO RADIO JOBS BE SURE TO USE . . .



**MALLORY MIDGETROLS®**—Simplified design cuts replacement time to minutes. Accurate tapers, noise-free operation, and excellent stability. Versatile line of single and dual types.



**MALLORY CAPACITORS**—FP electrolytics . . . the only fabricated plate capacitors for replacement work . . . have long life even at 85° C. Plasecaps®, tubular plastic type, have permanent, moisture-proof terminal seals.

P. R. MALLORY & CO. INC.  
**MALLORY**

CAPACITORS • CONTROLS • VIBRATORS • SWITCHES • RESISTORS  
RECTIFIERS • POWER SUPPLIES • FILTERS • MERCURY BATTERIES  
**APPROVED PRECISION PRODUCTS**

P. R. MALLORY & CO. Inc., INDIANAPOLIS 6, INDIANA

P. R. MALLORY & CO. INC.  
**MALLORY**

APPROVED PRECISION PRODUCTS

P. R. MALLORY & CO. INC.  
**MALLORY**

APPROVED PRECISION PRODUCTS

P. R. MALLORY & CO. INC.  
**MALLORY**

APPROVED PRECISION PRODUCTS

# Now!

# KAY-TOWNES

brings you complete

# Protection from the Rear

# Plus

## Quick Rig!

THE  
SNAP-OUT

# first

ANTENNA WITH THE  
EXCLUSIVE  DOUBLE LOCK  
FEATURE!

Boom also folds to take less room in storage and for ease of installation. Sure-grip mast clamp holds in gale-force winds... will not slip or crush.



Exclusive with KAY-TOWNES Elements will not droop, sag or fold up on a Kay-Townes Antenna... they're nested and double locked in position to stay in position.

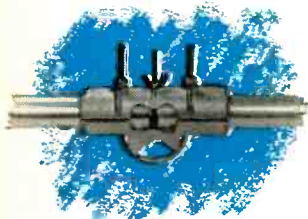

Patents applied for

## New features that make the K-T "REAR-GUARD" America's most advanced TV Antenna!

- ★ Completely Preassembled, it's mechanically safe!
- ★ It snaps in place to stay in place! Elements are double locked in position! A K-T Exclusive!
- ★ No bolts or nuts to tighten on elements!

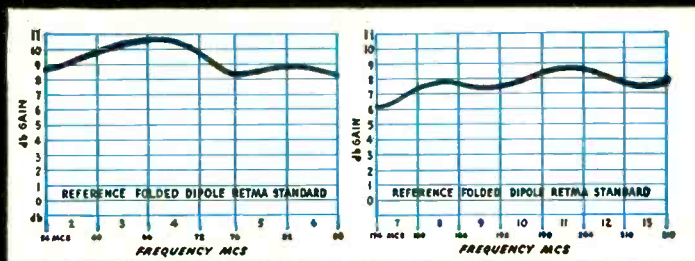

Front to back ratio is better than 25/1 forward lobe 30° or better standing wave ratio 1.2:1 average.

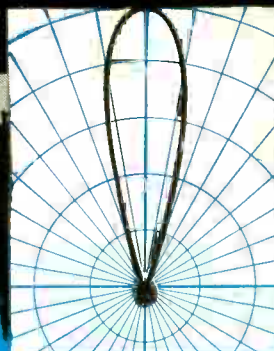

RADIATION CURVE REPRESENTING ALL VHF CHANNELS  
Over 20 to 1 ratio on ALL Channels

## For Quality...

Manufactured and distributed in Canada by Delhi Metal Products, Ltd. Delhi, Ontario



# REAR GUARD

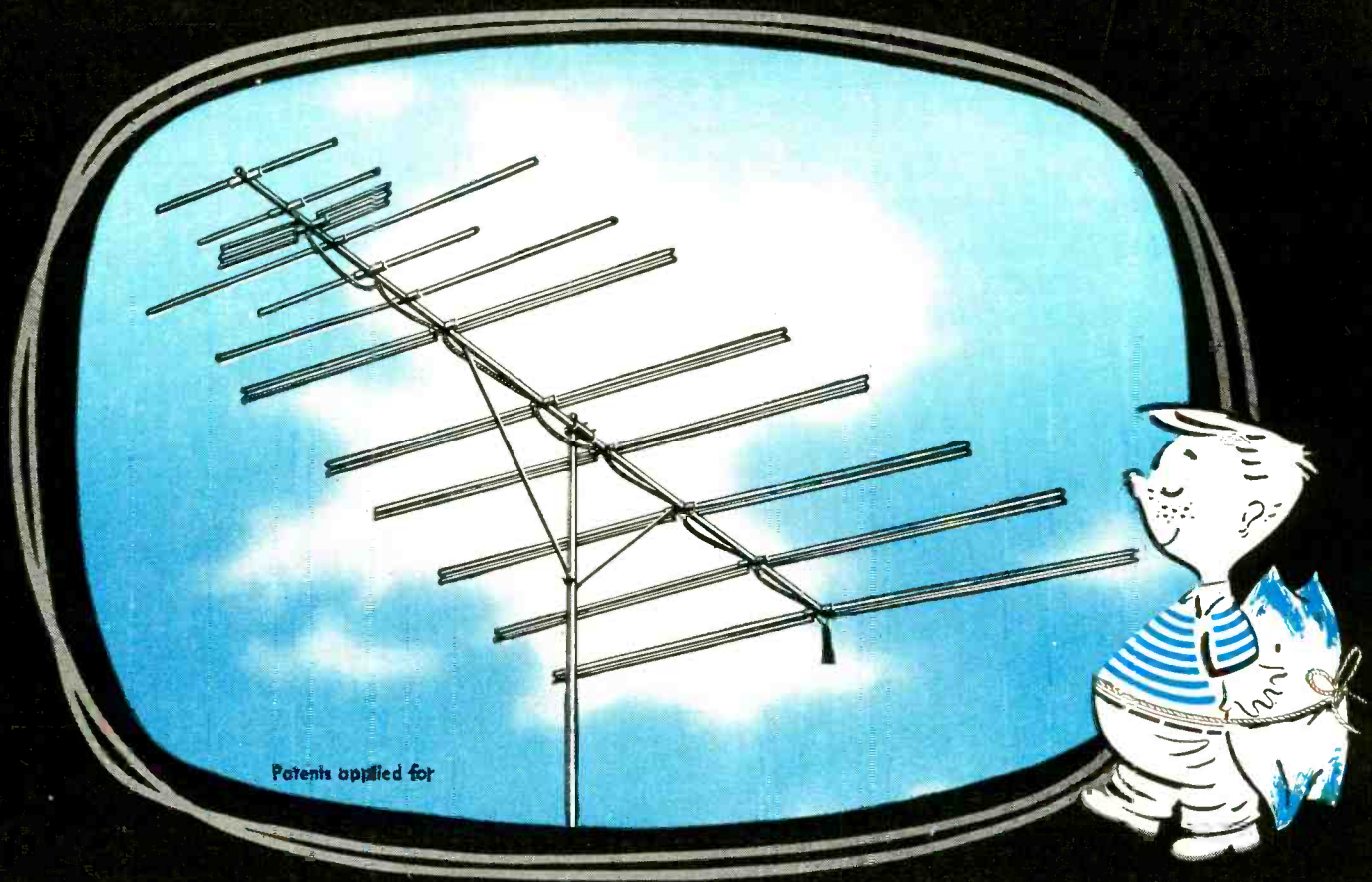

## THE ANTENNA DESIGNED TO REJECT UNWANTED SIGNALS FROM REAR AND SIDES!

In areas where many local stations or stations from near-by cities interfere with reception, ordinary antennas cannot filter out unwanted signals from sides and rear ... BUT the KAY-TOWNES REAR-GUARD, with a front to back ratio far in excess of 20 to 1, is designed for *this* particular job ... to give quality reception even in problem areas.

Add to the REAR-GUARD'S pin point selectivity such exclusive K-T features as double locked and nested elements that cannot droop or sag, Sure-Grip Mast Clamp that holds in gale-force winds without slipping or crushing, extra rigid construction and wood dowel pins and crimped ends that relieve metal fatigue due to vibration ... they all add up to America's most wanted TV Antenna.

... for Performance look to KAY-TOWNES!

The First Name in TV Antennas

# KAY-TOWNES

ANTENNA COMPANY

BOX 593B, ROME, GEORGIA

Use the K-T Line  
of television  
accessories

# NEW! TV DOCTOR

1955  
ATTENTION: NOVICE SERVICEMEN



The new TV DOCTOR was written expressly for the novice by H. G. Cisin, noted TV educator and author. Mr. Cisin has trained thousands of TV technicians, many of them now holding important positions in television. His years of experience are embodied in this valuable book!

TV DOCTOR contains just the info you need to start in TV servicing. No theory, math or formulas, but full of practical information. Copyrighted Trouble Shooting Guide pin-points hundreds of TV troubles, enabling you to diagnose faults without previous experience. Method applies to all TV sets, old and new. Special chptrs. on COLOR TV and U.H.F. Useful data about TV sets, tuners, antennas, lead-ins, interference, safety suggestions. How to read schematic diagrams. Practical hints for prospective service men. Many clear illustrations. Postpaid \$1

## ABC OF COLOR TV

### LEARN COLOR TV THIS EASY WAY!

Just off the Press!



H. G. Cisin's remarkable book takes the mystery out of Color TV. The only book which explains this fascinating new TV development in a simple down-to-earth manner. It actually translates the highly technical descriptions of research scientists into plain everyday language.

Covers basic color principles, compatible color TV system, the color signal, color TV reception, plus practical pointers on color pix tubes, tests, etc. Just the info TV servicemen must have to cash in on this rapidly expanding new field. Profusely illustrated. Postpaid \$1

## FAMOUS "TV CONSULTANT"

### TV Serviceman's Silent Partner



New, easy-to-use way to solve toughest TV troubles. UHF section includes conversions, installations and servicing. Modern alignment methods shown by pictures, diagrams and simple directions, tell exactly what to do and how to do it. Practical pointers on use of all TV Test Instruments. Over 300 pix, raster and sound symptoms. Detailed directions tell where and how to find faulty parts. Over 135 RAPID CHECKS, many using pix tube as trouble locator. 125 illustr. of scope wave forms, diagrams, station patterns, show various defects—take mystery out of TV servicing. NO THEORY—NO MATH—NO FORMULAS—just practical service info. covering all types of TV sets. Postpaid \$2

using pix tube as trouble locator. 125 illustr. of scope wave forms, diagrams, station patterns, show various defects—take mystery out of TV servicing. NO THEORY—NO MATH—NO FORMULAS—just practical service info. covering all types of TV sets. Postpaid \$2

**NEW! 1954 TV TUBE LOCATOR**  
TROUBLE INDICATING TUBE LOCATION GUIDES for over 3000 most popular models from Admiral to Zenith plus PIX TUBES used in each model! 1947 to 1953 models. A storehouse of valuable TV servicing info. priced very low for large volume sales. Postpaid \$1

**NEW! Trouble Shooting PIX GUIDE incl. TV TERMS Explained**  
Sect. 1 is a fully illustrated GUIDE to off-recurring pix faults. Causes and cures explained. Copyrighted. Trouble indicating illustrated chart tells where troubles start in typical TV set—illustrations show resulting faults TV pictures. Sect. 2 explains hundreds of TV terms in non-technical language. Postpaid \$1

**NEW! TV TROUBLE TRACER**  
Each vol. contains different copyrighted "Trouble Indicating TUBE LOCATION GUIDES" of over 500 most popular TV models. Vol. 1 has older sets, vol. 3 newest 1954 models. 40 common picture troubles illustrated, traced to source and cured. Vols. 1, 2 & 3. Postpaid 50c ea.

H. G. CISIN, PUBLISHER

Order from your Jobber today, or if not stocked, order postpaid from:  
Harry G. Cisin, Dept. E-30  
Amagansett, New York

Enclosed find \$..... Send postpaid

Color TV                       TV Pix Guide  
 TV Doctor                       TV Tracer, Vol. 1  
 TV Consultant                   TV Tracer, Vol. 2  
 TV Tube Locator                 TV Tracer, Vol. 3

Name.....  
Address.....  
City..... Zone..... State.....

## AUDIO—HIGH FIDELITY

triode conducts. When the phase is reversed, the right triode conducts. This causes a continuous change in the phase of the V3 output signal over approximately a 90° range.

When the left triode conducts, one signal of a given phase goes through. When the right triode conducts, the other quadrature signal comes through and there has been approximately a 90° phase shift. And the shift is smooth, for the signal emerging from the mixer is the vectorial sum of the two voltages at the plates of the two triodes. If both are conducting equally, as is the case at the 0°, 180° and 360° points of the low-frequency push-pull signal, the mixer output is 45° away from either extreme. Thus the phase at any instant is dependent on the contributions of the two triodes, a function of the relative low-frequency grid signals at that instant. These signals vary in a sine-wave manner, producing a phase swing that is smooth and natural.

The output of the mixer is connected through C8 to a filtering stage which, by using frequency-selective negative feedback, cuts off sharply below 130 cycles so that none of the vibrato-frequency signal can affect the amplifier and speaker.

### Phase-shift circuit

The oscillator is shown in Fig. 5; it is half a 6SL7-GT operating as a standard phase-shift oscillator. The primary control is the two-circuit three-point VIBRATO SPEED switch. In the FAST position R2 is used as the second resistor of the phase-shift network, determining the frequency at about 6.7 cycles. The second section of the switch connects the grid circuit of the other half of the 6SN7-GT, a phase splitter, to the arm of the VIBRATO DEPTH switch. This switch determines how much oscillator signal is sent to the phase splitter.

When the VIBRATO SPEED control is at SLOW, R1 is in the phase-shift network, making the oscillator frequency about 5.7 cycles. When it is in the OFF position, the output section of the switch disconnects the phase-splitter grid from the oscillator output.

Since the rate of phase swing and apparent music signal frequency swing depend on the oscillator frequency, the SPEED switch determines the vibrato rate in the music. And because the oscillator output determines how much total phase shift will occur, the DEPTH switch determines how deep or wide the vibrato will be.

This vibrato circuit effectively does the same job as the Hammond vibrato scanner, but it does the job electrically, without moving parts, in a manner which can only be called elegant. Such a vibrato, with its ease of construction and compactness, does an almost impossible job which has puzzled many who wished to add automatic vibrato to guitar amplifiers and the like, only to be forced to settle for an inferior amplitude tremolo. END

## EVERY PRICE SLASHED!!!

For New Year Stock Clearance!  
T.V. WOOD CABINETS Beautiful Mahog. veneer table model. Inside: 19 1/2" x 15 1/2" H. x 19" deep. Opening: 13 1/2" x 10 1/2" H. With safety glass & 12 1/2" mask. Adaptable to larger screen sets. makes \$5.95  
HI-FI 12"-15" SPEAKER BAFFLE.....  
"OUNCER" OUTPUT XFMR (1 1/2"x7 1/2")  
Beam power tube to 3.2 ohm voice coil.....ea. \$ 79  
1" FIBREGLASS CABINET LINING.....Finest acoustical material, 36" wide—per run.....ft. 1.15  
PLASTIC GRILLE CLOTH Beautiful Gold or Mahogany veneer. Cut to order—50c sq. ft.  
CRYSTAL HAND MIKE hi-impedance. Rugged moulded bakelite case; 6 ft. shield cable..... 3.95  
20 PUSH-BACK WIRE Red, Yellow, Blue or Black.....100 ft. roll 89c; 1000 ft. \$6.95  
MAGNET WIRE #32 P.E., 12 oz. spool.....98  
#30 P.E. ....100 ft. spool—ea. 29c; 4/ 1.00  
#12 S.C. enamel.....50 ft. \$1.29; 100 ft./ 1.98  
POWER RHEOSTATS Brand New: 1/2" shafts.  
25 Watt—75, 100, 150, 250, 350 or 370 ohms.....ea. 69  
50 Watt—15 ohms.....ea. \$1.29; 6/ 5.95  
50 Watt—32 ohms.....ea. \$1.49; 6/ 6.95  
50 Watt—1250 ohms.....ea. \$1.49; 6/ 6.95  
WOOD CABINET & CHASSIS FOUNDATION Handsome walnut veneer. Inside: 11 1/2" x 7 1/2" x 6 1/2" 4" sq. dial opening (right). PLUS matching \$1.75  
6 tube punched chassis & back.....SET

## !! ALNICO MAGNETS !!

Just a few of the many types always in stock or cut to order

CYLINDRICAL: 5/8" O.D.	
3/16" I.D., 7/16" L.	ea. \$ 79
POLISHED BAR: 9/16" x 7/32" x 3/12	
12	\$1.00; 100/ 7.50
"U" TYPE: 3/4" x 3/8" x 1/2"	ea. 12/ 5.00
LARGE "U" TYPE: 2" x 1 1/2" x 3/4"	ea. \$1.39; 6/ 5.95
ROUND BAR: 1 1/4" x 3/16" O.D., pol.	ea. 69c; 3/ 1.98

ALNICO "CHIP" MAGNETS small irreg. shapes. Approx. 90 pcs/oz. 15c/oz. \$1.50/lb.

ALNICO MAGNET KIT Powerful Bar, Block, Rod, "U", etc. Kit of 10 ass'd..... 1.98  
(WRITE FOR LATEST "ALNICO" SUPPLEMENT)

## !! JUMBO RADIO-ELECTRONICS PARTS KIT !!

OVER 10,000 ALREADY SOLD !!  
WANT TO SAVE REAL MONEY ON PARTS? Well, here's a "GOLD-MINE" of new & surplus inventory odds & ends AT A FRACTION OF ORIGINAL COST! 17 FULL LBS. OF CONTROLS, SOCKETS, SWITCHES, WIRE, RESISTORS, CAPACITORS, PHOTOFACTS, TV & RADIO DIAGRAMS, COILS, TRIMMERS, PLUS DOZENS OF OTHER ITEMS!! \$3.95 (shpg. wt. 20 lbs.)

"DIRECT FACTORY SPEAKER REPAIRS SINCE 1927"  
Min. Order \$3.00. 20% deposit req. on all C.O.D.'s. Full remittance with foreign orders. Please add sufficient postage—excess refunded.

**LEOTONE RADIO CORP.**  
67 Dey Street  
New York 7, N. Y.

## SEE THE LATEST IN Electronics EQUIPMENT

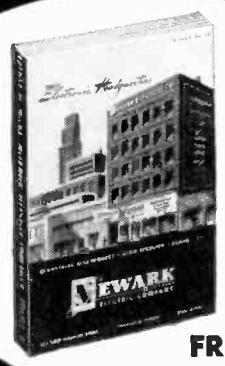

FREE

Send for Newark's 1955 Catalog

Select the fast, easy, dependable way from the New Electronics Reference Book — full of the latest releases and largest selections of High Fidelity, Radio, TV, Amateur and Electronics equipment.



Dept. RE-1 223 W. Madison, Chicago 6, Ill.

# SELLING OUT!

# COMPLETE STOCK

of Nationally Advertised Radio & Television Testing Equipment, Parts, and Electrical Appliances to be sold regardless of cost.

**This is the opportunity of a lifetime!**

## PRICES REDUCED UP TO 80%

Below mentioned units are not kits, but all factory wired and brand new. Some models have been discontinued by the manufacturer, but every one is factory sealed and carries a one year, factory guarantee.

	Model	Dealers Net Price	Dur Selling-Out Price
SUPERIOR	1553 Multitester	\$ 29.25	\$ 14.50
"	P8-100 Multitester	28.40	15.00
"	680-5000 Ohms per volt Multitester	27.65	14.50
"	670-A Supermeter	28.40	22.75
"	TV-11 Tube Tester	47.50	37.95
"	660 Signal Generator	42.95	34.50
"	TV-50 Genometer	47.50	38.00
"	Television Bar Generator	39.95	32.50
METROPOLITAN	111, A.C.-D.C. Multitester	21.50	11.50
"	999, A.M.-F.M. & Television Signal Generator A.C. Operated	39.50	19.50
TEST CRAFT	TC-10, A.C.-D.C. Multitester	14.85	9.85
"	TC-50, Combin. Tube and Set Tester	49.50	29.50
"	TC-75, Combin. Test Speaker and Signal Tracer	39.50	24.50
SUPREME	543-S, Multitester	24.50	14.50
RADIO CITY PRODUCTS	322, Tube Tester	41.50	29.50
"	461 AP Multitester	39.50	19.95
"	668, Electronic Multitester	74.50	39.50
"	665, A.C.-D.C. V.T. Volt-Ohm Capacity	95.40	59.50
GENERAL ELECTRONICS	200, A.M.-F.M. & Television Signal Generator, A.C. operated	39.50	24.50
WESTON	689-IF, Ohmmeter, incl. leather case	36.50	19.85
SHALLCROSS	630, Wheatstone Resistance Bridge	145.00	75.00
"	637, Kelvine Wheatstone Res. Bridge	185.00	100.00
REINER ELECTRONICS	333, D.C. Volt-Ohm Milliammeter	26.95	14.50
ELECTRONIC MEASUREMENTS CORP.	102, Volometer	14.90	11.90
"	104, Volometer	26.95	21.50
"	106, Vacuum Tube Voltmeter	35.90	28.75
"	205-P, Tube Tester	47.50	37.50
"	206-P, Mutual Conductance Tube Tester	83.50	67.50
"	600, Oscilloscope	99.50	79.50
GRUEN	2 1/2" D.C., D'Arsonval Type, 1 Milliammeter, Meter	9.95	2.95
WESTON	507, F.S.-1.2 Milliam. Meter	12.95	3.95
TRIPLETT	331-JP 30 Amperes, Meter	12.95	4.95
MARION	3" D'Arsonval Type 1 Milliam. with calibrated Volt-Ohm Current Scale, Meter	12.95	3.95
ACRO	Radio & Phonograph Chassis Cradles	6.95	2.95
DUOTONE	8" Glass Recording Discs, sold only in cartons of 24	.75 each	.15
"	12" Metal Recording Discs, sold only in cartons of 50	1.50 each	.30
HOLYOKE	180 ohm resistance line cords, 6 feet with plug.. No. 22, stranded, tinned, copper push-back wire on 500" spools.....each spool	1.25 each 5.00	.35 2.50
SUPREME	3 speed recordplayers, with life-time needle, portable case, speaker & amplifier	reduced to	14.95
DUOSONIC	Capri, 3 speed recordplayers, cartridge with double-needle, plastic case, speaker and amplifier	reduced to	19.95
MAGUIRE	Recordchanger	37.50 each	9.95
CAPITOL	Automatic Pop Up Toaster, fully guaranteed	19.95 each	9.95
NELSON	Electrical Waffle maker	reduced to	3.95
CUCKOO CLOCK	Genuine, imported Black Forest, hand-carved, cuckoos every 15 minutes	reduced to	7.95
GLO	Electronic, oscillating massager with infra-red heat combined	8.95 each	3.95
"	Teletron Radio, plastic cabinet	reduced to	9.95
ROTO-BROIL 400 MODEL IMPERIAL DELUXE..	Fully Automatic Rotisserie and Broiler Combination, 7-way, with time clock, 3 heat element, double powered	69.50	29.95

All prices are f.o.b. New York, 20% deposit with order, balance C.O.D., or full remittance with order

WRITE, PHONE OR WIRE YOUR ORDER FOR IMMEDIATE DELIVERY, QUANTITIES ARE LIMITED.

## METROPOLITAN ELECTRONICS & INSTRUMENT CO.

106 Fifth Ave., New York 11, N. Y.

Telephone: OREGON 5-1707  
Cable Address: METRONICS

### TEST-CRAFT Model TC-10

Quality Multitester

AC and DC Voltage Ranges: 0-5/15/150/1500/3000 Volts. DC Current Ranges: 0-5/50 ma. 0-1.5 Amps. Resistance Ranges: 0-100 ohms, 0-100 K. Size: 6"x3 1/2"x2. Complete with batteries and full instructions. **Only \$9.85**

Reg. \$14.85

### Model 999 Combination

F. M., A. M. and Television Signal Generator A.C. Operated

Generates R.F. frequencies from 150 kilocycles to 50 megacycles. Positive action attenuator provides effective output control at all times. R.F. is obtainable separately or modulated by the Audio Frequency.

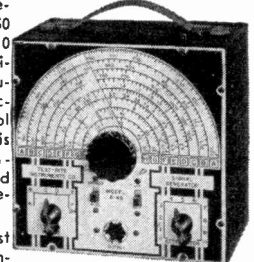

Complete with test leads and full instructions.

Reg. \$39.50 **Only \$19.50**

### TEST CRAFT Model TC-50

Tube and Set Tester

tests all tubes up-to-date incl. 4, 5, 6, 7L, octals, loctals, television, magic eye, thyrtators, single ended, floating filament, mercury vapor, new miniatures, etc.

Multimeter Specifications: AC and DC Voltage Ranges: 0-1-100-1000-5000. DC Current Ranges: 0-10/100/1 Amp. Low Resistance Range: 0-10,000 Ohms. Medium Resistance Range: 0-100,000 Ohms. High Resistance Range: 0-1 megohm.

Complete with test leads and full instructions. **Only \$29.50**

Reg. \$49.50

### TEST CRAFT Model TC-75

Combination Test Speaker and Signal Tracer



Reg. \$39.50 **Only \$24.50**  
plus speaker substitution plus resistor tester plus field substitutor plus condenser tester plus voice coil substitutor plus output indicator tuffon  
Complete with full instructions

# TRANSVISION

Now brings you a compact  
Flyback — Yoke — Continuity  
Tester...in 1 low cost unit



for only  
**\$24.95**

(A \$59 value)

- Checks low and high impedance yokes and flybacks.
- Detects even one shorted turn.
- An improved Continuity Checker: Checks condensers for opens, electric shorts, or leakage. Ordinary continuity testers will not do this.

cal shorts, or leakage. Ordinary continuity testers will not do this.

## TV Component Tester

PERFORMS  
SIX  
VITAL  
FUNCTIONS

You get \$176 worth of Testing and Repair Instrumentation in 1 compact unit for the amazing low price of only . . .

**\$49.95**



It's terrific as a

- PICTURE TUBE TESTER
- FLYBACK & YOKE TESTER
- SELENIUM RECTIFIER TESTER
- CONDENSER TESTER
- CONTINUITY TESTER
- PICTURE TUBE REACTIVATOR

## FIELD STRENGTH METER

For Battery Operation and 110V AC

Saves 50% of installation cost . . .  
Measures pic signal strength directly from antenna . . .  
Identifies TV, FM, TVI signals . . .  
Has 12 channel selector; multiplier switch for weak signal areas . . .  
Range, 10-50,000 microvolts . . .  
Must include fringe areas, UHF or VHF . . .

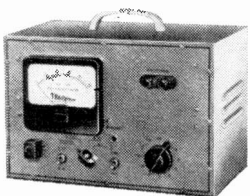

Money Back Guarantee

Model FSM-5B, for Battery Operation and 110V AC. Weight 22 lbs. . . . . net \$89.

TRANSVISION, Inc., New Rochelle, N.Y.  
JOBBER INQUIRIES INVITED

## ELECTRONICS

# LIGHT-SENSITIVE NEON-TUBE CIRCUITS

*Interesting characteristic permits use as "photocell"*

By JOSEPH BRAUNBECK

It is not generally known that most neon lamps, especially the low-voltage types, are considerably light-sensitive and may be used successfully as photocells for experiment.

Illuminating a neon lamp results in

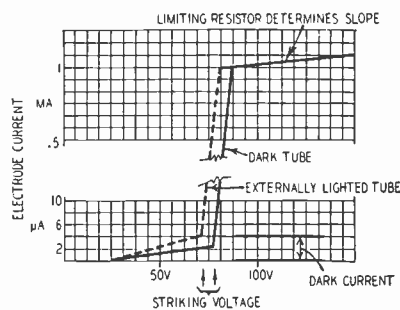

Fig. 1—Neon tube characteristics.

a decrease in the striking voltage and in an increase in the so-called "dark current." This dark current is the current which flows through the lamp when the voltage across the electrodes is not sufficient for firing. Fig. 1 shows these characteristics.

The simplest circuit for experimenting with a light-sensitive neon lamp is shown in Fig. 2. It consists of a 100,000-ohm potentiometer for varying the supply voltage, a neon lamp, a limiting resistor and a sensitive meter. Any instrument having a deflection of 50 microamperes or less is usable. When the neon lamp is illuminated with a flashlight or exposed to sunlight, the pointer of the instrument will move a little. Currents up to 5 microamperes can be obtained.

Though this is an interesting experiment, such a circuit is not useful for controlling any device by light—the current flow is too slight.

Fig. 3 shows an amplifier with a relay in the plate circuit, controlled by a light-sensitive neon lamp. When light falls upon the neon lamp, the dark current increases. The resulting voltage drop across the 50-megohm grid re-

sistor biases the amplifier tube to cut-off. When the illumination is removed, the bias disappears and plate current flows, energizing the relay. Adjust the neon-lamp voltage for maximum sensitivity when the hookup is finished. The circuit will operate from daylight in a shadowy room or from a 60-watt bulb at 2 feet.

If there is no need for extreme sensitivity, this circuit can be used in much equipment containing photocells. The relay should have a resistance of about 1,000 ohms or more and a sensitivity of about 10 ma or less.

Instead of the relay, or in series with it, a milliammeter with about a 10-ma full-scale deflection may be used for comparing light intensities.

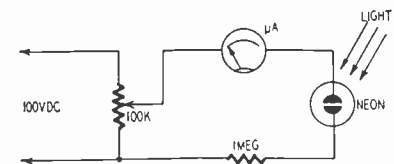

Fig. 2—Simple experimental circuit.

If a 50-megohm resistor is not obtainable, one can be made up of several smaller values. Any triode out of your junkbox can be used for the amplifier tube.

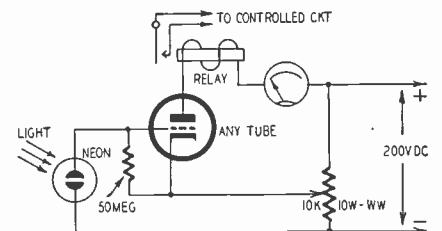

Fig. 3—Improving circuit sensitivity.

A more sensitive circuit using the 0A4-G cold-cathode trigger tube is shown in Fig. 4. When the neon lamp is illuminated, C1 is charged by the dark current. After reaching a critical

# BUILD 15 RADIOS AT HOME ONLY \$19.95 COMPLETE

With the NEW IMPROVED 1955 Progressive Radio "EDU-KIT"  
Now Includes: HIGH FIDELITY SIGNAL TRACER, CODE OSCILLATOR



## FREE EXTRAS

- ELECTRICAL & RADIO TESTER
- ELECTRIC SOLDERING IRON
- RADIO TROUBLE-SHOOTING GUIDE
- TV BOOK
- F.C.C. TRAINING
- QUIZZES
- CONSULTATION SERVICE
- GUIDE TO HIGH FIDELITY

**Absolutely No Knowledge  
of Radio Necessary**

**NO ADDITIONAL PARTS NEEDED  
ATTRACTIVELY GIFT-PACKED  
EXCELLENT BACKGROUND FOR TV**

Used in 79 Countries **10-DAY MONEY-BACK GUARANTEE**

## WHAT THE PROGRESSIVE RADIO "EDU-KIT" OFFERS YOU

The Progressive Radio "Edu-Kit" offers you a home study course at a rock bottom price. Our Kit is designed to train Radio Technicians, with the basic facts of Radio Theory and Construction Practice expressed simply and clearly. You will gain a knowledge of basic Radio Principles involved in Radio Reception, Radio Transmission and Audio Amplification.

You will learn how to identify Radio Symbols and Diagrams; how to build radios, using regular radio circuit schematics; how to mount various radio parts; how to wire and solder in a professional manner. You will learn how to operate Receivers, Transmitters, and Audio Amplifiers. You will learn how to service and trouble-shoot radios. You will learn code. You will receive training for F.C.C. license.

## THE PROGRESSIVE RADIO "EDU-KIT" IS COMPLETE

You will receive every part necessary to build 15 different radio sets. Our kits contain tubes, tube sockets, chassis, variable condensers, electrolytic condensers, mica condensers, paper condensers, resistors, line cords, selenium rectifiers, tie strips, coils, hardware, tubing, instruction manuals, etc.

Every part that you need is included. These parts are individually packaged, so that you can easily identify every item. A soldering iron is included, as well as an Electrical and Radio Tester. Complete, easy-to-follow instructions are provided. All parts are guaranteed, brand new, carefully selected and matched.

In addition, the "Edu-Kit" now contains lessons for servicing with the Progressive Signal Tracer, F.C.C. instructions, quizzes. The "Edu-Kit" is a complete radio course, down to the smallest detail.

## THE PROGRESSIVE RADIO "EDU-KIT" IS USED THROUGHOUT THE WORLD

The Progressive Radio "Edu-Kit" is used in every state of the U.S.A., the District of Columbia, Alaska, Virgin Islands, Puerto Rico, Hawaii, Guam and the Canal Zone. It is used in 79 countries in all parts of the world, including Canada, Philippines, Korea, South Africa, Saudi Arabia, Venezuela, Israel, France, England, Japan, India, etc. The "Edu-Kit" is very popular with American servicemen stationed overseas.

The "Edu-Kit" is designed to work with satisfaction anywhere. Consequently, its power supply operates on 105-125 volts, AC or DC. Also, since some countries use other voltage supplies, an adaptor for 210-250 volts AC or DC is available for \$2.50.

The U.S. Post Office permits COD shipments only within the U.S. and U.S. possessions and territories. Shipments to

other countries and to Army Post Office and Fleet Post Office addresses must be paid for in advance.

There is an extra charge of \$1.00 for shipment outside of continental U.S.A., for special handling and packaging. Send check on U.S. bank, money order (U.S. or International) Unesco coupons or currency.

## THE KIT FOR EVERYONE

The Progressive Radio "Edu-Kit" was specifically prepared for any person who has a desire to learn Radio. The Kit has been used successfully by young and old in all parts of the world. It is not necessary that you have even the slightest background in science or radio.

The Progressive Radio "Edu-Kit" is used by many Radio Schools and Clubs in this country and abroad. It is used for training and rehabilitation of Armed Forces Personnel and Veterans throughout the world.

The Progressive Radio "Edu-Kit" requires no instructor. All instructions are included. All parts are individually boxed, and identified by name, illustration and diagram. Every step involved in building these sets is carefully explained. You cannot make a mistake.

## TROUBLE-SHOOTING LESSONS

Trouble-shooting and servicing are included. You will be taught to recognize and repair troubles. You will build and learn to operate a professional Signal Tracer. You receive an Electrical and Radio Tester and learn to use it for radio repairs. While you are learning in this practical way, you will be able to do many a repair job for your neighbors and friends, and charge fees which will far exceed the cost of the "Edu-Kit". Here is your opportunity to learn radio quickly and easily, and have others pay for it. Our Consultation Service will help you with any technical problems which you may have.

## PROGRESSIVE TEACHING METHOD

The Progressive Radio "Edu-Kit" comes complete with instructions. These instructions are arranged in a clear, simple and progressive manner. The theory of Radio Transmission, Radio Reception, Audio Amplification and servicing by Signal Tracing is clearly explained. Every part is identified by illustration and diagram. You will learn the function and theory of every part used.

The Progressive Radio "Edu-Kit" uses the principle of "Learn by Doing". Therefore you will build radios to illustrate the principles which you learn. These radios are designed in a modern manner, according to the best principles of present-day educational practice. You begin by building a simple radio. The next set that you build is slightly more advanced. Gradually, in a progressive manner, you will find yourself constructing still more advanced multi-tube radio sets, and doing work like a professional Radio Technician. Altogether you will build fifteen radios, including Receivers, Transmitters, Amplifiers, Code Oscillator and Signal Tracer. These sets operate on 105-125 V. AC/DC.

## SCHOOL INQUIRIES INVITED

The "Edu-Kit" has met the test of years of use by individuals and groups in every part of the world. Among constant users of the "Edu-Kit" are Schools, Clubs, Boy Scout Troops, etc. It is used for training and rehabilitation of Armed Forces Personnel and Veterans throughout the world.

Mr. Crite Mason, Jr., Director of Radio Department, Crite College, writes: "Your records will tell you just how many kits we have used in the past three years and I want you to know that we have had excellent success in using them in our training program. Your kits serve many purposes, and we are finding more uses for them as the months come and go. Thanks."

## Comments from Satisfied Users of the Progressive Radio "Edu-Kit"

Cyril Chupina, 130 Grant St., OLYPHANT, PENNA.: "I wish to thank you for that marvel of an "Edu-Kit" which you have sold me. I have put all of the radios together, and have fixed two of my own sets with the Signal Tracer. I have more than gotten my money out of it in less than two months, along with quite a bit of enjoyment."

"I have been looking for something that would interest me and help me for the future. Through your help I think I have found it in Radio."

Goldburn P. Maynard, Box 632, Pedro Miguel PO, PARAIISO, CANAL ZONE: "Through this medium I would like to say that I am very glad that I sent for your "Edu-Kit." I have studied the lessons very carefully and have built many sets."

"I am now enjoying the Transmitter that I built recently. Through this "Edu-Kit," I am now in the Radio business and progressing nicely. Enclosed are my quizzes that I answered honestly."

Dorothy M. Walker, 2455 N.W. Quimby St., PORTLAND, OREGON: "I have enjoyed reading and studying the "Edu-Kit" instruction Book, and have just completed Set #4 with excellent results."

"The new you greatly under-estimate the value of the knowledge that the Kit offers. I received a promotion to Inspector in the Electronics Dept. of the firm where I am employed. This happened just one week after I received the "Edu-Kit." In that time I had completed Sets #1 and #2. My employer was quite interested in my new-found knowledge."

Joseph E. Stasatis, 25 Poplar Place, WATERBURY, CONN.: "I have been working on the Radio Kit and have learned much. Your course has saved me a great deal of money. I was ready to spend \$240.00 for a course, but I found your ad and sent for your "Edu-Kit."

"I have repaired several sets for my friends, and made money. The "Edu-Kit" paid for itself. Your Troubleshooting Guide alone is worth the money that I paid for your course."

Robert L. Shuff, 1534 Monroe Ave., HUNTINGTON, W. VIRGINIA: "Thought I would drop you a few lines to say that I received my "Edu-Kit," and was really amazed that such a bargain can be had at such a low price. I have already started repairing radios and phonographs. My friends were really surprised to see me get into the swing of it so quickly. The kit is really swell and finds the trouble if there is any to be found."

Clark Smith, 913 Willbanks Ave., E. GADSDEN, ALA.: "This is to let you know how much I am enjoying your Kit. It is the only Kit that I have seen, that is so complete. I believe the kit is worth much more than you charge for it. It is very easy to understand. It has helped me to understand my Navy Reserve Training better."

Bill Leonard, famous CBS commentator, 481 Madison Ave., N.Y., N.Y.: "I certainly did receive one of your Radio "Edu-Kits" and I'm happy to report that my ten-year-old boy, with very little supervision, built a complete three-tube receiver—one that works—in less than three hours. He's mighty proud and you should be too. Your instructions are clear and the electronic material wholly adequate for educational purposes, and I'm speaking as a radio ham operator of twenty years standing."

## LEARN PRACTICAL ELECTRONICS . . . WITH THE PROGRESSIVE RADIO "EDU-KIT"

- \* YOU BUILD A CODE OSCILLATOR
- \* YOU BUILD A PROFESSIONAL SIGNAL TRACER
- \* YOU BUILD 15 RADIOS
- \* YOU RECEIVE MANY FREE GIFTS
- \* YOU LEARN TROUBLE-SHOOTING
- \* YOU GET OUR FREE CONSULTATION SERVICE
- \* YOU RECEIVE QUIZZES

**MAIL  
TODAY  
YOUR ORDER  
SHIPPED SAME  
DAY RECEIVED**

PROGRESSIVE "EDU-KITS" INC.  
497 UNION AVE., DEPT. RE-100, BROOKLYN 11, N.Y.

- 10-Day Money-Back Guarantee. Include ALL FREE EXTRAS
- Send "Edu-Kit" Postpaid, I enclose full payment of \$19.95 (U.S.A. only).
- Send "Edu-Kit" Postpaid, I enclose full payment of \$20.95 (Outside U.S.A.).
- Send 210-250 V. Adapter for "Edu-Kit"—\$2.50.
- Send "Edu-Kit" C.O.D. I will pay \$19.95 plus postage (U.S.A. only).
- I wish additional information describing "Edu-Kit". No Obligation.
- Send me FREE Radio-TV Servicing Literature. No Obligation.

Name \_\_\_\_\_  
Address \_\_\_\_\_

**PROGRESSIVE "EDU-KITS" INC.**  
497 UNION AVE., Dept. RE-100 Brooklyn 11, N.Y.

**AMPHENOL**

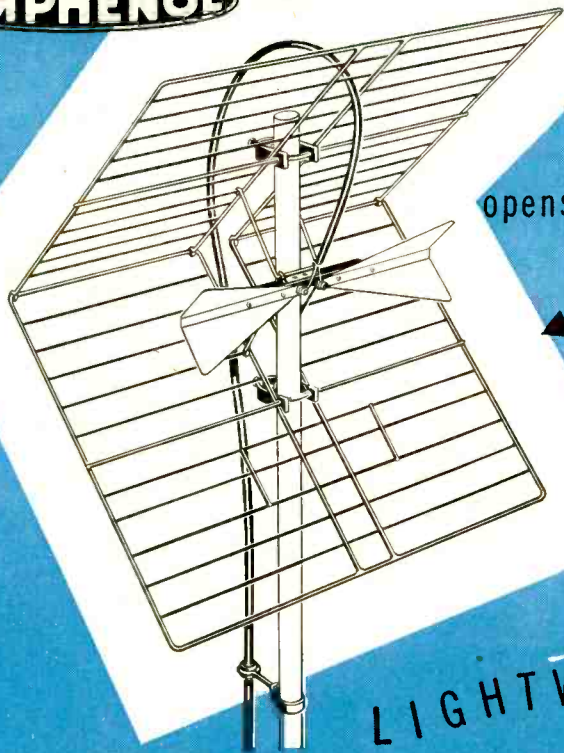

opens like a book!

model 114-093

**LIGHTWEIGHT**  
**UHF CORNER REFLECTOR**

- easy installation!
- high gain!
- fine directivity!

Fast and easy installation, high db gain, exceptionally fine directivity—these aren't new features, by themselves, but when combined in a single fine antenna, that's news! They have made the AMPHENOL Lightweight Corner Reflector popular alike with dealers, servicemen and set owners. Installers are particularly happy with the Lightweight. When the reflector screens are opened (like a book) the element snaps out and the antenna is easily attached to the mast That's all there is!

Gain rises from 8 db at 470 mc to 12½ db at 890 mc for the single bay model. When two Lightweights are stacked these figures are 11 db to 15 db. Directivity patterns reveal a single strong forward lobe on each channel, single and stacked.

Reflector screens are made of sturdy electro-galvanized steel with a positive rust-resistant chromate conversion seal. The element is heavy gauge aluminum. The Lightweight is a rugged antenna which will give many years of fine service!

All these PLUS features at only \$9.85 list each.

AMERICAN PHENOLIC CORPORATION  
Chicago 50, Illinois

In Canada: AMPHENOL CANADA LTD.,  
Toronto

**AMPHENOL**

**ELECTRONICS**

voltage, C1 discharges across the grid-cathode circuit of the 0A4-G and fires that tube.

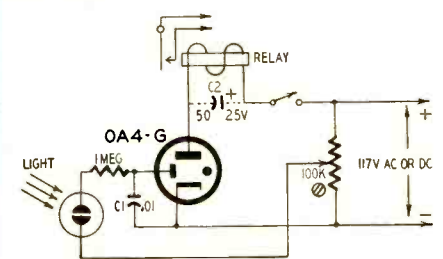

Fig. 4—Circuit uses 0A4G trigger tube

The circuit may be operated from an a.c. or d.c. supply. If a.c. is used, C2 is necessary to smooth the relay current. Anode current will flow only as long as light is present. For d.c. operation, C2 may be omitted. Plate current will flow until the circuit is interrupted by the switch.

For these experiments you may use any type neon lamp with an ignition voltage lower than 100. This is because lamps designed for low striking voltages have activated electrodes, increasing their light sensitivity. Higher power illumination glow lamps perform especially well because their greater electrode surface results in increased sensitivity. A built-in resistor does not affect performance. I recommend types NE-34 and NE-40.

As sensitivity varies widely for lamps of the same type, it is advisable to try different lamps until you find the best. It is also possible to build a relaxation oscillator for testing, as shown in Fig. 5. The light-sensitive neon lamp functions as a variable resistor for a re-

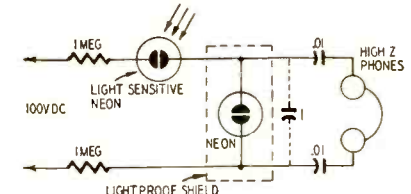

Fig. 5—Relaxation oscillator circuit.

laxation oscillator using another neon lamp. To avoid confusing results, the second lamp has to be shielded against light, as it might also be sensitive. Illumination of a light-sensitive tube in this circuit increases the oscillator frequency. With a neon lamp of good sensitivity the frequency varies from about 1 cycle (darkness) to about 1,000 cycles (sunlight).

This circuit is also useful for testing and comparing conventional phototubes. As neon lamps sometimes show a definite polarity, try each lamp "both ways." If you wish to compare lamps more accurately, the frequency of the relaxation oscillator may be lowered by adding a large charging capacitor of about 1 µf. This capacitor is indicated by the broken lines. If it is not in the circuit, the electrode capacitance of the second neon lamp acts as a charging capacitor.

END

# Jerrold TV Multi-Outlet SYSTEM

...for fast, low-cost installation  
in motels, apartments, clubs



## DISTRIBUTION AMPLIFIER

Type ABD-1—Amplifies antenna signal 25db, channels 2-13. Sensitive 5-tube cascade circuit. Exceptionally low noise—only 6db (approaching theoretical minimum). Mounts indoors. 115 volt operated. 72 or 300 ohm antenna input. 72 ohm output to "Splitter." Flat response for color.

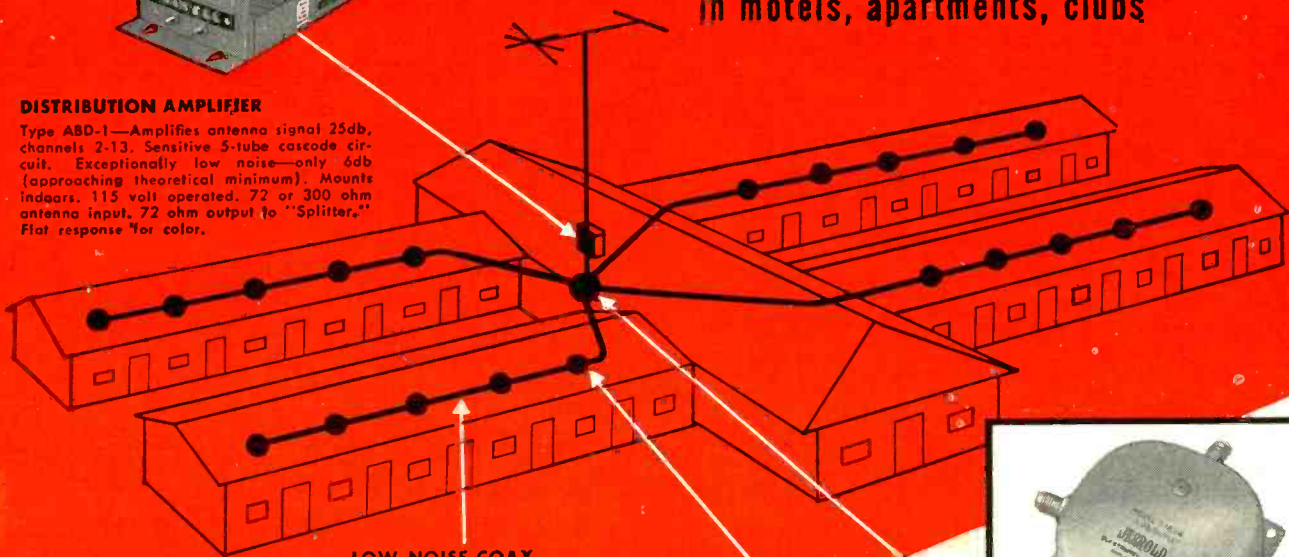

## LOW-NOISE COAX

Use any length to interconnect receiver, Amplifier and Line Tap compensate for line losses.



## LINE SPLITTER (if needed)

Type T1604—Equally divides amplifier output up to 4 ways. No tubes. Cannot overload.

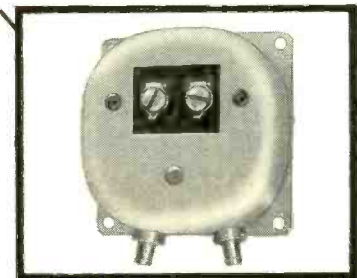

## LINE TAP IMPEDANCE MATCHER

One for each receiver. Compensates for line response tilt. Completely isolates receivers from each other. Matches 72 ohm feed line to 300 ohm set. No tubes.

Here's a TV *Multi-Outlet* distribution system that gives clean, snow-free reception to every receiver . . . with an increase in signal strength and with signal-to-noise ratio maintained in the bargain. A single *Multi-Outlet* Jerrold System can feed 20 receivers, and Jerrold Distribution Amplifiers can be grouped for larger installations. Reception at each receiver, on all channels, will be the best the antenna can provide in the area.

The complete Jerrold Distribution System designed for 24 hour operation is built to the same standards as larger Jerrold Community TV systems which serve as many as 5000 sets from a single antenna. Yet a Jerrold *Multi-Outlet* System costs less than half the price of ordinary installations using unsightly separate antennas for each receiver.

Investigate this profitable field now! Send for free catalog sheets describing all components.

## INSTALLATION MADE EASY

Profusely-illustrated booklet tells all about distribution systems— theory, cost estimates, installation, etc. Free with each ABD-1 Amplifier. 25c separately. Write for your copy today.

# JERROLD

JERROLD ELECTRONICS CORPORATION  
26TH & DICKINSON STS.  
PHILADELPHIA 46 PA.

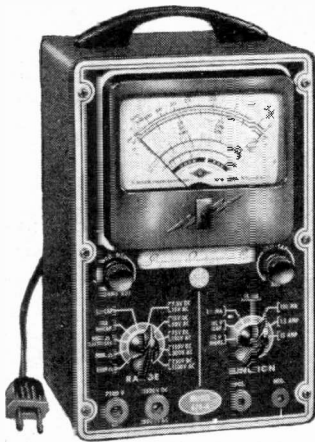

Measures 6 1/4" x 9 1/2" x 4 1/2"

Superior's new  
Model 670-A

# SUPER METER

A COMBINATION VOLT-OHM MILLIAMMETER PLUS  
CAPACITY REACTANCE INDUCTANCE AND DECIBEL MEASUREMENTS

**SPECIFICATIONS:**

D.C. VOLTS: 0 to 7.5/15/75/150/750/1,500/7,500 Volts  
A.C. VOLTS: 0 to 15/30/150/300/1,500/3,000 Volts  
OUTPUT VOLTS: 0 to 15/30/150/300/1,500/3,000 Volts  
D.C. CURRENT: 0 to 1.5/15/150 Ma. 0 to 1.5/15 Amperes  
RESISTANCE: 0 to 1,000/100,000 Ohms 0 to 10 Megohms  
CAPACITY: .001 to 1 Mfd. 1 to 50 Mfd. (Good-Bad scale for checking quality of electrolytic condensers.)  
REACTANCE: 50 to 2,500 Ohms 2,500 Ohms to 2.5 Megohms  
INDUCTANCE: .15 to 7 Henries 7 to 7,000 Henries  
DECIBELS: -6 to +18 +14 to +38 +34 to +58

**ADDED FEATURE:**

Built-in ISOLATION TRANSFORMER  
reduces possibility of burning out  
meter through misuse.

The Model 670-A comes  
housed, in a rugged  
crackle-finished steel  
cabinet complete with  
test leads and operating  
instructions.

**\$2840**  
NET



Superior's new  
Model TV-11

# TUBE TESTER

**SPECIFICATIONS:**

- ★ Tests all tubes including 4, 5, 6, 7, Octal, Lock-in, Peanut, Bantam, Hearing Aid, Thyatron Miniatures, Sub-miniatures, Novals, Sub-minars, Proximity fuse types, etc.
- ★ Uses the new self-cleaning Lever Action Switches for individual element testing. Because all elements are numbered according to pin-number in the RMA base numbering system, the user can instantly identify which element is under test. Tubes having tapped filaments and tubes with filaments terminating in more than one pin are truly tested with the Model TV-11 as any of the pins may be placed in the neutral position when necessary.
- ★ The Model TV-11 does not use any combination type sockets. Instead individual sockets are used for each type of tube. Thus it is impossible

to damage a tube by inserting it in the wrong socket.

- ★ Free-moving built-in roll chart provides complete data for all tubes.
- ★ Newly designed Line Voltage Control compensates for variation of any Line Voltage between 105 Volts and 130 Volts.
- ★ NOISE TEST: Phono-jack on front panel for plugging in either phones or external amplifier will detect microphonic tubes or noise due to faulty elements and loose internal connections.

The model TV-11 operates on 105-130 Volt 60 Cycles A.C. Comes housed in a beautiful hand-rubbed oak cabinet complete with portable cover

EXTRA SERVICE — The Model TV-11 may be used as an extremely sensitive Condenser Leakage Checker. A relaxation type oscillator incorporated in this model will detect leakages even when the frequency is one per minute.

**\$4750**  
NET



SUPERIOR'S NEW MODEL TV-40

# C.R.T. TUBE TESTER

A complete picture tube tester  
★ for little more than the price of a "make-shift" adapter!!

Tests all magnetically deflected  
★ tubes . . . in the set . . . out of the set . . . in the carton!!

The Model TV-40 is absolutely complete! Self-contained, including built-in power supply, it tests picture tubes in the only practical way it is understood test such tubes; that is by the use of a separate instrument which is designed exclusively to test the ever increasing number of picture tubes!

**EASY TO USE:**

Simply insert line cord into any 110 volt A.C. outlet, then attach tester socket to tube base (Ion Trap Need Not Be on Tube). Throw switch up for quality test . . . read direct on Good-Bad scale. Throw switch down for all leakage tests.

**SPECIFICATIONS:**

- Tests ALL magnetically deflected picture tubes from 7 inch to 30 inch types.
- Tests for quality by the well established emission method. All readings on "Good-Bad" scale.
- Tests for inter-element shorts and leakages up to 5 megohms.
- Tests for open elements.

Model TV-40 C.R.T. Tube Tester comes absolutely complete—nothing else to buy. Housed in round cornered, molded bakelite case. Only.....

**\$1585**  
NET

**SHIPPED ON APPROVAL  
NO MONEY WITH ORDER — NO C.O.D.**

Try any of the above instruments for 10 days before you buy. If completely satisfied then send down payment and pay balance as indicated on coupon. No Interest or Finance Charges Added! If not completely satisfied return unit to us, no explanation necessary.

MOSS ELECTRONIC DISTRIBUTING CO., INC.  
Dept. D-91, 3849 Tenth Ave., New York 34, N.Y.

Please send me the units checked. I agree to pay down payment within 10 days and to pay the monthly balance as shown. It is understood there will be no finance, interest or any other charges, provided I send my monthly payments when due. It is further understood that should I fail to make payment when due, the full unpaid balance shall become immediately due and payable.

Model 670-A.....Total Price \$28.40  
\$7.40 within 10 days. Balance \$3.50  
monthly for 6 months.  Model TV-11.....Total Price \$47.50  
\$11.50 within 10 days. Balance \$6.00  
monthly for 6 months.  Model TV-40.....Total Price \$15.85  
\$3.85 within 10 days. Balance \$4.00  
monthly for 3 months.

Name .....  
Address .....  
City..... Zone..... State.....



The Model  
TV-50

# GENOMETER

A versatile all-inclusive GENERATOR which provides ALL the outputs for servicing:

**A. M. Radio    F. M. Radio    Amplifiers    Black and White TV    Color TV**

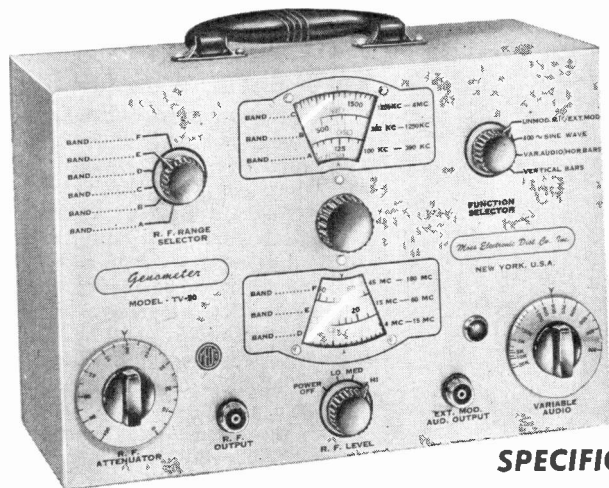

## 7 Signal Generators in One!

- ✓ R. F. Signal Generator for A.M.
- ✓ R. F. Signal Generator for F.M.
- ✓ Audio Frequency Generator
- ✓ Bar Generator
- ✓ Cross Hatch Generator
- ✓ Color Dot Pattern Generator
- ✓ Marker Generator

### SPECIFICATIONS:

#### R. F. SIGNAL GENERATOR:

The Model TV-50 Genometer provides complete coverage for A.M. and F.M. alignment. Generates Radio Frequencies from 100 Kilocycles to 60 Megacycles on fundamentals and from 60 Megacycles to 180 Megacycles on powerful harmonics. Accuracy and stability are assured by use of permeability trimmed Hi-Q coils. R.F. is available separately, modulated by the fixed 400 cycle sine-wave audio or modulated by the variable 300 cycle to 20,000 cycle variable audio. Provision has also been made for injection of any external modulating source.

#### VARIABLE AUDIO FREQUENCY GENERATOR:

In addition to a fixed 400 cycle sine-wave audio, the Model TV-50 Genometer provides a variable 300 cycle to 20,000 cycle peaked wave audio signal. This service is used for checking distortion in amplifiers, measuring amplifier gain, trouble shooting hearing aids, etc.

#### BAR GENERATOR:

This feature of the Model TV-50 Genometer will permit you to throw an actual Bar Pattern on any TV Receiver Screen. Pattern will consist of 4 to 16 horizontal bars or 7 to 20 vertical bars. A Bar Generator is acknowledged to provide the quickest and most efficient way of adjusting TV linearity controls. The Model TV-50 employs a recently improved Bar Generator circuit which assures stable never-shifting vertical and horizontal bars.

#### CROSS HATCH GENERATOR:

The Model TV-50 Genometer will project a cross-hatch pattern on any TV picture tube. The pattern will consist of non-shifting, horizontal and vertical lines interlaced to provide a stable cross-hatch effect. This service is used primarily for correct ion trap positioning and for adjustment of linearity.

#### DOT PATTERN GENERATOR (For Color TV)

Although you will be able to use most of your regular standard equipment for servicing Color TV, the one addition which is a "must" is a Dot Pattern Generator. The Dot Pattern projected on any color TV Receiver tube by the Model TV-50 will enable you to adjust for proper color convergence. When all controls and circuits are in proper alignment, the resulting pattern will consist of a sharp white dot pattern on a black background. One or more circuit or control deviations will result in a dot pattern out of convergence, with the blue, red and green dots in overlapping dot patterns.

#### MARKER GENERATOR:

The Model TV-50 includes all the most frequently needed marker points. Because of the ever-changing and ever-increasing number of such points required, we decided against using crystal holders. We instead adjust each marker point against precise laboratory standards. The following markers are provided: 189 Kc., 262.5 Kc., 456 Kc., 600 Kc., 1000 Kc., 1400 Kc., 1600 Kc., 2000 Kc., 2500 Kc., 3579 Kc., 4.5 Mc., 5 Mc., 10.7 Mc. (3579 Kc. is the color burst frequency.)

The Model TV-50 comes absolutely complete with shielded leads and operating instructions. Only .....

**\$47<sup>50</sup>**  
NET

# SHIPPED ON APPROVAL NO MONEY WITH ORDER — NO C.O.D.

Try it for 10 days before you buy. If completely satisfied then send \$11.50 and pay balance at rate of \$6.00 per month for 6 months. No Interest or Finance Charges Added! If not completely satisfied return unit to us, no explanation necessary.

MOSS ELECTRONIC DISTRIBUTING CO., INC.  
Dept. D-91, 3849 Tenth Ave., New York 34, N. Y.

Please rush one Model TV-50. I agree to pay \$11.50 within 10 days and to pay \$6.00 per month thereafter. It is understood there will be no finance, interest or any other charges, provided I send my monthly payments when due. It is further understood that should I fail to make payment when due, the full unpaid balance shall become immediately due and payable.

Name .....

Address .....

City ..... Zone ..... State .....

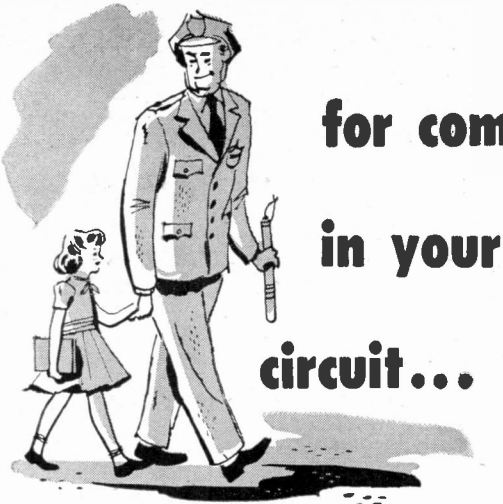

for complete protection  
in your  
circuit...

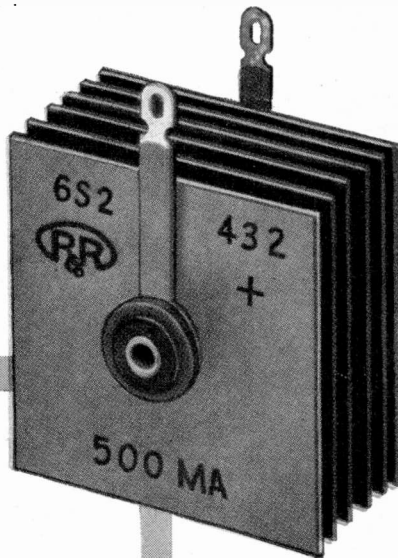

**SELENIUM  
RECTIFIERS**

with

**"SAFE CENTERS"**

The rectifier center is a real trouble zone. That's why all Radio Receptor selenium rectifiers are specially built and tested to eliminate arc-over danger, short circuits and heating at the center contact point. Even assembly pressure, or pressure applied in mounting the rectifier cannot affect its performance.

This "Safe Center" feature of RRco. rectifiers is accomplished by deactivating the area of the plate under the contact washer . . . An added safety factor that gives protection during mounting and when the rectifier is in use.

No wonder RRco. selenium rectifiers are preferred by leading manufacturers of radios, TV and other electronic equipment. Millions in use under all conditions—including high humidity—give eloquent testimony to their dependable service. Next time you need rectifier replacements demand the bright green RRco. units with "Safe Centers."

*We also manufacture transistors  
and silicon and germanium diodes*

Semi-Conductor Division

**RADIO RECEPTOR COMPANY, INC.**

*In Radio and Electronics Since 1922*

SALES DEPT.: 251 West 19th Street, New York 11  
WAtkins 4-3633 • Factories in Brooklyn, N. Y.



**RACKET ALLEGED**

Four persons were taken into custody as a result of a raid on the Sutter Television Service, Brooklyn, N. Y. According to the District Attorney, whose Rackets Bureau made the raid, the concern has been doing a \$350,000-a-year business, a large part of which was suspected to be in overcharges.

The District Attorney's office stated that the company took service calls only by telephone and did no repair work whatever in the home. The minimum charge for a repair appeared to be about \$18, though the majority of charges followed a pattern of \$28.50, \$37.50 and \$45.70, it was said.

It was also alleged by the District Attorney's office that in many cases new parts were taken out of TV sets and replaced with old ones, though it was not explained just how the company made money by the practice.

**LONG ISLAND PUSHES PRP**

A Public Relations Program, initiated by the Radio Television Guild of Long Island (N. Y.), will feature cooperative advertising and service of customer complaints.

"Guild licensing," or issuing credentials to members who meet minimum technical and other requirements, has been under discussion and the Rules and Membership Committees have been assigned the job of classifying the membership.

The proposed customer complaint bureau had been intended to work in cooperation with local Better Business Bureaus, but since there is no BBB nearer than New York City a different approach will be needed.

Other proposals included a means of financing consumer repairs through a local bank, use of new and improved types of bill forms, group insurance and a service clinic. It was expected that the various committees handling the propositions would be able to synchronize their work so the proposals could be embodied in a package program for presentation to both the membership and to prospective members.

**NETSDA DEBATES LICENSES**

Licensing was the main theme of discussion at the November meeting of the National Electronic Technicians and Service Dealers Associations. The association's counsel, Mr. Joseph Forman, using the New York City bill as

**BRAND  
NEW**

# FEATURES

**THAT MAKE *TRIO* THE LEADER IN '55**



**HEAVIEST BOOMS!**

Thick-wall, extra-sturdy 1 1/4" diameter Booms. Nothing approaching them for strength! Now used on ALL low-band yagis.

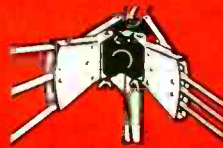

*New* "VARI-CON" HEAD

Four Hi-strength aluminum adjusting arms. Interlocking Butterfly sections. Heavier snap-action spring assembly. The "Vari-Con" is the only antenna with spring dampeners to lessen vibration and breakage. The "Vari-Con" head also used on the popular TRIO 88 Series.



*Sensational*  
**INSTA-LOK CLAMP**  
(Good-Bye Nuts)

This revolutionary clamp permits instant flip-out assembly, permanent alignment with ultra strength. Nothing stronger — nothing faster! Insta-Lok employed on ALL TRIO Antennas that have parasitic elements.



*New* MINI-UP CONICAL HEAD

Swing out element mounting plates, fan out elements into snap-fastenings and it's set! Used throughout conical line.

*New* MYCASTYRENE INSULATORS USED THROUGHOUT TRIO LINE

 ZZ12L	 Twin-Six
 C44	 FDLH
 UBT-4	 SQ-1
 SV-2	 44

*New* TRIO ARISTOCRAT ROTATOR

NOW AVAILABLE IN **FOUR** GLORIOUS COLORS!



**TRIO 88**

Far superior construction. Rugged, foolproof — easily installed. Parasitic elements supported by TRIO's revolutionary new "Insta-Lok" clamps. Low channel dipoles supported by the strongest conical head made. No vibration — No element shedding. Completely pre-assembled. Available in single or two bay models.

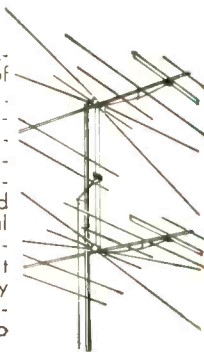

**TRIO 66**

Three dipoles provide exceptionally high gain on all VHF channels. Exclusive TRIO grid reflector gives improved performance. Extremely rugged yet lightweight. Pre-assembled — simply unfold and tighten reflector and dipole assemblies. Three vertical braces on reflector screen for increased strength. Available in single or two bay models.

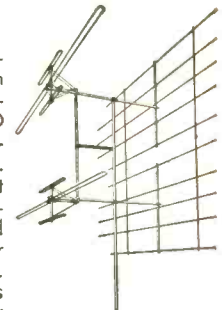

COPYRIGHT 1954 BY TRIO MANUFACTURING CO.

Ask To See America's Most Dependable And Beautiful Rotator:

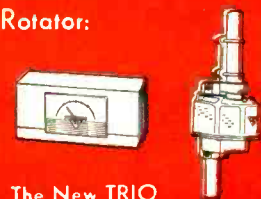
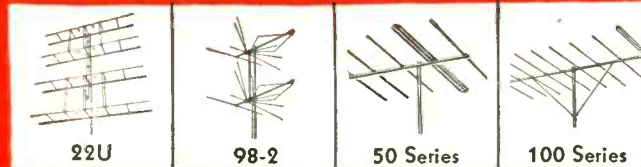

The New TRIO "ARISTOCRAT"

**TRIO** Leader in Antenna Development

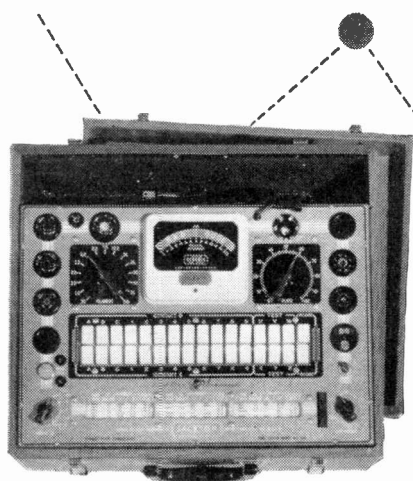

IT'S IDEAL FOR . . .

# Color

## JACKSON 648 DYNAMIC<sup>®</sup> TUBE TESTER

Here's another Jackson Test Instrument that takes color in its stride without changes. Years ago, Jackson "Service-Engineering" provided the basic design of this original Dynamic Tester. And, even the advent of color has not required changes. Jackson Sequence Switching not only provides test settings for every receiving type, new or old, but provides them so fast that you save valuable time in checking any set. And, that's money in your pocket, especially with the new 40-tube color chassis. Look at these Jackson features. Then see the 648 in action at your distributor's showroom.

**Simplified Operation**—Only three control units to be set—Heater Voltage, Plate Control, and Sequence Switch. Only other adjustments are line voltage and shorts test.

**Super-Speed Use**—Set up is speedy, clear and accurate. You can change from one tube to another in just seconds. No confusing levers. Only two rotary controls. All other tube test functions are provided by positive, push-button sequence switch. Either row of push buttons can be cleared instantly by merely pushing a button. Eliminates the chance for error.

**Tests All Types**—Sockets and setting provided for all receiving tubes currently used, including subminiatures, and the new 600-mil TV types. Spare socket positions provided for any new types.

**Metered Plate Current**—Four-inch meter shows only the current flowing in the plate circuit. Meter calibrated in Good-Bad, as well as Percent Transconductance.

**Husky Filament Transformer**—the right voltage for every receiving type from .75

volts to 117 volts. Ample current capacity for testing even the newest rectifiers.

**Fast, Accurate Shorts Test**—Each element completely tested for possible shorts. Easily visible shorts lamp remains lighted only on actual short. No hard-to-understand meter readings. Test made under heated conditions.

**Noise Test**—Plug in a set of headphones, and you have an audible indication of noisy tubes. Makes it easy to catch those tough ones that give trouble in audio and video circuits.

**Correct Test Voltages and Load Settings**—protects tube under test against overloads. Even low-voltage battery types are provided with suitably low operating potentials. Meter is sufficiently sensitive that "Low-Scale" readings are not required.

**Rotary Settings Chart**—Quickly provides the correct test settings for every receiving type. Chart is revised frequently. You get one-year free replacement chart service. Information on new types is rushed to your distributor as soon as information is available, by super-speed Bullet-In Service.

**Life-Line Indicator**—An ingenious test that indicates when tube is approaching the end of its life. You can tell when to replace a tube, even before it actually goes bad.

**Automatic Line Voltage Indicator**—You adjust the line voltage by watching the meter. Control then shows you the actual line voltage. Saves carrying a volt meter on house calls.

**Rugged Construction**—Use the 648 on the bench. Carry it in your truck. Use it on home calls. It's made to "take a beating" for its "Service-Engineered" for your kind of work.

### Available in These Styles

Model 648 in bench type steel case . . . . . \$104.50, net  
 Model 648P Portable Model in Handsome Wood Case . \$109.50, net  
 Model CB-48 Counter Base for bench type case . . . . . \$ 8.50, net

"Service Engineered"  
 Test Instruments



16-18 S. Patterson Boulevard, Dayton 2, Ohio • In Canada: The Canadian Marconi Company

TECHNICIANS' NEWS (Continued)  
 a basis, gave an excellent view of the problems to be met.

### SETTING THINGS STRAIGHT

Recently in a San Antonio newspaper column appeared the "Confessions of a Local TV Repairman." He informed the readers that 90% of the TV receivers he was called on to repair could be fixed in a jiffy, with no need to remove the chassis. Of course he didn't make these quick repairs because people would balk at paying his price. The writer went on to enlighten his readers that a good technician can diagnose precisely what ails a set just by looking at the picture. (What if there is no picture?—Editor)

The San Antonio Radio and Television Association immediately contacted the newspaper and set the record straight. As a result, an article was written from material furnished by the association. Starting out "At least 500 of San Antonio's sets will go on the blink tonight," it brought out the idea that TV receivers do break down and their repair is not always a simple matter. It informed readers that service technicians usually handle between 50 and 60 brands, each with its own peculiarities, and more often than not, needed repairs cannot be made in the home.

### SURE-FIRE SERVICE?

A part-time service "technician" in the Milwaukee area, swears the *Marts News* (Milwaukee Association of Radio and Television Services), had trouble with a defective picture tube. No matter how he tried, the yoke and tube neck were stuck firmly together. Struck by a brilliant idea, he put the set in the backyard, loaded up his trusty .22 and fired. The implosion wasn't exactly atomic, but it did permit him to take the tube out in sections. But the bullet had also ripped through the yoke and mowed down a few other components in its path! Undaunted, our screw-driver-and-ideas repairman called up the owner of the receiver and informed her: "Madam, your set is shot!" END



"It's a sympathy card from our service technician. He's sorry to hear our set's on the blink and he'll be out as soon as we pay our last repair bill."

# NEW

## SYLVANIA

### TUBE *and* TOOL TENDER

...ends  
"tool hunting"  
for good!



Here's the newest idea in TV service cases. It's the Tube and Tool Tender's "PEG PLATE" panels and adjustable metal holders. With this combination, set up your tools in the arrangement that suits you best. Then enjoy the time- and temper-saving convenience of having the tools you want, right where you want them, whenever you need them.

And of course the Sylvania Tube and Tool Tender also gives you generous tube and equipment storage.

Your Sylvania Distributor has your Tube and Tool Tender now. It's another Sylvania exclusive, designed for your easier TV servicing, offered only by your Sylvania Distributor.

It's spacious—carries tubes, tools, meter, mirror, parts... everything you need on your calls.

See it at your Sylvania Distributor

**FREE**  
with the purchase of  
Sylvania Tubes  
**\$15.95 VALUE**  
... for only  
**32 Sylvania Tokens**

Remember, you get one Sylvania Token each time you buy 25 Sylvania Receiving Tubes.



It's light and attractive, it's aluminum... weighs only 20 pounds fully loaded.

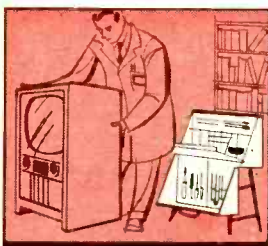

It's durable and sturdy—will stand up in constant field use.

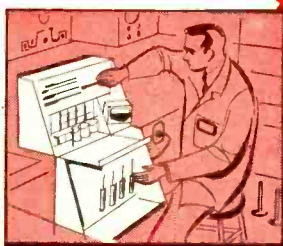

It's convenient—for shop as well as field use. Complete with "self-service."



# SYLVANIA

Sylvania Electric Products Inc.  
1740 Broadway, New York 19, N. Y.  
In Canada: Sylvania Electric (Canada) Ltd.  
University Tower Bldg., St. Catherine St.  
Montreal, P. Q.

LIGHTING • RADIO • ELECTRONICS • TELEVISION • ATOMIC ENERGY

JANUARY, 1955

145

# New EMC instruments increase your testing ability

## EMC model 107 VTVM

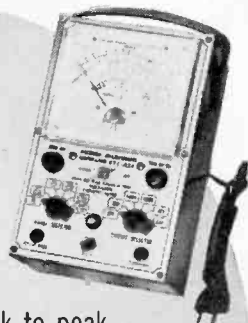

Directly measures capacity, resistance and complex waveforms peak to peak.

This new multi-function meter contains an exclusive combination of features never before offered for less than \$100. Expanded scale meter cannot burn out . . . measures capacity from 50 MMFD to 5000 MFD . . . inductance from 1.4 henries to 140,000 henries in 4 ranges . . . uses an electronic balanced push-pull circuit and peak to peak rectification . . . 1% multipliers for voltage capacity and resistance measurements . . . has zero center position for FM discriminator alignment.  
Measures directly in 6 ranges—all peak to peak voltages of complex waveforms . . . between .2 volt and 2800 volts—RMS values of sine wave voltages . . . between .1 volt and 1000 volts—capacity of condensers between 50 MMFD to 5000 MFD—resistance from .2 ohms to 1000 megohms.

model 107 **\$48.90**  
complete with leads

kit form . . . . . **\$34.50**

ACCESSORY PROBES AVAILABLE

## EMC model 206 mutual conductance tube tester

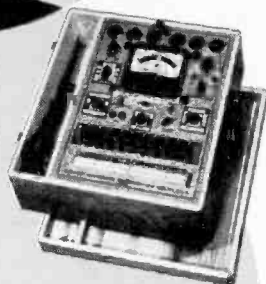

Extremely accurate results with new ease of operation.

Lever-type switches assure complete and extremely accurate testing of all present and future tube types regardless of element location. Mutual conductance checked on calibrated micromho scale and "reject-good" scale . . . tubes checked for gas content . . . 5 element tubes checked as pentodes . . . all loctal, octal, miniature and subminiature tubes checked for both shorts and opens . . . sufficient plate current to check emission and mutual conductance . . . tests all tubes from .75 volts to 117 filament volts . . . checks for radio frequency and other noise . . . tests all cold cathode, magic eye, voltage regulators and ballast resistors . . . plus individual sections of multipurpose tubes . . . Individual tube sockets eliminate prong damage . . . instrument fuse replaced from panel front . . . handy built-in roll chart makes accurate testing easy.

model 206 **\$83.50**  
(hand rubbed oak carrying case)

MODEL 206G (sloping counter case) **\$79.50**

MODEL CTA (picture tube adaptor) **\$9.95**

SAVE MORE... SERVICE BETTER... with EMC precision test equipment.

New EMC catalog of precision test equipment available . . . write Dept. RE-1 today!

**EMC** ELECTRONIC MEASUREMENTS CORPORATION  
280 LAFAYETTE STREET NEW YORK 12, N. Y.  
EXPORT DEPT.—136 LIBERTY ST. N. Y. 6, N. Y.

# new Devices



**PISTON CAPACITOR**, variable trimmer, JFD VC-13G, has traverse motion, free from mechanical backlash, giving smooth

D.c. current is from 50  $\mu$ a to 15 amperes; a.c. current from 1.5 ma to 15 amperes. Decibels from -10 to +50 and resist-



capacitance tracking over complete range. A rigid grip at all times between the piston and inner wall of dielectric tube. The capacitor is relatively free from effects of vibration and shock. Temperature stability enables it to operate beyond +125°C and below -55°C. Voltages in excess of 10,000 d.c. easily withstood because VC-13G has long flashover path from outer electrode to mounting base.—JFD Manufacturing Co., Inc., 6101 16th Ave., Brooklyn 4, N. Y.

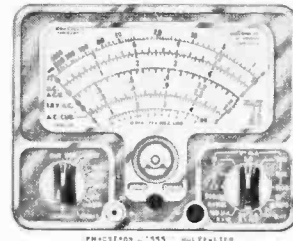

ance from 0.25 ohm to 10 megohms.—Phaotron Co., 151 Pasadena Ave., South Pasadena, Calif.

**LOUDSPEAKERS**, Tru-Sonic models 152AX and 206AXA, 15-inch coaxial. Model 152AX houses 15-inch curvilinear cone and 2-inch voice coil with extra-large spider assembly. Uses 2½-lb Alnico. Reproduction down to 30 cycles; Metal-spun diaphragm with 1-inch voice coil provides high frequencies to 18,000 cycles. Free space cone resonance 48 cycles, nominal impedance 12 ohms,

**TABLE-TOP AMPLIFIER**, Radio Craftsmen *Solitaire*, combines hi-fi 20-watt amplifier, preamplifier-equalizer and dual filter system. Height 4 inches. Six positions of record equalization; four inputs for records,



radio tuners, television and tape; cathode-follower output for tape recording. Dual filters eliminate turntable rumble, spurious high and low frequencies, and record noise.—The Radio Craftsmen, Inc., 4401 No. Ravenswood Ave., Chicago 40, Ill.

**HI-FI AMPLIFIER**, Regency model HF-80, weighs 10½ lb and is housed in a brass-plated steel chassis. A 10-watt amplifier, preamplifier and power supply unit.—Regency, Division of I.D.E.A., Inc., 7900 Pendleton Pike, Indianapolis, Ind.

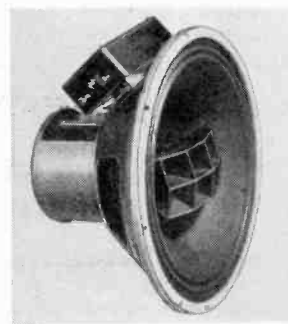

power capacity 20 watts. Model 206AXA has dividing network with high-frequency control and 7½-lb Alnico V magnet which operates two voice coils. Impedance 16 ohms and power capacity 30 watts.—Stephens Manufacturing Corp., 8538 Warner Drive, Culver City, Calif.

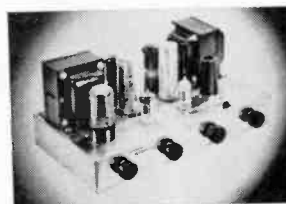

**POCKET-SIZE MULTIMETER**, 555, has 43 ranges with accuracies of 2% d.c. and 3% a.c. for measurement of d.c. volts from 1.5 to 1,500 at 20,000 ohms per volt and a.c. volts from 1.5 to 1,500 at 2,000 ohms per volt.

**VOLT-OHM-MILLIAMMETER**, pocket-size Superior model 770-4, built around an 850-micro-

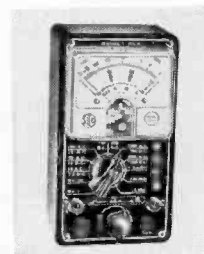

RADIO-ELECTRONICS

# FINCO\* introduces

# 3 SENSATIONAL

# New Antennas

Patent No.'s. 2,566,287 2,630,531 2,655,599 other patents applied for.

## FINCO 400-SA

\*Trade marks of the Finney Company.  
Registration No.'s 559,104 575,345

FEATURING "FRO-BAC"\* FULL DIMENSIONAL SCREEN

The engineering masterpiece of the antenna industry! The sensational, new Finco 400-SA eliminates rear signal interference (adjacent and co-channel), ghosts and electronic noise — delivers famous Finco high gain for clear, sharp pictures in the SUPER fringe area on all channels, UHF and VHF. The special electronic FRO-BAC screen has 80 sq. ft. of highest efficiency, FULL LENGTH reflector surface. Pre-assembled for quick installation.

## FINCO 200-A

The ideal antenna for "in-between areas" . . . (too far out to use "Local" type antenna, too close to warrant use of a super-fringe antenna). The new Finco 200-A combines basic, double CO-LATERAL\* design with exclusive Finco electronic patents to deliver unbeatable gain and performance in the Semi-Fringe area on all channels, UHF and VHF. Completely pre-assembled.

## FINCO 200-SA

The Finco 200-SA was engineered specifically for the "in-between", semi-fringe areas where a FRONT-TO-BACK problem exists. The special FRO-BAC full dimensional screen eliminates rear signal interference, ghosts and electronic noise. This antenna delivers reception power that cannot be matched by ordinary antennas. Completely pre-assembled.

Write for Free Literature

Copyright 1954, The Finney Co.

**The FINNEY  
Company**

Dept. RE-15

4612 ST. CLAIR AVENUE • CLEVELAND 3, OHIO

JANUARY, 1955

## MODEL 14-S CONVERSION KIT

**FRONT-TO-BACK PROBLEM IN  
YOUR AREA??? MANY FINCO  
400-A INSTALLATIONS???**

This kit contains special electronic FRO-BAC screen and stainless steel hardware for quick conversion of models 400-A and 400 to model 400-SA.

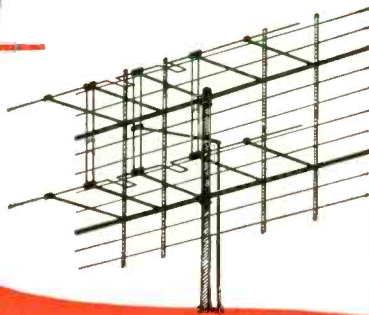
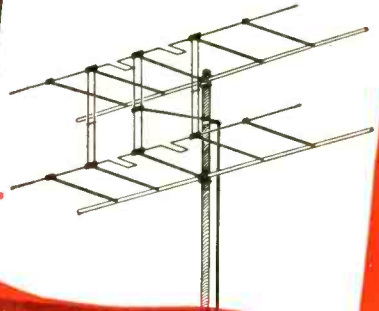
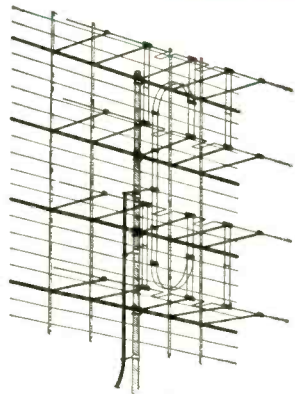

FOR TV . . . IT DODGES

TROUBLE YOU CAN'T STOP

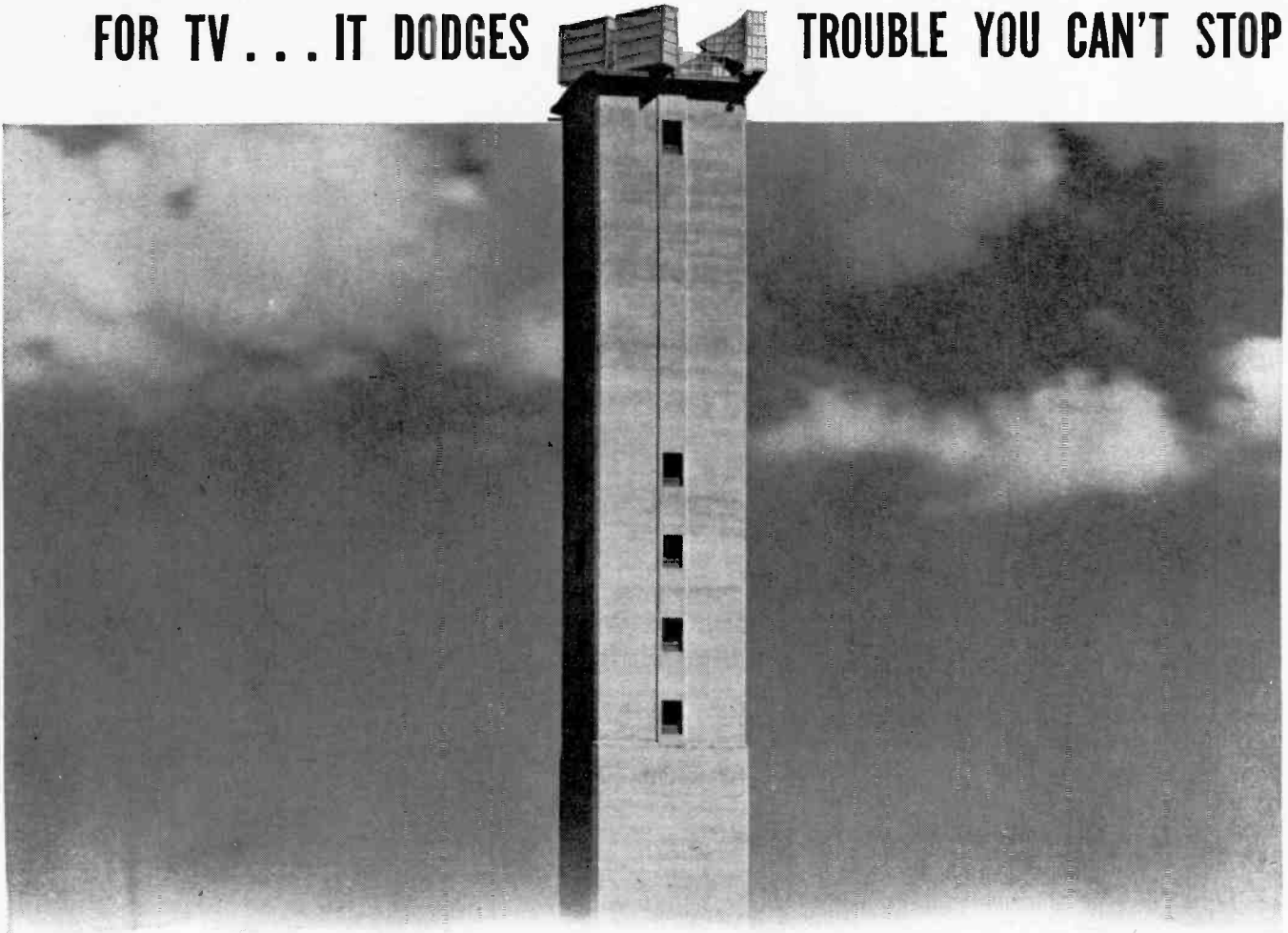

*Radio Relay station on route between Chicago, Ill., and Des Moines, Iowa. Every fifth or sixth relaying tower is a control station, where high-speed*

*switching equipment enables a TV picture to skip out of a troubled channel and into a stand-by protection channel faster than the eye can wink.*

There's no way to stop atmospheric changes that threaten television with "fade." But, for TV that travels over Bell's Radio Relay System, Bell Laboratories engineers have devised a way to sidestep Nature's interference.

When a fade threatens—usually before the viewer is aware—an electronic watchman sends a warning signal back by wire to a control station perhaps 200 miles away. An automatic switching mechanism promptly transfers the picture to a

clear channel. The entire operation takes 1/500 of a second. When the fade ends, the picture is switched back to the original channel.

This is an important addition to the automatic alarm and maintenance system that guards Bell's Long Distance network for television and telephone calls. It marks a new advance in Bell Laboratories' microwave art, developed to make your Long Distance telephone service, and your TV pictures, better each year.

## BELL TELEPHONE LABORATORIES

Improving telephone service for America provides careers for creative men in scientific and technical fields.



RADIO-ELECTRONICS



NEW DEVICES

(Continued)

ampere D'Arsonval meter of 2% accuracy and housed in a 3 1/2 x 5 1/2 x 2 1/4-inch molded bakelite case. A.c. voltage ranges: 0-15, 30, 150, 300, 1,500, 3,000. D.c. voltage ranges: 0-7.5, 15, 75, 150, 750, 1,500. Two resistance ranges: 0-.01, 1 megohm. D.c. current ranges: 0-15, 150, 1,500 milliamperes. Decibel ranges: -6 to +18, +14 to +38, and +34 to +58.—Superior Instruments Co., 2435 White Plains Rd., New York 67, N. Y.

signals for direct performance testing of hi-fi audio amplifiers, carrier current systems and other wide-range devices. Continuous sine-wave coverage from 20 cycles to 200 kc in four bands; square-wave coverage

cuit operation. Full 5-inch (5UP1) cathode-ray tube. New type sweep generator circuit produces stable linear sweeps

**LINEARITY GENERATOR**, white dot, Winston model 160, provides both large and small white dots for ease of color receiver convergence adjustments plus vertical and horizontal bars for sweep-circuit alignment. Internally generated ver-

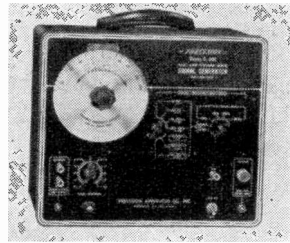

from 20 through 20,000 cycles in three bands. Square-wave signals at 50, 100, 250 and 500 kc. Output impedance on variable-frequency ranges: 0-2,000 ohms, 0-10 volts r.m.s., flat within ±1 db. Accuracy ±2% from 50 cycles to 200 kc, ±1 cycle from 20 to 50 cycles. Distortion: less than 1% from 20 cycles through 200 kc. Square-wave rise time at 20 kc: 0.5 microsecond. — Precision Apparatus Co., Inc., 92-97 Horace Harding Blvd., Elmhurst, L. I., N. Y.

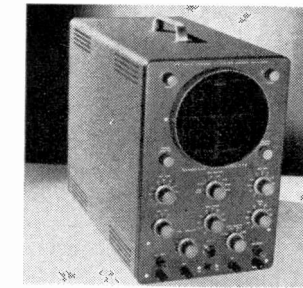

up to 500,000 cycles.—Heath Co., Benton Arbor, Mich.

**HYCON OSCILLOSCOPE** model 617 and digital voltmeter model 615. Scope has 3-inch tube, 4.5 mc bandpass (±1 db, vertical amplifier), high deflection sensitivity (.01 volt r.m.s. per inch),

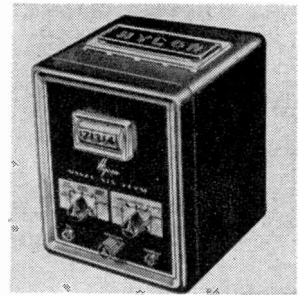

internal calibrating voltages and edge-lighted bezel.

Voltmeter replaces deflecting needle and multiple scales of conventional voltmeters with revolving 3-digit counter. Sensitivity ranges from 1 millivolt to 1,000 volts and 1,000 ohms to 10 megohms with accuracy rating of 1% on d.c. and ohms, 2% on a.c.—Hycon Manufacturing Co., 2961 E. Colorado St., Pasadena 8, Calif.

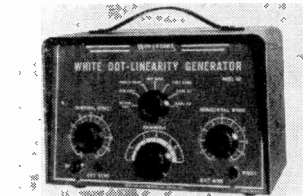

tical sync pulses and locked-to-line frequency give stable operation. Has r.f. carrier output and external modulation provisions.—Winston Electronics, Inc., 4312 Main St., Philadelphia 27, Pa.

**SIGNAL GENERATOR**, Precision model E-300, provides accurate sine- and square-wave

**OSCILLOSCOPE**, Heath model 0-10, essentially flat vertical channel response from 5 cycles to 5 mc; down only 1 1/2 db at 3.58 mc (color TV sync burst frequency). Printed-circuit boards for reduced kit construction time and stable cir-

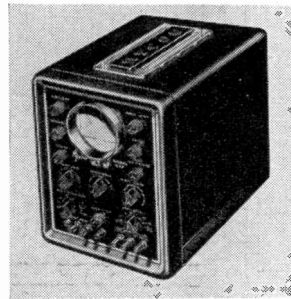

**C-R TUBE TESTER**, Superior model TV-40, tests all tubes from 7 to 30 inches by emission method. Indicates open ele-



Get This Valuable Book

Just for Examining COYNE'S New 6-Volume Set

**FREE**



"Applied Practical Radio-Television"

Yes, you get this big, new 1954 book, "150 Radio-Television Picture Patterns and Diagrams Explained", absolutely FREE! Just off the press! Gives complete 11x22" Schematic Diagrams on leading models Radio and Television Sets. Easy-to-read, large 8 1/2 x 11" pages, with full instructions on how to read and use the diagrams. A "must" in every Radio and Television service-man's repair kit. You get this valuable book as a FREE Gift for asking to see Coyne's great new 6-book set, "Applied Practical Radio-Television"!

ON 7 DAY FREE TRIAL!

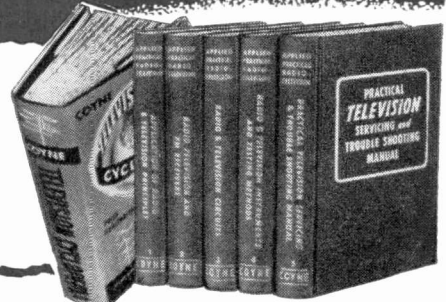

At Last! Money-Making "Know-How" on Transistors, Color TV and Servicing

Coyne's great new 6-volume set gives you all the answers to servicing problems—quickly! For basic "know-how" that is easy to understand, you'll find everything you want in volumes 1 to 5 which contain over 5000 practical facts and data. They cover every step from principles to installing, servicing, trouble-shooting and aligning all types of radio and TV sets. So up-to-date it includes COLOR TV and UHF, adapters, converters. Also covers latest data on TRANSISTORS.

SEND NO MONEY! Just mail coupon for 6-volume set on 7 days free trial. We'll include book of 150 TV-Radio Patterns & Diagrams. If you keep the set, pay \$2 in 7 days and \$2 per month until \$22.50 plus postage is paid. (Cash price \$20.95). Or you can return the library at our expense in 7 days and owe nothing. YOU BE THE JUDGE. Either way, the book of TV-Radio Patterns is yours FREE to keep! Offer is limited. Act NOW!

Extra! 802-Page Television Cyclopedic Included And then, for speedy on-the-job use, you get volume 6—the famous Coyne TELEVISION CYCLOPEDIA. It answers today's television problems on servicing, alignment, installation and others. In easy-to-find ABC order, cross indexed. Use this 6 volume TV-RADIO LIBRARY free for 7 days; get the valuable Servicing Book ABSOLUTELY FREE!

FREE BOOK—FREE TRIAL COUPON!

Educational Book Publishing Division  
**COYNE ELECTRICAL SCHOOL, Dept. 15-T1**  
 500 S. Paulina St., Chicago 12, Ill.  
 YES! Send 6-volume "Applied Practical Radio-Television" for 7 days FREE TRIAL per your offer. Include TV-Radio Patterns & Diagram Book FREE.  
 Name ..... Age.....  
 Address .....  
 City ..... Zone ..... State.....  
 Where Employed.....  
 ( ) Check here if you want library sent COD. You pay postman \$20.95 plus COD postage on delivery. 7-day money-back guarantee.

Educational Book Publishing Division  
**COYNE ELECTRICAL SCHOOL**  
 500 S. Paulina St., Dept. 15-T1, Chicago 12, Ill.

# WE ARE SHARING the success of our products WITH YOU

as a *CUSTOMER'S DIVIDEND* in the most *SENSATIONAL PRICE SLASHING EVER!*

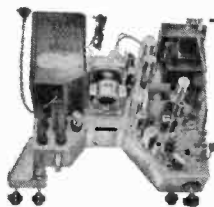

*Build your own*  
**SUPER DE LUXE**  
**31-TUBE**  
**#630 TV CHASSIS**

**#630 SUPER DE LUXE 31-TUBE TV KIT**  
Engineered in strict adherence to the genuine RCA #630 plus added features • OPERATES 16" to 24" PICTURE TUBES • CASCADE TUNER • COSINE YOKE • LARGER POWER TRANSFORMER • KEYPED AGC • 12" SPEAKER • CONDENSERS and RESISTORS at rated capacities and tolerances. You receive a COMPLETE SET OF PARTS AND TUBES. Everything needed is included. You will enjoy building it with "LIFE-SIZE" easy to follow step-by-step ASSEMBLING INSTRUCTIONS" included with each KIT.

slashed to **\$99.99** Less CRT

## #630 SUPER DE LUXE TV CHASSIS

LICENSED UNDER RCA PATENTS  
**COMPLETE READY TO PLUG IN AND PLAY—**  
Similar in characteristics and features to the TV KIT above • Manufactured especially for us by nationally known manufacturers • No efforts or expense have been spared in workmanship or materials, to make this #630 SUPER DE LUXE TV CHASSIS the best obtainable for fringe areas. clarity and all-around-performance. Customers report reception better than 200 miles. Each set is factory aligned and air-tested • All parts carry the RMA three month guarantee • Our mass volume of business on this CHASSIS (numbering thousands of pleased customers) now makes it possible for us to reduce the price.

slashed to **\$142.27** Less CRT

We Also Sell the **TECH-MASTER**  
Complete Line of #630 TV CHASSIS. Catalog mailed on request.

**STANDARD CASCADE TUNER**  
complete with tubes and instructions.....\$17.97

### #639 TV BASIC PARTS KITS

**PUNCHED & DRILLED CHASSIS PAN BRACKET & SHIELD KIT** (18 items) VIDEO & I.F. KIT (19 items) POWER TRANSFORMER #201T6 All for VERTICAL OUTPUT TRANSFORMER only VERTICAL BLOCKING TRANSFORMER FLYBACK TRANSFORMER #211T5 \$32.95 FOCUS COIL, 470 ohms #202D2 COSINE DEFLECTION YOKE 70. Including LIFE-SIZE TV BUILDER INSTRUCTIONS

### #630 PARTS in COMPLETE SETS

TV WIRE & SOLDER KIT, for any Set.....\$ .98  
VIDEO AND I.F. KIT, 19 items..... 4.99  
VARIABLE CONTROL KIT, 9 controls..... 3.97  
CARBON RESISTOR KIT, 107 resistors..... 4.98  
WIREWOUND RESISTOR KIT, 4 resistors..... 1.76  
BRACKET AND SHIELD KIT, 18 items..... 6.44  
ELECTROLYTIC CONDENSER KIT, 6 cond..... 4.96  
TUBULAR CONDENSER KIT, 38 condensers..... 3.63  
CERAMIC CONDENSER KIT, 28 condensers..... 1.98  
MICA CONDENSER KIT, 11 condensers..... .97  
TERMINAL STRIP KIT, set of 30..... .69  
COMPLETE SET OF TUBES, 29 tubes..... 24.64

### PULSE KEYED AGC KIT

Finest, most accurate and the easiest Kit to install in a #630 or in any other make TV receiver. Improves performance, and insures a steady picture on all channels.

**COMPLETE SET OF PARTS**  
Including 6AU6 tube & Instructions  
was \$4.59 SLASHED TO **\$2.99**

## CUSTOM-BUILT CABINETS FOR #630 AND ALL OTHER TV SETS

*From Factory to You*

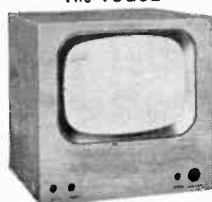

The VOGUE  
H-25", W-26", D-22"

**\$35.91**

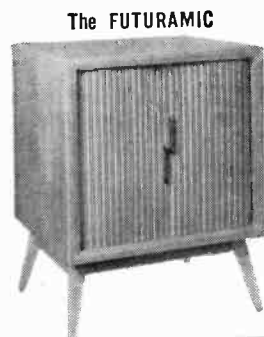

The FUTURAMIC  
H-37", W-28", D-24 1/4"

**\$79.34**

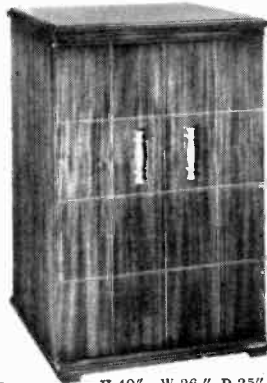

The MAYFAIR  
H-40", W-26", D-25"

**\$88.70**

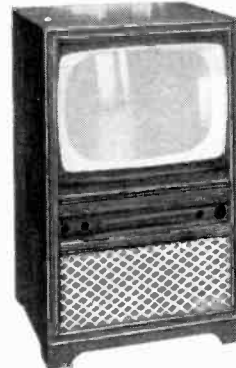

The MANHATTAN  
H-41", W-25", D-23"

**\$53.43**

4 LEADING STYLES in genuine mahogany or walnut (blond 10% extra)  
• Ready drilled for any #630 TV chassis and cutout for any 16", 17", 19", 20" or 21" picture tube at no extras in price • Also supplied with undrilled knob panel for any other TV set • EVERYTHING NECESSARY for an easy perfect assembly is included • Each cabinet is delivered complete as pictured with mask, safety glass, mounting brackets, backboard, backcup, hardware and chassis & CRT assembling instructions • Each cabinet is shipped in an air cushioned carton from FACTORY to YOU!

## NATIONALLY KNOWN BRAND PICTURE TUBES

BRAND NEW in Factory Sealed Cartons—With a Full Year Guarantee

17" #17BP4A \$26.66 | 21" #21EP4B Aluminized \$39.21 | 24" #24CP4A Aluminized \$59.99 | 27" #27EP4A Aluminized \$74.31

**Brooks CASCADE MANUAL**  
**25¢** postpaid



**72 OHM COAXIAL CABLE**  
Slashed Was to  
100' — hank ..... \$4.84 \$3.99  
500' — spool ..... 22.99 19.46  
1000' — two 500' spools ..... 43.86 37.96

COAXIAL CABLE #RG-11U, 1,000 feet...\$87.50

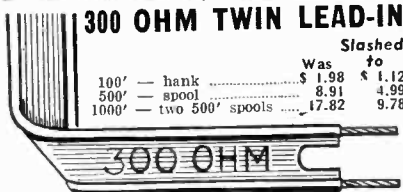

**300 OHM TWIN LEAD-IN**  
Slashed Was to  
100' — hank ..... \$1.98 \$1.12  
500' — spool ..... 8.91 4.99  
1000' — two 500' spools ..... 17.82 9.78

**UNIVERSAL Picture Tube MOUNTING BRACKETS**  
Fits All 12 1/2" to 21" picture tubes Complete—Including band that holds picture tube.



was \$6.97  
SLASHED TO **\$4.97**

**Brooks LIFE-SIZE Edition**  
#630 TV KIT BUILDER-SET OF INSTRUCTIONS  
only **\$1.25** postpaid

HINTS FOR BETTER PICTURES ON 630TV

**50¢** postpaid

### TV CRYSTAL-CLEAR LUCITE MASKS

Framed in Rich Gold Leaf Finish  
Tube Size Overall Dimensions Was Slashed to  
17"—Rect. 13 1/2" x 17" ..... \$ 5.97 ..... \$ 4.56  
21"—Rect. 15 3/4" x 20 7/8" ..... 8.84 ..... 6.92  
24"—Round 20 1/2" x 26 1/4" ..... 14.65 ..... 11.84  
27"—Rect. 21 1/2" x 27" ..... 15.48 ..... 12.98  
(Including Set of Rosettes)

### TV PLASTIC OPEN MASKS

Used in conjunction with safety glass  
Was Slashed to  
17"—Rect. 14 1/8" x 17 1/2" ..... \$1.87 ..... \$ .99  
21"—Rect. 18" x 22 3/4" ..... 3.36 ..... 1.92  
24"—Rect. 21 1/8" x 24 1/4" ..... 6.74 ..... 4.93  
27"—Rect. 21 1/2" x 27" ..... 7.23 ..... 5.87

### TV SAFETY GLASS IN HANDY SIZES

Was Slashed to  
13 3/8" x 16 1/4" ..... \$2.96 ..... \$1.79  
15 7/8" x 20 1/4" ..... 3.72 ..... 2.24  
16" x 22" ..... 4.29 ..... 3.89  
17 3/8" x 23 3/8" ..... 5.24 ..... 4.12  
22 3/8" x 25 3/8" ..... 6.47 ..... 5.36  
21 1/2" x 27" ..... 6.98 ..... 5.64

**BROOKS RADIO & TV CORP., 84 Vesey St., Dept. A, New York 7, N.Y.** TELEPHONE CORtland 7-2359

ments and interelement shorts and leakages of up to 5 megohms. Tester socket attached to tube base. Ion trap need not be on the tube, and tube may be in set or in carton.—Superior Instrument Co., 2435 White Plains Rd., New York 67, N. Y.

**FM TUNER**, Fisher model *FM-80*, equipped with two meters (one for sensitivity and one to indicate center of channel for micro-accurate tuning). Uses Armstrong system with two i.f. stages, dual limiters, cascode r.f. stage; has eleven tubes. Dual antenna inputs—72 and 300 ohms balanced. Full limit-



ing on signals as weak as 1 microvolt. Sensitivity 1½ microvolts for 20 db of quieting on 72-ohm antenna input; 3 microvolts for 20 db of quieting on 300-ohm antenna input. Two bridged low-impedance cathode-follower outputs permit output cables of any length to 200 feet.—Fisher Radio Corp., 21-21 44th Drive, Long Island City 1, N. Y.

**12-INCH TURNTABLE**, Rek-O-Kut *Rondine Jr.*, designed for two-speed operation only—33½ and 45 r.p.m. Floating idler eliminates acoustical coupling between motor and turntable. Driven by 4-pole induction

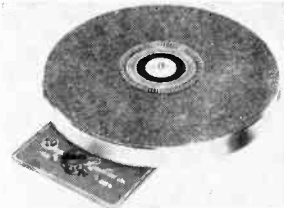

motor. Built-in retractable hub for 45-r.p.m. records and per-

manently affixed strobe disc for instantaneous speed checking.—Rek-O-Cut Co., 38-01 Queens Blvd., Long Island City 1, N. Y.

**SUPEREX FILTA-COUPLER**, combines high-pass interference eliminator with two-set coupler. provides for two-set operation from one antenna,

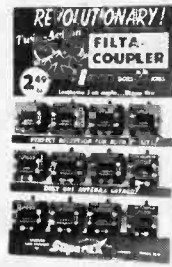

eliminates outside interference from both sets. Another feature: the freedom from inter-set interference.—Superex Electronics Corp., 23 Atherton St., Yonkers, N. Y.

**FLYBACK AND YOKE CHECKER**, Cornell-Dubilier model *BF-80*, has oscillator circuit, 6V6 vacuum tube and 4½-inch microammeter with separate indicator scales for short, continuity and yoke tests. Open-cir-



cuit conditions detected in transformers, coils and switches, or shorted elements in vacuum tubes. Weight, 8½ lb.—Cornell-Dubilier Electric Corp., South Plainfield, N. J.

*A Star Is Born...*

**Only EICO #232 Peak-to-Peak VTVM has all these Advanced Features**

- ★ FOR THE FIRST TIME ALL CALIBRATION IS DONE WITH INSTRUMENT IN CABINET.
- ★ 7 non-skip ranges on every function — DC/RMS sine volts: 0-1.5, 5, 15, 50, 150, 500, 1500. (To 30 kv with HVP probe.) Res.: 0.2 ohms to 1000 megohms.—Uniform 3 to 1 scale ratio assures extreme wide-range accuracy.
- ★ Flat freq. response 30 cps to 3 mc.
- ★ Measures directly peak-to-peak voltage of complex & sine waves: 0-4, 14, 42, 140, 420, 1400, 4200. Vital for TV servicing. Saves the cost of separate Peak-to-Peak Probe.
- ★ Modern styling, etched panel; compact, easily portable. Size: 8½" x 5" x 5".

**NEW PEAK-TO-PEAK VTVM AT LOWEST COST**  
With Exclusive **Uni-Probe**

**KIT \$29.95**  
Complete with UNI-PROBE at no extra cost

**Factory Wired \$49.95**

Excellent for your bench  
Model 249 Peak-to-Peak VTVM with Giant 7½" Meter  
**KIT \$39.95**      **Wired \$59.95**  
Complete with UNI-PROBE

See this amazing engineering achievement at your jobber today. Write now for FREE latest catalog **CV-1**

**EICO**® ELECTRONIC INSTRUMENT CO. INC.  
84 Withers Street  
Brooklyn 11, N. Y.  
Prices 5% higher on West Coast. © 54

**WATCH FOR OUR FEBRUARY ISSUE  
ON SALE JAN. 25**

The "happy medium"  
in the *Regency* line of high quality amplifiers.

The two years research and development of the REGENCY HF1000 Ensemble are reflected in the quality of this "moderate-priced" line of REGENCY high fidelity.

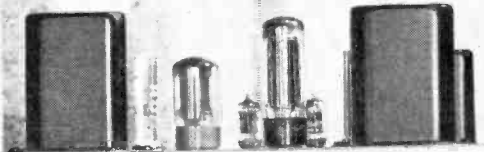
350A Amplifier      Audiophile Net \$134.50  
350P Pre-amplifier      Audiophile Net \$154.50

**REGENCY DIVISION, I.D.E.A., INC. • INDIANAPOLIS 26, INDIANA**

Burton Brown Advertising

# THIS IS IT!

TEST EQUIPMENT YOU CAN'T BEAT FOR  
VALUE — PERFORMANCE — PRICE

## RCP

ONLY \$39.75 net

Fast, reliable testing of flyback transformers and yokes

### The original FLYBACKER

Incredibly sensitive, the model 123 Flybacker, made ONLY by RCP, immediately shows up a shorted turn in a flyback transformer or yoke. The light, portable transformer is designed to advantage in the home as well as the shop. All tests can be carried out under operating conditions with the common substitutes in place in the TV receiver. Accept Flybacker. . . only RCP makes the



## RCP MODEL 123

## RCP

ONLY \$14.85 net

All molded—unequaled by any other in its class

ready to operate

### AC-DC MULTITESTER

Greater multitester value than ever before at a far lower price. 3" square meter with 800 ampere D'Arsonval movement gives 1000 ohms per volt sensitivity on DC. Battery for ohmmeter circuit is readily removable and replaceable without soldering or unsoldering. Truly a must for every laboratory, shop and serviceman's kit; its smart appearance is matched only by its high performance.



## RCP MODEL 480

## RCP

ONLY \$51.95 net

Meets all today's needs . . . plus tomorrow's color requirements

### Portable TUBE TESTER

Positively the greatest testing performance ever built into a tube tester. Tests all tubes in current radio and television receivers, as well as in color TV receivers. Checks transmitting, hearing aids, ballasts, gaseous rectifiers and tuning indicators. With CR adapter cable (available at slight additional cost), will check CR picture tubes . . . both black and white and color.

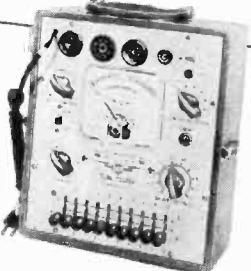

## RCP MODEL 327P

See your distributor or write department RE-1 for latest RCP catalog.

**RADIO CITY PRODUCTS CO., INC.**



EASTON, PENNSYLVANIA

## NEW DEVICES

(Continued)

**WIREWOUND CONTROL.** Clarostat series 43c, 1½ inches, available in standard ohmages from 1 to 50,000 with electrical tolerance of 5% and independent linearity to 2%; rated at 2 watts.

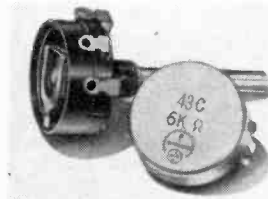

Terminals directly fastened to winding, insuring low contact resistance and improving end termination. Collector and terminal in one piece, eliminating rivets as mechanical fasteners and current conductors. Stop is integral with base instead of in the cover.—Clarostat Manufacturing Co. Inc., Dover, N. H.

**TEFLON PRODUCTS.** Erie standoff and feed-through insulator, 7- and 9-pin Teflon and Kel-F miniature tube sockets, crystal sockets, 15- and 18-pin connectors, and five sizes of spaghetti in three colors. Loss

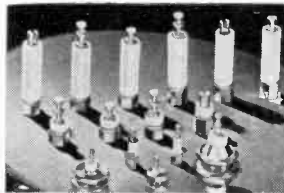

factor less than 0.0005; dielectric constant 2.0 through frequency range of 60 cycles to 30,000 megacycles. Serviceable from -110°F to +500°F for long periods with negligible change in dielectric strength.—Erie Resistor Corp., Erie, Pa.

**NEW RECTIFIERS.** Pyramid, feature edge-mounted plates to provide full air circulation between plates, light constant contact pressure to eliminate center hot spots, rigid construction, smaller over-all size per rating, simpler mounting. Avail-

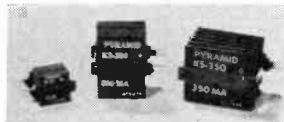

able in all current ratings. Usable as replacements for all existing standard rectifiers. Rated for use in high ambient temperatures.—Pyramid Electric Co., 1445 Hudson Blvd., North Bergen, N. J.

**TV ROTATOR.** Trio Aristocrat, has on-off switch and direction switch on the rear panel of cabinet. Large illuminated indicator dial.—Trio Manufacturing Co., Griggsville, Ill.



**RESISTORS.** 5- and 10-watt Tru-Ohm Econohm units wound on ceramic cores. Tinned copper leads attached to eliminate stresses being transmitted to the winding. Completely impervious to moisture.—Tru-Ohm Products, 2800 Milwaukee Ave., Chicago 18, Ill.

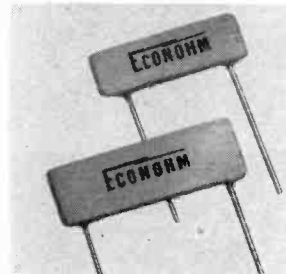

**SIX REPLACEMENT TRANSFORMERS.** Ram horizontal output models X107, X108, X109, X110, X111, X112, (for 91 chassis and 436 models) for Airline (Montgomery Ward), Firestone,

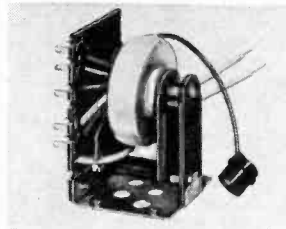

Raytheon, Silvertone (Sears Roebuck), Trans-Vue, Wells Gardner, Coronado (Gamble Skogmo), Mitchell, Sentinel, Spartan, Truetone (Western Auto) and Sonora units. Operate in 66-70° horizontal deflection systems, and deliver 11, 11.5, 18, 12.5 and 15 kv, respectively, under actual operation conditions.—Ram Electronics Sales Co., Irvington-on-Hudson, N. Y.

**FOUR REPLACEMENT FLYBACKS.** Stancor model A-8248 replaces Crosley and Hallcrafters models and chassis; models A-8250 and A-8251 replace Du Mont models and chassis. Exact duplicates, electrically and physically, they require no chassis or circuit alterations.—Chicago Standard Transformer Corp., Addison and Elston Aves., Chicago 18, Ill.

**ROTO-CUTTER.** Alpert, for cutting and trimming wires in hard to reach places utilizes rotary shearing action. It is ¼-inch in diameter throughout its length of 6 inches. Reaches points in circuits inaccessible to conventional di-

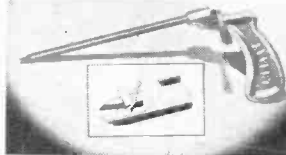

agonal cutters and eliminates the necessity of removing parts and assemblies to reach a defective part. Will cut copper wire sizes up to 14 gauge.—Alpert Manufacturing Co., 2950 N. Holton St., Milwaukee, Wis.

END

All specifications given on these pages are from manufacturer's data.

# new Tubes & Transistors

## 5U4-GB

RCA has announced the 5U4-GB, specifically designed for use in the power supplies of television receivers and radio equipment with high d.c. requirements. Its voltage ratings are the same as those of the 5U4-G, but the peak current rating of 1 amp per plate is considerably higher than the 675 ma of the 5U4-G. The 5U4-GB has a maximum peak inverse plate voltage of 1,550.

Operated as a full-wave rectifier with an a.c. plate-to-plate supply of 900 volts in a capacitor-input filter, the 5U4-GB can deliver a d.c. output voltage of approximately 460 to the filter at a current of 275 ma. With a choke input to the filter, it can deliver 340 volts at 348 ma.

## 6AF4-A

Another RCA announcement concerns the 6AF4-A, a miniature triode designed for use as an oscillator in tuners of u.h.f. television receivers. It is similar to the 6AF4, but is  $\frac{3}{8}$  inch shorter in over-all length to permit more compact tuner designs.

## 6550

Tung-Sol has announced a powerful new tube designed specifically for high-fidelity audio circuits. The tube, type 6550, is a pentode beam-power amplifier. It has a 35-watt plate dissipation rating that permits push-pull amplifier designs up to 100 watts output. The tube has an over-all length of  $4\frac{3}{4}$  inches and a diameter of 2-1/6 inches. The base connections are the same as for the 6L6.

Electrical characteristics are: heater voltage, 6.3; heater current, 1.8 amp; maximum d.c. plate voltage, 600; maximum d.c. cathode current, 175 ma; maximum screen grid voltage, 400.

Typical AB<sub>1</sub> operating conditions for 100 watts output (values for two tubes) are: plate voltage 600, screen 300, control grid -31; zero signal-current, plate 115 ma, screen 4 ma; maximum-signal current, plate 273 ma, screen 41 ma. Load resistance 5,000 ohms plate-to-plate, peak grid-to-grid driving voltage 62.

The tube may also be used as a single-tube class-A<sub>1</sub> amplifier with 250 volts on the plate and screen and -14 on the control grid, with 12.5 watts output and a load resistor of 1,500 ohms. Various other conditions are possible, including a triode push-pull amplifier with a plate voltage of 450

The Sensation of Two Audio Fairs . . .



# PERMOFLUX

Largo and Diminnette

2-WAY SPEAKER SYSTEMS



Now Available Under

# HTP\*

Acclaimed at the Sight and Sound Exposition in Chicago and the Auditorama in New York, these amazing high-fidelity speaker systems are now available under HTP—an exclusive Permoflux insured plan that enables you to try a Largo or Diminnette in the quiet and comfort of your own home for 15 days. See your hi-fi dealer today!

\*EXCLUSIVE PERMOFLUX 15-DAY INSURED HOME TRIAL PLAN, INTRODUCED AT THE CHICAGO AND NEW YORK AUDIO FAIRS, OCT., 1954

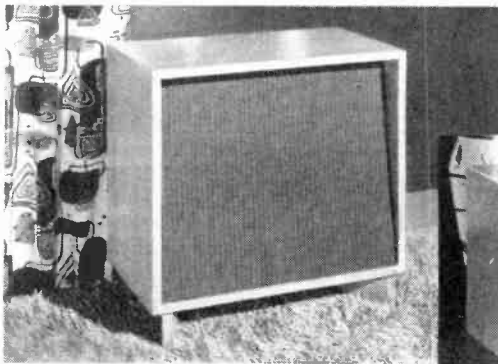

### THE LARGO

Outstanding wide-range speaker system at moderate cost. Uses the "Super Royal Eight" speaker and Super Tweeter. Unique new-type back-loading horn enclosure is matched, octave by octave, to speakers . . . assuring undistorted reproduction from 35-16,000 cps. In selected  $\frac{3}{4}$ " Mahogany or Korina veneers. Exclusive: Special connection for headset extension cord. Size: 24" W, 23" H, 14" D. Impedance, 8 ohms.

Suggested Audiophile Net . . . \$99.75

### THE DIMINETTE

A marvel of compactness featuring "big-system" reproduction over the full audio range and low cost. Ideal for use in a bookcase or as extension speaker. With 2 "Royal 6" speakers and Super Tweeter. In Mahogany or Blonde finish  $\frac{3}{4}$ " Veneers. Size: 23 $\frac{1}{2}$ " W, 11 $\frac{1}{2}$ " H, 12" D. Impedance, 4-8 ohms.

Suggested Audiophile Net . . . \$49.50

As above, but with selected  $\frac{3}{4}$ " Mahogany or Korina veneers.

Suggested Audiophile Net . . . \$64.50

HEARING IS BELIEVING! Try either system at home under HTP! Read what High-Fidelity Magazine says:

"It's best to try a speaker at home before buying."

—Audio Forum Dept., Oct. 1954 issue

FOR A LIMITED TIME ONLY: Every HTP participant will receive, absolutely FREE, the new Permoflux "Maestro" Speaker-Headset Control Box. See your Permoflux-authorized HTP dealer, or write for full details, to:

Permoflux CORPORATION

4912 West Grand Avenue • Chicago 39, Illinois

West Coast Plant • 4101 San Fernando Road • Glendale 4, California  
Canadian Licensee • Campbell Manufacturing Co., Ltd., Toronto, Canada

# NEW Year's News from Hallicrafters

CHICAGO 24, ILLINOIS

IN CANADA: BOX 27  
TORONTO 17, ONTARIO

## Model SX-96 SELECTABLE SIDEBAND RECEIVER

- Covers Broadcast 538-1580 kc plus three S/W 1720 kc—34 Mc.
- Full precision gear drive dial system.
- Double conversion with second oscillator crystal controlled.
- Selectable side band reception of both suppressed carrier and full carrier transmissions.
- Mixer type second detector.
- CW operation with AVC on.
- Delayed AVC.
- Calibrated bandspread — "S" meter — double superhet.
- 10 tubes, 1 rectifier and voltage regulator.



## NEW TUBES

(Continued)

and grid voltage of  $-46$ . Output with this circuit is 28 watts, peak-to-peak driving voltage 92 and plate-to-plate load 4,000 ohms.

## 12SN7-GTA, 6AX4-GT, 6BX7-GT

Development of three new "service-designed" TV receiving tube types—the 12SN7-GTA, 6AX4-GT, 6BX7-GT—was announced by G-E.

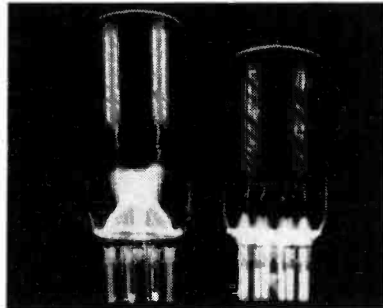

Aside from improved construction, the 12SN7-GTA has 28% less bulb height (see photo), a maximum plate voltage rating of 450 per plate compared with 300 for the 12SN7-GT, and a maximum heat dissipation per plate of 5 watts.

The construction design of the 6AX4-GT features protection against plate-cathode arc-overs that cause fuse blow-outs in horizontal deflection circuits. The 6BX7-GT is designed to reduce microphonics and vertical jitter in vertical deflection amplifiers.

## Silicon transistors

Expanding their line of silicon transistors, Texas Instruments, Dallas, has announced their type 903 with an alpha (current amplification factor) of 0.90 to 0.95, type 904 with an alpha of 0.95 to 0.975, and type 905 with an alpha of 0.975 or better. The average alpha cutoff frequency of these transistors is 3 megacycles; their alpha rating is guaranteed. Another type, the 904A, has an alpha cutoff frequency of 8 megacycles and an alpha of 0.95 or better.

## 2N54, 2N55, 2N56

Westinghouse has announced three new germanium p-n-p junction transistors, types 2N54, 2N55, 2N56. They are designed for low-power, low-frequency amplifier applications. Each is capable of dissipating 200 milliwatts at 25°C. Their average cutoff frequency at the 6-milliwatt power level is 500 kc. The average current gain of the 2N54 is 0.97; for the 2N55, 0.95; for the 2N56, 0.92.

## High-power transistor

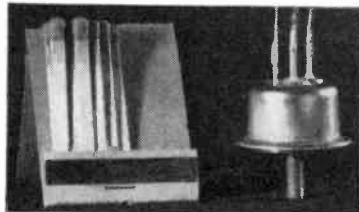

# "650C"

# HICKOK

**ALL-PURPOSE  
VIDEO GENERATOR**  
*for Black & White  
or Color*



The first instrument of its kind to accurately and rapidly solve your TV servicing problems with the necessary tests to visually identify trouble in any section of a TV receiver.

- ★ Provides electronically accurate patterns for Black & White or Color... Independent of station operation.
- ★ RF Output is directly calibrated in Microvolts for sensitivity measurements.
- ★ Crystal controlled timer for greater accuracy.
- ★ Acclaimed by TV Service Experts as... "The Greatest Single Test Equipment Accomplishment Ever Made".
- ★ Ask for a demonstration of the 650C from your TV Parts Jobber Today!
- ★ Write for the HICKOK Test Equipment catalog showing the Latest Servicing Instruments.

THE HICKOK ELECTRICAL INSTRUMENT CO.  
10531 Dupont Avenue • Cleveland 8, Ohio

**Fabulous..Revolutionary  
..Completely New..**

# MIGHTY MO\*

\*Pat. No. 2680196, others pending.

**the most powerful antenna  
ever built, featuring TESCON'S  
NEW exclusive DDP (Double Diamond Phasing)**

Tescon's miraculous Mighty Mo will make prime signal areas out of even the deepest fringe sections of the country.

Mighty Mo... complete with DDP, an entirely new and revolutionary concept of phasing, will trap even the weakest signal and perk it up to a clear, brilliantly sharp, deep-toned picture. Tescon absolutely guarantees that each and every Mighty Mo will perform where other antennas have actually failed!

Unshakeable proof, substantiated by exhaustive field tests, definitely shows that Mighty Mo **does more** than any other antenna manufacturer loudly claims his product will do. Theoretical ratings will never pay off. Rely on tested results... that's your real proof, that's your money in the bank.

**Here's Mighty Mo's proof  
...the results of ACTUAL  
FIELD TESTS.**

- On channels 2 to 13, Mighty Mo outperforms every other antenna manufactured today.
- Higher uniform gain over all channels. Does not vary more than 1½ D.B. on any channel across band. Perfect on color TV.
- Clearer, sharper, deeper pictures on all channels.
- Higher average gain than 6 of the most advertised antennas

**STOCK**

**this red-hot, fast moving,  
money-making antenna... right now!**

## MIGHTY MO'S FEATURES

- DDP (Double Diamond Phasing) precision-timed phasing regulator enables the weakest of signals to be trapped and then boosted to a clear, magnificently sharp, photo-like picture.
- Flat response... a must for color reception.
- Largest screen area... over 70 sq. ft. Screen elements spaced less than 1/10 wave length apart for maximum reflector efficiency.
- Highest front to back ratio ever achieved.
- Absolutely no rear pick up or co-channel interference... no "venetian blinds."
- ½ wave element spacing on all channels for super-gain.
- Completely preassembled... not an erector set type antenna.
- Uniform gain response... no erratic audio and video patterns.
- Thoroughly tested for mechanical stress and strain... exceptionally rugged.
- Guaranteed to perform where other antennas fail

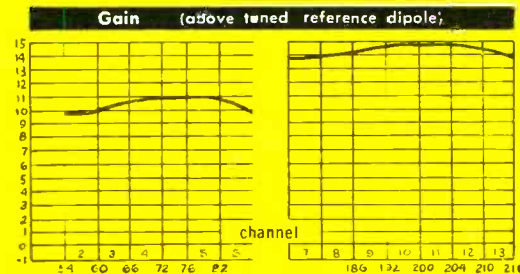
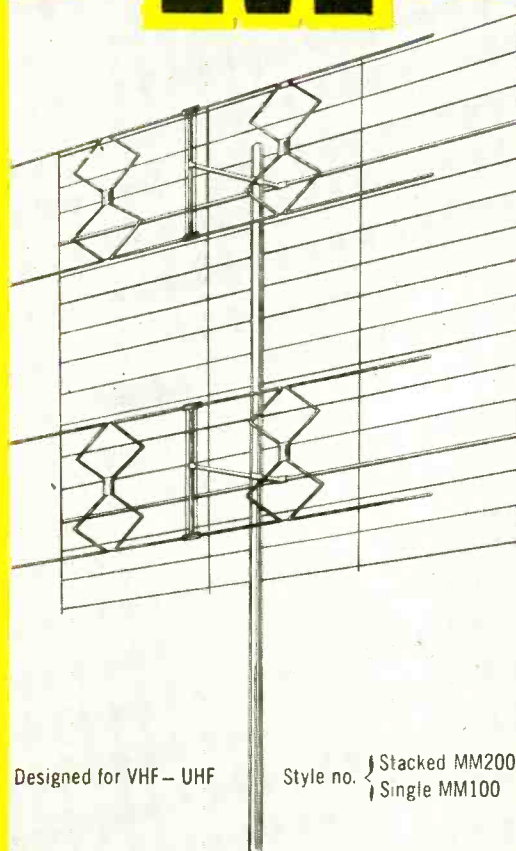

Most uniform gain response ever recorded.  
Does not vary more than 1½ D.B. on any channel.  
Extremely important for quality color reception.

©NTI

**TESCON TV PRODUCTS COMPANY**  
SPRINGFIELD GARDENS 13, NEW YORK

# New Year's News from Hallicrafters

CHICAGO 24, ILLINOIS

IN CANADA: BOX 27  
TORONTO 17, ONTARIO

## Model SX-99 RECEIVER

Here is everything you could wish for in a DX receiver. Covers Broadcast Band 540-1680 kc plus three short-wave bands 1680 kc-34 Mc calibrated for the 10, 11, 15, 20, 40 and 80 meter amateur bands over a large easy-to-read dial. Features for the amateur—"S" meter, separate bandspread tuning condenser, crystal filter, antenna trimmer, one r-f, two -if plus 3.2 and 500 ohm speaker terminals.

Gray-black steel cabinet with brushed chrome trim and piano hinge top, 18 1/2" x 8 1/2" x 11". Shipping weight 36 lbs.

Seven tubes plus rectifier. 105/125 V. 50/60 cycle AC. \$149.95 (less speaker). Use Hallicrafters R-46A Speaker.



## NEW TUBES

(Continued)

A transistor capable of delivering up to 5 amperes has been developed by Minneapolis-Honeywell Regulator Co. (see photo). The power-handling ability of this unit is made possible by a special structure that permits rapid flow of heat to the outside of the transistor.

A feature of this unit is its high current gain even at collector currents up to 1 ampere.

## 6BQ6-GTB, 12BQ6-GTB, 25BQ6-GTB

Three new tube types designed especially for use in the horizontal deflection amplifier of a television receiver have been released by RCA. The tubes, types 6BQ6-GTB, 12BQ6-GTB, and 25BQ6-GTB, are high-perveance beam-power units.

The 6BQ6-GTB has maximum peak positive- and negative-pulse plate voltage ratings of 6,000 and 1,250, respectively, and a maximum d.c. plate supply voltage of 600, plate dissipation of 11 watts, screen-grid input of 2.5 watts. It is designed to deflect fully picture tubes having deflection angles up to 90°.

The 12BQ6-GTB is like the 6BQ6-GTB except that it has a 600-ma heater for series-string operation. The 25BQ6-GTB is also the same except for having a 300-ma heater.

These tubes can directly replace the 6CU6, 12CU6 and 25CU6. They will be double-branded 6BQ6-GTB/6CU6, 12BQ6-GTB/12CU6, 25BQ6-GTB/25CU6.

## AX5727

Amperex Electronic Corp. has added type AX5727 to its line of thyatron tubes. It is a ruggedized version of the standard type 2D21.

The AX5727 is an inert gas-filled thyatron with negative control characteristics. It has a high control ratio which is stable over a wide temperature range.

## Germanium diodes

Three new germanium diodes of the "all-glass envelope" type, have been announced by Amperex. The diodes, types 0A71, 0A73, and 1N87G, feature unusual resistance to humidity.

The 1N87G is a high-quality video detector which offers high rectification efficiency, coupled with low loading on resonant circuits.

The 0A71 is a high back resistance type designed for computer and general purpose applications.

The 0A73 is designed for use as a video detector, having advantages similar to the 1N87G, and is intended for higher level i.f. signals where its greater back resistance eliminates sync clipping.

## OB2WA

Designed as a replacement for the OB3, this Raytheon voltage regulator features rugged construction for use in critical military and commercial applications. END

## NEW! ATLAS CJ-30 COBRA-JECTOR

INDESTRUCTIBLE FIBER-GLASS  
ALL WEATHER  
WIDE ANGLE DISPERSION

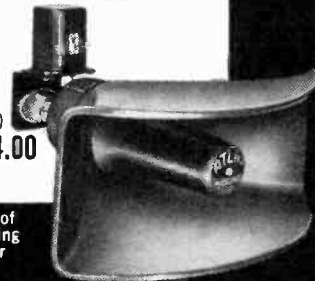

List \$40.00  
NET \$24.00

Complete with Driver.

Weatherproof Line Matching Transformer as shown, Net \$5.10.

New versatile all-purpose projector—excellent for paging & talk-back, intercom, marine, and industrial voice & music systems. Penetrating articulation assures wide angle intelligible coverage even under adverse sound conditions. "ALNICO-V-PLUS" magnetic assembly. Double-sealed against all weather. Omni-directional mounting bracket. Quick, easy installation. An amazing "power package"—Specify the CJ-30 for the "tough" jobs!

Input Power (continuous).....15 watts  
Input Impedance.....8 ohms  
Response .....250-9000 cps  
Dispersion .....120° x 60°  
Dimensions: .....Opening, 14" x 6"  
Overall Length, 14"



WRITE FOR COMPLETE CATALOG

**ATLAS SOUND CORP.**

1443—39 St., Bklyn. 18, N. Y.

In Canada: Atlas Radio Corp., Ltd., Toronto, Ont.

## It pays to train for something different! FIX ANY ELECTRIC MOTOR!

There's good pay in repairing electric motors . . . and this big, profusely illustrated book helps you cash in on the hundreds of opportunities that exist wherever electricity is used.

ELECTRIC MOTOR REPAIR shows exactly how to handle every phase of motor repair and maintenance including profitable rewinding.

Covers both AC and DC motors and generators PLUS mechanical, electrical and electronic motor control systems. Fully approved by leading specialists, unions, etc. Thousands of copies now used in motor shops, schools and for home study by men who want to get ahead in this fast-growing field. And it's the ideal guide if you only want to fix motors for yourself and friends as a sideline or hobby.

### ELECTRIC MOTOR REPAIR

560 pages—Over 900 step by step pictures  
Price \$6.00

The complete how-to-do-it guide for repairing practically any motor in common use

### — PRACTICE 10 DAYS FREE —

Dept. RE-15, RINEHART & CO., INC.  
232 Madison Ave., New York 16, N. Y.

Send ELECTRIC MOTOR REPAIR training book for 10 days free trial. I will then either send \$6.00 (plus postage) in full payment or return book post-paid and owe you nothing.

Name .....

Address .....

City, Zone, State.....

OUTSIDE U.S.A.—\$6.50 cash with order only.  
Money back if book is returned in 10 days.



# So Simple...A Child Can Tune It!



the new  
**SKY CHIEF**  
**ANTENNA ROTATOR**



SINCE 1906

Finger tip tuning *plus* better performance... greater dependability... superior design... outstanding efficiency! Half a century of Brach electronic know-how makes the difference. And Brach's merchandising policy insures fair margin and mark up.

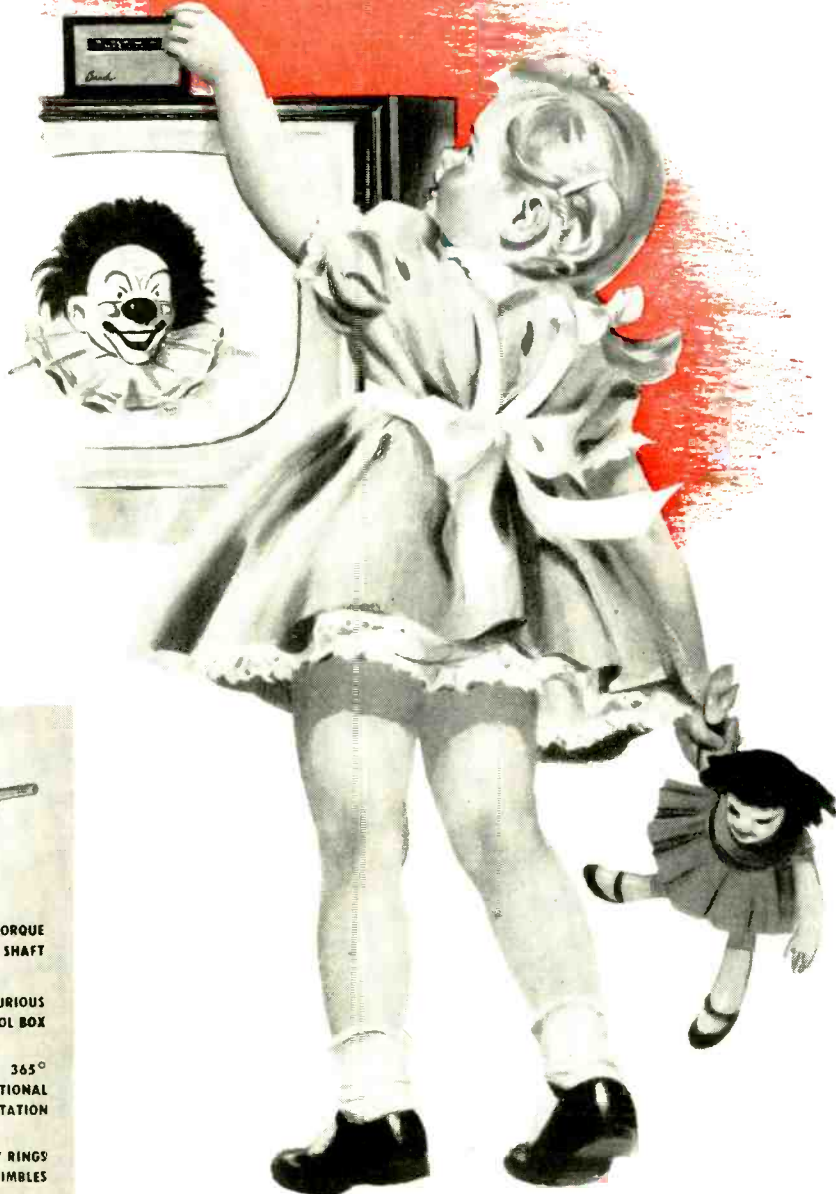

FLEXIBLE WORM DRIVE

BUILT-IN THRUST BALL BEARING

AUTOMATIC ELECTRICAL AND MECHANICAL SAFETY STOPS

PLUG-IN MOTOR

WEATHER PROOF CONSTRUCTION

PRECISION GEARING

HOLLOW TORQUE SHAFT

LUXURIOUS CONTROL BOX

365° DUO-DIRECTIONAL ROTATION

BUILT-IN GUY RINGS WITH THIMBLES

REINFORCED CASTINGS — HIGH STRENGTH ALLOYS

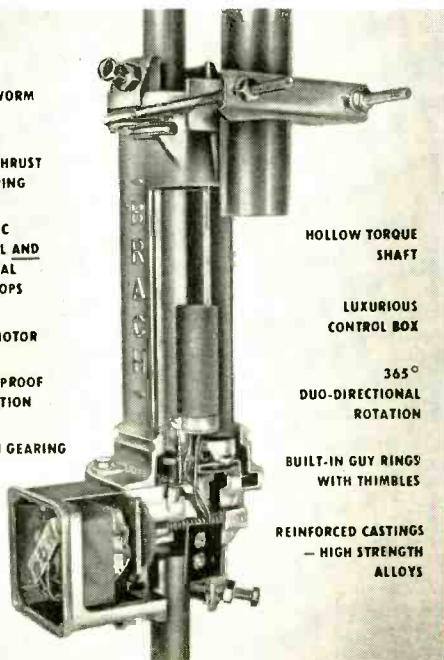

**BRACH MANUFACTURING CORPORATION**

Division of General Bronze Corp.

200 Central Avenue, Newark 3, N. J., HUmboldt 2-1500



# LAFAYETTE'S SPECTACULAR MULTITESTER VALUE!

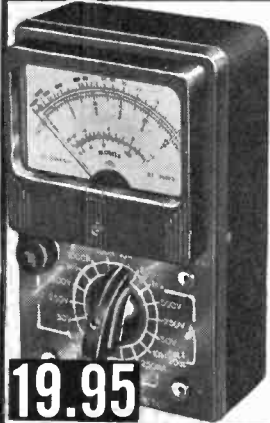

**HIGH SENSITIVITY  
AC-DC MULTITESTER**  
20,000 ohms per Volt

The new Lafayette High Sensitivity Multitester is a complete instrument (not a kit). Here is an instrument packed with every desirable feature found only in instruments costing twice as much. One of the most sensitive multitesters ever offered. 20,000 ohms per volt DC; 3,000 ohms AC, having a high sensitivity 45 microamps meter. Full scale AC-DC voltage ranges are 0-10V, 0-50V, 0-250V, 0-500V, 0-1000V; DC current ranges 50 microamps, 2.5 ma, 25 ma, 250 ma. Resistance: 0-5K ohms, 0-50K ohms, 0-500K and 0-5 megohms. Decibel range: -20 -45 db; +5 +22 db (0 db = 0.775V - 600 ohms). Extreme versatility and accuracy. 1% precision resistors; 3" meter; beautiful plastic front, with metal bottom for ruggedness. Size: 3 1/2" x 5 1/2" x 2 1/2". Complete with batteries and leads. Shpg. Wt. 4 lbs.

**19.95**

RW-30G ..... NET **19.95**  
In lots of 3 **19.25**

**NEW POCKET AC-DC  
VOM MULTITESTER**  
1,000 ohms per Volt

This instrument is one of the best buys that Lafayette has ever offered in a Wide Range AC-DC MULTITESTER. An ideal portable unit that meets the need for a compact, yet rugged test instrument. Has ease of operation usually found ONLY IN MORE EXPENSIVE INSTRUMENTS. Has 1000 ohms/volt sensitivity on both AC or DC. Uses full 3" rectangular meter with large easy to read scale. Uses 1% precision resistors. Jeweled D'Arsonval microamp meter movement. Ranges: AC-DC and output volts 0-5, 0-25, 0-250, 0-1000V; DC current 0-1, 0-10, 0-100, MA; Resistance 0-10K and 0-100K ohms. In handsome sturdy bakelite case. Size: 4 1/2" x 2 1/2" x 1 1/2". Supplied Complete with test leads and batteries. A Must for every serviceman, shop, Laboratory or experimenter—and at Lafayette's Price you can afford to own one. Shpg. Wt. 2 1/2 lbs.

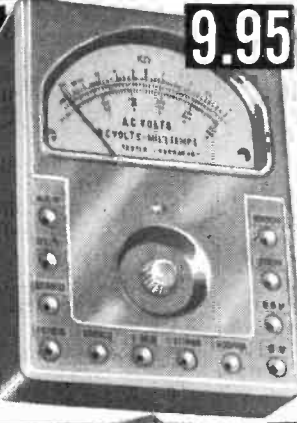

**9.95**

MODEL RW-27C—Complete  
In Lots of 3 **9.45**  
Single. ea. **9.95**

**Collaro**  
THE WORLD'S FINEST 3 SPEED  
AUTOMATIC RECORD CHANGER  
SPECIAL **29.50** LIST PRICE **54.50**



Lafayette scores again with an almost unbelievable price on the Collaro 3-speed Automatic record changer. We made a spectacular buy and we are passing the savings on to you. Here's the finest changer made. Manufactured in England—with a world-wide reputation. It plays all sizes and all speeds automatically. It's packed with quality features that the Hi-Fidelity enthusiast will appreciate: Jam-proof ball bearing mounted tone arm; automatic shut-off after last record; powerful fan cooled turntable; 4-pole motor with self-aligning oilite bearings; automatic muting switch; weighted ball-bearing mounted constant speed turntable; rubber drive couplings—and more! Base size 14 1/2" x 12 1/2". Depth below base 2 1/2". Shpg. Wt. 19 lbs. Available either less cartridge with plug-in shell, or with famous turnover Ceramic or G.E. Triple-Play cartridge.  
COLLARO Model 3/531 changer ..... Net **29.50**  
COLLARO Model 3/531 with Turnover Ceramic cartridge ..... Net **31.50**  
COLLARO Model 3/531 with G.E. Triple Play RPN-050 cartridge installed ..... Net **32.50**  
45 RPM SPINDLE  
Slips on in place of regular spindle, eliminating use of center inserts on 45 RPM records.  
GSA Spindle ..... Net **3.23**

**COMPENSATOR**  
for G. E. CARTRIDGE  
Designed for use with G.E. reluctance cartridges and preamplifiers. Five settings include LP, AES, Flat, Good 78 and Poor 78. No circuit loss is produced by use of equalizer. A must where greater bass and treble response is desired. Flat position gives maximum high frequency response. No wiring required—just plug in. With lead and plug. 2 1/2" x 2" x 2"—Max. depth 4".  
Stock No. PK-60 ..... NET **4.95**



**DUAL STYLUS — TRIPLE PLAY**  
**DIAMOND and SAPPHIRE**  
(LP) (78)  
LIST **\$34.00**  
Replacement for All G.E. RPX-050 Triple-Play Cartridges!  
Stock No. PK-29 Net **11.95**

**TIMER-SWITCH SALE**  
Automatically turns on radios, television sets, toasters, coffeemakers, etc.—at any pre-set time within 12 hour period; also tells time. Built-in single-pole switch handles up to 15 amps, 115 volt. Requires 3 1/2" diameter round hole. Depth behind dial face 2 1/4". Shpg. Wt. 1 1/2 lbs. MS-62, for 110V/60 Cy AC  
**3.95**

**Top Quality CRYSTAL MIKE**  
**\$5.75**  
• -52 db output level  
• Range 30 - 10,000 cps  
• 10 ft. cable and connector  
• Handle and interlocking base  
A really fine microphone by a manufacturer known the world over. Use for amateur broadcasting, public address and home recording. Can be used with floor stand. Shpg. Wt. 2 1/4 lbs.  
PA-21 ..... **5.75**

**MINIATURE VOLUME CONTROL**  
3/4" DIAMETER  
Only 3/4" Diameter, overall depth approximately .4" including threaded shaft. Ideal for miniature radio, hearing aids, etc.  
VC-18—Range 0-500,000 audio taper. 39c  
VC-19—Range 0 to 1 Meg. linear taper 39c  
VC-20—Range 0 to 3 Meg. audio taper 39c  
In Lots of 10—\$3.25 **39c**

**PRECISION DRAFTING SET**  
11 Pieces—Fitted Felt-Lined Case  
Made in Germany, of heavy brass, nickel plated and polished. Instruments include 5 1/2" Compass with pencil and pen points and lengthening bar, 5/8" Divider, three 3 1/2" sidewheel bow dividers with needle point, pen point and pencil point. 5" Ruling pen, extra handle for pen or pencil, capsule with extra leads. Interchangeability of these many parts makes this an exceptionally versatile set. Your money back—if this set is not worth twice our price!  
F-13 ..... Net **2.75**

**Greatest Tape Buy Ever!**  
1200 FT. REEL  
Genuine Plastic Base  
RECORDING TAPE  
Shpg. Wt. 14 oz.  
LAFAYETTE made a terrific deal with one of the leading manufacturers of recording tape to supply us with their regular tape which sells for almost twice our price. WE GUARANTEE ABSOLUTE SATISFACTION OR YOUR MONEY BACK. The finest, professional-grade recording tape obtainable. Highest performance Red Oxide Base in a smooth, uniform coating; greater signal strength; with maximum fidelity; uniform frequency response from 40-15,000 cps.  
In lots of 10 rolls - **1.75 ea.**

**LAFAYETTE EXCLUSIVE!**  
DYNAMIC EAR PHONE  
A new lightweight plastic ear phone especially imported by Lafayette to bring you the high quality of a dynamic ear phone with the ease and comfort of an almost weightless unit—at a price less than half that of any comparable unit. Fits right into ear. Excellent sensitivity of 65 db. Ideal for use with miniature sets, hearing aids, transcribing, etc. DC resistance 2000 ohms; Impedance 5000 ohms at 1000 cycles. Complete with 3 ft. plastic covered cord.  
EXCELLENT FOR SILENT LISTENING OR VIEWING  
Will replace speaker on any radio set or T.V. for silent listening, by direct connection to secondary of output transformer.  
MS-72 ..... Net **1.95**

**SARKES TARZIAN VHF TUNER**  
Brand new—covers entire VHF spectrum. It is an exact duplicate of thousands now in use in many chassis including the Sylvania 510 and 520 series. Has 7" long concentric shafts. Excellent gain, noise factor, image and I.F. rejection. For 40 mc IF systems. Complete with 6BC6 and 6X8 tubes and shields. Shpg. Wt. 4 lbs. Worth 3 times the price!  
TL-24—In lots of 3 each ..... **4.45**  
Singly each ..... **4.95**

**CARDWELL UHF CONVERTER SALE!**  
List **42.50**  
Net **13.95 ea.**  
Lots of 3  
Singly **14.45 ea.**

Outstanding Value! The Cardwell ES-1 UHF converter covers the entire UHF spectrum—channels 14-83. Has 6AF4 oscillator, 6CB6 IF amplifier and 1N72 crystal diode. Features printed circuit oscillator, high overall gain (3 to 4 times), high sensitivity, constant L/C ratio tuner, 25-1 gear drive. Has AC cord and plug, 3-pos. switch for UHF, VHF and OFF. Handsome wood cabinet 8 1/2 x 6 1/2 x 3 1/2" with easy reading dial. Shpg. Wt. 4 1/2 lbs.

CARDWELL ES-1 Converter—Lots of 3 each ..... **13.95**  
Singly each ..... **14.45**

**5" Tweeter AND Crossover Network**  
**6.95**  
A specially designed 5" Tweeter and Crossover Network that will assure high frequency response when used with any speaker you now possess. You can now make your present speaker into a 2-way speaker system increasing the high frequency range up to 15,000 cycles. Diagram included. Shpg. Wt. 5 lbs.  
STOCK NO. SY-14 ..... Net **6.95**

**NEVER BEFORE AT THIS PRICE**  
**IMPORTED DIRECT PRISM-COATED LENSES BINOCULARS**  
• ALL-METAL CONSTRUCTION  
• INDIVIDUAL FOCUS  
• COMPLETE WITH LEATHER CASE & STRAPS  
F-86, 8 x 35 with case ..... Net **19.95**  
F-15, 7 x 35 with case ..... Net **22.50**  
F-103, 7 x 50 with case ..... Net **24.95**  
F-104, 12 x 50 with case ..... Net **32.50**  
with ord'r. Add 10% Fed. Tax

**Lafayette Radio**  
NEW YORK, N.Y. 100 Sixth Ave.  
BRONX, N.Y. 542 E. Fordham Rd  
NEWARK, N.J. 24 Central Ave.  
PLAINFIELD, N.J. 139 West 2nd St.  
BOSTON, MASS. 110 Federal St.  
DEPT. JA  
Include postage with order.  
Write for FREE Bargain Packed Catalog!

# Color's bigger than ever! AND THE NEW 2<sup>ND</sup> EDITION OF



## IS MORE THAN EVER A MUST

Color television receivers at much better prices are due to hit dealers' floors any time now. And when color television starts moving in volume . . . every technician must be ready for this new, different, profitable field. There's not a day to lose. Get your copy of the brand new 2nd edition of **PRACTICAL COLOR TELEVISION** . . . and get it right away!

Here is the latest *practical* color service information you can get from any source. Included in its 86 pages are: Principles of Color Television . . . Detailed Circuit Diagrams . . . Operating Instructions . . . Antenna Requirements . . . Test Recommendations . . . and much, much more. Time-tested information . . . brought up to the minute by RCA, pioneer in compatible color television.

\$2.00 a copy . . . and *worth far more* in future color television profits for you! See your RCA Parts and Tube Distributor, or mail the coupon . . . today.

## RCA SERVICE COMPANY, INC.

A Radio Corporation of America Subsidiary  
CAMDEN, NEW JERSEY

RCA Service Co., Inc.  
Commercial Service Section  
Camden, N. J.

Please send me \_\_\_\_\_ copies of "Practical Color Television" at \$2.00 each.

Check or  Money Order for \$\_\_\_\_ enclosed.

NAME \_\_\_\_\_

COMPANY \_\_\_\_\_

STREET \_\_\_\_\_

CITY \_\_\_\_\_ ZONE \_\_\_\_\_ STATE \_\_\_\_\_

### TECHNOTES

(Continued)

ondary of the discriminator transformer (inside the transformer can). Its outside plate should go to the low side of the coil. If the capacitor is connected properly, the trouble can generally be eliminated by slightly detuning the *primary* winding. This method is not recommended for fringe areas. In such areas, try inserting 220-ohm suppressor resistors at the 6AL5 socket, as shown in the diagram.—*Geo. R. Anglado*

### MOTOROLA TV COMBOS

In some cases, hum may be heard from Motorola 17F3 and similar TV combination receivers even when the TV and radio line switches are turned off. This trouble is caused by incorrect polarization of the leads from the AM-FM chassis to the speaker. It can be cured by reversing the leads from the speaker pin jacks.

When reinstalling the radio chassis in the cabinet, take care to plug the speaker leads in so the ground wire from the radio chassis plugs into the pin jack connected to terminal 2 on the receptacle that receives the speaker plug from the TV chassis. Terminal 2 is the ground connection for the TV chassis.—*E. M. Breckenridge*

### MASK CUTTING

In converting TV receivers for large screen tubes it is generally necessary to purchase a mask. These are brittle and crack easily. With 20-inch masks costing several dollars, spoilage is expensive. So if you have to cut down a mask to fit a cabinet, here is how it is done.

Several inches can be cut away safely in just a few minutes by using a disc sander. Mine is installed on a bench saw. Cut a disc of wood the size of the saw blade and insert a nut and bolt in the center to permit attachment in place of the rotary saw. Various motor shafts will require different mountings. Cut a sheet of emery paper the size of the wood disc—I generally use coarse emery or sandpaper—and glue on.

I have done this many times and never spoiled a mask. Some manufacturers recommend using a plane or file. I have tried that and chipped off edges.—*Jacob Dubinsky*

### TUNER ADJUSTMENT

When servicing TV sets having turret or selector-switch type tuners, poor picture or sound can often be traced to a misadjusted oscillator slug. Apparently the slug becomes misadjusted due to mechanical shock during transit. The slug screw is usually located directly behind the channel selector knob.

If the set is of the intercarrier type, adjust the slug for best picture and minimum buzz; if it is a dual-channel type, adjust the slug for best sound. In all cases use an *insulated* alignment tool for making the adjustments and preset the fine-tuning control to its center position.—*John Comstock* END



### TV VOLTAGE REGULATOR

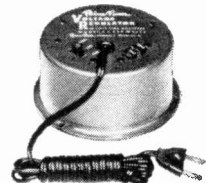

10 Volt Line Adjustor  
• Normal Line Volts  
• 10 Volts Increase  
• 10 Volts Decrease  
300 Watts. Returns full height & width of picture. Eliminates intermittent sync. **\$6<sup>75</sup>** LIST

## made better!



### UNIVERSAL TV TUBE BRITENER

**\$4<sup>45</sup>** LIST  
Isolation type transformer gives 6.3 V for cathode — filament short or 7.8 V to increase emission. • It's parallel • It's series • It's isolation • It's electrostatic • It's universal.

## made better!

### H·B·G HORIZONTAL BAR GENERATOR

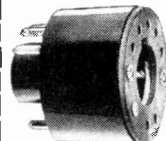

for quick TV set adjustment and alignment!  
• For adjustment of vertical linearity and height controls  
• Accurate positioning of focus coil or magnet  
• Precise setting of yoke  
• Complete with instructions **\$1<sup>95</sup>** LIST

## made better!

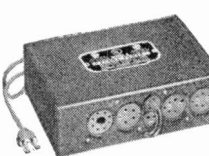

### MODEL "A" BATTERY ELIMINATOR

for 105-125V., 50/60 cycles  
**\$18<sup>95</sup>** LIST  
For 1/2 volt radios with 4 to 6 tubes. Gives nearly constant power from varying line voltages. Universal sockets for all battery plugs.

Available from electronic parts distributors  
Illustrated literature upon request



EXPORT: Scheel International, 4237 N. Lincoln, Chicago 13

# Patents

## LOW-POWER FREQUENCY MODULATOR

Patent No. 2,678,426

Robert E. Rawlins, North Hollywood, Calif.  
(Assigned to Lockheed Aircraft Corp.)

This modulator is suitable for telemetering, radio transmission, or signal generation. It is effective at high frequencies without frequency multiplication. Its circuits are simple and non-critical.

The modulating voltage is controlled by R1. Phase-splitter V1 contains plate load R2 and a cathode load R3. These provide out-of-phase voltages, with R3 adjustable. The voltages feed the plate and grid of V2, an oscillator.

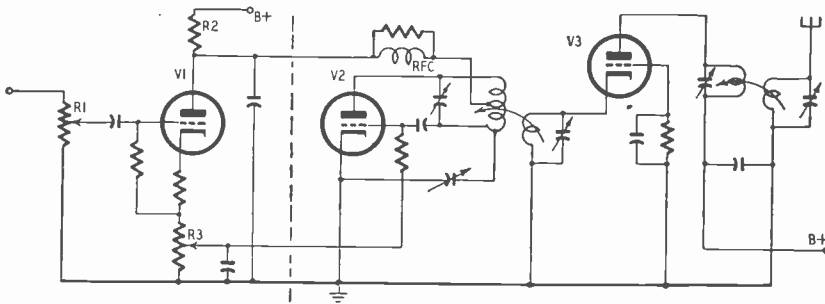

## GATING CIRCUIT

Patent No. 2,685,039

Alfred D. Scarbrough, Pasadena, and  
Elwood E. Bolles, Los Angeles, Calif.  
(Assigned to Hughes Aircraft Co.)

This gating circuit has several advantages over previous ones. It operates almost instantaneously and does not load the signal source. A square-wave source provides timing signals. If a pulse arrives during the higher level of the square wave, that pulse is transmitted. Pulses which

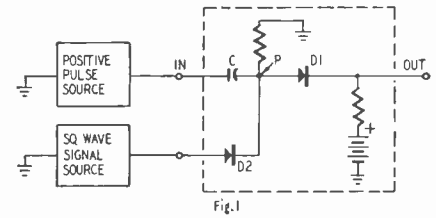

Just Out

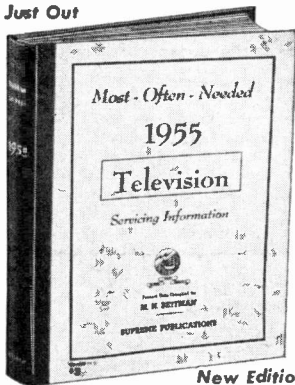

New Edition  
Covers all important 1955 Sets

# New SUPREME 1955 TV Manual

## AMAZING BARGAIN

The new 1955 TV manual is the scoop of the year. Covers all important sets of all makes in one giant volume. Your price for this mammoth manual is only \$3. This super-value defies all competition. Other volumes at only \$3 and \$2 each. Each manual has a whole year of service material. Includes all data needed for quicker TV repairs. Practically tells you how to find each fault and make the repair. More pages, more diagrams, more service data per dollar of cost. Get the best for less. Get SUPREME.

## COVERS ALL POPULAR SETS

Supreme TV manuals have all needed service material on every popular TV set of every important manufacturer. Here is helpful, practical, factory-prepared data that will really make TV servicing and adjustment easy for you. Benefit and save with these amazing values in service manuals. These giant TV manuals have complete circuits, alignment facts, test patterns, response curves, service hints, all recommended changes, voltage charts, waveforms, and many double-page diagram blueprints. Here is your TV service material to help you do more expert work quicker; and priced at only \$3 and \$2 per manual covering a full year of material. Be ready to repair any model by having in your shop all nine TV volumes listed in coupon below. Or try the new 1955 TV manual to see what an amazing bargain you get for only \$3. Send trial coupon for prompt shipment, or ask your jobber.

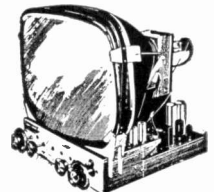

The repair of any television set is really simple with Supreme TV service manuals. Every set is covered in a practical manner that will simplify troubleshooting and repair. This is the help you need to find toughest faults in a jiffy. Each \$3 TV volume covers a whole year of service material. New Television Servicing Course will add you in learning TV. Be wise, buy Supreme Manuals only once each year instead of spending dollars every week for not needed data.

## TELEVISION SERVICING COURSE

Let this new course help you in TV servicing. Amazing bargain, complete, only \$3, full price for all lessons. Giant in size, mammoth in scope, topics just like a \$200.00 correspondence course. Lessons on picture faults, circuits, adjustments, short-cuts, UHF, alignment facts, hints, antenna problems, trouble-shooting, test equipment, picture analysis. Special, only \$3



Newest

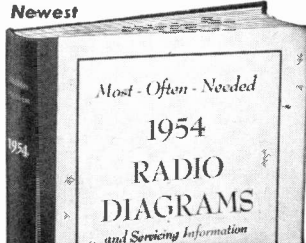

## RADIO DIAGRAMS

Here is your complete source of all needed RADIO diagrams and service data. Covers everything from most recent radios to pre-war old-timers; home radios, auto sets, combinations, changers, and portables. Sensational values. Still sold at pre-Korean prices. Only \$2 for most volumes. Every Radio manual contains large schematics, all needed alignment facts, parts lists, voltage values, trimmers, dial stinking, and helpful service hints. All volumes are large in size, 8 1/2 x 11 inches, about 192 pages. See coupon at right for a complete list of these low-priced manuals.

## NO-RISK TRIAL ORDER COUPON

SUPREME PUBLICATIONS, 1760 Balsam, Highland Park, ILL.

### Radio Diagram Manuals

Most-Ofen-Needed Series  
(See full description at left.)

- 1954 Radio Manual, \$2.50
- 1953 Diagrams
- 1952 Radio
- 1951 Diagrams
- 1950 Manual
- 1949 Radio
- 1948
- 1947
- 1946
- 1942
- 1941
- 1940
- 1939
- 1926-1938 Manual, \$2.50
- Master INDEX only 25¢

EACH \$2.50  
PRICED AT ONLY \$2 EACH

Rush today Radio manuals checked  at left and TV manuals below. Satisfaction guaranteed.

- New 1955 Television Manual, \$3.
- 1954 TV, \$3.
- 1953 TV Manual, \$3.
- UHF Manual, \$1.50
- 1952 Television Manual, \$3.
- 1951 TV, \$3.
- 1950 Television Manual, \$3.
- 1949 TV, \$3.
- 1948 TV, \$3.
- 1947 TV & FM, only \$2.
- Television Servicing Course, complete, only . . . \$3.

I am enclosing \$ . . . . . Send postpaid.

Send C.O.D. I am enclosing \$ . . . . . deposit.

Name: . . . . .

Address: . . . . .

**Supreme Publications**  
Sold by All Leading Parts Jobbers

# GREATEST TUBE BUYS

EVERY TUBE GUARANTEED A FULL YEAR

Branded—Bulk Packed in Original Mfr's. Nested Cartons or Individually Boxed  
**JOBBER! DISTRIBUTOR! We have a Wonderful Deal For You. Write—Wire—Phone!**

0A2	5.87	1U4	.46	6AT6	.36	6N7	.95	7F7	.64	12SF5	.48	35Z3	.40	
0A3	VR75	.97	1U5	.40	6AU6	.40	6Q7	.90	7B7	.68	12SF7GT	.68	35Z5GT	.59
0A4G	.60	1X2	.55	6AV5GT	.79	6R7	.49	7G7	.80	12SG7	.70	36	.35	
0B2	.74	2A3	.90	6AV6	.37	6S7	.39	7K7	.80	12SH7	.70	37	.35	
0B3	VR90	.90	2A5	.49	6AX4GT	.57	6S7G	.55	7L7	.77	12SJ7	.55	39.44	.35
0C3	VR105	.95	2A6	.49	6B7	.93	6SA7	.40	7N7	.57	12SK7GT	.49	42	.40
0D3	VR150	.95	2A7	.60	6BB6	.29	6SC7	.75	7Q7	.57	12SL7GT	.49	43	.53
0Z4	.35	2X2	.39	6BA6	.38	6BD7GT	.38	7R7	.59	12SN7GT	.50	45Z3	.40	
1A4P	.35	2X2A	1.14	6BA7	.55	6BF5GT	.45	7S7	.83	12SQ7GT	.53	46	.45	
1A5GT	.40	2X2A	.44	6BC5	.49	6BF7	.58	7V7	.87	12SR7	.49	47	.85	
1A7GT	.40	3A5	.44	6BE6	.37	6B7	.40	7W7	.85	12S7	.39	49	.38	
1AB5	.38	3A5	.90	6BF5	.69	6SH7	.60	7X6	.57	14A4	.65	50L6GT	.61	
1B3GT	.67	3A8GT	.59	6BG6G	1.15	6SH7GT	.50	7Y4	.40	14A5	.57	50X6	.62	
1C5GT	.40	3B7	.39	6BH6	.45	6S7	.54	7Z4	.45	14A7	.53	50Y6GT	.57	
1C7G	.37	3D6	.38	6BJ6	.41	6SK7	.39	12A6	.49	14AF7	.59	56	.47	
1D7GT	.75	3LF4	.71	6BK7	.89	6SL7GT	.49	12A7	.98	14B6	.45	57	.53	
1E7GT	.35	3Q4	.48	6BL7GT	.65	6SN7GT	.48	12AH7GT	.85	14B8	.63	58	.56	
1F4	.40	3Q5GT	.48	6BN6	.89	6SQ7	.49	12AL5	.40	14C5	.80	70L7GT	1.00	
1F5G	.44	3S4	.46	6BQ6GT	.75	6SR7	.45	12AT6	.35	14C7	.65	71A	.52	
1H4G	.40	3V4	.50	6C7	.88	6ST7	.48	12AT7	.62	14E5	.65	76	.52	
1H5GT	.38	5T4	1.25	6C4	.35	6T8	.57	12AU6	.36	14E7	.80	77	.53	
1J6G	.59	5U4G	.49	6C5	.39	6U7G	.45	12AU7	.59	14F7	.65	78	.43	
1L4	.45	5V4G	.76	6C6	.54	6U8	.58	12AV6GT	.48	14FH	.90	81	1.10	
1L6	.59	5Y3G	.38	6C8G	.85	6V6	.48	12AV7	.64	14H7	.57	82	.67	
1L44	.59	5Z3	.33	6C86	.42	6W4GT	.41	12AX4GT	.55	14N7	.57	83	.77	
1L66	.75	6A6	.45	6CD6G	1.05	6W6GT	.41	12AX7	.55	14Y4	.67	84	.67	
1L84	.77	6A7	.90	6D6	.67	6X4	.45	12B6	.46	19	.85	85	.57	
1LC5	.59	6A8	.65	6D8G	.95	6X5	.35	12BA6	.47	19B6GG	1.15	89Y	.29	
1LC6	.75	6AB4	.42	6E5	.76	6X8	.70	12BA7	.59	19T8	.75	117L7GT	1.17	
1LD5	.49	6AB7	.71	6E6	.45	7A4	.45	12B6	.46	22	.40	117Z3	.38	
1LE3	.75	6AC5GT	.95	6E7	.90	7A5	.55	12BE6	.45	25AV5GT	.80	117Z4GT	.73	
1LG5	.75	6AC7	.68	6F8G	.69	7A6	.65	12BH7	.65	25B05GT	.75	117Z6GT	.70	
1LH4	.75	6AF4	.89	6GG6	.63	7A7	.65	12B7	.65	25L6GT	.40	20S1	.93	
1LM5	.55	6AF6G	.75	6H6	.49	7AD7	.90	12F5GT	.35	25W4GT	.45	803	2.95	
1NSGT	.61	6AG5	.47	6J5	.38	7AG7	.55	12H6	.45	25Z3	.60	807	1.45	
1PSGT	.56	6AG7	.90	6J6	.50	7AH7	.55	12J5GT	.39	25Z6GT	.45	814	3.50	
1Q5GT	.55	6AH6	.98	6J7	.48	7B4	.44	12J7GT	.57	26	.42	832A	5.95	
1R4	.81	6AK5	.59	6J8G	.90	7B5	.55	12K7	.53	27	.37	866A	1.45	
1R5	.55	6AQ5	.39	6K7G	.38	7C4	.55	12Q7G	.57	32L7GT	.37			
1S4	.55	6AQ5	.39	6K7G	.38	7C4	.55	12Q7G	.57	35C5	.37			
1S5	.40	6AQ6	.36	6K8G	.64	7C7	.65	12S8GT	.60	35L6GT	.45			
1SA6	.48	6AS5	.62	6L6G	.69	7E5	.65	12S7GT	.62	35V4	.44			
1T4	.46	6AS5	.62	6L6GA	.99	7E6	.65	12S7	.68					

Our Tubes are of Excellent Quality Because—

1. We've specialized in selling vacuum tubes exclusively for many years.
  2. All tubes offered herein are obtained from Receiver Manufacturers' surplus, various gov't. agencies and other surplus sources. Most of these tubes are brand new and the balance is removed from gov't. and other equipment. WE UNCONDITIONALLY GUARANTEE EVERY TUBE YOU BUY.
  3. Our modern, completely equipped laboratories check every tube received. You are invited to see this special equipment in operation.
- Even though our inventories include almost every tube type made over the past 20 years—in quantities of more than a million assorted types—it is impossible to list every type. You are, therefore, urged to include any additional types required in your order.
- Minimum Order: \$10.00. Terms: 25% with order, balance C.O.D. Please include postage. All prices subject to change without notice.

## TRANSAMERICA ELECTRONICS CORP.

115 LIBERTY ST., NEW YORK 6, NEW YORK



"Watch that old dame.  
 She uses  
 a JENSEN NEEDLE."

## YOU'LL SAVE AT "WHOLESALE"

### RECORDING TAPE

First Quality! Wide Range!



Wide range, plastic base recording tape. 1200 ft. on 7" reel.

\$2.49 per reel

\$2.15 per reel 6 or more reels

### HI-GAIN VHF ANTENNA

#### "TEXAS RANGER"

For Ultra Fringe

All channels 2 to 13. High gain for ultra fringe. Rejects co-channel and adjacent channel interference. Gain is better than stacked conical on the low band, equal to or better on the high band.



Model AX-513 \$850

### TV PICTURE TUBE BOOSTER

Adds new life to picture tubes

95c 90c ea., 6 or more  
 85c ea., 12 or more

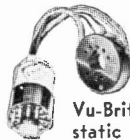

Vu-Brite model C401. For electrostatic magnetic focus tubes.

Write for FREE "FYI" Bulletin No. 301

**WHOLESALE**  
**RADIO PARTS CO., Inc.**  
 311 W. Baltimore St.  
**BALTIMORE 1, MD.**

PATENTS

(Continued)

arrive during the lower level of the square wave are suppressed. The circuit is shown in Fig. 1.

The amplitude of the square wave alternates between E1 and E2 (Fig. 2). If a positive pulse is fed through C during the E2 period, the pulse adds to the square wave and the voltage is sufficient to overcome the bias on D1. Thus the pulse is transmitted. If the pulse coincides with the

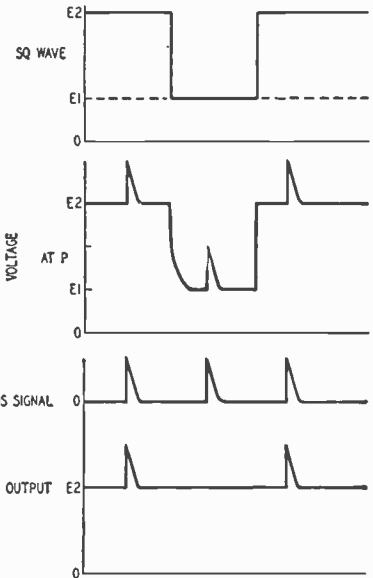

Fig. 2 TIME

lower amplitude (E1) of the square wave, D1 remains blocked by battery bias and the gate is closed. Diode D2 transmits the square wave to point P but it blocks the pulse signal.

## WIDE-RANGE TAPE PLAYBACK

Patent No. 2,685,618

Michael Rettinger, Encino, Calif.

(Assigned to Radio Corp. of America)

The upper frequency limit of a tape machine is determined by the gap width of its playback head. For example, at a tape speed of 7.5 inches per second, a .0005-inch gap cannot reproduce a frequency of 12,500 cycles. At this speed and frequency, a complete cycle is recorded on .0005 inch of tape, which is equal to the gap width. Thus a complete magnetic cycle exists on the tape between the pole pieces of the head, and all output is cancelled. For any given tape speed and

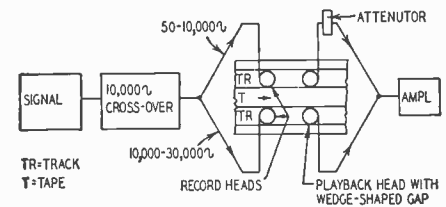

gap width there is such a null frequency. This invention eliminates null frequencies and permits a very wide frequency band to be recorded and played back. It uses two tracks on the same tape (see diagram). Here the upper track has a conventional playback head. The lower track uses a playback head with a wedge-shaped gap. A crossover network divides and feeds the signal as shown.

The tape travels through the machine at 18 inches per second, so there is no problem reproducing up to 10 kc with the 1-mil gap (upper playback head). The lower playback head has a gap tapered from 1 to 2 mils. Each part of such a gap has a different null frequency. For example, a 1-mil gap corresponds to a null frequency of 18 kc, but adjacent frequencies are reproduced. A 1.5-mil gap cannot reproduce 13.5 kc but passes adjacent frequencies. Therefore, the gap as a whole passes all frequencies.

To compensate for loss in the lower track, an attenuator cuts the output from the 1-mil head. Increased gain is provided in the amplifier. The result is uniform response from 50 to 30,000 cycles.

END

# Famous ALLIANCE TENNA-ROTOR

...at *New low prices*



T-10 was ~~\$3995~~  
 Finger-tip electrically controlled. Compact and smartly styled.  
**NOW \$2995**

U-83 was ~~\$4495~~  
 Deluxe Model—The only fully automatic antenna rotator on the market.  
**NOW \$3495**



**Lowest prices in the industry**—Now you can sell famous Alliance Tenna-Rotor easier... step up your volume and profits! New, low prices will melt sales resistance.

**Quality and style go up... prices down**—And there's an improvement in Alliance Tenna-Rotor quality that makes the new, reduced prices an even better bargain! Technical improvements are built into Alliance products—users get the benefits of research and progress... and at lower prices.

Cooperation does it... thanks to the splendid cooperation of dealers and distributors the demand keeps climbing—and Alliance Manufacturing Co. has been able to step up production and the economies that result are passed along in these sharp price reductions!

## And now—a brand new low-price TENNA-ROTOR!



K22  
 electrically operated  
 Alliance Tenna-Rotor.  
 Price **\$2495**

Model K22—New, lowest priced rotator on the market! This new economy styled champion features finger tip control—sells on sight—is undoubtedly the *biggest value* in the industry!

The Alliance line keeps pace with the coming changes in television and electronics. Alliance TV aids are styled right—built to last! They include three UHF Converters—Boosters—three Alliance Tenna-Rotors—the new Triceptor line of antennas. Add to this the Alliance radio-controlled Lift-A-Dor... electrically operated garage door opener; the first low-priced, quality, automatic garage door operator.

**Alliance is in its sixth year of continuous TV advertising!**  
**ALLIANCE PRODUCTS ARE PRE-SOLD!**

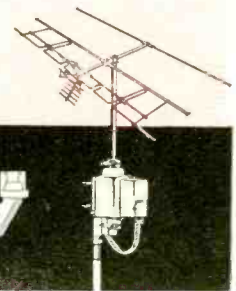

# ALLIANCE MANUFACTURING COMPANY • Alliance, Ohio

**BUY DIRECT...  
SAVE MONEY!**

**HI-FI and  
Binaural units...  
wired or kits!**

**New Imperial V—  
12-tube AM-FM  
Tuner Kit**

- Band width — 200 kc • Tuned RF stage • Tuning Range 88-108 mc • Sensitivity 5-10 u/v, 20-30 db
- Iron core tuned I.F. disc, trans. • 6CB6 RF amplifier • 6AB4 mixer • 6AB4 oscillator • 6AU6 1st I.F. amplifier • 6AU6 2nd I.F. amplifier • 6AU6 1st limiter • 6AU6 2nd limiter • 6AL5 detector • 6C4 cathode follower output • AM tuning range 530-1650 kc • 6BA6 RF amplifier • 6BE6 converter • 6BA6 1st I.F. amplifier • 1N34 or 1N60 crystal diode detector • Tuned RF stage • Chassis dimensions: 9 3/4" long, 5" high, 8" W.

Complete kit of parts including tubes, \$37.50 pictorial and schematic diagrams

Frequency Response (FM) 20 — 20,000 CPS ± 5 DB

Frequency Response (AM) 20 — 7,500 CPS ± 3 DB

**New V-9 FM  
Receiver Kit**

- Self-contained AC Power Supply
- 3 section variable condenser • Tuning range 88-108 mc • Band width 200 kc • Sensitivity 10 microvolts 20 db • Tuned RF stage • Iron core tuned I.F.—disc, trans. • 6CB6 R.F. amplifier • 6AB4 mixer • 6AB4 oscillator (temp. compensated) • 6AU6 1st I.F. amplifier • 6AU6 2nd I.F. amplifier • 6AU6 1st limiter • 6AU6 2nd limiter • 6AL5 detector • 6C4 cathode follower output • #65 selenium rectifier • Dimensions 9 3/4" x 5" x 5 1/2"

Complete kit of parts including AC power supply, tubes, pictorial and schematic diagrams \$29.50

Frequency response 20—20,000 CPS ± 5 DB

Wired & Tested extra \$5.00

**New V-5 AM  
Receiver Kit**

- Self-contained AC power supply
- Tuning range 530-1650 kc • 6BA6 RF Amplifier • 6BE6 converter • 6BA6 1st I.F. amplifier • 6AL5 detector • 6C4 cathode follower output • #65 selenium rectifier
- 3 section variable cond. • Tuned RF stage • Sensitivity 5 microvolts • Iron core tuned coils throughout • Dimensions 9 3/4" x 5" x 5 1/2"

Complete kit of parts, including AC power supply, tubes, pictorial and schematic diagrams \$24.50

Frequency Response 20—7,500 CPS ± 3 db

Wired & Tested extra \$4.25

**FREE CATALOG OFFER!**

Write today for free complete Approved catalog!

ORDER DIRECT FROM

**APPROVED**  
ELECTRONIC INSTRUMENT CORP.

928 BROADWAY NEW YORK 10, N. Y.

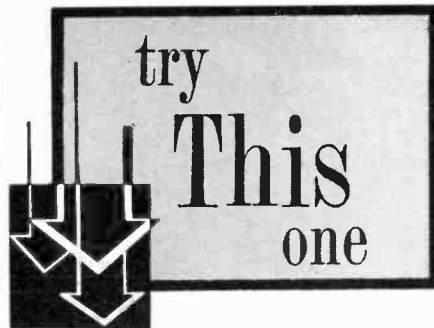

**ANTENNA CLIP**

A pair of miniature pin jacks soldered as shown to the sides of clothes-pin type TV antenna connectors will simplify connections to chassis with plug connectors to the antenna terminal board on the cover that must be removed for servicing.—Bruce A. Brown

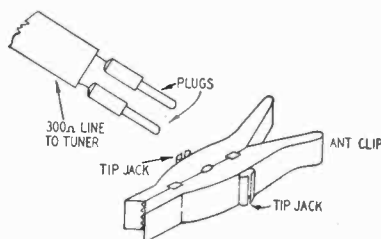

**PLASTIC CABINETS**

Cracked and broken plastic radio cabinets can be repaired successfully. Use sandpaper or steel wool to remove gloss along both sides of the break on the inside of the cabinet. Wipe off the dust and coat the roughened surface with plastic or bakelite cement. Regular service cement will do but the special cements are better. When the first coat is about dry, apply a heavier coat and cement a strip of cloth on the inside of the cabinet to cover the space to be filled.

When the cloth patch has dried, prepare wood putty with water according to the directions on the package to make a thick workable paste. Add spar varnish up to about 10% of the bulk of the paste and mix thoroughly. Use the paste to fill the cracks and holes. Leave a little excess on the surface to compensate for shrinkage and final rubbing down. While the patch is soft, any cracks that have sprung open should be held closed by pressure, using weights or a few turns of heavy string.

Let dry overnight or longer. Plane off excess or rub down with steel wool or sandpaper backed with a pad. Work slowly to avoid abrading the outer surface of the cabinet.

If the plastic is black or walnut in color, dry powdered lampblack or burnt umber pigment can be mixed with the putty along with the varnish. Or the smoothed patch can be painted with tube oil color thinned with japan drier. Allow extra drying time when lampblack is used.

Left-over putty can be pressed into sheets between paper or pressed into paper tubes for future use. The dry

**RECORDING TAPE (Plastic Base)  
40% OFF (NEW)**

- 1200 ft. plastic tape with plastic reel included.
- Each reel individually boxed.
- Choice of nationally famous top quality brands such as: Reeves (SPN-12) 3.20; Audio (1251) 3.25; Scotch (111-A) 3.25; Encore 3.25; Irish. Professional grade (111) 3.30.
- FREE! A 7.95 tape carrying case included with purchase of 12 new tapes!

**Used Recording Tape (Plastic Base)**

ATTENTION: Radio Stations, electronic calculators, industrial users: We have the new 1 1/2 or 2 mil mylar, "sound-plate," "lifetime," or "H.O." tapes and we will buy or exchange your present 1 mil mylar or plastic tapes.

1.89 for 7"—1200 foot
.99 for 5"—600 foot
.59 for 4"—300 foot
.29 for 3"—150 foot

**USED "MYLAR" TAPE (1 Mil)**

(Impact Strength 9 Times Greater Than Plastic Tape)

1200 ft. (7" reel) .....	2.59
1800 ft. (7" reel) .....	3.89

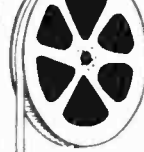

New empty plastic reels in boxes for easy labeling. 3" 10c; 4" 22c; 5" 24c; 7" Professional reel (2 1/2" hub) 29c ea. **EMPTY BOXES:** 3" 3c; 4" 5c; 7" 5c ea.

We carry all brands of new tape, recording blanks, tape recorders, etc., at low prices. **PLEASE INCLUDE SUFFICIENT POSTAGE.**

**COMMISSIONED ELECTRONICS CO.**  
2503 Champlain St. N.W. Washington 9, D. C.

**When answering advertisements please mention RADIO-ELECTRONICS**

**SAVE MONEY... MAKE MONEY...  
LEARN TV  
the practical way--**

**17", 21" and 27"**

**ASSEMBLE A TRANSVISION TV KIT**

**Pay as You Wire \$39**

Down Payment

WE WILL HELP YOU to start learning TV the practical way —by assembling a TRANSVISION TV KIT in EASY STAGES. For only \$39 you get PACKAGE #1 (standard first pkg. for all of our kits). This package gives you the BASIC CHASSIS and over 450 TV COMPONENTS with complete Instructions, Drawings, Photos, and Service Booklet. When ready, you order the next stage (pkg. #2), etc. Low prices make your complete kit a terrific buy.



**FREE CATALOG**

**Shows 6 Great TV Kits:**  
EXCLUSIVE: Only Transvision TV Kits are adaptable to UHF. Ideal for FRINGE AREAS. No Previous Technical Knowledge required. Write now!

**TRANSVISION**  
THE OLDEST NAME IN TV KITS

NEW ROCHELLE, N. Y.

MAIL THIS COUPON TODAY

Educational Director  
TRANSVISION, INC., NEW ROCHELLE, N. Y. Dept. RE-1

I'm enclosing \$\_\_\_\_\_ deposit. Send standard kit PACKAGE #1, with all Instruction Material. Balance C.O.D.

Send FREE copy of your new TV Kit Catalog.

Name \_\_\_\_\_

Address \_\_\_\_\_

City \_\_\_\_\_ State \_\_\_\_\_



TRY THIS ONE

(Continued)

product can be turned, drilled and worked like hardwood or any plastic. A cylinder cast in a short length of mailing tube is handy for making special end plugs for homemade test prods. Saw off a disc of the required thickness, drill a hole in the center, and then chuck it in an electric drill and spin against a wood rasp to turn it down to fit.

An attractive instrument control knob with a pointer was made by slotting one side of a plastic bottle cap and inserting a strip of clear plastic with a scored hairline. The putty-varnish mixture was used to fill the bottle cap and cement in the pointer. When the mixture dried, a hole was drilled and tapped for a set-screw. This custom-built dial pointer served its particular purpose.—*Van L. Ferguson*

### ION-TRAP INDICATOR

I use a simple photoelectric light meter that works perfectly and eliminates guesswork when adjusting ion-trap magnets on TV receivers. A mirror is not needed. The beam bender is positioned for maximum reading.

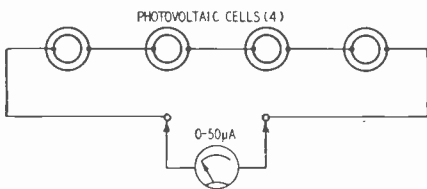

The instrument consists of four inexpensive photovoltaic cells and a 50- $\mu$ a d.c. meter or the basic range of a 20,000-ohms-per-volt voltmeter connected as shown in the diagram. The cells are mounted on a flat bakelite strip in a suitable housing that can be suspended against the screen by the meter leads. (For details on a simple mounting arrangement, see "Transistorized Commercial Killer" in the July, 1954, issue.—*Editor*)

The unit is used with the photocell suspended against the screen and the meter on top of the set with the dial facing the rear. Tune the set to a vacant channel, advance the brightness control for an indication on the meter and then adjust the beam bender for maximum deflection on the meter.—*George L. Garvin*

### SMALL-PARTS BOX

Small boxes partitioned into two or three sections are handy to have around any shop to keep the parts from a TV set when you remove it from a cabinet or strip the chassis. Sectioning is a great advantage because some of the screws in the back of a TV set may be differently threaded from those in other parts of the set, although they may look alike. Instead of dumping all the parts in one box and then having to sort the screws again, it saves your time and temper to use the divided boxes.—*B. W. Welz* END

**BUY DIRECT AND SAVE**

# OUTSTANDING for HIGH FIDELITY!

# COLLINS TUNERS and RECEIVERS

**'PRE-FAB' AUDIO PRODUCTS CO.**

**NOW!** with AFC

Collins Audio Products Co. is the way affiliated with Collins Radio Co.

Each Collins Tuner Kit is complete with punched chassis, tubes, power transformer, power supply components, hardware, dial assembly, tuning eye, knobs, wire, etc., as well as the completed sub-assemblies: FM tuning units, AM tuning units, IF amplifiers, etc., where applicable. All sub-assemblies wired, tested and aligned at the factory make Collins Pre-Fab Kits easy to assemble even without technical knowledge. The end result is a fine, high quality, high fidelity instrument at often less than half the cost—because you helped make it and bought it direct from the factory.

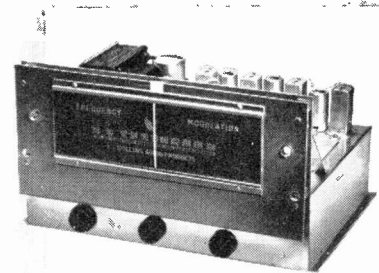

FM Tuner Kit

**\$55**

with AFC \$58.50

The FM-11 tuner is available in kit form with the IF Amplifier mounted in the chassis, wired and tested by us. You mount the completed RF Tuning Unit and power supply, then after some simple wiring, it's all set to operate. 11 tubes: 6J6 RF amp, 6AG5 converter, 6C4 oscillator, 6BA6 1st IF, (2) 6AU6 2nd and 3rd IF, (2) 6AU6 limiters, 6AL5 discriminator, 6AL7-GT double tuning eye, 5Y3-GT rectifier. Sensitivity 6 to 10 microvolts, less than 1/2 of 1% distortion, 20 to 20,000 cycle response with 2DB variation. Chassis dimensions: 12 1/2" wide, 8" deep, 7" high. Illustrated manual supplied. Shipping weight 14 lbs.

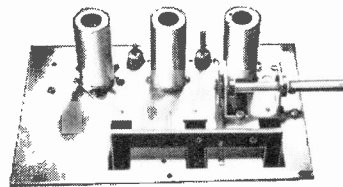

FMF-3 Tuning Unit

**\$15.25**

with AFC \$18.75

The best for FM. The most sensitive and most selective type of "front end" on the market. 6 to 10 microvolts sensitivity. Image ratio 500 to 1. 6J6 tuned RF stage, 6AG5 converter, 6C4 oscillator. Permeability tuned, stable and drift-free. Chassis plate measures 6 1/2" x 4 1/2". In combination with the IF-6 amplifier, the highest order of sensitivity on FM can be attained. Tubes included as well as schematic and instructions. Draws 30 ma. Shipping weight FMF-3: 2 1/2 lbs. Dial available @ \$3.85.

IF-6 Amplifier

**\$19.75**

6 Tubes, Shipping Wgt. 3 lbs.

#### FOR USERS OF COLLINS TUNERS:

Receive \$5.00 credit toward the new FMF-3A front end! Mail us your old front end with \$13.75 and we will send you the new, improved FMF-3A with AFC, or, remit the full amount of \$18.75 and when we receive your old unit in return a check will be mailed you for \$5.00.

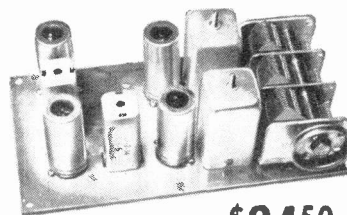

AM-4 Tuning Unit

**\$24.50**

Tops in AM superhet performance! A 3-gang tuning condenser gives 3 tuned stages with high sensitivity and selectivity. Assembly is completely wired, tested and aligned ready for immediate use. Frequency coverage 540 KC to 1650 KC at a sensitivity of 5 microvolts. Tubes 6BA6 RF amplifier; 6BE6 converter; 6BA6 IF amplifier and 6AT6 detector. Draws 30 ma @ 220 volts. Mounts on a chassis plate measuring 4" x 7 3/8". Shipping weight 2 1/2 lbs. Dial available at \$3.85.

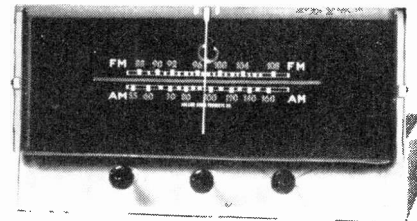

FM/AM Tuner Kit

**\$77.50**

with AFC \$81.00

The original 15 tube deluxe FM/AM pre-fab kit redesigned on a smaller chassis. The tuner now measures 14" wide by 12" deep by 7 1/2" high. This attractive new front and dial assembly opens up new applications where space is at a premium. Kit includes everything necessary to put it into operation—punched chassis, tubes, wired and aligned components, power supply, hardware, etc. Kit comprises FMF-3 tuning unit, IF-6 amplifier, AM-4 AM tuning unit, magic eye assembly and complete instructions. All tubes included. Shipping weight 19 lbs.

**MAIL COUPON TODAY**

To: Collins Audio Products Co. Inc. RE-1  
P.O. Box 368, Westfield, N. J.  
Tel. Westfield 2-4390

- FM Tuner Kit  FM/AM Tuner Kit  FMF-3 Tuning Unit  
 with AFC  with AFC  with AFC  
 IF-6 Amplifier  AM-4 Tuning Unit

NAME .....

ADDRESS .....

CITY ..... STATE .....

Amount for Kit \$ ..... See weights, add shipping cost \$ .....

Total amount enclosed \$ ..... Check  Money Order

**WHEN YOU THINK OF TUNERS, THINK OF COLLINS AUDIO PRODUCTS**

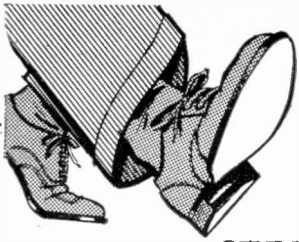

STEP INTO  
**BIGGER**  
BUSINESS

with the  
**NEW**

**Radion**

FIELD STRENGTH METER



Model FSM 5000 Only **\$97.50**  
less batteries.

**BATTERY OPERATED - FOR VHF-UHF**

Put yourself ahead of the "cut-and-try" boys. No guessing whether the antenna or receiver is at fault. Save time, money.

On new installations you KNOW which antenna location is best before proceeding. A Radion Meter builds customer confidence, often pays for itself in two months time.

Beautifully designed, easy to use. All TV channels 2 to 83 and FM band. Weighs only 16 lbs. with standard batteries. Absolute readings in microvolts. Monitoring jack for audio. Size 11 x 8½ x 6 in. Ask your distributor or write direct for specifications.



No guesswork  
in your methods.



Quickly locate cause  
of weak signals.



**THE RADION CORPORATION**  
Dept. J, 1130 W. Wisconsin Ave.  
Chicago 14, Ill.

# radio-electronic Circuits

## 1-TUBE DEFLECTION CIRCUIT

The Ace Astra model 553 TV receiver (British) uses a novel 1-tube horizontal sweep generator and output circuit designed around a 6CD6-G. The circuit operates as a blocking oscillator. The feedback voltage needed to sustain oscillation is tapped off a section of the flyback transformer and

fed into the grid through the hold control that varies the frequency by changing the R-C of the grid circuit.

Negative-going sync pulses are tapped off the plate of the sync separator and fed through a differentiating network (R1-C1-R2) to the oscillator grid.

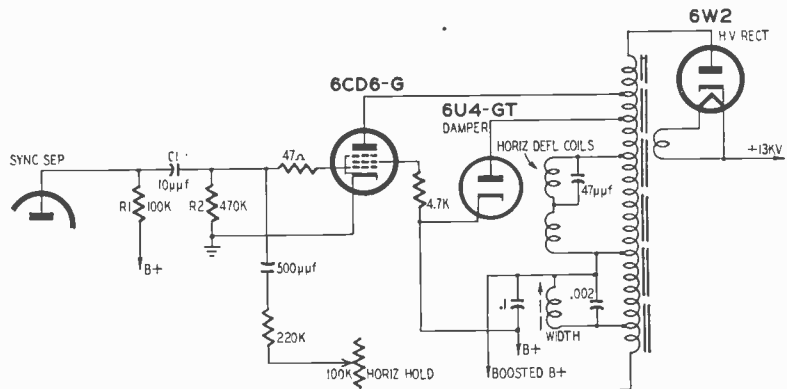

## STAGGER-TUNED I.F.'S

Modern TV receivers often use stagger-tuned i.f. circuits because they develop more gain than an equal number of mutually coupled (double-tuned) stages adjusted for the same bandwidth. Another advantage of the stagger-tuned system is that its alignment is simpler. It is possible to obtain the desired over-all i.f. response by connecting a signal generator to the input of each stage in turn and adjusting the tuning slug for maximum response at the correct frequency.

When designing stagger-tuned i.f. circuits, the average constructor finds it hard to determine the resonant frequencies and bandwidth of the tuned circuits to get the desired gain and over-all bandwidth. In *Data and Circuits of Television Receiver Valves* (Philips Technical Library), J. Jager introduces a novel and simple method of determining the resonant frequencies and stage bandwidths for a stagger-

tuned system with any number of stages. (For American vestigial-sideband transmission, center the diagram on the center of the i.f. passband instead of the carrier.)

Knowing the carrier frequency and the number of stages to be used in the i.f. strip, the first step is to determine the desired over-all bandwidth at 3-db points. Draw a baseline with linear calibrations 0.5 mc or less apart with the ends representing the 3-db points. (Assuming that bandwidth is 5 mc, a 5-inch line is a convenient length. Divide it into 10 equal parts with each division representing 0.5 mc.) Use the base line as a diameter and draw a semicircle. Now, divide the arc into a number of equal parts—one more than the number of stages in the amplifier strip. For example, a 4-stage amplifier has five tuned circuits—one input, three interstage and one output

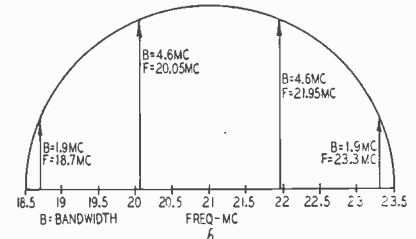
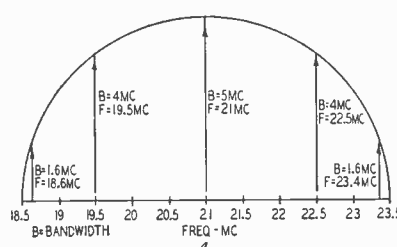

RADIO-ELECTRONIC CIRCUITS (Continued)  
—so the arc of the design diagram must have five parts. Draw a perpendicular line from the center of each part of the arc to the base line. The length of each perpendicular equals half the bandwidth B of that circuit; the point of intersection with the base line gives the center frequency.

The diagram at a gives the frequencies and circuit bandwidths for a 4-stage amplifier with a 21-mc carrier frequency. Diagram b gives the same data for a 3-stage amplifier. Note that in a stagger-tuned system there is a circuit tuned to the carrier frequency only when the system has an even number of stages.

This data was taken from the application notes on the EF80 (RETMA equivalent is 6BX6) appearing in the reference mentioned previously. The notes also contain complete data for determining the desired circuit Q and the method of obtaining it.

### TAPE RECORDER SWITCH

This photoelectric switch was developed as an automatic shut-off switch for a tape recorder. Its operation is based on a light beam shining across the tape path onto a photoelectric tube. When the tape is running through the machine, the light is blocked off and plate relay RY1 is released. The circuit is conventional except that the 117-volt power relay is wired so it locks in when its coil is energized momentarily by closing S1 to start the recorder. The power relay remains closed and the recorder operates as long as the plate relay is released (the light path is blocked off by the tape).

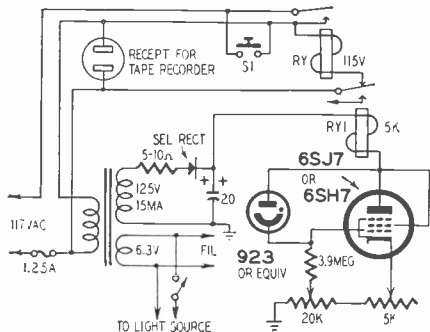

The control circuit obtains power from a half-wave type power transformer (a Stancor PS-8415) but can take its power—100–150 volts at about 10 ma—from any radio or amplifier operated with the recorder. The plate-circuit relay is a Potter & Brumfield LM-5 with a 5,000-ohm coil. A 923 phototube was used because it was readily available. Other types can be substituted. A miniature 3S4 or a 3Q5-GT can be substituted for the 6SJ7 or 6SH7 shown by changing the filament supply to 3 volts.

The only controls needed are the push-button switch and the switch for the light source. These can be mounted on the tape chassis and the rest of the circuit tucked away in an unused corner of the cabinet.—Russ Sherwin END

# YOU CAN BUILD A Professional HIGH FIDELITY SOUND SYSTEM

## WITH TECH-MASTER AMPLIFIER and PRE-AMPLIFIER Kits

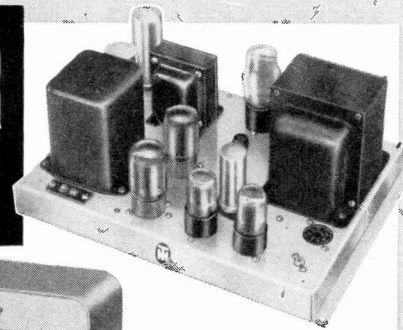

The finest components obtainable are easily assembled by following the complete step-by-step pictorial diagrams.

Your home assembled Tech-Master Amplifier and Pre-Amplifier kits will be of the highest professional quality with a frequency range of 8 to 100,000 cps at less than 1/4% distortion for normal listening levels.

At All Leading Radio Parts Jobbers and Sound Dealers

**DELUXE UL\* WILLIAMSON TYPE 20 WATT AMPLIFIER KIT:** Famous Williamson circuit with modifications for increased, undistorted power output. Uses famous-make, specially wound, quality output transformer. All sockets, terminal strips and connectors are riveted to chassis, ready for wiring.  
**MODEL TM 15A** .....Net Price: **\$49.95**

\*Ultra linear operation through use of screen-tapped primary output transformer

**DELUXE 4-CHANNEL PREAMPLIFIER-EQUALIZER KIT with CATHODE FOLLOWER OUTPUT.**

Provides complete equalization for virtually all recording characteristics now employed. Input channels for radio or TV tuner, crystal or magnetic pickup, tape recorder or other signal sources. Independent bass and treble boost and attenuation controls. Cathode follower output permits remote control operation without high frequency loss.  
**MODEL TM 15P** .....Net Price: **\$19.95**



Literature Upon Request

**TECH-MASTER CORPORATION**  
75 Front Street, Brooklyn 1, N. Y.

## NEW EICO PROBES\*

### SCOPE PROBES



**SCOPE DEMODULATOR PROBE**  
KIT \$3.75 WIRED \$5.75

**LOW CAPACITY PROBE**  
KIT \$3.75 WIRED \$5.75

**DIRECT PROBE**  
KIT \$2.75 WIRED \$3.95

**SPECIAL . . . All 3 Scope Probes**  
KIT \$9.95 WIRED \$14.95

### VTVM PROBES

**VTVM RF PROBES**  
KIT \$3.75 WIRED \$4.95

**PEAK-TO-PEAK PROBES**  
KIT \$4.95 WIRED \$6.95



**Sensational High Voltage Probe**

**Model HVP-2 . . . ONLY \$4.95**

© 54 Extends range of VTVMs & VOMs to 30 KV  
\*pat. pend.



Write for FREE Catalog CP-1

**ELECTRONIC INSTRUMENT CO., INC.**  
84 Withers Street • Brooklyn 11, N. Y.

## New Secret Recorder

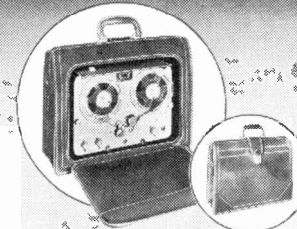

### with Built-In Microphone and Playback Facilities

Available for the first time, a really secret and dependable tape recorder for your investigative work with full assurance of catching every word and whisper. Specifically designed for all forms of fool-proof sure-fire investigative work. Completely self-contained, operates anywhere!

Briefcase ingeniously camouflaged to open, without disclosing recorder in operation. In-built super-sensitive microphone plus new circuits record all sounds from a whisper to a roar. Picks up whispers at a distance of 12 feet and ordinary speech at 100 feet. Secret latch switch operates recorder. Provides 1½ hours of uninterrupted recording time. Built-in headphone playback. Tapes also play back on any 1½ ips recorder.

Available to all legitimate commercial, professional, industrial, municipal, state and federal investigative agencies.

**SPECIAL INTRODUCTORY OFFER \$225.00**  
Limited for sixty days. Price subject to increase afterwards without notice.

**AMPLIFIER CORP. of AMERICA**  
398 Broadway, N. Y. 13, N. Y.

**REVOLUTIONARY!**

**Twin Action**

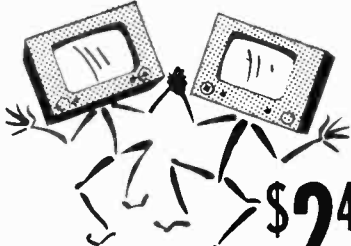

**\$2<sup>49</sup>** list

**FILTA-COUPLER®**  
**1 COUPLER DOES 2 JOBS**

SUPEREX brings you greater value . . . more for your money by combining 2 necessary items for all homes with two TV sets. 2-set coupler eliminates second antenna . . . built-in Hi-pass filter insures perfect reception for BOTH sets.

**HARD HITTING DISPLAY CARD WORKS FOR YOU:** order the smart Superes Filta-Coupler today . . . order in quantity!

**AND be sure you are well stocked with these fast moving Suprex winners too!**

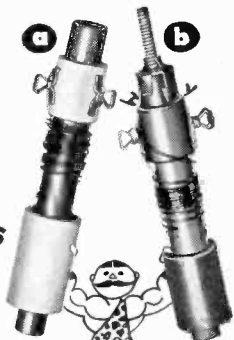

**MIDGETS**  
that  
do

**a Giant Job**

**a Grayburne FERRI-LOOPSTICK**  
World's most sensitive, compact, efficient small radio antenna . . . **75c**

**b Grayburne VARI-LOOPSTICK**  
Same as Ferri-Loopstick with variable micrometer adjustment . . . **1.00**

Over 50,000,000 small radios are prospects for Loopsticks. Replaces inefficient loop antennas . . . pulls in stations strong and clear. Customers rave over performance . . . you'll rave over profits.

**DON'T ACCEPT IMITATIONS!** Ask for the Ferri-Loopstick and Vari-Loopstick by name.

**SupereX** successor to Grayburne  
23 Atherton St., Yonkers, N. Y.

# Question Box



## TUNER FOR ALL-WAVE SET

I want to construct an all-wave receiver that uses commercial coils to cover the range from 540 kc to about 30 mc. Oscillator coils for this range are designed for intermediate frequencies around 450 kc. I want to use an i.f. around 1500 kc to minimize image interference on the shortwave bands.—H.T.H., St. Louis, Mo.

The J. W. Miller Co. has a series of shortwave oscillator coils for 1500-kc i.f.'s and tuning ranges of 3.75 to 11, 8.5 to 23 and 12 to 36 mc. Modifying existing coils designed for 450-kc i.f.'s for 1500-kc operation is difficult and tracking is likely to suffer. The selectivity of a 1500-kc i.f. stage is not as good and the gain probably will not be as high as at 456 kc. For this reason we suggest an arrangement similar to that shown in the diagram. The set operates as a conventional superhet with a 456-kc i.f. in the first two ranges covering from 540 kc to 4.5 mc and as a double-conversion cir-

cuit on the 3.75-11- and 12.5-36-mc ranges. The gap in the tuning range between 11 and 12.5 mc will not be noticed in most instances.

The diagram shows a 6BE6 mixer, 6C4 oscillator, 6BE6 second converter and 6BD6 first i.f. amplifier. On the first two ranges the incoming signal—either direct from the antenna or from an r.f. amplifier—is converted to 456 kc in the plate circuit of the mixer and then fed to the grid of the i.f. amplifier. On the two higher ranges the mixer converts the incoming signal to 1500 kc and feeds it into the second converter.

The oscillator coils are Miller types A-727-C, B-727-C, C-727-W and E-727-W. Suffix C indicates oscillator coils designed for 455-kc i.f.'s and W indicates 1500-kc i.f.'s. Antenna and r.f. coils for each range have the same prefix letter and number with the suffixes A and RF substituted for antenna and r.f. coils, respectively.

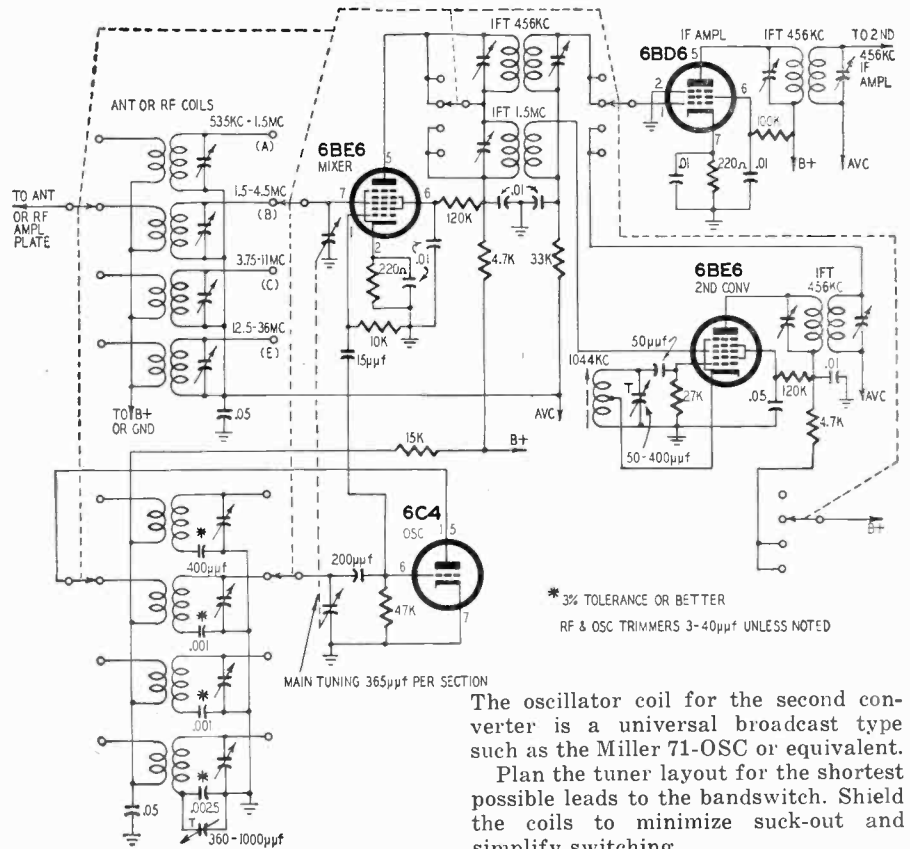

The oscillator coil for the second converter is a universal broadcast type such as the Miller 71-OSC or equivalent.

Plan the tuner layout for the shortest possible leads to the bandswitch. Shield the coils to minimize suck-out and simplify switching.

**OLD-BAND FM RADIO**

I want to convert a Pilot T-301 AM-FM receiver so the FM section covers the 88-108-mc band instead of the 40-50-mc band. Is there an inexpensive way of doing this without rebuilding the FM front end and i.f. circuits?

—R. A. R., Philadelphia, Pa.

Many readers have had good results

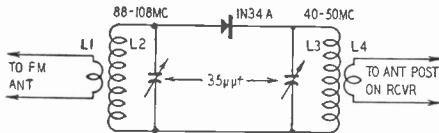

with this inexpensive tubeless converter (see diagram) connected between a good FM (88-108-mc) antenna and the antenna posts of their old FM receiver.

Response to our query on continuing the Question Box has swamped our staff with questions. If you don't get your answer in a month or so, don't worry—we'll get to it in time. Incidentally, the Question Box will continue.

All coils are self-supporting and are space-wound with an inside diameter of 7/16 inch. L1 is two turns of No. 18 insulated hookup wire interwound with L2. L2 is three turns of No. 10 solid enameled wire. L3 is 10 turns of No. 10 solid enameled wire and L4 three turns of No. 18 hookup wire interwound with it. The tuning capacitors are small air trimmers with a maximum capacitance of about 35 µf. L2 tunes to the new signal frequency and L3 tunes to a frequency in the 40-50-mc band.

**SURE-FIRE OSCILLATOR**

I am a Novice radio amateur with only a few months of experience with transmitter circuits. Please print the circuit of a crystal oscillator that I can use to drive an 807 directly on 80, 40 and 15 meters. I want to use fundamental crystals.—M. W. F., Central Islip, N. Y.

This circuit, recommended by Petersen Radio Co., should provide sufficient

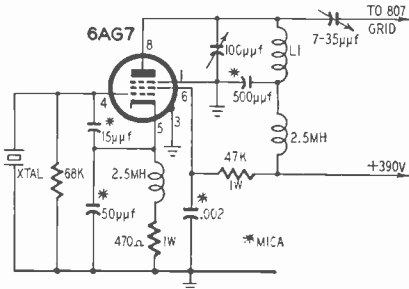

output to drive your final.

The inductor in the plate tank circuit must be tuned to the desired output frequency. The output may be at the fundamental or the second, third or fourth harmonic. You can use standard 25-watt coils in the oscillator plate circuit. The oscillator supply voltage should be 390 for best results. END

For QUALITY - PERFORMANCE - DEPENDABILITY

**Rad-Tel Tubes Guaranteed 1 FULL YEAR**

**70% to 90% OFF**

- Same Day Service
- All Tubes Individually Boxed
- 300 Types Always in Stock



Type	Price	Type	Price	Type	Price	Type	Price	Type	Price	Type	Price
OA2	.74	5J6	.64	6BZ7	.90	7A5	.59	12BH7	.63	32L7	.89
OA4	.68	5T4	.79	6C4	.40	7A6	.67	12BZ7	.65	35	.58
OB2	.81	5U4G	.55	6C5	.39	7A7	.69	12B7	.65	35A5	.58
OC3	.72	5U8	.75	6C6	.58	7A8	.68	12C8M	.24	35B5	.52
OD3	.70	5W4GT	.50	6CB6	.54	7AD7	.79	12H6	.56	35C5	.51
OZ4M	.65	5Y3GT	.37	6CD6	1.11	7AF7	.53	12J5	.42	35L6GT	.51
1A5	.49	5Y4	.51	6CF6	.64	7AG7	.69	12J7	.49	35W4	.47
1A7GT	.47	5Z3	.45	6CS6	.51	7AH7	.79	12K8	.59	35Y4	.54
1AX2	.62	6A6	.51	6D6	.59	7B4	.44	12Q7	.59	35Z3	.59
1B3GT	.73	6A7	.69	6E5	.48	7B5	.45	12S8GT	.62	35Z4	.47
1C5	.43	6AB4	.44	6F5GT	.39	7B6	.69	12SA7GT	.65	35Z5GT	.47
1E7	.29	6AC5	.69	6F6	.59	7B7	.49	12SC7M	.63	36	.39
1G6	.24	6AC7M	.86	6G6	.42	7C4	.59	12SF5	.50	45	.55
1H4	.30	6AF4	.90	6H6GT	.42	7C5	.69	12SG7	.51	45 (Spec)	.27
1H5GT	.49	6AG5	.56	6J5GT	.43	7C6	.59	12SJ7M	.67	45Z5	.49
1L4	.46	6AG7M	.99	6J6	.52	7E5	.59	12SK7GT	.67	46	.69
1LA4	.59	6AH4	.57	6J7	.42	7E6	.30	12SL7GT	.57	50A5	.65
1LA6	.69	6AH6	.73	6K5	.47	7E7	.59	12SN7GT	.56	50B5	.52
1LB4	.69	6AJ5	.65	6K6GT	.45	7F7	.79	12SQ7GT	.52	50C5	.51
1LC5	.59	6AK5	.55	6K7	.44	7F8	.79	12SR7M	.49	50L6GT	.61
1LC6	.79	6AK6	.59	6L6	.64	7G7	.89	12S8GT	.46	50X6	.49
1LD5	.59	6AL5	.42	6L7M	.68	7H7	.59	12X4	.38	50Y6	.49
1LE3	.59	6AM8	.78	6N7M	.63	7J7	.79	14A4	.69	50Y7	.50
1LG5	.69	6AQ5	.50	6Q7	.45	7K7	.69	14A5	.59	55	.49
1LH4	.69	6AQ6	.37	6R7	.69	7L7	.59	14A7	.63	56	.49
1LN5	.59	6AQ7	.70	6S4	.48	7N7	.69	14AF7	.59	57	.58
1N5GT	.67	6AR5	.45	6S7M	.79	7Q7	.66	14B6	.63	58	.60
1PEGT	.57	6AS5	.50	6S7B	1.90	7R7	.89	14B8	.63	70L7	.97
1Q5GT	.58	6AS6	1.49	6S8GT	.53	7S7	.79	14C5	.79	75	.49
1R5	.62	6AT6	.41	6SA7GT	.55	7V7	.89	14C7	.79	76	.44
1S4	.59	6AU4GT	.68	6SD7GT	.41	7X6	.54	14E6	.75	77	.57
1S5	.51	6AU5GT	.82	6SF5GT	.46	7X7	.70	14E7	.88	78	.47
1T4	.58	6AU6	.46	6SG7GT	.41	7Y4	.69	14F7	.65	80	.43
1T5	.59	6AV5GT	.83	6SH7GT	.49	7Z4	.59	14F8	.69	83V	.68
1U4	.57	6AV6	.40	6SJ7GT	.41	12A6	.54	14H7	.59	84/6Z4	.46
1U5	.50	6AX4GT	.65	6SK7GT	.53	12A8GT	.61	14J7	.30	85	.59
1V	.43	6B4	.54	6SL7GT	.48	12AL5	.37	14N7	.84	117L7	.99
1X2A	.63	6BA6	.49	6SN7GT	.59	12AQ5	.52	14R7	.79	117P7	.99
2A3	.30	6BA7	.57	6SQ7GT	.46	12AT6	.41	14S7	.89	117Z3	.37
2W3	.38	6BC5	.54	6SR7GT	.45	12AT7	.72	14W7	.30	117Z6	.69
2X2	.49	6BD5	.59	6S7GT	.42	12AU6	.46	14X7	.69	807	.99
3A4	.45	6BD6	.45	6T4	.99	12AU7	.60	14Y7	.62	866A	1.39
3B7	.27	6BE6	.51	6T8	.80	12AV6	.39	19B66	1.39	1274	.30
3BC5	.54	6BF5	.41	6U5	.57	12AV7	.73	19T8	.69	HI-PO	
3BN6	.74	6BF6	.37	6U6	.59	12AX4	.67	19V8	.79	#567	1.39
3CB6	.54	6BG6G	1.25	6U8	.78	12AX7	.63	24A	.39		
3D6	.27	6BH6	.53	6V6GT	.50	12AY7	.69	25AV5GT	.83	JAN TUBES	
3E5	.46	6BJ6	.49	6V6GT	.47	12AZ7	.59	25B06GT	.98	1619	.27
3LF4	.69	6BK5	.80	6W4GT	.57	12B4	.60	25L6GT	.51	1626	.27
3Q4	.48	6BK7	.80	6X4	.37	12BA6	.49	25W4GT	.59	1629	.27
3Q5GT	.69	6BL7GT	.83	6X5GT	.37	12BA7	.60	25Z5	.66	615	.27
3S4	.58	6BN6	.74	6X8	.75	12BD6	.45	25Z6	.49	7193	.27
3V4	.58	6BQ6GT	.98	6Y6G	.48	12BE6	.51	26	.45	954	.27
5AZ4	.59	6BQ7	.90	7A4	.47	12BF6	.39	27	.39	45 Special	.27

**TERMS:**

A 25% deposit must accompany all orders—balance C.O.D. All shipments F.O.B. Irvington warehouse. ORDERS UNDER \$10.—\$1.00 HANDLING CHARGE. Subject to prior sale.

**PLEASE:**

Send full remittance... allow for postage and save C.O.D. charges! We refund all unused money! Dept. RE-1.

Tubes in Bold Type Cover 90% of Demand

Phone: Essex 5-2947

**Rad-Tel TUBE CO.**

*'Integrity Is Our Chief Asset'*

115 COIT ST., IRVINGTON II, N. J.

When answering advertisements please mention **RADIO-ELECTRONICS**

**TV GLO-TEST**

Replaces \$279 in TESTING EQUIPMENT

This sensational new all-purpose tester does the work of equipment costing nearly 12½ times as much. Recently featured in RADIO-ELECTRONICS and other publications, the GLO-TEST has been bought and used enthusiastically by hundreds of TV and Radio Servicemen, Sound Technicians, Amateurs, Experimenters and Electricians.

More than 50 uses: Pixtube Tester—AC-DC; Measures Voltage to 50 KV; Signal Generator; Signal Tracer; Tube Tester; Resistor and Capacitor Measurements; Checks Distortion, Linearity. Accuracy is comparable to VTVM. GLO-TEST complete with test leads and instruction booklet, postpaid... only \$14.50. Send check or money order. Satisfaction guaranteed. Free literature on request. Dealer Inquiries Invited.

V. A. ENTERPRISES, Dept. AA, 608 E. Rosecrans Blvd., Compton, Calif.

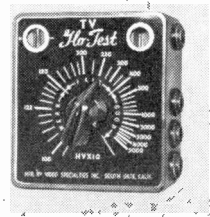

FULLY GUARANTEED

Just what the TV Doctor ordered...

# R STANCOR

## EXACT REPLACEMENT FLYBACKS

Whether the "patient" is a Crosley, a Muntz, an RCA, or any other brand, you can be sure of a prompt recovery when the prescription reads "STANCOR"

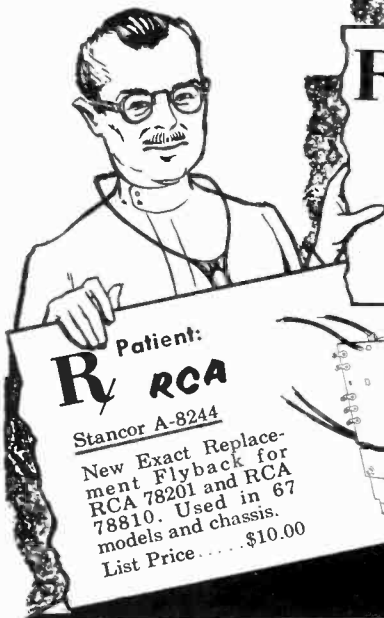

**R Patient: Muntz**

**Stancor A-8242**  
New Exact Replacement Flyback for Muntz TO-0028 and TO-0029  
List Price.....\$9.00

**R Patient: Crosley Super V, Hallicrafters**

**Stancor A-8241**  
New Exact Replacement Flyback for Crosley 157820 and Hallicrafters 550251  
List Price.....\$8.10

**R Patient: RCA**

**Stancor A-8244**  
New Exact Replacement Flyback for RCA 78201 and RCA 78810. Used in 67 models and chassis.  
List Price.....\$10.00

**FREE—HIGH FIDELITY, Ultra-Linear Amplifier Bulletin 479** describing performance and construction of the 24 watt Stancor-Williamson Amplifier, using Stancor Ultra-Linear Output Transformer A-8072 (\$15.00 net). Available from your distributor.

**CHICAGO STANDARD TRANSFORMER CORPORATION**  
3592 ELSTON AVENUE • CHICAGO 18, ILLINOIS

EXPORT SALES: Roburn Agencies, Inc. • 431 Greenwich Street • New York 13, N. Y.

Stancor transformers are listed in Photo-fact Folders, Counter-facts, Radio's Master, and File-O-Matic.

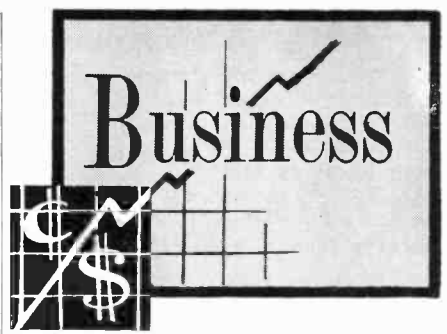

Merchandising and Promotion  
Ward Products Corp., Cleveland, is promoting its 8-Ball automobile aerials with the offer of a hole saw, which



will fit any 1/4-inch drill, to service technicians and distributors who present 20 end labels from Ward 8-Ball cartons.

Astron Corp., East Newark, N. J., has streamlined its capacitor line to promote sales by minimized duplication of types.

Columbia Wire and Supply Co., Chicago, has designed a colorful new box for packaging its v.h.f.-u.h.f. foam

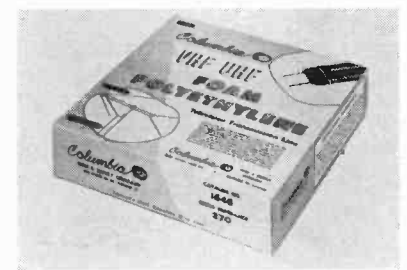

polyethylene television transmission line. The box makes for easier storing and inventory and doubles as an attractive display.

Cornell-Dubilier Electric, South Plainfield, N. J., and Radiart Corp., Cleveland, have launched the biggest consumer promotional campaign in their history to promote CDR rotors. TV spot announcements, direct mail, point-of-purchase displays and newspaper advertisements are being used.

Permoflux Inc., Chicago, devised a new Insured Home Trial plan under which consumers may try Largo or Diminnette speaker systems in their homes for 15 days and return them for full refund if the system does not meet

**1200 Ft. 7" Reel Finest Plastic Base RECORDING TAPE 3 for \$5.55**

**Buy A "BAKERS DOZEN"** Pay for 12 Reels — Receive 13

We honestly feel that there is no finer recording tape on the market today than the **COMPLETE SATISFACTION CHEERFULLY REFUNDED!!** New **CONCORDIA** Plastic Base High Fidelity Tape. **UNCONDITIONALLY GUARANTEED OR YOUR MONEY** slitters under constant Quality

**CONCORDIA TAPE** is made on precision coaters and Control. Superior dispersion of the red oxide coating results in a tape that is inherently smooth with a strong adherence of oxide to base. Freq response at 7 1/2 IPS is 40 to 15,000 cycles with extremely low distortion and maximum signal to noise ratio. Oxide wound in. Shpg. Wt. 1.4 Oz.

7" reels ..... 3 for \$5.55 13 for \$22.20  
5" reels ..... 3 for \$3.87 13 for \$15.48

**CONCORD RADIO** 54 Vesey St. N. Y. 7  
Dept C1  
20% deposit with C.O.D. MINIMUM ORDER \$5.00  
 Send new CONCORD CATALOGI

NAME \_\_\_\_\_  
ADDRESS \_\_\_\_\_  
CITY \_\_\_\_\_ ZONE \_\_\_\_\_ STATE \_\_\_\_\_

**CONCORD RADIO • 54 VESEY ST. NEW YORK 7, N. Y. • Dlgy 9.1132**

## OPPORTUNITY ADLETS

Rates—45c per word (including name, address and initials). Minimum ad 10 words. Cash must accompany all ads except those placed by accredited agencies. Discount, 10% for 12 consecutive issues. Misleading or objectionable ads not accepted. Copy for March issue must reach us before Jan. 15, 1955.

### Radio-Electronics

25 W. Broadway, New York 7, N. Y.

**SPEAKER REPAIRS ON ALL MAKES.** 8" & 12" HI-FI speakers for sale. Amprite Speaker Service, 70 Vesey St., New York 7, N.Y.

**TEST EQUIPMENT REPAIR**—Kit construction. Free information. Bigelow Electronics, Pioneer Road, Beulah, Michigan.

"Buy Surplus Radio, Electronic Equipment direct from Government. List \$1.00. Box 213AK, East Htd 8, Conn."

**SPEAKER RECONING:** Guaranteed workmanship. C&M Recone Co., 255 Tioga St., Trenton 9, N.J.

**TUBES**—70% to 90% DISCOUNT. Government, manufacturers, jobbers, etc. surplus. Guaranteed 1 year. Free catalog on request. Cadillac Trading, Dept. AA, 231-07 Linden Blvd., Jamaica 11, N.Y.

**RADIO DIAGRAMS** \$1.00. Television \$2.00. Give make model. Diagram Service, 672-RE, Hartford 1, Conn.

**HI-FIDELITY BARGAINS**—Brand new, factory packed, Collaro 3 522, dual sapphires, 45 spindle—\$36.95. GE RFX-050—\$3.95. University 6201 Coax—\$38.85. PRE-PAID. Tuners, Amplifiers, Speakers, Turntables, Baffles, Changers, etc. ALL LOW PRICED, PREPAID, BRAND NEW—WRITE TODAY. FIDELITY UNLIMITED, 63-05 39 Ave., Woodside, N.Y.

**TUBES**—TV, RADIO, TRANSMITTING, AND SPECIAL PURPOSE TYPES BOUGHT, SOLD AND EXCHANGED. Send details to B. N. Gensler W2LN1, 136 Liberty, N. Y. 6, N. Y.

**TEST EQUIPMENT REPAIRED**—New modern lab equipped to handle all makes and types of meters and testers. Free estimates. Catalogue available. General Electronic Dist. Co., 100 Park Place, N. Y. 7, N. Y.

**TOP DOLLAR** paid for ART-13s, dynamotors, parts racks and all other component parts. Write: Harjo Sales Company, 4109 Burbank Blvd., Burbank, Calif.

**ALL MAKES OF ELECTRICAL INSTRUMENTS AND TESTING** equipment repaired. Write for free catalogue on new and used instruments at a savings. Hazelton Instrument Co., 128 Liberty Street, New York, N. Y.

**TELEVISION SETS** \$18 up. Jones TV, 1115 Rambler, Pottstown, Pa.

"**RADIORIDER**" Magazine for Experimenters, beginners. 12 issues \$1.50; copy 15c. Unusual Catalog free. Laboratories, 328-B Fuller, Redwood City, California.

**WANTED:** AN/APR-4, other "APR.", "TS-", "IE-", ARC-1, ARC-2, ART-13, BC-348, etc. Microwave Equipment, Everything Surplus, Special tubes, Tec Manuals, Lab Quality Equipment, Meters, Fast Action, Fair Treatment, Top Dollar! Littell, Fairhills Box 26, Dayton 9, Ohio.

**MATHEMATICS SERVICE**, problems solved, calculations, computations, Electronics, physics, mathematics, Reasonable rates. Mathematics Service, Box 6671, Orlando, Fla.

**BUY WHOLESALE**—25,000 items—Catalog 25c. Matthews, 1472-P-3 Broadway, NYC 36.

**SPEAKER RECONING:** 25 years experience. Michigan Speaker Reconing Service, 930 Metropolis, Marine City, Michigan.

**ALUMINUM TUBING**, Angle and Channel, Plain and Perforated Sheet. Willard Radcliff, Fostoria, Ohio.

**Power Transformers Rebuilt:** all makes, Victor R32—\$12.95. Red Arrow Radio, 924 Metropolis, Marine City, Michigan.

**TEST EQUIPMENT BUILT**—Speakers reconed—For information Write Selco Products, Danvers, Massachusetts.

**TELEVISION RECEIVERS** \$30 UP. W4API, 1420 South Randolph, Arlington 4, Virginia.

**FIFTEEN ASSORTED**—Resistors, Condensers, knobs, 30c. Trowbridge, 312 W. 55th, Chicago 21.

**FOR SALE**—"URANIUM DETECTOR" Scintillator and Geiger Counter Diagram. Send \$1.00 to: Uranium, 13833 San Antonio, Norwalk, Calif.

**TV Trade-In Sets**, Philco—Emerson—GE—Admiral—Motorola—Tolo-King—Others. List Available. 10"—\$17, 12"—\$20 up. Washtek Service, 1501 Boston Road, Bronx, N.Y. DA 3-9281.

**TV FM ANTENNAS**, ALL TYPES INCLUDING LHF. Mounts, accessories. Lowest prices. Wholesale Supply Co., Lunenburg 2, Mass.

**FREE!**

REQUEST PORTFOLIO 200

**TO EVERY TV SERVICEMAN**

GET IT TODAY!

TV accessories and parts catalogs, literature, data sheets, etc. Yours for the asking!



**Vidaire**

**ELECTRONICS MFG. CORP**

Main Office & Plant

576 WEST MERRICK ROAD LYNBROOK, N.Y.

# TESTED AND PROVEN E-Z WAY TILT OVER TOWERS



E-Z Way TV Towers crank up and down. Can be easily lowered and the antenna tilted over to a height of only six feet above the ground and made absolutely hurricane proof!

- CRANKS UP AND DOWN • TILTS OVER
- NO GUY WIRES—NO CONCRETE
- NO ROOF DAMAGE
- NO LIGHTNING RISK • HURRICANE PROOF
- GREATER DISTANCES—BETTER PICTURES

The only practical free-standing tower is one that can be lowered in case of strong winds. E-Z Way Tower is the sturdiest, most unique and versatile tower in the industry. High-test steel construction. Electric Arc welded. Each section completely immersed in Pliotite S-5 (rubber base) aluminum enamel for long-lasting weather resistance. Most economical. Easiest to install. Easiest to service and add antennas. Twelve tilt-over types from 30' to 85' VHF heights. Fifteen building-attached crank-up types of towers. Each tower specifically designed for a particular use.

## E-Z WAY DEMONSTRATION TRAILER

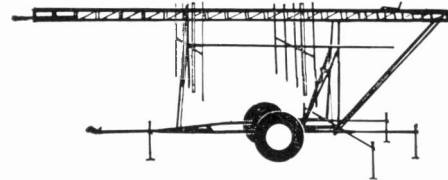

One-man operation. Light weight. Saves time and money. Carries antenna completely assembled—no guy wires necessary. Five types with towers 40' to 85' as low as \$149.95 to dealers.

DISTRIBUTOR INQUIRIES INVITED

FOR FREE CATALOGUE AND INFORMATION WRITE:

**E-Z WAY TOWERS, Inc.**  
5901 E. BROADWAY • P. O. BOX 5491 • TAMPA, FLORIDA

1440 pgs.

Fully catalogs Radio-TV-Electronic parts & equipment: Tubes, Transmitters, Test Equipment, Comm. Receivers, Transformers, Capacitors, Antennas, Resistors, Coils & Relays, Recording & PA Systems, Hardware, Tools, etc., etc. OFFICIAL BUYING GUIDE OF THE INDUSTRY

1440 page MASTER for everything in Electronics

Make rapid selections from one industry-wide MASTER CATALOG complete with SPECIFICATIONS, ILLUSTRATIONS, DESCRIPTIONS, DIAGRAMS, PRICES on thousands of Radio-TV-Electronic parts and equipment.

NEW! 1955 BUYING GUIDE

List \$6.50

As low as \$1.95 • Over 85,000 items • Fully indexed • 8 1/2" x 11"

• Over 8,500 illus. • Weighs 6 lbs.

From leading parts distributors or write to: UNITED CATALOG PUBLISHERS, INC. 110 Lafayette Street, New York 13, N. Y.

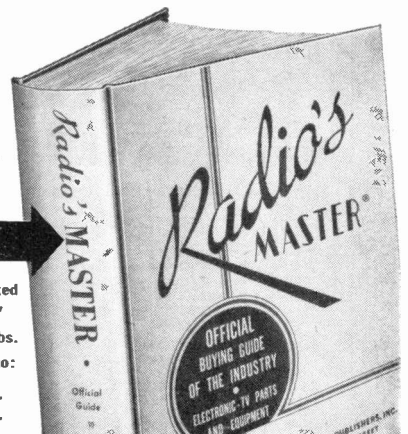

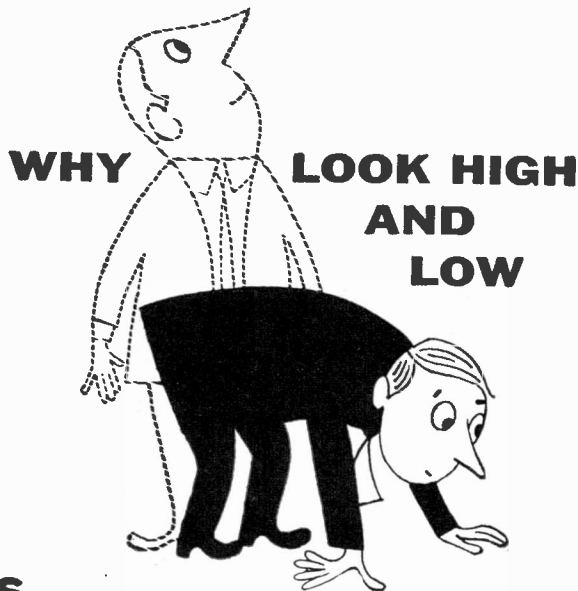

## C-D IS THE ONLY COMPLETE LINE OF ELECTROLYTICS

No matter what you need in electrolytic capacitors—C-D has it. Every type, shape and rating... all of consistent high quality proven by outstanding field performance. C-D capacitors are always reliable... and readily available—because Distributors *who know*, carry the complete Cornell-Dubilier line.

Free! TV Capacitor "Replacement Guide"—and C-D Twist Prong Cross Index from your C-D Distributor. He's listed in your local Classified Telephone Directory.

C-D's "UP" twist prong

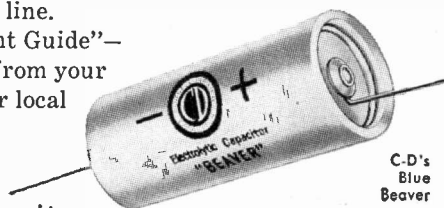

C-D's Blue Beaver

There are more C-D capacitors in use today than any other make.



## CONSISTENTLY DEPENDABLE CORNELL-DUBILIER CAPACITORS

PLANTS IN SOUTH PLAINFIELD, N. J.; NEW BEDFORD, WORCESTER AND CAMBRIDGE, MASS.; PROVIDENCE AND HOPE VALLEY, R. I.; INDIANAPOLIS, IND.; SANFORD AND FUQUAY SPRINGS, N. C.; SUBSIDIARY: THE RADIART CORPORATION, CLEVELAND, O.

### Important Notice to

## SUBSCRIBERS

If you're moving, please don't forget to send us your address as it appears on the copy of the magazine, including the numbers shown beside your name, as well as your new address. If possible, send us your address label which is pasted on the upper left hand corner of the back cover.

If we receive this information before the 20th of the month, you will continue getting the magazine without interruption.

Your cooperation will be most helpful and greatly appreciated.

# VIDEO TUBES

ELECTRIC COMPANY

## AT WHOLESALE

★ 100% GUARANTEED ★

BRANDED!	★	SAME DAY SERVICE!
1A4P . . . . .29	6BD5 . . . . .59	7F8 . . . . .59
1A7 . . . . .49	6BE6 . . . . .39	7J7 . . . . .59
1B3 . . . . .59	6BG6 . . . . .99	7K7 . . . . .59
1B4P . . . . .79	6BF6 . . . . .49	7U5 . . . . .49
1C6 . . . . .29	6BJ6 . . . . .49	7Z4 . . . . .39
1C7 . . . . .29	6BK7 . . . . .69	12AL5 . . . . .39
1E7GT . . . . .39	6BL7 . . . . .69	12AT6 . . . . .39
1F5G . . . . .29	6BN6 . . . . .99	12AT7 . . . . .69
1H5 . . . . .49	6BQ6 . . . . .79	12AU6 . . . . .39
1L4 . . . . .49	6BQ7 . . . . .79	12AU7 . . . . .59
1L6 . . . . .59	6BY5G . . . . .59	12AV6 . . . . .39
1LA6 . . . . .39	6BZ7 . . . . .79	12AV7 . . . . .69
1LC5 . . . . .39	6C4 . . . . .39	12AX7 . . . . .59
1LC6 . . . . .39	6CB6 . . . . .49	12BA6 . . . . .39
1N5 . . . . .49	6CD6 . . . . .99	12BA7 . . . . .59
1R5 . . . . .49	6CU6GT . . . . .99	12BE6 . . . . .39
1S5 . . . . .39	6F6 . . . . .39	12BH7 . . . . .59
1T4 . . . . .49	6F7 . . . . .69	12SA7 . . . . .49
1T5GT . . . . .69	6J6 . . . . .59	12SK7 . . . . .49
1U4 . . . . .49	6J8 . . . . .79	12SN7 . . . . .59
1U5 . . . . .39	6K6 . . . . .39	12SL7 . . . . .59
1X2 . . . . .59	6L6 . . . . .69	12SQ7 . . . . .39
2A3 . . . . .29	6N6 . . . . .69	14S7 . . . . .79
2A7 . . . . .29	6S4 . . . . .39	19BG6 . . . . .99
3AGT . . . . .99	6S8 . . . . .59	19T8 . . . . .69
3O4 . . . . .49	6SA7 . . . . .49	25BQ6 . . . . .79
3Q5 . . . . .59	6SD7 . . . . .49	25L6GT . . . . .39
3S4 . . . . .49	6SK7 . . . . .49	25W4GT . . . . .39
3V4 . . . . .49	6SL7 . . . . .59	25Z6 . . . . .39
5U4 . . . . .39	6SN7 . . . . .59	35B5 . . . . .39
5V4 . . . . .49	6SQ7 . . . . .39	35C5 . . . . .39
5Y3 . . . . .29	6SR7 . . . . .49	35W4 . . . . .29
5Y4 . . . . .49	6T8 . . . . .69	35Z3 . . . . .29
5Z3 . . . . .29	6U8 . . . . .69	35Z5 . . . . .29
6AB4 . . . . .39	6V6 . . . . .49	35/51 . . . . .29
6AG5 . . . . .49	6W4GT . . . . .39	36 . . . . .23
6AJ5 . . . . .69	6X4 . . . . .29	37 . . . . .29
6AK5 . . . . .69	6X5 . . . . .29	39/44 . . . . .29
6AL5 . . . . .39	7A4/XXL . . . . .39	49 . . . . .29
6AQ5 . . . . .49	7A6 . . . . .49	50B5 . . . . .49
6AS5 . . . . .49	7A7 . . . . .49	50C5 . . . . .49
6AT6 . . . . .39	7A8 . . . . .49	50L6 . . . . .49
6AU6 . . . . .39	7AK7 . . . . .79	75 . . . . .29
6AV6 . . . . .39	7B4 . . . . .49	76 . . . . .29
6B7 . . . . .79	7B5 . . . . .49	77 . . . . .29
6BA6 . . . . .49	7B6 . . . . .49	80 . . . . .29
6BA7 . . . . .59	7B7 . . . . .49	117L7GT . . . . .99
6BC5 . . . . .49	7F7 . . . . .59	117Z3 . . . . .29

### Surprise Package of Radio & TV Parts

3 lbs. of parts including resistors, controls, coils, IF cans, etc. Easily worth \$10.00

**\$1.95**

FREE! with every order of \$20 or more—famous "Oxwall" magnetic screw driver kit. Includes all sizes—Phillips head, long handles to get in those tight spots, etc. 7 screwdrivers in all. May be purchased outright. List value \$4.89 \$1.99 each; 3 for \$5.50.

MINIMUM ORDER \$7.00

25% deposit with order. Balance COD. If full remittance is sent, please include postage. Excess money will be refunded. We have more than 250 types in stock at all times. Order your other needs at similar savings or write for quotations. Quantity users—write for special discounts!

**VIDEO** ELECTRIC COMPANY  
79 CLINTON PLACE  
NEWARK, N. J.



their requirements or expectations.

Pyramid Electric, of North Bergen,



Jack Berman, Pyramid representative, and Betty Rice "at work" on rack stand.

N.J., has designed a two-color display rack for its capacitors. The company also brought out a new capacitor carton.

Tele-Matic Industries, Inc., Brooklyn, N. Y., is offering its distributors a counter display for its *Tele-Pal* extension speaker for remote control personal TV listening.

James B. Lansing Sound, Inc., Los Angeles, is distributing for a nominal fee mounted illustrations of early historical musical instruments to emphasize the beauty and craftsmanship of their *Signature* speakers and enclosures.

Electrovox Co., East Orange, N. J., has designed a new 3-D display for its Walco needles.

Javex, Redlands, Calif., is offering distributors a birch and maple shadow-box display with the purchase of \$50 worth of Javex merchandise.

Reeves Soundcraft Corp., New York City, has made a 12-inch easel for its *Plus 50* magnetic recording tape available to dealers.

Recoton Corp., New York City, has

**Calendar of Events**

Symposium of Printed Circuits sponsored by RETMA Engineering Department, January 20-21, University of Pennsylvania, Philadelphia.

Audio Fair, Los Angeles, February 11-13, Alexandria Hotel, Los Angeles, Calif.

Symposium on Design Principles of Transistor Circuits sponsored by New York section of IRE—Dr. John Linwill, Bell Labs. moderator; January 8, Engineering Societies Building, New York, N. Y., 9:45 A.M.

designed a counter display for its phono needle line.

**Production and Sales**

RETMA reported the production of 4,733,315 TV sets and 7,042,442 radios during the first nine months of 1954 compared with 5,524,370 TV sets and 10,149,163 radios for the 1953 period. September production of 947,796 TV

# Sales-builders

by **TACO**

**MAGI-MIX ANTENNA Couplers**

An extremely efficient band pass filter permitting the use of a single transmission line with the following antenna combinations:  
 Cat. No. 1425A High-band and low-band VHF antennas  
 Cat. No. 1460 UHF and VHF antennas  
 Cat. No. 1465 Two UHF antennas  
 Cat. No. 1433 VHF high-band, VHF low-band and UHF antennas

**MULTI-SET Couplers**

Three models—Cat Nos. 820-2; 820-3; and 820-4 permit two, three, or four set operation respectively from a single antenna installation. Units split signal equally between receivers and provides necessary isolation to eliminate interaction between sets. Eliminate those trade-in headaches—sell a second set — not a second-hand set.

**SELECTRONIC Switch**

A multi-purpose, 300-ohm impedance switch with high-efficiency contacts for minimum loss. Used for manual switching from antenna to antenna, switching signal from one receiver to another, and ideal for use in high-fidelity signal switching.

Taco, the oldest and most respected name in antennas, offers you real SALES-BUILDERS in the line of antennas, accessories and promotional backing. You can't lose with Taco as your brand. Stop in and see your Taco distributor. Pick up your copy of the Taco catalog and see for yourself why Taco has been the STEADY LINE since 1932 . . .

**TECHNICAL APPLIANCE CORPORATION**  
**SHERBURNE, NEW YORK**  
 In Canada: Hackbusch Electronics, Ltd., Toronto 4, Ont.

*Imagine!*

YOU CAN OWN THE HIGHEST QUALITY  
 IMPORTED HOME AUDIO SYSTEM  
 FOR THE BARGAIN PRICE  
 OF ONLY **\$173<sup>90</sup>**

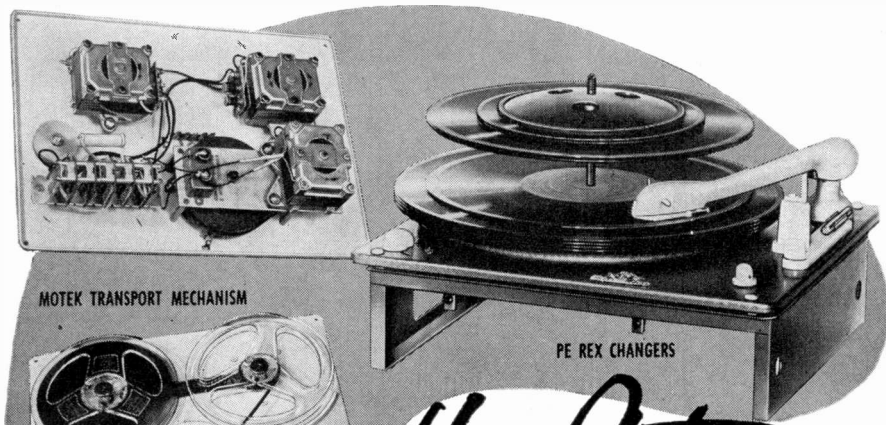

*You Get*

**1 Fenton MOTEK TRANSPORT MECHANISM**

- Driven by three individual AC motors.
- Speed 7½ I.P.S., dual tracks.
- All electrical push button switching and braking.
- Hi-Fi record/playback and erase heads.
- Frequency response better than 50 - 10,000 C.P.S.
- WOW and FLUTTER less than .3%
- Accommodates 7" reels (1200').

**2 Fenton EAP 2 AUDIO AMPLIFIER**

- Output 6 watts, 3 - 5 ohms impedance.
- Separate power pack for remote installation to avoid HUM.
- Record frequency range 50 - 10 000 C.P.S. Erase and Bias frequency 45 kc/s.
- Controls — record, play-back and amplifier selector switch, tone, volume, phono, master volume.
- Input — for microphone, phono, radio and telephone pick-up with provision for mixing, also input for feeding into your present amplifier. Preset tone compensation on record, to provide correct equalization.
- Monitoring — Magic Eye Record Indicator, with provision for headphone monitoring (2,000 ohms).

**3 Fenton PE REX CHANGERS**

- The only truly automatic and foolproof changer (patented), playing ten intermixed records, without pre-setting, in any odd size between 6" and 12".
- Precision built: free from rumble and acoustic feedback.
- Automatic muting switch, Automatic shut-off. Built in 3-stage tone filter. Spring mounted chassis.
- Price includes famous PE8 dual cartridge with sapphire stylus. (45 spindle + \$3.50)
- You can play PE Rex independently with the selector switch of the EAP 2 Amplifier on "Amplifier" position thus getting a response of 50 - 15,000 cps on playback.

At Your Nearest Hi-Fi Center.

**FENTON COMPANY** 15 MOORE STREET • NEW YORK 4, N. Y.

receivers set an all-time record for monthly production.

RETMA reported the retail sale of 3,658,927 TV sets and 3,269,115 radios, exclusive of automobile sets, during the first eight months of 1954. This compares with 3,546,407 TV sets and 3,875,293 radios for the 1953 period.

**New Plants and Expansion**

Raytheon Manufacturing Co., Waltham, Mass., opened a new equipment sales office in Los Angeles for its microwave, power and cathode-ray tube operations. D. R. Yoder was named district manager in charge of the new Western district sales office. He was formerly with RCA.

Sylvania Electric Products, New York City, recently dedicated a new 51,000-square-foot TV picture-tube manufacturing plant in Fullerton, Calif. The company also completed automatic aluminized TV picture-tube facilities in Seneca Falls, N. Y., which will make possible the production of 25,000 more large size tubes per month.

Insuline Corp. of America and National Electronic Manufacturing Corp. formally dedicated their new manufacturing facilities in Manchester, N. H.

Radio Apparatus Corp., an affiliate of I.D.E.A., Inc., moved to 7900 Pendleton Pike, Indianapolis, home of the parent company.

Haydu Brothers, Plainfield, N. J., a division of Burroughs Corp., acquired 30,000 square feet of additional space for the production and storage of reprocessed TV tubes.

Pyramid Electric Co., North Bergen, N. J., constructed a new 27,000-square-foot building on its present site. It will house the executive and general offices, engineering and research laboratories, jobber division warehouse and shipping department. The space formerly occupied will be converted to additional manufacturing facilities.

Clarostat Mfg. Co., Dover, N. H., purchased Campbell Industries Inc., Chattanooga, Tenn., manufacturer of specialized carbon type resistance products for TV-radio-audio, and military use. George S. Campbell will continue to head the new subsidiary as general manager.

E-Z Way Towers, Inc., is now located in new larger quarters at 5901 E. Broadway, Tampa, Fla.

Gudeman Co., Chicago, purchased Diectron, Inc., Monrovia, Calif., ceramic capacitor manufacturer, and will operate it as a division. There will be no personnel changes.

Imperial Radar and Wire Corp., New York, opened a new factory and warehouse in Van Nuys, Calif.

**Business Briefs**

... RCA Service Co., Camden, N. J., was appointed by Theatre Network Television, Inc. to supervise installation and servicing of 50 large-screen closed circuit TV projection units which it has acquired for hotel use. END

**EASY TO LEARN CODE**

It is easy to learn or increase speed with an Instructograph Code Teacher. Affords the quickest and most practical method yet developed. For beginners or advanced students. Available tapes from beginner's alphabet to typical messages on all subjects. Speed range 5 to 40 WPM. Always ready—no QRM.



**ENDORSED BY THOUSANDS!**

The Instructograph Code Teacher literally takes the place of an operator-instructor and enables anyone to learn and master code without further assistance. Thousands of successful operators have "acquired the code" with the Instructograph System. Write today for convenient rental and purchase plans.

**INSTRUCTOGRAPH COMPANY**  
 4701 Sheridan Rd., Dept. RC, Chicago 40, Ill.

**OSCIL-O-PEN**

Extremely convenient test oscillator for all radio servicing; alignment • Small as a pen • Self powered • Range from 700 cycles audio to over 600 megacycles u.h.f. • Output from zero to 125 v. • Low in cost • Used by Signal Corps. • Write for information.

**GENERAL TEST EQUIPMENT**  
 38 Argyle Ave. Buffalo 9, N. Y.

**SOUND-OFF!**

Build fully automatic electronic brain. The MUSICON cuts out commercials. Lets any radio, TV play only music! Priceless possession for home, business, office. Simple, low-cost construction. 2-tubes. Handsome booklet, schematic, full instructions PLUS special component, \$3.50 with order. Free literature.

**NORMAN ELECTRONICS COMPANY**  
 P.O. Box 733 Brooklyn 1, N. Y.

**6 VOLT BATTERY SOLDERING IRON AND WELDER**

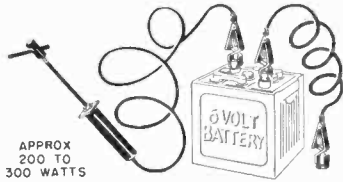

APPROX  
200 TO  
300 WATTS

U.S. Army release. Brand New—Never Used. Fully Guaranteed. This soldering iron can be used to solder or weld when connected to any six-volt storage battery. Uses approximately 200 to 300 watts. The high intensity arc created between the metal to be soldered and the carbon electrode (carbons supplied free with iron) can be used to heat tin or aluminum solder. Suitable also for light brazing and spot welding. Arc can be used for melting metals, cutting holes and soldering seams in chassis. Also useful for analyzing metals and minerals.

Battery soldering iron outfit includes 2 carbons, 3 heavy duty spring clips, 2 pieces 5 ft. heavy duty wire cable. (Battery not included.) Ideal for use where current is not available. Ship wt. 4 lbs.

**\$1.95**

ITEM NO. 126 (Ship. Chgs. 40c)  
UNUSUAL BUY

**POWERFUL ALL PURPOSE MOTOR**

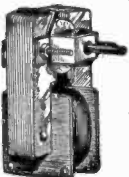

Sturdy shaded pole A.C. induction motor. 15 watts, 3000 rpm. 3"x2"x1 1/4"; 4 mounting studs; 7/8" shaft, 3/16" diameter; 110-120 volts, 50-60 cycles. A.C. only. When geared down, this unit can operate an 18" turntable with a 200 lb. dead weight. Use it for fans, displays, timers and other purposes. Ship wt. 2 lbs.

**\$2.45**

ITEM NO. 147  
UNUSUAL BUY (Ship. Chgs. 35c)

**WATTHOUR METER**

Leading makes—reconditioned. Ideal for trailer parks. 100-110 volts, 60 cycles, 2-wire A.C. 5 amp. Heavy metal case 8 1/2" x 6 1/4" x 5". Easy to install. Ship. wt. 14 lbs.



**\$4.50**

ITEM NO. 33  
NOW ONLY (Ship. Chgs. \$1.25)

**WESTERN ELECTRIC BREAST MIKE**



Lightweight 1 lb. carbon microphone. Aircraft type. Breastplate mounting, adjustable 2-way swivel. Easily fastened straps. For home broadcasts, communications etc. Complete with 6 foot cord, hard rubber plug. Sheradized plate, non-rusting finish. Ship. wt. 2 lbs.

**\$1.98**

ITEM NO. 152  
NEW LOW PRICE (Ship. Chgs. 32c)

**AMAZING BLACK LIGHT**



250-watt ultra-violet light source. Makes fluorescent articles glow in the dark. Fits any lamp socket. For experimenting, entertaining, unusual lighting effects. Ship. wt. 2 lbs.

**\$2.45**

ITEM NO. 87  
A SAVING AT (Ship. Chgs. 35c)

**250 POWER TELESCOPE LENS KIT**

Make your own high powered 6 ft. telescope! Kit contains 2" diam., 75" focal length, ground and polished objective lens and necessary eye pieces. Magnifies 50x to 250x. Full instructions. Ship. wt. 1 lb.

**\$2.95**

ITEM NO. 123  
YOU SAVE AT (Ship. Chgs. 10c)

**HUDSON SPECIALTIES CO.**  
25 West Broadway, Dept. RE-1-55  
New York 7, N. Y.

I am enclosing full remittance for items circled below. (Be sure to include shipping charges.)  
OR, my deposit of \$... Ship balance C.O.D.  
MINIMUM C.O.D. ORDER \$5.00.  
C.O.D. ORDERS ACCEPTED ONLY WITH 20% DEPOSIT  
INCLUDE SHIPPING CHARGES.

Circle Items Wanted  
87 147 33 152 126 123

Name ..... Please Print Clearly  
Address .....  
City ..... Zone ..... State .....



**"CHECK THESE UNUSUAL VALUES"**

**TERRIFIC VALUE!**



**5 TUBE AC/DC Superhet Kit**

Kit #1: 5 tube superhet kit, AC/DC includes all quality components required to construct this latest design, highly sensitive superhet broadcast receiver, complete with black, glistening bakelite cabinet (excludes wire & solder). Kit of 5 tubes, 12AT6, 2/12BA6, 12BE6, 35W4, 50B5.  
Price, Less Tubes..... **\$7.95**  
Extra for Tubes..... **\$3.25**

**3-Way Portable RADIO KIT AC/DC Batteries**



**NEW**, compact, lightweight portable radio kit with the very latest supersensitive superhet. circuit. Wonderful reception from either batteries, or 115 V., 50-60 cycle AC or DC. Includes all complete parts (except wire & solder) necessary to build a great sounding radio. Also includes circuit diagrams and simplified, complete step-by-step instruction folder which makes assembling easy. Housed in a beautifully high-glossed Catalin cabinet in two delightful and distinctive colors: maroon or alabaster (ivory). Size: 9 1/2" x 5 3/8" x 4 3/4". Includes tubes! (maroon or ivory)  
**\$13.95**  
**BATTERY KIT: add..... \$2.59**

**AM/FM TUNER with BUILT-IN 10 WATT HI-FI AMPLIFIER**

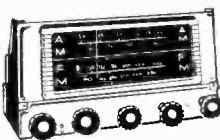

117 V., AC, 60 cycles, using an oversized power transformer. Includes push-pull audio output providing for 10 Watt undistorted output, full range Bass & Treble control, built-in powerful antenna for FM, plus hi-gain Ferrite antenna for AM. Provision for phono input, and an additional audio amplifier.  
Tubes: 6BE6, 2-6AV6, 6CB6, 6BA6, 6AL5, 2-6V6, 5Y3. Completely shock mounted chassis: 12 1/2 x 5 1/2 x 7 1/2". 11 Lbs.  
If tuner is to be used for a re-luctance pick-up, a pre-amplifier will be contained. Add.....\$6.75  
Now Only **\$48.75**

**3-SPEED PORTABLE PHONOGRAPH**



Unusual Value  
Plays all speed records (33 1/2, 45 & 78 RPM) with a new, all purpose permanent needle. Complete with excellent amplifier and speaker for unusual fine tone. Luggage type carrying case, durable and long lasting. 12 1/2" x 10" x 5 1/4". 8 1/2 lbs.  
**Special \$14.75**



**3-TUBE PHONO AMPLIFIER NOT A KIT**

An assembled unit ready for installation using tone and volume control and 6 ft. rubber cord. (less tubes)..... **\$2.95**  
Lowest Price!  
With complete set of tubes..... **\$4.45**

**Great Savings! 6-TUBE RADIO KIT**

Kit #2: Low priced 6-tube kit designed for extra high sensitivity, excellent selectivity and good rich tone quality. Uses 25L6, 25Z6, 6SQ7, 6SA7, 2-6SK7 in an easily constructed circuit. Includes all parts: punched chassis, resistors, condensers, coils, sockets, PM speaker, hardware, etc. Special closeout price. (less tubes & cabinet)..... **\$6.95**  
Matched set of 6 tubes for kit..... **\$3.25**

**Phone Oscillator NEW SAVINGS! NOT A KIT!**

Wireless phono oscillator transmits recording for crystal pickups or voice from carbon mike through radio without wires. Can also be used as an intercom by using PM speaker as \$2.95 mike (less tubes)..... **\$2.95**  
With complete set of tubes..... **\$3.95**

**NEW KIT SUPERSENSITIVE 2-STATION INTER-COMMUNICATIONS SYSTEM—Kit**

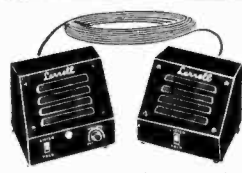

**\$12.95**

This fine unit is suitable for use in home, office, factory, nursery, or sick room. So sensitive it will pick up baby's whimper. Operates from 115 V. AC/DC. Both stations housed in compact, handsome grey, hammer-tone metal cabinets. Requires only 2 wires to connect for quick installation. Complete with 50 ft. of twin conductor wire. Factory Wired..... **\$16.95**

**Just Out! First Time Anywhere Larrel's E-Z TV REPAIR GUIDE**

The only Fix-It-Yourself guide made expressly for YOUR TV SET! Save costly TV repairs with this new, simplified method which includes all necessary data for just your set. No confusing, unimportant information applicable to hundreds of different makes. Simplifies detection of faulty tubes in your TV receiver. It's a great idea—it's a great guide! Order today and have your set back in perfect condition at once. Send us make and model of your set when ordering. **50¢**

**E-Z TV REPAIR GUIDE**



TERMS: All made shipped FOB New York City, prices subject to change without notice. Include 20% deposit for COD's. WRITE TODAY FOR NEW FREE CATALOG!

**EDLIE Electronics**

154 Greenwich St.  
DI 9-3143  
New York 6, N. Y.

Watch for the February Issue of RADIO-ELECTRONICS On Sale Jan. 25

**NEW STOCK OF FIRST QUALITY  
TELTRON TUBES  
GUARANTEED! . . . LOWEST PRICES EVER!**

All tubes individually boxed . . . unconditionally guaranteed for one year!

**GIFT OFFER!**  
One 6BG6G tube will be shipped FREE with any order accompanying this ad.

**FREE  
Bonus  
Offer!**



**Model 625K**

- Illum. gear-driven "Speed Rollchart"
- New lever-action switches for individual testing of every element
- Tests all conventional and TV tubes

May be bought outright from Teltron for \$34.95

This Eico Tube Tester is yours FREE when you buy \$199 worth of tubes or more within 60 days at Teltron.

Type	Price	Type	Price	Type	Price
1A7GT	.53	6BC5	.48	7F8	.49
1H5GT	.51	6BE6	.46	7N7	.49
1L4	.51	6BF5	.48	12AL5	.43
1L6	.51	6BF6	.48	12AT6	.37
1LC6	.49	6BG6G	1.18	12AU6	.43
1N5GT	.51	6BK5	.75	12AU7	.58
1T4	.51	6BJ6	.51	12AV6	.42
1U5	.43	6BH6	.51	12AV7	.73
1X2	.65	6BK7	.78	12AX4GT	.60
2A3	.35	6BL7GT	.78	12AX7	.61
2A7	.35	6BN6	.90	12AZ7	.65
3Q4	.53	6BQ6GT	.83	12B4	.72
3Q5GT	.61	6BQ7	.85	12BA6	.46
3S4	.48	6BY5G	.60	12BA7	.58
3V4	.48	6BZ7	.95	12BE6	.46
5U4G	.43	6C4	.41	12BH7	.61
5V4G	.49	6CB6	.51	12BY7	.65
5Y3GT	.30	6CU6	.95	12BZ7	.63
5Y4G	.40	6F6	.42	12SL7GT	.60
5Z3	.42	6FSGT	.44	12SN7GT	.56
6A8	.40	6H6	.50	198G6G	1.48
6K7	.40	6J5GT	.49	19T8	.71
6AB4	.43	6K6GT	.39	25CU6	1.09
6AF4	1.02	6L6	.78	25L6GT	.41
6AG5	.52	6Q7	.40	25Z5	.55
6AH4GT	.65	6S4	.41	25Z6GT	.36
6AK5	.96	6S8GT	.65	35A5	.48
6AL5	.43	6SA7GT	.45	35B5	.48
6AQ5	.48	6SK7GT	.45	35C5	.48
6AR5	.48	6SL7GT	.60	35L6GT	.41
6AT6	.37	6SN7	.60	35W4	.33
6AU5GT	.60	6SQ7GT	.38	35Y4	.42
6AU6	.43	6T8	.71	35Z5GT	.33
6AV5GT	.60	6U8	.76	50A5	.49
6AV6	.37	6Y3	.80	50B5	.48
6AX4GT	.60	6Y6GT	.48	50C5	.48
6AX5GT	.60	6W6GT	.53	TYPE 80	.40
6BA6	.56	6X4	.37	117L7GT	1.20
6BA7	.58	6X5GT	.38	117Z3	.33
		6X8	.80	117Z6GT	.65

**FREE** \$7.20 list value Bonus Box of three 6SN7 tubes and 25 assorted resistors with each order of \$25 or more.

**SAME DAY SERVICE**

48 Hour Postal Delivery To West Coast

TERMS: Save all freight and postage charges. All orders accompanied by full remittance will be shipped POSTAGE PAID anywhere in the continental U.S.A. 25% deposit required on C.O.D.'s. Minimum order \$10.00. Open accounts to rated firms only.

Send for Free complete tube listing and monthly specials! Get on our mailing list.

**SPECIALS!—till FEB. 1**

Type	Price	Type	Price
1B3GT	.56	6W4GT	.37
1R5	.42	12AT7	.55
1U4	.42	12SA7	.42
6AC7	.59	12SK7	.40
6CD6G	.99	12SQ7	.36
6J6	.49	25BQ6GT	.73
6SN7GT	.49	50L6GT	.42

**TELTRON ELECTRIC COMPANY**

428 Harrison Ave.,

Harrison, N. J.

Dept. RE-1

Phone Humboldt 4-9848

**PHOTOGRAPHS**

RADIO-ELECTRONICS can use good photographs of service benches, service shops, high-fidelity audio layouts, and any other interesting and original radio-electronic devices.

We will pay \$6.00 each for good professional photos or equivalent, suitable for reproduction.

Full information on subject photographed will increase their acceptability.

**The Editor, RADIO-ELECTRONICS  
25 West Broadway, New York 7, N. Y.**



Lee F. Holleran was promoted to general marketing manager of the RCA Tube Division, Harrison, N. J. A 20-year veteran with the company, he was general sales manager of the division for the past year.



Edwin A. Freed was appointed general sales manager of General Instrument Corp., Elizabeth, N. J. He was formerly operational head and sales manager of the Elizabeth headquarters division.



Col. Mark E. (Ted) Smith, recently retired from the U. S. Army, joined Hallcrafters, Chicago, as administrative assistant to the president.



F. E. Anderson, distributor tube sales manager of Raytheon Manufacturing Co., Newton, Mass., was honored at a special anniversary luncheon tendered by the executives of the receiving and cathode-ray tube operations on the occasion of his 25th anniversary with the company.



F. E. Anderson, right, receives congratulations from N. B. Krim, Raytheon v.p.



the Walsco company.

Robert J. Mueller was promoted to vice president in charge of sales for Walsco Electronics Corp., Los Angeles. He was formerly sales manager for

# Suppress TELEVISION Interference

with **Miller FILTERS**



**NO HERRINGBONE  
NO SOUND BARS  
NO JITTERS!**

This New TV HIGH-PASS FILTER will reduce interference which may be picked up by the i-f. amplifier of your tv. receiver.

The Miller No. 6168 High-Pass Filter diminishes spurious signals which arise from strong, local fields generated by:

1. Amateur radio transmitters.
2. X-ray or medical diathermy equip.
3. Short wave stations.
4. Industrial r.f. heating units.
5. Various electrical appliances.

Filter is designed to attenuate all signals to 40 megacycles. All television channels passed with minimum loss. Installed easily in antenna lead-in. No tuning required. Dim. 1-7/16" by 1-7/8" by 3-1/2" high.



Cat. No. **6168** Net Price For 300-ohm line **\$3.30**  
See your Wholesaler or write us for literature

**J. W. MILLER COMPANY**  
5917 S. Main St., Los Angeles, Calif.

● BUILDERS OF QUALITY RADIO INDUCTANCES SINCE 1924

FOR **The Finest MASTER AMPLIFIED AND COMMUNITY TV ANTENNA SYSTEMS-**

— Send Us Your Problem for FREE Engineering Advice.

**FREE:** Important Technical Manual for Community and Master TV Systems

FIELD STRENGTH METER, operates both on Battery and AC . . . \$89.

Write today to:  
**TRANSVISION, INC. NEW ROCHELLE, N. Y.**

**HI-GAIN TUNER-BOOSTER**  
LESS TUBES WITH DIAL

**\$ 2.00**

COMPLETE WITH TUBES **\$ 2.75**

Solve poor TV reception with a Hi-Gain Booster. Banish weak fringe areas, reduce snow. This unit comes to you as a highly serviceable High-Gain Tuner. Uses 6J6 Tubes in very efficient Hi-Q Circuit. Has 8 tuned circuits using pure silver inductances and individual compensation providing high gain on all channels. Built in S-1 Vernier Drive. All necessary parts and instr. included. Add postage for 5 lb. shipping wt. No C.O.D.'s. Send for TV parts bulletin.

**FRANK W. DECRAY & ASSOC.**  
11842 W. Jefferson Blvd. Culver City, Calif.

## PEOPLE

(Continued)

James L. Brown was named regional manager, Midwest sales for CBS-Hytron, Danvers, Mass., with headquarters in Chicago. He was formerly with General Electric and Westinghouse.



Robert L. Shoemaker was promoted to manager of the newly formed Sales Promotion Department of DuKane Corp., St. Charles, Ill. He was formerly manager of the Audio-Visual Division. Alfred F.



Hunecke, former assistant to the executive vice president, succeeds Shoemaker, and J. McWilliams Stone, Jr., succeeds to Hunecke's position.

Donald L. McKenna was named Tung-Sol sales representative in the Southeastern states working out of the Atlanta office. He was formerly in the Production Planning Department in Newark, N. J.



Dr. Lee de Forest, "The Father of Radio," was honored at a dinner recently by members of the de Forest Pioneers. Dr. Allen B. Du Mont, president of Allen B. Du Mont Laboratories, presented Dr. de Forest with one of the first audion tubes, of a type presumed to have been lost many years ago.



Dr. Lee de Forest receives one of the first audion tubes from Dr. A. B. Du Mont.

## Obituaries

Frank G. Gracyk, purchasing agent for Quam-Nichols, Chicago, and associated with the company for 22 years, died of a heart attack.

Simon Wexler, founder and vice president of Allied Radio Corp., Chicago, died suddenly last November in his office after being stricken with a heart attack. Mr. Wexler was a pioneer in the electronics industry, being among the first manufacturers of crystal sets and components. He was 56 years old at the time of his death. END

# The Quickest Way to the Best Jobs

for • TV TECHNICIANS  
• SERVICEMEN  
• STUDENTS

Have the **ESSENTIAL** math at your fingertips

## Elements of Mathematics for Radio, TV & Electronics

You'll EASILY gain FULL COMMAND of the most important rock-bottom requirement for TV from this book. You'll learn every step in the math you need and how to USE it for all such calculations as voltage drops, frequency resolutions, decibels, thousands of others. Thoroughly explains the slide rule, useful rule-of-thumb short-cuts. Very clear and practical. NO mathematical smog!

Over 3000 examples and problems for practice

## Radio & Television Mathematics

Whatever your problem—to correct the power factor of a motor, find the impedance and length of matching stub between antenna and transmission line, convert from polar to j-notation in a matter of seconds—you'll find the complete worked-out solution here. Fully indexed for quick reference on all common problems requiring math in radio & TV.

Complete quick-reference handbook of problems and SOLUTIONS

Learn the **SURE, QUICK** methods of installation and servicing

## Mandl's Television Servicing

The NEW printing of this famous service guide includes all latest improvements, full section on color. Clear, specific instruction on ALL techniques of efficient installation and servicing. Practical aids for locating trouble quickly and FULLY correcting it. Excellent material on antennas; improving reception in difficult areas.

Unique Master Trouble Index Complete Color Section

## 10-day FREE TRIAL

The Macmillan Co., 60 Fifth Ave., New York 11

Please send me the books checked below. I will remit full price plus small delivery charge, or return books in 10 days. (Save: Send check or money order and we pay delivery charge)

- Elements of Mathematics by Fischer & Jacobs \$7.20  
 Radio & Television Mathematics by Fischer \$6.75  
 Mandl's Television Servicing \$5.75

Signed \_\_\_\_\_

Address \_\_\_\_\_

This offer good only within continental limits of U.S.A.

# HERSHEL RADIO CO. BIGGEST BUYS!

## FIL. TRANSFORMER

PRI. 117V. 60 cycle

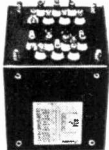

Sec. 1  
6.4v 12amp.  
6.4v 10amp.  
5.0v 3amp.  
5.0v 3amp.  
2.5v 1.75amp.

**\$4.95**

SIZE: 5 1/16" x 5 1/16" x 5 1/4" H.

## RCA OUTPUT



### TRANSFORMER

P.P. 616's 25 watt

PRI 5000 Ohms  
output. Sec. #1  
500 Ohms. Sec.  
#2 600 Ohms.  
Sidetone 15 to  
15,000 cy. flat.

**\$1.95**

## OIL COND.

MFD VDC PRICE

.05	3000	\$1.95
.05	7500	2.29
.1	4000	1.29
.1	7000	1.75
.1	7500	2.49
.5	2500	1.75
2 x .5	8000	1.49
1	3000	2.49
1	3600	2.95
1	5000	4.95
2	600	.49
2	1000	.95
2	3000	4.95
4	1000	1.95
7	600	1.29
7	600	1.75
8	600	1.39
8	1000	2.49
10	600	2.49
10	1500	4.95

## DUAL 4-1000

2x4 600 3.95  
13.5 220 vac. 1.95  
6 330 vac. .95

## PAPER CAN

MFD	VDC	PRICE
250	10	\$ .39
500	12	.49
1000	3	.69
1000	15	.95
1000	25	1.29
1200	10	.95
1600	15	1.29
24000	3	1.49
117	110 vac.	1.45

## PHOTO-FLASH SPECIAL!

MFD	VDC	PRICE
525	450	\$9.95

## 1 KW ANT. CHANGEOVER

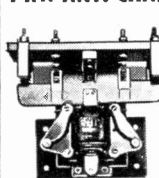

### RELAY

110 VAC  
60 Cycle  
15 Amp  
2500 Volt  
D.P.D.T.

**\$9.95**

## BUTTERFLY CONDENSERS

TYPE A-106-330 MC-  
Antenna Type  
TYPE B-300-1000 MC-  
Uses 368AS tube  
TYPE C-300-1000 MC-  
Clip for Xtal Det.  
TYPE D-135-485 MC

### YOUR CHOICE

**\$4.95**

## CHOKE SPECIALS!

DUAL 4.5	120MA	\$ 1.95
4.5	70MA	
DUAL 1H	400MA	\$2.95
4.2H	75MA	
15H	80MA 385 OHM	\$ 1.95
2-7H.	Swinging 550MA	\$ 5.95

## MODULATION and DRIVER TRANSFORMERS



**\$4.95 for Both**  
Modulation  
trans. 815 Class  
AB2 56 Watt  
DRIVER, 6SN7  
to Modulator.

## VIBRATOR SUPPLIES

PE 117C	YOUR CHOICE
Input 6 or 12V DC to Supply Fil. and Plate Power. Used with BC 659.	<b>9.95</b>
PE 204C	
Input 12V DC. Supply Fil. and Plate Supply. Used with EE99.	

## JANUARY SPECIALS

A-Ignition Coil Pri. 3 V. Sec. 15,000 V. Ideal for Photo-flash \$1.29  
B-Full Wave Meter Rectifier. For use with 0-1 Ma. Meter 95c  
C-Willard Battery. 2 Volt 20 AH \$2.50  
D-Headset Adapter MC 385-A. High to low use with HS-33 or HS-38 .95c

## HI-LO ANTENNAS

Outdoor improved Model K 1/2" Aluminum-Seamless Tubing with 1 1/4"-5 Foot Mast and Roof Mount. Buy Now and Save. Complete **\$5.95** Ea.

## PLATE TRANS. only



## TELEGRAPH SOUNDER



**HERSHEL RADIO CO.**

5245 GRAND RIVER  
Detroit 8, Michigan  
Phone TYler 8-9400

TERMS: Cash with order or 25% DOWN—BALANCE C.O.D. NET 10 DAYS RATED ACCOUNTS ALL PRICES NET F.O.B. DETROIT Merchandise Subject to Prior Sale

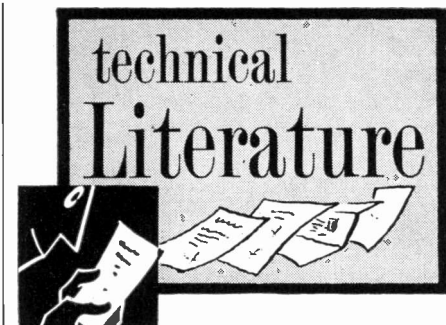

# technical Literature

## INDOOR ANTENNAS

An 8-page catalog describes RMS indoor antennas, with list prices and illustrative photos.

Radio Merchandise Sales, 2016 Bronxdale Ave., New York 62, N. Y.

## TRANSFORMER

A 6-page, 2-color brochure describing the Vernistat precision variable ratio transformer includes performance curves, application schematics in computer and servo systems, specifications of the 60- and 400-cycle types and step-by-step drawings illustrating the combination autotransformer and potentiometer mode of operation of the variable ratio transformer.

Vernistat Division, Perkin-Elmer Corp., Norwalk, Conn.

Any or all of these catalogs, bulletins, or periodicals are available to you on request direct to the manufacturers, whose addresses are listed at the end of each item. Use your letter-head—do not use postcards. To facilitate identification, mention the issue and page of RADIO-ELECTRONICS on which the item appears. UNLESS OTHERWISE STATED, ALL ITEMS ARE GRATIS. ALL LITERATURE OFFERS ARE VOID AFTER SIX MONTHS.

We specialize in preparing you to pass

# FCC LICENSE EXAMINATIONS

The Grantham Radio License course is offered by Correspondence or in Residence

## Here are Ten Reasons why Grantham Training is best for you

- ✓ Lessons complete and easy to understand
- ✓ Detailed explanations for each student
- ✓ Necessary mathematics simplified
- ✓ Constant practice with F.C.C. type tests
- ✓ No technical background necessary
- ✓ Complete training in a minimum of time
- ✓ Our guarantee—you will get your license
- ✓ No binding contract required
- ✓ Low cost tuition
- ✓ Free placement service to graduates

Write for our free booklet which gives complete details about how you can prepare quickly for the particular class of F.C.C. commercial operator license you want.

**GRANTHAM SCHOOL OF ELECTRONICS, Dept. 101-R**  
6064 Hollywood Blvd., Hollywood 28, Calif.  
Phone HO 2-1411

RADIO-ELECTRONICS is paying good rates on acceptance for original and unusual articles on audio, television, FM and AM servicing, as well as articles on industrial electronic equipment and applications. Send for a copy of our Authors' Guide. Address:

THE EDITOR  
RADIO-ELECTRONICS  
25 West Broadway, New York 7, N. Y.

## TV MANUAL

The seventh edition of Sprague's TV Replacement Capacitor Manual K-101 covers 4,664 models of 85 set manufacturers. The 65-page pocket-sized manual lists each manufacturer alphabetically with Sprague replacement capacitors fully described and cross-referenced to the original part numbers. It shows the number of models in the common picture-tube sizes for which each capacitor has been specified as original equipment.

Free from all Sprague distributors, or send 10c to Sprague Products Co., 81 Marshall St., North Adams, Mass.

## ROTO-KING BROCHURE

An 8-page, 2-color brochure, No. 288 contains an analytical and evaluation report and technical information on the Roto-King rotator along with photographs, diagrams and charts.

JFD Manufacturing Co., Inc., 6101 16th Ave., Brooklyn 4, N. Y.

## GLASS-CASED CAPACITORS

Four-page Bulletin GC-1 describes hermetically sealed high-voltage glass-cased GC type paper dielectric d.c. capacitors. Data includes explanation

# Now

a complete, practical, how-to-do-it book on radio control!

## RADIO-CONTROL HANDBOOK—

Gernsback Library Book No. 53

By Howard G. McEntee, W2SI.  
The book radio control fans—beginners and experts alike—have been waiting for.

192 Pages. 175 Illustrations.  
\$2.25

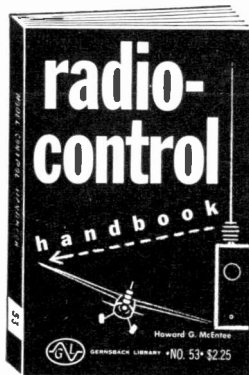

Here's a book that skips theory and gets right down to the business of putting radio-control systems together so they will operate your model planes, boats, trucks, etc.

### Emphasizes the Practical

RADIO-CONTROL HANDBOOK concentrates on construction details of a number of practical radio-control units which will actually work and work well. It also covers the hitherto neglected field of trouble shooting radio-control systems. Whether or not you know radio, this is a book for anyone and everyone interested in R/C. For the first time, it combines

the necessary practical information on radio with detailed instructions on mechanical construction of control units.

### Written by an authority on Radio Control

Howard G. McEntee's experience in radio goes back some 25 years. And he has been hailed as a leader in the model field for just as long. Probably no man living knows more about the practical application of electronics in model control, than the author. Certainly no one writes about it better. Here's a book slated to become a classic on model control by radio. Be the first in your area to profit from the ideas it gives you.

### CONTENTS OF RADIO-CONTROL HANDBOOK

- Complex Control Systems
- Motor and Auxiliary Controls
- Single-Tube Receivers
- Multi-Tube Receivers
- Simple Transmitters
- Complex Transmitters
- Keying the Transmitter
- Installation Parts
- Adjustments
- Test Instruments
- Complete Control Systems

## Other Gernsback Library Books you'll want to read

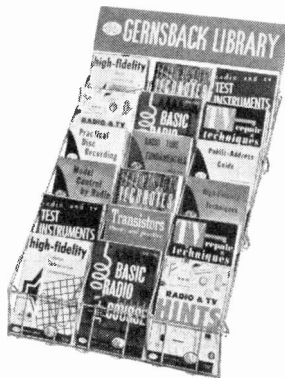

- The Oscilloscope—No. 52. \$2.25.
- Transistors—Theory and Practice—No. 51. \$2.00.
- TV Repair Techniques—No. 50. \$1.50.
- Radio & TV Test Instruments—No. 49. \$1.50.
- High-Fidelity—Design, Construction, Measurements—No. 48. \$1.50.
- Radio & TV Hints—No. 47. \$1.00.
- Television Technotes—No. 46. \$1.50.
- Radio Tube Fundamentals—No. 45. \$1.00.
- Basic Radio Course—No. 44. \$2.25.
- High-Fidelity Techniques—No. 42. \$1.00.
- Public-Address Guide—No. 41. 75c
- Practical Disc Recording—No. 39. 75c.

From the publishers of  
**RADIO-ELECTRONICS**

**MODEL CONTROL BY RADIO—No. 43** By Edward L. Safford. 112 Pages. 114 Illustrations. \$1.00

Here's the perfect companion volume to Radio-Control Handbook! It covers theory as well as construction details for control units and complete systems for the beginner and more advanced fans. The author is a guided missiles instructor and winner of many awards in model-airplane meets.

Some of the contents  
Basic concepts • Methods of coding • Radio transmission • Wired transmission • Receivers • Decoders • Relays • Power control circuits • Servomotors • Transmitter construction • Construction of receivers, coders and decoders • Complete control systems • Trouble shooting • Receiver adjustment • Transmitter hints.

For a complete library on model control—order both books today.

See your distributor—or mail this coupon

**GERNSBACK PUBLICATIONS, INC., Dept. 15**  
25 West Broadway  
New York 7, N.Y.

Enclosed is my remittance of \$.....

Please send me the following books postpaid.

- 53 Radio-Control Handbook \$2.25.  
 43 Model Control by Radio \$1.00.

- 39  41  42  44  45  46  
 47  48  49  50  51  52

Name .....  
(Please print clearly)

Street .....

City ..... Zone ..... State.....

## arkay kits

world's finest radio, phono, TV, and test kits

### hi-fi ac/dc amplifier kit

arkay kit model A-5: A high-fidelity AC/DC amplifier kit featuring a new, improved push-pull output circuit plus a specially designed output transformer utilizing 2 speakers for the new 3d-dimensional qualities of audio reproduction. New engineering developments give you hi-fi at the lowest possible price. Kit is complete, except for speakers. **\$9.95**

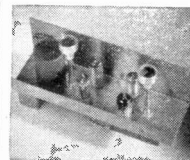

### hi-fi pre-amp kit

arkay kit model PA-3: Complete compensation for LP, NARTB, AES and early 78 RPM records. Kit also may be used as a control unit for custom hi-fi installations. Includes bass and treble control and contains 5 turnover and roll-off switch positions; 3 dual triode tubes are used to give maximum performance always. **\$16.95**



### 10 watt hi-fi amplifier kit

arkay kit model A-10: Complete with built-in pre-amplifier for magnetic cartridge, mike, crystal phono or radio tuner. Frequency response  $\pm 1$  db., 20 to 20,000 cps, with wide response bass and treble controls. Speaker output inductance: 4, 8, 16 ohms; negative feedback; hum: 70 db below rated output. Complete with tubes! **\$21.95**



### hi-fi amplifier with built-in pre-amp

arkay kit model FL-10: A striking new design with physical dimensions and style for use on a shelf or corner without elaborate or expensive enclosures. Specifications: same as model A-10 (above). **\$27.95**



### 3-way portable radio kit

arkay kit model 3W10-P: A smartly styled portable radio kit that operates on AC/DC or self contained batteries. Has 4 tubes and selenium rectifier with a fine quality Alnico V speaker, built-in loop antenna and hi-gain coils. Includes pictorial and schematic diagrams that are easy to follow. Colorful plastic cabinet. **\$18.95**

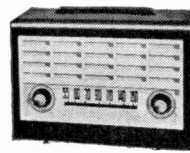

### ac/dc radio kit

arkay kit model S-5E: New, 5-tube superhet. kit designed for radio students and hobbyists. Includes new 3D color instruction book. 550-1600 kc, complete with glistening walnut bakelite cabinet. **\$14.95**



Write today for new catalog including complete arkay line of radio, TV, phonograph, amplifier and test equipment kits.

the world's finest kits

**arkay** RADIO KITS, INC.  
120 Cedar Street  
BEckman 3-6686 New York 6, N. Y.

**NEW!** All Channel VHF-UHF TV RECEPTION IN ALL DIRECTIONS  
**SUPER POWERFUL** Only \$23.50  
 Model AX-524  
**ROCKET DIRECTRONIC MOTORLESS TV ANTENNA 360° ELECTRONICALLY SWITCHED BEAM**

In the fringe or ultra-fringe, the NEW 1955 Motorless Directional will out-perform any ordinary antennas. This sensational new 360° UHF-VHF TV Antenna offers "around the compass" reception WITH-OUT Rotors. Provides superb ghost-free picture clarity. Model AX-524 "Serviceman's Array" contains Hi-Pac Molekied Insulator of Extreme tensile strength, 24 hi-tensile aluminum elements, including 6 Multi-purpose Reflector-directors, 1 set matched tie rods, Universal Mast Clamps, 6-position Beam Selector Switch, 75' Low-loss UHF-VHF Tubular TRI-X Cable.

**Super UHF RECEPTION HI-GAIN YAGI**

Provides guaranteed sensational UHF fringe reception. Amazing sensitivity provides up to 30 db gain, using 2, 4, or 6 bay stacked arrays. Ghosts, interference minimized or eliminated. Each serviceman's array provides 4 directors, 2 folded dipoles, 2 reflectors. And our low price insures a low cost installation. Select the model required in your area.

**NEW LOW PRICE! RADIART TELEROTOR**

Radiart's famous TR-2 at new money-saving price. Powerful, rugged, weather-proof — handles installations up to 150 lbs. Control box light indicates orientation of antenna. Factory lubricated for life. Truly a good buy at our new price. Uses 8-cond. wire. 8 conductor wire \$0.08 Ft.

**Our Greatest BARGAIN**  
 2-Bay 16-ELEMENT CONICAL ARRAY with Hi-Band Adapters Sturdy 3/8" Elements

**\$4.99** IN LOTS OF THREE EACH \$5.30  
 NEVER BEFORE HAS NATIONAL ELECTRONICS HAD A BARGAIN LIKE THIS. We made a special purchase in order to get these sensational prices. And this array has everything. This conical 2-bay 16-element array provides ultra-fine fringe reception. Includes sixteen 3/8 inch airplane type aluminum elements, including hi-band adapters for greater gain on the high channels and is complete with one pair of stacking bars to each array. These are packed in cartons of three 16-element arrays per carton, with tie rods at \$14.95 per carton. When purchased in single 16-element arrays, separately boxed—your cost is..... \$ 5.30 each

3 Two-Bay Arrays per carton without Tie Rods ..... 13.50 carton  
 4 Bay Ultra-Fringe Stacking Assembly for Above—Model 4B ..... 1.95 set

100 ft. UHF Tubular Lo-Loss Lead..... \$4.95  
 PAM-9 Chimney Mount with Strapping..... 1.49  
 TWA Lightning Arrestor..... .69  
 BO Barkhausen Eliminator..... .69

**UHF CORNER REFLECTOR**  
 ONLY \$2.99 EACH IN LOTS OF 6  
 SINGLE LOTS \$3.50 EACH

This hi-gain UHF Corner Reflector can only be offered you at this low, low price for a short time. 8 to 11 db gain across UHF band. Order Model F-6.

**ALL PRICES F.O.B. CLEVELAND, OHIO**  
 Do not remit more than complete purchase price. Pay shipping charges on receipt of goods. 25% deposit on all C.O.D. orders, please. Money-back guarantee. Prices Subject to Change Without Notice.

**National Electronics OF CLEVELAND**  
**THE HOUSE OF TV VALUES**  
 6608 Euclid Ave., Dept. E-1 Cleveland 3, Ohio

of catalog numbers, high-altitude application, lead specifications, ripple voltage and complete engineering specifications. Illustrations consist of GC45 and GC46 series, dimensional drawings, typical performance curves for power vs. temperature, insulation resistance vs. temperature and change of capacitance vs. temperature.

Gudeman Co., 340 W. Huron St., Chicago 10, Ill.

**SOLENOID CONTRACTORS**

Bulletin SC-9 describes a wide range of enclosed and sealed models with power ranges up to 250 amperes. It is fully illustrated with dimensional drawings. Military specification numbers, type numbers and specific approval information are also included.

Guardian Electric Manufacturing Co., 1621 W. Walnut St., Chicago 12, Ill.

**COMPONENTS**

Smith's Catalog No. 55 lists in 25 pages plugs, jacks, connectors, switches, terminals, etc., with dimensional drawings. Among 50 new items listed are telephone type plugs and jacks, linen and nylon cable, nylon plastic cable clamps and panel fasteners.

Herman H. Smith Inc., 2326 Nosstrand Ave., Brooklyn 10, N. Y.

**WIRES AND CABLES**

A 6-page brochure on Chester Plasticore and Plasticote wires and cables illustrates and describes antenna loop wire; telephone, coaxial and rotor cable; hookup wire, etc.

Chester Cable Corp., Chester, N. Y.

**STRIP TURRET SYSTEM**

Ten-page Bulletin 54A describes the Vector strip turret system. Descriptions and photos of deck, tinker and wall turrets are also given.

Vector Electronic Co., 3352 San Fernando Rd., Los Angeles 65, Calif. END

**Radio Thirty-Five Years Ago**  
 In Gernsback Publications

**HUGO GERNSBACK**  
 Founder

Modern Electrics	1908
Wireless Association of America	1908
Electrical Experimenter	1913
Radio News	1919
Science & Invention	1920
Television	1927
Radio-Craft	1929
Short-Wave Craft	1930
Television News	1931

Some of the larger libraries still have copies of ELECTRICAL EXPERIMENTER on file for interested readers.

**In January, 1921 Science and Invention (formerly Electrical Experimenter)**

Cold Light, by H. Gernsback  
 Telegraphing Photos by Code  
 The Geltow Radio Station  
 Locomotive Cab Radio Signal  
 Unique Portable Radio Set  
 Turning Book Leaves Tunes Radio

When answering advertisements please mention  
**RADIO-ELECTRONICS**

CATALOG NO. 155

**Announcing THE NEW Miller TV COIL REPLACEMENT GUIDE**

**ASK YOUR JOBBER FOR YOUR COPY TODAY**  
 (Replacement Catalog No. 155)

THE MILLER EMBLEM — ASSURES THE FINEST IN RADIO AND TV REPLACEMENT COMPONENTS

For a Complete Listing of MILLER PRODUCTS Get Our Latest General Catalog.  
**J. W. MILLER COMPANY**  
 5917 South Main Street • Los Angeles 3, California



# RADIO SCHOOL DIRECTORY

## MORE JOBS

than graduates

Demand for our engineering graduates exceeds supply. *Effective placement.* Study in this world-famed college established 1884. Quarters start March, June, September, January.

### Bach. Sc. degree in 27 months

Complete Radio Eng. courses . . . TV, UHF and FM. Also Mech., Civil, Elec., Chem., Aero. and Adm. Eng.; Bus. Adm., Acct. Small classes. Well-equipped labs. Modest costs. Prep. courses. Write Jean McCarthy, Director of Admissions, for Catalog and Campus View Book.



## TRI-STATE COLLEGE

2415 College Avenue, Angola, Indiana

## Electronic Engineers

Excellent opportunity for professional growth and advancement. Interesting and advanced.

## F.C.C. LICENSE

Get your FCC commercial operator license quickly

We specialize in rapid and thorough preparation for FCC examinations. Correspondence or resident training. Results guaranteed. Write for free booklet.

### GRANTHAM School of Electronics

Dept. 101-C, 6064 Hollywood Blvd., Hollywood 28, Calif. (Phone HO 2-1411)

## GET INTO ELECTRONICS

You can enter this uncrowded, interesting field. Defense expansion, new developments demand trained specialists. Study all phases radio & electronics theory and practice: TV; FM; broadcasting; servicing; aviation, marine, police radio. 18-month course. Graduates in demand by major companies. B.S. or equivalent required. Begin Jan., March, June, Sept. Campus life. Write for catalog. VALPARAISO TECHNICAL INSTITUTE Dept. C Valparaiso, Ind.



## RADIO-TV ELECTRONICS



CREI graduates in big demand. ECPD-Accredited Technical Institute Curricula. New classes start monthly. Free placement service for grads. Courses: Radio Engineering, Broadcast or TV Engineering; TV, FM, AM servicing; resident studies leading to "Associate in Applied Science" degree. Write for free catalog. Approved for vets.

### CAPITOL RADIO ENGINEERING INSTITUTE

Dept. RE, 3224-16th St., N.W., Washington 10, D. C.

## RADIO ENGINEERING 27 MONTHS DEGREE

Intensive, specialized course including strong basis in mathematics and electrical engineering, advanced radio theory and design, television. Modern lab. Low tuition. Self-help opportunities. Also B.S. degree in 27 months in Aeronautical, Chemical, Civil, Electrical, and Mechanical Engineering. G.I. Gov't approved. Enter March, June, September, December. Catalog. INDIANA TECHNICAL COLLEGE

1512 E. Washington Blvd., Fort Wayne 2, Indiana

### CODE SENDING SPEED

Be a "key" man. Learn how to send and receive messages in code by telegraph and radio. Commerce needs thousands of men for jobs. Good pay, adventure, interesting work. Learn at home quickly through famous Candler System. Qualify for Amateur or Commercial License. Write for FREE BOOK. CANDLER SYSTEM CO. Dept. 3-A, Box 928, Denver 1, Colo., U.S.A.

## TELEVISION

PREPARE FOR A GOOD JOB!

BROADCAST ENGINEER  
ELECTRONICS  
RADIO SERVICING

### Television Servicing

(Approved for Veterans)

SEND FOR FREE LITERATURE

BALTIMORE TECHNICAL INSTITUTE  
1425 EUTAW PLACE, BALTIMORE 17, MD.



## TV REPAIRMEN EARN TOP MONEY!

IN JUST 12 MONTHS, COMPLETE TV SERVICE TRAINING, INCLUDING COLOR TV. Streamlined course gives you all essentials for a good job as service technician. Graduates in great demand; jobs are plentiful in this growing field. Other electronic courses in radio operation and maintenance. Day or evening classes. Opportunity for employment in local industry. Approved for Korean veterans.

Write for Catalog 111 Today

INDIANAPOLIS ELECTRONIC SCHOOL  
312 E. Washington, Indianapolis 4, Ind.



## RCA INSTITUTES, INC.

A service of Radio Corporation of America  
350 West 4th St., New York 14, N. Y.

OFFERS COURSES IN ALL TECHNICAL PHASES OF RADIO, TELEVISION, ELECTRONICS

Approved for Veterans

Write Dept. RE-55 for Catalog

## EARN MORE MONEY— BE A PROFESSIONAL TELEVISION SERVICE TECHNICIAN



GET DOWN-TO-EARTH PRACTICAL TV TRAINING WITH WTI EXPERTS FOR THE TOP PAYING \$5,000-\$10,000 PER YEAR JOBS.

### UHF—COLOR—VHF

Master the latest, up-to-the-minute TV and Color TV developments QUICKLY.

SEND FOR

FREE

BOOK TODAY!

WESTERN TV offers real experience on live equipment in our BIG SHOPS AND LABORATORIES in the shortest practical time under expert instructors. Graduates are in big demand because they have the "field experience" necessary for immediate "bench" or supervisory positions. You learn every phase of Radio and TV servicing (AM, FM, VHF, UHF). WTI men win fast promotion . . . can demand better pay . . . develop highly profitable businesses of their own with the latest and most PRACTICAL PERSONALIZED TRAINING BEHIND THEM. You concentrate all your time on being a PROFESSIONAL TV SERVICE TECHNICIAN — non-essential math and engineering theory omitted. YOU CAN EARN WHILE YOU LEARN. Special Finance Plan.

APPROVED FOR VETERANS. Find out how you can get into the TOP PAY GROUP — Send for this fact-packed book NOW!

### WESTERN TELEVISION INSTITUTE

America's Leading Television Servicing School

Western Television Institute Dept. E-Z-5  
341 W. 18th St., Los Angeles 15, Calif.  
Without obligation, please send FREE fully illustrated booklet. (No salesman will call.)

NAME \_\_\_\_\_ AGE \_\_\_\_\_  
ADDRESS \_\_\_\_\_  
CITY \_\_\_\_\_ ZONE \_\_\_\_\_ STATE \_\_\_\_\_

Become an

## ELECTRICAL ENGINEER

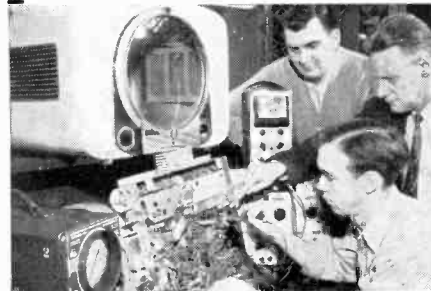

### Major in Electronics or Power BS Degree in 36 months

Prepare now for a career as an electrical engineer or engineering technician — and take advantage of the many opportunities in these expanding fields.

You can save a year by optional year 'round study. Previous military, academic, or practical training may be evaluated for advanced credit.

### Enter Radio and Television — courses 12 to 18 months

You can be a radio technician in 12 months. In an additional 6-months you can become a radio-television technician with Associate in Applied Science degree. Color television instruction is included in this program.

These technician courses may form the first third of the program leading to a degree in Electrical Engineering. Twenty-one subjects in electronics, electronic engineering and electronic design are included in these courses.

Courses also offered: radio-television service (12 mos.); electrical service (6 mos.); general preparatory (3 mos.).

Terms — April, July, September, January

Faculty of specialists. 50,000 former students—annual enrolment from 48 states, 23 foreign countries. Non-profit institution, 52nd year. Courses approved for veterans. Residence courses only.

MS-6A

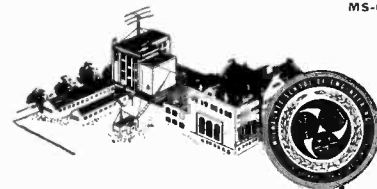

## MILWAUKEE SCHOOL OF ENGINEERING

MILWAUKEE SCHOOL OF ENGINEERING  
Dept. RE-155, 1025 N. Milwaukee Street  
Milwaukee 1, Wisconsin

Send FREE illustrated booklets

- Career in Electrical Engineering,  
 Career in Radio-Television.

I am interested in \_\_\_\_\_ (name of course)

Name \_\_\_\_\_ Age \_\_\_\_\_

Address \_\_\_\_\_

City \_\_\_\_\_ Zone \_\_\_\_\_ State \_\_\_\_\_

If veteran, indicate date of discharge \_\_\_\_\_

**TOP QUALITY TUBES ONE YEAR GUARANTEE** **BELOW MFRS' PRICES!**

We want your business now—and in the future too! That's why we carefully test every ELECTRON tube before shipping—then GUARANTEE it, not for 3 or 6 months, but FOR ONE FULL YEAR! More than 3000 different types, Receiving, Transmitting, Special Purpose Tubes in stock, in huge quantities, for immediate delivery! Individually boxed in handsome 3-color cartons.

Type	Price	Type	Price	Type	Price	Type	Price
0B2	.79	5V4	.82	6C4	.92	6S17	.50
0C3/VRI50	.98	5Y3GT	.89	6C7	.41	6SK7	.49
0D3/VRI50	.89	5Z3	.44	6C5	.39	6SL7GT	.59
0Z4	.54	6AR4	.51	6C6	.57	6SN7GT	.59
1A5GT	.43	6AC5GT	.99	6C8G	.85	6SQ7	.45
1A7	.53	6AC7	.72	6CB6	.97	6SR7	.45
1AX2	.59	6AF4	.89	6CD6	.59	6SS7	.60
1B3	.69	6AF6	.75	6CF6	.64	6T8	.79
1D6GT	.77	6AG5	.56				
1G6GT	.54	6AG7	.95				
1H5GT	.43	6AH6	.89				
1L4	.49	6AK5	.89				
1LA4	.59	6AJ5	.77				
1LA6	.79	6ALS	.41				
1L84	.79	6AL7	.89				
1LC5	.59	6AM8	.69				
1LDS	.52	6A05	.39				
1LE3	.78	6AR5	.45				
1LG5	.77	6AS5	.48				
1LNS	.57	6AT6	.41				
1PSGT	.56	6AUG	.46				
1Q5GT	.57	6AV6	.34				
1RS	.54	6AX4GT	.59				
1S4	.55	6B06	.56				
1S5	.55	6BA6	.39				
1T4	.55	6BC5	.54				
1U4	.39	6BD6	.49				
1U5	.49	6BE6	.48				
1V	.68	6BG6	1.24				
1V2	.50	6BH6	.48				
1X2A	.59	6BK7A	.69				
2X2	.39	6BL7GT	.89				
2X2A	1.85	6BN6	.79				
3A4	.44	6BQ6	.95				
3A5	.44	6BQ7A	.72				
3Q4	.55						
354	.56						
3V4	.58						
SU4G	.55						

**THIS MONTH'S SPECIALS**

Our GOODWILL OFFERING to you: Tube types shown in BOLDFACE at prices BELOW OUR OWN COST! Terrific saving—ORDER NOW!

6C56	.51	6U8	.79	7Z4	.49
6D6	.69	6V6GT	.41	10Y	.69
6D8G	.98	6W4GT	.39	12A6	.59
6F6	.45	6X4	.39	12A5	.49
6F8G	.69	6X5GT	.29	12A6	.35
6G6G	.65	6X8	.79	12A7	.68
6H6	.32	6Y4	.54	12A8	.49
6J5	.40	6Z4	.59	12A9	.45
6J6	.59	6Z5	.59	12AV6	.44
6K7	.39	6Z6	.59	12AV7	.72
6N7	.98	6Z7	.59	12AX4GT	.68
6P7	.49	6Z8	.59	12AX7	.53
6S7	.54	6Z9	.59	12AY7	.89
6S87Y	.89	6Z0	.59	12B6	.49
6S7	.79	6Z1	.59	12B7	.59
6S07GT	.38	6Z2	.59	12B8	.49
6S7	.45	6Z3	.59	12B9	.49
6S7GT	.49	6Z4	.59	12C6	.39
6S7	.59	6Z5	.59	12B7	.59
6S7GT	.45	6Z6	.59	12B7	.59
6S7	.79	6Z7	.59	12B7	.59
6S7GT	.49	6Z8	.59	12B7	.59
6S7	.60	6Z9	.59	12B7	.59
6S7GT	.50	6Z0	.59	12B7	.59

**EXPORT INQUIRIES INVITED!**  
New Complete Listing—Send For Free Copy!

**ELECTRON TUBE WHOLESALERS, INC.**  
140 DUANE STREET • NEW YORK 13, N. Y. • Phone: BArday 7-7616

**FREE OFFER!**  
7 Assorted 12, 7, 6, 1 and 2-volt type tubes. List Value \$23.00. FREE with every order for \$25.00 or more!

**Books**

TELEVISION, by V. K. Zworykin and G. A. Morton. John Wiley & Sons, Inc., 440 4th Ave., New York, N. Y. 6 x 9 inches, 1,037 pages. \$17.50.

The tremendous upsurge of television can be estimated by comparing this second edition with the original which appeared 14 years ago. Written primarily for engineers, the language (surprisingly enough) is such that it can be understood by persons at all technical levels. This is a refreshing departure from the average engineering textbook approach and, if encouraged, may start a trend toward understandable texts on advanced subjects.

Primarily, the job of the book is to tell you all you need know about television transmission and reception. It does much more than that since it covers such topics as fundamental physical principles, electron optics, fluorescent materials. Television transmission and reception are carefully detailed in chapters on high-definition pictures, video pickup devices, picture-reproducing systems, television pickup tubes, video amplifiers, scanning and synchronization. You will also find sections on the fundamentals of color television, as well as television in industry.

The book is conscientiously and thoroughly documented by bibliographical references at the end of each chapter. Not only are the latest developments listed, but the authors include material of historic interest. There is, for example, a section on mechanical scanning, an absorbing and useful introduction to modern electronic techniques.

While this book is extremely readable, its sheer volume is such that its greatest value will be as a reference source.—MC

DATA AND CIRCUITS OF TELEVISION RECEIVER VALVES (Book III C in the Electronic Valves series of Philips Technical Library), by J. Jager. Distributed in the U. S. A. by Elsevier Press, 155 E. 82nd St., New York, N. Y. 216 pages. \$4.50.

This book is essentially a tube manual covering the ten European vacuum tubes and two C-R tubes especially adapted to TV receivers. The tubes listed have RETMA equivalents.

The first chapter (145 pages) gives complete technical data on the tubes along with design data for many circuit applications. For example, the ECC81 (12AT7) includes complete design data for use as an r.f. amplifier

**NEW! EICO FLYBACK & YOKE TESTER KIT**

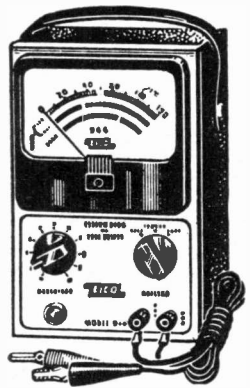

MODEL 944

Checks all flybacks & yokes instantly—in or out of set!

- Detects even 1 shorted turn!
- Exclusive separate calibration for air & iron-core flybacks for accurate testing of all types.
- Tests continuity of coils, speakers, switches, etc.
- Large 4 1/2" meter, 3 colored scales.
- Complete with easy instructions.
- Compact, rugged, smartly styled.

See it at your jobber today. Write for FREE Catalog CF-1 describing EICO's 38 Kits and 42 Wired Instruments. Prices 5% higher on West Coast.

**EICO** ELECTRONIC INSTRUMENT CO., Inc. 84 Withers Street, Brooklyn, N. Y. © 54

LOWEST PRICED KIT \$23.95 Wired \$34.95

**TELEVISION**

Big demand for graduates  
B.S. DEGREE IN 27 MONTHS in radio including TV engineering—VHF, UHF, AM and FM. Students use over \$100,000 worth of equipment including 2 large commercial type transmitters in new TV lab. Intense specialized course includes strong basis in mathematics, science and advanced design in radio and TV. Hundreds of young men each year are earning engineering degrees in this recognized institution. Start any quarter. Many earn a major part of expense in this industrial center. Low tuition. Competent instruction. Thorough, intense, practical program. Also B.S. DEGREE IN 27 MO. in Aeronautical, Chemical, Civil, Electrical and Mechanical Engineering. G.I. Gov't approved. Enter March, June, Sept., Dec. Free catalog. ENROLL NOW.

INDIANA TECHNICAL COLLEGE  
1715 E. Washington Blvd., Fort Wayne 2, Indiana

**FIGHT POLIO!**

prevention treatment

Join the MARCH OF DIMES

National Foundation for Infantile Paralysis

When answering advertisements please mention **RADIO-ELECTRONICS**

## TRANSISTORS: Theory and Application

Just Published!

Treats theory, practical applications and manufacture of transistors in a way useful to technicians, engineers, and advanced workers alike. Discusses both silicon and germanium transistors—how they work, how they are made, and how they are used—step-by-step from basic concepts to advanced topics. By A. Coblenz, Transistor Product Co., Boston, and H. L. Owens, Signal Corps Engineering Laboratories. 313 pp., 115 illus., \$6.00



## ACOUSTICS

A practical approach to better acoustics — for improved noise control, high fidelity music reproduction, and other applications. Uses the background of electrical engineers and communication physicists to solve a wide variety of acoustical problems. Discusses effects of sound in many aspects. By L. L. Beranek, Technical Dir., Acoustics Lab.,

M.I.T. 467 pages, 312 illus., \$9.00

## Principles of TELEVISION SERVICING

Step-by-step information on all types of commercial receivers—how to install, service, and repair them. Shows how to do most testing with just three pieces of equipment: vacuum-tube voltmeter, oscilloscope, and alignment generator. Dozens of troubleshooting charts . . . suggestions about going into a servicing business. By C. V. Rabinoff, Dean, and M. Wollbrecht, Vice Pres., American TV Laboratory of California, 560 pp., 475 illus., \$7.50



## UNDERSTANDING RADIO

Gives you complete introduction to practical radio—enabling you to handle radio apparatus understandingly, construct workable sets, and know the theory needed in following the more advanced literature and specialized training of radio operations. An amazingly clear, step-by-step treatment, excellently fitted for home-study use. By H. M. Watson, Consulting Radio Eng'r, H. E. Welch and G. S. Eby, Stockton College. 2nd Ed., 700 pp., 536 illus., \$6.50

## NATIONAL ELECTRICAL CODE HANDBOOK

Just Published—8th Edition!

Explains how to handle wiring and installation jobs in line with the 1953 National Electrical Code. Gives Code rules in simple, clear language—tells WHAT they mean, HOW to apply them. New form and typesetting make book much easier and quicker to use. Index lists Code Rules by job title for all types of electrical installation. By A. L. Abbott, Revised by C. L. Smith, Elec. Field En'r., Nat'l. Fire Protection Assn. 8th Ed., 642 pp., 394 illus., \$7.50

## 10-DAY FREE EXAMINATION

McGraw-Hill Book Co., Dept. RE-1  
330 W. 42, NYC 36

Send me book(s) checked below for 10 days' examination on approval. In 10 days I will remit for book(s) I keep, plus few cents for delivery, and return unwanted book(s) postpaid. (We pay for delivery if you remit with this coupon—same return privilege.)

- Coblenz & Owens—Transistor—\$6.00  
 Beranek—Acoustics—\$9.00  
 Rabinoff & Wollbrecht—TV Servicing—\$7.50  
 Watson, Welch & Eby—Understanding Radio—\$6.50  
 Abbott & Smith—Nat'l. Elec. Code Hndbk.—\$7.50

(Print)  
Name .....

Address .....

City ..... Zone ..... State.....

Company .....

Position .....

For price and terms outside U.S.  
write McGraw-Hill Int'l., N.Y.C.

RE-1

## BOOKS

(Continued)

in grounded-grid, grounded-cathode, cascode and mixer-oscillator circuits.

The section on the EF80 (6BX6) includes a considerable amount of valuable information on the design of 3- and 4-stage stagger-tuned i.f. amplifiers.

Equally useful and interesting are the data and notes on tubes that are equivalents of the 6AB8, 6BX6, 15A6, 16A5, 21A6, 19W3, 19Y3 and 6BE7. Design data and application notes include such sections of the TV receiver as phase detectors, deflection oscillators and sync circuits.

The second chapter is devoted to the intercarrier receiver and flywheel sync circuits. A number of unusual applications are discussed. Among them are a keyed sync separator operating as a pentode coincidence detector, the equivalent of a 6BE7 used as a multigrad phase detector and the same type tube used as a combination FM limiter and FM detector and squelch.

The final chapter is a complete component-by-component circuit analysis of a typical TV receiver using the tubes covered in the book.—RFS

**MINIATURE INTERMEDIATE-FREQUENCY AMPLIFIERS**, by Robert K-F Seal. (National Bureau of Standards Circular 548). U. S. Government Printing Office, Washington 25, D. C. 46 pages, 40c.

This booklet describes some of the work that has been done at the National Bureau of Standards in the development of miniaturization techniques for airborne electronic equipment. Details are given on three miniature high-gain, high-frequency (20- to 200-mc) i.f. amplifiers designed with emphasis on simplicity, circuit flexibility, ease of manufacture, and the use of subminiature tubes in low-noise input circuits.

**RELAYS FOR ELECTRONIC AND INDUSTRIAL CONTROL**, by R. C. Walker. Chapman & Hall, London, England. 303 pages, 42 shillings.

A handy reference guide for engineers, students, and experimenters interested in the principles and potentialities of the relay as a switching device. Text describes in detail the functions of all the many basic types of relays.

**TELEVISION RECEIVER DESIGN (Book VIII-A)**, by A. G. W. Uitjens, 177 pages, \$4.50; **(Book VIII-B)** by P. A. Neeteson, 156 pages, \$4.50. Published by Philips Technical Library, Eindhoven, Netherlands. Distributed in U. S. by Elsevier Book Co., New York City.

Book VIII-A, *I.F. Stages*, deals with the application of the pentode in the i.f. stages of superheterodyne and r.f. stages of t.r.f. TV receivers. Book VIII-B, *Flywheel Synchronization of Sawtooth Generators*, analyzes the flywheel action of resonant circuits and discusses in detail automatic phase control as applied to TV deflection oscillators.

END

# INTERNATIONAL

# Selenium Rectifiers

for  
TV  
RADIO  
Replacement

the  
Replacement  
Rectifier  
that's Right!

all types  
available  
from your  
parts distributor

## INTERNATIONAL RECTIFIER

CORPORATION

El Segundo, Calif.

NEW YORK

ORegon 8-6281

CHICAGO

World's Largest Supplier of  
Quality Industrial Rectifiers

from **TELEMATIC INDUSTRIES INCORPORATED**

**TOP VALUE**  
in Antenna Switches at

L-O-W  
L-O-W  
Price

\$2.00  
list



**Model AS-46**  
Matched two-position  
(300 ohm) Switch  
Tops in performance

It's TELEMATIC for the Most  
Complete Line in Antenna Switches

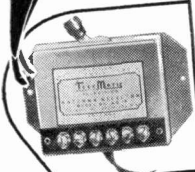

**Model AS-18**  
Three-Position  
(300 ohm)  
Impedance matched.  
Low-Loss Antenna  
Switch

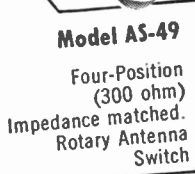

**Model AS-49**  
Four-Position  
(300 ohm)  
Impedance matched.  
Rotary Antenna  
Switch

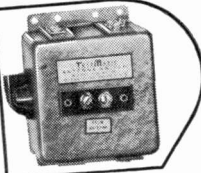

**Model AS-47**  
Three-Position  
(72 ohm) Antenna,  
Phono, Audio and  
Microphone Switch

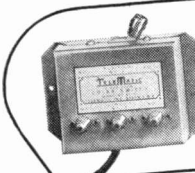

**Model AS-48**  
Two-Position Co-Ax  
Switch for Antenna,  
Phono, or Micro-  
phone, etc.

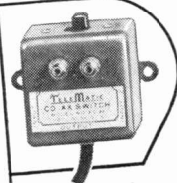

Prices slightly  
higher west  
of the Rockies



16 Howard Ave., Brooklyn 21, N.Y.

Write for catalog.

**ADVERTISING INDEX**

Radio-Electronics does not assume responsibility for any errors appearing in the index below.

Alliance Mfg. Co.	163
Allied Radio Corp.	15
Almo Radio Co.	126
American Phenolic Corp.	138
Amplifier Corporation of America	167
Approved Electronic Instrument Corp.	164
Arky Radio Kits, Inc.	179
Astron Corp.	30
Atlas Sound Corp.	156
Audel Publishers	112
Barry Electronics Corp.	184
Bell Telephone Labs.	148
Bjonder Tongue Labs.	105
Bland & Boyce, Inc.	14
Book of the Month Club	13
Brach Mfg. Co.	157
Brooks Radio & TV Corp.	150
Burstein Applebee Co.	130
CBS Hytron (Div. of Columbia Broadcasting System)	117
Capitol Radio Engineering Institute	113, 114
Channel Master Corp.	20, 21
Chicago Standard Transformer Corp.	130
Cisin, H. G.	134
Clarostat Mfg. Co.	17
Cleveland Institute of Radio-Electronics	11
Colling Audio Products Co.	165
Commissioned Electronics Co.	164
Concord Radio	170
Cornell-Dubilier Electric Corp.	172
Coyne Electrical & TV Radio School	25, 149
DeCray, Frank W.	177
DeVry Technical Institute	7
DuMont, Allen B., Labs.	Inside Front Cover
Dun & Bradstreet	3
Edie Electronics	175
Electric Soldering Iron Co.	101
Electro Products Laboratories	112
Electro-Voice, Inc.	Inside Back Cover
Electron Tube Wholesalers	182
Electronic Instrument Co. (EICO)	32, 151, 167, 182
Electronic Measurements Corp.	146
Eric Resistor Corp.	170
E-Z Way Towers, Inc.	171
Fenton Company	174
Finney Company	147
Franklin Electronics	110
General Test Equipment	174
Grantham School of Electronics	178
Hallicrafters Co.	154, 156, 158
Hawkins Co., P.E.	126
Heath Co.	87-98
Hershel Radio Co.	178
Hickok Electrical Instrument Co.	154
Hudson Specialties Co.	175
Hughes Research & Development Labs.	10, 104
Hycon Mfg. Co.	104
Indiana Technical College	182
Instructograph Co.	174
International Rectifier Corp.	183
JFD Mfg. Co., Inc.	102, 103
Jackson Electrical Instrument Co.	144
Jensen Industries	162
Jerrod Electronics Corp.	139
Kay-Townes Antenna Corp.	132, 133
Lafayette Radio Corp.	159
Leotone Radio Corp.	134
Macmillan Co., The	177
Malloy & Co., Inc.	171
McGraw-Hill Book Co.	183
Merit Coil & Transformer Co.	155
Metroplex Electronics & Instrument Co.	177, 180
Miller, J. W. Co.	112
Mosley Electronics	9
Moss Electronic Distributing	140, 141
Musical Masterpiece Society, Inc.	180
National Electronics of Cleveland	185
National Radio Institute	27, 28, 185
National Schools	5
Newark Electric Co.	134
Norman Electronics	174
Perma-Power Co.	160
Permoflux Corp.	153
Phaestron Co.	166
Pickering Co.	107
Precision Apparatus Co., Inc.	124
Precision Electronics	122
Precise Development Corp.	122
Prentice Hall, Inc.	158
Progressive "Edu-Kits", Inc.	124
Quam-Nichols Co.	101
Quietrol Co.	101
RCA Institutes, Inc.	31
RCA Service Company	179
RCA Victor Div. (Radio Corp. of America)	22, Back Cover
Rad-Tel Tube Co.	168
Radiart Corp.	24
Radio City Products	152
Radio Receiver, Inc.	142
Radio Television Training Association	23
Ration Corporation	166
Raytheon Mfg. Co.	19
Regency Division (I.D.E.A.)	151
Rinehart & Co., Inc.	101, 110, 120, 125, 156
Rohn Mfg. Co.	8
S & A Electronics	158
Sams & Co., Inc., Howard W.	14
Shure Brothers, Inc.	118
Simpson Electric Co.	127
Sonotone Corp.	18
Sprague Products Co.	109
Sprayberry Academy of Radio	85
Stan-Burr Radio & Electronics	130
Steve-EI Electronics Corp.	161
Superec Electronics	169
Supreme Publications	169
Sylvania Electric Products, Inc.	145
T. V. Products Co.	155
Tab	186
Tarzian, Sarkes, Corp.	111
Techmaster	167
Technical Appliance Co.	173
Telex, Inc.	184
Teltron Electric Co.	176
Transamerica Electronics	162
Transvision, Inc.	136, 164, 177
Trio Mfg. Co.	43
Tung-Sol Electric Co.	6
Turner Co.	110
United Catalog Publishers	171
University Loud Speakers, Inc.	126
V. A. Enterprises	168
Vidair Electronics Mfg. Corp.	171
Video Electric Co.	172
Weston Electrical Instrument Co.	29
Wholesale Radio Parts Company	162
Winegard Co.	16, 121
Zingo Products	126

**RADIO SCHOOL DIRECTORY PAGE 181**

Baltimore Technical Institute	152
Candler System Co.	142
Capitol Radio Engineering Institute	23
Grantham School of Electronics	166
Indiana Technical College	166
Indianapolis Electronic School	19
Milwaukee School of Engineering	151
RCA Institutes, Inc.	101, 110, 120, 125, 156
Tri-State College	8
Valparaiso Technical Institute	158
Western Television Institute	14
Radio City Products	118
Sams & Co., Inc., Howard W.	127
Shure Brothers, Inc.	108
Simpson Electric Co.	109
Sonotone Corp.	85
Sprague Products Co.	130
Sprayberry Academy of Radio	161
Stan-Burr Radio & Electronics	169
Steve-EI Electronics Corp.	169
Superec Electronics	145
Supreme Publications	155
Sylvania Electric Products, Inc.	186
T. V. Products Co.	111
Tab	167
Tarzian, Sarkes, Corp.	173
Techmaster	184
Technical Appliance Co.	176
Telex, Inc.	162
Teltron Electric Co.	136, 164, 177
Transamerica Electronics	43
Transvision, Inc.	6
Trio Mfg. Co.	110
Tung-Sol Electric Co.	171
Turner Co.	126
United Catalog Publishers	168
University Loud Speakers, Inc.	171
V. A. Enterprises	172
Vidair Electronics Mfg. Corp.	29
Video Electric Co.	162
Weston Electrical Instrument Co.	162
Wholesale Radio Parts Company	16, 121
Winegard Co.	126
Zingo Products	126

**STANDARD BRAND TUBES**  
"AT THE NEW LOW PRICES"

- Individually boxed.
- Only 1st quality.
- Latest Dating—
- No private label, electrical or mechanical rejects.
- No rebrands or rewashed "bargains."

Write for Free 1955 New Air-Mail Handy-Order Blank.

- Lists ALL Popular TV & Radio Types.
- Makes Mail-Order a Pleasure.
- All Tube Orders Over \$25.00 (with Remittance) Postpaid.

**SPECIAL-PURPOSE TUBES**

Write for our complete listing on XMTG, Industrial, Special-Purpose and Crystal Diodes. We stock over 2,000 types at excellent prices.

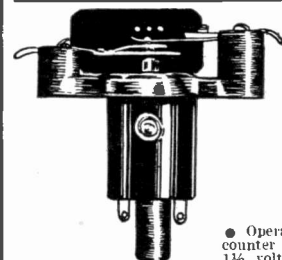

**Miniature High-Voltage Converter for Geiger Counter**

Operate your geiger counter from standard 1 1/2 volt flash-light cells. This compact powerful unit converts regular battery voltage to 900 volts for direct operation of geiger counter tubes. Actual range of output is 0 to 7,000 Volts AC (easily rectified and regulated with circuits supplied) so that any type of geiger counter or photo multiplier tube can be operated from unit. Weighs only 3 ounces and small enough to fit in the palm of your hand. Unit ready to operate—factory tested.

**Model 10MVT**.....\$10.00 each with instructions

New! Sensitive Geiger-Mueller Counter... contains 2 subminiature tubes, Victoreen 1B85 plus hi-voltage converter described above. Sensitive 3/4" microammeter. Strictly a sensitive, deluxe unit. Measures 5 1/2" W x 7 1/2" H x 3" deep. Manufactured by Kaybar Mfg. Co. in kit form.....\$69.75 Wired & factory tested.....\$84.75

Victoreen Voltage Regulator VKR-130, subminiature. Brand New. Users net cost.....\$75

**100 Amp (Fan Cooled)**

**SELENIUM RECTIFIER STACK**

Input: Up to 10—10 V.A.C.  
Output: 7 1/2 V.D.C.

This rectifier will handle 50 amps, convection cooled or up to 150 amps, fan cooled, depending on air flow. \$11.98 apiece. In lots of 3 or more \$11 each

**TRANSFORMERS AND FAST CHARGER STACKS**  
MADE TO ORDER—48 HOUR SERVICE  
Time-proven Directron selenium rectifiers now available to Radio-Electronics readers exclusively by Barry only! Continuously improved—same low prices. Immediate delivery. Also in stock matched rectifier transformer, chokes, & capacitors. Write or call!  
In 5 minutes you can install new type rectifier to convert 6 volt fast chargers into unit which will charge both 6 volt batteries up to 100 Amps. and the new 12 volt batteries up to 50 Amps. Rectifier with details only \$24.00 net. (Specify make and model of battery charger).

**Meteorological Transmitter**

Type T-49C. Uses RCA 3A5. Complete with tube, antenna, battery harness. Brand New Only \$1.75

**SUPER SPECIAL!**

**3000 Volts DC—330 Ma. BASIC COMPONENT KW POWER SUPPLY KIT**

Contains:  
● 350V V. AC. XFMR @ 400 MA. Primary—115 V., 60 cy.  
● 400 Ma. Matched Smoothing Choke.  
● 115 Volts Primary Bridge Filament for Four 866-A's.

Complete only \$39.95

Also These Individual Components for Sale—Write

**3,000 VOLT POCKET MULTITESTER**

AC: 0-15, 150, 750, 3000 volts.  
DC: 0-15, 75, 300, 750, 3000 volts.  
DC MA: 0-3, 350 ma.  
Resistance: 0-10,000, 100,000 ohms.  
Complete with battery, test leads. Only 3 1/2" W x 3 1/4" H x 1 3/4" deep. Brand New @ only \$9.95.

**TWO-COLORED TUBE CARTONS**, with new Safety Partitions. Prevents Tube Breakage. This Super-Gloss Red and Black Carton is the Most Distinctive Box Available Today! Minimum: 100 any one size. Quantity prices on request. Boxes F.O.B., N.Y., N.Y.

SIZE Miniature.....(6AU6, 6AL5, etc.).....\$0.1  
GT.....(6SN7, 6W4, etc.).....\$0.125  
LARGE GT.....(183, 6B06GT, etc.).....\$0.15  
LARGE G.....(5U4G, 6B6GG, etc.).....\$0.2

Terms: 25% with order, balance C.O.D. All merchandise guaranteed, F.O.B., N.Y.C.

New phone and address Phone: Walker 5-7000.

**BARRY ELECTRONICS CORP.**  
512 Broadway N.Y. 12, N.Y.

# Here's a NEW Way to Reach the Top in TV SERVICING

**All-practice method—  
professional techniques,  
skills, knowledge of  
circuits, etc.**



**Includes 17" picture tube, all other  
tubes, components for a TV Receiver,  
Scope, Signal Generator, HF Probe.  
Low Introductory price under \$200,  
on easy terms. Mail Coupon today.**

**I**F YOU HAVE some Radio or Television experience, or if you know basic Radio-Television principles but lack experience—NRI's new Professional Television Servicing course can train you to go places in TV servicing. This advertisement is your personal invitation to get a free copy of our booklet which describes this training in detail.

### **LEARN-BY-DOING "ALL THE WAY"**

This is 100% learn-by-doing, practical training. We supply all the components, all tubes, including a 17-inch picture tube, and comprehensive manuals covering a thoroughly planned program of practice. You learn how experts diagnose TV receiver defects quickly. You see how various defects affect the performance of a TV receiver—picture and sound; learn to know the causes of defects, accurately, easily, and how to fix them. You do more than just build circuits. You get practice recognizing, isolating, and fixing innumerable TV receiver troubles.

You get actual experience aligning TV receivers, diagnosing the causes of complaints from scope patterns, eliminating interference, using germanium crystals to rectify the TV picture signal, obtaining maximum brightness and definition by properly adjusting the ion trap and centering magnets, etc. There isn't room on this or even several pages of this magazine to list all the servicing experience you get.

### **UHF AND COLOR TV MAKING NEW BOOM**

Installing front-end channel selector strips in modern UHF-VHF Television receivers and learning UHF servicing problems and their solution is part of the practice you get if you live in a UHF area. To cash in on the coming color TV boom you'll need the kind of knowledge and experience which this training gives.

### **GET DETAILS OF NEW COURSE FREE**

Once again—if you want to go places in TV servicing, we invite you to find out what you get, what you practice, what you learn from NRI's new course in Professional Television Servicing. See pictures of equipment supplied, read what you practice. Judge for yourself whether this training will further your ambition to reach the top in TV servicing. We believe it will. We believe many of tomorrow's top TV servicemen will be graduates of this training. Mailing the coupon involves no obligation.

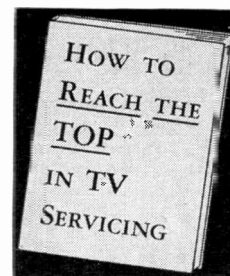

**National Radio Institute, Dept. 5AFT  
16th and U Sts., N.W., Washington 9, D. C.**

Please send my FREE copy of "How to Reach the Top in TV Servicing." I understand no salesman will call.

Name \_\_\_\_\_ Age \_\_\_\_\_

Address \_\_\_\_\_

City \_\_\_\_\_ Zone \_\_\_\_\_ State \_\_\_\_\_



**NOW—Better  
choice than ever!  
—in CRYSTAL  
MICROPHONES**



**NEW  
MODEL 924**

Unique crystal Lavalier for chest or hand use. Supplied with neck cord, support clips and 18' cable. Output —60 db. Response 70-8,000 cps. For home recording, paging, PA and amateur radio. Pressure cast case in lustrous satin chrome finish. Wire-mesh head acoustically treated for wind and moisture protection. Hi-Z. Size 3-5/32" x 1-7/32".  
Net wt. 8 oz. List Price \$18.00



**Model 915 CENTURY**

Most popular microphone ever produced! Stands by itself. Fits in hand or on stand. Smooth response 60-7000 cps. Output —50 db. AC-DC Insulated. Moisture-sealed crystal. Satin Chromium finish. Hi-Z.  
Model 915. List Price \$11.25  
Model 915-S. With switch. List \$13.00

**NEW "926"**



**E-V QUALITY, AT LOW COST  
—IN NEW SLIM DESIGN**

The "926" crystal microphone combines handsome new styling with E-V quality features! Designed for public address, tape recording and communications. Frequency response is smooth, peak-free 70-8000 cps. Output level—60 db. Omnidirectional. Hi-Z. Moisture-sealed crystal. 3/8"-27 thread stand coupler. Die cast case, finished in Satin Chromium. Size 1 1/16 x 6 3/4" including swivel mount. 18 ft. cable. Net wt. 11 oz.

Model 926. List Price \$24.50

With two brand new models, *E-V* again sets the pace in crystal microphones! This 1954 line makes selection easier, more complete... assures top performance... provides maximum value. Each has the advantage of E-V research-engineering, precision manufacturing and quality control. Each is styled to suit individual taste and purpose. Each offers smooth, clear reproduction of voice and music—and high output—for public address and paging, for amateur communications, for improved home tape recording. Write for full information.

**Electro-Voice**

**ELECTRO-VOICE, INC. • BUCHANAN, MICH.**

Export: 13 E. 40th St., N.Y. 16, U.S.A. Cables: Arlab

Licensed under Patents of the Brush Development Co. E-V Pat. Pend.

**Model 920 SPHEREX**

All-direction pick-up for round-table conferences, home recording and public address. Response 60-7000 cps. Output level —50 db. Omnidirectional. Acoustic filter protects against wind and breath blasts. Moisture-sealed crystal. Hi-Z. Satin Chromium finish.

Model 920. List \$22.50



**Model 911 MERCURY**

Smartly designed for general-purpose use. Response 50-8000 cps. Output —50 db. Omnidirectional. Metal Seal crystal. Hi-Z. Tilttable head. "On-Off" switch. Built-in cable connector. 5/8"-27 thread. Satin Chromium finish. 6 ft. and 18 ft. cable.

Model 911-8. List \$25.50  
Model 911-20. List \$27.50

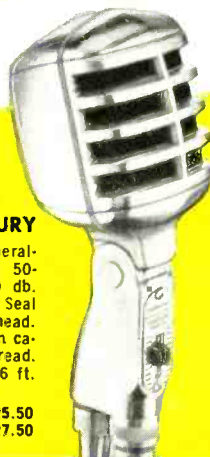

**Model 950 CARDAX**

World's favorite high level crystal cardioid\* with dual frequency response for high fidelity sound pick-up or for extra crispness of speech. Reduces feedback and background noise. Metal Seal Crystal. Hi-Z. "On-Off" switch. 5/8"-27 thread. Tilttable head. Satin Chromium finish. 18 ft. cable.

Model 950. List \$42.50



\* E-V Pat. 2,627,558

# GET BETTER PERFORMANCE From TV-Deflection and High-Voltage Circuits . . .



Use **RCA TUBES**... with built-in quality!

Better performance and longer life are *built into* each RCA Tube. In TV Deflection and High-Voltage Circuits, RCA Tubes operate with high efficiency. That's because rigid structural specifications help them to deliver the required currents or to withstand the high voltages. For instance, on the new RCA 6BQ6GT/6CU6 striking structural changes have produced a decidedly uniform temperature radiation and new cathode material assures greater reliability. You get greater deflection and higher efficiency. RCA's severe dynamic life tests simulate actual operating conditions and help assure you better-performing, long-life tubes.



When you replace with RCA Tubes, your customers are sure of dependable performance. Insist on genuine RCA Tubes for all your service work!



**RADIO CORPORATION of AMERICA**  
ELECTRON TUBES

HARRISON, N. J.

First Choice for TV circuits . . . dependable RCA Tubes!