

APRIL 1954

RADIO - ELECTRONICS

TELEVISION • SERVICING • HIGH FIDELITY

HUGO GERNSBACK, Editor

In this issue:

Killing TV
Alignment Bugs

RADIO-ELECTRONICS
Golden Ear
Amplifier

Installing
Marine
Radiotelephones

Regenerative
Transistor
Receiver



35¢

U. S. and
CANADA

Adjusting an Experimental Color TV Receiver

(See page 4)

\$5000

IN PRIZES

... easy to win

503

PRIZES!

\$2000 - 1st prize

\$500 - 2nd prize,

\$100 - 3rd prize

100 - \$10 prizes,

400 - \$5 prizes

HOW TO WIN

To win one of these 503 prizes all you have to do is complete in 25 words or less "I like Pyramid capacitors because_____." You fill in this statement on a Pyramid contest entry blank which can be obtained from any electronic parts jobber selling Pyramid capacitors. You have this entry blank countersigned by your jobber or one of his salesmen and forward it to us attached to a Pyramid Dry Electrolytic Capacitor box top—the top being the part which carries the description of the item. There is no limit to the number of entries which you may make in this contest but each entry must be accompanied by a box top. Full rules for the contest appear on the entry blank.

It's so easy. Here is the kind of statement that might win:

"I like Pyramid capacitors because they always check out perfectly and don't deteriorate and so I know I won't have to call back at my expense."

"I like Pyramid capacitors because the line is so complete that I can always get what I need and don't have to worry about an off-brand capacitor."

PYRAMID



PYRAMID FEATURES:

- ① Only one quality—the best at no premium. All Pyramid capacitors are made of materials commanded by rigid military specifications.
- ② All Pyramid capacitors are non-hygroscopic.
- ③ Highest quality insulator material used in all production results in low leakage factor.
- ④ Exclusive non-contamination technique guarantees close tolerances and no deterioration. Peak performances for life.
- ⑤ Pyramid capacitors operate unchanged at ambient temperature of 85° centigrade.
- ⑥ Designed by service technicians across the country for their requirements.
- ⑦ Individually packaged for protection.
- ⑧ Permanently legible, high visibility ratings on each item.
- ⑨ 100% absolute electronic inspection before shipment.

Pyramid is in its 10th year as a leading manufacturer of high-quality capacitors.

PYRAMID ELECTRIC COMPANY

1445 HUDSON BOULEVARD
NORTH BERGEN, N. J.



You Build THIS TRANSMITTER
with Parts I Send



I WILL TRAIN YOU FOR YOUR FCC LICENSE

LEARN COMMUNICATIONS by Practicing at Home in Spare Time

Use parts I send for Actual Experience

My Training Leads to Jobs Like These

BROADCASTING: Chief Technician, Chief Operator, Power Monitor, Remote Control Operator. **SHIP AND HARBOR RADIO:** Chief Operator, Radiotelephone Operator. **GOVERNMENT RADIO:** Operator in Army, Navy, Coast Guard, Forestry Service Dispatcher. **POLICE RADIO:** Transmitter Operator, Service Technician. **AVIATION RADIO:** Plane Radio Operator, Airport Transmitter Operator. **TELEVISION:** Pickup Operator, Voice Transmitter Operator, TV Technician.



The Communication Course I offer you is backed by NRI's 40 year record of training men at home. My well-illustrated lessons give you the basic principles you must have to assure success. My skillfully developed kits "bring to life" what you learn from my lessons, give you practical experience on circuits common to BOTH Radio and Television. You build the low-power Broadcasting Transmitter shown above (at left). You put this station "on the air," and conduct procedures required of Broadcasting Station operators. My book shows other valuable equipment you build and keep.

mitter Operators, Remote Control Operators, Service and Maintenance Technicians, etc. Mail Coupon. Find out, without obligation, what I offer. NRI training can assure you more of the better things of life; can help you qualify for high pay and promotion when times are good, enjoy greater security when jobs are scarce. Progressive, ambitious men consider Radio-TV an outstanding field for their life's work. My 64-page book, "How to Be a Success in Radio-Television," gives important facts about America's fast growing industry, details of job opportunities, tells about kits I furnish for practical experience, shows what my graduates are doing and earning. You don't have to leave home or give up your job to take NRI courses. You learn at home in your spare time, at low cost, on terms as low as \$5 a month. Many of my graduates make more than the total cost of my training in just two weeks. Mail coupon now. J. E. SMITH, President, National Radio Institute, Dept. 4D-F, Washington 9, D. C. OUR 40th YEAR.



J. E. SMITH
PRESIDENT,
National Radio Institute
For 40 years, the leader in training men at home.

I TRAINED THESE MEN AT HOME

"Am employed as transmitter engineer-studio operator at KPAT. Most important day of my life was when I enrolled with NRI."—Elmer Frewaldt, Madison, S. Dak.

"A former employer recommended National Radio Institute training to me. Now employed as transmitter operator in Harrisburg."—Albert Herr, New Cumberland, Pa.

"Am with WCOC. Happy with my job. NRI course can't be beat. Fassed exam for 1st class Radio-phone license with no trouble."—Jesse W. Parker, Meridian, Miss.

"I did not know a thing about Radio before I enrolled for your training. Now I have a job as Studio Engineer at Radio Station KMMJ."—Bill Delzell, Central City, Nebr.

"My position with WNBT is video control engineer on the RCA color project. I owe a lot of my success to your textbooks."—Warren Deem, Malverne, N. Y.

Television's Rapid Growth Making Good Jobs, Prosperity

Radio is bigger than ever with over 3000 Broadcasting Stations on the air making good jobs for Chief Operators, Recording and Remote Control Operators, Power Monitors, Technicians, etc. Now there's Television, too. About 200 TV Stations are on the air with many more being built, construction of hundreds of additional stations authorized, and new TV Station applications being filed every month. Think of the demand this is creating from coast to coast for Pickup and Voice Trans-

AVAILABLE TO VETERANS UNDER G.I. BILLS

I Also Have a Course in Radio-TV SERVICING



If you prefer a career in Radio-Television Servicing, I'll train you at home for it. Course includes many Kits of parts. My book shows that many make \$10, \$15 a week EXTRA fixing sets while training.

Send for **FREE 64Pg. Book**

Mr. J. E. SMITH, President, Dept. 4DF
National Radio Institute, Washington 9, D. C.

Mail me 64-page Book FREE. (No salesman will call. Please write plainly.)

Name.....Age.....

Address.....

City.....Zone.....State.....

VETS write in date of discharge

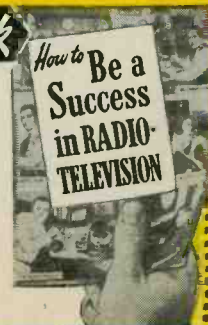

RADIO - ELECTRONICS

Formerly RADIO-CRAFT • Incorporating SHORT WAVE CRAFT • TELEVISION NEWS • RADIO & TELEVISION

Hugo Gernsback
Editor and Publisher

M. Harvey Gernsback
Editorial Director

Fred Shunaman
Managing Editor

Robert F. Scott
W2PWG, Technical Editor

Jerome Kass
Associate Editor

I. Queen
Editorial Associate

Matthew Mandl
Television Consultant

Charles A. Phelps
Copy Editor

Angie Pascale
Production Manager

Wm. Lyon McLaughlin
Tech. Illustration Director

Sol Ehrlich
Art Director

Lee Robinson
General Manager

John J. Lamson
Sales Manager

G. Aliquo
Circulation Manager

Adam J. Smith
Director, Newsstand Sales

Robert Fallath
Promotion Manager



Member
Magazine Publishers
Association

ON THE COVER: *Du Mont* research engineers adjusting a developmental color television monitor receiver. The pattern on the receiver screen consists of the primary colors and their complements, in the form of vertical bars. This color-bar pattern is generated electronically, and is used to check and adjust the chrominance circuits of color receivers.

Color original
courtesy Allen B. Du Mont Labs.

CONTENTS

APRIL, 1954

Editorial (Page 31)

Specialization by Hugo Gernsback 31

Television (Pages 32-47)

Killing Those Alignment Bugs
by the Engineering Staff, Scala Radio Company 32

Noise-Free Sync Circuits by Robert F. Scott 35

Basic Color TV, Part IV (First half—Elimination of Interference)
by D. Newman and J. J. Roche 37

Key to Keyed A.G.C. by Wayne E. Lemons 39

Television—it's a Cinch, (Ninth Conversation, 2nd half—The iconoscope,
image orthicon, electron multipliers) by E. Aisberg 41

V.H.F. Comes to a U.H.F. Area by Charles F. Mahler, Jr. 44

TV Service Clinic by Matthew Mandl 46

TV dx. April-June 47

Electronics (Pages 48-49)

The Cosmic Generator by Mohammed Ulysses Fips, I.R.E. 48

Audio—High Fidelity (Pages 50-66)

Milady's Golden Ear Amplifier by Joseph Marshall 50

Ground Loops and Hum by Hector E. French 56

Servicing High-Fidelity Audio Equipment, Part III—Measurements and
Equipment by Joseph Marshall 58

High-Fidelity Loudspeakers, Part II—Mechanical and Electrical Features of
Voice Coil Design by H. A. Hartley 60

High-Quality Audio, Part VIII—High-Quality Tuners .. by Richard H. Darf 63

Radio (Pages 71-101)

Transistor Regenerative Receiver by Edwin Bohr 71

Installing Marine Radio by Elbert Robberson 78

A Few Unusual Service Cases 91

Radio 35 Years Ago 96

Transistor Oscillator Produces Subharmonics by I. Queen 97

Departments

| | | | | | |
|-----------------|-----|------------------|-----|--------------|-----|
| The Radio Month | 6 | Radio-Electronic | | With The | |
| Correspondence | 12 | Circuits | 110 | Technician | 118 |
| Business | 14 | Try This One | 112 | People | 121 |
| New Devices | 103 | Question Box | 114 | Electronic | |
| New Patents | 108 | Technotes | 116 | Literature | 124 |
| | | | | Book Reviews | 126 |



MEMBER Audit Bureau of Circulations

Average Paid Circulation over 169,000

Vol. XXV, No. 4

RADIO-ELECTRONICS, April, 1954, Vol. XXV, No. 4. Published monthly at Erie Ave., F to G Sts., Philadelphia 32, Pa., Gernsback Publications, Inc. Entered as Second Class matter September 27, 1948, at the Post Office at Philadelphia, Pa., under the Act of March 3, 1879. Copyright 1954 by Gernsback Publications, Inc. Text and Illustrations must not be reproduced without permission of copyright owners.

EXECUTIVE, EDITORIAL and ADVERTISING OFFICES: 25 West Broadway, New York 7, N. Y. Telephone REctor 2-8630. Gernsback Publications, Inc. Hugo Gernsback, President, M. Harvey Gernsback, Vice-President, G. Aliquo, Secretary.

SUBSCRIPTIONS: Address correspondence to Radio-Electronics, Subscription Dept., Erie Avenue, F to G Sts., Philadelphia 32, Pa., or 25 West Broadway, New York 7, N. Y. When ordering a change please furnish an address stencil impression from a recent wrapper. Allow one month for change of address.

SUBSCRIPTION RATES: In U. S. and Canada, and in U. S. possessions, \$3.50 for one year; \$6.00 for two years; \$8.00 for three years; single copies 35¢. All other foreign countries \$4.50 a year; \$8.00 for two years; \$11.00 for three years.

BRANCH ADVERTISING OFFICES: Chicago: 7522 North Sheridan Road, Tel. Rogers Park 4-8000. Los Angeles: Ralph W. Harker and Associates, 1127 Wilshire Blvd. Tel. MAdison 6-1271. San Francisco: Ralph W. Harker and Associates, 582 Market St., Tel. GARfield 1-2481. **FOREIGN AGENTS:** Great Britain: Atlas Publishing and Distributing Co., Ltd., London E.C.4. Australia: McGill's Agency, Melbourne. France: Brentano's, Paris 2e. Belgium: Agence et Messageries de la Presse, Brussels. Holland: Trilectron, Heemstede. Greece: International Book & News Agency, Athens. S. Africa: Central News Agency Ltd., Johannesburg; Capetown, Durban, Natal. Universal Book Agency, Johannesburg. Middle East: Stelmatsky Middle East Agency, Jerusalem, India: Broadway News Centre, Dadar, Bombay #14. Pakistan: Paradise Book Stall, Karachi 3. **POSTMASTER:** If undeliverable send form 3578 to: RADIO-ELECTRONICS, 25 West Broadway, New York 7, N. Y. *Trademark registered U.S. Patent Office.

RADIO-ELECTRONICS

ADVANCE! Raise your earning power—learn RADIO-TELEVISION-ELECTRONICS by SHOP-METHOD HOME TRAINING

GOOD JOBS AWAIT THE TRAINED RADIO-TV TECHNICIAN

There is a place for *you* in the great Radio-Television-Electronics industry when you are trained as National Schools will train you at home!

Trained technicians are in growing demand at good pay—in manufacturing, broadcasting, television, communications, radar, research laboratories, home Radio-TV service, and other branches of the field. National Schools Master Shop-Method Home Training, with newly added lessons and equipment, trains you in your spare time, right in your own home, for these fascinating opportunities. **OUR METHOD IS PROVED BY THE SUCCESS OF NATIONAL SCHOOLS TRAINED MEN, ALL OVER THE WORLD, SINCE 1905.**

EARN WHILE YOU LEARN

Many National students pay for all or part of their training with spare time earnings. We'll show you how you can do the same! Early in your training, you receive "Spare-time Work" Lessons which will enable you to earn extra money servicing neighbors' and friends' Radio and Television receivers, appliances, etc.



Signal Generator



T. R. F. Receiver

Audio Oscillator

National Schools Training is All-Embracing

National Schools prepares you for your choice of many job opportunities. Thousands of home, portable, and auto radios are being sold daily—more than ever before. Television is sweeping the country, too. Co-axial cables are now bringing Television to more cities, towns, and farms every day! National Schools' *complete* training program qualifies you in all fields. Read this partial list of opportunities for trained technicians:

- Business of Your Own • Broadcasting
- Radio Manufacturing, Sales, Service • Telecasting
- Television Manufacturing, Sales, Service
- Laboratories: Installation, Maintenance of Electronic Equipment
- Electrolysis, Call Systems
- Garages: Auto Radio Sales, Service
- Sound Systems and Telephone Companies, Engineering Firms
- Theatre Sound Systems, Police Radio
- And scores of other good jobs in many related fields.

TELEVISION TRAINING

You get a complete series of up-to-the-minute lessons covering all phases of repairing, servicing and construction. The same lesson texts used by resident students in our modern and complete Television broadcast studios, laboratories and classrooms!



MASTER ALL PHASES!

Get Master Shop-Method Home Training from an Established Practical Resident School with its own Training Shops, Laboratories, Studios — almost 50 Years of Successful Experience in Training Ambitious Men.

We Bring National Schools To You!



You also receive this Multitester

Superheterodyne Receiver

LEARN BY DOING

You receive and keep all the modern equipment shown above, including tubes and valuable, professional quality Multitester. *No extra charges.*

FREE! RADIO-TV BOOK AND SAMPLE LESSON!

Send today for National Schools' new, illustrated Book of Opportunity in Radio-Television-Electronics, and an actual Sample Lesson. No cost—no obligation. Use the coupon now—we'll answer by return airmail.

APPROVED FOR VETERANS AND NON-VETERANS
Check coupon below

Both Resident and Home Study Courses Offered!

NATIONAL SCHOOLS

LOS ANGELES 37, CALIFORNIA • ESTABLISHED 1905
IN CANADA: 811 W. HASTINGS STREET, VANCOUVER, B.C.



GET FACTS FASTEST! MAIL TO OFFICE NEAREST YOU!

(mail in envelope or paste on postal card)

NATIONAL SCHOOLS, Dept. RG-44

4000 S. Figueroa Street or 323 West Polk Street
Los Angeles 37, Calif. Chicago 7, Ill.

Send FREE Radio-TV Electronics book and FREE sample lesson. No obligation, no salesman will call.

NAME _____ BIRTHDAY _____ 19__

ADDRESS _____

CITY _____ ZONE _____ STATE _____

Check if interested **ONLY** in Resident Training at Los Angeles.
VETERANS: Give Date of Discharge _____

636
Slimair
DYNAMIC MICROPHONE

Gives you features similar to those in the famous E-V Slim-Trim TV Microphones. That's why it is so outstanding for Public Address, Recording and other general-purpose use.
List Price \$70

SMOOTH RESPONSE
60-13,000 CPS
HIGH OUTPUT
OMNIDIRECTIONAL
ACOUSTALLOY DIAPHRAGM
BUILT-IN BLAST FILTER

Can be used in the hand, on a stand, or overhead

SEND FOR BULLETIN

Electro-Voice
421 CARROLL ST. • BUCHANAN, MICH.
Export: 13 E. 40th St., N. Y. 16, U. S. A.

HUGO GERNSBACK, publisher of **RADIO-ELECTRONICS** has been named an Officer of the Order of the Oaken Crown by the Grand Duchess of Luxembourg, as a "savant and man of letters."

The citation and presentation was made at a banquet in New York City,



held on the birthday of the Grand Duchess. Beside the scroll shown, Mr. Gernsback received a decoration in the form of a cross-shaped medal surrounded by an oaken cluster. The award, coincidentally, was made on the 50th anniversary of the day Mr. Gernsback left Luxembourg to come to the United States.

EIGHT NEW TV STATIONS have gone on the air since our last report. These are:

| | | |
|---------|--------------------------------------|----|
| KBID-TV | Fresno, Calif. | 53 |
| WRDW-TV | Augusta, Ga. | 12 |
| WTOC-TV | Savannah, Ga. | 11 |
| WMGT | Adams-Pittsfield, Mass. 74 | |
| WNEM-TV | Bay City - Saginaw, Mich. | 5 |
| KCEB | Tulsa, Okla. | 13 |
| WARM-TV | Scranton, Pa. | 16 |
| WKAQ-TV | San Juan, Puerto Rico 2 | |

A third u.h.f. station has gone off the air—KCTY, Kansas City, Mo., channel 25. This brings the total number of stations on the air to 367 (128 of which are u.h.f.) as of February 13, 1954.

Canada has one new station this month, CKCO-TV, Kitchener, Ont., channel 13.

FIRST PRIZE OF \$5,000 in the nationwide Raytheon transistor application contest, was won by Robert T. Bayne of Los Angeles. The winning entry was an audio frequency meter using two CK722 transistors and four CK705 germanium diodes.

Second prize of \$2,000 was awarded to Peter G. Sulzer of Kensington, Maryland for his transistorized audio frequency and voltage standard. Third and fourth prizes were taken by G. F. Montgomery of Bethesda, Maryland and Lt. Robert Perkins, a Navy dental officer, respectively. Montgomery's entry was a general purpose a.c.-d.c. voltmeter using transistors, while Lt. Perkins' entry was a Vitalometer, a device

for measuring the condition of tooth pulp, thus indicating the possibility of decay. Mr. Sulzer is already known to our readers, and they will see an article by Montgomery in one of our next few issues.

Presentation to the top four prize winners was made by John A. Hickey of the Raytheon receiving tube division, in ceremonies held in Philadelphia, Washington and Los Angeles.

ELECTRONIC BRAIN that operates an automatic punch press has been developed by G-E. Directions are fed to the punch press by an electronic digital computer, which reads information on size, number, and location of holes to be punched from a perforated card. The punch press automatically positions the material to be perforated and performs its punching operations within an accuracy of a few thousandths of an inch. This represents a substantial saving in jobs which require too large a number of chassis to permit profitable manual operation of the press, but which are not big enough to have special dies made to punch out the sheets or chassis.

In a talk presented at an Institute of Radio Engineers symposium on automation, the machine was described as

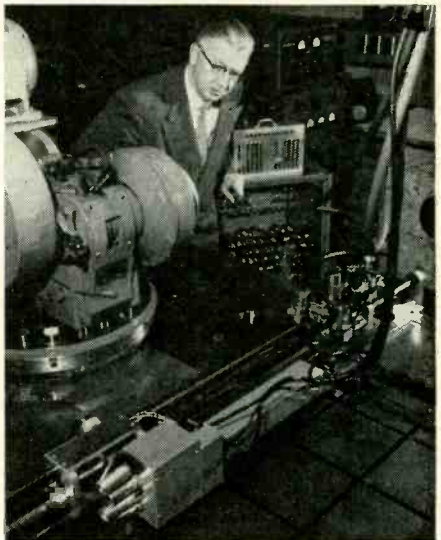

Electronic computer operates press

one more step toward the automatic factory of the future.

OUTSTANDING HAM J. Stan Surber, W9NZZ, of Peru, Ind., was winner of G-E Tube Department's Edison Radio Amateur Award for public service during 1953.

Surber, a ham for 31 years, won the Edison award for handling 12,000 letters during 1953 between weather men and servicemen at Arctic Islands, and their families elsewhere. Last year he transmitted and received over a million and a half words in Morse code to and from such points as T-3, an ice island near the North Pole.

Some of these far-northern stations receive mail only once or twice a year.

Surber also received a special citation from the U. S. Weather Bureau, and was made an honorary postman by Postmaster General Summerfield. G-E also cited Mrs. Surber as "the most understanding wife of the year".

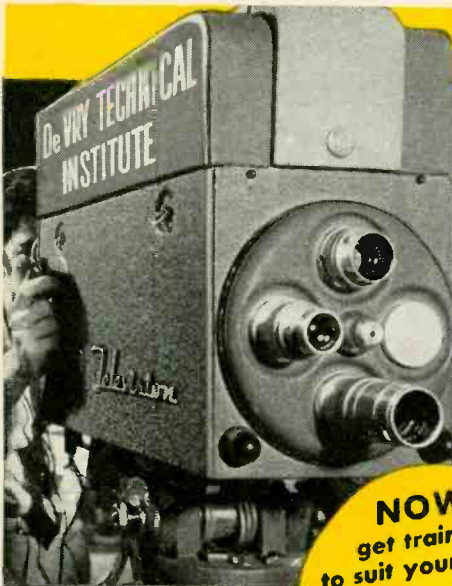

NOW...from D.T.I.'s MILLION DOLLAR TRAINING CENTER

Learn to master **TELEVISION**

RADIO - ELECTRONICS
by getting **EVERYTHING YOU NEED!**

**NOW—
get training
to suit your NEEDS**

**TAKE YOUR
CHOICE**

Come to
**D.T.I.'s
great CHICAGO
LABORATORIES**

...one of the Nation's FINEST!

Now, in the heart of the nation's TV Center, you can get all of your preparation in D.T.I.'s big, modern, wonderfully equipped training laboratories. Loads of commercial equipment and ample, well qualified instructors help you get a thorough, practical preparation in the **SHORTEST POSSIBLE TIME**. Part time student Employment assistance can help you pay your way while in training.

EMPLOYMENT SERVICE

As soon as you complete either the Chicago Laboratory or Home Training, you'll find D.T.I.'s grand Employment Service ready to help you start earning real money. Get full facts. Mail coupon today.

MILITARY SERVICE: If subject to military service, the training information we have for you should prove very helpful. Mail coupon today.

**89 WAYS TO
EARN
MONEY
IN TELEVISION
RADIO-ELECTRONICS**

ACT NOW! MAIL COUPON TODAY
Get this publication FREE!

DEVRY TECHNICAL INSTITUTE

4141 BELMONT AVE., CHICAGO 41, ILL. DEPT. RE-4-K

I would like your Opportunity News Bulletin showing "89 Ways to Earn Money In Television-Radio-Electronics"; also, complete facts about the training opportunity made possible by your organization.

Name _____ Age _____
Address _____ Apt. _____
City _____ Zone _____ State _____

America's amazing multi-billion dollar Television field now offers you a chance of a lifetime to get started toward a grand job or your own business. With TV station limit now raised from over 100 to 2053, Television is headed for almost every community. Mail coupon today. See how you may prepare to cash in on the coming TV BOOM.

Get **ALL** of your training
AT HOME!...including setting
up your own **HOME LABORATORY**



ABOVE: You build and keep this big 5 INCH commercial-type oscilloscope — one of the most useful test units used in TV today.

See how you may now get one of today's most complete, effective combinations of major home training aids—including (1) well illustrated lessons, (2) the wonderful aid of HOME TRAINING MOVIES and (3) 21 big shipments of electronic parts for setting up your own HOME LABORATORY. You work over 400 construction and test procedures to get the practical experience you need. This includes building and keeping a 5 INCH "SCOPE", jewel bearing MULTI-METER and a big 21 INCH TV SET. (D.T.I. offers another home training in Television-Radio-Electronics, but without the TV set.) Mail coupon today for exciting facts.



Build and keep this **BIG DTI** Engineered TV set—easily converted to U.H.F. (DTI offers another home training, but without the TV set.)



Multimeter

Use 16 mm.
MOVIES

Only D.T.I. provides you with the loan of visual training movies at home to help you master important basic points faster... easier... better!



Projector and films



"ONE OF AMERICA'S FORE-
MOST TELEVISION
TRAINING
CENTERS"

DEVRY TECHNICAL INSTITUTE

AFFILIATED WITH
DEFOREST'S TRAINING, INC.
CHICAGO 41, ILLINOIS

the BOOSTER with the CASCODE CIRCUIT

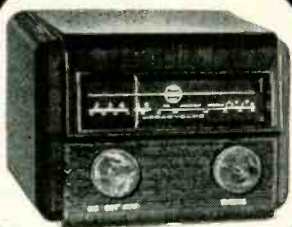

Turner:
Model TV-2

...for sharper reception
on any set—new or old!

We'll give it to you straight. This booster costs a little more. *It's worth it!* Who wants to watch Milton Berle through a blizzard of snow. The high-quality cascode circuit in the Turner booster reduces noise and snow to a minimum. Produces an excellent picture even in extreme fringe areas. Many servicemen say, "The Turner is the *only* booster that will help the new sets with cascode tuners." *Install* a Turner booster and you guarantee the best possible reception.

THE  COMPANY

The TURNER Company
933 17th Street N.E.,
Cedar Rapids, Iowa

Gentlemen: Please send me complete information on the superior performance of your booster.

Name _____

Address _____

City _____

State _____

COMPACT TV RECEIVER with cabinet dimensions scarcely larger than the face of its 17-inch tube has been introduced by Crosley. Called the Super V, the new receiver features a vertical chassis, and occupies one-third less space and is one third lighter than most other 17-inch receivers.

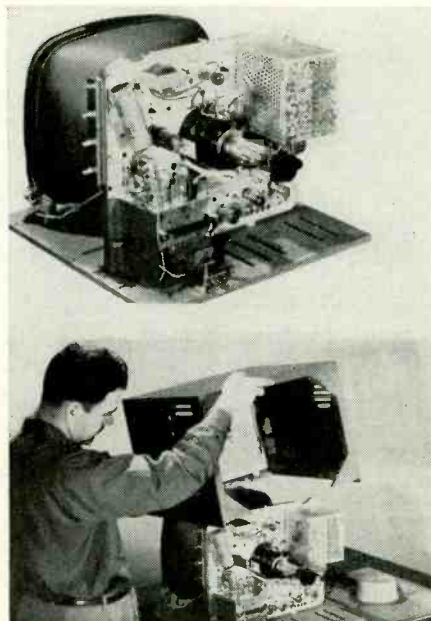

The easy-service set and its cabinet.

By using recently developed dual-purpose tubes, the set requires only 15 instead of 22 conventional tubes, thus eliminating circuitry and weight. Because of its vertical chassis, all tubes can be reached from the back of the receiver without removing the chassis from the cabinet. To get at the entire chassis, the service technician merely removes a few screws and lifts off the bonnet type cabinet.

10 MILLION COLOR TV receivers will be in the homes of American consumers by the end of 1958, W. E. Boss, manager of television market development for RCA, predicted before a meeting of the Electric League of Western Pennsylvania. He gave assurances that black-and-white receivers would remain popular. Boss based this on the compatibility of the present system, the relatively low price of black-and-white receivers, and the trend toward families owning more than one receiver.

TV AND USED CARS were coupled as a merchandising gimmick by an enterprising Buffalo, N. Y. television and appliance dealer. The maneuver consisted of offering a used car as a bonus with the purchase of a Hallicrafters console model TV receiver. The minimum receiver price was set at \$299.95. At last reports, response to the promotion was described as "very satisfactory."

TELEVISION CONFERENCE sponsored by the Cincinnati section of the Institute of Radio Engineers will be held April 24 at the Engineering Society Building, Cincinnati.

The subject of this Eighth Annual Spring Conference will be black-and-white and color TV, and u.h.f. The program will include nine technical papers covering various phases of TV.

INTERNATIONAL SYMPOSIUM organized by the Polytechnic Institute of Brooklyn has been scheduled for April 12, 13, and 14.

The topic of this, the third annual symposium, will be Information Networks. At the two previous gatherings, attendance exceeded 500 engineers and scientists, including many from Canada and Europe. The program will take place at the Engineering Societies Building, N. Y. C.

FIRST WOMAN secretary of the Federal Communications Commission has taken over her new post. The new secretary, Mary Jane Morris, is no newcomer to the FCC; she has been an attorney in the FCC's Office of General Counsel since 1948. As secretary to the Commission, Miss Morris succeeds T. J. Slowie, who served for 16 years.

FM RADIO CHAIN to be known as the Good Music Network has been put into operation in Washington to continue an important FM broadcasting service which was privately financed for many years by the late Maj. Edwin H. Armstrong.

The network operates as a public service to replace the live high-fidelity programs from Washington formerly carried by Maj. Armstrong's privately operated Continental Network. That network ceased to exist after his death on Feb. 1.

Six stations, WFLN, Philadelphia, Pa.; WLAN-FM, Lancaster, Pa.; WNYC and WNYC-FM, New York City; WSNJ-FM, Bridgeton, N. J.; WTOA, Trenton, N. J. and WGMS—AM-FM, Washington, D. C. are the participating stations, with WGMS as the key station. It is expected that others will be added. At present the programs are largely picked up direct with telephone line use at a minimum.

CHEAP COLOR TV CONVERTER which may sell for \$50 to \$100 has been demonstrated by Airtronic Research, Inc., of Bethesda, Maryland.

The adapter breaks down the NTSC-type signals and re-arranges them in the form of a sequential-field system, then uses a color wheel like the old-fashioned color receivers of a few years ago. The action is the reverse of that of the *Chromacoder*, a device which permits using a sequential-field camera, then converts the signals into the NTSC type for transmission.

One of the limitations of the receiver converter is the size of the color wheel, which must be twice that of the picture being viewed. The wheel rotates at 600 r.p.m. instead of the 1440 of the obsolete color system. Due to that and to the lower frame frequency of compatible television, more flicker is expected with the new converter than with the old CBS-type color television receivers.

END



DELCO RADIO CAREFULLY CONTROLS THE MANUFACTURING OF ITS SPEAKERS TO ASSURE HIGHEST POSSIBLE QUALITY

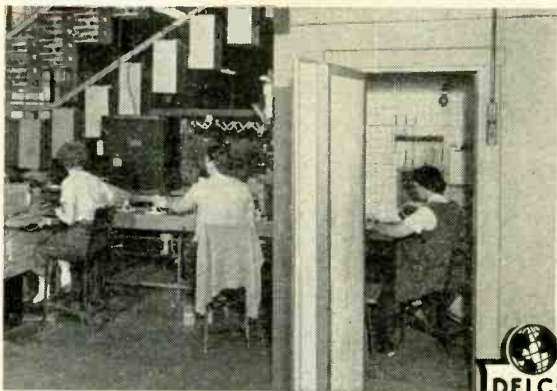

In the audio test booth, the speaker is checked for its ability to deliver good listening. In the background you can see a small section of the speaker production line.



High quality in the final product can be had only through rigid quality control. Take speakers, for example. Speaker baskets are formed in our stamping department. Special machines wind the voice coils. On the assembly line the cones are secured to the voice coils and then assembled with the basket. All along the line inspectors have been checking and rechecking. Then, the speaker is magnetized and goes into a specially designed sound booth for a final check.

This continuing quality control is one important reason why Delco Radio replacement parts assure customer satisfaction. Made by the world's largest manufacturer of auto radios, they are available from your UMS Delco Electronic Parts Distributor.

**DISTRIBUTED BY
ELECTRONICS
WHOLESALEERS
EVERYWHERE**

DELCO RADIO

DIVISION OF GENERAL MOTORS CORPORATION, KOKOMO, INDIANA

A GENERAL MOTORS PRODUCT  **WARRANTED SERVICE**  **A UNITED MOTORS LINE**

Now... SOLDERING MADE TWICE AS EASY!

FIRST, the Soldering Aid.
Now, the **NEW CBS-HYTRON
SOLDER DISPENSER**
makes soldering twice as easy.

No more tangling with haywire coils of solder. Your thumb on knurled control wheel of unique Solder Dispenser feeds solder . . . retracts it neatly when job is done . . . without waste. A one-hand tool, Dispenser eliminates time out to unroll and straighten solder. Holds 72 inches of solder . . . a month's supply. It's compact . . . light . . . convenient . . . pencil-like . . . with handy pocket clip. Soldering becomes a pleasure with this time-and-money saver. Servicemen say, "Wouldn't be without it."



FREE . . . APRIL 15
THROUGH MAY 31

You can get this complete package free from April 15 through May 31. Your CBS-Hytron distributor will give you a free Solder Dispenser (loaded with 20 Refills) . . . and a plastic tube of 80 additional Refills. Enough to last 5 months.



HOW TO USE. Your CBS-Hytron Solder Dispenser comes ready to use . . . with 20 lengths of 0.050-inch, 40/60 activated rosin core solder.

To start: Point Dispenser vertically downward. Shake a length of solder into position . . . at the same time rotating the knurled wheel toward you to begin the feed. Roll out an inch of solder and go ahead with the job. Need more solder? Just rotate the wheel with your thumb. When through, turn wheel away from you to draw unused solder back into Dispenser.

Knurled cap of Dispenser unscrews for refilling. Your package of 80 specially cut and sealed Refills gives you four months' supply. Plus the month's supply already loaded in the Dispenser.

Your new Solder Dispenser is fun to use . . . a natural companion to your Soldering Aid. And your Dispenser saves you time and money, too. Get yours today!

**WITH YOUR ORDER FOR CBS-HYTRON TUBES . . .
ONLY 75 RECEIVING OR 3 PICTURE TUBES**
Just order 75 CBS-Hytron receiving tubes . . . or 3 CBS-Hytron picture tubes. Your CBS-Hytron distributor will give you this valuable, time-and-money saver . . . free. Remember, offer is limited to April 15 through May 31. And the unique Solder Dispenser and Refills are available *only* on this special offer.
ACT NOW!

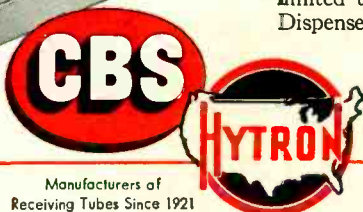

Manufacturers of
Receiving Tubes Since 1921

CBS-HYTRON Main Office: Danvers, Mass.

A Division of Columbia Broadcasting System, Inc.

A member of the CBS family: CBS Radio • CBS Television
Columbia Records, Inc. • CBS Laboratories • CBS-Columbia • and CBS-Hytron

RECEIVING • TRANSMITTING • SPECIAL-PURPOSE • TV PICTURE TUBES • CRYSTAL DIODES AND TRANSISTORS
RADIO-ELECTRONICS

Six months from today

Which Will You Hold?

this-

or this

REGRET TO ADVISE YOU FAILED YOUR FCC EXAMINATIONS -

1ST CLASS RADIO TELEPHONE OPERATOR'S LICENSE

Add Technical Training To Your Practical Experience - **GET YOUR FCC LICENSE IN A HURRY!**

Then use our Amazingly Effective **JOB-FINDING SERVICE**

Money-Making **FCC** Commercial Radio Operator **LICENSE** Information

Get This Valuable Booklet

TV ENGINEERING INCLUDED IN OUR TRAINING & COACHING

FREE!

● TELLS HOW -

Here Is Your **GUARANTEE**

If you fail to pass your Commercial License exam after completing our course, we guarantee to continue your training without additional cost of any kind until you successfully obtain your Commercial license, provided you first sit for this examination within 90 days after completing your course.

WE GUARANTEE

TO TRAIN AND COACH YOU AT HOME IN SPARE TIME UNTIL YOU GET

YOUR FCC LICENSE

If you have had any practical experience—Amateur, Army, Navy, radio repair, or experimenting.

● TELLS HOW -

Employers make **JOB OFFERS** Like These to Our Graduates Every Month

Letter from nationally-known Airlines, "We would also appreciate if you would place the following additional advertisement in your bulletin-Wanted-Superintendent of Communications . . . Salary \$686.66 per month."

Letter from nationally-known airplane manufacturer, "We need men with electronic training or experience in radar maintenance to perform operational check-out of radar and other electronics systems . . . starting salary . . . amounting to \$329.33 per month."

These are just a few samples of the job offers that come to our office periodically. Some licensed radioman filled each of these jobs . . . it might have been you!

HERE'S PROOF FCC LICENSES ARE OFTEN SECURED IN A FEW HOURS OF STUDY With OUR Coaching AT HOME in Spare Time.

| Name and Address | License | Lessons |
|--|-----------|---------|
| Lee Worthy 2210 1/2 Wilshire St., Bakersfield, California | 2nd Phone | 16 |
| Clifford E. Vogt Box 1018, Dania, Florida | 1st Phone | 20 |
| Francis X. Foerch 38 Bueler Pl., Bergenfield, New Jersey | 1st Phone | 38 |
| Sgt. Ben H. Davis 317 North Roosevelt, Lebanon, Illinois | 1st Phone | 38 |
| Albert Schoell 110 West 11th St., Escondido, California | 2nd Phone | 23 |

Carl E. Smith, E.E., Consulting Engineer, President

CLEVELAND INSTITUTE OF RADIO ELECTRONICS
Desk RE-63, 4900 Euclid Bldg., Cleveland 3, Ohio

● TELLS HOW -

Our Amazingly Effective **JOB-FINDING SERVICE** Helps **CIRE** Students Get Better Jobs

Here are a few recent examples of Job-Finding results:

GETS CIVIL SERVICE JOB

"Thanks to your course I obtained my 2nd phone license, and am now employed by Civil Service at Great Lakes Naval Training Station as an Engineering Specialist."
Kenneth R. Lelser, Fair Oaks, Md. Del., McHenry, Ill.

GETS STATE POLICE JOB

"I have obtained my 1st class ticket (thanks to your school) and since receiving same I have held good jobs at all times. I am now Chief Radio Operator with the Kentucky State Police."
Edwin P. Healy, 264 E. 3rd St., London, Ky.

GETS BROADCAST JOB

"I wish to thank your Job-Finding Service for the help in securing for me the position of transmitter operator here at WCAE, in Pittsburgh."
Walter Koschik, 1442 Ridge Ave., N. Braddock, Pa.

GETS AIRLINES JOB

"Due to your Job-Finding Service, I have been getting many offers from all over the country, and I have taken a job with Capital Airlines in Chicago, as a Radio Mechanic."
Harry Clare, 4537 S. Drexel Blvd., Chicago, Ill.

Your FCC Ticket is required by most employers as proof of your technical ability

OURS IS THE ONLY HOME STUDY COURSE WHICH SUPPLIES FCC-TYPE EXAMINATIONS WITH ALL LESSONS AND FINAL TESTS.

Get All 3 Free

MAIL COUPON NOW

CLEVELAND INSTITUTE OF RADIO ELECTRONICS
Desk RE-63—4900 Euclid Bldg., Cleveland 3, Ohio

(Address to Desk No. to avoid delay)

I want to know how I can get my FCC ticket in a minimum of time. Send me your **FREE** booklet, "How to Pass FCC License Examinations" (does not cover exams for Amateur License), as well as a sample FCC-type exam and the valuable booklet, "Money-Making FCC License Information." Be sure to tell me about your Television Engineering Course.

NAME
ADDRESS
CITY ZONE STATE

Paste on two-cent postcard or send airmail

Exciting New Performance . . . Superb Cabinet Craftsmanship

THE PERMOFLUX

Fortissimo

2-Way Speaker System with "DUAL DRIVING POINT" Horn Design
Now Brings You

FULL RANGE HIGH FIDELITY
At Either Low or High Volume Level

Perfection
in Cabinetry
by
*Contemporary
American
Furniture*
in
Mahogany or
Korina Blonde.

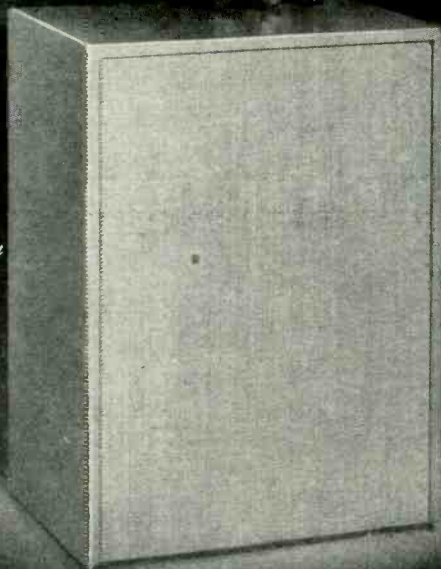

Unique "New Dual Driving Point" Enclosure Design, employing Dual Eight inch woofer system, surpasses bass and mid-range performance of finest conventional 12 and 15 inch systems. Satin smooth highs are added by specially designed Super Tweeter. Beautiful modern cabinet styling . . . precision constructed of carefully selected veneers . . . hand rubbed to a lustrous enduring finish . . .

New . . . Diminutive 2-Way Speaker System

THE PERMOFLUX

Diminutive

Exclusive New Design . . . combines full high fidelity performance with minimum cabinet size and low cost. Angled speaker mounting assures correct distribution of sound regardless of placement. Perfect for Binaural when used in pairs.



Two Royal 6 inch
Speakers and Super Tweeter
housed in choice of Mahogany or
Blonde enclosure.

See your Hi-Fi dealer for demonstration; also hear the
New Super Royal Speaker (8, 12 and 15 inch sizes).

For complete descriptive literature write to . . .

Permoflux CORPORATION

4912 West Grand Avenue • Chicago 39, Illinois

West Coast Plant
4101 San Fernando Road • Glendale 4, California

WHERE'S THE MONEY?

Dear Editor:

I read your article, "Wanted: Technicians," in the February, 1954, issue of RADIO-ELECTRONICS and was indeed amazed at its contents—however, in a differing light.

I am employed with American Airlines as a radio operator. My age is 25. I have been in the field of radio and electronics for more than five years, and have an FCC 2nd Radiotelephone and Amateur license (WOGMH). Although I did not have an opportunity to acquire a degree in electronics, I feel I have a good understanding of this field. My salary after three years with American is about \$325 a month. I have been looking for a job as a technician for better than 10 months and cannot find anything that will match the salary I am now making.

You stated there was an unprecedented shortage. Where??? You say the shortage has been acute since 1951. Where? Why? Maybe because of salary? A grocery clerk can make \$75 or more a week with next to nil for education! Where are those handsome dividends and where can you name your salary? I am indeed interested and would like to know where these jobs are.

The St. Louis paper carries one or two electronic jobs daily, TV service \$50 a week! Electronic technician \$290 a month! Tops of \$400 in 5 to 7 years. Are these good jobs???

Maybe I sound bitter about this but I am about to give up the field of electronics professionally and derive my enjoyment from ham radio and experimenting in my spare time. The incentive is lacking, as a guy just can't raise a family on these salaries. He can make more elsewhere without putting dollars and education into a job that pays peanuts.

Maybe there are jobs that the average guy doesn't know about. If so, I think you could help a lot of us in the industry—and yourself—by getting the word out where it will do some good.

Thanks for letting me blow my top on this subject. I enjoy the work and hate like heck to get out, but a guy has got to eat too!!!

JIM KAISER

St. Louis, Mo.

(See the editorial on page 31 of this month's issue—*Editor*)

FEBRUARY COVER

Dear Editor:

Some of the scientists up at Los Alamos think your photographer of the cover photo of your February issue should be censured for not using a smaller stop, and for incorrectly placing the flash bulb. It gives an uncanny penetrating look to Mona's eyes. They think it is more important to focus Mona sharply than the transistor. There are plenty of transistors at Los Alamos, but no Mona's! Anyway, they like your cover.

GEORGE PEARCE

Albuquerque, New Mexico

Get in on the TV boom...

starting today!

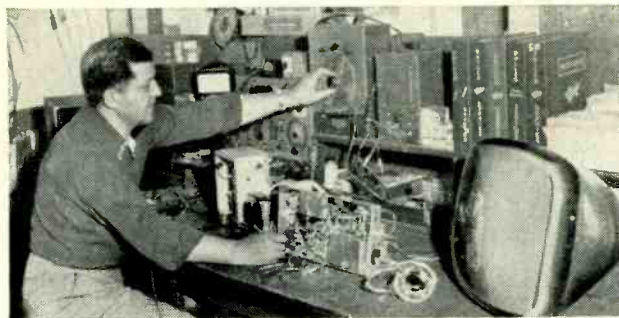
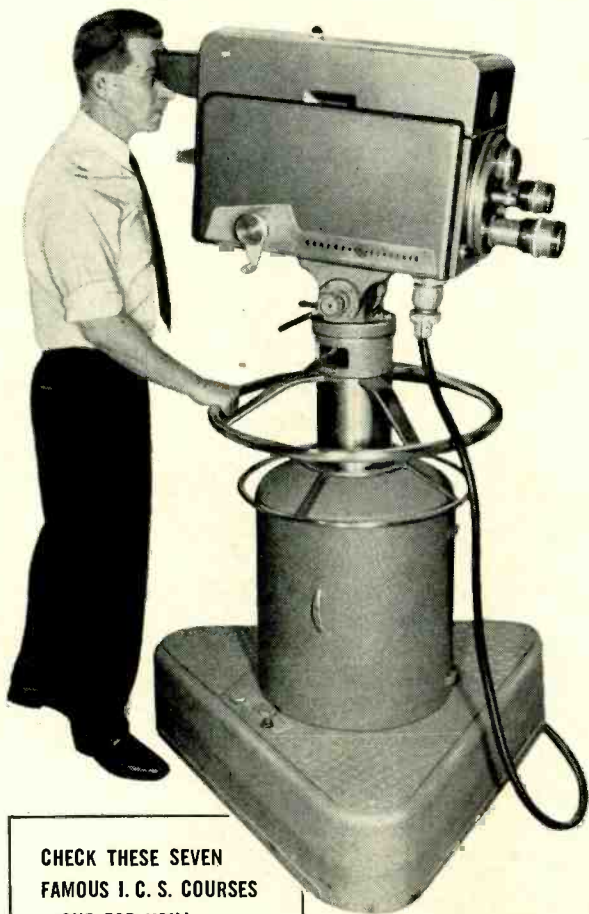

• Prepare now for the new Radio-TV-Electronics boom. Get in on VHF and UHF . . . aviation and mobile radio . . . color TV . . . binaural sound! The International Correspondence Schools can help you!

If you've ever thought about Radio or Television as a career . . . if you have the interest, but not the training . . . if you're waiting for a good time to start . . . NOW'S THE TIME!

No matter what your previous background, I.C.S. can help you. If Radio-TV servicing is your hobby, I.C.S. can make it your own profitable business. If you're interested in the new developments in Electronics, I.C.S. can give you the basic courses of training you need. If you have the job but want faster progress, I.C.S. can qualify you for promotions and pay raises.

I.C.S. training is *success-proved* training. Hundreds of I.C.S. graduates hold top jobs with top firms like R.C.A., G.E., DUMONT, I.T.&T. Hundreds of others have high ratings in military and civil service. Still others have successful businesses of their own.

With I.C.S., you get the rock-bottom basics and theory as well as the all-important bench practice and experimentation. You learn in your spare time—no interference with business or social life. You set your own pace—progress as rapidly as you wish.

Free career guidance: Send today for the two free success books, the 36-page "How to Succeed" and the informative catalog on the course you check below. No obligation. Just mark and mail the coupon. With so much at stake, you owe it to yourself to act—and act fast!

I. C. S., Scranton 9, Penna.

CHECK THESE SEVEN FAMOUS I. C. S. COURSES—ONE FOR YOU!

- PRACTICAL RADIO-TELEVISION ENGINEERING**—Foundation course for radio-television career. Basic principles plus advanced training. Radio, Sound, TV.
- TELEVISION TECHNICIAN**—To qualify you for high-level technical positions in television. Camera, studio, transmitter techniques. Manufacture, sale and installation of TV equipment.
- TELEVISION RECEIVER SERVICING**—Installation, servicing, conversion. Dealership. For the man who knows about radio and wants TV training.
- RADIO & TELEVISION SERVICING**—Designed to start you repairing, installing and servicing radio and television receivers soon after starting the course.
- RADIO & TELEVISION SERVICING WITH TRAINING EQUIPMENT**—Same as above but with addition of high-grade radio servicing equipment and tools.
- RADIO OPERATING COURSE**—Special course to help you pass the Government examination for operator's licenses. Code TV, FM. Radio regulations.
- INDUSTRIAL ELECTRONICS**—Broad, solid background course devoted to the electron tube and to its many applications.

For Real Job Security—Get I.C.S. Training!

INTERNATIONAL CORRESPONDENCE SCHOOLS



BOX 2880-K, SCRANTON 9, PENNA.

Without cost or obligation, send me "HOW TO SUCCEED" and the booklet about the course BEFORE which I have marked X:

- | | | | | |
|---|--|---|---|---|
| <ul style="list-style-type: none"> <input type="checkbox"/> ART <input type="checkbox"/> Commercial Art <input type="checkbox"/> Magazine Illustrating <input type="checkbox"/> Fashion Illustrating <input type="checkbox"/> Cartooning <input type="checkbox"/> Sketching and Painting <input type="checkbox"/> Show Card and Sign Lettering <input type="checkbox"/> AUTOMOTIVE <input type="checkbox"/> Automobile, Mechanic <input type="checkbox"/> Auto Elec. Technician <input type="checkbox"/> Auto Body Rebuilding and Refinishing <input type="checkbox"/> Diesel—Gas Engines <input type="checkbox"/> AVIATION <input type="checkbox"/> Aeronautical Engineering Jr. <input type="checkbox"/> Aircraft Engine Mechanic <input type="checkbox"/> Airplane Drafting <input type="checkbox"/> BUILDING <input type="checkbox"/> Architecture <input type="checkbox"/> Arch. Drafting <input type="checkbox"/> Building Contractor <input type="checkbox"/> Estimating <input type="checkbox"/> Carpenter and Mill Work <input type="checkbox"/> Carpenter Foreman <input type="checkbox"/> Reading Blueprints <input type="checkbox"/> House Planning <input type="checkbox"/> Plumbing | <ul style="list-style-type: none"> <input type="checkbox"/> Heating <input type="checkbox"/> Painting Contractor <input type="checkbox"/> Air Conditioning <input type="checkbox"/> Electrician <input type="checkbox"/> BUSINESS <input type="checkbox"/> Business Administration <input type="checkbox"/> Certified Public Accountant <input type="checkbox"/> Bookkeeping and Accounting <input type="checkbox"/> Office Management <input type="checkbox"/> Stenography and Typing <input type="checkbox"/> Secretarial <input type="checkbox"/> Federal Tax <input type="checkbox"/> Business Correspondence <input type="checkbox"/> Letter-writing Improvement <input type="checkbox"/> Personnel and Labor Relations <input type="checkbox"/> Advertising <input type="checkbox"/> Retail Business Management <input type="checkbox"/> Managing Small Business <input type="checkbox"/> Ocean Navigation <input type="checkbox"/> Sales Management <input type="checkbox"/> Short Story Writing <input type="checkbox"/> Estimating <input type="checkbox"/> Creative Salesmanship <input type="checkbox"/> Traffic Management <input type="checkbox"/> CHEMISTRY <input type="checkbox"/> Chemical Engineering <input type="checkbox"/> Chemistry <input type="checkbox"/> Analytical Chemistry | <ul style="list-style-type: none"> <input type="checkbox"/> Petroleum—Nat'l Gas <input type="checkbox"/> Pulp and Paper Making <input type="checkbox"/> Plastics <input type="checkbox"/> CIVIL, STRUCTURAL ENGINEERING <input type="checkbox"/> Civil Engineering <input type="checkbox"/> Structural Engineering <input type="checkbox"/> Surveying and Mapping <input type="checkbox"/> Structural Drafting <input type="checkbox"/> Highway Engineering <input type="checkbox"/> Reading Blueprints <input type="checkbox"/> Construction Engineering <input type="checkbox"/> Sanitary Engineering <input type="checkbox"/> DRAFTING <input type="checkbox"/> Aircraft Drafting <input type="checkbox"/> Architectural Drafting <input type="checkbox"/> Electrical Drafting <input type="checkbox"/> Mechanical Drafting <input type="checkbox"/> Structural Drafting <input type="checkbox"/> Sheet Metal Drafting <input type="checkbox"/> Ship Drafting <input type="checkbox"/> Mine Surveying and Drafting <input type="checkbox"/> ELECTRICAL <input type="checkbox"/> Electrical Engineering <input type="checkbox"/> Electrical <input type="checkbox"/> Electrical Maintenance | <ul style="list-style-type: none"> <input type="checkbox"/> Electrical Drafting <input type="checkbox"/> Electric Power and Light <input type="checkbox"/> Lineman <input type="checkbox"/> HIGH SCHOOL <input type="checkbox"/> High School Subjects <input type="checkbox"/> Mathematics <input type="checkbox"/> Commercial <input type="checkbox"/> Good English <input type="checkbox"/> MECHANICAL AND SHOP <input type="checkbox"/> Mechanical Engineering <input type="checkbox"/> Industrial Engineering <input type="checkbox"/> Industrial Supervision <input type="checkbox"/> Foremanship <input type="checkbox"/> Mechanical Drafting <input type="checkbox"/> Machine Design-Drafting <input type="checkbox"/> Machine Shop Practice <input type="checkbox"/> Tool Design <input type="checkbox"/> Industrial Instrumentation <input type="checkbox"/> Machine Shop Inspection <input type="checkbox"/> Reading Blueprints <input type="checkbox"/> Toolmaking <input type="checkbox"/> Gas—Electric Welding <input type="checkbox"/> Heat Treatment—Metallurgy <input type="checkbox"/> Sheet Metal Work <input type="checkbox"/> Sheet Metal Pattern Drafting <input type="checkbox"/> Refrigeration | <ul style="list-style-type: none"> <input type="checkbox"/> POWER <input type="checkbox"/> Combustion Engineering <input type="checkbox"/> Diesel—Electric <input type="checkbox"/> Electric Light and Power <input type="checkbox"/> Stationary Steam Engineering <input type="checkbox"/> Stationary Fireman <input type="checkbox"/> RADIO TELEVISION COMMUNICATIONS <input type="checkbox"/> Practical Radio—TV Eng'ing <input type="checkbox"/> Radio Operating <input type="checkbox"/> Radio and TV Servicing <input type="checkbox"/> Television—Technician <input type="checkbox"/> Electronics <input type="checkbox"/> Telephone Work <input type="checkbox"/> RAILROAD <input type="checkbox"/> Locomotive Engineer <input type="checkbox"/> Diesel Locomotive <input type="checkbox"/> Air Brakes <input type="checkbox"/> Car Inspector <input type="checkbox"/> Railroad Administration <input type="checkbox"/> TEXTILE <input type="checkbox"/> Textile Engineering <input type="checkbox"/> Cotton, Rayon, Woolen Mfg. <input type="checkbox"/> Carding and Spinning <input type="checkbox"/> Warping and Weaving <input type="checkbox"/> Loom Fixing <input type="checkbox"/> Throwing <input type="checkbox"/> Finishing and Dyeing <input type="checkbox"/> Textile Designing |
|---|--|---|---|---|

Name _____ Age _____ Home Address _____
 City _____ Zone _____ State _____ Working Hours _____ A.M. to P.M. _____
 Occupation _____

Canadian residents send coupon to International Correspondence Schools Canadian, Ltd., Montreal, Canada. . . . Special tuition rates to members of the U. S. Armed Forces.

7 Out of 8 Times

THE ORIGINAL CRYSTAL CARTRIDGE IS ASTATIC

SCIENTIFICALLY SELECTED
BY MANUFACTURERS AND
THEIR ENGINEERS

Player and changer manufacturers have made Astatic Crystal Cartridges their overwhelming choice . . . because of Astatic's ability to match exactly the performance characteristics called for . . . because of Astatic's ability to turn out hundreds of thousands of uniform duplicates of each cartridge from its unparalleled precision production lines. These same factors work to assure perfect matching of requirements . . . perfect results . . . when you REPLACE THE ORIGINAL WITH ANOTHER ASTATIC CRYSTAL CARTRIDGE!

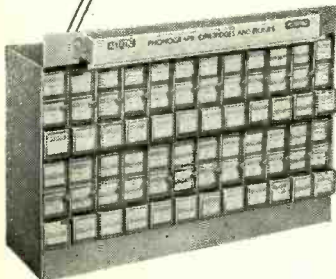

Ask for details on the new, FREE steel storage cabinet and dispenser for Astatic Crystal Cartridges.

EXPORT REPRESENTATIVE . . .

**KNOWN THE WORLD OVER
. . . FOR HIGHEST QUALITY
AT LOWEST POSSIBLE COST**



401 Broadway, New York 13, N. Y.
Cable Address . . . ASTATIC, N. Y.

Merchandising and Promotion

RCA Tube Department, Harrison, N. J., announced a \$50,000 prize contest for TV and radio service technicians. 400 prizes will be awarded to the entrants who give the best reasons for using and recommending RCA picture tubes and receiving tubes. The contest is the base of the company's consumer-aimed *Tell and Sell* sales promotion campaign. Winner of the first prize will be given the choice of a 1954 De Soto hard-top convertible or a 1954 Dodge panel truck plus a full set of RCA test equipment. Duplicate prizes will be awarded to distributor salesmen whose names appear on the winning entry blanks. Contest closes at midnight April 30, 1954.

Clarostat Manufacturing Company, Dover, N. H., released a new version of its Greenohm fixed wire-wound 10-watt power resistor kit. The new Greenohm kit consists of 20 wire-wound resistors of the most popular ohmages mounted on a two-color display board which also serves as an inventory reminder.

Ward Products Corp., Division of the Gabriel Co., Cleveland, Ohio, introduced a new promotion kit which includes display material, mailing stuffers, newspaper mats, TV slides, and radio commercials for promoting the company's new line of *Tele-vanes*, decorative TV antennas.

Federal Telephone and Radio Co., Clifton, N. J., sent a special poster-size message to 2,000 distributors

THE 1954 REPLACEMENT MARKET WILL BE GOOD!

Federal is confident that in the year before us the radio-TV replacement market will enjoy continuing prosperity. There are sound reasons for this belief.

In America today there are more than 100,000,000 radios in homes, institutions, business places and on the highways . . . an estimated 28,000,000 television sets in operation . . . plus thousands of converters, boosters and other units. These totals are sure to grow in '54 . . . to raise replacement potentialities to a new high!

Federal congratulates the distributors and servicemen of America on their contributions to the growth of the replacement market, and is confident that they will continue to meet its requirements with parts, components and service of the highest quality.

Federal will give its full cooperation in supplying this great market . . . in maintaining its consistently high standards of product quality . . . in helping in every way possible to assure more profitable selling.

Yes, the replacement market is big . . . is expanding . . . and it will be good in 1954 . . .!

SELENIUM RECTIFIERS - TV LEAD-IN - B-F CABLE - DIODES

Federal Telephone and Radio Company
SELENIUM-TELUM DEPARTMENT - 100 KINGSLAND ROAD, CLIFTON, N. J.

throughout the U. S., proclaiming the company's confidence that 1954 would be a good year for replacement sales. The poster is a reprint of a recent Federal advertisement. The blow-up is suitable for window or wall display.

General Electric Tube Department is advertising its aluminized TV picture tubes on *Today*, Dave Garroway's morning TV show on NBC.

Simpson Electric, Chicago, is conducting a series of servicing meetings

RADIO-ELECTRONICS



the only **COMPLETE** catalog for Everything in TV, Radio and Industrial Electronics

FREE value-packed

**1954 ALLIED
268-PAGE CATALOG**

The World's Largest Stocks

- TV and Radio Parts
- Test Instruments
- High-Fidelity Equipment
- Custom TV Chassis
- AM, FM Tuners and Radios
- Recorders and Supplies
- P.A. Systems, Accessories
- Amateur Station Gear
- Builders' Kits, Supplies
- Equipment for Industry

**Fastest Service
in Electronic Supply**

SEND FOR THE LEADING
ELECTRONIC
BUYING GUIDE
FREE!

NEW HOME OF
ALLIED RADIO
ultra-modern facilities
TO SERVE YOU BEST



EASY PAY TERMS

Use ALLIED'S liberal Easy Payment Plan—only 10% down, 12 months to pay—no carrying charge if you pay in 60 days. Available on Hi-Fi and P.A. units, recorders, TV chassis, test instruments, Amateur gear.

TV and HI-FI SPECIALISTS

To keep up with developments in High-Fidelity and TV, look to ALLIED. Count on us for all the latest releases and largest stocks of equipment in these important fields. If it's anything in High-Fidelity or Television—we have it in stock!



SEND FOR IT TODAY

Get ALLIED'S latest catalog—268 pages packed with the world's largest selection of quality equipment at lowest, money-saving prices. See all the latest releases in custom TV chassis, TV antennas and accessories; AM and FM tuners and radios; everything in High-Fidelity custom components; latest P. A. Systems and accessories; recorders and supplies; Amateur receivers, transmitters and station gear; specialized industrial electronic equipment; test instruments; builders' kits; huge listings of parts, tubes, tools, books—your choice of the world's most complete stocks of quality equipment. ALLIED gives you every buying advantage: speedy shipment, expert personal help, lowest prices, assured satisfaction. Get the big 1954 ALLIED Catalog. Keep it handy—and save time and money. Send for your **FREE** copy today.

**SAVE ON EVERYTHING
IN ELECTRONICS**

ALLIED RADIO
World's Largest Electronic Supply House

ALLIED RADIO CORP., Dept. 2-D-4
100 N. Western Ave., Chicago 80, Illinois

Send FREE 268-Page 1954 ALLIED Catalog

Name _____

Address _____

City _____ Zone _____ State _____

You can build a reputation on Tung-Sol® Quality

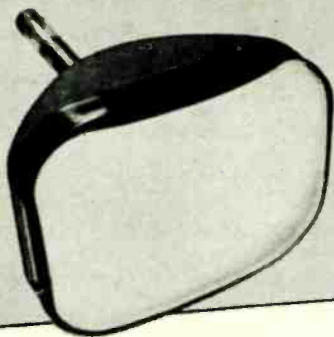

TUNG-SOL makes
All-Glass Sealed Beam Lamps,
Miniature Lamps,
Signal Flashers,
Picture Tubes, Radio, TV,
Special Purpose Electron Tubes,
Semiconductor Products.

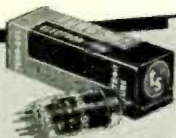

TUNG-SOL ELECTRIC INC.
Newark 4, New Jersey

Sales Offices: Atlanta, Chicago, Columbus, Culver City (Los Angeles), Dallas, Denver, Detroit, Newark, Seattle

throughout the country, to which service technicians are invited to bring their "dog" receivers for diagnosis and repair by a field engineer. One of the popular demonstrations included in the company's service meetings concerns impedance-matching tests with the Genescope and the demonstration of methods for correcting mismatch conditions.

Hallicrafters, Chicago, is awarding an all-expense-paid round-the-world trip for the three top winners and their wives in its current distributor sales contest.

Imperial Radar and Wire Corp., New York City, is offering a sample card containing all the different sizes of wire it manufactures including the gauge, weight, breaking strength, etc.

New Plants and Expansion

Granco Products, Long Island City, N. Y., has broken ground for a new addition to its plant. The new building will more than double the company's present facilities.

Orradio Industries, Opelika, Ala., manufacturer of magnetic sound recording tape, opened an office in New York City at 458 Broadway. James F. Kenney, recording and broadcast engineer, was placed in charge of the new office.

Quietrole Co., purchased a site in Spartanburg, S. C., where it will erect a new plant.

Erie Resistor of Canada, Canadian subsidiary of Erie Resistor Corp., is completing a new, larger factory in Trenton, Ontario, Canada.

World Radio Laboratories, Cedar Rapids, Iowa, one of the country's largest distributors, is now located in its new building at 3415 West Broadway. Leo I. Meyerson, president of the company, announced that the fire which damaged the company's stocks last January was in the old building. The damaged stock has been completely replenished. The company has been operating at 100% capacity for some months.

Dalmo Victor Co., San Carlos, Calif., has been sold to Textron Inc., Providence, R. I. Dalmo Victor now operates as a wholly owned subsidiary of Textron with no change in personnel or policy.

Production and Sales

RETMA reported that production of 7,214,787 TV sets during 1953 was the second highest in history, more than 1,000,000 better than 1952. Radio output of 13,368,556 was the highest since 1950. The association also noted that 6,375,279 TV sets and 7,064,485 radios, exclusive of automobile sets, were sold at retail during 1953. Both figures were well above the 1952 period.

RETMA announced that 9,839,138 TV

look for the
Howard W. Sams
"BOOK TREE"



at your
**PARTS
DISTRIBUTOR**

Make it a habit to "browse" at the Howard W. Sams "Book Tree". You'll find it at your Parts Distributor. It's loaded with the time-saving, profit-building books you want and need. Keep ahead with these timely, practical publications that help you learn more and earn more daily.

LOOK FOR THESE TITLES:

Television Books

| | |
|---|--------|
| "Telecasting Operations"..... | \$7.95 |
| "Photofact Television Course"..... | 3.00 |
| "TV Servicing Short-Cuts"..... | 1.50 |
| "TV Test Instruments"..... | 3.00 |
| "UHF Converters"..... | 1.00 |
| "UHF Antennas"..... | 1.50 |
| "Television Antennas"..... | 2.00 |
| "Servicing TV in the Customer's Home"..... | 1.50 |
| "Making Money in TV Servicing"..... | 1.25 |
| "TV Tube Location Guide" Vols. 4, 3, 2, each..... | 2.00 |
| "TV Tube Location Guide" Vol. 1..... | 1.50 |

Audio Publications

| | |
|---|--------|
| "Recording & Reproduction of Sound"..... | \$7.95 |
| "Audio Amplifiers" Vols. 4, 3, 2, each..... | 3.95 |

Record Changer Manuals

| | |
|---|--------|
| "Automatic Changer Manual" Vols. 5, 4, 3, each..... | \$3.00 |
| "Automatic Changer Manual" Vol. 2..... | 4.95 |

Handy Service Guides

| | |
|---|--------|
| "Radio Receiver Tube Replacement Guide"..... | \$1.25 |
| "AM-FM Servicing Short-Cuts"..... | 1.50 |
| "Dial Cord Stringing Guide" Vols. 4, 3, 2, 1, each..... | 1.00 |

Auto Radio Service Manuals

| | |
|---|--------|
| "Auto Radio Manual" Vols. 3, 2, each..... | \$3.00 |
| "Auto Radio Manual" Vol. 1..... | 4.95 |

Communications Receivers

| | |
|--|--------|
| "Communications Receivers" Vols. 2, 1, each..... | \$3.00 |
|--|--------|

Coyne and Boyce Books

| | |
|---------------------------------------|--------|
| "Coyne TV Servicing Cyclopedias"..... | \$5.95 |
| "Coyne Transistors"..... | 1.50 |
| "Coyne Practical TV Servicing"..... | 4.25 |
| "Coyne Latest Test Instruments"..... | 3.25 |
| "Coyne TV & Radio Handbook"..... | 2.75 |
| "Coyne Industrial Electronics"..... | 3.75 |
| "Boyce Video Handbook"..... | 5.95 |
| "Boyce Video Handbook"..... | 4.95 |

See these and dozens of other
invaluable books on the
Howard W. Sams "Book Tree"!

HOWARD W. SAMS & CO., INC.
Indianapolis 5, Indiana

Look for these books—
order them at your Parts Distributor

RADIO-ELECTRONICS



NO EXPERIENCE NECESSARY! LEARN TELEVISION AT HOME IN YOUR SPARE TIME!

L. C. Lane, B.S., M.A.
President: Radio Television Training Association
Executive Director: Pierce School of Radio & Television

Super-Het Radio Receiver

Public Address System

C-W Telephone Transmitter

AC-DC Power Supply

Giant Screen TV Receiver

Combination Voltmeter-Ammeter-Ohmmeter

RF Signal Generator



You build all this equipment and more! Everything yours to keep.

VETERANS! CIVILIANS! BE A SUCCESS AS A TRAINED TV TECHNICIAN!

Keep your present job while I prepare you AT HOME, using the same successful methods that have helped hundreds of men—many with no more than grammar school training—master television!

Those as in A dust want for "leat send hunt

WARNING!

ALL VETERANS DISCHARGED BEFORE AUGUST 20, 1952 must be enrolled and IN TRAINING by August 20, 1954. Otherwise you lose your G.I. rights to a free education under NEW G.I. BILL! Don't put it off . . . it takes several months to get your papers processed! RUSH COUPON BELOW. Tell your ex-G.I. friends!

state place s in- dustri ways come You nt I lped mar

VETERANS!

MY SCHOOLS FULLY APPROVED TO TRAIN VETERANS UNDER NEW G.I. BILL! If discharged after June 27, 1950 — CHECK COUPON! Also approved for RESIDENT TRAINING in New York City . . . qualifies you for full subsistence allowance up to \$160 per month.

EXPERT FM-TV TECHNICIAN TRAINING!

My FM-TV Technician Course can save you months of training if you have previous Armed Forces or civilian radio experience! Train at home with kits of parts, plus equipment to build BIG SCREEN TV RECEIVER, and FREE FCC Coaching Course! ALL FURNISHED AT NO EXTRA COST!

NEW! PRACTICAL TV CAMERAMAN & STUDIO COURSE!



(For men with previous radio & TV training)
I train you **at home** for an exciting big pay job as the man behind the TV camera. Work with TV stars in TV studios or "on location" at remote pick-ups! A special one-week course of practical work on TV studio equipment at Pierce School of Radio & TV, our associated resident school in New York City, is offered upon your graduation.

FREE FCC COACHING COURSE!

QUALIFIES YOU FOR HIGHER PAY! Given to all my students AT NO EXTRA COST after TV Theory and Practice is completed. Helps you qualify for the TOP JOBS in Radio-TV that demand a FCC License! Full training and preparation at home for your FCC License.

OPTIONAL: TWO WEEKS TRAINING IN NEW YORK CITY AT NO EXTRA COST

You get two weeks, 50 hours, of intensive Laboratory work on modern electronic equipment at our associated school in New York City—Pierce School of Radio and Television. And I give you all this AT NO EXTRA COST whatsoever, after you finish your home study training in the Radio-FM-TV Technician course and FM-TV Technician Course.

RADIO-TELEVISION TRAINING ASSOCIATION

52 East 19th Street, New York 3, N. Y.

Licensed by the State of New York

Approved by the VA

ENOUGH EQUIPMENT TO SET UP YOUR HOME LABORATORY!

As part of your training, I give you ALL the equipment you need to prepare for a BETTER PAY TV job. You build and keep a professional GIANT SCREEN TV RECEIVER complete with big picture tube (designed and engineered to take any size up to 21-inch) . . . also a Super-Het Radio Receiver, RF Signal Generator, Combination Voltmeter-Ammeter-Ohmmeter, C-W Telephone Transmitter, Public Address System, AC-DC Power Supply. Everything supplied including all tubes.

GOOD SPARE TIME EARNINGS!

Almost from the very start you can earn extra money *while learning*, repairing Radio-TV sets for friends and neighbors. Many of my students earn up to \$25 a week . . . pay their entire training from spare time earnings . . . start their own profitable service business. *Act now! Mail coupon and find out for yourself what a TV career can do for you!*

MAIL COUPON TODAY!

MY 4 FREE AIDS SHOW YOU HOW AND WHERE TO GET A BETTER PAY JOB IN TELEVISION! See for yourself how my simple, practical methods make success easy.



NO SALESMAN WILL CALL!

Mr. Leonard C. Lane, President
RADIO-TELEVISION TRAINING ASSOCIATION
52 East 19th St., New York 3, N. Y. Dept. R-4B

Dear Mr. Lane: Mail me your NEW FREE BOOK, FREE SAMPLE LESSON, and FREE aids that will show me how I can make BIG MONEY IN TELEVISION. I understand I am under no obligation and no salesman will call.

(PLEASE PRINT PLAINLY)

NAME _____ AGE _____
ADDRESS _____
CITY _____ ZONE _____ STATE _____

I AM INTERESTED IN:

- Radio-FM-TV Technician Course
- FM-TV Technician Course
- TV Cameraman & Studio Course

VETERANS! Check here for Training under NEW G.I. Bill

TO THE

E. E.

OR

**PHYSICS
GRADUATE**

WITH EXPERIENCE IN

RADAR

OR

ELECTRONICS

HUGHES RESEARCH AND DEVELOPMENT LABORATORIES ARE ENGAGED IN A CONTINUING PROGRAM FOR DESIGN AND MANUFACTURE OF ADVANCED RADAR AND FIRE CONTROL SYSTEMS IN MILITARY ALL-WEATHER FIGHTERS AND INTERCEPTORS.

YOU WILL serve as technical advisor in the field to companies and government agencies using Hughes equipment.

TO BROADEN your field of experience in radar and electronics you will receive additional training at full pay in the Laboratories to become thoroughly familiar with Hughes radar and fire control equipment.

AFTER TRAINING you will be the Hughes representative at a company where our equipment is installed; or you will direct operation of Hughes equipment at a military base.

THE GREATEST advancements in electronics are being made in this sphere because of military emphasis. Men now under 35 years of age will find this activity can fit them for future application of highly advanced electronic equipment.

HUGHESRESEARCH AND DEVELOPMENT
LABORATORIESSCIENTIFIC AND
ENGINEERING STAFF*Culver City, Los Angeles County, Calif.*

Assurance is required that relocation of the applicant will not cause disruption of an urgent military project.

picture tubes valued at \$234,721,038 were sold by manufacturers during 1953. This compared with 7,635,666 sold in 1952. RETMA also announced that 437,091,555 receiving tubes valued at \$303,675,313 had been sold during 1953 as compared with 368,519,243 valued at \$259,116,089 in 1952.

Meetings and Conferences

RETMA Engineering Department will hold a conference on reliability of electrical connections April 15 and 16 at the Illinois Institute of Technology, Chicago.

Stanford Research Institute and the U. S. Air Force are jointly sponsoring a symposium on the automatic production of electronic equipment at San Francisco's Fairmont Hotel, April 19-20.

Business Briefs

... An Operating Committee of the Industry Relations Committees of six trade associations was formed recently to co-ordinate the various regional conferences sponsored by representatives. W. D. Jenkins, Radio Supply Co., Richmond, Va., is chairman *pro tem*. Two members representing each of the following, comprise the committee: Sales Managers Club, Eastern Group; Association of Electronic Parts & Equipment Manufacturers; NEDA; "The Representatives"; RETMA; and the WCEMA. Tentatively the committee will support the Southwestern Conference; the Minnesota Conference; and the Missouri Valley Conference in 1954, and a Rocky Mountain and Pacific Northwest; a Southeastern; and Northeast Conference in 1955.

... RETMA has prepared a standard parts tag as an aid to radio and TV service technicians in returning components to manufacturers for replacement under a set warranty.

... Sylvania Electric Products' director of sales research, Frank W. Mansfield, stated that electronics in the U.S. is currently an \$8 billion industry which should exceed \$13 billion within the next eight years.

... RCA Tube Department, Harrison, N. J., has developed a new tube inventory service to provide industrial users of RCA transmitting and receiving tubes with a systematic inventory and re-order control.

... Wells & Winegard, Burlington, Iowa, television accessory manufacturer, is now under the sole ownership of John R. Winegard, who purchased the interest of John Wells.

... Tele King Corp., New York City, radio and TV manufacturer, filed voluntary proceedings for bankruptcy under Chapter XI. Petition estimates liabilities at \$4,050,000 and assets at \$4,439,000. They propose 100% settlement, payable in annual installments of 10%.

... NTSC, the industry-wide organization of electronic engineers and scientists which developed the color television standards recently approved by the FCC, disbanded early this year.

... John F. Rider Publisher, New York City, announced that it had been selected to publish the texts to be used in the RETMA courses in television servicing.

... Channel Master Corp., Ellenville, N. Y., held a series of regional conferences for its distributors in Ellenville, N. Y. During the first of these conferences, Harold Harris, vice-president in charge of sales and engineering for Channel Master, predicted that the total volume of TV antenna sales in 1954 would be the largest in history both in units and dollars.

... General Dry Batteries, Inc., Cleveland, now includes NEDA battery numbers on its cartons.

... CBS, General Electric, Motorola, Philco, RCA, Sylvania, Westinghouse, and Zenith were certified as "excellently managed" by the American Institute of Management.

... Allen B. DuMont Laboratories, Clifton, N. J., entered the field of mobile communications equipment with the formation of a new Communication Products Division, which will take over and expand the activities of the Television Transmitter Division. Herbert E. Taylor, Jr., manager of the former Transmitter Division, has been named to handle the new operation.

... The High Fidelity Institute of the Electronic Industries was organized as a non-profit association to promote the interests of the growing high-fidelity industry. It will work toward the establishment of uniformity of technical standards, new markets, equitable trade practices and effective promotional methods. Jerome J. Kahn was drafted as temporary commissioner. Temporary headquarters were set up in 1 N. LaSalle St., Chicago. A six man provisional Board of Governors was named which includes Charles A. Hansen, Jensen Mfg. Co.; Leonard Carduner, British Industries; Emmanuel Berlant, Berlant Associates; Gramer Yarbrough, American Microphone; John H. Cashman, Radio Craftsmen; and Walter O. Stanton, Pickering, Inc.

Electric Sweeper Service Co., 2034 Euclid Ave., Cleveland, O., designed a program whereby TV-radio service technicians may add to their regular income by servicing small appliances.

... The International Sight and Sound Exposition, Inc., sponsors of the 1954 High Fidelity Show to be held in the Palmer House, Chicago, Sept. 30-Oct. 2, announced that contracts for display space are running better than 40% ahead of the amount sold for the 1953 show at this time last year. **END**

RADIO-ELECTRONICS

NOW FROM P. R. MALLORY & CO. Inc. **MALLORY...**



the **1**st... All-Channel
UHF Converter
Designed to fit
Inside ANY VHF Set

Here's another first from Mallory . . . The Mallory Model '188' Concealed UHF Converter. It fits inside any VHF set to make it an all-channel receiver. And it's a sure-fire salesbuilder for you.

Look at these features of the Mallory '188'.

OUT OF SIGHT . . . The entire unit is mounted inside the cabinet. All that shows is a clear plastic selector dial and switch lever.

EASY TO INSTALL . . . No alteration in the set chassis is required and the '188' has its own power supply. Can be mounted inside the cabinet on either side or at the top. A bracket and four screws do the job on wood cabinets. On plastic or metal cabinets, the converter can be mounted on the fiber-board rear enclosure.

PROVED PERFORMANCE . . . The '188' offers you the same proved performance . . . the same high quality reception . . . as the Mallory '88' Cabinet Converter which has given outstanding performance in UHF areas across the Nation.

*Give Yourself Greater Converter Sales . . .
By Giving Your Customers Their Choice
of Mallory Converter Styles.*



*Mallory Concealed Converter
—first on the market*

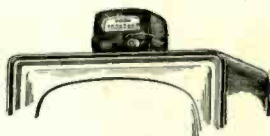

*Mallory Cabinet Converter
—first on the market*

.....
NO RADIATION PROBLEM!

Both Mallory Converters contain specially designed components to prevent troublesome interference from radiation—a problem common to low quality converters which ruin TV reception over a wide area.

P. R. MALLORY & CO. Inc.
MALLORY

CAPACITORS • CONTROLS • VIBRATORS • SWITCHES • RESISTORS
RECTIFIERS • POWER SUPPLIES • CONVERTERS • MERCURY BATTERIES

APPROVED PRECISION PRODUCTS

P. R. MALLORY & CO. Inc., INDIANAPOLIS 6, INDIANA

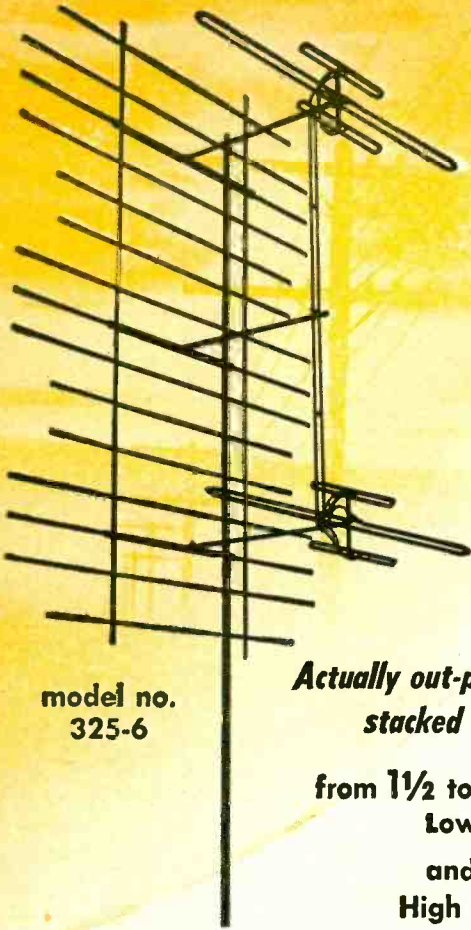

model no.
325-6

**Actually out-performs the
stacked CHAMPION**

**from 1½ to 3 DB more
Low Band gain
and 1 DB more
High Band gain!**

Channel Master proudly introduces the SUPER CHAMP — the newest addition to the Champion antenna family. The Super Champ is a super-powerful antenna that provides extraordinary VHF-UHF reception at greater distances than has ever before been possible.

How it Works:

The Tri-Pole assemblies of the stacked Champion have been wider-spaced by the addition of a third reflecting screen between the antennas. These antennas are joined with a newly-designed half-wave stacking harness. The result: Tri-Pole assemblies are spaced a full half-wave on the Low Band, increasing both Low and High Band gain.

Champion Performance on UHF

In addition to its sensational VHF performance, Channel Master's entire Champion series — including the Super Champ — has been carefully designed to provide excellent reception on the UHF band. Write for complete technical details.

AVAILABLE TWO WAYS:

- 1. As a complete antenna, model no. 325-6**
Consists of two Tri-Pole assemblies, three reflecting screen assemblies and a special stacking harness for wide-spaced Tri-Pole. **\$54¹⁷**
list
- 2. As a Conversion Kit, model no. 325-7**
For converting standard 2-bay Champions into Super Champs. Consists of reflecting screen and specially-designed stacking harness.

CHANNEL MASTER'S *new*
SUPER CHAMP

featuring wide-spaced stacking of Tri-Pole assemblies

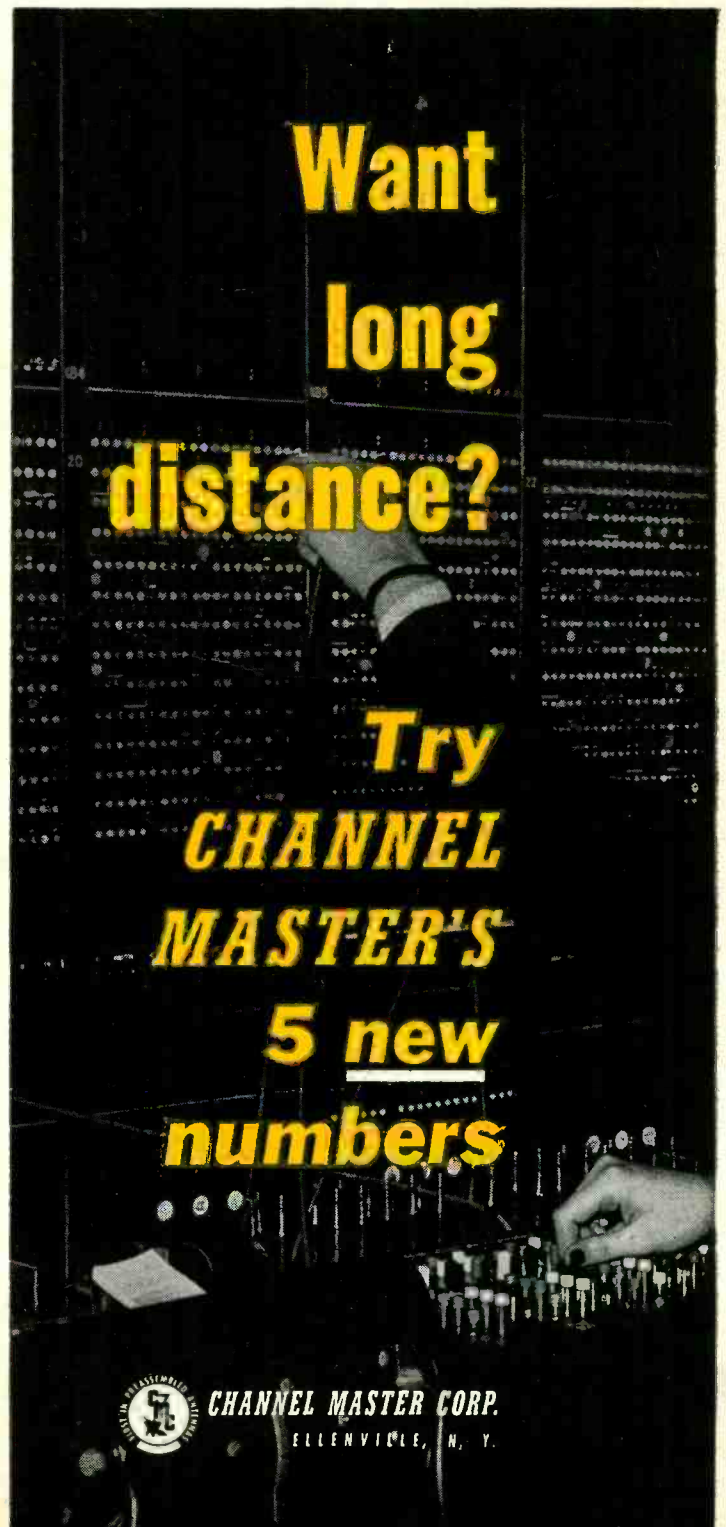

**Want
long
distance?**

**Try
CHANNEL
MASTER'S
5 new
numbers**



CHANNEL MASTER CORP.
ELLENVILLE, N. Y.

Designed for **POWER!** Low Priced for **ACTION!**

These new antennas are the most sensitive of their type — feature Channel Master's famous built-in quality at remarkable low prices, to help you meet competition on any level.



model no.
1573
\$14.58
list

covers channels
7 through 13

- 10 elements
- Featuring "Tuning Fork" for flat gain level
- Transformer-type dipole

CHALLENGER BROAD BAND YAGIS

Here's Broad Band coverage with the high gain and directivity of the Yagi. Ideal for areas served at present by two or more VHF stations on the same band and areas where new VHF stations are being added to present ones, on the same band. Feature 100% aluminum construction; are completely preassembled. They give high gain across the band; high front-to-back ratio. Can be stacked for extra sensitivity.

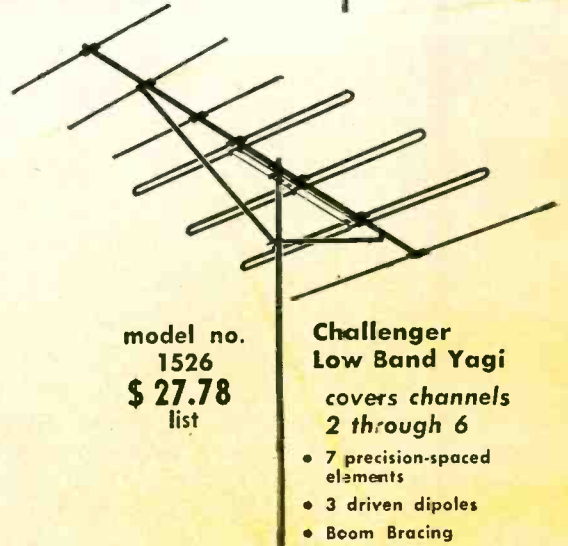

model no.
1526
\$27.78
list

**Challenger
Low Band Yagi**

covers channels
2 through 6

- 7 precision-spaced elements
- 3 driven dipoles
- Boom Bracing

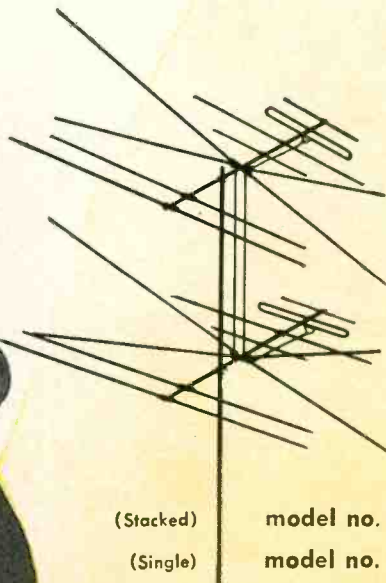

(Stacked)

model no. 321-2 **\$25.97** list

(Single)

model no. 321 **\$12.64** list

GLOBE TROTTER

- All-channel VHF *fringe* area coverage.
- All-channel UHF *primary* area coverage.
- 100% aluminum construction.
- Completely preassembled — no loose hardware.

MULTI-BOW

covers channels 14 through 83

- Outstanding fringe area reception.
- All-aluminum, solid sheet elements.
- "Free-Space" terminals.
- Heavy-duty welded wire screen, bright zinc electroplated.

model no.
410
\$11.11
list

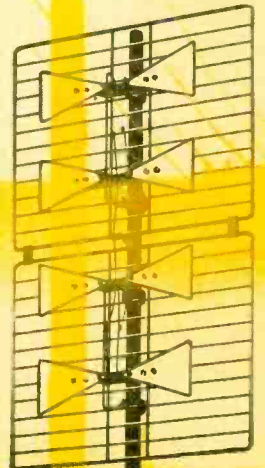

The World's Largest Manufacturer
of Television Antennas

Copyright 1954 Channel Master Corp.

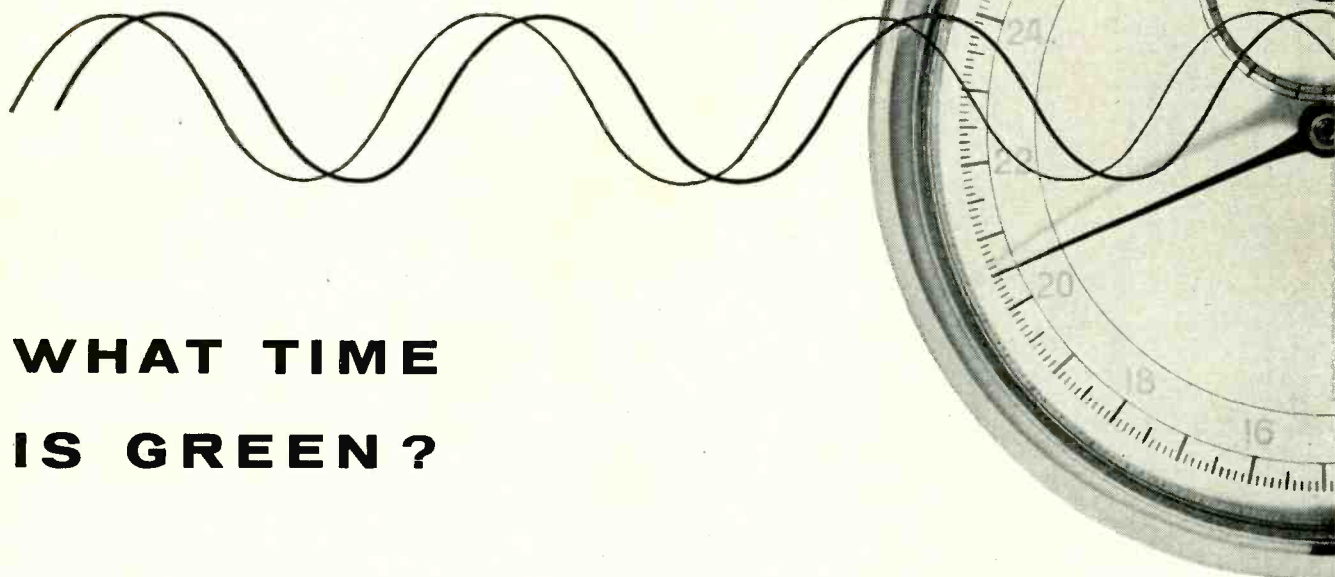
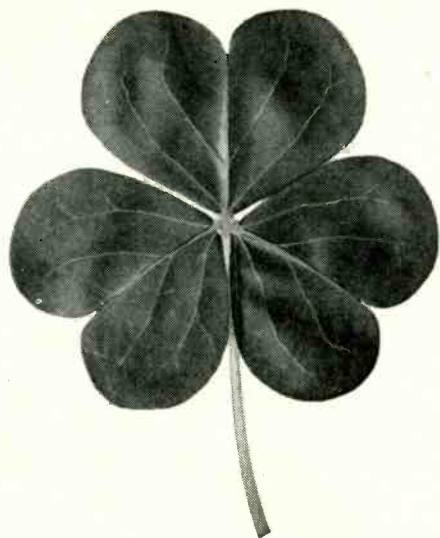

WHAT TIME IS GREEN?

In color television, the colors on the screen are determined in a special way. A reference signal is sent and then the color signals are matched against it. For example, when the second signal is out of step by 50-billionths of a second, the color is green; 130-billionths means blue.

For colors to be true, the timing must be exact. An error of unbelievably small size can throw the entire picture off color. A delay of only a few billionths of a second can make a yellow dress appear green or a pale complexion look red.

To ready the Bell System's television network for color transmission, scientists at Bell Telephone Laboratories developed equipment which measures wave delay to one-billionth of a second. If the waves are off, as they wing their way across the country, they are corrected by equalizers placed at key points on the circuit.

This important contribution to color television is another example of the pioneer work done by Bell Telephone Laboratories to give America the finest communications in the world.

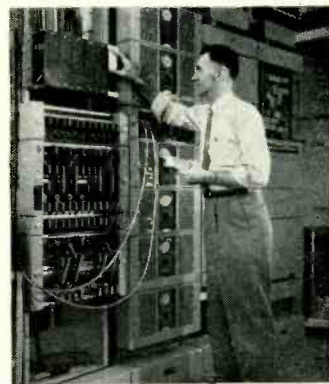

To keep colors true in television, signals must be kept on one of the world's strictest timetables. Equalizers that correct off-schedule waves are put into place at main repeater stations of the transcontinental radio-relay system.

BELL TELEPHONE LABORATORIES
IMPROVING TELEPHONE SERVICE FOR AMERICA PROVIDES CAREERS FOR
CREATIVE MEN IN SCIENTIFIC AND TECHNICAL FIELDS.



RADIO-ELECTRONICS

**PEOPLE WON'T LOOK FOR YOU TO GIVE YOU
RADIO AND TELEVISION SERVICE BUSINESS...**

because YOU'RE PRETTIER  THAN YOUR COMPETITOR OR

because YOU EMPLOY MORE MEN  OR

because YOU HAVE FLASHIER TRUCKS 

BUT... THEY WILL LOOK FOR YOU AND GIVE YOU

MORE BUSINESS* IF YOU ARE A



BONDED ELECTRONIC TECHNICIAN



and YOU'LL KEEP THE BUSINESS IF YOU USE



QUALITY RADIO AND TELEVISION TUBES



because THEY ARE **RIGHT... FOR SOUND AND SIGHT!**

**BETTER ASK YOUR RAYTHEON TUBE DISTRIBUTOR IF YOU CAN
QUALIFY FOR THIS EXCLUSIVE SALES STIMULATOR**

*In a recent survey Raytheon Bonded Electronic Technicians indicated that the Raytheon Bonded Program boosts their volume and profit at least 10 per cent.

RAYTHEON MANUFACTURING COMPANY

Receiving Tube Division
Newton, Mass., Chicago, Ill., Atlanta, Ga., Los Angeles, Cal.

RAYTHEON MAKES ALL THESE:

RECEIVING AND PICTURE TUBES • RELIABLE SUBMINIATURE AND MINIATURE TUBES • SEMICONDUCTOR DIODES AND TRANSISTORS • NUCLEONIC TUBES • MICROWAVE TUBES



Excellence in Electronics

HICKOK

MODEL

225

NEW LOW PRICE ELECTRONIC VOLT OHMMETER

\$ 89⁵⁰
NET

- Huge 9" Meter
- New Feature Permits Fast Continuity Tests
- Plus and Minus D.C. Voltages
- D.C. Zero-Center Scale

HICKOK practical engineering provides the low-cost answer to your needs for a multi-range Volt-Ohmmeter in a professional engineer's top quality instrument.

Designed around the HICKOK-built 9" internal pivot meter, the 225 offers many new features to improve the speed and accuracy of your radio-TV servicing.

Extra long scales minimize reading errors and permit permanent placement of the equipment at a more practical working distance.

Additional features: • Built-in buzzer for continuity tests • Accurate Peak-to-Peak scales for measurement of complex waveforms • D.C. Zero-Center scale for galvanometer applications • New, HICKOK single unit AC-DC probe.

Functions:

D.C. VOLTMETER: Plus D.C. Volts: 0 to 1.5, 3, 12, 30, 120, 300, 1200.

Minus D.C. Volts: 0 to 1.5, 3, 12, 30, 120, 300, 1200.
Input Resistance: 10 megohms with new HICKOK Dual-Probe.

Zero-Center Scale: For discriminator alignment and other galvanometer applications.

OHMMETER: Design Center: 10 ohms.

Ranges: x1, x10, x100, x1000, x10,000, x100,000, x1 megohm.

Readability: 0.2 ohms to 1,000 megohms.

A.C. VOLTMETER: 7 Ranges A.C. RMS: 0 to 1.5, 3, 12, 30, 120, 300, 1200.

7 Ranges A.C. Peak-to-Peak: 0 to 4, 8, 32, 80, 320, 800, 3200.

Frequency Characteristics: Flat from 40 cps. to 3.5 mc.



Dual Purpose
Single Unit AC-DC Probe

MODEL 225

See your Parts Jobber and ask for a demonstration of the Model 225 today!

PR30 High Voltage Probe

Extends range of the Model 225 to 30,000 volts DC.

\$ 11⁹⁰
NET



THE HICKOK ELECTRICAL INSTRUMENT COMPANY

10531 DUPONT AVENUE

CLEVELAND 8, OHIO

FREE



New 24-page handbook illustrating and describing the use and operation of a Cathode Ray Oscilloscope.

Write for your copy today!

RADIO-ELECTRONICS

NEW



TIGHTEST SEAL
LOCKS IN PERFORMANCE

TOUGHEST SHELL
LOCKS OUT TROUBLE

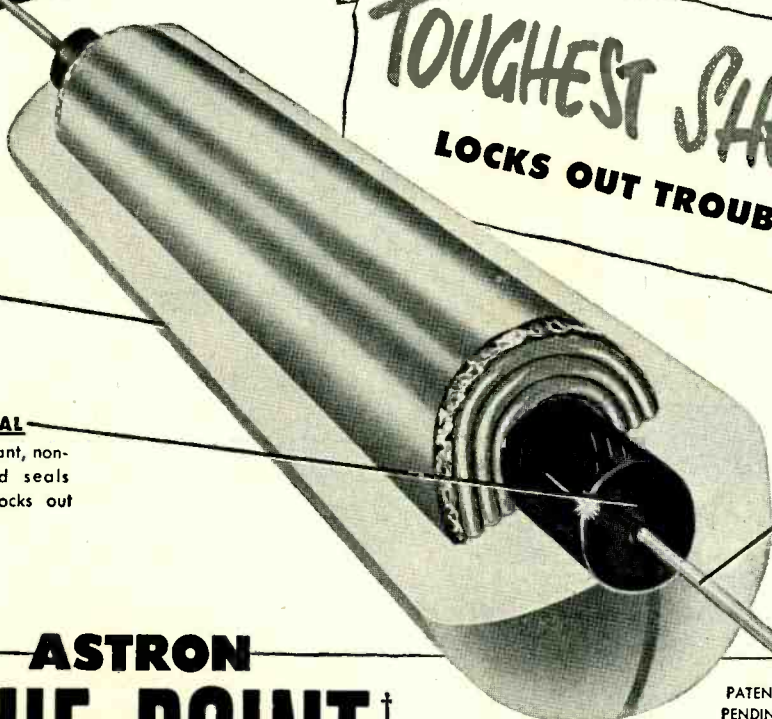
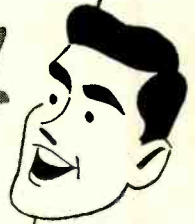

ATTRACTIVE YELLOW MOLDED PLASTIC SHELL

Non-inflammable. Will not burn or melt under soldering iron or flame.

BONDED SEAL

Positive, heat resistant, non-inflammable bond seals leads and shell, locks out humidity.

FIRMLY SECURED LEAD
Can't be pulled out, even under soldering iron heat.

PATENT PENDING

ASTRON BLUE-POINT[†] MOLDED PLASTIC PAPER *Capacitors*

THE NEWEST ADDITION
TO THE **SM**[†] LINE

Yes, the ASTRON BLUE-POINT's *tighter seal* and *tougher shell* give you heat and moisture protection to a degree never before possible—providing a longer life and greater dependability than has ever been achieved in a molded plastic capacitor! BLUE-POINT is a capacitor you can rely on *completely*, under every condition.

BLUE-POINT is suitable for continuous operation at 85°C. The bonded seal uses a special thermo-setting, heat-resistant, non-inflammable bonding agent—*positive* protection

against moisture. Solder leads as close to the capacitor as you like—they *won't* pull out! Every BLUE-POINT is clearly marked with voltage and capacitance, bears outside foil identification. Every BLUE-POINT is *tested* and *guaranteed*. Look for the ASTRON BLUE-POINT when you buy capacitors from your jobber, or if he doesn't carry it, send us his name. Insist on ASTRON BLUE-POINT, the capacitor you *know* you can depend on. Order a supply today.

For complete performance characteristics, specifications and listings, write to Department RE for Bulletin AB-20A.

DEPEND ON—INSIST ON



Vicix

THE ASTRON EXHIBIT
Booth 368

I.R.E. Radio Engineering Show
March 22-25

ASTRON CORPORATION

255 Grant Avenue, East Newark, New Jersey

In Canada: Charles W. Pointon, 6 Alcina Avenue, Toronto 10 Ont.

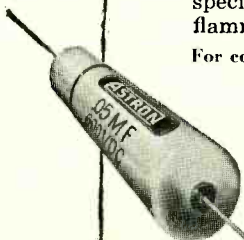

Patent Pending

†Trade Mark

* Safety Margin

8 vertical outputs
 1 deflection yoke
 1 filter choke
 5 width and linearity controls
 17 exact replacement flybacks
 23 TV power transformers

55 NEW TV REPLACEMENT COMPONENTS HAVE BEEN ADDED TO THE STANCOR LINE

STANCOR
 YOUR MOST COMPLETE SOURCE
 OF TV REPLACEMENT
 TRANSFORMERS

28 flybacks (27 exact duplicates)
 55 TV power transformers
 8 deflection yokes
 9 width and linearity controls
 15 vertical outputs
 8 blocking-oscillators
 3 focus coils
 5 filament transformers
 22 filter chokes
 19 audio outputs

NOW 172 TV REPLACEMENT COMPONENTS ARE IN THE STANCOR LINE

Ask for Stancor's new TV Replacement Guide listing replacement applications for these transformers in 6800 TV models and chassis. FREE from your local Stancor distributor, or from Chicago Standard Transformer Corporation.



CHICAGO STANDARD
 TRANSFORMER CORPORATION

3592 ELSTON AVE. • CHICAGO 18, ILL.

EXPORT SALES: Roburn Agencies, Inc., 39 Warren Street, New York 7, N.Y.

Stancor transformers are listed in Sams Photofact Folders and in Counter-facts.

A Brief Survey of COLOR TV

... how its
complex character
means job opportunity
for you



—by E. H. RIETZKE,
President, Capitol Radio Engineering Institute

cate—problems. That's a very quick run-down from the transmitter end. Every step is a technical opportunity.

What about color receivers? They'll be bigger—with roughly twice as many receiver tubes as black-and-white. There is at least one more tuning knob—the chroma control for color saturation. Maintenance is complicated, to say the least, with three highly critical video channels to trouble-shoot instead of one. Service contracts for color receivers will cost considerably more than for black-and-white, according to highly qualified sources—which should give you an idea of servicing complexity—and earnings possibilities. So much for transmission and reception. Manufacture of color equipment is another field for *trained* technicians.

Most well-informed sources agree that color television will be spread all over the U.S. by 1956 at the latest. *The years between now and then are crucial.* If you are interested in an honest-to-goodness career in this booming part of the booming electronics industry, here's how you can step ahead of competition, move up to a better job, earn more money, and be sure of a well-paid job: Study radio-television-electronics via CREI. You don't have to be a college graduate. You *do* have to be willing to invest some of your spare time—at home. You can do it while holding down a full-time job. Thousands have.

Since 1927 CREI has provided men with the technical knowledge that leads to more job security—and more money. CREI starts with fundamentals and takes you along at your own speed, not held back by a class, not pushed to keep up with others who have more experience. You master the fundamentals, then get into more advanced phases of electronics engineering principles and practice. Finally you may elect training at career level in highly specialized applications of radio or television engineering, or aeronautical radio. The coupon below, properly filled out, will bring you—without cost—a fact-packed booklet, "Your Future in the New World of Electronics," which includes outlines of courses offered, a resume of career opportunities, full details about the school, our Placement Bureau (with more requests for trained men currently on file than we can fill), and the names of some of the organizations using CREI training (like All American Cables & Radio, Inc., Canadian Broadcasting Corp., Columbia Broadcasting System, RCA Victor Division, United Air Lines, to name a few). I urge you—for your own good—to send for this free booklet immediately.

NOTE: CREI also offers Resident School instruction, day or evening, in Washington, D. C. New classes start once a month. If you are a veteran discharged after June 27, 1950, let the new GI Bill help you obtain resident (or home study) instruction. Check the coupon for more data.

A GOOD MANY YEARS AGO, when he was a young fellow, my Dad was one of the country's fastest typesetters. He could go anywhere and get a highly paid job with any newspaper in the country. *Then came the linotype machine!* Before he knew it, my Dad's job was obsolete. He had to start all over in another line of work.

How will *you* get along in the age of *Color TV* that has already arrived? Will you have to start all over? Or will you be prepared? The choice is a matter of black-and-white—or *color*. As you may know, color TV involves handling an understandably much more complicated signal than for black-and-white; the components must be in perfect balance; the margin for error is practically zero. Technical personnel need new skills in working to closer tolerances. Microwave relays and coaxial cables require added equipment and special adjustments. Before a station can originate color it needs a great deal of additional equipment, much more expensive and vastly more complicated than that for black-and-white. Slide and film equipment also require additional components and maintenance. Color camera chains are much more complex, requiring more highly skilled adjustments and care. Reports of network experiments indicate that live telecasting in color increases technical man-hours required by 30 to 50%. Lighting personnel need more skill in handling new—and deli-

CAPITOL RADIO ENGINEERING INSTITUTE

An Accredited Technical Institute • Founded in 1927
3224 16th Street, N.W. Dept. 144-A Washington 10, D. C.

Send booklet "Your Future in the New World of Electronics" and course outline.

CHECK
FIELD OF
GREATEST
INTEREST

- Practical Radio Engineering
- Broadcast Radio Engineering (AM, FM, TV)
- Practical Television Engineering
- TV, FM & Advanced AM Servicing
- Aeronautical Radio Engineering

Name.....
Street.....
City.....Zone.....State.....

Check:
 Residence
 School
 Veteran

Your Own Portable "TV Station" For Receiver Adjustment

NEW!

PHILCO

TELEVISION PATTERN GENERATOR

DEVELOPS BOTH RF AND VIDEO OUTPUT



A Must for Areas Where Continuous Station Broadcasts are Not Available

Now use the dot and line patterns from the new PHILCO Model G-805 to check linearity, focus, astigmatism, blooming and high voltage regulation. Trouble shoot receivers on any channel, 2 through 6, or with video output. The PHILCO G-805 Television Pattern Generator is an instrument especially adapted for service work . . . designed to save you time.

PHILCO MODEL S-8200 3" OSCILLOSCOPE

A sensitive, portable unit adaptable to either bench or field service. **VERTICAL AMPLIFIER:** DC coupled, Sensitivity—0.05V rms/inch. Frequency Response—0.1 mc/s within 6DB. DC coupled Vert. Amplifier circuits and low capacity probes facilitate video circuit trouble shooting. Built-in voltage calibrator permits use as high sensitivity vacuum tube voltmeter. **HORIZONTAL AMPLIFIER:** Sensitivity—0.5V rms/inch. Frequency Response—10 cps to 125 KC/s within 6DB. Sweep Circuit Frequency—Variable 15 to 30,000 cps . . . preset frequencies at vertical and horizontal sweep rates.



Look at These Philco Features . . .

1. Provides new white dot pattern and either white or black vertical lines for *all* cathode ray tube circuits.
2. Easy to operate: connect Pattern Generator output to TV set. Select proper test pattern. Accurately check both the vertical and horizontal sweep circuit performance.
3. External Sync. Jack improves stabilization in many special cases. Provides wide range operation.
4. A custom type instrument with new and novel circuits designed to reduce service time in both laboratories and service shops.

AVAILABLE THROUGH YOUR PHILCO DISTRIBUTOR
ON A NEW SPECIAL PAYMENT PLAN



Take advantage of the great
SHARE and PROFIT Program
on Philco Receiving Tubes
Parts and Accessories
NOW AT YOUR PHILCO DISTRIBUTOR



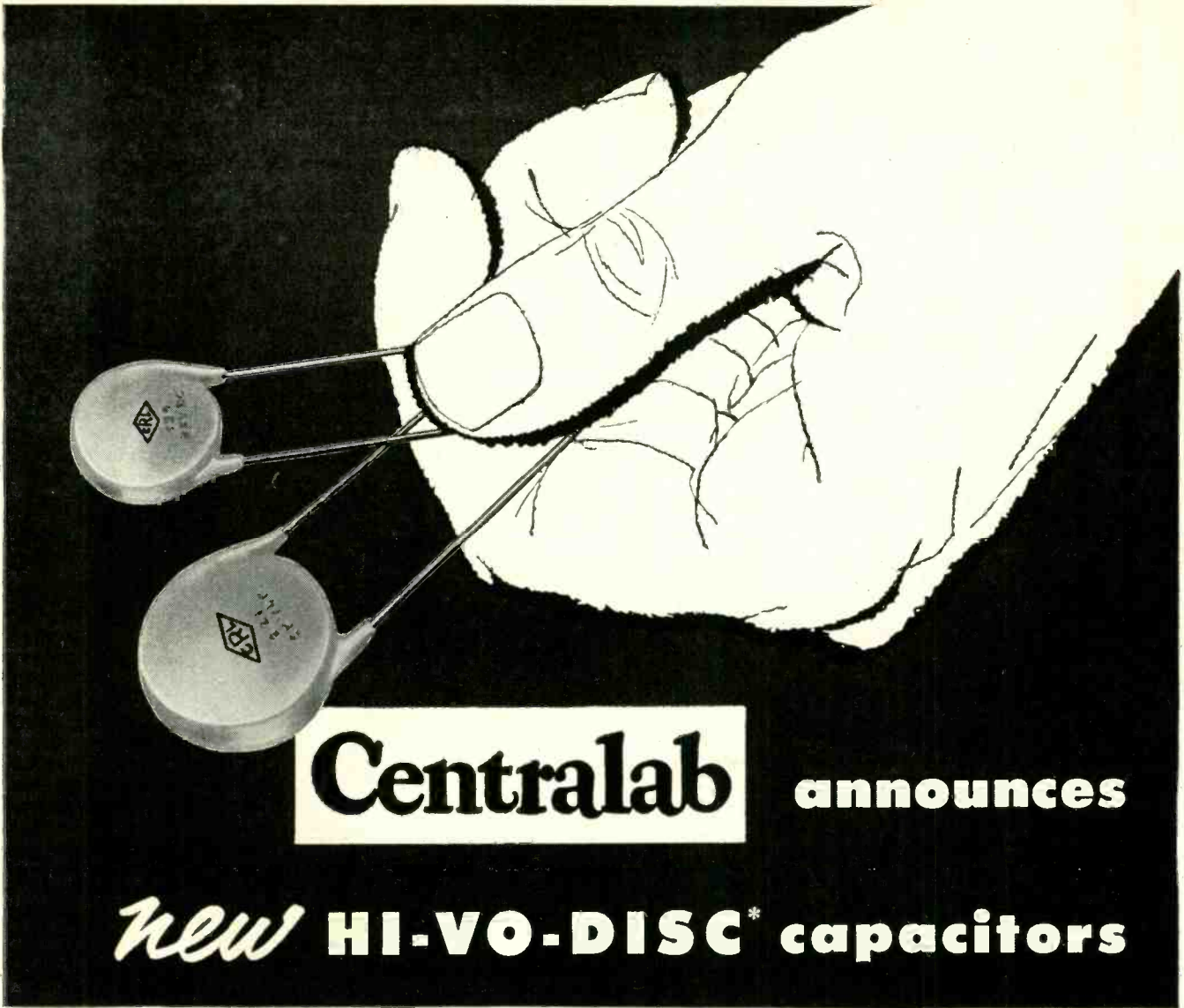

Centralab announces

new **HI-VO-DISC*** capacitors

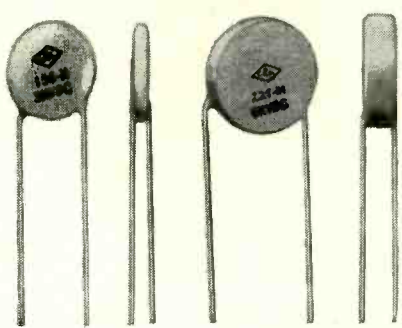

DD30

DD60

3000-VDCW and 6000-VDCW discs that are highly efficient as bypass and coupling capacitors in high-frequency circuits under conditions of extreme humidity or temperature

Centralab does it again — gives you and your customers more for your money in two new series of high-voltage disc capacitors. You'll agree that they're tip-top additions to the world's greatest line of ceramic capacitors.

Every unit in both the DD30 and DD60 series is tested at twice rated working voltage. So you know you can count on them for high capacity

and performance up to 85° C.

There are other reasons why these CRL Hi-Vo-Discs help end profit-robbing call-backs: The heavy, special phenolic insulation has triple-high-temperature wax impregnation. Tolerances are held to ± 20%.

Send coupon for catalog sheet 28-2 —for complete information on these new CRL capacitors for bypass, coupling, and general applications.

Centralab
A DIVISION OF GLOBE-UNION INC.
 Milwaukee 1, Wisconsin
 In Canada
 804 Mt. Pleasant Rd., Toronto 12, Ontario

CENTRALAB, A Division of Globe-Union Inc.
 922D E. Keefe Avenue, Milwaukee 1, Wisconsin

Send me catalog sheet 28-2 describing Centralab's new HI-VO-DISC capacitors.

Name.....
 Company.....
 Address.....
 City..... Zone..... State.....

D-2154

NOW... 2 SENSATIONAL EICO SCOPE VALUES!

NEW AMAZING FEATURE PACKED

7" PUSH-PULL OSCILLOSCOPE

Only **EICO** Has All These Features

- VERTICAL FREQ. RESPONSE: flat ± 2 db 10 cps - 1 mc
- VERTICAL SENS.: .01 volts rms/inch
- HOR. FREQ. RESP.: flat ± 0 db 10 cps - 200 kc, -4 db at 500 kc
- HOR. SENS.: .3 volts rms/inch
- SWEEP RANGE: 15 cps-100 kc
- 3-STEP FREQ.-COMPENSATED ATTENUATOR eliminates freq. distortion, overloading.
- CATHODE FOLLOWER inputs to both amplifiers
- PUSH-PULL outputs in both amplifiers
- RETURN TRACE BLANKING
- INT. VOLTAGE CALIBRATOR
- V & H TRACE EXPANSION & CENTERING: 1.5X full screen without distortion.
- DIRECT CONNECTION to vert. CRT plates.
- PHASING CONTROL of internal 60 cps sine wave sweep.
- AT FRONT PANEL: intensity mod. input; 60 cps, sawtooth outputs.

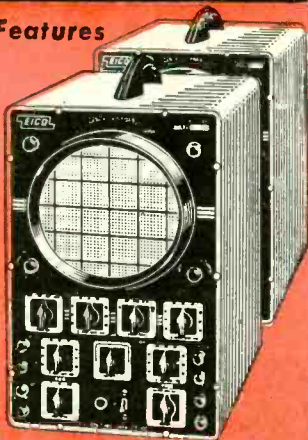

MODEL 470K
KIT \$79.95. WIRED \$129.50.

EICO EXCLUSIVE! 5" PUSH-PULL SCOPE, 425K, Amazing feature-packed economy-priced Wired, \$79.95. KIT, \$44.95.

- PUSH-PULL V & H amplifiers. Sens: 0.5-1 rms v/in. Useful to 2.5 mc.
- SWEEP: 15 cps-76 kc. Z-axis intensity modulation. Dual trace positioning controls.



SCOPE VOLTAGE CALIBRATOR KIT
495K KIT \$12.95. WIRED \$17.95.

- Sq. wave output at power-line freq. with full-scale readings of .1, 1, 10 or 100 V. peak-to-peak.
- Accuracy $\pm 5\%$ of full-scale on each range.

6V & 12V BATTERY ELIMINATOR KIT 1050K KIT \$29.95. WIRED \$38.95.

- DC output: 0-8 V or 0-16 V.
- Continuous current rating: 10 A at 6 V, 6 A at 12 V.
- Intermittent current rating: 20 A at 6 V, 12 A at 12 V.
- Separate Voltmeter & Ammeter.



221K VTVM KIT \$25.95. WIRED \$49.95.

- AC & DC volts: 0-5, 10, 100, 500, 1000 V (30 KV with HVP-1 probe).
- 5 ohm ranges from .2 ohm to 1000 megs.
- DC input 2 26 megs.
- $4\frac{1}{2}$ " meter movement in can't-burn-out circuit.
- 1% mult. resistors.



330K SWEEP GEN. KIT \$34.95. WIRED \$49.95.

- Continuous coverage of all TV & FM freqs. from 500 kc to 228 mc.
- Sweep width variable 0-30 mc.
- Crystal marker oscillator, variable amplitude.

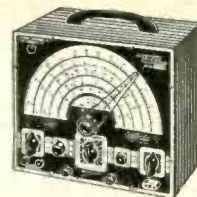

HIGH VOLTAGE PROBE \$6.95

- Extends range of VTVMs & voltmeters to 30 KV.



PIX TUBE ADAPTER for Tube Testers \$4.50. Checks TV picture tubes while in set.

214K VTVM KIT \$34.95. WIRED \$54.95.



- Large $7\frac{1}{2}$ " meter, can't-burn-out circuit.
- AC/DC volts: 0-5, 10, 100, 500, 1000 (30 KV with HV Probe).
- 5 ohms ranges from .2 ohm to 1000 megs.
- DC input 2 26 megs.
- 1% mult. resistors.

625K TUBE TESTER KIT \$34.95. WIRED \$49.95.



- Illum. gear-driven "Speed Rollchart."
- New lever-action switches for individual testing of every element.
- Tests all conventional & TV tubes.

COUNTER CABINET for above: add \$10.00 to Kit or Wired Prices.

CONDENSOR RESISTANCE TESTER WIRED \$29.95.



- Measures & tests all resistors; 5 ohm to 500 megohms.
- Every type condenser, 10 mmf to 5000 mfd.
- 0-500 DC voltage source for capacitor leakage testing.

NOW! ONLY **EICO** KITS & WIRED INSTRUMENTS Gives You LIFETIME SERVICE & CALIBRATION GUARANTEE*

*at less than our cost of handling (See EICO Guarantee Card enclosed with each Kit & Instrument).

117 K RES. DECADE BOX KIT \$19.95. WIRED \$24.95.

- Resistance values: from 0 to 99,999 ohms with 0.5% precision.
- All resistors have 0.5% accuracy

DECADE CONDENSER BOX KIT 1180K KIT \$14.95. WIRED \$19.95.

- All capacitors precision silver mica, accuracy $\pm 1\%$.
- Range from 100 mmf - 0.111 mfd in steps of 100 mmf.
- Smooth-action positive detent ceramic switches.

Prices 5% higher on West Coast. Specifications and prices subject to change without notice.

New! EICO SCOOPS!

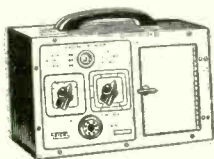

CATHODE RAY TUBE CHECKER 630K, WIRED \$24.95 KIT, \$17.95.

- Checks all types of TV picture and C.R. tubes in the set or carton. Bridge measurement of peak beam current (proportional to screen brightness).
- Detects shorted & open elements.

BAR GENERATOR 352K, WIRED \$19.95 KIT, \$14.95

- Enables rapid adjustment of TV picture V & H linearity without hard-to-find station-transmitted test pattern.
- Produces 16 V or 12 H bars. Operates on TV channels 3, 4, or 5.

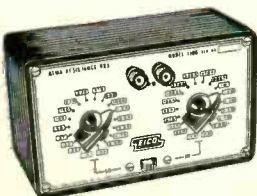
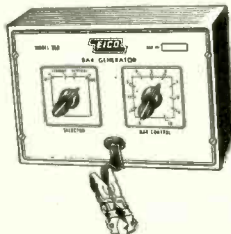

RTMA RESISTANCE SUBSTITUTION BOX 1100K WIRED \$9.95 KIT, \$5.50.

- Enables rapid substitution of resistances from 15 ohms to 10 megs in decade multiples of 15, 22, 33, 47, 68, 100 ohms.
- Uses 36 standard 1 watt, $\pm 10\%$ RTMA resistors.

315K DELUXE SIG. GEN. KIT \$39.95. WIRED \$59.95.

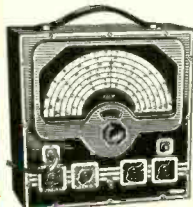

- Covers range of 75 kc to 150 mc.
- 7 calibrated scales: accuracy better than 1%.
- Bandsread vernier tuning.
- 4-step RF shielded output multiplier: constant output Z.

377K SINE & SQUARE WAVE AUDIO GEN. KIT \$31.95. WIRED \$49.95.



- Complete sine wave coverage, 20-200,000 cps in 4 direct-reading ranges.
- Complete square wave coverage, 60-50,000 cps.
- Cathode follower output circuit.

565K MULTIMETER KIT \$24.95 WIRED \$29.95.



- 555K MULTIMETER KIT \$29.95 WIRED \$34.95. (1% precision resistors)
- 20,000 Ω/V ; 31 ranges.
- DC/AC/Output volts: 0-2.5, 10, 50, 250, 1000, 5000.
- DC Current: 0-100 ua; 10, 100, 500 ma; 10 A.
- Ohms: 0-2K, 200K, 20 meg.

145K SIG. TRACER KIT \$19.95. WIRED \$28.95.



- Audibly signal traces all IF, RF, Video & Audio circuits from ANT to SPKR or CRT in all TV, FM, AM, etc. without switching.
- Germanium crystal diode probe responsive to over 200 mc.
- Integral test speaker

536K MULTIMETER KIT \$12.90. WIRED \$14.90.



- 1000 Ω/V ; 31 ranges.
- DC/AC volts: Zero to 1, 5, 10, 50, 100, 500, 5000.
- DC/AC Current: 0-1, 10 ma; 0.1, 1 A.
- Ohms: 0-500, 100 K, 1 meg.

320K SIG. GEN. KIT \$19.95. WIRED \$29.95.

322K SIG. GEN. KIT \$23.95. WIRED \$34.95.



- Fundamentals 150 kc to 34 mc, harmonics to 102 mc.
- 5-step band switching.
- Colpitts audio oscillator generates 400 cps pure sine wave voltage.
- Permits pure RF, modulated RF, or pure AF.

Write NOW for FREE latest Catalog C-4 showing entire EICO line. Ask your jobber for FREE EICO business building decals.



Separate Assembly & Operating Manuals supplied with each EICO KIT!

You build EICO Kits in one evening, but... they last a lifetime!

SAVE OVER 50%! See the famous EICO line TODAY, at your local jobber.

ELECTRONIC INSTRUMENT CO., Inc., 84 Withers Street, Brooklyn 11, N. Y.

SPECIALIZATION

... In this age of specialization, ordinary training is no longer sufficient ...

By HUGO GERNSBACK

THE editorial in the February issue, entitled "Wanted: Technicians," brought a variety of letters from readers. Many of these took issue with us; the writers seemed to think that there actually was an *over-supply* of technicians today.

One reader from Florida sent a page from a Miami newspaper containing dozens of advertisements of service technicians who were advertising their services. He jumped to the conclusion that here alone was a vast reservoir of technicians which should be tapped by the industrial firms requiring technical personnel.

He ended his letter with the remark: "Why don't the large corporations come to Florida and get their technicians here?"

Another letter from Ohio states that graduate electronic engineers are paid very little money, at the rate of only \$2 per hour. It states that there seems to be an overabundance of young men in this classification, and closes with: "If you doubt my statement, investigate the salaries paid by Convair, Pomona, Calif.; Hughes, Culver City, Calif.; North American, Downey, Calif.; and California Technical, Pasadena, Calif."

Another reader from Key West, Fla., writes as follows (*the spelling is his*): "I am a trained ambitious young man (22). I have a through background in electronic theory and approximately three years practical experience in electronics gained with the United States Navy. I have a good knowledg of mathematics. I am presently taking a course in television engineering to further my knowledge."

He ends his letter by stating that when he is released from the Navy a year hence, he would like to know how to acquire a desirable position. He furthermore wants to know if we can help him and others like him, who want to put their present knowledge to use and advance themselves to worthwhile positions. Many other letters were written in similar vein.

It is unfortunate that the writers seemingly misread the gist of the February editorial. We were careful to point out that the technicians wanted were mostly those who had superior knowledge and training. In the third paragraph, which we repeat here, we stated: "Since 1951, the shortage of technical personnel—*particularly in the higher brackets*—has been acute. It is likely to become worse during the next few years, until we can make up the deficiency."

In the next paragraph we stated that a *complex knowledge* is required by the present-day radio-electronic specialist. We mentioned radio engineers, radio-electronic specialists, technicians, physicists and others.

The point we were trying to make was that the world is full of the average type electrician and technician, but *these are not the men who make from \$15,000 to \$25,000 a year salary*. The editorial in the February issue made this quite clear by giving two examples of unusual technical requirements, namely *Automation* and *Electronic Computers*.

It stands to reason that the average technician could

hardly expect to fill such a position because it calls for specialists—*specialists of the highest order*.

The trouble is that too many young men think of themselves as high calibre specialists when they may be specialists in only a very narrow channel. Many radio or television technicians may be excellent specialists in trouble chasing of radio or television sets, but would they be qualified to design, for instance, a new color television set, or a new portable desk electronic computer, or a hundred other similar complex items? Not a chance in the world!

We discussed this problem at length in a former editorial entitled "Why Radio Specialization," in the March 1947 issue. We went to great lengths to point out that the age of electronic specialization was here and that there was a tremendous field for *advanced specialists*. This means high-grade men who have a *thorough* understanding of all phases of electronics. They must not only be thoroughly grounded in the electrical field, but they must be experts on vacuum tubes—nowadays transistors. They must know all about cathode ray tubes, multiplier tubes and a host of other tubes. They must know the mathematics of the field and, furthermore, should be well grounded in physics, particularly in connection with electronics.

This means a long road of specialized education, not necessarily college education, but knowledge of *EVERYTHING* connected with the art. This is not an easy road. It takes many years of studying, many years of actual work in the endeavor, to make one's self as near letter-perfect in the chosen profession as is humanly possible. The graduate engineer—or the technician with wide experience—will often have to take a low-paid beginners' job (in some important line of work, to be sure!) and continue to work *and study*, gaining valuable experience, till he is qualified to fill some of the higher technician shortages that certainly do exist in most plants.

People of this educational level do not find it very difficult to obtain high positions. If you set forth in a typewritten letter your entire past experience, your knowledge in a particular field or branch of electronics, and if this knowledge is adequate, it shouldn't be difficult to obtain a worthwhile position.

Usually men of this type have original ideas of their own, because in their work they come to conclusions usually not known to the ordinary type of man. A hint as to such a phase is usually sufficient to bring a rush call for the candidate.

It is not too much to say that it is the exceptional type of technician, *the man with an exceedingly high electronic I.Q.*, who is wanted, not only today, but in the future as well. The world is full of mediocrities. What the ranking leaders in radio-electronics desire mostly is men of exceptional intelligence and imagination who have the push and drive to put their ideas across, men with initiative and industry. Deservedly, they can name their own salary—and get it.

KILLING THOSE ALIGNMENT BUGS

Connection of the test equipment and precautions to be taken in i.f. alignment

By The Engineering Staff Scala Radio Co.

WHEN the TV technician gets a job, he is expected to know the answers. Busy fellow workers have no time to show him the ropes, even if they had the inclination. So the technician must try to recognize as many alignment bugs as possible. This series of articles will present in an entirely practical form the result of many years' experience in this regard. Every technician who takes his job seriously should literally cut out each article and paste it on the wallpaper in the shop.

Fig. 1 shows a typical visual-alignment test setup. The best grade of work can be done with such equipment by a man who knows what he is trying to do. A novice can try the same job, with the same equipment, and fail completely. This article tells why.

Calibrating marker generator

When starting on an alignment job the first step is to check the calibration of the marker generator. Without marker accuracy, the local-oscillator, ratio-detector, and sound-trap adjustments present a hopeless problem in the busy shop. Many marker generators have built-in calibrating facilities. Indication of zero-beat points—by beating the output from the marker generator with the harmonics from a quartz crystal—may be either audible or visual. If a generator does not have built-in calibrating facilities, the technician should obtain a 1-mc, 2-mc, or 5-mc crystal oscillator, and use the calibrating arrangement shown in Fig. 2. It would be advantageous to use a voltage-doubler probe (no polarization), as seen in Fig. 3.

If the harmonics of the crystal oscillator become too weak to check the higher frequencies of the generator, the technician must obtain another signal generator. First, he calibrates the auxiliary generator from the crystal at as high a frequency as possible. Next, he substitutes the calibrated generator for the crystal oscillator. Thus, the auxiliary generator acts as a "stepping stone" to higher frequencies.

Setting the marker-generator dial to

Fig. 1—Visual alignment test setup

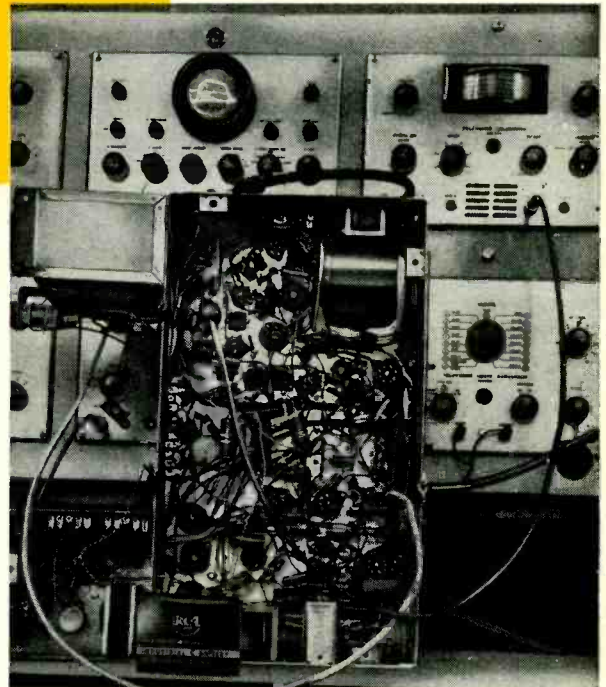

various frequencies may require a vernier scale, which can be used to split up the coarser divisions on the dial scale into very fine divisions.

Injecting the sweep signal

The sweep signal from the sweep generator must be injected into the i.f. circuits (as a preliminary operation) in a manner which will not disturb the operation of the i.f. amplifier. Some technicians connect the output cable from the sweep generator between the grid of the first i.f. tube and chassis. Such a connection shunts down the response of the first i.f. coil, due to the 75-ohm impedance of the sweep-output cable, and displays a response curve on the scope screen which has something missing—the contribution of the first resonant circuit in the amplifier.

To avoid this difficulty, most technicians use a so-called floating tube shield which is placed over the mixer tube in the front end of the receiver, as shown in Fig. 4. A floating tube shield is a tube shield which is slid over the tube, but which does not make contact with the chassis. By connecting the hot side of the sweep-output cable to the floating tube shield, and the braid conductor to chassis ground, a loose capacitive coupling is made to the plate of the mixer tube. This loose capacitive coupling permits ample injection of

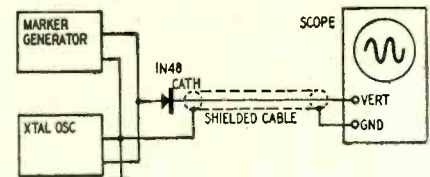

Fig. 2—Marker-generator calibration.

sweep voltage, without detuning the first i.f. circuit. This is a very important point which cannot be disregarded if a botched job is to be avoided.

For operation in the 23-mc range, the sweep-output cable may be operated open-ended, as shown. When operating in the 45-mc range, terminate the sweep-output cable with a carbon resistor having a value equal to the characteristic impedance of the cable. Otherwise, standing-wave distortion may result.

Oscillator harmonic bugs

Since the sweep generator usually has harmonics in its output, and the local oscillator in the receiver is a powerful generator of harmonics, it is possible for the two groups of harmonics to cross-beat in the nonlinear mixer tube, and produce undesirable sweeps and markers which distort the response curve into absurd shapes. A situation of this type is shown in Fig.

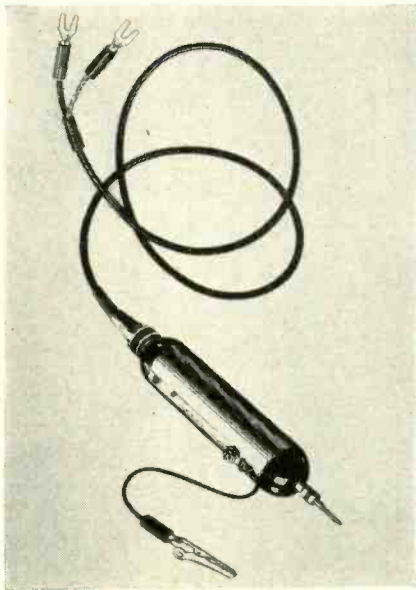

Fig. 3—Voltage-doubler crystal probe.

5. To check for this type of bug, the technician turns the channel-selector switch from one channel to the next. If the curve changes shape, he knows he has local-oscillator harmonics.

Local-oscillator harmonics can be killed either by unplugging the oscillator tube (if an individual local-oscillator tube is used) or by making up a dummy tube to disable the local oscillator and to permit the mixer section of the tube to continue normal operation.

In Standard Coil tuners, for example, the technician will usually remove the oscillator grid pin (pin 6) from the 6J6 local oscillator-mixer tube. Removing this pin converts the twin triode into a dummy tube. Inspecting the circuit diagram for the receiver is the only way to determine how to construct a dummy tube for visual alignment.

Mixer regeneration

In many cases—especially if a 45-mc i.f. amplifier is to be aligned—it may be found that although a dummy tube is used in the front end, the i.f. curve changes appreciably as the operator switches the channel selector from low to high channels. The greatest change in curve shape can be seen when he switches from channel 13 to channel 2. This change in curve shape is caused by mixer regeneration due to the frequencies shown in Fig. 6.

Triode tubes are commonly used as mixers, because triodes are low-noise tubes, and contribute less snow on weak signals than do pentodes. But a triode has the largest plate-to-control-grid capacitance, and hence is most suscep-

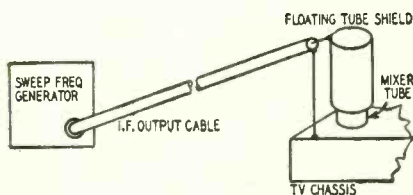

Fig. 4—Injecting an i.f. sweep signal.

tible to tuned-plate-tuned-grid regeneration in a mixer circuit. When the grid circuit is operating on channel 2, it is tuned in the vicinity of the 45-mc operating frequency of the plate circuit, causing maximum regeneration. However, when the grid circuit is operating on channel 13, it is tuned far from the vicinity of the 45-mc i.f., and tuned-plate-tuned-grid regeneration is negligible. (See Fig. 7 for a typical case of mixer regeneration.)

The effect of mixer regeneration is to make the response curve on channel 2 appear much narrower in bandwidth and more highly peaked than the response curve on channel 13. If no neutralizing circuits are provided in the mixer, as is often the case, the technician must then "split the difference" on low-channel and high-channel position of the selector switch. This means that the i.f. response curve will be less than ideal on both low- and high-channel positions, but it is the only practical solution to the problem. In severe cases, a tuner which has mixer neutralizing facilities should be installed.

Connection of scope

The scope is commonly connected at the output of the video detector. If a narrow-band (audio-frequency) scope is used, the marker indication on the response curve will be satisfactory when the scope is connected directly to the second-detector load resistor. A shielded cable should be used for this connection, to avoid pickup of stray fields from the sweep circuits as well as 60-cycle fields around the test bench.

However, if a wide-band troubleshooting scope is connected across the second-detector load, the technician will find that a beat marker appears very broad and fuzzy, and that the zero-beat point is difficult to locate. The solution is to use less of the bandwidth of the vertical amplifier in the scope. One method is to shunt a .005- μ f capacitor across the input terminals of the scope. This sometimes leads to difficulties. There may be sufficient 45-mc i.f. voltage in the output of a video detector to resonate strongly in the cable, which then acts as a resonant stub. Violent oscillation, or at least instability, results from such a situation, and requires other means of marker filtering. The preferred method is to use as the signal take-off point in the receiver an isolating resistor of approximately 75,000 ohms in series with the shielded input cable to the scope.

Setting of sweep-width control

After the center frequency of the

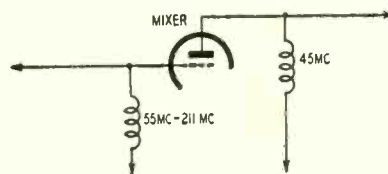

Fig. 6—Plate and grid frequencies.

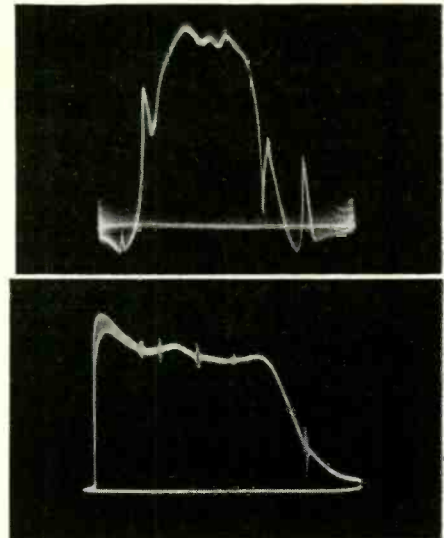

Fig. 5—Distorted response curves.

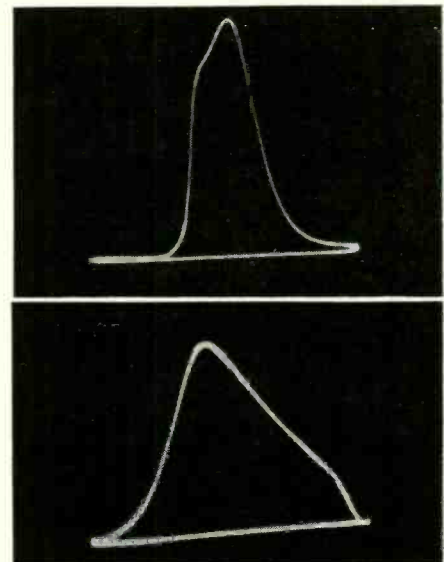

Fig. 7—I.f. response curves. Above, channel 2 setting; below, channel 13.

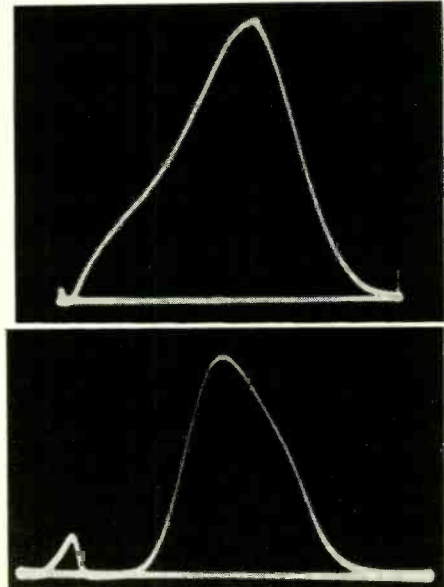

Fig. 8—I.f. response curves. Above, sweep-width control is insufficiently advanced; below, a proper adjustment.

sweep generator has been adjusted to coincide with the center frequency of the i.f. amplifier being aligned, a re-

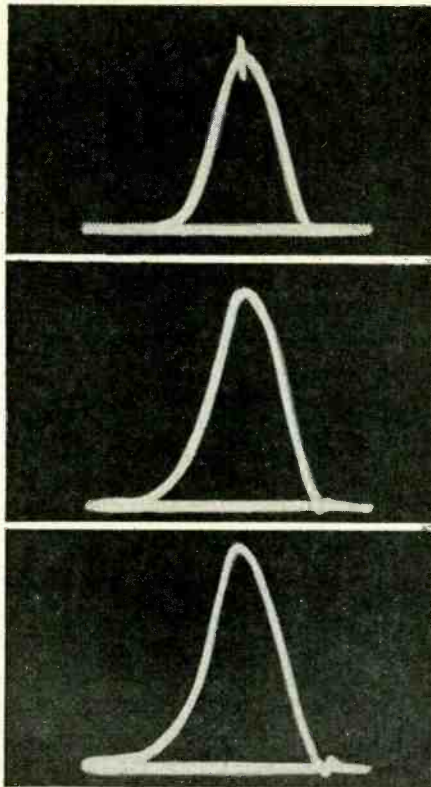

Fig. 9—Marker size diminishes as it gets further away from top of curve.

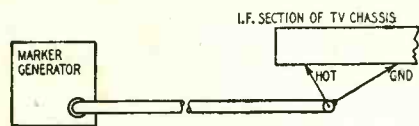

Fig. 10—Chassis current injection.

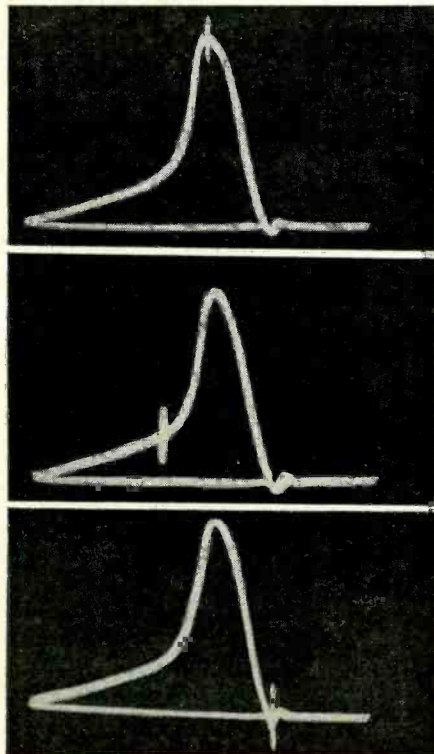

Fig. 11—Markers are of uniform size.

sponse curve will appear on the scope screen, as shown in Fig. 8. Then adjust the sweep-width control so that the entire response curve is displayed on the base line of the scope. Beginners sometimes lose time because they try to set the dial of the sweep generator with extreme accuracy. This is a misconception, because there is a wide tolerance on the center frequency setting; in fact, it is better practice to watch the scope screen while adjusting the tuning dial of the sweep generator, and to leave the dial at the point which centers the response curve on the scope screen. The dial may fail to read the center frequency accurately, because beat-frequency generators are notorious for drift when operating on a relatively small difference frequency.

The marker-generator dial, rather than the sweep-generator dial, should be set to a high degree of accuracy. The marker-generator is relied upon to identify various frequency points.

As shown in Fig. 9, the technician often fails to obtain markers which are satisfactorily large in the traps, near

the base line, or out along the base line. This is because it is impractical to inject enough marker voltage through the receiver circuits to obtain a satisfactory marker indication. Various types of marker injection are used in practice, and some types provide better marker indication than others. One of the customary marker-injection methods is the chassis-current method shown in Fig. 10. The output cable from the marker generator is grounded at two separated points along the i.f. chassis. At these frequencies, there will be an i.f. voltage drop along the chassis, which is picked up by the various ground points of the i.f. components, thereby injecting the marker voltage into the swept circuits.

However, to obtain uniform markers at all times, a bypass marker injector should be used. The bypass marker injector is an instrument which develops the marker pip independently of the circuits under test, so that the marker size is constant at any point along the response curve, in the traps, or on the base line, as shown in Fig. 11.

Fig. 12 is a photograph of a bypass marker injector unit. The circuit diagram is shown in Fig. 13. A sample of the sweep voltage is mixed with a sample of the marker voltage as shown in Fig. 14, and the marker indication will continue to appear along the base line of the scope, even if the TV receiver is turned off. When the TV receiver is operating, the swept output from the receiver circuits is mixed with the marker voltage and applied to the scope's vertical input terminals.

A marker injector unit of this type is useful in ratio-detector alignment, and in video-amplifier adjustment where marking is often a severe problem. The unit also finds use in front-end align-



Fig. 12—Front view of marker injector.

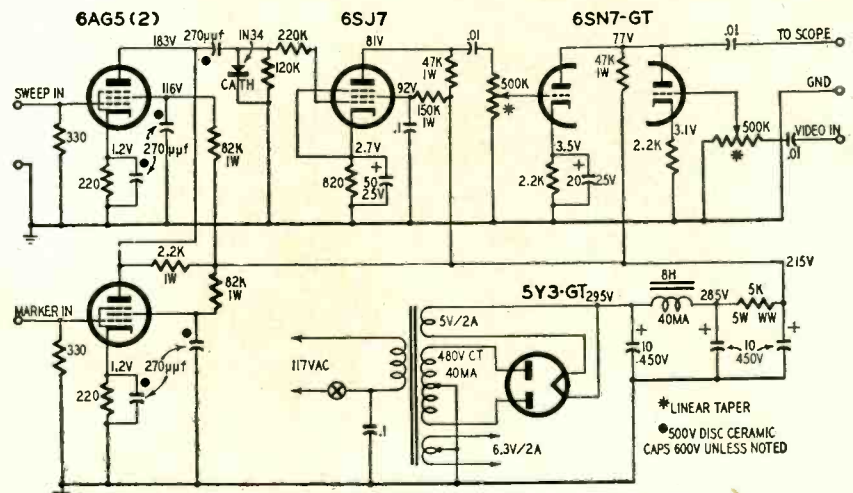

Fig. 13—Schematic diagram of the bypass marker injector shown in Fig. 12.

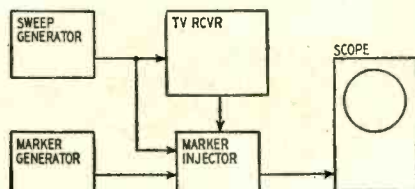

Fig. 14—Using the marker injector unit.

ment work, and in checking the impedance match of antennas to lead-ins, front-end input impedance, and characteristics of antenna matching units.

Many other alignment bugs lurk in waiting, ready to bite the unsuspecting and unwary technician. These various bugs will be described in following articles.

END

NOISE-FREE SYNC CIRCUITS

By ROBERT F. SCOTT
TECHNICAL EDITOR

DURING the last year or so, we have discussed three or four novel circuits which were developed to minimize the effects of noise pulses on the stability of sync circuits in TV receivers. Now, almost all TV set manufacturers have recognized the importance of noise immunity.

Westinghouse noise-free sync

A feature in some of the new Westinghouse TV receivers is a new sync system designed for high sync stability and noise immunity over a wide range of signal strengths. The circuit used in the V-2223-1 chassis is shown in Fig. 1.

The grid of the sync amplifier is direct-coupled to the video detector. The detector develops a video signal with a d.c. component negative with respect to ground. The major portion of this negative voltage appears across R1, which acts as the video detector load and the grid return of sync amplifier V1 and the video amplifier (not shown in Fig. 1). This negative voltage varies

directly as the strength of the incoming signal. On strong signals, the detector output is sufficiently high for the negative-going sync pulses to drive the sync amplifier to cutoff so that the sync tips are compressed.

To prevent sync compression, a positive voltage is applied to the sync amplifier grid through R5 and R3. The positive voltage on the grid cancels a portion of the high negative voltage produced by the video detector. Since the negative voltage is determined by the signal strength, and the positive voltage is obtained from a fixed source, the positive voltage must be controlled so that it cannot exceed the negative d.c. component of the video signal. This must be prevented, because if the grid goes positive, conduction takes place between the cathode and grid. This causes a loss of video and sync signals.

The sync control tube (V2) automatically adjusts the positive voltage on the sync amplifier grid to the optimum value for any signal level. The

voltage to the grid of amplifier tube V1.

As the signal level drops, the a.g.c. voltage becomes less negative, and V2 begins to conduct. The plate-to-cathode resistance of V2 now acts as a variable resistance. This increases the voltage drop across R5 and reduces the positive voltage which can be applied to the grid of V1.

The noise clipper

V3 is a diode noise clipper connected between the sync amplifier plate and the sync separator cathode. Positive-going sync pulses are fed from the sync amplifier to the plate of the noise clipper and to the grid of the sync separator (V4). Between sync pulses, C1 discharges slowly through R6, producing a negative voltage on the plate of V3. The time-constant of R6-C1 is much longer than the sync interval, so C1 discharges only slightly before the arrival of the next sync pulse. During each following pulse, V3 conducts just enough to restore the charge on C1. Thus, the plate of V3 is maintained at a negative potential controlled by the amplitude of the sync pulses.

When V3 is conducting, a small positive pulse appears across R7—the common cathode resistor for the noise clipper and sync separator. The time-constant of R7-C2 holds the voltage on the cathode of V4 constant during normal operation.

However, if a strong noise pulse reaches the plate of the noise clipper, it overcomes the negative voltage on the plate and causes the diode to conduct heavily and produce a large voltage pulse across R7.

Note that the positive-going sync and noise pulses are applied simultaneously to the plate of V3 and grid of V4. The noise pulse overcomes the negative bias on the plate of V3 and causes a positive pulse of equal amplitude to appear on the cathode of the sync separator V4. Since the noise pulses on the grid and cathode of V4 have the same amplitude and polarity, they cancel each other so that the sync separator is immune to the effects of the noise pulse.

Sync pulses do not cancel in the same manner because V3 is biased almost to cutoff immediately following the first sync pulse and thereafter conducts only on noise pulses whose amplitude exceeds that of the sync pulses.

Magnavox noise suppressor

The noise-suppression circuit in the Magnavox series 105L and 105M chassis (see Fig. 2) uses a grounded-grid type amplifier. A portion of the composite video signal is tapped off the video detector load resistor and is fed

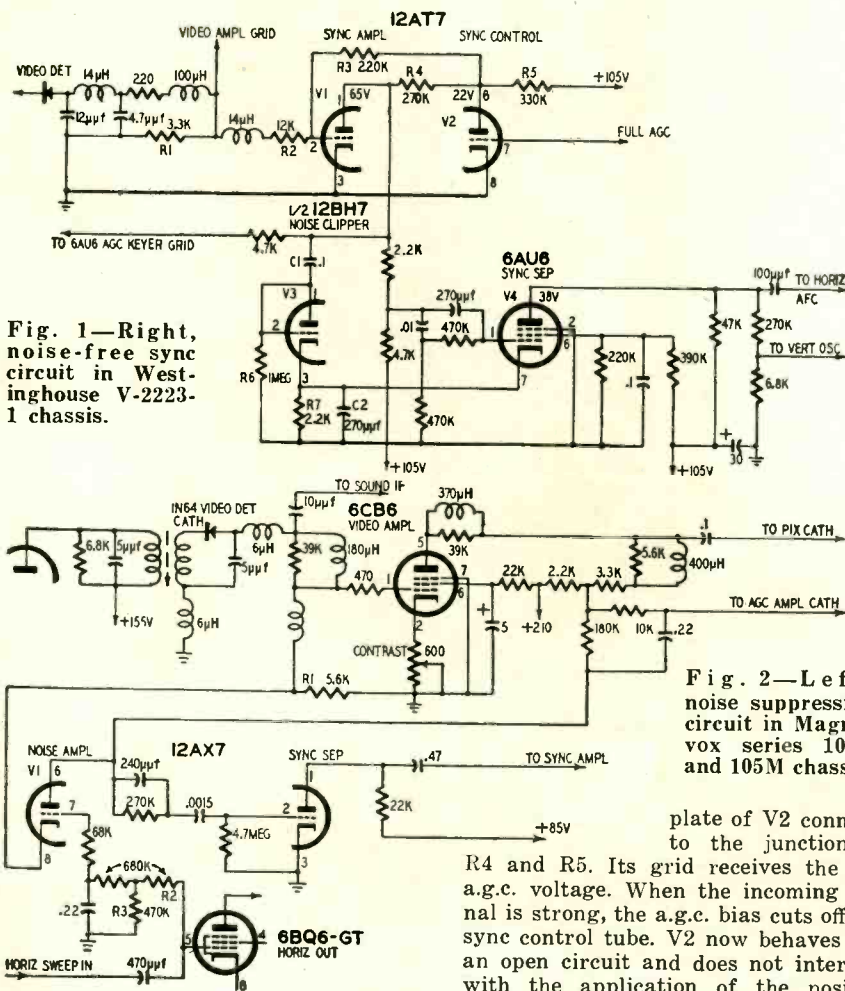

Fig. 1—Right, noise-free sync circuit in Westinghouse V-2223-1 chassis.

Fig. 2—Left, noise suppression circuit in Magnavox series 105L and 105M chassis.

plate of V2 connects to the junction of R4 and R5. Its grid receives the full a.g.c. voltage. When the incoming signal is strong, the a.g.c. bias cuts off the sync control tube. V2 now behaves like an open circuit and does not interfere with the application of the positive

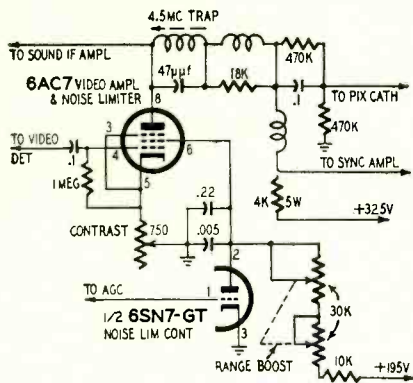

Fig. 3—Noise limiter and control circuit in Stewart-Warner 9210 chassis.

to the cathode of the noise amplifier (V1). The grid of V1 is biased highly negative by returning it to the junction of R2 and R3 which form the grid resistor of the horizontal output tube. The bias is sufficient to hold the noise amplifier cut off for normal video signals.

When a strong noise pulse arrives, the cathode is driven negative. This causes the noise amplifier to conduct and produce an amplified pulse on the grid of the sync separator. Simultaneously, the grid of the sync separator is fed with the composite video signal of positive polarity from the plate of the video amplifier. The circuit constants are such that the negative and positive pulses have equal amplitudes when they reach the sync separator and cancel each other just as in Fig. 1.

Since normal signals cannot drive the noise amplifier out of cutoff, they do not pass through. They reach the sync separator only through the plate circuit of the video amplifier.

The Stewart-Warner circuit

The noise-limiter and control circuit in the Stewart-Warner series 9210 TV chassis (Fig. 3) minimizes the effects of noise on the sync and picture by adjusting the video amplifier clipping to provide best performance.

The plate of the noise limiter (1/2 6SN7-GT) is connected to the screen grid of the 6AC7 video amplifier. The RANGE BOOST control in series with the 10,000-ohm resistor form the video amplifier screen-dropping resistor. The voltage drop across this resistor combination is determined by the combined 6AC7 screen and 6SN7 plate currents.

The level at which clipping occurs in the video amplifier (6AC7) is determined by its screen-grid voltage. Low screen voltages cause early plate saturation and a low clipping level. The 6SN7 control tube is biased by the voltage appearing on the a.g.c. line. When the incoming signal is weak, the a.g.c. voltage is low and the 6SN7 plate current is high. This lowers the voltage on the 6AC7 screen and the 6SN7 plate. The RANGE BOOST control is adjusted so the video amplifier clips signals which exceed the height of the sync tips.

On strong signals, the a.g.c. line is more negative; the plate current decreases and the 6AC7 screen voltage

increases just enough to prevent clipping the video signal of the sync tips.

Silvertone sync circuit

Although the Silvertone 132.044 chassis does not include actual noise suppression circuits like those just discussed, it is designed for good noise rejection. The composite video signal is taken off the video detector load resistor and fed to the grid of the sync stripper and amplifier (Fig. 4) through a double time-constant network C1-R1 and C2-R2. The plate voltage is held to a low value (about 35) by connecting it to voltage divider R3 and R4.

Grid current produced by the positive-going sync pulses causes C2 to charge and place a negative potential on the grid of V1. This negative bias voltage is sufficient to cut off V1 except for the sync pulses and the most positive (black) portions of the video signal. The low plate voltage compresses the sync pulse tips and any noise pulses in the video signal.

The signal from V1 is fed through a .047- μ f coupling capacitor to the cathode of the grounded-grid amplifier (V2). This stage operates with its grid at ground potential and its cathode and plate 10 and 30 volts positive, respectively. The low plate voltage and high bias produce a desirable characteristic which squares off the tops of the sync pulses, clips noise pulses to the level of the sync tips, and compresses any remaining video information. The output of the grounded-grid sync separator is direct-coupled to the triode sync phase inverter which feeds the sync signals to the vertical and horizontal oscillators.

An adjustable noise eliminator

Fig. 5 shows the circuit used in the Emerson 120174B chassis. Composite video signals with negative sync are

fed from the video detector to the grid of the sync amplifier. The amplified output of this stage appears across series load resistors R1 and R2. A portion of the output voltage is tapped off at the junction of R1 and R2 and is applied to the plate of the sync clamp tube V3, and the grid of noise inverter, V4.

High-amplitude sawtooth voltages are taken from the horizontal output transformer and applied to the grid of V3. Grid rectification develops a bias which holds the tube cut off between sync pulses on the plate. When a sync pulse is on the plate, V3 conducts and charges C1. Between sync pulses C1 discharges through R3 and develops a negative bias voltage which is equal to the peak voltage of the sync pulses. Thus, V4, the noise inverter, is held at cutoff by a bias which is equal to the sum of the positive voltage on its cathode and the negative voltage on its grid.

When noise pulses occur between sync pulses, they overcome the bias and drive V4 into conduction. The noise pulses are then amplified and appear with negative polarity across the 150,000-ohm plate-load resistor. The amplified and inverted noise pulses are applied to the grid of the sync separator V2 with the positive noise pulses from the sync amplifier.

Under normal operating conditions, grid-cathode rectification of the positive-going sync pulses produces a grid bias. This combines with the positive bias applied to the cathode through the variable FRINGE COMPENSATOR, to hold the tube at cutoff except for the positive peaks of the applied signal which exceed the blanking level. Since the noise pulses are negative, they cannot pass through the sync separator and upset the operation of the vertical and horizontal oscillators. END

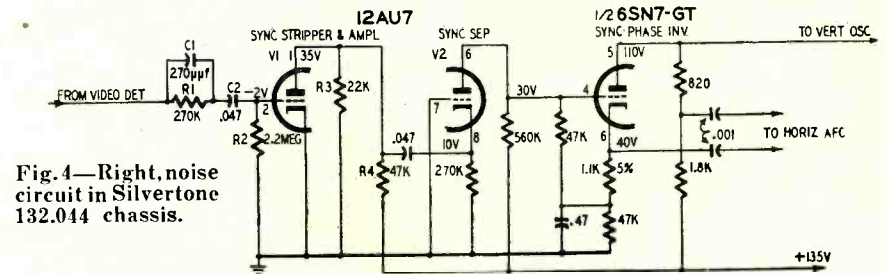

Fig. 4—Right, noise circuit in Silvertone 132.044 chassis.

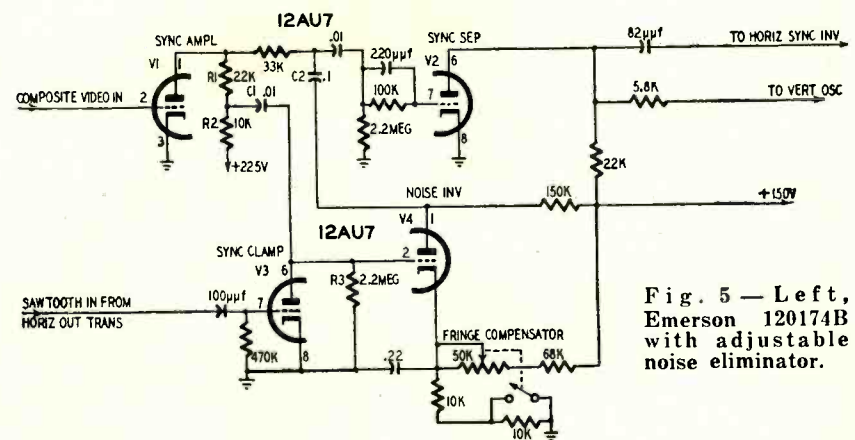
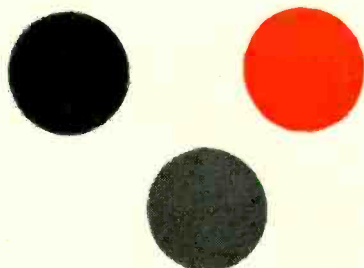

Fig. 5—Left, Emerson 120174B with adjustable noise eliminator.

BASIC COLOR TV



Part IV—First half, elimination of interference; a discussion on the important features in the NTSC system which reduces the visibility of the color sub-carrier beats

By D. NEWMAN* and J. J. ROCHE*

In the last three articles we discussed techniques which make it possible to transmit and receive compatible color-television signals in a 6-mc channel. To do so, it is necessary to transmit the brightness and the two color-difference signals within the same channel. In addition, of course, the sound signal must also be transmitted.

With four separate pieces of information in the same channel it is logical to expect interference or cross-talk. In theory, we can almost completely eliminate such interference. In practice, the interference is not completely eliminated. However, the amount remaining is so very slight as to be unobjectionable.

Color signal—video carrier beat

In the color television system, the chrominance signal lies within 4 mc of the video carrier and produces an interfering beat at the output of the video detector in monochrome receivers. By properly selecting the color subcarrier frequency and suppressing the subcarrier, we can reduce the visibility of the beat so that it is not objectionable in monochrome (black-and-white) receivers.

As the frequency of the color subcarrier is increased, the separation between it and the video carrier becomes greater. As a result, the structure of the interference pattern becomes finer and less noticeable.

In addition, the video response of the average black-and-white receiver falls off at the upper end of the video passband. This means that as the frequency of the subcarrier is increased, the amplitude of the visible beat pattern will be reduced in monochrome receivers.

In color receivers, the response of

the brightness channel is reduced just below the color subcarrier frequency, to minimize cross-talk. This sets the upper limit of the video passband and determines the maximum picture definition.

Thus we see that it is desirable to use as high a subcarrier frequency as possible for best operation of both monochrome and color television receivers.

We have learned that it is necessary to transmit two color-difference signals. One of these signals contains video frequencies up to approximately 1.5 mc, while the other contains video frequencies up to approximately 600 kc. This means that the sidebands of the chrominance signal will extend approximately 1.5 mc above and below the subcarrier frequency.

The sideband components of the chrominance signal which extend beyond 600 kc are a result of the wide-band color difference signal, while those below 600 kc are due to both color-difference signals.

To transmit all the sideband components without attenuation, the color subcarrier would have to be approximately 1.5 mc below the upper end of the video passband. In other words, the highest color subcarrier frequency we could use would be 4.2 mc minus 1.5 mc, or 2.7 mc. (4.2 mc is the practical upper limit of the video channel.)

A certain amount of sideband attenuation is permissible without degrading color reproduction. This means we can move the color subcarrier frequency higher than 2.7 mc, attenuating the upper sideband of the chrominance signal. The subcarrier frequency can be moved up to approximately 3.6 mc without noticeable loss in color fidelity.

This leaves approximately 600 kc of

the upper sideband of the chrominance signal remaining. Since the narrow-band color-difference-signal upper sideband extends only about 600 kc above the subcarrier, it has not been disturbed. Only that portion of the wide-band color-difference-signal upper sideband above 600 kc has been attenuated.

Dot interlace

If we were to set the color subcarrier at 3.6 mc, then slowly reduce its frequency while observing the interference pattern on a cathode-ray tube, we would pass through frequencies at which the visibility of the pattern would decrease to a minimum.

The frequencies at which the visibility of the interference pattern is minimum are odd multiples of half the horizontal scanning frequency, 15,750 c.p.s. One half of this is 7,875 c.p.s. If we multiply 7,875 c.p.s. by any odd number and use the resulting frequency as the color subcarrier, we will be operating at one of the frequencies at which the visibility of the pattern was observed to be minimum.

Recalling the previous discussion on the desirability of using the highest

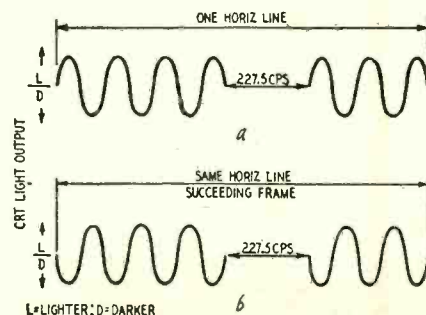

Fig. 1—Variations in light intensity.

*Allen B. DuMont Laboratories, Inc.

possible subcarrier frequency, a frequency as close as possible to 3.6 mc is selected. One convenient frequency close to 3.6 mc which results in minimum visibility of the beat pattern is the 455th multiple of 7,875 c.p.s., or 3,583,125 c.p.s. (This frequency also corresponds to $277.5 \times 15,750$ c.p.s.).

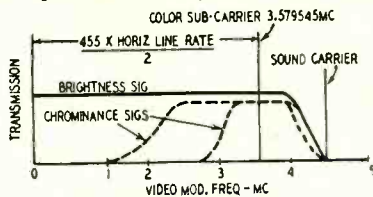

Fig. 2—Frequencies in NTSC system.

The reason why minimum visibility of the beat pattern occurs at odd multiples of half the line frequency is illustrated in Fig. 1.

Fig. 1-a represents a period of time equal to the duration of one horizontal line. During this time there are 227.5 cycles of the beat between the video and the color subcarrier signals. This means that 455 variations in light intensity take place on each horizontal line, since each cycle represents two changes in light intensity. These would appear as tiny light-and-dark dots.

When this same line is scanned $\frac{1}{30}$ of a second later, 227.5 cycles of the subcarrier frequency again occur. However, as shown in Fig. 1-b, the subcarrier frequency has now been shifted 180° , reversing the polarity. This means that the space originally occupied by the light dots will now be occupied by the dark dots, and vice versa.

Due to the viewer's persistence of vision, a blending or average process takes place in the eye, and as a result the visibility of the dot structure is minimized.

In addition, the odd number of dots per line causes the tiny light-and-dark dots to be displaced by one dot on successive lines. Since the scanning lines blend together at normal viewing distances, an additional cancellation effect occurs.

In practice, perfect cancellation does not occur; this is due to nonlinearities in the human eye as well as in the television transmitting and receiving equipment.

It is interesting to note that this type of canceling dot interlace is equivalent to frequency interlace, which was discussed in an earlier article. (Frequency interlace describes the condition in which the sidebands of the brightness and chrominance signals are interlaced in frequency with one another.) Thus, both terms describe the same condition.

Color—sound-carrier beat

With the color subcarrier tentatively located at 3.583125 mc, another beat possibility exists. This beat is produced between the chrominance signal and the sound carrier frequency (at 4.5 mc), and has a frequency of approximately 917 kc.

Being relatively low in frequency, the beat would be highly objectionable if permitted to appear. To minimize it,

the sound carrier and the color subcarrier are frequency-interlaced, taking advantage of the cancellation effects previously described.

Frequency interlace between the color subcarrier and the video carrier, as well as the subcarrier and the sound carrier, is achieved by slight readjustment of the subcarrier frequency and the horizontal and vertical scanning rates.

The frequencies used in the NTSC system are 3.579545 mc for the color subcarrier, 15,734.264 c.p.s. for the horizontal line rate, and 59.94 c.p.s. for the vertical field rate. (Since the horizontal scanning rate must be 525 times the vertical frame rate, the vertical field rate changes from 60 to 59.94 c.p.s.)

This change in horizontal and vertical scanning rate amounts to only 0.1%. Since existing black-and-white receivers will tolerate changes in scanning rates of up to 1%, their operation is not affected.

Fig. 2 shows the actual frequencies used in the NTSC system. It is interesting to note that perfect frequency interlace between the color subcarrier and the sound carrier occurs only when the sound carrier is unmodulated. Since FM is used, the sound carrier varies above and below its resting frequency when modulated.

As a result, some of the benefit of frequency interlace between the subcarrier and the sound carrier is lost.

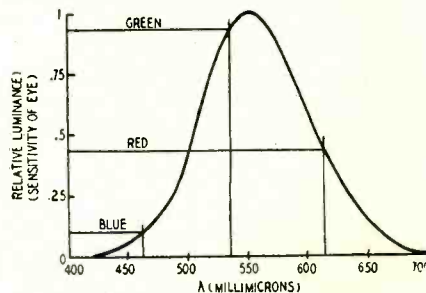

Fig. 3—Relative sensitivity of the eye to light of different colors.

Nevertheless, a worthwhile reduction in the visibility of the beat pattern is achieved.

Subcarrier suppression

Another important feature of the NTSC system which reduces the visibility of the color subcarrier beats is the use of subcarrier frequency suppression.

You will recall that in the preceding article we discussed the use of balanced modulators in the transmitter to greatly suppress the color subcarrier frequency.

As mentioned, carrier suppression results in transmitting only the sidebands of the chrominance signal. One important advantage of this is that the chrominance signal disappears when no color information is being transmitted. This means that the chrominance signal is not present when the color camera is scanning achromatic (white, gray, or black) objects. In addition, when scanning objects of low color

saturation, the amplitude of the chrominance signal is low.

Low-color, or no-color conditions occur often in the average televised scene. Therefore subcarrier suppression results in a substantial reduction in the visible beats.

If ordinary modulation methods were used, the color subcarrier, and hence the interfering beats, would always be present. At least 67% of the energy available for the subcarrier video information remains in a subcarrier which uses conventional modulation. This portion of the subcarrier energy is eliminated by carrier suppression, and naturally helps to reduce beat visibility.

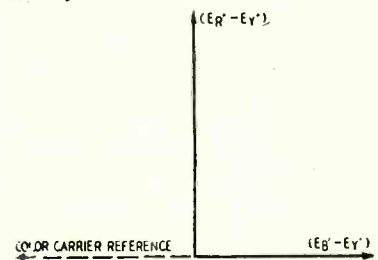

Fig. 4—Modulating the subcarriers.

It was pointed out previously that good color reproduction can be obtained by transmitting two color-difference signals. One signal contains frequency components up to approximately 1.5 mc, while the other signal consists of components up to approximately 600 kc. The third color component (green) does not have to be transmitted separately, since it can be derived at the receiver by adding the two color signals and subtracting their sum from the brightness signal.

Color-difference signals

As stated, the red and blue color components are transmitted in the form of color-difference signals, since complete information regarding the brightness of the televised scene is transmitted via the luminance signal.

The red color-difference signal is formed by taking the voltage output of the red camera tube and subtracting from it the voltage amplitude of the brightness signal. The brightness (Y) signal is formed by adding certain fixed percentages of the voltage outputs of the red, green, and blue cameras as follows:

$$E_Y' = .59 E_G' + .30 E_R' + .11 E_B'$$

These particular percentages, of each color signal, were chosen to provide excellent tonal rendition in black-and-white receivers, when receiving color transmissions. The percentages correspond to the relative brightness sensations produced by fully saturated red, green, and blue objects of equal light energy.

For example, suppose we were to view a white screen which was illuminated by a red, a green, and a blue light, each of which radiated an equal amount of light energy. If we turned off the blue light, we might expect to see a $\frac{1}{3}$ decrease in brightness. However, such is not the case.

Instead, we would observe a reduction

tion in brightness of only about 10%. If instead we turned off the green light, we would observe a reduction in brightness of approximately 60%.

This phenomenon is due to the eye not responding with equal sensitivity to light of different colors, as shown in Fig. 3.

Let us find how the color-difference signals are obtained. Assume that our color camera is scanning a saturated red object. In this case the voltage outputs of the three color cameras would be:

$$\begin{aligned} E_R' &= 1 \\ E_G' &= 0 \\ E_B' &= 0 \end{aligned}$$

where E_R' , E_G' , and E_B' are the gamma-corrected red, green, and blue camera outputs respectively. Therefore, the brightness signal, E_Y' , is, in volts:

$$\begin{aligned} E_Y' &= .59 E_G' + .30 E_R' + .11 E_B' \\ E_Y' &= .59 (0) + .30 (1) + .11 (0) \\ E_Y' &= .30 \end{aligned}$$

And:

$$\begin{aligned} E_R' - E_Y' &= 1 - .30 = .7 \\ E_G' - E_Y' &= 0 - .30 = -.3 \\ E_B' - E_Y' &= 0 - .30 = -.3 \end{aligned}$$

where $E_R' - E_Y'$, $E_G' - E_Y'$, and $E_B' - E_Y'$ are the red, green, and blue color-difference signals respectively.

In other words, by adding the stated proportions of the red, green, and blue camera outputs to form the brightness signal (E_Y'), and subtracting E_Y' from the individual voltage outputs of the red, green, and blue cameras, the three color-difference signals are obtained.

At the receiver, we can recover the original color camera output voltages, E_R' , E_G' , and E_B' , by simply adding E_Y' (which is transmitted separately) to each color-difference signal.

For example, using the voltages previously mentioned:

$$\begin{aligned} E_R' &= E_Y' + (E_R' - E_Y') \\ &= .3 + .7 \\ &= 1 \end{aligned}$$

$$\begin{aligned} E_G' &= E_Y' + (E_G' - E_Y') \\ &= .3 + (-.3) \\ &= 0 \end{aligned}$$

$$\begin{aligned} E_B' &= E_Y' + (E_B' - E_Y') \\ &= .3 + (-.3) \\ &= 0 \end{aligned}$$

You may wonder why color-difference signals are used instead of the color signals themselves. The reason is that for a given change in color the amplitude of the corresponding color-difference signal changes less than that of the color signal from which it is derived. This reduces the amplitude variations of the chrominance signal, and consequently the amount of information which must be transmitted. It also amounts to a substantial reduction in the average amplitude of the chrominance signal.

The color-difference signals can be transmitted by modulating two sub-carriers 90° out-of-phase with each other, to produce chrominance signal components, as shown in Fig. 4.

The next and concluding installment will discuss color reproduction above 600 kc, the I and Q signals, and will summarize this series of articles.

(TO BE CONTINUED)

KEY TO KEYED

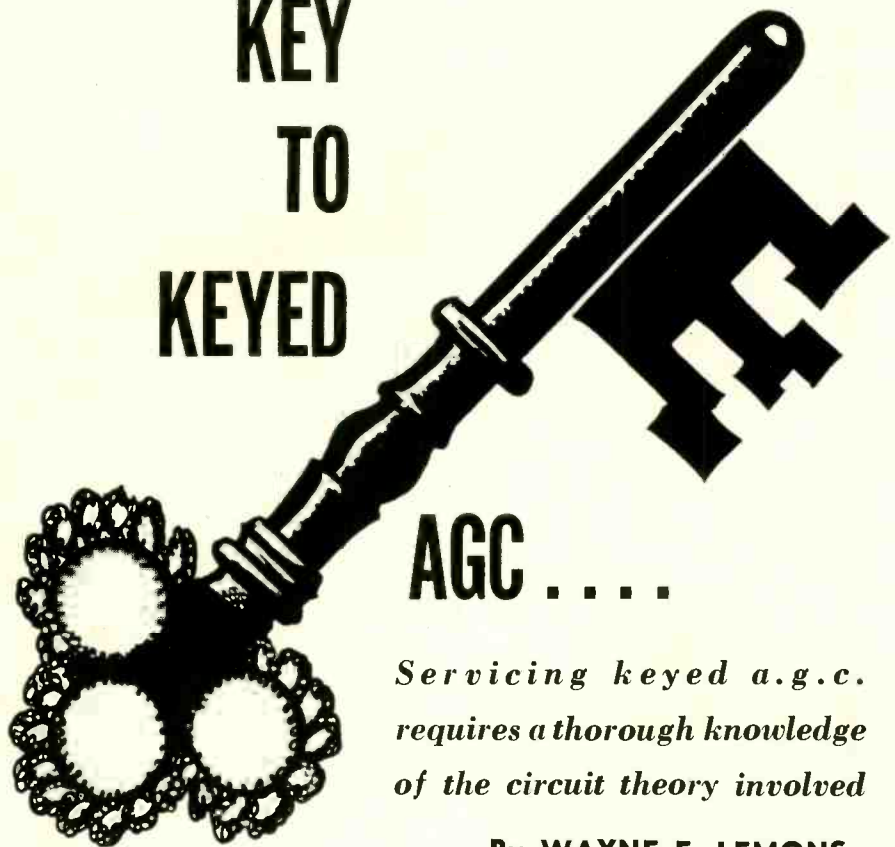

AGC

*Servicing keyed a.g.c.
requires a thorough knowledge
of the circuit theory involved*

By WAYNE E. LEMONS

TROUBLE-SHOOTING a.g.c. circuits is perhaps the hardest job in a TV set. This is especially true of keyed or gated a.g.c. Trouble in the a.g.c. circuit is reflected to many other stages of the receiver. It causes overloading in the r.f. and i.f. stages and compresses the sync pulses. Sync compression upsets a.g.c., aggravating the trouble, and so goes the vicious cycle.

A v.t.v.m. on the a.g.c. line quickly determines whether or not any a.g.c. voltage is present. If there is none, or if it is low or high, the v.t.v.m., scope, and other instruments are almost helpless in quick diagnosis, especially in weak-signal areas, unless other measures precede.

To accurately trouble-shoot a keyed a.g.c. circuit, we must know what the circuit does, or is required to do.

How keyed a.g.c. works

In Fig. 1 we have a simplified keyed a.g.c. circuit. The positive-going sync pulse from the plate of the video amplifier is very important to the proper operation of the circuit. The keying tube is biased to approximate cutoff by the current through the plate-load resistors of the video amplifier. Current flow down through the resistors causes the potential to be more negative at the plate side than at B plus. Now notice that this voltage is placed directly between the cathode and grid of the key-

ing tube, usually a 6AU6. The tube will remain cut off indefinitely unless something comes along to upset the grid-cathode voltage. This "something" is our positive-going sync pulse.

If the keying tube has plate and screen voltage it will conduct by an amount proportional to the voltage of the pulse. Thus on a strong pulse, as would be developed by a strong signal, the keying tube will conduct more than on a weak pulse. This takes care of the input end of the keyer tube. It's as simple as that.

There is still another limitation to keyer-tube conduction. Looking at Fig. 1 again, we find that the plate of the keyer tube normally reads a few volts negative. Certainly this tube cannot conduct, regardless of the size of the grid pulse, until we have positive voltage on the plate.

We now begin to uncover the complications. The plate of the keyer tube also receives a pulse, but instead of from a variable source as is the sync pulse, it is derived from a steady source. This may be from an extra winding on the horizontal output transformer as in Fig. 1 or taken through a small capacitor from one side of the width coil. Regardless of how the voltage is tapped off, it usually is from 350 volts to 550 volts peak to peak depending upon the set and its design. This pulse to the plate of the keying tube arrives at a

15,750 c.p.s. rate. This means the keyer can conduct only while one of the 15,750-cycle voltage peaks is applied to the plate.

Timing is important and we see why as we go further. The sync pulse at the grid and the pulse at the plate arrive at the same time normally and the keyer tube will conduct proportionately to the amplitude of the sync pulses applied to the grid. The only d.c. return path for the plate of the keyer is through resistors R1, R2, and R3. As the keyer-tube plate current flow is through these resistors to ground, a negative voltage will be developed in proportion to the amount of tube conduction (plate current). This is the a.g.c. voltage.

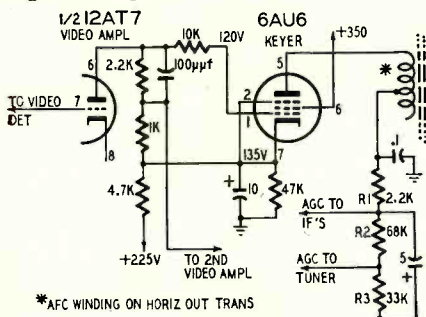

Fig. 1—Simplified keyed a.g.c. circuit.

We see then that any noise pulse arriving at a time different to that of the horizontal sync pulse cannot affect the over-all gain of the receiver.

Another interesting feature of this a.g.c. circuit is the seemingly high screen voltage, about 350 volts (in some sets it is not so large). Actually this is for two reasons. First, because the cathode of the keyer tube is approximately 135 volts positive, the relative screen voltage is only 215. This is still fairly high by most standards. This high screen voltage means that the keyer tube will not conduct until the plate pulse rises to well over 200 volts (remember the cathode is 135 volts positive). This has the effect of shortening the conduction time of the tube because the pulse must rise to a fairly high value before it can overcome the effect of the screen and cathode voltage. This prevents noise pulses that are very close to the sync pulse from keying the circuit.

Trouble-shooting

The first step in servicing keyed a.g.c. circuits is to replace the keyer tube and make a preliminary check of socket voltages. Usually the heater is at or very near the same d.c. cathode potential. In some sets the heater is at ground potential. In the event of excessive a.g.c. voltage in these circuits, always check for heater-to-cathode leakage. Sometimes it is necessary to try several tubes to find one with sufficiently limited leakage. Often new tubes have slight heater-cathode leakage that could very easily cause improper a.g.c. action.

Checking the circuit, it becomes immediately evident that the keyer can be

made to conduct by a very simple method, provided the plate pulse is present and other voltages are correct, by merely shorting the grid to cathode. A v.t.v.m. on the a.g.c. line will read a large negative voltage in a properly operating circuit. This reduces our trouble-shooting job considerably.

A negative voltage on the a.g.c. line indicates:

- (1) the keyer tube is working,
- (2) the pulse is present at the plate, and
- (3) the a.g.c. load resistors and capacitors are O.K.

If the voltage is more than minus 30 to 35 volts there is reason to suspect an open a.g.c. load resistor. In this case the only d.c. return path is through the input resistance of the v.t.v.m. and the negative voltage reading will remain for several seconds or even a minute or more after the grid-cathode jumper is removed.

If no negative grid voltage is present with keyer-tube grid shorted to cathode, then we can surmise that the tube is not conducting for one of the following reasons:

1. No pulse at the plate.
2. Below normal plate keying pulse.
3. Defective keyer tube.
4. Low or no screen voltage.
5. No heater voltage on keyer tube.
6. Poor socket connections.
7. Shorted a.g.c. capacitor.

The peak-to-peak voltage at the keyer plate may be measured with a peak-reading or peak-to-peak reading v.t.v.m. or a 20,000-ohms-per-volt meter. Remember that a peak-reading-meter reads only one-half of the peak-to-peak voltage, so it must be doubled to get the correct reading. The peak-to-peak voltage should be from 350 to 550 volts for most sets and in every case should be 50 to 100 volts or more higher than the d.c. screen voltage of the keyer tube.

If this pulse voltage is too low and is taken from a separate winding on the horizontal output transformer, we can be reasonably sure that the winding is defective if no raster defects such as low brightness, loss of linearity, narrowing or other troubles commonly associated with horizontal and damper circuits, are noted.

To determine if the winding is defective, connect a 100,000-ohm resistor from plate of keyer tube to ground, and attach a .001-µf, 600-volt capacitor between the keyer plate and the hot side of width coil or other point in horizontal circuit supplying a 450- to 600-volt peak-to-peak pulse. Place jumper from grid to cathode of keyer as before and check for negative voltage at keyer plate. If this restores the set to normal operation we can reasonably assume the winding is defective.

Poor socket connections can be elusive and may cause a.g.c. troubles that defy trouble-shooting. Always move the keyer tube from side to side while checking for a fluctuation of voltage on the a.g.c. bus.

A shorted a.g.c. capacitor will of course prevent the a.g.c. voltage from reaching the rest of the circuits. An

ohmmeter usually will determine this type of trouble.

A leaky coupling capacitor from the flyback transformer to the keyer plate will cause a positive a.g.c. voltage and the keyer tube may be damaged by excessive current flow.

If a normal reaction is received when the keyer tube has a grid-cathode jumper, then we can assume that the trouble precedes or is in the input circuit of the keyer tube. The first check is the bias voltage. There should be from 12 to 20 volts from grid to cathode with the grid the most negative. Excessive bias voltage prevents tube conduction except perhaps on very strong signals. This may be caused by opening or increase in value of the video plate-load resistors. The video amplifier tube may be defective or incorrectly biased.

For further checks, we must restore the set to normal operation. We can do so by using a low-voltage battery connected across a 2,000-ohm potentiometer to supply a normal bias voltage to the a.g.c. line. A schematic is shown in Fig. 2. Connect the positive side to ground and the center tap of the control to the a.g.c. line. Vary the voltage until the set is restored to normal operation. Now we can check the pulses with a scope and determine where compression occurs.

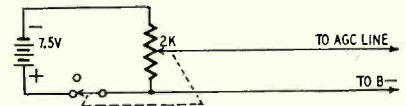

Fig. 2—Battery supplies a.v.c. bias.

A really tricky trouble is when we have slight leakage in an i.f. coupling capacitor. This may cause the a.g.c. line to be positive, thus affecting proper operation of the a.g.c. circuits. To trouble-shoot, attach the battery box to the a.g.c. bus and measure the voltage at each grid on the a.g.c. line. The grid that reads very near zero voltage has the offending capacitor tied to it. Remember that grid-to-cathode leakage in the r.f. or i.f. amplifier tubes may also cause this trouble.

Servicing keyed a.g.c. circuits requires a workable knowledge of the theory involved, but it doesn't mean you have to have a bench full of expensive equipment. A screwdriver may be used very successfully for shorting the grid to cathode. A jumper wire with a couple of alligator clips is more convenient, however.

A little headwork and a little patience should make you very adept at trouble-shooting keyed a.g.c. circuits. But don't fall into a trap such as I once did. After repairing an a.g.c. winding on a horizontal output transformer, I still had the same trouble when the unit was slipped back in its shield can. I knew that I had repaired the defect—and yet I hadn't. I was several hours finding that I had failed to resolder a wire in the a.g.c. line that I had removed in a previous check. I had created the same trouble I had just repaired and had failed to recheck the circuits I had already found perfect. END

TELEVISION . . .

it's a cinch

By E. AISBERG

Ninth conversation, second half: The iconoscope—it's not so simple; image orthicon; electron multipliers

From the original "La Télévision? . . . Mais c'est très simple!" Translated from the French by Fred Shunaman. All North American rights reserved. No extract may be printed without the permission of RADIO-ELECTRONICS and the author.

KEN—To tell the truth, it's really very complicated. Such little things as secondary emission mess up that simplicity you think you see.

WILL—Secondary emission! You mean like in a tetrode, where an electron hits the plate at high speed, and knocks off a number of others, which go back to the screen grid?

KEN—One of your good points is that if you ever learn something, you remember it! The iconoscope mosaic is bombarded with just such high-speed electrons, and they do knock off secondary electrons. Some of them get to the anode, but others just rain back on the mosaic, and make it slightly negative. So you can see that the action isn't quite as simple as you think.

WILL—You told me once that if you can make virtues out of the faults of people and things, you can really get somewhere. This secondary emission looks interesting. If one electron can set several into motion, why can't we use the effect to give us some amplification?

KEN—You were just born fifty years too late, Will! Your ideas would have made you the world's greatest inventor a half century ago!

WILL—And even today they're not so bad, either! I understand that this secondary emission is actually used for amplification.

KEN—Yes, and has been for some time, in a tube even more important to us than the iconoscope. It's the *image orthicon*, which is so much more sensitive than the iconoscope that it's the most widely used TV camera tube today. Here's a cross-section.

A tube that looks simple . . .

WILL—Well, it doesn't look quite as funny as the iconoscope. But what is this *photocathode* just ahead of what I take to be the mosaic?

KEN—It's one of the things that makes the tube more

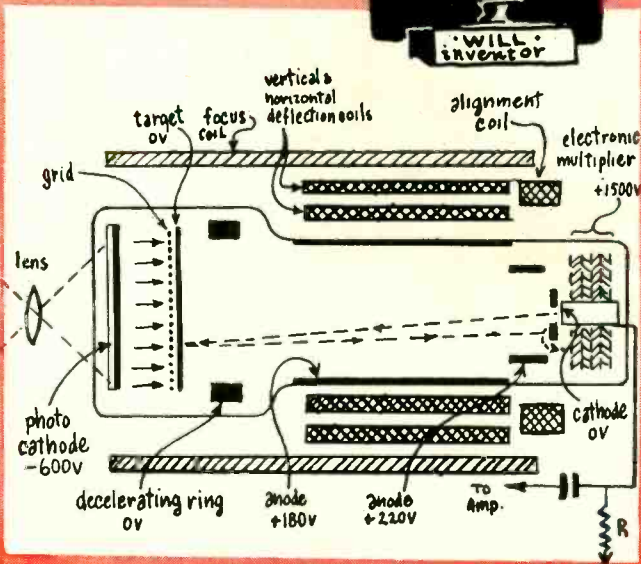
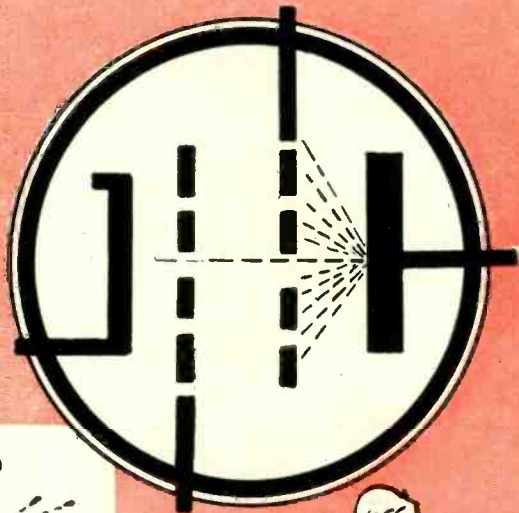



sensitive. It's a thin translucent sheet with a sensitized inside surface. The light coming from the outside releases electrons from the inside surface.

WILL—Sort of mosaic in reverse, eh?

KEN—But it's not a mosaic. *All* the surface is conductive, with no waste space. So it's more sensitive than a mosaic. The electrons which leave it go to the *target*, which may be as much as 600 volts more positive than the photocathode, although at the same voltage as the regular cathode in the electron gun. The target is a very, very thin plate of glass.

WILL—About how thin is very, very?

KEN—In this case, it means you would have to stack up about 5,000 of them to get a pile an inch high.

WILL—And why would anyone want to go to the trouble of making glass that thin?

KEN—And real trouble it is, especially when you consider that this plate of glass has to stand up under the baking-out temperatures when the tube is evacuated! But it has to be done so that the charges which form on its opposite faces can leak through the glass in the time between successive scans—that is, in 1/30 second.

... but whose action is complex

WILL—What charges?

KEN—Hold the questions for a few minutes, Will, and you'll get your answers quicker. Those electrons emitted from the photocathode where the light strikes it form an electronic image of the televised scene. As I just told you, they are attracted by the more positive target. They are kept in straight lines by the focusing coil, so the electron image is transferred to the target intact. Each electron striking the target produces a number of secondary electrons, which are captured by a fine-mesh grid placed very close to the target and kept 1 volt more positive than it.

WILL—So we again have positive charges on the face of the target, and they are exactly proportional to the light that falls on each corresponding spot on the photocathode. Now what?

KEN—These charges move through the glass. That's why it has to be so thin, and of the right resistivity. If the charge can't all leak through the glass in 1/30 of a second, some of it may hang over to the next scan, and if it can travel too fast, it may spread out on the surface so that adjacent picture elements won't be sharply defined.

WILL—Quite a critical proposition! But once the charges get through the glass in good order, they are scanned just as in the iconoscope?

KEN—Not just as in the iconoscope. For one thing, this tube works with *slow electrons*. For another, the electron stream itself carries the signal to the amplifier. Notice the low voltages on the *accelerating* electrodes—only 220 on the first and 180 on the second anode (which is our metalized layer on the inside of the glass tube). Then just before the electron beam reaches the target there is a *decelerating ring* at zero volts. At the same time the electrons feel the pull of the 180-volt electrode behind them. The net result is that they are going to stop sooner or later, turn around, and go back down the tube again.

WILL—But they do scan the target first?

KEN—They do. The voltages are so adjusted that the beam just reaches the target—makes it a turnaround point. If there were no positive charges on the target, all the electrons in the beam would go back. But wherever the beam sweeps past a positive charge on the target, it loses just enough electrons to neutralize the charge. *So the returning beam varies with the amount and distribution of charge on the target.* You might say that every little bit of returning beam carries a message telling the amount of illumination on a given spot on the target. Or, you can say that the returning beam current varies much as did the current through resistor R in the iconoscope diagram.

WILL—Now the only thing to do is to get the video-frequency signals into an amplifier, I suppose.

KEN—We're going to do quite a bit of amplifying before we even leave the tube. Here's where we use your secondary emission for the second time. As our electrons start back,

they are kept going in a reasonably straight line by the same focusing coil that kept them together on the way out. But now the voltages on the accelerators are increasing, and by the time they get back to the area of the cathode they are traveling at a pretty fair clip. Then they strike the first *dynode* of the *electron multiplier* . . .

WILL—Hey! What's that?

A day at the races

KEN—Just another of those things you could have invented yourself, if someone hadn't done it before you were born.

WILL—That's the way it always is with me! But before you start on something new, let's get straight on what we've gone over already. Light falls on a *photocathode* and produces an *electronic image*, which is transported to a *target*, where it produces *positive charges* by releasing *secondary electrons*. These charges are neutralized by being swept by an electron beam which leaves behind enough electrons to neutralize the charges. Because it has lost electrons in proportion to the size of the charges, it is *modulated* by them. The modulated beam now moves toward the *electron multiplier*. Is that right?

KEN—Spoken like an engineering instructor, Will! Now, about that electron multiplier . . . Have you ever played the horses, Will?

WILL—Hardly! If you can figure enough to use Ohm's law, you know better than to try to beat the odds at the races. But what has that to do with electrons?

KEN—You'd be surprised at the number of good mathematical minds who spend their time and money at the tracks. But I think I can give you an example without leading you astray. Suppose you go to the races with \$10 to bet. You put it all on a horse in the first race. He wins, and brings you in \$50. Let's suppose you're not wise enough to pocket your winnings, but put it all on another horse, and he wins, also at five to one. Now you have \$250, and if you have the spirit of a true gambler, nothing in the world could keep you from trying to lose it all in the next race, and—since it's necessary for our example—suppose your horse comes in first, giving you a cool \$1,250. And so it is also with the fourth and fifth races. You leave the course with \$31,250 in your pocket.

WILL—I wouldn't leave. I'd phone for an armored car and wait right there for it! But I don't understand why you're wasting all this time. Don't you think I understand a straight geometric progression?

KEN—Don't get excited! I've been describing an electron multiplier. It is composed of a number of targets, or dynodes, each one operating at a higher voltage. When our modulated stream of electrons gets back to the first of these dynodes (shaped like a disc with a hole in the center to let the electron beam from the gun through), it knocks several electrons loose. The only thing around that isn't at a lower voltage than the first dynode is the second dynode, so most of the electrons are attracted to it, and are also speeded up by its higher voltage. So if your original electron caused 5 electrons to reach the second dynode, they might jar loose enough to send 25 to the third one. Actually you do get gains of 200 to 500 in the 5-stage multiplier of an image orthicon. It has 1,500 volts on the last stage. The intermediate stages are connected to taps on a voltage divider incorporated in the tube.

WILL—Now I can see why—with sensitivity like that—they don't need so much lighting in modern studios. Why, the image orthicon ought to work with ordinary room light!

KEN—It will. I've seen part of a demonstration program televised with the light from a kitchen match! But with a little better lighting, the camera men can stop down their lenses and increase the definition and the depth of focus. So they get a clearer picture without losing any brightness.

WILL—Well, you've said that the image orthicon is the most widely used tube today, so you can't finish up our conversation in the usual way, by saying that all the things we've been talking about are long abandoned.

(TO BE CONTINUED)

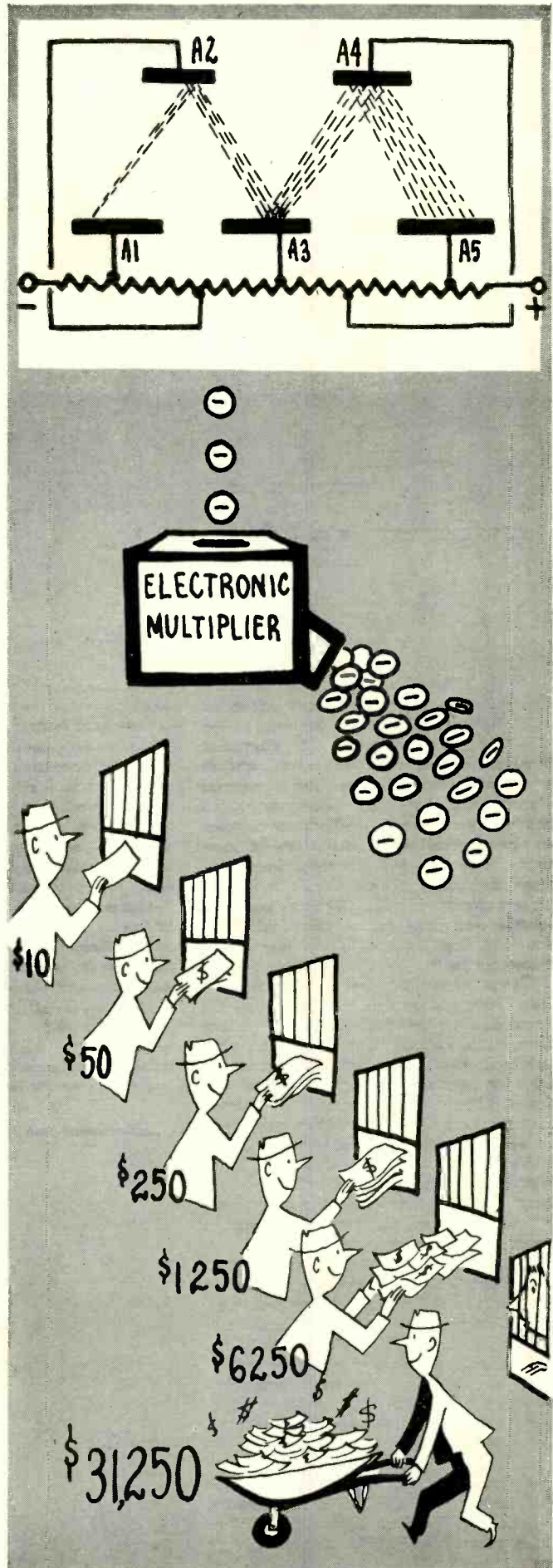

V.H.F.

COMES TO A

U.H.F.

AREA

Antenna and tuner problems in a u.h.f. area that took on v.h.f.

By CHARLES F. MAHLER, JR.

WHAT happens when a u.h.f. area gets its first v.h.f. channel? This question was asked by everyone in Portland, Oregon, when our first v.h.f. station went into action. There was a popular opinion that the u.h.f. antennas would have to be changed to all-channel types, or else special installations would have to be made for each channel. Some said that the u.h.f. Yagis would act as a direct short on v.h.f. Others said the bowtie antennas would work all right on v.h.f. and u.h.f. No one seemed to have the facts.

Up to now, the new u.h.f. channels have been going to areas where no TV existed or where v.h.f. channels have been on the air for some time. The only problem was the job of converting old sets or adding u.h.f. "strips" to the tuner. Often the v.h.f. antennas worked satisfactorily. U.h.f. antennas were added only when necessary.

We found over 50% of the antenna installations made in or around Portland were straight u.h.f. type. Channel 27 came on the air last year with a transmitter that had been used by RCA on an experimental basis in Connecticut. From this transmitter were patterned most of the u.h.f. units later designed. The power radiated from this transmitter was so low that some points less than a mile away were considered impossible areas for clear reception. This condition made it extremely difficult to get snow-free pictures on most of the sets. Special u.h.f. antennas had to be installed to try to compensate for the low power output of the station and the poor sensitivity of the receivers. All-channel antennas were installed when possible. Built-in antennas were rarely used.

Channel 6, our first v.h.f. station, was eagerly awaited. It promised more power and better coverage. TV dealers anticipated a boom in business. But the burning question was: "What will be necessary to pick up channel 6?"

It looked like we were going to be the guinea pig again. It was rumored that all sets using a dual-conversion system would require retuning. Dual-conversion is the method some manufacturers used to convert u.h.f. to v.h.f. Either a u.h.f. unit was put in the set at the factory or the dealer or distributor had to install it. Some units were external and others were cut into the front or side of the cabinets. The units turned on and off with the set. Some were given the name "continuous-tuner", but usually a manual operation was required to switch from one tuner

to the other. Most of the units were designed for channel 5 or 6.

It was feared that channel 6 would come in so strong that it would feed through to the v.h.f. tuner in the set when operating on u.h.f. There was also the feeling that channel 6 would slop over into channel 5. Actually, no slop-over of any great degree has been noticed. Of course it was necessary to retune the converters set for channel 6 to channel 5. Radiation on channel 6 from a converter-booster was noticed up to 100 feet from the unit. The unit had to be retuned to either channel 5 or 4.

All the u.h.f. antennas are picking up channel 6 with amazing results. Good, clean, ghost-free and snow-free pictures are the rule rather than the exception. The folded-dipole Yagis are

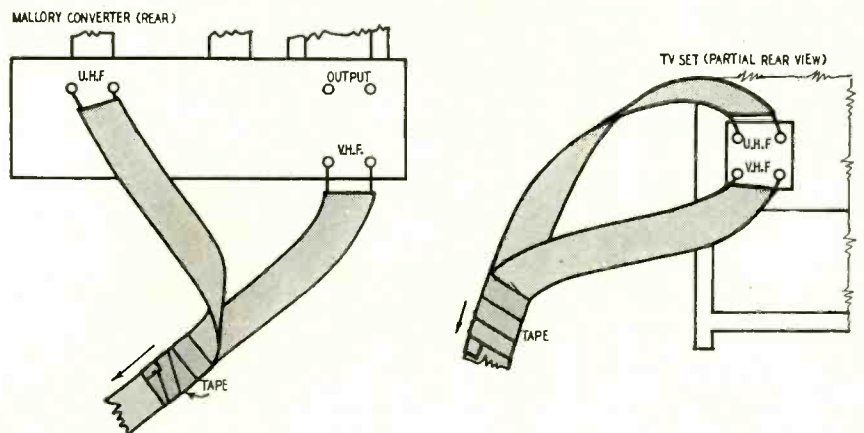

Fig. 1—When a outside u.h.f. antenna is used in a situation that calls for a u.h.f. and v.h.f. input, a capacitance coupling arrangement could be used. A short length of 300-ohm flat lead is connected to the v.h.f. input. The other end is taped parallel to the u.h.f. lead-in as shown above.

performing very well on v.h.f., but the Yagis with a straight dipole are not doing as well.

The bowtie and corner reflector type antennas used in difficult locations are delivering a satisfactory picture on v.h.f. In fact, when too strong a signal is encountered on v.h.f. and a weak signal on u.h.f., they have been found to be excellent. But usually it has been found that an installation change was necessary. This change consists of mounting a good v.h.f. antenna below the u.h.f., on the mast. Care had to be taken when this was done. We didn't want to lose any of the u.h.f. reception that the customer had paid good money for. We did not find it profitable to try to put an all-channel antenna in place of the corner reflector or bowtie antennas. These antennas were generally used because of a severe ghost problem on u.h.f., and to remove these antennas in favor of all-channel type was found to be a waste of time. The method used to couple these antennas together will be dealt with later in the article.

Collinear type u.h.f. antennas are performing equally as well as the folded-dipole type Yagis. However, there has been some indication that antennas with all-metal construction are doing better than the same type with the insulated elements. This might lead us to believe that the more metal you have in the air the better chance your u.h.f. antenna has of delivering a good v.h.f. picture.

Many installations of the all-wave type antenna gave good reception on u.h.f. but have been picking up ghosts on v.h.f. Special v.h.f. Yagis had to be installed to overcome this condition. The most widely used all-channel antennas have been the V type and rhombic. The V type antenna seems to increase in gain with frequency. The higher the frequency the more wavelengths each leg of the V resonates to. However, this type antenna on v.h.f. is as broad as a barn. Some of them are bidirectional. But on u.h.f. the angle of direction is very critical. Where no ghost or reflec-

tion problem is evident, they are very satisfactory.

The sensitivity of today's receivers has had a lot to do with the success we have had with u.h.f. antennas on v.h.f. The new continuous tuners being offered this year on most of the chassis has boosted the sensitivity of some sets on u.h.f. to the same level as on v.h.f. There is no amplification at u.h.f. The idea is to get the u.h.f. signal converted down without any loss. Most of the new sets this year using continuous tuners convert the u.h.f. signal directly down to the i.f. A good continuous tuner will outperform a strip type tuner in a rough area.

Many sets have two antenna inputs—one for v.h.f. and the other for u.h.f. When only one external antenna is used, a method must be devised to couple these inputs together so they both can use the outside antenna. In some cases it was found that by connecting the built-in antenna in the set to the v.h.f. terminals, a satisfactory picture was obtained, leaving the u.h.f. input for the outside antenna. In most primary areas this was all that was necessary. But when snow or ghosts were encountered with the built-in antenna on v.h.f., it was necessary to connect both inputs of the set to the outside antenna.

A very effective way to do this is to capacitance-couple the two (Fig. 1). Leaving the u.h.f. antenna alone, we cut a piece of 300-ohm flat lead about two or three feet long. The exact length is not important. Connect one end to the v.h.f. terminals of the receiver, leaving the other end open. Tape about six inches along the lead-in coming from the outside antenna. This short piece of lead-in taped parallel along the outside antenna lead-in picked up enough signal from the outside antenna to deliver a snow-free picture on v.h.f.

If it is found that this capacitance coupling attenuates the u.h.f. signal, move the short piece back and forth on the antenna lead-in until a spot is found which does not attenuate. This has the same effect as sliding a piece

of tinfoil along the line. When the correct spot is found, tape the short piece of lead-in along the antenna line, as much as it takes to deliver a snow-free picture—presuming, of course, the outside antenna is picking up a good v.h.f. signal.

When it is necessary to connect two or more outside antennas to a set which has only one input it will usually be necessary to use a matching device to couple the multiple lead-ins into one lead. Some types of matching transformers should be avoided if much wet weather is encountered; they will split open at the seams during a hot spell and water will seep in during the first rain—water is murder in u.h.f. Mount the transformer under the roof eaves or attach onto the back of the set. (Fig 2.) There is a slight loss at u.h.f. through these devices on all the brands tested. However, it will not be noticeable in good signal areas. The new antennas with a matching transformer mounted on the antenna with a broad-band u.h.f. and broad-band v.h.f. antenna such as a conical and fan coupled together, have worked well. However, there is a condition on one make of conical and fan combination where the lobe on the u.h.f. fan is not in the same direction as the lobe on the v.h.f. conical behind it. This can become a problem when both signals are coming from the same point of origin. (Fig 3.) Another manufacturer has a Yagi mounted in front of a broad-band dipole combination with printed circuits providing proper match. The printed circuit connecting the two antennas is not reliable in wet weather. The manufacturer has sent us improved replacement circuits, but we still have not been able to use this antenna with any degree of success.

I think we should not underestimate the brute-force power of v.h.f. as compared to u.h.f. That these u.h.f. antennas are working well on v.h.f. indicates there are open fields ahead in the design of efficient all-channel antennas.

END

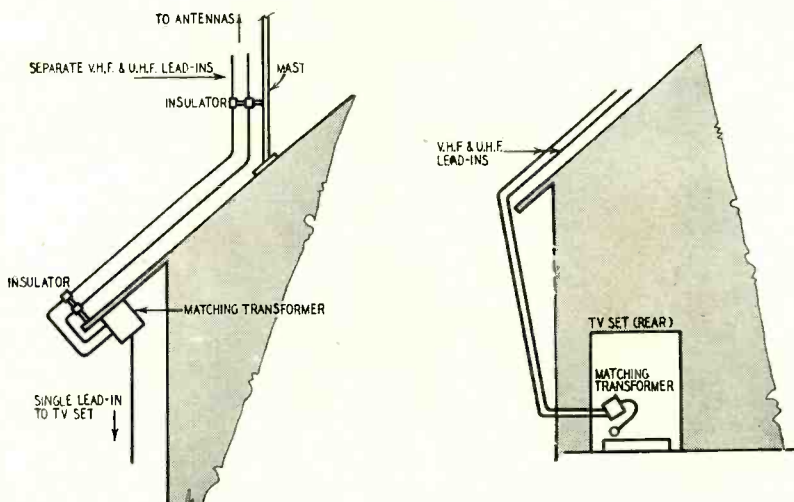

Fig. 2—Diagrams show location of matching transformer to protect it from rain.

APRIL, 1954

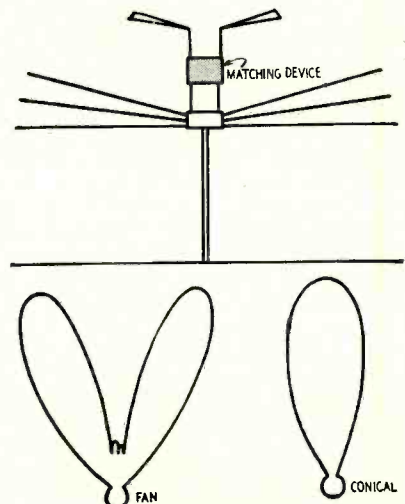
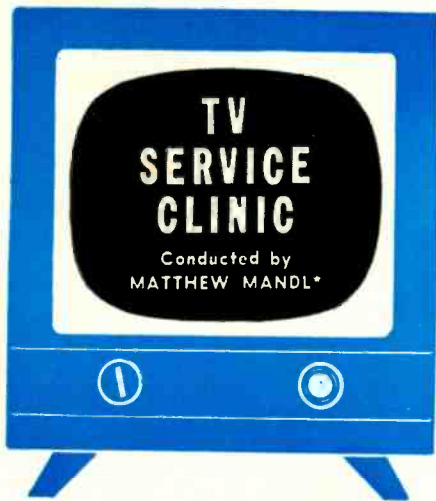

Fig. 3—A conical and fan combination where the direction of the lobes differ.



JOSEPH HESS of Philadelphia wrote us about an item which is often a stumbling block in video i.f. alignment. He emphasizes that technicians not only should check all tubes before aligning the receiver, but should replace any tube weaker than the others even if it checks good on a tube tester. This is particularly true in stagger-tuned i.f. systems where each stage is tuned to a different frequency.

The importance of this can be seen in Fig. 1. This is a typical response curve for stagger-tuned systems used in the popular 630 type receiver, as well as the Admiral 30A1 and others. With intercarrier receivers the response curve will be somewhat different, but the same factors will apply if the i.f. system is stagger-tuned.

Fig. 1 shows five tuned circuits, each having a response curve different from the other with respect to amplitude and width.

Thus, the over-all response as shown by the dotted line of Fig. 1 will appear as in Fig. 2 when the set is aligned properly. However, suppose that the tube associated with tuned circuit A is weak. This would prevent tuning that stage to the peak indicated, with the result that the bandpass would appear as shown in Fig. 3. In this instance some of the high-frequency sideband components are lost and picture detail is poor (Fig. 4); the vertical wedge is hazy and the individual lines are hardly visible. Note the difference in Fig. 5, which illustrates the same receiver at a later date when a weak video i.f. tube was replaced and the i.f. stages re-aligned. Picture quality is much better.

To get a flat response for the desired 4 megacycles, you would have to adjust the other tuned circuits to have less gain in proportion to circuit A. Thus, total gain would be down and insufficient contrast may result.

Vincent Halbauer of Kansas City, Mo., reports about vertical foldover. This is usually caused by a defective coupling capacitor to the vertical output amplifier. In a Motorola 17T5D receiver, however, he found an open 8,700-ohm resistor (3 watts) going to ground

*Author: Mandl's Television Servicing.

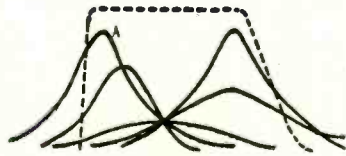

Fig. 1—Stagger-tuned characteristic.

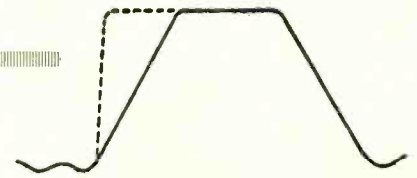

Fig. 3—"A" circuit reduces bandpass.

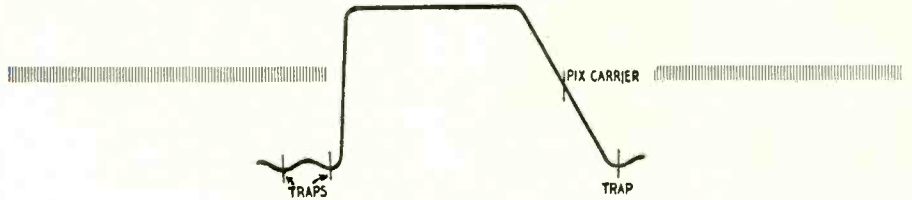

Fig. 2—Overall bandpass for Fig. 1.

from the vertical linearity control. This proved particularly difficult to find because the resistor was intermittent and would work well for hours while the set was on the bench.

Bruce Moore of Reagan, Texas, finds that tuner tracking and video i.f. alignment is critically important when using split-carrier receivers for u.h.f. reception. He reports that in a Philmore receiver reception was good for both sound and picture on channels 2 to 6, but from channel 7 to 13 it was difficult to get both the picture and sound well. On channel 34 (using strips in the tuner) it was possible to receive either the picture or the sound, and not both.

When the receiver is aligned properly, the condition is minimized for all but the weaker stations. If reception is to be improved for the latter, a higher or better antenna is recommended, plus a good booster.

Centering troubles

I am having trouble centering the picture in a Radio Craftsman 201 receiver which uses a 17BP4B and a permanent-magnet centering and focus arrangement. I have tried the suggestions given in the January, 1954, issue, page 73, but evidently something else is wrong with this receiver. When the arm of the picture-centering adjustment is in its extreme position for moving the picture to the right, it still is about an inch or so from the edge of the mask. Are there any other procedures I can undertake? J. E. B., Richford, Vt.

The trouble may be caused by incorrect line-up of the yoke with respect to the focus unit. Check the yoke-holding bracket to make sure it lines up with the axis of the yoke and focus device. In most instances the picture tube will have to be removed and the yoke and focus assembly aligned optically. The holding bracket of a yoke may require bending to get proper line-up. You can also replace the focus assembly with a larger type for better results. The focalizer bolt should be loosened and the focalizer shifted around to aid in getting perfect alignment. Also observe the action of the

focalizer shunt ring and see if there are any burrs or binding which would prevent the adjustment from going through its complete range. Also make sure the yoke is set firmly against the flare of the picture-tube neck.

21EP4B vs. 21FP4A

A Capehart CX-36 receiver uses a 21FP4A picture tube and I would like to replace it with an aluminized tube such as a 21EP4B. However the 21FP4A is an electrostatic focus tube and the 21EP4B is electromagnetic focus. Can you suggest means of making this change-over; and do you think such a change would be worth the effort and expense involved? G. W. C., Portland, Oregon

The 21EP4B tube can replace the 21FP4A tube without any circuit changes. The 21FP4A tube has pin 6 connected to the focus electrode variable resistor, but the 21EP4B has no connections to pin 6, and therefore the old focus control can be left in the circuit and it will be inoperative. For the 21EP4B a focus magnet ring can be used. These have a lever for adjusting picture centering, as well as a focus adjustment.

Whether the change is worth while depends on the condition of the original tube. If the old tube is still giving good results the only difference noted would be increased brilliancy for daylight viewing. With the aluminized tubes the high-voltage system must be operating at peak efficiency for best results.

12VP4 to 12LP4

A 12VP4 picture tube is used in a Sylvania 1-245. The picture tube requires replacement and I would like to use the more popular 12LP4 which has a second grid and a double ion trap. What must be done for this replacement? O. W. P., Holland, Ohio

The 12VP4 has no first anode, while the 12LP4 does. The first anode terminal is pin 10. Thus, when a 12LP4 is installed you will have to apply approximately 300 volts to pin 10 of the picture tube. You can get this voltage from the low-voltage power supply.



Fig. 4—High frequency sideband loss.



Fig. 5—Fig. 4 condition corrected.

Instability in Zenith

I'm working on a Zenith 23H22 receiver which has poor sync stability, both vertically and horizontally. I've tried all new tubes from tuner up to the horizontal output section. I've also checked all voltages throughout the receiver, as well as checking all parts and substituting any in question, but to no avail. W. K., N. Y.

In some of these receivers such troubles occurred because of loose rivets in the Phonevision connector plug. Since you have made a thorough check of all other factors, you should examine the rivets in that plug and tighten any which are loose. Also look out for any portions of the plug which might be shorting intermittently to adjacent wires or terminals.

Selenium rectifier failures

In an Emerson model 649A I've experienced repeated selenium-rectifier failure. I have even tried 350-milliampere rectifiers instead of the 200- and 250-milliampere ones that were originally in the receiver. In a relatively short time, however, I get low voltage and accompanying loss of vertical and horizontal size and contrast. I have been planning to eliminate these rectifiers in sets of this type in the future and have been wondering if there is a simple type of replacement power supply I could use.—G. S., Union City, Conn.

As with many receivers using selenium rectifiers for the low-voltage power supply (and bias supply) peak current limiting resistors are used in series with the rectifiers and the line voltage. Thus, if the two 15-ohm resistors in series with the 80- μ f capacitors and rectifiers are off value, they could cause this trouble. In some instances these resistors increase in value and should be replaced with new ones of the proper value.

Another possibility is that some of the filters are leaky and are drawing an excessive amount of current. For this reason the power factor of each capacitor should be checked with a capacitor

checker. Replace if they are loading the power supply too much. We do not recommend your replacing this power supply with the transformer type. This would require an extra-heavy-duty transformer to accommodate the large current requirements. Besides this, a negative supply would also have to be used to furnish the necessary minus 225 volts.

Stacking factors

I'm trying to improve reception for u.h.f. channel 34 in this area and would like to stack the ordinary u.h.f. antenna to favor this channel. I notice that some antennas are stacked a half wavelength apart, while others are stacked only a quarter wavelength. I would like to know just what is the correct wavelength?—B. M., Reagan, Texas.

If only one channel is to be used, best results are obtained by stacking the antennas one-half wavelength apart. When manufacturers use a quarter wavelength for stacking, they do so with antennas which are designed to pick up more than one station. In broadband antennas the quarter wavelength spacing favors the higher channels. This is advantageous since the higher channels are usually weaker because of increased losses after transmission of the signal.

Uhf drift

I have recently installed u.h.f. strips for channel 34 in a Tech-Master 630-type receiver. I find that the sound drifts considerably and requires retouching of the fine-tuning control quite often. What procedures do you suggest for correcting this drifting?—D. S., Bristol, Ind.

Try a new local oscillator tube in the tuner. If the local oscillator drifts slightly for v.h.f. the condition will be aggravated for u.h.f. reception. On occasion the crystal mixers in the channel strips are not up to standard and may introduce some drift. When the local oscillator has been corrected for good stability and drift is still present, try new u.h.f. strips. **END**

If you've been wondering what this business of TV dx is all about, the next three months is the time to find out for yourself. This is the season that TV dx enthusiasts and hams who work on the v.h.f. bands live for—the period when anything can happen on the frequencies from 50 mc up.

In the more southerly parts of the country things will be happening before the end of April, though above Latitude 40 or so it may be the first week in May, or even later, before the first dx breaks through. Watch particularly during the early evening hours, and on channels 2 and 4, for the first signs.

Your chances of seeing dx are best if you have no local service on one or the other of these channels, as the first dx is likely to be too weak to override a local signal. With stations now operating in Alaska, Hawaiian Islands, Mexico, Cuba, Venezuela, Brazil, and Argentina this year, the chances of record-breaking dx are better than ever.

As the season advances, dx will develop more frequently, show up during a greater portion of the day, and come through from more widespread areas. By the latter part of May it should be possible to catch something every few days; and years of records prove that June allows hardly a day to pass that dx is not recorded somewhere.

Tropospheric reception will begin to improve as the weather moderates with the advance of spring. If there are warm days and cool nights, barometer readings of 30.0 or higher, calm weather with a gradually thickening overcast, large slow-moving high-pressure centers drifting across your locality on the daily weather maps—all these are the signs that point to improved fringe-area reception.

Anyone who thinks that TV dx can be seen only in the warm months should have a look at the pile of reports that have come in from year-round dx observers in the past three months. Joe Foyer, Westville, Ill., has logged 57 v.h.f. and 15 u.h.f. stations, many of them during the winter months. Albert Brant, Salem, Ore., caught KFMB, San Diego, Cal., channel 8, late in the fall, a distance of about 900 miles, and he received low-band dx frequently during November and December. Scores of observers report sporadic-E dx reception during the minor dx period in December and January. Perhaps the most interesting of these reports comes from northern Venezuela, where Miami and Cuban stations have been picked up since TV service was inaugurated in Caracas. Has anyone seen Venezuelan stations in this country? **END**

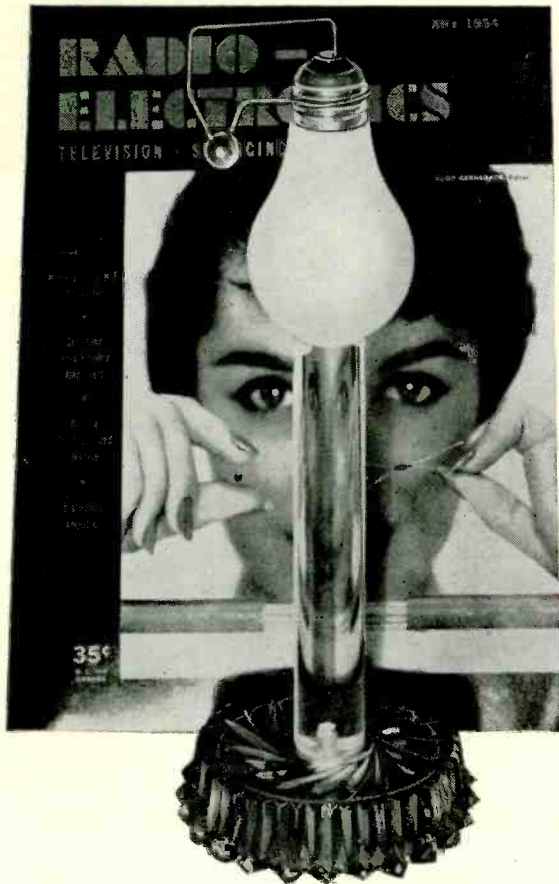

Above: A view of the Cosmic Generator. Note 60 watt 110 volt bulb mounted on top of the transparent lucite column. The Cosmic Generator at top left supplies the full voltage which keeps the lamp going for a number of years.

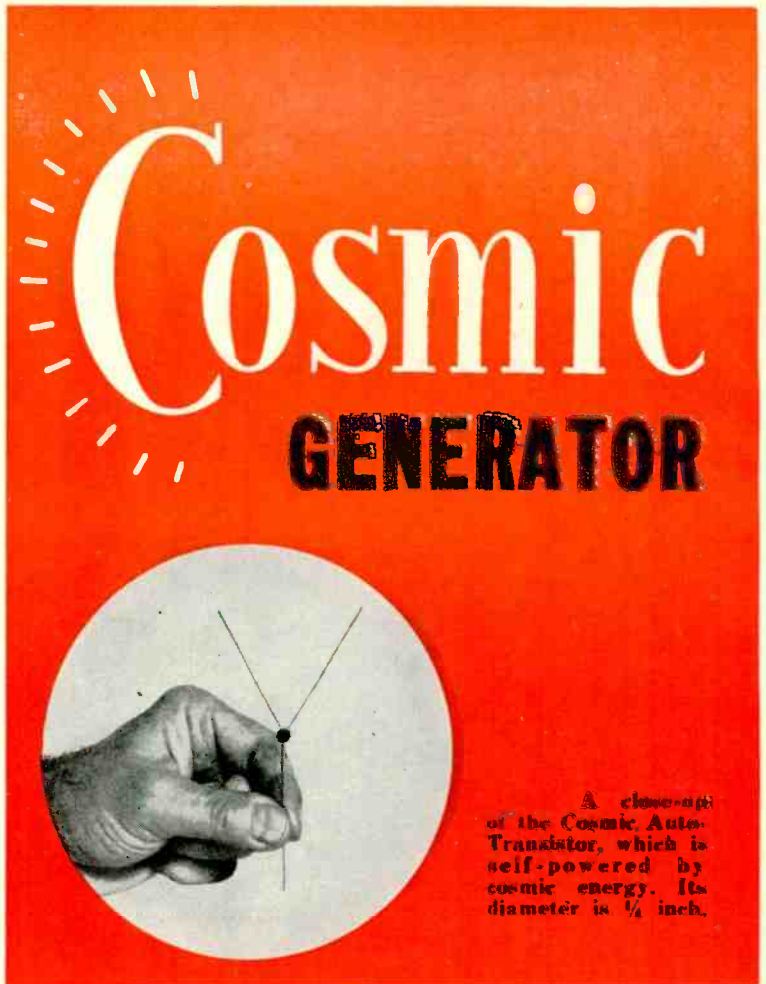

By MOHAMMED ULYSSES FIPS, I.R.E.*

FOR over 40 years scientists have wrestled with the problem of what they mistakenly call *cosmic rays*. Actually, they are not rays at all, but the most powerful *radiation* in the Universe—streams of heavy particles: *protons*, flying at terrific speeds from one-tenth to one-fifth the speed of light.

Cosmic radiation—as the term cosmic implies—comes from outer space. It comes from all directions of the compass, indicating its universality in Nature. The cosmic particles, heavier than iron, are—as I have been able to prove in my researches—created spontaneously by gravitational stresses throughout the Universe. These stresses, existing in all gravitational fields, continuously create unbelievably large surges of power. This is the source of all cosmic radiation.

This theory, incidentally, fits in exactly with Einstein's universal field theory, linking gravitation with all electromagnetic phenomena.

To prove my theory, I set out to do something about it. Knowing that cosmic radiation pierces lead shields many feet thick, it was obvious that we must first find a means to contain them, if we ever wished to make use of this titanic energy that makes the most powerful atomic radiation look and act, by com-

parison to it, like mere cigarette smoke.

It is easy enough to capture cosmic radiation, but accumulating it and putting it to work are different and far more difficult undertakings.

I knew that not a single one of the 99 known atomic elements was suitable for my researches, so it became necessary to explore the unknown. *Eka-holmium*, element No. 99, with an atomic weight of 247, was the last discovered element of the series.† (Element 100—unnamed—was also discovered in Feb. 1954.)

I soon discovered element No. 103—atomic weight 251—but this so-far unnamed metal also was too radioactive.

The next element, No. 104, with an atomic weight of 252, which I have named *isolum*, proved to be the missing link. Weakly radioactive, with a chromium-like color, this heavy metal is soft, like lead.

By means of a simple electronic device, cosmic radiation could be stored in an isolum box. This device, not unlike a storage battery—except that it contains no liquids—can store cosmic radiation for long periods of time, simply by converting the radiation DIRECTLY into electrical current.

†Eka-holmium (tentative name) was announced on February 1, 1954, by the Atomic Energy Commission. It was first made in the University of California's cyclotron at Berkeley, California.

But my researches soon showed that if cosmic radiation is universal, it must be possible to generate it spontaneously. As cosmic radiation was known to possess enormous amounts of energy, exceeding many billions of electronvolts, I also knew the potential danger to man. For that reason, I proceeded cautiously. In due time, I isolated a small speck of pure *cosmium*—element No. 105, with an atomic weight of 253! The heaviest of all elements, it is a bluish metal which continuously gives off cosmic-radiation bombardment. Even a small speck of the element generates lethal radiation, killing frogs and other small animals at a distance of 20 feet. When working with *cosmium*, in the laboratory, one must be shielded with *isolum*.

To use *cosmium* for useful work, it must be contained in an isolum enclosure, the latter (being radioactive) shielded with lead.

(For military reasons—*cosmium* is several million times as powerful as an H-bomb, gram for gram—no details as to its manufacture can be divulged.)

However, I am permitted here to show several practical applications. The first is the basic cosmic generator. It is a rather simple sphere measuring only 1/2 inch in diameter. A speck of *cosmium* is held in a thick isolum

*Institute of Radiation Engineering

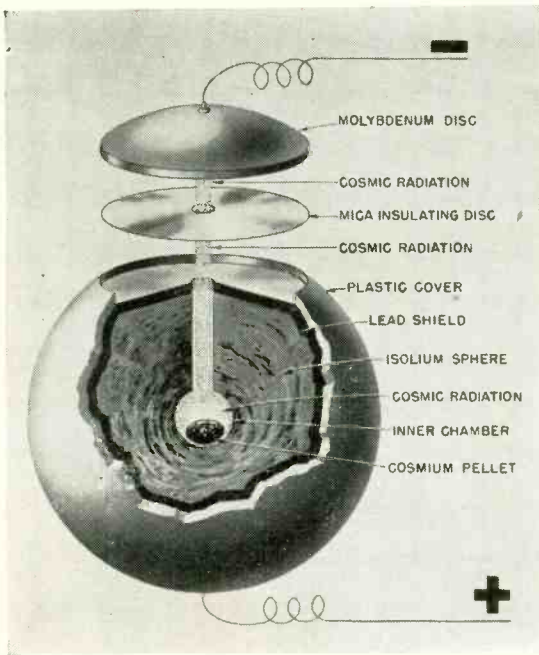

Left: Cross-section of Cosmic Generator showing *modus operandi*. The cosmic radiation goes up through hole of isolium sphere is absorbed in molybdenum disk, thus generating electric current.

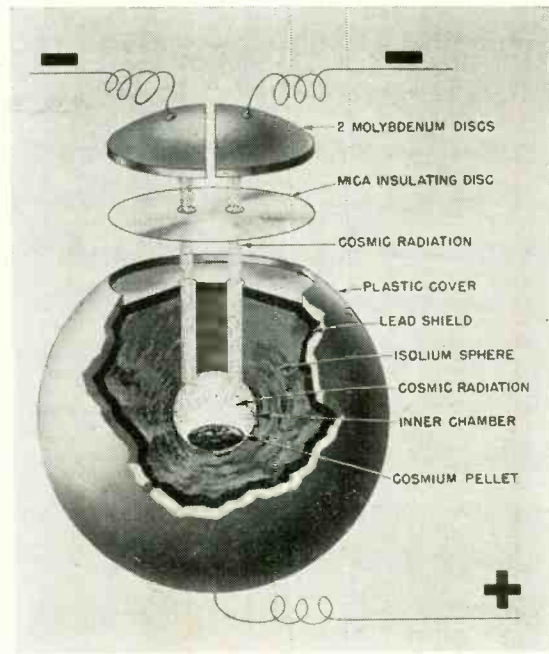

Right: Cosmic Auto-Transistor is self-powered. Cosmium pellet gives off cosmic radiation through two holes which, impinging on two molybdenum disks, operate the Auto-Transistor.

shield. The latter is enclosed in a lead shield. A fine hole pierces the isolium and lead shields. A sheet of mica also pierced with a fine hole, covers the flat top of the assembly. On top of the mica sheet we have a thick wafer of molybdenum metal.

The latter now is bombarded with protons from the cosmium, through the fine hole. Each proton liberates billions of electrons from the molybdenum, giving rise to a powerful electric current which will go on for several hundred years.

Our photograph shows the cosmic generator operating a 110-volt, 60-watt lamp, mounted on a transparent lucite rod.

Another illustration shows the *cosmic auto-transistor*, which is self-powered, requiring no battery, as it generates its own current. Made into a powerful radio receiver the size of a lipstick, it can operate a loudspeaker with volume sufficient to fill a large auditorium. The photograph shows this somewhat startling assembly.

A further illustration also depicts the cosmic auto-transistored radio schematic.

There is no end to the versatility of *cosmic-electronics*. It will, in time, surpass all other radio-electronic developments. There is conceivably only one thing that will hold back its quick ascendancy—the Russians. Naturally, we don't want such a potential weapon as cosmium to fall into their hands. Therefore, it will not be possible for some time to manufacture it for public and private use. Hence you will not be able to buy even a speck for experimental purposes.

This is a very sad state of affairs for scientific progress. Unfortunately, nothing can be done about it.

Perhaps there will be better news for all by next

APRIL 1

APRIL, 1954

Right: Cosmium Auto-Transistored Radio mounted in lipstick case. This mini-radio set has sufficient power to drive a 15-inch loudspeaker to fill an entire auditorium.

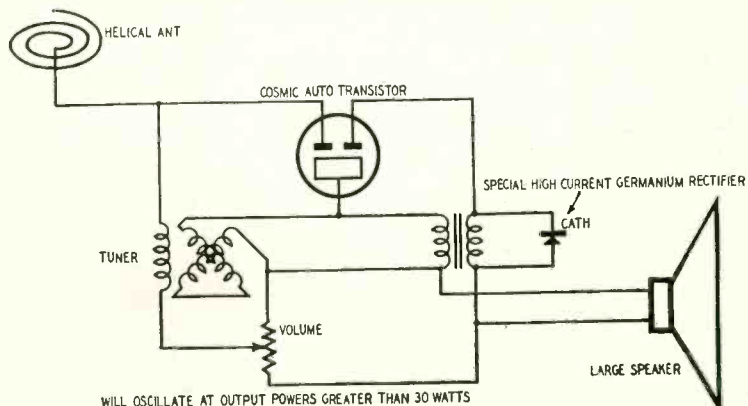
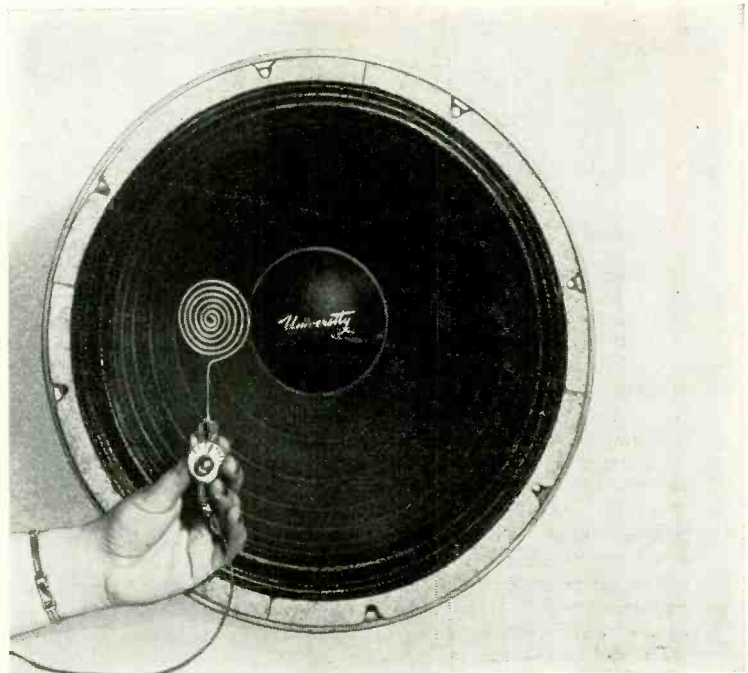

Circuit diagram of Cosmic Auto-Transistor receiver seen in photograph above. Tiny cosmic vest-pocket radio gives sufficient power to operate several large auditorium speakers.

MILADY'S

GOLDEN
EAR

We are proud to present the latest in the *Golden Ear* series, designed and built to our order by Mr. Marshall, and tested by our editors



AMPLIFIER

By JOSEPH MARSHALL

NOW it came to pass that Homo Sap was bitten by the high-fidelity bug. Not having the funds to purchase a commercial amplifier with less than 1% distortion, a bandwidth as great as an autobahn, and enough output to heat the house, he decided to build his own, following a design in one of the magazines. After heroic labors with drill, reamers, files, hacksaw, and even a hammer and chisel—aided and expedited by some fearful Elizabethan oaths—he managed to cut out a sufficient number of holes in a blank chassis to accommodate the various transformers, tube sockets, filter capacitors, etc. The chassis was no longer a thing of beauty. He had made a couple of miscalculations in layout with the result that the amplifier boasted several gaping holes which contributed nothing but ventilation. This didn't bother him. It was what came out of the amplifier that interested him. When at last he tried it out he was in raptures.

"Most beautiful music this side of heaven," he said.

"Maybe," milady of the household said, looking sourly at the pride and joy as it stood on an open bookshelf, "but it's the ugliest thing this side of hell. Get it out of sight."

His neighbor, Joe Doakes, profiting from this experience, played it safe. He purchased a kit with two punched chassis and a decalced escutcheon. Most of his mistakes were hidden underneath the chassis. Placed on the bookshelf the finished product, though not beautiful, had a sort of functional handsomeness—if you like functional handsomeness and Mrs. Doakes wasn't crazy about it. Still Milady Doakes, though she did not think the amplifier complemented the decor, made no serious objections to having it around—at first. But, coming home from his bread-winning pursuits one day, Joe was amazed to find the helpmeet facing him with a crudely

bandaged hand and sparks in her eyes. "Listen," she ultimated; "get that damned amplifier of yours out of sight and out of reach."

"But sweet," Joe protested. "What's the trouble? You know we can't afford any fancy cabinet for it."

"We can't afford any divorces either," Milady replied; "and that's what we're going to get if you don't get that thing out of sight. It attracts dust like a platinum blonde attracts frustrated husbands. I burned my hand on one of the tubes trying to get it dusted clean. So either it goes out of sight or I go to my lawyer!"

Believe me, brethren of the bond, I know whereof I speak from actual experience, not mere book learning.

Clearly what is needed in high-fidelity is some kind of design which will hide most of the tool marks and mistakes, and will not rouse the antagonism of the others in the household by catching dust and clashing with interior decorations.

Therefore, I present Milady's Golden Ear which claims electrical performance right up there with the best of commercial gear, and at the same time a retiring, house-broken disposition, calculated to win milady's tolerance if not love. As the photos show, it blends inconspicuously into its environment. Moreover, it has no dust-catching projections or burn-producing hot spots. Milady's Golden Ear is flexible and compact; it can be tucked into any odd corners of cabinet or closet. For, although it puts out 20 watts of very pure sound, it occupies less than 1/2 cubic foot of space.

The circuit

Regular readers of this magazine will recognize the circuit (Fig. 1) as a modified form of the Golden Ear presented in my article of last November. The new circuit is adapted to tubes of

the Williamson class requiring around 40 volts-per-grid of drive and delivering an output of from 10 to 20 watts. It also embodies a new combination of current and voltage feedbacks which seems to me to deliver a remarkable degree of faithfulness in reproducing the input waveform both in form and in amplitude.

The output stage is the now familiar Ultra Linear version of the Williamson (as developed by Hafler and Keroes), using the Williamson biasing arrangement. The input section is the Golden Ear combination of cross-coupled inverter (developed by Van Scoyoc) direct-coupled to a voltage amplifier. This section has no phase shift at the low-frequency end because there is no internal coupling capacitor. There is very little low-frequency phase shift at the input either. The input tubes are cathode followers with extremely high input resistance, and this is increased by the current feedback of the outer loop. Any value of input capacitor in excess of about .025 μf will pass signals below 10 cycles. It is important, however, that the input capacitor be free of d.c. leakage, for any d.c. voltage appearing at the grid of the input tube will disturb the balance of the amplifier. To insure against this, I include a .05 μf input capacitor. The capacitor at the output of control unit, the tuner, or other device will be in series and therefore the leakage is reduced by at least 6 db, which should be more than sufficient. Provided the capacitor at the output of the tuner, preamplifier, or other device, is .05 μf or larger, the amplifier will still pass a 10-cycle wave with little distortion.

The high-frequency response is similarly good. Since the input tubes are cathode followers they have a very good high-frequency response. The inverter, since it is fed by the low impedance of the cathode followers, has very little

RADIO-ELECTRONICS

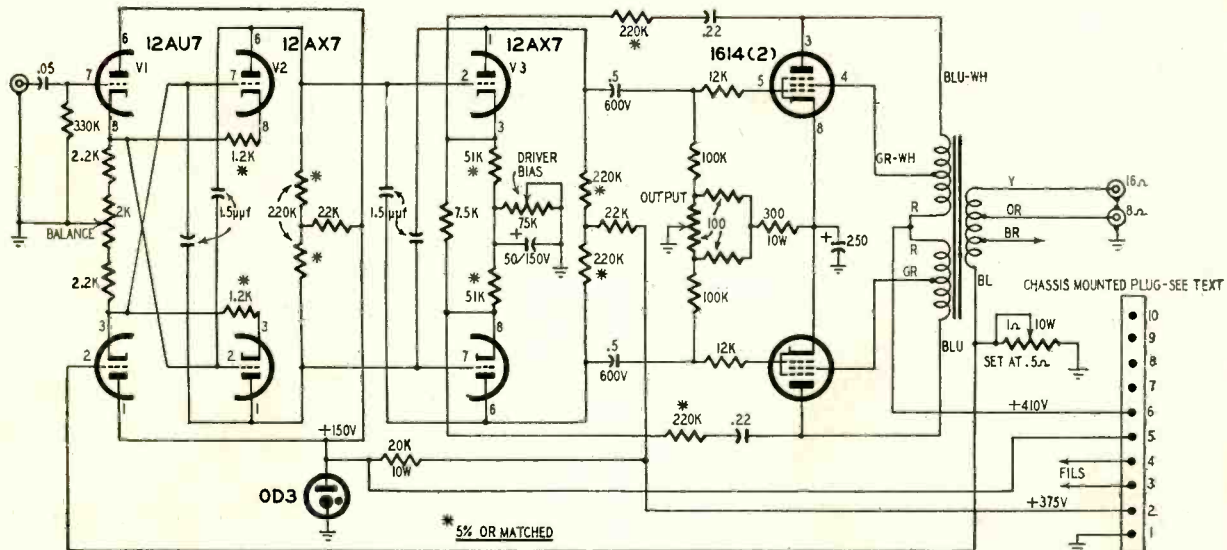

Fig. 1—The schematic diagram of the amplifier section of the RADIO-ELECTRONICS Golden Ear. All values are shown.

Miller effect and this is further minimized by neutralization with 1.5- μ f capacitors. The 12AX7 driver also is neutralized. The result is that this section goes to 50,000 cycles with a slight droop of 1 or 2 db in the last octave.

The only coupling capacitor, and therefore the only point of phase shift within the amplifier, occurs between the front section and the Williamson style output stage. Because of the low value of grid resistors the time-constant is

short, even with the very large capacitors. However, this phase shift is at least partially, if not entirely, neutralized by the inner feedback loop which goes from the plates of the output tubes to the cathodes of the driver. This is achieved by making the time-constant of the loop the same as that of the coupling between drivers and output tubes. The effect of the time-constant in the loop is the opposite to that of the interstage capacitance; one produces a lag and attenuation, the other produces a lead and boosting. Thus, the total effect is more or less to neutralize the interstage time-constant.

This is the critical point in Golden Ear design. On one hand the high value of cathode resistance in the drivers makes it easy to obtain a complementary time-constant in the loop with reasonable capacitances; on the other hand, the very same high resistance results in large amounts of degeneration of the drivers. In the Junior Golden Ear amplifier, which was designed for maximum quality at normal home levels with inexpensive components, I deliberately made no compensation for the degenerative feedback in the drivers; with the result that with this factor and the voltage feedback too, the stage had no gain but some loss. This was alright at low levels, but people who wanted to drive it to maximum output had trouble supplying sufficient undistorted drive.

I made one serious oversight in the article describing that amplifier. In hurrying to write it, I failed to point out the necessity for making changes in the driver stage and feedback loops to produce enough sensitivity to drive larger tubes. Curiously enough, no one who reported modifying a Williamson complained of poor performance, and all reported an improvement in quality. Obviously they were people who were much more interested in day-to-day performance than in maximum-output demonstrations.

The circuit used in Milady's Golden Ear makes the necessary corrections to

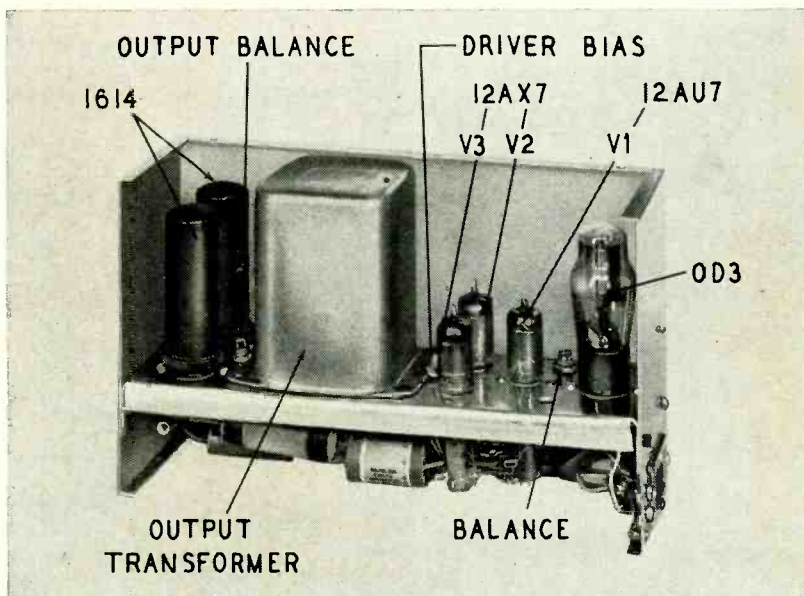

Milady's Golden Ear amplifier. Vector sockets are used to simplify the wiring.

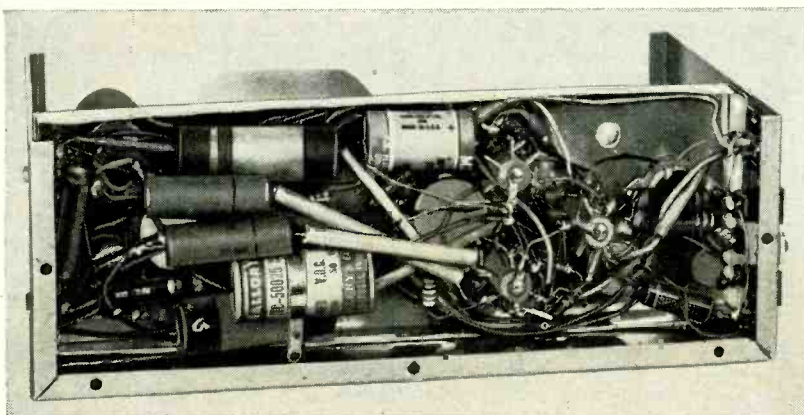

Vector socket wiring leaves ample room for placement of the larger components.

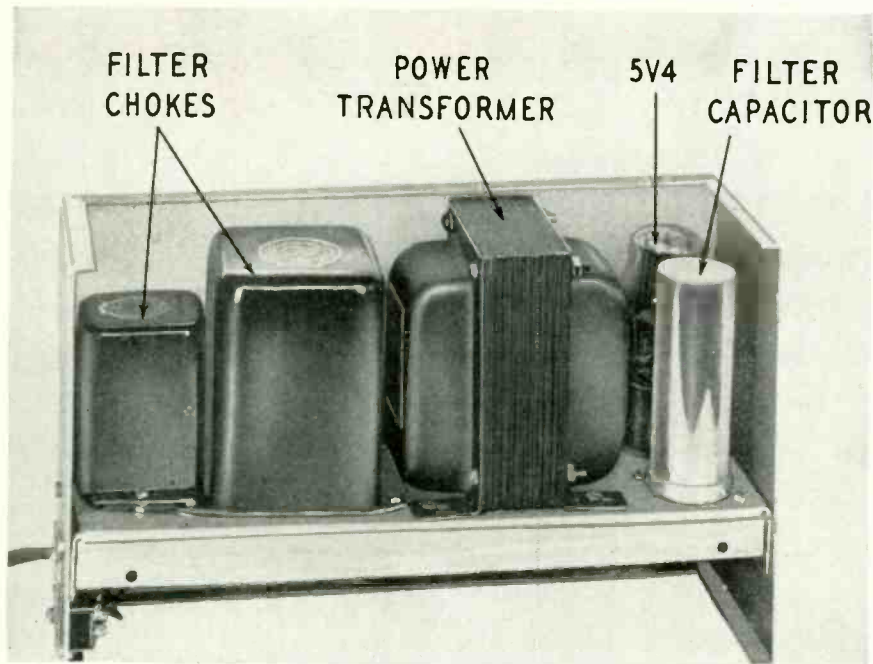

Golden Ear power supply. Select parts carefully to fit the chassis and case.

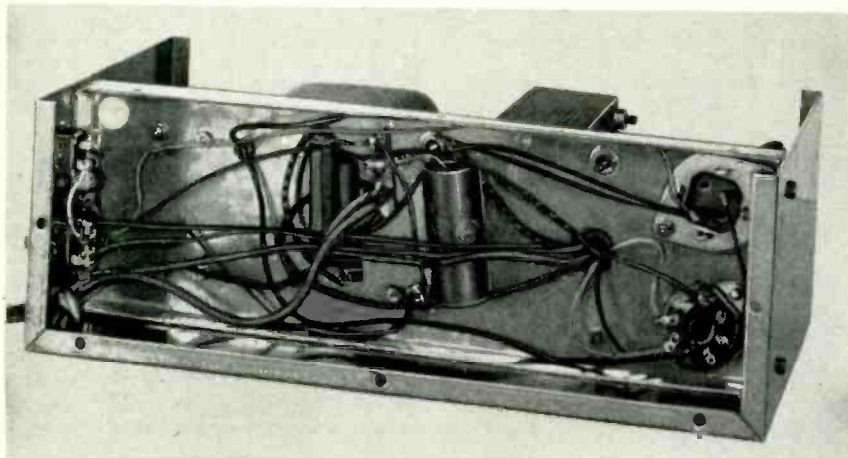

Underchassis view of the power supply. Anchor parts securely to the chassis.

achieve normal power outputs with moderate input voltages, and it can be applied to any Williamson tube simply by changing the front section. It will provide well in excess of 40 volts per grid of drive and can be used with any tubes up to and including the 6B4 series.

I have tried many combinations of current and voltage feedback in the driver stage. Either type reduces driver distortion of course; but for phase-shift neutralization the voltage feedback should be at least 12 to 14 db. Of all the combinations I tried, the one shown in Fig. 1 works best. The cathode bias is supplied by a combination of independent and common bias resistors. The independent resistors develop the feedback; the bypassed common resistor stabilizes the direct-coupled stage. The two are proportioned so that about 40% of the bias is developed in the independent resistors. A rheostat or potentiometer is used to establish the exact bias, because the 2 volts required is less than 1% of the plate voltage and even 1% resistors might vary enough to miss the

exact value bias by a great many volts.

Even with this proportion of bypassed to unbypassed resistors, the current feedback is still excessive. It could be reduced by decreasing the size of the independent resistors and increasing the common one. This would require very large capacitors in the feedback loop to duplicate the time-constant of the coupling capacitor. Therefore, the current feedback is reduced by shunting the cathodes. With the shunt value given, the current feedback is reduced to 6 db. Of course, the shunt also reduces the voltage feedback. Thus, a much higher proportion of the output voltage must be fed back. Still, the R-C combination permits us to obtain the required time-constant with a reasonable size capacitor. The voltage feedback is around 14 db. The net gain of the 12AX7 is reduced by the combination of current and voltage feedbacks to about 7 times. The inverter therefore has to deliver about $6\frac{1}{2}$ volts per grid for maximum output with the 1614's or similar tubes. Since the inverter is capable of putting out 50

volts grid-to-grid with some distortion, and 25 volts with very little distortion, the 11 volts required presents a very modest demand on it and the inverter always works on the straightest portion of its curve.

Correction of phase shift below 20 cycles is nearly complete in the case of output tubes used as triodes, since the loss in the feedback loop is about the same as the gain in the output stage. It is not complete in the case of tetrodes in Ultra Linear form since the gain of such stages is about 10. However, the Acrosound transformer is so flat at the low end that complete correction is not essential. The improvement over a completely uncorrected phase-shift is in any case marked, especially in the clean bass and transient abilities.

The output stage consists of 1614's operated Ultra Linear. These tubes are used because they are capable of somewhat higher outputs than 6L6's and are cheaper than 5881's, 807's, KT66's, and the like. They give excellent performance. However, any of the other tubes can be used interchangeably and without any changes in the circuit.

Recently my attention was attracted to the use of current feedback in the White Powrtron amplifiers to correct for the power compression which pure negative-voltage feedback produces. The general idea can be summarized thus:

Although voltage feedback damps the loudspeaker, it also damps the amplifier, and results in a certain amount of power compression. Voltage feedback tends to maintain a more or less constant voltage condition in the output, and flattens peaks more than diminishes. White suggests and uses a certain amount of current feedback to compensate for this. Negative current feedback is proportional to the current flowing through the load rather than the voltage developed across it. It is relatively insensitive to variations caused by changes in speaker impedance, but it is highly sensitive to variations in the power delivered to the speaker. It responds to such variations by raising the effective load resistance, and therefore results in a larger voltage drop across the load. The effect of a combination of current and voltage feedback is rather comparable to that of having both loud and soft pedals in a piano. The theory is that each form will do its job without canceling the good work of the other, and that a proper proportioning of the two types will produce a condition in which the power delivered to the speaker will be unaffected by either variations in speaker characteristics or changes in waveform produced within the amplifier.

Obviously, working out the right combination is a tricky business, as I discovered immediately when I started to experiment with the idea. For instance, the design diagramed appears to be the optimum combination from the distortion control point of view.

Any increase in either the current or voltage feedback increases the intermodulation (IM) distortion. This is a most curious phenomenon which I don't quite follow but it certainly worked out in this instance. I made many adjustments of both, tried another overall loop of voltage feedback, changed the ratios of each loop and of the two together. The present design resulted in the lowest IM figures on a Heathkit IM analyzer with either a 3,000- or 7,000-cycle high-frequency tone and 60-cycle low frequency (4:1 ratio).

The current feedback is developed across the power resistor in series with the output-transformer secondary and ground. The resistor is a 10-watt, 1-ohm, adjustable; approximately half value appears to be optimum. This loop provides about 14 db of current feedback. So the total feedback applying to the output stage is about 26 to 28 db, and the drivers have an additional 6 db of current feedback. This reduces distortion to an extremely low level. The current feedback is applied to the off grid of the input tubes. Actually, as applied, the feedback is positive; however, the phase cancellation effect of the inverter produces precisely the same result that negative feedback to the other grid would produce.

The result of the combination of the two loops is very gratifying to me. The amplifier measures well and sounds even better in my living room and with my speaker system. However, not everybody will like the effect of the current feedback and it will not be entirely satisfactory in all rooms and with all speaker systems. The most noticeable effect is a definite bass boost. Whether this is caused by lessened damping of the speakers, or by power expansion, I do not know. Actually, my own measurements with my own speaker system, indicate that the damping factor remains excellent; but the measurements of others, on other amplifiers, seem to indicate that the damping is reduced substantially. In any event, in a room which is quite "live" the bass may be excessive and boomy. Also, the cavity resonance of such resonant enclosures as the bass-reflex, is accentuated; although with non-resonant systems, the effect is good and without peaks.

If you do not like the effect, or if it does not work well in your living room and with your speaker system, you can easily correct matters. Remove the current feedback loop entirely; ground the lower end of the output transformer, and connect a 39,000-ohm resistor from the 16-ohm tap of the output transformer to whichever cathode of the 12AU7 produces a reduction in volume. This will provide about 14 db of negative voltage feedback. Then readjust the BALANCE and DRIVER BIAS controls.

It will be noted that 5% resistors are specified and were used in the prototype. This does not produce optimum balance, even though there is a balancing control, and therefore maximum benefit of push-pull distortion cancella-

tion is not obtained. Also, no attempt was made to match the coupling or feedback capacitors. As a matter of fact, in the prototype, a mixed 60-cycle and 7,000-cycle signal is unbalanced at the grids of the 1614's by a little more than 5%, principally because of variations in the reactance of the coupling capacitors at 60 cycles, and also because of slight unbalance due to the use of 5% resistors. And yet, the IM figures with an 8-ohm *loudspeaker* load are as follows: at output levels below 1 watt IM runs from 0 to .001%; at 1 watt—0.2%; at 10 watts—0.6%; at 20 watts—1.8%.

Improvements in balance make a very marked difference in distortion levels. This is easily demonstrated on Golden Ear amplifiers by varying the balance slightly with the balance control. Presumably, therefore, the more complete balance which could be obtained by the use of 1% resistors and matching the capacitors would lower these figures further.

Actually, however, it would appear that 5% resistors and run-of-the-stock capacitors are adequate for low-level home listening. With speakers of any efficiency, Milady's Golden Ear will deliver a volume level loud enough to drive most people out of the house on less than 1/2 watt of output. At this level, with the 5% resistors, IM is scarcely measurable, and undetectable to any ear. Even a crescendo which drove the amplifier to 10 watts or more, would be free of significant distortion. 1% resistors would add about \$4 to the cost, and matching capacitors would call for a bridge or an a.c. voltmeter and audio generator and a stock of a half-dozen capacitors to chose from. Those who can afford the additional trouble and expenditure will buy good insurance by using 1% resistors; however, I repeat, 5% resistors will produce performance with which even the most meticulous cannot quarrel.

No measurements were made of harmonic distortion. However, since it is almost invariably lower than the IM, and since listening tests discerned none, even at maximum output, it seems safe to assume that it too is below 1% throughout the useful range.

The band-width is exceptional even by today's standards when many amplifiers boast a band width of 13 to 15 octaves and despite the fact that the overall feedback loop (whether the cur-

rent or voltage type is used) is only 14 db as against 20 db on most commercial amplifiers in the same class. At low levels the amplifier is perfectly flat from 20 cycles to 80 kc and the response extends considerably beyond these limits. The power output depends somewhat on the line voltage. Here at home, where our line voltage runs high and averages 125 volts, it delivered almost 20 watts before clipping was evident on the scope. In New York where line voltage is average or a little low, it delivered 16 watts at 1000 cycles before clipping was evident. At this 16-watt level, the amplifier delivered 14 watts at 20 cycles and 20,000 cycles without clipping, and 5 watts at 100,000 cycles. Neither of the audio oscillators used went below 16 cycles and I'm not sure of the response below this point. The scope I used at the time Milady was measured was not too kind to a 20-cycle square wave; but as near as I could determine, the amplifier passed the 20-cycle square wave with no significant deformation, which would indicate very little slope at least down to 5 cycles. These curves compare very favorably with those of the best commercial amplifiers. There is no sign of ringing at any frequency at maximum output; in contrast some very high priced commercial amplifiers I have tried showed signs of ringing at or around maximum output, and this despite the fact that they used "anti-ringing" capacitors in the feedback loop, whereas Milady does not.

A V-R tube regulates the voltage to the cross-coupled stage. This produces more complete hum filtering, improves the stability of the direct coupled section and, equally important, produces a very high degree of decoupling. This decoupling, with the cross-neutralization, makes Milady so nonresonant, nonregenerative, and, of course, nonoscillating, that it is all but incapable of hangover. The transient response is in consequence superb. Indeed, I think it is unequalled even by amplifiers which use multiple power supplies.

The power supply (Fig. 2) is conventional except for the positive bias (about 50 volts) on the filament string. The hum level of Milady's Golden Ear is inaudible even when used with corner horns. In fact, it is so low that you are likely to forget to shut off the amplifier when finished with it at night. Thus, I recommend the addition of a

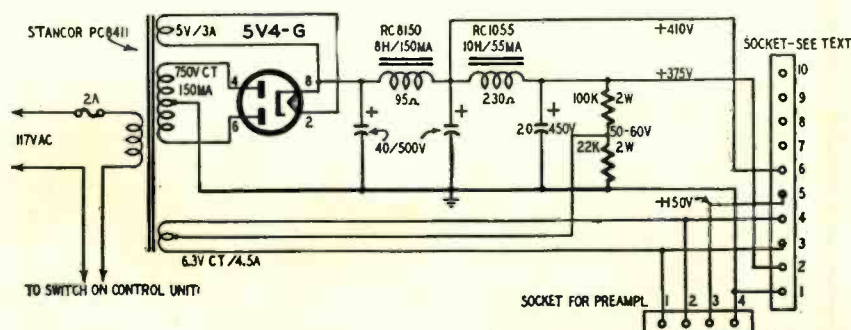

Fig. 2—Schematic diagram of power supply for Milady's Golden Ear Amplifier.

pilot light to the power supply. I did not install one in the prototype shown because I overlooked ordering one and didn't have one on hand.

Stability of the direct-coupled section is further improved by the 22,000-ohm series resistors in the plate return circuits and by the high value of the common bias resistor in the driver stage. Milady will maintain her balance nicely indeed, and is no worse than ordinary R-C coupled amplifiers in this respect. Because of the Ultra Linear output stage the plate supply drain is constant and relatively low for an amplifier of this much power output. The 150-ma power transformer is adequate, in fact, it can also supply power to the Golden Ear preamp and control unit.

You will note that the cathodes of the output tubes are bypassed with 250 μ f and that the common portion of the driver bias resistance is also heavily bypassed. Both these capacitors are essential to hold distortion down to the specified levels, especially at high output levels.

Adjustment procedure

1. Interconnect the two units, without tubes in the amplifier. Check with an ohmmeter for possible shorts from B plus to ground; also for a short from either side of the filament string to ground. (Such a short might apply 50 volts to the filaments and burn them

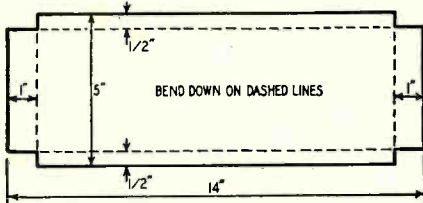

Fig. 3—Diagram shows chassis layout.

out). The resistance from either side of filament string to ground should be around 20,000 ohms. From B plus to ground, you should measure about 30,000 to 50,000 ohms. Now turn on the power and check voltages. B plus, without a load, will run to nearly 500 volts.

2. Now insert output tubes and balance them. This is done by connecting a high-resistance v.t.v.m. from plate to plate of the output tubes, using a 25-volt scale at first and then shifting to the 5- or 2.5-volt scale, and adjusting the 100-ohm OUTPUT BALANCE control until you get a zero reading.

3. Insert the other tubes. Check to see that the V-R tube glows. Now connect a v.t.v.m. from either cathode of the driver stage to the grid of the same stage and adjust the DRIVER BIAS control for about 2 to 2.5 volts. (Be sure it is minus 2 volts; it is quite possible to get a positive voltage here which would produce positive bias on the drivers.)

4. Now connect the v.t.v.m. from cathode to cathode of the drivers and adjust the BALANCE control carefully for zero voltage on a 5 or even 3-volt scale. With care you can get exact balance at this point.

5. Move the v.t.v.m. to one cathode

and grid and check bias again and adjust for exactly 2 volts. Check the balance again and adjust if necessary. These two steps are interrelated and it may take several adjustments to arrive at proper bias and complete balance. Once this is done, the bias potentiometer can be locked, and further adjustments of balance, with changes of tubes, aging, etc., can be done with the balancing control only.

The amplifier is now balanced and ready to go. It would be a good idea to check the balance periodically, preferably once a month.

Construction

The amplifier is divided into two parts: the power supply and the power amplifier. Each is housed in a 5 x 7 x 12-inch Flexi-Mount aluminum case with Hammertone gray finish. These cases are available at most parts distributors. The only modification is that of drilling ventilation holes. (It is likely that these cases will soon become available with ready-punched ventilation holes). The two subchassis are formed from a single, standard 10 x 14-inch aluminum bottom plate which is cut in half to make two 5 x 14-inch strips. These strips are then cut as indicated in Fig. 3 and bent to make the subchassis. When making these bends, be careful to check with the cases, to insure an exact fit. Once they are formed to fit the case, you can drill the four holes necessary to mount the chassis to the case. Self-tapping screws are most convenient for fastening the chassis to the case.

Once a fit is assured, the chassis is removed and the case put aside. The chassis is drilled and punched for the various components. The exact power transformer specified should be used; it fits the case exactly. The Acrosound output transformer also fits exactly. Probably other chokes can be used with no trouble. However, for the least trouble, I suggest duplicating the listed components exactly.

The tubes are placed nearest to the front of the cases, although a more conventional layout would put the output and power transformers in these positions. This is important. The tubes radiate the most heat. Placed nearest the front, the heat will be dissipated most completely when the units are installed in shelves or cabinets. The power supply is no problem in this respect, since it warms up very little even with day-long periods of use. But the two output tubes put out a lot of heat. As designed, the cases will protrude an inch or more beyond the edge of any bookshelf; this will provide good ventilation. The front of the amplifier case may attain a temperature of between 125° and 150° after long periods of continuous use; but the combination of ventilation holes and aluminum case produces satisfactory dissipation of the heat.

All the wiring, testing, adjusting, trouble-shooting, etc., is done with the chassis removed from the case. When

the units operate properly the chassis can be mounted in the cases. In this way, the finish of the case will not be marred. If your craftsmanship is faulty, or you make mistakes, all this will be hidden and locked tight within the cases. The fact that the prototype, a development model, has a commercial appearance, is the best evidence.

I recommend the use of the Vector sockets (the 6-lug type specified in the parts list, not the 9-lug type shown in the photos). These sockets eliminate the need for terminal strips; they produce a more compact layout; and they lower the stray capacitances by elevating most of the components above the chassis. A common ground bus should be run from the ground terminal of the input jack through the lugs on the bottom of the turrets, and all ground connections should be made to this bus. The output stage and the V-R tube use ordinary sockets. Two 3-terminal lugs should be attached to the output tube sockets at the panel end. This leaves room for the very large capacitors and resistors. The only critical problem in placement is the output balance control. It has to fit between the tube sockets underneath the chassis and yet clear the output transformer on the top. Be careful to leave room for it by allowing space between the output transformer and the tubes.

The only troublesome problem in chassis work is that of providing holes on the cases for the cable jacks. A $\frac{3}{4}$ -inch square punch would make the forming of these holes a breeze. In the absence of such a punch, the bigger hole can be made by drilling three $\frac{3}{4}$ -inch round holes and squaring off the sides and corners with a file; the aluminum can be worked easily and this isn't at all difficult. The smaller hole for the 4-point plug can be made with a single cut of the $\frac{3}{4}$ -inch square punch, or by squaring up a $\frac{3}{4}$ -inch hole. If you cover the case with paper, held in place with cellophane tape, you'll take almost no risks in marring it.

The holes for ventilation require an electric drill and a $\frac{3}{16}$ -inch bit. Lay out the pattern of holes on one of the covers with a combination square and a pencil. A knife point, or an awl, can be used to form small dents for each hole. After the first cover is drilled, it should be deburred. An old wood-chisel is ideal for this. Now this cover will serve as a template for the other cover.

The wiring is simple and straightforward. Wire the turrets individually before mounting them on the chassis. The resistors go from socket terminals to the terminals at the other end of the turret. Neutralizing capacitors go around the turret. On the socket for the 12AX7 driver, use this procedure: (1) run the far ends of both plate resistors to a common lug at the turret; (2) run the ends of the two independent cathode resistors to a common lug; (3) run a jumper from each cathode to a separate terminal on the turret; (4) wire the shunt resistor across these two terminals; (5) run a

jumper from one grid to a terminal on the turret. These terminals are now easily accessible points to which a meter can be connected for checking the bias and balance of the amplifier.

Just a note to the rare uncautious constructor: This is a main amplifier only—does not even have an on-off switch or volume control. They are on the Control Unit described last month, or may be installed on the control unit of your choice.

The book-style lettering can be duplicated with Tekni-Cals. The titles have to be assembled from capital letters. Here is a suggestion: When removing the lacquer film with lacquer solvent and a brush, wipe off the scum, immediately after brushing, with a soft cloth slightly moistened with solvent. Do only one big letter, or two or three small letters at a time. This will produce a very clean panel with little or no trace of lacquer or scum.

Conclusion

Once in operation Milady's Golden Ear should please not only milady but also the master with the golden ear. Actually, when the editors of RADIO-ELECTRONICS and I started discussions about this version we referred to it as the Adolescent or Silver Ear, presuming that the compromises I would have to make in the interest of low cost and simplicity would reduce the performance sufficiently to keep it out of the Golden Ear class. In actual fact, I believe the performance will stand comparison with any amplifiers in or out of the same class. To really appreciate the performance a very wide-range speaker system is necessary—especially one with a bass response down to 30 cycles. At first hearing Milady's Golden Ear may seem slightly lacking in both bass and treble. Actually it is fantastically flat within the entire audible range. When used with the Golden Ear phono preamplifier and the control unit described last month it has some bass and treble boost in normal positions of bass and treble controls. But the almost complete absence of distortion, especially transient distortion and hangover at low frequencies, produces an extreme cleanliness at both extremes. Just wait, how-

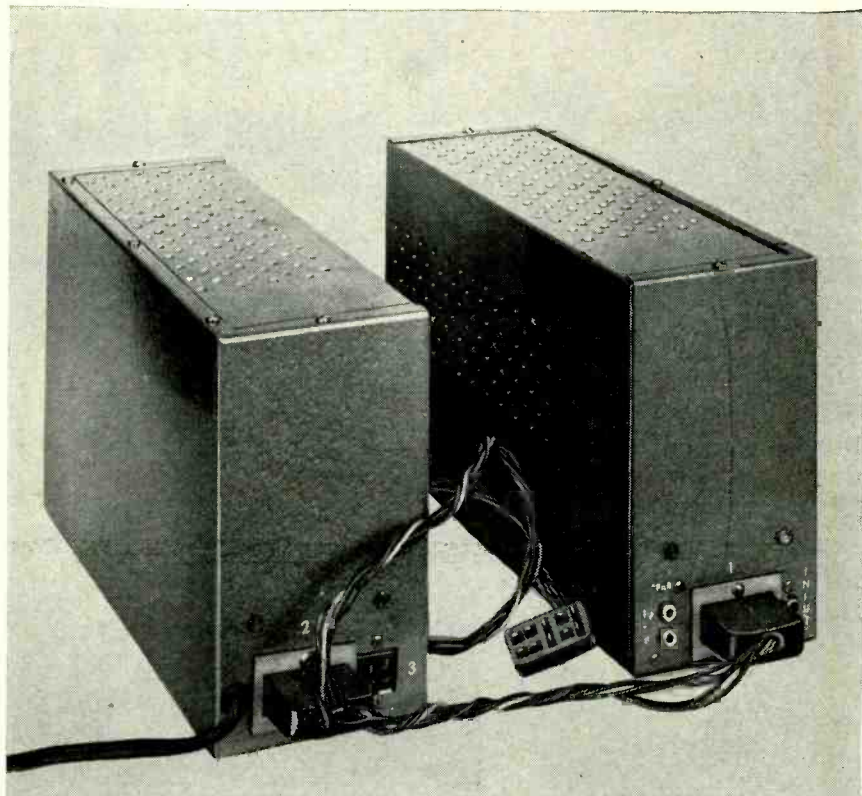

Exterior views of the RADIO-ELECTRONICS Golden Ear Amplifier and power supply.

ever, for some real bass tones to come along and you'll see it has a most genuine, fundamental bass; as for the treble, listen to high-frequency transients—all that is lacking is the distortion, too typical of many high-fidelity amplifiers. Milady was in operation in our household for 8 to 10 hours a day for two weeks at high volume levels. No one complained of headaches or irritation, and the illusion of presence, especially with the voice of announcers of FM stations, was so startling that often we were fooled into thinking a visitor had entered the house. The difference between Milady's Golden Ear and the Master Golden Ear, which costs about three times as much, is so slight that only the most highly experienced and critical ears can discern it.

To hear the Milady's Golden Ear at

its best, try it with really critical test records, such as the new Capitol recording, *A STUDY IN HIGH FIDELITY*, and with a fine speaker system. Listen especially to the two percussion bands on this record, especially the final burst of the Chinese gong in band 2 of the classic music side. This gong takes nearly 15 seconds to decay, and as it decays a beat note of apparently not over 20 cycles is plainly audible with the Golden Ears but not with all other amplifiers.

There is just one trouble. The slightest distortion in records and radio programs will now be plainly audible. You'll need to change needles more often and perhaps to discard your records sooner. Perfection is indeed difficult to attain. The more closely it is approached, the more apparent the imperfections. But Milady's Golden Ear will take you a long way along the road and at a relatively low price.

(As the photographs show, power is fed into the main amplifier through a 10-point socket on one end of the case. The exposed tips of the power-cable plug create a serious shock and fire hazard if the cable pulls loose from the power amplifier or control unit (March, 1954) while the power is on. To eliminate this hazard, the diagram and parts list have been modified to permit chassis-mounting plugs on the main amplifier and control unit. The remote ends of the power cables should then be terminated with cable-end type sockets.—Editor)

The Golden Ear Preamplifier mentioned in this article will be described in this magazine soon. END

Certified Parts List

- 2—1,200-ohm resistor, 1/2 watt, 5%
- 2—1,200-ohm resistor, 1/2 watt
- 2—2,200-ohm resistor, 1/2 watt
- 1—7,500-ohm resistor, 1/2 watt
- 2—51,000-ohm resistor, 1/2 watt, 5%
- 6—220,000-ohm resistor, 1/2 watt, 5%
- 1—330,000-ohm resistor, 1/2 watt
- 2—100-ohm resistor, 1 watt, 5%
- 2—22,000-ohm resistor, 1 watt
- 2—100,000-ohm resistor, 1 watt, 5%
- 1—22,000-ohm resistor, 2 watt
- 1—100,000-ohm resistor, 2 watt
- 1—300-ohm resistor, 10 watt
- 1—20,000-ohm resistor, 10 watt
- 1—1-ohm resistor, 10 watt, adjustable
- 1—100-ohm potentiometer
- 1—2,000-ohm potentiometer
- 1—75,000-ohm potentiometer
- 4—1.5- μ f ceramic capacitor
- 1—.05- μ f 400-volt paper capacitor
- 2—.022 μ f 600-volt paper capacitor
- 2—.05- μ f 600-volt paper capacitor
- 1—50- μ f 150-volt electrolytic capacitor
- 1—20- μ f 150-volt electrolytic capacitor

- 1—250- μ f 50-volt electrolytic capacitor
- 1—40-40- μ f 500-volt electrolytic
- 2—12AX7 tube
- 1—12AU7 tube
- 2—1614 tube
- 1—OD3/V-R 150 tube
- 1—5Y4-G tube
- 3—Vector naval sockets, 6 point
- 4—Octal sockets
- 1—Acrosound TO-300 output transformer
- 1—Power Trans. 750 v.c.t., 150 ma; 5 v, 3 amp.; 6.3 v.c.t., 4.5 amp (Stancor PC 8411)
- 1—Choke, 8 h, 105 ma, 100 ohms (Chicago RC 8150)
- 1—Choke, 10 h, 55 ma, 230 ohms (Chicago RC 1055)
- 2—4 x 7 x 12-inch Flexi-Mount case
- 1—10 x 14-inch aluminum chassis
- 2—Jones sockets, type S-310-CCT
- 1—Jones plug, type P-310-CCT
- 1—Jones socket, type S-304-AB
- 1—Jones plug, P-310-AB
- 1—Jones socket, S-310-AB
- 1—Pilot light and mount
- 1—Panel mounted fuse holder
- 1—2 ampere fuse
- 1—Line cord
- Total cost of parts, \$79.04

GROUND LOOPS

and Hum-m-m-m

A common source of hum frequently overlooked can be eliminated

By HECTOR E. FRENCH

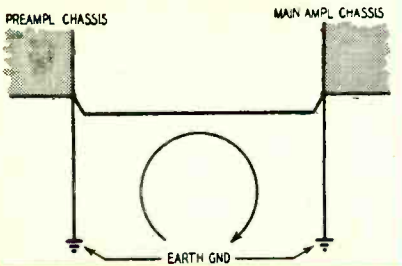

Fig. 1—Basic form of ground loop.

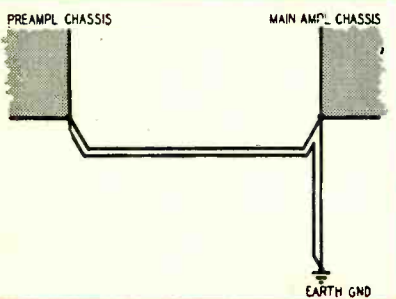

Fig. 2—Reducing ground loop area. Fig. 3—Using one ground connection.

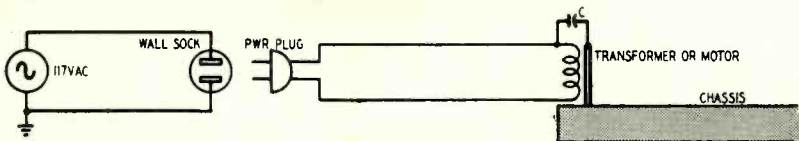
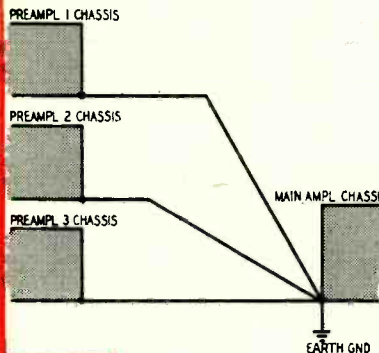

Fig. 4—Coupling effect is equivalent to a capacitor connected to the line.

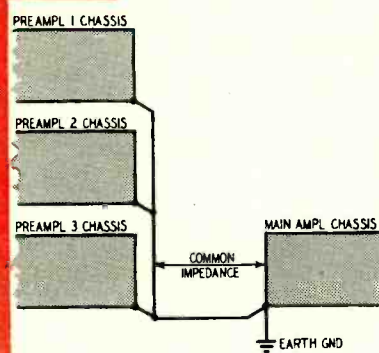

Fig. 5—Common impedance coupling.

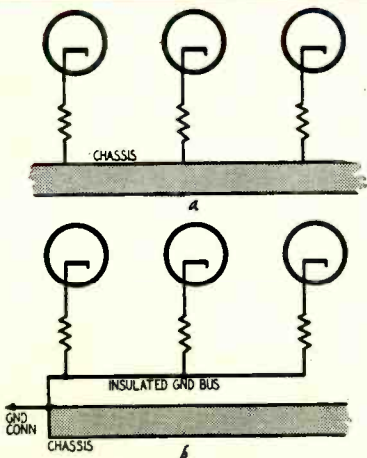

Fig. 6-a—Individual stages are grounded. Fig. 6-b—Using a common ground.

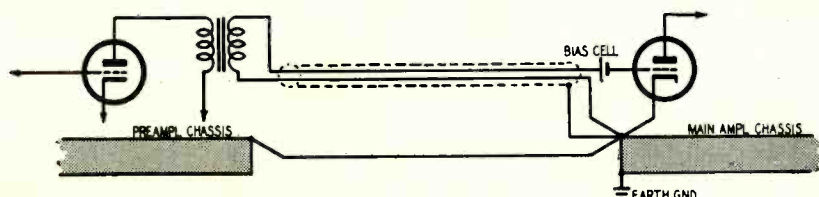

Fig. 7—Separating the signal circuit ground from chassis-to-chassis ground.

GROUND loops, and their resulting hum, are a much more common problem today than they were several years ago. One reason lies in the greater complexity of modern equipment. The older amplifiers were seldom called upon to do more than one or two jobs, such as amplifying the output of a 78 r.p.m. crystal pickup and the output of an AM tuner. Also the conventional practice was to have all the components, including the power supply, on the same chassis.

But those days have gone. Now, an up-to-date amplifier has to operate from an imposing list of inputs: AM, FM, TV; phono 33½ r.p.m., 45 r.p.m., 78 r.p.m.; and tape (plus a couple of other stand-by input circuits waiting for some new audio mediums to be invented). It is expected to perform with less noise, distortion, intermodulation, and hum than even laboratory equipment of 10 years ago.

Another factor making modern equipment more susceptible to hum is the extension in the range of bass-frequency reproduction. Obviously, the hum won't bother you if you can't hear any of its effects. If the woofer runs out of woof at 70 cycles, a lot of 60-cycle hum can go into the speaker before much comes out (unless the speaker starts to generate hum harmonics or intermodulation products or frequency-modulation of the signal).

Still another factor that makes some modern systems more susceptible to hum is the way the complete system is

spread all over the house—the TV in one corner, the AM-FM tuner in another, the phono pickup in still another, the amplifier down in the cellar, and a big speaker assembly built into the wall of the living room. This is an open invitation to hum.

Electrostatic hum pickup can usually be controlled by using a good grade of shielded wire for all the high-impedance or low-level signal leads, being careful to keep the cable capacitance low to avoid losing the high frequencies. This type of hum can frequently be identified by the characteristic buzzing quality of its tone.

But sometimes even the most perfect shielding won't clear up all the hum—and then the fun begins.

When this kind of hum appears, the first cure is to connect each chassis to a good ground, such as a water pipe. Though this is a completely logical way to try reducing the hum, the hum is often made worse than ever!

When this happens, usually a ground loop is at fault. And a ground loop has some of the most puzzling characteristics that can be imagined. For example, the better the grounding connection, the worse the hum becomes.

The reason for this unusual result is easy to understand when the ground loop is reduced to its basic form, as shown in Fig. 1. The ground side of the signal circuit connects the two chassis together, and the individual lead from each chassis to ground completes a loop. This loop has no apparent source of voltage, but this circuit is actually a one-turn pickup loop, which immediately proceeds to couple itself enthusiastically to every power line in the vicinity. Since often there are a.c. lines running through the floors and walls, it isn't hard to visualize the induced circulating current.

Once this circulating current is set up, there will be a voltage drop along the ground wire between the two chassis, which appears at the input to the main amplifier as a 60-cycle hum mixed with the signal (or 50-cycle hum, in the 50-cycle power areas). To make things even worse, the lower the resistance from each chassis to ground, the higher this circulating current and the louder the hum.

The cure is simple. Since the amount of hum depends on the area of the loop, reducing the loop area should reduce the hum. Fig. 2 shows how this can be done, by running the grounding wire of the preamplifier right along with the other conductors. This approach makes the circulating current vanish when the area of the loop becomes very small.

This might be all right with just one amplifier and preamplifier, but when there are a number of preamplifiers feeding one main amplifier (such as a phono preamplifier, a tape preamplifier, an FM preamplifier, etc.), the resulting wiring can become a major project. Then it becomes much easier to break the ground loop completely. This is done by grounding only the main amplifier and depending on the

ground side of the signal circuit from each preamplifier to bring all the chassis to the same potential, as shown in Fig. 3.

But even here, it is possible to run into trouble if a few simple precautions are not observed. Each ground line between the chassis must be solidly made, with heavy wire. Each preamplifier must have its own individual ground wire to the main amplifier. Each ground wire must run in straight lines, with no coils or loops, and these grounding line connections must be made between points on the various chassis that are at a true ground potential.

The reasons for using a low-resistance connection between the chassis is obvious, since the whole intention of the connection is to bring the two chassis to the same potential. If the ground side of the signal circuit has a questionable resistance, as is sometimes the case with braided shielding, it will do no harm to run a heavy chassis-to-chassis wire in parallel with the signal-circuit wiring to make sure the resistance is low. Be careful to keep this wire as close to the signal circuit as possible, otherwise another one-turn inductive loop may be set up, and the same old trouble will appear again. Or, use a multiconductor shielded cable between the chassis, with the extra conductors as the chassis-to-chassis connection.

Capacitive coupling

The precaution that each preamplifier have its own individual ground wire to the main amplifier is to remedy a certain disagreeable habit of power transformers, phonograph motors, tape drive motors, and similar components, of creating capacitive coupling to the power line through the transformer or motor.

This coupling effect is usually shown as being due to one equivalent capacitor, connected to one side of the power line, as in Fig. 4. Since one side of the power line is grounded, with the standard grounded-neutral wiring, it is obvious from following through the schematic that when the power plug is inserted the wrong way, the entire power-line voltage is capacitively coupled to the chassis. To demonstrate, just connect an ordinary 1,000-ohm-per-volt a.c. meter between the chassis of an amplifier and a water-pipe ground. With the meter set to the 10-volt scale, each volt indicated on the meter means 100 microamperes of charging current is flowing into the capacitor and then to ground through the meter. Reversing the power plug will change the current.

Ordinarily, this charging current flows directly to ground and can be forgotten. But when more than one preamplifier is connected to the same chassis-to-chassis ground wire, the current from one preamplifier will raise the potential of the next chassis up above ground again (Fig. 5). This is the same old trouble that existed at the beginning, where the different chassis all had different potentials with respect to

ground. Plugging in the power cord the right way on all the units will reduce the effect, but it is obviously much better to avoid the whole problem by providing each preamplifier with its own grounding wire to the chassis of the main amplifier.

Connecting two capacitors in series across the power line *inside the chassis*, with the junction of the two capacitors grounded to the chassis, is often given as a sure cure for hum reduction or prevention. The reason this does not always work is that it is effective only for shorting out the *high-frequency* interference, which is often hum-modulated, and therefore appears as hum when it is rectified somewhere inside the equipment. The *power-frequency* charging current is always increased by this type of simple filter, and this current can cause additional hum if it is not allowed to flow to ground through its own ground wire.

Grounding the connections between points on each chassis which are at a true ground potential is especially important when a power transformer or motor is mounted near the chassis. The magnetic field around the motor or transformer will induce circulating currents in the chassis itself. As a result, two points only a few inches apart on the chassis can be at different potentials, even with a good, heavy chassis. So if any part of the chassis is included in the signal circuit, a hum problem can develop. Some of this hum is introduced into the signal by the grounding of the individual stages of the amplifier, as shown in Fig. 6-a. If the heater current of the tubes or the charging current of the first filter capacitor should pass through the chassis, a hum problem is practically built into the equipment.

The only sure way to avoid this kind of hum is actually very simple and requires only a little planning when wiring the equipment. This is to use an insulated ground bus inside the chassis for the ground point of all the circuits. Then connect this bus to the chassis at only one point—the point where the ground connection *between* the chassis is connected, as shown in Fig. 6-b.

Even after taking all these precautions, there is sometimes a small amount of hum present. In such a case, especially with high-gain equipment or when there is a considerable distance between the preamplifier and the main amplifier, there is a simple change in the circuit design which will usually eliminate all remaining traces of chassis-to-chassis hum. This change requires only a transformer at the preamplifier, with the connections made as shown in Fig. 7. With this hookup, the signal circuit ground line and the chassis-to-chassis ground line are in two separate circuits, and any hum developed between the chassis does not appear in the signal circuit. Using a grid bias cell instead of the usual cathode biasing resistor and capacitor, adds the finishing touch to what can be an entirely hum-free installation. END

SERVICING HIGH-FIDELITY AUDIO EQUIPMENT

*Part III—Measurements must be made
with specialized audio test equipment*

By JOSEPH MARSHALL

IT IS possible to provide emergency servicing of high-fidelity equipment with only a v.t.v.m. and headphones.

But to do a good job, some specialized instruments are necessary. High-fidelity is achieved principally by taking infinite pains with little details. Very often the defect which mars the performance is due to a very small departure from permissible tolerances. So the shop which does, or expects to do, a good deal of high-fidelity servicing, should invest in a few specialized audio instruments.

There was a time when good audio instruments were fully as expensive as they were scarce. Today, however, the market offers every type of instrument necessary for proper servicing of high-fidelity equipment.

The characteristics of high-fidelity equipment which require accurate measurement and testing are the following:

Frequency response

Ideally the performance of any piece of equipment ought to be measured and judged with the material it is normally called upon to handle. And, indeed, the final, crucial test of all high-fidelity equipment is that made by listening with a critical ear as it reproduces various types of music and speech. This is a matter we shall cover in detail in one of the succeeding articles.

Unfortunately, the waveforms of music and speech are too complex to use for measuring the electrical specifications and characteristics of amplifiers and they cannot be duplicated in the form of standard signals. However, we can get a pretty accurate idea of performance by measuring the response to waveforms such as sine and square waves. At one time we depended nearly entirely on sine-wave measurement; today we know that sine-wave measurement, though quick and convenient, is not adequate in itself. Therefore, we also measure and test response to square waves—a waveform which resembles the waveforms of complex music but is even more difficult to reproduce with faithfulness than musical waveforms—rather on the principle that a garage big enough to handle a Cadillac will take a Chevy nicely.

Distortion

No matter how carefully we coddle the signal as it passes through a reproducing system, we inevitably distort it. Some of these changes are not significant; but others are so serious that they not only destroy the fidelity of the system but may be outright annoying.

In good high-fidelity systems distortion is always held below the point of annoyance. However, even small amounts of distortion, not noticeably annoying in themselves, may destroy the realism of the system by masking the more subtle components of music, thus destroying its ability to distinguish the fine details of music. There are many forms of distortion:

1. Amplitude distortion produces sounds which are harmonics of the original sound. For instance, harmonic distortion of a 400-cycle tone would produce sounds of 800, 1,200, 1,600, 2,000, etc., cycles. This type of distortion is not too serious in small amounts since the harmonics resemble the natural harmonics produced by musical instruments themselves. The situation is rather like that existing when a pedigreed bitch has a litter by an equally pedigreed dog; there are more dogs than one wants but since all are thoroughbreds the over-all aesthetic effect isn't too bad. The effect is different with intermodulation.

2. Intermodulation (IM) produces sounds which are the sums and differences of two or more frequencies passing through the system. Thus a 60-cycle tone and a 2,000-cycle tone would produce sounds of 1,940 and 2,060 cycles respectively. These new sounds have no relation to the original and are non-musical since they are not in the musical scale. It is as if the pedigreed bitch had strayed across the tracks to produce a litter of ugly, nondescript and dissimilar mutts.

Obviously the situation is worse if amplitude distortion is also present, as it always is; for if we have not only the 60- and 2,000-cycle tones but also their harmonics, then the sum and difference frequencies increase fantastically. We would have not only the intermodulation product of the original two tones but also the products of the harmonics of each tone, the harmonics of one beating with the harmonics of the other, and even the sum-and-difference products of the intermodulation sounds themselves.

3. Transient distortion, hangover or ringing. If any portion of the reproducing system is resonant it may turn into a generator and produce sounds of its own. It may do so constantly, if it is oscillating, or it may do so only when triggered into momentary oscillation by a suitable signal. The triggered signal does not have to be related to the resonant frequency of the guilty system; any strong signal may do the job, just as a stick, a stone, or even a ripe tomato, will produce a boom if they hit

a drum hard enough. The jukebox boom of some speaker cabinets is just such a generated tone—the generator being the resonant cavity of the enclosure.

A related form of distortion is produced by a system which, though not resonant, or only broadly resonant, is not highly damped. The condition is very much like that which exists when one depresses the loud pedal of a piano: the undamped strings will now produce sound if the piano case is struck; and when a key is struck we obtain not only the tone produced by the original striking of the string but also echoes of the original which continue for some time. Similarly, a poorly damped reproducing system—especially a loudspeaker—will produce echoes of each peak of the waveform. A certain amount of hangover is not unpleasant, since it gives a vibrant, live effect, similar to that produced by playing an instrument in a room with very live acoustics; and indeed some loudspeakers have been designed deliberately to produce hangover and thus to increase the illusion of presence. It is clear, however, that such echoes not only change the character of the original music, but they also degrade the definition by obscuring the fine detail of the music.

4. Phase distortion does not ordinarily produce additional sounds, but it is of great practical importance in obtaining and maintaining high performance. To increase the bandwidth of a system and to reduce the distortion we use large amounts of feedback. How much feedback we can use without generating transient distortion depends principally on the phase shift of the amplifier. Therefore, the measurement of phase shift is one of the most valuable procedures in servicing high-fidelity equipment.

There is considerable difference of opinion about what constitutes permissible levels of distortion in high-fidelity systems. Generally speaking, most of the popular equipment has a distortion level of less than 2% at rated power output, and in some of it distortion has been reduced to levels as low as 0.1% at maximum rated output.

Measuring and checking harmonic distortion is rather difficult. Actually it is not as significant in indicating the performance of equipment as intermodulation or IM distortion. On the other hand, two-frequency IM distortion measurements yield significant information on over-all distortion characteristics.

There is a relationship of some sort between harmonic and IM distortion. Both are products of nonlinearity and

they are invariably found together. Unfortunately, however, we do not yet know exactly what this relationship is. It used to be accepted that IM and harmonic distortion were present in a ratio of approximately 4 to 1, with the IM on the high side of the ratio line. This simple and convenient relation, however, has not stood the test of greater knowledge. It does appear to hold fairly well for high output and high distortion levels, but breaks down at low output and low distortion levels. In any event, the measurement of IM distortion is the most important single measure of audio distortion; and present high-fidelity practice calls for IM distortion levels of 2% or less at an output power of 6 watts or more.

Power output, efficiency and Sensitivity

None of these items is of really critical importance in high-fidelity performance. A system needs adequate power to handle the dynamic range of the signal and a little to spare; but at present most high-fidelity amplifiers are, if anything, over-designed in this respect because this is the easiest way to achieve low distortion. Sensitivity and efficiency are way at the bottom of the high-fidelity totem pole. Nobody cares how much input power is wasted in heat; and as for sensitivity, another very easy way to achieve low distortion is to operate every stage at a very low level, throwing away much of the possible gain.

However, power output and sensitivity are both significant clues to the behavior of a high-fidelity system. For instance, a falling off in tube performance decreases the power output, and measuring the power level while changing tubes is one of the best indications of the value of new tubes. Similarly, reduced gain may result in distortion through overloading or through a shifting of the operating curves; and gain measurements provide clues to the point in the system where low gain is producing the harmful effects.

All the tests essential for servicing and adjusting equipment can be made with four or five instruments: an audio signal generator; frequency test records to provide standard signals for phono testing; oscilloscope; a.c. v.t.v.m.; audio wattmeter; and intermodulation analyzer.

Audio signal generator

For high-fidelity servicing an audio signal generator should have these specifications:

1. Adequate frequency range—at least from 20 to 20,000 cycles. A range of 2 to 200,000 cycles would be even better and is often used for design purposes; however, it is difficult to obtain so wide a range without some sacrifice of other necessary qualities, and such instruments are more costly.

2. Constant output. To simplify the setup necessary for accurate frequency runs, and to reduce the number of instruments, the output of the generator

should be as nearly as possible uniform over the full range. My own instrument, for instance, delivers an output over its full range of 20 to 20,000 cycles, which does not vary by more than 1/2 db except at around 20 cycles and 20,000 cycles where it departs from flatness by an additional 1/2 db or 1 db in all. This means that it is not necessary to monitor the output of the generator, as well as the output of the equipment under test; a saving of one instrument.

3. Low distortion. Since, as we have seen, the permissible distortion of high-fidelity equipment has to be extremely low, it is very important that the signal used for testing and measuring distortion be as free as possible of all forms of distortion. The R-C type generators, fortunately, produce almost pure sine waves, and if the associated amplifiers are adjusted for minimum distortion the total distortion can be held below 1%. Mine has less than 1/2%. Incidentally, the distortion of such generators can often be reduced by as much as 50% simply by adjusting the amplifiers or feedback network for minimum gain and minimum output. This may reduce the normal 10-volt output to 5 volts or even 2 volts, but actually this is more than sufficient.

4. Provisions for supplying square waves. Suitable square waves can be

produced by clipping the output of a sine-wave generator. Many generators include such a clipper and therefore provide a source of square waves as well as sine waves. Clipped sine waves are not as square as square waves generated by other means, and this should be taken account of in making tests. Examine the square wave at the output of the generator on a scope and note its shape—especially departures from classic square-wave patterns—so that you will not ascribe such departures to the behavior of the amplifier under test. A square-wave range of 20 to 20,000 cycles is ideal for high-fidelity purposes, although a 60- to 15,000-cycle range will serve.

5. Adequate range of output. For servicing purposes the test signal does not have to be high. The 10-volt output of typical generators is more than sufficient, and as little as 2 volts will do. It is more important that the minimum output be low enough to feed into low-level stages without overloading them. My generator, for instance, delivers a minimum signal of 1.5 mv and is adjustable to any value above that. Therefore I can check phono preamplifiers, mike input transformers, etc., without causing them to operate at distortion-producing high levels.

(TO BE CONTINUED)

Typical test equipment necessary for high-fidelity servicing; distortion must be kept to an extreme minimum.

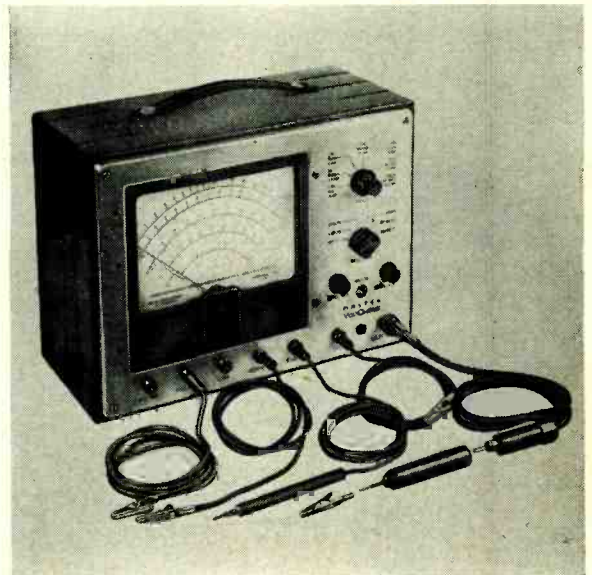

HIGH-FIDELITY LOUDSPEAKERS

By H. A. HARTLEY

Part II—Mechanical and electrical features of voice-coil design

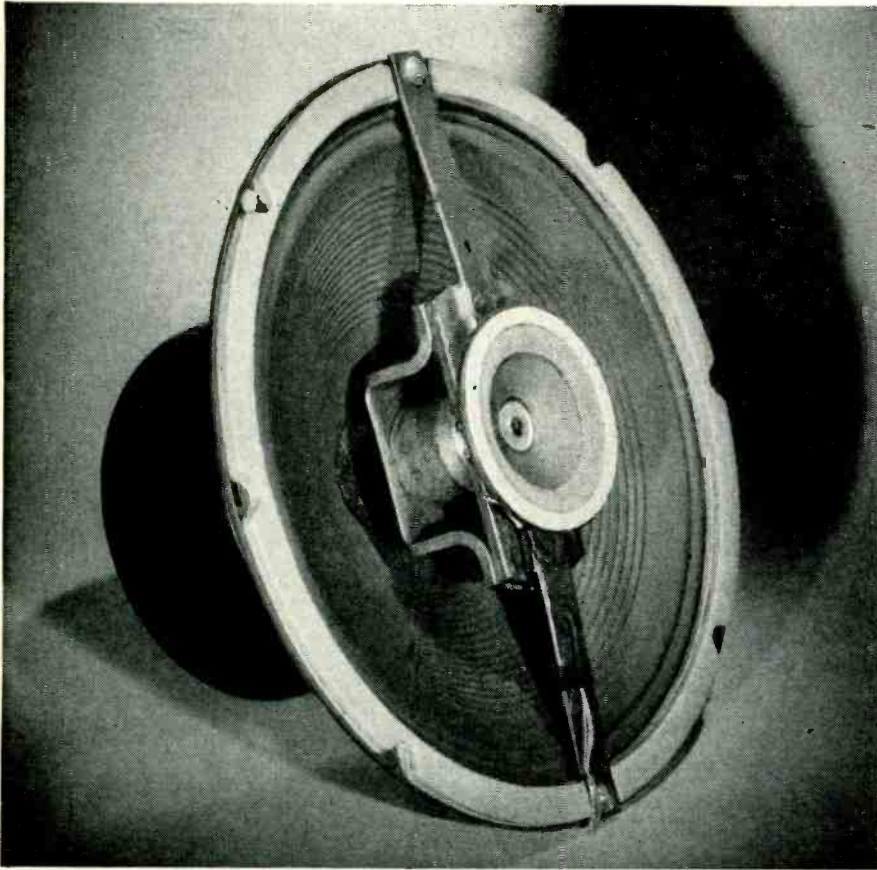

A Stromberg-Carlson coaxial speaker. Note difference in voice-coil diameters.

IN the previous installment it was shown that the mass of the cone has a direct bearing on the treble response of a speaker. Since the voice coil is attached to the cone, the mass of the voice coil is equally important.

There are two ways by which the voice coil can be made *selective* for treble and bass. The simpler way is to wind the coil in two sections separated by a space, on an elastic or compliant form (Fig. 1). At high frequencies the coil nearest the cone apex drives the cone directly, but because of the elastic form the weight of the more distant half is "left behind"; at low frequencies the elasticity is not effective and the entire coil drives the cone. It would seem, however, that if this is what actually happens, then the sensitivity of the speaker at high frequencies is reduced, since only half of the coil is cutting the flux in the gap—or rather, only half of the coil is actually driving the cone. In the other method a *metallic* tube is firmly cemented to the cone apex (aluminum being chosen to save weight); over the metal tube is stretched a flexible sleeve. The voice coil is wound on a nonmetallic form, the internal diameter being such that it snugly slides over the flexible sleeve (Fig. 2). The diameter of the aluminum tube is now increased (spun out from the inside) so that the

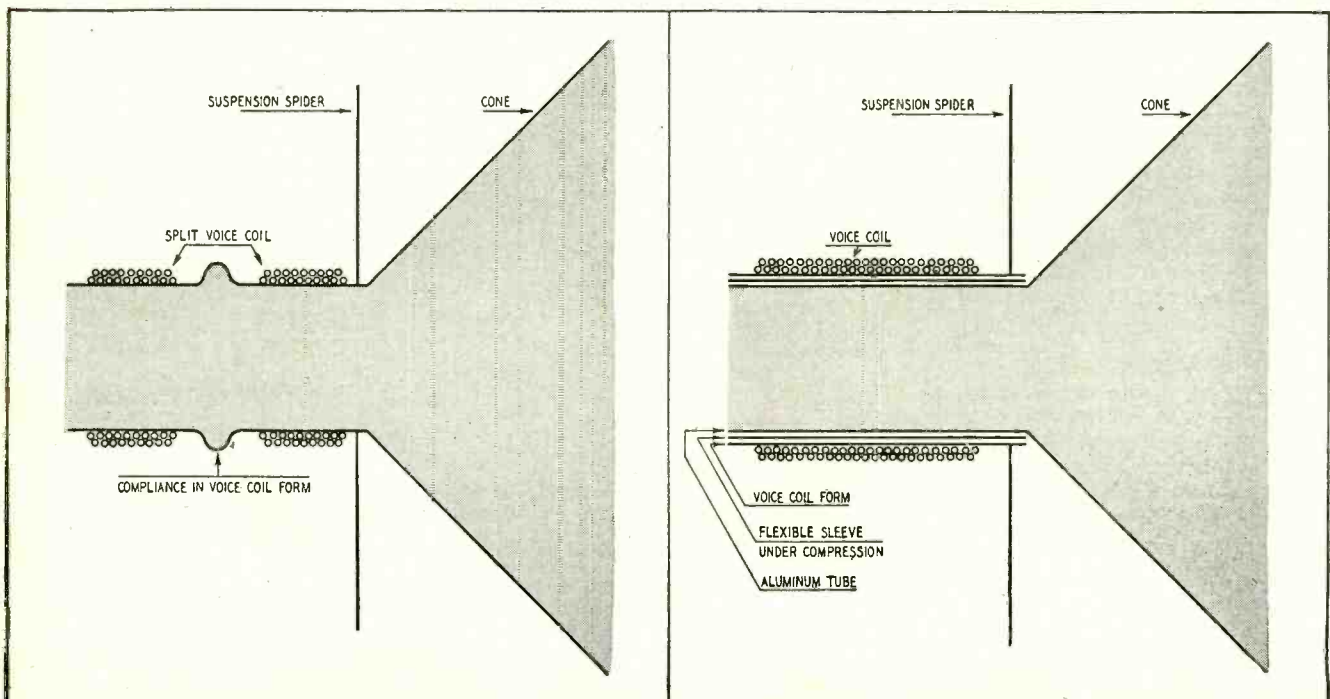

Fig. 1—(Left) Diagram shows split voice coil wound on compliant form. Fig. 2—(Right) Unusual voice coil coupling.

sleeve is subjected to compression. The voice coil and the internal tube form a transformer, the secondary being a single turn. This transformer, being air-cored, is effective for high frequencies but not for low. The presence of the flexible sleeve allows for some independence of movement axially between the metal tube and the voice coil winding.

When a high-frequency signal is applied to the winding, a current is induced in the aluminum tube, the secondary of the transformer; because this tube is loosely coupled (mechanically) to the voice coil, it can move independently and drive the cone without the handicap of the mass of the voice coil. At low frequencies there is no induced current in the tube and the flexible sleeve is under too great a compression to permit movement between the tube and the coil; therefore the drive is direct from the voice coil to the cone. A little thought will show that this arrangement is virtually a mechanical cross-over filter.

One final point in cone design does not seem to have been mentioned by other writers. The cone partially encloses a body of air, as does an organ pipe or a speaker cabinet. This air has its own resonant frequency, called air-column resonance. When this body of air is set in motion it resonates at its natural frequency and this acoustic output will be added to the normal output of the speaker. The effect is extremely difficult to measure and is best judged by the sound of the speaker. As would be expected, exponential cones do not suffer from this fault, since the amount of air enclosed is small, but large straight-sided cones give a pronounced hoot at some frequency between about 500 and 1,000 cycles. Smaller cones necessarily enclose air too, but the resonant frequency of small volumes of air is high enough to compensate for the natural loss of output resulting from the mass of the cone. A smart designer can proportion the cone so that this air-column resonance can fill up a hole in the response curve. Normally speakers do not have dips in the curve between 500 cycles and 1,000 cycles.

Voice coil design

Returning to the voice coil, we are concerned mainly with mechanical and electrical features. Special voice coils for acoustical effects have been mentioned, but, generally speaking, a voice coil is just a voice coil. The coil should be rigid and remain circular under temperature extremes so that, with small gap clearances, it never rubs on the pole pieces. It should be as light as possible so that the treble response is not impaired and transients are not distorted. Two layers of wire are necessary so that the points of entry and exit can be brought out at the same end, nearest the suspension. Some coils have four layers, seemingly to provide a higher impedance, but there is nothing to be gained by this, and there are disadvantages, such as lack of rigidity.

Design features for baffle-loaded speakers.

1. A single speaker capable of reproducing the frequency range needed for high-fidelity reproduction requires great skill to design, but is possible.

2. A complex wave is reproduced by a single diaphragm because of cone breakup. For best results this breakup must be carefully controlled. The apex of the cone reproduces the highs; the entire cone moving as a piston reproduces the bass.

3. The harder the cone material the better the treble and bass response, but this interferes with cone break-up. Concentric ridges in the cone do not appear to affect the break-up, but improve the bass response by stiffening the cone radially and so counteract the development of nodes.

4. Large cones node radially more easily than do small ones, and exponential cones node axially. Nodes reduce bass output and introduce undesirable harmonics.

5. The cone material should be acoustically inert. Metal diaphragms produce a characteristic *ringing* coloration.

6. Narrow-angle cones cause excessive focusing of the high frequencies. Wide-angle cones give better diffusion but tend to node more easily.

7. Large cones are too massive for good treble response and transient reproduction. Their size can cause phase distortion of the low-frequency components of a heavy transient.

8. Small cones cannot reproduce low frequencies with sufficient output unless the suspension is free enough to enable them to move the same amount of air as a large one.

9. Subsidiary tweeter cones give more treble, but the undamped outer rim causes feathery reproduction if driven hard. The narrow angle of the tweeter cone also causes excessive focusing of the highs.

10. Large straight-sided cones cause the enclosed air to resonate at its own natural frequency, causing a superimposed hoot. Exponential and small cones do not suffer audibly from this defect.

11. Treble response can be improved by specially designed voice coils, where the diaphragm is relieved of the weight of the coil at high frequencies.

12. The voice coil should be as light and rigid as possible, with only two layers of wire. The wire should be double-silk-insulated to provide a good key for the varnish. A 1-inch coil is more rigid than a 2-inch, but a 2-inch pole piece allows for a greater flux density in the gap.

13. Tight suspension gives a high bass resonant frequency, and frequencies below this will be reproduced mainly as third harmonic. Free suspension can introduce intermodulation distortion and nonlinear distortion.

14. To avoid intermodulation distortion the voice coil must cut constant flux at all points in its excursion. The coil must be substantially longer than the gap.

15. To avoid nonlinear suspension distortion the magnetic field must be symmetrical about the gap. If the center pole is shouldered, a flat front magnet plate cannot give a symmetrical field.

I am of the opinion that the wire should be double-silk-wound to provide the best tooth for the cement which must be applied to prevent loose turns. Enameled wire is most frequently used, but this is false economy. The cement or varnish will penetrate the silk layers and give a strength not otherwise obtainable.

The diameter of the coil is dependent on what the designer is trying to do. A one-inch coil is more rigid than a two-inch, but a one-inch magnet pole is more quickly saturated than a two-inch. The diameter of the center pole determines the attainable flux density in the gap. If, for a given gap width, the flux obtained with a one-inch pole is 12,000 lines per square cm, no increase in the quantity or quality of the magnetic material can improve on this figure; if the diameter of the center pole is increased to two inches, the flux can be raised to 17,500 lines. On the other hand the lesser rigidity of the two-inch coil demands greater clearances in the gap and this will reduce the flux to some extent. Free suspension also requires greater mechanical clearances.

The design of the voice coil must be determined by the freedom of suspension, as must that of the magnet sys-

tem. The ordinary speaker has little freedom of movement, so the magnetic gap need not be long. (Most cheap speakers have a gap about $\frac{3}{16}$ inch.) The voice-coil winding is made a little longer than this, so that the fringing flux is cut, to improve sensitivity. Concentration of the flux in a short gap also saves magnetic material. Such a design is useless for high-fidelity reproduction, since a tightly suspended speaker may be unable to reproduce any frequency below approximately 100 cycles.

With free suspension new problems are met. A short coil moving in a short gap will cut fewer lines as it moves from its normal position. Under this condition the sensitivity will be reduced. If the displacement is brought about by a low-frequency signal (as it normally would be) then a simultaneous high frequency will result in the high-frequency output being modulated by the low, owing to the periodic desensitizing of the speaker. This has been called the Doppler effect, because of the assumption that the movement of the diaphragm was what produced the wobble.

This is a mistake, as can easily be proved by constructing a speaker in which the coil remains in a constant

field of flux while simultaneous propagation of a high and low note produces no wobble. Some designers have resorted to multiple-speaker systems in the belief that they could avoid the so-called Doppler effect, yet the effect can be heard on any woofer if the coil is allowed to move into a weaker magnetic field. The trouble can be avoided if the coil is long with respect to the gap, or the gap is long with respect to the coil; but a long gap demands a powerful magnet. The usual method is to keep the coil long.

Cone suspension

If the cone is very freely suspended and the magnetic field is not absolutely symmetrical about the gap, the phenomenon of electromechanical rectification can be seen when a signal of about 50 cycles is applied to the speaker. In conventional magnet design the fringing flux is stronger behind the front plate of the magnet than in front of it, and with the application of the 50-cycle signal the coil crawls out of the gap and stays out. This is due to the first half-cycle driving the coil into a weaker field and the second half-cycle not having the same restoring force due to the weaker field.

Most speakers use a corrugated surround for the cone and a somewhat restricted rear suspension spider for the voice coil. These limit the movement; they also provide a powerful restoring force. The rectification effect therefore is not very obvious, but nevertheless it exists, and it is in conflict with the restraining suspension. A properly designed speaker will show the cone-coil assembly oscillating symmetrically about the gap, the suspension being used only to hold the coil concentric with the gap.

If, however, an asymmetrical magnetic field causes the coil to move out from the gap, even by a small amount, then movement will not be symmetrical about the mean position and the suspension will be strained to keep the coil centered. In other words, with the application of a steady signal, the suspension will not be linear, and the acoustic output of the speaker will contain nonlinear distortion.

The foregoing discussion has been somewhat long and involved, yet without it a proper appreciation of all the factors in baffle speaker design cannot be acquired.

As in all technical subjects the study of fundamentals is rarely exciting. However, it is only through this method that we can ascend to a plain of thorough understanding of the comprehensive subject. From my discussion in this and the previous article, we are now prepared to examine conventional present-day types of loudspeakers.

This "High-Fidelity Loudspeakers" series will continue in the future on a bi-monthly basis. The next installment, Part III, will appear in the June issue. It will discuss horn-loaded speakers and multiple-unit speaker systems. END

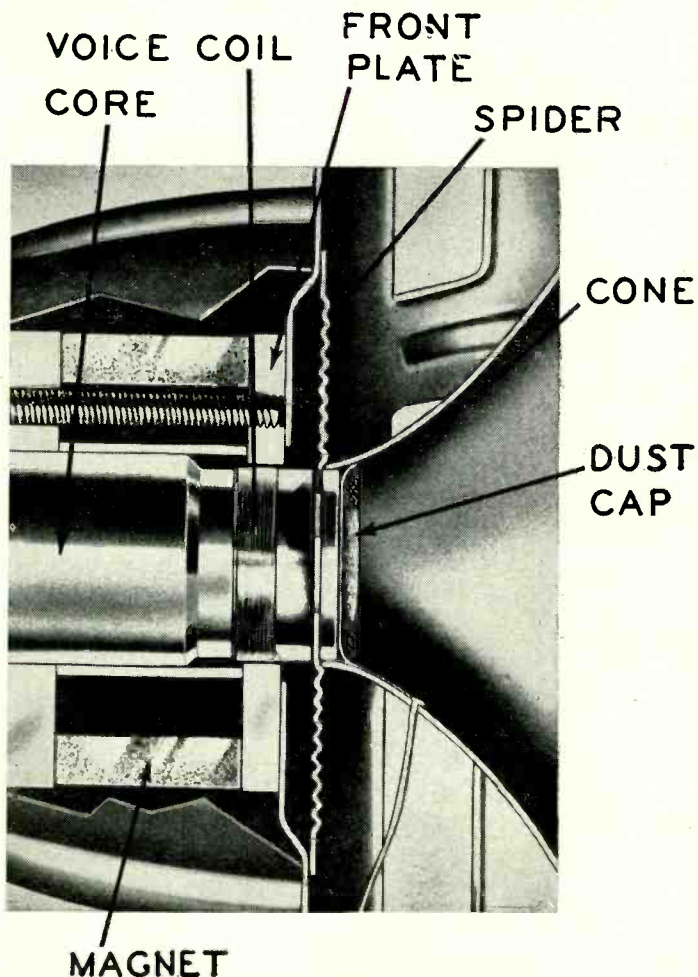

Sectional view of the G-E S-1201-D showing suspension of voice coil in magnetic gap.

HIGH-QUALITY AUDIO



Part VIII—High-quality tuners; AM and FM amplification and detection

By RICHARD H. DORF*

Fig. 1—Radio Craftsmen type 800 tuner.

HOME music systems are by no means useful only for listening to phonograph records. Many owners derive their greatest enjoyment from the reproduction of good radio programs, at least in those areas where good programs (from a technical viewpoint) are available.

A good radio tuner is not cheap; yet it is important to the over-all sound quality of the system.

FM and AM tuners have existed as long as radio itself, but the tuners in radio sets and radio-phonograph combinations of what we like to call the department-store variety have always been on the same chassis as the audio amplifier and power supply. More important, the tuner quality has been on a par with the rest of such mass-produced merchandise—adequate, but hardly what we consider suitable for high-quality system use.

In principle, the tuners which are now supplied as separate units for high-quality systems are similar to the traditional ones. Their function is to tune in the station and demodulate the signal. But, just as in audio amplifiers, the resulting sound is good, mediocre, or bad, depending on the circuits and parts used in the tuner.

Tuner quality

What makes for quality and what should we look for when selecting a tuner? You can buy a rather nice table-model FM-AM receiver for less than \$100, and yet, you can't buy many tuners for less than \$100.

Fig. 1 is a photo of the Radio Craftsmen type 800 tuner. It is representative of several tuners on the market. It tunes both AM and FM, and has tone controls and phonograph preamplifier.

Fig. 2 is a block diagram of the 800. Starting at the AM antenna, the first stage is a 6BJ6 r.f. amplifier. R.f. amplifiers are not usually found on ordinary receivers. A better and more descriptive name for this stage is pre-selector, because its purpose is not only amplification but also rejection of undesirable signals. Containing at least one tuned circuit, it discriminates between the desired signal and an image signal—one removed in frequency from the desired signal by twice the intermediate frequency.

Existence of a preselector or r.f. amplifier stage is obviously a quality factor and should be expected in any high-quality tuner. It also improves the signal-to-noise ratio. In Fig. 2 the FM section also begins with a preselector stage, a 6CB6.

The local oscillator is one-half of a 12AT7 and is used for both AM and FM. Naturally, there is a difference in the operating frequencies for the two bands, but there is no reason why (with proper design) a single oscillator will not work for both.

The mixer stages are one-half of a 12AT7 for FM and another for AM. The pentagrid mixer commonly found in ordinary receivers is there as a matter of economy. In a high-quality tuner a separate oscillator tube is a quality factor. Oscillator frequency drift can be a major FM problem, but by use of stabilizing circuits and components with proper temperature coefficients, a separate oscillator stage could be made extremely stable. The triode mixer is a nonlinear amplifier fed directly by the preselector and through a small gimmick or pickup coil from the oscillator tank circuit.

The i.f. amplifier in Fig. 2 has three stages for FM and two for AM. The stages common to both AM and FM

use the same tubes but separate i.f. transformers. The bandwidth of a tuner depends largely on the i.f. section. On this tuner the AM band is 13 kc wide, giving AM frequency response to about 6,500 cycles. While AM could in theory be as high in sound quality as FM, that is impractical, especially in crowded areas, because of band crowding and increased noise with wider bands. Some tuners have an adjustable AM bandwidth, allowing a wider band—perhaps to about 9,000 cycles—when conditions warrant it. The FM bandwidth on the RC-800 is 190 kc, sufficient for receiving the full FM bandwidth set by the FCC at a maximum of plus and minus 75 kc from the carrier frequency—a total of 150 kc. Smaller-bandwidth i.f.'s would clip audio peaks.

The gain of an FM i.f. stage is less than that of an equivalent AM stage. First, the band is wider, meaning that the tuned circuits have a far lower Q. Second, at the higher frequency (10.7 mc is the usual FM i.f.; 455 kc for AM), gain from a given tube is always somewhat smaller. In addition, limiter stages reduce the signal amplitude at the detector.

The AM detector is one of the diodes of a 6AV6 duo-diode-triode, the other diode plate is used for a.v.c. The a.v.c. on AM is conventional. Following the AM detector there is a 10-kc trap that filters out the whistle which might result from the heterodyning of two stations separated by the 10-kc AM bandwidth. This trap is a high-quality feature; before the popularization of high-quality home systems it almost never appeared in anything but professional type equipment. From the trap, the AM audio goes to a point on the switch provided to select various sound sources.

A third FM i.f. amplifier is provided for additional i.f. gain. This is followed by two of the most important stages in the tuner—the limiters. The presence or absence of limiters and the type of FM detector is one of the important quality-determining factors

* Audio Consultant, New York City

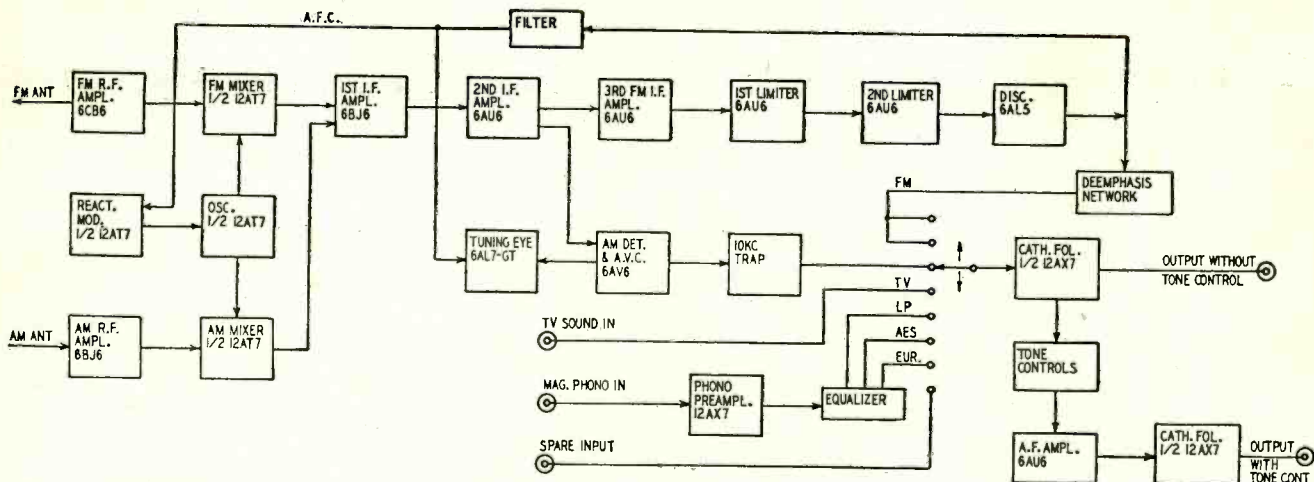
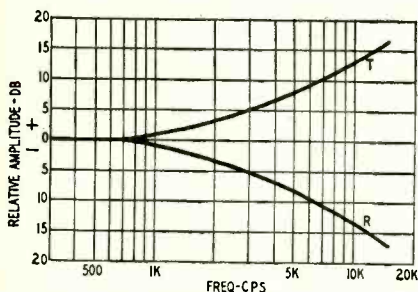

Fig. 2—Block diagram of Craftsman 800. Common oscillator is used for FM and AM. Switch selects various audio inputs.

of a tuner.

Features of FM reception are wide, low-distortion, audio-frequency range and low noise. I.f. amplifiers of adequate bandwidth maintain a good signal-noise ratio and keep amplitude distortion low. Some cheaper receivers and tuners do not have adequate bandwidth because the manufacturer wished to economize by reducing the number of i.f. stages. To get adequate gain he had to peak the i.f.'s.

Most atmospheric noise is principally AM—it exists as variations in ampli-



T—TRANSMITTER NETWORK; R—RECEIVER NETWORK

Fig. 3—Complementary response curves.

tude. The FM signal consists of variations in the frequency of a constant-amplitude signal. The trick in the receiver is to recover the frequency variations of the signal without passing the amplitude variations of the atmospheric. The limiter does this by acting as an amplitude clipper.

The number of limiters in a particular receiver—one or two—determine the signal-to-noise ratio of the final

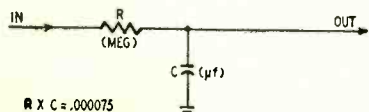

Fig. 4—Simple de-emphasis network.

audio. The ratio detector has some inherent amplitude-limiting action, and is sometimes used without any i.f. limiter stages as a matter of economy. In practice, the ratio detector does not limit sufficiently, and tuners which use it should have at least one separate

limiter stage. It is better practice to use two limiters and a detector of the Armstrong type.

The audio which modulates every FM transmitter passes through an equalizer which emphasizes the treble in accordance with a 75-microsecond curve. This simply means that a high-pass R-C or L-C filter is used which has a time constant of .000075 second. The resulting pre-emphasis curve is shown in Fig. 3. It has a turnover (3-db boost) point at slightly over 2,000 cycles and rises approximately 6 db per octave.

At the receiver the audio circuit following the detector should have an exactly complementary network to reduce highs at this rate so that an overall flat transmission results. At the same time, of course, any noise which may have crept in between transmitter and detector and which is in the region above 2,000 cycles will be attenuated by

the receiver network.

There are some tuners which do not have the proper de-emphasis network, probably because the manufacturer felt that exaggerated treble would impress buyers. The network consists only of a single resistor and capacitor as illustrated in Fig. 4. The user should either buy a receiver with the right values or insert them himself. To check values it is necessary only to know that $R \times C$ should equal .000075, with R in ohms and C in farads, or R in megohms and C in micromicrofarads, with 75 as the desired result. Typical values are 750 μμf and 100,000 ohms, or .0075 μf and 10,000 ohms.

The last point to be gathered from Fig. 2 is the a.f.c., a circuit which makes FM receivers more convenient to tune, and minimizes drifting. The latter is important, because distortion is created whenever the signal is not tuned to exact center. This is due to

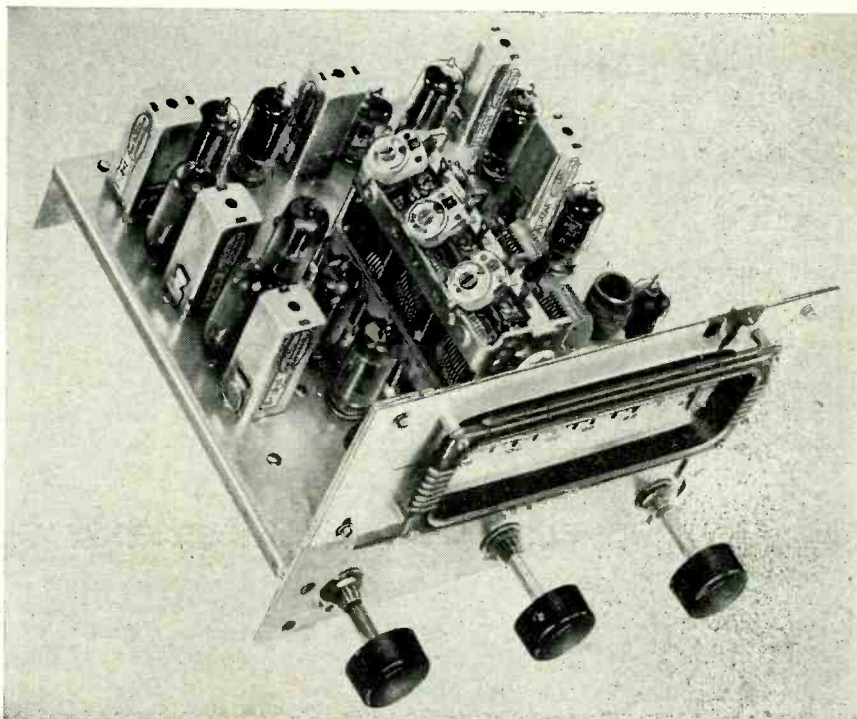

Fig. 5—The Approved type A-710 AM-FM tuner, typical of present day design. Layout of tuner makes for simplification of operation and ease of servicing.



**I Send You
18 BIG
KITS
OF RADIO-
TELEVISION
EQUIPMENT**

I'll Train YOU at Home in Your Spare Hours for Big Pay Job • Your Own Business • Exceptional Opportunity in
RADIO-TELEVISION
ON New NO-OBLIGATION PLAN!

You Have NO MONTHLY PAYMENT CONTRACT
to sign . . . you pay for your training as you learn and earn... ENROLL NOW!
Be Ready in Little as 10 MONTHS!

Now you can get into Radio-Television, today's fastest growing big money opportunity field, in months instead of years! My completely new "package unit" training plan prepares you to qualify as a Radio-Television Technician in as short a time as 10 months, or even less! I offer you my training with no monthly payment contract to sign—thus NO RISK and NO OBLIGATION for you! This is America's finest, most modern and really practical training. Includes FM . . . UHF Television and all the most recent developments. My training gets you ready to handle any practical job in the booming Radio-Television industry. Start your own profitable Radio-Television Service Shop . . . or accept a fine paying job. I have trained hundreds of successful Radio-Television technicians—and I can train you regardless of lack of previous experience. Mail coupon and get all the facts—FREE!

VALUABLE EQUIPMENT INCLUDED WITH TRAINING

Much of your Sprayberry Training is actual construction, demonstration and experimentation. You get priceless practical experience this way. You build the 6 tube Sprayberry Short Wave and Broadcast Training Radio Receiver, the Sprayberry Television set, multi-range test meter, signal generator, signal tracer, cathode ray oscilloscope and many other projects. All this equipment is yours to keep. You have practically everything you need to set up your own profitable Radio-Television shop. All lessons and books I send you remain your own property.

OUR 21st YEAR TRAINING MEN FOR RADIO-TELEVISION

Earn Extra Money While You Learn

All your Sprayberry Training is given IN YOUR OWN HOME during your free time. Keep on with your present job and income while learning Radio-Television. With each Sprayberry "Package Training Unit" I include money-making plans and special "Business Builders" for spare time Radio-Television service jobs. New Television stations opening everywhere open big money opportunity for men to install-UHF antennas—I tell you how! If you expect to be in the Armed Forces later, there is no better preparation than Radio-Television. Mail coupon below . . . get facts FREE. No salesman will call.

FREE TO YOU 3 BIG RADIO-TELEVISION BOOKS

I invite you to get all the facts—

I want you to have ALL the facts—without cost! Rush coupon for my three big Radio-Television books! "How to Make Money in Radio-Television" PLUS my new illustrated Television Bulletin PLUS an actual sample Sprayberry Lesson—ALL FREE. No obligation and no salesman will call. Mail coupon NOW!

SPRAYBERRY ACADEMY OF RADIO

111 NORTH CANAL STREET, DEPT. 20-H
 CHICAGO 6, ILLINOIS

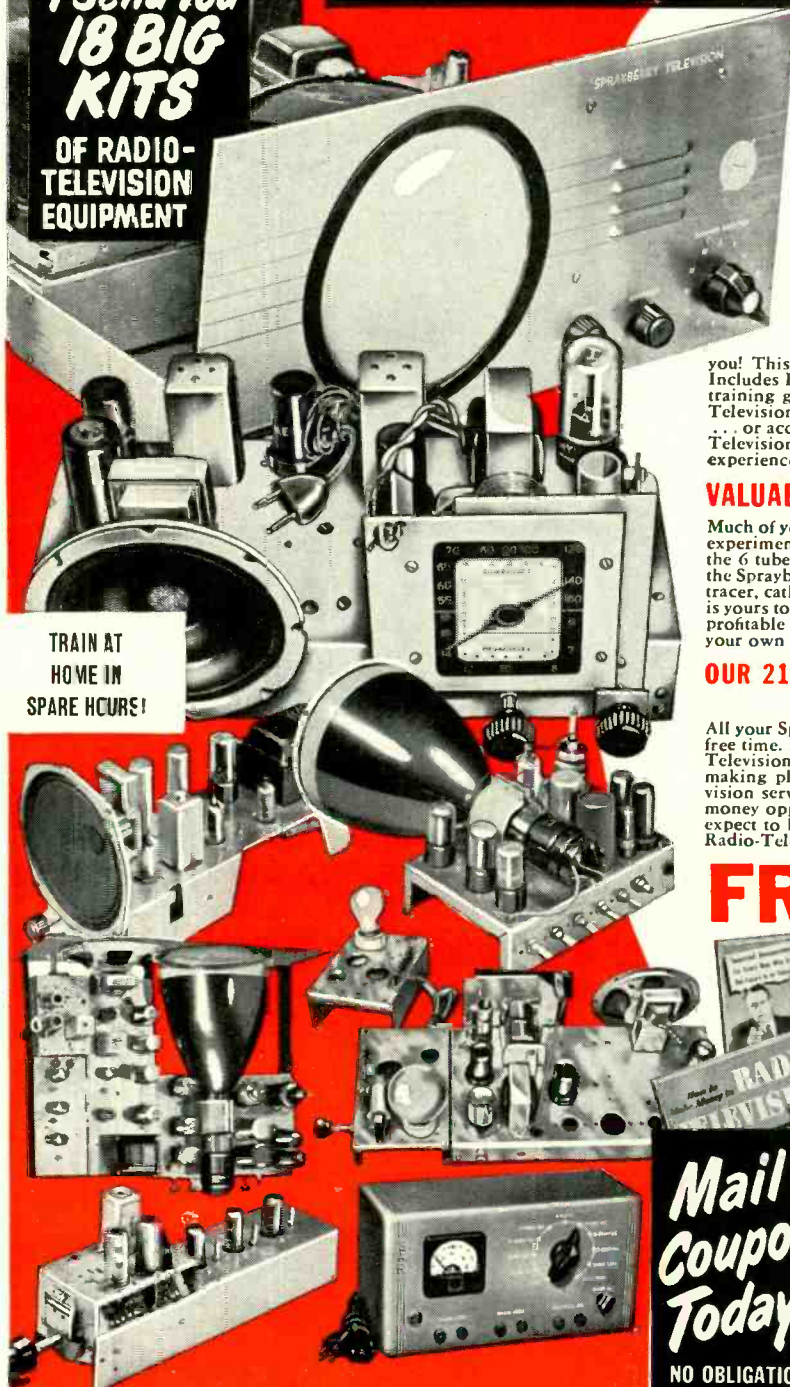

**TRAIN AT
HOME IN
SPARE HOURS!**

**IF YOU ARE
EXPERIENCED IN RADIO**

Men already in Radio who seek a short intensive 100% TELEVISION Training with FULL EQUIPMENT INCLUDED are invited to check and mail the coupon at the right.

**Mail
Coupon
Today!**
 NO OBLIGATION
 No Salesman
 Will Call

SPRAYBERRY ACADEMY OF RADIO, Dept. 20-H
 111 North Canal St., Chicago 6, Illinois

Please rush to me all information on your 10-MONTH Radio-Television Training Plan. I understand this does not obligate me and that no salesman will call upon me. Be sure to include 3 books FREE.

Name Age

Address

City Zone State

Are you Experienced? No Experience

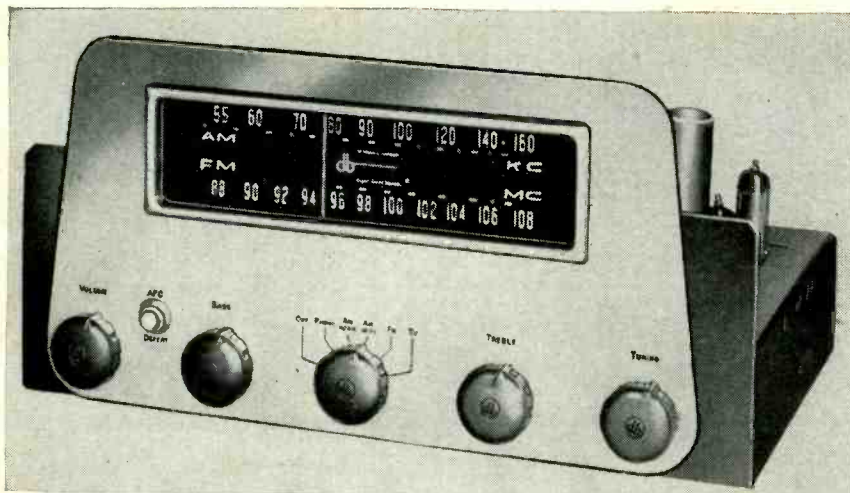

Fig. 6—The Bogen model R701 FM-AM tuner features high sensitivity.

the response of the i.f. stages being no longer symmetrical with respect to the carrier center.

Excellent and simple a.f.c. is possible because an FM detector actually produces from the i.f. signal a direct current whose polarity and value depend on the signal frequency variations with respect to the center frequency. If the signal is tuned to one side or the other, the average d.c. level assumes a particular polarity and amplitude. A reactance modulator is connected across the local oscillator tank circuit so that with zero grid voltage its reactive shunt value tunes the oscillator to the frequency corresponding to the dial setting. When there is no signal or when the signal is tuned exactly right this condition exists because the detector output averages zero.

However, when the signal drifts to one side or is manually tuned incorrectly—which is to say that the local oscillator frequency is incorrect—the detector output biases the reactance tube grid in such a way as to add or subtract reactance to the oscillator tank and correct the condition. A.f.c. cannot correct for really large errors nor can its correction be absolutely perfect—if there is no error signal there can be no correction. In practice it provides a kind of *slot tuning*. The dial is turned and suddenly the signal drops into the slot and is heard, without the *tuning-in* sound normally heard. It is still very desirable to tune to center manually by observing the double-beam electron-ray tube (which also operates from the a.f.c. voltage), for if the a.f.c. is required to make too much correction it is unable to perform at its best; in addition, the preselector circuits will not be correctly tuned.

The Craftsman 800, as do many other tuners, includes some audio amplification, a function switch, tone control, phono preamplifier, and so on. These are not related to the tuner, and some people feel they should not be included, since their presence detracts from the idea of selecting each component separately.

We can sum up the specifications to be examined in an FM-AM tuner with

comments on what may be expected.

Tube complement is not important, though probably a simple tuner (without extra gadgetry) with less than 10 tubes or so will lack gain or some one of the quality features we have discussed. But do not buy a tuner just because it has more tubes than another.

Controls should be sufficient to do the job and no more. Essentials are a tuning knob, volume control, FM-AM switch, and power switch which may be on the volume control.

Antenna requirements should be easy to meet. Most tuners incorporating FM have 300-ohm inputs for the ribbon-line normally used for TV reception. Where signals are not excessively poor, most family television antennas should be satisfactory for tuner use. Connect it to both the TV receiver and tuner by using a two-set coupler.

Sensitivity is defined differently for AM and FM. On AM, between 5 and 10 microvolts for 1 volt audio output is very good sensitivity. In normal- and high-signal areas much less sensitivity (larger input for the same output) is adequate. On FM, sensitivity is defined as the input required for a certain quieting action by the limiters. This is affected both by the gain of the antenna-tuner system and by the limiters. The RC-800, for example, is rated

at 5 microvolts for 30 db quieting, which is excellent performance.

Audio output and distortion figures are easy to understand. A tuner should give at least 1 volt output, and preferably slightly more, since most amplifiers require this level. Distortion originating in the tuner's detector and audio stages should be negligible—well below 0.5%. Incidentally, some tuners have cathode-follower output stages which are advantageous because they permit a fairly long transmission line between the tuner and the rest of the equipment without noise pickup or treble bass.

Intermediate frequencies are of no interest from a quality standpoint. They are usually 455 kc and 10.7 mc for AM and FM respectively.

Bandwidth is important. It must be over 150 kc for FM and may be up to 20 kc for AM in rare cases.

Frequency response can be judged as it would be in any other equipment. There is no excuse for anything poorer than 20 to 20,000 cycles within 1 db.

Distortion originating in the tuner components and the i.f. section should be well below 1% on both AM and FM.

Selectivity is normally rated for AM only, where it can be judged by examining ratings of various tuners. High selectivity is not usually demanded on FM, where a large response is required. On AM the RC-800 has 60 db rejection at 20 kc from the carrier.

Hum and noise originating in the tuner should be very low, 50 to 60 db below rated audio output. This is another point of departure from the standard receiver where hum is usually quite audible.

Power consumption is unimportant, 40 to about 75 watts being common.

The fact that the Craftsman 800 has been used here for illustration does not imply any preference for it, though it is an excellent tuner; it was simply very suitable for a talking point. Whereas only a very few good tuners were available a few years ago, today many acceptable to excellent units are made. An example is the Approved type A-710 shown in Fig. 5, and another is the Bogen type R701 of Fig. 6.

(TO BE CONTINUED)

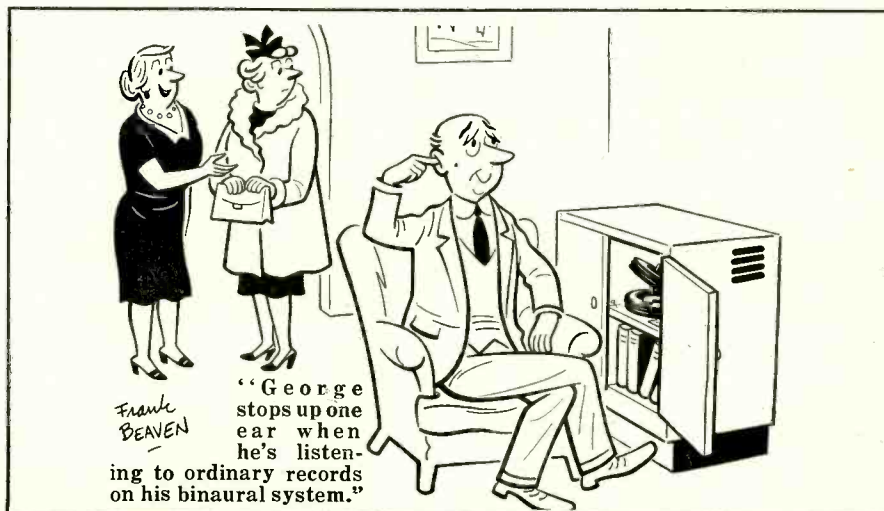

BUILD YOUR OWN

Heathkits

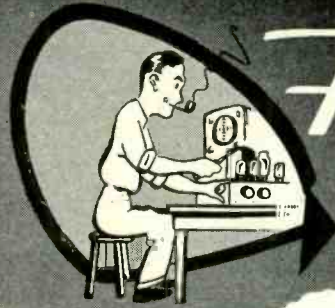

- TEST INSTRUMENTS
- AMPLIFIERS
- RECEIVERS, etc.

- ① Save by ordering direct from manufacturer.
- ② All high quality standard brand components.
- ③ Increased knowledge through actual construction.
- ④ Sound engineering insures excellent performance.
- ⑤ Kit construction is fascinating and enjoyable.



Heathkit MODEL O-9 OSCILLOSCOPE KIT

MODEL
O-9
\$59⁵⁰
Shipping
Wt. 28 lbs.

New features unheard of in a kit oscilloscope have been added to the already popular Heathkit series. All top quality components are used including a brand new RCA 5UP1 CRT. Ten other first line tubes complete the lineup. Voltage regulation provides a rock steady pattern regardless of normal line voltage variations. A built-in blanking amplifier eliminates the retrace line entirely. Other important advantages are a phasing control, Z axis input, direct connections to the deflection plates, 1 volt peak-to-peak calibration voltage and a calibrated grid screen.

Wiring is simplified by the use of the harness technique which also results in a neat professional appearance. Extremely wide vertical bandwidth allows accurate reproduction of even a 500 KC square wave. Excellent focusing characteristics are made possible by the use of the new RCA 5UP1 CRT and a spot shape control. One of the most versatile of test instruments, the Heathkit O-9 Oscilloscope will be invaluable in the radio and TV service shop, as a work project in schools and for all types of circuit investigation work in the laboratory. Its new features make Model O-9 comparable in every way to many commercially built oscilloscopes selling for as much as \$400. Don't pass up this opportunity to add a really fine instrument to your service or experimental lab.

Heathkit VOLTAGE CALIBRATOR KIT

The use of a Voltage Calibrator will greatly increase oscilloscope usefulness. Provides a convenient method of making peak to peak voltage measurements by establishing a relationship between the unknown wave shape and the Voltage Calibrator. Voltage ranges .01-100 volts peak to peak. The Voltage Calibrator features direct reading scales and a regulated power supply system.



MODEL VC-2
\$11⁵⁰
Shipping Wt. 4 lbs.

Heathkit ELECTRONIC SWITCH KIT

The Heathkit Electronic Switch Kit will further extend scope usefulness by permitting simultaneous observation of two individually controlled traces. Continuously variable switching rates 10 cps to 2,000 cps in three ranges. Will also serve as a square wave generator over the range of switching frequencies.



MODEL
S-2
\$23⁵⁰
Shipping
Wt. 11 lbs.

Heathkit VACUUM TUBE VOLTMETER KIT

The beautiful new 1953 Heathkit Model V-6 VTVM, the world's most popular kit instrument, now offers many outstanding new features in addition to retaining all of the refinements developed and proven through the production of over 70,000 VTVM kits. The Heathkit VTVM now features extended voltage ranges with 50% greater coverage on the DC range. New 1 1/2 volt low scale provides well over 2 1/2 inches of scale length per volt permitting faster measurements with greater accuracy. AC and DC ranges are 0-1.5-5-15-50-150-500-1500 volts (1,000 volts maximum on AC). Ohmmeter ranges are X1, X10, X100, X1,000, X10K, X100K, X1 meg. Measures .1 ohm to 1,000 megohms. Other features are db scale, center scale zero adjust and polarity reversal switch. High 11 megohm input resistance virtually eliminates circuit loading.

The low anti-inflation price of this tremendously popular kit includes all tubes, necessary constructional material, test leads and the construction manual.



MODEL V-6
\$24⁵⁰
Shipping
Wt. 6 lbs.



Heathkit AC VACUUM TUBE VOLTMETER KIT

MODEL AV-2
\$29⁵⁰
Shipping
Wt. 5 lbs.

A new amplifier type AC VTVM that makes possible those sensitive measurements so essential in laboratory or audio work. Ten voltage ranges covering from .01 RMS full scale to 300 volts RMS full scale. Input impedance 1 megohm with frequency response 20-50,000 cycles. Ten DB ranges from -52 to +52 DB. Four diodes in meter bridge circuit for maximum linearity.



Heathkit HANDITESTER KIT

MODEL M-1
\$14⁵⁰
Shipping
Wt. 3 lbs.

The ever popular Handitester is now supplied with a Simpson 400 microampere meter movement. Provides AC and DC voltage ranges 0-10-30-300-1,000-5,000 volts. Ohmmeter ranges 0-3,000 and 0-300,000 ohms. DC current measurements 0-10 and 0-100 milliamperes. A completely self contained portable instrument.

HEATH COMPANY • Benton Harbor 20, Mich.

HEATHKITS for the ENGINEER

Heathkit VISUAL AURAL SIGNAL TRACER KIT



MODEL T-3 \$23⁵⁰

Shipping
Wt. 10 lbs.

Designed especially for service applications in AM-SW, FM-TV repair work. RF and audio two channel input. More than adequate sensitivity—new noise locator circuit—calibrated wattmeter—substitution speaker—visual signal indication. Can be used with scope and VTVM, checks phono cartridges, phono mechanisms, microphones, tuners, etc. Let the Heathkit Visual Aural Signal Tracer help you.

Heathkit CONDENSER CHECKER KIT

An instrument designed solely for its particular job. Not a "sideline" or a multiple function instrument. Measures value and quality of unknown condensers and resistors. Capacity range .00001 mfd to 1,000 mfd. Resistance range 100 ohms to 5 megohms. Sensitive electron beam indicator—five polarizing test voltages—safety spring return leakage test switch. An amazingly accurate instrument at this low price.



MODEL C-3
\$19⁵⁰ Shipping
Wt. 8 lbs.

Heathkit SIGNAL GENERATOR KIT



MODEL SG-8
\$19⁵⁰

Ship. Wt. 8 lbs.

The standard service instrument for alignment work. .1 volts output from 160 KC to 110 MC. Calibrated harmonics up to 220 MC. Internal (400 CPS) and external modulation. Pre-calibrated coils for all 5 bands. Good stability and accuracy. All test leads included.

Heathkit GRID DIP METER KIT

One hand operation. 5 pre-wound coils cover 2—250 MC. Controlled sensitivity. Usable as an oscillator or an absorption wavemeter. Extra low frequency coils available.



MODEL GD-1B
\$19⁵⁰

Ship. Wt. 4 lbs.

Heathkit LABORATORY REGULATED POWER SUPPLY KIT



MODEL PS-2
\$33⁵⁰

Ship. Wt. 20 lbs.

A regulated variable 160-450 volt DC output power supply for the lab or service shop. Accurate voltage and current measurements with large Simpson meter. AC supply 6.3 volts at 4 amperes—standby switch eliminates warmup time. Low hum content—5 tube circuit. AC and DC output voltages isolated from panel for maximum operational flexibility.

Heathkit RESISTANCE SUBSTITUTION BOX KIT

MODEL RS-1

Ship. Wt. \$5⁵⁰
2 lbs.

Choice of 36 switch selected resistance values 15 ohms to 10 megohms. All standard RTMA 1 watt 10% resistors. Buy several for those lab and service applications.



NEW Heathkit 20,000 OHMS PER VOLT MULTIMETER KIT

Here is the solution to all service problems requiring a portable measuring device of high accuracy. 20,000 ohms/volt sensitivity on DC and 5000 ohms/volt on AC. Full scale voltage ranges of 1.5, 5, 50, 150, 500, 1500 and 5000. DC current ranges of 150 microamperes; 15, 150 and 500 milliamperes; and 15 amperes. Resistances are measured from .2 ohms to 20 megohms in 3 ranges and decibels from -10 to +65 db.

Model MM-1 uses standard commercially available batteries and is not affected by strong RF fields as encountered in and near transmitting equipment. 1% precision resistors on a very easily wired ring type range switch and a highly accurate Simpson 50 microampere meter fully qualifies the Heathkit Multimeter for close tolerance laboratory and service work. The meter movement is placed in a recessed position for maximum non-glare readability. The kit includes the attractive black bakelite cabinet, 2 color meter scales, test leads, batteries and all other necessary components. Overall cabinet size is 5 1/4" wide x 4" deep x 7 1/2" high.



MODEL MM-1
\$26⁵⁰
Ship. Wt. 6 lbs.

Heathkit TUBE CHECKER KIT



MODEL TC-2
\$29⁵⁰

Shipping Wt. 12 lbs.

Checks overall tube quality, filament continuity, and individual elements for shorts and opens. Features chart illumination, harness type wiring, and large 3-color meter scale.

Portable Model TC-2P at \$34.50. Wt. 14 lbs. No. 91-8 Cabinet only at \$7.50. Wt. 7 lbs. No. 355 TV Picture Tube Adapter at \$4.50. Wt. 1 lb.

Heathkit LABORATORY GENERATOR KIT



MODEL LG-1
Ship. Wt. \$39⁵⁰
16 lbs.

A professional laboratory instrument designed for extreme accuracy in frequency and output level. Colpitts oscillator operates in 5 ranges from 150 KC to 30 MC. Panel meter calibrated in output voltage and percent of modulation. Output in excess of 1 volts. Features complete shielding of oscillator, buffer and attenuator sections; regulated power supply and 50 ohm output cable. Comparable instruments priced many times higher than the cost of this new kit.

Heathkit AUDIO WATTMETER KIT



MODEL AW-1
Ship. Wt. \$29⁵⁰
6 lbs.

Measure output power levels directly with the Heathkit Audio Wattmeter. Flat response to frequencies from 10 CPS to 250 KC. Full scale ranges of 5 MW, 50 MW, 500 MW, 5 W and 50 W. Db calibration from -10 to +48. Uses non-inductive built-in load resistors providing impedances of 4, 8, 16 and 600 ohms. Meter bridge uses 4 germanium diodes.

HEATH COMPANY • Benton Harbor 20, Mich.

SERVICEMAN · AMATEUR · STUDENT

Heathkit IMPEDANCE BRIDGE KIT

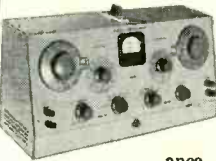

MODEL IB-2
\$59.50

Ship. Wt. 15 lbs.

Modern design with built-in 1 KC generator for AC measurements. A choice of the Wheatstone, Maxwell, Hay or capacitance comparison bridges for measuring resistance, capacitance, inductance, dissipation factor and storage factor. 1/4% resistors and precision mica condensers provide maximum accuracy. Completely AC operated.

Heathkit DECADE RESISTANCE KIT



MODEL DR-1
\$19.50

Ship. Wt. 4 lbs.

Individual switch selection of twenty 1% precision resistors in 1 ohm steps from 1 to 99,999 ohms. Sturdy ceramic wafer switches featuring silver plated contacts and smooth, positive detent action.

Heathkit COMMUNICATIONS RECEIVER KIT



MODEL AR-2
\$25.50
Ship. Wt. 12 lbs.
(Less Cabinet)

Full coverage from 550 KC to 35 MC on 4 bands, with good sensitivity and selectivity. Features electrical bandspread, BFO, headphone jack, slide rule dial with ham band identification, RF gain control, noise limiter and phone-stand-by-CW switch. Top quality, high gain components used throughout. Pre-wound coils in a shielded turret assembly and a transformer operated power supply assure trouble-free performance.

Cabinet available separately. No. 91-10. Shipping wt. 5 lbs. Price \$4.50.

Heathkit AUDIO OSCILLATOR KIT

MODEL AO-1
\$24.50

Ship. Wt. 11 lbs.



Features sine or square wave coverage from 20-20,000 cycles in 3 ranges. Variable 10 volt output level at 600 ohms impedance. Thermistor controlled linearity—precision multiplier resistors—distortion less than .6%. An outstanding instrument value at this amazing low price.

Heathkit Q METER KIT

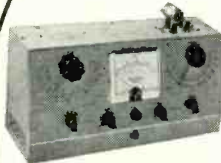

MODEL QM-1
\$44.50 Ship. Wt. 14 lbs.

A typical Heathkit invasion of the laboratory instrument field. Here is the first successful low priced Q meter ever offered in kit form. Oscillator supplies RF in the range of 150 KC to 18 mc. Reads Q directly on calibrated meter scales. Measures Q of condensers, RF resistance and distributed capacity of coils. Calibrate capacitor with range of 40 mmf to 450 mmf with vernier ±3 mmf. All measurements made at the operating frequency.

Heathkit AMATEUR TRANSMITTER KIT



MODEL AT-1
\$29.50

Ship. Wt. 16 lbs.

Power input up to 35 watts on 80, 40, 20, 15, 11 and 10 meters. Can be crystal or VFO excited. Complete with modulator input socket and VFO power output provisions. Other desirable features are good shielding, AC line filter, key click filter, standby switch and a 52 ohm coaxial output. Model AT-1 is AC operated and is suitable as an exciter for a higher powered rig. Complete with full instructions for construction and use.

Heathkit TELEVISION SWEEP GENERATOR KIT

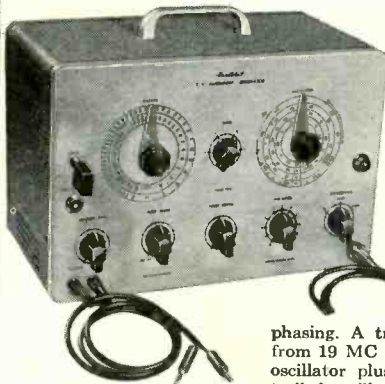

MODEL TS-3
\$44.50

Ship. Wt. 18 lbs.

Simplify your TV alignment jobs with the new Heathkit TS-3. Full coverage on fundamentals from 4 MC to 220 MC at an output of well over 100,000 microvolts. . . Automatic blanking and wide range phasing. A triple marker system ranges from 19 MC to 180 MC using a Colpitts oscillator plus the 4.5 MC crystal controlled oscillator for check points (crystal furnished). Provisions are also made for using an external marker.

Featured is the new sweep system, using an *INCREDUCTOR controllable inductor. Sweep width is variable from 0 to 12 MC at the lower RF frequencies and increases to 0-50 MC at the highest. . . Other advantages are power supply regulation, constant RF output level, independent marker and RF output control circuits, low impedance output and properly terminated output cables. The construction manual is complete in all detail and with a reasonable amount of care, Model TS-3 will serve faithfully for many years to come.

*Trademark, C.G.S. Laboratories, Stamford, Connecticut

Heathkit DECADE CONDENSER KIT

Switch selected 1% silver mica precision condensers providing capacity range of 100 mmf. to 0.111 mfd. in steps of 100 mmf.

MODEL DC-1
\$16.50

Shipping Wt. 4 lbs.



Heathkit AUDIO GENERATOR KIT

A new extended range 18 cycles—1 megacycle audio instrument at a remarkably low price. Five continuously variable output ranges—600 ohm output impedance—low distortion figure, less than .4% from 100 cps through audible range.

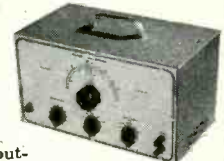

MODEL AG-8
\$29.50

Ship. Wt. 11 lbs.

Heathkit BAR GENERATOR KIT



Small, compact and easy to use, Model BG-1 supplies horizontal or vertical bars for TV linearity adjustments. Output cable clips directly to the TV receiver antenna terminals.

MODEL BG-1

Ship. Wt. **\$14.50**
6 lbs.

Heathkit BATTERY ELIMINATOR KIT

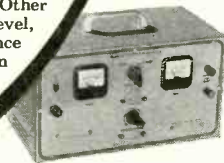

MODEL BE-4
\$31.50
Ship. Wt. 18 lbs.

6 or 12 volt operation with current and voltage constantly monitored. Double protection with a fused transformer and automatic overload relay. Well filtered output and all heavy duty components. Designed for auto radio repair and as a storage battery charger.

WRITE FOR Free CATALOG

New 40 page 1954 Catalog lists all kits, specifications, schematics and latest price information.

HEATH COMPANY · Benton Harbor 20, Mich.

Transistor REGENERATIVE Receiver

By EDWIN BOHR

Single-transistor receiver features high gain and sharp selectivity

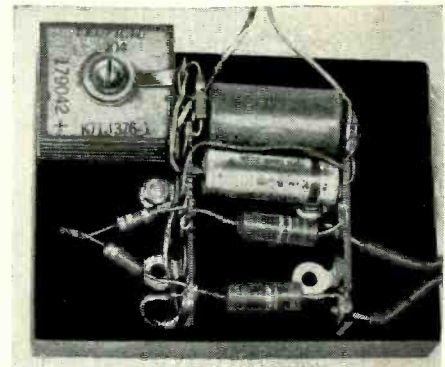

REGENERATION "soups up" the performance of transistor receivers. Simple transistor radios without regeneration are just crystal detectors followed by audio amplification. There is no r.f. amplification, and sensitivity and selectivity are always poor. In contrast, the regenerator has high gain and sharp selectivity.

You or your friends may have attempted to build a transistor regenerator and found it did not work. Several factors make the design of a workable transistor regenerator different from the vacuum-tube equivalent.

First, the transistor must be able to sustain r.f. oscillation throughout the entire broadcast band. Whether or not this can be done successfully depends upon the design of the feedback and tuning circuits. Unlike vacuum-tube oscillators, transistor oscillators are not inherently self-starting. Tubes draw heavy current when they are first turned on and shock their circuits into oscillation. The transistor circuit must have starting features built into it. Furthermore, the transistor must be made d.c. stable or it may lock itself into a condition of inoperation.

Fig. 1 is the successful regenerative transistor circuit. Feedback is from collector to emitter. The emitter circuit impedance is very low, unsuitable for a parallel-tuned circuit. This is the reason the tuning capacitor and coil are placed in the collector circuit. Here the impedance is moderately high. The tickler winding feeds the emitter.

With tubes, detection or demodulation takes place in the tube. The grid

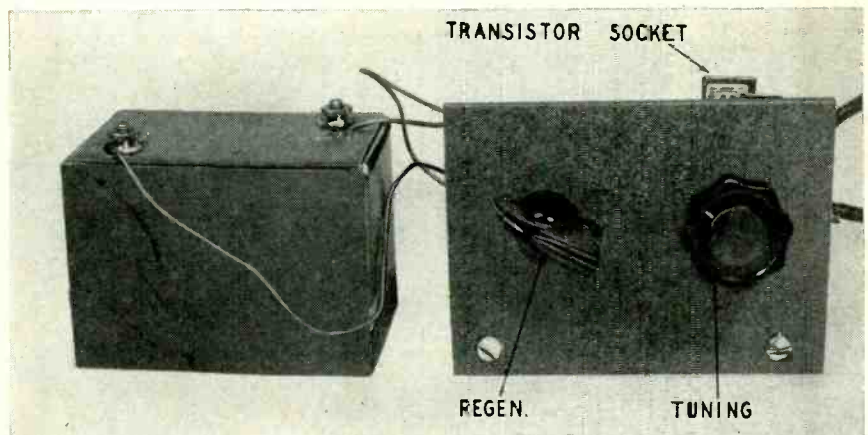

Top, a.c. power supply for receiver. 100 ma selenium rectifier and components are mounted on a bakelite chassis.

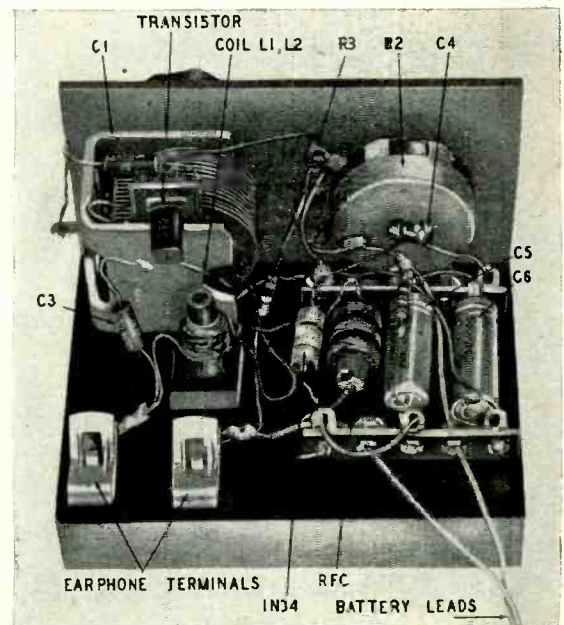

Center, with only two controls, operation is simple. Low current drain insures long battery life.

Right, layout of the regenerative receiver. Mounting strips permit neat arrangement of parts.

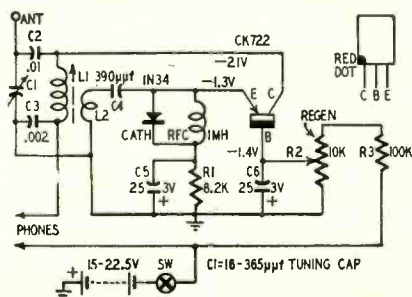

Fig. 1—Regenerative transistor circuit. APRIL, 1954

rectifies the r.f., charging a grid-leak capacitor. The voltage across the grid-leak follows the modulation, placing an audio signal on the grid. Unfortunately, this scheme of things will not work with the junction transistor.

The reason it does not work is simple. To cause enough collector current to flow for r.f. oscillation, the emitter

must have a constant bias current flowing through it. This emitter-current flow ruins the emitter's effectiveness as a detector-rectifier. This means the signal must be detected by something other than the transistor. The problem of allowing the transistor to oscillate and still detect the signal can be solved by using a separate rectifier (a1N34).

RADIO

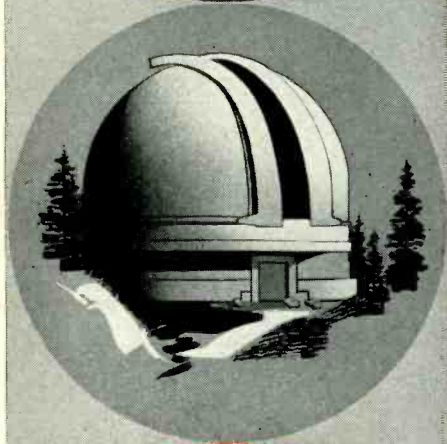

"To find and follow the better way" . . . Out of the vision of Dr. George Ellery Hale came the great "American Idea" that resulted in the creation of the "Glass Giant of Palomar"—world's largest telescope—to gather new light from the farthest stars for the searching eye of science.

With us, the "American Idea" is, by directed effort and applied know-how, to continue to lead in bringing you electronic products of the highest quality.

INSIST ON AMERICAN MICROPHONES
 D-33 Broadcast
 D-22 Public Address

Send for FREE catalog 46

American microphone co.

370 South Fair Oaks Ave. • Pasadena, 1, Calif.

Let us get a complete picture of the circuit operation by following an r.f. signal through the detector. The signal, arriving from the antenna, is fed into L2 by transformer action from L1. The signal then passes through C4. This capacitor prevents the d.c. emitter bias from shorting to ground through the tickler coil (L2). It also blocks the audio signal that will be developed by the 1N34. C4 and R1 provide an action without which most transistors will not oscillate past a frequency of 600 or 700 kilocycles.

From C4 the r.f. flows both to the 1N34 and to the emitter. The r.f. choke RFC prevents the r.f. signal from bypassing to ground. The r.f. that reaches the emitter is amplified in the transistor and is fed back into L1. This feedback gives r.f. amplification by reducing the r.f. resistance of the tuning circuit.

Part of the r.f. signal reaches the 1N34 and is rectified by it and charges C5. The charge on C5 then varies with the modulation frequency and amplitude. This audio voltage flows easily through the r.f. choke (RFC) and varies the emitter current. From here, it is amplified in the transistor, flows through the tuned circuit and into the earphones.

Some will ask why the 25- μ f capacitor (C5) does not shunt all the audio to ground. The answer is the low impedance of the emitter. For all but the very highest audio frequencies, the emitter impedance is lower than the shunt reactance of C5. Therefore the emitter absorbs the audio power. Experiment will bear this out. Try low values for C5—say .05 to 0.5 μ f—and the audio amplification will be very low. The same thing results if the 1N34 is disconnected. Without the 1N34 rectifier, detection will take place only with the regeneration control rotated all the way to ground. Then the set will not regenerate!

Potentiometer R2, in the base circuit, controls the emitter bias and r.f. gain. Capacitor C6 bypasses audio and r.f. around the potentiometer. Here, 25 μ f is a good bypass value because of the higher impedance of the base.

Capacitor C2 isolates the battery voltage from the tuning-capacitor plates.

Construction

The small size of the transistor and its socket makes wiring difficult. Two wires are about all that can be soldered to the tiny terminals on the socket. This makes it necessary to mount the receiver components on terminal strips onto which the many connections can be soldered. From these terminal strips, wires are run up to the transistor socket. None of the lead lengths are critical.

A metal front panel is very necessary. Without the panel, hand capacitance effects make tuning extremely difficult.

The electrolytic capacitors may have any rating of 3 volts or higher. Any commonly used voltage rating will do for the paper and ceramic capacitors.

TRAIN FOR TELEVISION

in 3 easy steps!



5 Months to Pay!
..earn while you learn



These three widely-known books make it easy for you to train for television—at absolute minimum cost. No lessons to wait for! No wasted time! Read singly, each book is an authentic, easy-to-understand guide to an essential phase of modern TV. Add all three together and you have a specialized training that can help you win better pay in TV service, a good job as a studio technician, or even a business of your own in the fastest-growing industry of all!

The famous **RINEHART TV LIBRARY**

FREQUENCY MODULATION

This great, 448-page book with over 300 illustrations provides complete training in F-M—the subject so often neglected in TV training and which so frequently "stumps" service technicians. F-M, of course, is used for TV sound and many other important developments. Book covers F-M control circuits, receivers, transmitters, mobile equipment, detectors, antennas, test equipment, service problems, etc. Price \$5.00 separately. (Outside U.S.A. \$5.50.)

TELEVISION SERVICING

After studying this great book, you'll find even the most puzzling TV service problems greatly simplified. You'll work better, faster—more profitably! Actual service case histories make things amazingly clear. Illustrations explain details step by step. Subjects range from testing, repair and component replacement, antennas, testing, improving picture linearity to fringe area reception, vital service data, and many others. Price \$4.00 separately. (\$4.50 outside U.S.A.)

TV ENGINEERING (TELECASTING)

This 700-page book can help you forge quickly ahead of the average TV student! In particular, it takes you right into the TV station and shows how the work is done . . . from camera chains to lighting . . . from ordinary transmission and reception to the latest UHF, VHF and color television developments. Ideal for general TV training . . . a "MUST" for those who want to get into studio work. 385 illus. Price \$7.50 separately. (Outside U.S.A. \$8.00.)

YOU CAN'T LOSE on this offer!

Read this famous RINEHART TV LIBRARY for 10 full days before you decide! Bought singly, these 3 fact-packed books cost \$16.50. Under our special offer for all 3 books you save \$1 and have the privilege of paying in easy monthly installments while you use them!

10-DAY FREE EXAMINATION

Dept. RE-44, RINEHART & CO., Inc.,
 232 Madison Ave., New York 16, N. Y.

Send me the famous RINEHART TV LIBRARY (3 books) for 10-DAY FREE EXAMINATION. If the books are not what I want, I will return them postpaid in good condition at the end of 10 days and owe you nothing. If I decide to keep them, I will then enclose \$3.50 as my first payment and will send you \$3 a month for 4 months until the total special price of \$15.50 is paid.

NOTE: Any of these books may be bought separately at prices indicated for each.

Name.....

Address.....

City, Zone, State.....

(Outside U.S.A. price of set \$16.50, cash only, with same 10-day return privilege.)

THE MOST
SPECTACULAR

ANTENNA
DEVELOPMENT
IN YEARS...

THE

TACO

TRAPPER

FOR CHANNELS

2
thru
13

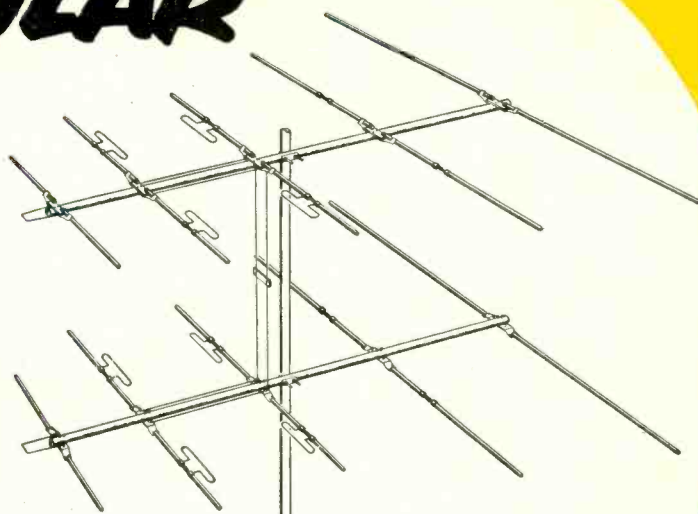

GAIN:

Up to 10 DB single and
13 DB two bay stacked

DIRECTIVITY:

Excellent pattern and
high front-to-back ratio for ghost-free performance

SIZE:

No larger than a single
channel five element
low band Yagi

DURABILITY:

High tensile strength
aluminum and Fiber-
glas insulation assures
stability

APPEARANCE:

Streamlined and sym-
metrical. Provides
neat installation

COLOR TV:

Sharply directional, a
color TV requirement

PACKAGING:

No KING SIZE cartons
—easily transported &
stored

PRICE:

Cat. No. 1880 Trapper.
List: \$19.75 ea.
Cat. No. 1882 Stacking
lines. List: \$1.75 pr.

All around, your BEST antenna buy!

AT LAST, A SINGLE MODEL PACKAGED TWO PER CARTON, TO FILL
EVERY VHF INSTALLATION NEED. REDUCES INVENTORY.

TECHNICAL APPLIANCE CORPORATION, SHERBURNE, N. Y. In Canada: Hackbusch Electronics, Ltd., Toronto 4, Ontario

INSURE CUSTOMER SATISFACTION . . .

OHMITE®**WIRE-WOUND
RESISTORS**Provide an
**EXTRA MARGIN
OF SAFETY**

One replacement resistor that doesn't hold up can cause a faulty repair job . . . and one faulty repair job can cost you one good customer. For your higher wattage replacement needs, the most dependable resistors you can buy are OHMITE wire-wound resistors. They provide an *extra margin of safety* that puts your mind at ease, and helps you build confidence among your customers. OHMITE vitreous-enameled resistors have all-welded construction for greater reliability. Brown Devil resistors are available in 5, 10, and 20-watt sizes, 0.4 to 100,000 ohms. Other fixed resistors to 200 watts. Dividohm adjustable resistors, useful as voltage dividers, available in sizes from 10 to 200 watts, and 1 to 100,000 ohms. Order a supply, today.

**OHMITE
MANUFACTURING COMPANY**3646 Howard St., Skokie, Illinois
(Suburb of Chicago)Write for
Stock
Catalog*Be Right With***OHMITE****DEPENDABLE RESISTANCE UNITS**

Capacitor values may vary 50% from those specified. The resistors may be $\frac{1}{2}$ watt or larger.

The tuning coil is a modified *Ferri-Loopstick*. The extra-high Q of the loopstick is responsible to a large extent for the easy oscillation of the circuit through the entire broadcast band. Every CK722 we have used oscillated easily. None of the other coils experimented with worked nearly as well.

To modify the loopstick, first remove the cardboard sleeve that covers the winding. The short antenna supplied with the coil is discarded. Remove 5 turns of wire from the free end of the coil. When this is done, L2 is wound directly over the loopstick winding. L2 is 7 turns of about No. 22 wire (the exact size of the wire is not important). A single twist of the free ends keeps the coil from unwinding. Push the iron core into the coil until it extends an equal distance from each end of the coil.

When the receiver is put in operation it will be necessary to slide the core out slightly to adjust the tuning range. The length of antenna connected to the receiver also changes the tuning range. The slug will compensate for this too.

Operation

After the set is wired, check off all parts and connections against the diagram. Make sure the electrolytics are wired properly—positive side to ground.

Plug in the CK722 transistor before the battery is connected. Connecting the battery backward can damage the transistor. Be sure the negative battery terminal is fastened to the earphones and 100,000-ohm resistor, R3.

With the earphones and battery connected, a "rushing" sound should be heard in the phones. The lack of this sound does not indicate a bad transistor. The only possible reason for the sound not being heard is that something is wired wrong. This sound is the noise generated by all transistors.

For a voltage check of the circuit, typical voltages are shown on the diagram. These measurements were made using a 10,000-ohms-per-volt meter with the regeneration control in mid-position.

The rushing sound is heard at any setting of the control regardless of whether or not the set is regenerating. However, the loudness of the rushing will increase slightly with clockwise rotation of the regeneration control.

Connect an antenna 25 feet or longer to the stator terminal of the tuning capacitor. When tuning, have the regeneration control advanced all the way. This does not give best reception but each station that is passed—even one too weak to be heard—will sound a tweet or whistle.

At some settings—usually near the center of the dial—the receiver tends to motorboat at critical regeneration. Weak stations come in better just below critical regeneration; strong stations, above this point.

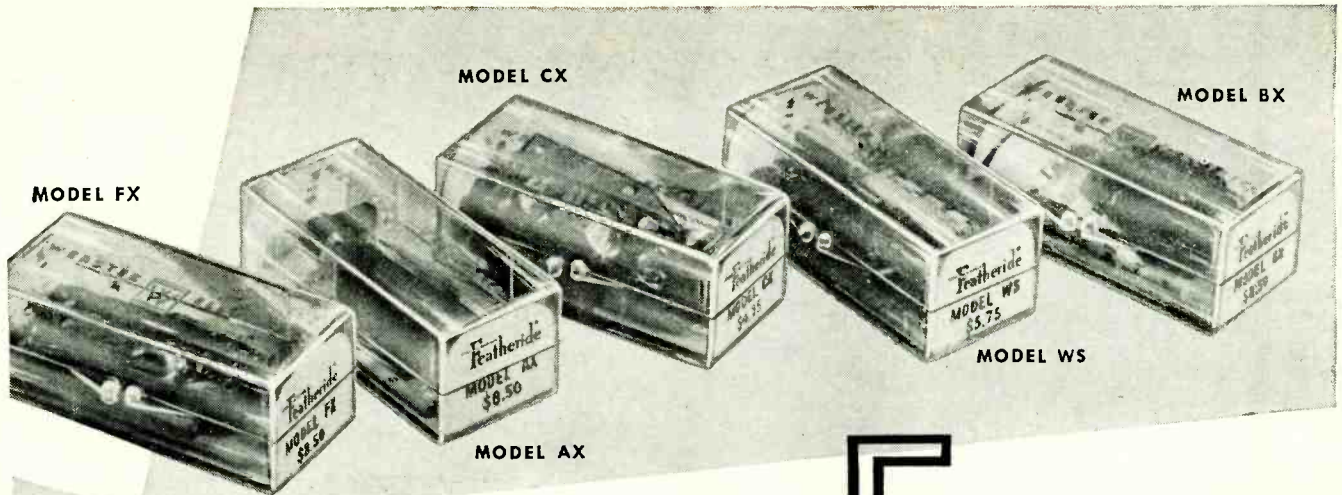

MODEL FX A two-needle twist cartridge, delivering high or low output

MODEL AX A complete unit for three-speed application, furnished with a removable twist mechanism

MODEL CX May be used with a three-mil needle for 78 RPM or two-mil needle for three-speed application

MODEL WS A versatile unit capable of replacing the majority of 78 RPM cartridges in the field

MODEL BX Designed primarily for RCA Automatic record changers and Columbia players Unusually high fidelity

FREE
Replacement
Chart...

Write for your **FREE** copy of new Featheride Replacement Chart It shows how, with only 5 Featheride models, you can replace hundreds of different cartridges of many makes



fill Practically All Replacement Needs!

- Profit-minded servicemen and technicians are joining the big swing to WEBSTER ELECTRIC Featheride Crystal Cartridges these days. And with good reason, too—they have learned that, with *just five Featheride models*, they can fill virtually any and every replacement need *quickly and profitably!*

- Featheride Replacement Cartridges are *crystal* cartridges—made, inspected and individually packaged according to WEBSTER ELECTRIC's rigid standards. That means the user is assured of the finest possible reproduction of recorded music of which his record player or changer is capable.

- You profit *two ways* when you carry the Featheride Five in your kit. You build good will by giving your customers the best the market affords, and you save time and trouble on every cartridge replacement job.

WEBSTER ELECTRIC
RACINE WISCONSIN

"Where Quality is a Responsibility and Fair Dealing an Obligation"
WEBSTER ELECTRIC COMPANY, RACINE, WISCONSIN • EST. 1909

NEW PROBES!

FOR VTVM'S & SCOPES

- FULLY SHIELDED
- SHOCK-MOUNTED TERMINAL BOARD
- SWIVEL ACTION
- ALL PARTS ACCESSIBLE
- COLOR CODED

Only EICO Probes Have All These Features!

SCOPE DEMODULATOR PROBE
MODEL PSD
KIT \$3.75 WIRED \$5.75

LOW CAPACITY PROBE MODEL PLC
KIT \$3.75 WIRED \$5.75

DIRECT PROBE MODEL PD
KIT \$2.75 WIRED \$3.95

VTVM RF PROBES MODEL PRF-11 OR 25
For any 11 or 25 megohm VTVM
KIT \$3.75 WIRED \$4.95

PEAK-TO-PEAK PROBES
MODEL PTP-11 OR 25
For any 11 or 25 megohm VTVM
KIT \$4.95 WIRED \$6.95

SENSATIONAL HIGH VOLTAGE PROBE
MODEL HVP-2
ONLY . . . \$4.95
FOR VTVM'S & VOM'S

See these amazing probe values at your jobber today. Write now for free catalog PC-4. Turn to our full-page ad on page 30 of this magazine.

EICO® All Above Probes Pat. App. For
ELECTRONIC INSTRUMENT CO., Inc.
84 WITHERS STREET, BROOKLYN, NEW YORK

A good antenna and ground reduce the tendency to motorboat; and the detector will pass over critical regeneration with a single "plop" sound.

The regeneration control setting affects the tuning slightly. On the high end of the dial, moving the control may detune the station, making a tuning readjustment necessary.

If it is impossible to pick up a station at either extreme of the tuning capacitor, the iron core can be adjusted in the coil to bring in the station.

Power supply

A small a.c. power supply for the receiver is shown in Figure 2. Do not use a direct earth ground with the power supply. Two .001- μ f capacitors

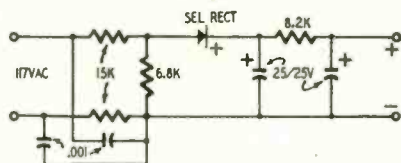

Fig. 2—Schematic of a.c. power supply

in the diagram are not shown in the picture—they were added later. Any ordinary receiving type selenium rectifier will work. A 100-ma rectifier was in the parts box. This is the reason for the large unit pictured. The resistors can be any wattage. We made the 6,800-ohm resistor from two smaller ones because they were at hand, not for more power.

(The reader can make a much safer supply with a 12.5-volt filament transformer and a small germanium rectifier. The present job—if used—should be enclosed and treated with caution.—Editor)

From a small country town, in two weeks of listening with a 25-foot antenna, 12 stations were recorded. The nearest powerful station was more than 100 miles away. No ground was used.

The regenerator circuit is a good starting point for experimentation. With a hearing-aid battery, padder type tuning capacitor, and a smaller regeneration control, the circuit will shrink to shirt-pocket size.

The radio is a real performer considering its very small power consumption. The audio gain is much better than some vacuum-tube circuits operating on this low voltage. In the same location mentioned, a transistor radio without regeneration was able to pick up just two stations—and it was almost impossible to separate them. With regeneration many more stations were received, all with good selectivity.

Parts list for receiver

Resistors: 1—8,200, 1—100,000 ohms, 1/2 watt; 1—10,000 ohms, potentiometer (linear).
Capacitors: 1—16-365 μ mf, variable; 1—390 μ mf, ceramic; 1—.01 μ f, 200 volts, paper; 2—25 μ f, 3 volts, electrolytic.
Miscellaneous: 1—CK722 transistor and socket; 1—1N34; 1—1-mh r.f. choke; 1—Ferri-Loopstick; 1—battery, 15-22 1/2 volts; 2—Fahnestock clips; 1—antenna wire (25 feet or more); 1—metal front panel; 1—bakelite chassis; 2—mounting strips.

Parts list for a.c. power supply

Resistors: 1—6,800, 1—8,200, 2—15,000 ohms, 1/2 watt.
Capacitors: 2—.001 μ f, 200 volts, paper; 2—25 μ f, 25 volts, electrolytic.
Miscellaneous: 1—selenium rectifier, 25 ma min.; 2—mounting strips; 1—bakelite chassis. END

MR. SERVICEMAN and TECHNICIAN

Thanks for Your Acceptance

THE **KIRBY**

Model 98

ORIGINAL FLYBACK TRANSFORMER TESTER

Has PROVEN ITSELF!



Patent Applied for

- Takes the Guesswork Out of Horizontal Sweep Circuit Servicing
- Saves Time
- Inexpensive
- Easy-to-Operate

Detects shorted turns in Flyback Transformer and indicates as low as one shorted turn.

Tests transformer while in Television Receiver.

Also tests continuity on yokes, coils, speakers, switches, etc.

Suggested Dealer Net Price **\$39⁹⁵**

SEND FOR FREE INFORMATION

KIRBY PRODUCTS CORPORATION

20 East Herman Street, Philadelphia 44, Pa.

"How to Test Flyback Transformers" Instruction Manual

"Specification and Data Sheets"

Name _____

Address _____

State _____ RE

RADIART
Seal-Vent
VIBRATORS

are **TOPS**

The complete rugged service line of vibrators that has dominated the field for years. Exclusive design plus controlled manufacture guarantees long-life performance! Built to "take it", they work under the most adverse conditions. You too will agree RADIART VIBRATORS are the STANDARD of COMPARISON!

the Complete
 Replacement Line

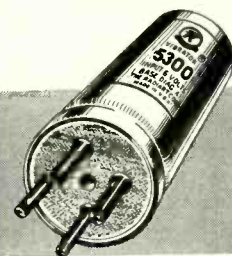

THE **RADIART** CORPORATION
 CLEVELAND 13, OHIO

TV ANTENNAS • AUTO AERIALS • VIBRATORS • ROTORS • POWER SUPPLIES



30-watt 6-channel radiotelephone and all-wave receiver in schooner cabin.

INSTALLING MARINE RADIO

*An opportunity for you
landlubbers to get your
sea legs in a rapidly
expanding field*

By **ELBERT ROBERSON**

ALTHOUGH marine radiotelephony is similar in some ways to radio broadcasting, to amateur communications, and to big-ship radio, the procedures in these fields cannot be directly applied to the small boat.

Indeed, since it is a relatively new field, service technicians have had to work out their own techniques. This article is intended to start the beginner off on the right course.

The very first technical requirement for a marine radiotelephone service technician is that he hold a valid first- or second-class radiotelephone or radiotelegraph license issued by the FCC. The Commission requires that all adjustments and tests on transmitting equipment must be made by a licensed technician, who then enters the data in the log and signs it.

On the water, there are two main departures from shoreside radio practice—one philosophical, and one technical.

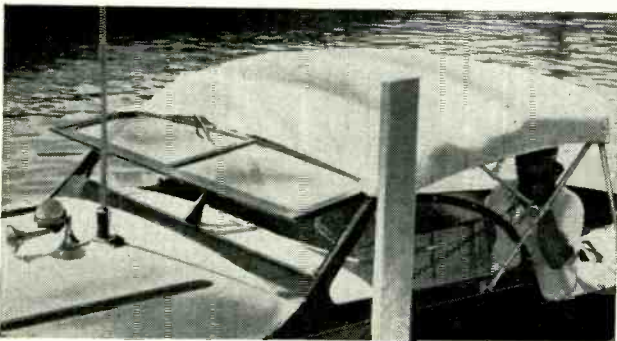

Tubular antenna is mounted on a combination base insulator and loading coil.



A typical tough antenna installation problem.



An ideal case. Antenna is strung from top of mast.

RADIO-ELECTRONICS

Don't improvise...



RTV-ize!

FOR FAST, SURE, ECONOMICAL CONTROL REPLACEMENTS

As easy as using the 'phone book. As sure as if you looked up the original specs of that chassis.

All because Clarostat engineers, responsible for the majority of TV controls in use, have compiled the replacement data available to you in the **Clarostat TV Control Replacement Manual** and the **Supplementary Sheets**.

Listings are by set-manufacturer's model and chassis, part number, Clarostat catalog number, function and description. Cross references, too.



← **New 265-page
Second Edition.**

**Supplementary
sheets available
from your distributor.** →



RTV replacements available when Standard types won't do.

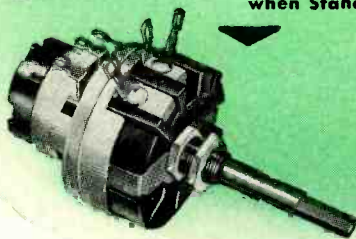

Standard types, especially field-assembled "Pick-A-Shaft" and "Ad-A-Switch" controls.

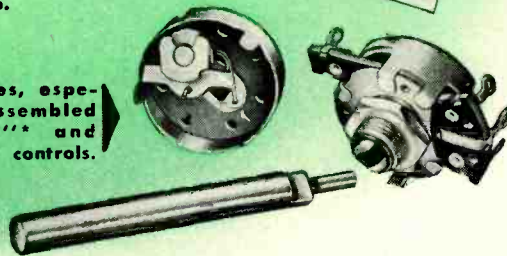

The 265-page Clarostat TV Control Replacement Manual (2nd Edition) and Supplementary Sheets to this Manual provide you with our latest TV control-replacement data. Ask your distributor for the Manual and Supplementary Sheets.

* Trade Mark



CONTROLS AND RESISTORS

CLAROSTAT MFG. CO., INC., DOVER, NEW HAMPSHIRE

In Canada: Canadian Marconi Co., Ltd., Toronto, Ontario

Buy on our radically new
NO INTEREST!! **Time Payment Plan** **NO CARRYING CHARGES!!**

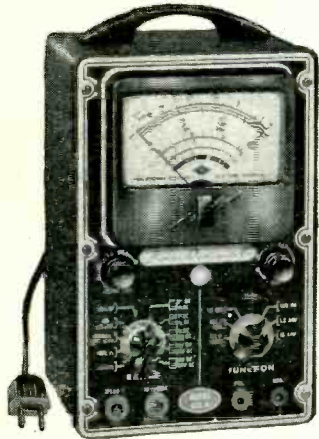

Superior's new
 Model 670-A **SUPER METER**

**A COMBINATION VOLT-OHM MILLIAMMETER PLUS
 CAPACITY REACTANCE INDUCTANCE AND DECIBEL MEASUREMENTS**

SPECIFICATIONS:

D.C. VOLTS: 0 to 7.5/15/75/150/750/1,500/7,500 Volts
 A.C. VOLTS: 0 to 15/30/150/300/1,500/3,000 Volts
 OUTPUT VOLTS: 0 to 15/30/150/300/1,500/3,000 Volts
 D.C. CURRENT: 0 to 1.5/15/150 Ma. 0 to 1.5/15 Amperes
 RESISTANCE: 0 to 1,000/100,000 Ohms 0 to 10 Megohms
 CAPACITY: .001 to 1 Mfd. 1 to 50 Mfd. (Quality test for electrolytics)
 REACTANCE: 50 to 2,500 Ohms 2,500 Ohms to 2.5 Megohms
 INDUCTANCE: .15 to 7 Henries 7 to 7,000 Henries
 DECIBELS: -6 to +18 +14 to +38 +34 to +58

ADDED FEATURE:

The Model 670-A includes a special **GOOD-BAD** scale for checking the quality of electrolytic condensers at a test potential of 150 Volts.

The Model 670-A comes housed in a rugged, crackle-finished steel cabinet complete with test leads and operating instructions.

\$28⁴⁰
 NET



Superior's new
 Model TV-11 **TUBE TESTER**

SPECIFICATIONS:

- ★ Tests all tubes including 4, 5, 6, 7, Octal, Lock-in, Peanut, Bantam, Hearing Aid, Thyatron, Miniatures, Sub-miniatures, Novals, Sub-minars, Proximity fuse types, etc.
- ★ Uses the new self-cleaning Lever Action Switches for individual element testing. Because all elements are numbered according to pin-number in the RMA base numbering system, the user can instantly identify which element is under test. Tubes having tapped filaments and tubes with filaments terminating in more than one pin are truly tested with the Model TV-11 as any of the pins may be placed in the neutral position when necessary.
- ★ The Model TV-11 does not use any combination type sockets. Instead individual sockets are used for each type of tube. Thus it is impossible

to damage a tube by inserting it in the wrong socket.

- ★ Free-moving built-in roll chart provides complete data for all tubes.
- ★ Newly designed Line Voltage Control compensates for variation of any Line Voltage between 105 Volts and 130 Volts.
- ★ **NOISE TEST:** Phono-jack on front panel for plugging in either phones or external amplifier will detect microphonic tubes or noise due to faulty elements and loose internal connections.

The model TV-11 operates on 105-130 Volt 60 Cycles A.C. Comes housed in a beautiful hand-rubbed oak cabinet complete with portable cover

\$47⁵⁰
 NET

EXTRA SERVICE—The Model TV-11 may be used as an extremely sensitive Condenser Leakage Checker. A relaxation

type oscillator incorporated in this model will detect leakages even when the frequency is one per minute.

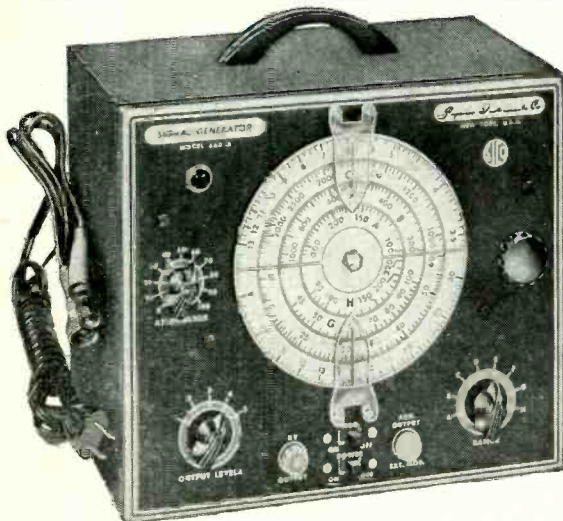

Superior's New Model 660-A AN AC OPERATED
SIGNAL GENERATOR

PROVIDES COMPLETE COVERAGE for AM-FM & TV Alignment

SPECIFICATIONS:

• Generates Radio Frequencies from 100 Kilocycles to 60 Megacycles on fundamentals and from 60 Megacycles to 220 Megacycles on powerful harmonics. • Accuracy and Stability are assured by the use of permeability trimmed Hi-Q coils. • R.F. available separately or modulated by the internal audio oscillator. — Built in 400 cycle sine wave audio oscillator used to modulate the R.F. signal also available separately for audio testing of receivers, amplifiers, hard of hearing aids, etc. • R.F. Oscillator Circuit: A high transconductance hep-

tone is used as an R.F. oscillator, mixer and amplifier. Modulation is effected by electron coupling in the mixer section thus isolating the oscillator from load changes and affording high stability. • A.F. Oscillator Circuit: A high trans-conductance heptode connected as a high-mu triode is used as an audio oscillator in a High-C Colpits Circuit. The output (over 1 Volt) is nearly pure sine wave. • Attenuator: A 5 step ladder type of attenuator is used.

TUBES USED:

- 1—68E6 as R.F. Oscillator, mixer and amplifier.
- 1—6BE6 as Audio Oscillator.
- 1—6H6 as Power Rectifier.

The Model 660-A comes complete with coaxial cable test lead and instructions.

\$42⁹⁵
 NET

MOSS ELECTRONIC DISTRIBUTING CO., INC.
 Dept. B-96, 3849 Tenth Ave., New York 34, N. Y.

Please send me the units checked. I am enclosing the down payment with order and agree to pay the monthly balance as shown. It is understood there will be no carrying, interest or any other charges, provided I send my monthly payments when due. It is further understood that should I fail to make payment when due, the full unpaid balance shall become immediately due and payable.

Name.....

Address.....

City..... Zone..... State.....

- MODEL 670-A Total Price \$28.40 \$7.40 down payment. Balance \$3.50 monthly for 6 months.
- MODEL TV-11 Total Price \$47.50 \$11.50 down payment. Balance \$6.00 monthly for 6 months.
- MODEL 660-A Total Price \$42.95 \$12.95 down payment. Balance \$5.00 monthly for 6 months.
- I enclose \$..... as down payment.
- Ship C.O.D. for the down payment.

Buy on our radically new

Time Payment Plan

NO CARRYING CHARGES!!

NO INTEREST!!

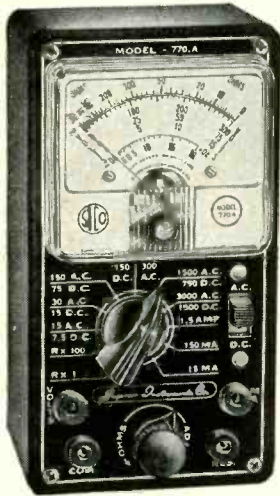

Superior's New Model 770-A The *FIRST* Pocket-Sized

VOLT-OHM MILLIAMMETER

USING THE NEW "FULL-VIEW" METER

71% MORE SCALE AREA!!

Yes, although our new FULL-VIEW D'Arsonval type meter occupies exactly the same space used by the older standard 2 1/2" Meters, it provides 71% more scale area. As a result, all calibrations are printed in large easy-to-read type and for the first time it is now possible to obtain measurements instead of approximations on a popular priced pocket-sized V.O.M.

- Features**
- ★ Compact—measures 3 1/8" x 5 7/8" x 2 1/4"
 - ★ Uses "Full View" 2% accurate, 850 Microampere D'Arsonval type meter
 - ★ Housed in round-cornered, molded case
 - ★ Beautiful black etched panel. Depressed letters filled with permanent white, insures long-life even with constant use.

- Specifications**
- 6 A.C. VOLTAGE RANGES: 0-15/30/-150/300/1500/3000 Volts. 6 D.C. VOLTAGE RANGES: 0-7.5/15/75/150/-750/1500 Volts. 2 RESISTANCE RANGES: 0-10,000 Ohms, 0-1 Megohm. 3 D.C. CURRENT RANGES: 0-15/150 Ma., 0-1-5 Amps. 3 DECIBEL RANGES: -6 db to +18 db, +14 db to +38 db, +34 db to +58 db.

THE MODEL 770-A COMES COMPLETE WITH SELF-CONTAINED BATTERIES, TEST LEADS AND ALL OPERATING INSTRUCTIONS. ONLY

\$1585

NET

Superior's
New

TELEVISION BAR GENERATOR

THROWS AN ACTUAL BAR PATTERN ON ANY TV RECEIVER SCREEN



- Two Simple Steps**
1. Connect Bar Generator to Antenna Post of any TV Receiver.
 2. Plug Line Cord into AC Outlet and Throw Switch.
- Result:** A stable never-shifting vertical or horizontal pattern projected on the screen of the TV receiver under test.

SPECIFICATIONS:
 Power Supply: 105-125 Volt 60 Cycles
 Power Consumption: 20 Watts
 Channels: 2-5 on panel, 7-13 by harmonics
 Horizontal lines: 4 to 12 (Variable)
 Vertical lines: 12 (Fixed)
 Vertical sweep output: 60 Cycles
 Horizontal sweep output: 15,750 Cycles

- FEATURES:**
- Provides linear pattern to adjust VERTICAL linearity, height, centering • Provides linear pattern to adjust HORIZONTAL drive, width, peaking, linearity, centering • Provides vertical sweep signal for adjusting and synchronizing vertical oscillator discharge and output tubes • Provides vertical signal to replace vertical oscillator to check vertical amplifier operation • Provides horizontal sweep signal for adjusting and synchronizing horizontal oscillator A.F.C. and output tubes • Provides horizontal sweep signal to check H.V. section of fly-back and pulse operating power supplies • Provides signal for testing video amplifiers • Can be used when no stations are on the air.

TV BAR GENERATOR COMES COMPLETE WITH SHIELDED LEADS AND DETAILED OPERATING INSTRUCTIONS. ONLY.....

\$39.95

NET

SUPERIOR'S NEW MODEL TV-40

C.R.T. TUBE TESTER



★ A complete picture tube tester for little more than the price of a "make-shift" adapter!!

★ Tests all magnetically deflected tubes . . . in the set . . . out of the set . . . in the carton!!

The Model TV-40 is absolutely complete! Self-contained, including built-in power supply, it tests picture tubes in the only practical way to efficiently test such tubes; that is by the use of a separate instrument which is designed exclusively to test the ever increasing number of picture tubes!

EASY TO USE:
 Simply insert line cord into any 110 volt A.C. outlet, then attach tester socket to tube base (Ion trap need not be an tube). Throw switch up for quality test . . . read direct on Good-Bad scale. Throw switch down for all leakage tests.

- SPECIFICATIONS:**
- Tests all magnetically deflected picture tubes from 7 inch to 30 inch types.
 - Tests for quality by the well established emission method. All readings on "Good-Bad" scale.
 - Tests for inter-element shorts and leakages up to 5 megohms.
 - Test for open elements.

Model TV-40 C.R.T. Tube Tester comes absolutely complete—nothing else to buy. Housed in round cornered, molded bakelite case. Only

\$1585

NET

MOSS ELECTRONIC DISTRIBUTING CO., INC.
 Dept. B-96, 3849 Tenth Ave., New York 34, N. Y.

Please send me the units checked. I am enclosing the down payment with order and agree to pay the monthly balance as shown. It is understood there will be no carrying, interest or any other charges, provided I send my monthly payments when due. It is further understood that should I fail to make payment when due, the full unpaid balance shall become immediately due and payable.

Name.....

Address.....

City.....Zone.....State.....

- Model 770-A Total Price \$15.85 \$3.85 down payment. Balance \$4.00 monthly for 3 months.
- Bar Generator Total Price \$39.95 \$9.95 down payment. Balance \$5.00 monthly for 6 months.
- Model TV-40 Total Price \$15.85 \$3.85 down payment. Balance \$4.00 monthly for 3 months.
- I enclose \$..... as down payment.
- SHIP C.O.D. for the down payment.

ERIE 413

HIGH VOLTAGE CERAMICONS®



THE REPLACEMENT for high voltage TV filter applications

The ERIE 413 High Voltage Ceramicon is an innovation in capacitor design and has had wide acceptance by servicemen everywhere.

Now, for even greater convenience, each body is individually packaged with 7 terminals in 5 different styles. With a minimum stock the serviceman is now able to supply the correct replacement terminals for practically any receiver rated at 20 KV or lower. Inventory is reduced, service time is reduced, profits are increased. The illustrations on the left tell the story.

ERIE components are stocked by leading electronic distributors everywhere.



ELECTRONICS DISTRIBUTOR DIVISION ERIE RESISTOR CORPORATION

Main Offices: ERIE, PA.
Factories: ERIE, PA. • LONDON, ENGLAND • TORONTO, CANADA

GUARANTEED TELTRON TUBES LOWEST PRICES EVER

All of our tubes are individually boxed and unconditionally guaranteed for one year.

To insure your complete satisfaction and to do away with costly "call backs" all Teltron tubes have been "set tested."

| TYPE | PRICE | TYPE | PRICE | TYPE | PRICE | TYPE | PRICE | TYPE | PRICE |
|-------|-------|--------|-------|--------|-------|---------|-------|---------|-------|
| 1A7GT | .53 | 6AB4 | .43 | 6BQ6GT | .76 | 6S97GT | .38 | 12SA7GT | .45 |
| 1B3GT | .62 | 6AC7 | .65 | 6BQ7 | .85 | 6T8 | .71 | 12SK7GT | .45 |
| 1H5GT | .51 | 6AG5 | .52 | 6BY5G | .60 | 6U8 | .76 | 12SN7GT | .56 |
| 1L4 | .51 | 6AJ5 | .96 | 6BZ7 | .95 | 6V6GT | .48 | 12SQ7GT | .38 |
| 1L6 | .51 | 6AK5 | .96 | 6C4 | .41 | 6W4GT | .43 | 19B6GG | 1.48 |
| 1LC6 | .49 | 6AL5 | .43 | 6C8B | .51 | 6W6GT | .53 | 19T8 | .71 |
| 1NSGT | .51 | 6AQ5 | .48 | 6CD6G | 1.63 | 6X4 | .37 | 25BQ6GT | .82 |
| 1R5 | .51 | 6AT6 | .37 | 6CU6 | .95 | 6X5GT | .38 | 25L6GT | .41 |
| 1S5 | .43 | 6AU6 | .43 | 6F6 | .42 | 12AL5 | .43 | 25W4GT | .43 |
| 1T4 | .51 | 6AV5GT | .60 | 6F5GT | .40 | 12AT6 | .37 | 25Z5 | .55 |
| 1U4 | .51 | 6AV6 | .37 | 6H6 | .50 | 12A77 | .71 | 25Z6GT | .36 |
| 1U5 | .43 | 6AX4GT | .60 | 6J5GT | .49 | 12AUG | .43 | 35B5 | .48 |
| 1X2 | .65 | 6AX5GT | .60 | 6J6 | .61 | 12AU7 | .58 | 35C5 | .48 |
| 2A7 | .35 | 6BA6 | .56 | 6K6GT | .38 | 12AV6 | .42 | 35L6GT | .41 |
| 3Q4 | .63 | 6BA7 | .58 | 6L6G | .78 | 12AV7 | .72 | 35W4 | .33 |
| 3Q5GT | .63 | 6BC5 | .48 | 6L6GA | .78 | 12AX4GT | .60 | 35Z6GT | .33 |
| 354 | .48 | 6BE6 | .46 | 6S4 | .41 | 12AX7 | .61 | 50B5 | .48 |
| 3V4 | .48 | 6BQ6G | 1.18 | 6S8GT | .65 | 12BA6 | .46 | 50C5 | .48 |
| 5U4G | .43 | 6BH6 | .51 | 6SA7GT | .45 | 12BA7 | .58 | 50L6GT | .50 |
| 5V4E | .49 | 6BJ6 | .51 | 6SK7GT | .45 | 12BE6 | .46 | Type 80 | .40 |
| 5Y3GT | .30 | 6BK7 | .78 | 6SL7GT | .60 | 12B7 | .65 | 117Z3 | .33 |
| 5Z3 | .42 | 6BL7GT | .78 | 6SN7GT | .60 | 12BH7 | .61 | 117L7GT | 1.20 |

FREE

\$5.00 list value Bonus Box of Radio & TV components including resistors, condensers—controls, and many other items with each order of \$25.00 or more.

Minimum order \$10.00. 25% deposit on C.O.D. orders—save parcel post charges. Orders accompanied with full remittance will be shipped prepaid anywhere in continental U.S.A.—All orders subject to prior sale.

We have hundreds of tube types in stock—you may order any type at similar savings.

Send for Free complete tube listing

SPECIAL

while they last
39¢ Each
10 for \$3.50

| TYPE | TYPE | TYPE | TYPE | TYPE |
|-------|-------|------|-------|-------|
| 1A4P | 1E7GT | 19 | 34 | 37 |
| 1C6 | 1F4 | 1629 | 35 | 39/44 |
| 1C7G | 1H4G | 22 | 35/51 | 46 |
| 1D5GP | 2A7 | 33 | 36 | 1F5G |
| 1D7G | | | | |

These specials are new Sylvania's individually boxed. Order now.

TELTRON ELECTRIC COMPANY

P.O. Box 107, Harrison, New Jersey

Phone: Waverly 6-1338

Philosophy is never mentioned in radio texts, but, to be successful in the marine field, the service technician must be familiar with a sort of *Code of the Sea*.

When men venture out in a small boat, what they are doing is for keeps, and no excuses are accepted. Lives may depend upon some fabrication of wood and metal; the marine service technician must accept the responsibility. All work must be *solid*—this is no place for chewing-gum splices, or anything slapdash and flimsy. This is for keeps!

Installation

This brings us to the technical department. Installation of a radio-telephone on a boat consists of securing the equipment in place, installing power wiring, providing the antenna and ground, putting the transmitter and receiver on the air, treating engine noise, and instructing the boatman in operation. If the first steps are done properly, the last will be easy.

After the equipment has been tentatively set in place on the boat to "try for size", get the gear out of the way and bore all of the holes required for the cable runs. In routing power cables, keep clear of the ship's compass. Most owners want the cabling routed so it is largely concealed or can be covered with a molding.

In this respect, make a definite agreement with the owner as to the placement of the equipment, the routing of the cable, the number and nature of the holes to be drilled in the boat, and whether cabinet work and molding (if required) are to be done by and at the expense of the radio installer or the owner. Situations may be found in the glossier barges where the cabinet work of imported mahogany may run into a greater expense than the cost of the radio installation. Who is to foot this bill should be clearly understood at the beginning.

After the holes are bored the equipment may be put in place—and from there on *everything* must be screwed down.

In placing a TV set in the parlor, it is sufficient merely to set it down without scratching the floor. When a radio-telephone is installed on a 40-footer the technician must be careful not only to avoid scratching any of the expensive paint, varnish, and chromium, but also to use shiny noncorrosive screws. On a boat this is called "securing" the telephone. It should be secured to the bulkhead (wall) or deck (floor) so solidly that the owner and all his crew can hang on it without anything tearing away or coming adrift. The motion of a boat in a seaway is sometimes so violent that anything not bolted down is liable to end up in the bilge or over the side.

This applies to cable as well as equipment. Use brass or plastic cable clips as often as required by the weight of the wire, and fasten in place with brass or chromium-plated screws—never nails. The common insulated staples used to tack wires in place ashore don't belong

Push the tube that PROTECTS YOU TWO WAYS!

**SYLVANIA
PICTURE TUBES
GUARD YOUR
REPUTATION
AND PROFITS!**



Be sure to show your customers the name SYLVANIA now etched on the lower left face of every Sylvania Picture Tube.

These letters are small in size (imperceptible when the tube is lighted), but they're mighty big in importance! For, they identify a genuine Sylvania Picture Tube... the tube found best in exhaustive tests conducted by an independent laboratory on tubes of 9 different makes.

Naturally, this high performance record helps maintain your reputation. It

also helps protect your profits, eliminates customer complaints and costly call-backs.

Remember, most customers regard a picture tube as an important investment. So, you're doing them a valuable service when you sell them the best their money can buy... a SYLVANIA! For new characteristics booklet covering all the latest Sylvania Picture Tubes, call your regular Sylvania Distributor or write direct to Dept. 4R-3804 Sylvania today!

Sylvania Television Program telling millions!

Most of your customers have seen and heard about Sylvania's high quality during the big popular show "Beat the Clock" on CBS-TV. Week after week, from coast to coast, the facts about Sylvania quality are being demonstrated to millions.



**Get this new booklet
for your files!**

SYLVANIA

Sylvania Electric Products Inc.  1740 Broadway, New York 19, N. Y.

In Canada: Sylvania Electric (Canada) Ltd.
University Tower Bldg., St. Catherine Street, Montreal, P. Q.

LIGHTING • RADIO • ELECTRONICS • TELEVISION

APRIL, 1954

WIN \$8,000⁰⁰



STAN
MUSIAL



MICKEY
MANTLE



Westinghouse LEAGUE LEADERS AND DEALERS AID CONTEST

You never saw such an easy contest! Just fill in the names of the teams which were leading each major league on August 1, 1953. Then you have the first leg on the \$1,000 CASH First Prize in the exciting League Leaders and Dealer Aid Contest.

Fill in the Entry Blank on the opposite page. Have your distributor salesman certify that you have purchased 25 Westinghouse Receiving Tubes OR 1 Westinghouse Picture Tube. And mail your Entry Blank

ET-95051

NOW! An early entry can win one of the big prizes for you.

After naming League Leaders on August 1, 1953, write your answer to the cartoon situation pictured on the Entry Blank. Winners will be judged on the basis of correctness of team selection, and aptness, originality and effectiveness of cartoon solution.

Enter as often as you wish. The more entries you submit, the better chance you have at the 209 Big Cash and Merchandise Prizes. Ask your distributor salesman for additional entry blanks. He will be glad to sign them when he takes your tube order.

YOU CAN BE SURE...IF IT'S
Westinghouse

RELIATRON® TUBES

WESTINGHOUSE ELECTRIC CORPORATION, ELECTRONIC TUBE DIVISION, ELMIRA, N. Y.

RADIO-ELECTRONICS

IN PRIZES...

209 PRIZES FOR SMART SERVICE MEN

2ND PRIZE— \$700 in YOUR Choice of Merchandise

3RD PRIZE— \$400 in Merchandise YOU Select

4TH PRIZE— \$300 YOU Choose the Merchandise

FIRST, SECOND, THIRD AND FOURTH PRIZE WINNERS WILL MEET MICKEY MANTLE OR STAN MUSIAL IN THE BIG PRIZE AWARD DINNER WESTINGHOUSE HAS PLANNED FOR YOU IN NEW YORK

- 5 Fifth Prizes of \$140 Each in Merchandise
- 20 Sixth Prizes of \$70 Each in Merchandise
- 30 Seventh Prizes of \$35 Each in Merchandise
- 50 Eighth Prizes of \$20 Each in Merchandise
- 100 Ninth Prizes of \$15 Each in Merchandise

FILL IN THIS ENTRY BLANK TODAY!

1. League Leaders on August 1st, 1953, were:

AMERICAN LEAGUE

NATIONAL LEAGUE

2. Here is what I would say to the lady in the Cartoon:

(ATTACH AN ADDITIONAL SHEET OF PAPER IF NECESSARY—100 WORDS, MAXIMUM)

MY NAME

SHOP NAME

STREET.....

CITY.....STATE.....

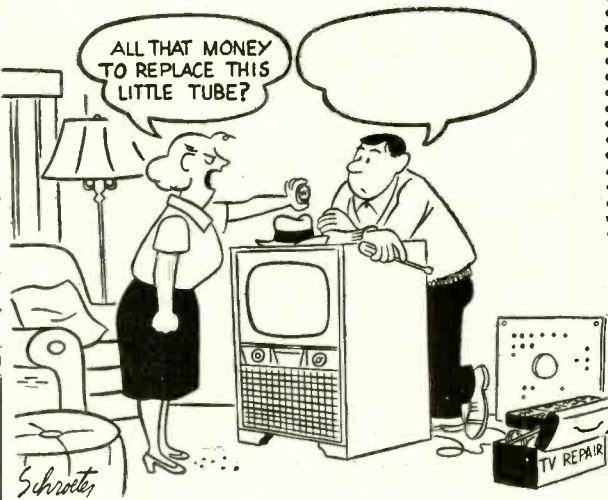

THIS SPACE FOR DISTRIBUTOR SALESMAN'S CERTIFICATION

I certify this Entry Blank has been qualified by the purchase of (25 Westinghouse Receiving Tubes) (1 Westinghouse Picture Tube)

SALESMAN'S SIGNATURE

COMPANY NAME

CITY.....STATE.....

SEND ALL ENTRIES TO:

WESTINGHOUSE TUBE CONTEST

Box 610, Grand Central Station, New York 17, New York

Build Your Own Interior - Styled Cabinets

KITS by Cabinart

presenting the paul klipsch-designed REBEL IV . . .

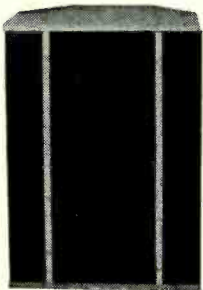

Now you can build your own Klipsch Corner Horn Enclosure and save money — identical in acoustic design to assembled units and easily put together with a minimum of tools. Priced for the home-builder in unfinished birch.

\$36.00* Net for 12" model
\$42.00* Net for 15" model

BASS REFLEX and EQUIPMENT CABINETS

Ideal housing for hi-fi components make future changes easier. Loudspeaker cabinet acoustically designed for either 12" or 15" speaker.

Overall dimensions: 33 1/2", 23", 16". Tuner Compartment: 20" H., 21 3/4" W. (inside dimensions), 15 1/4" Deep. Baffle volume: 6 cubic feet.



All kits include 5/8" white pine plywood cut to size, baffle pre-cut for 12" or 15" speaker, Saran Plastic AcoustiCloth, Kilmul Acoustic Insulation, Assembly and finishing Instructions, hardware, plastic wood, sandpaper and glue.

- No. 80 . . \$27.00***
(Equipment Kit)
- No. 8112 . \$18.00***
(12" speaker)
- No. 8115 . \$18.00***
(15" speaker)

CORNER FOLDED HORN ENCLOSURES

Reintroduces a quality of bass heretofore only possible through the use of far more expensive designs.

- No. 61 (12" speaker) . . \$19.95***
- No. 63 (15" speaker) . . \$23.95***

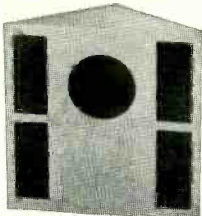

Write for free catalog and nearest distributor
 * Prices higher West and South.

G & H WOOD PRODUCTS COMPANY
 75 NORTH 11th STREET
 BROOKLYN 11, N. Y.

on a boat. They rust, pull out, and will usually weaken the insulation of the wire.

Another departure from home radio practice is that *heavy* wire must be used. Lamp cord is not suitable for any part of a marine radio installation. Solid wire may crystallize and break from vibration or flexing, so it should never be used. Stranded cable only, of No. 10 gauge or larger, is the absolute minimum requirement for seagoing service.

The proper size of cable is usually recommended by the radiotelephone manufacturers, and depends on the maximum current drain of the gear, and also on the supply voltage. Small boats commonly have only a 6-volt engine battery aboard, and on these craft be prepared for some really husky wire (see Table). Equipment can perform in its rated manner only if the specified input voltage is applied to its terminals. For instance, if a marine radiotelephone is supposed to have a transmitter power of so-many watts with 6 volts input, and line loss on the boat reduces the voltage at the set terminals to 5 volts, the actual output will be less than 80% of what the customer paid for.

MINIMUM WIRE SIZES FOR 25-WATT UNIT

| Distance from battery | 12 volts | 32 volts |
|-----------------------|----------|----------|
| 1 to 15 feet | No. 4 | No. 8 |
| 15 to 30 feet | No. 2 | No. 8 |
| 30 to 40 feet | No. 0 | No. 6 |

The heaviest, best insulated wire in the world is of no use whatever if it falls off the terminal—or is poorly connected—as might well be the case when it is subject, as always on a boat, to the dual effects of vibration and corrosion. For example, a service shop may receive a call that a transmitter is not working. When the technician boards the vessel, he sees that the full battery voltage can be measured across the radiotelephone terminals and the receiver is working. But, when the "transmit" button on the handset is pressed and the dynamotor should start humming—nothing. Even the receiver goes dead. This sounds like a dead short in the transmitter—serious trouble—and it *would* be if it happened with no technician on call, 200 miles off-shore in a heavy sea or on a disabled boat. But actually, this is just a symptom of a poor connection, either loose or corroded, in the battery circuit. Enough power gets by the high-resistance connection to supply the relatively light drain of the radiotelephone receiver, but when the heavy load of the transmitter is shunted onto the line, all of the voltage drop takes place across the loose or corroded connection with none left to energize the transmitter dynamotor.

The rule is (and it should be steadfastly adhered to) that twisted connections, or wires simply wrapped around terminals, are taboo. Every wire used

REAL SAVINGS!

AT PART-MART

TRIPLE-PLAY CARTRIDGE

G. E. RPX-050. Only a limited quantity left at this price! Popular variable reluctance cartridge. Plays all records! Complete with dual sapphire-tipped needle: .001" tip for 33 1/3 and 45 rpm; .003" tip for 78 rpm. Wt. 6 oz. Stock No. LD120.



\$4.88 EA.

7-GANG LO-LOSS SWITCH

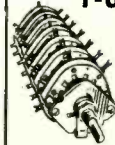

Lowest price ever for this quality ceramic rotary switch. 5-Pos., 7-Pole, Non-shorting type. All contacts silver-plated. Removable wafers. Positive action, ball-bearing detent mechanism with heavy spring. Wt. 12 oz. No. LD121.

88¢ EA.

SPECIAL! INDUCTUNER

Below wholesale! Popular 3-gang tuner for replacement or in own designs for TV and FM receivers and boosters. Continuous tuning from 52-120 mc and 175-216 mc with 4 turns of 3" shaft. Size, 4 1/16" x 2 1/8". Wt. 3 lbs. No. LD108. **\$2.49 EACH.**



LOTS OF 3 **\$2.19 EA.**

LINE VOLTAGE TESTER



NEW! Accurate line voltage meter giving you instantaneous readings right at the receptacle. **JUST PLUG IN!** Swivel head. Easy reading. AC only. Reads 0-150 Volts ±.5%. Precision-made. Wt. 8 oz. No. SD113.

\$3.00 EA.

WRITE FOR ADDITIONAL LISTINGS

Include Postage—Excess Promptly Returned
 TERMS: F.O.B., N. Y. C.—MIN. ORDER \$3.00.
 25% Deposit on C.O.D. Orders. SAVE C.O.D. CHARGES—REMIT IN FULL PLUS POSTAGE. Subject Prior Sale.

PART-MART

ROCKVILLE CENTER L. I., N. Y.

ATLAS RADIALS

FOR CHURCHES

FOR FACTORIES

FOR TERMINALS

FOR CARNIVALS

With uniform 360° coverage, non-resonant construction, and 100% storm-proofing, ATLAS Radial Driver Unit Projectors often solve the most difficult sound problems—are excellent for reproduction of speech, chimes and music. For complete details on Radials and the famous ATLAS line of Public Address and Microphone Stand Equipment . . .

WRITE NOW for FREE Catalog 553

ATLAS

SOUND CORP.

1443 39th St., Brooklyn 18, N. Y.
 In Canada: Atlas Radio Corp. Ltd., Toronto, Ont.

CHECK These Terrific RAD-TEL Tubes and Parts SAVINGS!

70% to 90% OFF on TUBES INDIVIDUALLY FULL YEAR GUARANTEE!
SAME DAY SERVICE . . . OVER 300 TYPES IN STOCK AT ALL TIMES!

| | | | | | | | | | | | | | | | | | |
|-------|-------|-------|-------|--------|-------|--------|-------|--------|-------|--------|-------|---------|-------|---------|-------|---------|-------|
| Type | Price | Type | Price | Type | Price | Type | Price | Type | Price | Type | Price | Type | Price | Type | Price | Type | Price |
| OA2 | .74 | 1T4 | .49 | 6AK5 | .55 | 6BQ7 | .90 | 6SH7GT | .49 | 7C5 | .69 | 12BE6 | .39 | 14A17 | .59 | 42 | .42 |
| OA4 | .68 | 1U4 | .49 | 6AK6 | .59 | 6BZ7 | .90 | 6SJ7GT | .41 | 7C6 | .59 | 12BF6 | .39 | 14H7 | .59 | 43 | .55 |
| OB2 | .81 | 1U5 | .43 | 6AL5 | .38 | 6C4 | .37 | 6SK7GT | .41 | 7E5 | .59 | 12BH7 | .63 | 14J7 | .30 | 45 | .55 |
| OC3 | .72 | 1V | .53 | 6AQ5 | .39 | 6C5 | .39 | 6SL7GT | .48 | 7E6 | .30 | 12BY7 | .65 | 14N7 | .84 | 45Z3 | .44 |
| OD3 | .70 | 1X2A | .63 | 6AQ6 | .37 | 6C6 | .58 | 6SN7GT | .52 | 7E7 | .59 | 12BZ7 | .65 | 14W7 | .30 | 45Z5 | .49 |
| OZ4M | .55 | 2A3 | .30 | 6AR5 | .37 | 6CB6 | .44 | 6SQ7GT | .37 | 7F7 | .79 | 12C8M | .34 | 19B6 | .95 | 50A5 | .55 |
| 1A5 | .30 | 2A4G | .24 | 6AS5 | .50 | 6CD6 | 1.11 | 6SR7GT | .45 | 7G7 | .89 | 12H6 | .56 | 19C8 | .70 | 50B5 | .43 |
| 1A7GT | .47 | 2W3 | .38 | 6AT6 | .37 | 6D6 | .59 | 6S7GT | .42 | 7H7 | .59 | 12SC7M | .63 | 19T8 | .69 | 50C5 | .39 |
| 1AX2 | .62 | 2X2 | .59 | 6AU4GT | .68 | 6E5 | .48 | 6T4 | .99 | 7J7 | .79 | 12J5 | .42 | 19V8 | .79 | 50L6GT | .61 |
| 1B3GT | .68 | 3A4 | .45 | 6AU5GT | .82 | 6F5GT | .39 | 6T8 | .56 | 7L7 | .59 | 12J7 | .49 | 24A | .39 | 50Y6 | .49 |
| 1C5 | .43 | 3E5 | .46 | 6AU6 | .38 | 6F6 | .59 | 6U6 | .60 | 7N7 | .69 | 12K8 | .59 | 25AV5GT | .83 | 50Y7 | .50 |
| 1E7 | .29 | 3Q4 | .48 | 6AV5GT | .83 | 6G6 | .52 | 6U6 | .59 | 7X7 | .70 | 12Q7 | .59 | 25BQ6GT | .79 | 55 | .49 |
| 1G6 | .24 | 3Q5GT | .49 | 6AV6 | .37 | 6H6GT | .41 | 6U8 | .61 | 7Y4 | .69 | 12S8GT | .62 | 25L6GT | .39 | 57 | .58 |
| 1H4 | .30 | 3S4 | .49 | 6AX4GT | .53 | 6J5GT | .43 | 6V6GT | .39 | 7Z4 | .59 | 12SA7GT | .65 | 25W4GT | .59 | 58 | .60 |
| 1H5GT | .49 | 3V4 | .51 | 6B4 | .64 | 6J6 | .52 | 6W4GT | .44 | 12A6 | .54 | 12SF5 | .50 | 25Z5 | .66 | 70L7 | .97 |
| 1L4 | .46 | 5U4G | .50 | 6BA6 | .39 | 6J7 | .47 | 6W6GT | .44 | 12A8GT | .61 | 12SG7 | .51 | 25Z6 | .49 | 75 | .49 |
| 1L6 | .59 | 5W4GT | .50 | 6BA7 | .57 | 6K5 | .47 | 6X4 | .37 | 12AL5 | .37 | 12SJM | .67 | 26 | .45 | 76 | .44 |
| 1LA4 | .59 | 5Y3GT | .37 | 6BC5 | .49 | 6K6GT | .37 | 6X5GT | .37 | 12AQ5 | .52 | 12SK7GT | .63 | 27 | .39 | 77 | .57 |
| 1LC5 | .59 | 5Z3 | .45 | 6BD5 | .59 | 6K7 | .44 | 6X8 | .75 | 12AT6 | .37 | 12SK7M | .63 | 32L7 | .89 | 78 | .47 |
| 1LC6 | .79 | 5Z4 | .59 | 6BD6 | .45 | 6L6 | .64 | 6Y6G | .48 | 12AT7 | .66 | 12SL7GT | .47 | 35 | .58 | 80 | .35 |
| 1LD5 | .59 | 6A6 | .51 | 6BE6 | .39 | 6L7M | .68 | 7A4 | .47 | 12AU6 | .38 | 12SN7GT | .52 | 35B5 | .40 | 83V | .68 |
| 1LE3 | .59 | 6AB4 | .44 | 6BF5 | .41 | 6Q7 | .45 | 7A5 | .59 | 12AU7 | .54 | 12SQ7GT | .56 | 35C5 | .39 | 84/6Z3 | .46 |
| 1LH4 | .69 | 6A7 | .69 | 6BF6 | .37 | 6R7 | .69 | 7A6 | .69 | 12AV6 | .39 | 12SR7M | .49 | 35L6GT | .41 | 85 | .59 |
| 1LN5 | .59 | 6AC7M | .86 | 6BG6G | 1.25 | 6S4 | .38 | 7A7 | .69 | 12AV7 | .63 | 12V6GT | .46 | 35W4 | .37 | 117L7 | .99 |
| 1NSGT | .67 | 6AF4 | .90 | 6BH6 | .46 | 6S7M | .79 | 7A8 | .68 | 12AX4 | .56 | 12X4 | .38 | 35Y4 | .54 | 117P7 | .99 |
| 1PSGT | .57 | 6AG5 | .48 | 6BJ6 | .43 | 6S8GT | .53 | 7AF7 | .53 | 12AX7 | .56 | 14A5 | .59 | 35Z3 | .59 | 117Z3 | .37 |
| 1QS7 | .58 | 6AG7M | .99 | 6BK7 | .80 | 6SA7GT | .43 | 7B4 | .44 | 12AY7 | .99 | 14A7 | .63 | 35Z4 | .47 | 117Z6 | .69 |
| 1R5 | .49 | 6AH4 | .57 | 6BL7GT | .83 | 6SD7GT | .41 | 7B6 | .69 | 12BA6 | .38 | 14B6 | .63 | 35Z5GT | .47 | 807 | .99 |
| 1S4 | .59 | 6AH6 | .73 | 6BN6 | .59 | 6SF5GT | .46 | 7B7 | .49 | 12BA7 | .60 | 14B8 | .63 | 36 | .39 | 866A | 1.39 |
| 1S5 | .43 | 6AJ5 | .65 | 6BQ6GT | .79 | 6SG7GT | .41 | 7C4 | .59 | 12BD6 | .45 | 14C7 | .79 | 41 | .42 | HiPo567 | 1.39 |

RAD-TEL Parts - TOPS in Quality - LOW LOW in Price!

PHILCO TV BOOSTER
 Made by PHILCO, famed for quality and precision communications equipment. Completely self-contained, including 2 tubes for High Channels and 1 for Low Channels and selenium rectifier plastic cabinet. In factory-sealed cartons, complete with instructions.

10.95
 In Lots of 3
9.95

STANDARD BOOSTER
 12 channel RF Amplifier with self-contained AC power supply. Handsome plastic cabinet. List price \$23.00.

7.95
 Lots of 3
7.45
 ea.

Granco "Star" UHF CONVERTER
 Brand new! Latest model! Unit is highly engineered, receives all UHF channels. Co-axial tuned cavity elements complete with 6AF4 oscillator, 6CB6 I-F and crystal mixer. Shipped ready to install and operate. List Price \$29.95
22.45

29.97
 De luxe model Five Star UHF Converter. Pre-selector 1N82 - 6BQ7 cathode and 6AF4 oscillator. List price \$39.95

FLYBACK TESTER
 Your Price **39.95**

A Must for every Service-Man!
 Fast, sure a 1+ turn short. Tested while in receiver! Tests continuity on yokes, coils, speakers, switches, etc.
FREE! Flyback & Yoke with each order!

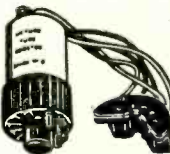
CATHODE RAY TUBE REJUVENATOR
 Fits all makes of picture tubes. Completely automatic. Easy to install, no tools needed. For A.C. parallel circuits. Your Old Picture Tubes Are Still Useful. List price - \$5.95.

1.39
 Lots of 10
1.29

SELENIUM RECTIFIERS
 Mfd. by FEDERAL
 6559¢
 7569¢
 10079¢
 15084¢
 2001.25
 250-1010A1.75
 250-1028A1.75
 3001.39
 350-1238A1.59
 350-1023A1.59
 4001.59
 5001.99

HI-VOLTAGE POWER SUPPLY
 4500 VOLTS 6 MA.
 12AU7 oscillator
 IB3 rectifier
 Completely wired, enclosed in shielded metal case, removable cover. Improve performance of your scope; use as R.F. high voltage supply.
BRAND NEW!
2.95
 Kit of 2 tubes for above - \$1.22
 Lots of 5 \$2.75 ea.

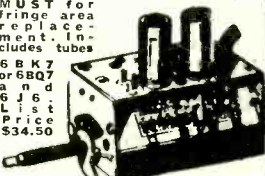
UNIVERSAL FLYBACK
 High efficiency FERRITE core horizontal transformer. Supplies 14,000 Volts. For all 65" to 70" kinescopes. Famous Type. In constant demand. List price \$11.50

1.95
 each
 Lots of 3
1.85
 each

Famous Standard Coil GASCODE TUNER
 Famous standard tuner TV front end. Double the gain with a great reduction in noise. A MUST for fringe area replacement. Includes tubes 6BK7 or 6BQ7 and 6J5. List Price \$34.50
 ea. **18.95**
 Lots of 2
 ea. **17.95**

Famous Make CLOCK RADIO
 With Telechrome luminous clock. Automatic shut-off and wake-up features. Starts coffee perkins; switches on appliances. 5 tubes including rectifier. Built-in antenna. 60 cycles AC. U. L. approved. Pure bakelite or ivory body. Color-molded pure plastic grille.
 Ebony - \$22.95
 Lots of 5 - \$22 ea.
 Walnut - \$23.95
 Lots of 5 - \$23 ea.
 Ivory - \$24.95
 Lots of 5 - \$24 ea.

Famous Make Personal Portable BATTERY RADIO
 4 TUBES (2 DUAL-PURPOSE)
 Has extra long life hundred hour batteries. Long distance reception. Large dynamic speaker. Thumb wheel tuning. All stations, plastic case, with collapsible handle. Rich gold finish trim. Red, brown or grey. Complete with batteries and leather case. each 19.95 complete. Lots of 3 \$19. ea.

Sensational! New! Famous 3-Way INDOOR ANTENNA
 For UHF, VHF and FM radio. Delta-beam. 50% increase in pulling power by extending dipoles. For average, fringe and UHF areas. For movie-clear pictures. Single antenna \$5.95

 Lots of 6 - \$5.37
 Lots of 12 - \$4.83
 Lots of 24 - \$4.47

300 OHM TWIN LEAD TV Lead-In Wire
 AWG 20 strand copper. 55 mil. web poly. 2 1/2¢ per foot \$1.95 per 100 ft. \$14.50 per 1000 ft.

TERMS: A 25% deposit must accompany all orders - balance C.O.D. All shipments F.O.B. Irvington warehouse. Orders under \$10-\$1.00 Handling Charge. Subject to prior sale.
PLEASE: send full remittance . . . allow for postage and save C.O.D. charges! We refund all unused money!

Send For FREE Illustrated PARTS CATALOGUE

RAD-TEL TUBE CO.

"Integrity Is Our Chief Asset"

Phone: Essex 5-2947, Dept. RE4, 115 Coit St., Irvington 11, N. J.

NEW for TV NOW

operate 2 TV sets from
1 antenna at same time
(VHF-UHF)

WITH BOOST
IN
SIGNAL STRENGTH

WALDOM Electronic

Duo-Tenna

TV DISTRIBUTION AMPLIFIER



Install
anywhere indoors.

- Booster effect improves picture quality in "fringe" as well as metropolitan areas.
- Reduces existing noise and "snow" conditions.
- When used with single UHF Converter, converts TWO sets to UHF.
- Broad band width. (Ideal for color telecasts.)
- Save cost and installation of second antenna.
- Easily installed.

It will PAY you to get the
whole story . . . Write to —

WALDOM

ELECTRONICS INC.

911 N. LARRABEE ST.
CHICAGO 10, ILL.

in the installation should be ended in a good solid lug, secured under the terminal with a lockwasher.

Soldering is difficult on most boats, so screw-type or crimping lugs will be found simplest to apply.

If the supply voltage is only 6 or 12 volts, the voltage drop across a small fuse may be considerable. If more than 0.1 volt loss is encountered, use heavier fuses, and if necessary add additional fuses in parallel. Any switch used in the power circuit should have a continuous current rating greater than the maximum drawn by the transmitter. After the transmitter has been in operation for a few minutes, inspect all installation wiring. Anything that is hot is too light—replace or add a parallel circuit now, rather than have something happen later when the boat is in the middle of a fogbank.

Always make sure that the grounded polarity of the battery is followed in the equipment. One make of boat may have a positively grounded battery, while another may be negative—and at least one very popular make of boat with two engines has one battery with a positive ground, and the other negative. If the radio equipment is accidentally installed with an opposite ground, the technician may soon suffer the embarrassment of having to poke around the mud in the bottom of the bay, looking for the boat. Fittings that keep out the water have been known to become eaten away in a matter of hours when such a mistake is made.

The antenna

A feature of marine radiotelephone installations that requires more than ordinary care, both in planning and construction, is the antenna system.

The installer is likely to find the equipment must be accommodated to one of two extremes—either the boat cannot carry an antenna large enough to be efficient or the antenna will be too large for efficiency. Incredibly, these conditions are the two most common ones, and which of the two will exist depends on whether the small boat is a motor vessel or sailboat.

Marine radiotelephone transmitters are designed to operate at the base of a Marconi type antenna. On a small motor yacht or workboat, the size of the vessel limits antenna height to from 12 to 25 feet, which is a small fraction of a wavelength on the more common marine frequencies.

Such short antennas have an extremely low radiation resistance, from about 0.3 ohm for a 12-footer to 1.8 ohms for an antenna 25 feet high. With such low resistance, ground current is heavy in comparison to that found in other types of radio stations, so to keep losses low an exceptionally good ground is required. This necessitates putting a large-area copper plate on the hull below the water-line, the installation of which is a shipyard haul-out job. If this is impractical, the engine, or any other "wetted" metal, such as a keel or rudder, may be used temporarily. The ground wire from the transmitter

FREE CATALOG

LISTING HUNDREDS OF TRULY EXCEPTIONAL
"BUYS"—WRITE FOR YOUR FREE COPY NOW!

COAXIAL CABLES:

RG-8/U (SPECIAL) 51.5 ohms. Same size as RG-8/U. Prices: 1 to 100 ft. @ 8¢ per ft.—100 to 500 ft. @ 7½¢ per ft.—500 to 1000 ft. @ 7¢ per ft.—1000 ft. Rolls @ 6½¢ per ft.
RG-34/U—71 ohms, 145 ft. length \$15.00

AERIAL WIRE—Phosphor Bronze #16 Stranded, 200 lb. test. Weatherproof, 150 Feet on Reel. RL-3 with Clips **\$1.50**

SOUND POWERED HEAD AND CHEST SET

Navy Type—No Batteries Required—Ideal for TV Antenna Installations and many other uses. 20 Ft. Cord. Used Tested: **\$5.95 EA.**



TELEPHONE WIRE FOR THE ABOVE

COMBAT TYPE—2 Cond. Twisted, Rubber Covered. Medium Weight, W-130 @ .01¢ per Ft.
FIELD WIRE—2 Cond. Twisted, Weatherproof, Heavy Duty, W-110—525 Ft. Roll **\$4.75**
COPPER WELD WIRE—Weatherproofed, 2 Cond. Solid. 1200 Ft. Roll. \$10.00. Per Ft. @ .01¢ per Ft.

TG-34A KEYS

PORTABLE—115 or 230 V. @ 50 to 60 cycles—KEYER TG-34A is an automatic unit for reproducing audible code practice signals previously recorded in ink on paper tape. By use of the self contained speaker, the unit will provide code practice signals to one or more people or provide a keying oscillator for use with a hand key. The unit is compact, in portable carrying case, and complete with tubes, photo cell, and operating manual. Size: 10½" x 10½" x 15½". Shipping weight: 45 lbs. BRAND NEW **\$14.95**—In original Box: NEW: \$24.95—USED:

Address Dept. RE • Minimum Order \$5.00
Prices F.O.B., Lima, O. 25% Deposit on C.O.D. Orders

FAIR RADIO SALES
132 SOUTH MAIN ST. • LIMA, OHIO

WE WANT YOUR BUSINESS . . .

and low, low prices plus
fast service is how we
hope to get it!

A typical
Steve-El
Value!

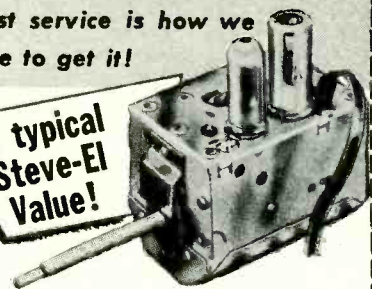

CASCODE TUNER

Most popular of all tuners. Used in millions of TV sets and chassis. Covers all channels from 2 to 13 with interchangeable coils on strips for UHF work. Each channel has individual oscillator adjustment screw reached from front of panel for alignment of picture brilliance, definition and sound. Balanced 300-ohm input. Supplied with 616 and 6BQ7. Price \$14.59 each. **only \$13.99 ea.** (lots of 3)

FREE! Write Dept. RE-4 for latest STEVE-EL SUPER-VALUE catalog. Hundreds of values typical to Cascode Tuner bargain.

STEVE-EL Electronics Corp.
61 Reade St. New York 7, N. Y.

arkay HI-FI AUDIO kit

AMPLIFIER



10 Watt high-fidelity amplifier. Separate tone controls for bass and treble through inverse feedback circuit; 10 watt output or 32 db. less than 3% distortion; frequency response ± 1 db. from 20 to 20,000 cps. Tone controls produce maximum bass boost ± 8 db. @ 100 cps. Treble controls produce maximum treble boost ± 10 db. @ 10,000 cps. Num: 70 db. below rated output.

Model A10 21.95
Write for new catalog of the complete ARKAY line of radio, TV, phonograph and test equipment kits.

arkay RADIO KITS, INC.
120 CEDAR STREET
NEW YORK 6, N. Y.
BE 3-6686

BLAK-RAY SELF-FILTERING ULTRA-VIOLET LAMP



BLAK-RAY 4-watt lamp, model X-4, complete with U-V tube. This lamp gives long-wave ultra-violet radiation having a wave-length of 3654 to 4000 angstrom units. Some of the substances made to fluoresce visibly when illuminated by U-V light are certain woods, oils, minerals, milkstone, cloth, paints, plastics, yarn, drugs, crayons, etc. This lamp is self-filtering and the invisible U-V rays are harmless to the eyes and skin. Equipped with spectral-finish aluminum reflector. Consumes only 4 watts and can be plugged into any 110 volt 50-60 cycle A.C. outlet. Will give 2000 to 3000 hours of service. It weighs but 1 3/4 lbs. Approved by the Underwriters Laboratories and has a built-in transformer so that it may be safely used for long periods when necessary. Extra U-V tubes are available.

Ship wt. 4 lbs.
ITEM NO. 125
UNUSUAL BUY..... \$16.75 (Shp. Chgs. 70c)

WATTHOUR METER



Leading makes—reconditioned. Ideal for trailer parks. 100-110 volts, 60 cycles, 2-wire A.C. 5 amp. Heavy metal case 8 1/2" x 6 1/4" x 5". Easy to install. Ship. wt. 14 lbs.

ITEM NO. 33 \$4.50
NOW ONLY (Shp. Chgs. \$1.25)

WESTERN ELECTRIC BREAST MIKE



Lightweight 1 lb. carbon microphone. Aircraft type. Breastplate mounting, adjustable 2-way swivel. Easily fastened straps. For home broadcasts, communications etc. Complete with 6 foot cord, hard rubber plug. Sheradized plate, non-rusting finish. Ship. wt. 2 lbs.

ITEM NO. 152 \$2.25
NEW LOW PRICE (Shp. Chgs. 35c)

250 POWER TELESCOPE LENS KIT



Make your own high powered 6 ft. telescope! Kit contains 2" diam., 75" focal length, ground and polished objective lens and necessary eye pieces. Magnifies 50x to 250x. Full instructions. Ship. wt. 1 lb.

ITEM NO. 123 \$2.95
YOU SAVE AT (Shp. Chgs. 10c)

HUDSON SPECIALTIES CO.
25 West Broadway, Dept. RE-4-54
New York 7, N. Y.

I am enclosing full remittance for items circled below. (Be sure to include shipping charges.)
OR, my deposit of \$..... Ship balance C.O.D.
MINIMUM C.O.D. ORDER \$5.00.
C.O.D. ORDERS ACCEPTED ONLY WITH 20% DEPOSIT
INCLUDE SHIPPING CHARGES.

Circle Items Wanted
87 147 33 152 125 123

Name
Please Print Clearly
Address
City Zone State

should be the heaviest cable that can be wrestled into place.

Short antennas are also highly reactive, which means that r.f. voltage will be high. To prevent leakage, very good insulation must be used. Glass is best, but glazed porcelain is satisfactory if it is protected from moisture by silicone or waterproofing wax.

If the power boat has a mast high enough, a satisfactory antenna can be erected. Lacking this, a light mast of spruce or bamboo can be mounted on the boat, guyed, and the wire antenna hung from it with standoff or strain type insulators. Another method is to use one of the many self-supporting antennas on the market. In any case, the antenna should be well insulated, and this alone rules out the wrapping of wire of any description on a wooden or bamboo pole. Wrapped-pole antennas lose their "oomph" when wet.

All rigging work in connection with antennas should be just as substantial as power wiring, with terminals and lock washers at points of connection, and eye-splices or cable clamps used for mechanical strain points. Wire should be larger than No. 10 gauge, and insulated at every point of contact with any foreign object. Phosphor-bronze stranded cable is the best, since it combines the good conductivity, high tensile strength, and resistance to corrosion necessary in marine use.

The other extreme is the sailing vessel with a lofty guyed spar or two. The problem on these vessels is to find an area clear of rigging, close enough to the set to keep the under-the-deck portion of the lead-in at a minimum.

On a small sailboat it is possible to insulate the top and bottom of a permanent backstay and use it for the radiotelephone antenna. In larger vessels, however, the usual location of the radiotelephone lies amidships. Therefore, the lead-in must run below decks and near the waterline, by the engine, surrounded by other wiring. The length of the usual standing backstay plus this lead-in (half the length of the boat) adds up to more than a quarter length on the marine band, which complicates transmitter tuning.

The most successful large sailing vessel installations require some modification in the usual procedure. This may be carried out in one of two ways—by locating the equipment aft, at the foot of the backstay antenna, and having only a remote-control station amidships in the quarters; or by keeping the equipment in the main cabin and using a coaxial line to feed a tuning and coupling unit at the bottom of the antenna.

If this kind of rig cannot be arranged, a movable wire can be hung from a spreader or the masthead, in a position that will be out of the way of the boom when the telephone is not in use, and hauled out and secured to an "eye" on deck (as much in the clear as possible) when it is desired to place a call.

On vessels having hollow spars, antennas have been hung down through

**PRECISE — THE FASTEST-GROWING
KIT MANUFACTURER IN THE WORLD**

precise

KIT AND WIRED
INSTRUMENTS

EXCLUSIVE...

IN STOCK
AT YOUR
JOBBER

precise
MODEL #308
8 1/2" SCOPE
KIT \$129.50
#308W \$229.50

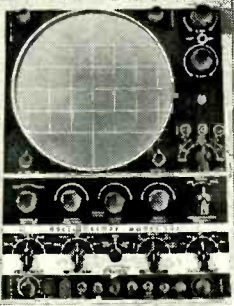

No other oscilloscope, at any price, can meet all the specifications of this electronic masterpiece.

- VERTICAL FREQ. RESPONSE—Flat $\pm 1/2$ db DC thru 5 MC.
- SENSITIVITY—Greater than 10 millivolts push-pull (3.9 Millivolts/CM)
- BLANKING—60 cycle or 120 cycle Blanking through Blanking amplifier circuit.
- SWEEP RATE—Linear sweeps from 1 cycle to 80 KC in 5 ranges. (1-10 uses Ext. C.) DRIVEN and RECURRENT sweeps.
- MAGNIFIER—Expands and magnifies signal up to 10 times.
- PUSH-PULL—Output in both amplifiers.
- CRT—The latest type 8 1/2" NEW tube a PRECISE EXCLUSIVE.
- VOLTAGE REGULATED.
- ANODE INTENSIFIER—a PRECISE FIRST.
- INTERNAL CALIBRATOR

NEW 7" OSCILLOSCOPE
MODEL #300K \$94.95
MODEL #300W \$199.50

LOWEST PRICED IN ITS FIELD
NEW MODEL #909
VACUUM TUBE VOLTMETER
FACTORY WIRED \$37.50

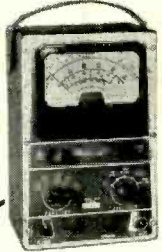

Model 909 Vacuum Tube Voltmeter. 1% Ceramic precision Resistors; Coax DC connector; FM zero alignment scale; burn-out proof circuit; DC input 25 Meg. Rugged oversize 4 1/2" meter.
MODEL #909 KIT... \$25.98

OTHER PRECISE TEST INSTRUMENTS AVAILABLE

- 907 - 7 1/2" VTVM - Kit \$38.98 • Wired \$58.98
- 610 - RF SIG. GEN. - Kit \$23.95 • Wired \$39.95
- 630 - RF-AF TV MARKER - Kit \$33.95 • Wired \$53.95
- 635 - AF SINE, SQ., PULSE GEN. - Kit \$33.50 • Wired \$52.50
- 468 - RESISTANCE DECADE BOX - Kit \$18.95 • Wired \$24.95
- 478 - CAPACITY DECADE BOX - Kit \$18.95 • Wired \$24.95
- 912 - RF PROBE - Wired and Calib. \$4.25
- 960 - 10-1 CA. PROBE - Wired \$5.95
- 999 - HIGH VOLTAGE PROBE - Wired \$6.95

SEND FOR YOUR FREE 1954 DESCRIPTIVE CATALOG
Prices slightly higher in West

precise
DEVELOPMENT CORP.
OCEANSIDE, NEW YORK

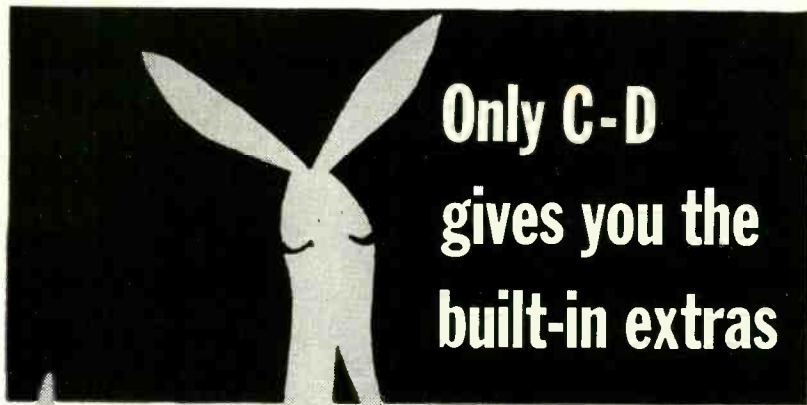

**Only C-D
gives you the
built-in extras**

No other line puts so much engineering, so many heavy duty construction features, and so much experience into every capacitor.

Whether it's an electrolytic, a ceramic, a paper or a mica, you know you're getting field-proved performance when you ask for C-D. Why take less?

Don't accept substitutes on the basis that they even "look-alike". It's what's inside that counts. Insist on C-D's. Order a supply today from your C-D jobber! His name is in the Yellow Pages of the Classified Telephone Directory. For catalog write to Dept. RC-44, Cornell-Dubilier Electric Corporation, South Plainfield, New Jersey.

CONSISTENTLY DEPENDABLE

**CORNELL-DUBILIER
CAPACITORS**



*There are more
C-D capacitors in
use today than any
other make.*

PLANTS IN SO. PLAINFIELD, N. J.; NEW BEDFORD, WORCESTER AND CAMBRIDGE, MASS.; PROVIDENCE AND HOPE VALLEY, R. I.; INDIANAPOLIS, IND.; SANFORD AND FUGUAY SPRINGS, N. C. SUBSIDIARY: RADIART CORP., CLEVELAND, OHIO

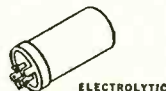

**OVER 50,000
TECHNICIANS
HAVE LEARNED**

**HOW TO GET
THE MOST OUT
OF BASIC TEST
EQUIPMENT**

for A.M. - F.M. - TV

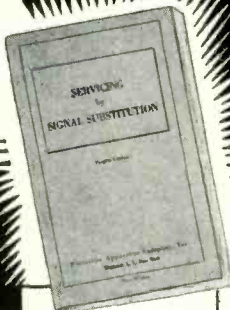

ONLY 40¢
103 pages. Invaluable information that will help you re-double the value of your basic test equipment.

**'SERVICING BY
SIGNAL SUBSTITUTION'**

A BEST SELLER FOR OVER 12 YEARS!
(NEW, UP-TO-DATE, 12th EDITION)

The Modern, Simplified, Dynamic Approach to Receiver Adjustment & Alignment Problems.

- ★ Nothing complicated to learn
- ★ No extra equipment to purchase
- ★ Universal... non-obsolete
- ★ Employs only Basic Test Instruments

Ask for "S.S.S." at your local Radio Parts Jobber or remit 40¢ in small stamps or coin directly to factory.

PRECISION APPARATUS COMPANY, INC.
92-27 HORACE HARDING BLVD., ELMHURST 4, N. Y.

the center of the mast. This is not good practice, because nearby there is usually a metal sail track, one or more wire halyards, and masthead and spreader-light power cables. Also, the antenna at this point is almost completely enclosed by the standing rigging. The farther from this mess of wire the antenna can be hung the more successful the installation is likely to be.

Interference

Ignition and electrical noise is more troublesome on boats than in automobiles, due to the low power of marine transmitters; the network of power and light wiring usually strung around the boat; and, unlike the car with its metal body, there is nothing to shield or confine noise energy to a small area. Thus, the best way to quiet a gasoline engine is to install a complete ignition harness of flexible conduit, such as used on aircraft. Another method is to use suppressor spark plugs, and bypass capacitors on generators, electric motors, fuel pumps, and wires leaving the engine compartment.

Electrical racket is by no means confined to gasoline engines, however. Some of the most difficult cases are often encountered in diesel craft, which may not even have a spark plug on board. Varying electrolytic currents, frictional electricity from belts, generators and voltage regulators, and even the rigging, can generate noise.

These "transmitters" must painstakingly be tracked down individually and taken off the air by bypassing, shielding or grounding. Some success has been had in quieting noisy engines by the enclosure of the engine compartment in a copper screen, similar to a laboratory screened room. This system has the disadvantage of requiring constant maintenance to combat the loss of contact between its elements due to corrosion and vibration.

Finally, the antenna on any boat, either power or sail, should be safeguarded against lightning. A heavy switch can be installed to ground the antenna while it is not in actual use, or a lightning gap can be used. The open type, preferably with a lightning choke, is best for transmitter use, as it has the least leakage loss and also will be less likely to break down under the transmitter output voltage than other types. Most types of shoreside lightning arresters are not suitable for this use—they corrode and short out.

Up to this point it has been pretty largely all work—but now the technician can brush himself off, button his wilted collar, and engage in tuning and testing the equipment.

At first the service technician may find it takes a couple of days to make a complete radiotelephone installation, but if he keeps a notebook, learns the shortcuts, and works out a standard procedure for the different makes of boats, he will soon find himself installing one of these miniature broadcasting stations in half a day. That leaves half a day for basking at the beach—or making another installation. **END**

A FEW UNUSUAL SERVICE CASES

THE MAN IN THE RADIO

If you are a service technician you have probably met mothers who warn their children about "the small man who talks from inside the radio!" I was servicing a console, and my job was almost over. I was tuning in short wave and checking calibration. The customer's kid, a 3-year-old stick of dynamite, was plying me with questions about "the small man in the radio."

"Of course he's asleep," I told him, "and you better not knock on the radio if you don't want him to awake and scream!"

"I like him when he screams," was the kid's reply as he gave the radio's cabinet three knocks and said, "Little man in the radio wake up and scream!"

Then I distinctly heard the loud-speaker say: "Who is this? Who is this? Who are you?" I was paralyzed. It couldn't be!

I just couldn't believe it. I knocked three times on the radio's cabinet. Three similar knocks were the answer.

The kid was happily repeating, "The small man in the radio is awake!" I neared the speaker and shouted: "Can you hear me?"

"Yes I can, who are you?" was the answer. Only then I noticed a strong carrier was tuned in on short wave with plenty of modulation hum.

"Where are you?" I asked.

"In 7 Park Street!" It was the address where I was.

I said, "I'm in 7 Park Street too, on first floor. What floor are you on?" There was an exclamation, and the voice continued,

"I'm Mr. Davis on the second floor!"

I found that Mr. Davis was tuning on short wave at the time when he picked up a strong carrier and heard the knocks, and the kid's voice. He too was scared when he found his radio answering him. I located the phenomenon.

Both local oscillators were beating together, and as both sets had a tendency to microphonics a sort of FM was established by shouting toward the tuning capacitor. I tried it out in my shop too, and it worked on several sets.—*E. Sternklar*

UNUSUAL ACCELERATION

My most unusual service job was on a battery radio in the mid '20's. I sold a set to a lady about 20 miles out on a farm, and told her if she had any trouble the first three months I would service the set free of charge. I heard nothing from her until the morning of the last day of the guarantee. Then she phoned and told me the set was not working right and to please come over to her place that day by all means.

There was about a foot of snow on the roads and the temperature was near zero. I had some doubts as to

OUTSTANDING for HIGH FIDELITY!

BUY DIRECT AND SAVE

'PRE-FAB'

COLLINS TUNERS and RECEIVERS

AUDIO PRODUCTS CO.

Two ALL NEW Complete Kits for Every High-Fidelity Need

Collins Audio Products Co. is in no way affiliated with Collins Radio Co.

Each Collins Tuner Kit is complete with punched chassis, tubes, power transformer, power supply components, hardware, dial assembly, tuning eye, knobs, wire, etc., as well as the completed sub-assemblies: FM tuning units, AM tuning units, IF amplifiers, etc., where applicable. All sub-assemblies wired, tested and aligned at the factory make Collins Pre-Fab Kits easy to assemble even without technical knowledge. The end result is a fine, high quality, high fidelity instrument at often less than half the cost—because you helped make it and bought it direct from the factory.

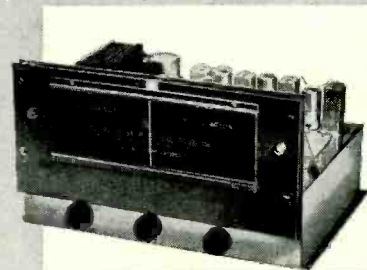

FM Tuner Kit

\$55

The FM-11 tuner is available in kit form with the IF Amplifier mounted in the chassis, wired and tested by us. You mount the completed RF Tuning Unit and power supply, then after some simple wiring, it's all set to operate. 11 tubes: 6J6 RF amp, 6AG5 converter, 6C4 oscillator, 6BA6 1st IF, (2) 6AU6 2nd and 3rd IF, (2) 6AU6 limiters, 6AL5 discriminator, 6AL7-GT double tuning eye, 5Y3-GT rectifier. Sensitivity 6 to 10 microvolts, less than 1/2 of 1% distortion, 20 to 20,000 cycle response with 2DB variation. Chassis dimensions: 12 1/2" wide, 8" deep, 7" high. Illustrated manual supplied. Shipping weight 14 lbs.

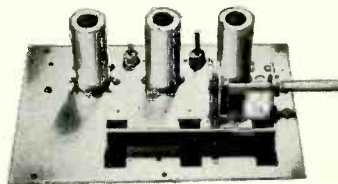

FMF-3 Tuning Unit

\$15²⁵

The best for FM. The most sensitive and most selective type of "front end" on the market. 6 to 10 microvolts sensitivity. Image ratio 500 to 1. 6J6 tuned RF stage, 6AG5 converter, 6C4 oscillator. Permeability tuned, stable and drift-free. Chassis plate measures 6 1/2" x 4 1/2". In combination with the IF-6 amplifier, the highest order of sensitivity on FM can be attained. Tubes included as well as schematic and instructions. Draws 30 ma. Shipping weight FMF-3: 2 1/2 lbs. Dial available @ \$3.85.

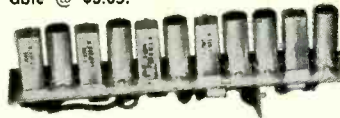

IF-6 Amplifier

\$19⁷⁵

A remarkable value! 6 tubes are used in the IF amplifier: 6BA6 1st IF, (2) 6AU6 2nd and 3rd IF's, (2) 6AU6 limiters and 6AL5 discriminator. High gain, wide-band response (200 KC) for highest fidelity. 20 to 20,000 cycles. Distortion less than 1/2 of 1%. Draws 40 ma @ 220 volts. Chassis plate dimensions: 11 1/8" x 2 1/2". Shipping weight: 3 lbs.

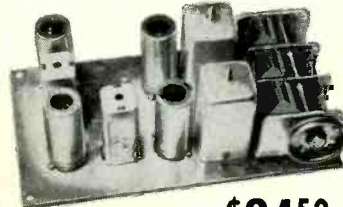

AM-4 Tuning Unit

\$24⁵⁰

Tops in AM superhet performance! A 3-gang tuning condenser gives 3 tuned stages with high sensitivity and selectivity. Assembly is completely wired, tested and aligned ready for immediate use. Frequency coverage 540 KC to 1650 KC at a sensitivity of 5 microvolts. Tubes 6BA6 RF amplifier; 6BE6 converter; 6BA6 IF amplifier and 6AT6 detector. Draws 30 ma @ 220 volts. Mounts on a chassis plate measuring 4" x 7 3/8". Shipping weight 2 1/2 lbs. Dial available at \$3.85.



FM/AM Tuner Kit

\$77⁵⁰

The original 15 tube deluxe FM/AM pre-fab kit redesigned on a smaller chassis. The tuner now measures 14" wide by 12" deep by 7 1/2" high. This attractive new front and dial assembly opens up new applications where space is at a premium. Kit includes everything necessary to put it into operation—punched chassis, tubes, wired and aligned components, power supply, hardware, etc. Kit comprises FMF-3 tuning unit, IF-6 amplifier, AM-4 AM tuning unit, magic eye assembly and complete instructions. All tubes included. Shipping weight 19 lbs.

MAIL COUPON TODAY

To: Collins Audio Products Co. Inc. RE-4
P.O. Box 368, Westfield, M. J.
Tel. Westfield 2-4390

FM Tuner Kit FM/AM Tuner Kit Slide Rule Dial Assembly
 FMF-3 Tuning Unit IF-6 Amplifier AM-4 Tuning Unit

NAME

ADDRESS

CITY STATE

Amount for Kit \$ See weights, add shipping cost \$

Total amount enclosed \$ Check Money Order

WHEN YOU THINK OF TUNERS. THINK OF COLLINS AUDIO PRODUCTS

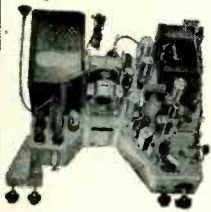

Build your own
SUPER DELUXE
31-TUBE
#630 TV CHASSIS
 With—U. H. F.

#630 SUPER DELUXE 31-TUBE TV KIT
 including your favorite U.H.F. Station. Engineered in strict adherence to the genuine RCA #630 plus added features... OPERATES 16" to 24" PICTURE TUBES... CASCADE TUNER... COSINE YOKE... LARGER POWER TRANSFORMER... KEYS AGC... 12" SPEAKER... CONDENSERS and RESISTORS at rated capacities and tolerances. You receive a COMPLETE SET OF PARTS AND TUBES, everything needed. Included... You will enjoy building it with "LIFE-SIZE" easy to follow step-by-step ASSEMBLING INSTRUCTIONS" included with each KIT.

only ... **\$119.44** (less CRT)

#630 SUPER DELUXE TV CHASSIS \$157.97
 Features similar to KIT above. Complete ready to plug in and play. (less CRT)

SHELDON PICTURE TUBES—With a Full Year Guarantee
 21" #21EP4A Aluminized. \$44.68
 24" #24CP4A Aluminized. 58.26
 27" #27NP4A Aluminized. 82.57

#630 SPECIALS BY TECH-MASTER
No. C30. TV CHASSIS. A modified model retaining the outstanding characteristics of the RCA-630. (30 tubes). **\$149.50**
 Complete Ready to plug in and Play. (less CRT)

TECH-MASTER Gold Medal Model 2439 TV CHASSIS. 90° deflection, operates 24" or 27" rectangular picture tubes. Ideal for wall or custom-cabinet mounting. A 30-tube #630 with both TECH-MASTER'S and OUR guarantee. Complete Ready to Plug in and Play. **\$262.50** (less CRT)

Brooks **LIFE-SIZE TV INSTRUCTIONS**, for building any #630 TV Receiver. Postpaid **\$2.49**

HINTS FOR BETTER PERFORMANCE on your #630 TV Receiver. Postpaid **\$1.00**

Brooks **CASCADE MANUAL**, how to install Cascade Tuner in any make TV Set. Postpaid **50c**

BROOKS RADIO & TV CORP., 84 Vesey St., New York 7, N.Y.

I JUST WANT THE FACTS—"LEE"
NOTHING PAYS OFF LIKE THE FACTS



PERMO'S CATALOGS, REPLACEMENT GUIDES AND SALES AIDS HAVE ALWAYS BEEN LOADED WITH FACTS

NOW! in addition

PERMO
PHONO NEEDLES

WILL BE LISTED IN
SAMS' PHOTOFACTS



PERMO, INC.

CHICAGO 26

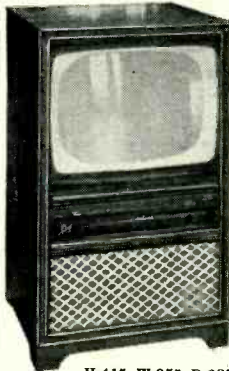

H-41", W-25", D-23"
MANHATTAN \$59.37

CUSTOM-BUILT TV CABINETS

2 LEADING STYLES in genuine Mahogany or Walnut (blond 10% extra). Drilled for a #630 or blank knob. For any make TV SET. Complete as pictured for 16", 17", 20" or 21" C.R.T.

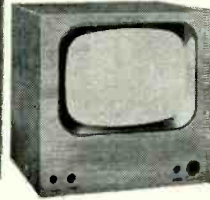

H-25", W-26", D-22"
VOGUE \$39.89

STANDARD CASCADE TUNER

Complete with tubes, and Brooks CASCADE MANUAL with step-by-step instructions and all extra parts needed. **\$22.49**

PULSE KEYED AGC KIT

COMPLETE SET OF PARTS \$4.59
 Including 6AU6 tube & Instructions

UNIVERSAL Picture Tube MOUNTING BRACKETS

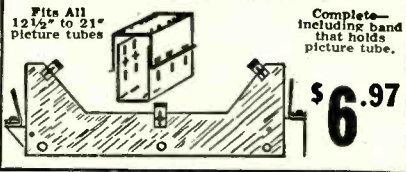

Complete—including band that holds picture tube. **\$6.97**

RADIO

whether the Model T could get through even with chains, but I hired a boy for \$3.00 to shovel and push, and we started.

It took two hours to make the 20 miles, and I was colder than I have ever been before or since—I spent 30 minutes hugging the stove before I even thawed out enough to turn the set on. When I did, a station in the next State popped in like a local.

I let the set play about 15 minutes while I continued to absorb heat, then ran the dial from the top to bottom several times as stations bounced in from all over the country. I checked the batteries and found them O.K., so turned to the lady—who had just come in from feeding the chickens—and asked what was the exact nature of the trouble? "The set plays too fast on some stations," she told me, "and I want you to slow it down."

I was so hot when I left that I never even got chilled on the return trip!
 —James R. Journey

UNUSUAL HUM

After a small 5-tube a.c.-d.c. table radio had been returned to our shop because of a persistent hum at certain points on the dial, we discovered the metal pointer on the end of the tuning capacitor shaft was shorting to the grounded metal foil on the face of the dial at certain spots.

Bending the pointer away from the foil cleared the trouble, only to reveal a smaller hum caused by an unusual quirk.

On some small sets, the tuning capacitor is isolated from the chassis by rubber grommets around the mounting bolts. If one of these rubber grommets is cut through or slips out of position, the tuning capacitor shorts to the chassis, causing a hum.—Harvey Muller

TELEPHONE INSTALLATION

When one of our customers bought a new house and couldn't get a telephone immediately, we installed a mobile phone in his car. When he gets a call while the car is in his garage, a relay-operated mike rings a bell in his house.

Since then we've installed similar equipment on the cars of home-buyers. This has helped builders sell their houses promptly. In reciprocation, these contractors have thrown appliance sales our way.—H. Josephs

UNUSUAL COMPUTER

No matter how expert and well acquainted a service technician is with the theory and practice of electronics, some unrelated fact or condition may be the key to the solution of a whole problem. And it may be overlooked or undiscovered if he keeps his nose too close to the grindstone (service bench).

The set was an a.c. radio of reputable make. The customer complained of abnormal maintenance cost. The radio with its built-in amplifier and a record player with its own a.c. amplifier were

QUARTZ CRYSTALS—GUARANTEED

FT-243-.093" PIN DIA.—.486" PIN SFC
 FOR HAM OR GENERAL USE

| | |
|-------------------------------|-------------------------------|
| 4035 5437 5940 6775 7600 7850 | 1015 3990 6500 7125 8025 8425 |
| 4080 5485 5973 6800 7606 7873 | 1990 6000 6506 7150 8050 8450 |
| 4165 5500 6240 6806 7610 7875 | 1995 6025 6550 7175 8075 8475 |
| 4190 5660 6290 6825 7625 7900 | 2065 6050 6575 7200 8075 8500 |
| 4280 5675 6273 6850 7650 7906 | 2125 6075 6575 7250 8100 8525 |
| 4300 5700 6275 6875 7641 7925 | 3500 6100 6600 7300 8125 8550 |
| 4330 5706 6300 6900 7650 7940 | 3640 6125 6606 7306 8140 8575 |
| 4397 5725 6325 6925 7673 7950 | 3680 6140 6625 7325 8150 8600 |
| 4490 5740 6330 6930 7675 7973 | 3735 6150 6640 7340 8175 8625 |
| 4495 5750 6375 6975 7700 7975 | 3760 6175 6650 7350 8175 8650 |
| 4535 5773 6375 7450 7706 8206 | 3800 6200 7000 7375 8200 8700 |
| 4735 5780 6400 7473 7725 8250 | 3840 6440 7025 7400 8340 8733 |
| 4840 5806 6406 7475 7725 8250 | 3885 6450 7050 7425 8350 |
| 4930 5840 6425 7500 7740 8273 | 3940 6473 7075 7440 8380 |
| 4950 5852 6475 7506 7750 8275 | 3955 6475 7100 8000 8400 |
| 4980 5873 6475 7525 7773 8300 | |
| 5030 5875 6700 7540 7775 8325 | |
| 5205 5880 6706 7550 7800 8630 | |
| 5300 5906 6725 7573 7825 8663 | |
| 5385 5925 6750 7575 7840 8690 | |

49¢ each—10 for \$4.00

99¢ each—10 for \$8.00

Low Frequency—FT-241A for 55B, Lattice Filter etc., .093" Pins, .486" SFC marked Channels Nos. 0 to 79, 54th Harmonic and 270 to 389, 72nd Harmonic, Listed below by Fundamental Frequencies, fractions omitted.

| | | |
|-------------------------|--------------|----------------|
| 370 393 414 436 498 520 | 400 459 510 | 2030 2300 3155 |
| 372 394 415 437 501 522 | 440 461 6370 | 2045 2305 3202 |
| 374 395 416 438 502 523 | 441 482 6350 | 2052 2320 3215 |
| 375 396 418 481 503 525 | 442 463 6470 | 2065 2360 3232 |
| 376 397 419 483 504 526 | 444 464 6497 | 2082 2390 3237 |
| 377 398 420 484 505 527 | 445 465 6522 | 2105 2415 3259 |
| 379 401 422 485 506 529 | 446 466 6547 | 2125 2435 3262 |
| 380 402 423 486 507 530 | 447 468 6610 | 2131 2442 3510 |
| 381 403 424 487 508 531 | 448 469 7350 | 2145 2532 3520 |
| 383 404 425 488 509 533 | 450 470 7380 | 2155 2545 3550 |
| 384 405 426 490 511 534 | 451 472 7390 | 2220 2557 3570 |
| 385 406 427 491 512 535 | 452 473 7480 | 2258 2660 3580 |
| 386 407 428 492 513 537 | 453 474 7580 | 2260 2660 3585 |
| 387 408 430 493 514 538 | 454 475 7810 | 2280 3035 3955 |
| 388 409 431 494 515 | 455 476 7930 | 2282 3120 |
| 390 411 433 495 516 | 456 477 | 2290 3150 3995 |
| 391 412 434 496 518 | 457 479 | |
| 392 413 435 497 519 | 458 480 | |

49¢ each—10 for \$4.00

99¢ each—10 for \$8.00

Add 20¢ postage for every 10 crystals or less

SPECIAL—200 or 500kc XTALS in FT241A Holder—\$7.79

SUN
PARTS DISTRIBUTORS, LTD.

520 Tenth St. N.W.—Wash. D.C., Dept. R

THE PRICES SPEAK FOR THEMSELVES

All Merchandise New . . . Standard Brands . . . Sold With A Money Back Guarantee!

CUSTOM-BUILT AUTO RADIOS
 Ford—Dodge—Plymouth—Chevrolet—
 Mercury—Hudson—Henry J—Stude-
 baker—Willys. Most of them in models
 1948 to 1954. **\$38.76**

Complete ready to install only

SELENIUM RECTIFIERS

75 ma 57¢
 100 ma 68¢
 175 ma 76¢

FINEST PM SPEAKERS

Brand new—factory packed
 with heavy Alnico 5 magnets
 5" \$1.14 8" \$2.97
 6" 1.49 12" 4.62

RCA FLYBACK #218T1

finest horizontal transformer **\$1.67**
 worth \$7.50 only

TV POWER TRANSFORMER

110 volts—60 cycles
 350v-350v each side @ 250 ma worth \$14.
 5v-3 amp. 6.3v-1.2 amp. **\$4.97**
 6.3v-5 amp. 6.3v-1.2 amp only

WIRE-WOUND TV RESISTOR

5300/2-500 ohms
 Worth \$1.85 slashed to **18¢**

TV HORIZONTAL CONTROL

20 K for use on #630 and
 other TV sets only **19¢**

72 OHM CO-AX WIRE

Handy Roll of
 100 feet for only **\$3.68**

PICTURE TUBE SOCKETS

with long 18" leads
 only **19¢**

ESCUTCHEON PLATE FOR TV

for Standard and other Tuners
 Universal Brass type
 channels 2 to 13 only **29¢**

REGULAR ELECTRIC LINE CORD

6 foot complete
 with molded plug only **14¢**

ELECTROLYTIC CONDENSER

8 mfd-450 volts
 lists for \$1.35 slashed to **26¢**

CLOSING OUT SPECIAL

Electric motors that
 were made for color TV **\$3.97**
 Regular price \$28.50 slashed to

SPECIAL UNIVERSAL FLYBACK

uses single 1B3
 excellent for conversions
 only **\$2.98**

We are overstocked on the following
**STANDARD BRAND TV AND RADIO
 TUBES** and are closing them out at 49¢
 each.
 35Z5, 35W4, 5Y3, 6AL5, 6X5, 6F5, 12SJ7, 5U4,
 6H6, 6K7, 6SQ7, 43, 12SF7, 11D5, 1Q5, 6J5,
 1H5, 12SQ7.

**\$24.95 AC-DC TABLE MODEL
 RADIO**

beautiful standard model in
 gleaming plastic walnut cabinet **\$13.99**
 complete with 5 tubes slashed to

TOP QUALITY 40/60 SOLDER

only 69¢ a pound in 5 pound spools
 single pound **74¢**

AUDIO OUTPUT TRANSFORMERS

50L6 type 29¢
 6K6 44¢
 Universal type 78¢

COSINE 70° DEFLECTION YOKE

matches most TV sets **\$2.98**
 completely wired only

**VERTICAL OUTPUT
 TRANSFORMER**

standard type 10 to 1 ratio
 good for most TV sets only **99¢**

TV ELECTROLYTIC CONDENSER

40/10/10 mfd-450/450/350 volts
 slashed to **79¢**

DUMONT FRONT END TUNER

complete with tubes
 ready to install only **\$16.94**

300 OHM TRANSMISSION WIRE

handy roll of
 100 feet for only **98¢**

TV SAFETY LINE CORDS

with both plugs
 finest quality and
 the lowest price ever only **19¢**

QUARTER AMP FUSE

at only **2¢** each

**100 ASSORTED TUBULAR
 CONDENSERS**
 All Are Standard Brands
 & Desirable Sizes **\$3.69**
 \$15.00 Value Only

**100— ASSORTED 1/2 WATT
 RESISTORS \$2.97**

**15 — Asst. Radio Electrolytic
 CONDENSERS \$3.74**

**15 — Assorted TV Electrolytic
 CONDENSERS \$5.88**

**100— ASSORTED MICA
 CONDENSERS \$3.99**

**100— ASSORTED CERAMIC
 CONDENSERS \$3.99**

**100— ASSORTED 1 WATT
 RESISTORS \$4.86**

100— ASSORTED SOCKETS \$2.92
 Octal, Loctal & Miniature

100— ASSORTED KNOBS \$2.97
 SCREW & PUSH-ON

10— VOLUME CONTROLS \$2.94
 ASSORTED, WITH SWITCH
 1/4, 1/2, 1, 2 meg. and others

\$32.95 PHILCO TV BOOSTER

#TB-3 uses 2 6J6 tubes
 for power and clarity **\$12.34**
 Complete ready to plug in. only

**\$49.95 REGENCY UHF
 CONVERTER**

#RC-600 operates on all TV sets
 gets all UHF stations **\$29.97**
 complete ready to plug in. only

TV OPEN MASKS

16" Rectangular Gold Type 69¢
 17" Rectangular Standard Grey Type 99¢
 20" Rectangular Standard Grey Type \$1.43
 21" Rectangular Standard Grey Type \$1.99

FOCUS COIL #202D1

special at
 only **99¢**

FILTER CHOKE 62 OHMS

popular type
 only **99¢**

COMPLETE SET OF TV KNOBS

good for #630 and
 many other TV sets only **99¢**

SPECIAL HARDWARE KIT

screws, washer, nuts,
 rivets, etc.
 good for radio or TV,
 handy for the shop. **\$1.38**

SPECIAL TV WIRE SOLDER KIT

good for radio or TV
 assembling or repair only **\$1.38**

**TV HIGH VOLTAGE
 CONDENSERS**

10 KV-500 mmf 19¢
 20 KV-500 mmf 39¢
 30 KV-500 mmf 97¢

PHONOGRAPH MOTORS

single speed \$2.38
 three speed 3.99
 Webster changer 26.88

**1000 ASSORTED
 TUBE CARTONS \$13.98**

**SMALL PEANUT—LARGE PEANUT—
 GT SMALL G—LARGE G—EXTRA
 LARGE**

**\$5-CENTURY PHONOGRAPH
 SAPPHIRE NEEDLE**

good for thousands of hours only **59¢**

PHONOGRAPH AMPLIFIER

complete including **\$4.97**
 3 tubes only

RADIO VARIABLE CONDENSER

regular super type
 that fits most radios only **64¢**

RADIO IF TRANSFORMER

most popular
 456 KC type only **34¢**

IF TRANSFORMER for FM RADIO

10.7mc only **59¢**

Resistor & cond. code charts FREE with each order

You Aint Heard Nothing Yet—Take Off 5% On Orders Of \$50 Or Over

BROOKS RADIO & TV CORP., 84 Vesey St., Dept. A, New York 7, N. Y.

WHEN CORROSION TRIES TO SMEAR PERMA-TUBE STAYS CLEAN

... and so does your reputation!

Here's why PERMA-TUBE backs up quality service:

1. **PERMA-TUBE IS CORROSION-PROOF** . . . it's treated with vinsynite—then coated *inside and outside* with a metallic vinyl resin base. It's guaranteed to be free from rust in a salt spray test of 500 hours minimum to an American Society of Testing Materials Specification B117-49T. This assures long life.
2. **PERMA-TUBE IS STURDY** . . . it's made of special, high-strength J&L Steel.
3. **PERMA-TUBE IS EASILY INSTALLED** . . . it's the only mast with *both ends* of the joint machine fitted.

Here's proof of how PERMA-TUBE resists corrosion.

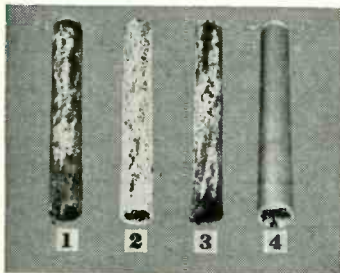

Test samples after 40-day corrosion test. Immersed in 3.3 per cent salt solution in jars:

- 1 . . . Mechanical tubing (note white corrosion and pitting)
- 2 . . . Mechanical tubing (note white corrosion and pitting)
- 3 . . . Galvanized mechanical tubing (note zinc is completely gone and steel severely pitted)
- 4 . . . PERMA-TUBE (note there is literally no creepage of corrosion from the cut edge and coating is intact down to base steel)

What is your reputation worth?

This book is like an insurance policy for quality service. Write for your copy today! It's free.



Jones & Laughlin Steel Corporation
Dept. 496, 3 Gateway Center, Pittsburgh 30, Pa.
Please forward a copy of your "PERMA-TUBE" booklet.

Name _____
Company _____
Address _____

used with a very fine and expensive high-fidelity speaker, housed in a large cabinet type baffle. The owner had the three units arranged so that he could plug the speaker into the radio when it was in use and into the record player amplifier when it was used.

The two amplifiers were of the same type with identical tubes in push-pull output. The 3-wire cable from the output transformer on the PM speaker to the amplifier was conventional (one wire to B plus and one wire each to the plates of the output tubes). Everything was normal here.

The customer complained that over a comparatively short period he had three different service organizations repair the radio. As the record player was used more than the radio, he could not understand why the radio broke down so often.

The past repair bills showed that the work had been done by reliable service organizations. Replacement parts were of high quality. This indicated that the cause of the trouble was probably abnormal. Almost the same parts had been replaced for each repair job. These consisted of tubes and filter capacitors.

A service check at the bench showed that about the same components had failed again. Conditions pointed to just one fact: abnormally high B plus voltages were breaking down the filter capacitors and causing the tubes to become gassy. These conditions would be caused by switching the radio on when the speaker was disconnected. No plate current would be drawn by the power-output tubes, and the rectifier voltage would rise abnormally high.

The radio could on occasion be turned on when the speaker was not connected, but should someone do this he would normally switch the radio off if he heard nothing. An occasional mistake like this would cause no harm, since the radio components are subjected to the same conditions during the warmup period when the speaker is connected.

These facts pointed to only one thing—prolonged use of the radio with the speaker not connected. But could there be a use for a soundless radio? There was!

A telephone conversation with the owner confirmed this fact. It seems that when record player and amplifier were used with the speaker, the children used the radio for a game. The radio was equipped with a motor-driven push-button slide-rule type dial, and the chil-



"Strong Signal Area."
RADIO-ELECTRONICS

The best TV set is only as good as its antenna!

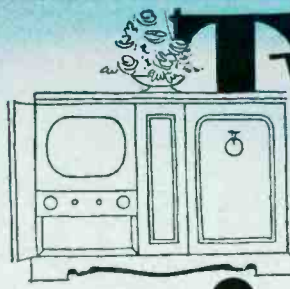

FROM A SELLING AND SERVICING STANDPOINT . . .
why CONSIDER LESS THAN THE BEST ANTENNAS?

KAY-TOWNES
Super **KATYS**

truly deserve your most
careful consideration!

From every standpoint, they are the finest, farthest-reaching all-channel "fringe" area antennas ever designed. No other antennas, regardless of type or number of bays can match their performance . . . for photo-clear reception and consistent, trouble-free service.

4½ YEARS OF DEVELOPMENT have gone into research, design, engineering and development of the KAY-TOWNES SUPER "KATYS." Right at this very moment our own exhaustive tests are being substantiated by dealer installations all over the country. These dealers are convinced . . . as you will be, when you test the SUPER "KATYS" yourself . . . that these amazing antennas are the answer to complete customer satisfaction!

Guaranteed TO OUT-PERFORM
ANY OTHER ALL-CHANNEL
TV ANTENNA *Ever Made!*

KAY-TOWNES unique and exclusive "Snow-Filter" design eliminates cloudy and spotty pictures . . . and will open markets for TV Set sales in many areas now considered "impossible." Think of the tremendous profit-possibilities the SUPER "KATYS" offer to the Television Industry!

KAY-TOWNES
Super **KATY-2**
2-BAY

Manufactured and Distributed in CANADA By
DELHI METAL PRODUCTS, LTD., DELHI, ONTARIO

COPYRIGHT 1954

KAY-TOWNES
Super **KATY-1**
Single-Bay

Now!
LONG DISTANCE
Plus
PHOTO-CLEAR
RECEPTION!

KAY-TOWNES
ANTENNA COMPANY
ROME, GEORGIA

LEADERS IN THE FIELD OF FRINGE AREA ANTENNA DESIGN

... you can believe what you read
on the **PRECISION** Series 40
COMPACT, WIDE-RANGE AC-DC CIRCUIT TESTER

A 100% factory-engineered, factory-wired, factory-tested and factory-calibrated professional instrument.

PRECISION-designed and constructed to provide long, trouble-free, accurate performance... to withstand the hard usage of Radio-TV Service, Radio Communications, and other phases of electronic equipment production and maintenance.

The compact Series 40 provides highest quality components and specifications as associated with PRECISION's larger and more costly instruments.



Sold by leading Electronic Pads and Equipment Distributors

Compare These Specifications:

- ★ 31 self-contained ranges to: 6000 volts, 600 ma., 5 megohms, +70 db.
- ★ 1% wirewound and film-type multipliers and shunts.
- ★ Easy-reading, full-sized, rugged 3" rectangular PACE meter. 400 microamperes, ±2% accuracy.
- ★ All standard ranges available from only 2 pin jacks, for utmost convenience and simplicity of operation.
- ★ All switch contacts silver plated for positive performance.
- ★ Recessed 6000 volt safety jack.
- ★ Anodized, aluminum panel and markings that resist rubbing and moisture.
- ★ Compact, rugged molded phenolic case, 3 3/4" x 6 1/4" x 2 1/2".
- ★ Complete with ohmmeter batteries, test leads \$26.95 and full operating instructions.....

LC-2: Leather carrying case, custom designed for Series 40\$5.75

PRECISION APPARATUS CO., INC.
92-27 Horace Harding Blvd., Elmhurst 7, N. Y.
Export: 458 Broadway, New York, U.S.A.
In Canada: Atlas Radio Corp., Ltd., Toronto, Ont.



ORDER THIS ASTONISHING BARGAIN TODAY!

FAMOUS *Telechron*
CLOCK-TIMER MECHANISM
AN ELECTRIC CLOCK!
A DEPENDABLE TIMER!
AT LEAST A \$10.00 VALUE!
\$3.27

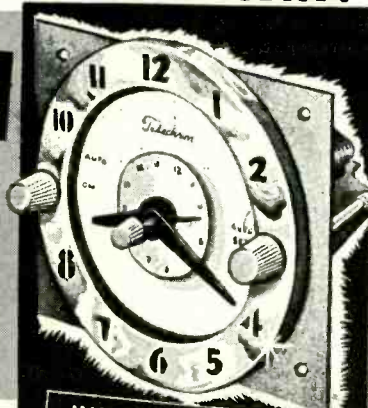

Turns "off" automatically anything rated up to 660 watts at any preset time from a minimum of 15 minutes to a maximum of 11 hours and 45 minutes. Also has self-contained manual "off" switch.

Experimenters, hams, laboratories, dealers, home makers — just about everybody will find lots and lots of uses for this genuine "Telechron" clock with timer mechanism.

Attractive 3 1/2" diameter round face clock with easy to read red numerals inset on a bright finished chrome bezel. Front time set control. Metal base plate with mtg. holes measures 4" wide x 3 3/4" high. Mechanism requires 1 3/4" behind plate. Operates on 115 V. 60 cycles AC only. Switch rating 660 watts. Complete with template and wiring diagram. Shpg. wt. 1 1/2 lbs.

No. 37A316 6 Lots Special Each\$3.27 Each\$2.97

BURSTEIN-APPLEBEE CO.

1012-14 McGee St., Kansas City 6, Mo.

Send me.....Clock-Timers. \$..... enclosed.
 Send Free B-A Catalog

Name.....

Address.....

City.....State.....

JUST TO MENTION A FEW OF THE 100's OF USES!

- In The Ham Shack For Rack Panel or Cabinet. Gives a professional appearance to Equipment and Turns it "Off" automatically when desired.
- In the Laboratory. A timing device for experiments plus many, many other uses.
- In the Shop or Store for Turning Off Window Display Lights, Demonstration Sets, Fans, etc.
- In the home for All Kinds of Electric Appliances such as Coffee Makers, Radios, TV Sets, Phonographs, Window and Attic Fans, Night Lights and what have you.
- For the experimenter there's no end of uses. It's a Terrific Gim-mick!
- And Last but not Least it's a Clock for mounting almost anywhere.

Include postage for parcel post

dren used it for an electronic computer (something they had picked up on "Space Cadets"). The owner did not realize that any harm could be done to the radio if used without the speaker, as he thought that only the dial lamps and motor were consuming power.

A simple explanation of comparing the operation of his radio under such conditions with the wide-open throttle of his automobile when out of gear enlightened him.

To prevent any future trouble, the 117-volt a.c. line to both the radio and amplifier of the record player was wired as shown on the diagram, so that when the speaker plug was removed from either unit the 117-volt a.c. power would automatically be cut off.

This remedy will not only reduce the expense of service calls and repairs, but will prevent the gradual deterioration of performance through the overheating of resistors and the strain put on the other components.

Removing a similar motor-driven push-button slide-rule dial from a discarded radio and installing it in a suitable cabinet solved the electronic computer problem.—C. W. Battels END

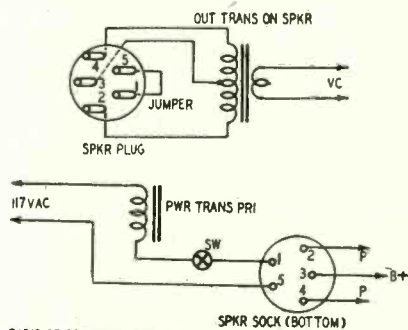

RADIO OR RECORD PLAYER AMPL.

Removing speaker plug breaks a.c. line.

Radio Thirty-Five Years Ago
In Gernsback Publications

HUGO GERNSBACK
Founder

| | |
|---------------------------------------|------|
| Modern Electrics | 1908 |
| Wireless Association of America | 1908 |
| Electrical Experimenter | 1913 |
| Radio News | 1919 |
| Science & Invention | 1920 |
| Television | 1927 |
| Radio-Craft | 1929 |
| Short-Wave Craft | 1930 |
| Television News | 1931 |

Some of the larger libraries still have copies of ELECTRICAL EXPERIMENTER on file for interested readers.

APRIL 1920
ELECTRICAL EXPERIMENTER

- The Physiophone, by H. Gernsback
- Talking Over a Sunbeam, by Prof. A. O. Rankine
- Long Distance Radio Telephone Tests, by Robert F. Gowen
- Music 400 miles by Radio "Direct Current" Transmitter
- Automatic S.O.S. Bell Signal for Ships
- New Amateur Wireless Transmitting Set
- Selective Wireless Control, by Everett Leo Deeter
- War Versus Pre-War Apparatus, by "Sparks," C. E. Radio, U. S. N.

TRANSISTOR OSCILLATOR PRODUCES SUBHARMONICS

By I. QUEEN

If you like to experiment with new, unconventional circuits, try this one. It is a subharmonic crystal oscillator using a junction transistor. It acts just like an oscillator with a crystal frequency between 75-125 kc. Crystals in this range are very expensive and not generally available. We get the same results with a surplus crystal in the 400-kc range. The cost of transistor plus surplus crystal is actually less than that of a standard low-frequency crystal.

The circuit uses a CK722 transistor. This is the low-cost junction unit now available at most parts distributors. The crystal is connected between emitter and collector as shown in the diagram. If desired, it may be connected between emitter and base instead, results being about the same.

The two coils are part of a 262-kc i.f. transformer with about 30% of the turns removed from the primary (red-blue) winding. Without the crystal, this circuit looks and acts like a conventional Hartley (tapped coil) circuit. It generates a low-frequency signal with strong harmonics through the broadcast band. The oscillator frequency is approximately 140 kc, and harmonics can be heard at 560 kc, 700 kc, 840 kc, etc. One or both trimmers may be used to vary the fundamental over a small range. These self-excited signals will sound about T7 or T8. Like those from any low-C oscillator they will be shaky and susceptible to hand capacitance and other external effects.

To set the subharmonic generator, tune the circuit (still without crystal) so that its output is slightly lower than the desired subharmonic. For example, if you use a 375-kc crystal and want a 125-kc subharmonic, set the oscillator to about 120 kc. You will hear harmonics at 600 kc, 720 kc, etc. When you insert the crystal into its socket, the signal will change to a pure T9 tone. It will suddenly become highly stable regardless of hand capacitance.

Adjust one or both trimmers for maximum stability and output. A good test is to turn the battery on and off several times to see if the oscillations start each time. If you have a 400-kc crystal, and wish to build a 100-kc crystal oscillator, tune the i.f. transformer to about 100 kc or slightly below. If 100 kc is too low for your transformer, you may need added capacitance across the secondary (green-black) winding (see dotted lines in diagram).

A single 1.5-volt penlight cell supplies sufficient power for the transistor. Its drain is low, so battery life should approach shelf life.



"SAVE WITH CONFIDENCE" TERRIFIC BUYS—KITS AND WIRED UNITS

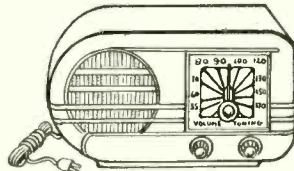

5-TUBE AC/DC SUPERHET KIT
Kit #1.5-tube superhet kit. AC/DC includes all quality components required to construct this latest design, highly sensitive superhet broadcast receiver, complete with black, glistening bakelite cabinet (excludes wire & solder). Kit of 5 tubes. 12AT6, 2/12BA6, 12BE6, 35W4, 50B5.
Write For Our Special Low Prices



**NEW
SUPERSENSITIVE 2 STATION
INTERCOMMUNICATION
SYSTEM**

This fine unit is suitable for use in home, office, factory, nursery, or sick room. So sensitive it will pick up baby's whimper. Operates from 115 V. AC/DC. Both stations housed in compact, handsome, plastic cabinets: 6" x 6" x 3 1/2". Requires only 2 wires to connect for quick installation. Complete with 50 ft. of twin conductor wire.
Model D-1910
Special Price **\$16.95**

Terrific Value!

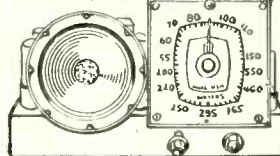

Great Savings! **6-TUBE RADIO KIT**

Kit #2: Low priced 6-tube kit designed for extra high sensitivity, excellent selectivity and good, rich tone quality. Uses 25L6, 25Z6, 6SQ7, 6SA7, 2/6SK7 in an easily constructed circuit. Includes all parts: punched chassis, resistors, condensers, coils, sockets, PM speaker, hardware, etc. Special close-out price.
(Less tubes & cabinet)..... **\$6.95**
Matched set of 6 tubes
for kit **\$3.25**

**3-TUBE
PHONO
AMPLIFIER**



NOT A KIT

An assembled unit ready for installation using tone and volume control and 6 ft. rubber cord (less tubes) **\$2.95**

Lowest Price!

With complete set of tubes ... **\$3.95**

**PHONO OSCILLATOR
NEW SAVINGS! • NOT A KIT!**

Wireless phono oscillator transmits recording for crystal pickups or voice from carbon mike through radio without wires. Can also be used as an intercom by using PM speaker as mike.
..... **\$2.95**
(less tubes)
With complete set of tubes **\$3.95**



**SIGNAL GENERATOR
BROADCAST BAND**

Completely Wired — New, simplified circuit provides the following switch tuned, tone modulated frequencies:

1. 455 KC — Intermediate IF frequency
 2. 1500 KC — HI freq. of b'cast band
 3. 600 KC — Lo freq. of b'cast band
 4. Audio tone for audio amplifier trouble shooting
 5. Attenuator control is included for adjustment of the output signal strength.
- Housed in small, black bakelite cabinet, 6"x6"x3 1/2". Excellent for alignment of all Broadcast Band Radio receivers.
Completely Wired **\$7.95**
—only

**WE'VE GOT IT!
CBS—Hytron
5AW4**

New, Heavy-Duty Work Horse Cuts 5U4G Call-Backs. Save Here!

Worried about slumping TV set performance because of heavily loaded 5U4G's? Forget it. Use new CBS-Hytron CTS-Rated 5AW4. A replacement for the 5U4G, the 5AW4 refers captures and keeps that new-set sparkle. Maintain high voltage, despite heavy load. Minimizes burn-outs. Avoids filament shorts while testing chassis on side. Loafs on tough jobs. Gives long, long trouble-free life. The 5AW4 will cut your call-backs. Boost your **\$1.59** profits.

**SHOP THESE
COLUMNS
Cash In On These
GREAT VALUES**

**SPECIAL
Tube Offerings
STANDARD MAKES
GUARANTEED
FIRST GRADE**

| | | |
|--------------|-------|--------|
| 0A2 | | \$.75 |
| 2D21 | | .95 |
| 3A4 | | .55 |
| 5Z3 | | .75 |
| 5Z4 | | .95 |
| 6-4B | | .15 |
| 6AG5 | | .65 |
| 6AJ5 | | .75 |
| 6AK5 | | .65 |
| 6AQ5 | | .45 |
| 6BB | | .35 |
| 6BA6 | | .55 |
| 6C4 | | .45 |
| 6F6 | | .45 |
| 6J5 | | .45 |
| 6J6 | | .55 |
| 6K7 | | .45 |
| 6L7 | | .45 |
| 6N7 | | .65 |
| 6SC7 | | .45 |
| 6SQ7 | | .65 |
| 6V6GT | | .55 |
| 12AU7 | | .65 |
| 12K8 | | .35 |
| 12SG7 | | .65 |
| 14E6 | | .45 |
| 28D7 | | .95 |
| 30 | | .65 |
| 39/44 | | .25 |
| 8K34 | | .25 |
| VR90 | | .95 |
| VR105 | | .75 |
| 89 | | .35 |
| 211 | | .45 |
| 958A | | .55 |
| 1626 | | .25 |
| 1632 | | .45 |
| 1633 | | .45 |
| 1644 | | .65 |
| 2050 | | .95 |
| 5654 | | .75 |
| 5670 | | 2.95 |
| 5686 | | 1.95 |
| CK5702 | | 1.95 |
| 5814 | | .75 |
| 6095 (6AQ5W) | | .45 |
| 6096 (6AK5W) | | .55 |
| 6097 (6AL5W) | | .45 |
| 6101 (6J6W) | | .55 |
| 6CU6 | | 2.69 |

Save More Than Half COMPONENT KITS

**INSULATED
RESISTOR KIT
\$10. Value—Now \$1.65**

Includes 100 resistors 1/4, 1/2, 1 & 2 watts from 5% to 20% tolerance. Comes in transparent plastic box. New low price. No. D 1273 **\$1.65**
Complete

**DISC
CONDENSER KIT
Save over \$7**

Includes assortment of 50 disc ceramicos including the following capacities: 001, 2 x .001, .0015, 2 x .0015, 2 x .004, .0047, .005, 2 x .005, .01, 2 x .01 PLUS 10 assorted printed .circuited .capacitors complete in a plastic transparent box. Sells for \$10.
EDLIE saves you over \$7.
No. D 1279
Complete kit: ... **\$2.95**

**Paper Tubular By-Pass
CONDENSER KIT
Worth \$15—Yours
for \$2.95**

Includes 50 by-pass condensers ranging in capacity from .005 mfd. to .5 mfd and at voltages from 200 to 1800. Complete with transparent plastic cabinet, 7" x 3 1/2" x 1 1/2". EDLIE Special No. D 1278. **\$2.95**
Complete

**PRECISION
RESISTOR KIT**

Consists of 50—1% Wilkor carbon film resistors of 50 different ohmages, housed in a transparent plastic box. May be combined in series or parallel to produce almost any desired ohmage. Each resistor retails for about 85¢.

Terrific Cash Saver!
Kit of 50
only **\$2.45**

TERMS: All mdse. shipped FOB New York City. Prices subject to change without notice. Include 20% deposit for COD's. WRITE TODAY FOR NEW FREE CATALOG!

EDLIE Electronics 154 Greenwich St.
DI 9-3143
New York 6, N. Y.

for every
audio
need

**CANNON
PLUGS**



you can hear
the difference

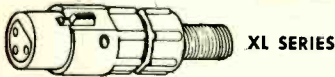
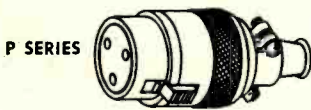

In addition to the lines illustrated, the 45E Test Point Jacks and connectors in the GB, U, and M1-4 series are available through the 130 selected franchised distributors for Cannon Electric. Other electronic-electric distributors also sell certain items in the Cannon line, including XL, M1-4, and GB series connectors, and a variety of Cannon Specialty Lights. Write for the RJC and Audio Connector Bulletins.

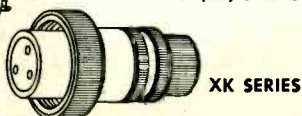
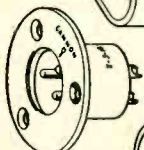
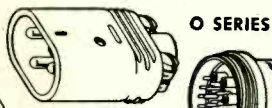
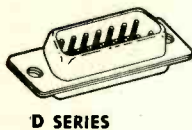

CANNON ELECTRIC

Since 1915
FACTORIES IN LOS ANGELES, TORONTO, NEW HAVEN
Representatives in principal cities. Address inquiries to Cannon Electric Co., Dept. 144, Los Angeles 31, California.

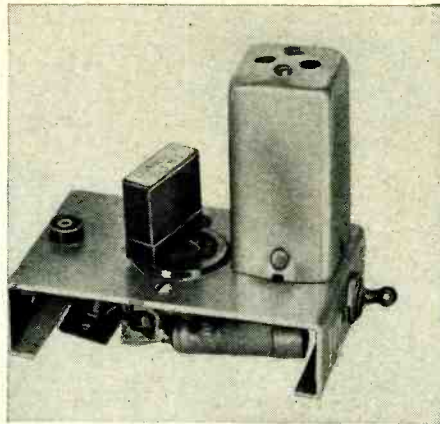

The complete subharmonic oscillator.

A few different transistors were tried in this circuit. All functioned satisfactorily. All were good subharmonic generators, and in each case the harmonics were strong—well into the high-frequency spectrum. For example, a 100-kc subharmonic generator (using a 400-kc crystal) provided harmonics beyond 20 mc. For greatest output, connect the antenna lead of the oscillator to the receiver antenna post.

I arrived at this unusual circuit while experimenting with transistor crystal oscillators. I am not sure what the theory is, but the following may come quite close to the truth. Evidently the two coils in series act like a Hartley tank, tapped near the middle. The tank resonates near 125 kc, and may be adjusted over a narrow range by tuning either trimmer of the transformer. This is the frequency which I have observed when the crystal is removed from its circuit. Now, one of the

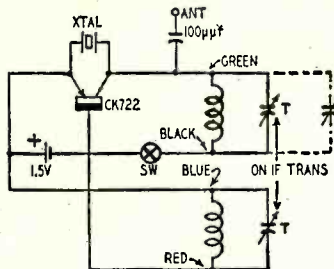

Diagram of the subharmonic generator. transformer coils alone resonates near 400 kc, the crystal frequency. The coil is between collector and base, and acts like the plate tank of a conventional tube oscillator. The "plate" coil, with the crystal, makes a crystal oscillator. Thus we have two signals, one near 125 kc, the other, approximately 400 kc. The first signal is self-controlled, the other is crystal-controlled. By tuning one or both trimmers we can adjust these frequencies so that one is an exact subharmonic of the other. When this happens, the low-frequency signals can be heard but their quality equals that of the high-frequency crystal tone. In other words, they are synchronized and controlled by the crystal.

A similar explanation is offered by Frank Dukat of Raytheon. He says: "It looks as if we have two oscillators operating somewhat independently, but when one is a harmonic of the other, they lock together at the fre-

**COMPLETE
TRAINING
FOR BETTER RADIO-TV
SERVICE JOBS**



Let these two great new Ghirardi training books teach you to handle all types of AM, FM and TV service jobs by approved professional methods—and watch your efficiency and earnings soar!

Completely modern, profusely illustrated and written so you can easily understand every word, these books pave the way to fast, accurate service on any type of home radio-TV electronic equipment ever made. Each book is brand new. Each contains the latest data on the latest methods and equipment—NOT a re-hash of old, out-of-date material. Each is co-authored by A. A. Ghirardi whose famous RADIO PHYSICS COURSE and MODERN RADIO SERVICE were, for 20 years, more widely used for military, school and home study training than any other books of their type!

**THE NEW Ghirardi
RADIO-TV SERVICE LIBRARY**

Almost 1500 pages and over 800 clear illustrations show step-by-step how to handle every phase of modern troubleshooting and servicing.

**1—Radio and Television Receiver
TROUBLESHOOTING & REPAIR**

A complete guide to profitable professional methods. For the novice, it is a comprehensive training course. For the experienced serviceman, it is a quick way to "brush up" on specific jobs, to develop improved techniques or to find fast answers to puzzling service problems. Includes invaluable "step-by-step" service charts. 820 pages, 417 illus., price \$6.75 separately.

**2—Radio and Television Receiver
CIRCUITRY AND OPERATION**

This 669-page volume is the ideal guide for servicemen who realize it pays to know what really makes modern radio-TV receivers "tick" and why. Gives a complete understanding of basic circuits and circuit variations; how to recognize them at a glance; how to eliminate guesswork and useless testing in servicing them. 417 illus. Price separately \$8.50.

New low price . . . You Save \$1.25!

If broken into lesson form and sent to you as a "course," you'd regard these two great books as a bargain at \$50 or more! Together, they form a complete modern servicing library to help you work faster, more efficiently and more profitably.

Under this new offer, you save \$1.25 on the price of the two books—and have the privilege of paying in easy installments while you use them!

10-DAY FREE TRIAL

Dept. RE-44, RINEHART & CO., Inc.
232 Madison Ave., New York 16, N. Y.

Send books below for 10-day FREE EXAMINATION. In 10 days, I will either return (plus postage) or return books postpaid and owe you nothing.

Radio & TV Receiver TROUBLESHOOTING & REPAIR (Price \$6.75 separately)

Radio & TV Receiver CIRCUITRY & OPERATION (Price \$8.50 separately)

Check here for MONEY-SAVING COMBINATION OFFER . . . Save \$1.25. Send both of above big books at special price of only \$12.00 for the two. (Regular price \$13.25 . . . you save \$1.25.) Payable at rate of \$3 (plus postage) after 10 days if you decide to keep books and \$3 a month for 3 months until the total of \$12 has been paid.

Name

Address

City, Zone, State

Outside U.S.A.—\$7.25 for TROUBLESHOOTING & REPAIR; \$7.00 for CIRCUITRY & OPERATION; \$13.00 for both books. Cash with order, but money refunded if you return books in 10 days.

New
**UHF & VHF
 LEAD-IN**

Thousands of separately sealed tiny cells, filled with inert gas, make this waterproof cable stable and efficient electrically.

ADVANTAGES:

- 1 Lowest losses at UHF and VHF frequencies.
- 2 Great abrasion resistance and mechanical strength.
- 3 No time-consuming end seal required; easy to install.
- 4 No internal moisture to cause signal loss.
- 5 No kinking when used with antenna rotors.
- 6 Resistant to snow, ice, rain, and wind.
- 7 Resistant to ultraviolet rays from the sun.
- 8 Uses Belden Weldohm conductor for long conductor life.
- 9 Can be clamped tightly in stand-off insulators without crushing. No special fittings required.
- 10 Conductor spacing is constant even when the lead-in is transposed.
- 11 No stripping problem for attaching the conductor.

...Cuts
SIGNAL LOSS

This heavy wall of brown virgin polyethylene protects the cable against mechanical abuse and damage from ultraviolet sun rays.

This completely new 300-ohm line results from the development of a new cellular plastic core where each separate cell is filled with an inert gas to make an efficient cable with the lowest possible losses at both UHF and VHF frequencies. With this absolutely waterproof cable, no sealing of the ends is necessary. Cellulene cable can be fixed in stand-off insulators without crushing. The thick outer wall of polyethylene serves to protect the cable from abrasion and sun damage.

By fusing *only* virgin polyethylene, the wall can be made smooth—absolutely free from rough spots—to prevent the adherence of dust and other impurities which would increase the losses.

The copper-covered steel strands, which make up the conductors, assure 49% greater resistance to breaking from flexing or stretching than any all-copper conductor.

8275 CELLULINE[®]
 TRANSMISSION LINE

by **Belden**
 WIREMAKER FOR INDUSTRY

Check THESE N. J. R. T. TUBE PRICES 70% to 90% OFF LIST

Guarantee

ALL NJRT TUBES ARE BRAND NEW AND FULLY GUARANTEED FOR ONE YEAR

| Type | Price | Type | Price | Type | Price | Type | Price |
|-------|-------|--------|-------|--------|-------|---------|-------|
| 1A7GT | .45 | 6A5 | .49 | 6BQ6GT | .70 | 6W6GT | .45 |
| 1B3GT | .67 | 6AB4 | .42 | 6BQ7A | .92 | 6X4 | .35 |
| 1H5GT | .38 | 6AF4 | .92 | 6BZ7 | .95 | 6X5GT | .35 |
| 1L4 | .50 | 6AF6 | .75 | 6C4 | .39 | 7E6 | .35 |
| 1N5GT | .62 | 6AG5 | .47 | 6CB6 | .45 | 7F8 | .63 |
| 1R5 | .48 | 6AJ5 | .73 | 6CD6G | 1.15 | 12AL5 | .40 |
| 1S5 | .40 | 6AK5 | .75 | 6F6 | .45 | 12AT6 | .35 |
| 1T4 | .48 | 6AL5 | .37 | 6J5 | .40 | 12AT7 | .65 |
| 1U4 | .48 | 6AQ5 | .37 | 6J6 | .50 | 12AU6 | .38 |
| 1U5 | .40 | 6AQ6 | .36 | 6K6GT | .37 | 12AU7 | .55 |
| 1X2 | .65 | 6AT6 | .37 | 6L6 | .62 | 12AV6 | .50 |
| 3A4 | .43 | 6AU4GT | .70 | 6R7 | .49 | 12AV7 | .60 |
| 3LF4 | .49 | 6AU6 | .40 | 6S4 | .38 | 12AX4GT | .55 |
| 3Q4 | .48 | 6AV6 | .37 | 6S8GT | .51 | 12AX7 | .55 |
| 3Q5GT | .48 | 6AX4GT | .55 | 6SA7GT | .41 | 12BA6 | .40 |
| 3S4 | .48 | 6BA6 | .40 | 6SD7GT | .39 | 12BA7 | .40 |
| 3V4 | .48 | 6BA7 | .57 | 6SK7GT | .39 | 12BE6 | .41 |
| 5A24 | .50 | 6BD5 | .49 | 6SL7GT | .49 | 12BH7 | .65 |
| 5U4G | .55 | 6BD6 | .45 | 6SN7GT | .50 | 12BY7 | .65 |
| 5Y3GT | .39 | 6BE6 | .37 | 6SQ7GT | .37 | 12BZ7 | .65 |
| 5Z3 | .45 | 6BGG | 1.20 | 6T8 | .57 | 12SA7 | .58 |
| 5Y4G | .39 | 6BH6 | .45 | 6T8 | .57 | 12SK7 | .58 |
| 6A3 | .57 | 6BL7GT | .65 | 6U8 | .59 | 12SL7GT | .49 |
| | | | | 6V6GT | .38 | 12SN7GT | .50 |
| | | | | 6W4GT | .42 | 12SQ7 | .55 |

| Type | Price | Type | Price |
|----------|-------|---------|-------|
| 12SR7met | .55 | 35Z3 | .43 |
| 12V6GT | .50 | 35Z5GT | .45 |
| 19B6GG | 1.15 | 42 | .40 |
| 19T8 | .75 | 43 | .53 |
| 25BQ6GT | .75 | 45 | .53 |
| 25L6GT | .40 | 50B5 | .41 |
| 25W4GT | .45 | 50C5 | .41 |
| 25Z6 | .37 | 50L6GT | .59 |
| 35A5 | .49 | 70L7GT | 1.07 |
| 35B5 | .38 | 76 | .42 |
| 35C5 | .38 | 117Z3 | .39 |
| 35L6GT | .45 | 117L7GT | 1.19 |
| 35W4 | .37 | 807 | 1.25 |

quency of the more stable one, or, in this case, at a sub-harmonic of the crystal. It appears that the lower frequency oscillator is a Colpitts oscillator. This is the upper tuned circuit, and its feedback is set by collector-to-base and base-to-emitter capacitance within the transistor. We think that the crystal oscillator is a Hartley oscillator with feedback due to the inductive coupling between the

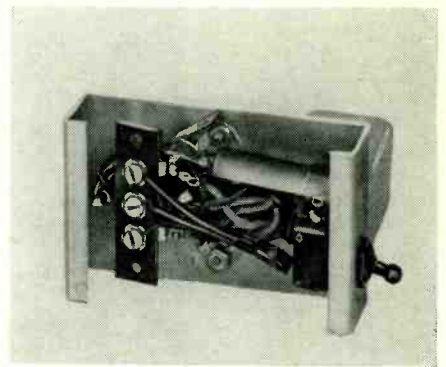

Transistor is mounted below chassis.

coils and only able to oscillate at 400 kc because at other frequencies the lower tuned circuit is shunted out by the crystal."

Not all transistors tried in this circuit act alike. I tried three and all gave satisfactory results. However, one transistor generated much lower frequencies than the other two. For example, with the crystal removed from its socket, we have a self-controlled oscillator as already explained. Now with the tank values we have we would expect a fundamental frequency near 140 kc. This is what I observed when two of our transistors were used. The third generated a frequency only half as much, 70 kc, and without changing the tuning of the transformer. Possibly this particular transistor is more active than the others. Evidently it acts as a "halver" as well as subharmonic generator. Other tests show that this transistor performs better than the others in high-frequency circuits.

The transistors which generate os-



"Funny, I brought it to four radio repair shops and they all just nodded and laughed."

T.V. PIX TUBE BRIGHTENER...\$1.39
For T.V. sets where voltage supply is low AC LINE BOOSTER with safety fuse and switch\$5.95

Free Five 1L4 tubes individually cartoned list value \$11.25 with every order of \$25.00 or more. Many 7 volt types not listed. All tubes individually boxed. Orders under \$10 subject to \$1 handling charge. Tubes offered subject to prior sale. Prices subject to change. All orders shipped F.O.B. 2% discount if full remittance accompanies order. 25% deposit required on c.o.d. shipments.

SEND FOR FREE TUBE LISTING



NEW JERSEY TELEVISION SUPPLY CO.

Sole Distributor of NJRT Tubes

906A WESTFIELD AVE., ELIZABETH, N. J. EL. 3-6166

OPPORTUNITY ADLETS

Rates—45¢ per word (including name, address and initials). Minimum ad 10 words. Cash must accompany all ads except those placed by accredited agencies. Discount, 10% for 12 consecutive issues. Misleading or objectionable ads not accepted. Copy for June issue must reach us before April 21, 1954.

Radio Electronics, 25 W. Broadway, New York 7, N. Y.

SPEAKER REPAIRS ON ALL MAKES JOBBERS wanted, Ambrite Speaker Service, 70 Vesey St., New York 7, N. Y.

AUDIOPHILE BULLETIN, MONTHLY CONFIDENTIAL hi-fi equipment reports. \$2.00 year. Department K, 1379 East 15th, Brooklyn 30, N. Y.

REVOLUTIONARY NEW TYPE TV ANTENNA PROVES SUPERIOR. Exclusive territory rights available. Derr, 1018 Taylor, Vallejo, California.

DIAGRAMS, RADIO \$1.00 TELEVISION \$2.00. Give make and model. Diagram Service, Box 672-R.E., Hartford, Conn.

PITTSBURGH, PA. 4PM-\$1.00—20x20-150 29¢—616 @ 39¢—Electronic Parts—5744 Baum. Stop—Today.

TUBES-TV, RADIO, TRANSMITTING, AND SPECIAL PURPOSE TYPES BOUGHT, SOLD AND EXCHANGED. Send details to B. N. Gensler W2LNI, 136 Liberty, N. Y. 6, N. Y.

ALL MAKES OF ELECTRICAL INSTRUMENTS AND TESTING equipment repaired. Write for free catalogues on new and used instruments at a savings. Hazelton Instrument Co., 128 Liberty Street, New York, N. Y.

SALESMEN WANTED—SELL AT MANUFACTURERS LOW PRICES—Television Wire to Retail Outlets. 10% commission on Original and Repeat orders. All Territories Open. King Mfg. Co., 45 Huron Road, Mohegan Heights, Yonkers, New York.

DIAGRAMS—10 ASSORTED WITH DATA AND illustrations, our selection \$1.10. Kramer's Radio Service, Dept. A54, 36 Columbus Ave., New York 23, N. Y.

24 PAGES PLANS "I-TUBE RECEIVER" (RECORD 12,000 miles) with 6 issues "Radiobuilder" \$1.00. Laboratories, 326-B Fuller, Redwood City, California.

WANTED—SURPLUS SELSYNS, SYNCHROS, TORQUE Units, Autodynes, Amplifiers, Aircraft Radio Equipment, Tubes, Etc. Highest Prices. Leotron Research, 715 Arch St., Philadelphia, Pennsylvania.

WANTED: AN/APR-4, other "APR", "TS", "JE", ARC-1, ARC-3, ART-13, RC-348, etc. Microwave Equipment, Everything Surplus. Special tubes, Tec Manuals, Lab Quality Equipment, Meters. Fast Action. Fair Treatment. Top Dollar! Littell, Fairhills Box 26, Dayton 9, Ohio.

BUY WHOLESALE—25,000 ITEMS—CATALOG 25¢. Matthews, 1472-P5, Broadway, N. Y. C. 36.

MAGNETIZER DELIVERS HIGH PEAK DC FROM 115 a-c. using simple hand-wound Magnetizer coils, wood case complete \$60.00. Parts kit, less case \$36.00. CAPACITORS—500 electrolytic new 340 mfd, 110 volts a-c or 150 d-c. Bakelite case \$1.10. PYRANOL, used, 3 mfd, 660 volt a-c, tested at 2300 d-c, \$1.20. McNeal, 794 Quinipiac Ave., New Haven, Conn.

ALUMINUM TUBING, ANGLE AND CHANNEL. Plain and perforated sheet. Willard Radcliff, Fostoria, Ohio.

TELEVISION SETS \$30 UP. W4API, 1420 SOUTH Randolph, Arlington 4, Virginia.

TV FM ANTENNAS, ALL TYPES INCLUDING UHF. Mounts, accessories. Lowest prices. Wholesale Supply Co., Lunenburg 2, Mass.

ONLY \$4.95 Ppd. + C.O.D. or Chgs.

THE NEW TV DYNATRACER

- TRACES TV SIGNALS AND VOLTAGES
- LOCATES DEFECTIVE COMPONENTS
- REQUIRES NO ADDITIONAL EQUIPMENT

This sensationally new piece of test equipment is ideal for trouble-shooting television sets in the home or in the shop. The "DYNATRACER" will outperform more expensive testers and should pay for itself on the very first repair.

A Must For Every TV Technician

SPECIFICATIONS: The "DYNATRACER" is a self-powered quality test instrument designed to trace TV signals through any Video, Sound, Sync, AFC, Horizontal or Vertical Sweep Circuit—will isolate trouble to a stage or component.

ADDED FEATURE: The "DYNATRACER" will also trace voltages (50/500 V. AC/DC) and instantly locate open, shorted, intermittent or leaky (up to 20 MEGOHMS) condensers, resistors, coils, XFormers, etc.

Instruction and Trouble-Shooting Book Enclosed

10 DAY MONEY-BACK GUARANTEE

Cut out advertisement, attach name and address with \$5.00 bill, check or money order and mail to

Century ELECTRONICS CO.

8509-21st Ave., Dept. 112, Brooklyn 14, N. Y.

When answering advertisements please mention **RADIO-ELECTRONICS.**

collations near 140 kc are used to generate 125 kc from a 375-kc crystal. With a small capacitor across the transformer winding (black-green) we can reach 100 kc. This gives the equivalent of a 100 kc-crystal oscillator when we plug in a 400 kc crystal. As for the transistor which oscillates near 70 kc, I am using this in a 75-kc crystal oscillator by plugging in a 375-kc crystal. With slight change in trimmer tuning, I have an excellent 80-kc crystal oscillator when I insert a 400-kc crystal.

If your transistor does not generate low enough oscillations and you want a very low-frequency oscillator, shunt the transformer coils until you reach the desired frequency. Of course it is preferable not to use a capacitor across the transformer if you don't need it. For one thing, the instrument will be smaller.

Regardless of what actually makes this circuit "tick", there are many useful applications for it. A low-frequency crystal oscillator provides numerous stable check points over the broadcast band. It generates standard frequencies on the ham bands, and for testing receivers. There is nothing to plug in and nothing to tune (once the instrument is working). Also, if your oscillator does not start each time you switch it on (due to sluggish crystal or other causes) flip the switch on and off a few times or simply disconnect and reconnect the transistor oscillator antenna lead. END

LAST MINUTE SPECIALS

We just scooped the market on standard top brand tubes latest 1954 dating . . . The prices speak for themselves!!!

ALL AMERICAN KIT

12SA7, 12SK7, 12SQ7, 35Z5, 50L6
List price \$8.20

Your Cost only \$3.54

TV TUBES

| TYPE | LIST PRICE | YOUR COST |
|--------|------------|-----------|
| 1B3GT | \$2.65 | 56¢ |
| 5U4G | 1.75 | 98¢ |
| 6BQ6 | 3.80 | \$1.22 |
| 6J5 | 1.70 | 49¢ |
| 6J6 | 2.50 | 49¢ |
| 6BA6 | 1.95 | 87¢ |
| 6AL5 | 1.75 | 69¢ |
| 6AG5 | 2.25 | 49¢ |
| 6AU6 | 1.85 | 82¢ |
| 6BG6G | 5.25 | \$1.99 |
| 6K6GT | 1.80 | 69¢ |
| 6AC7 | 3.35 | \$1.16 |
| 6AT6 | 1.65 | 59¢ |
| 6SN7GT | 2.35 | 64¢ |
| 6SH7 | 2.50 | 68¢ |
| 5V4G | 2.80 | \$1.28 |
| 12BH7 | 2.75 | 72¢ |
| 12AU7 | 2.40 | 94¢ |
| 12AL5 | 1.80 | 78¢ |
| 6AV6 | 1.65 | 59¢ |
| 6C4 | 1.65 | 56¢ |

TREMENDOUS STOCK—

At these prices they will move fast.
Buy Quickly and buy plenty.

BROOKS—84 Vesey St., New York, N.Y.

First And Only Book With

**COLOR TV
CIRCUITS &
SERVICING**

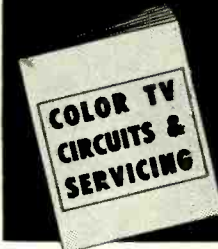

- See Actual Circuits Used In Color Sets
- Color TV Principles
- Simplified Color TV Servicing

JUST OFF THE PRESS!
Everything You Want To Know About Color TV!

Down-to-earth explanations of color TV circuits with actual diagrams of various manufacturers. Basic principles told in everyday language. NTSC system explained in detail. Trouble-shooting and servicing simplified. Detailed explanation of color TV theory. Over 100 pages packed with all the answers on color TV. Profusely illustrated. \$2.95 postpaid. **ORDER BY MAIL TODAY . . . NOW!**

BEECO

Dept. P-2
Matheson Building
Baltimore 2, Md.

Get This Valuable Book

Just for Examining COYNE'S New 6-Volume Set

FREE



Applied Practical Radio-Television

**ON 7 DAY
FREE
TRIAL!**

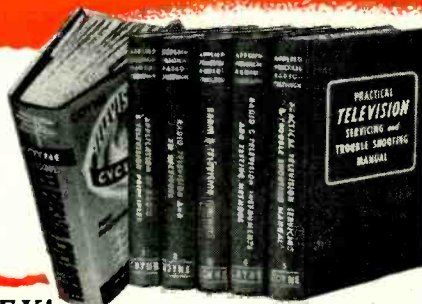

Yes, you get this big, new 1954 book, "150 Radio-Television Picture Patterns and Diagrams Explained", absolutely FREE! Just off the press! Gives complete 11x22" Schematic Diagrams on leading models Radio and Television Sets. Easy-to-read, large 8 1/2 x 11" pages, with full instructions on how to read and use the diagrams. A "must" in every Radio and Television service-man's repair kit. You get this valuable book as a FREE Gift for asking to see Coyne's great new 6-book set, "Applied Practical Radio-Television"!

At Last! Money-Making "Know-How" on Transistors, Color TV and Servicing

Coyne's great new 6-volume set gives you all the answers to servicing problems—quickly! For basic "know-how" that is easy to understand, you'll find everything you want in volumes 1 to 5 which contain over 5000 practical facts and data. They cover every step from principles to installing, servicing, trouble-shooting and aligning all types of radio and TV sets. So up-to-date it includes COLOR TV and UHF, adaptors, converters. Also covers latest data on TRANSISTORS.

Extra! 802-Page Television Cyclopaedia Included

And then, for speedy on-the-job use, you get volume 6—the famous Coyne TELEVISION CYCLOPEDIA. It answers today's television problems on servicing, alignment, installation and others. In easy-to-find ABC order, cross indexed. Use this 6 volume TV-RADIO LIBRARY free for 7 days; get the valuable Servicing Book ABSOLUTELY FREE!

SEND NO MONEY! Just mail coupon for 6-volume set on 7 days free trial. We'll include book of 150 TV-Radio Patterns & Diagrams. If you keep the set, pay \$2 in 7 days and \$2 per month until \$22.50 plus postage is paid. (Cash price \$20.95). Or you can return the library at our expense in 7 days and owe nothing. **YOU BE THE JUDGE.** Either way, the book of TV-Radio Patterns is yours FREE to keep! Offer is limited. Act NOW!

FREE BOOK—FREE TRIAL COUPON!

COYNE ELECTRICAL & TELEVISION-RADIO SCHOOL, Dept. 44-T1
500 S. Paulina St., Chicago 12, Ill.

YES! Send 6-volume "Applied Practical Radio-Television" for 7 days FREE TRIAL per your offer. Include TV-Radio Patterns & Diagram Book FREE.

Name.....Age.....

Address.....

City.....Zone.....State.....

Where Employed.....

() Check here if you want library sent COD. You pay postman \$20.95 plus COD postage on delivery. 7-day money-back guarantee.

COYNE ELECTRICAL & TELEVISION-RADIO SCHOOL
500 S. Paulina St., Dept. 44-T1 Chicago 12, Ill.

be sure with



TV ANTENNAS Best designed, best constructed and best selling—the complete line of AMPHENOL UHF and VHF antennas are best in every way. Dealers have found that *highest quality* can be always counted on in every AMPHENOL antenna.

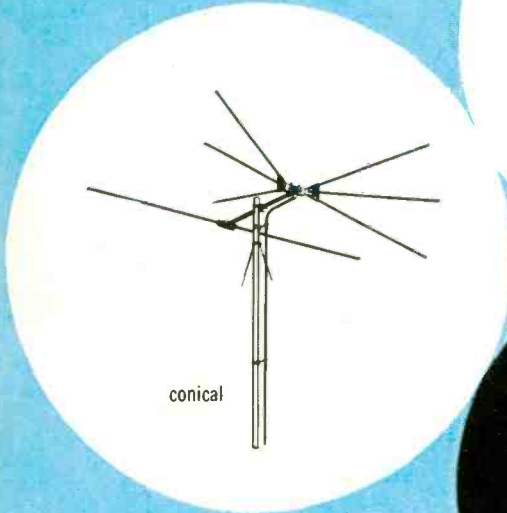
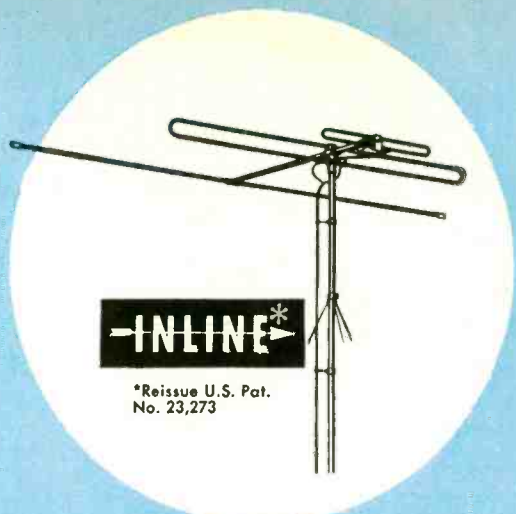

conical

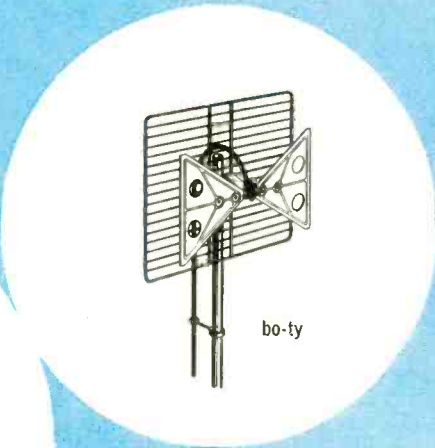

bo-ty

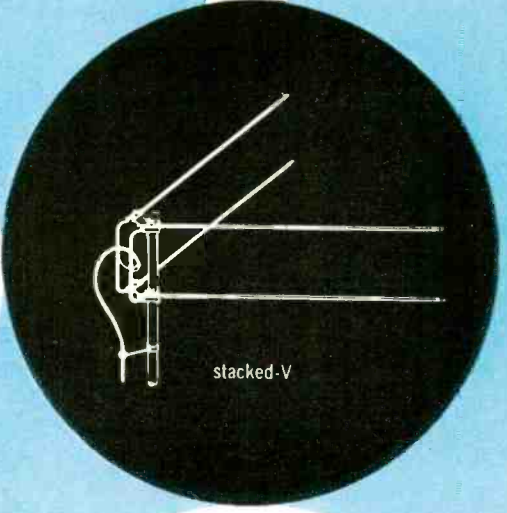

stacked-V



corner reflector

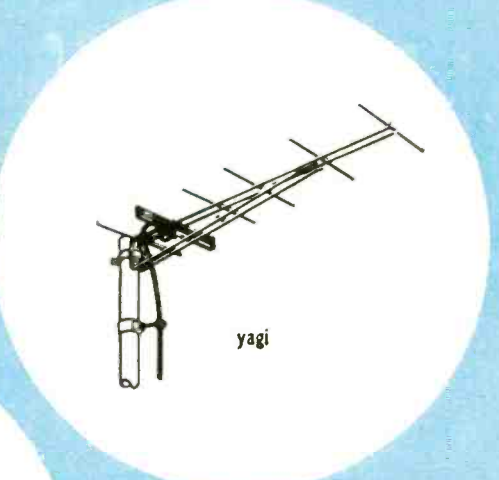

yagi

--- and accessories



twin-lead

Proved by time and every test, AMPHENOL Flat Twin-Lead and AIR-CORE Tubular Twin-Lead (U.S. Pat. No. 2,543,696) assure low-loss transmission of the signal. Flat Twin-Lead is designed for VHF while unique AIR-CORE Tubular is best for UHF.

New AMPHENOL Isonet provides highly efficient coupling of UHF and VHF antennas to a single lead-in. Lumped-circuit-constants-filter-network assures extra low-loss performance. Attractive blue case adds to installation appearance.



isonet

Lowest measurable loss of any lightning arrester! New UL approved Lightning Arrester gives full protection to the signal as well as to the set. Accommodates flat, open or tubular type lead-ins. Makes positive "bite" on heavy line.

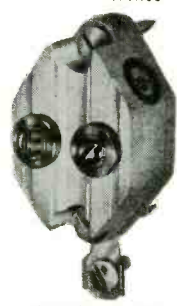

lightning arrester

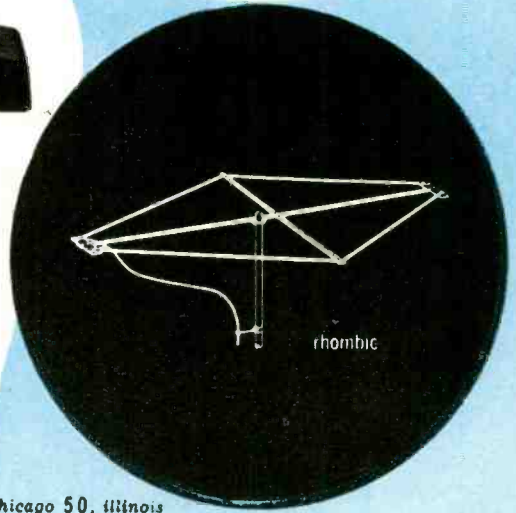

rhombic



AMERICAN PHENOLIC CORPORATION

chicago 50, illinois

MINIATURE CAPACITORS

National Capacitor Co., 385 Washington St., Quincy, Mass., has announced its line of T₁ capacitors for exceptional stability between temperature extremes. The capacitance variance is less than 5% from minus 80°C to plus 200°C. Insulation resistance, even at 150°C, will definitely exceed 1,000 meg-

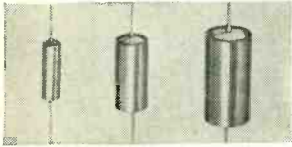

ohms. Capacitance is substantially unaffected by frequency and has a dissipation factor less than .0008.

These capacitors are hermetically sealed with tin-coated glass-kovar end seals. They are available in the complete RETMA capacitance series in standard tolerances of ±10% and can also be obtained with tolerances of ±5% and ±2%.

ROTARY ANTENNAS

Telrex, Inc., Asbury Park, N. J., is producing a line of rotary antennas for 10-, 15-, and 20-meter performance, the Beamed Power Rotaries. All of

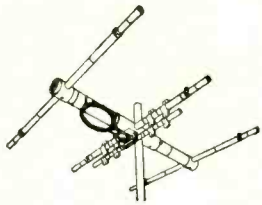

these antennas are equipped with pre-assembled "Perfect Match Balun" and T-match for optimum coupling. They are designed to be fed with 50- or 75-ohm coaxial lines.

INSTALLATION AID

Mosley Electronics, Inc., 8622 St. Charles Rack Rd., St. Louis 14, Mo., has designed an aid for u.h.f. and v.h.f. antenna orientation, the *Orienter*. The device consists of two pocket-size units comprising an isolation net-



work that permits the single transmission line to carry the signal to the television set and return the video signal without interaction and with little or no insertion loss. The video signal can then be read in terms of relative strength by means of an ordinary portable volt-ohm-meter. Thus, the installer on the roof can tell instantly when the TV set is receiving maximum video signal.

This eliminates the need for an extra man standing by the TV set and the need of a telephone to relay information to the installer on the roof.

AM-FM TUNER

Newcomb Audio Products Co., 6824

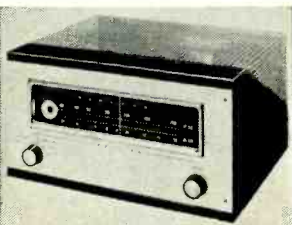

Lexington Ave., Hollywood, Calif., has announced a self-powered, dual-knob, high-fidelity AM-FM tuner, the *Classic 200*, designed for use with amplifiers that have their own controls.

The unit features an improved a.f.c. circuit which may be disabled for tuning to weak stations adjacent to stronger ones. The circuit is adjustable to meet local conditions. The model 200 has a new a.v.c. dual-triode cascade front end, a TV type high-efficiency mixer, dual limiters, Foster-Seeley discriminator, Armstrong circuit, and drift-compensated oscillator. It offers 1-microvolt sensitivity for 20 db of quieting, 20-20,000-cycle response ± 1/2 db, and distortion below 1%.

MICROPHONES

American Microphone Co., 370 S. Fair Oaks, Pasadena 1, Calif., has announced a new line of hand-held dynamic and carbon mikes, known as the 501 series. This series is designed for mobile, police, ship-to-shore, and aircraft communications, as well as amateur radio, paging, and intercom systems.

The units are finished in gray and weigh 10 ounces exclusive of cable or plug.



AMATEUR AID

Electro-Voice, Inc., Buchanan, Mich., is producing an operating aid for radio amateurs, the *Second Op*. This device is a 10 1/2-inch circular computer which has data on every country and amateur-recognized subdivision.

Included are data on prefixes, great circle beam headings, times and dates at dx locations, postage rates, international reply coupon exchange rates, dx zones, prefix-to-country translations, and QSL Bureau addresses. There is also a log for date of contact and receipt of the QSL card for each country.



POWER RESISTORS

Claroast Manufacturing Co., Inc., Dover, N. H., has added a 15-watt Series C8JJ resistor to its *Greenohm Jr.* line. Axial pigtail leads provide support and connections in point-to-point wiring. Leads are 1 1/2-inch length No. 20 tinned copper wire.

The 15-watt unit measures 2 x 1/2 inches, compared with the 5-watt unit measuring 1 x 5/16 inches and the 10-watt unit which measures 1 3/4 x 5/16 inches. The units are available in a resistance range from 1 ohm to 10,000 ohms.

BUILD 15 RADIOS

ONLY

AT HOME \$19.95

With the New Improved 1954 Progressive Radio "EDU-KIT"

NOW INCLUDES
SIGNAL TRACER
and
CODE OSCILLATOR

- ATTRACTIVELY GIFT PACKED
- FREE SOLDERING IRON
- ABSOLUTELY NO KNOWLEDGE OF RADIO NECESSARY
- NO ADDITIONAL PARTS NEEDED
- EXCELLENT BACKGROUND FOR TV
- 10 DAY MONEY-BACK GUARANTEE
- SCHOOL INQUIRIES INVITED



WHAT THE PROGRESSIVE RADIO "EDU-KIT" OFFERS YOU

The Progressive Radio "Edu-Kit" offers you a home study course at a rock bottom price. Our Kit is designed to train Radio Technicians, with the basic facts of Radio Theory and Construction Practice expressed simply and clearly. You will gain a knowledge of basic Radio Principles involved in Radio Reception, Radio Transmission and Audio Amplification.

You will learn how to identify Radio Symbols and Diagrams; how to build radios, using regular radio circuit schematics; how to mount various radio parts; how to wire and solder in a professional manner. You will learn how to operate Receivers, Transmitters, and Audio Amplifiers. You will learn how to service and trouble-shoot radios. You will learn code. You will receive training for F.C.C. license.

In brief, you will receive a basic education in Radio exactly like the kind you would expect to receive in a Radio Course costing several hundreds of dollars.

THE KIT FOR EVERYONE

The Progressive Radio "Edu-Kit" was specifically prepared for any person who has a desire to learn Radio. The Kit has been used successfully by young and old in all parts of the world. It is not necessary that you have even the slightest background in science or radio.

The Progressive Radio "Edu-Kit" is used by many Radio Schools and Clubs in this country and abroad. It is used for training and rehabilitation of Armed Forces Personnel and Veterans throughout the world.

The Progressive Radio "Edu-Kit" requires no instructor. All instructions are included. All parts are individually boxed, and identified by name, photograph and diagram. Every step involved in building these sets is carefully explained. You cannot make a mistake.

PROGRESSIVE TEACHING METHOD

The Progressive Radio "Edu-Kit" comes complete with instructions. These instructions are arranged in a clear, simple and progressive manner. The theory of Radio Transmission, Radio Reception, Audio Amplification and servicing by Signal Tracing is clearly explained. Every part is identified by photograph and diagram. You will learn the function and theory of every part used.

The Progressive Radio "Edu-Kit" uses the principle of "Learn by Doing". Therefore you will build radios, perform jobs, and conduct experiments to illustrate the principles which you learn. These radios are designed in a modern manner, according to the best principles of present-day educational practice. You begin by building a simple radio. The next set that you build is slightly more advanced. Gradually, in a progressive manner, you will find yourself constructing still more advanced multi-tube radio sets, and doing work like a professional Radio Technician. Altogether you will build fifteen radios, including Receivers, Transmitters, Amplifiers, Code Oscillator and Signal Tracer. These sets operate on 105-125 V. AC/DC.

THE PROGRESSIVE RADIO "EDU-KIT" IS COMPLETE

You will receive every part necessary to build 15 different radio sets. Our kits contain tubes, tube sockets, variable condensers, electrolytic condensers, mica condensers, paper condensers, resistors, line cords, selenium rectifiers, tie strips, coils, hardware, tubing, etc.

Every part that you need is included. These parts are individually packaged, so that you can easily identify every item. A soldering iron is included, as well as an Electrical and Radio Tester. Complete, easy-to-follow instructions are provided. In addition, the "Edu-Kit" now contains lessons for servicing with the Progressive Signal Tracer, F.C.C. instructions, quizzes. The "Edu-Kit" is a complete radio course, down to the smallest detail.

TROUBLE-SHOOTING LESSONS

Trouble-shooting and servicing are included. You will be taught to recognize and repair troubles. You will build and learn to operate a professional Signal Tracer. You receive an Electrical and Radio Tester, and learn to use it for radio repairs. While you are learning in this practical way, you will be able to do many a repair job for your neighbors and friends, and charge fees which will far exceed the cost of the "Edu-Kit". Here is your opportunity to learn radio quickly and easily, and have others pay for it. Our Consultation Service will help you with any technical problems which you may have.

FREE EXTRAS

- ELECTRICAL & RADIO TESTER
- ELECTRIC SOLDERING IRON
- TV BOOK
- RADIO TROUBLE-SHOOTING GUIDE
- CONSULTATION SERVICE
- QUIZZES
- F.C.C. TRAINING

Progressive "Edu-Kits" Inc.

497 Union Ave., Dept. RE-82, Brooklyn 11, N. Y.

MAIL TODAY—Order shipped same day received.

10-Day Money-Back Guarantee. Include ALL FREE EXTRAS.

- Send "Edu-Kit" Postpaid. I enclose full payment of \$19.95 (U.S.A. only).
- Send "Edu-Kit" Postpaid. I enclose full payment of \$20.95 (Outside U.S.A.).
- Send "Edu-Kit" C.O.D. I will pay postage (U.S.A. only).
- I wish additional information describing "Edu-Kit". No Obligation.
- Send me FREE Radio-TV Servicing Literature.

Name

Address

PROGRESSIVE "EDU-KITS" INC.

497 UNION AVE., Dept. RE-82, Brooklyn 11, N. Y.

UHF ANTENNA

Ward Products Corp., Division of the Gabriel Co., 1148 Euclid Ave., Cleveland 15, Ohio, has announced an in-door antenna for u.h.f., model TV-215. It is finished in simulated wrought iron and bronze, and is called the *Con-Con*.

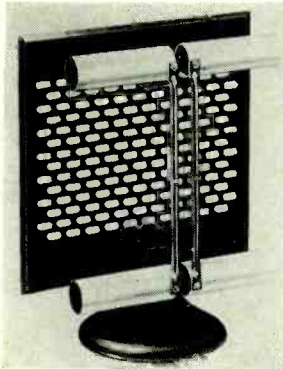

LIGHTNING ARRESTERS

RCA Tube Dept., Harrison, N. J., has announced two quick-service types of u.h.f. lightning arresters designed to protect home u.h.f. TV receivers from damage by lightning and static charges.

The two arresters are a screw type (234A), for direct mounting to baseboards or window sills, and a strap type (235A) for attachment to antenna masts and cold-water pipes. Both are listed by Underwriters Laboratories, Inc.

The arresters can be installed in most applications in four quick steps which eliminate such procedures as splicing wires, stripping insulation, and soldering. A screw cap forces the line against staple contacts in the arrester which pierce the insulation and make electrical contact with the wire.

The units can be used with virtually all types of 300-ohm u.h.f. transmission lines—tubular, oval, foam, and jacketed—and do not affect the electrical characteristics of the line.



DISTRIBUTION UNIT

Waldom Electronics, Inc., 911 N. Larabee St., Chicago 10, Ill., has announced an electronic distribution amplifier which permits the use of two TV sets from a single antenna and acts as a booster to improve the picture reception on both sets.

The *Duo-tenna* is said to be ideal for color reception because of its broad bandwidth. The unit can also convert two sets to u.h.f. reception from a single u.h.f. converter.



HI-FI PHONOGRAPH

Hallcrafters Co., 4401 W. Fifth Ave., Chicago 24 Ill., has introduced a low-priced high-fidelity phono-graph with a frequency response ranging from

to 16,000 cycles per second. The *Virtuoso*, as it is called, features a 3-speed record changer with a variable-reluctance pickup, bass and treble controls, a loudness control, and a control for compensation.

The audio system is an 8-watt, low-distortion push-pull output with inverse feedback. The 5-tube and 1-rectifier transformer type amplifier supplies sufficient volume for auditorium use. Two speakers are used.

The set measures 20 x 25 1/2 x 11 3/4 inches. Its legs are 14 1/2 inches high. The *Virtuoso* is done in contemporary styling and is available in blonde or mahogany finishes.



GUY WIRE

Fenton Co., 15 Moore St., New York 4, N. Y., has introduced a guy wire packed flat in a box instead of being wound on conventional spools. The flat pack is called the *Tuf-Guy Ten Spot*, since the wire is marked every 10 feet for easy measuring. A 7-inch circle on the top of the box is perforated for easy lifting.



BAR GENERATOR

Perma-Power Co., 4727 N. Damen Ave., Chicago 25, Ill., has placed a new horizontal bar generator on the market. The neon-tube relaxation oscillator provides a series of equally spaced horizontal lines to indicate picture linearity. The unit provides precise setting of yoke, accurate positioning of focus coil or magnet, and quick adjustment of vertical linearity, height, and centering.

Completely self-contained, the bar generator plugs on picture tube. Simple instructions are included.

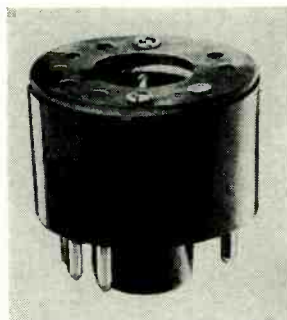

SUB-MINIATURE UNITS

Cornell-Dubilier Electric Corp., South Plainfield, N. J., has developed a compact subminiature tantalum electrolytic capacitor. The tiny units meas-

ure 3/16 inch in length and 3/16 inch in diameter. They are especially well suited for application in transistor circuits.

These sub-miniature tantalum electrolytic capacitors cover an operating temperature range from -55° C to 85° C, and have considerably lower leakage current than other electrolytic types. Power-factor characteristics are excellent even at lowest rated operating temperature. The wound-foil type construction results in excellent frequency characteristics.

Thirty-five new subminiature units are available, ranging in capacitance from 0.01 to 8.0 µf and from 3 to 150 v.d.c. (working), in both polarized and non-polarized types.

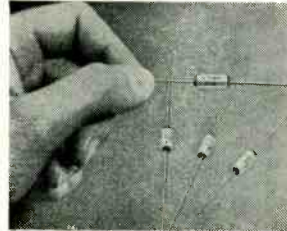

V.O.M. CASE

Triplett Electrical Instrument Co., Bluffton Ohio, is producing a Neolite case to house its three v.o.m. models, Nos. 630, 630-A, and 630-T.

The case has a built-in stand that rests the unit at a convenient 45° angle when in use. It also has a back compartment that contains sufficient room to store an instruction book, leads, the stand, and small tools.

The No. 639-N case has a firm handle for carrying.



VHF CONICAL

Trio Manufacturing Co., Griggsville, Ill., is now offering a conical v.h.f. antenna, the *Colorite*, available in single or two-bay models, complete with phasing harness. Element ends are securely riveted to the head, so there is no danger of loosening or "shedding."

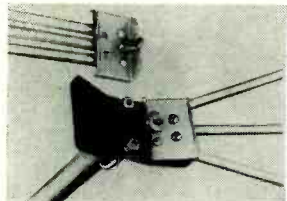

UHF CONVERTER

Granco Products, Inc., 32-17 20th Ave., Long Island City 5, N. Y., has developed a rear-attached, out-of-sight u.h.f. converter which mounts on the rear protective cover of the usual TV set. The converter is based on a new version of the company's coaxial-cavity tuner. The simplified and more compact tuner is adjusted by tuning knob extending at one side of the TV set cabinet and providing 10-to-1 tuning ratio. A miniature slide-rule tuning dial can be seen by looking to the rear edge of the TV set cabinet. A v.h.f.-u.h.f. switch cuts in the converter when u.h.f. reception is desired. The u.h.f. signal is fed into the set tuned to channel 5 or 6.

Three models of the new converter will be made available shortly. The

first type gets its power supply from the TV set by means of an adapter socket, eliminating any wiring alterations. The second type is self-powered, while the third type includes high-gain amplification for use in low-signal-level areas or locations. A fourth model mounts on the front panel of the TV set for a built-in installation, and has been in use for some time.

INSTRUMENT STAND

Electronic Measurements Corp., 280 Lafayette St., New York 12, N. Y., has announced an instrument stand for the service technician. By placing his v.o.m. or v.t.v.m. on the stand, the instrument scale is at an easy, convenient angle, and the instrument cannot tip over. Known as model IS, the stand is rubber-covered to protect the instrument.

REPLACEMENT TRANSFORMER

Halderson Transformer Co., 4500 Ravenswood Ave., Chicago 40, Ill., has announced flyback transformer FB412, an exact replacement for Part No. C-201-21025-1 used in Airline, Raytheon and Truetone TV sets.

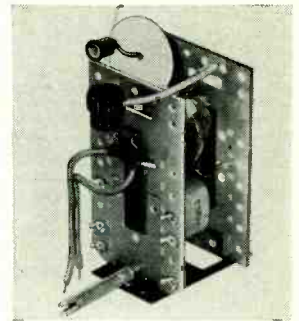

The new unit features a variable-gap width control, tapped a.g.c. winding, and a special mounting base. The FB412 services 84 models and chassis of the manufacturers mentioned.

MARKER-GENERATOR

Electronic Measurements Corp., 280 Lafayette St., New York, N. Y. has announced a new r.f.-a.f. crystal marker-TV bar generator, model 700. The unit gives complete coverage from 18 cycles to 108 mc on fundamentals.



Model 700 provides a bar generator for TV adjustment, with a variable number of bars available for horizontal or vertical alignment, and a square-wave generator to 20 kc. It has a Wien bridge a.f. oscillator with a sine wave output from 18 cycles to 300 kc, and crystal marker and amplitude control.

PORTABLE SPEAKER

Jensen Manufacturing Co., 6601 S. Laramie Ave., Chicago 38, Ill., has introduced a portable version of the 2-way loudspeaker system, the *Duette*, model DU-202. The unit is designed for use with tape recorders, portable record players, musical instruments, and band sound reinforcement.

The loudspeaker equipment is the same as that of the *Duette* home model, and is housed in a black leatherette case measuring 11 x 23 1/4 x 11 1/4 inches and weighing 21 pounds.

Here's your Opportunity

**to prepare for a good job or a business
of your own in TV SERVICING**

ARE YOU SATISFIED with the position you now hold? Do you feel you're worth more money? Are you pleased with yourself, your work, your associates . . . and your future? What does the next year hold for you . . . and the year after that?

Are you content merely to plod along through the best years of your life . . . or do you want to get into more pleasant work . . . hold a well-paid job . . . perhaps establish your own business?

If you are looking for a REAL opportunity . . . If you want to GROW with a GROWING INDUSTRY . . . If you want to grasp the success that should be yours, *then we say to you, study TV Servicing.*

Everyone knows that Television is the fastest growing industry today. Opportunities are going begging for men who have

the training and ability to grasp them. *Now is the time to start on the road to success in TV Servicing.*

Study at Home in your spare time

The RCA Institutes Home Study Course in TV Servicing is easy to learn. You progress rapidly, step by step, as you learn the procedure of servicing and trouble-shooting TV receivers and installing TV antennas. Hundreds of pictures and diagrams help you understand the how-it-works information and the how-to-do-it techniques.

A Service of

Radio Corporation of America

The RCA Institutes TV Servicing course was written and planned by instructors with years of specialized experience in training men. You get up-to-the-minute information, too, because you study right at the source

of the latest developments in Television. Your lessons are carefully examined and accurately graded by competent teachers who are interested in helping You to succeed.

RCA Institutes is licensed by the University of the State of New York . . . an affiliate member of the American Society for Engineering Education . . . approved by leading Radio-TV Service Organizations . . . approved by Veterans Administration.

It costs so little to gain so much

RCA Institutes makes it easy for you to take advantage of the big opportunities in TV Servicing. The cost of the TV Servicing Home Study Course has been cut to a minimum. You pay for the course on a pay-as-you-learn unit lesson basis. *No other home study course in TV Servicing offers so much for so little cost to you.*

RCA Institutes conducts a resident school in New York City offering day and evening courses in Radio and TV Servicing, Radio Code and Radio Operating, Radio Broadcasting, Advanced Technology. *Write for free catalog on resident courses.*



RCA INSTITUTES, INC.
A SERVICE OF RADIO CORPORATION OF AMERICA
350 WEST FOURTH STREET, NEW YORK 14, N.Y.

APRIL, 1954

SEND FOR FREE BOOKLET—Mail the coupon—today. Get complete information on the RCA INSTITUTES Home Study Course in Television Servicing. Booklet gives you a general outline of the course by units. See how this practical home study course trains you quickly, easily. Mail coupon in envelope or paste on postal card.



MAIL COUPON NOW!

RCA INSTITUTES, INC., Home Study Dept. RE454
350 West Fourth Street, New York 14, N. Y.

Without obligation on my part, please send me copy of booklet "RCA INSTITUTES Home Study Course in TELEVISION SERVICING." (No salesman will call.)

Name _____ (please print)

Address _____

City _____ Zone _____ State _____

Another BRACH First!

"DESIGNED WITH COLOR IN MIND."
FLAT RESPONSE ON COLOR SUBCARRIER



BRACH #555
\$10.56 LIST PRICE

HIGH GAIN VHF-UHF ON ONE ANTENNA.

NO MIXERS • NO COUPLERS • NO INTERACTION
STOPS FM INTERFERENCE

FREE! Technical Bulletin
"SOLVING THE COLOR-BLACK & WHITE TV, VHF/UHF RECEPTION PROBLEM!"
by IRA KAMEN.



BRACH #556
\$22.62 LIST PRICE



MANUFACTURING CORP.
Div. of General Brance Corp.
200 Central Avenue Newark 3, N. J.
Humboldt 2-1500

CORNER REFLECTOR

Channel Master Corp., Ellenville, N. Y., has announced a new u.h.f. corner reflector, model 409. This antenna features optional two-way mounting and can be mounted either behind or in

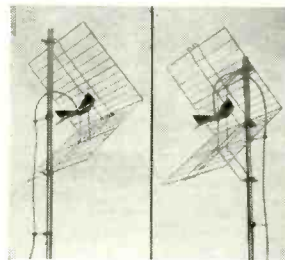

front of the mast. Gain across the u.h.f. band ranges up to 12½ db. Directivity patterns are sharp.

HIGH-VOLTAGE PROBE LEAD

Radio City Products Co., Inc., 152 West 25th St., New York, N. Y., has brought out a new high-voltage multiplier probe lead for extending the d.c. voltage ranges of their model 655 peak-to-peak v.f.v.m.

The new probe comes complete with multiplier resistor and terminals and is of the heavy-duty type with safety barrier. It multiplies the scale used by 100.

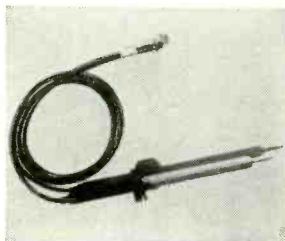

NEW TOWER DESIGN

Spaulding Products Co., Tipton, Ind., has designed a self-supporting tower, the *Strato-Tower*, with all-riveted construction. The six sections of the tower nest together so compactly that 100 feet of tower occupies less than 2½ feet of warehouse space.

The tower has heavily galvanized, all-steel construction, and all-riveted bracing with no welds. No additional accessories are needed to install rotators down inside of the tower.

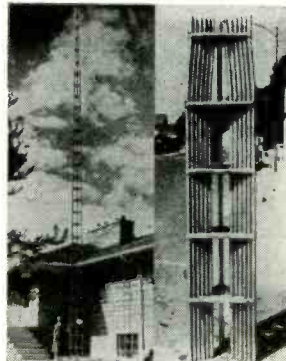

TINY TRANSFORMER

J. W. Miller Co., 5917 S. Main St., Los Angeles 3, Calif., has added a sub-miniature 455-kc transformer to their K-Tran line. The unit is ½ inch square and 1½ inches high. Its over-all height, including terminals, is 1½ inches.



The intermediate frequency transformer is smaller than a miniature tube, while retaining all the desirable features of the conventional size i.f.

transformers. Through the use of a ferrite shell core material, the i.f. transformers offer the gain and bandwidth characteristics necessary.

ANTENNA COUPLER

Tele-Matic Industries, Inc., 1 Joralemon St., Brooklyn, N. Y., has announced their *Add-A-Set* coupler, model AM-74, which operates two TV sets from one antenna on all v.h.f. channels on 72- or 300-ohm line.

The unit is an inductive coupler incorporating an efficient transformer with a special high-frequency core. This maintains a constant impedance over the entire band and a minimum of loss as compared to a resistance-network coupler.

The AM-74 isolates the antenna and receivers by the use of individual windings of the transformer and therefore minimizes inter-receiver action.

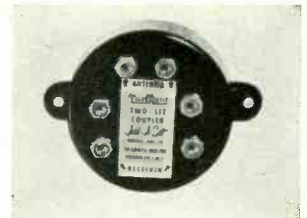

FLYBACK REPLACEMENTS

Chicago Standard Transformer Corp., Addison and Elston, Chicago 18, Ill., has added three replacement flyback transformers to its Stancor line. The units—A-8230, A-8231, and A-8232—are used in Air King, CBS-Columbia, Emerson, Firestone, and Silvertone sets. They cover 88 chassis and 194 models.

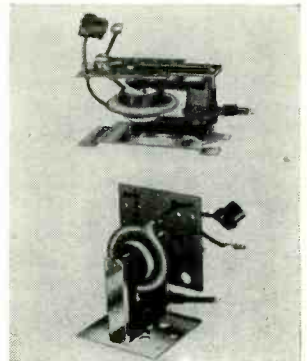

16-ELEMENT YAGI

Channel Master Corp., Ellenville, N. Y., has developed a 16-element u.h.f. Yagi for fringe-area reception, the *Sweet 16*. This antenna, model 420 has its elements welded on to the cross-arm, and has a delta-matched dipole for good 300-ohm match.

Model 420 can be designed to cover as many as 21 different channels. The average gain is 11 db single and 14 db stacked.

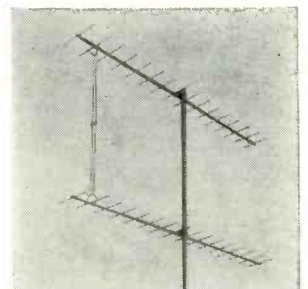

Since all the elements except the dipole are welded in position at the factory, the antenna is ready for installation within seconds after it is removed from the box by the technician.

All specifications given on these pages are from manufacturers' data.

RADIO-ELECTRONICS

XCELITE Hand Tools

PREFERRED BY THE EXPERTS



LOSE SOME TOOLS, MISTER?

SAVE TOOLS, TEMPER AND TIME WITH XCELITE NUT DRIVER SETS!



No. 137 Bench Set
3/16, ¼, 5/16, 11/32, ¾ regular; ½ and 9/16" hollow shaft nut drivers with COLOR CODED handles. No more fumbling—everything's where you need it. Ask your supplier!



No. 127 Lockable Wall Set
Tamper-proof. Has 3/16, 7/32, ¼, 9/32, 5/16, 11/32, ¾ regular nut drivers with COLOR CODED genuine XCELITE plastic handles. Lifetime tools.

XCELITE, Incorporated
(Formerly Park Metalware Co., Inc.)
Dept. J
Orchard Park, N. Y.

For Originality
LOOK TO XCELITE

Now a

COLOR

TELEVISION HOME STUDY COURSE

by RCA Institutes



"Color Television is here—not around the corner, or in the developmental labs, but here! The big question now is . . . Are You ready for Color TV?"

"You may now have a successful TV servicing business. When color sets come to your bench for servicing, will you be able to handle them?"

"Color Television is a vast new field, embodying entirely new concepts . . . principles of light and vision, radically new circuitry."

First Home Study Course in Color TV

Now is the time to prepare. Now, for the first time, you can train yourself for the

opportunities in this brand-new field. The just-announced RCA Institutes Home Study Course is the *first* home study course covering all phases of color television. Offered only to those already experienced in radio-television servicing, it explains the "why" of basic theory, as well as the "how-to-do-it" of servicing techniques.

Planned and written by RCA instructors, the entire course is based on the practical experience of RCA engineers—the men who have pioneered in the research and development of color television since the very first color experiments, many years ago.

Remember when black-and-white television first became a reality? Overnight, the demand for men who knew television grew. Even now, a shortage of qualified servicemen exists. Think, then—of the even greater demand for servicemen who will understand the many additional problems of color reception!

Costs so little to gain so much

RCA Institutes makes it easy for you to prepare yourself now for color television. Not only is the cost of the home study course for qualified servicemen extremely low, but you pay for the course on a pay-as-you-learn basis.

RCA Institutes conducts a resident school in New York City offering day and evening courses in Radio and TV Servicing, Radio Code and Radio Operating, Radio Broadcasting, Advanced Technology. Write for free catalog on resident courses.

Send for **FREE Booklet**—Mail the coupon, today. Get complete information on the RCA INSTITUTES Home Study Course in Color Television. Booklet gives you a general outline of the course lesson by lesson. See how thoroughly you can learn Color TV.

Mail coupon in envelope or paste on postal card.



MAIL COUPON NOW!

RCA INSTITUTES, INC., Home Study Dept. RE-454
350 West Fourth Street, New York 14, N. Y.

Without obligation on my part, please send me copy of booklet "RCA INSTITUTES Home Study Course in COLOR TELEVISION." (No salesman will call.)

Name _____ (please print)

Address _____

City _____ Zone _____ State _____



RCA INSTITUTES, INC.

A SERVICE OF RADIO CORPORATION OF AMERICA
350 WEST FOURTH STREET, NEW YORK 14, N. Y.

APRIL, 1954

EICO

TEST EQUIPMENT
for AM, FM, and TV



TUBE TESTER

Tests all conventional tube types: Octal, Lactal, Noval, Hytron, VR, Magic Eye (4, 5, 6, and 7-prong (large and small)) Pilot lamps, and CR Tubes with picture-tube test adaptor (Model CRA). Tests for 'open', 'shorts', continuity, and emission. Easy-reading, 4 1/2-inch meter gives both numerical data and color coded evaluation. Illuminated, gear-driven SPEEDROLL charts individual tube settings. Dimensions: 9 1/2 x 12 1/2 x 4 1/4" - 12 lbs.

- Model 625-K Complete Kit \$34.95
- Model 625 Factory Wired 49.95
- Model 625-CK Same as 625-K, but with counter display case, Complete Kit 44.95
- Model 625-C Same as 625-CK, but Factory Wired 59.95
- PICTURE TUBE TEST ADAPTOR Model CRA Designed for use with all Eico Tube Testers \$4.50

New EICO PROBES*



SCOPE DEMODULATOR PROBE

- Model PSD Complete Kit \$3.75
- Factory Wired 5.75

LOW CAPACITY PROBE

- Model PLC Complete Kit \$3.75
- Factory Wired 5.75

DIRECT PROBE Model PD

- Complete Kit \$2.75
- Factory Wired 3.95

VTVM RF PROBES

Model PRF-11 or 25

- For any 11 or 25 megohm VTVM Complete Kit \$3.75
- Factory Wired 4.95

PEAK-TO-PEAK PROBES

Model PTP-11 or 25

- For any 11 or 25 megohm VTVM Complete Kit \$4.95
- Factory Wired 6.95

We carry the entire line of Eico Kits and Wired Instruments

*PAT. APP. FOR Prices Net, F.O.B. N. Y. C. Subject to change without notice.

HARVEY

ALWAYS HAS IT... IN STOCK
for IMMEDIATE DELIVERY

MULTIMETERS

Ideal portable instruments for in-the-field or on-the-bench use. Designed to laboratory precision accuracy standards. Employ only high quality components.



4 1/2-INCH METER 20,000 OHMS-PER-VOLT

- Model 565-K Complete Kit \$24.95
- Model 565 Factory Wired 29.95
- 31 full-scale ranges
- VOLTS: DC, AC, and Out-put -0 to 2.5, 10, 50, 250, 1000, and 5000.
- DC CURRENT: 0 to 100 μ a, 10 ma, 100 ma, 500 ma, and 10 amps.
- OHMS: 0 to 2000, .2 meg, and 20 meg.
- FIVE db RANGES: -12 to +55.
- 50 μ a meter movement. DIMENSIONS: 6 3/4 x 5 1/4 x 3" - 3 lbs.
- Model 555-K Same as 565-K, but with 1% precision resistors. Complete Kit \$29.95
- Model 555 Factory Wired with 1% precision resistors 34.95

4 1/2-INCH METER 1000 OHMS-PER-VOLT

- Model 566-K Complete Kit \$14.90
- Model 566 Factory Wired 18.95
- 38 full-scale ranges.
- VOLTS: DC, AC, and Out-put -0 to 1, 5, 10, 50, 500, and 5000.
- AC and DC CURRENT: 0 to 1 ma, .1 amp, and 1 amp.
- OHMS: 0 to 500, .1 meg, and 1 meg.
- SIX db RANGES: -20 to +69.
- 400 μ a meter movement. DIMENSIONS: 6 3/4 x 5 1/4 x 3" - 3 lbs.
- Model 556-K Same as 566-K, but with 1% precision resistors. Complete Kit \$16.90
- Model 556 Factory Wired with 1% precision resistors 23.50



3-INCH METER 1000 OHMS-PER-VOLT

- Model 536-K Complete Kit \$12.90
- Model 536 Factory Wired 14.90
- 31 full-scale ranges.
- VOLTS: AC and DC -0 to 1, 5, 10, 50, 100, 500, 5000.
- AC and DC CURRENT: 0 to 1 ma, .1 amp, .1 amp, 1 meg.
- OHMS: 0 to 5000, .1 meg, and 1 meg.
- SIX db RANGES: -20 to +69.
- 400 μ a meter movements.
- DIMENSIONS: 6 1/2 x 3 3/4 x 2 3/4" - 2 lbs.
- Model 526-K Same as 536-K, but with 1% precision resistors. Complete Kit \$13.90
- Model 526 Factory Wired with 1% precision resistors 16.90

HARVEY RADIO CO., INC.

103 W. 43rd Street, New York 36, N. Y. • JUdson 2-1500

SCALA SUPER-MARKER INJECTOR



mixer-amplifier unit mixes small sample of sweep voltage with small sample of marker voltage (from external sweep-marker generator). Injects a large, stable pip into scope being used for alignment of TV receiver. Marker pip is always same size—from base line to top of curve. Pip does not affect pattern on scope, even at resonance peaks. Greatly speeds up and simplifies alignment jobs. Separate video and marker gain controls. May be used with any standard marker generator, sweep generator, and scope. Five tubes and Germanium diode. Size, 10x8x7". Cables and instructions supplied. For operation from 110-120 volts, 60 cycle AC. Net, at leading jobbers, \$67.50.

SCALA TEST PROBES—

—May be accurately used with all oscilloscopes—

- BZ-1 Signal Tracing Probe for individual check of IF stages, calibrating marker generator, checking output of sweep generator, etc. Low C, Hi-Z demodulator range, non-resonant to 225 mc; useful to 1000 mc. Cables supplied. Net, at leading jobbers, \$9.75.
- BZ-2 Low Capacity Probe permits tracing waveforms through Hi-Z circuits without distortion from circuit loading. Cuts effective input capacity of scope, attenuation 10 to 1. Net, at leading jobbers, \$9.75.
- BZ-3 Voltage Divider Probe for checking horizontal sweep waveforms and voltages at plates of horizontal output or damper tubes. Does not distort waveform. Net, at leading jobbers, \$9.75.
- BZ-4 Voltage Doubler Probe provides virtually double deflection on scope screen compared to half-wave probes. Dual low C Hi-Z demodulators useful to 150 mc. Net, at leading jobbers, \$10.75.

SCALA RADIO COMPANY, 2814—19th Street, San Francisco 10, Calif.

IMPEDANCE MATCHING

Patent No. 2,657,362

William H. Epperson, Coral Gables, Fla.
(assigned to Aeronautical Communications Equip., Inc.)

Many hams and commercial operators use the Collins (pi) network or a similar type. It is an efficient arrangement for matching a final amplifier to any antenna system. However, it requires several adjustments. In its simplest form, there is an input capacitor, an output capacitor and an inductor, all of which may need adjustment. This patent is a single dial control for obtaining optimum impedance match.

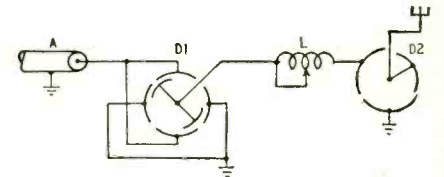
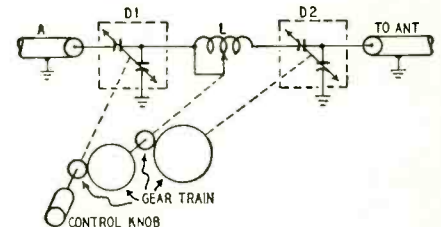

In the diagram, transmission line A (from final amplifier) feeds voltage divider D1. The output of D1 then flows through variable inductor L to a second divider, D2. D1 and D2 are differential capacitors with split stators. For example, as D1 varies it may increase its series capacitance while decreasing its shunt capacitance. After the rotor passes a stator, this is reversed. D1 and D2 may rotate continuously; the effect is that of a tap that moves continuously up and down on each divider.

Using a train of gears, D1, D2 and L are controlled simultaneously by a single dial; but each varies at a different speed. The variation of L is slowest. It makes only one complete variation (from maximum to minimum or vice versa) while D2 undergoes 15 complete cycles, and D1 makes 600 complete cycles.

To tune the network, L is adjusted first. Its variation is slow, so it remains nearly constant while the optimum setting for D2 is located. Finally, the dial is rotated further to tune D1. The latter requires relatively little dial rotation, so its tuning does not disturb the other two components which are already tuned to the best operating point.

Because of its single-dial feature, this invention may be adapted for automatic control. It is operated by a motor which rotates until maximum power is delivered to the antenna.

D.C. TO A.C. CONVERSION

Patent No. 2,659,043

James E. Taylor, New York, N. Y.
(assigned to Norden Laboratories Corp., White Plains, N. Y.)

A.c. amplifiers are more stable than circuits for d.c. The d.c. amplifier requires direct coupling, so they may be troubled with random emission, drift, etc. For best results, a weak d.c. should first be converted to a.c., then amplified.

This converter uses a bismuth coil in the gap

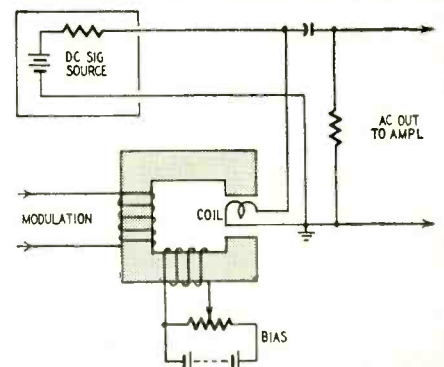

of an electromagnet. Bismuth has the property of varying resistance in a magnetic field. For example, its resistance becomes three times greater if placed in a field of 34,000 gauss. The electromagnet is energized by a.c. This produces an alternating field which modulates the resistance of the coil. Thus, although the coil is fed from a d.c. source, its current has an a.c. component that can be amplified.

The coil's resistance depends only on the strength of the field, not its direction. Thus the positive and negative half-waves of modulation have the same effect on the resistance. The resistance of the coil undergoes two complete cycles of variation for each cycle of a.c. If this is not desirable, a d.c. supply should be added (as shown) to bias the electromagnet. This produces a direct (but pulsating) field. The a.c. output has the same frequency as the modulation, when d.c. bias is added.

NOISE GENERATOR

Patent No. 2,658,149

Charles J. Gallagher, Schenectady and Stanley Ruthberg, Middletown, N. Y. (assigned to United States of America as represented by the Secretary of War)

A noise generator covers a wide band of frequencies. This generator produces a uniform signal that ranges from audio frequencies to several megacycles. It uses a diode within a magnetic field.

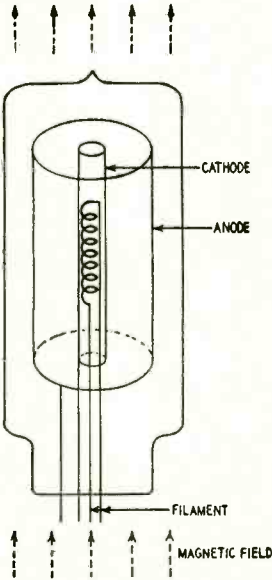

The diagram shows how the tube is constructed. Its cathode and anode are cylindrical. The tube is filled with argon to a pressure of 15 microns and is placed in a vertical magnetic field of about 830 gauss.

Under the influence of the positive anode and magnetic field, electrons leave the cathode and move along spiral paths. These spirals fall short of the anode, so the electrons soon return to the cathode. Practically none arrive at the anode. Due to continual collisions between electrons and gas molecules, a continuous noise spectrum is generated. END

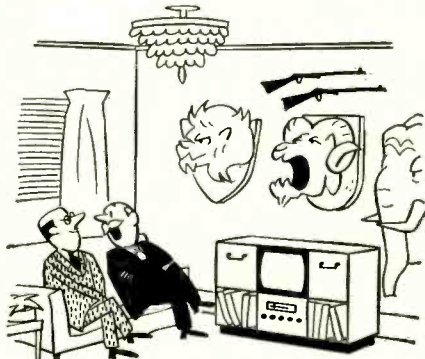

Side Program

"You'll never guess where they installed the speaker"

APRIL, 1954

**STAN-BURN
ELECTRONICS**

CATHODE RAY TUBE SPECIALS

| ONE YEAR GUARANTEE | | STAN-BURN | |
|--------------------|--------|------------|--------|
| G.E. | | STAN-BURN | |
| 7JP4 | 517.10 | 10BP4 | 510.50 |
| 10BP4A | 19.25 | 12LP4 | 12.50 |
| 10FP4A | 24.00 | 12LP4A | 14.50 |
| 12KP4A | 27.10 | 12QP4 | 12.50 |
| 12LP4A | 21.70 | 12RP4A | 12.50 |
| 12QP4A/B1014 | | 12UP4A | 15.00 |
| Dumont | 21.00 | 14CP4 | 17.00 |
| 12UP4B | 28.75 | 15DP4 | 18.50 |
| 14CP4 | 24.50 | 16KP4 | 18.50 |
| 15DP4/B1014 | | 16DP4 or A | 18.50 |
| Dumont | 23.75 | 16P4 or A | 18.50 |
| 16AP4A | 30.95 | 16CP4 or A | 18.50 |
| 16DP4A (N.U.) | 25.25 | 16FP4 | 18.50 |
| 16GP4 or B | 31.25 | 16WP4 | 18.50 |
| 16HP4/16RP4 | 24.20 | 16P4A | 19.00 |
| 16KP4A | | 16AP4A | 23.00 |
| (Aluminum) | 28.75 | 16EP4 | 19.00 |
| 16LP4A (N.U.) | 25.25 | 16FP4A | 23.50 |
| 16LP4A | 28.50 | 16GP4 or A | 21.00 |
| 16WP4A | 26.50 | 17BP4 | 19.50 |
| 16GP4B | 31.25 | 17CP4A | 21.60 |
| 17BP4 | 24.00 | 17GP4B | 22.60 |
| 17CP4 | 23.90 | 19FP4 | 23.00 |
| 17CP4B | | 19FP4A | 24.00 |
| (Aluminum) | 29.00 | 19AP4 | 23.90 |
| 19AP4A | 41.50 | 19AP4A | 24.90 |
| 20CP4 | 34.50 | 20CP4A | 26.00 |
| 20P4 | 37.50 | 21EP4 | 26.50 |
| 21AP4 | 42.00 | 21AP4 | 26.50 |
| 21EP4A | 36.35 | 24AP4 | 49.00 |
| 24AP4A | 78.50 | | |

QUANTITY CRT USERS
We will give you DUD allowances if you ship them to us Prepaid, 10 CRT's minimum shipment. WRITE FOR DETAILS.

ANTENNA SPECIALS

| | | | |
|--|----------|-------------|------|
| RED DOUBLE "V" Antenna | 2.19 | 6 or more | 1.5 |
| 10 ELEMENT CONICAL Dowled Insert | 2.98 | | 1.98 |
| Folded Hi Straight Low Quick Rig 1/2" elements | 4.25 | | 3.25 |
| WINDOW CONICAL 5 FOOT SWEGGED | 4.95 | | 3.75 |
| MASTS 10 FOOT PLAIN | 1.39 | | 1.29 |
| NEPCO MASTS | 1.69 | | 1.49 |
| TV WIRE 55 Mil. 300 OHM | | 99.95 M Ft. | |
| 72 OHM COAXIAL | | 11.95 M Ft. | |
| | | 35.00 M Ft. | |
| CHASSIS 630 TECHMASTER | | | |
| Model C-30 with Cascode Tuner | \$149.50 | | |
| OPEN FACE CABINET | \$42.00 | | |

TAPE RECORDERS IN STOCK

| | | |
|--|-------------|------------------|
| PENTRON—Model 9T3C—2-speed Tape Recorder | | Write for Price. |
| RADIO CRAFTSMAN Model C400—Hi Fi Amplifier | Net \$42.90 | |
| Model C10—AM-FM Tuner | Net \$31.50 | |
| Model C50—Williamson Amplifier | Net \$9.50 | |
| We also carry MASCO—BOGEN—PILOT, etc. Amplifiers—Pre-Amps, FM Tuners and WEBSTER Tape Recorders. | | |
| 6"x9" PM SPEAKER | \$3.98 | |
| 7" PM SPEAKER | 3.98 | |
| 70" Yoke | 1.98 | |
| 630 Vert. Output Upright | 1.98 | |
| 630 Vert. Output Potted | 1.29 | |
| 630 Vert. Blocking Osc. Xform. | 1.29 | |
| CASCODE TUNERS | 17.95 | |
| DUMONT 21.25 mod. | 14.95 | |
| Famous INPUTUNER | 10.00 | |
| TV Permanent Magnet Focus Assembly | 1.98 | |

CONVERSION SPECIAL

21EP4 American Standard Tube—21" Beveled Mask—Ram Conversion Kit. (Mention set to be converted) **\$43.50**

AUTHORIZED DISTRIBUTORS for: General Electric, Kenrad, Tung-Sol, National Union, De Wald, Regal, Automatic and General Motors.

AUTOMATIC CUSTOM-BUILT RADIOS for Plymouth, Ford, Chevrolet and many others, always in stock.

We carry a complete stock of HI-FIDELITY and SOUND EQUIPMENT. Send us your requests. We also carry a complete line of popular makes of Radio tubes at 50/10% discount. Also many other special purpose and transmitting types, and all electronic parts and equipment at lowest prices. Send us a list of your requirements for prompt quotations. Terms: 20% with order. Balance C.O.D. All prices FOB. NEW YORK Warehouse. Minimum order \$5.00. Write for our latest price list and Hi-Fi Catalog to Dept. RE-4.

STAN-BURN RADIO and ELECTRONICS CO.
(C.B.S. THEATRE BLDG.)
1697 BROADWAY • NEW YORK 19, N.Y.

TAKE IT FROM EDWIN SCHAFFER:

"KRYLON TV Acrylic Spray cuts down contract calls, and spreads the word about my servicing reliability!"



Edwin G. Schaffer, President, Edwin G. Schaffer Co., 7920 Frankford Avenue, Phila., sprays hi-dielectric strength KRYLON on the high voltage sections of TV receivers to prevent corona . . . and he also sprays KRYLON on antennas to weather-proof them. KRYLON TV Acrylic Spray is crystal clear . . . gives lasting protection. It's the push-button spray coating that's become the TV industry's most useful right-hand man!



KRYLON, INC.

2038 Washington Ave., Phila 46, Pa.

Krylon also available in Bright Aluminum, Flat Black, Glossy Black, Touch-up White, and Bright Gold.

AT TV JOBBERS EVERYWHERE

CLOSE OUT! ONE SHOT!

| | | |
|---|--------------|-------|
| 100 FM-Quick Rig Antennae—Complete with 5 foot pole and Guy Ring | ea. | 2.00 |
| 6,000 Chimney Mounts—Model CM-4—"Z" Type—Strapping slightly tarnished in some | ea. | .55 |
| | In Gross | .52 |
| 6,000 Chimney Mounts—Model CM-Y—"Y" Type—Strapping slightly tarnished in some | ea. | .60 |
| | In Gross | .55 |
| 280 Mod Carrier type Peak Roof Mounts—Model HC-6 | ea. | 1.10 |
| 489 Mast Joiners—Model MJ-2 | ea. | .15 |
| 120 Pair—18" Eave Mounts with support—Model EM-18 | ea. | 1.40 |
| 2,000 Standard Brand Tubes—Bulk—Out of Date but New—6BA6 | ea. | .51 |
| 120 Pair—16" Eave Mounts with Support—Model EM-18 | ea. | 1.40 |
| 20 Metal Bases for Webster Changers | ea. | 2.25 |
| Galvanized steel strapping—1/8" X .023 | per lb. | .01 |
| 80,000' RG59U Coaxial Cable in 60 Foot Hanks | per hank | 1.25 |
| 3000 3" Wall Mounts—WM-2 | ea. | .26 |
| 2,000 6W4GT Standard Brand—Bulk—Out of Date | ea. | .57 |
| 150,000' 300 Ohm Twin Lead on 2500' spools—20/65 (order in 2500' spools) | per 1000 Ft. | 10.00 |
| 92 PM-6 Peak Mounts—Adjustable for slant of roof | ea. | 1.10 |
| 460 Guying Clamps—Model GC-4 | ea. | .09 |

ORDER ANY PART OR ALL—25% WITH ORDER—BALANCE C.O.D. FIRST COME—FIRST SERVED

METALACE CORPORATION—2101 Grand Concourse, Dept. E, Bronx 53, N.Y.

off. When a reasonably strong signal is received, the detector output biases V1 to cutoff. There is no current through R1, so V2 operates normally. When V1 and V2 are 6AT6's or British type EBC41's, the circuit constants shown permit the squelch to open at the same level that the delayed a.v.c. goes into operation. The squelch circuit can be disabled by closing the switch across R1.

The a.v.c. voltage is delayed by returning the cathode of V1 to a point about 2 volts positive on a voltage divider. The a.v.c. diode plate (D2) returns directly to ground so it is normally negative with respect to its cathode.

Materials for AM squelch

Resistors (1/2 watt or larger unless noted): 1—470, 1—2,200, 2—22,000, 1—100,000, 1—270,000, 1—470,000 ohms; 1—62,000 ohms, 1 watt; 4—1 megohm; 1—500,000 ohms; potentiometer with audio taper.
Capacitors: 1—50, 2—100 μ f mica or ceramic; 2—.02, 1—0.1 μ f, 400 volts, paper; 1—8 μ f, 450 volts, 1—8 μ f, 250 volts, electrolytic; 1 (unmarked on schematic) .05 μ f, 600 volts, paper.

C-R TUBE BEAM POSITIONING

While constructing an oscilloscope, I was faced with the problem of using single-ended beam-positioning circuits or buying new dual controls. A conventional single-ended control would do the job, but it permits serious defocusing of the beam as it sweeps across the screen. The problem is not nearly so bad with dual controls because the d.c. voltage on the deflection plates varies in opposite direction while the average voltage between them and the second anode remains almost constant.

This circuit shows how a single potentiometer can be used to approximate the performance of a dual con-

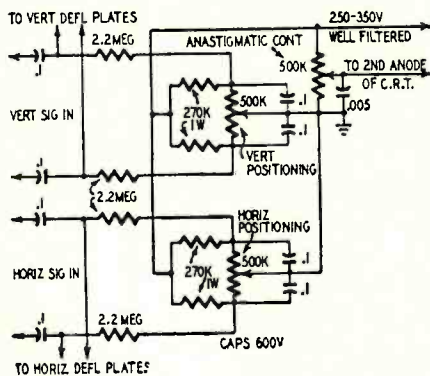

trol by simultaneously varying in opposite directions the voltage on both of a pair of deflection plates. The circuit also includes an anastigmatic control to further minimize defocusing.

Each deflection plate is about 150 volts positive with respect to ground and the positive side of the high-voltage supply (assuming a 300-volt B supply). The positioning controls are linear types so the resistance from the center to each end will equal the value of the series resistors.

The anastigmatic control permits varying the second-anode voltage as much as 150 volts above or below the average on the deflection plates to minimize defocusing of the beam at the edges of the screen.—L. H. Trent END

APRIL, 1954

first requisite FOR HIGH FIDELITY

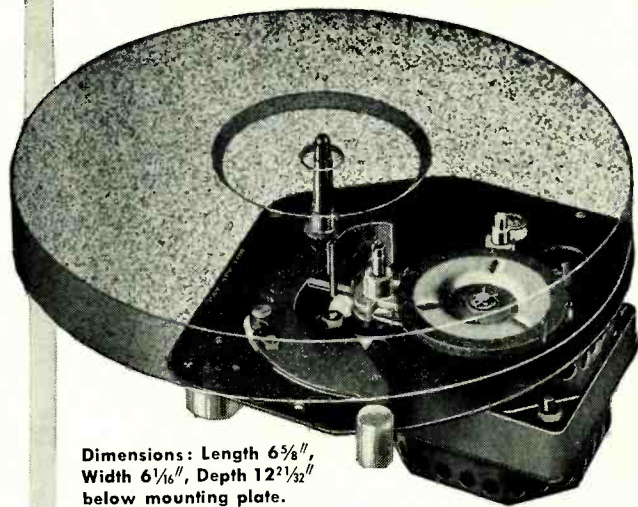

Dimensions: Length 6 5/8",
Width 6 1/16", Depth 12 1/32"
below mounting plate.

GENERAL INDUSTRIES Model DSS (4-pole) Phonomotor

Typical of General Industries' leadership in phonomotor design and engineering is this three-speed phonomotor, produced expressly to meet the rigid requirements of true, high-fidelity reproduction.

Model DSS is ideally suited for use with magnetic pickups. Its heavy-duty 4-pole, 4-coil motor holds stray field radiation to an absolute minimum. Moving speed shift lever to "OFF" position automatically disengages idler wheel from motor shaft and cuts off the current to the motor.

The Model SS, 3-speed phonomotor is well adapted to hi-fi systems where crystal or ceramic pickups are used. Idler wheel is disengaged from motor shaft during non-operating periods. Power by a 2-pole, shaded-pole type motor.

General Industries also offers a complete line of single and dual-speed models powered for either 2 or 4-pole motors. Write for complete information, including specifications and quantity price quotations.

THE GENERAL INDUSTRIES CO.
DEPARTMENT ME • ELYRIA, OHIO



EASY TO LEARN CODE

It is easy to learn or increase speed with an Instructograph Code Teacher. Affords the quickest and most practical method yet developed. For beginners or advanced students. Available tapes for beginner's alphabet to typical messages on all subjects. Speed ranges 5 to 40 WPM. Always ready—no QRM.



ENDORSED BY THOUSANDS!

The Instructograph Code Teacher literally takes the place of an operator-instructor and enables anyone to learn and master code without further assistance. Thousands of successful operators have "acquired the code" with the Instructograph System. Write today for convenient rental and purchase plans.

INSTRUCTOGRAPH COMPANY

4701 Sheridan Rd., Dept. RC, Chicago 40, Ill.

 * **Coils & Kits for THEREMIN** *
 * described in Jan. issue of Radio & *
 * T.V. News (Reprint upon request) *
 * Pretested coil assemblies: Pitch Control Coil *
 * \$2.95, Volume Control Coil \$2.95, Fixed Oscilla- *
 * tor Coil \$2.50, R.F. Transformer (T1) \$1.50. *
 * or all 4 for **ONLY \$8.95.** (Plus 1 lb. postage. *
 * We refund overpayments.) *
 * Kit containing all parts for construction of the *
 * Theremin. Chassis comes completely punched. *
 * Complete step-by-step wiring instructions and *
 * large, easy-to-read diagrams are included. *
 * Shipping wt. 25 lbs. **OUR PRICE \$59.95** (less *
 * cabinet) plus postage. *
 * Completely assembled and tested Theremin *
 * housed in a beautiful hand polished mahogany *
 * cabinet. 25 lbs. **OUR PRICE \$57.95.** *
 * **ONE YEAR GUARANTEE.** *
 * **R. A. MOOG Co.** 51-09 Parsons Blvd. *
 * FLUSHING, NEW YORK *

NEW **Electro** ELECTRONIC EQUIPMENT

completely assembled

6 and 12 volt
DC POWER SUPPLY
at a comparable **KIT PRICE**

MODEL D-612

UNMATCHED PERFORMANCE

only **\$39⁹⁵** Net

0 to 8, 0 to 16v. completely variable.
0 to 10 amps at 12 v. continuous.

This unbeatable combination of unequalled performance, low price and quality makes the D-612 a must for service technicians. Backed by Electro's reputation for high quality products.

CHECK! COMPARE! More uses for you! See Your Jobber

- Operates all auto radios. For relays, phone circuits, low voltage devices, electroplating and battery charging.
 - Less than 5% ripple over rated ranges.
 - Patented EPL conduction cooling.
 - Withstands high overloads for long service.
 - Same top quality as other EPL models.
- ... or contact factory for details and literature. You can't afford to be without the D-612, it's everything you need in a DC Power Supply.

Rush FREE Bulletin DCS-123, giving detailed specifications

ELECTRO PRODUCTS LABORATORIES

4501-Rd North Ravenswood Avenue — Chicago 40, Illinois

Manufacturers of Battery Eliminators and Power Supplies Since 1936

TELEVISION

Big demand for graduates

B.S. DEGREE IN 27 MONTHS in radio including TV engineering—VHF, UHF, AM and FM. Students use over \$100,000 worth of equipment including 2 large commercial type transmitters in new TV lab. Intense specialized course includes strong basis in mathematics, science and advanced design in radio and TV.

Hundreds of young men each year are earning engineering degrees in this recognized institution. Start any quarter. Many earn a major part of expense in this industrial center. Low tuition. Competent instruction. Thorough, intense, practical program.

Also B.S. DEGREE IN 27 MO. in Aeronautical, Chemical, Civil Electrical and Mechanical Engineering. G.I. Gov't approved. Enter June, Sept., Dec., March. Free catalog. **ENROLL NOW.**

INDIANA TECHNICAL COLLEGE
1744 E. Washington Blvd., Fort Wayne 2, Indiana

RADIO • TELEVISION SERVICEMEN!

HERE IS YOUR 1954 OPPORTUNITY TO DEVELOP A PROFITABLE SMALL APPLIANCE REPAIR SERVICE WITH PRESENT SHOP EQUIPMENT

We supply a complete program designed to maintain you in the highly profitable traffic appliance repair field.

ELECTRIC SWEEPER SERVICE CO.

"The House of **ESSCO** 100,000 Parts"

2034 EUCLID AVE. • CLEVELAND 15, OHIO

TRY THIS ONE

LOCATING A BREAK IN OPEN CABLE

Finding the break in a bad piece of cable can be a discouraging bit of guesswork, and for short lengths of inexpensive cord it is probably best to replace the entire section. However, for multiconductor cables it may be worth while from a cost point of view to locate and repair the break.

The simple method described here, using measurements made with a capacitor checker, has been found to be quite accurate. In one case where an open occurred in the cable for an Altec Lansing 21-B microphone, the break was found within half an inch of the calculated location. This particular cable has lines for filament, B plus, ground, and signal, so random cuts for testing would probably have been extremely risky.

As shown in the photo, the cable end



is connected directly to the capacitor analyzer terminals with short pieces of wire, to avoid uncertain capacitance between the leads of the tester. An ohmmeter was used to identify the open conductor and one good conductor. Measure capacitance on these two leads from both ends of the cable, and then compute the distance by the formula:

$$L_x = L_t \times \frac{C_a}{C_a + C_b}$$

where L_x is the unknown distance in feet from A to the break, (see diagram) L_t is the total length of the cable, C_a

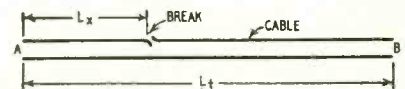

is the capacitance at end A, and C_b is the capacitance at end B, in μmf . For example, when L_t is 50 feet and C_a and C_b are 250 and 500 μmf respectively:

$$\begin{aligned} L_x &= 50 \times \frac{250}{250 + 500} \\ &= 50 \times 250/750 \\ &= 16.66 \text{ or } 16 \text{ feet and } 8 \text{ inches} \end{aligned}$$

From this procedure you can see that cable length and capacitance go right along together. Thus, for a certain over-all length there is a certain capacitance, and for a fraction of this length there will be the same fraction of capacitance.

It is good practice to have the two ends handy at the tester terminals at the start so the cable will not have to be disturbed, because this may change the condition at the break.—Hugh Lineback

TUBE IDENTIFICATION

Most service technicians and experimenters have a set of good tubes which they use only as substitutes for questionable ones when testing or repairing equipment. Sometimes the tubes get mixed and it is difficult to tell which tube is the original and which is the substitute.

Confusion can be avoided if the test tubes are marked. Stickers marked TEST can be glued to the tubes, or the bottoms of bakelite-based types can be notched with a file or marked with nail polish.—*B. W. Welz*

HOT-TUBE PULLER

A corrugated insert from inside a miniature tube carton can be used to avoid burning your fingers while removing hot tubes from tight spots in a radio or television set. Simply slip the insert over the tube before removing it.—*R. B. Frank*

HIGH-EFFICIENCY WAVE TRAP

Blanketing and overloading often cause serious interference problems on radio receivers operated in the immediate vicinity of powerful broadcast transmitters. There are a number of ways of combating this type of BCI. The trap shown in the diagram is one of the most effective for this purpose that I've ever seen. When properly constructed and adjusted on the broadcast band, it is possible to have 30-db rejection at the carrier frequency while signals 10 kc on either side are hardly affected.

For broadcast stations between 540 and 1600 kc, use a 30-250- μ f capacitor and a 350- μ h, high-Q, low-loss inductor wound in a single layer and tapped at the exact center. (The author did not include coil-winding data. You can use about 120 turns of No. 18 enameled wire close-wound on a 2½-inch low-loss form.—*Editor*) The trap components must be mounted in a shielded box and there should not be any exposed lead between the shield and the receiver's antenna post. If necessary, use coaxial between the trap and the receiver. Mount the tuning capacitor clear of the shield and use an insulated flexible coupling and a plastic rod in

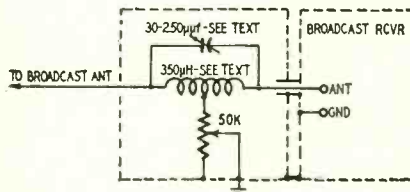

order to bring the shaft through the shield can.

When adjusting the trap, set the potentiometer for maximum resistance, tune in the unwanted station on the receiver, tune the capacitor for minimum signal, adjust the resistor for a deeper minimum, and then touch up the capacitor setting.—*CP1BK* END

A fascinating field! A great future! A good job or independence in a business of your own! TV is growing by leaps and bounds—1227 new communities, 1845 new stations given "go-ahead", Trained men are worth their weight in gold!

COYNE HAS TRAINED MORE SUCCESSFUL MEN

Thousands of successful men trained at COYNE—the largest, oldest, best-equipped school of its kind (established 1899). A Coyne-trained man is a top-trained man. Coyne methods require no advanced education or previous experience.

TRAINING TAILORED TO MEET YOUR NEEDS

Resident Shop Training—You can learn on real equipment in the Great Shops of Coyne. Learn quickly-easily at Coyne. Practical Technical method gives practical experience on massive outlay of full-size equipment plus necessary technical training. Finance Plan whereby you can enroll now and pay most of tuition later. Also Monthly Payment Plan especially designed for K-Vets. If you need part-time work to help out with living expenses while at COYNE, we'll help you get it. Coupon brings FREE BOOK and details.

OR

Coyne Tested Home Training—To those who cannot come to the Coyne shops here in Chicago, we offer modern, up-to-the-minute training designed to meet Coyne standards. Practical, down-to-earth, easy to follow, step-by-step instruction. So practical, you can quickly be earning money in

B. W. COOKE, President FOUNDED 1899

COYNE ELECTRICAL SCHOOL
A TECHNICAL TRADE INSTITUTE CHARTERED NOT FOR PROFIT
500 S. Paulina Street, Chicago 12, Dept. 44-TR4
ELECTRICITY • RADIO • TELEVISION • REFRIGERATION • ELECTRONICS

Television and Radio while learning—personal supervision by Coyne Staff—men who know TELEVISION AND RADIO, AND KNOW HOW TO TEACH IT—and the cost is low—you pay only for training—no costly extras. Send coupon below for Picture Folder and full details, including easy Payment Plan.

MAIL COUPON FOR FREE INFORMATION

Fill in and mail coupon. TODAY, Check the training you're interested in. If you want information on both, check both. Complete details will come by return mail. No cost—No obligation—No salesman will call.

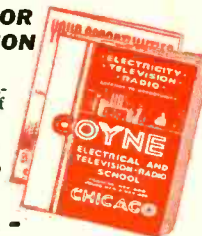

B. W. COOKE, President
COYNE ELECTRICAL SCHOOL
500 S. Paulina Street, Chicago 12
Dept. 44-TR4

Send details of your offer on training checked below. This does not obligate me and no salesman will call. I am interested in:

- TELEVISION-RADIO HOME TRAINING
- TELEVISION-RADIO IN COYNE SHOPS

Name

Address

City State



Free!
Get More Service Calls with **EICO DECALS**
For Store Windows & Cars.
Write EICO
Brooklyn 11, N.Y. Dept. DC-4

ENJOY 3 COLOR TELEVISION FILTER SCREEN NOW

Changes dull eye-straining black and white pictures into beautiful color tones. Seconds to attach. No tools used. Helps eliminate glare and snow in fringe areas. Order direct. Send \$1 for screen size up to 16". \$1.25 size 17". \$1.50 size 20". \$2 size 21". \$2.50 size 24". \$3 size 27". (Also available are single solid color screens in blue, green, or amber.) Prices on solid color screens are 10% less. We pay postage except on C.O.D. orders. Satisfaction Guaranteed. Inquiries from dealers also welcomed.
Zingo Products, Johnstown 13, New York

PRES-PROBE CONDENSER TESTER



Finds Intermittent Condensers Instantly

NET **795** Postpaid U.S.A.
Pres-probe's sliding tip with variable resistance prevents condenser heating. Tests with power on. Requires no adjustment. Stops guesswork. Saves time. Convenient probe size (7/8" long). Satisfaction guaranteed.

See Your Dist. or Order Direct

PRES-PROBE CO.

4034 N. Sixth St., Milwaukee 12, Wisc.

Here's how to GET MORE WORK OUT OF YOUR Oscilloscope!



A complete, easily understood guide to using the handiest, most profitable service instrument of all MODERN OSCILLOSCOPES AND THEIR USES

By Jacob H. Ruiter, Jr.

of Allen B. Du Mont Laboratories, Inc. 326 pages, 370 illustrations. Price \$6.

Oscilloscopes are gold mines for servicemen who learn to use them fast, fully and accurately on all types of work—and here at last is a book that really shows you how.

In clear, easily understood terms, it teaches you when, where and exactly how to use the oscilloscope . . . how to interpret patterns . . . how to use your 'scope to handle tough jobs easier, faster, and better.

It contains no involved mathematics—no complicated discussions. Instead, it gets right down to "brass tacks" in explaining how oscilloscopes operate. Then you learn exactly how to use them in lab work and on all types of AM, FM and television service—from locating troubles to handling tough realignment jobs.

Each operation is clearly explained step by step. You learn to determine just where and how to use the 'scope on a specific job; how to make connections and adjust the circuit components; how to set the controls; and HOW TO ANALYZE OSCILLOSCOPE PATTERNS fast and accurately. 370 illustrations including dozens of pattern photos make things doubly clear.



No other type of specific service training can mean so much to you in boosting your efficiency and earning power! Send coupon NOW for 10-day FREE examination!

'SCOPE EXPERTS get better jobs . . . bigger pay!

PRACTICE 10-DAYS FREE!

Dept. RE-44
RINEHART & COMPANY, Inc.
232 Madison Ave., New York 16, N. Y.

Send MODERN OSCILLOSCOPES AND THEIR USES for 10-Day FREE EXAMINATION. If book is satisfactory, I will then send you \$6.00 plus postage promptly in full payment. If not, I will return book postpaid in good condition and owe you nothing.

NAME

ADDRESS

CITY, ZONE, STATE

OUTSIDE U.S.A. \$6.50, cash only. Money back if you return book within 10 days.

QUESTION BOX

VOLTAGE MULTIPLIERS FOR TRANSFORMERLESS TV SUPPLY

? I am constructing the DeLuxe Televiser from details given in the January through May, 1950, issues. A suitable power transformer is difficult to find, so I have decided to substitute a transformerless B plus supply if you will kindly print a diagram.—G. S., Philadelphia, Pa.

bypassed by a capacitor of about .001 μ f. Even then, use extreme caution when handling the chassis (or that of any other receiver using a transformerless supply).

The quadrupler output voltage is about 400 under load and is quite a bit higher before the load is applied, so, a

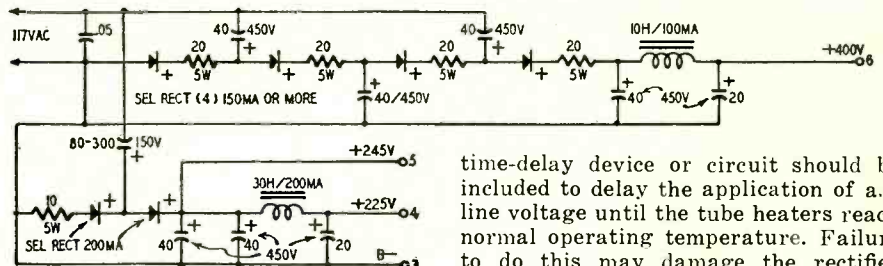

A. The transformerless B supply circuit shown consists of a quadrupler delivering 400 volts and a voltage doubler delivering a maximum of about 245 volts.

When using a supply of this type, insulate the B minus bus from the chassis and connect it to the chassis through a resistor of about 200,000 ohms or so

time-delay device or circuit should be included to delay the application of a.c. line voltage until the tube heaters reach normal operating temperature. Failure to do this may damage the rectifier units. A delay of about 30 seconds should be sufficient. Thermostatic-type delay relays made by Amperite and others are readily available from most radio and electronic parts distributors.

The output terminals are numbered to correspond to those on the original receiver diagram in the March, 1950, issue.

CONVERTING ZENITH MODEL 7D222 TO PUSH-PULL OUTPUT

? I would like to convert the output stage of a Zenith 7D222 a.c.-d.c. radio into a push-pull circuit using as many of the original components as possible. Please print a circuit showing a simple modification.—C. H. L., St. Louis, Mo.

swings with the audio signal on the grid. The audio signal on the screen of V1 is fed to the control grid V2. Adjust the value of the 6,800-ohm screen resistor for equal signal voltage on the 25L6 control grids.

A. The diagram shows one method of converting the power amplifier circuit to push-pull. A resistor of approximately 6,800 ohms is inserted in series with the screen grid of the driven output stage (V1). The screen voltage

If you replace the 25Z6 rectifier with a 100-ma selenium rectifier, you can use the socket for the extra 25L6. This arrangement will also make it possible to add the extra tube without changing the value of the filament-dropping resistor.

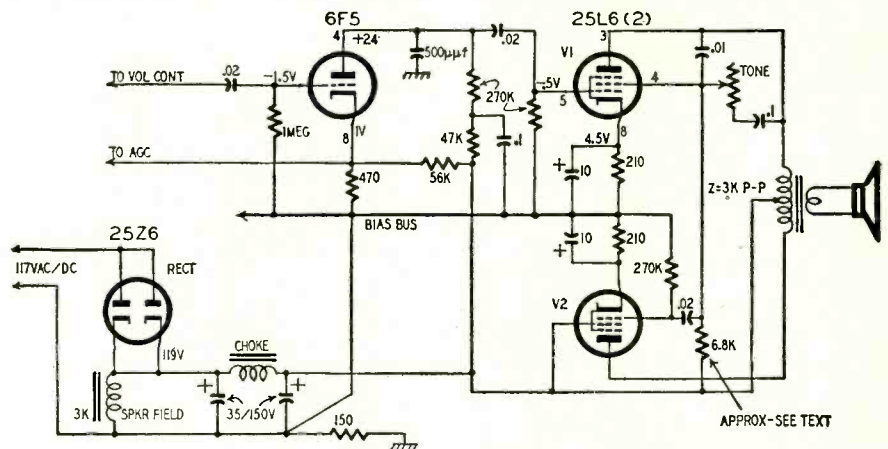

CONSTRUCTING A 10-ELEMENT YAGI FOR CHANNEL 7 AND 9

? I want to construct 10-element Yagi antennas for TV channels 7 and 9. Please print diagrams showing the pertinent dimensions.—Z. S., Mercedes, Argentina

quency end (in megacycles) of the desired channel. For example, f is 174 for channel 7 and 186 for channel 9. The spacing between the reflector and radiator and between the directors is set at about 0.2 wavelength to provide high gain with a good back-to-front ratio.

A. The diagram (Fig. 1) shows the construction of a 10-element Yagi with constants which may be used to find the dimensions in inches for any frequency for which a Yagi is practical. Simply divide the constants by f , the low-fre-

The folded-dipole radiator should consist of 1-inch and $\frac{3}{8}$ -inch conductors spaced 1 inch center-to-center to match a 300-ohm lead-in.

There are a number of ways to connect the ends of the dipole conductors. Perhaps the simplest is to use metal clamps or straps made of the same ma-

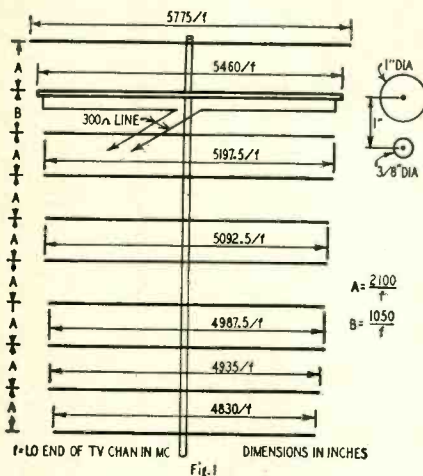

Fig. 1—Diagram of 10-element Yagi.

terial as the dipole conductors. Fig. 2 shows two types of straps. The type at a is easier to construct since it can be bent from comparatively thin sheet metal. One piece is needed for each end

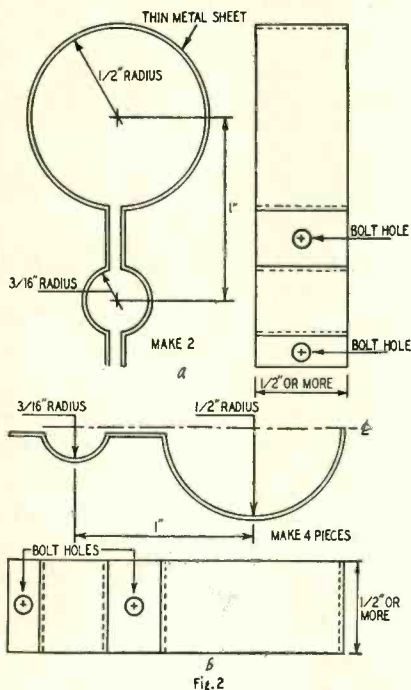

Fig. 2—Two types of mounting straps.

of the dipole. The type at b is more difficult to form because thicker metal is required. However, it is not too hard a job if you have access to a fairly heavy bench vise. END

Dear Lady

by Jeanne DeGood

Don't let your husband keep his threat
To fix your TV set;
If anything will make it rattle,
That'll!

irish BRAND GREEN BAND Professional



The *Finest Tape Your Recorder Can Use...*

Just as the reflection of a perfect mirror is faithful to the original image, in every detail, so too does IRISH Green Band RECORD, RETAIN, and REPRODUCE the original sound with flawless fidelity.

Instruments will reveal that IRISH Green Band offers lower noise level, uniform sensitivity, minimum amplitude variation, less distortion. But instrument tests are only the landmarks of good design and production. The final proof is in the hearing. To appreciate the quality of IRISH Green Band Tape, it must be listened to and compared with other tapes on the same recorder.

You will find that the only limitation to IRISH Green Band quality is the limitation of the tape recorder itself... it is the finest tape your recorder can use.



irish GREEN BAND professional

is fast becoming the choice of audio engineers in broadcast stations, recording studios and wherever sound quality is of paramount importance.

1200 feet on plastic reel... \$3.30 net
2400 feet on metal or
fiberglass reel... \$7.71 net

One day you will surely use IRISH...
so write today for free test sample reel.

irish BROWN BAND for POPULAR PRICED RECORDERS

IRISH Brown Band, expressly designed for home and office recorders. Reproduces with true fidelity the frequency range from 100 to 8000 cycles. A high quality, plastic base tape for the price of ordinary paper tape!

1200 feet, plastic base, on
plastic reel... \$2.50 NET

At all leading radio parts distributors

ORRADIO INDUSTRIES, INC.

OPELIKA 5, ALABAMA

World's Largest Exclusive Magnetic Tape Manufacturer
EXPORT DIVISION: Morhan Exporting Corp., 458 Broadway, New York, N. Y.

SOUND RECORDING

TRAIN AT HOME FOR COLOR-TV and

TELEVISION SERVICING

Learn practical, professional type TV Servicing without leaving your present job. Included are money-making extras, such as set conversion, master antenna installation, UHF-TV, NTSC Color System, field servicing short cuts. You can start earning Television money after first few lessons. You learn to test, trouble shoot and repair all types of TV sets.

HERE'S HOW YOU GET EXPERIENCE!

You train on a large screen, modern TV receiver, furnished with the course and yours to keep! As an optional feature you can get two weeks actual experience with Chicago's largest independent servicing organization. You learn by doing! Age is no barrier. Many students are over 40! ACT NOW! Send for FREE Catalog and SAMPLE LESSON today!

TV COMMUNICATIONS INST.
605W. Washington Blvd., Dept. RE-28
Chicago 6, Ill.

VETERANS! T.C.I. is approved for G.I. training. Under Public Law 550, Check coupon.

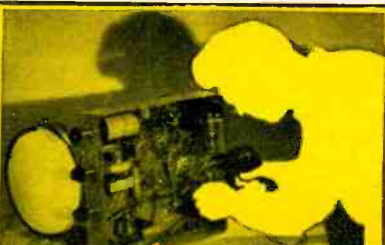

MAIL NOW FOR FREE BOOKLET

MILTON S. KIVER, President
TELEVISION COMMUNICATIONS INST.
605 W. Washington Blvd., Dept. RE-28, Chicago 6, Ill.
Rush FREE Catalog and Sample Lesson. I am not obligated. Salesman will not call.

Name..... Veterans; Check here

Address.....

City..... Zone..... State.....

BEGINNERS check here for Basic TV Course.

NOW EICO® brings you
A LABORATORY SCOPE AT A PRICE YOU CAN AFFORD!

Now you can enjoy all the tremendous advantages of trouble-shooting with the greater speed, precision and visual meaning which only an oscilloscope gives you. With the EICO 5" Scope you can:

- Visually align TV, FM and AM sets
 - Visually signal trace and trouble-shoot every stage of any electronic device
 - Visually analyze complex waveforms
- All without disturbing circuits

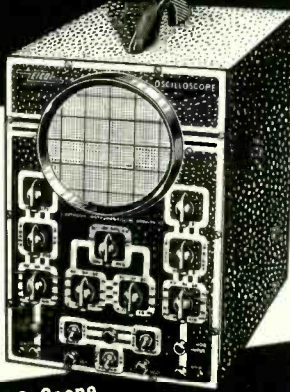

425K 5" Push-Pull Scope KIT \$44.95. Wired \$79.95.

NEW 3 PROBES make 3 INSTRUMENTS of your EICO Scope

DEMODULATOR PROBE KIT \$3.75. Wired \$5.75 — For signal tracing every stage of TV, FM and AM sets.
 LOW CAPACITY PROBE KIT \$3.75. Wired \$5.75 — For broad bandwidth and high impedance circuits.
 DIRECT PROBE KIT \$2.75. Wired \$3.95 — For voltage and current measurements and general analysis.

Special introductory price, set of three PROBE KITS \$9.95. Wired \$14.95

- Compare these specifications with scopes selling at many times the EICO economy price!
- Push-pull Vert. & Hor. amplifiers
 - Full-screen V & H centering controls
 - Intensity (Z-axis) mod.
 - 6.3 volt AC, 60 cps test signal output
 - Direct connections to deflection plates
 - V & H Freq. Resp: 5 cps — 500 kc; usable to 2.5 mc.
 - V Sens: .05 to .1 volts rms/inch
 - V & H input imp: 1 megohm
 - Multivibrator Sweep Generator Range: 15 cps — 75 kc
 - Tubes: 2-5Y3, 2-6J5, 3-6SN7, 1-5" CRT.



See this amazing Scope value at your jobber today. Write NOW for FREE Catalog SC-4 describing the complete EICO line. Turn to our full page ad on page 30 of this magazine.

ELECTRONIC INSTRUMENT CO., INC.
 84 Withers Street, Brooklyn 11, N. Y.

WE SPECIALIZE EXCLUSIVELY IN TUBES RECEIVING — XMITTING SPECIAL PURPOSE, ETC.

AT LOWEST WHOLESALE PRICES!

The only thing we handle is—TUBES—of every kind and description—serving the industry for years. Thus, we can give you a more comprehensive selection of types and the advantage of more competitive prices. All our tubes are fully guaranteed. From amongst the 3000 different types we have in stock, for immediate delivery, we list here only a few of the common types. These are but a sampling of our immense variety—therefore we urge you to order any other unlisted types. Minimum order \$10. Please include 25% deposit with order.

| | | | | | |
|-----------|------------|------------|-----------|-------------|------------|
| 08Z .74 | 6C5 .39 | 6SG7GT .40 | 7Z4 .49 | 12SC7 .69 | 43 .55 |
| 024 .54 | 6C6 .55 | 6SH7GT .50 | 10Y .69 | 12SF8 .49 | 4523 .42 |
| 1A4AP .39 | 6C8B .45 | 6S17 .49 | 12A6 .69 | 12SH7GT .59 | 35C5 .37 |
| 1ASGT .39 | 6C8E .45 | 6SL7GT .44 | 12AH7 .89 | 12SG7 .75 | 35W4 .37 |
| 1A6 .37 | 6C8G .45 | 6SN7GT .52 | 12AT6 .39 | 12SH7 .75 | 50B5 .40 |
| 1A8S .39 | 6C9 .69 | 6SR7 .45 | 12AT7 .69 | 12SK7GT .62 | 50C5 .44 |
| 1AX2 .61 | 6AF4 .89 | 6D8 .98 | 12A7 .69 | 12SL7GT .49 | 50L6GT .62 |
| 1B3 .67 | 6AF6 .75 | 6DB .98 | 12A8 .69 | 12SQ7 .54 | 50Y6GT .59 |
| 1B5 .26 | 6AG5 .46 | 6E5 .39 | 12A7 .69 | 12SR7 .49 | 50Z6 .64 |
| 1C5GT .35 | 6AG7 .95 | 6F7 .93 | 12A7 .69 | 12S7 .55 | 50Z6GT .59 |
| 1C6 .35 | 6AJ5 1.49 | 6F8 .99 | 12A7 .69 | 12S7 .55 | 50Z6GT .59 |
| 1C6GT .39 | 6AK5 .73 | 6F8G .99 | 12A7 .69 | 12S7 .55 | 50Z6GT .59 |
| 1D5GP .48 | 6AQ5 .37 | 6H6 .49 | 12A7 .69 | 12S7 .55 | 50Z6GT .59 |
| 1D7G .39 | 6AS5 .50 | 6J6 .49 | 12A7 .69 | 12S7 .55 | 50Z6GT .59 |
| 1D7GT .39 | 6AT6 .37 | 6J7 .49 | 12A7 .69 | 12S7 .55 | 50Z6GT .59 |
| 1D8GT .77 | 6AU6 .40 | 6J7G .39 | 12A7 .69 | 12S7 .55 | 50Z6GT .59 |
| 1E4 .29 | 6AV6 .77 | 6J7GT .52 | 12A7 .69 | 12S7 .55 | 50Z6GT .59 |
| 1E7GP .35 | 6AX5GT .95 | 6J8 .95 | 12A7 .69 | 12S7 .55 | 50Z6GT .59 |
| 1F4 .34 | 6B5 .85 | 6K7 .67 | 12A7 .69 | 12S7 .55 | 50Z6GT .59 |
| 1F5G .34 | 6B5 .85 | 6K7 .67 | 12A7 .69 | 12S7 .55 | 50Z6GT .59 |
| 1G4GT .34 | 6B6 .85 | 6K7G .39 | 12A7 .69 | 12S7 .55 | 50Z6GT .59 |
| 1GGGT .25 | 6B7 .85 | 6K8G .67 | 12A7 .69 | 12S7 .55 | 50Z6GT .59 |
| 1H5G .25 | 6B8 .85 | 6L5G .79 | 12A7 .69 | 12S7 .55 | 50Z6GT .59 |
| 1H5GT .48 | 6B8 .85 | 6L7 .85 | 12A7 .69 | 12S7 .55 | 50Z6GT .59 |
| 1H6GT .38 | 6B8 .85 | 6L7G .85 | 12A7 .69 | 12S7 .55 | 50Z6GT .59 |
| 1J6G .59 | 6B8 .85 | 6M7 .98 | 12A7 .69 | 12S7 .55 | 50Z6GT .59 |
| 1J6GT .65 | 6B8 .85 | 6N7 .79 | 12A7 .69 | 12S7 .55 | 50Z6GT .59 |
| 1L4 .45 | 6B8 .85 | 6N7G .55 | 12A7 .69 | 12S7 .55 | 50Z6GT .59 |
| 1LA4 .74 | 6B8 .85 | 6R7 .79 | 12A7 .69 | 12S7 .55 | 50Z6GT .59 |
| 1LCS .69 | 6B8 .85 | 6S7 .55 | 12A7 .69 | 12S7 .55 | 50Z6GT .59 |
| 1LD5 .77 | 6B8 .85 | 6S7G .59 | 12A7 .69 | 12S7 .55 | 50Z6GT .59 |
| 1LN5 .59 | 6B8 .85 | 6T7 .85 | 12A7 .69 | 12S7 .55 | 50Z6GT .59 |
| 1R4 .89 | 6B8 .85 | 6T7G .85 | 12A7 .69 | 12S7 .55 | 50Z6GT .59 |
| 1R5 .48 | 6B8 .85 | 6T8 .85 | 12A7 .69 | 12S7 .55 | 50Z6GT .59 |
| 1S4 .58 | 6B8 .85 | 6T8G .85 | 12A7 .69 | 12S7 .55 | 50Z6GT .59 |
| 1S5 .42 | 6B8 .85 | 6T9 .85 | 12A7 .69 | 12S7 .55 | 50Z6GT .59 |
| 1S6 .48 | 6B8 .85 | 6T9G .85 | 12A7 .69 | 12S7 .55 | 50Z6GT .59 |
| 1T4 .48 | 6B8 .85 | 6U7 .98 | 12A7 .69 | 12S7 .55 | 50Z6GT .59 |
| 1U4 .42 | 6B8 .85 | 6V7 .98 | 12A7 .69 | 12S7 .55 | 50Z6GT .59 |
| 1U5 .48 | 6B8 .85 | 6V7G .98 | 12A7 .69 | 12S7 .55 | 50Z6GT .59 |
| 1X2A .63 | 6B8 .85 | 6W7 .98 | 12A7 .69 | 12S7 .55 | 50Z6GT .59 |
| 2A3 .95 | 6B8 .85 | 6W7G .98 | 12A7 .69 | 12S7 .55 | 50Z6GT .59 |
| 2A4G .99 | 6B8 .85 | 6X7 .98 | 12A7 .69 | 12S7 .55 | 50Z6GT .59 |
| 2A5 .59 | 6B8 .85 | 6Y7 .98 | 12A7 .69 | 12S7 .55 | 50Z6GT .59 |
| 2A6 .48 | 6B8 .85 | 6Z7 .98 | 12A7 .69 | 12S7 .55 | 50Z6GT .59 |
| 2A7 .64 | 6B8 .85 | 6Z7G .98 | 12A7 .69 | 12S7 .55 | 50Z6GT .59 |
| 2B7 .62 | 6B8 .85 | 6Z8 .98 | 12A7 .69 | 12S7 .55 | 50Z6GT .59 |
| 3A4 .44 | 6B8 .85 | 6Z8G .98 | 12A7 .69 | 12S7 .55 | 50Z6GT .59 |
| 3A5 .93 | 6B8 .85 | 6Z9 .98 | 12A7 .69 | 12S7 .55 | 50Z6GT .59 |
| 3A8 .60 | 6B8 .85 | 6Z9G .98 | 12A7 .69 | 12S7 .55 | 50Z6GT .59 |
| 3B7 .39 | 6B8 .85 | 6Z10 .98 | 12A7 .69 | 12S7 .55 | 50Z6GT .59 |
| 3D .39 | 6B8 .85 | 6Z10G .98 | 12A7 .69 | 12S7 .55 | 50Z6GT .59 |
| 3Q4 .48 | 6B8 .85 | 6Z11 .98 | 12A7 .69 | 12S7 .55 | 50Z6GT .59 |
| 3S4 .48 | 6B8 .85 | 6Z11G .98 | 12A7 .69 | 12S7 .55 | 50Z6GT .59 |
| 3V4 .51 | 6B8 .85 | 6Z12 .98 | 12A7 .69 | 12S7 .55 | 50Z6GT .59 |
| 5T4 1.28 | 6B8 .85 | 6Z12G .98 | 12A7 .69 | 12S7 .55 | 50Z6GT .59 |
| 5Y3GT .36 | 6B8 .85 | 6Z13 .98 | 12A7 .69 | 12S7 .55 | 50Z6GT .59 |

ELECTRON TUBE WHOLESALE, INC.
 RECEIVING • TRANSMITTING • SPECIAL PURPOSE

140 DUANE STREET • NEW YORK 13, N. Y. • Phone: BArlay 7-7616

MAGNETIC TAPE RECORDING TAPE
 Red oxide on plastic (not paper) base; full acoustic range; 600 ft. (no breaks, no patches—no seconds) on 5" reels. Try one reel for \$1.00 (postpaid), then order 12 for \$11.50.
 G. GREEN, 252 Greenwich St., N. Y. 7

AT LAST! A REAL INDOOR ANTENNA
Tenna Legs

Graceful black iron legs serve as powerful and invisible TV antenna. Simple device offers countless tuning combinations. Legs attach to bottom of TV, or to your plywood to create modern tables. Shipped prepaid. Complete, \$7.95. Add 1% in Pa.

ELECTRONIC EQUIPMENT CO., BOX 1142, LANCASTER, PA.

AIR-KING 700-93

A loud hum or strong buzz in these sets has been traced to pickup in the 6SQ7-GT tube. To remedy this, replace the tube with a metal type or install a good tight-fitting metal shield. Although this trouble occurs most frequently in the 700-93, it has been noticed in other models.—Wayne Miller

EMERSON 686 TV SET

The set produced a raster but the sound and video circuits were dead. Tubes were substituted without localizing the trouble. All voltages checked O.K. at the tube sockets. While double-checking the voltage readings, the sound and picture came on momentarily when I pressed down on the plate pin of the 6AU6 second picture i.f. amplifier. Since the plate voltage was correct, I checked continuity between the socket pin jack and the plate pin at the base of the tube. The circuit was open. There was a break in the socket between the two bakelite wafers where it could not be seen. Replacing the socket restored operation to the sound and video circuits.—Andrew B. Lucas, Jr.

PHILCO 46-480

A slight crackling noise that is noticeable at low volume has been traced to a defective 220,000-ohm plate-load resistor in the first audio-amplifier stage. This resistor will test O.K. but should be replaced because it is starting to crystallize.

If noise originates in the converter stage or if 7F8 converter tube fails frequently, the difficulty can be eliminated by replacing the 4,700-ohm resistor in the mixer plate circuit with a 47,000-ohm unit and removing the 100,000-ohm resistor between the mixer cathode and B plus.—John Flint

EMERSON GC CHASSIS

When one of these sets operates on batteries but not on a.c. or d.c. lines, check the two resistors mounted upright on the chassis near the 117Z4-GT rectifier. These resistors, R16 and R17 on the manufacturer's diagram, should be 1,500 and 950 ohms respectively. They frequently increase in value and cause the set to fail on line operation. Replace them with 10-watt units of the required value.—Lyle Briggs

U.H.F. TV OSCILLATOR TUBES

Frequently, intermittent operation or failure of 6AF4 and 6T4 oscillators in u.h.f. converters and tuners is caused by slight corrosion or oxidation of the silver-plated base pins. Cleaning the pins with crocus cloth restores the tubes to operation temporarily, but heat of operation causes reoxidation and the trouble returns within a few hours.

Such tubes can be restored to reliable operation by replating the pins with pure silver. If you don't have facilities for electroplating, comparable results can be obtained with a new liquid sold at large department stores for touching-up worn silver-plated tableware and similar items. Apply the solution

to the pins with a saturated cloth and then rub them for a few seconds with a second cloth. Be sure to clean off all dried solution which may have gotten

on the glass envelope. If allowed to remain, it will disturb the interelectrode capacitances of the tube.—Horace S. Harmer

STROMBERG-CARLSON SERIES TC-125

Here are some minor circuit changes that improve the performance of early Stromberg-Carlson TC-125 series receivers:

To improve the signal-noise ratio of the ratio detector for clearer audio reproduction, change capacitor C56 (Fig. 1) from 1.0 to 5.0 μ f.

To improve vertical scanning and

increase the height, change R49 (Fig. 2) from 8,200 to 470 ohms and R131 from 1.5 megohm to 500,000 ohms.

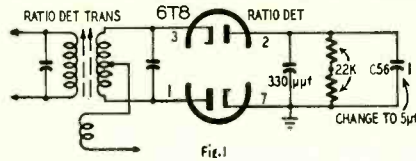

Fig. 1

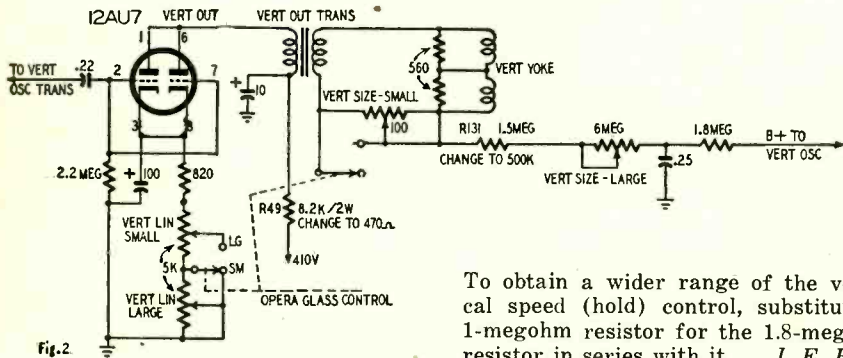

Fig. 2

To obtain a wider range of the vertical speed (hold) control, substitute a 1-megohm resistor for the 1.8-megohm resistor in series with it. J. E. Ryan

RCA BX6 3-WAY PORTABLE RADIO

This set was dead on a.c. line operation but operated normally on batteries. B plus voltage checked O.K., thus eliminating the selenium rectifier, the 33-ohm current limiting-resistor, and the B plus filter capacitors as possible causes of the trouble. When the d.c. voltmeter was connected across the 15,000-ohm bleeder (R20) to check the

and 160- μ f, 25-volt electrolytics on the filament line were temporarily replaced without restoring the original performance of the set. Replacing R20 did not cure the trouble, so this left only R17 the series filter resistor under suspicion.

Evidently the 2,700-ohm, 7-watt resistor had a high-speed intermittent

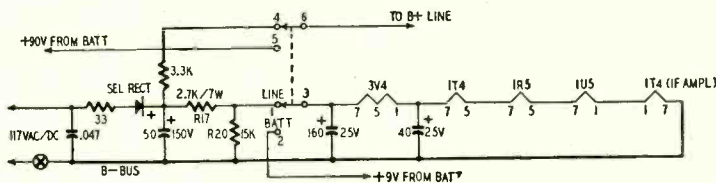

filament voltage, its needle vibrated violently about the 5-volt mark. R17 (a molded wire-wound unit mounted above the chassis next to the 3V4) and R20 were well within normal tolerances when checked on an ohmmeter. The 40-

which opened and closed, causing the meter to act as it did, because performance returned to normal when it was replaced with a new unit. The manufacturer's type number is 74319.—Edward Lee

RCA MODEL 55X RADIO RECEIVERS

If these sets lack volume and the last i.f. trimmer capacitor has no effect on the response, the trouble is probably caused by a short in the combination i.f. trimmer and r.f. filter unit built into the transformer.

The most efficient method of elim-

inating the trouble is to replace the output i.f. transformer. This trouble may occur also in the RC-1001, RC-1003, and RC-462 series chassis. The diagram shows color coding and connections to the second i.f. transformer in a typical set of this type.—Milo Bannister

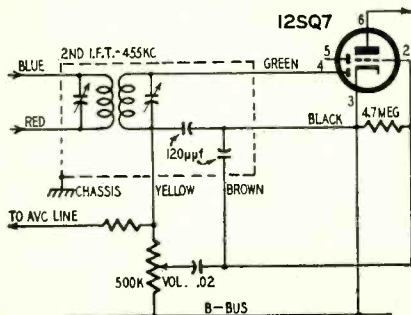

AUTOMATIC MODEL 620 RADIO

The audio on this receiver kept going on and off as I tuned across the dial. A check showed that the oscillator was intermittent. Changing the converter tube showed no improvement. I then noticed that the oscillator coil on this permeability-tuned receiver moved back and forth as I turned the tuning dial. A resistance measurement disclosed an intermittent open, caused by this motion.—S. E. Kay

Mr. Serviceman check these items for... Value!

See your local Parts Jobber

Align-o-Pak

Model BE2

Eliminates TV Alignment Bias Batteries. Provides voltages recommended by all TV manufacturers. Quickly diagnoses AGC trouble.

\$7.85

UHF HI-PASS FILTER

Model HP2

Passes UHF, rejects VHF up to 50 DB without tuning. Eliminates FM, Airport, Taxi cab interference, etc.

\$2.37

Up-Down VOLTAGE BOOSTER

Model LB2

Adds or subtracts 10 volts line voltage with heavy, safe toggle switches for any TV set. Line restored to normal when turned off.

\$5.97

for additional information, clip out coupon and mail TODAY to:

SERVICE INSTRUMENTS CO.
422 So. Dearborn—Chicago 5

I am interested in:

ALIGN-O-PAK HI-PASS FILTER

UP-DOWN VOLTAGE BOOSTER

NAME: _____

ADDRESS: _____

END

ALL RADIO AND TV TYPES

CLOSE OUT SET MFR'S SURPLUS TUBES

- STANDARD BRAND WARRANTY
- BRANDED
- BULK PACKED IN ORIGINAL MFR'S NESTED CARTONS OR INDIVIDUALLY BOXED
- EVERY TUBE METER AND CHASSIS TESTED FOR TOP QUALITY

| | | | | | | | |
|-------|-------|--------|------|--------|-----|---------|------|
| 0A4G | \$.50 | 6AQ6 | .36 | 6L6GA | .99 | 12J7 | .29 |
| 0Z4 | .49 | 6AS5 | .62 | 6SA7 | .59 | 12SA7GT | .58 |
| 1B3GT | .65 | 6AT6 | .36 | 6SA7GT | .81 | 12SH7 | .49 |
| 1B24 | 4.95 | 6AU6 | .36 | 6SC7 | .81 | 12SK7GT | .49 |
| 1L4 | .47 | 6AV5GT | .79 | 6SF5 | .58 | 12SN7GT | .46 |
| 1R5 | .46 | 6AV6 | .36 | 6SG7 | .59 | 12SQ7GT | .49 |
| 1S4 | .40 | 6BA6 | .33 | 6SH7 | .65 | 12SR7 | .49 |
| IS5 | .38 | 6BA7 | .57 | 6SJ7 | .54 | 12T3 | .39 |
| IT4 | .46 | 6BC5 | .46 | 6SK7 | .69 | 12Z3 | .39 |
| IU4 | .46 | 6BE6 | .37 | 6SK7GT | .39 | 19B66G | 1.15 |
| IU5 | .38 | 6BF5 | .69 | 6SL7GT | .49 | 19T8 | .81 |
| 1X2A | .65 | 6BD6G | 1.16 | 6SN7GT | .46 | 25AV5GT | 1.05 |
| 2E22 | 1.45 | 6BH6 | .45 | 6SQ7GT | .37 | 25BQ6GT | .75 |
| 2X2A | .33 | 6BL6 | .46 | 6SR7 | .49 | 25L6GT | .40 |
| 3A8 | .33 | 6BL7 | .65 | 6T8 | .57 | 25Z6GT | .37 |
| 3B24W | 2.95 | 6BN6 | .72 | 6U7 | .49 | 33 | .29 |
| 3D6 | .25 | 6BQ6 | .70 | 6U8 | .59 | 34 | .29 |
| 3B26 | 1.95 | 6BQ7 | .76 | 6V5GT | .38 | 35B5 | .38 |
| 3Q4 | .48 | 6C4 | .31 | 6W4GT | .41 | 35C5 | .38 |
| 3Q5GT | .48 | 6C5 | .41 | 6W6GT | .41 | 35L6GT | .42 |
| 3S4 | .46 | 6C5GT | .41 | 6X4 | .35 | 35W4 | .32 |
| 3V4 | .46 | 6C6 | .49 | 6X5GT | .35 | 35Z5GT | .33 |
| 4C35 | 24.95 | 6CB6 | .42 | 7R7 | .59 | 50B5 | .41 |
| 5FP14 | 9.95 | 6CD6G | 1.08 | 12A6 | .39 | 50C5 | .41 |
| 5U4G | .49 | 6E5 | .76 | 12AT6 | .31 | 50L6GT | .39 |
| 5Y3G | .36 | 6F6GT | .45 | 12AT7 | .57 | 11723 | .39 |
| 6A6 | .35 | 6H6 | .49 | 12AU6 | .34 | 801A | .19 |
| 6AB7 | .69 | 6H6GT | .49 | 12AU7 | .52 | 803 | 2.95 |
| 6AC7 | .68 | 6J4 | .99 | 12AV7 | .60 | 814 | 2.95 |
| 6AG5 | .46 | 6J5GT | .34 | 12AY7 | .72 | 832A | 4.95 |
| 6AH6 | .88 | 6J6 | .50 | 12BA6 | .40 | 836 | 2.95 |
| 6AK5 | .75 | 6J7G | .49 | 12BE6 | .41 | 866A | 1.49 |
| 6AL5 | .34 | 6K6GT | .36 | 12BH7 | .53 | 5718 | 1.45 |
| 6AQ5 | .37 | 6K7G | .49 | 12H6 | .49 | 6101CT | 4.95 |
| | | | | | | 9003 | 1.10 |

MINIMUM ORDER: \$10.00. Terms: 25% with order, balance C. O. D. Please include postage.
All prices subject to change without notice. F. O. B. New York City. Mail Order Division:

TRANSAMERICA ELECTRONICS CORP.
120 LIBERTY ST., NEW YORK 6, N. Y., COrrlandt 7-4307

COLUMBUS SENDS NEWS

A special issue of the mimeographed *Associated Radio-Television Service Dealers' News* announces the 1954 officers and committees.

The 1954 officers are: Fred Oberle, president; Harry Walcutt, vice-president; Bob Duckworth, secretary; and Jim Cumbow, treasurer.

Standing committees include membership, publicity and public relations, ethics, trade relations, price stabilization, educational and technical, and entertainment. In addition to these committees, which include from two to four members each, there is listed the editor of the *ARTSD News* and a special committee expeditor.

The two-sheet paper uses illustration, special borders, carefully planned layout, and excellent mimeographing to make an attractive appearance and ensure that it will be read by the members.

TULSA ADOPTS BY-LAWS

A constitution and set of by-laws has been adopted by the Tulsa (Oklahoma) Radio and Television Association, which had been operating as a temporary group. Membership is limited to service shop operators, managers, and technicians in the Tulsa area.

Permanent officers elected were: Lee Ackley, president; Carl Lindsey, vice-president; Clarence Snead, vice-president in charge of public relations; Mickey Holt, secretary; Howard Hunter, treasurer; and Virgil Weaver, chairman of the association's executive committee.

The association states that its purpose is to protect the public against service organizations not qualified to provide satisfactory service. A list of the association's Code of Ethics was recently placed as an ad in the *Tulsa Tribune*, and was stated to be the first of a projected series of advertisements by the association.

COLOR TV IN TEXAS

A lecture on color TV was announced by the San Antonio Radio and Television Association Inc. Speaker was C. R. Bowman of P. R. Mallory Co. A G-E Business Course was also planned, to start with the last meeting in March. The expenses of the course, which amount to \$5 per student, are being borne by Modern Radio Co., which insists, however, that each person taking the course pay \$5 to the association treasurer as a means of increasing the financial strength of San Antonio RTA.

Officers for 1954, announced in the same release, are: Albert R. Niehaus, president; Elmo Bohmann, vice-president; Ora G. Fretz, secretary; Thomas F. Boyd, treasurer. H. M. Willman, and Esteban S. Viera are directors.

TWO TV PROBLEMS

Two prime elements in the television service business will always cause difficulty, according to Norman Foster, owner of a prosperous TV service-while-you-wait business in Chicago.

One of the difficulties, says Mr. Fos-

*"Oh, boy!
JENSEN NEEDLES"*

**FASTER
EASIER
more
PROFITABLE
operation**

GET INTO THE MASTER HABIT!

**RADIO'S MASTER
NEW! 1954
EDITION**

- 1370 pages
- Over 85,000 items
- Over 8,000 illus.
- Completely indexed

\$1.95 at your parts distributor. Publisher's price \$6.50

Have complete access to the many thousands of products vital to your daily sales and service operations. In the customer's home, across the counter or on the bench, you'll value the Master's thoroughly complete descriptions, specs, illustrations and prices . . . all systematically organized in 18 big sections for instant reference. Increase your sales . . . sell directly from the Master. Facilitate your stock problem . . . use the Master for jiffy comparison of all electronic products. The Master is the only Official Buying Guide for the TV-Radio-Electronics industry. It contains unabridged catalog data direct from the manufacturers. For buying and selling—the Master gives you all the needed facts in a single volume.

Over 100,000 in active daily use. Get into the Master habit. Order your copy today!

Just a few of the products included: Tubes — Test Equipment — Tools — Transformers — Capacitors — Resistors — Relays — Coils — Antennas — Recording & PA Systems — Hardware — Transmitters — Receivers — Kits — Wire — Cable . . . and thousands of allied products!

Eliminate Incomplete Small Catalogs and Loose Literature

UNITED CATALOG PUB., INC.
110 LAFAYETTE ST., NEW YORK 13, N. Y.

WHILE THEY LAST!

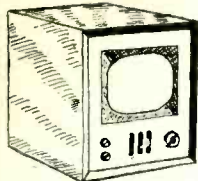

10" TV REMOTE "SLAVE" SETS

HERE'S YOUR CHANCE TO GET THAT EXTRA SET FOR PLAYROOM, BEDROOM, KITCHEN, ETC.!!

These are COMPLETE, OPERATING slave units. Hook up to any standard TV receiver (only 4 soldered connections) to reproduce any tuned TV channel. COMPLETE SCHEMATIC & HOOK-UP DATA SUPPLIED. Operates on 110V. D.C. AC conversion data included.

FEATURES:

- 19 TUBES including 10BP4. ALL TUBES 90 DAY GUARANTEED.
- H.V. OSC. POWER SWITCH, detachable unit.
- 4" H.V. DUTY PM SPEAKER.
- MAJOR STANDARD PARTS INCLUDE: Defl. Yoke, Focus Coil, Horiz. & Vert. Outputs, two 10H-100ma Chokes, 150ma Sel. Rect., Electrolytics, Controls, etc.
- HANDSOME WALNUT VENEER & LEATHERETTE CABINET (20 1/2" x 17" x 14 1/2")

!! PARTS ALONE WORTH SERIAL \$23.95
TIMES THE PRICE !! Perfect condition
—used. Shipped Railway Exp. (Sorry No C.O.D.'s).

POWERFUL ALNICO "MAGNETRON" MAGNET

Approx. 2000 gauss. 8 1/4" x 5 5/8" x 2 3/4". Poles 1 1/4" O.D., gap 1 1/2". Shpg. wt. 18 lbs. \$23.95

TUBES!! ... UP TO 80% OFF!!

90 DAY GUARANTEED. Standard Brands, unsealed cartons.

| | |
|---|-----|
| #24, 26, 27, 34, 41, 42, 55, 89 or 6K7 | 29c |
| #1A6, 1C6, 1H4, 1H6, 1J6, 5Y3, 5Y4, 6B7, 6C5, 6F5, 6G5, 6J3, 6K6, 6SD7, 6SQ7, 6K7, 35Z3, 7B, 7C, 7F, 78, or 80 | 39c |
| #1A7, 1I4, 2A3H, 6AR, 6AG5, 6AU6, 6BE6, 6CB6, 6F6, 6H6, 6J6, 6J8, 6SA7, 6SK7, 6W4, 6SN7, 7A7, 7AG, 7B6, 7C7, 7D7, 7E6, 7C6, 7G7, 7Y4, 12SN7, 25L6, 35, 37 or 45 | 49c |
| #1L6, 1H4, 1L6, 2A5, 2A6, 5V4, 6A3, 6A5, 6AG7, 6A15, 6R8, 6R9, 6S7, 6L7, 6SC7, 6SF5, 6T8, 6U7, 7C7, 7W7, 12A6, 12AU7, 12AT7, 50, 58, or 81 | 69c |

OVER 5000 SOLD!!!

of our "Jumbo Radio Electronics Parts Kit" ... A "grab-bag" of inventory odds & ends worth Several Times the Price. Coils, Sockets, Switches, Controls, Wire, Resistors, Condensers, TV Parts & Diagrams, Photofacts, etc. etc. (Shpg. wt. 20 lbs.) \$3.95

30 RPM A.C. MOTOR (115V, 60 cy) ... dble. 1/8" shaft, 5" x 2 1/2" x 1 1/2" (Shpg. wt. 2 lbs.) ... 2.95

2" CR TUBE SHIELD (12B7) ... 1.29

DIRECT FACTORY SPEAKER REPAIRS SINCE 1927
Min. Order \$3.00. 20% deposit reqd. on all C.O.D.'s. Please add sufficient postage—excess refunded.

LEOTONE RADIO CORP.
67 Dey Street
New York 7, N. Y.

SAVE MONEY... MAKE MONEY... LEARN TV the practical way...



ASSEMBLE A TRANSVISION TV KIT

Pay as You Wire \$39

I WILL HELP YOU to start learning TV the practical way — by assembling a TRANSVISION TV KIT in EASY STAGES. For only \$39 you get PACKAGE #1 (standard first pkg. for all of our kits). This package gives you the BASIC CHASSIS and over 450 TV COMPONENTS with complete Instructions, Drawings, Photos, Service Booklet, and a year's subscription to my "TV and Electronics Notes". When ready, you order the next stage (pkg. #2), etc. Low prices make your complete kit a terrific buy!



FREE CATALOG Shows 6 Great TV Kits:

EXCLUSIVE: Only Transvision TV Kits are adaptable to UHF. Ideal for FRINGE AREAS. No Previous Technical Knowledge required. Write now!

TRANSVISION, INC., Dept. E4
NEW ROCHELLE, N. Y.

— MAIL THIS COUPON TODAY —

Educational Director
TRANSVISION, INC., NEW ROCHELLE, N. Y. Dept. E4

I'm enclosing \$_____ deposit. Send standard kit PACKAGE #1, with all Instruction Material. Balance C.O.D.

Send FREE copy of your new TV Kit Catalog.

Name _____
Address _____
City _____ State _____

ter, is the fact that a TV set is—and is likely to be for some time—a very complicated piece of equipment. The other is that there are—and always will be—some very complicated TV set owners!

EASTERN CONFERENCE

The Eastern Television Service Conference will be held in Philadelphia, April 2, 3, and 4. The Philadelphia Council of Radio and Television Service Associations will handle local arrangements during the three-day conference. All service technicians and service dealer groups throughout the U.S. and Canada are welcome to participate, but it is expected that the attendance will be largely from the northeastern section of this country.

Harold B. (Dusty) Rhodes of Paterson, N. J., was elected chairman of the 1954 conference. Committees include: publicity, J. Palmer Murphy, Paterson; banquet, Albert Haas, Philadelphia; program and agenda, Sam Brenner, Philadelphia, and Max Liebowitz, New York City; industry co-ordination, Milan Krupa, Wilkes-Barre, Pa.; credentials, Roger Haines, Haddonfield, N. J.

Special attention will be paid to color TV and u.h.f. at this year's conference. More than 12 sessions will be devoted to color, and a full line of color receiving equipment will be on hand. Arrangements to receive live color pictures are under way, with every prospect of success. An attendance of more than 300 is expected. The conference will be held in the Bellevue-Stratford Hotel.

BBB ACTS IN ST. LOUIS

Because of a rash of advertising offering service calls at \$2.50 or \$3.00, the Better Business Bureau of St. Louis has asked all advertising media to observe a new set of regulations when accepting ads from TV service companies. The president of the BBB pointed out that these ads are merely a gimmick to get the company's representative into the home, rather than actually to repair the sets as the ads claimed.

Typical excerpts from the regulations are:

"Advertisers who offer to service television sets shall make no reference to repairing in the home.

"Advertisers who quote a price for a service call shall state definitely the period of labor time included in that price and rate per hour to be charged for labor time in excess of that period. For example: Service call \$5—includes 15 minutes' work; additional work at rate of \$5 per hour; plus cost of necessary parts."

The city's large metropolitan dailies, the *Post-Dispatch* and the *Globe-Democrat*, both stated that after Feb. 1, 1954, all TV service advertising would be required to conform to the BBB regulations.

The BBB president emphasized that the questionable service practices represent a small minority in the industry.

The COLOR TV BOOM will mean... NEW PROFITS for the experts!

INTRODUCTION TO COLOR TV

by Kaufman & Thomas

Here is the complete story about color television—all types of receivers—all types of picture tubes—all types of circuits—written in a clear, understandable language without mathematics. The most complete book on the subject. Easy to understand! A "must" for all technicians, engineers and students.

Over 140 (5 1/2" X 8 1/4") pages, illus. \$2.10

HIGHLIGHTS OF COLOR TELEVISION

by J. R. Locke, Jr.

A tight-to-the-point explanation of the highlights of the NTSC color television system—such as colorimetry—matrixing—the color sub-carrier—synchronous detection—etc. A "quickie" on color TV.

58 (5 1/2" X 8 1/4") pages, illus. Only \$.99

HOW TO INSTALL AND SERVICE AUTO RADIO RECEIVERS

by Jack Darr

An expert gives practical, detailed instructions on how to install and service all types of automobile radios. Not a schematic book. Shows where to run lead-ins, how to install antennas, eliminate noise and gives methods for vibrator testing. Furnishes a complete list of tools, spare parts and other equipment and how to set up an auto radio service business.

128 (5 1/2" X 8 1/4") pages, illus. \$1.80

SERVICING TV VERTICAL AND HORIZONTAL OUTPUT SYSTEMS

by Harry Thomas

Complete. Easy-to-understand. Discusses all types of vertical and horizontal output circuits used in TV receivers—recognition of trouble—how to locate faults and their repairs. No other book in print offers equivalent coverage of the subject or explains details as clearly.

Over 140 (5 1/2" X 8 1/4") pages, illus. \$2.40

RADIO TROUBLESHOOTING GUIDEBOOK VOL. 1

by Rider and Johnson

A practical guide to radio receiver operation, trouble diagnosis and repair. Detailed instructions on how to shoot trouble. Specify lists of symptoms and the parts and sections that should be checked. Direct approach.

160 (5 1/2" X 8 1/4") pages, illus. \$2.40

Write for information on all RIDER books. Buy these books now from your jobber... bookstore. If not available from these sources, write to:

JOHN F. RIDER PUBLISHER, INC.
480 Canal Street, New York 13, N. Y.

TRANSVISION FIELD STRENGTH METER

*Finest
at
Any Price*



For 110V AC,
and BATTERY
OPERATION

**SAVES 50% OF
INSTALLATION COST**

*Works from antenna
(no TV set needed)*

\$69
NET*

FINEST because: Each Meter is individually calibrated in microvolts on every channel. Widest range—10-50,000 microvolts. 12 channel selector. Multiplier switch for weak signal areas.

Pays for itself on 3 or 4 jobs. Measures relative picture signal strengths *directly from antenna.* Determines best antenna system and orientation. (Checks receiver re-radiation (local oscillator.) Identifies signals—TV, FM, TVI. Easy to operate, light, rugged. Many other exclusive features.

*Model FSM-4, for 110V AC only. Complete with tubes. Wt. 13 lbs. net \$69.

Model FSM-4B, for Battery Operation and 110V AC. Wt. 13 lbs. net \$89.

**TRANSVISION, INC.
NEW ROCHELLE, N.Y.**

**A MUST IN
FRINGE AREAS**

**UHF
or
VHF**

10 DAY TRIAL:
Try these fine instruments for 10 DAYS. Then, if you return them, your cost less 10% (our cost of re-packaging) will be refunded.

Test & Repair CRTs

Make **BIG PROFITS** this **EASY** way:

Every Service Shop needs these Transvision Instruments. *Can be used white curtains.* Choice of 4 types:

TESTER-REACTIVATOR-SPARKER: 3 instruments in 1. Measures cathode emission; locates shorts between elements; locates high resistance shorts (leakage) as high as 3 megohms. Gives rapid check of gas condition of tube. Reactivates dim tubes—renews brightness and detail. Sparks out electrical leakage. net \$34.95

TESTER-REACTIVATOR: 2 instruments in 1. Similar to the above but without the sparking function. net \$19.95

TESTER-SPARKER: 2 instruments in 1. Sparks out electrical leakage between elements—saves many variable 5,000-14,000V D.C. supply; useful for analyzing hard-to-solve deflection problems. net \$25.95

SPARKER: Eliminates leakage between elements in C.R.T.s and small tubes. net \$18.95



Transvision, Inc., New Rochelle, N. Y., Dept. E4

- Send me _____
- Enclosed find \$_____ deposit. Balance C.O.D.
- My **JOBBER** is _____
I accept your 10 Day Trial terms.

Name _____
Address _____
City _____ State _____

JOBBER INQUIRIES INVITED

LICENSES FOR MICHIGAN?

A bill to license Michigan TV and radio service technicians has been proposed by Representative Michael Novak of Detroit.

Michigan licenses barbers and plumbers, and licenses for service technicians are equally important, declared Representative Novak. A television set, he said, is a complicated thing and "it does not take much for an unqualified man to gum up the works."

The proposal was to create a state board to examine and license qualified service technicians.

OPPOSES LICENSING

A city council proposal to license TV and radio technicians in Binghamton, N. Y., was condemned by the Southern Tier Chapter, Radio Servicemen of America, at a recent meeting.

A resolution was drawn up to be forwarded to the city council. It stated in part:

"We do not believe the licensing of technicians will stop the complaints aimed at the radio and television servicing profession.

"However, should the legislative body of this city deem licensing imperative, it would be acceptable to us only on a state-wide basis."

The resolution went on to say:

"We feel that TV and radio service technicians are being singled out and condemned for some customer reaction that exists in any trade or business."

It further pointed out that the customer is able to select a service technician who is reliable, capable, and experienced, because "there is now, and has been for 20 years, a reliable service technicians' organization in this city, whose members are capable of rendering such service and can give a guarantee on their work that is backed by the organization."

K. C. ELECTS OFFICERS

The Television Service Engineers, Inc., of Greater Kansas City, has announced its 1954 slate of officers.

Ray Crawford, AAA Television Service, is president; Bob Hester, Hester Radio and Television Co., Mission, Kan., vice-president; Walter Nieswonger, Telorad Radio Sales and Service, secretary; and Bill Dunfee, Dunfee Television Sales and Service, treasurer. Al Richards, past president, was elected to be chairman of the board of directors to be. **END**

Hopscotch

by Jeanne DeGood

When I'm dx-ing on TV,
I try to catch sporadic-E
Before it makes another skip
And gives my TV set the slip;
For yesterday, sporadic-E
Skipped completely over me.

RADELCO HI-CHANNEL BROAD BAND YAGI

*Gives Clearer,
Brighter*

**TV PICTURES
ON ALL 7
HIGH BAND
VHF CHANNELS**



Ideal for areas having two or more high channel stations. Completely preassembled.

LIST

\$995

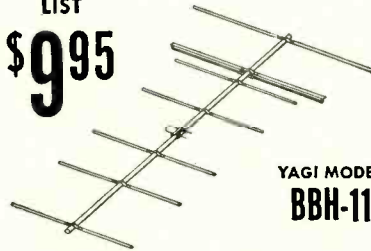

YAGI MODEL
BBH-11

**ORDER FROM YOUR
NEAREST PARTS JOBBER**

**DON'T
THROW
OLD
RADIOS
AWAY!**



Here's the data you need to fix them **FAST** and **r-i-g-h-t**

There's a "secret" to repairing old radios fast and profitably and this big **RADIO TROUBLESHOOTER'S HANDBOOK** is it!

Just look up the old make and model you want to fix. This manual-size, 3 1/2 pound, 744-page Ghirardi handbook tells what the trouble is likely to be . . . and shows you exactly how to fix it. No useless testing! No wasted time! Even beginners can handle jobs "slick as a whistle."

THE ONLY GUIDE OF ITS KIND

Cuts service time in half!

Included are common trouble symptoms and their remedies for over 4,800 models of old home and auto radios and record changers. Actual case histories cover practically every model made by 202 manufacturers between 1925 and 1942—Airline, Apex, Arvin, Atwater Kent, Belmont, Bosch, Brunswick, Clarion, Crosley, Emerson, Fada, G-E, Kolster, Majestic, Motorola, Philco, Pilot, RCA, Silvertone, Sparton, Sironberg and dozens more. Gives how-to-do-it data on SPECIFIC jobs—NOT general theory. Includes hundreds of pages of invaluable tube and component data, service short cuts, etc.

TRY IT 10 DAYS . . . at our risk!

Dept. RE-44, RINEHART & CO., Inc.
232 Madison Ave., New York 16, N. Y.

Send Ghirardi's **RADIO TROUBLESHOOTER'S HANDBOOK** for 10-day free examination. If I decide to keep book, I will then remit the full price of only \$6.50 plus a few cents postage. Otherwise, I will return book postpaid and owe you nothing.

NAME _____
ADDRESS _____
CITY, ZONE, STATE _____

Charles F. Stromeier, recently appointed executive vice-president of CBS-Hytron, Danvers, Mass., was named president of the company, succeeding Bruce A. Coffin, founder and president of the company since 1921. Lloyd H. Coffin, treasurer of CBS-Hytron, also announced his retirement. Both Bruce Coffin and Lloyd Coffin will retain their memberships on the Board of Directors of CBS, Inc. Stromeier was subsequently elected a vice-president and a director of CBS, Inc.

F. N. McGlynn was promoted to sales manager, AC Motors, of General Indus-



F. N. McGlynn



M. L. Young

tries Co., Elyria, Ohio, and M. L. Young was upped to assistant sales manager, AC Motors. McGlynn was formerly in charge of the Chicago sales office and Young was a sales engineer.

William H. Rickards joined Ward Products Corp., Division of the Gabriel Co., Cleveland, as director of engineering. He was formerly with Radiart and Cleveland Electronics.



W. H. Rickards

Emory S. Todd was promoted to vice-president for sales of Krylon, Inc., Philadelphia. He was previously field sales manager of the Protective Coating Division of the company.



E. S. Todd

Merle (Bud) Cain was named distributor sales manager of V-M Corp., Benton Harbor, Mich. He was formerly Chicago District representative for General Electric, and more recently was assistant TV sales manager for Hallcrafters.



Left, Merle (Bud) Cain; right, K. L. Bishop, V-M general sales manager.

Gerald Florence, president of Benchmark Manufacturing Co., Gardena,

APRIL, 1954

TV GLO-TEST

Replaces \$279 in TESTING EQUIPMENT



This is the instrument that appeared in feature articles in RADIO-ELECTRONICS and other publications. GLO-TEST is the sensational new tester that almost talks! For TV and Radio servicemen, Sound Technicians, Amateurs, Experimenters, Electricians.

OVER 50 USES, INCLUDING—
PICTURE TUBE TESTER—AC-DC VOLTAGE MEASUREMENTS TO 50 KV—SIGNAL GENERATOR—SIGNAL TRACER—TUBE TESTER—RESISTOR AND CAPACITOR MEASUREMENTS—DISTORTION AND LINEARITY CHECKER. ACCURACY COMPARABLE TO VTVM. FULLY GUARANTEED
Replaces instruments costing many times its cost, does a comparable job yet is only a small fraction of their total weight and size. GLO-TEST, complete with test leads and instruction booklet, postpaid, is priced at only **\$14.50**

Send check or money order. 10-day money back guarantee. Free literature on request.
V. A. ENTERPRISES, Dept. AA
608 Rosecrans Blvd., Compton, Calif.

HERE IT IS! The tool that takes the work out of dial-cord stringing!

DOC'S STRING-AID

Perfect for looping cord over pulleys—hooking and shaping springs—working in close places. Makes any dial job a breeze.

• All steel
• Five-inch length
• Insulated, easy-to-grip shank

ORDER FROM THIS AD! Money Back Guarantee

DOC'S RADIO TOOLS 509 FISK AVE. BROWNWOOD, TEXAS

75¢

WATCH FOR OUR
MAY ISSUE
AT YOUR DEALER'S
APRIL 23

CONCORD'S BUY OF THE MONTH

New **MUSICANA Phonograph AMPLIFIER**

\$11.95 Reg. Value \$29.50

Another Concord Super-Special. A complete high quality Phono Amplifier designed to give a lifetime of musical enjoyment. Just plug your phonograph or changer into our Musicana Amplifier and enjoy top performance from your records. Three tube plus ballast amplifier. A large 5" heavy duty Alnico V speaker. Designed to match any crystal cartridge or microphone. Separate tone control. Available in either Walnut veneer cabinet, size 13 1/4" x 7 1/2" x 7" D. or molded Bakelite cabinet, size: 10 1/2" x 6 1/2" x 6 1/2" D. Shpg. Wt. 9 lbs.

99-B-CM3TW. Walnut Cabinet. Net. \$11.95
99-B-CM3TP. Plastic Cabinet. Net. \$12.95

FREE! NEW 1954 CATALOG!

A complete, comprehensive listing of all your electronic requirements. Bursting with SPECIAL VALUES

CONCORD RADIO, 54 Vesey St., N. Y. 7 Dept C 4
Please send _____ model _____ at _____ ea.
Enclosed find complete payment. 20% C.O.D.
 Send new 1954 CONCORD CATALOG!

NAME _____
ADDRESS _____
CITY _____ ZONE _____ STATE _____

CONCORD RADIO • 54 VESEY ST.
NEW YORK 7, N. Y. • Dlgby 9-1132

TRANSVISION

makes this greatest of TV offers—backed by **MONEY-BACK GUARANTEE:**

\$88 TV SERVICE INSTRUMENT VALUE FOR— **\$39.95**

NEW TV Component Tester performs functions you've always wanted. Look what you get:-
FLYBACK and YOKE TESTER, value\$39.
SELENIUM RECTIFIER TESTER, value 29.
CRT TESTER and REACTIVATOR, value 20.
Total Instrumentation, value 88.
ALL 4 in 1 great instrument, net 39.95

SELENIUM RECTIFIER TESTER

FLYBACK TRANSFORMER and YOKE TESTER



PIC. TUBE TESTER

PIC. TUBE REACTIVATOR

NEVER BEFORE SUCH GREAT VALUE. For only \$39.95 you get 4 testing-and-repair instruments all in one! Compact, weighs only 3 lbs. Does things never been done before. Pays for itself quickly. Prove it yourself—

TRY IT for 10 DAYS
on Money-Back Guarantee:

10 DAY TRIAL: Try this Transvision TV COMPONENT TESTER for 10 days. Then, if you are not 100% satisfied, you may return it. Your purchase price, less 10% (our cost of handling and repacking) will be promptly refunded.

TRANSVISION, INC. • NEW ROCHELLE, N. Y.

RUSH THIS COUPON NOW

TRANSVISION, INC.
DEPT. RE-44 NEW ROCHELLE, N. Y.

() Send _____ TV COMPONENT TESTERS @ \$39.95
() Enclosed find \$ _____ deposit. Balance C.O.D.
() Enclosed find \$ _____ in full.
I accept Your 10 Day Trial terms.

Name _____
Address _____
City _____ State _____
My Jobber is _____

JOBBER INQUIRIES INVITED

AUDELS TV-RADIO SERVICE LIBRARY

HERE IS LATE INFORMATION IN A HANDY FORM FOR RADIO AND TELEVISION REPAIRMEN, SERVICEMEN AND STUDENTS

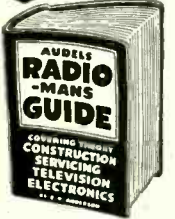
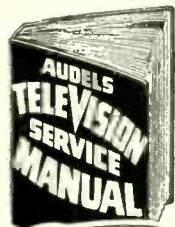

2 VOLS. \$6 COMPLETE \$1 A MONTH PAY ONLY 1 MO.
AUDELS T.V.-RADIO SERVICE LIBRARY—
 Highly Endorsed—1001 Facts—Over 1552 Pages—625 Illustrations, Diagrams of Parts. Presents Important Subjects of Modern Radio, Television, Industrial Electronics, F.M., Public Address Systems, Auto, Marine & Aircraft Radio, Phonograph Pick-Ups, etc.

IT PAYS TO KNOW!
 The Basic Principles—Construction—Installation—Operation—Repairs—Trouble Shooting. Shows How to get Sharp, Clear T.V. Pictures. Install Aerials—How to Test. Explains Color Systems, Methods of Conversion, Terms, etc. Includes Ultra High Frequency (U.H.F.)—Valuable for Quick Ready Reference & Home Study. Tells How to Solve T.V. & Radio Troubles—Answers Your Questions.

Get this Information for Yourself. 7 DAY TEST—ASK TO SEE IT!

MAIL ORDER

AUDELS Publishers, 49 W. 23 St., N.Y. 10, N.Y.
 Mail AUDELS T.V. RADIO SERVICE LIBRARY 2 Vols. \$6 on 7 days free trial. If O. K. I will remit \$1 in 7 days and \$1 monthly until \$6 is paid. Otherwise I will return them.

Name _____
 Address _____
 Occupation _____
 Employed by _____ RE

The Magnemite*

Battery-Operated Spring-Motor Portable Recorder

Field recordings can now be made with equivalent quality and with as little effort as studio console recordings. Smaller than a portable typewriter (11½ x 10 x 8 inches) and weighing 15 lbs. including the dry-cell batteries that last 100 operating hours, the Magnemite* is easily carried and operated anywhere.

- Here are truly professional specifications:
- Model 610-SD (7½ ips, 50 to 7500 cycles meets NARTB standards.
 - Model 610-E (15 ips, 50 to 15,000 cycles) meets primary NARTB standards.
 - Dynamic range 50 db.
 - Flutter ± 0.1%.
 - Constant speed governor-controlled.
 - Monitoring and playback facilities.

Write for complete technical literature and direct factory prices to Dept. RE:

AMPLIFIER CORP. of AMERICA
 398 Broadway, N. Y. 13, N. Y.
 * Trade Mark Reg. Pat. Pend.

Calif., announced the purchase of Clear Beam Television Antenna Co., Burbank, and Tempo T. V. Products Co., Los Angeles, television mast manufacturers. Harold Florence was elected as president of Clear Beam and Harry Lieb as president of Tempo.



H. Florence

Dr. William Osborn and Dr. Miao Yung-Miao joined the engineering staff of Channel Master Corp., Ellenville, N.Y. Dr. Osborn, formerly with the University of Virginia's Naval Ord-



Left, Dr. Yung-Miao; right, Dr. Osborn.

nance Research Laboratory, will be project engineer in the development of new v.h.f. and u.h.f. antenna types. Dr. Miao, formerly with International Harvester Corp., will be project engineer in the development of mechanical test equipment for antennas.

W. Walter Jablon was named sales manager, Home Instruments Division, of Freed Electronics Controls Corp., New York, N. Y. Jablon, a veteran in the electronics industry, joined Freed late last year.



W. W. Jablon

Vito Racanelli joined Chicago Standard Transformer Corp., as advertising manager. He was formerly with Edward C. Kennedy Co., advertising agency.

Obituary

Einar W. Nielsen, a founder and president of Best Manufacturing Co., Irvington, N. J., died recently of a heart attack while vacationing in Fort Lauderdale, Fla.

Personnel Notes

... Robert A. Seidel was appointed vice-president of the RCA Sales and Service Subsidiaries Division, with headquarters in New York City. He will be responsible for the activities of RCA Institutes, RCA Service Co., and RCA Distributing Corp. Seidel has been a vice-president of RCA since 1949.

NOW Start fixing TV and Radio sets right away!



Even if you never fixed a lamp or door bell before...

Here's the practical television and radio repair book for you—easy, plain, and simple, and written for the man with no technical training. Just think—without math or heavy circuit theory, you can start doing actual repair work *even before you finish the book!* No trick methods—only the sound, correct, safe way to do things. Read it and—so quickly it will surprise you—you can fix your own and friends' sets... get a service shop job... even start your own money-making business. Here's the reason you'll learn so quickly: You deal only with the things that go wrong in sets—the parts—instead of spending long weeks studying circuits and doing lab work.

TELEVISION AND RADIO REPAIRING

by John Markus
 Assoc. Editor, *Electronics*
 556 pp., 225 illus., \$7.95
 Simple! Easy-to-read!

For every television and radio part, no matter what make the set is, Markus shows you how to recognize symptoms of trouble... how to test to make sure... how to order the new part... and how to install it. He explains everything in plain language and uses pictures throughout so you actually see what he's talking about.
 Be a well-paid repairman—Even start your own business.
 Here's your chance to share big money going to servicemen today—without investing a good deal of cash and by starting right in your own home or working for a service outfit.
 The book tells you what few tools to buy, how to make a service call, how to collect the bills. It shows you all you need to know to make the business pay off.

Gives all these help:
 How to run your own business
 How to test and replace tubes
 How to test tubes without a tester
 How to eliminate receiver noises
 How to improve dim TV pictures
 How to solder, replace and adjust:
 —power supplies
 —carbon and wire-wound resistors
 —controls and switches
 —condensers, coils and transformers
 —tuning devices
 How to fix phono pickups
 How to repair wood and plastic cabinets
 How to install, adjust, and repair different types of antennas
 and many others

Just one repair job pays for the book!

10 DAYS' FREE EXAMINATION

McGraw-Hill Book Co., Dept. RE-4
 330 W. 42nd St., New York City 36

Send me John Markus' TELEVISION AND RADIO REPAIRING for 10 days' examination on approval. In 10 days I will remit \$7.95, plus few cents for delivery, or return book postpaid. (We pay for delivery if you remit with this coupon; same return privilege.)
 (Print)
 Name.....
 Address.....
 City.....Zone.....State.....
 Company.....
 Position.....RE-4
 (This offer applies in U.S. only)

... Guy A. Wilson, former assistant purchasing agent for United Motors Service Division of General Motors Corp., Detroit, Mich., was appointed general purchasing agent.

... Michael F. Callahan was promoted to vice-president in charge of manufacturing for all CBS-Hytron plants. Other executive promotions at CBS-Hytron include: Edgar K. Wimpy, to director of general engineering; Dr. Russell R. Law, to director of research and development; Clifford Hughes, to plant manager of the Newburyport, Mass., receiving tube plant; Elwood W. Schafer, to manager of color planning; J. Farley, to director of quality control; and David A. Sokolov, to supervisor of development of receiving tubes.

... Captain John N. Boland, USN, (ret.) was appointed manager of the Raytheon Manufacturing Company's Washington, D. C. office. He formerly did Government liaison and contract work for the company.

... Albert Lederman was appointed engineering specialist in the new Mechanized Circuits Department of Sylvania Electric Products, with headquarters in Long Island City, N. Y. He was formerly a technical representative for Sylvania in Washington, D. C.

... John J. Corcoran was promoted to sales representative and commercial engineer on the West Coast for Tung-Sol Electric, Newark, N. J. He was previously an initial-equipment tube salesman for the company.

... Robert A. Hoagland joined Aerovox - New Bedford Division, Aerovox Corp., New Bedford, Mass., as sales manager. He had been with Mills Industries.

... Alfred Y. Bentley was placed in charge of advanced planning for the Television Receiver Manufacturing Division of Allen B. DuMont Laboratories, Clifton, N. J. He had been head of the Division's Engineering Department for the past year.

... Larry F. Hardy was named vice-president in charge of Product Development for Philco Corp., Philadelphia. He was formerly president of the Television and Radio Division. At the same time, John M. Otter, vice-president and general manager of the Refrigeration Division, was placed in charge of Consumer Product Divisions, and Morgan Greenwood, advertising manager of the Television and Radio Division, was upped to general advertising manager of Philco.

... David H. Kutner joined Motorola, Chicago, as director of advertising. He formerly held a similar position with the Norge Division of Borg-Warner.

... Edwin Cornfield joined Pilot Radio Corp., Long Island City, N. Y., as sales manager. He comes to Pilot from Hudson Radio and Television Corp. END

Windsor TUBES

RADIO & TV RECEIVING

TESTED and GUARANTEED for **PEAK PERFORMANCE**

WHAT EVERY SERVICEMAN SHOULD KNOW . . . No tube checker reading of "Good" can positively insure that a specific tube will function perfectly in a TV set . . . only a substitution test in an actual set will do that! This is particularly true of tubes used in power and sweep circuits, deflection amplifiers, oscillators, reactance modulators, etc.

YOU PLAY IT SAFE when you buy Windsor tubes—because every tube we ship has been carefully pre-tested in a radio or TV set for **PEAK PERFORMANCE** under actual operating conditions. So we unconditionally guarantee every Windsor tube in accordance with the Standard Warranty: full replacement of any defective tube within 90 days of purchase, excepting only burnouts and breakages. Each tube is attractively packaged in individual cartons.

BUY — AND SELL — WINDSOR TUBES, WITH CONFIDENCE

| Type | Each | Type | Each | Type | Each | Type | Each |
|-------|------|--------|------|--------|------|---------|------|
| IA7GT | 5.67 | 3V4 | .62 | 6BD5GT | .98 | 6Q7GT | .55 |
| IB3GT | .69 | 5R4GY | 1.00 | 6BD6 | .54 | 6S4 | .51 |
| IH5GT | .51 | 5U4G | .44 | 6BE6 | .51 | 6S8GT | .75 |
| IJ6 | .93 | 5V4G | .83 | 6BF5 | .66 | 6SA7GT | .57 |
| IL4 | .63 | 5Y3G | .37 | 6BF6 | .43 | 6SC7 | .63 |
| IL6 | .66 | 5Y3GT | .32 | 6BG6G | 1.47 | 6SD7 | .55 |
| ILA4 | .82 | 5Y4G | .43 | 6BH6 | .63 | 6SF5GT | .66 |
| ILB4 | .82 | 6AB4 | .51 | 6BJ6 | .53 | 6SH7GT | .52 |
| ILCS | .80 | 6AC5GT | .82 | 6BK5 | .76 | 6SIZGT | .52 |
| ILC6 | .80 | 6AG5 | .59 | 6BK7 | .97 | 6SK7GT | .55 |
| ILD5 | .80 | 6AH4 | .68 | 6BL7GT | .94 | 6SL7GT | .68 |
| ILE3 | .80 | 6AH6 | .89 | 6BN6 | .68 | 6SN7GT | .59 |
| ILG5 | .80 | 6AK5 | 1.05 | 6BQ6GT | .98 | 6SQ7GT | .46 |
| ILH4 | .80 | 6AL5 | .44 | 6BZ7 | 1.09 | 6U4GT | .60 |
| ILNS | .80 | 6AQ5 | .51 | 6C4 | .41 | 6U8 | .86 |
| IN5GT | .63 | 6A06 | .47 | 6C5GT | .60 | 6V3 | 1.09 |
| IR4 | .85 | 6AQ7 | .75 | 6C8B | .58 | 6V6GT | .51 |
| IR5 | .62 | 6AR5 | .42 | 6C06G | 2.04 | 6W4GT | .50 |
| IS4 | .67 | 6AS | .55 | 6D6 | .63 | 6W6GT | .63 |
| IS5 | .52 | 6AT6 | .42 | 6E5 | .72 | 6X4 | .37 |
| IT6 | .62 | 6AUSGT | .85 | 6F5GT | .54 | 6X5GT | .36 |
| IU4 | .61 | 6AU6 | .47 | 6H6GT | .55 | 6Y6G | .57 |
| IU5 | .51 | 6AV5 | .85 | 6J5GT | .44 | 7A4/XXL | .57 |
| IYA2A | .74 | 6AV6 | .41 | 6J6 | .68 | 7A5 | .70 |
| 2X2 | 1.43 | 6AX4 | .72 | 6J7 | .70 | 7A6 | .57 |
| 3FL4 | .76 | 6B8G | .93 | 6K6GT | .45 | 7A7 | .58 |
| 3Q4 | .66 | 6BA6 | .50 | 6K7 | .70 | 7A8 | .56 |
| 3Q5GT | .72 | 6BA7 | .66 | 6L6G | .88 | 7AD7 | 1.05 |
| 3S4 | .61 | 6BC5 | .58 | 6L6GA | .88 | 7AF7 | .63 |

| Type | Each | Type | Each |
|-------|------|---------|------|
| 7AG7 | .65 | 12BY7 | .77 |
| 7AH7 | .85 | 12J5GT | .48 |
| 7AJ7 | .70 | 12SA7GT | .57 |
| 7B4 | .54 | 12SH7GT | .67 |
| 7B5 | .51 | 12SK7GT | .55 |
| 7B6 | .52 | 12SL7GT | .67 |
| 7B7 | .58 | 12SN7GT | .59 |
| 7C4 | 1.05 | 12SQ7GT | .46 |
| 7C5 | .56 | 14A7 | .58 |
| 7C6 | .50 | 14AF7 | .68 |
| 7C7 | .58 | 14B6 | .50 |
| 7E5 | .85 | 14C5 | .70 |
| 7E6 | .65 | 14E6 | .70 |
| 7E7 | .85 | 14E7 | .85 |
| 7F7 | .89 | 14F7 | .69 |
| 7F8 | .97 | 14F8 | .99 |
| 7H7 | .81 | 14J7 | .85 |
| 7J7 | .85 | 14N7 | .75 |
| 7K7 | .85 | 14Q7 | .62 |
| 7L7 | .85 | 14R7 | .85 |
| 7N7 | .62 | 14S7 | .80 |
| 7Q7 | .62 | 18B6G | 1.53 |
| 7R7 | .70 | 19T8 | .87 |
| 7S7 | .90 | 25B06GT | .98 |
| 7V7 | .92 | 25L6GT | .53 |
| 7W7 | .99 | 25W4GT | .53 |
| 7Y6 | .62 | 25Z6GT | .46 |
| 7Y4 | .66 | 35A5 | .65 |
| 7Z4 | .50 | 35B5 | .53 |
| 12AT6 | .53 | 35C5 | .53 |
| 12AT7 | .75 | 35L6GT | .52 |
| 12AU6 | .47 | 35W4 | .33 |
| 12AU7 | .58 | 38Z5GT | .33 |
| 12AV6 | .41 | 50A5 | .55 |
| 12AV7 | .87 | 50B5 | .52 |
| 12AX4 | .72 | 50C5 | .52 |
| 12AX7 | .67 | 50L6GT | .52 |
| 12AY7 | 2.15 | 52E6 | .43 |
| 12B4 | .66 | 117Z3 | .43 |
| 12BA6 | .50 | 117Z6GT | .75 |
| 12BA7 | .66 | | |
| 12BD6 | .51 | | |
| 12BE6 | .52 | | |
| 12BH7 | .69 | | |

FREE! WINDSOR TUBE CADDY



The most practical Service-Aid ever designed for the radio and TV repairman. This ideal television carry-all now offered free with every purchase of \$160.00 or accumulated purchases totaling \$160.00 within 90 days. (You get caddy credit memo with each purchase). Windsor Tube Caddy may also be purchased outright for \$14.95.

- Carries approximately 125 tubes including meters and tools.
- 16 3/4 inches long x 8 1/4 inches wide x 13 3/4 inches high.
- Weighs only nine pounds.
- Ruggedly constructed with heavy letherette covering, strong plastic handle, nickel plated hardware, and reinforced with metal clamps.

DON'T MISS THIS SENSATIONAL OFFER!

Windsor ELECTRONIC TUBE CO.
2612-C NOSTRAND AVENUE, BROOKLYN 10, N. Y.

25% Deposit with Order. All merchandise F.O.B. NYC. For orders less than \$10, add \$1 handling cost. Deduct 2% if full remittance accompanies order. All merchandise subject to prior sale and price changes without notice.

WRITE FOR ADDITIONAL TUBE TYPES AND PRICES. We also stock Special Purpose and Transmitting Tubes at similar savings! Dept. C-4

CUSTOM CABINETS *Elegance*

for TV and Hi-Fi at LOW COST!

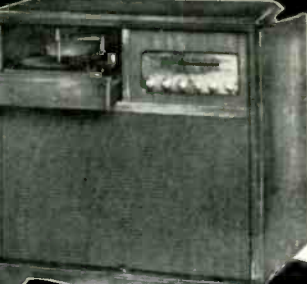

You get far more for your cabinet dollar when you buy *Standard*. Beautiful fidelity styling, choice select-grain woods, careful construction, functional design, acoustical correctness — all to the acknowledged *finest standards* of the industry.

FRENCH PROVINCIAL Closed View
Compare — Write now for FREE Catalog RE-4 showing our entire line.

FRENCH PROVINCIAL 3 Way Combination

Standard Wood Products Corp. / 47 West 63rd Street, New York 23, N. Y.

Watch for the May Issue of RADIO-ELECTRONICS At Your Dealers April 23

Insure Yourself FASTER, EASIER Installations AT LOWEST COST

NEW SUPER-FRINGER MOTORLESS

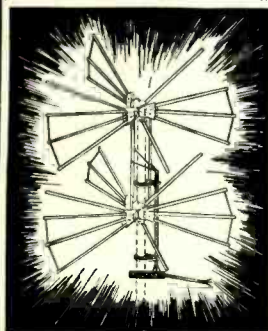

DIRECTRONIC

- 24 Elements
- New High Gain
- Clearer, Sharper Pictures
- Electronically Beamed in All Directions
- New Low-Loss Tubular Tri-X Cable
- Eliminates Ghosts—Interference

New improved Hi-Gain Super Directronic offers sensational advantages over motorized antennas—less installation cost—less upkeep. The new 24-element Directronic is beamed to any transmitter-in-fringe range by new 6-position Directronic switch located at receiver. Twenty-four elements provide high gain in all directions. New Tri-X low-loss tubular cable minimizes attenuation. Serviceman's kit contains 24 hi-tensil aluminum elements, including 6 reflectors, Directronic 6-position switch, 75 ft. Tubular Tri-X, 3 matched stacking bars, Universal U-Clamps.

Model AX-524 \$23.50 as shown

Switch located at receiver. Twenty-four elements provide high gain in all directions. New Tri-X low-loss tubular cable minimizes attenuation. Serviceman's kit contains 24 hi-tensil aluminum elements, including 6 reflectors, Directronic 6-position switch, 75 ft. Tubular Tri-X, 3 matched stacking bars, Universal U-Clamps.

FAMOUS ROCKET ZOOM-UP TOWERS

- Sturdy
- Reliable
- Easiest Installation

Economize with Rocket Zoom-up Towers. Offers quickest, easiest way to make an installation up to 50'. Each section telescopes inside the other—to erect, simply slide out each section in its turn—insert bolt thru section below—tighten to keep mast from turning. Each tower complete with guy rings, bolts, and mounting base suitable for peak or flat roof. Handsome and sturdy, Rocket Zoom-ups offer you economy and long life. Order by size.

20' \$ 9.95 30' \$15.95
40' 19.95 50' 29.95



UHF STRIPS—Now available for Standard Coil tuners. To order, specify channel No. and series designated by letter, such as F, G, Q, etc., stamped on each strip of your present tuner. (Set consists of osc. & aut.)

- UHF (tubular low-loss twin lead 100 coil) \$4.95
- Rocket twin lead—7/28 stranded02 ft.
- UHF-VHT Antenna Coupler, permits use of 1 lead for both UHF & VHT Antennas 2.75
- UHF-VHT Antenna Coupler, permits use of 1 lead69
- Lightning Arrester—for tubular or flat lead12
- UHF Mast Stand-off Insulators—7"06
- UHF Screw—7"06

\$750 Ea.

NEW SPRING CATALOG AVAILABLE Includes Sensational Profit Sharing Point Plan

SENSATIONAL SAVINGS 2 BAY—16 ELEMENT CONICAL ARRAY WITH HIGH BAND ADAPTERS

at Rockbottom Prices
Single lots \$5.30 Each in Lots of 3 \$4.99

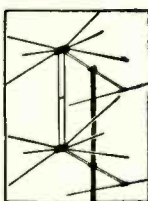

Never before has National Electronics had a BARGAIN like this. We made a special purchase in order to get these sensational prices. And this array has everything. This conical 2-bay 16-element array provides ultra-fine fringe reception. Includes sixteen 3/8 inch airplane type aluminum elements, including hi-band adapters for greater gain on the high channels and is complete with one pair of stacking bars to each array. These are packed in cartons of three 16-element arrays per carton, with tie rods, at \$14.95 per carton.

DEALERS—SERVICEMEN—ATTENTION
Single 16 element Array \$5.30 Ea.
1 Carton 6 arrays—No Tie Rods 13.50 Ea.
4 Bay Stacking Assembly—No. 4B 1.95 Ea.

ROCKET BROAD BAND YAGIS

- SENSATIONAL GAIN
- SENSATIONAL PICTURES IN FRINGE AND ULTRA FRINGE AREAS

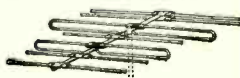

Switch to Yagi! Broad Band Hi-Gain Antennas! These new Yagis give you Yagi reception on the 5 low-band and 7 hi-band channels—no restriction to one single channel. A two-bay array will out-perform even a 10 or 12-element single channel Yagi. Price is sensationally low. Complete serviceman's array includes 1 double reflector, 2 folded dipoles, 3 directors, Universal mast clamp. Easy-to-assemble quick rig construction. Model RB 26—Ch. 2 thru 6—7-element \$10.95 ea.
Model RB 713—Ch. 7 thru 13—9-element 5.95 ea.
Matched Stacking Bars 1.25 ea.

ALL PRICES F.O.B. CLEVELAND, OHIO
Do not remit more than complete purchase price. Pay shipping charges on receipt of goods. 25% deposit on all C.O.D. orders, please. Money-back guarantee. Prices Subject to Change Without Notice

National Electronics OF CLEVELAND THE HOUSE OF TV VALUES
204 Delco Building Cleveland 3, Ohio

Any or all of these catalogs, bulletins, or periodicals are available to you on request direct to the manufacturers, whose addresses are listed at the end of each item. Use your letterhead—do not use postcards. To facilitate identification, mention the issue and page of RADIO-ELECTRONICS on which the item appears. All literature offers void after six months.

ELECTRONIC COMPONENTS

Bud Radio's Catalog No. 154 is a well-illustrated 52-page book listing electronic components and sheet-metal products. Among the many products listed are racks, panels, chassis, enclosures, antenna hardware, amateur equipment, capacitors, chokes, connectors, and coils.

Obtainable free from Bud Radio Corp., 2118 E. 55th St., Cleveland 3, Ohio.

COLOR TV FACTS

The Better Business Bureau's booklet, *The Facts About Color Television*, is a tool with which dealers can clarify for themselves and the public some of the rumors, misinformation, and wishful thinking which has been stimulated by the advent of color television.

It offers information on the development of color TV, the meaning of compatibility, the facts about conversion, availability of color programming and receivers, prices, and picture sizes.

This booklet is being distributed free through General Electric dealers and distributors.

METER-RELAY CIRCUITRY

Assembly Products has issued an 8-page bulletin explaining the functioning of 11 control and alarm circuits using meter relays. Circuits for battery-charging control, null-balance pulsing, over- or under-voltage current alarm, and temperature control are among those described. These circuits have been adapted for vacuum pump control, radiation detection, and microwave stand-by transmitter control, and other applications.

With each control diagram is a list of components for use in the circuit. Plug-in assemblies from which the controls can be made are also listed. Complete control units to accomplish a given purpose are described with each circuit. Ask for Bulletin 112 from Assembly Products Inc., Chagrin Falls, Ohio.

AMPLIFIER DATA

Stancor has issued a bulletin describing the construction of their Ultra-Linear high-fidelity amplifier, with chassis drawings, schematics, and parts lists. Data on converting the Stancor Williamson amplifier to Ultra-Linear operation is included in the bulletin.

Write for Bulletin 479, available without charge from Chicago Standard Transformer Corp., Standard Division, Addison and Elston, Chicago 18, Ill.

RELAY DATA FILE

Price Electric Corp. is offering a handy relay data file containing specifications

RADIO-ELECTRONICS

RECOGNIZE TELEVISION TROUBLES At A Glance!

... FIX 'EM TWICE AS FAST!



HANDLE 90% OF TV TROUBLES BY EASY PICTURE ANALYSIS

The looks of the picture on a bad Television receiver . . . or the lack of any picture at all . . . can usually tell you in a jiffy what is wrong. PIX-O-FIX Troubleshooting Guides not only make this easy, but also show just where and how to make repairs. Just turn the PIX-O-FIX dial until the picture appearing in its "window" shows the same trouble symptoms as the picture in the set you're repairing. PIX-O-FIX then tells what is likely to cause this trouble and gives step by step repair instructions. Testing time is cut to minutes. Repairs are made fast, easy and right!

WORK BETTER AND FASTER!

The two PIX-O-FIX Guides cover 47 different kinds of TV trouble . . . just about anything you're likely to be called on to fix. Operation is simple and easy.

Remember! PIX-O-FIX Guides are NOT "gadgets". They're practical, professional servicing devices by two of America's best-known servicing authorities. Our money-back guarantee protects you fully!

PIX-O-FIX TV TROUBLE FINDING GUIDES

by Ghirardi and Middleton

Don't guess . . . don't waste time on television receiver repairs! Cut service time in half on 2 jobs out of 3!

PIX-O-FIX No. 1—Identifies 24 of the more common television receiver troubles by actual TV screen photos. Gives 194 causes and 253 remedies for these troubles. Price separately \$1.25.

PIX-O-FIX No. 2 (Just out!)—Covers 23 additional troubles not included in No. 1 with accurate repair instructions. Together, the 2 volumes are a practical guide to "picture analysis" servicing of any TV set. Price \$1.25 separately.

SPECIAL! Get both at only \$2.00 for the two. Use coupon.

10-DAY MONEY-BACK GUARANTEE

Dept. RE-44, Rinehart & Company, Inc. 232 Madison Ave., New York 16, N. Y.

Enclosed find \$ for which please rush the following:
 PIX-O-FIX No. 1 (\$1.25) PIX-O-FIX No. 2 (\$1.25)
 BOTH PIX-O-FIX No. 1 and No. 2 at the special price of only \$2.00 for two plus postage.
If not satisfactory, I will return PIX-O-FIX postpaid in 10 days and you guarantee to refund the purchase price.

Name.....
Street.....
City, Zone, State.....
OUTSIDE U.S.A. \$1.50 each. \$2.50 for both. Same return privilege.

and photographs of relays of 42 types, both commercial and military.

There are no loose sheets or attachments. All information is printed on the body of the folder itself. Information provided includes contact arrangements and rating, coil data, dimensions, and weight.

Available free on letterhead request from Price Electric Corp., Frederick, Md.

CANNON CONNECTORS

A new 8-page loose-leaf brochure describing Cannon's new series E line of AN-type lightweight vibration-proof connectors with integral cable clamps and grounding lugs has just been issued.

Free upon request to Cannon Electric Co., 3209 Humboldt St., Los Angeles 31, Calif.

NEEDLE GUIDE

Jensen has issued an 8-page needle catalog, No. 53, three pages of which are a guide for replacement needles. Data included are cartridge manufacturer, cartridge number, point material, point size, picture of needle, cartridge manufacturer's needle number, Jensen needle number, list price, usage per 1,000 needles, and number of the correct substitute needle.

Available free from Jensen Industries, Inc., 329 S. Wood Street, Chicago 12, Ill.

SPEAKERS AND ENCLOSURES

Kingdom has issued a 4-page catalog illustrating and describing Lorenz woofers and tweeters, Kingdom cabinets, and Kingdom-Lorenz combination units. Construction notes and plans for speaker enclosures are included in the catalog.

Free from Kingdom Products, Ltd., 23 Park Place, New York 7, N. Y. END

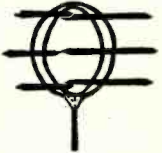

THE RESI-SPHERE
Pat.-Pend.
LONG RANGE ANTENNA

Has been used with fine results up to 200 miles. For maximum gain on multiple channels.

\$24.95
prepaid

1605 N. E. Alberta
Portland, Ore.

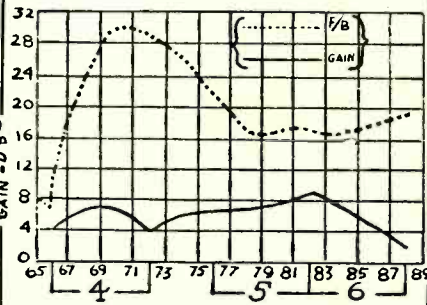

ZERO REFERENCE TUNED DIAPOLE CUT
FOR EACH CHANNEL

APRIL, 1954

for *like - new* performance

replace with original **ROGERS TV DEFLECTION COMPONENTS**

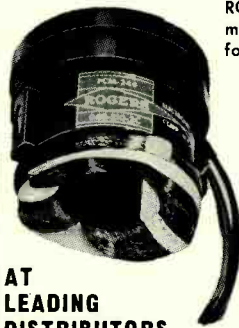

AT LEADING DISTRIBUTORS

ROGERS Deflection Yokes and Flybacks are used in the manufacture of most better sets, that's why it's wise to use these same quality components for replacements.

Every **ROGERS Full-Focus Deflection Yoke**—precision made and tested for perfect focus—is designed for peak performance and extra long life; and assures double brilliance with knife-edge sharpness.

ROGERS Flybacks—pride of the industry—feature higher voltage insulation, greater efficiency and higher voltages.

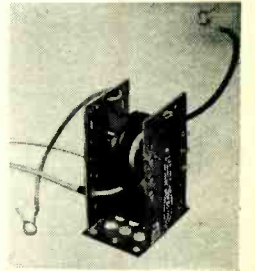

“the eye tells why”

packaged individually—attractively

ROGERS ELECTRONIC CORP. 43-49 Bloeker St. New York 12, N. Y.

FREE: Send for new catalog “A,” listing TV set models and ROGERS Yoke and Flyback replacements, or see your jobber.

OSCIL-O-PEN

Extremely convenient test oscillator for all radio servicing: alignment • Small as a pen • Self powered • Range from 700 cycles audio to over 600 megacycles u.h.f. • Output from zero to 125 v. • Low in cost • Used by Signal Corps • Write for information.

GENERAL TEST EQUIPMENT
38 Argyle Ave. Buffalo 9, N. Y.

TEST EQUIPMENT REPAIRED

Contractors to U.S. Government

Repairs and calibration by skilled craftsmen on all makes of Meters, Testers, Sig. Gens., V.T.V.M.'s, Scopes, etc. Prompt service. All work guaranteed. For immediate estimate send instrument by P.P. Ins. to

DOUGLAS INSTRUMENT LABORATORY
Electronic Instrument Repairers
176a NORFOLK AVENUE BOSTON 19, MASS.

The Greatest Tape Buy Ever!

1200 FT. REEL
Genuine Plastic Base
RECORDING TAPE



\$1.89 per roll plus postage (C.O.D.'s accepted)

LAFAYETTE made a terrific deal with one of the leading manufacturers of recording tape to supply us with their regular tape which sells for almost twice our price. **WE GUARANTEE ABSOLUTE SATISFACTION OR YOUR MONEY BACK.** The finest, professional-quality recording tape obtainable. Highest performance for thousands of playings. Red Oxide Base in a smooth, uniform coating; greater signal strength; with maximum fidelity; uniform frequency response from 40-15,000 cps.

Write for free catalog.

| | |
|------------------|-------------------|
| NEW YORK, N.Y. | 100 Sixth Ave. |
| BRONX, N.Y. | 542 E. Fordham Rd |
| NEWARK, N.J. | 24 Central Ave. |
| PLAINFIELD, N.J. | 139 West 2nd St. |
| BOSTON, MASS. | 110 Federal St. |

LAFAYETTE RADIO
DEPT. JD

Non-mathematical home study course

“TV STUDIO OPERATIONS”

helps you grow with television

The four major networks cooperated with CREI in the preparation of this course (so up-to-date it contains two lessons on the approved color system). Non-mathematical but *not* non-technical, it is for broadcast engineers and technicians who must convert to tv, as well as for inexperienced personnel who want to increase their income in the rapidly expanding field of television operations.

Field-tested for more than a year, course is backed by CREI's 27 years of technical teaching experience, by 15 years experience with our own tv studio facilities, by engineering leaders in the industry. You proceed at own speed in spare time; does not interfere with your present work. For complete details—course outlines and costs—use coupon today.

CAPITOL RADIO ENGINEERING INSTITUTE

Dept. RE,
3224 16th St., N.W.
Washington 10, D. C.

Send details of TV Studio Operations course

Name _____
Street _____
City _____ Zone _____ State _____

Reliable— AIDS FOR SERVICEMEN

These books will help you do the BEST service job in the quickest time

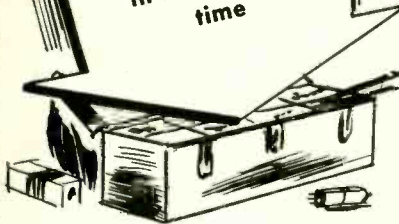

Elements of Mathematics for Radio, TV, and Electronics

By *Bernhard Fischer & Herbert Jacobs*. Begins with arithmetic and makes every step in the math needed by servicemen crystal clear. No one using this book can fail to understand the reasoning and applications of the calculations he must make to do a good job on today's radio, TV and electronic equipment. Hundreds of training exercises and problems are included. Ready April 9

Mandl's TV Servicing

By *Matthew Mandl*. The first choice of thousands of servicemen, this outstanding guide shows, in the most usable terms, how to locate and correct flaws in TV receivers and how to improve reception in difficult areas. Includes time-saving trouble index. \$5.50

TV Service Course Lab Manual

By *M. Mandl*. What-to-do and what-to-observe directions give training in the recognition and adjustment of trouble in each part of the TV receiver. \$3.90

Radio and TV Mathematics

By *Bernhard Fischer*. This handbook of problems and solutions gives worked-out examples of over 400 common problems requiring math. Arranged under radio topics for quick reference. \$6.75

TV and FM Antenna Guide

By *E. M. Noll & M. Mandl*. Clear, brief review of antenna theory and specific directions for determining the best type of antenna for the particular site and installing it for best performance. \$5.25

Hearing Aids

By *M. Mandl*. Explains the construction of the major types of modern hearing aids, comparing their advantages and disadvantages, and gives directions for servicing. \$3.50

Order from your parts dealer or from

The Macmillan Company
60 FIFTH AVENUE, NEW YORK 11, N.Y.

MOST - OFTEN - NEEDED TELEVISION SERVICING INFORMATION (Volume TV-8), compiled by M. N. Beitman. Published by Supreme Publications, 1760 Balsam Rd., Highland Park, Ill. 8 1/2 x 10 3/4 inches, 192 pages. Price \$3.00.

Diagrams, chassis layouts showing the location of tubes, alignment, and test points; oscilloscopic waveform patterns—these and other pertinent servicing information are supplied on approximately 120 different chassis used in hundreds of TV receiver models of 23 different makes; all designed to facilitate servicing.

The usefulness of the manual is obvious to the service technician. Students, instructors, engineers, and other interested persons will find it useful in comparing and analyzing circuits in a great many of the modern TV receivers.—RFS

THE RADIO AMATEUR'S HANDBOOK, 31st (1954) edition. Published by The American Radio Relay League, Inc., West Hartford 7, Conn. 6 1/2 x 9 1/2 inches, 300 pages. Price \$3.00.

The latest edition of "the Handbook" is revised to provide the reader with details on all that is new or novel as well as expanded treatments on subjects that are taking on ever-increasing importance in the lives of amateurs. For example, there is a new section on crystal diodes and transistors, the latest developments in mobile converters, transmitters, and antennas are discussed and described; and the section on interference has been revised to include suppression measures for interference at ultra-high frequencies and color TV.

The tube data section has been brought up to date with the addition of about 150 new tube types, about 40 of the recently developed transistors, and the latest types of germanium diodes. To engineers and students, this feature alone is well worth the price of this 31st edition of an old standby.—RFS

AMECO RADIO AMATEUR QUESTION AND ANSWER LICENSE GUIDE. Published by American Electronics Co., 1203 Bryant Ave., New York, N. Y. 6 x 8 3/4 inches, 32 pages. Price 50 cents.

The first 12 pages of this book are devoted to the novice, with 60 questions on basic electricity, power supplies, transmitters, and rules and regulations. The second section, "General and Technician Practice Questions," contains 128 questions on the subjects mentioned and also on vacuum tubes and audio amplifiers. The questions are of the multiple-choice type used in FCC examinations, and a typical examination closes each section.

Answers to all questions are given on page 30. Pages 31 and 32 carry diagrams which answer those questions that require the drawing of figures.

—RFS END

V-M HIGH FIDELITY 936^{HF} RECORD CHANGER ATTACHMENT

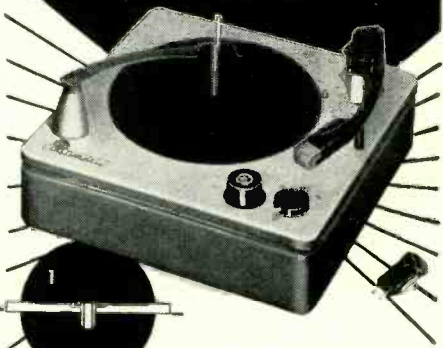

Model 936HF, \$69.95* list.
Model 935HF, \$59.95* list.
(less metal pan)

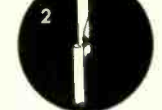

Exclusive laminated, balanced, precision-formed turntable!



Patented tri-o-matic spindle!



Exclusive die cast tone arm!

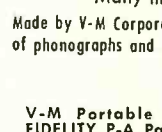

Exclusive 4-pole, 4-coil motor!

Leads in Features that help you profit!

The custom-engineered 936HF is the first changer specifically designed for high fidelity performance. It helps you win more profitable hi-fi sales and satisfied customers. Comes complete with two plug-in heads and V-M 45 Spindle.

*Slightly higher in the west.

Many more deluxe features. Made by V-M Corporation, World's largest manufacturer of phonographs and record changers exclusively.

V-M Portable HIGH FIDELITY P-A Package. Model 960 changer, \$64.50* list. Model 160 amplifier and 10" Jensen speaker, \$66.50* list.



MAIL COUPON FOR SPECIFICATIONS

V-M Corporation, Benton Harbor 10, Michigan
Send full details on the V-M 936HF
and the V-M high fidelity P-A package

NAME _____
FIRM _____
ADDRESS _____
CITY _____ STATE _____

MORE JOBS
than graduates

Electronic Engineers
Excellent opportunity for professional growth and advancement in interesting and advanced work.

Demand for our engineering graduates exceeds supply. *Effective placement.* Study in this world-famed college established 1884. Quarters start June, Sept., Jan., March. *Approved for Korean Vets.*

Bach. Sc. degree in 27 months

Complete Radio Eng. courses . . . TV, UHF and FM. Also Mech., Civil, Elec., Chem., Aero. and Adm. Eng.; Bus. Adm., Acct. Small classes. Well-equipped labs. Modest costs. Prep. courses. Write Jean McCarthy, Director of Admissions, for Catalog and Campus View Book.



TRI-STATE COLLEGE

2444 College Avenue, Angola, Indiana

GET INTO ELECTRONICS

You can enter this uncrowded, interesting field. Defense expansion, new developments demand trained specialists. Study all phases radio & electronics theory and practice: TV; FM; broadcasting; servicing; aviation, marine, police radio. 18-month course. Graduates in demand by major companies. H.S. or equivalent required. Begin Jan., March, June, Sept. Campus life. Write for catalog. VALPARAISO TECHNICAL INSTITUTE Dept. C Valparaiso, Ind.



TV REPAIRMEN MAKE TOP MONEY!

In just 39 weeks, you can get complete TV service training! Streamlined course gives you all essentials for a good job as service technician. Graduates in great demand; jobs are plentiful in this growing field. Other courses in electronics, radio operation and maintenance. Day or evening classes; modern equipment. Opportunity for employment in local industry.

Write for Catalog 111 Today
INDIANAPOLIS ELECTRONIC SCHOOL
312 E. Washington, Indianapolis 4, Ind.

WANTED for Murder...

CANCER is the cruelest enemy of all. No other disease brings so much suffering to Americans of all ages.

YET—though 23 million living Americans will die of cancer, at present rates—there is reason for hope. Thousands are being cured, who once would have been hopeless cases. Thousands more can have their suffering eased, their lives prolonged. And every day, we come closer to the final goal of cancer research: a sure and certain cure for all cancer.

THESE THINGS have all been helped by your donations to the American Cancer Society. This year, please be especially generous!

Cancer
MAN'S CRUELEST ENEMY
Strike back—Give
AMERICAN CANCER SOCIETY



APRIL, 1954

Get Your F.C.C. LICENSE Quickly!

Correspondence or residence preparation for F.C.C. examinations. Results guaranteed.

An FCC commercial operator license means greater opportunities and higher pay. We are specialists in preparing you, in a MINIMUM OF TIME, to pass FCC examinations for all classes of licenses. Beginners get 2nd class license in 5 weeks and 1st class in 3 additional weeks. Write for free booklet.

GRANTHAM SCHOOL OF ELECTRONICS
Dept. 101, 6064 Hollywood Blvd., Hollywood 28, Calif.

SENDING SPEED
CODE RECEIVING

Be a "key" man. Learn how to send and receive messages in code by telegraph and radio. Commerce needs thousands of men for jobs. Good pay, adventure, interesting work. Learn at home quickly through famous Candler System. Qualify for Amateur or Commercial License. Write for FREE BOOK. CANDLER SYSTEM CO. Dept. 3-D, Box 928, Denver 1, Colo. U.S.A.

RADIO ENGINEERING 27 MONTHS
DEGREE IN 27 MONTHS

Intensive, specialized course including strong basis in mathematics and electrical engineering, advanced radio theory and design, television. Modern lab. Low tuition. Self-help opportunities. Also B.S. degree in 27 months in Aeronautical, Chemical, Civil, Electrical, and Mechanical Engineering. G.I. Gov't approved. Enter June, September, December, March. Catalog.

INDIANA TECHNICAL COLLEGE
154 E. Washington Blvd., Fort Wayne 2, Indiana



RCA INSTITUTES, INC.

A service of Radio Corporation of America
350 West 4th St., New York 14, N. Y.

OFFERS COURSES IN ALL TECHNICAL PHASES OF RADIO, TELEVISION, ELECTRONICS

Approved for Veterans
Write Dept. RC-54 for Catalog

EARN MORE MONEY—
BE A PROFESSIONAL
TELEVISION
SERVICE
TECHNICIAN

STEP INTO THE TOP PAY
\$5,000—\$10,000 A YEAR
CLASS. 7 MONTHS' SHOP
TRAINING QUALIFIES YOU.



If you want to reach your goal as a Successful Service Technician you will need plenty of "KNOW HOW" to qualify for the better servicing jobs or profitable shop ownership.

SEND FOR
FREE
BOOK TODAY!

WESTERN TV offers real experience on live equipment in our BIG SHOPS AND LABORATORIES in the shortest practical time under expert instructors. Graduates are in big demand because they have the "field experience" necessary for immediate "bench" or supervisory positions. You learn every phase of Radio and TV servicing (AM, FM, VHF, UHF). WTI men win fast promotion . . . can demand better pay . . . develop highly profitable businesses of their own with the latest and most PRACTICAL PERSONALIZED TRAINING BEHIND THEM. You concentrate all your time on being a PROFESSIONAL TV SERVICE TECHNICIAN—non-essential math and engineering theory omitted. YOU CAN EARN WHILE YOU LEARN. Special Finance Plan.

APPROVED FOR VETERANS. Find out how you can get into the TOP PAY GROUP—Send for this fact-packed book NOW!

WESTERN TELEVISION INSTITUTE

America's Leading
Television
Servicing School

Western Television Institute Dept. E-4-4
341 W. 18th St., Los Angeles 15, Calif.
Without obligation, please send FREE fully illustrated booklet. (No salesman will call.)

NAME _____ AGE _____
ADDRESS _____
CITY _____ ZONE _____ STATE _____

There's a future for you as an
ELECTRICAL ENGINEER

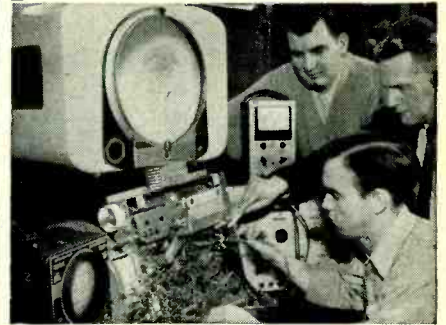

Bachelor of Science Degree
in 36 Months. Major in Electronics or Power

Everyone knows the tremendous opportunities ahead in electrical engineering. The expanding field of color television alone is one example. In addition to the demand for engineers, thousands of engineering technicians are needed. The Milwaukee School of Engineering can prepare you to become an engineer in 36 months or an engineering technician in 12 to 18 months.

It takes only 12 months to become a radio technician. An additional 6-month course qualifies you to become a radio-television technician with the degree of Associate in Applied Science. Or you can earn an industrial electronic technician certificate in 12 months.

These technician courses form the first third of the program leading to a Bachelor of Science degree in Electrical Engineering with a major in electronics. Twenty-one subjects in electronics, electronic engineering and electronic design are studied in this course.

Also offered are a 12-month radio-television service course; a 6-month electrical service course; and a 3-month general preparatory and refresher course.

Terms open July, Sept., January and April
Faculty of specialists — 50,000 former students — Annual enrollment from 48 states and 23 foreign countries — Non-profit institution — 51st year of service — Course approved for veterans — Residence courses only.



MILWAUKEE SCHOOL OF ENGINEERING

MILWAUKEE SCHOOL OF ENGINEERING
Dept. RE-454, 1025 N. Milwaukee St.
Milwaukee 1, Wisconsin

Send me Free bulletin on opportunities in Electrical Engineering or Free bulletin on careers in Radio-TV.

I am interested in _____ (name of course)
Name _____ Age _____
Address _____
City _____ Zone _____ State _____
If veteran, indicate date of discharge _____

Halldorson's *New* FB412 FLYBACK

An exact replacement for
Part No. C201-21025-1

Services **83** models and
chassis of

AIRLINE RAYTHEON TRUETONE

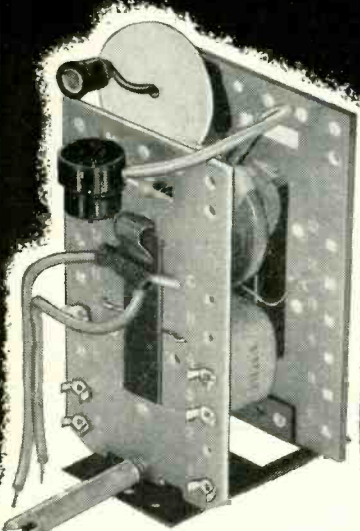

↑ with Special
VARIABLE GAP
Width Control

Another needed flyback for fast,
economical *sure-fire* servicing.
Get it now—at your distributor
—and be ready to service these
popular TV sets not covered
before. Quality-made by one of
the oldest firms in the business.

Write for descriptive
Bulletin No. 116 today.

HALLDORSON TRANSFORMER CO.
4500 N. Ravenswood Ave.
Chicago 40, Illinois

For your convenience
Halldorson Replacements
are now being listed in
**PHOTOFACTS and
COUNTERFACTS**

Halldorson
QUALITY Transformers SINCE 1913

ADVERTISING INDEX

Radio-Electronics does not assume responsibility for any errors appearing in the index below.

| | |
|---|--------------------|
| All Channel Antenna Corp. | Inside Back Cover |
| Allied Radio Corp. | 15 |
| American Microphone Co. | 72 |
| American Phenolic Corp. | 102 |
| Amplifier Corporation of America | 127 |
| Arkay Radio Kits, Inc. | 89 |
| Astatic Corp. | 14 |
| Astron Corp. | 25 |
| Atlas Sound Corp. | 86 |
| Audel Publishers | 122 |
| Barry Electronics Corp. | 128 |
| Beaco | 101 |
| Belden Manufacturing Co. | 99 |
| Bell Telephone Labs | 22 |
| Brach Manufacturing Co. | 106 |
| Brooks Radio & TV Corp. | 92, 93, 101 |
| Burstein-Apiblee Co. | 96 |
| CBS Hytron (Division of Columbia Broadcasting System) | 10 |
| Cannon Electric Co. | 98 |
| Canitol Radio Engineering Institute | 27, 125 |
| Centralab—Division of Globe Union | 29 |
| Century Electronics Co. | 100 |
| Channel Master Corp. | 20, 21 |
| Chicago Standard Transformer Corp. | 26 |
| Clarostat Manufacturing Co. | 78 |
| Cleveland Institute of Radio Electronics | 11 |
| Collins Audio Products Co., Inc. | 91 |
| Concord Radio | 121 |
| Cornell-Dubilier Electric Corp. | 90 |
| Coyne Electrical & TV Radio School | 101, 113 |
| Deico Radio (Division of General Motors Corp.) | 9 |
| DeVry Technical Institute | 7 |
| Doc's Radio Tools | 121 |
| Douglas Instrument Laboratory | 125 |
| Edlie Electronics | 97 |
| Electric Sweeper Service Co. | 112 |
| Electro Products Labs., Inc. | 112 |
| Electro-Voice, Inc. | 6 |
| Electron Tube Wholesalers, Inc. | 116 |
| Electronic Equipment Co. | 123 |
| Electronic Instrument Co. | 30, 76, 113, 116 |
| Erie Resistor Corp. | 82 |
| Fair Radio Sales | 88 |
| G & H Wood Products Co. | 86 |
| General Industries Co. | 111 |
| General Test Equipment | 125 |
| Gould Green | 116 |
| Halldorson Transformer Co. | 128 |
| Harvey Radio Co., Inc. | 108 |
| Heath Co. | 67-70 inclusive |
| Hickok Electrical Instrument Co. | 24 |
| Hudson Specialties Co. | 89 |
| Hughes Research & Development Labs. | 18 |
| Indiana Technical College | 112 |
| Instructograph Co. | 111 |
| International Correspondence Schools | 13 |
| Jensen Industries | 118 |
| Jones & Laughlin Steel Corp. | 94 |
| Kay-Townes Antenna Corp. | 95 |
| Kirby Products | 76 |
| Kryon, Inc. | 109 |
| Lafayette Radio | 125 |
| Leotone Radio Corp. | 119 |
| Macmillan Co., The | 126 |
| Mallory & Co., Inc., P. R. | 19 |
| McGraw-Hill Book Co. | 122 |
| Metalfac Corp. | 109 |
| Moog, R. A., Co. | 111 |
| Moss Electronic Distributing Co. | 80, 81 |
| National Electronics of Cleveland | 124 |
| National Radio Institute | 3, 129 |
| National Schools | 5 |
| New Jersey Television Supply Co. | 100 |
| Ohmite Manufacturing Co. | 74 |
| Opportunity Adlets | 100 |
| Orradio Industries Inc. | 115 |
| Part-Mart Co. | 86 |
| Permo, Inc. | 92 |
| Permolux Corp. | 12 |
| Phico Corp. | 28 |
| Precise Development Corp. | 89 |
| Precision Apparatus Co., Inc. | 90, 96 |
| Pres-Probe Co. | 113 |
| Progressive "Edu-Kits" Inc. | 103 |
| Pyramid Electric Co. | Inside Front Cover |
| RCA Institutes, Inc. | 105, 107 |
| RCA Victor Division (Radio Corporation of America) | Back Cover |
| Rad-Tel Tube Co. | 87 |
| Radelco Manufacturing Co. | 120 |
| Radiart Corp. | 77 |

RADIO SCHOOL DIRECTORY PAGE 127

| | |
|-------------------------------------|-----------------------|
| Candler System Co. | 17 |
| Grantham School of Electronics | 123 |
| Indiana Technical College | 119 |
| Indianapolis Electronic School | 124 |
| Milwaukee School of Engineering | 125 |
| RCA Institutes, Inc. | 110 |
| Tri-State College | 108 |
| Valparaiso Technical Institute | 117 |
| Western Television Institute | 112 |
| Radio-Television Training Ass'n. | 23 |
| Raytheon Manufacturing Co. | 17 |
| Rest-Sphere, Inc. | 125 |
| Rider, Inc. John F. | 119 |
| Rinehart & Co., Inc. | 72, 98, 114, 120, 124 |
| Rogers Electronics Corp. | 125 |
| Sams & Co., Inc., Howard W. | 16, 110 |
| Scala Radio Co. | 108 |
| Service Instruments Co. | 117 |
| Spraberry Academy of Radio | 115 |
| Stan-Burn Radio & Electronics Co. | 109 |
| Standard Wood Products | 123 |
| Steve-El Electronics Corp. | 88 |
| Sun Parts Distributors Ltd. | 92 |
| Sylvania Electric Products | 83 |
| Tab | 130 |
| Technical Appliances Co. | 73 |
| Television Communications Institute | 115 |
| Teltron Electric Co. | 82 |
| Transamerica Electronics | 118 |
| Transvision, Inc. | 119, 120, 121 |
| Tung-Sol Electric Co. | 16 |
| Turner Co. | 8 |
| United Catalog Publishers | 118 |
| V.A. Enterprises | 121 |
| V-M Corporation | 126 |
| Waldom Electronics | 88 |
| Webster Electric Corp. | 75 |
| Westinghouse Electric Corp. | 84, 123 |
| Windsor Electronic Tube Co. | 106 |
| Xcelite Inc. | 106 |
| Zingo Products | 113 |

FIVE TOP NAME BRANDS



STANDARD BRAND TUBES

at Sensational
Savings!

• FULLY GUARANTEED
• INDIVIDUALLY BOXED

NO SECONDS OR REMANDED "BARGAINS." YOU CAN PLACE YOUR CONFIDENCE IN OUR DEPENDABLE NEW TUBES.

Tube Orders Over \$25.00, with full remittance, PREPAID to you in U.S.A.

RECEIVING TUBES

| Type | Net | Type | Net | Type | Net |
|--------|------|----------|------|---------|------|
| 0B2 | .95 | 6AX5GT | .80 | 7A8 | .69 |
| 0B3 | .82 | 6B7GT | .75 | 7B7 | .75 |
| 0C3 | .80 | 6BA6 | .60 | 7B7 | .76 |
| 0D3 | .89 | 6B8C | .69 | 7B8 | .78 |
| 0Z4 | .55 | 6B8G | .95 | 7C7 | .89 |
| 1A7GT | .77 | 6B8GG | 1.79 | 7C8 | .69 |
| 1B2T | .85 | 6BH6 | .80 | 7E5 | .39 |
| 1H5GT | .77 | 6BK5 | .95 | 7F8G | 1.55 |
| 1L6 | .95 | 6BK7 | 1.10 | 7H7 | .70 |
| 1L6A | 1.10 | 6B7GT | .70 | 7H7 | 1.20 |
| 1L6B | 1.10 | 6BN6 | 1.10 | 7Q7 | .98 |
| 1L6S | 1.10 | 6BQ6GT | 1.17 | 7X7 | .90 |
| 1N5GT | .95 | 6BQ7A | 1.23 | 12AT6 | .50 |
| 1R4 | .59 | 6B7G | 1.35 | 12AR7 | .89 |
| 1R5 | .75 | 6BZ7 | 1.28 | 12AU7 | .79 |
| 1S5 | .70 | 6C4 | .50 | 12AV6 | .50 |
| 1T4 | .75 | 6C8B | .65 | 12AW6 | .88 |
| 1U4 | .50 | 6CD6G | 1.80 | 12AX4 | .90 |
| 1U5 | .70 | 6D6 | .65 | 12BA6 | .70 |
| 1V | 1.03 | 6F4 | 3.50 | 12B8A | .98 |
| 1V2 | .90 | 6F5 | .68 | 12B8G | .65 |
| 1X2A | .85 | 6F5GT | .68 | 12BD6 | .75 |
| 1Z2 | 3.25 | 6F6 | .70 | 12BE6 | .64 |
| 2A4 | .75 | 6F6C | .80 | 12BH7 | .85 |
| 2A5 | .85 | 6F8G | .85 | 12BY7 | 1.05 |
| 3A4 | .59 | 6GG6 | .85 | 12BZ7 | 1.10 |
| 3B7 | .39 | 6H6 | .52 | 12SA7 | .64 |
| 3Q5GT | .89 | 6J4(RCA) | 5.75 | 12SF5 | .70 |
| 3S4 | .75 | 6J5 | .50 | 12SG7 | .80 |
| 3L4 | .90 | 6J6 | .75 | 12SH7 | .63 |
| 3V4 | .75 | 6K4/6K4A | 2.25 | 12SK7 | .61 |
| 5A4W | 1.55 | 6K6GT | .59 | 12SL7GT | .65 |
| 5R4G | 1.50 | 6K7 | .60 | 12SN7GT | .75 |
| 5U4 | .56 | 6L6G | 1.10 | 12SQ7GT | .55 |
| 5V4G | .92 | 6L6G | 1.10 | 12SR7 | .69 |
| 5W4G | .75 | 6L6GA | 1.10 | 12SX7GT | 1.10 |
| 5Y3GT | .44 | 6L6M | 1.25 | 14F7 | .75 |
| 6AGT | 1.10 | 6L7 | .80 | 19BG6G | 2.05 |
| 6A4 | .75 | 6N7M | .70 | 1E6 | .55 |
| 6A7 | .95 | 6Q7GT | .80 | 25BQ6GT | 1.25 |
| 6AC7 | 1.04 | 6S4 | .58 | 25L6GT | .62 |
| 6AF4 | 1.39 | 6S7M | .98 | 25W4GT | .65 |
| 6AG4 | .75 | 6S7 | .98 | 25Z5 | .70 |
| 6AG7 | 1.10 | 6SC7 | .88 | 25Z6GT | .59 |
| 6AH4GT | .80 | 6SD7GT | .80 | 28D7 | 1.35 |
| 6A5 | .80 | 6S7 | .88 | 6S7 | .88 |
| 6AJS | 1.30 | 6SH7 | .98 | 35B5 | .60 |
| 6AKS | .99 | 6S7 | .65 | 35C5 | .62 |
| 6AKS-W | 1.50 | 6SK7GT | .65 | 35W4 | .45 |
| 6AL5 | .55 | 6SN7GT | .73 | 35Z3 | .70 |
| 6AS5 | 1.50 | 6S7 | .81 | 50A5 | .75 |
| 6AQ5 | .55 | 6TR | .89 | 50A5 | .75 |
| 6AQ6 | .73 | 6U8 | .90 | 50B5 | .65 |
| 6AS6 | 1.95 | 6V3 | 1.50 | 50L6GT | .65 |
| 6AS7G | 3.75 | 6V6GT | .61 | 80 | .66 |
| 6A6 | .59 | 6W4GT | .59 | 81 | .75 |
| 6A6G | .59 | 6W6GT | .75 | 83V | 1.15 |
| 6AV5GT | 1.10 | 6XS7 | .50 | 84 6Z4 | .65 |
| 6AV6 | .48 | 6X8 | .85 | 117Z | .75 |
| 6AX4GT | .72 | 7A7 | .75 | 11Z6 | .98 |

SPECIAL PURPOSE TUBES

| | | | | | |
|-----------|--------|----------------|-------|--------|---------|
| 1N21B | 1.88 | 211(VTAC) | .88 | CK1005 | .65 |
| 1N23B | 2.25 | 304TH | .88 | 1619 | .33 |
| 1N34A | 1.78 | (Surplus) | 7.75 | 1622 | .195 |
| 1N48 | .55 | 310A(WE) | 3.75 | 1625 | .30 |
| 1N54 | .75 | 407A(WE) | 4.05 | 1626 | .20 |
| 2C51 | 4.80 | 408A(WE) | 3.00 | 1629 | .25 |
| 2E26 | 3.40 | 803 | 3.25 | 1629 | .25 |
| 2E30(Hyt) | 2.20 | 805 | 2.95 | 2050 | 1.40 |
| 2J19 | 12.50 | 807 | 1.35 | 5516 | 7.65 |
| 2J61 | 29.50 | 809 | 3.50 | 5528 | C6L5.00 |
| 2J62 | 25.00 | 812A | 3.65 | 5654 | 1.75 |
| 2K28 | 25.50 | 816 | 2.50 | 6096 | 1.45 |
| 3BP11 | 7.00 | 830B | 2.75 | 5670 | 3.25 |
| 3B28 | 4.95 | 851 | 39.95 | 5687 | 2.95 |
| 3C23(CE) | 6.75 | 866A | 1.25 | 5693 | 6.20 |
| 4B24 | 4.50 | Large Quantity | | 5814 | 1.75 |
| 5C22 | 44.95 | 872A(GE) | 3.25 | 6096 | 1.45 |
| 5D21 | 11.80 | 10 for 29.50 | | 9003 | .015 |
| 7C25 | 110.00 | | | 9004 | .30 |
| 7C30 | 85.00 | | | 9006 | .25 |

Above is only a partial listing of our huge stock. Types not listed may be ordered at approx. the same savings. Many new special purpose types in stock.

AUTHORIZED DISTRIBUTORS
CBS-HYTRON EIMAC WESTINGHOUSE

ORIGINAL JOBBERS' BOXED TUBES

In Stock—Late Dates,
AT WHOLESALE PRICE LEVELS!

TWO-COLORED TUBE CARTONS, with new Safety Partitions. Prevents Tube Breakage. This Super-Gloss Red and Black Carton is the Most Distinguishing Box Available Today! Minimum: 100 any one size. Quantity prices on request.

| SIZE | EACH | |
|-----------|---------------------|-------|
| Miniature | (6AU6, 6AL5, etc.) | 5.01 |
| GT | (6SN7, 6W4, etc.) | .0125 |
| LARGE GT | (1B3, 6BQ6GT, etc.) | .015 |
| LARGE G | (5U4G, 6B8GG, etc.) | .02 |

Terms: 25% with Order, balance C.O.D.
All Merchandise guaranteed. F.O.B. NYC.

Phone: REctor 2-2562

BARRY ELECTRONICS
CORP.
136-B LIBERTY ST. N. Y. 6, N. Y.

An Invitation . . .

To men who want to "go places" in TV SERVICING

*Find out about this NEW,
ALL-PRACTICE WAY
of becoming a Professional
TV SERVICEMAN*

If you have some Radio or Television experience, or if you know basic Radio-Television principles but lack experience—NRI's new Professional Television Servicing course can train you to *go places* in TV servicing. This advertisement is your personal invitation to get a free copy of our booklet describing this training in detail.

Learn-by-Doing "All the Way"

This is 100% learn-by-doing, practical training. We supply *all* components, *all* tubes, *including* a 17-inch picture tube, and comprehensive manuals covering a thorough program of practice. You learn how experts diagnose TV defects quickly. You see how various defects affect receiver performance—picture and sound; learn causes of defects, accurately, easily, and how to fix them. You do more than just build circuits. You get practice recognizing, isolating, and fixing innumerable troubles.

You get actual experience aligning TV receivers, diagnosing the causes of complaints from scope patterns, eliminating interference, using germanium crystals to rectify the TV picture signal, obtaining maximum brightness and definition by properly adjusting the ion trap and centering magnets, etc. There isn't room on this or even several pages of this magazine to list all the servicing experience you get.

UHF & COLOR TV Making New Boom

Installing front-end channel selector strips in modern UHF-VHF Television receivers and learning UHF servicing problems and their solution is part of the practice you get. To cash in on the coming color TV boom you'll need the kind of foundation in knowledge and experience this training gives.

Get Details of New Course Free

Once again—if you want to go places in TV servicing, we invite you to find out what you get, what you practice, what you learn from NRI's new course in Professional Television Servicing. See pictures of equipment supplied, read what you practice. Judge for yourself whether this training will further your ambition to reach the top in TV servicing. We believe it will. We believe many of tomorrow's top TV servicemen will be graduates of this training. Mailing the coupon involves no obligation.

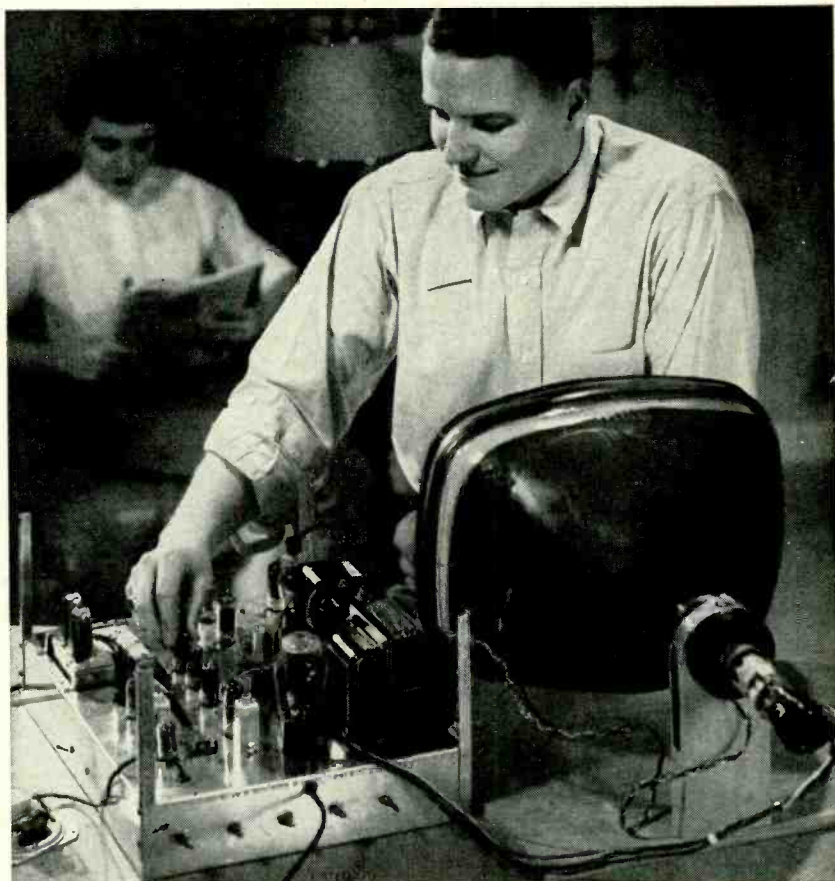

Train at home easily, quickly, for TV's top servicing jobs. NRI's Professional Television Servicing course includes a 17-inch picture tube and all other tubes and components to build a complete TV Receiver, Oscilloscope, Signal Generator, H.F. Probe. Complete training, including all equipment, available now for a low introductory price—under \$200 on easy terms.



National Radio Institute, Dept. 4DFT
16th and U Sts., N.W., Washington 9, D. C.

Please send my FREE copy of "How to Reach the Top in TV Servicing." I understand no salesman will call.

Name Age

Address

City Zone State

CRYSTAL DIODES

- 1N21 Lots of 50 35¢ ea
Smaller qty. 70¢ 10 for \$5.00
Kemptron-Winn-Dixie

TUBE SPECIALS

- YOU PICK THEM 39¢ ea
Cracked base or broken key electrically perfect
TESTED & 90 DAY GUARANTEED

ZIMPHONE INTERCOM

(2) TELEPHONE HANDSETS, WALL BRKTS. BATTERIES, 50 FT. WIRE, MAKERS ONE YEAR GUARANTEE. OPENED TO 1 MILE CLEAR AS A BELL. Postpaid \$4.39

YOU PICK THEM 59¢ WHILE THEY LAST

- LOTS OF 10
Your selection of 10 at 59¢ each or smaller quantity at indicated prices.
ELECTROLYTIC CONDENSERS

INFRARED SNOOPSCOPE

SEE-IN-DARK TUBE
Image-Converter Tube HiSensitivity simple design 2" dia. Willemite screen data & tube ea. \$7.98

TAB THAT'S A BUY

WATCH! THIS SECTION EVERY MONTH
FOR TREMENDOUS BARGAIN PRICES
RF PI CHOKE 20MH/500MA 89¢; 12/7.49

METER SPECIALS
0-30 VDC "AN" Type \$3.33 for 8.00
0-60 ADC "AN" Type \$2.95 for 5.00

TELEVISION ANTENNA
Vee Conical Broad-Response, all channel, power-response, 800Mfd filter

DC POWER SUPPLY
Variable DC Power Supply. Full wave rectification, 800Mfd filter

SELENIUM RECTIFIERS

Table with columns for Current, Voltage, and Price for various selenium rectifier models.

Rectifier & Transformer
up to 14VDC at 12 amps. \$19.98
up to 28VDC at 4 amps. 14.98

HIGH CURRENT PWR SUPPLIES
Variable 0-28VDC. Completely Built, Ready to Go. Full wave Selenium Rectifier,

RECTIFIER XFMRs
Primary 115V 60 Cyc
Secondary 0-9-12-18-24-36V

RECTIFIER CHOKES
4 Amp .07 Hy 6 Ohm \$7.95
12 Amp .01 Hy 1 Ohm 14.95

FEDERAL "ITT" SELENIUM BATTERY CHARGER RECTIFIER
10-0-10V CT 10 Amp fan cooled. Replace your old inefficient sulfide

Large table listing various electronic components like diodes, capacitors, and resistors with their respective prices.

TV & COAX CABLE

300 Ohm Twinex. Heavy duty 65 mil copper TV lead in. \$1.39 per ft. 2; 100 feet \$139.00

RCA LICENSED ONE YEAR GTD PICTURE TUBES

Table showing tube types, durations, and prices for RCA licensed picture tubes.

IMPORTANT! Ship Dub with order prepaid only. Prices indicated are for Glass Tubes. Metal or Electrostatic add 10¢ per inch.

VARIABLE VOLTAGE TRANSFORMERS
VARIAC-GR-STACO
0-135V/3A \$11.25
CSD/135V/7.5A \$20.70

7.5 Meg "MVP" 10W 10KV .79 10 \$ 5.00
2 Meg "SPRG" 4W 5KV .89 10 \$ 7.50

866A KIT and XFOMER
2 Tubes, Sektors xmftr, 115V/60Cyc Inpt, output 2.5Vct/10A

100 WATT SEC PHOTOFASH KIT
Includes ML Flash Lamp Rated 150 Watt Second, Flash Gun and Reflector & Cabinet

"TAB" PHOTOFLASH LAMPS
"Tab" No. Replaces Max. Each
TLV FA104/U5W 150 \$5.98

SOLDERING GUNS FAMOUS MAKE GTD
Lenk #27LP Blow torch with light no priming, no soot or odor, adj flame \$3.75

OIL CONDENSER SPECIAL
10 MFD \$1.75 ea
lots of 3
insulators 4 1/2 x 2 3/4 x 1 3/4"

OIL CONDENSERS NEW WAREHOUSE LIST
.00025MFD/25KV \$2.00 for \$10
.0016MFD/15KV \$7.00 for \$12

Money Back Guarantee (Cost of Mds. Only) \$5 Min. Order F.O.B. N.Y.C. Add Shpg. Charges or 25% Dep. Tubes Gtd. via R-Exp. only.

Table listing various vacuum tube models and their prices.

Table listing various electronic components like diodes, capacitors, and resistors.

FILAMENT TRANS.
2.5VCT/10A 12 3KVNS \$5.50 3 for \$14
2.5VCT/10A 5KVNS \$3.59; 2 for \$6.50

TRANSFORMERS
All 1/2 xmftr 60 Cyc Input TV, & CR
VOLTS to 20 Kv (w/quadrupler)

TEST CORDS
8 FT 26 Strand Wire Alligator Clips, as Shown 3 PK. \$1.00

FILTER CHOKES
12Hv/80ma H'sid/3KVns 2.25
10Hv/125ma DTC/Csd/ 1.98

KITS AND COMPONENTS
Oil Condensers Assorted. \$1.25
Electrolytics Assorted. 5 for 1.25

RHEOSTAT SALE
2 ohm 50W Model J. 2.25; 5 for 10.00
6 ohm 25W Model J. 1.49; 2 for 2.49

TRANSFORMER SPECIAL
6.3 VOLT 3 3/4 AMP
Continuous Duty, 115V/60CY Input

THAT'S A BUY TAB THAT'S A BUY
Dept. 4RE 111 LIBERTY STREET, NEW YORK 6, N.Y. U.S.A.

AUDIO AMPLIFIERS READY TO GO
MODEL TUSP Ultra Hi-Fi 5 watts, with built in Pre Amp 15DB Bass boost & cut same for trbl.

AUDIO COMPONENTS
Electrovoice triplay cart. \$1.98
GE RPX040 78 Goldtone \$5.25

COAXIAL SPEAKERS
All 8 ohm. V.C., Alnico V Magnets, Inhibit Network, 2 wires needed for LP Response.

TACHOMETER GENERATOR
MARCO STUD MTC GENERAL ELECTRIC \$3.98 ea. Part #2CM5-AAK-20

FACTS

NOT JUST CLAIMS

**FACT- 53 CLAIMS GRANTED
IN 5 UNITED STATES PATENTS -**

#2,585,670; 2,609,503; 2,625,655; 2,644,091; 2,661,423, others pending.

FACT- These antennas positively receive **ALL** channels 2-83 from **ALL** directions without a rotor motor.

FACT- These antennas have consistently **OUT-GAINED** and **OUT-PERFORMED** all others in actual public demonstrations.

FACT- These antennas will unquestionably **OUT-PERFORM** all others, on **YOUR** roof, with **YOUR** set, or **YOUR** money back.

FACT- **SAVES YOU MONEY.** Eliminates rotor motor, uses only **ONE** transmission line, uses only **ONE** antenna for both UHF & VHF—and only **ONE** simple, quick installation.

FACT- Perfect pictures have consistently been received as far as 3 times the guaranteed distances.

FACT- **ONLY** one antenna, **ONLY** one transmission line, **ONLY** one installation. You solve once and for all your **PRESENT** and **FUTURE** antenna problems.

MONEY BACK GUARANTEED TO RECEIVE All CHANNELS 2-83 FROM All DIRECTIONS AND POSITIVELY OUTPERFORM All OTHER ANTENNAS WITH OR WITHOUT A ROTORMOTOR

Guaranteed
60 mi UHF
60 mi VHF



SUPER 60

LIST PRICE
\$36.75
SEE YOUR
JOBBER

Guaranteed
100 mi VHF
30 mi UHF



ULTRA 150

LIST PRICE
\$43.50
SEE YOUR
JOBBER

**9 POSITION
ELECTRONIC
ORIENTATION
SWITCH**



PRICE INCLUDES

Antenna arrays - necessary stacking bars - 9 position switch - switch-to-set coupler - necessary hook-up harness - 7 1/2" stand-offs Individually boxed in mailable carton.

**NEW POLYMICALENE
4 CONDUCTOR TRANSMISSION LINE**

- Low Loss External Air Dielectric
- Matched Impedance
- Eliminates End Sealing
- Eliminates Condensation
- Up to 50% Less Loss Than Tubular When Wet
- Easily Spiraled
- No Breaking or Shorting
- Patents Pending - T. M. Reg.

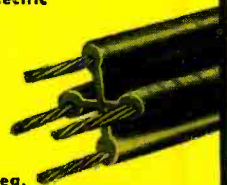

ALL CHANNEL ANTENNA CORP.,

70-07 Queens Blvd., Woodside 77, N. Y.

Hickory 6-2304

\$50,000 "TELL & SELL" CONTEST

400 FABULOUS PRIZES

For Dealers and Servicemen* who use RCA Tubes

1954 Dodge, Deluxe 1/2-Ton Panel Truck—complete with "Truck-o-matic" transmission, radio, heater and accessories . . . plus a full set of RCA Test Equipment, aluminum ladder, and winner's business name and address on truck panel.

1st prize
(your choice)



1954 DeSoto Automatic "Hard-Top"—170-H.P. Fire Dome V8 engine, Power-Flite Transmission, Power Steering . . . completely equipped, including radio and heater.

HURRY, HURRY, HURRY . . . contest closes April 30, 1954. See your RCA Distributor Salesman right away, and get your copy of the "clue book" that includes complete contest rules, official entry blank, and clues that will help you win.

* Your RCA Distributor Salesman will be glad to help you . . . because if you win, he wins a duplicate prize!

PLUS Powerful promotion campaign to help you sell more in '54

The RCA "Tell and Sell" campaign was designed to help you sell your service on a local level. Everything you need, from giant illuminated signs and window displays, to a consumer booklet that will give your customers the facts of TV servicing—is available from your RCA Distributor. See him today!

Consumer Booklet
Tells the customer what is needed to bring him expert service. Points you out as "the man who keeps the show going."

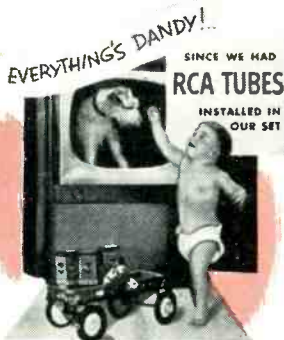

1954 RCA BABY DISPLAY



NEW GIANT OUTDOOR SIGN



NEW RCA SERVICE DECAL



RCA DOOR-BELL FLIPPER



DRAMATIC "EDGE-LIT" SIGN

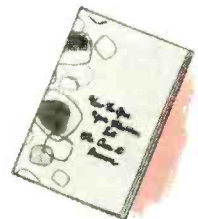

RCA TUBE RACK



RADIO CORPORATION of AMERICA
ELECTRON TUBES
HARRISON, N. J.