

MARCH 1954

RADIO — ELECTRONICS

TELEVISION • SERVICING • HIGH FIDELITY

HUGO GERNSBACK, Editor



In this issue:

Control Unit for
Junior Golden Ear
Amplifier

•

TV Remote
Control Units

•

Testing Video
Amplifiers

•

Optimum Load —
What Is It?

•

Starved-Current
Ultra-High-Gain
Amplifier

•

Getting the Most
From Rabbit Ears

35¢

U. S. and
CANADA

Design Testing U. H. F. and V. H. F. Antennas

(See page 4)



yours is a serious business . . .

If TV service is your chosen profession, you have a serious stake in it. It's your way of life and it serves a vital role in man's newest and most powerful means of communication. The man who takes his service seriously will enjoy the benefits of a successful business career. Customers turn to the serviceman who believes that only quality components are worthy of quality workmanship.

You can depend on Du Mont quality picture tubes to do more for your service.



Photography Magazine Contest Winning Photo by Cornelius E. Westveer

Replacement Sales, Cathode Ray Tube Division
Allen B. Du Mont Laboratories, Inc., Clifton, N. J.

PIONEER IN BIG PICTURE TUBES • ORIGINATOR OF THE FAMOUS BENT-GUN AND SELFOCUS •
LEADER IN HIGH-RESOLUTION • MAJOR SUPPLIER TO MOST FINE TELEVISION RECEIVER MANUFACTURERS

*Trade-Mark

I'll Train You For Your FCC License

Training plus opportunity is the PERFECT COMBINATION for job security, good pay, advancement. A Federal Communications Commission Commercial Operator's License puts you in line for a good job in Radio or Television Broadcasting, Police, Marine, Aviation, Two-Way, Mobile or Micro-Wave Relay Radio. Mail Coupon for 64-page book FREE. It will give complete facts about my Communications Course.

You Build This Transmitter with parts I send. Use it to get practical experience. Put this station "on the air." Perform procedures required of broadcasting station operators, conduct many experiments, make practical tests.

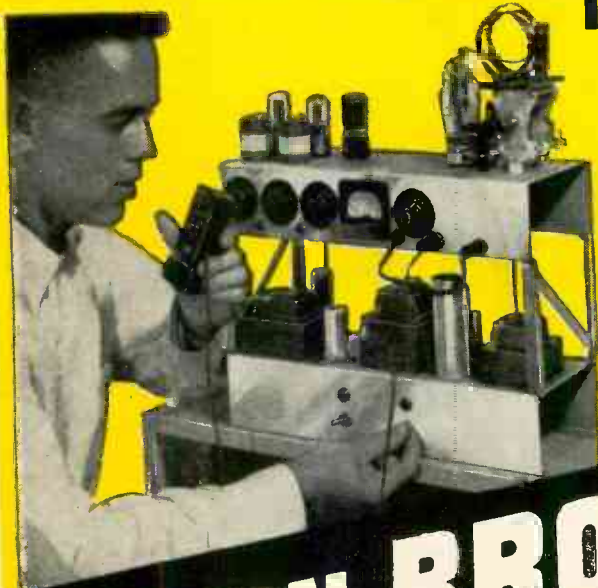

LEARN BROADCASTING by PRACTICING at Home in Spare Time

Get Practical Experience on Circuits Common to Radio & TV

Ever think HOW FAST Radio-Television Communications is changing, developing, growing? Have you considered what this amazing progress can mean to you?

Even without Television the industry is bigger than ever before. Over 115 million home and auto radios, 3900 radio stations, about 200 TV stations with hundreds more being built. Expanding use of Aviation and Police Radio, Micro-Wave Relay, Two-Way Radio for buses, taxis, etc. makes opportunities for Communications Technicians and FCC licensed operators. New jobs, more jobs for beginners! Better jobs, better pay for experienced men!

Television Is Today's Good Job Maker

Over 25 million television sets are in use. Thousands more being sold every week. Good TV jobs opening for Technicians, Operators everywhere. The time to act is NOW! Start learning Radio-TV communications. America's fast growing industry offers good pay, a bright future, security. If you are a beginner, my course can help you get FCC License, prepare for the job

J. E. SMITH, President
National Radio Institute
Washington, D. C.

has trained more men for Radio-Television than any other man. OUR 40TH YEAR.



MY COURSE INCLUDES TELEVISION

you want. If you've had some training in Radio or Radar, or as a Licensed Operator, my course modernizes—increases the value of your knowledge.

Includes New Developments

Mail coupon now for facts about my practical course in Radio-Television Communications. Let me send you my FREE book. See the nine big Kits of Parts I send that "bring to life" theory you learn. You get practical experience by working on circuits common to both Radio and Television; also lessons on TV principles. Read about the Transmitter you build and operate, about the Electronic Multimeter you get. All equipment is yours to keep. My graduates are filling jobs, making good money in both Radio and Television. Remember, the way to a successful career in Television is through experience in Radio.

Mail Coupon for Book FREE

Send today! See what my Communications course is like. Find out how I get you ready for a brighter future, better earnings, more security in Radio-Television. Send coupon now in envelope or paste on postal. NO OBLIGATION, NO SALESMAN WILL CALL! My book, sent to you FREE, tells the full story. J. E. SMITH, President, Dept. 4CF, National Radio Institute, Washington 9, D. C. Our 40th year.



YOU BUILD this Transmitter Power Supply used in the basic experiments in RF and AF amplifiers, frequency multipliers, buffers, etc.

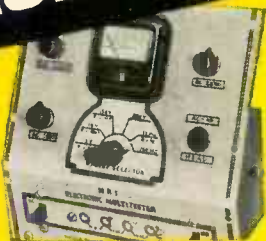

YOU MEASURE current, voltage (AC, DC and RF), resistance and impedance in circuits with Electronic Multimeter you build. Shows how basic transmitter circuits behave; needed to maintain station operation.



YOU PRACTICE setting up code, amplitude and frequency modulation circuits (put voice, music, etc., on "carrier signals" you produce). You learn how to get best performance.



YOU BUILD this Wavemeter and use it to determine frequency of operation, make other tests on transmitter currents.

Training Leads to Jobs Like These

BROADCASTING
Chief Technician
Chief Operator
Power Monitor
Recording Operator
Remote Control Operator
SHIP AND HARBOR RADIO
Chief Operator
Assistant Operator
Radiotelephone Operator

GOVERNMENT RADIO
Operator in Army, Navy, Marine Corps, Coast Guard
Forestry Service
Dispatcher
Airways Radio Operator
POLICE RADIO
Transmitter Operator
Service Technician

AVIATION RADIO
Plane Radio Operator
Airport Transmitter Operator
TELEVISION
Pick-Up Operator
Voice Transmitter Operator
TV Technician
Remote Control Operator

I TRAINED THESE MEN



"My position with WNBT is video control engineer on the RCA color project. I owe a lot of my success to your textbooks."—Warren Deem, Malverne, N. Y.



"I am a technician at WTOP in Washington and I like it very much. Most of my radio knowledge was from N.R.I."—John Britto, Hyattsville, Md.



"A former employer recommended N.R.I. training. Now employed as transmitter operator at WKBO."—Albert Herr, New Cumberland, Pa.

AVAILABLE TO **VETERANS** UNDER G. I. BILLS

SERVICING TRAINING ALSO AVAILABLE

If you prefer a good-pay job in Radio-Television Servicing . . . or your own money-making Radio-Television Sales and Service Shop, I'll train you at home. My famous Servicing Course also includes many Kits of Parts. You use them to get PRACTICAL EXPERIENCE with circuits common to Radio and Television. I also show you how to make \$10, \$15 a week or more EXTRA MONEY fixing neighbors' Radios while training. Full information in my 64-page book . . . Mail coupon.

MAIL NOW-BOOK FREE

MR. J. E. SMITH, President, Dept. 4CF, National Radio Institute, Washington 9, D. C. Mail me your 64-page Book, FREE. (No salesman will call. Please write plainly.)

Name.....Age.....
Address.....
City.....Zone.....State.....
VETS write in date of discharge

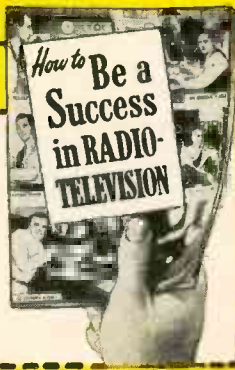

RADIO - ELECTRONICS

Formerly RADIO-CRAFT • Incorporating SHORT WAVE CRAFT • TELEVISION NEWS • RADIO & TELEVISION*

Hugo Gernsback
Editor and Publisher

M. Harvey Gernsback
Editorial Director

Fred Shunaman
Managing Editor

Robert F. Scott
W2PWW, Technical Editor

Jerome Kass
Associate Editor

I. Queen
Editorial Associate

Matthew Mandl
Television Consultant

Charles A. Phelps
Copy Editor

Angie Pascale
Production Manager

Wm. Lyon McLaughlin
Tech. Illustration Director

Sol Ehrlich
Art Director

Lee Robinson
General Manager

John J. Lamson
Sales Manager

G. Allquo
Circulation Manager

Adam J. Smith
Director, Newsstand Sales

Robert Fallath
Promotion Manager



Member
Magazine Publishers
Association

ON THE COVER (More details
on page 61)

Measuring the characteristics
of a new u.h.f. antenna at the
Channel-Master laboratory. In
the background, the adjustable
test mast, which can hold an
antenna in almost any position.

Color original by Avery Slack

CONTENTS

MARCH, 1954

Editorial (Page 31)

600,000 U. S. Transmitters 31

Audio—High Fidelity (Pages 32-44)

Control Unit for Golden Ears. by Joseph Marshall 32
High Fidelity Loudspeakers, Part I—The tangibles and intangibles of loud-
speaker design; diaphragm behavior by H. A. Hartley 35
What is Optimum Load? by Norman H. Crowhurst 38
High-Quality Audio, Part VII—Bass and treble equalizing circuits can be
made to produce ideal playback characteristics by Richard H. Dorf 40
Servicing High-Fidelity Audio Equipment, Part II by Joseph Marshall 43
Ultra-High-Gain Starved-Current Amplifier by Paul S. Lederer 45

Television (Pages 46-64)

2 Remote TV Control Units by Robert F. Scott 46
Testing Video Amplifiers by Engineering Staff, Scala Radio Co. 49
Basic Color TV, Part III—Transmitting the color subcarrier, detecting
color signals. by D. Newman & J. J. Roche 52
TV DX in March 54
Printed Circuit TV Receiver by M. Bonhomme 55
Getting the Most from Rabbit Ears by John K. Frieborn 56
G-Line 57
The "Best Teacher" by Henry Farad 58
TV Service Clinic Conducted by Matthew Mandl 60
Television—It's a Cinch (Ninth Conversation, first half—Forming the
electron image; photoelectric cells) by E. Aisberg 62

Radio (Pages 78-90)

Transistor Code Practice Oscillator by A. L. Cleland, K2ADS 78
Transistorized Wrist Radio 82
High Gain Low-Drain Portable Radio by I. Queen 84

Test Instruments (Pages 94-96)

An R-C Bridge Test Unit by Alan G. Sorensen 94
Transistor Layout Board Saves Experimenting Time by J. R. Steen 96

Electronics (Pages 97-106)

Display in Electrotherapeutics by F. J. G. van den Bosch 97
Smallest X-Ray Tube 106

New Design (Pages 119-121)

New Tubes 119

Departments

Radio Month ..	6	With the		Try This One ..	133
Correspondence	16	Technician ..	116	Question Box ..	136
Business	22	New Devices ..	122	Technotes ..	140
Miscellany	92	New Patents ..	126	People	144
The Service		Radio-Electronic		Electronic	
Runaround ..	108	Circuits	130	Literature ...	147
				Book Reviews ..	149



MEMBER Audit Bureau of Circulations

Average Paid Circulation over 173,000

Vol. XXV, No. 3

RADIO-ELECTRONICS, March, 1954, Vol. XXV, No. 3. Published monthly at Erie Ave., F to G Sts., Philadelphia 32, Pa., Gernsback Publications, Inc., Entered as Second Class matter September 27, 1948, at the Post Office at Philadelphia, Pa., under the Act of March 3, 1879. Copyright 1954 by Gernsback Publications, Inc. Text and illustrations must not be reproduced without permission of copyright owners.
EXECUTIVE, EDITORIAL and ADVERTISING OFFICES: 25 West Broadway, New York 7, N. Y. Telephone REctor 2-8630. Gernsback Publications, Inc. Hugo Gernsback, President; M. Harvey Gernsback, Vice-President; G. Allquo, Secretary.
SUBSCRIPTIONS: Address correspondence to Radio-Electronics, Subscription Dept., Erie Avenue, F to G Sts., Philadelphia 32, Pa., or 25 West Broadway, New York 7, N. Y. When ordering a change please furnish an address stencil impression from a recent wrapper. Allow one month for change of address.
SUBSCRIPTION RATES: In U. S. and Canada, and in U. S. possessions, \$3.50 for one year; \$6.00 for two years; \$8.00 for three years; single copies 35¢. All other foreign countries \$4.50 a year; \$8.00 for two years; \$11.00 for three years.
BRANCH ADVERTISING OFFICES: Chicago: 7522 North Sheridan Road, Tel. Rogers Park 4-8000. Los Angeles: Ralph W. Harker and Associates, 1127 Wilshire Blvd., Tel. Madison 6-1271. San Francisco: Ralph W. Harker and Associates, 582 Market St., Tel. GARfield 1-2481. FOREIGN AGENTS: Great Britain: Atlas Publishing and Distributing Co., Ltd., London E.C.4. Australia: McGill's Agency, Melbourne. France: Breniano's, Paris 2e. Belgium: Agence et Messageries de la Presse, Brussels. Holland: Trilictron, Heemstede. Greece: International Book & News Agency, Athens. So. Africa: Central News Agency Ltd., Johannesburg. Capetown, Durban, Natal: Universal Book Agency, Johannesburg. Middle East: Stelmatsky Middle East Agency, Jerusalem. India: Broadway News Centre, Dadar, Bombay #14. Pakistan: Paradise Book Stall, Karachi 3. POSTMASTER: If undeliverable send form 3578 to: RADIO-ELECTRONICS, 25 West Broadway, New York 7, N. Y. *Trademark registered U.S. Patent Office.

ADVANCE! Raise your earning power—learn RADIO-TELEVISION-ELECTRONICS by SHOP-METHOD HOME TRAINING

GOOD JOBS AWAIT THE TRAINED RADIO-TV TECHNICIAN

There is a place for *you* in the great Radio-Television-Electronics industry when you are trained as National Schools will train you at home!

Trained technicians are in growing demand at good pay—in manufacturing, broadcasting, television, communications, radar, research laboratories, home Radio-TV service, and other branches of the field. National Schools Master Shop-Method Home Training, with newly added lessons and equipment, trains you in your spare time, right in your own home, for these fascinating opportunities. **OUR METHOD IS PROVED BY THE SUCCESS OF NATIONAL SCHOOLS TRAINED MEN, ALL OVER THE WORLD, SINCE 1905.**

EARN WHILE YOU LEARN

Many National students pay for all or part of their training with spare time earnings. We'll show you how you can do the same! Early in your training, you receive "Spare-time Work" Lessons which will enable you to earn extra money servicing neighbors' and friends' Radio and Television receivers, appliances, etc.



Signal Generator



T. R. F. Receiver

Audio Oscillator

National Schools Training is All-Embracing

National Schools prepares you for your choice of many job opportunities. Thousands of home, portable, and auto radios are being sold daily—more than ever before. Television is sweeping the country, too. Co-axial cables are now bringing Television to more cities, towns, and farms every day! National Schools' *complete* training program qualifies you in all fields. Read this partial list of opportunities for trained technicians:

Business of Your Own • Broadcasting
Radio Manufacturing, Sales, Service • Telecasting
Television Manufacturing, Sales, Service
Laboratories: Installation, Maintenance of Electronic Equipment
Electrolysis, Call Systems
Garages: Auto Radio Sales, Service
Sound Systems and Telephone Companies, Engineering Firms
Theatre Sound Systems, Police Radio
And scores of other good jobs in many related fields.

TELEVISION TRAINING

You get a complete series of up-to-the-minute lessons covering all phases of repairing, servicing and construction. The same lesson texts used by resident students in our modern and complete Television broadcast studios, laboratories and classrooms!



MASTER ALL PHASES!

Get Master Shop-Method Home Training from an Established Practical Resident School with its own Training Shops, Laboratories, Studios—almost 50 Years of Successful Experience in Training Ambitious Men.

We Bring National Schools To You!



You also receive this Multitester

Superheterodyne Receiver

LEARN BY DOING

You receive and keep all the modern equipment shown above, including tubes and valuable, professional quality Multitester. *No extra charges.*

FREE! RADIO-TV BOOK AND SAMPLE LESSON!

Send today for National Schools' new, illustrated Book of Opportunity in Radio-Television-

Electronics, and an actual Sample Lesson. *No cost—no obligation.* Use the coupon now—we'll answer by return airmail.

**APPROVED FOR
VETERANS
AND
NON-VETERANS**
Check coupon below

**Both
Resident and
Home Study
Courses Offered!**

NATIONAL SCHOOLS

LOS ANGELES 37, CALIFORNIA • ESTABLISHED 1905
IN CANADA: 811 W. HASTINGS STREET, VANCOUVER, B.C.

GET FACTS—FASTEST! MAIL TO OFFICE NEAREST YOU!

(mail in envelope or paste on postal card)

NATIONAL SCHOOLS, Dept. RG-34

4000 S. Figueroa Street or 323 West Polk Street
Los Angeles 37, Calif. or Chicago 7, Ill.

Send FREE Radio-TV Electronics book and FREE sample lesson. No obligation, no salesman will call.

NAME _____ BIRTHDAY _____ 19 _____

ADDRESS _____

CITY _____ ZONE _____ STATE _____

Check here if interested in Resident School Training at Los Angeles.
VETERANS: Give Date of Discharge _____

Electro-Voice 

CARTRIDGES

Guarantee

FINER REPRODUCTION

LONGER RECORD LIFE

MORE NEEDLE PLAYS

MODEL 43

Ceramic Cartridge. Plays 78, 45, 33 1/2 rpm with single 2.3-mil all-purpose needle-tip. Output 7 to 1.0 volt. 43. Osmium. List \$6.50 43-S. Sapphire. List \$7.50

MODEL 44

Ceramic Cartridge. Plays 45 and 33 1/2 rpm, with 1-mil needle. Impervious to heat and humidity. Output, 7 volt. 44. Osmium. List \$6.30 44-S. Sapphire. List \$7.30

MODEL 46-T

Ceramic Turnover. Plays 78, 45, 33 1/2 rpm with separate 3-mil Osmium and 1-mil Sapphire tip needles. Output, 7 volt. With turnover mechanism. 46-T. List \$10.00 46. Without turnover mechanism. List \$9.00

MODEL 16-TT

Crystal Twin Tilt. Uses one piece twin tip needle for 78, 45, 33 1/2 rpm. Merely turn selector handle for 1-mil Sapphire or 3-mil Osmium tip. Output 1 volt. 16-TT. List \$10.00 16. Same without tilt mechanism. List \$9.00

MODEL 12

Crystal Cartridge. Plays 78 rpm with 3-mil needle. Light weight. High compliance. Tracks perfectly. Output 2 volts. With snap-in holder. 12. Osmium. List \$7.50 12-S. Sapphire. List \$8.50

MODEL 60

Crystal Duo Volt. Permits selection of high or medium output (2 or 4 volts on 33 1/2-45, and 3 or 6 volts on 78). No soldering. Uses any standard 3-mil, 1-mil or all-purpose needle. 1/4" mounting hole centers. 60. Less needle. List \$4.95

6 BASIC TYPES make over 92% of all replacements

With these preferred types, you can quickly make most replacements. By demonstrating the improvement in performance, you can make many more sales. Furthermore, the new E-V high output, high compliance, permanent Ceramic Cartridges are not affected by moisture or heat—and are directly interchangeable with silent-needle type crystal cartridges that do not use a thumb screw. E-V cartridges are widely used in original equipment and for replacement. Send now for **FREE Phono-Cartridge Replacement Chart No. 170-A.**

Crystal cartridges licensed under Brush patents.

Electro-Voice

BUCHANAN • MICHIGAN

1954 IRE NATIONAL CONVENTION will be held on March 22-25 in New York City. It will take place in two locations, the Waldorf-Astoria hotel and Kingsbridge Armory.

The program, consisting of over 200 technical papers and 600 engineering exhibits, will cover many of the recent advances in the radio-electronics field, including subjects as different as "Engineering Based on Biological Design" and "High Fidelity in Audio Engineering."

RADIO-ELECTRONICS will occupy Booth 452, at the Armory.

ATOMIC BATTERY which makes it possible to convert atomic energy directly and simply into small but usable quantities of electrical energy sufficient to operate a transistor, was announced January 26 by Brig. General David Sarnoff, Chairman of the Board of RCA.

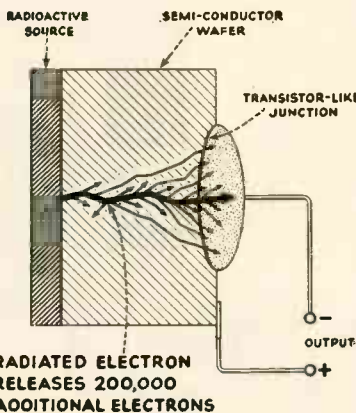

"The RCA atomic battery," said the general, "is now generating sufficient electricity from a minute quantity of strontium-90 to energize a transistor and to produce an audible tone in a telephone receiver." The new experimental battery, as described by Dr. E. W. Engstrom of the RCA Laboratories, consists of a semi-conductor wafer (germanium or silicon), to one side of which has been applied a thin layer of radioactive material (strontium-90 in this case) and to the other side of which an "impurity material" has been alloyed to form a transistor-like junction.

The strontium bombards the wafer with several billion electrons per second. As each of these penetrates the wafer it releases an average of 200,000 additional electrons. (Earlier radioactive generators—**RADIO-ELECTRONICS** July 1953, page 12—released only about one electron for each bombarding ray.)

These released electrons flow across the wafer's junction, producing a voltage which would cause a current to flow in an external circuit. This electron action within the wafer is known as the electron-voltaic effect, and has not previously been put to any practical use.

The cell delivers 5 microamperes at 0.2 volt. Life expectancy is not known, but the half-life to strontium-90 is 20 years. The cells may be used in series or parallel like other types of batteries.

ELEVEN NEW TV STATIONS have gone on the air since our last month's listing. These are:

KTVU	Stockton, Calif.	36
KOA-TV	Denver, Colo.	4
KSLA	Shreveport, La.	12
WKAR-TV	East Lansing, Mich.	60
WLBT	Jackson, Miss.	3
WCOC-TV	Meridian, Miss.	30
KHOL-TV	Kearney, Nev.	13
WNCT	Greenville, N. C.	9
WFBC-TV	Greenville, S. C.	4
KMID-TV	Midland, Texas	2
WBTM-TV	Danville, Va.	24

This brings the total number of stations on air to 360 (124 of which are u.h.f.) as of January 16, 1954.

The only station shifting channels this month was WRGB, Schenectady, N. Y., from channel 4 to channel 6.

19-INCH COLOR TUBE was demonstrated by RCA late in January. The new tube is a developmental model only. It may be available to manufacturers during the last half of 1954, and then only in limited quantities. The new tube has a picture area of 162 square inches, with the same brightness and definition as the 15-inch tube.

Three major developments in the larger tube are a new electron gun assembly, improved phosphors, and a shadow mask of modified design. The deflection angle of the electron beam has been increased because the larger tube's length is not greater than that of the smaller model.



Explaining that the 19-inch tube, like its 15-inch predecessor, is an interim model, Mr. E. C. Anderson, vice-president in charge of the RCA Commercial Department, told the tube manufacturers that RCA is continuing research and development work on other types and sizes of tubes for color receivers.

"Approximately eight months ago, we demonstrated in these laboratories a color tube—in the research stage—producing a much brighter picture," he said. "That tube employed principles differing from those in the current shadow mask tricolor kinescope.

"We are pressing forward in our research work on that brighter tube and other color tubes." **END**

NOW... from one of the foremost Electronic training centers of its kind...

Learn TELEVISION RADIO-ELECTRONICS

at home

89 WAYS TO EARN MONEY IN TELEVISION RADIO ELECTRONICS

MAIL COUPON TODAY for valuable free publication showing how and where real money is being made in Television—and how you may prepare to break into this promising field.

ABOVE: Build and operate scores of interesting circuits from these parts for real Learn-By-Doing experience.

16 shipments of electronic parts. Over 300 projects

Looking for a chance to earn **REAL MONEY** . . . to get a really interesting job or your own business . . . to enjoy the satisfaction that comes from knowing your future is tied in with one of America's promising opportunity fields? Then mail the coupon at once. Find out about a training method that thousands of graduates **PROVE** is one of today's most **EFFECTIVE WAYS** to learn Television-Radio-Electronics—America's great, billion dollar opportunity field.

Now you can have your own HOME LABORATORY

Using the D.T.I. Way, no previous technical experience is needed. You can get (1) laboratory type training at home in your spare time—or (2) full time training in one of the nation's finest TV-Radio-Electronic training laboratories. The home method includes **EVERYTHING YOU NEED** to Learn-By-Doing. You work over 300 experiments from 16 shipments of quality parts which you keep. This even includes building and keeping the valuable commercial-type test equipment shown to the right—ideal for helping you earn while you learn. You also get easy-to-read, well-illustrated lessons. And to help you master important fundamentals faster, easier, better, you get D.T.I.'s remarkable and exclusive home training advantage—Learn-By-Seeing **HOME MOVIES**.

Mail Coupon TODAY!

Why not get **ALL** the facts about D.T.I.'s wonderful training program . . . about the effective Employment Service available to all graduates . . . about the special advantages that may be yours if called to military service? Mail coupon today. We believe the late facts we have for you are really going to surprise you.

BELOW: New Home of D.T.I.

D.T.I. has purchased and now occupies this large, modern, daylight building devoted exclusively to mail the finest TV-Radio-Electronic Training Centers of its kind. This now locates all of our training operations under one roof—to serve you even better.

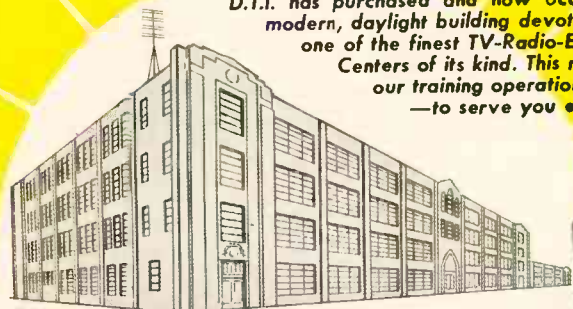

Jewel Bearing MULTI-METER



High Quality OSCILLOSCOPE a "must" for TV service



Learn by Seeing MOTION PICTURES at home



21 INCH

Build and keep this **BIG DTI** Engineered TV set—easily converted to U.H.F. (DTI offers another home training, but without the TV set.)

DeVRY TECHNICAL INSTITUTE
4141 BELMONT AVE., CHICAGO 41, ILL. Dept RE-3-K

I would like your Opportunity News Bulletin showing "89 Ways To Earn Money in Television-Radio-Electronics"; also, complete facts about the training opportunity made possible by your organization.

Name _____ Age _____
Address _____ Apt. _____
City _____ Zone _____ State _____

DeVRY TECHNICAL INSTITUTE

AFFILIATED WITH DEFOREST'S TRAINING, INC. CHICAGO 41, ILLINOIS

Another Outstanding Service Success Story...

with SYLVANIA!

From Basement Repair Shop
to prosperous Service Business...
featuring Sylvania Tubes, Parts
and Promotion Programs!

The steady and substantial growth of the Ball Television and Radio Service, from basement shop to the large handsome brick building, shown below, is a tribute to the fair practices and alert policies of the owner, Mr. Ted Ball.



Early photo of Ball Radio Service Shop.

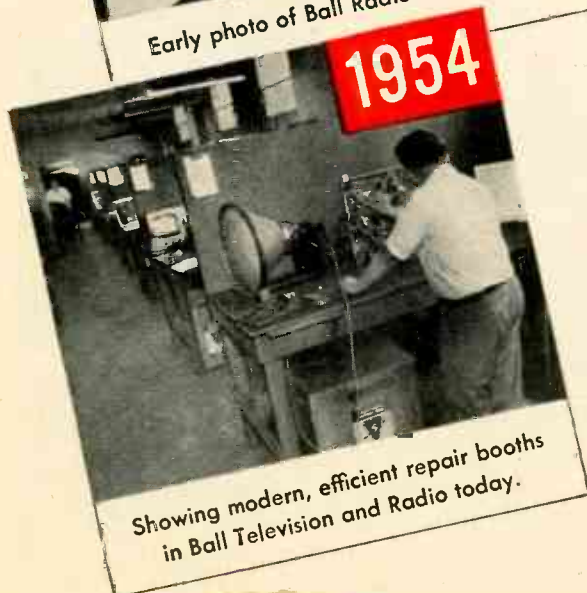

Showing modern, efficient repair booths
in Ball Television and Radio today.

Says Mr. Ball: "My men are as skilled and experienced as any you'll find anywhere, and each is instructed to do the best job possible with the best of parts... and that, of course, includes Sylvania Tubes."

Ted Ball is another important Radio-TV Service Manager that appreciates the quality performance, dependability, and the nation-wide high reputation of Sylvania products.

Mr. Ball also knows about the business-boosting power of Sylvania's promotion and display offers. Find out how Sylvania can step up *your* business. Your friendly Sylvania Distributor is ready and anxious to give you full cooperation. Call him today.

SYLVANIA

Sylvania Electric Products Inc., 1740 Broadway, New York 19, N. Y.



In Canada: Sylvania Electric (Canada) Ltd., University
Tower Bldg. St. Catherine St., Montreal, P. Q.

LIGHTING • RADIO • ELECTRONICS • TELEVISION
RADIO-ELECTRONICS



Where Will You Be in **ELECTRONICS** 6 Months from Today?



ADD TECHNICAL TRAINING to your practical experience
Get Your FCC License In A Hurry!

**Then Use Our Amazingly Effective
JOB FINDING SERVICE**

Get This Valuable Booklet FREE



TV ENGINEERING INCLUDED IN OUR TRAINING & COACHING

TELLS HOW—

HERE IS YOUR GUARANTEE
If you fail to pass your Commercial License exam after completing our course, we guarantee to continue your training without additional cost of any kind, until you successfully obtain your Commercial license, provided you first sit for this examination within 90 days after completing our course.

WE GUARANTEE
TO TRAIN AND COACH YOU AT HOME IN SPARE TIME UNTIL YOU GET
YOUR FCC LICENSE

If you have had any practical experience—Amateur, Army, Navy, Radio repair, or experimenting.

TELLS HOW—

**Our Amazingly Effective
JOB-FINDING SERVICE**

Helps CIRE Students Get Better Jobs
Here are a few recent examples of Job-Finding results:

GETS AIRLINES JOB

Due to your Job-Finding Service, I have been getting many offers from all over the country, and I have taken a job with Capital Airlines in Chicago, as a Radio Mechanic.
Harry Clare, 4537 S. Drexel Blvd., Chicago, Ill.

GETS FIVE JOB-OFFERS FROM BROADCAST STATIONS

"Your 'Chief Engineer's Bulletin' is a grand way of obtaining employment for our graduates who have obtained their 1st class license. Since my name has been on the list I have received calls or letters from five stations in the southern states, and am now employed as Transmitter Engineer at WMMT."
Elmer Powell, Box 274, Sparta, Tenn.

GETS CIVIL SERVICE JOB

"I have obtained a position at Wright-Patterson Air Force Base, Dayton, Ohio, as Junior Electronic Equipment Repairman. The Employment Application you prepared for me had a lot to do with me landing this desirable position."
Charles E. Loomis, 4516 Genesee Ave., Dayton, Ohio

**TELLS HOW—Employers make
JOB OFFERS Like These
to Our Graduates Every Month**

Letter from nationally-known Airlines, "We would also appreciate if you would place the following additional advertisement in your bulletin—Wanted—Superintendent of Communications . . . Salary \$666.66 per month."

Letter from nationally known manufacturer of high quality AM and FM transmitters, "We are very much in need at the present time of radio-electronics technicians and would appreciate any helpful suggestions that you may be able to offer. Salary up to \$412 per month to start."

These are just a few examples of the job offers that come to our office periodically. Some licensed radioman filled each of these jobs . . . it might have been you!

**HERE'S PROOF FCC LICENSES ARE OFTEN SECURED
IN A FEW HOURS OF STUDY WITH OUR COACHING
AT HOME in Spare Time.**

Name and Address	License	Lessons
Lee Worthy 2210 1/2 Wilshire St., Bakersfield, Calif.	2nd Phone	16
Clifford E. Vogt, Box 1016, Dania, Fla.	1st Phone	20
Francis X. Feerch, 38 Beutler Pl., Bergenfield, N. J.	1st Phone	38
S/Sgt. H. Davis, 317 North Roosevelt, Lebanon, Ill.	1st Phone	28
A. Ibert Schoell, 110 West 11th St., Escondido, Calif.	2nd Phone	23

CLEVELAND INSTITUTE OF RADIO ELECTRONICS
CARL E. SMITH, E.E., Consulting Engineer, President
Desk RE-62, 4900 Euclid Bldg., Cleveland 3, Ohio

**OURS IS THE ONLY
HOME STUDY
COURSE WHICH
SUPPLIES FCC-TYPE
EXAMINATIONS
WITH ALL LESSONS
AND FINAL TESTS.**

Your FCC Ticket is recognized in all radio fields as proof of your technical ability.

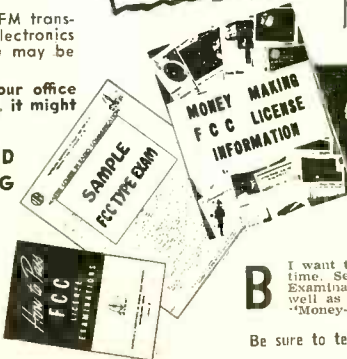

**GET ALL 3 FREE!
MAIL COUPON NOW!**

CLEVELAND INSTITUTE OF RADIO ELECTRONICS
Desk RE-62, 4900 Euclid Bldg., Cleveland 3, Ohio
(Address to Desk No. to avoid delay)

B I want to know how I can get my FCC ticket in a minimum of time. Send me your FREE booklet, "How to Pass FCC License Examinations" (does not cover exams for Amateur License), as well as a sample FCC-type exam and the amazing new booklet, "Money-Making FCC License Information."

Be sure to tell me about your television engineering course.

Name

Address

City Zone State

Paste on 2-cent postcard or send air mail.

You can build a reputation on Tung-Sol® Quality



TUNG-SOL makes
All-Glass Sealed Beam Lamps,
Miniature Lamps,
Signal Flashers,
Picture Tubes, Radio, TV,
Special Purpose Electron Tubes,
Semiconductor Products.

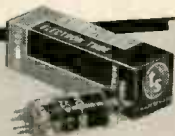

TUNG-SOL ELECTRIC INC.
Newark 4, New Jersey

Sales Offices: Atlanta, Chicago, Colum-
bus, Culver City (Los Angeles), Dallas,
Denver, Detroit, Newark, Seattle

MAJOR E. H. ARMSTRONG, inven-
tor of our present system of frequency
modulation and other basic radio cir-
cuits died on February 1 at the age
of 63.

His most widely used and renowned
development, the superheterodyne cir-
cuit, is almost universally used in both
AM, FM, and TV receivers. He was the
inventor of the superregenerative cir-
cuit, and an independent inventor of

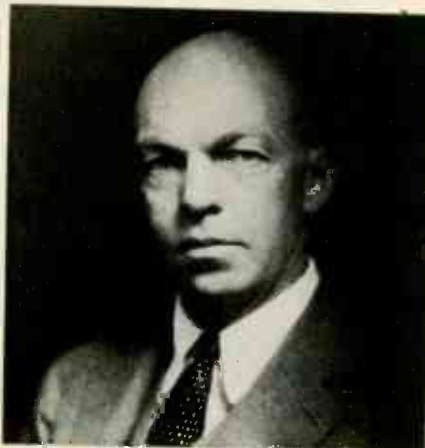

regeneration, though the courts—after
a 12-year battle—ruled that de Forest
had discovered it earlier. Frequency
modulation came in 1935.

His most recent development was a
system of multiplexing FM broadcasts
so that more than one program could
be transmitted simultaneously at the
same frequency.

His FM station KE2XCC operating
on 92.1 mc is known by radio engineers
throughout the world. There, Arm-
strong did much of his FM develop-
ment, and the station became the proto-
type of modern FM stations.

Armstrong served in the Army Signal
Corps in World War I. In World War
II his major contributions were in the
field of radar, much of which is still
secret.

He also contributed many improve-
ments in radio communications, particu-
larly in short-wave transmission. It
was upon his recommendation that the
Army adapted FM for mobile radio
communication.

During his lifetime Major Armstrong
received many honors including the
Medal of Honor of the I.R.E. and the
Army Medal of Merit, presented to
him by President Truman in 1947 with
a citation stating that "Maj. Armstrong
contributed greatly to the improvement
of military communications by his in-
ventions in the field of radio and by
his unselfish, patriotic service to the
Signal Corps."

At the time of his death, Major Arm-
strong was professor of electrical en-
gineering at Columbia University, from
which he graduated in 1913.

DUOSCOPIC TV RECEIVER which
permits two audiences to view two dif-
ferent television programs at the same
time from the same screen has been
introduced by the Du Mont Laboratories.

The receiver, known as the Du Mont
Duoscopic, performs as two separate
receivers in one. Looking at the Duo-

scopic receiver with the naked eye, the
viewer sees two superimposed pictures.
He eliminates one or the other by look-
ing through polaroid filters (placed on
a stand in front of the receiver), or by
wearing polaroid glasses similar in ap-
pearance to those used to view 3-D
films. When the glasses are reversed,
the viewer sees the other program.

It is possible to tune in one picture
that can be viewed without glasses as
in a standard receiver.

Individual earpieces are used to sepa-
rate the sound portions of the pro-
grams. A remote control unit permits
the viewer to listen to either of the
two programs.

The Duoscopic receiver uses two C-R
tubes, a dual chassis, and a twin audio
system.

The chief uses of the new receiver
are expected to be in stores and public
places where it may be used as a
crowd-stopper, but it is expected that a
number of specialized applications may
appear and that it may also solve do-
mestic relations problems in television-
divided households.

ELECTRONIC TRANSLATOR capa-
ble of turning Russian into English has
been demonstrated by IBM.

The mechanical part of the device,
which is mostly electronic, is the IBM
type 701 electronic data processing ma-
chine. The Russian sentences that are
to be translated are first coded on punch
cards similar to those used for Govern-
ment checks, and then fed into the
machine. Seconds later, an automatic
typewriter spells out the translation.

The electronic translator has a 250-
word vocabulary covering a broad
range. It converts these words into its
own binary language and then trans-
lates them, using its "stored dictionary"
and "syntax."

RADAR SPEED DETECTION was
recently upheld in New York State.
Monroe County Judge D. J. O'Mara has
upheld an auto speeding conviction
based on radar evidence. The appellant,
who was convicted last June, argued
that there was no proof of the accuracy
of the radar detector.

TV ANTENNA ACCIDENTS figured
prominently in a recent report by the
American Mutual Liability Insurance
Co. As a result of the current do-it-
yourself rage, the report says, approxi-
mately 59,000 TV set owners were
injured this past year in the process of
installing their antennas.

In addition to the accidents definitely
attributed to antenna installation, an-
other 47,000 injuries were classified as
"roof accidents." No indication was
given as to how many of these injuries
may have been due to patching® the
roof after an antenna had been erected
by an amateur do-it-yourself installer.

FREQUENCY MODULATION is
taking a major role in British broad-
casting. To overcome interference to its
radio programs by European radio sta-
tions, the BBC will build 51 FM trans-
mitters. The estimated construction
time is 10 years. **END**



the only **COMPLETE** catalog for Everything in TV, Radio and Industrial Electronics

FREE value-packed

1954 ALLIED 268-PAGE CATALOG

The World's Largest Stocks

- TV and Radio Parts
- Test Instruments
- High-Fidelity Equipment
- Custom TV Chassis
- AM, FM Tuners and Radios
- Recorders and Supplies
- P.A. Systems, Accessories
- Amateur Station Gear
- Builders' Kits, Supplies
- Equipment for Industry

Fastest Service in Electronic Supply

SEND FOR THE LEADING
ELECTRONIC
BUYING GUIDE
FREE!

NEW HOME OF
ALLIED RADIO
ultra-modern facilities
TO SERVE YOU BEST

EASY PAY TERMS

Use ALLIED'S liberal Easy Payment Plan—only 10% down, 12 months to pay—no carrying charge if you pay in 60 days. Available on Hi-Fi and P.A. units, recorders, TV chassis, test instruments, Amateur gear.

TV and HI-FI SPECIALISTS

To keep up with developments in High-Fidelity and TV, look to ALLIED. Count on us for all the latest releases and largest stocks of equipment in these important fields. If it's anything in High-Fidelity or Television—we have it in stock!

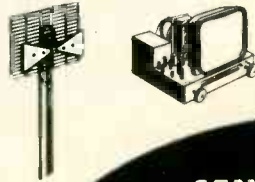

SEND FOR IT TODAY

Get ALLIED'S latest catalog—268 pages packed with the world's largest selection of quality equipment at lowest, money-saving prices. See all the latest releases in custom TV chassis, TV antennas and accessories; AM and FM tuners and radios; everything in High-Fidelity custom components; latest P. A. Systems and accessories; recorders and supplies; Amateur receivers, transmitters and station gear; specialized industrial electronic equipment; test instruments; builders' kits; huge listings of parts, tubes, tools, books—your choice of the world's most complete stocks of quality equipment. ALLIED gives you every buying advantage: speedy shipment, expert personal help, lowest prices, assured satisfaction. Get the big 1954 ALLIED Catalog. Keep it handy—and save time and money. Send for your FREE copy today.

**SAVE ON EVERYTHING
IN ELECTRONICS**

ALLIED RADIO
World's Largest Electronic Supply House

ALLIED RADIO CORP., Dept. 2-C-4
100 N. Western Ave., Chicago 80, Illinois

Send FREE 268-Page 1954 ALLIED Catalog

Name _____

Address _____

City _____ Zone _____ State _____



Ask your
TUBE DISTRIBUTOR
how you can get the

time and money saving new **RAYTHEON BROW-LITE**

Here's another sensational *Raytheon first*. It's a different kind of flashlight that sheds a new light on Radio-TV servicing — makes it faster, easier, more profitable.



RAYTHEON BROW-LITES are available through your Raytheon Tube Distributor. Ask him how to get a supply for you and your men.

Here's why Service Dealers from coast to coast are hailing the RAYTHEON BROW-LITE:

- **FREES BOTH HANDS** — work is easier, faster
- **DIRECTS LIGHT AUTOMATICALLY**—you see what you look at in a clear, bright light
- **USES STANDARD PARTS** — 1½ volt penlite batteries and 3 volt penlite bulb
- **ANYONE CAN USE IT** — fits easily above glasses
- **EASY TO CARRY** — folds compactly to pocket size
- **REPLACES FLASHLIGHTS** — easier, safer to use
- **DURABLE** — made of rugged plastic



RAYTHEON MANUFACTURING COMPANY

Receiving Tube Division

Newton, Mass., Chicago, Ill., Atlanta, Ga., Los Angeles, Cal.

Excellence in Electronics

RECEIVING AND PICTURE TUBES • RELIABLE SUBMINIATURE AND MINIATURE TUBES • SEMICONDUCTOR DIODES AND TRANSISTORS • NUCLEONIC TUBES • MICROWAVE TUBES

RADIO-ELECTRONICS



Get yourself on the beam to the **BIG MONEY** in **RADIO AND TV**

That's the way to become an expert Radio or Television service man. Study the bedrock theories and principles. These are vitally important. Nothing can take their place—not even the most elaborate kits.

Listen to what radioman R. G. Hamlin of Bay City, Michigan, says, "There's no royal road to learning. I am convinced more than ever after examining the lessons of friends who were lured by the alleged short-cut methods of competitors . . . 'understandability' and 'rememberability' are of utmost importance and I.C.S. lessons qualify on both counts."

I.C.S. offers you two new courses in radio and television servicing—one for beginners, the other for experienced amateurs.

The beginner's course, Radio and Television Servicing with training Equipment, is extremely thorough. You get extra texts featuring experiments and job assignments. You get equipment second to none. Matched parts for an excellent 5-tube superheterodyne receiver. Your own professional-quality multimeter. A complete single generator kit. High-grade servicemen's tools. The principles of Television including the most up-to-date developments (VHF and Color TV, for example).

The second course quickly reviews the essentials then goes step by step into advanced phases of Radio and Television, including modern methods of installation and repair. Course contains valuable supplementary material. For example, you get a special book giving characteristics of all tubes used in Radio and Television receivers.

Learn by doing! That's the world-famous I.C.S. method. Thoroughly practical. Completely modern. Success proved. The coupon below brings you full details—on Radio and Television Servicing or any of the more than 400 I.C.S. Courses. Mark and mail it *today!*

I. C. S., Scranton 9, Penna.

INTERNATIONAL CORRESPONDENCE SCHOOLS		ICS		
BOX 2879-K, SCRANTON 9, PENNA.				
Without cost or obligation, send me "HOW to SUCCEED" and the booklet about the course BEFORE which I have marked X:				
<ul style="list-style-type: none"> <input type="checkbox"/> ART <input type="checkbox"/> Commercial Art <input type="checkbox"/> Magazine Illustrating <input type="checkbox"/> Fashion Illustrating <input type="checkbox"/> Cartooning <input type="checkbox"/> Sketching and Painting <input type="checkbox"/> Show Card and Sign Lettering <input type="checkbox"/> AUTOMOTIVE <input type="checkbox"/> Automobile, Mechanic <input type="checkbox"/> Auto Elec. Technician <input type="checkbox"/> Auto Body Rebuilding and Refinishing <input type="checkbox"/> Diesel—Gas Engines <input type="checkbox"/> AVIATION <input type="checkbox"/> Aeronautical Engineering Jr. <input type="checkbox"/> Aircraft Engine Mechanic <input type="checkbox"/> Airplane Drafting <input type="checkbox"/> BUILDING <input type="checkbox"/> Architecture <input type="checkbox"/> Arch. Drafting <input type="checkbox"/> Building Contractor <input type="checkbox"/> Estimating <input type="checkbox"/> Carpenter and Mill Work <input type="checkbox"/> Carpenter Foreman <input type="checkbox"/> Reading Blueprints <input type="checkbox"/> House Planning <input type="checkbox"/> Plumbing 	<ul style="list-style-type: none"> <input type="checkbox"/> Heating <input type="checkbox"/> Painting Contractor <input type="checkbox"/> Air Conditioning <input type="checkbox"/> Electrician <input type="checkbox"/> BUSINESS <input type="checkbox"/> Business Administration <input type="checkbox"/> Certified Public Accountant <input type="checkbox"/> Bookkeeping and Accounting <input type="checkbox"/> Office Management <input type="checkbox"/> Stenography and Typing <input type="checkbox"/> Secretarial <input type="checkbox"/> Federal Tax <input type="checkbox"/> Business Correspondence <input type="checkbox"/> Letter-writing Improvement <input type="checkbox"/> Personnel and Labor Relations <input type="checkbox"/> Advertising <input type="checkbox"/> Retail Business Management <input type="checkbox"/> Managing Small Business <input type="checkbox"/> Ocean Navigation <input type="checkbox"/> Sales Management <input type="checkbox"/> Short Story Writing <input type="checkbox"/> Creative Salesmanship <input type="checkbox"/> Traffic Management <input type="checkbox"/> CHEMISTRY <input type="checkbox"/> Chemical Engineering <input type="checkbox"/> Chemistry <input type="checkbox"/> Analytical Chemistry 	<ul style="list-style-type: none"> <input type="checkbox"/> Petroleum—Nat'l Gas <input type="checkbox"/> Pulp and Paper Making <input type="checkbox"/> Plastics <input type="checkbox"/> CIVIL, STRUCTURAL ENGINEERING <input type="checkbox"/> Civil Engineering <input type="checkbox"/> Structural Engineering <input type="checkbox"/> Surveying and Mapping <input type="checkbox"/> Structural Drafting <input type="checkbox"/> Highway Engineering <input type="checkbox"/> Reading Blueprints <input type="checkbox"/> Construction Engineering <input type="checkbox"/> Sanitary Engineering <input type="checkbox"/> DRAFTING <input type="checkbox"/> Aircraft Drafting <input type="checkbox"/> Architectural Drafting <input type="checkbox"/> Electrical Drafting <input type="checkbox"/> Mechanical Drafting <input type="checkbox"/> Structural Drafting <input type="checkbox"/> Sheet Metal Drafting <input type="checkbox"/> Ship Drafting <input type="checkbox"/> Mine Surveying and Drafting <input type="checkbox"/> ELECTRICAL <input type="checkbox"/> Electrical Engineering <input type="checkbox"/> Electrician <input type="checkbox"/> Electrical Maintenance 	<ul style="list-style-type: none"> <input type="checkbox"/> Electrical Drafting <input type="checkbox"/> Electric Power and Light <input type="checkbox"/> Lineman <input type="checkbox"/> HIGH SCHOOL <input type="checkbox"/> High School Subjects <input type="checkbox"/> Mathematics <input type="checkbox"/> Commercial <input type="checkbox"/> Good English <input type="checkbox"/> MECHANICAL AND SHOP <input type="checkbox"/> Mechanical Engineering <input type="checkbox"/> Industrial Engineering <input type="checkbox"/> Industrial Supervision <input type="checkbox"/> Foremanship <input type="checkbox"/> Mechanical Drafting <input type="checkbox"/> Machine Design-Drafting <input type="checkbox"/> Machine Shop Practice <input type="checkbox"/> Tool Design <input type="checkbox"/> Industrial Instrumentation <input type="checkbox"/> Machine Shop Inspection <input type="checkbox"/> Reading Blueprints <input type="checkbox"/> Toolmaking <input type="checkbox"/> Gas—Electric Welding <input type="checkbox"/> Heat Treatment—Metallurgy <input type="checkbox"/> Sheet Metal Work <input type="checkbox"/> Sheet Metal Pattern Drafting <input type="checkbox"/> Refrigeration 	<ul style="list-style-type: none"> <input type="checkbox"/> POWER <input type="checkbox"/> Combustion Engineering <input type="checkbox"/> Diesel—Electric <input type="checkbox"/> Electric Light and Power <input type="checkbox"/> Stationary Steam Engineering <input type="checkbox"/> Stationary Fireman <input type="checkbox"/> RADIO, TELEVISION COMMUNICATIONS <input type="checkbox"/> Practical Radio—TV Eng'ring <input type="checkbox"/> Radio Operating <input type="checkbox"/> Radio and TV Servicing <input type="checkbox"/> Television—Technician <input type="checkbox"/> Electronics <input type="checkbox"/> Telephone Work <input type="checkbox"/> RAILROAD <input type="checkbox"/> Locomotive Engineer <input type="checkbox"/> Diesel Locomotive <input type="checkbox"/> Air Brakes <input type="checkbox"/> Car Inspector <input type="checkbox"/> Railroad Administration <input type="checkbox"/> TEXTILE <input type="checkbox"/> Textile Engineering <input type="checkbox"/> Cotton, Rayon, Woolen Mfg. <input type="checkbox"/> Carding and Spinning <input type="checkbox"/> Warping and Weaving <input type="checkbox"/> Loom Fixing <input type="checkbox"/> Throwing <input type="checkbox"/> Finishing and Dyeing <input type="checkbox"/> Textile Designing
Name _____		Age _____ Home Address _____		
City _____	Zone _____ State _____	Working Hours _____ A.M. to P.M. _____		
Occupation _____	Canadian residents send coupon to International Correspondence Schools Canadian, Ltd., Montreal, Canada. . . . Special tuition rates to members of the U. S. Armed Forces.			



BOLTING VOICES TOGETHER

Adjusting casing over splice in polyethylene cable. Edges and ends are sealed with a new Butyl rubber compound that won't harden, dry out or lose adhesion even in extreme heat or cold.

More than ever, light, flexible polyethylene sheathed cable developed by Bell Telephone Laboratories is providing speedy answers to the demand for more telephone service.

But at thousands of splices, the sheath must be thoroughly sealed against moisture. Laboratories engineers developed a protective casing which is quickly and simply bolted in place. The edges and ends of the casing are *permanently* sealed with a new compound developed by Laboratories rubber chemists.

Now, economical polyethylene cable can be installed much faster and at lower cost. Here is another example of how Bell Laboratories continually finds ways to keep telephone service high in quality, while the cost stays low.

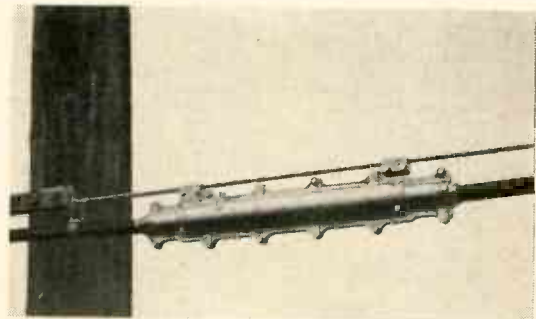

CLOSED CASING IN PLACE

BELL TELEPHONE LABORATORIES



EXPLORING AND INVENTING, DEVISING AND PERFECTING, FOR CONTINUED IMPROVEMENTS AND ECONOMIES IN TELEPHONE SERVICE

RADIO-ELECTRONICS



WANT MORE PAY? MORE SECURITY? A JOB WITH FUTURE UNLIMITED?

VETERANS! CIVILIANS! NO EXPERIENCE NECESSARY!

Go Into TELEVISION

I'll train you at home... in your spare time

for better-pay jobs in TV

L. C. Lane, B.S., M.A.
President: Radio-Television Training Association
Executive Director: Pierce School of Radio & Television

LEARN MORE

I give you ALL the practical training you need to qualify for the highest-paid technician jobs in TV.

RADIO-FM-TV TECHNICIAN TRAINING

No experience necessary! You learn by practicing with equipment I send you. It's easy! I give you the same successful guidance that has helped hundreds of men towards a TV career. Many started with only grammar school training.

FM-TV TECHNICIAN TRAINING

Saves you months if you have previous Armed Forces or civilian radio experience! Train at home. I give you kits, plus equipment to build **BIG SCREEN TV RECEIVER**, and **FREE FCC COACHING COURSE!** Everything **AT NO EXTRA COST!**

OPTIONAL: TWO WEEKS TRAINING IN NEW YORK CITY AT NO EXTRA COST!

You get two weeks, 50 hours, of intensive Laboratory work on modern electronic equipment at our associated school in New York City—Pierce School of Radio and Television. And I give you all this **AT NO EXTRA COST** whatsoever, after you finish your home study training in the Radio-FM-TV Technician course and FM-TV Technician Course.

FREE FCC COACHING COURSE!

Important for **BETTER PAY JOBS** requiring FCC License. You get this training **AT HOME** and **AT NO EXTRA COST!** Top TV jobs go to FCC licensed technicians.

NEW! PRACTICAL TV CAMERAMAN & STUDIO COURSE!

(For men with previous radio and TV training)

I train you at home for an exciting high pay job as the man behind the TV camera. Work with TV stars in TV studios or "on location" at remote pick-ups! A special one-week course of practical work on TV studio equipment at Pierce School of Radio & TV, our associate resident school in New York City, is offered upon your graduation.

VETERANS!

MY SCHOOLS FULLY APPROVED TO TRAIN VETERANS UNDER NEW G.I. BILL! If discharged after June 27, 1950 — CHECK COUPON! Also approved for **RESIDENT TRAINING** in New York City at Pierce School of Radio and Television... qualifies you for full subsistence allowance up to \$160 per month. Write for details.

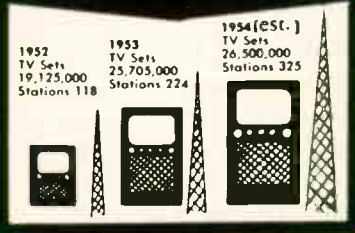

PROOF!

TV NEEDS THOUSANDS OF TECHNICIANS!

TV is coming into practically every community. More than 2,000 new TV stations authorized in this country alone! Thousands of new studios being planned and built. All kinds of new equipment coming on the market. Millions of new TV-set owners will need servicing. It's the rich field of the future with money-making opportunities **NOW**... if you get in on the ground floor. There just won't be enough TV Technicians to go around. It's your chance of a lifetime for **GOOD EARNINGS** in a **TOP JOB** or **YOUR OWN BUSINESS!**



EARN MORE

MORE MONEY AND A CAREER ARE WAITING FOR YOU HERE!

Earn while you learn by repairing TV sets for friends and neighbors. Many of my students make up to \$25 a week in spare time... pay for their entire training this way... start their own money-making service business. When they complete training and go into TV full time, their earnings zoom into big figures! My graduates are now working at RCA, NBC-TV, CBS-TV, DUMONT TV and numerous other TV studios and plants.

yours to build and keep!

GET MORE



Enough equipment to start your own home Laboratory! You learn by doing. I give you ALL the equipment. You build and keep a professional **GIANT SCREEN TV RECEIVER** complete with mammoth picture tube (takes any size up to 21 inch)...

...also a Super-Het Radio Receiver, RF Signal Generator, Combination Voltmeter-Ammeter-Ohmmeter, C-W Telephone Transmitter, Public Address System, AC-DC Power Supply, and more! 15 full Kits! All tubes supplied, too!

YOU GET ALL 4 FREE!

Just by mailing coupon. Try the Sample Lesson. Read how and where you can make big money in TV... easily!



MAIL THIS COUPON NOW! No Salesman Will Call!

Mr. Leonard C. Lane, President
RADIO-TELEVISION TRAINING ASSOCIATION
52 East 19th Street, New York 3, N. Y. Dept. R-3B

Dear Mr. Lane: Mail me your **NEW FREE BOOK, FREE SAMPLE LESSON, and FREE aids** that will show me how I can make **BIG MONEY IN TELEVISION**. I understand I am under no obligation and no salesman will call.

(PLEASE PRINT PLAINLY)

NAME _____ AGE _____
ADDRESS _____
CITY _____ ZONE _____ STATE _____

I AM INTERESTED IN:
 Radio-FM-TV Technician Course
 FM-TV Technician Course
 TV Cameraman & Studio Course
 VETERANS! Check here for Training under NEW G.I. Bill

RADIO-TELEVISION TRAINING ASSOCIATION

52 EAST 19th STREET, NEW YORK 3, N. Y.

Approved by the State of New York • Approved by the VA

WHY IT'S BETTER BUSINESS TO REPLACE WITH

Astatic Crystal Pickup Cartridges

IN APPROXIMATELY 75 percent of all cases, the original crystal pickup cartridge for which you are supplying the replacement will be an ASTATIC! The record player manufacturer's highly skilled engineers have carefully selected each Astatic Cartridge because . . . down to the last detail . . . its performance characteristics match the requirements of the particular player or changer. Thus, for finest results, the serviceman replacing the cartridge must again match these requirements. **AND ONLY THE PRECISION-BUILT, RECOMMENDED ASTATIC REPLACEMENT CARTRIDGE WILL DO IT.** And, despite quality results, cost is almost invariably lower.

One way or another, a substitute cartridge is bound to fall down. It is not sound business to stake your reputation on such substitutions. Beware particularly of claims that ALL cartridge replacement needs can be filled by six or eight magic models. Actually, it takes an absolute minimum of 24 different cartridge models to meet all of today's requirements. The far-sighted jobber or dealer, knowing that what is good for the record-playing public is good for him, sees to it that the kind of cartridge originally intended is used on all replacements. Usually, too, he **MAKES DOUBLY SURE OF BEST RESULTS BY RELYING ON ASTATIC CRYSTAL CARTRIDGES.**

NEW STEEL STORAGE CABINET AND DISPENSER FOR ASTATIC CRYSTAL CARTRIDGES

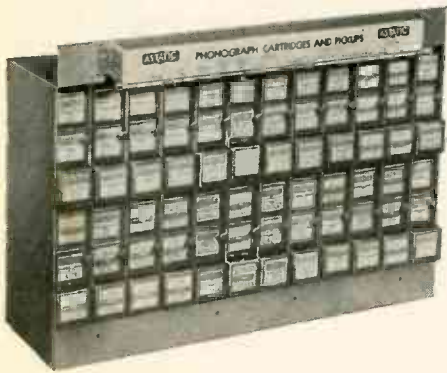

THERE ARE ADVANTAGES for everyone because jobbers dispense Astatic Crystal Cartridges from this handsome, rugged steel cabinet. No one — dealer, serviceman or record player owner — ever gets an Astatic Cartridge which has grown old from being accidentally shunted back and forth on the shelf. This can't happen to Astatic Cartridges because new stock is put in the cabinet by feeding into the top of each bin . . . and the cabinet dispenses the oldest cartridge first, from the bottom of the bin. To make sure that everyone enjoys these advantages, the cabinets are given to Astatic Jobbers entirely free of charge, and

without a single string attached or special purchase to be made. Attractively finished in light grey Hammerlin, this truly fine cabinet keeps all Astatic Cartridges together and permits taking accurate inventory in one glance. It is designed to stand solidly on the counter, on the shelf, hang on the wall, or even stack securely when two or more are used. Included is a handy Roll-a-fax cartridge replacement chart, which attaches to the top of the cabinet and works like a miniature window blind. Note that the bottom cartridge in each bin always protrudes, for quick, easy grasping.

EXPORT REPRESENTATIVE

401 Broadway, New York, N. Y.
Cable Address: ASTATIC, New York



CORRESPONDENCE

I CAN GET IT WHOLESALE

Dear Editor:

I am beginning to see more and more retail selling prices coinciding with wholesale prices. This results in a state of utter confusion. My first experience in this respect was in a Sears Roebuck retail store. A Hallicrafters communication receiver was on display with the same price tag as quoted in a mail-order wholesale catalog.

My second experience was when I picked up a local newspaper and saw a quarter-page advertisement of an audio center showing standard high-fidelity components at wholesale prices.

My third experience occurred when I received a sound catalog from a wholesaler suggesting high-fidelity components be purchased from dealers recommended by him. Those mentioned were recognized retail dealers. What's puzzling me is, at what price is the wholesaler selling the equipment to the retail outlet?

This business of retail and wholesale prices in the radio field has us all spinning. It looks like the expression "retail price" is rapidly becoming merely a reference point from which prices are discounted. That isn't all: how do you price an installation?

For example, suppose we equip a home with a high-fidelity installation; what will govern the price of our job? Will we figure super prices, union rates, private bills, the prevailing wage and list prices, or enter into sealed competitive bidding?

Gentlemen, it's a problem we cannot shelve! The public has a right to know how we do business. If we wish to raise our level, performance must be in accordance with better business practices.

We can borrow from the automotive industry. They set the retail price of an automobile at the factory. The f.o.b. charges to any point in the United States are added to the factory price, resulting in an established retail price for that area. The distributor in the territory conforms with the policy of the auto manufacturer. The only loophole an automobile dealer has in regard to list price is to give you a little extra on a trade-in. If it is as simple as all that for them, there is no reason why the radio industry cannot do the same.

CLYDE D. KIEBACH

Arlington, Va.

(Inquiry has shown the Hallicrafter "wholesaler" to be a large Chicago mail-order retail company. There has been considerable confusion between retailer and wholesaler in the electronic field. This confusion has been aided by the retail selling practices of some distributors and a tendency (at least in the past) of some retail mail-order houses to refer to themselves as wholesalers. To discover whether a company is a wholesaler, request their catalog on a plain postcard. If you get it, they are not wholesalers! The question of cut-price selling cannot be so easily resolved, and we would welcome further comment on it from our readers.—
Editor)

New CBS-Colortron

NOW IN MASS PRODUCTION



Unique photographic process, like photoengraving, uses aperture masks as negatives to print consecutively the red, green, and blue phosphor dots (250,000 of each) on CBS-Colortron screens.



After tri-color screens are printed, aperture masks are temporarily removed and face plates move on to critical inspection for screen imperfections.

COLOR TV IS COMING . . . faster than you think. The revolutionary new CBS-Colortron . . . a practical color picture tube . . . hastens the day. Already it is in lower-cost, mass production . . . made possible by its simplified, advanced design.

As in black-and-white tubes, the CBS-Colortron's screen is deposited directly onto the inside of its face plate. A unique photographic technique makes this possible. Because each aperture mask serves as a negative to print its tri-color screen, perfect register of mask and screen is automatically achieved

and maintained. The rugged, simple, light-weight mask sharply reduces assembly and exhaust problems. And the spherical design of mask and screen simplifies convergence circuitry and adjustment.

The CBS-Colortron is now a 15-inch, round tube. But, as soon as tooling is completed, it will be made in larger sizes. Watch for the new CBS-Colortrons. You'll see plenty of them soon. And you'll be sold on sight by their logical simplicity . . . their superior performance . . . their many advantages.

CBS-Colortron OFFERS MANY ADVANTAGES



Cross-section (face plate, aperture mask, funnel, tri-color electron gun) shows simplicity of CBS-Colortron and its adaptability to low-cost, mass production.

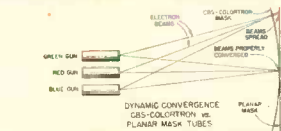

Spherical screen and aperture mask of CBS-Colortron simplify convergence and focus. Electron beams remain in focus over entire surface of screen.



Light-weight (6 oz.), rugged, simple aperture mask of CBS-Colortron minimizes problems of exhaust, handling, and assembly.

COMPLETE CBS-Colortron DATA FREE!

Take a look into the future. Write today for complete information on CBS-Colortron 15HP22: Construction . . . operation . . . application . . . installation and adjustment . . . electrical and mechanical data. Four packed pages . . . free!



CBS-HYTRON, Main Office: Danvers, Massachusetts

Manufacturers of Receiving Tubes Since 1921

A Division of Columbia Broadcasting System, Inc.

A member of the CBS family: CBS Radio • CBS Television • Columbia Records, Inc. • CBS Laboratories • CBS-Columbia • and CBS-Hytron

RECEIVING • TRANSMITTING • SPECIAL-PURPOSE • TV PICTURE TUBES • GERMANIUM DIODES AND TRANSISTORS

MARCH, 1954

There's **REAL** Money in
TV Signal Distribution

with the

Add-A-Unit

MASTER TV SYSTEM

for UHF and VHF

The B-T Add-A-Unit System is a new tool.
It is your 'open sesame' to the biggest boom
that has ever hit the TV servicing industry.

Hotels, motels, schools, apartment houses, community developments, hospitals, and hundreds of others with multi-receiver problems are clamoring for low cost, easy-maintenance, efficient TV distribution systems.

This is YOUR BIG MARKET...your real money market

The B-T Add-A-Unit System offers you these advantages:

1. It is the lowest cost amplified distribution system ever designed.
2. It is the easiest system to install under all conditions... requires no special tools and no outside engineering assistance.
3. Its flexibility is practically unlimited and it can serve 2000 TV receivers as effectively as it can serve 2.
4. It has no 'bugs' and requires little or no maintenance.
5. It permits complete control of signal strength: amplification or attenuation, as may be required, assuring high quality reception at all TV outlets from all available channels.
6. Every B-T Master System installed by you is a sure fire 'clincher' for additional business.

Let the B-T System
Work for You.

The B-T Add-A-Unit Master TV System consists of the following B-T units:

- MIXER AMPLIFIER
- DISTRIBUTION AMPLIFIERS
- COMMERCIAL ANTENSIFIER
- RESISTOR OUTLET BOX
- TV SYSTEM ACCESSORIES

Attenuator Matching Transformer
Remote Control Line Splitters
Line Loss Equalizer
Weather-Proof Housing

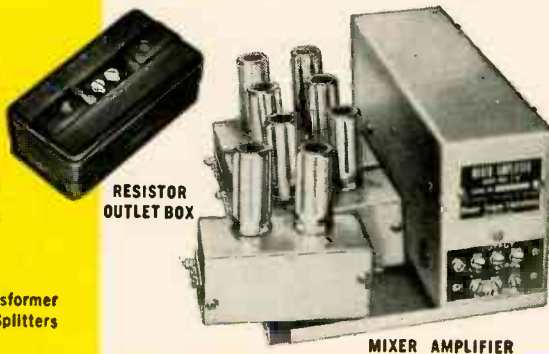

B-T
LABS

Write to Dept. NC-3 for Free Installation Manual
and Complete Specification Data.

BLONDER-TONGUE LABORATORIES, INC.

Westfield, New Jersey

IONIC OSCILLATOR

Dear Editor:

I was greatly interested in the article "The Ionic Oscillator" in the December, 1953, issue of RADIO-ELECTRONICS. Although it has been well known that fluorescent tubes and gaseous rectifiers create hash throughout the radio spectrum, the fact that gas tubes will oscillate at voltages as low as $22\frac{1}{2}$ is quite a discovery, as is the use of a resistance to vary the frequency of multielement gas tubes. Actually, this principle of oscillation has been known for many years. Frequencies as high as 1,000 mc have been detected in rarified gas discharges. A quotation from the book *Conduction of Electricity Through Gases*, Vol. II, by Thomson, published by Cambridge University Press in 1933, is appropriate. On page 447 appears the following:

"Intermittence in the electric discharge under a constant potential difference seems to have been first observed by Gassiot in 1860. An excellent account of the researches made on this subject down to 1926 has been given by Valle. More recent investigations have been made by Appleton and West, Newman, R. E. Clay, Whiddington, Gill, R. W. Wood, and J. J. Thomson. Direct experiments on the oscillations of dense streams of electrons in mercury vapor have been made by Tonks and Langmuir, who estimated the frequency of some of the vibrations they observed to be as high as 10^9 (1,000 megacycles)."

A reference to Gassiot's experiments is given in *Deschanel's Natural Philosophy*:

"By means of a battery of some thousands of cells, discharge in rarified gases can be obtained without the use of an induction coil, and with the advantage of greater steadiness. This has been done by Mr. Gassiot . . ."

A more recent application of this principle was the electrically quenched spark gap of some years ago. (A series of gas-filled cavity resonators.) The discovery of the low-voltage operation may have interesting microwave possibilities.

The articles on the Electronic Flame in RADIO-ELECTRONICS for December, 1952, and February, 1953, also made good reading. While Mr. Conant's explanation of the action taking place in his electro-forming apparatus is undoubtedly correct, I cannot agree with his comparison of the electronic flame to St. Elmo's fire. I believe that the true explanation of this phenomenon is to be found in the cover feature of RADIO-ELECTRONICS, March, 1950. (The dissociation of diatomic gas molecules by means of r.f. energy and the subsequent recombination of the unit atoms with other elements.) This theory could easily be tested by enclosing the electronic flame in an inert gas such as argon or neon.

I find your magazine very interesting—keep up the good work.

JOHN NOVAK

San Francisco, Calif.

END

"LOCAL" UHF BOW TIE KIT

For local and in-town installations, in strong signal areas. Kit complete.

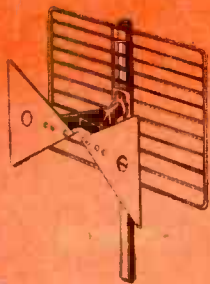

- LIST
- No. 9030* (Series 1 accessories) \$13.95
 - No. 9034 (Series 2 accessories) 13.95
 - No. 9038 (Series 3 accessories) 13.95
 - No. 9042 (Series 4 accessories) 13.95

"FRINGE" UHF TWO STACK BOW TIE KIT

For fringe areas up to 30 miles (depending on local conditions). Kit complete.

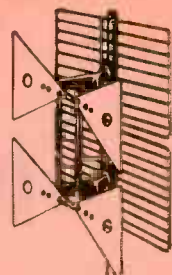

- LIST
- No. 9031* (Series 1 accessories).....\$16.75
 - No. 9035 (Series 2 accessories)..... 16.75
 - No. 9039 (Series 3 accessories)..... 16.75
 - No. 9043 (Series 4 accessories)..... 16.75

SERIES NO. 1 HARDWARE

UHF

"DO IT YOURSELF"

ANTENNA KITS

CHOICE OF 4 DIFFERENT SETS OF MOUNTING HARDWARE FOR EACH ANTENNA

16 COMBINATIONS TO CHOOSE FROM!

These new TELCO Antenna Kits are just what you need for profitable selling to the "do-it-yourself" market. There's a wide range of styles to meet every requirement . . . with four choices in hardware components for each kit. Your favorite distributor's got them . . . or can get them for you!

***WHAT EACH TELCO KIT CONTAINS**

SERIES 1 ACCESSORIES

- Complete Antenna, as shown
- 1-6 ft. 1 1/4" Mast
- 50 ft. Guy Wire
- 50 ft. UHF Low Loss Line
- 1-Guy Wire Clamp
- 4-Screw Eyes
- 2-Universal Mast Stand-Offs
- 2-3" Wood Screw Stand-Offs
- 2-7" Wood Screw Stand-Offs
- 1-Mast Base

SERIES 3 ACCESSORIES

- Complete Antenna, as shown
- 1-5 ft. 1 1/4" Mast
- 50 ft. UHF Low Loss Line
- 2-Universal Mast Stand-Offs
- 2-3" Wood Screw Stand-Offs
- 2-7" Wood Screw Stand-Offs
- 1-All-Purpose Antenna Mast Bracket

SERIES 2 ACCESSORIES

- Complete Antenna, as shown
- 1-6 ft. 1 1/4" Mast
- 50 ft. UHF Low Loss Line
- 2-Universal Mast Stand-Offs
- 2-3" Wood Screw Stand-Offs
- 2-7" Wood Screw Stand-Offs
- 1-Chimney Mount

SERIES 4 ACCESSORIES

- Complete Antenna, as shown
- 1-5 ft. 1 1/4" Mast
- 50 ft. UHF Low Loss Line
- 2-Universal Mast Stand-Offs
- 2-3" Wood Screw Stand-Offs
- 2-7" Wood Screw Stand-Offs
- 1-Snap-In Wall Mount

SERIES NO. 2 HARDWARE

SERIES NO. 3 HARDWARE

SERIES NO. 4 HARDWARE

"DELUXE" UHF CORNER REFLECTOR KIT

For troublesome areas, or where extra high gain is required. Kit complete.

- LIST
- No. 9032* (Series 1 accessories) \$19.50
 - No. 9036 (Series 2 accessories) 19.50
 - No. 9040 (Series 3 accessories) 19.50
 - No. 9044 (Series 4 accessories) 19.50

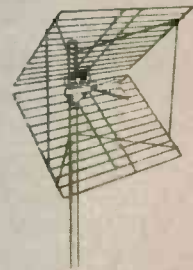

"DOUBLE V" UHF & VHF ANTENNA KIT

Highly directional and very satisfactory where both UHF & VHF signals are to be received on same antenna. Complete.

- LIST
- No. 9033* (Series 1 accessories) \$14.95
 - No. 9037 (Series 2 accessories) 14.95
 - No. 9041 (Series 3 accessories) 14.95
 - No. 9045 (Series 4 accessories) 14.95

AN ANTENNA STYLE AND HARDWARE SELECTION FOR EVERY INSTALLATION — 16 KITS IN ALL!

NOTE — Special kits for particular areas made to order. Write for details!



FREE!
Your new TELCO Catalog. Ask your jobber . . . or write direct.



TELEVISION HARDWARE MFG. CO.
DIVISION OF GENERAL CEMENT MFG. CO.
910 Taylor Avenue Rockford, Illinois

over **100,000**
already installed!



CHANNEL MASTER'S *fabulous*
CHAMPION*

the world's most powerful
all-channel VHF antenna
—OUT-PERFORMS AND OUT-SELLS THEM ALL!

Never before in the history of television has an antenna received such an overwhelming reception. Channel Master's CHAMPION — in a few short months — has rocketed to the top as the nation's most-wanted, best-selling, best-performing VHF antenna!

CHAMPIONSHIP Performance: Only the CHAMPION has the unique new "Tri-Pole", a triple-powered dipole system in which the Low Band dipole also functions as three dipoles tied together, in phase, on the High Band.

All-aluminum. Assembles faster than a 5-element Yagi! The CHAMPION is another great contribution of the Channel Master Antenna Development Laboratories.

CHAMPIONSHIP Promotion: The CHAMPION is the antenna America knows best!

• Publicized in leading magazines! • Outstanding dealer Cooperative Advertising Program! • Free newspaper mats, window streamers and TV film commercials!

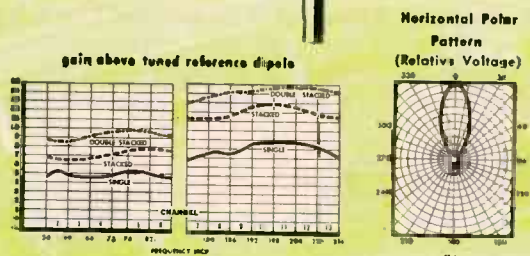
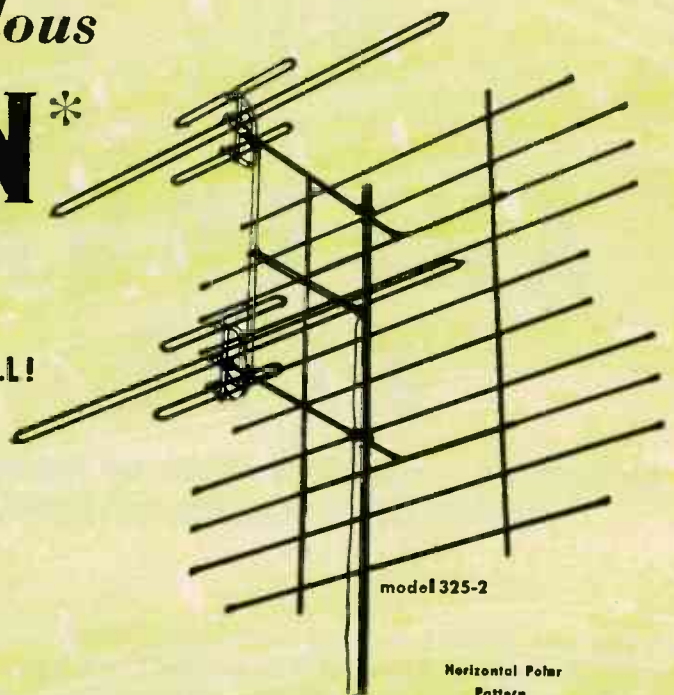

THE STACKED CHAMPION PROVIDES:

11-13 DB High Band gain
6 1/2 - 7 1/2 DB Low Band gain

THE STACKED CHAMPION



OUT-PERFORMS

this ...



this ...



this ...



or this



Model No.		List Price
325	Single Bay	\$20.83
325-2	2-Bay	\$42.34
325-4	4-Bay	\$88.89
Separate Stacking Harness		
325-3	2-Bay Harness	\$ 2.08
325-5	4-Bay Harness	\$ 4.17



CHANNEL MASTER CORP.

GREENVILLE, N. C. WORLD'S LARGEST MANUFACTURER OF TELEVISION ANTENNAS

*pat. pending

TIE SEPARATE ANTENNAS TO ONLY ONE TRANSMISSION LINE

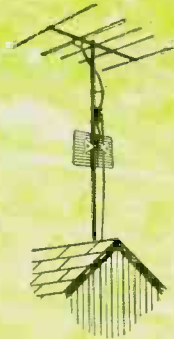

CHANNEL MASTER inter-action filters

Only Channel Master filters are permanently sealed in a block of moisture-proof, high melting-point electrical wax, locked in an attractive styrene case.

- Single lead
- No switching
- No signal loss
- No inter-action, effective isolation.

New!
VHF only
TENNA-TIE

model no. 9033-A



Use with leads of any length! New, specially designed High and Low Pass filters entirely eliminate the need for critical lead lengths! This new, extremely effective circuit makes the TENNA-TIE the most effective filter of its type now available.
— only \$3.50

VHF-UHF

ULTRA-TIE

model no. 9034



JOINS — separate VHF and UHF antennas for use with a single lead.
SEPARATES — VHF and UHF signals at the set or converter where separate terminals are provided. "Free-space" terminals.
new low price — \$3.75

VHF-UHF

TRIPLE-TIE

model no. 9035



Ties together all three TV reception bands:
1. Low Band VHF
2. High Band VHF
3. All UHF
High and Low Pass filters enable the Triple-Tie to adapt all Hi-Lo VHF installations to UHF — quickly and effectively. "Free-Space" terminals for perfect all-weather UHF reception.
new low price — \$4.86

THE ANTENNA IN COLOR TELEVISION

by Harold Harris, Vice President, Sales and Engineering

Now that color telecasting is a reality, we will see an ever-increasing flow of color sets to the consumer. Although much is being said and written on the subject of color sets, many unanswered questions remain about the role of the television receiving antenna in color television.

Will present antennas work on color?

Will a special antenna be needed?

The results of thorough laboratory and field tests made by engineers of the Channel Master Antenna Development Laboratories show that practically all present TV antenna types will perform satisfactorily on color. Gain variations as high as 3 DB across one channel can be tolerated. When this figure is exceeded blurring or smearing of the picture may occur. Although there are certain antennas on the market which do have excessive gain variation, this is not the case of the vast majority of present installations.

There are also indications that fringe area color reception may be more critical. This may necessitate the use of fringe area antennas in areas closer to the TV station.

In the nation's most advanced television research laboratory, Channel Master antennas have always been designed for full band width and minimum variation in gain on any one channel.

For this reason, every Channel Master antenna which you have installed in the past, as well as the ones you install today, will provide reception of outstanding quality when color TV comes to your area.

Channel Master antennas were the antennas selected for the tests which led to the F.C.C.'s approval of the National Television Standards Committee color system.



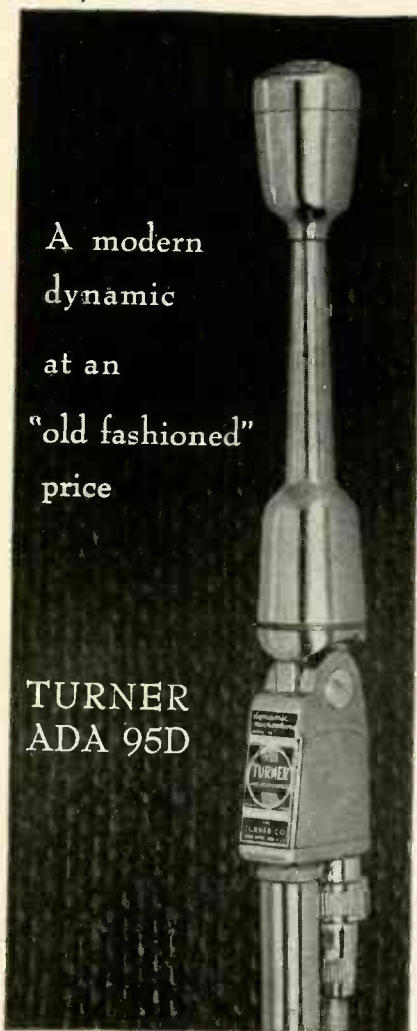

A modern
dynamic
at an
"old fashioned"
price

TURNER
ADA 95D

This is a modern dynamic microphone all right . . . with Alnico V Magnets and moving coils for maximum sensitivity to voice and music. Wide response range and outstanding sound characteristics make it ideal for tape recorder, PA, or commercial broadcasting use. Its design is certainly modern, too . . . trim, handsome, functional.

And about that price. We call it "old-fashioned" because it's so much lower than you would expect to pay in these expensive days. Only \$35.00 list.

Frequency response, 70 to 10,000 cps; output level, -58 db; 20 ft. removable grey plastic cable set; standard 5/8"-27 coupler; high impedance wired single ended (single conductor shielded cable); 50, 200, or 500 ohms wired for balanced line (two conductor shielded cable). About 8 1/2" high.

ADA 95D. List Price-----\$35.00

ADAS 95D. List Price
with slide switch-----\$38.50

THE TURNER COMPANY
933 17th St., N.E.,
Cedar Rapids, Iowa

CANADA: Canadian Marconi Co.,
Toronto, Ont. and Branches
EXPORT: Ad. Auriema, Inc.
89 Broad Street, New York 4, N.Y.

Merchandising and Promotion

CBS-Hytron, Danvers, Mass. is offering service technicians four new sales aids in connection with its nationally advertised Certified Quality Service program: an illuminated Plexiglass



sign for indoor use, a metal flange sign, direct-mail postal cards and advertising mats.

Pyramid Electric Co., North Bergen, N.J., is conducting a \$5,600 cash prize contest for service technicians. The contest runs from February through April. Contestants must complete the



sentence, "I like Pyramid capacitors because . . ." and send their entry in with the top of a box from a Pyramid dry electrolytic capacitor. J. K. Poff, Pyramid jobber sales manager, announced that duplicate prizes would be awarded to parts distributors from whom winning service technicians made their purchases.

Raytheon Manufacturing Co. Receiving Tube Div., Newton, Mass., reported that about 500 service technicians attended its recent *Service Saver* meetings held in Reading and Wilkes-Barre, Pa. and Hagerstown, Md. Local distributors sponsored the meetings.



Blonder-Tongue Laboratories, Westfield, N. J., developed an attractive new display carton for all its TV accessories.

Cornell-Dubilier Electric Corp., South Plainfield, N. J., and Radiart Corp.,



Cleveland, O., are now packaging their CDR rotors in a colorful new shipping carton which also doubles as an "in-stock" box.

Technical Appliance Corp., Sherburne, N. Y., has augmented its field meeting program for TV service technicians. The technical forums, conducted by "Taco" personnel, are held under the auspices of the company's distributors throughout the country.

Radio City Products, New York City, introduced a new test lead counter dis-



play which features a storage compartment in the rear of the display permitting the maintenance of a steady stock on hand.

Hallicrafters, Chicago, awarded MG sports cars to the four winning distributor salesmen in its recent contest.



Hallicrafters J. Mahoney, Adv. Mgr., left, and M. Kelly, TV Sales Mgr.

Mr. Ray Snyder
General Manager
Educ. Book
Division

You Get
This Valuable Book

FREE

Just for Examining

COYNE'S NEW 6-VOLUME SET

"Applied Practical Radio-Television" ON 7 DAYS FREE TRIAL!



Now! The most liberal "get-acquainted" offer you've ever seen! Think of it—Coyne gives you this big, new 1954 Edition of book, "150 Radio-Television Picture Patterns and Diagrams Explained", ABSOLUTELY FREE. This up-to-the-minute, practical book gives you complete 11 x 22" Schematic Diagrams covering 170

AT LAST! MONEY-MAKING "KNOW-HOW" ON TRANSISTORS, COLOR TV AND SERVICING

You get all the right answers to today's TELEVISION-RADIO servicing problems—and get them quickly—in Coyne's great new 6-volume set. Right at your finger-tips is the TV-Radio knowledge that makes you worth more money! Over 5,000 practical facts and data are fully covered in easy-to-understand fashion in volumes 1 through 5. Every step is completely explained—from principle of radio and television to installing, servicing, trouble-shooting and aligning including full facts on COLOR TV and UHF adapters and converters. Also includes latest information on TRANSISTORS. Hundreds of photos, illustrations, charts and diagrams help you understand quicker. For speedy on-the-job use, I'll also include the famous 762 page Coyne TELEVISION SERVICING CYCLOPEDIA—covering today's television problems in easy-to-find alphabetical order. Use this complete 6 volume TV-RADIO LIBRARY FREE for 7 days. Get the valuable Picture Pattern-Diagram Book ABSOLUTELY FREE!

ACT NOW—SEND NO MONEY!

Just mail the coupon for Coyne's 6-volume set on 7 days free trial. I'll include the book of 150 TV-RADIO Patterns & Diagrams. If you keep the set, pay \$2 in 7 days and \$2 per month until \$22.50 plus postage is paid. (Cash price, \$20.95.) Or you can return the library at our expense in 7 days and owe nothing. Either way, the book of TV-Radio Patterns is yours to keep FREE! Take advantage of this offer AT ONCE!

2500 PAGES OF PRACTICAL RADIO AND TELEVISION FACTS AT YOUR FINGER TIPS!

- Vol. 1. APPLICATION OF TELEVISION-RADIO PRINCIPLES: 300 pages, covers resonance & tuning, amplifiers, oscillators, etc.
- Vol. 2. RADIO, TELEVISION & FM RECEIVERS: 403 pages, covers rectifiers, high frequency, short wave, FM, antennas, etc.
- Vol. 3. RADIO-TELEVISION CIRCUITS: 336 pages, covers power tubes, de-coupling, distortion, photo-tubes, phase inverters, etc.
- Vol. 4. LATEST INSTRUMENTS FOR SERVICING RADIO-TELEVISION: 345 pages, covers all types of testing instruments, their use in service work.
- Vol. 5. TELEVISION SERVICING & TROUBLE-SHOOTING MANUAL: 400 pages, practical servicing of all types of TV sets, UHF, boosters, color TV printed in 4 colors, etc.

★ PLUS TV CYCLOPEDIA!

A "must" for the TV serviceman. Quick answers to all TV problems in A-B-C order, cross-indexed. 762 pages, fully illustrated; covers hundreds of facts on servicing, installation, alignment, UHF, transistors much more.

COYNE ELECTRICAL & TELEVISION — RADIO SCHOOL
500 South Paulina Street
Dept. 33-T1, Chicago 12, Illinois

FREE BOOK — FREE TRIAL COUPON!

Mr. Ray Snyder, Technical Book Manager
COYNE ELECTRICAL & TELEVISION-RADIO SCHOOL
500 S. Paulina St., Dept. 33-T1, Chicago 12, Ill.

O.K., Mr. Snyder! I'll take advantage of your Get-Acquainted Offer! Send new, 6-book set, "Applied Practical Radio-Television" for 7 days FREE TRIAL per your offer. Include TV-RADIO Patterns & Diagrams Book FREE!

Name _____ Age _____
 Address _____
 City _____ Zone _____ State _____
 Where Employed _____

Check here if you want library sent C.O.D. You pay postman \$20.95 plus C.O.D. postage on delivery. 7-day Money Back Guarantee.

MAIL COUPON TODAY

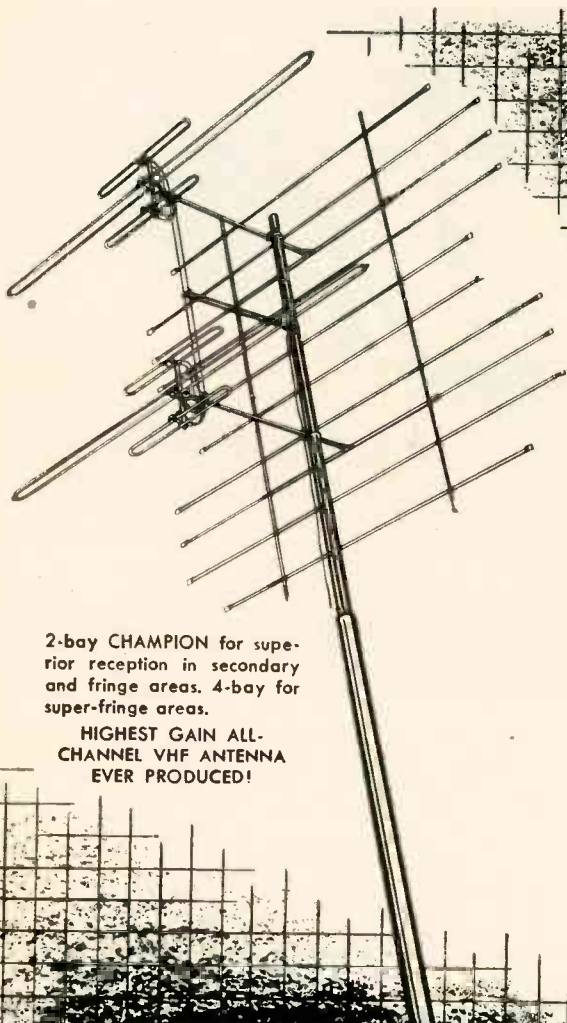

2-bay CHAMPION for superior reception in secondary and fringe areas. 4-bay for super-fringe areas.

HIGHEST GAIN ALL-CHANNEL VHF ANTENNA EVER PRODUCED!

ANTENNA RESEARCH
made it Possible!

the **CHANNEL MASTER CHAMPION**

WORLD'S MOST POWERFUL ALL-CHANNEL ANTENNA

Out of famous Channel Master Antenna Development Laboratories have come improvements to make the servicemens' job easier—the viewers' enjoyment greater.

Latest development, the CHAMPION antenna, employs a unique Broad Band dipole system, the "Tri-Pole". This is a triple power dipole system in which the low band dipole also functions as three dipoles tied together, in phase, on the high band. The "Tri-Pole" is the heart of the CHAMPION—the secret of its phenomenal performance. Completely pre-assembled, all-aluminum construction—and the mast is WHEATLAND WHETHA-TUBE, hot dip galvanized electric weld tubing.

MASTING RESEARCH
made it Permanent!

Rust Resistant!

HOT DIP GALVANIZED ELECTRIC WELD TUBING FOR TV MASTS

WHEATLAND WHETHA-TUBE

Wheatland Tube Company has produced steel pipe for many years. Their research engineers have faced the severest weather and durability problems—in irrigation, oil fields and wherever rigid wear needs arise.

NOW—WHEATLAND introduces WHETHA-TUBE, hot dip galvanized electric weld steel tubing. For the life of your antenna—select this tested tubing that will stand up and insure permanence for your antenna. The hot dip galvanized coating is perfect protection against rust and scratches—inside and out—because it seals out destructive elements.

WHEATLAND WHETHA-TUBE

WHEATLAND TUBE COMPANY • Bankers Securities Building Juniper & Walnut Sts., Philadelphia 7, Penna.

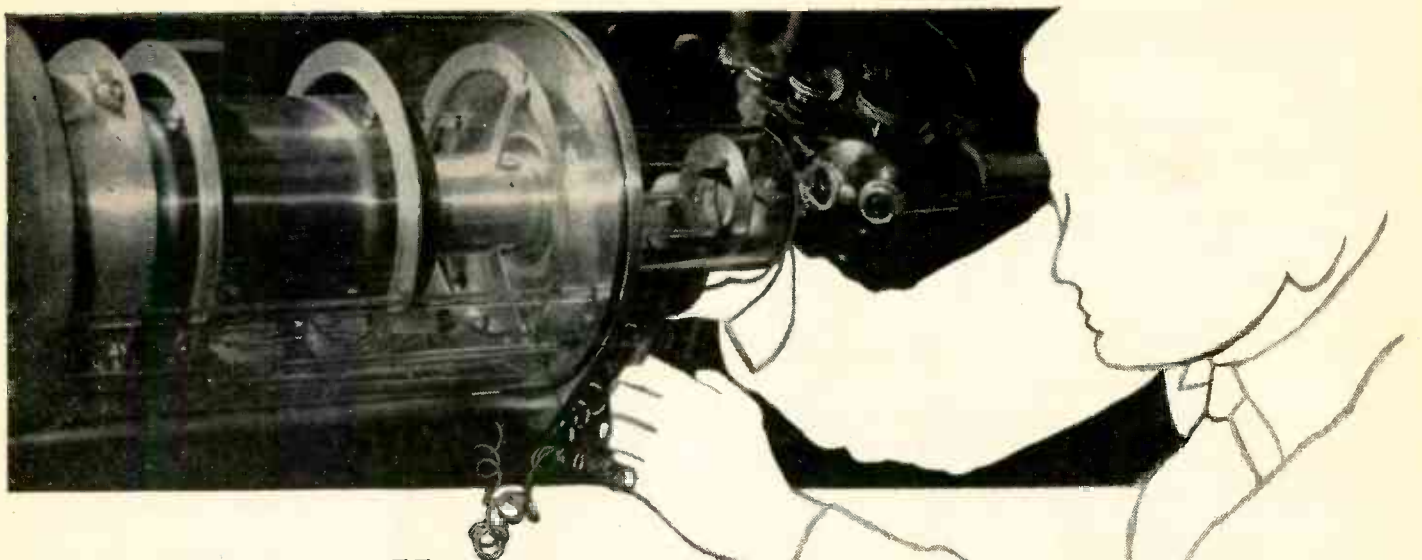

If you're willing to lose your job tomorrow to a technically-trained man, turn the page, Mister

But, if you're interested in an honest-to-goodness career in the vigorous young electronics industry, here's how you can step ahead of competition, move up to a better job, earn more money, and be sure of holding your technical job even if the brass is firing instead of hiring.

The "how" is CREI training in radio-television-electronics.

You don't have to be a college graduate. You *do* have to be willing to study—at home. You can do it while holding down a full-time job. Thousands have. Since 1927 CREI has provided alert young men with the technical knowledge that leads to more responsibility, more job security, more money. More than a quarter century of experience qualifies CREI to train you.

What qualified *you* for CREI? If you have a high school education, you're off to a good start. If you have a knack for math, so much the better. If you are currently working in some phase of the electronics industry, you'll get going faster. But remember this: CREI starts with fundamentals and takes you along at your own speed. You are not held back by a class, not pushed to keep up with others who have more experience or education. You set your own pace. Your CREI instructors guide you through the lesson material and *grade* your written work personally. You master the fundamentals, then get into more advanced phases of electronics engineering principles and practice. Finally you may elect training at

career level in highly specialized applications of radio or television or aeronautical radio.

How good is CREI training? Here are a few ways to judge. Ask an electronics engineer if you know one. Ask a high-school or college physics teacher. Ask a radio station engineer. Check up on our professional reputation: CREI home study courses are accredited by the Engineers' Council for Professional Development; CREI is an approved member of the National Council of Technical Schools. Ask personnel managers how they regard a man with a CREI "ticket." Look at this partial listing of organizations *that pay CREI* to train their own personnel: All American Cables & Radio, Inc., Canadian Aviation Electronics, Ltd., Canadian Broadcasting Corporation, Columbia Broadcasting System, Hoffman Radio Corp., Machlett Labs., Glenn L. Martin Co., Magnavox Co., Pan American Airways, Atlantic Division, RCA Victor Division, United Air Lines. Finally, ask a CREI graduate to tell you about our Placement Bureau, which currently has on file more requests for trained men than we can fill.

What's the next step? The logical one is to get more information than we can cram into one page. The coupon below, properly filled out, will bring you a fact-packed booklet called "Your Future in the New World of Electronics." It includes outlines of courses offered, a resume of career opportunities, full details about the school, and tuition details. It's free.

NOTE: CREI also offers Resident School instruction, day or evening in Washington, D.C. New classes start once a month. If you are a veteran discharged after June 27, 1950, let the new GI Bill help you obtain resident instruction. Check the coupon for more data.

CAPITOL RADIO ENGINEERING INSTITUTE

An Accredited Technical Institute • Founded in 1927

3224 16th Street, N.W. Dept. 143A Washington 10, D.C.

Send booklet "Your Future in the New World of Electronics" and course outline.

CHECK
FIELD OF
GREATEST
INTEREST

- Practical Radio Engineering
- Broadcast Radio Engineering (AM, FM, TV)
- Practical Television Engineering
- Aeronautical Radio Engineering
- TV, FM & Advanced AM Servicing

Name

Street

City Zone State

Check— Residence School Veteran

Why is the SHURE SLIM-X "777" all-purpose crystal* microphone a "best buy?"

Professor Profit

BECAUSE IT'S VERSATILE LIKE THIS!

CAN BE USED IN EVERY POSSIBLE WAY

BECAUSE IT'S "HANDABLE" LIKE THIS!

CAN BE REMOVED IN A FLASH—NO TOOLS NEEDED!

SIMPLY PULL OUT LIKE THIS!

BECAUSE IT'S USEFUL ALMOST EVERYWHERE!

IDEAL FOR SO MANY APPLICATIONS

- HOME RECORDING
- HAMS
- OUTDOOR P.A.
- PAGING
- AUDIENCE PARTICIPATION
- NIGHT CLUBS
- AUDITORIUMS

IF you're looking for a low-cost, versatile, good-quality microphone, ask your Shure Distributor about the "777". After he has given you technical information and shown you its amazing versatility—you will see why the "Slim-X" is the answer to your requirements.

SHURE *with special Humi-Seal for protection against heat & humidity

SHURE BROTHERS, Inc.
225 West Huron St.—Chicago 10, Illinois
Cable Address: SHUREMICRO

Winners were M. Newman, HSM Distributors, Los Angeles; Al Roth, Minsky Bros., Pittsburgh; J. Morris, Century-Ekon Distributors, Minneapolis; and R. Martin, Cladco, Buffalo.
Brach Manufacturing Corp., Newark, N. J., introduced its new No. 555 antenna



na designed for color with a life size "cloak and dagger" display in parts jobbers' establishments.
Jensen Industries, Chicago, is featuring a versatile needle container of flexible plastic construction which may

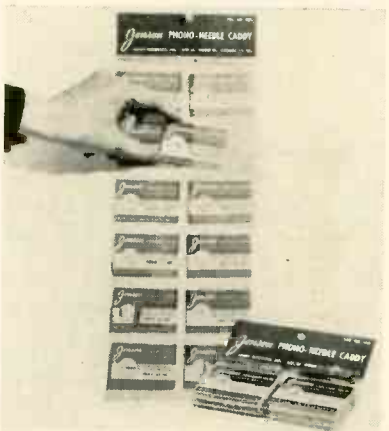

be used either as a hanging wall display or a shirt pocket container to be taken out on service calls. It has been nicknamed the Needle Caddy.
Pilot Radio Corp., Long Island City, N. Y., is sponsoring a series of twelve 1-minute spot announcements per week for the next year over station WQXR, New York City, on its high-fidelity components and complete matched systems.

Production and Sales

RETMA reported a record breaking TV set production for the first 11 months of 1953 of 6,765,000, 62% above the 1952 period. Of that total, 1,319,818 TV sets were equipped with u.h.f. tuning facilities. The association also reported radio production of 12,267,441 for the first 11 months of 1952. This was almost 30% better than last year.

Show Notes

The 1954 WESCON (Western Electronic Show & Convention) will be held in the Pan-Pacific Auditorium in Los Angeles, August 25-27. END

SERVICE TECHNICIANS: FOR YOUR SHOP!

THE COMPLETE **PHOTOFACT SERVICE DATA LIBRARY**

(world's best TV-Radio service data)

in this one handy file cabinet

YOURS FOR ONLY

\$25 DOWN NO CARRYING CHARGES

1. If you now own some Sets of PHOTOFACT Folders, you can COMPLETE your present library this EASY-PAY-WAY
2. If you've never used PHOTOFACT, you've never realized your full earning power. Put this file cabinet with its 220 Sets of PHOTOFACT Folders to work... starting right NOW!

YES, ONLY \$25 DOWN PUTS THE COMPLETE PHOTOFACT LIBRARY IN YOUR SHOP... COVERS OVER 17,000 TV, RADIO, RECORD CHANGER, RECORDER AND AMPLIFIER MODELS



SEE YOUR PARTS DISTRIBUTOR TODAY FOR FULL DETAILS
HOWARD W. SAMS & CO., INC.
INDIANAPOLIS 5, INDIANA

NEW

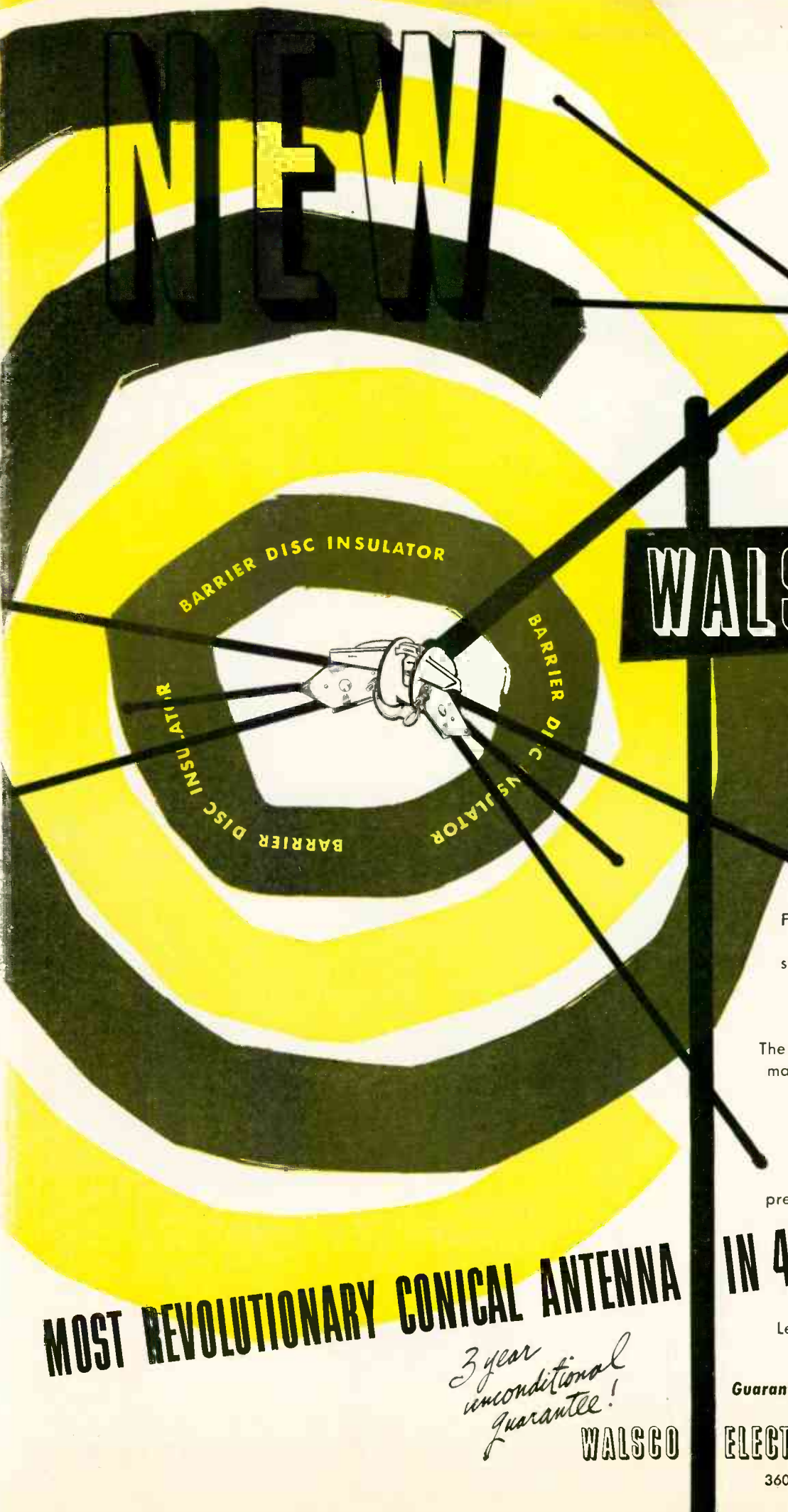

WALSCO

Imperial

INTRODUCING the greatest advance in Conical antennas ... it's the *all-new* WALSCO *Imperial*. Featuring a new "barrier disc" insulator with 2 inches of air space between the terminals to prevent shorts. Soot deposits, dirt, moisture, salt, etc., cannot affect this insulator.

The WALSCO *Imperial* will therefore maintain *lasting* high gain performance *anywhere*, regardless of weather conditions. Contact surfaces and terminals will never rust or oxidize. Front end hardware is *stainless steel* to prevent corrosion losses *permanently*.

Front end elements are pre-assembled to holding plates which are fastened to the insulator with one wing nut. Less than 2 minutes to assemble.

MOST REVOLUTIONARY CONICAL ANTENNA

IN 4 YEARS

3 year unconditional guarantee!

WALSCO

Guaranteed lasting high gain on all VHF channels

ELECTRONICS CORPORATION

3602 Crenshaw Blvd., Los Angeles 16, Calif.

the newest

addition

TR-4



TR-4 ... the de-luxe HEAVY DUTY rotor complete with modern design meter control dial cabinet, using 4 wire cable.....

53.95



CORNELL-DUBILIER

SOUTH PLAINFIELD, NEW JERSEY

to the family of C*D*R Rotors

C * D * R ROTOR

the ultimate in heavy duty Rotors

*incorporating all the fine features
that have made the TR-2 outstanding
plus these fine features:*

★ Handsome Meter Dial Cabinet

★ Uses 4 Wire Cable

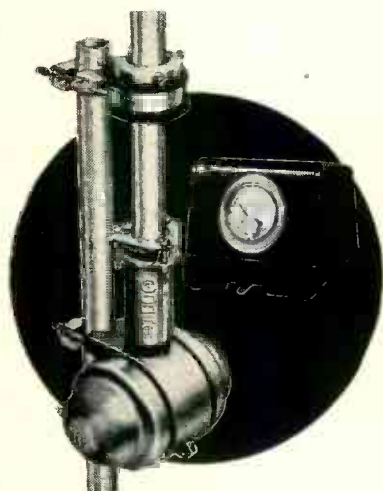

TR-12 . . . a special combination value consisting of complete rotor, including thrust bearing . . . handsome modern design cabinet with meter control dial, 4 wire cable
47.95

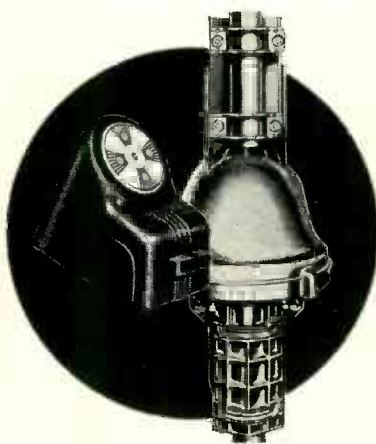

TR-2 . . . the Heavy-Duty rotor, complete with "Compass Control" cabinet having illuminated "perfect pattern" dial . . .
49.95

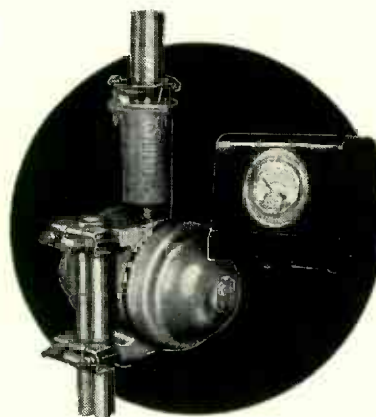

TR-11 . . . the all-purpose rotor with handsome modern design cabinet with meter control dial, uses 4 wire cable . . .
44.95



THE **RADIART** CORPORATION

CLEVELAND 13, OHIO

NOW... 2 SENSATIONAL EICO SCOPE VALUES!

NEW AMAZING FEATURE PACKED
7" PUSH-PULL OSCILLOSCOPE

Only **EICO** Has All These Features

- VERTICAL FREQ. RESPONSE: flat ± 2 db 10 cps - 1 mc
- VERTICAL SENS.: .01 volts rms/inch
- HOR. FREQ. RESP.: flat ± 0 db 10 cps - 200 kc, -4 db at 500 kc
- HOR. SENS.: .3 volts rms/inch
- SWEEP RANGE: 15 cps-100 kc
- 3-STEP FREQ.-COMPENSATED ATTENUATOR eliminates freq. distortion, overloading.
- CATHODE FOLLOWER inputs to both amplifiers
- PUSH-PULL outputs in both amplifiers
- RETURN TRACE BLANKING
- INT. VOLTAGE CALIBRATOR
- V & H TRACE EXPANSION & CENTERING: 1.5X full screen without distortion.
- DIRECT CONNECTION to vert. CRT plates.
- PHASING CONTROL of internal 60 cps sine wave sweep.
- AT FRONT PANEL: intensity mod. input; 60 cps, sawtooth outputs.

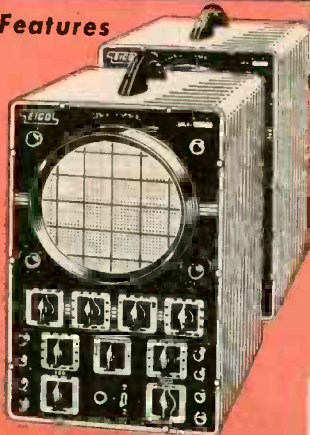

MODEL 470K
KIT \$79.95. WIRED \$129.50.

EICO EXCLUSIVE! 5" PUSH-PULL SCOPE, 425K, Amazing feature-packed economy-priced Wired, \$79.95. KIT, \$44.95.

- PUSH-PULL V & H amplifiers. Sens: 0.5-1 rms v/in. Useful to 2.5 mc.
- SWEEP: 15 cps-76 kc. Z-axis intensity modulation. Dual trace positioning controls.



SCOPE VOLTAGE CALIBRATOR KIT
495K KIT \$12.95. WIRED \$17.95.

- Sq. wave output at power-line freq. with full-scale readings of .1, 1, 10 or 100 V. peak-to-peak.
- Accuracy $\pm 5\%$ of full-scale on each range.

6V & 12V BATTERY ELIMINATOR KIT
3050K KIT \$29.95. WIRED \$38.95.

- DC output: 0-8 V or 0-16 V.
- Continuous current rating: 10 A at 6 V, 6 A at 12 V.
- Intermittent current rating: 20 A at 6 V, 12 A at 12 V.
- Separate Voltmeter & Ammeter.

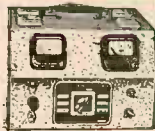

New! EICO SCOOPS!

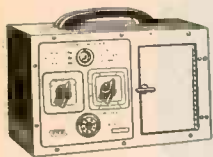

CATHODE RAY TUBE CHECKER
630K, WIRED \$24.95 KIT, \$17.95.

- Checks all types of TV picture and C.R. tubes in the set or carton. Bridge measurement of peak beam current (proportional to screen brightness).
- Detects shorted & open elements.

BAR GENERATOR
352K, WIRED \$19.95 KIT, \$14.95

- Enables rapid adjustment of TV picture V & H linearity without hard-to-find station-transmitted test pattern.
- Produces 16 V or -12 H bars. Operates on TV channels 3, 4, or 5.

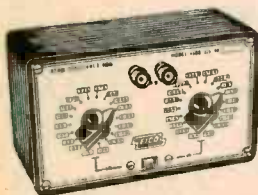
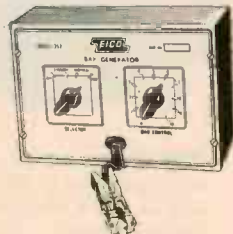

RTMA RESISTANCE
SUBSTITUTION BOX
1100K WIRED \$9.95 KIT, \$5.50.

- Enables rapid substitution of resistances from 15 ohms to 10 meg in decade multiples of 15, 22, 33, 47, 68, 100 ohms.
- Uses 36 standard 1 watt, $\pm 10\%$ RTMA resistors.

221K VTVM KIT \$25.95. WIRED \$49.95.

- AC & DC volts: 0-5, 10, 100, 500, 1000 V (30 KV with HVP-1 probe).
- 5 ohm ranges from .2 ohm to 1000 meg.
- DC input Z 26 meg.
- $4\frac{1}{2}$ " meter movement in can't-burn-out circuit.
- 1% mult. resistors.



360K SWEEP GEN. KIT \$34.95. WIRED \$49.95.

- Continuous coverage of all TV & FM freqs. from 500 kc to 228 mc.
- Sweep width variable 0-30 mc.
- Crystal marker oscillator, variable amplitude.

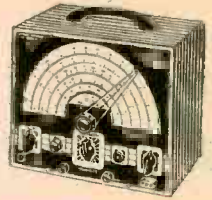

HIGH VOLTAGE PROBE \$6.95
● Extends range of VTVMs & voltmeters to 30 KV.



PIN TUBE ADAPTER
for Tube Testers \$4.50.
● Checks TV picture tubes while in set.

214K VTVM KIT \$34.95. WIRED \$54.95.



- Large $7\frac{1}{2}$ " meter, can't-burn-out circuit.
- AC/DC volts: 0-5, 10, 100, 500, 1000 (30 KV with HV Probe).
- 5 ohm ranges from .2 ohm to 1000 meg.
- DC input Z 26 meg.
- 1% mult. resistors.

625K TUBE TESTER KIT \$34.95. WIRED \$49.95.



- Illum. gear-driven "Speed Rollchart."
- New lever-action switches for individual testing of every element.
- Tests all conventional & TV tubes.

CONDENSOR RESISTANCE TESTER
WIRED \$29.95.



- Measures & tests all resistors; 5 ohm to 500 megohms.
- Every type condenser, 10 mmf to 5000 mfd.
- 0-500 DC voltage source for capacitor leakage testing.

COUNTER CABINET for above: add \$10.00 to Kit or Wired Prices.

NOW! ONLY EICO KITS & WIRED INSTRUMENTS Gives You LIFETIME SERVICE & CALIBRATION GUARANTEE*

*at less than our cost of handling (See EICO Guarantee Card enclosed with each Kit & Instrument).

1171K RES. DECADE BOX KIT \$19.95. WIRED \$24.95.

- Resistance values from 0 to 99,999 ohms with 0.5% precision.
- All resistors have 0.5% accuracy

DECADE CONDENSER BOX KIT
1186K KIT \$14.95. WIRED \$19.95.

- All capacitors precision silver mica, accuracy $\pm 1\%$.
- Range from 100 mmf - 0.111 mfd in steps of 100 mmf.
- Smooth-action positive detent ceramic switches.



Prices 5% higher on West Coast. Specifications and prices subject to change without notice.

315K DELUXE SIG. GEN. KIT \$39.95. WIRED \$59.95.



- Covers range of 75 kc to 150 mc.
- 7 calibrated scales: accuracy better than 1%.
- Bandsread vernier tuning.
- 4-step RF shielded output multiplier: constant output Z.

565K MULTIMETER KIT \$24.95 WIRED \$29.95.

555K MULTIMETER KIT \$29.95
WIRED \$34.95.
(1% precision resistors)



- 20,000 Ω/V ; 31 ranges.
- DC/AC/Output volts: 0-2.5, 10, 50, 250, 1000, 5000.
- DC Current: 0-100 ua; 10, 100, 500 ma; 10 A.
- Ohms: 0-2K, 200K, 20 meg.

377K SINE & SQUARE WAVE AUDIO
GEN. KIT \$31.95. WIRED \$49.95.

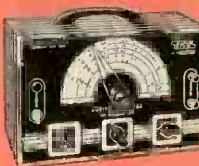

- Complete sine wave coverage, 20-200,000 cps in 4 direct-reading ranges.
- Complete square wave coverage, 60-50,000 cps.
- Cathode follower output circuit.

145K SIG. TRACER KIT \$19.95.
WIRED \$28.95.



- Audibly signal traces all IF, RF, Video & Audio circuits from ANT to SPKR or CRT in all TV, FM, AM, etc. without switching.
- Germanium crystal diode probe responsive to over 200 mc.
- Integral test speaker.

536K MULTIMETER KIT \$12.90. WIRED \$14.90.
526K MULTIMETER KIT \$13.90. WIRED \$16.90.



- 1000 Ω/V ; 31 ranges
- DC/AC volts: Zero to 1, 5, 10, 50, 100, 500, 5000.
- DC/AC Current: 0-1, 10 ma; 0.1, 1 A.
- Ohms: 0-500, 100 K, 1 meg.

320K SIG. GEN. KIT \$19.95. WIRED \$29.95.
322K SIG. GEN. KIT \$23.95. WIRED \$34.95.



- Fundamentals 150 kc to 34 mc, harmonics to 102 mc.
- 5-step band switching.
- Colpitts audio oscillator generates 400 cps pure sine wave voltage.
- Permits pure RF, modulated RF, or pure AF.

Write NOW for FREE latest Catalog Key #C-3

See our I.R.E. Booth #209-211. Ask your jobber for FREE EICO business building decals.

Separate Assembly & Operating Manuals supplied with each EICO KIT!

You build EICO Kits in one evening, but... they last a lifetime!

SAVE OVER 50%! See the famous EICO line TODAY, at your local jobber.

ELECTRONIC INSTRUMENT CO., Inc., 84 Withers Street, Brooklyn 11, N. Y.



600,000 U. S. TRANSMITTERS

. . . From the cradle to the grave—the rôle of radio and television . . .

By the Federal Communications Commission

(The well-nigh incredible penetration of Radio and Television into every conceivable human endeavor has now reached hitherto undreamed proportions. This summary of present day radio and television uses, by the FCC, makes spectacular reading—Editor)

RADIO usage extending from the cradle to the grave is encompassed in the flow of applications to the Federal Communications Commission for new or extended radio services.

There are existing radio facilities for calling and otherwise speeding doctors to the homes of expectant mothers as well as other persons requiring medical assistance in rural areas; and in the cities radio-equipped ambulances and other vehicles can bring medical aid.

After the baby arrives, radio-equipped vehicles can deliver milk, pick up and return diapers, and perform other chores in the interest of the newcomer.

Going to the other extreme, radio is being used for dispatching vehicles in connection with the death and burial of the departed. This includes the movement of funeral corteges at a number of large cemeteries.

The Commission's now more than 60 different classes of radio stations—which hold over 250,000 authorizations covering the use of some 600,000 fixed and mobile transmitters—represent a varied and rapidly expanding utilization of this instantaneous communication medium.

The wide extent of the application of radio for communication purposes is indicated here:

Public Communication—Domestic and international communication by telephone and telegraph over radio facilities.

Public Safety—Radio aids to police, fire, highway and forestry protection.

Transportation—Radio navigational, safety and communication aids for ships and airplanes; radio dispatching for railroads, street car systems, taxicabs, intercity buses, and highway trucks.

Industry—Radio communication to control and speed the movement of personnel and material in the production and delivery process.

Entertainment—Programming by commercial AM, FM and TV broadcast stations.

Education—Programming by noncommercial educational FM and TV broadcast stations.

Experimentation—Use of radio in research, and for the development of equipment and techniques.

The diversification of radio's uses is shown by the following miscellaneous examples: To control city and highway traffic systems . . . To direct movement of crews cleaning city streets, water mains, etc. . . . To expedite delivery of food, fuel, building material, etc. . . . To speed repair of home and business office fixtures and appliances . . . To dispatch trucks to pick up garbage, dead animals, and other refuse . . . To route rural school buses . . . To aid beach and other recreation area patrols . . . To contact workers on isolated ranches, etc. . . . To direct the movement of machinery on large farms . . . To look for oil on land and under off-shore waters . . . To spot schools of fish from moving planes and radio their locations to fishing boats . . . To direct motion picture crews on location . . . To aid bank and business protective patrol systems . . . To relay news between reporters on assignment and their newspaper offices . . . To control model airplanes, etc. . . . To send fingerprints and other information from one police department to another . . . To time and photograph the finish of track-racing events.

To communicate between the engine and caboose of long freight trains; between moving trains and wayside stations; and in yard operations . . . To control railroad track switches by the engineer on a moving train . . . To pick up and deliver telegrams by auto . . . To relay telephone

and telegraph messages, also TV programs . . . To bridge gaps in disrupted wire lines . . . To transmit pictures and facsimile . . . To control crowds at large regattas, horse shows, golf matches, and other big outdoor events . . . To transmit orders from "car hops" to kitchens of drive-in restaurants . . . To control movement of ships in harbors . . . To page doctors and other persons . . . To determine the position of ships and aircraft, also the proximity of objects . . . To direct firefighters at the scene of a blaze . . . To enable garage and automobile associations to provide emergency road service . . . To send weather and market reports . . . To supervise and control valves, pressures and fluid levels along pipe lines . . . To record sunspot cycles, measure radio propagation, and study planetary reflection . . . Also, to provide emergency communication in time of local, regional and national disaster.

Because of the "housing shortage" in the radio spectrum and the increasing demand for available frequencies by recognized radio services, the Commission is unable to allocate radio space for the exclusive use of—to quote one request—a machine "to take the kinks out of woolly hair." However, electronic hair-removing apparatus does function under rules which govern the technical operation of miscellaneous radiation devices to prevent interference.

Though not used for communication purposes, there is growing use of appliances which emit energy that can disrupt radio services—not only TV and aural broadcast reception, but also services on which the safety of life and property depend. It is significant that the collective power of this group now exceeds the total transmitter power required for all forms of radio communication. Some of these units employ power far in excess of the 50-kilowatt maximum permitted AM broadcast stations.

Industrial, scientific and medical equipment employing radio-frequency energy includes heaters for the quick drying of products used in the manufacturing process, medical diathermy machines used for therapeutic purposes, welding outfits, etc. Specific frequency bands are provided to absorb their radiations and so keep them from straying into the regular communication channels.

Then there are restricted radiation devices, such as phonograph oscillators; garage-door openers and other remote-control gadgets; electronic cook stoves which heat food from the inside out; community antenna systems in areas of poor TV reception which pick up programs and relay them by coaxial cable to the homes of subscribers; and carrier current (closed-circuit) systems which use wire facilities to furnish music, voice and signaling services. The technical operation of these things, too, are subject to rules to guard against unlawful radiation.

Closed-circuit television operation, in particular, is extending into many fields and its possibilities appear to be without end. Present uses include: Demonstrating survey and other medical techniques to doctors and students . . . Instructing several classes of a school or college at the same time . . . Checking signatures, etc., between branches of a bank . . . Watching babies in large nurseries . . . Guarding prisoners in jails . . . Relaying church, concert, entertainment and other programs to overflow or supplemental audiences . . . Demonstrating new products to scattered groups of salesmen . . . Observing planes take off and land at airports . . . Supervising freight car movements . . . Detecting unnecessary chimney smoke . . . Checking documents in different parts of a large filing system . . . Serving industry as a robot eye to follow production and handling processes—such as watching boiler, water-level and other gages from the main control room; detecting delays in the movement of material; and otherwise enabling supervisors to see into several places at the same time . . . "Kibitzing" dangerous operations from a safe distance—such as those involving use of atomic energy, furnace combustion, detonation of explosives etc.

CONTROL UNIT for

Compact and inexpensive, this unit is designed for use with the Junior Golden Ear amplifier, but is highly applicable to any amplifier

By JOSEPH MARSHALL

THE weak spot in most home-built high-fidelity systems is the control unit. It is, in fact, the weak spot of many commercial units. This is not surprising. It is by no means easy to compromise the often conflicting demands of the several jobs a control unit is called upon to do, and especially not easy to do so in a compact and inexpensive form. As an example of the extremes one can go to in trying to approach the ideal, I can cite the present control unit for the Master Golden Ear Amplifier in my own home which uses 5 double triodes (not including the phono preamplifier) and occupies a 7 x 17-inch chassis, and the same sized panel with just about a dozen knobs). Often I have thought that this was surely a case of complication *ad absurdum*; but the fact is that though I designed and built many simpler units, until recently I could not arrive at one which was capable of living up to the standards of the Golden Ear.

For instance, there is the matter of distortion. We take elaborate pains to reduce distortion in power amplifiers to a fraction of 1 percent. Adding a control unit which contributes high levels of distortion would be like throwing away the hard work and expense devoted to the amplifier. And yet it is extremely difficult to hold down distortion in a control unit. For one thing, unless we can afford a to-hell-with-expense attitude, the control unit must be single sided, rather than push-pull, for the simple reason that providing tone equalization in push-pull is a very complicated matter. Thus we are deprived of the distortion-canceling benefits of push-pull configuration. Further, since tone equalizers are included it is also hard to make use of the distortion-canceling properties of negative feedback. Single-sided amplifiers without feedback can produce large amounts of distortion (by high-fidelity standards) even with outputs of 1 or 2 volts.

There is also the matter of satisfactory tone compensation. I don't think anyone will argue with the proposition that a good tone-control circuit should provide direct boosting or attenuation without readjustment of the volume

control. There aren't too many good circuits which provide direct boost.

A tone-control circuit should also control the bass or treble but leave the rest of the band unaffected. When you want to bring out the drums, you don't want to change the contralto into a female baritone; nor when bringing up the snares and triangles do you want to change the baritone into a thin tenor. Unfortunately, the simpler tone-control circuits do not fill this specification. Even a reasonable amount of bass boost usually results in a boomy voice.

Finally, when independent bass and treble controls are involved, the two should be reasonably, if not completely, free of interaction. This is far from true in the case of the average control circuits; satisfactory setting of the controls takes considerable skill.

Another important consideration is frequency response. The better high-fidelity amplifiers today have bandwidths of around 13 octaves and even more; and—as I have repeatedly pointed out—this wide bandwidth is essential for faithful, distortion-free reproduction. In contrast, the typical single-sided control unit is flat—in the flat position—from perhaps 30 to 12,000 cycles, with rapid slopes at the extremes. Of course this minimizes the range of the tone-control circuits since part of the boost is needed merely to flatten the response of the control unit itself. Worse yet, however, the slopes produce distortion, especially at low frequencies. And yet, here too, without the benefits of push-pull operation and negative feedback, it is very difficult if not impossible to obtain wide bandwidth.

Finally, there is the matter of so-called "loudness control." Without getting into debate in a field already very noisy with argument, we can say that it would be nice to be able to preserve a reasonably good tone balance when changing the volume level. The high-fidelity crank may be perfectly happy to spend two or three minutes adjusting—in proper coordination—the volume, bass, and treble controls, every time he changes the volume level. But his wife

—and most people who buy high-fidelity systems—would much prefer to simply turn the volume control up or down and still maintain a reasonably good tonal sound. Much design energy is currently being expended on loudness controls and some are very complicated with their stepped or variable slopes, etc. Even then, most designers confess their failure to solve the problem satisfactorily by including a switch to remove the loudness control from the circuit.

By no means to be disregarded is the matter of physical size and form of the control unit. To meet the infinite variety of installation problems and preferences, the unit should be small, compact, and capable of being inserted in an odd corner of a cabinet, or used by itself in plain sight, of being a part of a single cabinet, or of being used remotely.

A simple and compact job

When—in view of all the above—I present the simple unit pictured and diagrammed here, the reader is entitled to lift his eyebrows high and to look with skepticism at any claims made for it. And I am not going to say that here is the perfect control unit. It is not as good or as flexible as the master outfit mentioned above; but it costs only a fraction as much and occupies less than one-tenth the space. Only one or two people besides myself have noticed any difference, and these were either engineers or high-fidelity cranks. Furthermore, I am the only one in the family who understands the operation of the big unit, whereas all members of the family find this one simple to use properly. I could not conscientiously recommend the master unit except to the very crankiest of cranks; whereas, I do not hesitate to recommend this one even to all cranks. Its performance is good enough to bring out the best qualities of the Golden Ear amplifiers and to me, the proud brain-father, that is adequate praise.

Let us look at the performance of this small handful of gadget to see how it meets the various conditions I have mentioned. The distortion level, though higher than I would like it to be, is





Left, photo shows front view of compact control unit. Right, rear view of control unit shows jacks and socket.

still low enough to take nothing discernible away from the performance of top-quality amplifiers. The IM distortion (60 and 7,000 cycles, 4-1) is under 1% until the output exceeds 1½ volts, and rises to 2% at levels of 3 to 5 volts. The Golden Ear amplifiers are among the least sensitive of all amplifiers, because of the large amounts of feedback they incorporate. However, less than 0.2 volt will produce an output level high enough to drive most women out of the house and to break almost any lease. At this level the distortion is below 0.5%. This is the result of two factors: the smooth and wide frequency response and the very considerable amount of feedback applied to both stages.

Tone compensation circuitry

Now for tone compensation. Recently Britain, which has sent us so many excellent high-fidelity products and circuits, has produced a tone-compensating circuit (introduced by Baxendall) which for a combination of virtue and simplicity is little short of fabulous.

First of all, it is a direct-acting tone-control circuit. Turning either bass or treble controls up or down brings an immediate boost or attenuation with no need to compensate the volume control. Second, it is a circuit in which the turnover on both ends varies with the amount of boost or attenuation. Thus the turnover is below 100 cycles for a boost of 6 db; it rises to about 200 cycles at 12 db; and at maximum boost of some 20 db the mid-frequencies are still relatively unaffected to the ear. The treble turnovers are similarly variable. This results in very pleasant and satisfactory tone compensation; large amounts of boost can be applied to the extremes of the spectrum, with very little audible effect on the mid-frequencies. The total range of control from maximum boost to maximum attenuation at the two extremes of 20 and 20,000 cycles approaches 50 db for the bass and is over 40 db for the treble. This includes the unit as a whole, not merely the tone control unit, and therefore includes all circuit gains and losses. Finally, because this is a feedback circuit, the distortion is minimized except at the points of maximum

boost where it becomes the same as that of a similar stage without feedback. However, the maximum boosts are almost unusable with high-fidelity program material; and with any normal amount of boost the distortion is considerably lower than that of an ordinary single-sided stage without feedback. The boost continues smoothly to 10 cycles and perhaps less, on the low end, and at least to 30,000 cycles on the high end. One more thing. Because of the high feedback the output resistance is very low—almost as good as that of a cathode follower—and therefore a long line can be used between control unit and amplifier without serious loss of high-frequency response.

As for bandwidth. By a combination of very low stray capacitance (due to the use of the Vector socket and the method of construction) and of feedback, the over-all bandwidth is flat from about 10 cycles to just over 20,000 cycles, with the volume control half-on. There is a little boost at the low end and a fairly gradual slope beyond 20,000 cycles which can be corrected with just a crack of the treble control to around 30,000 cycles.

The volume control includes a considerable amount of bass boost, amounting to a total of nearly 20 db between maximum and minimum positions of the volume control—and not counting any boost made by the bass control. This is done by the rather novel feedback loop in the first stage where feedback is introduced through a resistor in series with the volume control. The feedback amounts to about 6 db with the volume control at maximum and approaches 30 db at the minimum position of the volume control. The combination of control taper and variable feedback produces a smooth reduction of volume and, because of the R-C constant of the loop, the bass varies as the volume varies. Assuming the control is set at mid-rotation—which would be about the normal home-listening position—the bass boost is about 10 or 12 db. From this position, turning the volume to maximum reduces the level at 20 cycles by 9 db, while turning it to minimum increases it by 10 db. Thus, if the bass control is set for a desired balance at normal listening level, a

change in the volume control setting up or down will produce compensation which is pleasant.

It's not perfect

This circuit has one fault: the volume is not completely cut off at the minimum position of the volume control. However, radio and TV receivers will have volume controls which can be set to produce complete cutoff if desired. If the record input is too high to produce an acceptable minimum volume, a resistor of 500,000 ohms or more can be inserted between record input and the appropriate point on the switch to reduce input level to the desired degree. This system could be used with the other inputs, the resistors being selected so that each input source delivers the same input signal. This, however, is a small price to pay for the virtues of loudness control and reduced distortion which the circuit yields. (Complete control of volume with somewhat higher bass boost could be obtained by using an IRC type Q17-133X control and returning the feedback to the 25,000-ohm tap.)

Because of the two feedback loops, the control unit is excellent for remote operation. The feedback on the input stage reduces the input resistance and therefore cable losses at high frequencies; the feedback in the output stage reduces the output resistance and therefore losses in cables. As much as 25 or 30 feet of shielded cable can be used with losses moderate enough to be compensated for easily with the treble boost control. The on-off switch on the volume control controls the whole audio system. Two wires in the cable feed one side of the 117-volt line to the switch.

So the circuit does rather better at meeting the specifications for a high-quality control unit than the skeptical might believe possible. Whether the result is measured by ear or by instrument, it is a superior control unit, despite its small size and simplicity. It will not harm the performance of even the most expensive combination of amplifiers, pickups, and speakers; on the contrary, it will work considerably better than most. The over-all performance will in any case belie the cost given in the certified parts list.

Construction details

The unit (shown in Fig. 1) is very simple to construct. It is mounted within a 3 x 4 x 5-inch Flexi-Mount aluminum case to match the phono preamplifier (to be described in a future article). The two units could be combined in a single larger case; but I recommend separate cases for better isolation and a better over-all noise figure, as well as greater flexibility in placement.

There is only one critical part. The treble control should be a 500,000-ohm potentiometer with a *linear* taper and a tap at 250,000 ohms. Only a linear control with a mid-tap will result in

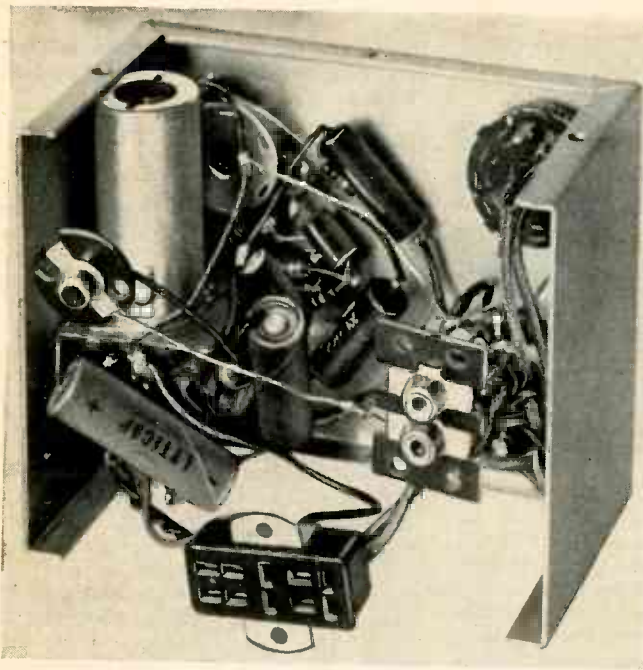

Photo shows internal view of control unit. Thorough shielding includes tubes and wires.

obtaining a flat position at mid-rotation and equal amounts of attenuation and boost. Unfortunately, such units are hard to find. The prototype uses a Mallory UF55-T254. While it is not exactly correct it comes very close to being right. The flat position is a little to the attenuation side of center; but the center position will provide just enough boost to make up for line and program losses beyond 10,000 cycles.

20 cycles useful without instability, and will keep the transient response up to that of fine power amplifiers. All Golden Ears except the Junior provide a V-R tube regulated source of 150 volts for this purpose.

The wiring is done in two steps. The turret socket is wired with the plate and cathode resistors; bypass and coupling capacitors. The rest of the wiring is done on the panel after the

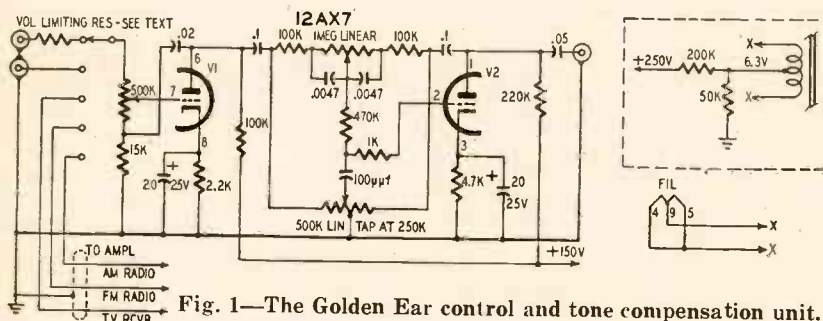

Fig. 1—The Golden Ear control and tone compensation unit.

(Tone control components, dual concentric control and couplate, can be ordered from Centralab—part number C3-300.)

Calibration—centering of the bass control—will be simplified if the two 100,000-ohm resistors are 5% units; in that case, it can safely be assumed that mid-rotation is the flat position. Otherwise the components are not at all critical. Ten or even 20% resistors and good-quality plastic-covered paper capacitors—the smaller in physical size the better—are plenty good enough. For minimum hum the filaments should be fed by a balanced and biased filament supply as diagrammed in the dotted square. Golden Ear amplifiers have such a source and will feed the control unit.

To allow the best use of the wide bandwidth and boost this unit permits, it is highly desirable that the 150-volt B supply come from a V-R tube. This will produce the high degree of decoupling which will make boosting at

controls are mounted. Fig. 2 shows the recommended wiring of the tone-control circuits as viewed from the rear or wiring side. Note that the two coupling capacitors must be connected to the points indicated to obtain clockwise boost. The various resistors and capacitors are supported by the terminals of the controls. Be sure the .0047-µf capacitors are the miniature type specified. Ordinary ones will take too much space. Connection to the second-stage grid is through the 1,000-ohm resistor with spaghetti tubing over the bare wires. The connections to the two plates are through the coupling capacitors, also covered with spaghetti. The vector turret socket is mounted on a small square of aluminum bent to make a bracket and punched with a hole for the socket. This bracket must be positioned precisely with the tube shield in place. There is just room enough to permit the cover to slip on and off, if

this bracket is properly placed. Do not leave out the tube shield; the two feedback loops might produce instability without it.

A 5-position single-pole switch of the miniature type permits the choice of 5 inputs. One for the phono-equalizer and another for a tape recorder are phono jacks mounted on the cover of the case. The two radio and the TV input are fed via the cable which brings the operating voltages. Or, rather, this cable consists of two cables strapped together: one is a 3-conductor shielded cable for the audio circuits; the other a 6-conductor unshielded cable for the plate and filament supplies. Although the model pictured has a cable jack and plug, the jack could be dispensed with and the plug used only at the far end, the power supply or amplifier. In that case the cable could enter the cabinet through a grommet.

The only precaution to take in assembling the unit is to make the leads

Certified Parts List

- 1—500,000-ohm potentiometer, audio taper, with switch.
 - 1—1-megohm linear potentiometer.
 - 1—500,000-ohm linear potentiometer with tap at 250,000.
 - 1—12AX7 tube.
 - 1—Vector noval turret socket, 6-lug, 1/2-inch.
 - 1—Shield and base for above.
 - 1—Miniature 5-position, single-pole switch.
 - 2—20-µf 25-volt capacitor.
 - 1—.02-µf 200-volt paper capacitor.
 - 2—.01-µf 200-volt paper capacitor.
 - 1—.05-µf 200-volt capacitor.
 - 2—.0047-µf Aerovox microminiature.
 - 1—100-µmf miniature, mica.
 - 3—Phono style jacks.
 - 2—100,000-ohm 5% resistors 1/3 watt:
 - 7—10%, 1/3 watt resistors: 1—15,000; 1—2,200; 1—4,700; 1—100,000; 1—220,000; 1—470,000; 1—1,000 ohms.
 - 1—Jones socket, 10 contact, type AB.
 - 1—3 x 4 x 5-inch Flexi-Mount case.
 - 4—Knobs.
- Total cost of the above, as purchased from a large mail-order house, was \$12.09.

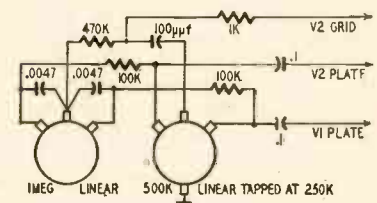

Fig. 2—Wiring of tone-control circuit.

between the parts on the case and points on the cover long enough so that when the cover is slipped on there is enough of a crack or opening to permit easy soldering.

Whether used with Golden Ear or other amplifiers, this control unit will add greatly to the flexibility of performance, and—equally important perhaps for the other members of the household—to the ease and simplicity of operation and therefore to the pleasure the whole family obtains from the high-fidelity installation.

Next Month we expect to present Milady's Golden Ear amplifier, a new version of the Golden Ear configuration using big output tubes, with performance right up there at the top, and a revolutionary method of construction which will hide all clumsy handiwork and mistakes and produce a piece of equipment which Milady of the household will not object to having in plain view.

END



HIGH-FIDELITY LOUDSPEAKERS

Part I—the tangibles and intangibles of loudspeaker design; diaphragm behavior

By H. A. HARTLEY

Courtesy Wireless World

Fig. 1—The Vogt Oscilloplan speaker, shown at the Berlin Radio Show, 1927.

A VAST amount has been written about what we call "high fidelity." Some is original work; much of it has been lifted from standard works, revised, and offered as something new. Old fallacies and errors are repeated, apparently through lack of the necessary technical knowledge, and these sometimes become accepted principles of design.

I believe that I invented the concept of high-fidelity in 1927; at that time I was, as now, seriously interested in music, and it so happened that my job was designing speakers and amplifiers for the phonographs we had in those days. They were not very good and we invariably used some sort of balanced armature speaker with a large paper diaphragm. The moving coil, or dynamic speaker, had been invented a long time previously by the English scientist Sir Oliver Lodge, but nothing very much had been done about making it a practical proposition until the original horn-loaded dynamic speaker of Magnavox appeared in the early 1920's. This sounded better than the other "tin trumpets," but not good enough to compete with the remarkable "Kone" speaker of Western Electric. Then the American designers Rice and Kellogg produced a real dynamic speaker in, I think, 1926 or 1927, and the modern reproducer was born.

The Rice-Kellogg was so good that I thought it had possibilities of becoming better. The hidden meaning of this remark forms the foundation of the whole science and art of reproducing music. Earlier speakers were not even an imitation of music, because they lacked bass and extreme treble. The R-K was not very good above about 5,000 c.p.s. but it reproduced bass of a sort we had never heard before, simply because it had a diaphragm that could move. The sound of this speaker was the first clear signal that electrical gramophones could be designed to give some sort of approximation to an original performance instead of just being a little better than musical toys. Why not, therefore, make them better still? As both an engineer and a

musician, I felt that was a suitable question.

I have used the expression "the science and art of reproducing music," and I want to emphasize something that is not generally understood by the layman. It is not possible to define musical appreciation in terms of mathematical equations alone; something must be added. Similarly, the design of audio equipment intended to give a close approximation to an original performance is basically mathematical (amplifier design, for example, is entirely mathematical). But, particularly in the speaker, some design features cannot be computed; they are best thought of as the outcome of inspired hunches.

The best mathematical essay on the mechanics of speaker design is the book "Loudspeakers" (long out of print) by Dr. N. W. Maclachlan. The mathematician will enjoy the elegant treatment, but it is heavy going for the ordinary reader. Maclachlan shows that only the simplest of diaphragm behavior can be analyzed. When the book first appeared, a colleague of mine said that "Mac" had pulled off a remarkable *tour de force*, but it didn't tell us how to design speakers. That was true, but it wasn't Mac's fault. The complete behavior of

a speaker diaphragm *cannot* be analyzed; you can only listen to it and hope that it sounds good, and some musical knowledge is required if you desire to criticize it with authority.

For example, a question often put to me is, "What is the damping factor of your speaker?" The formula for the damping factor at bass resonant frequency can be found in any standard engineering textbook. The factors in the equation include: a figure for the damping resistance equivalent to the combined effect of friction and acoustical loading on the cone; the impedance of the voice coil plus that of the secondary of the output transformer and the connecting leads *and* of the primary related to the secondary; the effective plate resistance of the output stage of the amplifier; the frequency of the bass resonance; and the shunt capacitance of the system. Now I could reply to this question by saying that I can't answer it until he tells me what his output stage is, what sort of output transformer he has (in exact mathematical terms), how long his speaker leads are, what their capacitance is, and at what frequency he wants the figure. Then, if he has the patience to wait while I work out the equation, he can have his damping factor. If this seems poor salesmanship, all I need do is to check up on the damping factors of other speakers and quote a better figure than anyone else; I couldn't be proved wrong, and it would sound impressive. But the honest answer to the question is, "I haven't the faintest idea." And my truth seeker would consider me a fool.

I am pleading for sanity in assessing speakers. A speaker must obviously have a wide and level frequency response; it must be free from intermodulation distortion; it must have a good polar diagram at all frequencies; it must have good "attack" to reproduce transients faithfully, and good damping to avoid hangover; and, most elusive quality of all, it must have absolutely no "personality" whatsoever. A speaker is not a musical instrument, it is a reproducer of musical instruments, and must not add any sort of

This is the first of a series of articles on High-Fidelity Loudspeakers by the British high-fidelity specialist, H. A. Hartley. Having been closely associated with the audio field since its inception as a writer, engineer, and manufacturer, Mr. Hartley has gained world-wide renown as an outstanding authority on audio design in general and loudspeakers in particular. Mr. Hartley is president of H. A. Hartley Co., Inc., formerly Hartley-Turner, Ltd.

coloration to its sound output.

The final article in this series will give some information on testing speakers. This is not easy, except in properly equipped acoustical laboratories. Inadequate testing may lead to erroneous conclusions. I believe that long experience in designing speakers enables one to acquire a fund of practical knowledge of the acoustical behavior of materials and shapes used in speaker design. This enables the expert to make a pretty shrewd guess as to how any speaker will sound just by looking at it. These articles are designed to impart as much of that knowledge to you as possible. They cannot do this with complete success because the written word cannot take the place of experiment and

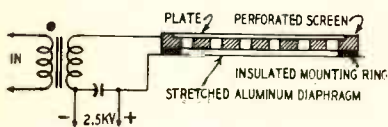

Courtesy Wireless World

Fig. 2—Oscilloplan speaker circuit.

measurement. But it is hoped that they will prove a reliable guide.

As the writer, I suppose it is inevitable that my own personal "coloration" must appear in the general treatment. I have tried to avoid this. Where my personal *opinion* appears, I'll say so; where I make categorical statements, you may safely assume that practical work proves them. Yet speaker design cannot be entirely a matter of right and wrong. Set two designers to produce a new calculating machine. Working independently, they will likely produce different designs; but the worth of their designs can be evaluated by simply working the machines to see if they give the right answer. Speaker design is not like that, for no one knows what the right answer is. Perfect reproduction is impossible, so assessment of an imperfect result can be only a matter of personal taste.

Direct radiators (baffle speakers)

The two main classes of speakers are the direct radiator type, in which the diaphragm acts directly on the air in front of the baffle or cabinet, and the horn-loaded type. They must be designed differently. It is a good test of design when the direct radiator will not work into a horn, and a horn speaker will not work on a baffle. Many present-day multiple-speaker systems use direct radiators working into what are called folded horns. All this is a contradiction in terms and principles. This point will be discussed further in the design of speaker housings.

Direct radiators can be widely different types—crystal, electrostatic, electromagnetic, or electrodynamic. The last is the only one to survive, so the others will not be considered, except for a few words on the electrostatic—necessary because of talk of new and better speakers coming along, based on electrostatic principles.

An electrostatic speaker is nothing more nor less than a capacitor, one plate of which is a metallic diaphragm. A good early type was the Oscilloplan (Fig. 1) of Hans Vogt, a German designer, in 1927. This had a 12-inch thin aluminum diaphragm tightly stretched across an annular mounting ring. Behind this was a perforated nonmetallic screen, and behind the screen was a plate forming the other electrode of the capacitor. A polarizing voltage (of about 2,500) was applied to the unit to set up a condition of strain, and the speech frequencies were added across the capacitor (Fig. 2). At low frequencies the movement of the aluminum diaphragm was appreciable and the insulating screen prevented short-circuiting. Unfortunately, when the diaphragm was near the screen the polarizing voltage sparked across, with distressing acoustic results, and the frequency response was very uneven. With the arrival of talking films it was thought that a battery of such speakers (they were conveniently thin and light) could be used, spread across the whole projection screen, but extended testing gave little promise of satisfactory results. Other electrostatic speakers were made of pleated metallized paper on aluminum electrodes, but these had no bass response and were feathery at high frequencies. In all types, the polarizing voltage was a nuisance, even dangerous. I have mentioned these to show that there is very little new under the sun. It is very difficult to acquire a valid patent on speakers—all has been done before—and we can look for no great progress until someone invents an entirely new method.

Attention therefore can be directed toward the ordinary dynamic speaker, in which a more or less conical diaphragm carries at its apex a coil of wire which oscillates in a magnetic

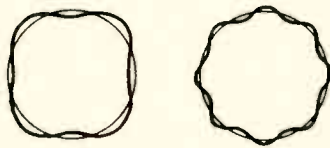

Fig. 3—Front view shows nodes in a straight-sided conical diaphragm.

field. Such a speaker cannot reproduce low frequencies unless it is mounted on a baffle, because as the sound from the front of the diaphragm is 180° out of phase with that from the back, the slower longer sound waves will cancel out each other unless prevented from doing so by an obstruction—the baffle plate. The baffle need not be flat, and its effective size is the total distance from the front of the cone, around the edge of the baffle, to the back of the cone. The most economical baffle therefore will be circular, and the most economical box spherical, considered from the viewpoint of raw materials.

A direct radiator's performance depends on the design of the diaphragm, the voice coil, the magnet system, and the mounting of the whole unit. The

last point will be considered under housing design; the other three will be discussed now.

Someone sometime in the past said that it is impossible to design a single diaphragm which will reproduce the whole range of frequencies required for high-fidelity reproduction. I may be the originator of this fallacy, for I produced the first tweeter-woofer combination as far back as 1929, and put it on the market in 1930. I withdrew it in 1931 because I didn't like it. It is difficult to produce a single-diaphragm speaker to cover all frequencies, but it is far from impossible. Another fallacy is that the perfect diaphragm would be an infinitely rigid piston of no mass. I have shown (*Audio Engineering*, January, 1953, "The Great Loudspeaker Mystery") that if such a perfect diaphragm could be made, it could reproduce only one frequency at a time. Loudspeakers do reproduce many frequencies simultaneously, and it is obvious that they can do so only because the cone does not behave like an infinitely rigid piston; in other words, cones "break up." It is the designer's task to see that they break up in a controlled manner, so that the frequency response shall be as level and smooth as possible.

The high frequencies come from the apex zone of the diaphragm; the lows are generated by the cone moving as a whole. The bass reproduction is not affected by the breakup at high frequencies because the movement of breakup is so small that there is no output at other than high frequencies. For a given cone, the harder the material the better the treble response—a cone made of blotting paper would have no top response worth considering. This led to the widespread practice of doping the apex of the cone to make it harder.

On the other hand, for good response

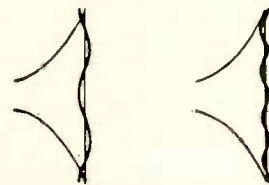

Fig. 4—Diagram shows side view of nodes in an exponential diaphragm.

in the bass, the cone should move as a nearly rigid piston, since the amount of air to be moved at very low frequencies is considerable; it would therefore seem logical to make the cone material harder and stiffer for low-frequency reproduction, and such proves to be the case. A very stiff cone made of high-grade Bakelite-impregnated paper gives cleaner and more powerful bass than one made of molded pulp, the commonly

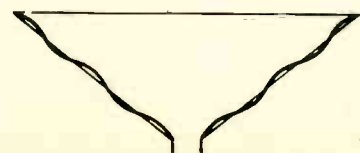

Fig. 5—Low-frequency wave motion.



Fig. 6—The Voigt twin-cone speaker.

Courtesy, Wireless World

used material. Molded cones are used because they are cheaper to produce and capable of being made within fairly close limits, but they are too soft for the best bass reproduction. If they are stiffened by being doped, to improve the bass, they will not break up in the desired manner, and the added weight of the dope will impair the treble response as well as the attack, since good transient reproduction depends not only on good frequency response but on low inertia of the moving cone—it must respond almost instantaneously to the kick of a transient wave. This point will be discussed again when I deal with multiple-unit speakers.

Apart from frequency response the diaphragm material affects the "color" of the reproduction. Some organ pipes and musical instruments are made of wood, others of brass or steel, or even silver. These materials are not used haphazardly. Wooden pipes and instruments have a tone color of their own and very distinct from that of metallic sound producers. A speaker is also a sound producer and the vibrating part will have its tone color associated with the material of which the cone is made; but a speaker is primarily a sound reproducer and should have no tone color. Metal diaphragms are therefore undesirable, even if they are strong for a given mass. Soft paper is nearly inert, but poor at both the low and the high ends of the frequency scale. If the paper is doped to improve the treble, it must be done in such a way that coloration is not introduced. This can be detected only by ear since it does not show up on a measured response curve.

The size of the diaphragm has an important bearing on the performance of the speaker, but the size is related to the freedom of suspension. For example, if one speaker is fitted with an 8-inch flat diaphragm and another with a 13-inch, for equal inputs the 8-inch cone will have to move about $2\frac{1}{2}$ times as much as the 13-inch to produce the same acoustic output. This is of importance only for low frequencies since the movement at high frequencies is microscopic. Other things being equal, and provided a sufficiently free suspension avoids clipping of the input signal

through nonlinearity of output, the size of the cone is no positive indication of bass reproduction capabilities.

But other things are not equal. I have shown that the diaphragm should be rigid for good bass reproduction, and a large cone is not so rigid as a small cone, for a given cone material. With small inputs this is not of great importance, but large cones are used to increase power-handling (since free suspension is a very tricky matter) at low frequencies. If the cone is rigid, its weight will spoil the response in the treble; if it is soft, the bass response will be impaired by *nodding* even before the limit of input power is reached. The node pattern is a function of the applied frequency and the phenomenon is not restricted to speaker cones; every suspended system develops nodes when an oscillating force is applied to it.

In a speaker diaphragm, which can be conical or exponential in section, nodes will cause loss of output at fundamental frequencies and introduce harmonic frequencies. If the power input is increased until the limit of movement has been reached, the proportions will be approximately one-twentieth of the fundamental, one-eighth of 2nd harmonic and the rest of 3rd. The strongest cone, for a given mass of material is one with an included angle of 90° , but such a narrow cone causes undue focusing of the highs. If the cone angle is widened to obtain good forward radiation, as is usual, the diaphragm will be weakened radially and nodes will show a flower pattern when the cone is viewed from the front (Fig. 3). The exponential cone was developed to overcome this defect, but it is weak axially and the node pattern can be seen from the side (Fig. 4).

The large cone has a further defect. I have pointed out that cones must break up to reproduce more than one frequency simultaneously. This breakup occurs in concentric waves radiating from the center of the cone. Very short waves (high frequencies) will die out quickly, but the longer waves will continue to the edge of the cone (Fig. 5). Parts of the cone will be out of phase with other parts. In a large cone they may be 180° out of phase. Acoustic

measurement with a sine-wave input will show irregularities in the response, but reproduction of music involves the reproduction of complex waves. Phase distortion therefore will be inevitable; the amplitude of the component frequencies *may* be reproduced approximately correctly, except for loss of output at the low frequencies (as explained above), but the lower frequencies will be out of phase with respect to the highs. It is impossible to lay down hard and fast rules concerning design, but in a general way it can be said that this sort of phase distortion is less with small diaphragms.

Attempts to control the cone breakup and remove the defects just described are seen in the use of concentric molded depressions or ridges in the cone. One cannot express any opinion on the value of this by comparing two different speakers, one with rings and one without, for other design features are also present. The only test is to have two identical speakers, one with a plain cone, the other with a ridged cone of exactly the same weight, and make direct comparison measurements between the two under precisely similar test conditions. I have done this and found no noticeable difference in frequency response in the middle register and treble; but molding ridges into the outer zone of an exponential diaphragm increases axial rigidity, reduces the formation of nodes, and improves bass.

A favorite method of trying to overcome the conflicting requirements of treble and bass reproduction in a single diaphragm is to add a tweeter cone to the diaphragm voice-coil assembly (Fig. 6). This method was invented by Voigt in about 1934, and it is beyond argument that the Voigt twin cone had more treble output than a Voigt single cone. But the Voigt was a horn-loaded speaker of unusual electro-acoustic efficiency and required only 1 or 2 watts to produce a very sensible volume. I applied this idea to a direct radiator but without success, although the treble response was improved. A direct radiator is not as efficient as a horn-loaded speaker, and application of 4 or 5 watts to the tweeter cone caused edge flutter, giving a tissue-paper effect to the reproduction. This could be overcome by cementing damping material to the free edge of the tweeter cone, but the added mass destroyed the increased treble output. Some manufacturers have tried to avoid this trouble by molding the small cone into an exponential shape, and it is partially successful, but the apex of an exponential cone is not even a cone but almost a parallel-sided tube, and focusing of the highs is very pronounced.

Other methods of modifying the main cone have been tried, but any departure from the minimum possible area of cone material will increase the mass and decrease the treble response; ideally the designer should try to reduce the mass at high frequencies. This can be done by a special design of voice coil.

(TO BE CONTINUED)

what is OPTIMUM LOAD?

By **NORMAN H. CROWHURST**

EVERYBODY knows about loads, so we won't start by explaining what a load is—yet. The word "optimum" means "best," but it should be qualified. If someone asked you what is the best tube type on the market, you would need to know what he wanted it for: a low noise level input stage; a high-gain preamplifier stage; a driver stage; or a power-output stage—to name just a few. The same thing is true about the plate load for any given tube. What do you want the plate load to do?

Probably the most common use of the term *optimum load* is in connection with output tubes, where we are interested in getting the maximum power output from a tube without exceeding its plate dissipation rating. In such a case, optimum means the load for giving maximum output without over-driving the tube. But it may not be as simple as that. What kind of output do you want? Square wave? Or something similar to the input wave? Or do you want it to have the lowest possible distortion while still giving close to its maximum output? Another application of output tubes is when a specific output power is required with a minimum of input grid swing. This can be called optimum load for maximum sensitivity. All these objectives cannot be obtained with the same optimum load value for the same tube.

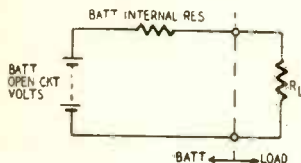

Fig. 1—Equivalent battery circuit.

Leaving tubes behind for the moment, let's assume we have a battery from which we want to operate a heating element. The element can be wound to any specified resistance, but we want all the heat in the element that we can get from the battery. If we make the resistance too high, the battery voltage remains high, there is a small current flow, and little heat is created. If the resistance is too low, the battery voltage drops, and although the battery may get warm the resistance element will not get enough voltage to warm it appreciably. The optimum resistance for the heater is the one that will draw the maximum wattage from the battery—somewhere between these two extremes.

To simplify this problem, the battery is regarded as being made up of two separate components: a perfect battery that gives constant voltage regardless of what is connected to it; and an internal resistance which accounts for

the drop in terminal voltage when current is drawn from the battery. Fig. 1 shows this idea. Let's put in some figures. Suppose the battery is a group of small cells giving 24 volts, and having an internal resistance of 12 ohms. The total resistance which determines the current, is the internal plus the external heater resistance. The voltage across the heater can be obtained by Ohm's law and the wattage dissipated by the heater is terminal voltage times current. We can tabulate this for different values of heater resistance. (See wattage table.)

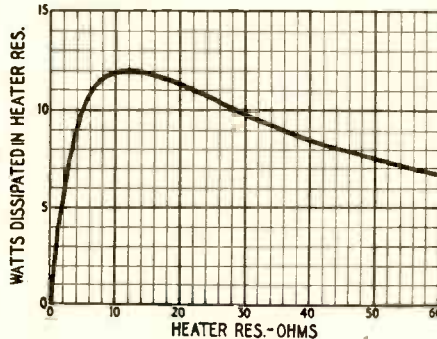

Fig. 2—Varying the load resistance.

Fig. 2 shows heater dissipation plotted against heater resistance. It appears that a 12-ohm heater gives the maximum wattage—12. This is the same resistance as the internal resistance of the battery. This numerical example illustrates an important principle: The *maximum wattage* in the external circuit is obtained by making the external circuit resistance equal to the internal resistance.

Maximum sensitivity

Assume we have a tube connected to the necessary voltages (Fig. 3), and the plate choke-coupled to the plate load, so we can change the plate load without altering the plate voltage. Now apply an audio signal to the grid, well within the maximum swing allowed for the bias used, so that the distortion is small no matter what load we use. If we leave the plate load unconnected, then assuming that the choke does not itself constitute a load, the audio volt-

age at the output will be the audio voltage at the grid multiplied by the amplification factor of the tube. If we short the output terminals, the voltage disappears, the same as it did with the simple battery. Any amount of plate load we connect will *reduce* the audio voltage at the terminals, according to the load value. This can be explained by regarding the tube as an audio-voltage generator combined with an internal resistance. The so-called internal resistance is the plate resistance of the tube. For the case we are now considering, the maximum wattage in the load occurs when the plate load is equal to plate resistance.

This result is expected, but it doesn't seem to line up with practice, you will be thinking. All the same, it is true for

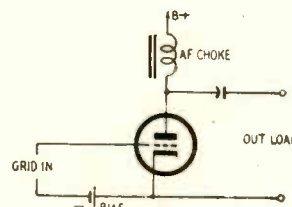

Fig. 3—A basic type output circuit.

the particular case dealt with. The conditions should be emphasized: Audio signal level at the grid is well inside the maximum swing allowable for the grid bias used, and is restricted to this level; the output variation considered is the power in the plate load as plate load value is varied, using the fixed grid input.

If we wanted an output tube to provide its maximum gain in terms of power in the load, we should use an optimum load equal to the plate resistance of the tube. But gain is usually easy to obtain elsewhere. The more difficult thing with power tubes is to get a large audio output with reasonable plate dissipation. So we start at a different place. We assume that whatever grid swing is needed will be found somehow, although it will generally be advantageous to use a tube with a small grid-swing. The problem is to get the biggest possible swing in plate voltage and current at the same time, so the output watts are as high as possible, with little distortion.

Matters are complicated because tube characteristics have boundaries. We have assumed we were well enough within these boundaries so we could ignore their existence. But in each kind of tube there are at least three boundaries that have to be considered. Fig. 4 shows the case for triode types, and Fig. 5 for tetrode or pentode types. In each case dashed lines are used to show how the curves would go in theory if there were no boundaries at all.

WATTAGE TABLE

Heater resistance (ohms.)	Total resistance (ohms.)	Current (amperes)	Terminal volts	Heater watts
3	15	1.6	4.8	7.68
4	16	1.5	6	9
6	18	1.33	8	10.67
8	20	1.2	9.6	11.52
12	24	1.0	12	12
18	30	0.8	14.4	11.52
24	36	0.67	16	10.67
36	48	0.5	18	9
48	60	0.4	19.2	7.68

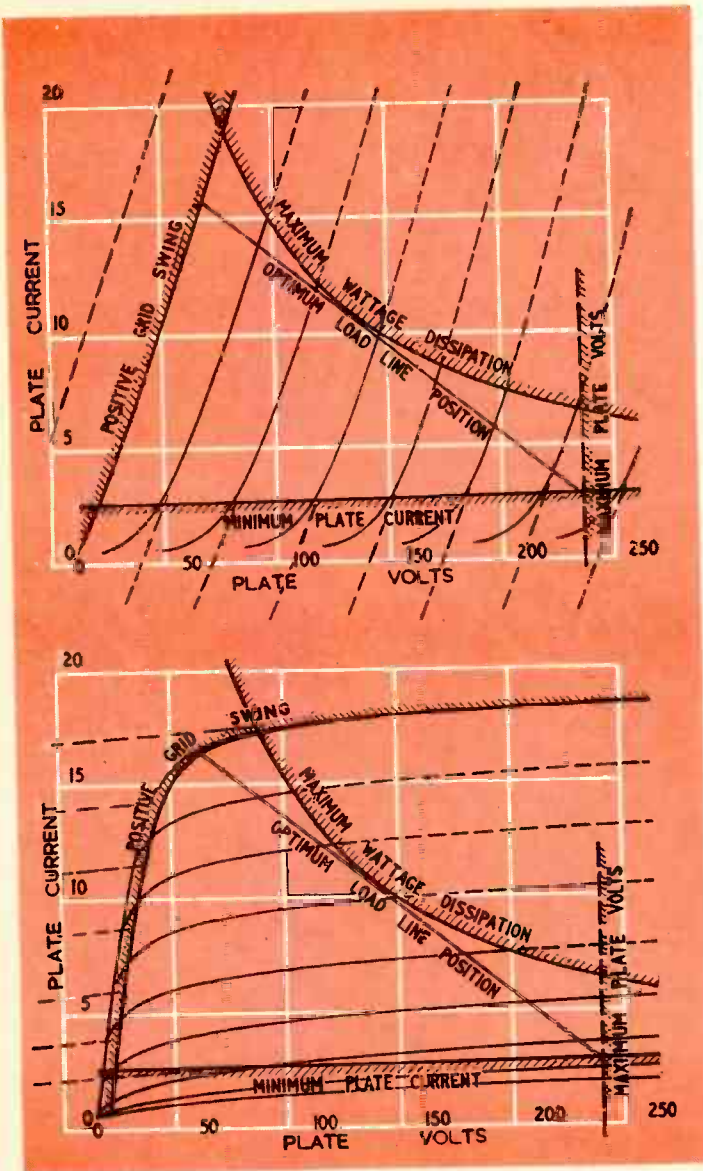

Fig. 4—Tube characteristics of typical triode, showing boundaries controlling optimum load.

Fig. 5—Tube characteristics of typical tetrode or pentode, showing boundaries controlling optimum load.

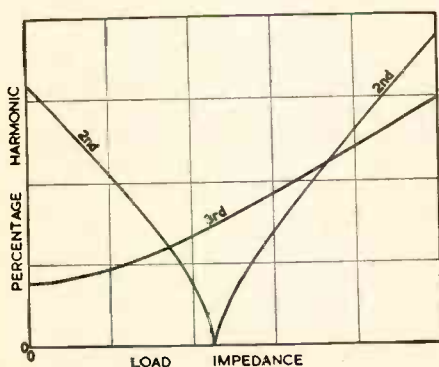

Fig. 6—Harmonic distortion analysis.

The first boundary for a power tube, and for any tube when it is to be operated close to maximum conditions, is the wattage-dissipation curve, a line of points showing maximum plate dissipation (volts \times current).

The secondary boundary can be called the positive grid-swing boundary. For the triode tubes, this will usually be the zero grid-voltage curve, unless power is available to supply the grid current that flows when the grid runs positive. In such a case, some specific value of positive grid-voltage curve will determine

this boundary. For pentode and tetrodes the zero grid curve applies as boundary above the *knee*, but in the vertical part it is advisable to set the boundary over, as the curves merge here, so that use of the zero grid curve would cause severe distortion.

The third boundary is the line representing zero plate current. Plate current does not normally go into reverse, and before it reaches zero there is a converging of the characteristics that will cause distortion, so the boundary should be set at some minimum value of plate current. This can be called the minimum plate-current boundary.

In addition to these three boundaries that apply every time, there is another that sometimes chips in, while in other cases the three regular boundaries take care of it automatically. This is: maximum permissible plate voltage.

For any given tube the optimum plate load is found by varying the slope of the load line (varying the plate-load resistance) until the product of plate voltage and plate current swings is a maximum. The slope of this line gives

a value of optimum load. (Calculation procedures for determining the power output of tubes are given in the RCA Receiving Tube Manual, Technical Series RC 16, pages 17 to 21.)

Load values for triodes are not usually too critical. A value two or three times greater than the rated optimum will not introduce distortion, but the power will be reduced somewhat. In triode output tubes the optimum load is several times the plate resistance—usually three times, and often five or more times. Further increase of plate load improves waveform slightly, increases output voltage swing slightly, but reduces output power, because the current swing is cut down more than the voltage swing is increased. Use of a plate load less than about three times the plate resistance results in distortion, unless the grid input swing is restricted, which limits the output.

For pentode and tetrode tubes, the term optimum load can have a stricter meaning. Working at a level a little below maximum output, variation of the load changes the nature of the distortion. In triodes, all the curvature is in the region of the minimum plate current boundary, which results in 2nd harmonic distortion. In tetrodes and pentodes, curvature is also introduced at the positive grid-swing boundary when the top end of the load line swings below the knee of the curves, representing load values higher than optimum. The higher order harmonics are introduced, and the amount of second harmonic depends on how the two sources of curvature balance one another. It is possible, by selection of load value, to eliminate 2nd harmonics altogether. An analysis of distortion from typical tetrode or pentode tubes is shown in Fig. 6. For some purposes the point where the 2nd harmonic disappears, or the total harmonic is a minimum, is considered the optimum load.

We have assumed that the object is to get the maximum output with minimum distortion. But as in audio work the maximum output is somewhat of an unused figure, reached at only fairly rare peaks, it can be said that distortion is more important at lower output levels. The exact curvature of the characteristic along any given load line follows a rather complicated law. The result can lead to the following kind of experience: Assume that plate load is made adjustable, so that it can be varied. With a harmonic analyzer connected to give minimum distortion at or near full output, turn the level down 10 or 20 db. Readjustment of the plate load will probably reduce distortion at this reduced level. Consequently it is probably better to choose a load value that gives minimum distortion at low levels, even though the distortion at maximum level may be up slightly.

In later articles we will consider frequently asked questions such as: Can feedback modify optimum load? What is optimum load for push-pull circuits? Just what does a cathode follower do and what does it not do? END

HIGH-QUALITY AUDIO

By RICHARD H. DORF*

Part VII—Bass and treble equalizing circuits can be made to produce ideal playback characteristics

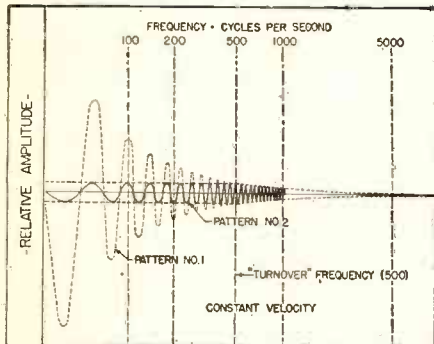

Fig. 1—Chart shows groove variations.

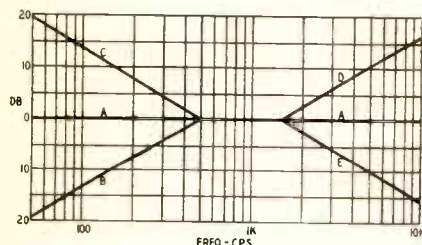

Fig. 2—Frequency characteristic curves.

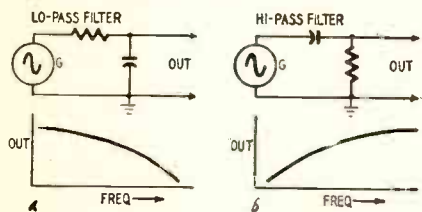

Fig. 3—Two basic equalizer circuits.

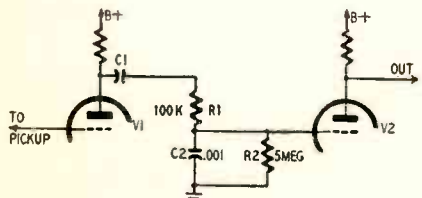

Fig. 4—Preamplifier with equalizer.

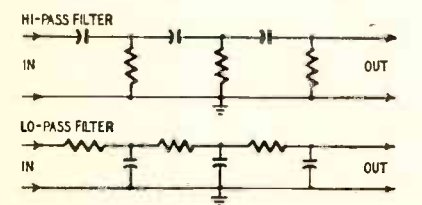

Fig. 5—Equalizers can be cascaded.

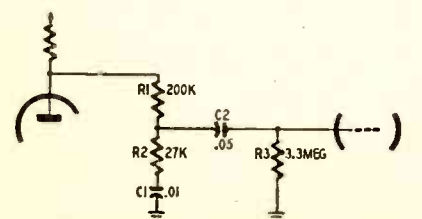

Fig. 6—A simple bass-boost circuit.

MAGNETIC-TYPE pickups are used in most high-quality audio systems today. To understand the equalizing circuits that must be used with them, we must treat groove-width *vs* output a little differently from the way we think when crystal or other constant-amplitude pickups are used.

Last month we showed how records are made when, as is always the case commercially, magnetic cutters are used to engrave the groove. Let us briefly refresh our memories with the aid of Fig. 1, a chart showing groove width against frequency for constant-voltage input to the recording cutter.

Pattern 1 shows what happens when an unequalized magnetic cutter is used. The groove becomes wider as frequency decreases and narrower as frequency increases. This is exactly offset by the ideal unequalized magnetic pickup, which produces more output for a given stylus movement as frequency rises and less output as frequency decreases. Since the two devices—cutter and pickup—are complementary, let us lump them together and consider only the transfer characteristic between the input of the cutter and the output of the pickup. If we do that, we find that the pickup output is exactly proportional to the voltage input to the cutter, regardless of frequency. Let us, furthermore, become parties to the convention common in the record industry that says, "The frequency characteristic of a record is always shown as if it were to be played back with an ideal unequalized magnetic pickup." Thus, regardless of the actual fact that with constant input to the cutter the groove width decreases with rising frequency, we show the frequency characteristic or curve of a record as simply the voltage input to the cutter (usually translated to decibels) against frequency.

If we make a record without equalization, then curve A of Fig. 2 will show the frequency characteristic. The flat line means that between 50 and 10,000 cycles the record follows the constant-velocity magnetic characteristic.

Now look at Fig. 1 again. With the constant-velocity cut of pattern 1, the low-frequency grooves are so large that the spiral would have to be very widely spaced. Not only would we get very little playing time, but the cutter would have to be built so that the cutting stylus could describe very wide swings, a great mechanical difficulty. So we

insert an equalizer in the recording system which attenuates frequencies below a certain frequency (let us assume it is 500 cycles) at the rate of 6 db per octave. This means that by the time the audio signal reaches the cutter terminals, the voltage is directly proportional to frequency below 500 cycles.

With the magnetic cutter, the cutter itself makes a groove whose width is *inversely* proportional to frequency. With our equalizer in the circuit, the equalizer and the cutter's own characteristic exactly offset each other. The result is that the groove width remains constant below 500 cycles, as shown in pattern 2 of Fig. 1. With the groove width restricted, we can wind a much closer spiral.

But in adding this equalizer during recording we have made a change in the record frequency curve. Instead of curve A (Fig. 2) being flat throughout its low-frequency end, we have curve B, which shows attenuation of the low frequencies at the 6-db-per-octave rate. This means that an unequalized ideal magnetic pickup will play back the record with a gradual loss of bass. If we want the pickup to reproduce sound as it originally was before being changed by the recording equalizer, we must add an equalizer of exactly opposite or complementary effect to the playback system. The playback equalizer must have the low-frequency characteristic shown by curve C. It must give the playback system an output which rises with falling frequency below 500 cycles. It is exactly opposite in effect to the recording equalizer and cancels it out, producing once again the flat characteristic of curve A.

Referring again to Fig. 1, we see that in pattern 2 the high frequencies are still very small in groove width; so small, in fact, that the audio variations compare in size to the random variations caused by disc surface irregularities and dust particles which create noise. To make the audio far greater than the noise, we insert a second "equalizer" in the recording equipment to boost the treble. The treble recording equalizer may have the characteristic of curve D in Fig. 2. But again, we have created a deviation from the ideal constant-velocity characteristic.

So, to offset the treble recording emphasis we must have a treble equalizer in the playback system. Again, it must have an effect exactly opposite to that of the recording equalizer. Its effect is shown by curve E. Since curves D and E are exactly complementary, they can-

*Audio Consultant, New York



Fig. 7—Pickering 230 H preamplifier.

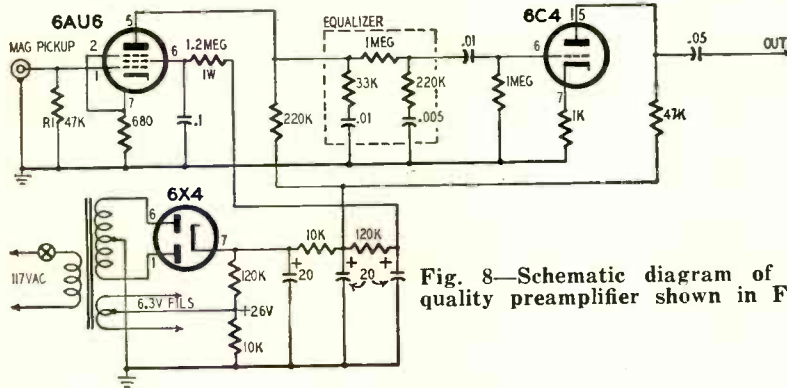

Fig. 8—Schematic diagram of high-quality preamplifier shown in Fig. 7.

cel, and once again we have the flat sound transfer between microphone and loudspeaker of curve A.

Suppose we sum up. We could have had a perfect frequency characteristic by omitting all equalizers and using ideal magnetic cutter and pickup. Instead, we have inserted a bass equalizer to give more playing time and a treble equalizer to reduce noise, together with complementary equalizers in the playback system. As a result, we again have a flat frequency characteristic but with longer playing time and quiet records. The whole scheme smacks just a little of Rube Goldberg, but since equalizers are inexpensive and easy to make, it is highly practical.

Equalizer circuits

Unfortunately, the different record manufacturers have failed to standardize on the amount of equalization included in their records. Some start the bass equalization at about 200 cycles, others at 500 cycles or more. Some use a straight 6-db-per-octave bass cut, others modify it. There is a similar lack of standardization in the treble equalization. To add to the confusion some record makers have changed their equalization standards from time to time, so that an old record may have been equalized differently than a late release from the same company. Because of this lack of standards, the home reproducing system must provide a flexible system of playback equalizers to match the various equalizing characteristics used by record manufacturers.

Equalizers used for home phonograph reproduction are simple; they are com-

posed of resistors and capacitors. In addition, the general scheme of designing them is easy to remember.

Fig. 3 shows the two basic equalizer circuits. In each case generator G represents the pickup or tube supplying the audio signal. In circuit A, the output attenuates high frequencies and passes low frequencies; in circuit B the lows are attenuated while the highs pass. The theory is simple: In circuit A the resistor and capacitor constitute a voltage divider. While the resistor opposes all frequencies equally, the capacitor presents a greater impedance at low frequencies than at high. Therefore, if

voltage divider has R1 as the upper or series leg, with the combination of R2 and C1 as the shunt leg. At high frequencies the reactance of C1 is insignificant. But beginning at around 500 cycles, the reactance of C1 becomes large enough to be important (27,000 ohms at just below 600 cycles) and it begins to make the shunt leg larger as frequency decreases. This equalizer never does reach the rate of 6 db per octave, but it comes close enough for general use.

The playback equalizer characteristic must exactly complement the equalizers used in making the record. Only by using the right equalizers for both bass and treble can the loudspeaker produce sound with the same tonal balance as existed at the original microphones.

Commercial units

Magnetic pickups require some preamplification to bring the output up to the 0.5- to 2-volt level of a tuner so that it can be switched to the input of the main power amplifier. Most preamplifiers include bass equalization adjusted to a crossover frequency somewhere between 500 and 1,000 cycles.

An example of the better standard preamplifiers is the Pickering type 230H shown in Fig. 7 and diagrammed in Fig. 8. This preamplifier has enough gain to give normal records an average output of from 1 to 2 volts with the Pickering pickup. R1 is chosen to terminate the Pickering pickup but can be changed to suit manufacturers' recommendations for other pickups. The bass equalizer is shown within a dashed box. Two sections similar to that of Fig. 6 are used to get excellent equalization, down to a satisfactorily low frequency.

It is important to determine before buying a preamplifier (or an amplifier with built-in preamplifier) that its bass equalization gives the full 6-db-per-octave rise, for some do not.

Few preamplifiers contain any but bass equalization so the treble equalizer must be provided for elsewhere, unless, as in the case of some pickups, a satisfactory treble rolloff can be provided by terminating the pickup in a certain resistance. A unit such as the Pickering type 132E record compensator is suitable for this purpose. The pickup cable is plugged into a jack on the side of the compensator (see Fig. 9) and a cable from the compensator goes to the preamplifier. Six switch positions provide for six different treble characteristics to match various records.

Records cannot be equalized successfully with the tone controls found on some amplifiers. These tone controls (which many people, including the writer, believe ought not to exist) are—theoretically—to compensate for room characteristics, but are actually for people who like to fiddle with controls. Ordinary living rooms are sufficiently dead acoustically not to add anything undesirable to the sound coming from a good speaker system. On the other hand, the controls cause an uncomfortable feeling because the listener never can

output is taken across the capacitor, the output voltage will increase as the frequency decreases. In circuit B the exact opposite is true.

Either equalizer can be estimated with very little calculation. For circuit A, output decreases at the rate of 6 db per octave above the frequency at which resistance and capacitive reactance are equal. For circuit B, output decreases at the rate of 6 db per octave below the frequency at which R and X_c are equal. In both cases, at the frequency of equal impedances (usually called the turnover or crossover frequency) the attenuation is 3 db, while the rate of attenuation does not reach the full 6 db per octave immediately, being rather a gradual increase of attenuation. The sharp changes of line in Fig. 2 are ideal curves only; actual characteristics of records are really curves.

Circuit A is useful for playback equalization of the treble. To produce the characteristic of curve E, for example, in Fig. 2, the circuit of Fig. 4 could be used. The diagram shows a two-stage preamplifier with equalizer R1-C2 between stages. The reactance of C2 equals the resistance of R1 at 1,500 cycles. From that frequency upward the voltage to the grid of V2 decreases at about 6 db per octave. C1 is a large-value blocking capacitor, while R2 is a grid resistor high enough to avoid affecting the impedance of C2.

These equalizers can be cascaded, as shown in Fig. 5, when greater attenuation is required, but that is rarely necessary in record playback systems.

Fig. 6 shows a simple bass-boost circuit used in a G-E preamplifier. The



Fig. 9—Left, the Pickering type 132E record compensator.



Fig. 10—Right, the Brociner preamplifier-equalizer.

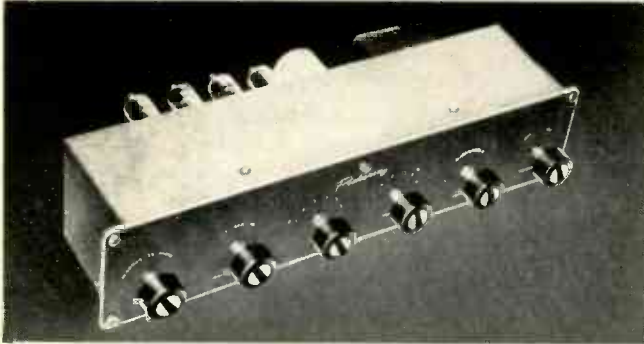

Fig. 11—Left, the Pickering type 410 audio input system. Fig. 12—Right, Childs model 352 preamplifier-control.

decide whether he has the right setting, which, in fact does not exist. The only legitimate function of a tone control might be to add some bass at low volume settings; but again it is impossible to do the job right with continuously variable controls.

Several manufacturers offer preamplifier-equalizers which include a variety of bass and treble equalizer combinations for obtaining correct compensation for all kinds of records. Such a system is the Brociner unit pictured in Fig. 10. The Pickering type 410 audio input system shown in Fig. 11 is more complete in that it also includes switching for various inputs—record, tuner, etc.—as well as three variable record equalizers and a volume and power control.

The Childs preamplifier-control unit (Fig. 12) is an especially interesting device of this type. It has high- and low-frequency equalizers giving 20 different calibrated equalization curves to match any of the various recording characteristics now in use (AES, Columbia, London frr, etc.), a four-position input selector, and a power switch and pilot for the main amplifier.

The Childs unit is shown in the circuit diagram of Fig. 13. Both high- and low-frequency equalization is controlled by negative feedback loops with frequency-selective transfer characteristics. The feedback loop is between the plate of the second stage and the cathode of the first. Bass boost is brought about by passing the feedback signal through a 1.8-megohm resistor in parallel with one of five selectable capacitors. The combination is in series with a 51,000-ohm resistor. The capacitor and the 1.8-megohm resistor have equal impedance at a frequency just below the

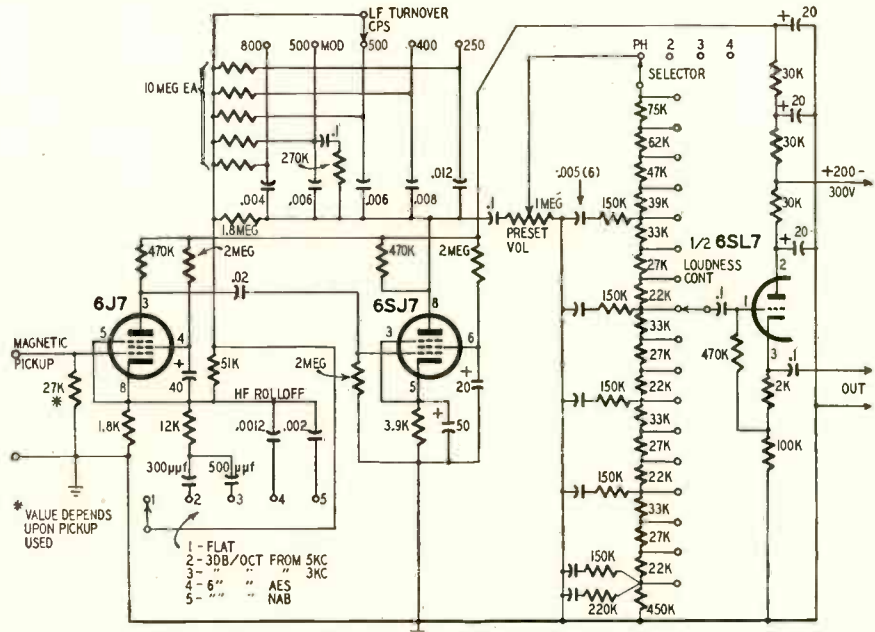

Fig. 13—Childs control-preamplifier model 352; all controls are indicated.

desired audio range; therefore the capacitance, whose reactance becomes smaller as frequency rises, causes more feedback signal transfer with rising frequency until the turnover frequency, at which it is equal to the resistance of the 51,000-ohm resistor, and at which time response flattens off. Since the feedback loop is negative, the preamplifier as a whole gives a complementary curve, which is precisely the desired 6-db-per-octave bass rise with selectable turnovers.

The 51,000-ohm resistor is paralleled by one of four capacitors selected by the high-frequency rolloff switch, giving a rising characteristic above a selected

turnover frequency. This becomes a rolloff, again with precisely calibrated characteristics. In addition to precise equalization, the negative feedback, even at frequencies where it is lowest, is sufficient to give the usual feedback advantages of improved linearity and signal-to-noise ratio. The loudness control is a 17-point switch with R-C networks to add the bass compensation required by the ear at low volumes.

Having discussed the primary source of sound in high-quality systems—records and pickups—we shall inquire next month into the other main source, the radio tuner.

(TO BE CONTINUED)

SERVICING



FIDELITY AUDIO EQUIPMENT

Part II—Particular attention must be paid to balance, feedback and hum

By JOSEPH MARSHALL

IN THE servicing of high-fidelity equipment, circuits are tested to an extent almost unthinkable in conventional audio amplifiers. Typical of this testing is that for unbalance in push-pull stages. The low distortion in high-fidelity amplifiers is in considerable part due to the use of distortion-canceling properties of push-pull driver and output stages of amplifiers. The distortion cancellation depends on maintaining balance. The circuit of a typical high-quality audio amplifier is shown in Fig. 1.

Output stages should be balanced to 1 or 2%. R-C-coupled voltage amplifier, driver, and phase-inverting stages, should be balanced to at least 5%. To check the d.c. balance, connect a high-resistance d.c. voltmeter from plate to plate of the push-pull stage. A completely balanced stage will show zero voltage. Many high-fidelity amplifiers have provision for balancing the output stage with an adjustable resistor in the cathode circuit. Adjust this resistor until the plate to plate voltage is as close to zero as possible.

If the unbalance is considerable, or if balance can be obtained only by a marked difference in bias voltages, both the tubes and the circuit components should be checked. The plate loads and d.c. resistances on the two sides must be as nearly identical as possible. Good output transformers provide loads equal to 1 or 2%.

Plate-load resistors in voltage amplifying stages and phase inverters (R_k), should also be matched to 1 or 2% but seldom are, except in the highest-quality amplifiers. However, if measurement shows that the difference is much greater than 5%, one resistor should be replaced. Choose one whose resistance is equal within 1 or 2% to that load resistor which comes closest to the specified value. Be careful, when wiring, not to overheat the resistor; this may very easily change its value permanently.

If the two sides of the stage use different cathode resistors (R_k), check these for balance also and replace if

one is more than 5% higher or lower than the other. Except in the case of output-power stages, grid resistors R_g are not critical. However, they should match at least to 10%; and in output stages which may draw grid current, it is important to preserve balance in the grid resistors.

An open coupling capacitor C. can produce serious unbalance, and can be spotted with the headphones. If the phones show a much stronger signal on one grid than the other, check and replace the capacitor.

If the reactance of one capacitor is considerably higher than that of the other, there will be unbalance at low frequencies and harmonic distortion may not be completely canceled out. The harmonic distortion of bass tones is not in itself as noticeable or annoying as distortion at higher frequencies. However, it leads to increased intermodulation distortion. The situation is aggravated because in most high-fidelity installations there is considerable boosting of the low frequencies in the preamplifier or control unit; therefore, succeeding stages are driven harder and produce more distortion not only within the low-frequency range but also in the mid- and high-frequency ranges.

To check capacitors for balance or to match them, feed a 60- to 100-cycle tone into the amplifier. If no audio generator is available, use the 6-volt filament circuit. Connect a meter capable of reading such a low frequency between one of the grids and ground. Adjust the input volume control to obtain a reading of 1 or 2 volts. Transfer the meter to the opposite grid without changing the volume level. The meter should give nearly identical readings at both grids. (We are assuming that the previous stage is delivering equal signals to both sides. This can be checked by measuring the voltage on the plate side of the capacitor. We also assume that the grid resistors are fairly closely matched.)

If there is more than one push-pull

stage, measurements should start from the first one, to check balance all along the line.

When a push-pull stage uses a common cathode resistor, the resistor should be by-passed by a high capacitance, otherwise the odd harmonics will feed back in phase to increase by addition or even multiplication. Always check this bypass capacitor. If its d.c. resistance is too low, it should be replaced because the low resistance in parallel with that of the cathode resistor will reduce the bias voltage. This can be checked by measuring bias voltage with the capacitor connected and disconnected.

Positive feedback, parasitic oscillation, or improper operation of feedback network:

High fidelity amplifiers invariably use from 12 to 30 decibels of inverse feedback through one or more loops. Serious distortion may result if the feedback loop operates improperly. Under certain circumstances the feedback can turn positive and result in parasitic oscillation. This oscillation may occur at supersonic frequencies. There are two simple checks for such inaudible oscillations. Turn on a broadcast-band radio and tune it slowly. If the amplifier is oscillating at frequencies above 20kc, harmonics will beat with the stations in the radio receiver. If the beat disappears when the amplifier is turned off, the amplifier is generating parasitics. Another way is to break the B plus lead to the output transformer and insert a milliammeter. Momentarily disconnect the feedback loop; if the plate current drops, you can be sure that parasitic oscillation is taking place.

Commercial amplifiers are designed to prevent parasitic oscillation. If it occurs after a period of use, a component failure or deterioration can be safely assumed. First, change the tubes. Tetrodes used as triodes usually have 100 to 1000-ohm series resistors in the grid and plate circuits; check to see if these are O.K. Check the value of the series-feedback resistor R_b and the

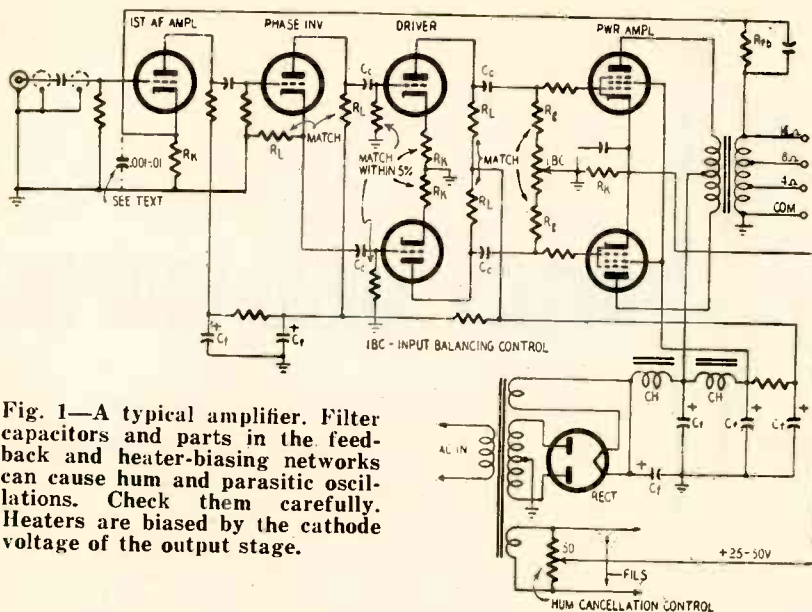

Fig. 1—A typical amplifier. Filter capacitors and parts in the feedback and heater-biasing networks can cause hum and parasitic oscillations. Check them carefully. Heaters are biased by the cathode voltage of the output stage.

resistor across which the feedback is applied. (Usually a cathode resistor in an early stage.) If the series resistor is lower than specified, or the other resistor is higher, the feedback has been increased over that of the original design. Replace one or both. If replacing tubes and feedback resistors does not cure the parasitic oscillation, it may be necessary to reduce the feedback by replacing the series feedback resistor with one of higher value. Increase the resistor value only if absolutely necessary and then only as much as necessary to kill the parasitics; further increase may not produce enough cancellation of distortion for optimum performance. Another expedient is to bypass the cathode resistor to which feedback is applied with a capacitor of around .01 to .001 μf ; the smaller the better. This has the effect of reducing the feedback at frequencies above 20,000 cycles without affecting the feedback at lower frequencies. It should be used only when new tubes and restoring the circuit to design values will not get rid of the parasitics.

Critical amplifiers may be triggered into oscillation. This usually occurs at very low frequencies and is at least as much the fault of poor decoupling in the B plus supply loop as of the feedback loop. If this form of instability occurs, the decoupling capacitors should be checked and replaced with larger capacitances if necessary. (Or a V-R tube can be inserted in the input stage or stages. See RADIO-ELECTRONICS March, 1953.)

Distortion can also be produced in the tuners or phono-pickups. Tuner distortion in AM receivers is usually due to the diode detector circuit. If the diode load is shunted with too low a resistance, distortion on peaks may be very serious. In FM receivers, distortion is usually the result of poor alignment or too narrow a bandpass in the i.f. stages. The narrow bandwidth can be caused by regeneration.

A worn needle can produce very

serious distortion from phonograph records. Sapphire needles are by no means as permanent as once advertised. Only a few hundred sides will produce sufficient wear to seriously increase distortion. In some instances, misalignment of the needle or cart-ridge, misadjustment of the tracking angle, or dirt between the needle and coils or poles may cause serious distortion. Clean the needle and gap with a fairly stiff brush.

Hum

Commercial high-fidelity equipment is designed to have a very low hum level and *any sudden increase* in hum should be due to one or more of following: (1) failure of power-supply filtering (chokes CH and capacitors C_f); (2) failure of cathode by-pass capacitors; (3) tube heater to cathode leakage; (4) failure of feedback loop; (5) serious imbalance of output stage; (6) failure or imbalance in heater-biasing circuit; (7) failure of shielding, or grounding in preamp tubes; (8) pickup by connecting cables; and (9) excessive bass boosting. The first three causes are the familiar ones common to radios.

Inverse feedback not only reduces distortion but reduces hum; the failure of the feedback loop may therefore result in increased hum.

Power-output tubes, usually fed with less-filtered plate voltage than earlier stages, depend on balance of the push-pull circuit to cancel the hum. Balance the output stage for minimum hum.

In many amplifiers, all or part of the heater chain is biased with a positive voltage of anywhere from 25 to 50 volts d.c. This voltage is applied to the center-tap of the filament winding or to a low value potentiometer which shunts the winding—adjust it for minimum hum.

In some amplifiers, the parallel-connected heaters are biased positive by connecting the center of the heater line to the high side of the output

cathode-biasing resistor. If the heater winding is center-tapped, the bias may be applied to this point. Otherwise, it can be connected to the center of two identical low-value resistors or to the arm of a hum-balancing potentiometer connected across the heater winding as in Fig. 1. Fig. 2 shows how the bias voltage can be obtained from a

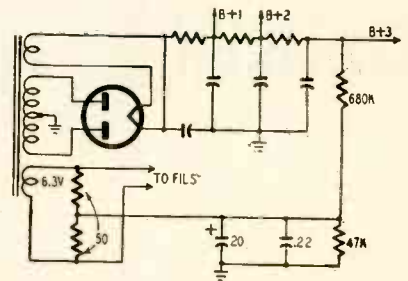

Fig. 2—Heater string is biased by drop across 47,000-ohm resistor in bleeder.

B plus voltage divider.

Examine the shielding and grounding of preamps and control units if these are independent of the main amplifier. Also check their location. If located too close to a phonomotor or to the power transformer on an adjacent chassis, they may be within the magnetic field and picking up hum this way. Check the grounding of the plugs of shielded interconnecting cables. Frequent removal and reinsertion may have loosened contact between plug and jack, or dirt may have increased the resistance of the grounding contacts. Interconnecting cables may be too close to power transformers, phono motors, etc. If the main amplifier, control unit, tuners, etc., have separate power supplies, try reversing the a.c. plugs. Hum is easily traced by removing the tubes in the string one by one, starting with the preamp and working toward the speakers.

It should be possible with good equipment to limit the hum to a level so low that it is audible only very close to the woofer under no-signal conditions and with bass controls flat.

Adjustment of hi-fi equipment

When a repair is made correcting the immediate defect, always adjust the equipment for peak operation. This is not difficult even without instruments. Follow these steps:

1. Check all tubes.
2. Check operating voltages and replace filter capacitors if they show deterioration.
3. Check the balance of the output stage.
4. If the unit has a hum-canceling control (see Fig. 1), adjust it for minimum hum.
5. Check the interconnecting cables for good contacts, especially for low-resistance grounds.
6. Check the various tuners, record players, etc. Tuners may need realignment. Phono needles may need replacement. Record changers may need new drive wheels or adjustment for proper cycling.

(TO BE CONTINUED)

ULTRA HIGH GAIN

STARVED-CURRENT AMPLIFIER

By PAUL S. LEDERER

Appearance is conventional. Differences are in resistor values.

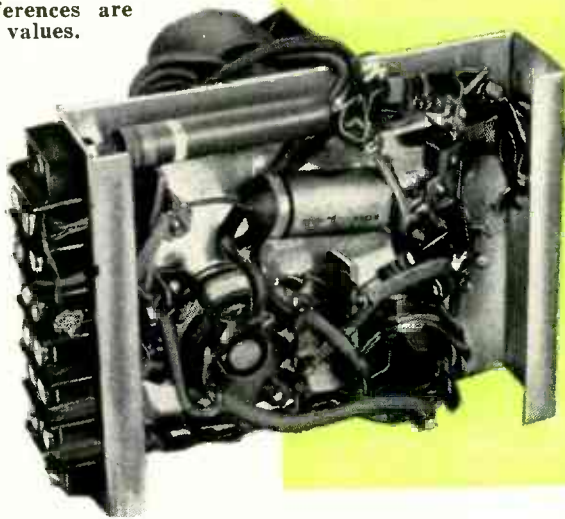

The amplifier looks exactly like the more standard models.

FOR conventional circuits, a gain of about 250 for a resistance-coupled pentode stage is usually the maximum obtainable. Transformer coupling will give more gain, but at the cost of increasing price, volume and weight.

But there is a way of achieving extremely high gain with only a few inexpensive, conventional components.

The method was described in a paper entitled "Ultra-High-Gain Direct-Coupled Amplifier Circuits" by Dr. Walter K. Volkers, and read before the 1950 IRE National Convention in New York. He stated that by lowering the screen voltage of pentodes below 10% of their plate supply voltage, and by increasing the resistance of their plate load 10 or more times beyond conventional values, the amplification factor of tubes so "starved" is greatly increased in spite of a decrease in mutual transconductance.

Following this principle, I built a two-tube amplifier using only five resistors, two capacitors, and an output transformer.

This amplifier delivers 0.1 watt output with an input of 2 millivolts, a power gain of about 92 db.

The circuit uses a 6AU6 "starved" pentode with a gain of about 750, direct coupled to a 6V6 power amplifier. Direct coupling is important, for only by

working into the practically infinite input resistance of a negatively biased stage can the extremely high gain of the first stage be retained. The plate supply delivers 26 ma at 200 volts.

As we have all found out, one cannot

get something for nothing. To get high gain, frequency response must be sacrificed. This circuit is therefore *not* recommended as a preamplifier for variable-reluctance pickups or other high-fidelity uses. However, there are many occasions where a 3-db response from about 180 to 2,500 c.p.s. is sufficient and even desirable. Possible uses: a very sensitive and compact signal tracer; a sensitive null detector for audio frequency impedance bridges; a lower-power modulator for communications equipment, or a general-purpose crystal mike amplifier. Used as a mike amplifier with an inexpensive crystal microphone, I obtained a very clear output at so-called "room level" when I *whispered* at the mike from a distance of about five feet.

To get more output, a higher plate-supply voltage is necessary. This will require some experiment to determine the proper values of load and cathode volume resistance for the 6V6. A 0.1-megohm volume control may be substituted for the 0.1-megohm grid resistor of the first stage.

When first constructed, the amplifier had a large amount of hum. This was almost entirely eliminated by connecting the center-tap of the filament transformer to the screen of the 6AU6, thus biasing the filament at about plus 3 volts with respect to ground. **END**

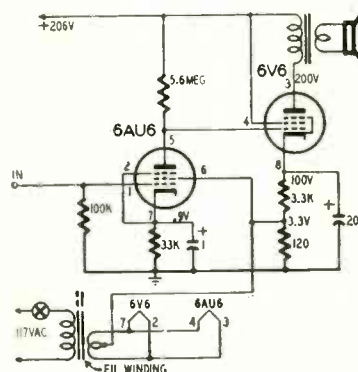

Circuit of starved-current amplifier.

Parts for high-gain amplifier.

- Resistors:** 1—33,000, 1—100,000 ohms, 1—5.6 meg-ohms, 1/2 watt; 1—120 ohms, 1 watt; 1—3,300 ohms, 5 watts.
- Capacitors:** 1—1 μ f, 100 volts, paper; 1—20 μ f, 150 volts, electrolytic.
- Tubes:** 1—6AU6, 1—6V6.
- Miscellaneous:** 1—3 x 4 x 1-inch chassis; 2—tube sockets; 1—output transformer (10,000-ohm primary); 1—filament transformer; 1—6-terminal barrier strip; assorted hardware, etc.



2 REMOTE TV CONTROL UNITS

With viewer comfort in mind, these units permit tuning, volume, and contrast control from a remote point

By **ROBERT F. SCOTT**
TECHNICAL EDITOR



REMOTE controls for TV sets seem to come and go in cycles of two to three years. A number of 1951 TV sets were designed with remote viewers. Several others were available with electromechanical accessories which could be added to turn the set on and off, select channels, and adjust volume and contrast from a remote point. (See "Remote Controls for TV Promote Viewer Comfort" in the November, 1951, issue.) Now, after nearly two years during which there was no noticeable activity in this field, remote controls for TV sets are booming again. A number of manufacturers are includ-

ing at least one remote-control TV receiver in their 1954 lines. Design features of these will be covered in an early issue. Gonset and Regency have recently introduced remote-control TV tuners which can be used in modernizing sets which do not include this feature.

The Gonset and Regency remote-control tuners permit full control over tuning, volume, and contrast from a remote point. The Standard Coil cascade tuner, used in both units, often provides enough gain to eliminate the booster required with some sets in fringe areas. The removable channel

strips permit u.h.f. strips to be installed, making a converter unnecessary in areas where the total number of v.h.f. and u.h.f. stations does not exceed 12. The remote-control units have built-in transformer type power supplies and are available for sets with 21- or 40-mc i.f. amplifier systems. Power to the TV receiver is controlled through a receptacle across the power primary of the remote-control unit.

The Gonset unit is designed to replace the tuner in the receiver. Its installation is simple; it can be connected to most sets without removing the chassis from the cabinet. Added features are a headphone jack and a switch for muting the speaker. When the unit is attached to the TV set, the original tuner is deactivated, so all tuning operations must be made at the remote unit.

The Gonset remote control

The circuit of the Gonset remote-control unit is shown in Fig. 1. The antenna is connected to the control unit. The signal is amplified and heterodyned to the intermediate frequency in conventional manner. The 21- or 40-mc i.f. output of the 6J6 mixer is capacitance-coupled to the grid of a 6AB4 cathode follower. A 5,000-ohm potentiometer controls the signal fed into the grid, thus controlling the contrast. The output of the cathode follower is fed to the receiver through a shielded cable. This cable terminates in an i.f. coupling transformer. The secondary leads of the transformer are fitted with pins which fit into pin jacks of a miniature button-base tube socket.

When installing the unit, all tubes are removed from the original tuner and the transformer secondary leads are plugged into the plate and cathode pin jacks on the mixer-tube socket. In a few tuners, the mixer cathode is hot (above ground for r.f.), and better results can be had by connecting the yellow transformer lead directly to ground. If one side of the heater line

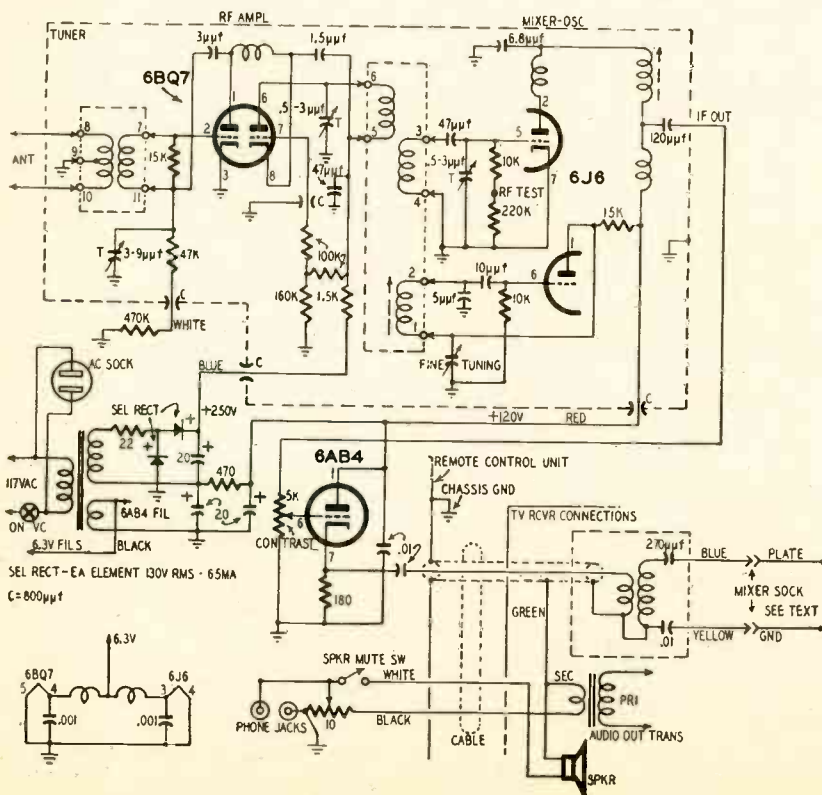
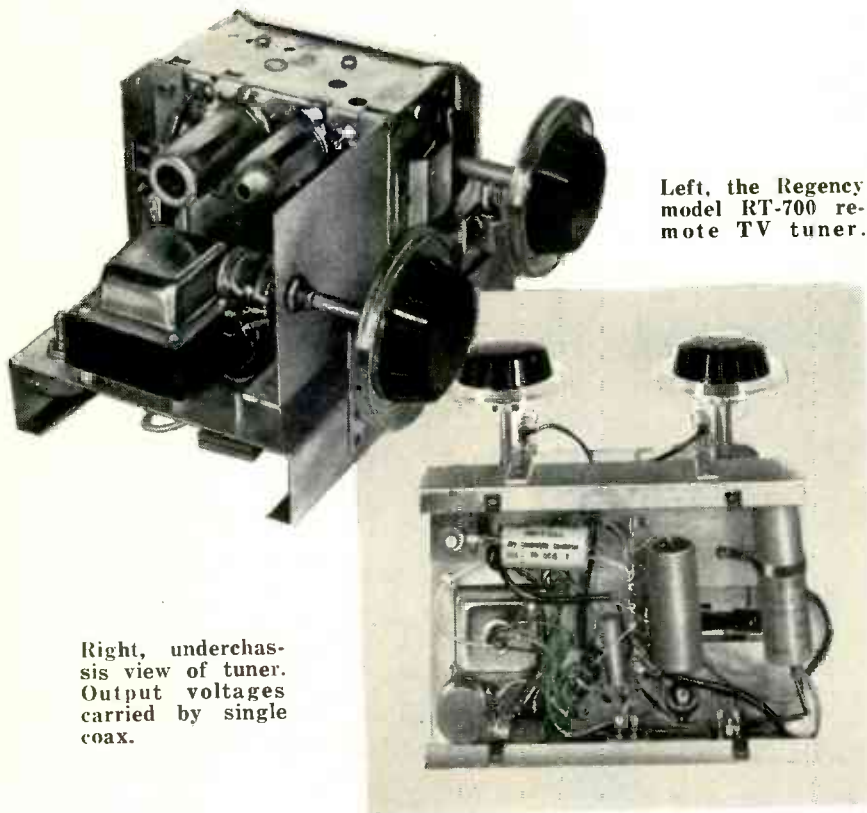

Fig. 1—Schematic diagram of the Gonset remote-control model 3050 (21 mc i.f.).



Left, the Regency model RT-700 remote TV tuner.

Right, underchassis view of tuner. Output voltages carried by single coax.

is grounded, the yellow transformer lead can be plugged directly into the grounded heater terminal on the mixer socket.

Both leads of the i.f. coupling transformer have series-blocking capacitors which eliminate the possibility of short-circuits when connecting to some types of tuners.

Volume is controlled at the remote point by a 10-ohm potentiometer that is connected in series with the speaker voice coil through the speaker muting

switch and a 2-wire line enclosed in a cable with the shielded lead carrying the i.f. signal. Headphones can be plugged into tip jacks across the remote volume control, and the speaker may be silenced by opening the muting switch. The switch can be used also to open the speaker circuit during commercials or when answering the telephone. High-impedance magnetic phones provide sufficient volume for persons with normal hearing. Low-impedance phones of about 600 ohms are recom-

mended for hard-of-hearing persons.

In some instances, a strong signal may overload the tuner and make it impossible to reduce contrast sufficiently to obtain a normal picture. In such cases, the manufacturer recommends that a 1,200-ohm, $\frac{1}{4}$ - or $\frac{1}{8}$ -watt resistor be soldered across the two outside terminals on the r.f. strip for the channel that overloads.

The Regency RT-700

The Regency model RT-700 remote TV tuner in Fig. 2 illustrates entirely different solutions to the problem of controlling volume and contrast from a remote point. The i.f. signal, contrast, and volume control voltages are all carried by a single length of RG-122/U coaxial cable between the tuner and receiver chassis. The coaxial line terminates in a potted matching unit (M6 on the diagram) and coupling and decoupling networks to the audio and a.g.c. circuits.

The potted terminating unit is mounted on the chassis close to the first i.f. amplifier socket. The i.f. grid lead connects to the grid pin of the first i.f. amplifier and the i.f. grid return goes to the ground point for the first i.f. stage.

Contrast-control circuits

Contrast is controlled from the remote tuner by supplying a variable d.c. bias voltage to the a.g.c. line in the set where the a.g.c. voltage is obtained by rectification of the video signal. When the set uses keyed or amplified a.g.c., the control bias is applied to the grid of the a.g.c. keyer or amplifier tube.

Two auxiliary controls are provided in the RT-730 for ease of operation of the contrast-control circuit. Approximately 50 to 60 volts of bias is developed across R2, the COARSE BIAS ADJUSTMENT. The polarity of the output voltage developed between the arm and one side of R2 can be reversed by switching the white lead from one end of the control to the other. (The need for reversing bias polarity will be discussed shortly.) The voltage output of the bias supply is applied across the contrast control R1.

The second auxiliary control is the local-distance switch. Operating bias for the 6BQ7 cascode r.f. amplifier in the tuner is developed across the series-connected 150- and 47-ohm resistors in the negative leg of the B plus supply. When the switch is set to LOCAL, full bias is applied to the cascode amplifier to prevent overloading by strong signals. Throwing the switch to LINSTANT reduces the grid bias to the point where the tuner operates with maximum gain and lowest noise.

Fig. 3 shows how the contrast control is connected to receivers with simple rectified a.g.c. The circuit in Fig. 3-a is used when the a.g.c. filter resistor in the receiver is 1 megohm or higher. When the filter resistor is less than 1 megohm, the a.g.c. line must be cut and the 470,000-ohm resistor R18 spliced across the break as in Fig. 3-b.

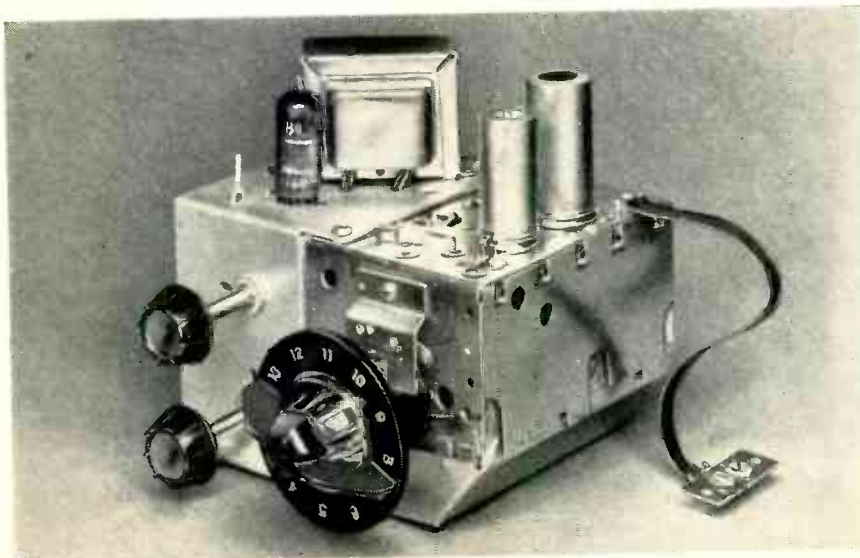

Photo shows the Gonset model 3050 for remote control of TV receivers.

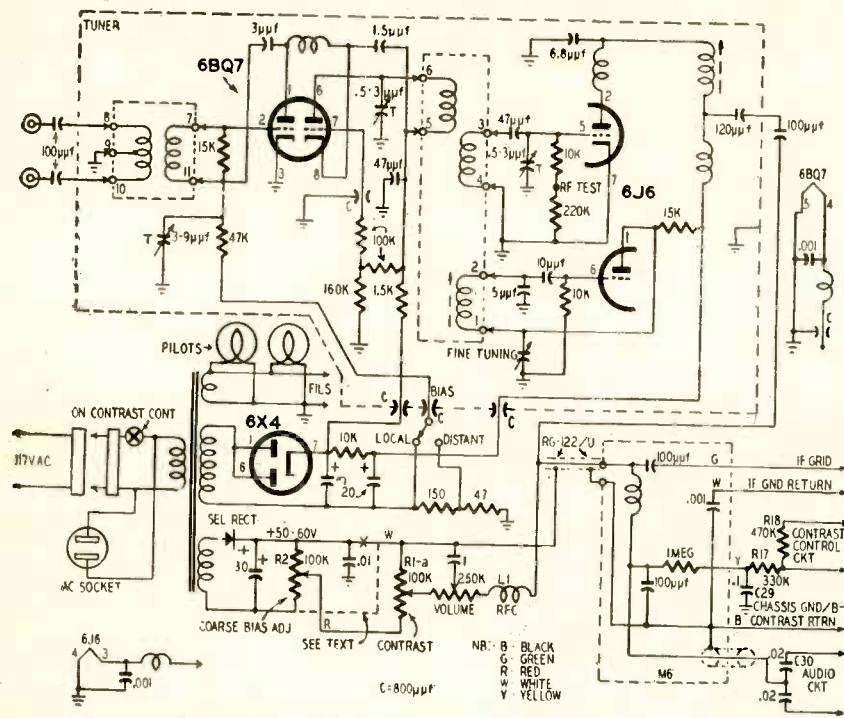

Fig. 2—Schematic diagram of the Regency model RT-700 remote TV tuner.

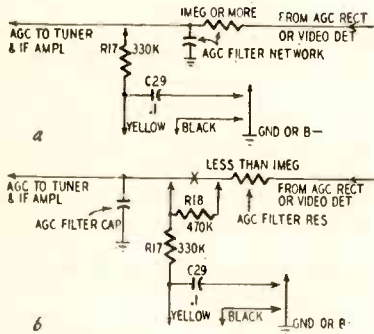

Fig. 3—Contrast control connections.

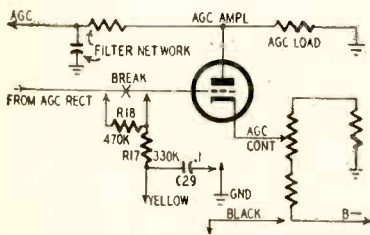

Fig. 4—An amplified a.g.c. circuit.

The bias supply circuit delivers a negative voltage to the contrast control. The voltage at the arm of the control is applied to the a.g.c. line through the inner conductor of the coaxial line. The positive side of the bias supply connects to the receiver chassis through the outer conductor.

Fig. 4 illustrates the contrast-control connections for receivers using amplified a.g.c. In this circuit, the a.g.c. amplifier plate is grounded through the a.g.c. load resistor, and its cathode is supplied

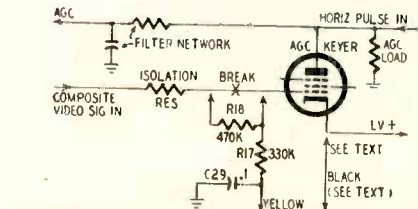

Fig. 5—Diagram of keyed a.g.c. circuit.

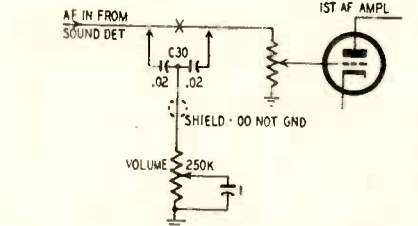

Fig. 6—Regency RT-700 volume control.

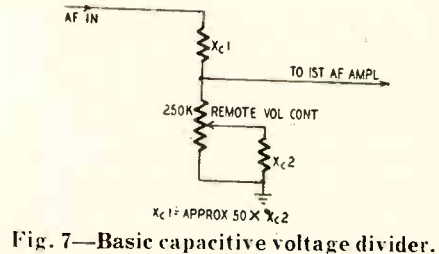

Fig. 7—Basic capacitive voltage divider.

from a point on a B minus voltage divider. The contrast-return line must then be connected to B minus (not ground). This B minus point must be bypassed to ground by 10 µf or more.

In keyed a.g.c. circuits, the contrast-controlling bias voltage is applied to the control grid of the a.g.c. keyer as in Fig. 5. The contrast-return (black) lead is shown connected to the cathode of the a.g.c. keyer. If there is a point in the receiver B plus circuit that is 10 to 20 volts less positive than the a.g.c.

keyer cathode, connect the contrast-return line to it and bypass it to ground with at least 10 µf. If this B plus tap is not adequately bypassed, sync buzz is likely to occur and it may be impossible to exercise full control over the volume at the remote tuner.

Keyed a.g.c. circuits require a positive voltage from the bias supply in the tuner. This is obtained by transferring the white lead to the opposite end of the bias adjustment control.

Remote volume control

The volume control in the RT-700 uses a resistance-capacitance voltage divider circuit as in Fig. 6. The audio lead from the sound detector is broken just ahead of the volume control, and two series-connected .02-µf capacitors (C30 on the diagram) are inserted. The inner conductor of the coaxial cable is connected to the junction of the two capacitors. At the remote-control unit, the shielded conductor is connected to a 250,000-ohm volume control. The arm of the control is grounded through a 1-µf capacitor.

A basic circuit of the capacitor voltage divider is shown in Fig. 7. X_{c1} and X_{c2} are reactances of the left-hand .02-µf capacitor and the 1-µf unit, respectively. Moving the arm of the control varies the resistance in the lower leg of the voltage divider and controls the proportion of the total developed voltage that is applied to the input of the audio amplifier. The r.f. choke L1 (Fig. 2) isolates the i.f. signal from the remote volume control and prevents the i.f. signal level from varying with the setting of the volume control.

Installation and adjustment

To make the initial adjustments on the RT-700, set the local-distance switch to DISTANT, turn the remote contrast control to the minimum position, and set the receiver's contrast control to maximum. Set the remote channel selector to the strongest TV channel in the area and rotate the tuner on the set to another channel. Set the bias adjustment control R2 for a weak picture with good sync stability. If stable sync cannot be obtained, throw the area switch to LOCAL and reset the bias adjustment control and back down on the set's contrast control until the remote contrast control operates properly. When using the remote-control tuner, the receiver's contrast control should be returned to the position used in the initial adjustments.

The volume-control circuit is set up with the remote control set to the maximum position and the receiver's volume control set slightly higher than normal. The remote control then permits the volume level to be varied from the preset maximum to a barely perceptible minimum.

The receiver can be operated with its built-in controls by removing the line plug from the rear of the remote-control tuner and plugging it into an a.c. receptacle and setting the remote volume control to maximum. END

TESTING VIDEO AMPLIFIERS

Obtaining frequency response curves for the video amplifier requires careful selection and use of generator and probe.

By Engineering Department, Scala Radio Co.

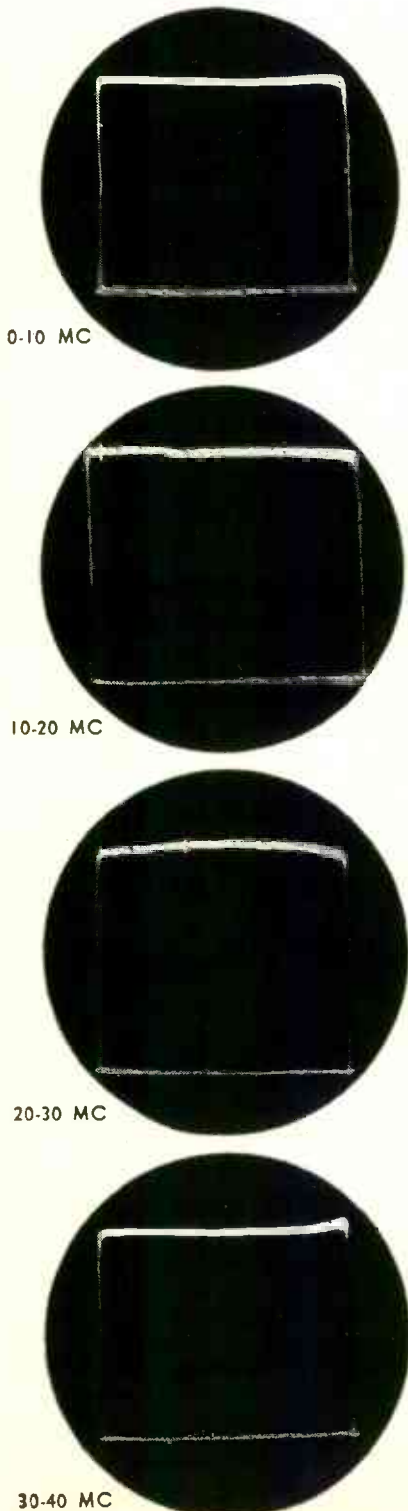

THE most common check of video-amplifier response is through use of a frequency-response curve. This method is undoubtedly best for preliminary checking, as major defects in circuit operation can be seen by a frequency-response curve.

However, the experienced technician finds that the phase characteristic of a video amplifier is even more important than its frequency characteristic. And although the phase characteristic can be approximately determined from an analysis of the frequency-response curve, few technicians have the desire to perform such an analysis. It is more practical to check phase characteristics in a more direct manner, by making a square-wave check of the amplifier. Obviously the equipment used for such tests must have a better response than the video amplifier to be tested. This rules out much of the run-of-the-mill test equipment.

Test setups for video amplifiers must meet rigid requirements concerning input and output impedances. Unless the video amplifier sees a suitable source resistance, and unless the amplifier works into a suitable capacitance, the test results may be misleading.

The output from the video sweep oscillator should be flat, as shown in Fig. 1. Unevenness will produce distortion of the response curve. For example, when the output level varies over the swept band as shown in Fig. 2, the middle portion of the reproduced response curve will appear to be abnormally high. The curvature in Fig. 2 indicates crystal probe resonance, or improper operation of sweep generator. Some crystal probes resonate at the high harmonic frequencies present in the output of some sweep generators. In the course of circuit adjustment, the technician would misadjust the circuit in order to compensate for the unevenness in the instrument output.

The output from the video sweep oscillator should also be free from

strong interfering impulses and harmonics which can develop confusing markers on the response curve. The small markers seen in Figs. 1 and 2 are such markers. As the desired markers are tuned along the curve, the undesired markers may run either forward or backward. In most cases, unwanted markers, if present, are distinguishable from desired markers upon the basis of size because the unwanted markers are usually the result of cross beats, interharmonic beats, or both which do not involve fundamental or beat-fundamental voltages.

Most video sweep generators can be tuned to sweep through zero beat, and to develop a video response curve on either side of zero beat. The output on either side of zero beat should be flat. However, there is some lower frequency, as the beat oscillators approach each other, at which pulling takes place, with the frequency of one oscillator pulling ahead to take the same frequency as the other oscillator, and the frequency of the second oscillator pulling back to take the same frequency as the first oscillator. This pulling action makes the video output meaningless at frequencies below 100 kc, even in instruments having good buffer action between the two beating oscillators. The typical output from a video sweep oscillator when sweeping through zero beat is shown in Fig. 3. (A shows a sweep 5 mc to either side of zero frequency; B shows a sweep through zero frequency, with the sweep width reduced to a few kilocycles; C shows a sweep through zero frequency, with the zero-frequency point moved to the right-hand end of the zero-volt reference line.) Commercial instruments eliminate pulling of the beating oscillator by adequate buffering between the two beat oscillators, and elimination of stray coupling.

The horizontal linearity of a video sweep oscillator can be checked by placing markers upon the swept output. As

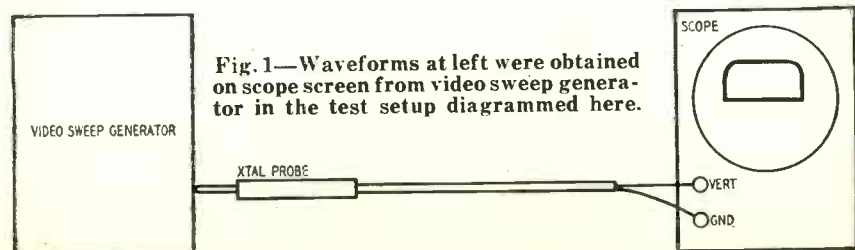

Fig. 1—Waveforms at left were obtained on scope screen from video sweep generator in the test setup diagrammed here.

in i.f. alignment, horizontal nonlinearity does not harm the accuracy of the alignment as long as the technician determines his frequency points along the response curve with markers.

To become familiar with the types of correct video response curves found in present-day TV receivers, the reader should refer to receiver service manuals. The video response curve should be essentially flat, with a slight amount of high video peaking. Such a video response curve, adjusted for a bandwidth of 4 mc, provides maximum picture quality. Some receiver manufacturers believe that a video-response curve should not always be flat, but may be more acceptable if there is a substantial amount of high video peaking. Some receivers provide a *picture control* or similarly named device which varies the amount of damping resistance across a series peaking coil, or varies the amount of bypass capacitance shunted across a video-amplifier cathode resistor. Such devices permit the viewer to vary the video-response curve.

In some receivers, the control for high video peaking is automatic, and operates with the contrast control, as shown in Fig. 4. The compensated contrast-control circuit is located in the output of the video amplifier. It can maintain a constant video-response curve as the picture contrast varies, or it can select any desired amount of high video peaking at low contrast levels. Without such compensating circuits, the high-frequency end of the video-response curve falls off as the signal-output level is reduced. The amount of high video peaking which appears on the response curve is determined by the internal resistance of the video detector. This resistance is nonlinear, as shown in Fig. 5. This is the internal resistance of the diode only, and is not the resistance presented to the driving i.f. circuit. The internal resistance of the detector tube varies from one tube to another. For this reason, changing the video detector tube often serves to greatly improve the quality of the picture.

To obtain video-response curves, a crystal probe at the output of the video amplifier should be used. The probe should have the same input capacitance as the grid of a picture tube, so that the video amplifier is normally loaded.

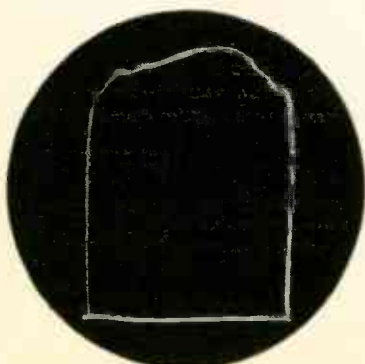
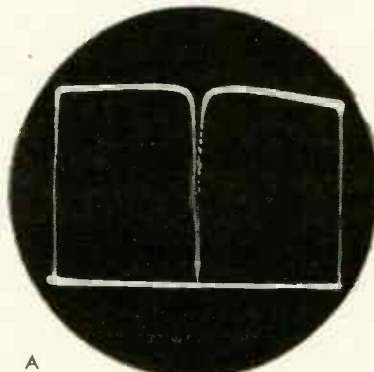

Fig. 2—Photo shows varying output.

Excessively high input capacitance to the probe will cause the high-frequency response of the video amplifier to fall off. On the other hand, excessively low input capacitance may increase the high-frequency response. The probe used must rectify video sweep frequencies from 100 kc to 4.5 mc, and pass the envelope frequencies of the sweep output. The envelope of the sweep output may be considered as a 60-cycle square wave. In other words, the probe must demodulate the carrier component of the modulated wave (sweep output), but must develop the 60-cycle square-wave modulation envelope on the scope screen without appreciable distortion. A typical demodulator probe suitable for this application is shown in Fig. 6.

The crystal diode type used for video-sweep demodulation may be a matter of concern, as a relatively high peak voltages may be encountered during video-amplifier testing. The normal output from a video amplifier is approximately 50 volts peak-to-peak. But when the amplifier is overdriven, as it frequently is, 75 to 100 volts peak-to-peak



A

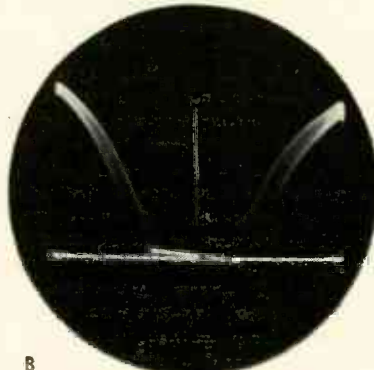

B

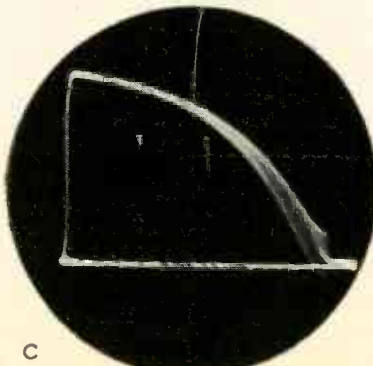

C

Fig. 3—Sweeping through zero beat.

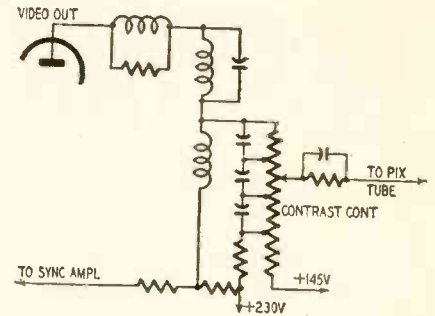

Fig. 4—Compensated contrast control.

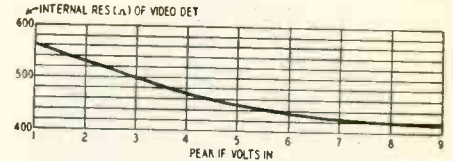

Fig. 5—Video detector resistance.

can be developed. In such a case, crystal diodes of the less rugged type will become damaged. However, there are several types that are quite rugged. See Chart.

The crystal diode in the probe must be able to withstand double the applied peak voltage of the signal. Of course, this is true only of symmetrical waveforms, such as sine waves and square waves. For nonsinusoidal signal voltages, the crystal diode may have to withstand nearly double the peak voltage, more or less.

The manner in which these considerations tie in with commercially available crystal diodes is shown in the chart. The continuous reverse working voltage is not applied to the crystal in normal testing, but the peak back voltage may be taken as the peak-to-peak output voltage from the video amplifier when the crystal diode is used in a standard crystal probe. Most of the types in the chart may be used without extra precaution, although there are a few types that could be damaged by the high temporary transients which are often found when connecting the equipment. Crystal diodes used with video detectors have become damaged by high peak surges caused by sweep leads being dressed too close to the detector leads. Fig. 7 shows that the back current of the crystal diode increases at a rapid rate in the region of maximum back voltage. Detailed test arrangements and procedures on what has been discussed will appear in a future article.

High on the list of important considerations is the subject of square-wave response of video amplifiers. A square-wave check of video-amplifier response is especially useful, because the phase characteristic of the amplifier is given directly, as well as the frequency response. The phase characteristic is important, because nonlinear phase shift (unequal time delay at various frequencies) causes the reproduced square wave to tilt, which may show up in the picture as smear, or as

TYPE	1N34	1N35*	1N38	1N39	1N40**	1N41**	1N42**	1N54	1N55	1N56	1N57	1N58
Description	General Purpose Diode	Matched Duo-Diode	100-Volt Diode	200-Volt Diode	Plug-In Varistor	Lug-Type Varistor	Plug-In 100-Volt Varistor	High Back Resistance Diode	150-Volt Diode	High Conduction Diode	80-Volt Diode	100-Volt Diode
Continuous reverse working voltage (volts max.)	60	50	100	200	25	25	50	35	150	40	80	100
Peak back voltage for zero dynamic resistance (volts min.)	75	75	120	225	75	75	120	75	170	50	90	115
Forward current at +1 volt (ma min.)	5.0	7.5	3.0	3.0	12.75 (@ 1.5 volts)	12.75 (@ 1.5 volts)	12.75 (@ 1.5 volts)	5.0	3.0	15.0	4.0	4.0
Average anode current (ma max.)	40.	22.5	40.	40.	22.5	22.5	22.5	40.	40.	50.	40.	40.
Recurrent peak anode current (ma max.)	150	60	150	150	60	60	60	150	150	200	150	150
Instantaneous surge current (ma max., 1 sec.)	500	100	500	500	100	100	100	500	500	1000	500	500
Reverse current (μa max.)	50 @ -10v 800 @ -50v	10 @ -10v	6 @ -3v 625 @ -100v	200 @ -100 volts 300 @ -800 volts	50 @ -10v	50 @ -10v	6 @ -3v 625 @ -100 volts	10 @ -10v	300 @ -100 volts 800 @ -150 volts	300 @ -30v	500 @ -75v	800 @ -100 volts
Shunt capacitance (μf.)	1 μf. nominal for all types											
Ambient temperature range (°C)	-50° to +70° for all types											
Average life (hours)	More than 10,000 hours for all types											

*Units are matched in the forward direction at +1 volt so that the current flowing through the higher resistance unit is within 10% of that in the lower resistance unit. Ratings shown for each diode.

**Consist of 4 specially selected and matched germanium diodes whose resistances are balanced within ±2.5% in the forward direction at 1.5 volts. For additional balance, the forward resistances of each pair of varistor crystals are matched within 3 ohms. Ratings shown for each diode.

—Courtesy Sylvania Electric

Chart 1—Voltage and current ratings for crystal diodes used in typical oscilloscope probes.

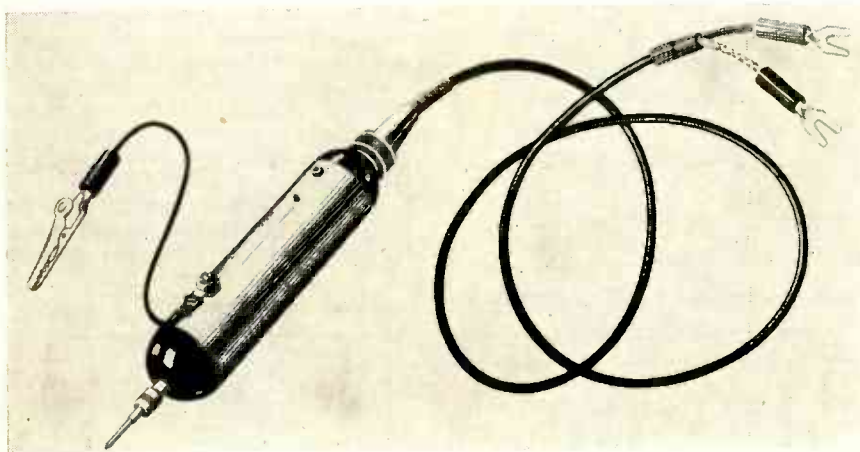

Fig. 6—Photo shows crystal probe.

a false change in picture shading from the top to the bottom of the raster.

The elements of picture (video) signals are essentially square waves of various frequencies. Typical distortions suffered by square waves in passing through defective video-amplifier circuits consist of tilt, curvature, overshoot, and ringing. These distortions, of course, are in addition to attenuation of the amplitude of the square wave due to poor amplifier gain at the test frequency. Tilt occurs when the top of the square wave is not level, but slopes uphill or downhill. Such tilt is the result of phase shift. There is always

some phase shift when a signal passes through an amplifier, but the phase shift should be proportional to frequency. Curvature in the reproduced square wave is caused by frequency distortion or frequency discrimination. Curvature may show up along the entire top of the reproduced square wave, or only at the corners of the wave. All four corners of the wave may be affected, or diagonal corners only may be rounded. When the peaking coils are underdamped, the leading edge of the wave overshoots its final voltage. If underdamping is severe, a ringing follows the initial overshoot. **END**

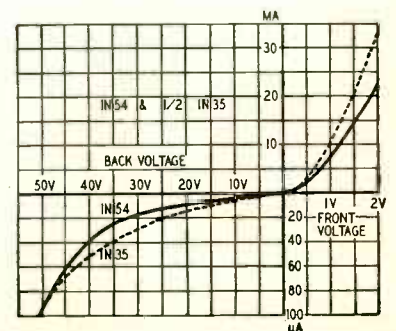
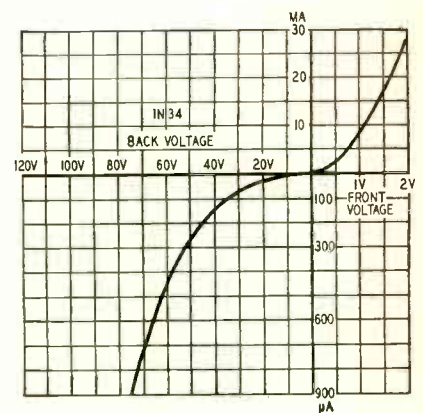
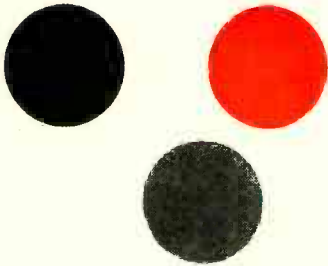

Fig. 7—Voltage-current relationships of three germanium crystal diodes.

BASIC COLOR TV



Part III—Transmitting the color subcarrier; detecting and separating the color difference signal

By D. NEWMAN* and J. J. ROCHE*

IN PART II we discussed the ways bandwidth requirements of the color television signal can be reduced.

It was pointed out that the brightness and color information can be separated and handled as individual signals, making it possible for black-and-white receivers to operate using the brightness (Y) signal. We also covered briefly the problem of transmitting the relatively narrow bandwidth color-difference signals within the 6-mc channel occupied by the brightness signal.

To transmit the color information within the same channel as the brightness signal, several new techniques are used.

The color subcarrier

In the previous article, it was shown that in addition to the brightness (Y)

The blue color-difference signal consists of frequencies between 0 and 600 kc, and the cross-talk will occur primarily at these frequencies. Since these frequency components represent the relatively large areas of the picture, the visible interference will be coarse and objectionable.

This problem can be minimized by shifting the blue color signal to the region around 3.6 mc. Cross-talk between the brightness and color signals will still be present, however, since the interference is taking place at much higher video frequencies, representing extremely small areas of the picture, the interference pattern will be fine in structure and much less noticeable to the viewer.

We see therefore that it is desirable to shift the color signal to the higher

we will discuss the second one.

The color-difference signal is first fed to a low-pass filter which removes all frequency components above approximately 600 kc. The output of this low-pass filter is applied to a circuit called a *balanced modulator*.

At the same time, a locally generated signal, or subcarrier, of approximately 3.6 mc is fed to the input of the balanced modulator. In this stage, the 3.6-mc subcarrier signal is modulated by the color-difference signal.

In the output of the balanced modulator, only the sidebands produced by the color-difference signal appear while the subcarrier is eliminated or suppressed.

The output of the balanced modulator is fed to a mixing amplifier along with the brightness signal as shown in Fig. 1. The output of the mixing amplifier—which consists of both the brightness and color signals combined—is then used to modulate the transmitter.

Fig. 2 shows the frequency relationship of the color-difference signal to the brightness signal in the transmitter output. The narrow-bandwidth (0 to 600-kc) color-difference signal has now been shifted to the region around 3.6 mc. Upper and lower sidebands extending

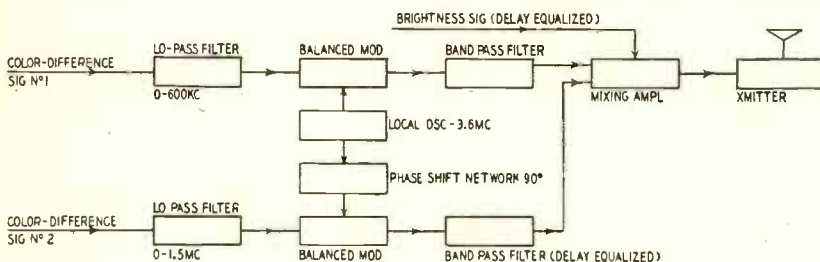

Fig. 1—Block diagram shows layout of transmitter color-handling circuits.

signal, two color-difference signals are needed to produce the color picture. The third color component (green) does not have to be transmitted separately, since it can be obtained at the receiver by adding the two color signals and subtracting their sum from the brightness signal. Due to the characteristics of the average eye, only those video frequencies up to approximately 1.5 mc are needed for the red color-difference signal, and only frequencies up to approximately 0.6 mc are needed for the blue color-difference signal.

Let us assume that we wish to transmit only one of our color-difference signals along with the brightness signal, and that the color signal is the blue one (B-Y).

If we modulate the video r.f. carrier simultaneously with the brightness and blue color-difference signals, there will be cross-talk between the two signals.

video-frequency region of the television channel. Now, let's see how this can be done.

Fig. 1 is a block diagram showing how the frequency of the color signal can be shifted to the desired portion of the channel. For purposes of explanation we will confine ourselves to the 3.6-mc oscillator and will assume that only the narrow-bandwidth color-difference signal (1) is involved. Later

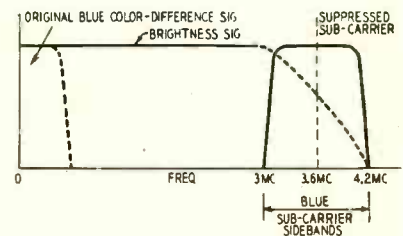

Fig. 2—How color signal is shifted.

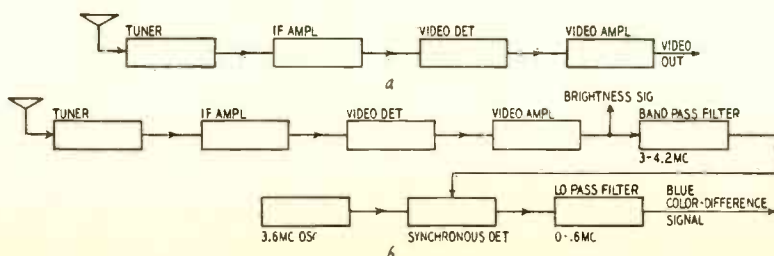

Fig. 3—How circuits are added to separate and detect the color signal.

*Allen B. DuMont Laboratories, Inc.

from 3 to 4.2 mc are present, having been generated in the balanced modulator circuit.

We have now produced and transmitted a combined brightness and color signal within a 6-mc channel. At the receiver, we must separate these signals.

Separating the signals

Fig. 3-a is a block diagram of the video channel of an ordinary black-and-white television receiver. The composite brightness and color signal is fed to the video detector, and its modulation envelope is obtained in the usual manner. The output of the video detector is fed through regular video amplifiers to the cathode-ray tube to produce a black-and-white picture.

Of course, the color signal is still superimposed on the high-frequency portion of the detected video signal, but as we have seen previously, the interference pattern will be very fine and not too objectionable. Later we will see how the visibility of this interference pattern is further reduced.

Fig. 3-b shows a similar receiver with several circuits added to separate and detect the color signal.

The composite video signal (consisting of both color and brightness information) at the output of the video detector, is applied to a bandpass filter which passes only frequencies between 3 and 4.2 mc. Most of the brightness signal is eliminated in this process.

The color (chrominance) signal is then fed to a special type detector, called a synchronous detector. In this circuit, the chrominance signal is combined with a locally generated signal of exactly the same frequency and phase as the originally transmitted unmodulated subcarrier. The sidebands of the chrominance signal combine with the local oscillator signal and produce the original 0-to-600-kc color-difference signal we desire.

Fig. 4 is a simplified diagram of one

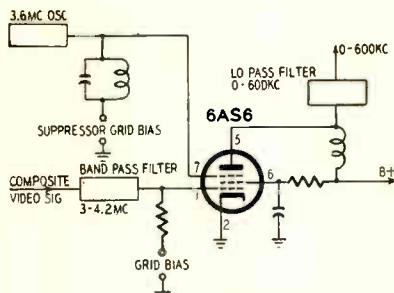

Fig. 4—Typical synchronous detector.

type of synchronous detector. A 3.6-mc local oscillator signal is applied to the suppressor grid. The chrominance signal is applied to the control grid, after being passed through a 3-4.2-mc bandpass filter.

The signal at the plate contains a number of frequency components. Among these are the difference frequencies between the locally generated 3.6-mc signal and the chrominance signal. A low-pass filter (0-600 kc) in the

plate circuit removes the undesired signals and permits only the desired color-difference signal to pass through.

To recover the color-difference signal without distortion, the locally generated 3.6-mc signal which is applied to the synchronous detector must be of exactly the same frequency and phase as the original subcarrier frequency used at the transmitter, as will be explained later.

Two color-difference signals

Up to this point, we have assumed for purposes of explanation that there was only one color-difference signal to be transmitted and received. The signal we used in the explanation was the color-difference signal whose bandwidth extends from 0 to approximately 600 kc (signal 1 in Fig. 1).

Actually we must also transmit another color-difference signal, whose bandwidth extends from 0 to approximately 1.5 mc (as was explained in the previous article). This is signal 2 of Fig. 1.

We have learned that it is possible to insert the narrow-band color-difference signal in the same channel as the brightness signal, and recover each separately at the receiver. The problem now is to insert a third signal (the wide-band color-difference signal) as well.

This is done by using two separate subcarriers at the transmitter instead of one. These subcarriers are identical in frequency but 90° out of phase with one another. The two subcarriers are obtained as shown in the block diagram of Fig. 1.

Subcarrier 1 is obtained from the 3.6-mc local oscillator. Subcarrier 2 is obtained by passing the output of the same oscillator through a 90° phase-shifting network.

Subcarrier 1 is modulated by one of the color-difference signals in a balanced modulator. Subcarrier 2 is modulated by the other color-difference signal in a second balanced modulator. The outputs of the balanced modulators are passed through filters to remove undesired frequency components.

The filter outputs are then combined with the brightness signal in a mixer amplifier and fed to the transmitter. In passing through the low-pass filters, the color-difference signals are delayed, due to the phase shift which takes place in the filters. The narrow-band color-difference signal is delayed more than the wide-band color-difference signal, because of the differences in filter characteristics. To equalize the delays of the three signals (brightness and two color-difference signals), additional delay is provided in the brightness and wide-band-color channels.

Fig. 5 shows the vector relationships of the unmodulated and modulated sub-carrier signals. Fig. 5-a shows the unmodulated sub-carrier signals which are applied to the balanced modulators. Note that these subcarrier signals are 90° out of phase with each other.

The outputs of the balanced modula-

tors are shown in Fig. 5-b. In each case the subcarrier has disappeared, while upper and lower sidebands have been generated for each corresponding color-difference-signal frequency component. (In the process of modulation, sideband pairs are generated for each frequency component in the modulating signal as in an audio signal, for example. For simplicity, only a single pair of sidebands is shown in Fig. 5, for each of the color signals.)

Fig. 5-c shows all of the sideband components which form the chrominance signal when the outputs of the balanced modulators are combined. In the illustration, all the sideband components are shown separately. Actually, since any signal can have only one amplitude and one phase at any instant, these sideband components combine to form a resultant signal.

Fig. 6-a shows this total resultant chrominance signal which is produced when the sideband components in Fig. 5-c combine. Vector addition by "completing the parallelogram and finding

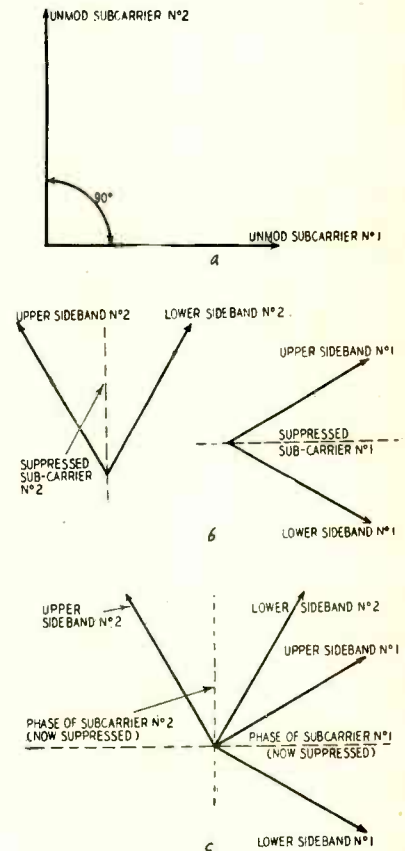

Fig. 5—Subcarrier phase relationships.

the diagonal" is shown, to clarify the process. This is the signal that is actually transmitted. Fig. 6-b shows how this resultant is affected when either of the sideband pairs is altered. Note that the total resultant chrominance signal changes in both amplitude and phase when this occurs. When both sideband pairs are altered, the total chrominance signal again changes in both amplitude and phase as in Fig. 6-c. Thus we see that the total chromi-

nance signal as transmitted is constantly varying in both amplitude and phase in accordance with the modulating signals. However, it is important to remember that all the sideband components are always present in the chrominance signal.

At the receiver, we must separate and recover the two color-difference

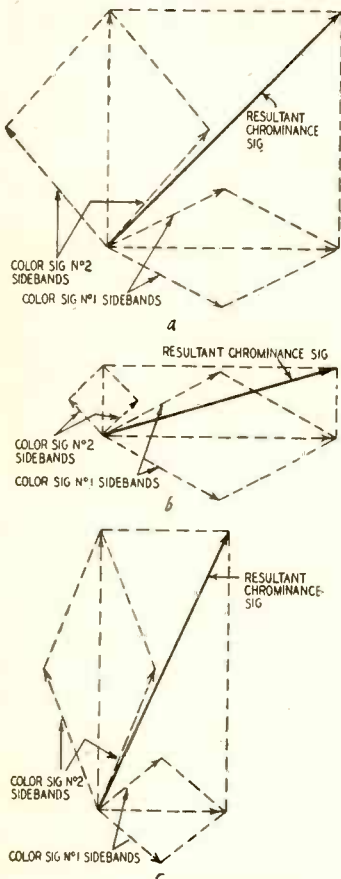

Fig. 6—Vector addition illustrates composition of chrominance signal.

signals. This is done by using two separate synchronous detectors as shown in Fig. 7.

To operate the synchronous detectors, two subcarrier signals are generated in the receiver for reference purposes. The composite video signal, consisting of the chrominance and brightness signals, is applied to separate bandpass filters which eliminate most of the brightness signal.

The outputs of the filters are applied to separate synchronous detectors. The subcarrier signals applied to the synchronous detectors are identical in frequency and phase to the original subcarrier signals at the transmitter.

These subcarrier signals are obtained in much the same way as at the trans-

mitter. One signal is obtained from the output of a local 3.6-mc oscillator; the other by passing the oscillator signal through a 90° phase-shifting network.

The synchronous detectors operate exactly as was described in the case of the single color signal. However, the output of each detector contains only one of the desired color-difference signals. Only one signal appears in the output of each detector because the phase of the reference subcarrier applied to it is chosen to cancel the sideband components representing the other color signal.

From the above, we can see that the frequency and phase of the subcarrier reference signals generated in the receiver must be identical to those of the original unmodulated subcarriers used in the transmitter, if reproduction of the original color signals is to be true. In other words, the frequency and phase of the subcarriers at the receiver must be *synchronized* with those in the transmitter.

The two subcarriers are synchronized by transmitting approximately 9 cycles (burst) of a 3.6-mc reference signal, at horizontal scanning rate intervals. This reference signal is inserted on the back porch of each horizontal blanking pulse, as shown in Fig. 8.

One of the primary reasons for locating the burst on the back porch of the horizontal blanking pulse is to avoid affecting the normal operation of the horizontal sync circuits in both black-and-white and color receivers.

The burst occurs during horizontal retrace time, when the receiver screen is normally blanked out by the horizontal blanking pulse. Also, since the burst occurs after horizontal retrace has started, it has no effect on synchronization of the horizontal sweep circuits.

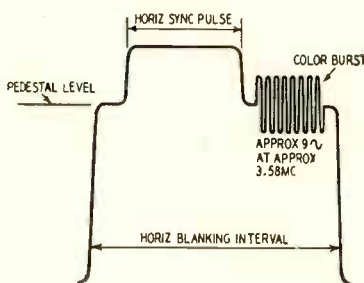

Fig. 8—Inserting color sync burst.

Having seen how the color-difference signals can be transmitted and detected, we can now turn our attention to the refinement of, and reduction of interference in the system.

(TO BE CONTINUED)

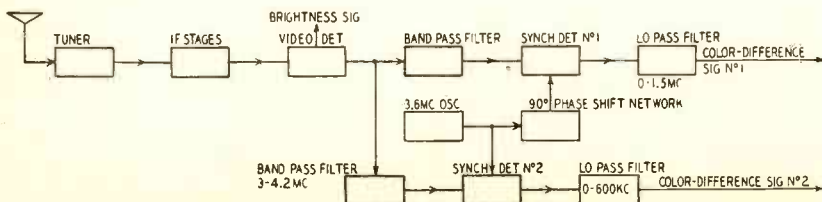

Fig. 7—Two synchronous detectors separate the color difference signals.



IN THE more southerly parts of the country, at least, March will mark the beginning of another TV dx season. Some sporadic-E dx is usually seen in the Deep South each year before the month is over. In these same latitudes, too, warming weather increases the viewers' chances of picking up some good tropospheric dx. This will be particularly true of the Gulf States.

Farther north there will be only a very slight upturn in general reception, unless we get a stretch of unseasonably warm weather that sometimes breaks out toward the end of the month. March is generally a good aurora month for the Northerners, though TV reports from this medium have thus far been few and far between.

Some real u.h.f. dx

It hasn't happened often, and very likely it never will become anything like the dx we experience on channels 2 through 6, but once in a blue moon an alert viewer will come up with a u.h.f. dx prize that defies explanation. A few such were listed in the 1953 TV dx summary published last month, and now we have another.

Observer R. J. Walker, Daytona Beach, Fla., reports a 10-second flash reception of KSTM-36, St. Louis, Mo., at 2:55 pm, December 13. This is a time of day and season of the year when tropospheric dx is highly unlikely. And it is generally thought that ionospheric propagation is impossible above 150 mc or so. What was the medium of propagation, then? Well, we'd like to know, too! When we've collected a few hundred such observations, perhaps we can make a guess.

New quarterly department

Beginning with the next issue, TV dx information (forecasts and reports) will be carried on a quarterly basis. It is hoped to be able by this means to present a more balanced column, as each one will span all or part of a particular type of seasonal phenomena. It is hoped, also, to be able to present outstanding dx reports regularly.

To achieve the latter aim we need the full co-operation of TV dx enthusiasts. If you catch anything unusual, report it *at once*. Don't wait until the end of a season and mail in a complete log. Reports several months old are satisfactory for long-term study, but they don't rate as news.

Interesting things are happening almost daily in the TV dx field. Can we count on your assistance in reporting them?

END

ing television receivers. In adjusting an antenna with this type of mounting, start with the V in a horizontal plane. After the other adjustments have been made, readjust the angle the arms make with the horizontal.

For the service technician, an adjustable-V antenna used in combination with an outdoor type in difficult locations often can produce nearly ghost-free reception to an extent that cannot be obtained with any practical single outdoor or indoor antenna. This combination was devised by the author to solve a ghost problem which had resisted several types of installation by different technicians, but the scheme

probably is not original. It consists simply of connecting an adjustable-V indoor antenna in parallel with the outdoor one, as shown in Fig. 3, and adjusting the indoor V to cancel out the ghost. With an arrangement of this type, the owner of an intermittently haunted TV set has something to do which is more constructive than complaining to his service technician. The indoor antenna need not be adjusted nor even connected if the received picture is satisfactory without it.

Impedance mismatch when the two antennas are thus connected together will not necessarily give trouble. In fact, the auxiliary antenna may be ad-

justed to correct a mismatch between the receiver and the outdoor antenna system. If a mismatch does exist when the two antennas are otherwise properly adjusted, it can be corrected by the usual means, but I have not found a case where it was necessary to do so.

Since an indoor antenna alone may not give sufficient signal pickup some distance from a station, it may be thought that such an antenna could not pick up enough ghost signal to cancel out that from the outside antenna. Actually, good results have been obtained 50 miles from a station.

If you never have used an indoor antenna, try it sometime! END

G-LINE

ONE of those fantastic scientific conceptions that seem fitted only for expression in long strings of mathematical calculations has come down to (or near) Earth, and may soon be seen on rooftops carrying u.h.f. TV antennas.

The new science-fiction-like apparatus is the G-line being made and sold as u.h.f. lead-in by Bogen. To all appearances, it is a single wire ending in a horn-like device at each end. (See photos and Fig. 1.) But radiomen know that u.h.f. does not travel readily on a single piece of wire. It tends to radiate off the wire into space, so little gets to a point any distance along the wire. For u.h.f., very special twin-line, coaxial or other types of transmission lines are needed, and even their losses go up rapidly with frequency. Is this new line some special kind of wire?

The G-line, so called after its inventor, Dr. George Goubau (RADIO-ELECTRONICS, May, 1950, and June, 1951) is a very special piece of wire. The



The launcher (from the antenna) and the catcher (at the window) match the G-line to the 300-ohm lead. Photos courtesy of David Bogen Co., Inc.

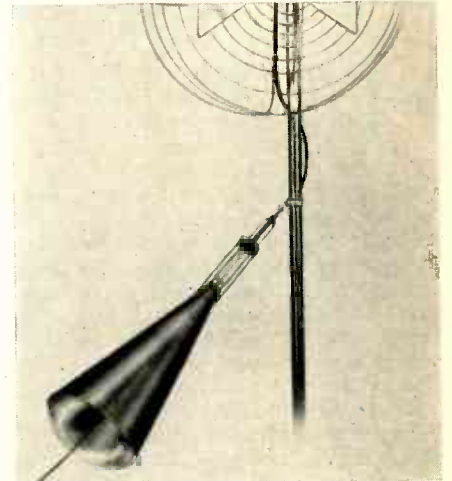

ductor, using only the inner one. The only difficulty is that we might expect the u.h.f. to radiate out in all directions from the wire, and that little would reach the end. This is just what does happen on an ordinary piece of wire.

As the waves spread outward from the wire of the G-line, they are reflected back toward it again by the boundary between the insulation and air. The short waves (3-30 mc) are similarly confined to the area near the surface of the Earth by bending due to the thinning out of the atmosphere. Waves which are not too near vertical are reflected back toward the Earth, instead of going on into space.

Thus, in the G-line, signals travel

(unbalanced) line. The launcher includes—at the narrow end, a balun (balance-unbalance transformer) and a gradually widening horn. The signals which may at first be inclined to treat the wire-horn combination as a new kind of coaxial finds the impedance rapidly going up as the horn widens, so that more and more of it follows the center conductor. A similar unit at the end where the lead enters the house transforms the signal back to a balanced one and puts it on a standard 2-conductor 300-ohm line. The two matching units contribute a loss of only 1/2 db each, and the line itself has a loss of 1 db per hundred feet. Radiation and noise pickup are very low because of the self-contained nature of the line, and it has an almost complete cutoff below 300 mc.

Insulation presents a problem. While the field falls off rapidly with distance from the surface of the wire, anything approaching it closely would cause severe losses. Therefore the line is supported wherever necessary by loops of nylon cord stretched between the ends of a small bracket, so that a minimum of solid material is brought near the line. Similar brackets are used wherever a bend is made, as the line must not have sharp turns, and 3 supports are needed for a 90-degree bend.

The new line will be especially useful wherever long runs have to be made. It will also be valuable in bad-weather and industrial areas and salt-air installations, since moisture, soot, or salt do not increase its losses. END

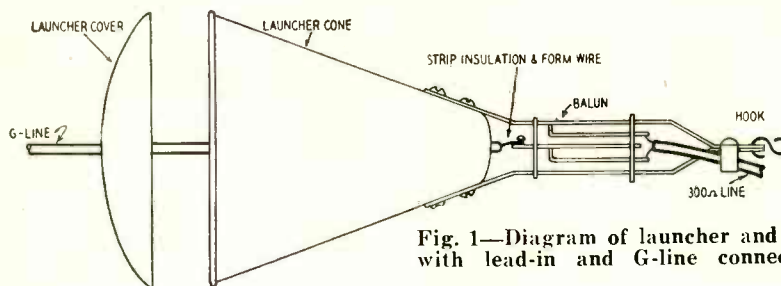

Fig. 1—Diagram of launcher and balun with lead-in and G-line connections.

ultra-high-frequency currents travel, not in the wire itself, but in the insulation around it! (To be more exact, they are confined to the area around the wire by the difference between the dielectric value of the insulation and that of the air around it.)

This is not as hard to understand as it may seem. We are all familiar with coaxial cable. At higher frequencies, the center conductor of the cable may be removed, and we have a waveguide. We know that u.h.f. current can be piped down waveguides without trouble. The G-line, in effect, removes the outer con-

ductor, much as in the exaggerated drawing of Fig. 2. The signals are picked up by an ordinary antenna with a balanced impedance of about 300 ohms. Therefore they must be launched onto the single

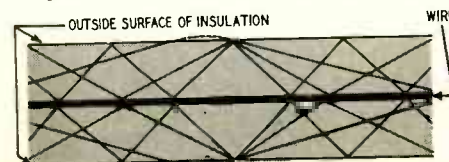

Fig. 2—Exaggerated illustration showing r.f. traveling between wire and surface of the insulation on G-line.



the "BEST TEACHER"

By HENRY FARAD

*"Experience is the best teacher,
but she keeps a dear school"*

HE DRIFTS into my TV repair shop two or three times a year. He's a different individual each time, but his problem is always the same. He has studied TV theory until it's running out of his ears; what he needs now is on-the-job experience to make that theory worth something in terms of dollars and cents. He is up against a problem as old as civilization—he hasn't been able to find a job because he has no experience; he can't get any experience because he can't find a job!

I can't help him directly. I'm a small-bore operator on a side street; my shop is in front of my home. You know the setup: in slack season not half enough work for one man; when things get snowed under, a few 12- or 14-hour days clear the decks. I get by, which is just fine. But hired help I can't use.

However, I can explain how I got my experience after I'd run up against the identical problem. Like many others, I learned my TV theory at home in my spare time; making a living occupied most of my daylight hours. My only teachers were books, magazines, and a study course.

Inevitably, as does every student, I reached a point where the books began to blur. I'd absorbed all the wordage I could handle for the time being. I needed actual contact with TV sets—preferably in bad order.

I could have gotten that contact in a residential TV school, but I had a family to support and no rich uncles. A job as a helper or apprentice in a TV shop was another possibility, but a shop helper's pay is too low and his progress not fast enough for any but single, unburdened individuals. I solved the problem by creating my own experience. The method is simple and relatively cheap; it can be duplicated anywhere. It can supply any student—as it supplied me—with experience at exactly the right pace; never too fast, never too slow; whenever he wants it—evenings, week-ends, any time.

My first step was to become what amounted to a part-time dealer in TV junk. This was simple enough. I inserted a classified ad in a local paper, offering to buy old TV sets—any size, shape, or condition for cash. You don't

have to be a big dealer to do this. I put a \$50 maximum on my offer, thus side-stepping big stuff; I never paid more than \$30 for any of the ten-inch clonkers I dragged home. \$30 was my top a couple of years back—a \$20 maximum would be more in line with today's situation.

Having dragged a relic home, I proceeded to restore it to working condition, which frequently took a little doing. As might be expected, there was something badly amiss with every one of my prizes. Some produced neither raster nor sound; some made with fearful planing-mill noises. Others were

toms. I practiced signal-tracing and alignment, to mention just a few of my earlier experiments. Then, after I'd milked a chassis dry of information I sold it down the river, as detailed a little later.

In one corner of my over-sized garage I fought first one piece of junk back into working order and then another—and another. A v.t.v.m. with a couple of probes, a tube tester, and some early printings by Rider and Photofact made up my equipment, plus the usual hand tools.

It's no fun—not at the start. Not for the student completely on his own, with not a soul to give him a lift when he gets stuck in the mud, which is often. It's not the most efficient method in the world, either; it involves frustrated hours of doing things the wrong way, stupid mistakes, wrong approaches, errors of both omission and commission. There were times when I'd have sold out for a fraction of the inventory.

But you can say this about the method—it works! It produces real, valuable experience. Moreover, it sticks with you, as does anything acquired the hard way; there's no time wasted simply memorizing. Another advantage is that you have neither employer nor impatient customer breathing down your neck—a handicap which can make even an experienced mechanic sometimes black out.

I started out in my garage loaded with theory but inclined to go numb from the neck up the moment I removed the back of a defective TV set. The first time I pulled one out of a cabinet and turned it over I recall sitting there for half an hour, just gawking, with a gone feeling at the pit of my stomach, wondering why I'd ever started this. The first few times I compared a schematic with a chassis I got lost so fast it was worse than pitiful. No fun at the start.

Little by little, however, stage by stage, I acquired competence and confidence, a backlog of experience. I discovered head-on attacks don't pay off in TV repairing. Strategy is the key to the jackpot; knowing when to attack a repair job via the *dynamic* approach, checking a.c. components with a v.t.v.m.



inhabited by gremlins or some of the many ailments common to TV sets. Sad cases every one, but you don't learn TV repairing by working with sets in good order. Assuming a receiver hasn't suffered a major burn-up (sniff well before buying), and hasn't been robbed of tubes, then the worse its condition the better for the student seeking experience.

The actual, hard-rock experience I gained in repairing those boxes was only part of the program. My next stop was to twist every nonoperating control I could find, with the idea of getting everything as far out of kilter as possible. Then I restored everything to normal, sometimes repeating the process several times. The further I progressed the bolder I became; the deeper I dug into my clonkers. I introduced defects and observed the symp-

or scope, and knowing when to use the *static* approach, routinely checking socket voltages, capacitors or resistors. It means knowing when to use a tube-tester and when to rely entirely on substitution. The difference between the strategic and the head-down approach is the difference between minutes and hours in wrapping up a repair job.

The strategist is always changing pace. He hangs onto an idea or a deduction just so long, then if it fails to pan out he dumps it. This is an attitude of mind to be cultivated. Let me illustrate the disadvantages of not having this attitude, by using a hypothetical Joe Doakes. Confronted with a fairly tough case of TV trouble, Joe looks the situation over and makes a quick deduction as to the probable cause. So far so good. However, Joe's test gear promptly reports that everything is under control in the suspected area. This is where real trouble starts.

Instead of changing pace and developing a second deduction, Joe stubbornly makes another pass at the original target. When this gets him nowhere, he promptly goofs off. Two hours, three hours later you may find him still working over the same group of components. Meanwhile in the process of checking and re-checking it's quite possible Joe's test gear has indicated the cause of the trouble. But because Joe is operating strictly under Condition Gooff, he pays no attention to what the test gear tells him. He ignores it, knot-headedly continuing his original line of attack.

After lunch or possibly the next day, he'll come to, kick himself, and proceed to repair the TV set in a normal manner. I goofed off like this more than once. Others far more competent than I have done exactly the same thing.

The calm, cool, and collected attitude is about twenty-five percent of the top-drawer technician. It increases output and accuracy, it inspires that precious gem, customer confidence. Move slowly and deliberately; it will reduce the number of chassis unnecessarily pulled, and the number of 6AU6's popped by forgetting to return the filament knob on the tester back from 12.6. In short, the less haste the more speed.

I once pulled a chassis and fought with it for an hour, trying to discover the reason for no-sound. I was knee-deep in gear and half-strangled with test leads when I noticed at long last that the record-player switch had somehow been snapped over to PHONO.

Then there was that memorable Philco on which I wasted more than half a morning trying to find out why the over-all bandwidth had decreased to about 2 megacycles. (Yes, I checked and re-checked the tubes.) The trouble, it eventually developed, grew out of the fact that a 12AU7 and a 12AV7 were planted side by side in the front end—and someone had swapped them! Later I discovered the owner had taken some of his tubes downtown for test-

ing before calling me in, which shows to go you—never take anything for granted.

When nothing produces results within a reasonable time, start taking wild shots in the dark. I am reminded of a certain series-filament conglomeration wherein all the symptoms of an open grid circuit in the C-R tube were produced by a heater-to-cathode short in the damper! Then there was that frightful case of horizontal nonlinearity which was caused by trouble in a 6SN7-GT horizontal oscillator which checked perfectly in my tester. In this case and as an added unattraction, the horizontal drive capacitor had insanely taken over the function of a horizontal centering control!

Anyway, and as I started to say some time back, little by little, stage by stage, headache by headache, I acquired competence and confidence at my garage workbench. If I've made it sound rough, I can only say it is indeed rough—at the start.

In the end, I no longer crept timidly up to each sour TV set, wondering whether this one would be my Waterloo as I began to probe its inards.

Oh, sure, you get thrown for a loss every so often by some box tougher than you, but repairing the vast majority of TV sets is so simple—even for a halfway competent technician—that it sometimes seems a shame to take the money(?).

I bought a lot of clonkers, but my actual inventory at any one time was seldom more than one TV set. As soon as I milked one dry, it was promptly sold.

I'd have a really good story here if I could say these transactions showed a nice profit, but not so. I had to price those boxes low enough to insure prompt disposal, and I had to get cash. The prices I got were anything but fancy. Considering the cost of advertising, mileage, replaced tubes and components, I lost something on every deal—around \$7.50 per box.

Holding on for higher prices could have showed a profit possibly, but I wasn't necessarily trying to make money; my objective was getting experience. Keeping a constant supply of TV cadavers coming my way was the all-important item.

I started my project with a v.t.v.m. and a tube-tester; eventually I acquired a scope, sweep and marker generators, 1,000-ke crystal marker oscillator, grid-dip meter, wattmeter, capacitance-bridge, short wave receiver to monitor WWV, complete set of service manuals, and trimmings. You don't have to be a big dealer to do this. I bought my gear one item at a time, in kit form wherever possible, because I couldn't afford ready-made gear. Moreover the purchases were spread out over a considerable period of time—a year or so all told.

Slow work? Well, acquiring electronic know-how is a slow process. The TV student in a hurry is licked before he starts; never less than a year and

often two years must elapse before he gains enough ground to tackle general repair work.

Also pretty well licked before he starts is the TV student who expects to draw a salary while he gets his practical experience. Students pay considerable sums to acquire theory, and without protest. However, the thought that practical experience must also have a price tag is something which seldom occurs to them. But that's what it amounts to when the inexperienced technician—sharp though he may be in theory—tries to hire out in Slowblow's TV shop.

Apprentice training works out well enough in some occupations, where other services may be rendered while the student learns.

Simply observing a TV repairman at work is of little value to the novice, assuming the repairman is not doubling as instructor. Ninety-nine per cent of the effort is quite invisible, consisting of mental processes.

If Slowblow takes him as a *bona-fide* apprentice or learner, the novice will be in Slowblow's way for a long time; he's only half a technician. Slowblow would be forced to make up his deficiencies. Slowblow must spend many hours *teaching* the novice the techniques he needs; inevitably the novice will make numerous and sometimes expensive mistakes. In short, he'll be a student drawing wages for being instructed!

The only practical way Slowblow can hire the student is on the basis of shop helper. Most of the time he will put up aerials, pull chassis, act as general man-of-all-work. Thus the student earns his wages, but acquiring experience is strictly hit-or-miss, at a woefully slow rate.

Hence, unless he's exceptionally lucky, or unless he can manage to take a residential course in a TV trade school, the average Joe must buy his experience—and the only visible method is along the general route I've been outlining. The cost of buying experience this way is never more than a few hundred dollars, with payments spread out over a rather long period.

Even if the student does not plan to go into business for himself, buying all this test gear is actually a necessity. Considering the strong economic position enjoyed by the experienced, competent TV service technician, a few hundred dollars represents a trivial investment indeed. END



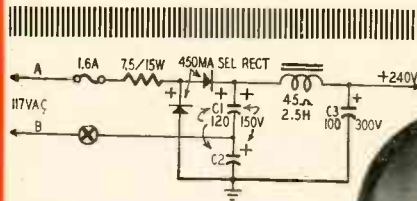
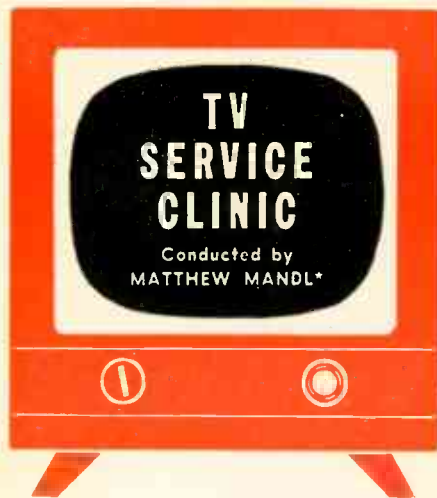

Fig. 1—Schematic diagram of voltage doubler used in Philco model 52-T2110



Fig. 2—Insufficient low-voltage supply.

THE increasing use of selenium rectifiers in television receivers has resulted in our receiving many queries regarding symptoms which appear when rectifiers go bad. Readers have also asked about replacement precautions and data.

In most instances when selenium rectifiers replace vacuum tubes in low-voltage power supplies, a voltage-doubling circuit is used to get an output of between 200 to 250 volts. In most instances the voltage-boost system of the damper tube contributes an additional 100 to 200 volts for circuits requiring B voltages in excess of 300.

When troubles develop in such voltage-doubling circuits, the fault may not always be the selenium rectifiers. Often a defect is due to other circuit components, because the voltage-doubling circuit is critical with respect to part values.

A typical circuit is shown in Fig. 1 and is used in many current Philco receivers. Two selenium rectifiers are used, each having a 450-ma rating. These, in addition to the two 120- μ f capacitors, form the voltage-doubling circuit.

A 1.6-ampere fuse is in series with one leg of the a.c. line, and a 7.5-ohm limiting resistor is also used to prevent excessive current peaks. When one-half of the a.c. cycle causes the input terminal A to be positive, the top selenium rectifier conducts and charges capacitor C1 to the peak value of the a.c. voltage. During the second half of the a.c. cycle the lower rectifier conducts and charges C2. The sum of these charges is double the input voltage.

The efficiency of the circuit depends on the conduction of the selenium rectifiers, plus the ability of C1 and C2 to maintain their charges. If these capacitors become leaky or change value, the voltage doubling will be seriously affected. Likewise, leakage of filter capacitor C3 can load down the circuit by drawing excessive current. A current drain in excess of what the circuit is

designed for results in draining off the energy from C1 and C2 at a faster rate than they can be charged, thus decreasing the voltage output.

In a television receiver, decreased output from the low-voltage supply can result in a shrunken picture which cannot be expanded by the width and height controls, corner shadows, poor picture quality, unstable synchronization, and low audio output. The degree to which these symptoms are present depends on the amount of voltage decrease in the power supply. Fig. 2 shows symptoms of vertical and horizontal shrinkage, as well as corner shadows caused by a decline in selenium-rectifier output.

When the rectifiers are at fault, they should be replaced with units having the same (or higher) current ratings. The 450-ma rectifiers shown in Fig. 1 can be replaced with 500-ma units, thus assuring somewhat longer life. The only factor to consider is whether or not the new units will fit in the same space used by the old units.

If possible, filter capacitors should be checked with a capacitor checker so that the power factor (leakage) can be read. Do not bridge old capacitors with new ones, as this does not eliminate any leakage. Also check the value of any series resistors and replace with values recommended in the service notes. Electrolytic capacitors used with selenium rectifiers require special consideration. Since the selenium rectifier has no warmup period, the capacitors will be subjected to high initial surge voltages. (See "Electrolytic Capacitors", February, 1954, issue.)

With respect to filter capacitor replacements, use the same values given in the receiver schematic. The values shown in Fig. 1 are only for the receiver mentioned. Other receivers may use lower-current rectifiers, or higher doubling capacitors. (Crosley chassis 411, for instance, uses 200- μ f capacitors in both the doubling circuit and the filter section.)

Selenium rectifiers have the advan-

tage of requiring no filament voltage and are fairly rugged. Their life may be as short as six months or as long as several years. Often their emission declines gradually, so that it becomes necessary to advance both the height and width controls every few months to keep the picture filled out. Eventually both controls are at their maximum and shrinkage can no longer be corrected except by rectifier replacement. By this time picture quality is also down, and the new rectifiers (and perhaps new filters also) will do much to give the set new life and sparkle. Don't forget to reduce those height and width controls, or your customers will be complaining about the tops of heads being chopped off, or never seeing the performer's feet!

Blanking differences

On some channels, the picture in a Transvision A-4 receiver lacks full width, while on other stations the picture fills out completely. What could cause this? I would also like your opinion regarding fine detail. Do you believe that excessive sharpness is possible?—R. Z., Eagle Lake, Texas.

There is a difference in the transmitted width of some stations. This is caused by a difference in the blanking duration; unfortunately all stations do not adhere to standards in this respect. You will also find that some stations fill out the mask to a greater extent than others do. A contributing cause in the receiver could be insufficient high voltage which will cause blooming for differences in contrast and brightness levels. The high-voltage system should be checked and brought to maximum efficiency by tube replacement.

With respect to fine detail, the correct procedure would be to align the tuner and video i.f. stages so that a 4-mc bandpass is obtained. This gives the sharpest picture. Excessive high-frequency peaking will cause repeat lines to be visible at the edges of sharply defined objects. Sometimes this is caused by incorrect peaking coils in the

*Author: Mandl's Television Servicing

GETTING THE MOST FROM

Indoor type antennas need not be "substitute" antennas; proper use makes them highly effective

By JOHN K. FRIEBORN

WHETHER you are a set-owner or a service technician, the adjustable-V type indoor antenna offers advantages which often are overlooked. This type of antenna is usually regarded as a mere substitute for an outside installation. Actually, an indoor antenna often can give you a satisfactory picture when an outdoor type cannot. Unless you can place an outdoor antenna high enough to eliminate the possibility of reflections ever occurring on any channel, you cannot be sure of obtaining ghost-free reception under all conditions, except with an extremely elaborate installation. The amount of signal pickup generally is less with an indoor antenna than with an outdoor one, but the greater ease of adjusting the indoor type makes it possible to eliminate ghosts more consistently.

To obtain maximum benefit from an indoor antenna, you should have one with as many adjustments as possible and adjust it whenever the picture indicates the need. Many set-owners feel that simply paying for a receiver and its installation should be enough to entitle them to perfect television reception. However, for many locations the service technician cannot obtain good reception at all times, and the set-owner who does some additional work will be well repaid for his efforts. In many cases, the most effective thing a set-owner can do to improve the quality of his picture is to have an adjustable antenna, and adjust it when necessary.

The set-owner usually is told to "adjust for the best picture," but that is not much help in making the many adjustments possible with some antennas. Any method is satisfactory as long as the adjustments are performed in a definite order and repeated if necessary. For example:

1. Extend each arm about halfway;
2. Adjust each arm to an angle of about 45° with the horizontal;
3. Rotate the antenna for the best picture;
4. Adjust the length of each arm individually (holding the insulators at the ends, not the metal parts of the arms);
5. Adjust the angle of each arm individually;
6. Re-check rotation, lengths, and

angles, until changing any adjustment does not produce any improvement;

7. Try the antenna in different locations.

If you adjust the arms individually, often you will find that an unsymmetrical configuration of the antenna is the best one. I have found that the best picture sometimes is obtained with a position like that in Fig. 1. This may not look right to you, and it doesn't look right to me, but it seemed to suit the signal. Incidentally, the higher-frequency channels (7 through 13) do not necessarily require that the antenna arms be shorter than those for the lower channels; an antenna does not have to be one-half wavelength. In adjusting your antenna, forget oversimplified theories about what it should look like and just give the incoming signals a chance to try all the different sizes, shapes, and positions your antenna can offer.

Even with the five adjustments which are available in the standard adjustable-V indoor antenna, still another would be desirable. In fact, a different type of antenna mounting would produce better results than the present one, both theoretically and practically. With present commercial indoor antennas, the V formed by the arms is always in a vertical plane. Better results usually would be obtained with the V in a horizontal plane, since the best direction for a V-type antenna is in the plane of the V, and television signals are received along an approximately horizontal line. (See Fig. 2.) The plane best for the antenna in a particular case usually is one tilted slightly up from the horizontal. In a number of actual cases where it has been tried by the author and others, changing the plane of the V from vertical to approximately horizontal resulted in improved signal strength so that the amount of snow was reduced, and often, a persistent ghost was removed.

To make an added adjustment possible, you must have an antenna base or mounting with some type of universal joint. Until such an antenna is manufactured, anyone wishing to experiment with it must build his own. Several devices which could be adapted for experimental mountings are available. Rubber-covered clamps with universal joints, for holding cameras and

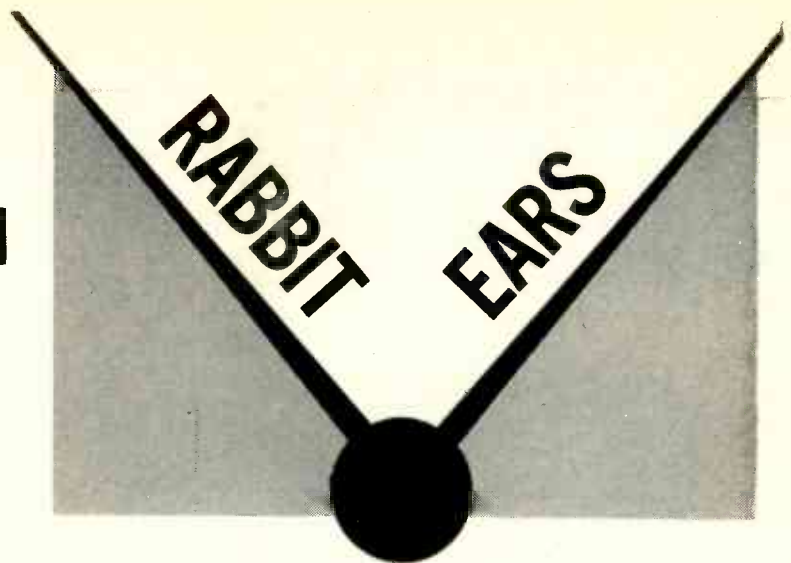

lights, are sold in photographic supply stores. Mirrors, similarly mounted, are available through radio and television supply distributors, for use in adjust-

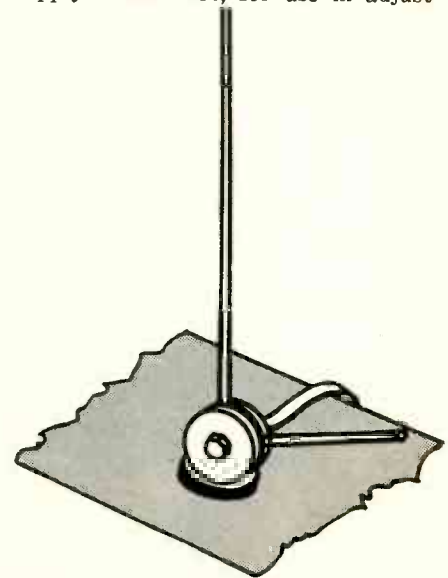

Fig. 1—Best pictures are often obtained with unsymmetrical arrangements.

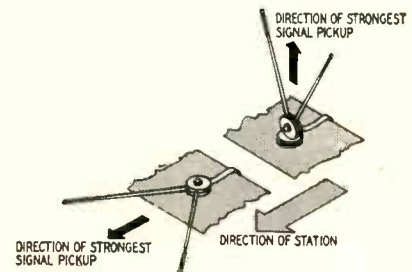

Fig. 2—Horizontal positioning of V.

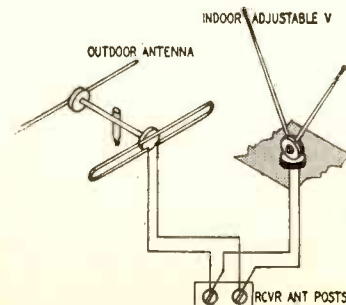

Fig. 3—Layout for eliminating ghosts.

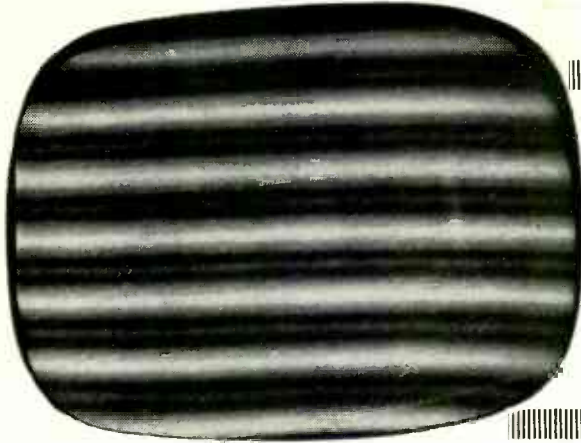

Fig. 3—Screen shows horizontal bars.

video amplifiers, as well as by improper alignment. It is preferable to have a clear and sharp picture without such repeat lines, which indicate abnormal high-frequency response.

Sound bars

In an RCA 21T176 there are a number of horizontal bars on the screen. (Fig. 3.)

I have tried new tubes and have made other checks but cannot find the trouble.—N. F., Milwaukee, Wis.

You mentioned having checked all tubes, but did not state whether or not you have adjusted the sound traps. If these check all right, the trouble may be caused by a.g.c. overload which causes one of the stages to go into oscillation. The a.g.c. control should be adjusted to see whether or not it makes a difference in the interference. If not, try replacing the crystal detector.

Another cause for this condition could be improper video i.f. alignment. When the alignment is overpeaked, stages may become critical, with possible oscillations. The same holds true for improper peaking coils in the video-amplifier section, as well as for defective component parts.

Capacitor failure

A Hallicrafter model 17825 receiver had excessive brilliancy and I replaced a shorted .01- μ f capacitor (C138) in the brightness control circuit. The set worked well for three weeks and the same trouble occurred. I replaced the same capacitor and made extensive voltage and resistance measurements, and checked the brightness control for any intermittent shorts. After another month the same trouble reappeared. Have you any suggestions as to why this capacitor would short out after a short period of time?—J. G., Brooklyn, N. Y.

The fact that the .01- μ f capacitor which you replaced to correct the trouble has again become defective does not necessarily indicate a circuit defect. Since the receiver operates well for several weeks before the capacitor be-

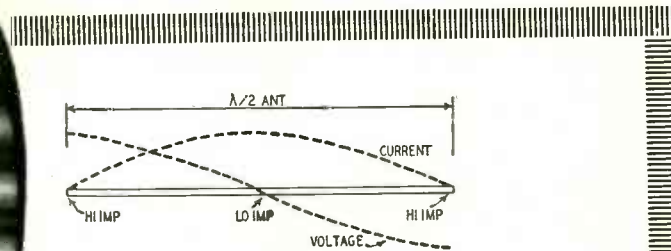

Fig. 4—Antenna impedance distribution.

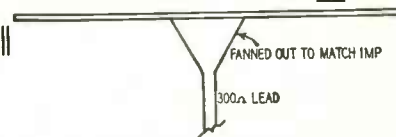

Fig. 5—Obtaining impedance match.

comes defective it may indicate that the replacement capacitors were defective or not of the proper voltage rating. Try another replacement, using a 600-volt rating. It is possible that you have used a 400-volt rating; if so, the capacitor will be short-lived.

Uhf-vhf delta match

I would like to have an explanation of the principle involved in using a delta-match Yagi antenna for u.h.f. or v.h.f. I want to try one of these units and I understand no insulator is needed.—G. C., Saskatchewan, Canada.

In a half-wavelength antenna the voltage is high at each end and therefore the impedance is high. At the center the voltage is zero and therefore the impedance is low. (See Fig. 4). When no insulator is used, the transmission line ends can be fanned out for an increasing impedance. Thus, a perfect match can be obtained by fanning out the line for the proper distance (Fig. 5). This is established when best reception occurs. The principle can be used for either u.h.f. or v.h.f. antennas. Since the match is for a narrow frequency span the system is best adaptable to Yagi antennas.

17BP4A to 21EP4

I have a Westinghouse H658T17 which contains a 17BP4A picture tube. I wish to substitute a 21EP4. Both

tubes are identical as to focus coil, deflection angle, etc. Can this be done without change to the circuit or components?—J. J. B., Sumter, S. C.

Since both tubes are identical with respect to deflection angle, etc., you could make the change without altering the circuits or additional components. Make sure the vertical and horizontal output tubes are operating at peak efficiency, and that the high-voltage system is also giving maximum output. If these components are not giving peak performance, you may not get sufficient size or brilliancy for the larger tube.

Transmitted linearity

When I set the linearity controls to get a perfect circle for one local station, I find the picture has bad left-hand stretch on another channel. I can't understand how the receiver would change linearity for a different station, and I assume the trouble is in the transmitted pattern of one station. Am I right in this assumption? W. O., Chicago, Ill.

There is often considerable variation in station-pattern linearity for the seven stations in any one locality. Linearity at the station (as in the receiver) must be adjusted carefully or the transmitted picture will be distorted. For most accurate results check the linearity adjustments on your receiver with a cross-bar generator. **END**

ON THE COVER: ANTENNA TESTING METHODS

With the scenic Catskill mountains as a background, engineer Julius Green of Channel Master, Ellenville, N. Y., is seen testing the Ultra-Bow antenna.

The experiment in process consists of measuring the characteristic impedance of the antenna. The girl, Barbara Watson, is recording standing-wave ratios as measured on a Lecher wire and is taking signal generator and voltmeter readings.

The large wooden mast behind them is used for field testing. The tower

mounted on the mast can be pivoted in a vertical plane. The tower and mast represent the receiving section of a transmit-receive setup.

At the end of the tower is mounted the antenna to be tested; in this case it is the 2-bay Champion. The antenna can be rotated 360° by a selsyn motor mounted on the tower and can be controlled from a nearby laboratory. The antenna under test is rotated at a speed of 2 r.p.m. while the receiving pattern is automatically recorded. **END**

TELEVISION . . .

it's a cinch

By E. AISBERG

*Ninth conversation, first
half—Forming the electron
image; photoelectric cells*

From the original "La Télévision? . . . Mais c'est très simple!" Translated from the French by Fred Shunaman. All North American rights reserved. No extract may be printed without the permission of RADIO-ELECTRONICS and the author.

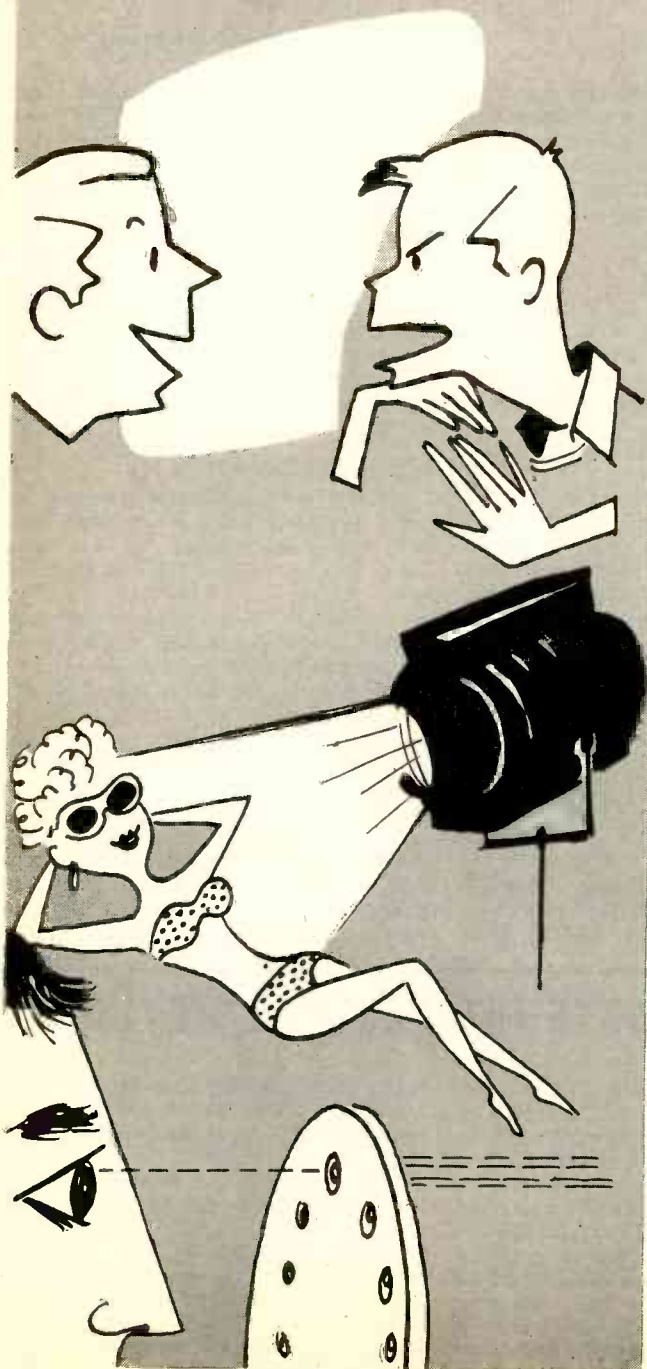

In the land of the microseconds

WILL—I've got news for you, Ken!

KEN—Go ahead!

WILL—This talk about time bases and deflection circuits has got me fed right up to the neck. Can't we change the subject for a while?

KEN—It just happens I was thinking the same thing myself. We should now be able to attack the main principles of television—we've pretty well cleared up the preliminaries. How about starting to learn something on how images are transmitted, as well as received?

WILL—I do know a little about that already. For instance, I've just been reading how a TV studio has to be so brightly lighted that the actors get sunburned and . . .

KEN—That's what you get for picking up back-number magazines! All that was out long ago! Nowadays TV camera tubes are as sensitive as the human eye, so they don't have to burn the skin off the actors with lighting, as they did in the early days. Color TV needs a little more illumination, of course, on account of the optical filters in front of the cameras.

WILL—Then they've been making photoelectric cells more sensitive?

KEN—No, the progress wasn't made in that direction. What they've done is learn to use more of the cells, and for more of the time. Instead of lighting the cells for short instants. . . .

WILL—Huh?

KEN—Remember the mechanical Nipkow disc we talked about a long time ago? And how each small element of the image could reflect its light onto the photocell only for the instant the hole in the disc was directly between the picture element and the tube? If you were to use a system like that for a standard 525-line scan, each of the picture elements would project its light on the cell only about a tenth of a microsecond.

WILL—That means that at 30 frames a second, each element would have a chance to get in front of the camera only about 3 microseconds out of each second. About 3-millionths of the time!

KEN—So you see that a system that could see *all the light* from the picture *all the time* would be much more sensitive—in theory at least.

WILL—Yes, over 300,000 times as sensitive—as many times as 3 microseconds is contained in a second.

KEN—Well, you can't actually get anything like that in practice. But you could get something like 25,000 times more sensitivity.

WILL—That ought to help a little! But how are you going to illuminate every part of your image—and get it picked up by a photocell—continuously?

KEN—Why use one photocell, Will? Why not use millions instead? Then each tiny image element would have half-a-dozen photocells for itself.

WILL—Now you're kidding! That's impossible, of course!

KEN—Nothing impossible about it at all! But before I show you how to use millions of photocells, let's take just one and see how it works. Look at this hookup. When light falls on the photosensitive cathode, it emits electrons. They are attracted by the positive anode, and from there go back to the battery, B1. Meanwhile, the upper plate of capacitor C, connected to the cathode, is charged . . .

WILL— . . . more or less positive, because of the negative electrons the cathode has lost.

KEN—Now, switch S turns 30 times a second, and—for a very short instant—connects the negative terminal of the high-voltage supply to the cathode. What happens?

WILL—Capacitor C's top plate gets back the lost electrons from the negative end of the high-voltage supply (battery B1).

KEN—Exactly! But, as the electrons from the battery neutralize the positive charge on capacitor C's upper plate, a corresponding negative charge is released from the lower plate. These electrons go to the positive pole of the battery through resistor R.

WILL—I see what happens. The current through resistor R is bigger or smaller according to the amount of light that falls on the photocell. And of course it produces a voltage drop across the resistor. So if we connect the control grid of an amplifier tube, as in the layout, its output will vary with the amount of illumination. But haven't you got a pretty heavy positive bias on that grid?

KEN—No. You're looking at the photocell battery. The amplifier is interested only in battery B2, its own supply. Both cathode and grid return are connected to B2's negative terminal. Standard hookup, no?

WILL—Sorry. I missed that one. But what I still can't see is how you're going to capture all those image elements with your photocell.

Millions of cells—Impossible!

KEN—Try to imagine a surface completely covered with photocells like this one. Their cathodes are all connected to contacts. The switch passes over all these contacts 30 times a second. Each cathode is also connected to its capacitor C. The lower plates of all these capacitors could be connected together—or you could use a common lower plate, like they show in the diagram of a multiple-section electrolytic—and you would need only one resistor R for all the cells. Each cell now takes its turn putting its voltage on the amplifier grid. Now if we illuminate all these cells together . . .

WILL— . . . your system will work—in theory, that is! You're saying that there'll be a voltage on the amplifier grid—at any given instant—proportional to the light falling on the photocell connected to the switch at that instant.

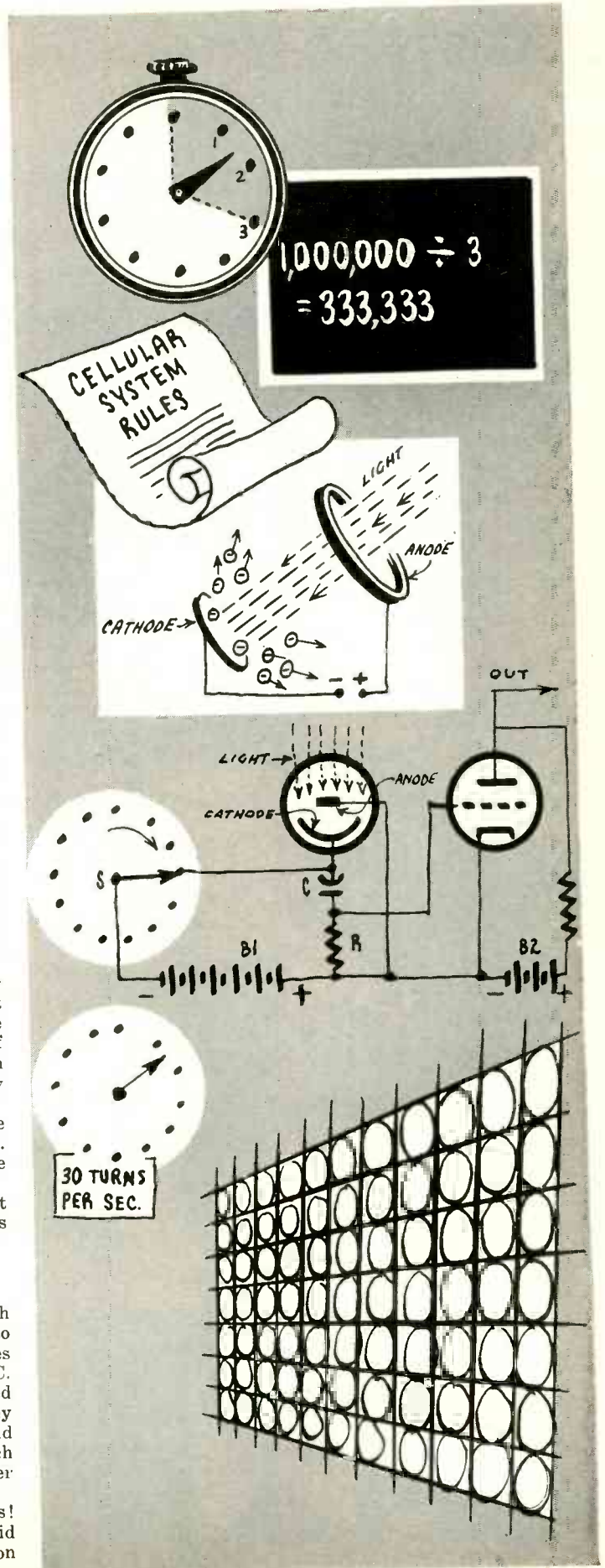

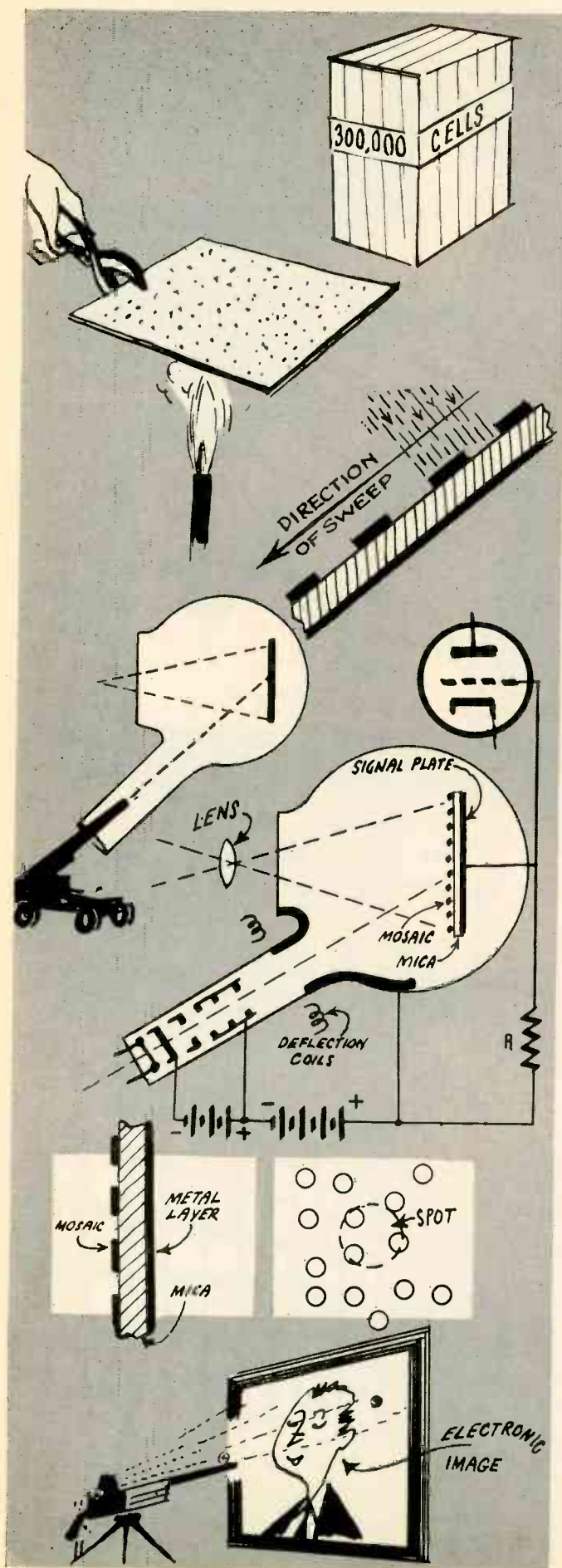

KEN—Your mental pickup is good today! Now keep in mind that the light is falling on *all* the photocells *all* the time, so the voltages are the results of an *accumulation of charge* for the thirtieth of a second between two discharges.

WILL—But all this is ridiculous! How are you going to assemble your panel of 300,000 photocells? And where are you going to get a switch that will make and break 9,000,000 contacts a second? It can't be done!

Nothing is impossible

KEN—But it is done—on the photosensitive mosaic of the *iconoscope*, which is what I've been leading up to.

WILL—Photosensitive mosaic . . . ?

KEN—Yes. It's a thin layer of silver deposited on a sheet of mica. After the silver is deposited, the sheet is heated. That makes it expand and cracks the silver layer up into millions of little bits, each separated from the others by a gap of insulating mica. Then cesium vapor is deposited on them, making each of these little silver islands a photocell.

WILL—I know about heating paint on metal cabinets to get a crackle finish. But crackle-finished silver is a new one on me. So that's how you get your millions of photocells!

KEN—That's how. Or at least it's how we get the most important part of the cells—the cathodes. And you only need one anode for all of them, so that's no problem.

WILL—But how about the capacitors in the cathode circuits.

KEN—Very easy—just plate a thin layer of metal on the other side of the mica sheet. Then each cathode forms one plate of a capacitor and the metal on the other side of the mica becomes the common lower plate we've been talking about. You understand, of course, that the cathodes don't have to be regular or symmetrical, because there are several of them in the space we've been allotting to one picture element. The capacitance of each of these tiny capacitors is proportional to its size, so the voltage induced on the common capacitor plate is the same for the same amount of light on the picture element, whether it's represented by two or three larger islands or a half-dozen smaller ones.

WILL—Wonderful! And now I begin to see that the switch to contact each of these tubes is going to be the electron beam in a cathode-ray tube.

KEN—I suppose watching me draw this diagram of an iconoscope didn't help you any?

WILL—Well, it is a funny shaped thing.

KEN—That shape is highly functional. You have to put the photomosaic where it can be swept by the electron beam and at the same time be exposed to the light from the scene you are televising. One face of the tube has to be flat so that a lens can form an image of the televised scene on the photomosaic. To keep it out of the way of the light, the electron gun is mounted in a cylindrical tube at an angle of about 45° from the mosaic. And the common anode for all the cathodes is a metallic film deposited over part of the inside of the glass.

WILL—It looks as though the beam is focused electrostatically and swept magnetically.

KEN—Doesn't matter. You could do it the opposite way and it would still be an iconoscope. What is important is that *all* the cells of the mosaic are *continuously* being illuminated by the rays of light from the corresponding points on the televised scene. That is, the positive charges on each cell—due to loss of electrons as the light strikes it—keep on increasing as the light keeps on jarring more electrons loose.

WILL—And what happens to the electrons?

KEN—They are attracted by the anode. But we're more interested in the positive charges. As they accumulate on the mosaic they form a veritable *electronic image* of whatever you are televising. Then the electron beam sweeps over each cell 30 times a second; replaces the lost electrons and wipes out the image. Of course that releases the negative charges on the other side of the mica dielectric, and produces a current that travels through resistor R and sets up a voltage across it . . .

WILL—. . . which depends on the amount of light on the element of the image the beam is passing over at the instant! Why, the iconoscope is really very simple! (TO BE CONTINUED)



TRAIN FASTER—TRAIN BETTER—TRAIN EASIER
IN 10 MONTHS—OR LESS—FOR
RADIO-TELEVISION
 Our 21st Year Training Men for Greater Incomes and Security in Radio-Television

I SEND YOU 18 BIG KITS

of Radio Television parts and equipment. Much of your training will be actual construction and experimentation . . . the kind of truly PRACTICAL instruction that prepares you for your Radio-Television career.



Frank L. Sprayberry
 President
 Sprayberry Academy
 of Radio



YOU BUILD the Television set and the powerful superhet radio receiver shown above. IN ADDITION to the other test units shown here (many are not shown because of lack of space). All equipment I send you is **YOURS TO KEEP.**

Approved for Veterans under the G. I. Bill

NEW! NO OBLIGATION PLAN

You Have No Monthly Payment Contract to Sign Pay For Your Training as You Earn and Learn

You can get into Radio-Television, today's fastest growing big money opportunity field, in *months* instead of years! My completely new "package unit" training plan prepares you in as little as 10 months or even less! *No monthly payment contract to sign—thus NO RISK to you!* This is America's finest, most complete, practical training—gets you ready to handle any practical job in the booming Radio-Television industry. Start your own profitable Radio-Television shop . . . or accept a good paying job. I have trained hundreds of successful Radio-Television technicians during the past 21 years—and stand ready to train you, even if you have no previous experience! Mail coupon and get all the facts—FREE!

Valuable Equipment Included With Training

The new Sprayberry "package" plan includes many big kits of genuine, professional Radio-Television equipment. You perform over 300 demonstrations, experiments and construction on projects. You build a powerful 6-tube 2-band radio set, multi-range test meter, signal generator, signal tracer, many other projects. All equipment and lessons are *yours to keep* . . . you have practically everything you need to set up your own profitable Radio-Television service shop.

Earn Extra Money While You Learn!

All your 10 months of training is IN YOUR HOME in spare hours. Keep on with your present job and income while learning. With each training "package" unit, you receive extra plans and "Business Builder" ideas for spare time Radio-Television jobs. New television stations everywhere, open vast new opportunities for trained Radio-Television Technicians—and those in training. If you expect to be in the armed forces later, there is no better preparation than practical Sprayberry Radio-Television training.

SPRAYBERRY ACADEMY OF RADIO 111 NORTH CANAL ST. Dept. 20-G, Chicago 6, Ill.

MAIL COUPON TODAY! NO OBLIGATION

SPRAYBERRY ACADEMY OF RADIO, Dept. 20-G
 111 North Canal St., Chicago 6, Ill.

Please rush to me all information on your 10-MONTH Radio-Television Training Plan. I understand this does not obligate me and that no salesman will call upon me. Be sure to include 3 books FREE.

Name..... Age.....

Address.....

City..... Zone..... State.....

I invite you to get all the facts—**FREE TO YOU 3 BIG RADIO-TELEVISION BOOKS**

I want you to have ALL the facts about my new 10-MONTH Radio-Television Training—without cost! Rush coupon for my three big Radio-Television books: "How to Make Money in Radio-Television." PLUS my new Illustrated Television Bulletin PLUS an actual sample Sprayberry Lesson—ALL FREE. No obligation and no salesman will call. Mail coupon NOW!



THE MOST *Outstanding* OSCILLOSCOPE IN HEATHKIT HISTORY
 NEW MODEL O-9
OSCILLOSCOPE KIT



Check THESE FEATURES

- Voltage regulated for rock steady traces—complete freedom from bounce and jitter.
- Wide band width down only 6 db at 3mc—reproduces 500 kc square wave and up to 10 mc sine wave.
- Acts as peak-to-peak vacuum tube voltmeter—measures directly on calibrated screen—built-in calibrator voltage.
- Retrace blanking amplifier eliminates confusion and gives clear concise picture of viewed wave form.
- Built-in 60 cycle sweep and phasing control—a necessity for TV service work.
- New production 5UP1 CR tube by RCA gives finest trace available for complex, hard-to-see wave forms.
- Properly compensated cathode follower vertical input controls trace reproduction at any input level.
- New ready formed and laced wiring harness eliminates unsightly and time consuming work of assembly.

MODEL O-9
\$59.50
 SHIPPING WT.
 28 LBS.

Announcing the newest addition to a brilliant series of Heathkit Oscilloscopes, the outstanding new model O-9 instrument. This Oscilloscope features a brand new 5UP1 cathode ray tube for really fine hairline focusing, good intensity and freedom from halation.

NEW FEATURES

Efficient voltage regulation system maintains rock steady trace stabilization. New retrace blanking amplifier circuit—amplifier band width further extended through efficient circuitry. Calibrated 1 volt peak-to-peak reference—wiring simplified by ready laced and formed wiring harness—new phasing control.

GOOD DESIGN

Terminal board for quick access to deflection plates—provisions for Z axis input—astigmatism control—balanced push-pull deflection amplifiers—internal sync on either positive or negative peaks.

VERTICAL AMPLIFIER

High impedance input with 6AB4 cathode follower, twin triode 12AT7 Cascade amplifier, 6C4 phase splitter and 12AT7 push-pull high gain deflection amplifier. Sensitivity .025 volts per inch.

HORIZONTAL AMPLIFIER

Five position input switch for choice of external input—line sweep—line sync—internal sync and external sync. Uses 12AU7 input stage, half as triode phase splitter driving 12AT7 push-pull high gain deflection amplifier. The remaining half of the 12AU7 used as retrace blanking amplifier.

POWER SUPPLY

New heavy duty internally shielded 100 milliampere power transformer. Efficient high voltage filtering system—voltage regulation completely eliminates trace bounce or jitter.

The Heathkit O-9 is the ideal general purpose oscilloscope for educational and industrial use. Radio and TV servicing and any other application requiring the instantaneous reproduction and observation of actual wave forms.

Heathkit **LOW CAPACITY PROBE KIT**



No. 342

\$3.50

SHIP. WT. 1 LB.

Oscilloscope investigation of high frequency, high impedance or broad band width circuits requires the use of a low capacity probe. The Heathkit Low Capacity Probe features a variable capacitor to provide the necessary degree of instrument impedance matching.

Heathkit **SCOPE DEMODULATOR PROBE KIT**



No. 337-B

\$3.50

SHIP. WT. 1 LB.

In applications such as trouble shooting TV, RF, IF and video stages, the frequency ranges encountered require the demodulation of signals before oscilloscope presentation. The Heathkit Demodulator Probe will fulfill this function and readily prove its value as a service accessory.

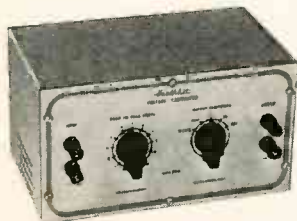

MODEL VC-2

\$11.50

SHIP. WT. 4 LBS.

Heathkit
VOLTAGE CALIBRATOR KIT

The Heathkit Voltage Calibrator provides a convenient method of making peak-to-peak voltage measurements with an oscilloscope. Peak-to-peak voltages are read directly on the calibrated panel scales in the range of .01 to 100 volts peak-to-peak. A convenient "signal" position on the panel switch can be used to by-pass the calibrator and apply the signal directly to the scope input.

Heathkit
ELECTRONIC SWITCH KIT

The basic function of the Heathkit S-2 Electronic Switch kit is to permit simultaneous oscilloscope observation of two separate traces which can be either separated or super-imposed for individual study. Continuously variable switching rates in three ranges from less than 10 cps to over 2000 cps. Individual gain controls for each input channel and a positioning control.



MODEL S-2

\$23.50

SHIP. WT. 11 LBS.

HEATH COMPANY • Benton Harbor 20, Mich.

Heathkit IMPEDANCE BRIDGE KIT

MODEL IB-2

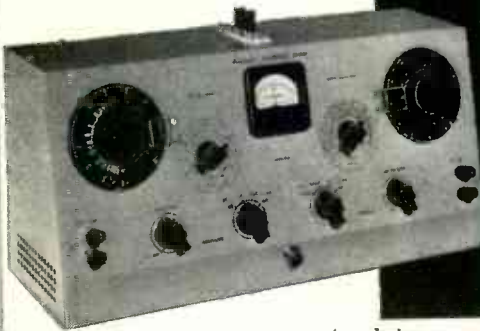
\$59⁵⁰SHIPPING WT.
15 LBS.

Another new, outstanding instrument design so typically characteristic of Heathkit operation in producing high quality instrument kits at the lowest possible price. A new, improved model Impedance Bridge kit featuring modern cabinet styling, with slanted panel for convenience of operation and interpretation of scales at a \$10.00 price reduction over the preceding model. Built-in adjustable phase shift oscillator and amplifier with all tubes of the battery operated type completely eliminates warm-up time. The instrument is entirely AC line operated. No bothersome battery replacements.

The Heathkit IB-2 Impedance Bridge Kit actually represents four instruments in one compact unit. The Wheatstone Bridge for resistance measurements, the Capacity Comparison Bridge for capacity measurements, Maxwell Bridge for low Q, and Hay Bridge for high Q inductance measurements. Read Q, D, DQ all on one dial thereby eliminating possible confusion due to the incorrect dial reference or adjustment. Only one set of instrument terminals nec-

essary for any measurement function. Panel provisions provided for external generator use.

A newly designed two section CRL dial provides ten separate "units" switch settings with an accuracy of .5%. Fractions of units are read on a continuously variable calibrated wire-wound control. A special minimum capacity, shielded, balanced impedance matching transformer between the generator and the bridge. The correct impedance match is automatically switch selected to provide constant load operation of the generator circuit. The instrument uses 1/2% precision resistors and condensers in all measurement circuits.

The new Heathkit IB-2 provides outstanding design features not found in any other kit instrument. The single low price includes the power supply, generator, and amplifier stages. No need to purchase separate instrument accessories in order to obtain the type of operation desired.

Features

- Simpson 100-0-100 microampere meter.
- Completely AC operated.
- Built-in phase shift generator and amplifier.
- Battery type tubes, no warm-up required.
- Newly designed two section CRL dial.
- Single knob D, Q, and DQ functions.
- Special impedance matching transformer.
- New modern cabinet styling.
- 1/2% precision resistors and silver mica condensers.

Heathkit AUDIO WATTMETER KIT

MODEL AW-1

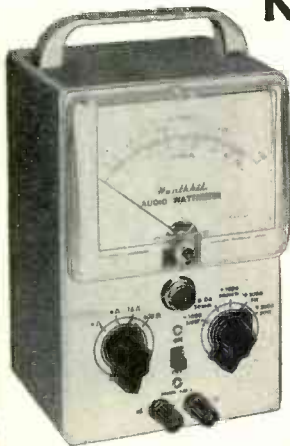
\$29⁵⁰SHIPPING WT.
6 LBS.

A new Heathkit design for the audio engineer, serious hi fi enthusiast, recording studio, or broadcast station; the Heathkit Audio Wattmeter Kit. This specialized instrument instantly indicates the output level of the equipment under test without requiring the use of external load resistors. All readings are taken directly from the calibrated scales of a 4 1/2" 200 microampere Simpson meter.

The Heathkit Audio Wattmeter features five full scale power measurement ranges from 5 milliwatts up to 50 watts with db ranges of -15 db to +48 db. The instrument has a power measurement rating of 25 watts continuous and 50 watts maximum for intermittent operation. Non-inductive resistance load impedances of 4, 8, 16, and 600 ohms are provided through a panel impedance selector switch. Frequency effect is negligible from 10 cycles to 250 kc. A conventional VTVM circuit utilizes a 12AU7 twin triode tube. The meter bridge circuit uses four germanium diodes for good linearity.

With the Heathkit AW-1 desired information can be obtained instantly and conveniently without bothering with the irksome setups and calculations usually required. Useful for power curve measurements, frequency response checks, monitoring indicator, etc. Convenient calibration directly from 110 volt AC line source. This new instrument will help to supply the answers to your audio operating or power output problems.

Heathkit LABORATORY GENERATOR KIT

MODEL LG-1

\$39⁵⁰SHIP. WT.
16 LBS.

Another welcome new addition to the popular line of Heathkit instruments, the Heathkit Laboratory Generator. Specifically designed for flexibility of operation, accuracy and versatility beyond the performance level provided by the conventional service type generator. Frequency coverage of the Colpitts oscillator is 150kc to 30mc in five convenient ranges with provisions for internal or external modulation up to 50%, and .1 volt RF output throughout the frequency range. Panel mounted 200 microampere Simpson meter for RF "set reference level" to provide relative indication of RF output. Individually shielded oscillator and shielded variable and step attenuator provide flexible control of RF output.

The circuit features a 6AF4 high frequency oscillator, a 6AV5 amplifier with grid modulation, 12AU7 400 cycle oscillator and modulator, OB2 voltage regulator tube, and a selenium rectifier for the transformer operated power supply. The smart professional instrument appearance and over-all flexibility of operation will prove a decided asset to any industrial or educational laboratory. The Heathkit Laboratory Generator sets a new level of operation, far superior to any instrument in this price classification.

HEATH COMPANY • Benton Harbor 20, Mich.



Heathkit VACUUM TUBE VOLTMETER KIT

MODEL V-6

\$24.50

SHIPPING WT. 6 LBS.

The beautiful Heathkit Model V-6 VTVM, the world's largest selling kit instrument, now offers many outstanding new features in addition to retaining all of the refinements developed and proven in the production of over 100,000 VTVM's. This is the basic measuring instrument for every branch of electronics. Easily meets all requirements for accuracy, stability, sensitivity, convenience of ranges, meter readability, and modern styling. It will accurately measure DC voltages, AC voltages, offers tremendous ohmmeter range coverage, and a complete db scale for a total of 35 meter ranges.

New 1½ volt full scale low range provides well over 2¼" of scale length per volt. Upper DC scale limit 1,500 volts. DC ranges 0-1.5, 5, 15, 50, 150, 500, 1,500 volts full scale. AC ranges 0-1.5, 5, 15, 50, 150, 500, 1,500 (1,000 volts maximum). Seven ohm-

meter ranges from .1 ohm to 1,000 megohms. For added convenience a DC polarity reversing switch and a center scale zero adjustment for FM alignment.

The smartly styled, compact, sturdy, formed aluminum cabinet is finished in an attractive gray crackle exterior. The beautiful two-color, durable, infra-red, baked enamel panel further adds to the over-all professional appearance.

Top quality components used throughout. 1% precision resistors — silver contact range and selector switches — selenium rectifier — transformer operated power supply. Individual calibration on both AC and DC for maximum accuracy. DB scale printed in red for easy identification, all other scales a sharp, crisp black for easy reading. A variety of accessory probes shown on this page still add further to over-all instrument usefulness.

Features

- ✓ New 1½ volt full scale low range
- ✓ 1,500 volt upper limit DC range
- ✓ Increased accuracy through 50% greater scale coverage
- ✓ High impedance 11 megohm input
- ✓ Center scale zero adjust
- ✓ Polarity reversal switch
- ✓ 1% precision resistors
- ✓ Clearly marked db scales

Heathkit 30,000 VOLT DC PROBE KIT

For TV service work or any similar application where the measurement of high DC voltage is required, the Heathkit Model 336 High Voltage Probe Kit will prove invaluable. A precision multiplier resistor mounted inside the two-color, sleek, plastic probe body provides a multiplication factor of 100 on the DC ranges of the Heathkit 11 megohm VTVM. The entire kit includes precision resistor, two-color plastic probe, tip connector spring, test lead, phone plug panel connector, and complete assembly instructions.



No. 336

\$4.50SHIP. WT.
2 LBS.

No. 338-B

Heathkit PEAK-TO-PEAK PROBE KIT

**\$5.50**

SHIP. WT. 2 LBS.

Now read peak-to-peak voltages on the DC scales of the Heathkit 11 megohm VTVM. Readings can be directly made from the VTVM scale without involved calculations. Measurements over the frequency range of 5 kc to 5 mc. Use this probe to extend the usefulness of your VTVM in radio and TV service work. The Peak-to-Peak Probe Kit features the new polished aluminum housing with two-color polystyrene probe ends. Detailed assembly sheet including instructions for probe operation.

Heathkit RF PROBE KIT

The Heathkit RF Probe used in conjunction with any 11 megohm VTVM will permit RF measurements up to 250 mc, ± 10%. A useful, convenient accessory for those occasions when RF measurements are desired. The RF probe body is housed in the new, smartly-styled polished aluminum probe body featuring two-color polystyrene probe ends and a low capacity flexible shielded test lead. The kit is complete with all necessary material and a detailed assembly sheet as well as instructions for probe operation.



No. 309-B

\$3.50

SHIP. WT. 2 LBS.

Heathkit AC VACUUM TUBE VOLTMETER KIT

MODEL AV-2

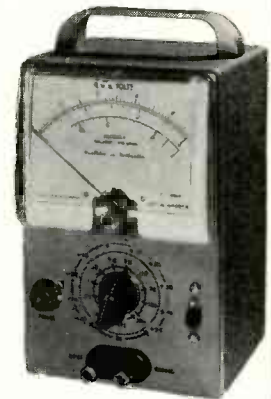
\$29.50SHIPPING WT.
5 LBS.

The new Heathkit AC VTVM that makes possible those sensitive AC measurements required by laboratories, audio enthusiasts, and experimenters. Especially useful for hum investigation, sensitive null detection, phono pick-up output measure-

ments, making frequency response runs, gain measurements, ripple voltage checks, etc. Low level measurements are easy to make because of the complete voltage coverage of the instrument and the one knob operation.

The large 200 microampere Simpson meter has clearly marked and easy to read meter scales. Ten voltage ranges covering from .01 rms full scale to 300 volts rms full scale, with frequency response ± 1 db from 20 cycles to 50,000 cycles. Instrument input impedance 1 megohm, ten db ranges from -52 db to +52 db. For stability and good linearity characteristics the meter bridge circuit features 4 germanium diodes. Attractive instrument styling, a companion piece for the popular Heathkit VTVM and the new AW-1 Audio Wattmeter.

HEATH COMPANY • Benton Harbor 20, Mich.

CHECK THESE *Features*

- ✓ 20,000 ohms per volt DC sensitivity, 5,000 ohms per volt on AC
- ✓ Polarity reversal switch
- ✓ 1% precision multiplier resistors
- ✓ 50 microampere 4½" Simpson meter
- ✓ Meter ranges for service convenience
- ✓ New resistor ring-switch assembly
- ✓ Total of 35 meter ranges
- ✓ New Modern cabinet styling

NEW *Heathkit* MULTIMETER KIT

MODEL MM-1

\$26⁵⁰

SHIPPING WT. 6 LBS.



The most important Heathkit announcement of the year, the new 20,000 ohms per volt Heathkit Multimeter, Model MM-1. The universal service measuring instrument, accurate, sensitive, portable, and completely independent of AC line supply. Particularly designed for service use incorporating many desirable features for the convenience of the service man. Full 20,000 ohms per volt sensitivity on DC ranges — 5,000 ohms per volt sensitivity on AC — polarity reversal switch, no bothersome transferring of test leads — 1% precision multiplier resistors — large 4½" recessed non-glare 50 microampere Simpson meter — conveniently slanted control panel — recessed safety type banana jacks — standard universally available batteries — rugged practical sized cabinet with plastic carrying handle, and a total of 35 calibrated meter ranges.

RANGES

Voltage ranges selected entirely for service convenience. For example 1½ volt full scale low range for measuring portable radio filament voltages, bias voltages, etc., 150 volt full scale range for AC-DC service work, 500 volt full scale range for conventional transformer operated power supply systems. Complete voltage ranges AC and DC, 0-1.5—5—50—150—500—1,500—5,000 volts. DC current ranges, 0-150 microamperes—15 milliamperes—150 milliamperes—500 milliamperes—15 amperes. Resistance measurements from .2 ohms to 20 meg-

ohms x 1 x 1,000 x 10,000.
DB coverage from -10 db
to +65 db.

CONSTRUCTION

Entirely new design permits assembly, mounting and wiring of precision resistors on a ring-switch assembly unit. The major portion of instrument wiring is completed before mounting the ring-switch assembly to the panel. No calibration procedure is required, all precision resistors readily accessible in event of replacement.

CABINET

Strikingly modern cabinet styling featuring two piece construction, durable black Bakelite cabinet, with easy to read panel designations. Cabinet size 5½" wide x 4" deep x 7½" high. Good cabinet physical stability when operated in vertical position.

The Heathkit MM-1 represents a terrific instrument value for a high quality 20,000 ohms per volt unit using all 1% deposited carbon type precision resistors. Here is quality, performance, functional design, and attractive appearance, all combined in one low priced package.

Heathkit BATTERY TESTER KIT



MODEL BT-1

\$8⁵⁰SHIP. WT.
2 LBS.

The Heathkit Battery Tester measures all types of dry batteries between 1½ volts and 150 volts under actual load conditions. Readings are made directly on a three color Good-Weak-Replace scale. Operation is extremely simple and merely requires that the test leads be connected to the battery under test. Only one control to adjust in addition to a panel switch for "A" or "B" battery types. The Heathkit Battery Tester features compact assembly, accurate meter movement, and a three deck wire-wound control, all mounted in a portable rugged plastic cabinet. Checks portable radio batteries, hearing aid batteries, lantern batteries, etc.

Heathkit HANDITESTER KIT



MODEL M-1

\$14⁵⁰SHIPPING WT.
3 LBS.

The Heathkit Model M-1 Handitester readily fulfills major requirements for a compact, portable volt ohm milliammeter. Despite its compact size, the Handitester is packed with every desirable feature required in an instrument of this type. AC or DC voltage ranges full scale, 0-10—30—300—1,000—5,000 volts. Two ohmmeter ranges, 0-3,000 and 0-300,000. Two DC current measurement ranges, 0-10 milliamperes and 0-100 milliamperes. The instrument uses a Simpson 400 microampere meter movement, which is shunted with resistors to provide a uniform 1 milliamper load on both AC and DC ranges. Special type, easily accessible, battery mounting bracket — 1% deposited carbon type precision resistors — hearing aid type ohms adjust control. The Handitester is easily assembled from complete instructions and pictorial diagrams. Necessary test leads are included in the price of this popular kit.

HEATH COMPANY • Benton Harbor 20, Mich.

New *Heathkit* 12 Volt BATTERY ELIMINATOR KIT

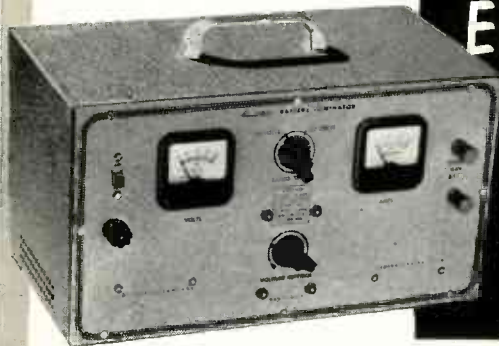

MODEL BE-4

\$31⁵⁰SHIPPING WT.
18 LBS.

CHECK THESE *Features*

- ✓ Either 6 or 12 volt operation
- ✓ Continuously variable voltage output
- ✓ Constant ammeter and voltmeter monitoring
- ✓ Automatic overload relay — self-resetting
- ✓ Two 10,000 mf condensers
- ✓ New 18 disc split type heavy duty rectifier unit
- ✓ Fuse protection

Here is the new Heathkit Battery Eliminator necessary for modern, up-to-date operation of your service shop. The Heathkit Model BE-4 furnishes either 6 volts or 12 volts output which can be selected at the flick of a panel switch. Use the BE-4 to service the new 12 volt car radios in addition to the conventional 6 volt radios.

This new Battery Eliminator provides two continuously variable output ranges, 0-8 volts DC at 10 amperes continuously, or 15 amperes maximum intermittent; 0-16 volts DC at 5 amperes continuously or 7.5 amperes maximum intermittent. The output voltage is clean and well filtered as the circuit uses two 10,000 mf condensers. The continuously variable voltage output feature is a definite aid in determining the starting point of vibrators, the voltage operating range of oscillator circuits, etc. Panel mounted meters constantly monitor voltage and cur-

rent output and will quickly indicate the presence of a major circuit fault in the equipment under test. The power transformer primary winding is fuse protected and for additional safety an automatic relay of the self-resetting type is incorporated in the DC output circuit. The heavy duty rectifier is a split type 18 plate magnesium copper sulfide unit used either as a full wave rectifier or voltage doubler according to the position of the panel range switch.

Here is the ideal battery eliminator for all of your service problems and as an additional feature, it can also be used as a battery charger. Another new application for the Heathkit Battery Eliminator is a variable source of DC filament supply in audio development and research. More than adequate variable voltage and current range for normal applications.

Heathkit VIBRATOR TESTER KIT

Your repair time is valuable, and service use of the Heathkit Vibrator Tester will save you many hours of work. This tester will instantly tell you the condition of the vibrator being checked. Checks vibrators for proper starting and the easy to read meter indicates quality of output on a large Bad-? Good scale. The Heathkit VT-1 checks both interrupter and self rectifier types of vibrators. Five different sockets for checking hundreds of vibrator types.

The Heathkit Vibrator Tester operates from any battery eliminator capable of delivering continuously variable voltage from 4 to 6 volts DC at 4 amperes. The new Heathkit Model BE-4 Battery Eliminator would be an ideal source of supply.



MODEL VT-1

\$14⁵⁰SHIPPING WT.
6 LBS.

NEW *Heathkit* VARIABLE VOLTAGE ISOLATION TRANSFORMER KIT

The new Heathkit Isolation Transformer Kit provides line isolation for AC-DC radios (not an auto transformer), thereby eliminating shock hazard, hum problems, alignment difficulties, etc. The output voltage is variable from 90 to 130 volts AC and is constantly monitored by a panel mounted AC volt meter. Use it to increase AC supply voltage in order to induce breakdown of faulty components in circuits thereby saving service time. Use it also to simulate varying line voltage conditions and to determine the line voltage level at which oscillator circuits cease functioning, particularly in three-way portable radios. Rated at 100 watts continuous operation and up to 200 watts maximum intermittent operation. A useful radio and TV service tool.



MODEL IT-1

\$16⁵⁰

SHIP. WT. 9 LBS.

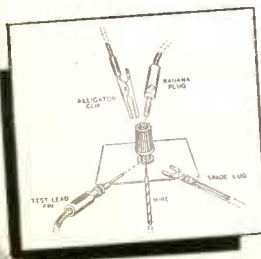

Heathkit BINDING POST

Binding post kit now available so that standardization of all instrument connectors is possible. This new, five-way binding post will accommodate an alligator clip, banana plug, test lead pin, spade lug, or hook-up wire. Sold in units of 20 binding post assemblies. Each assembly includes binding post, flat and shoulder fiber washers, solder lug, and nut. 120 pieces in all. Kit 362, \$4.00.



Heathkit TECHNICAL

APPLICATION BULLETINS

An exclusive Heathkit service. Technical application bulletins prepared by recognized instrument authorities outlining various combinations of instrument applications. Available now with 40 four-page illustrated bulletins and an attractive flexible loose-leaf binder. Only \$2.00. (No c.o.d. on this item, please.)

HEATH COMPANY • Benton Harbor 20, Mich.

CHECK THESE *Features*

- ✓ INCREDUCTOR controllable inductor sweep
- ✓ TV and IF sweep deviation 12-30 mc
- ✓ 4 mc- 220 mc continuous frequency coverage
- ✓ Oscillator operation entirely on fundamentals
- ✓ Output in excess of 100,000 microvolts
- ✓ Automatic amplitude circuit
- ✓ Voltage regulation
- ✓ Simplified operation

NEW *Heathkit*
**TV ALIGNMENT
 GENERATOR
 KIT**

MODEL TS-3

\$44.50SHIPPING WEIGHT
18 POUNDS

Proudly announcing an entirely new, advanced model TV and FM Sweep Generator, the Heathkit Model TS-3. This new design provides features and combinations of functions not found in any other service type instrument. Every design consideration has been given to the requirements of the TV service man to provide a flexible, variable sweep source with more than adequate RF output and complete frequency coverage throughout the TV and FM spectrum.

The frequency range of the TS-3 is from 4 mc to 220 mc in four switch selected ranges. All frequency ranges are overlapping for complete coverage. A particularly important feature of the instrument is that the oscillator operates entirely on fundamentals, thereby providing complete freedom from spurious oscillation and parasitics normally encountered in beat frequency type oscillators. This circuitry assures a much higher total RF output level and simplifies attenuation problems.

The new TS-3 features an entirely new principle of sweep operation. Sweep action is entirely electronic with no moving parts or electro-mechanical devices so commonly used. The heart of the sweep system is a newly-developed INCREDUCTOR controllable inductor. With this system, the value of inductance of each oscil-

lator coil is electrically varied with an AC control current, and the inductance variation is achieved by a change in the magnetic state of the core on which the oscillator coils are wound. This system provides a sweep deviation of not less than 12 mc on all TV frequencies, and up to a maximum of 30 mc on TV IF frequencies. The high RF output level throughout the instrument frequency range overcomes the most common complaint of the older type sweep generators. A new, automatic amplitude control circuit maintains the output level flat to ± 2 db throughout the instrument range. For convenience of operation a low impedance 50 ohm output is used.

Operation of the instrument has been simplified through the reduction of panel controls and separate panel terminals provide for external synchronization if desired. The circuit uses a voltage regulator tube to maintain stable instrument operation. A built-in variable oscillator marker further adds to flexibility of instrument operation. Provisions are also made for the use of an external marker, such as your service type signal generator, if desired. Use the Heathkit TS-3 for rapid, accurate TV alignment work, and let it help you solve those time consuming, irksome problems so frequently encountered.

NEW *Heathkit*
SIGNAL GENERATOR KIT

MODEL SG-8

\$19.50SHIPPING WEIGHT
8 POUNDS

Announcing the new Heathkit Model SG-8 service type Signal Generator, incorporating many design features not usually found in an instrument in this price range. The RF

output is from 160 kc to 100 mc in five ranges, all on fundamentals, with useful harmonics up to 200 mc. The RF output level is in excess of 100,000 microvolts throughout the frequency range.

The oscillator circuit consists of a 12AT7 twin triode tube. One half is used as a Colpitts oscillator, and the other half as a cathode follower output which acts as a buffer between the oscillator and external load. This circuitry eliminates oscillator frequency shift usually caused by external circuit loading.

All coils are factory wound and adjusted, thereby completely eliminating the need for calibration and the use of additional calibrating equipment. The stable low impedance output features a step and variable attenuator for complete control of RF level. A 6C4 triode acts as a 400 cycle sine wave oscillator and a panel switching system permits a choice of either external or internal modulation.

The transformer operated circuit is easy to assemble, requires no calibration, and meets every service requirement for an adjustable level variable frequency signal source, either modulated or un-modulated.

NEW *Heathkit*
BAR GENERATOR KIT

MODEL BG-1

\$14.50SHIPPING WEIGHT,
6 POUNDS

The Heathkit BG-1 Bar Generator represents another welcome addition to the fast growing line of popular Heathkits. The

station transmitted test pattern is rapidly disappearing, and the bar generator is the logical answer to the TV service man's problem in obtaining quick, accurate adjustment information without waiting for test patterns.

The Heathkit BG-1 produces a series of horizontal or vertical bars on a TV screen. Since these bars are equally spaced, they will quickly indicate picture linearity of the receiver under test. Panel switch provides "stand-by position" — "horizontal position" — "vertical position." The oscillator unit utilizes a 12AT7 twin triode for the RF oscillator and video carrier frequencies. A neon relaxation oscillator provides low frequency for vertical linearity tests. The instrument will not only produce bar patterns but will also provide an indication of horizontal and vertical sync circuit stability, as well as overall picture size.

Instrument operation is extremely simple, and merely requires connection to the TV receiver antenna terminal. The unit is transformer operated for safety when used in conjunction with universal or transformerless type TV circuits.

HEATH COMPANY • Benton Harbor 20, Mich.



NEW *Heathkit* TUBE CHECKER KIT

MODEL TC-2

\$29.50

SHIP. WT. 12 LBS.

The new Model TC-2 Heathkit Tube Checker features many circuit improvements, simplified wiring, new roll chart drive and illumination of roll chart. The instrument is primarily designed for the convenience of the radio and TV service man and will check the operating quality of tubes commonly encountered in this type of work. Test set-up procedure is simplified, rapid, and flexible. Panel sockets accommodate 4, 5, 6, and 7 pin tubes, octal and local, 7 and 9 pin miniatures, 5 pin Hytron and a blank socket for new tubes. Built-in neon short indicator, individual three-position lever switch for each tube element, spring return test switch, 14 filament voltage ranges, and line set control to compensate for supply voltage variations, all represent important design features of the TC-2. Results of tube tests are read directly from a large 4½" Simpson three-color meter, calibrated in terms of Bad?-Good. Information that your customer can readily understand. Checks emission, shorted elements, open elements, and continuity.

The use of closer tolerance resistors in critical circuits assures correct test information and eliminates the possibility of inaccurate test interpretation. Improvement has been made in the mechanical roll chart drive system, completely eliminating diagonal running, erratic operation, and backlash. The thumb wheel gear driven action is smooth, positive, and free running. As an additional feature, the roll chart is illuminated for easier reading, particularly when the tube checker is used on radio or TV home service calls.

Wiring procedure has been simplified through the extended use of multi-colored, color coded wires, providing a harness type installation between tube sockets and lever switches. This procedure insures standard assembly and imparts that "factory built" appearance to instrument construction. Completely detailed information is furnished in the new step-by-step construction manual, regarding the set-up procedure for testing of new or unlisted tube types. No delay necessary for release of factory data.

The new Heathkit Tube Checker will prove its value, in building service prestige through usefulness—simplified operation—attractive professional appearance. Don't overlook the fact that the kit price represents a savings of \$40.00 to \$50.00 over the price of a comparable commercially built instrument. At this low price, no service man need be without the advantages offered by the Heathkit Tube Checker.

CHECK THESE NEW *Features*

- ✓ Simplified harness wiring
- ✓ Improved, smooth, anti-backlash roll chart action
- ✓ Optional roll chart illumination
- ✓ Individual element switches
- ✓ Portable or counter style cabinet
- ✓ Spare blank socket
- ✓ Contact type pilot light test socket
- ✓ Simplified test set-up procedure
- ✓ Line adjust control
- ✓ 4½" three-color meter

New

HEATHKIT PORTABLE TUBE CHECKER KIT

MODEL TC-2P

\$34.50

SHIP. WT. 14 LBS.



The portable model is supplied with a strikingly attractive two-tone cabinet finished in rich maroon, proxylin impregnated, fabric covering with a contrasting gray on the inside cover. Detachable cover, brass-plated hardware, sturdy plastic handle help to impart a truly professional appearance to the instrument.

PORTABLE TUBE CHECKER CABINET as described above will fit all earlier Heathkit TC-1 Tube Checkers. Shipping weight 7 lbs. Cabinet only, 91-8, \$7.50.



No. 355
Ship. Wt. **\$4.50**
1 lb.

Heathkit TV PICTURE TUBE TEST ADAPTER

The Heathkit TV Picture Tube Test Adapter used with the Heathkit Tube Checker will quickly check for emission, shorts, etc., and determine picture tube quality. Consists of standard 12 pin TV tube socket, four feet of cable, octal socket connector, and data sheet.

Heathkit POWER SUPPLY KIT



MODEL PS-2

\$33.50SHIPPING WT.
17 LBS.

The Heathkit Laboratory Power Supply features continuously variable, regulated voltage output with good stability under wide load variations. A 4½" Simpson plastic enclosed panel mounted meter provides accurate meter output information of voltage or current. All panel terminals completely isolated from the cabinet. Separate 6.3 volt AC supply at 4 amperes for filament requirements. Ripple component exceptionally low, stand-by switch provided to eliminate warm-up time of the five tube circuit.



LABORATORY AND SERVICE SHOP BOOKLETS

"Planning Your Service Business" by John T. Frye, and "Establishing the Industrial Electronics Laboratory" by Louis B. Garner, Jr., are booklets available to Heathkit customers at no charge. These booklets, written by nationally recognized authorities, outline the various requirements and considerations for establishing your own service business or for setting up an industrial electronics laboratory. Full attention is given to various details that are frequently overlooked when projects of this nature are undertaken. Just write in to the Heath Company requesting your free copy, or attach a memo to your next order.

HEATH COMPANY • Benton Harbor 20, Mich.

CHECK THESE *Features*

- ✓ Visual and aural signal tracing
- ✓ Two channel input
- ✓ High RF sensitivity
- ✓ Unique noise locator circuit
- ✓ Calibrated wattmeter
- ✓ Substitution test speaker
- ✓ Utility amplifier
- ✓ RF, audio probes and test leads included

Heathkit VISUAL-AURAL SIGNAL TRACER

KIT

MODEL T-3

\$23⁵⁰

SHIPPING WEIGHT
10 POUNDS

An entirely new type of signal tracer incorporating a combination of features not found in any other instrument. Designed expressly for the radio and TV service man, particularly for the servicing of AM, FM, and TV circuits. Here in a five tube, transformer operated instrument are all of the useful functions so necessary for speedy, accurate isolation of service difficulty.

This new signal tracer features a special high gain RF input channel, used in conjunction with a newly-designed wide frequency range demodulator probe. High RF sensitivity permits signal tracing at the receiver antenna input. A separate low gain channel and probe available for audio circuit exploration. Both input channels are constantly monitored by an electron ray beam indicator, so that visual as well as aural signal indications may be observed. The instrument can also be used for comparative estimation of gain per stage.

A decidedly unusual feature is a noise localizer circuit in conjunction with the audio probe. With this system, a DC potential is applied to a suspected circuit component and the action of the

voltage in the component can be seen as well as heard. Invaluable for ferreting out noisy or intermittent condensers, noisy resistors, controls, coils, IF and power transformers, etc. A built-in calibrated wattmeter circuit is very useful for a quick preliminary check of the total wattage consumption of the equipment under test. Separate panel terminals provide external use of the speaker or output transformer for substitution purposes. Saves valuable service time by eliminating the necessity for speaker removal on every service job. The terminals also permit the utilization of other shop equipment, such as your oscilloscope or VTVM. The T-3 Signal Tracer can be used as a high gain amplifier for checking tuners, record changers, microphones, phono crystals, etc.

Don't overlook the interesting service possibilities provided through the use of this new instrument and let it work for you by saving time and money. The kit is supplied complete with all tubes, circuit components, demodulator probe, audio probe, and additional test leads.



Heathkit DECADE RESISTANCE KIT

MODEL DR-1

\$19⁵⁰

SHIP. WT.
4 LBS.

The Decade Resistance Kit provides individual switch selection of resistance values using twenty 1% resistors providing a choice of 1 to 99,999 ohms in 1 ohm steps. Ceramic wafer switches, silver-plated contacts, smooth, positive detent action, baked enamel panel, and handsome, polished birch cabinet.

Heathkit DECADE CONDENSER KIT

The Heathkit Decade Condenser Kit features silver mica, precision condensers with a rated accuracy of $\pm 1\%$. Capacity values are arranged in three decades from 100 mmf to .111 mf in steps of 100 mmf. Ceramic wafer switches with silver-plated contacts and smooth detent action. Useful in laboratory work, for circuit development.

MODEL DC-1

\$16⁵⁰

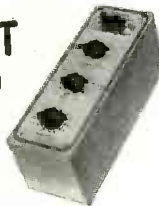
SHIP WT.
4 LBS.

Heathkit RESISTANCE SUBSTITUTION BOX KIT

MODEL RS-1

\$5⁵⁰

SHIP. WT.
2 LBS.

The Heathkit Resistance Substitution Box provides individual switch selection of any one of 36 RTMA 1 watt 10% standard value resistors, ranging from 15 ohms to 10 megohms. Many applications in circuit development work, and also in radio and TV service work. Ideal for experimentally determining resistance values and for quickly altering circuit operating characteristics. Entire unit housed in attractive Bakelite cabinet, featuring the new universal type Heathkit binding posts to simplify circuit connections.

Heathkit CONDENSER CHECKER KIT

MODEL C-3

\$19⁵⁰

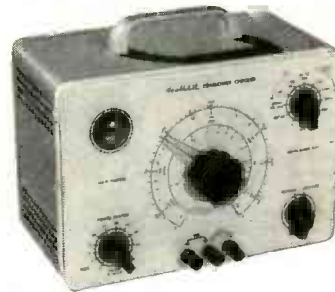
SHIPPING WT.
8 POUNDS

Use the Heathkit C-3 Condenser Checker to quickly and accurately measure those unknown condenser

and resistor values. All readings are taken directly from the calibrated panel scales without requiring any involved calculation. Capacity measurements in four ranges from .00001 mf to 1,000 mf. Checks paper, mica, ceramic, and electrolytic condensers. A power factor control is available for accurate indication of electrolytic condenser measurements. A leakage test switch with switch selection of five polarizing voltages, 25 volts to 450 volts DC, will indicate condenser operating quality under actual load condition. The spring return leakage test switch automatically discharges the condenser under test and eliminates shock hazard to the operator.

Resistance measurements can be made in the range from 100 ohms to 5 megohms. Here again all values are read directly on the calibrated scale. Increased circuit sensitivity coupled with an electron beam null indicator increases overall instrument usefulness.

For safety of operation the circuit is entirely transformer operated and the instrument is housed in the attractive, newly-styled Heathkit cabinet, featuring rounded corners, and drawn aluminum panel. The outstanding low kit price for this surprisingly accurate instrument includes necessary test leads. Good service shop operation requires the use of this specialized instrument, designed for the express purpose of determining unknown condenser values and operating characteristics.

HEATH COMPANY • Benton Harbor 20, Mich.



Heathkit AMATEUR TRANSMITTER KIT

MODEL AT-1

\$29.50

SHIPPING WEIGHT
16 POUNDS

Here is the latest Heathkit addition to the ham radio field, the AT-1 Transmitter Kit, incorporating many desirable design features at the lowest possible dollar-per-watts price. Panel mounted crystal socket, stand-by switch, key click filter, AC line filtering, good shielding, etc. VFO or crystal excitation—up to 35 watts input. Built-in power supply provides 425 volts at 100 ma.

This kit features pre-wound coils, single knob band switching, 52 ohm coaxial output, plug in chassis provisions for VFO or modulator and rugged clean construction. Frequency range 80, 40, 20,

15, 11, and 10 meters. Tube line-up 6AG7 oscillator-multiplier, 6L6 amplifier-doubler, 5U4G rectifier. Physical dimensions $8\frac{1}{8}$ " high x $13\frac{1}{8}$ " wide x 7" deep.

This amazingly low kit price includes all circuit components, tubes, cabinet, punched chassis, and detailed construction manual. The ideal kit for the novice just breaking into ham radio. It can be used later on as a stand-by rig or an all band exciter for higher powered transmitter.

CHECK THESE NEW Features

- ✓ Single knob band switching
- ✓ Pre-wound coils
- ✓ Metered operation
- ✓ 52 ohm coaxial output
- ✓ Crystal or VFO excitation
- ✓ Built-in power supply
- ✓ Rugged, clean construction

NEW Heathkit ANTENNA COUPLER KIT

New Heathkit Antenna Coupler, specially designed for the Heathkit AT-1 Transmitter. The Antenna Coupler can be used with any 52 ohm coaxial input—up to 75 watts power. Low pass filter with cut-off frequency of approximately 36 mc—L section tuning network—neon tuning indicator—rugged, compact construction—transmitter type variable condenser, and high Q coil are all outstanding features. The AC-1 has both inductance and capacity tuning for maximum operating versatility. Dimensions $8\frac{1}{8}$ " wide x $4\frac{3}{8}$ " high x $4\frac{7}{8}$ " deep.



MODEL AC-1

\$14.50 SHIP. WT.
3 LBS.

Heathkit ANTENNA IMPEDANCE METER

Use the Heathkit Antenna Impedance Meter for measuring antenna impedance for line matching purposes—adjustment of beam antennas—phone monitor, etc. It will determine antenna resistance at resonance, match transmission line for minimum SWR, determine receiver input impedance, and provide a rough indication of SWR. Precision resistors, germanium diode, 100 micro-ampere Simpson meter. Dial calibrated from 0-500 ohms. Shielded aluminum cabinet. 7" long x $2\frac{1}{2}$ " wide x $3\frac{1}{4}$ " deep.



MODEL AM-1

\$14.50
SHIP. WT. 3 LBS.

Heathkit COMMUNICATIONS RECEIVER KIT

MODEL AR-2

\$25.50 SHIP. WT.
12 LBS.



Here is the new receiver kit you have repeatedly asked for, the Heathkit Communications Receiver. The perfect companion piece for the AT-1 Transmitter kit. Many outstandingly desirable features have been incorporated in the design of the AR-2; such as, electrical bandspread for logging and tuning convenience—high gain miniature tubes—IF transformers for high sensitivity and good signal to noise ratio—separate RF gain control with optional automatic volume control or manual volume control, in addition to the conventional audio gain control. Noise limiter—stand-by switch—stable BFO oscillator circuit—headphone jack—transformer operation, etc., all contribute to a high performance standard.

Frequency coverage is continuous from 535 kc to 35 mc in four ranges. For added convenience, various ham bands have been separately identified in respect to their relative placement on the slide rule tuning scale. A chassis mounted, $5\frac{1}{2}$ " PM speaker is included with this kit. Tube line up 12BE6 mixer oscillator, 12BA6 IF amplifier, 12AV6 detector AVC audio, 12BA6 BFO oscillator, 12A6 beam power output, 5Y3GT rectifier.

RECEIVER CABINET

Proxylin impregnated, fabric covered, plywood cabinet with aluminum panel designed expressly for the AR-2 Receiver. Part 91-10, shipping weight 5 lbs., \$4.50.

IMPROVED Heathkit GRID DIP METER KIT

\$19.50 SHIP. WT.
4 LBS.

MODEL GD-1B



The invaluable instrument for service men, hams, and experimenters. Useful in TV service work for alignment of traps, filters, IF stages, peaking compensation networks, etc. Locates spurious oscillation, provides a relative indication of power in transmitter stages, use it for neutralization, locating parasitics, correcting TVI, measuring C, L, and Q of components, and determining RF circuit resonant frequencies. With oscillator energized, useful for finding resonant frequency of tuned circuits. With the oscillator not energized, the instrument acts as an absorption wave meter. Variable meter sensitivity control, head phone jack, 500 microampere Simpson meter. Continuous frequency coverage from 2 mc. to 250 mc. Pre-wound coil kit and rack, new three prong coil mounting, 6AF4 high frequency triode.

Two additional plug-in coils are available and provide continuous extension of low frequency coverage down to 355 kc. Dial correlation curves included. Shipping weight 1 lb., kit 341, \$3.00.



HEATH COMPANY • Benton Harbor 20, Mich.

CHECK THESE *Features*

- ✓ First popular priced Q Meter
- ✓ Reads Q directly on calibrated scale
- ✓ Oscillator supplies RF frequencies of 150 kc to 18 mc
- ✓ Calibrate capacitor with range of 40 mmf to 450 mmf with vernier of ± 3 mmf
- ✓ Measures Q of condensers, RF resistance, and distributed capacity of coils
- ✓ Many applications in design and development work
- ✓ Useful in TV service work for checking deflection yokes, coils, chokes, etc.

Heathkit "Q" METER KIT

MODEL QM-1

\$44.50

SHIPPING WT. 14 POUNDS

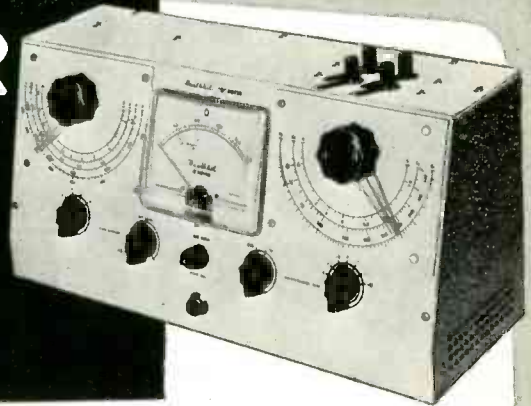

Another outstanding example of successful Heathkit engineering effort in producing a Q Meter Kit within the price range of TV service men, schools, laboratories, and experimenters. This Q Meter meets RF design requirements for rapid, accurate measurement of capacity, inductance, and Q at the operating frequency and all indications of value can be read directly on the meter calibrated scales. Oscillator section supplies RF fre-

quencies of 150 kc to 18 mc. Calibrate capacitor with range of 40 mmf to 450 mmf, with vernier of ± 3 mmf.

Particularly useful in TV service work for checking peaking coils, wave traps, chokes, deflection coils, width and linearity coils, etc. At this low kit price research laboratory facilities are within the range of service shops, schools, and experimenters.

Heathkit INTERMODULATION ANALYZER KIT



MODEL IM-1

\$39.50SHIPPING WT.
17 POUNDS

The Heathkit IM-1 is an extremely versatile instrument specifically designed for measuring the degree of inter-action between two signals in any portion of an audio chain. It is primarily intended for making tests of audio amplifiers, but may be used in other applications, such as checking microphones, records, recording equipment, phonograph pick-ups, and loud-speakers. High and low test frequency source, intermodulation unit, power supply, and AC vacuum tube volt meter all in one complete instrument. Per cent intermodulation is directly read on the calibrated scales, 30%, 10%, and 3% full scale. Both 4:1 and 1:1 ratios of low to high frequency easily set up. With this instrument the performance level of present equipment, or newly developed equipment can be easily and accurately checked. At this low price, you can now enjoy the benefits of intermodulation analysis for accurate audio interpretation.

Heathkit AUDIO GENERATOR KIT

MODEL AG-8

**\$29.50**

SHIP. WT. 11 LBS.

A Heathkit Audio Generator with frequency coverage from 20 cycles to 1 mc. Response flat ± 1 db from 20 cycles to 400 kc, down 3 db at 600 kc, and down only 8 db at 1 mc. Calibrated, continuously variable, and step attenuator output controls provide convenient reference output level. Distortion is less than .4% from 100 cps through the audible range. The ideal controllable extended frequency sine wave source for audio circuit investigation and development.

Heathkit AUDIO OSCILLATOR KIT



MODEL AO-1

\$24.50

SHIP. WT. 11 LBS.

Sine or square wave coverage from 20 to 20,000 cycles in three ranges at a controllable output level up to 10 volts. Low distortion, 1% precision resistors in multiplier circuits, high level output across entire frequency range, etc., readily qualify this instrument for audio experimentation and development work. Special circuit design consideration features thermistor operation for good control of linearity.

Heathkit AUDIO FREQUENCY METER KIT



MODEL AF-1

\$34.50

SHIP. WT. 12 LBS.

The Heathkit Audio Frequency Meter provides a simple and convenient means of checking unknown audio frequencies from 10 cycles to 100 kc at any voltage level between 3 and 300 volts rms with any non-critical wave shape. Instrument operation is entirely electronic. Just set the range switch, feed an unknown frequency into the instrument, and read the frequency directly on the calibrated scale of the Simpson $4\frac{1}{2}$ " meter.

Heathkit SQUARE WAVE GENERATOR KIT

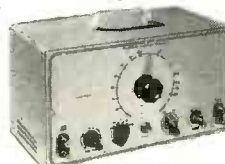

MODEL SQ-1

\$29.50

SHIP. WT. 12 LBS.

The Heathkit Square Wave Generator provides an excellent square wave frequency source with completely variable coverage from 10 cycles to 100 kc. This generator features low output impedance of 600 ohms and the output voltage is continuously variable between 0 and 20 volts, thereby providing the necessary degree of operating flexibility. An invaluable instrument for those specialized circuit investigations requiring a good, stable, variable square wave source.

HEATH COMPANY • Benton Harbor 20, Mich.

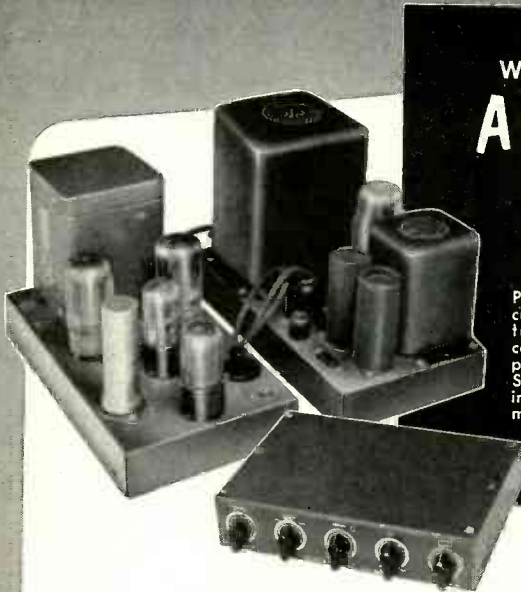

Heathkit WILLIAMSON TYPE AMPLIFIER KIT

MODEL W-2

Particularly designed for custom installations, featuring separate cable connected units for simplicity of installation. Sheet metal work finished in attractive gray hamertone for smart appearance. All control shafts of the adjustable length break-off type.

\$69.⁵⁰

PRICES OF COMBINATIONS

W-2 Amplifier Kit including main amplifier, power supply, and WA-P1 Preamplifier Kit. Shipping Weight 37 lbs. Shipped Express only. **\$69.⁵⁰**

W-2M Amplifier Kit includes main amplifier and power supply. Shipping Weight 29 lbs. Shipped Express only. **\$49.⁷⁵**

WA-P1 Preamplifier Kit only. Shipping Weight 6 lbs. Shipped Express or Parcel Post. **\$19.⁷⁵**

When selecting an amplifier for the heart of your high fidelity audio system, investigate the outstanding advantages offered by the Heathkit Williamson Type Amplifier. Meets every high fidelity audio requirement and makes listening to recorded music a thrilling new experience. This outstanding amplifier is offered with optional output transformer

operation, providing either the conventional triode output circuit or the new extended power circuitry in which the screen supply voltage is obtained from separate transformer primary taps. Frequency response within ± 1 db from 10 cycles to 100 kc. Tube complement — 6SN7 cascade amplifier and phase splitter, 6SN7 push pull driver, two 5881 push pull power amplifiers, one 5V4G cathode type rectifier.

Matching preamplifier available providing three switch selected inputs, correct compensation, and individual bass and treble tone controls. Uses 12AY7 (or 12AX7) preamplifier — 12AU7 tone control amplifier.

Particularly designed for the novice kit builder and requires no specialized knowledge or equipment for successful assembly and operation.

NEW Heathkit 20 WATT High Fidelity AMPLIFIER KIT

MODEL A-9A



\$35.⁵⁰

SHIP. WT. 18 LBS.

A new 20 watt high fidelity amplifier, designed especially for custom audio installations demanding clean reproduction, adequate power, and flexibility to meet individual requirements. Separate treble and bass tone controls provide up to 15 db boost or cut. Four switch selected inputs, each with the necessary compensation for the service desired. Output transformer impedances of 4, 8, and 16 ohms.

Preamplifier, tone control, and phase splitter circuits utilize 9 pin twin triode miniature tubes for low hum and noise level. Two 6L6 push pull power output tubes provide full 20 watts power. Frequency response ± 1 db, 20-20,000 cycles. Total harmonic distortion 1% (at 3 db below rated output). Tube line-up: 12AX7 preamplifier, 12AU7 voltage amplifier and tone control, 12AU7 voltage amplifier and phase splitter, two 6L6 push pull pentode power output, 5U4G rectifier. Truly outstanding amplifier performance coupled with low cost.



MODEL A-7B

\$15.⁵⁰

SHIP. WT. 10 LBS.

Heathkit ECONOMY 6 WATT AMPLIFIER KIT

The new Heathkit Model A-7B Amplifier offers many unusually fine features not normally expected in this low price range. Either of the two input circuits may be individually switch selected for phono or tuner operation. Separate bass and treble tone controls. Output impedances of 4, 8, and 15 ohms. Push pull beam power output stage for balanced reproduction. Excellent voltage gain characteristics, good frequency response, and full 6 watts power output. 12J5 amplifier, 12SL7 second amplifier and phase splitter, two 12A6 beam power output, one 5Y5 GT rectifier.

A-7C incorporates preamplifier stage with special compensated network to provide necessary gain for operation with variable reluctance or low output level phono cartridge. Circuit is properly compensated for microphone operation. \$17.50.

NEW Heathkit BROADCAST BAND RECEIVER KIT

Another new Heathkit for the student, beginner, or hobbyist. If you have ever had the urge to build your own radio receiver, this kit warrants your attention.

New high gain miniature tubes and IF transformers provide excellent sensitivity and good signal to noise ratio. A built-in ferrite core rod type antenna has been provided. A chassis mounted $5\frac{1}{2}$ " PM speaker provides excellent tone and volume. Convenient phono input. Can be operated either as a receiver or tuner. Simplified construction manual outlines circuit theory. Ideal for students. Tube line-up: 12BE6 mixer oscillator, 12BA6 IF amplifier, 12AV6 detector-AVC-first audio, 12A6 beam power output, 5Y3GT rectifier.



MODEL BR-2

\$17.⁵⁰ SHIP. WT. 11 LBS.

CABINET — Proxylin impregnated fabric covered plywood cabinet. Shipping weight 5 lbs. Part number 91-9, \$4.50.

Heathkit FM TUNER KIT

The Heathkit FM-2 Tuner was specifically designed for simplified kit construction.

Can be operated through the "phono" portion of your radio or with a separate amplifier. The kit features a pre-assembled and adjusted tuning unit, three double tuned IF transformers, and a discriminator transformer in an 8 tube AC operated circuit. Frequency coverage 88 to 108 mc. Experience the thrill of building your own FM tuner and at the same time enjoy all of the advantages of true FM reception.

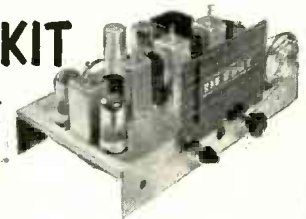

MODEL FM-2

\$22.⁵⁰

SHIP. WT. 9 LBS.

Free CATALOG

Write for free catalog containing latest price information, schematics, specifications, and descriptions of all Heathkits.

HEATH COMPANY • Benton Harbor 20, Mich.

Transistor Code Practice Oscillator

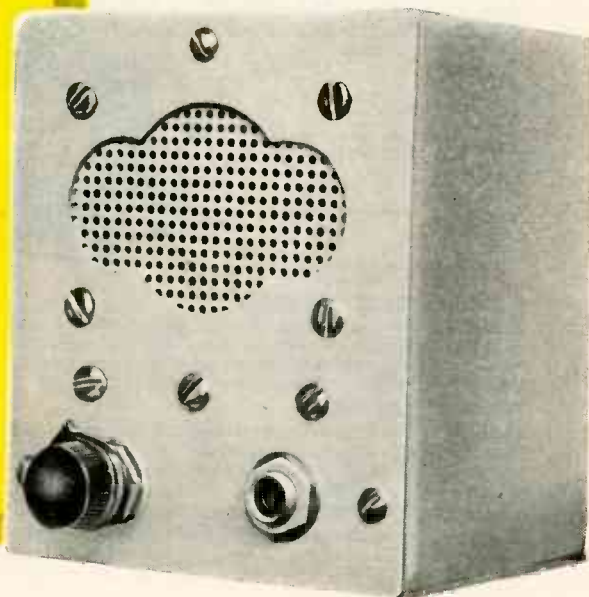

By A. L. CLELAND, K2ADS*

Front view of the miniature transistorized code-practice and a.f. oscillator.

THE point-contact transistor is a natural for a code-practice oscillator. It requires no warmup time and it can deliver enough output to drive a speaker or several headsets on a fraction of the power input required by a vacuum tube. Its circuitry is much simpler and more compact.

The fact that a transistor has no filament to heat up before the circuit can operate is a decided advantage in a code-practice oscillator because no power is consumed when the key is open, and the circuit starts oscillating the instant the key is closed. The saving in filament power greatly increases the efficiency of the circuit.

By taking advantage of the characteristics of the 2N32 point-contact transistor we can even eliminate entirely some of the usual oscillator-circuit components. This simplifies the layout, and the fact that the point-contact transistor operates on smaller B voltages and currents than a vacuum tube means that the remaining components can have very small voltage and power ratings. This reduces size and cost, and is a big step toward miniaturization. All these favorable factors were utilized in the design and construction of the experimental audio oscillator described here.

Built-in feedback

The effectiveness of the point-contact transistor as an oscillator is due partly to its built-in feedback circuit. As shown in Fig. 1 the collector and the emitter have a common coupling impedance (R_b) in the base lead which feeds a part of the output back into the input circuit in the correct phase

for oscillation. Only a small additional impedance is needed in the base arm to overcome the effects of the external components in the emitter and collector circuits.

(Emitter and collector currents flow in opposite directions in the base lead. Collector current I_c is larger than emitter current I_e in point-current transistors, so the resulting base current I_b is the difference in the two currents flowing in the same direction as the collector current. I_b flows through R_b to produce a voltage at point A that is in phase with the emitter signal. Thus we have the positive feedback required for oscillation.)

The schematic of the oscillator is shown in Fig. 2. A 2N32 point-contact transistor is connected in a relaxation oscillator circuit. The output waveform is a modified pulse having a pleasing tone quality. (A sine-wave oscillator was tried, but gave much less output than that obtained from the relaxation-oscillator circuit.)

The output-transformer primary is the external base-circuit impedance which provides the additional feedback needed to sustain oscillation. The oscillator is keyed by opening and closing the 22.5-volt battery circuit. When the key is open there is no current drain

and no power is consumed. This eliminates the need for an on-off switch. The current drain on the battery is determined by the external resistance in the emitter circuit; with the values shown this drain should be less than 5 ma, and in normal use even a hearing-aid battery should last approximately 6 months.

The external resistance in the emitter circuit affects not only the collector current but the oscillator frequency as well. Reducing the value of this resistance *increases* the collector current and *decreases* the frequency. In this

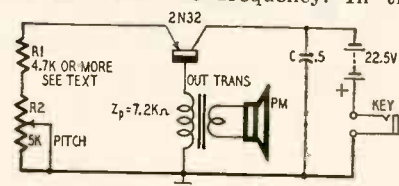

Fig. 2—Diagram of the transistorized code or experimental a.f. oscillator.

circuit R_1 (which should not be less than 4,700 ohms) limits the collector current to a value which will not damage the transistor; R_2 controls the frequency of oscillation.

The only critical values in this circuit are the resistor R_1 and the battery voltage. Almost any output transformer designed to couple a pentode or beam-power tube to a speaker voice coil will do. The speaker itself can be any size. The voltage rating of capacitor C is not important so long as it is rated for at least 22.5 volts. The parts used in this oscillator were chosen for their small physical size.

The fairly wide variation in the internal characteristics of transistors of the same type may call for some experimenting with R_1 to obtain the de-

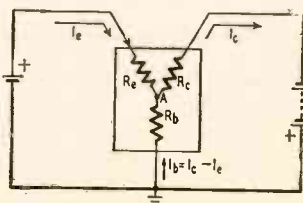
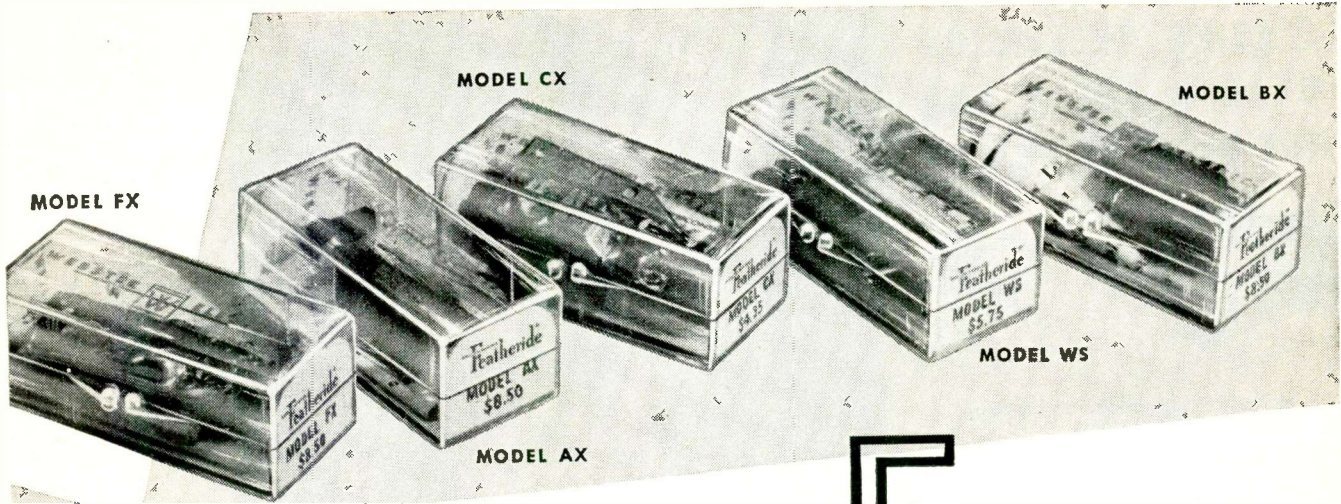

Fig. 1—Diagram showing current flow in equivalent circuit of a transistor.

* Tube Department, Radio Corporation of America, Harrison, N. J.



Just **5**

WEBSTER ELECTRIC
Featheride[®]
CRYSTAL CARTRIDGES

fill Practically All Replacement Needs!

MODEL FX A two-needle twist cartridge, delivering high or low output

MODEL AX A complete unit for three-speed application, furnished with a removable twist mechanism

MODEL CX May be used with a three-mil needle for 78 RPM or two-mil needle for three-speed application

MODEL WS A versatile unit capable of replacing the majority of 78 RPM cartridges in the field

MODEL BX Designed primarily for RCA Automatic record changers and Columbia players. Unusually high fidelity

FREE
 Replacement Chart...



Write for your **FREE** copy of new Featheride Replacement Chart. It shows how, with only 5 Featheride models, you can replace hundreds of different cartridges of many makes

- Profit-minded servicemen and technicians are joining the big swing to WEBSTER ELECTRIC Featheride Crystal Cartridges these days. And with good reason, too—they have learned that, with just five Featheride models, they can fill virtually any and every replacement need *quickly and profitably!*

- Featheride Replacement Cartridges are *crystal* cartridges—made, inspected and individually packaged according to WEBSTER ELECTRIC's rigid standards. That means the user is assured of the finest possible reproduction of recorded music of which his record player or changer is capable.

- You profit *two ways* when you carry the Featheride Five in your kit. You build good will by giving your customers the best the market affords, and you save time and trouble on every cartridge replacement job.

WEBSTER ELECTRIC
 RACINE WISCONSIN

"Where Quality is a Responsibility and Fair Dealing an Obligation"
 WEBSTER ELECTRIC COMPANY, RACINE, WISCONSIN • EST. 1909

LEADING TELEVISION DEALER TELLS YOU THE VALUE OF KRYLON

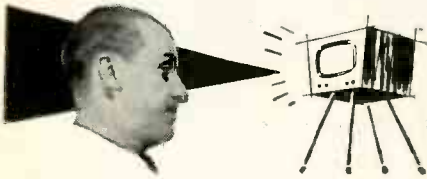

● "I use Krylon on the high voltage sections of TV receivers, and on the antennas as well. It does a good job, cuts down contract calls, and I know it gets the word around about my servicing reliability."—Edwin G. Schaffer, President, Edwin G. Schaffer Company, 7920 Frankford Avenue, Phila., one of the Quaker City's most progressive television organizations.

KRYLON 100% Acrylic Spray is a crystal clear, high dielectric strength coating in a push-button dispenser. For all high voltage sections and component parts of television receivers. Because of its weather-proofing qualities, it is ideal for coating antennas, lead-ins, etc.



"The most important handyman in the TV industry."

KRYLON, INC.

2038 Washington Ave., Phila. 46, Pa.

Krylon also available in Bright Aluminum, Flat Black, Glossy Black, Touch-Up White and Bright Gold

At TV Jobbers Everywhere

SUBSCRIBERS

If you're moving, please don't forget to send us your address as it appears on the copy of the magazine, including the numbers shown beside your name, as well as your new address.

If we receive this information before the 20th of the month, you will continue getting the magazine without interruption. Your cooperation will be most helpful and greatly appreciated.



Under side of the novel code oscillator.

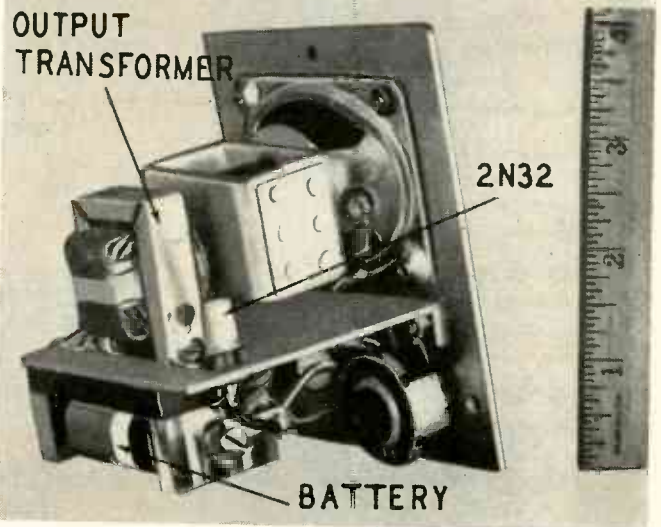

Rear view of the transistor oscillator.

sired frequency range, but in no case should R1 have a value less than 4,700 ohms. Do not allow the circuit to oscillate below 200 cycles, or the transistor may be damaged by excessive collector current.

Construction hints

The writer has access to complete shop facilities; therefore, the mechanical construction of the unit illustrated may seem quite elaborate to the average experimenter. However, almost any housing and component layout can be used, and there are no shielding problems. Lead lengths are not critical.

The battery mount is probably the biggest mechanical problem. A fairly

simple and easily constructed mount for an RCA VS084 or similar battery is shown in Fig. 3. Screw a pair of 1/2-inch angle brackets to a rectangular base of bakelite or similar insulating material. Recess the mounting holes in the bottom of the base so that the heads of the screws cannot short against the metal cabinet. Soldering lugs under the nuts provide good electrical contact. Solder a 6-32 brass nut over the inner face of the hole in the upright of each bracket so the two 6-32 contact screws are parallel to the base and in line. File the tip of each screw to a 60° point to fit the small hole in the terminal of the battery. Adjust the screws to hold the battery firmly between them and tighten the lock-nuts on the outsides of the brackets to keep the screws from loosening. This mount provides adequate mechanical support for the battery and good electrical contact to its terminals. When wiring, watch the transistor terminals carefully. Hooking a transistor up wrong will ruin it as quick as will putting B voltage across a tube filament; and transistors are more expensive than most tubes. Of the three leads coming out of the transistor's base, the collector is the one most widely sepa-

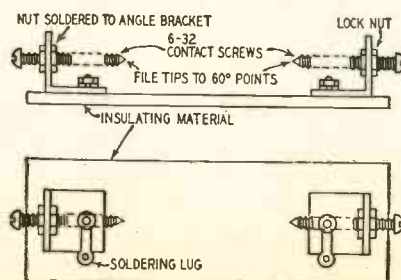

Fig. 3—Details of the battery mount.

rated from the other two. The base is the next one, and emitter the third. So the rule is that the collector and emitter are the outside leads, and that the base is nearer the emitter than the collector.

Alternate circuit

The size of the speaker and output transformer dictate to a large extent the physical size of the oscillator. For

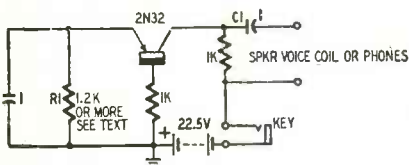

Fig. 4—The alternate circuit diagram.

those who may wish to miniaturize the oscillator even more, the circuit shown in Fig. 4 eliminates these two large components. It has the advantage of reducing cost as well as size, but these advantages are obtained at the expense of power output.

In the modified circuit a 1,000-ohm resistor replaces the primary of the output transformer as the external feedback impedance that keeps the circuit oscillating. Output is taken from the collector through C1. This gives a very poor impedance match because almost any headset or speaker which may be used will have relatively low internal impedance compared with the internal impedance of the collector. This poor match accounts for the comparatively low power output because maximum power output is obtained only when the source and load impedances are matched. This circuit is also affected more by the variations among transistors than is the circuit of Fig 2, and considerable experimenting may be required to obtain the desired results. Vary the value of R1 for the desired tone and the best operating characteristics.

The unit in Fig. 2 and the photographs lends itself quite readily to

Materials for code oscillator

Miscellaneous: 1—2N32 transistor; 1—4,700-ohm resistor, 1/2 watt; 1—5,000-ohm potentiometer; 1—0.5-uf paper capacitor; 1—miniature output transformer 7,200-ohm primary (approximate), secondary to match speaker voice coil; 1—2 x 3-inch PM speaker; 1—22.5-volt hearing-aid battery, RCA VS084 or equivalent; chassis, cabinet, hookup wire, and hardware.

group or class practice, as well as to private or mobile requirements, and has sufficient power output to be used with a class of 15 to 20 persons. Its self-contained power supply gives it the advantage of portability, and its use is not limited to locations where power lines are available. Not only is this oscillator useful to anyone interested in amateur radio, but it affords an excellent opportunity for one to become familiar with transistors and their associated circuitry.

The author wishes to acknowledge the advice of R. M. Cohen and R. E. Kleppinger on the electrical design of the oscillator and the advice of Ed Milavec and Don Beaulieu on the mechanical design. END

TRAIN for TELEVISION

in 3 easy steps!
Learn more to earn more!

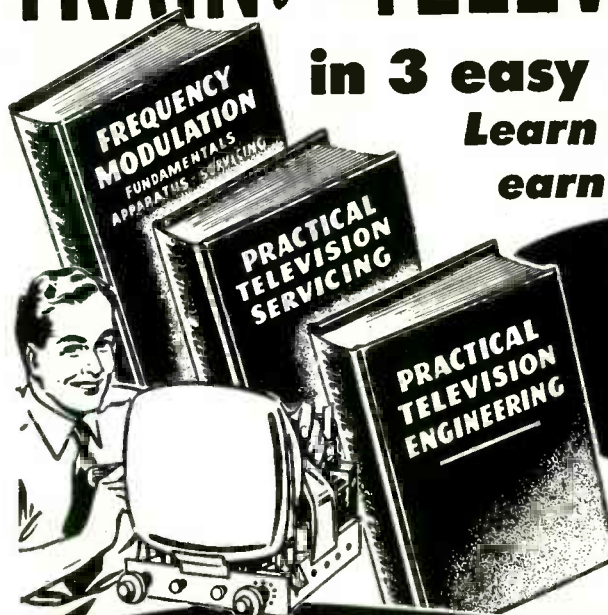

ONLY \$15.50

for the complete training (all 3 books)

5 Months to Pay!

The famous RINEHART TV LIBRARY

●1—FREQUENCY MODULATION (F-M)
The "heart" of TV sound

This essential book gives you complete training in F-M... the subject so frequently neglected in Television training and whose problems so often "stumps" service technicians. F-M, of course, is the system used for TV sound and on which many other developments are based. You learn all about F-M control circuits, receivers, transmitters, mobile equipment, detectors, amplitude limiters, antennas, etc. Clear explanations of F-M test equipment and how to use it are invaluable to busy service men. Book sold for \$5.00 if bought separately. Use coupon.

●2—PRACTICAL TV SERVICING

What to do... how to do it

After studying this famous book, you'll find even the most puzzling TV servicing problems greatly simplified. You'll work better, faster—more profitably! Actual service case histories make things amazingly clear. Dozens of illustrations and pattern photos explain details step by step. You learn how TV differs from radio, how receivers operate and, above all, how to service them properly. Other subjects include wiring details, component replacement data, testing tips, fringe area reception hints, improving picture linearity and dozens of other vital TV service subjects. Price \$4.00 if bought separately. Use coupon.

●3—PRACTICAL TV ENGINEERING

Basic training for the "big money" field.

The "know-how" so clearly presented in this big 700-page book can help you force quickly ahead of the average student! In particular, it takes you right into the TV station, outlines broadcasting problems, shows how the work is done... from camera claims to lighting... from the cathode ray tube to oscilloscopes... from video amplifiers to power supplies... from ordinary transmission and reception to the very latest UHF, VHF and color television developments. Ideal for general TV training... a "MUST" for those who hope to enter the glamorous field of telecasting. 385 illustrations. Price \$7.50 separately.

RECEIVERS... TRANSMITTERS... FM... COLOR and dozens of other subjects

Good training for television doesn't need to cost you a lot of money!

These 3 great books make it easy for you to study to get ahead in this fast-growing industry... at absolute minimum cost. No lessons to wait for! No wasted time!

The Rinehart TV Library is not a series or course containing a lot of costly or unnecessary material in which you are not interested. Each book is an authentic, complete and intensely practical guide to a different phase of television and related training. Add all 3 together and you have a broad, specialized knowledge that can help fit you for any one of a number of good-pay jobs... from FM and television service to work as a TV broadcast station technician, camera operator, sales engineer, etc. They're easy to understand and up-to-date... even to acquainting you with the latest developments and problems in COLOR TELEVISION transmission and reception.

SAVE \$1... pay as you learn

There's no need to send any money. You don't even pay the postman when the books arrive. Read them for 10 days... then make a worthwhile cash saving if you decide to buy! Bought singly, these books cost \$16.50. Under our special offer for all 3 you save \$1—and have 5 months to pay besides.

You can't lose on this offer!

10-DAY FREE TRIAL

Dept. RE-34, RINEHART & COMPANY, Inc.
232 Madison Ave., New York 16, N. Y.

SAVE \$1... ORDER COMPLETE SET!

Send me the RINEHART TELEVISION LIBRARY (all 3 books) for 10-DAY FREE TRIAL. If not what I want, I will return them postpaid at the end of 10 days and owe you nothing. If I keep the books, I will then mail \$3.50 as my first payment, and send you \$2 a month thereafter for four months until the special price of \$15.50 is paid. (Outside U.S.A. Price \$16.50, cash only—same 10-day return privilege.)

TO ORDER BOOKS SINGLY

Enclosed find \$... for books checked; or send C.O.D. and I will pay postman. In either case, I may return books postpaid in 10 days and you guarantee to refund my money.

FREQUENCY MODULATION \$5.00 (\$5.50 outside U.S.A.) **PRACTICAL TV SERVICING** \$4.00 (\$4.50 outside U.S.A.)

PRACTICAL TELEVISION ENGINEERING \$7.50 (\$8.00 outside U.S.A.)

Name

Address

City, Zone, State

Your Employer

Perma-Power
merchandise

sells!



Our Newest
Catalog is
Now Available

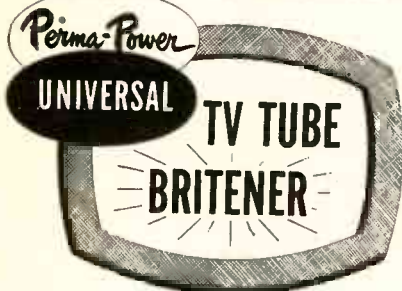

Here is Engineering
at its Peak!

- IT'S PARALLEL!
- IT'S SERIES!
- IT'S ISOLATION!
- IT'S ELECTROSTATIC!
- IT'S UNIVERSAL!

List Price
\$4.45

Sold Through Better Jobbers



Export—Scheel International
4237 N. Lincoln Ave., Chicago 13, Ill.

TRANSISTORIZED WRIST-RADIO



The transistor wrist-watch receiver is a regenerative, capacitance-tuned set.

TECHNICAL details on the transistorized wrist radio designed by Lt. Paul Cooper and Joseph O'Brien at the Signal Corps Engineering Laboratories, Fort Monmouth, N. J., have been released by the Signal Corps. The radio was built to demonstrate the feasibility of constructing a small radio receiver with transistors. This printed-circuit model, was fabricated by Harry French of the laboratory. The reduced power requirements of transistors as compared to vacuum tubes made it possible to use a very small battery which is included in the wrist case.

The receiver (see diagram and photo) uses three transistors; one as a regenerative r.f. stage and two as audio amplifiers. A point-contact transistor (type 1729) is used in the regenerative stage. Regeneration is controlled by varying the coupling between the two coils. A miniature capacitor is used for tuning. The audio is amplified by two p-n-p junction transistors (type TA-153). A bead diode (type 1764) is used as a detector and another one is used as a d.c. return. (Information on the exact commercial equivalents of the transistors and diodes was not available but we understand that the 1729 is similar to the 2N25, the TA-153 is similar to the 2N34, and the diodes (1764's) are roughly equivalent to 1N84's—*Editor*)

The power supply is a 6.5-volt battery ($\frac{1}{2} \times \frac{5}{8}$ inch) consisting of five 1.3-volt RM-412 mercury cells. Battery drain is about 20 milliwatts and battery life about 10 hours. Although in strong-signal areas no antenna is needed, usually a 1-foot wire should be used. The 2,000-ohm earphone is a small Telex hearing-aid type. The transistors can be replaced without making any circuit adjustments.

The receiver tunes from 1000 to 1600 kc; it has sharp selectivity, and a sensitivity of 50 microvolts. A number of New York stations (35 miles from Fort Monmouth) can be heard quite satisfactorily. When the receiver is in the vicinity of radiators, such as telephones, the reception is improved to the

extent that signals from the set can be heard 30 feet from the earphone.

In the evolution of the receiver, it was found that with a 60-foot outside wire antenna, only one regenerative stage was needed to hear New York City at Belmar, N. J., 45 miles from New York. With the addition of a single audio stage and an output transformer, a loudspeaker could be used. Two stages of audio were needed to compensate for the elimination of the antenna. In metropolitan areas the coils alone will pick up sufficient signal. In the wrist version, the antenna can be built into the strap.

When the receiver is held near the body both the tuning and regeneration are affected by body capacitance. The regeneration should be checked for each tuning adjustment. Regeneration can be more easily controlled electronically than by moving a coil. One method is

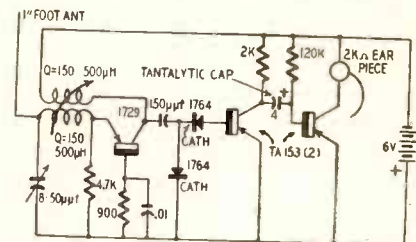

Three transistors are used in the set.

to insert a small 2,000-ohm potentiometer in series with the collector coil. Another is to use a trimmer capacitor for feedback from collector to emitter. In this case, the collector coil can be replaced with a resistor.

The selection of a power source was primarily determined by the point-contact transistor which operated best with 6 volts. Junction transistors, however, can be satisfactorily operated from a 1½-volt source. With minor modifications, the power requirements can be reduced by a factor of 2.5; and by replacing the point-contact transistor in the regenerative stage with a junction type the requirements can be reduced considerably more.

END

Permits mounting rotator
below chimney crown

Only
Superotor[®]
HAS BUILT-IN
Chimney Mount Design

No wonder TV servicemen and owners alike are cheering this great new rotator! Not only is **Superotor** easier to service, and easier to tune — it's a breeze to install! No need for a stub mast assembly. **Superotor** mounts directly on the chimney, but **below** the chimney crown, away from the soot and corrosive fumes that can damage other rotators. Yes, by every measure — performance, service, installation — **Superotor** is years ahead of them all!



A **Leader** First

Choose Superotor for All-Channel Reception . . . VHF, UHF and Color!



• Quick Detachable Drive Unit

A **Leader** First



• Double Lock Stop Prevents Drift & Coast

A **Leader** First



• Steel-Reinforced Construction

A **Leader** First



• VP* Tuning Accurate—Precise Simple

A **Leader** First



Patent Applied for Copyright

2925 EAST 55TH STREET • CLEVELAND 27, OHIO

LEADING THE WAY TO BETTER PRODUCTS

HIGH-GAIN

LOW-DRAIN

PORTABLE RADIO

By **I. QUEEN**
EDITORIAL ASSOCIATE

Compact and sensitive receiver for camping or civil emergency use

The portable radio with back removed to show how parts and batteries are placed.

Set with the subchassis removed, giving a view of the wiring of that unit. Switch at side is the "battery-saver."

WHEN anybody mentions "portable radio," most of us think immediately of the entertainment it can provide.

The set can go with us on picnics, vacation trips, and boat rides. We can enjoy ball games, national events and all our favorite programs while we work, play, and travel. But there is a serious side to this matter. In these days of H-bombs and supersonic jets, a portable radio might mean the difference between life and death. If that terrible day should ever come when air-raid sirens wail for real, the Conelrad system will go into effect. If worst comes to worst, if power goes out and wires down, civil defense messages and other essential communications will continue. In such an emergency, a portable radio can become a very important item.

The design of a radio for portable and emergency use is largely a compromise. Due to limitations of space, weight, and power supply, we cannot include all desirable features. At the outset we must decide: do we prefer to have high gain, loudspeaker volume, selectivity, low drain, compactness, simple tuning, high fidelity, low cost, etc. Which of these will we simply have to do without?

The standard portable circuit, with its four or more tubes, gives excellent results, but uses too much current to be practical in emergency periods when a set might have to be left running most of the time and when batteries might well be unobtainable. The little one-tube (usually duo-tube) receivers use less current, but have low gain. Two- or three-tube regenerators feeding headphones can be made with high gain, but are usually tricky to tune, and are intermediate in their power requirements. Ultra-compactness is also out, as it implies small batteries, with a limited

Front view of the receiver. The card lists stations that have been received.

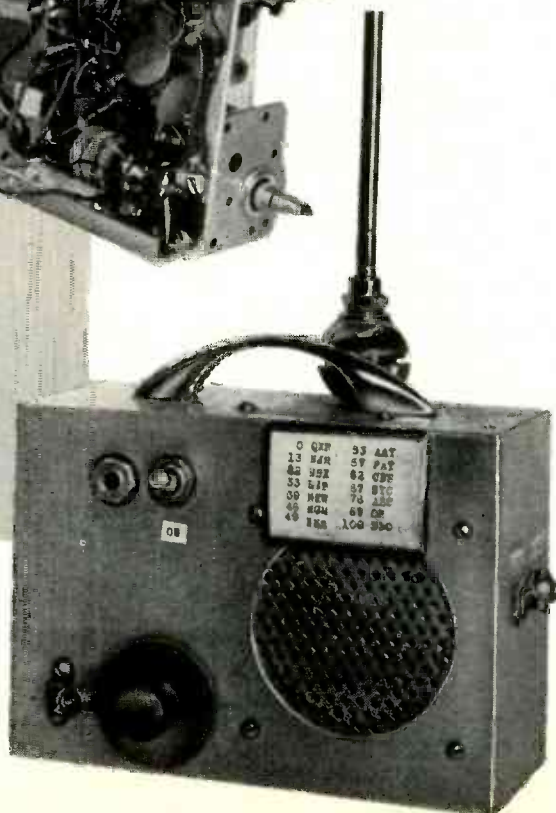



SPRAGUE KWIK-TEST

MODEL KT-1



TEST FOR	EYE INDICATION	CAPACITOR CONDITION
SHORT	REMAINS OPEN	SHORTED
	CLOSES	NOT SHORTED
	FLUTTERS	INTERMITTENT
OPEN	REMAINS OPEN	OPEN
	CLOSES	NOT OPEN
	FLUTTERS	INTERMITTENT

CAPACITORS MAY BE CHECKED FOR OPEN, SHORTED OR INTERMITTENT CONDITION WHILE IN THE CIRCUIT, BUT CIRCUIT UNDER TEST MUST BE TURNED OFF

OPEN
SHORT

PRESS
TO
TEST

OFF ON

SPRAGUE PRODUCTS COMPANY
North Adams, Mass. U. S. A.

"Kwik-Test"
CAPACITOR CHECKER

A NEW RIGHT ARM for the service technician

**URNS TROUBLE-SHOOTING HOURS INTO SECONDS!
CHECKS CAPACITORS FOR OPENS, SHORTS, OR
INTERMITTENTS, RIGHT IN THE CIRCUIT.**

Here's the most useful instrument to hit the service bench since the vacuum tube voltmeter—*Sprague's new "Kwik-Test" Capacitor Checker.*

No longer do you have to sweat through the time-consuming nuisance of unsoldering capacitors from a circuit just to check them.

Now by the mere flick of two switches, Kwik-Test tells you whether any bypass, coupling, or filter capacitor within the range of 30 mmf to 2000 mf is open, shorted, or intermittent . . . even when it is in parallel with a resistance as low as 60 ohms. Capacitors between .1 and 2000 mf may be tested for shorts and intermittent

shorts even if in parallel with a resistor as low as 2 ohms.

Yes, Kwik-Test is a basic instrument you can't afford to be without. You'll realize that more and more as capacitors in old TV sets begin to go . . . and as the number of capacitors in each set increase with the introduction of new and more complicated receivers.

Get a 10 second demonstration of the amazing Kwik-Test capacitor checker at your Sprague distributor. Don't delay! Once you try it, you'll be sure to buy it! Or write for descriptive data circular M-600 to Sprague Products Co., 81 Marshall Street, North Adams, Mass.

only **\$34.50** net

PAYS FOR ITSELF IN NO-TIME

DON'T BE VAGUE... ASK FOR

SPRAGUE

WORLD'S LARGEST CAPACITOR MANUFACTURER

CLEAR TV PICTURE

119 MILES FROM STATION



WITH A WINPOWER TV TOWER

Eliminate tower-mounting headaches. Insure better reception and fewer service calls with America's Lowest Cost TV Tower.

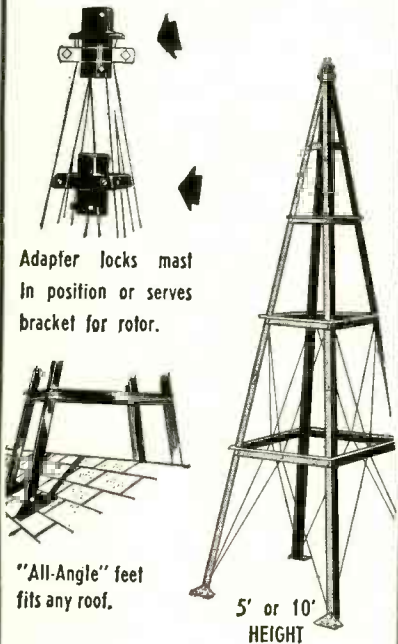

Adapter locks mast in position or serves bracket for rotor.

"All-Angle" feet fits any roof.

5' or 10' HEIGHT

DEALERS PROFIT TWO WAYS

1. One man erects a neat, firmly supported antenna without special tools. Towers are light weight easy handling — individually packaged. Reduces objectionable guy wires.
2. Increase television sales with these permanent tower installations. Raise antennas to correct height with mast adapter. Reception goes up — service calls go down.

WRITE FOR PROFITABLE DEALER PLAN

WINPOWER
NEWTON, IOWA U.S.A.

life and presumably limited availability in emergency periods.

The receiver described here gives good speaker volume on all local stations and some distant ones. For the more distant, headphones are provided. The set has very high gain and selectivity, permitting operation in skyscrapers, while walking along the street, even in a cellar or subway. It has sufficient selectivity to separate high-power local stations, and pick up stations 500 miles or more away. It tunes with a single dial and is contained in an aluminum box only 3 x 5 x 7 inches; batteries, speaker, and all. The receiver carries its own whip antenna which can be collapsed to 18 inches, or extended to almost 5 feet.

Last but not least, the battery drain is amazingly—almost unbelievably—low. The maximum A battery drain is 80 ma, but we get satisfactory results with about 50 or 60 ma from a single type 950 cell. This means that you can use a cell after it has been discarded as too old for a flashlight or buzzer! As for the B supply, we use a 45-volt battery. When the radio is set to maximum gain, this battery has to supply about 1.6 ma. For local reception this is reduced to about 500 microamperes. Obviously batteries are not a problem here. Reception is satisfactory long after the batteries are too old to function in other portable radios.

How can we combine such high gain with such low drain? The secret is in the use of *junction transistors as well as tubes*. The lineup includes 2 subminiature tubes, 2 transistors and a crystal detector. We have mentioned the power supply for the tubes. The transistors need, in addition, 3 penlight cells. The current consumption is so low that these cells will last a long time.

The schematic is shown in Fig. 1. It is a superheterodyne circuit using tubes in the r.f. and i.f. stages. The audio is handled by the two type CK722 transistors. The detector is a 1N34 crystal. In an experimental hookup I tried to eliminate the crystal, using a transistor for detection-amplification. Results were not satisfactory. Using the separate detector requires a second audio transformer, but it is well worth it.

The high-frequency portion of the circuit is conventional in most respects. The tubes are subminiature types. They are rated at 40 ma at 1.25 volts each, but they function very well with much lower currents. A 20-ohm potentiometer

(rheostat) is used to reduce filament voltage to 1.25 or less. This unit can also act as volume control to some extent. When the cell gets really old, this potentiometer can be turned down to zero resistance for maximum volume. With a new cell, it should always be turned up for low drain and filament protection.

The antenna coil is the well-known Vari-Loopstick. I cut off the 13-inch enameled wire lead from it and connected its terminal to the auto whip antenna. Tune this coil with the whip extended to its most commonly used length. I have done this with only a single section since this is the length we ordinarily use. The whip is extended to its full length only when needed to overcome the most unfavorable listening conditions.

The oscillator coil is a Miller universal type (unshielded). It is mounted below the small chassis which measures only 4 x 2½ x 1 inches. All other coils, including the i.f. transformers, are mounted above the chassis. Disregard the taps on the grid winding of the oscillator coil.

The variable ganged capacitor is a conventional but small superheterodyne unit. It measures about 2 inches along each dimension. The mail-order catalogs show a capacitor that is even smaller than ours by about ½ inch along each dimension. Inquiry in several radio stores failed to locate one, however. Since this capacitor is the largest unit on the chassis, it pays to obtain the smallest you can find.

The i.f. transformers are Miller K-Tran type. The first is an input, the second an output. We found that they need careful adjustment with a non-metallic screwdriver. Try not to press down while you are rotating the screw setting, since this changes the tuning.

The r.f. alignment is as usual. Tune the Vari-Loopstick for maximum signal on a station near 600 kc. Then adjust the trimmer on the antenna section of the dual capacitor while tuned near 1400 kc.

The 1N34 detects the signal and generates a d.c. component in this circuit. On powerful stations the current may go as high as 80 microamperes. During alignment, a microammeter may be inserted in the test jack. Every change in tuning, antenna length, or location of the set will show up by a corresponding increase or decrease in meter reading. This is a great help in getting maximum performance from the set.

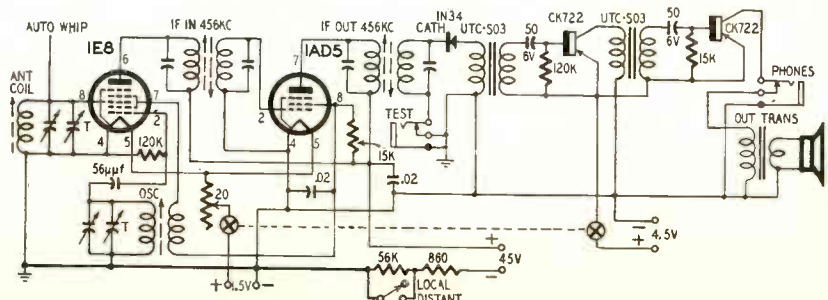

Fig. 1—Schematic diagram of the high-gain, low-drain portable radio receiver.

An alternative detector circuit is shown in Fig. 2. This one permits the use of a v.t.v.m. (at the test point) for measuring signal intensity. In this case a pin jack may be used instead of the phone jack.

The transistors are coupled by tiny transformers; UTC type SO3 subouncers. The high-impedance windings connect in the collector circuit in each case. Subminiature "in-line" sockets are used for the CK-722 transistors. The transistor supply is 4.5 volts from penlight cells. This part of the circuit should offer no difficulty. However, for maximum sound output and minimum distortion, you may experiment with the values of each base resistor.

A 3½-inch speaker is used for this set. Smaller sizes are manufactured and could be used. However, it is doubtful they are as efficient and they probably do not reproduce as well. The matching transformer is a type designed for a 6K6 pentode. I was unable to find a miniature type so settled for the smallest conventional unit that could be found.

During experimental work on this circuit a sad accident ruined the tubes. After this, I inserted a 860-ohm resistor in series with the plate battery. This resistor protects the tube filaments by limiting current from the B battery. It was left in permanently after I discovered that it didn't affect the set performance. It drops the B voltage by about 1 volt.

After using this set a short while I soon discovered that it overloaded on some of the stronger local stations. Several of these are located about 5 miles from me. To eliminate overload, I inserted a large resistance (56,000 ohms) in series with the plate battery. This reduces power input to the tubes by dropping the B voltage to about 25 volts. Due to lower gain, distortion is greatly reduced. Of course, this also cuts down battery drain to a fraction of 1 milliamperere, and greatly extends battery life! A toggle switch shorts out the 56,000-ohm resistor when high gain is needed.

This portable is easy to assemble, convenient to carry about, and is a source of much entertainment. It may be played for long periods continuously without worrying about battery costs, so it is ideal for children to play with.

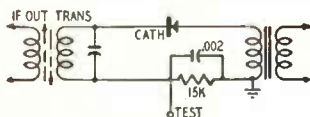

Fig. 2—Alternative detector circuit.

Like other portables, results may vary sharply from one location to another. For example, one local station came in consistently poor when the receiver was set on a table in my room. I was surprised one day to find that moving the receiver only a few feet away made a world of difference. In many cases, I found that performance is improved when the metal box is grounded. Indoors, this is done by setting the box on a metal cabinet, a radiator, or a grounded appliance. Outdoors, I auto-

MARCH, 1954



my Radio
and T.V.

REPAIR SECRET?

OHMITE[®]
DEPENDABLE REPLACEMENTS

Little Devil[®] COMPOSITION RESISTORS



Tiny, yes . . . but what dependability, ruggedness, and stability! And they provide an extra margin of safety—being rated at 70C rather than 40C. Completely sealed and insulated by molded plastic, they meet all JAN-R-11 requirements . . . are available in ½, 1, and 2-watt sizes in all RTMA values.

TYPE AB NOISE-FREE POTENTIOMETERS

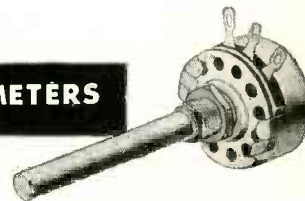

Because the resistance material in these units is solid-molded—not sprayed or painted on—continued use has practically no effect on the resistance. Often, the noise-level decreases with use . . . and they provide exceptionally long, trouble-free service. Rated at 2 watts, with a good safety factor.

BROWN DEVIL[®] AND DIVIDOHM[®] RESISTORS



BROWN DEVIL fixed resistors and DIVIDOHM adjustable resistors are favorite vitreous-enameled units! DIVIDOHM resistors are available in 10 to 200-watt sizes; BROWN DEVILS in 5, 10, and 20-watt sizes:

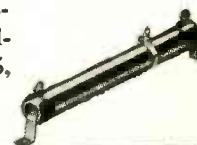

WRITE FOR
STOCK
CATALOG



OHMITE MFG. CO.
3646 Howard St.
Skokie, Illinois
(Suburb of Chicago)

Be Right With . . .
OHMITE

RHEOSTATS • RESISTORS • TAP SWITCHES

ANNOUNCING...

Superior's New Model TV-40

C.R.T. TUBE TESTER

A COMPLETE PICTURE TUBE TESTER FOR LITTLE MORE THAN THE PRICE OF A "MAKE-SHIFT" ADAPTER!



TESTS ALL MAGNETICALLY DEFLECTED TUBES ...
in the set ...
out of the set ...
in the carton!!

THE MODEL TV-40 IS ABSOLUTELY COMPLETE!

Self-contained, including built-in power supply, it tests picture tubes in the only practical way to efficiently test such tubes; that is by the use of a separate instrument which is designed exclusively to test the ever increasing number of picture tubes!

EASY TO USE!

SPECIFICATIONS

- Tests all magnetically deflected picture tubes from 7 inch to 30 inch types.
- Tests for inter-element shorts and leakages up to 5 Megohms.
- Tests for quality by the well established emission method. All readings on "Good-Bad" scale.
- Tests for open elements.

Simply insert line cord into any 110 volt A.C. outlet, then attach tester socket to tube base (Ion trap need not be on tube). Throw switch up for quality test ... read direct on Good-Bad scale. Throw switch down for all leakage tests.

Model TV-40 C.R.T. Tube Tester comes absolutely complete—nothing else to buy. Housed in round cornered, molded bakelite case. Only ...

\$15⁸⁵ NET

MANUFACTURED BY: SUPERIOR INSTRUMENTS CO., 2435 White Plains Road, New York 67, N. Y.

SEE OPPOSITE PAGE FOR LIST OF LEADING JOBBERS

SUPERIOR'S C. R. T. TUBE TESTER DISTRIBUTED BY THESE LEADING JOBBERS

ALABAMA

Beasomer Radio Supply Co., 116 N. 20th St., Bessemer, Ala.
Radio Distributing & Supply Co., 10 W. 20th St., Anniston, Ala.
Reid Distributing Company, 1724 5th Ave., North, Birmingham, Ala.
Fuel Supply Co., Inc., 2421 First Ave., North, Birmingham, Ala.

ARKANSAS

Carlton Wholesale, Inc., 106 W. 9th St., Little Rock, Ark.
Southern Radio Supply, 1119 Main St., Little Rock, Ark.
Wise Radio Supply, 814 Texas Ave., Fort Smith, Ark.

ARIZONA

Elliott Electronics, 418 N. Fourth Ave., Tucson, Ariz.
Southwest Wholesale Radio Co., 122 S. 3rd St., Phoenix, Ariz.

CALIFORNIA

Arrowhead Radio & Television Supply Co., 1212-16 "D" Street, San Bernardino, Calif.
Billings Wholesale, 260 Fulton St., Fresno, Calif.
Dow Radio, Inc., 1759 East Colorado St., Pasadena 4, Calif.
Fred S. Dean Co., 849 American Ave., Long Beach 13, Calif.
Valley Radio Supply, 449 Blackstone Ave., Fresno 3, Calif.

COLORADO

Pistell's Radio & Electrical Supply Co., 1085 Lincoln, Denver 3, Colo.
Inter-State Radio & Supply Company, 1200 Stout Street, Denver, Colo.
Radio Service Supply Co., 324 1/2 North Tejon, Colorado Springs, Colo.

CONNECTICUT

Grant Radio Supply, 6 Willow St., Waterbury, Conn.
Harry & Young, Inc., 203 Ann St., Hartford, Conn.
L. N. Waldhaus, 1133 Norman St., Bridgeport, Conn.
Tel-Had Co., 274 Farmington Ave., Hartford, Conn.
Universal Radio Co., 61 E. Main St., New Britain, Conn.

DELAWARE

Almo Radio Co., 34 and Orange Sts., Wilmington, Del.
Radio Electric Service Co. of Pa., Inc., 3rd & Tannall, Wilmington, Del.

FLORIDA

Cooper Radio Co., 648 Second Ave., St. Petersburg, Fla.
Herman Radio Supply, 1745 N. E. Ind. Ave., Miami, Fla.
Thomson Appliance Co., Panama City, Fla.
Thurrow Radio Dist., 505 Main St., Jacksonville, Fla.

GEORGIA

Edward-Harris Company, 258 Peachtree St., N.W., Atlanta 3, Ga.
Specialty Dist. Co., 425 Peach St., Atlanta, Ga.

IDAHO

Craddock's Radio Supply, 1922 State St., Boise, Idaho

ILLINOIS

Belmont Radio Supply, 1923 Belmont Ave., Chicago, Ill.
J. G. Bowman & Co., 515 East 75th St., Chicago, Ill.
Cooper Supply Co., 419 South 10th St., Quincy, Ill.
Green Hill Radio Supply, 148 West 11th St., Chicago 28, Ill.
Lofgren Distributing Co., 1802 Fourth Ave., Moline, Ill.
Loughrane & Co., Dist., 802 N. Water St., Decatur, Ill.
Olson Radio Warehouse of Chicago, Inc., 623 W. Randolph St., Chicago, Ill.
Radio Doctors Supply House, 220 E. Station, Kankakee, Ill.
Radio Parts Co., 612 West Randolph St., Chicago, Ill.

INDIANA

Castrop's Radio Supplies, 1014 W. Franklin St., Evansville, Indiana
Graham Electronics Supply, Inc., 103 S. Pennsylvania St., Indianapolis, Ind.
Booster Radio Supply Co., 793 N. Illinois St., Indianapolis, Ind.
Midwest Radio & Supply Co., 2015 Garfield Ave., Terre Haute, Ind.
Pemberton Laboratories, East Columbia at Barr St., Fort Wayne 3, Ind.
Television Radio Dist., 812 West Main St., Peru, Indiana

IOWA

Radio Trade Supply Company, 1224 Grand Ave., Des Moines, Iowa
Unions Supply Co., Burlington, Iowa
World Radio Lubs., 744 W. Broadway, Council Bluffs, Iowa

KANSAS

Amateur Radio Equipment Co., 1209 E. Douglas St., Wichita, Kan.
Radio Supply Co., 122 S. E. Douglas, Wichita, Kan.
R. C. Radio Parts & Dist. Co., 733 Central, Kansas City 6, Kan.
Western Distributors Radio & Supply Co., 227 North Santa Fe, Salina, Kan.

KENTUCKY

Ashland Radio Supply Co., 2125 Winchester Ave., Ashland, Ky.
Radio Equipment Co., 317 E. Main St., Lexington 34, Ky.

LOUISIANA

Electronics Supply Co., 1723 N. 21st St., Baton Rouge, La.
Shuler Supply Co., 413 Dryades St., New Orleans 3, La.

MARYLAND

Artercraft Electric Supply Co., Calvert & Baptist Sts., Salisbury, Md.
Zimmerman Wholesalers, 114 E. Washington St., Hagerstown, Md.

MAINE

Radio Service Lab., 47 1/2 Free St., Portland, Me.
Radio Supply Co., Inc., 28 Cross St., Auburn, Me.

MASSACHUSETTS

C. E. Beckmann Co., 11-56 Commercial St., New Bedford, Mass.
Commercial Radio Corp., 36 Brattle St., Boston 8, Mass.
David B. Dean & Co., 22 Chestnut St., Taunton, Mass.
Warner Radio Supply Co., 1370 Columbus Ave., Boston 19, Mass.
Frank P. McCarthy, 29, 81 Market St., Lowell, Mass.
Knap Radio Specialties Co., 222 Worthington St., Springfield, Mass.
The Lamond Greene-Bhav Co., 342 Watertown St., Newton 58, Mass.
Relton Distributing Co., 890 Massachusetts Ave., Cambridge, Mass.
Radio Shack Corp., 161 Washington St., Boston, Mass.

MICHIGAN

Bell-Lourin Electronics, Inc., 1839 Peck St., Muskegon, Mich.
Electric Product Sales Co., 427 E. Michigan Ave., Lansing 20, Mich.
Electronic Supply Co., 248 E. Pike St., Pontiac, Mich.

MINNESOTA

Gopher Electronics Co., 370 Minnesota St., St. Paul 1, Minn.

MISSISSIPPI

Radio Supply Co., Meridian, Miss.
Southern Wholesalers, Inc., 331 S. Farish St., Jackson, Miss.

MISSOURI

Burstein-Apolesbe, 1012-14 MacGeo St., Kansas City, Mo.
Henshaw Radio Supply, 3617 Troost Ave., Kansas City 9, Mo.
Radintex, 3040 Easton Ave., St. Louis 13, Mo.
Walter Ashb Radio Company, 1125 Pine St., St. Louis 1, Mo.

MONTANA

Electronic Supply Company, 214 Eleventh St. W., Billings, Mont.

NEBRASKA

Arbor Co., 223 Central, Nebraska City, Neb.
Hicks Radio Co., 1420-22 O Street, Lincoln, Neb.

NEVADA

Metcalf's Radio Supply, 1117 S. Main St., Las Vegas, Nev.

NEW HAMPSHIRE

American Radio Corp., Sixth at Chestnut Sts., Dover, N. H.
De Mambro Radio Supply, Inc., 1308 Elm St., Manchester, N. H.

NEW JERSEY

Carl B. Williams Co., 154 S. Main St., Phillipsburg, N. J.
Columbia Distributors, Inc., Route 64, Columbia, N. J.
Joe's Radio Shop, 67-69 S. Pearl St., Bridgeton, N. J.
Variety Electric Co., Inc., 465 Broad St., Newark 2, N. J.

NEW YORK

Adson Radio Co., 221 Fulton St., New York 7, N. Y.
Arrow Electronics, Inc., 82 Cortlandt St., New York 7, N. Y.
E. E. Taylor Company, 465 Central Ave., Albany, N. Y.
Fort Orange Radio Dist. Co., 904-916 Broadway, Albany, N. Y.
Fred C. Harrison Co., 108 W. Church St., Elmira, N. Y.
Ratee Company, 136 Irving Ave., Port Chester, N. Y.
Roy C. Stage, 265 Erie Blvd. West, Syracuse, N. Y.
Standard Electronics Distributing Co., Inc., 1487-1505 Main St., Buffalo 9, N. Y.
Standard Electronics Lockport Corp., 14 Main Street, Lockport, N. Y.
Standard Electronics Olean Corp., 514 West State St., Olean, N. Y.
Steve-El Electronics Corp., 61 Reade St., New York 7, N. Y.
Summit Distributors, Inc., 916 Main St., Buffalo, N. Y.
Victory Specialties Co., Inc., Dutchess Turnpike, Poughkeepsie, N. Y.
Moss Electronic Dist. Co., Inc., 3849 Tenth Ave., New York 34, N. Y.

NORTH CAROLINA

Freck Radio & Supply, 38 Baltimore Ave., Asheville, N. C.
Southeastern Radio Supply Co., 414 Hillsboro St., Raleigh, N. C.

OHIO

The D. & J. Electronic Supply Co., Inc., 236 Vine Ave., S. E., Warren, Ohio
Holub & Hook, 1400-1402 Sycamore St., Cincinnati, Ohio
Hynes-Peters, Inc., 111-117 E. Long St., Columbus 15, Ohio
The Mytronic Company, 1245 Florence Ave., Cincinnati 6, Ohio
Olean Radio Warehouse, 73 E. Mill St., Akron, Ohio
Scientific Supplies, Inc., 1320 Madison Ave., Toledo, Ohio
Thompson Radio Supplies, Zanesville, Ohio
Video Wholesale, Inc., 1103 Cherry Ave., N.E., Canton, Ohio

OKLAHOMA

Radio Supply, Inc., 734 N. Hudson, Oklahoma City, Okla.
Wolfe Dist., 710 N. W. 2nd., Oklahoma City, Okla.

OREGON

H & R Radio Supply, 5210 N.E. Sacramento St., Portland, Ore.
Verl G. Walker Company, 205 West Jackson, Medford, Ore.

PENNSYLVANIA

Albert Steinberg & Company, 2520 North Broad St., Philadelphia 32, Pa.
Altoona TV Supply, Inc., 1713-15 Union Ave., Altoona, Pa.
Barnett Bros. Radio Co., 117 N. 7th St., Philadelphia 6, Pa.
Buss Radio Electric Supply, 61-63 E. Broad St., Bethlehem, Pa.
Cameracac Company, 1121 Penn Ave., Pittsburgh 22, Pa.
Electronic Sales & Service, 734 Market St., Saubury, Pa.
General Radio & Electronic Co., 396 South Main, Wilkes-Barre, Pa.
Fred P. Pursell, 1221-27 N. Washington Ave., Scranton 9, Pa.
Radio 437 Store, 437 Market St., Philadelphia 6, Pa.
Radio Electric Service Co., 7th and Arch Sts., Philadelphia, Pa.
Radio Service Co., 346 S. Main St., Wilkes-Barre, Pa.
Williams Auto Sales Co., 204 North Third St., Clearfield, Pa.
Williamsport Radio Supply, 518 West Third St., Williamsport, Pa.

RHODE ISLAND

Television Accessory House, Inc., 45 Broadway, Providence 3, R. I.

SOUTH CAROLINA

McElhenny Co., Inc., 481 Union St., Spartanburg, S. C.

TENNESSEE

Curlee Radio Supply, 823 Cherry St., Chattanooga, Tenn.
L. K. Rush Company, 105 Highland Ave., Jackson, Tenn.

TEXAS

Bill Sulton's Wholesale Electronics, Commerce at Fifth St., Fort Worth, Tex.
Denison Radio Supply, 310 W. Woodard St., Denison, Tex.
Diehl Radio & TV Supply, 1927 7th St., Fort Arthur, Tex.
Electronic Equipment & Engineering Co., 803 South Stoules St., Corpus Christi, Tex.
Houston Radio Supply Co., La Branch at Clay, Houston 3, Tex.
Seooter's Radio Supply, 509-11 Commerce St., Fort Worth 2, Tex.
Southwest Radio Supply, 1820 N. Harwood St., Dallas, Tex.
Steering Radio Products Co., 1616 McKimney, Houston 3, Tex.
West Texas Radio Supply Co., 1026 West 8th, Amarillo, Tex.

VERMONT

Twin-State Elec. Supply Co., Inc., White River Junction, Vt.

VIRGINIA

Certified Electronics, 1930 Powhatan St., Alexandria, Va.
R. C. Baker Sales Co., Inc., 17-19 Franklin Rd., Roanoke, Va.
Eastern Electric Co., 920 Commerce St., Lynchburg, Va.

WASHINGTON

C & G Radio Supply Company, 2502-6 Jefferson Ave., Tacoma 2, Wash.
Coast Radio Company, 110 University St., Seattle 1, Wash.

WEST VIRGINIA

R. H. Kyle & Company, 1354 Mansford Street, Charleston 30, W. Va.
Radio Hospital & Music Store, Williamson, W. Va.

WISCONSIN

Badger Electronic Parts Co., 856-58 Washington Ave., Racine, Wis.
Nitz's Electronic Distributors, 1128 No. 8th St., Sheboygan, Wis.
Valley Radio Distributors, 518 N. Appleton St., Appleton, Wis.

CANADA

Commercial Radio Supplies, 54 Craig St., W. Montreal, Canada

MANUFACTURED BY: SUPERIOR INSTRUMENTS CO., 2435 White Plains Road, New York 67, N. Y.

New replacement control
helps you provide hi-fi reproduction
at low-volume levels

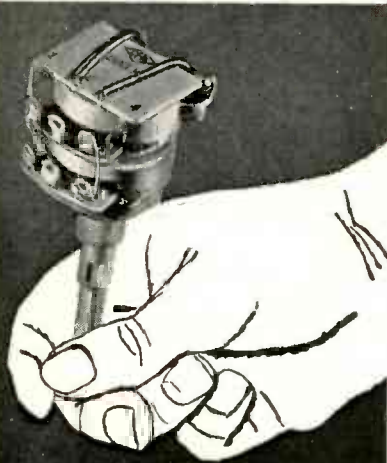

Centralab's new

**SENIOR
COMPENTROL***
with level-set

Combination volume control
and Printed Electronic Circuit*

There's nothing else like it for
improving tone performance

Now, Centralab's new Senior Compentrol with level-set lets your customer control bass and treble range to suit himself — something he cannot do with an ordinary compensated volume control. A universal unit, Senior Compentrol replaces any value without additional amplification. You install it easily and quickly — make money on the job.

Be set to cash in on today's increasing awareness of tonal qualities by your customers. Get several Senior Compentrols from your Centralab distributor — net price, \$4.50.

Centralab also has a Junior Compentrol. It is furnished in 1/2 and 1 meg., plain and switch types, for use in radio sets (5 or more tubes, AC or DC), audio amplifiers, or phono combinations.

Send coupon for 20-page booklet 42-182 telling the whole Compentrol story — or Centralab Catalog 28.

Centralab
® Trademark

CENTRALAB,
A Division of Globe-Union Inc.
922C E. Keefe Avenue, Milwaukee 1, Wisconsin
 Send Catalog 28.
 Send Compentrol bulletin 42-182.

Name.....

Company.....

Address.....

City..... Zone..... State.....

B-2054

matically ground the set by holding it or carrying it.

Because of the high gain, this radio is an excellent trouble-shooting device. It can pick up noise from a fluorescent lamp from 10 feet or more. Motors, intermittent joints, and other sources of interference may be located by the noise it generates.

Materials for portable

Resistors: 1—860, 2—15,000, 1—56,000, 2—120,000 ohms, 1/2 watt; 1—20 ohm, potentiometer.

Capacitors: 1—56 μf, 2—.02 μf, ceramic; 2—50 μf, 6 volts, electrolytic.

Batteries: 1—950 or equivalent; 3—penlight cells; 1—45 volts, XX30 or equivalent.

Miscellaneous: 1—1E8, 1—1AD5, 2—CK722; sockets for tubes and transistors; 1—1N34; 1—i.f. input transformer (456 kc); 1—i.f. output transformer (456 kc); 1—2 gang superhetrodyne capacitor; 1—antenna coil; 1—oscillator coil; 1—test jack; 1—phone jack; 1—s.p.s.t. toggle switch; 1—d.p.d.f. toggle switch; 2—interstage transformers (subouncer UTC SO3); 1—output transformer; 1—loudspeaker; 1—auto whip antenna; 1—chassis; 1—cabinet.

I have made tests to determine the end-point to which batteries are still usable. Good reception is possible with a B voltage of about 20 volts and an A supply less than 0.9 volt! At these potentials, the current drain is very small indeed.

This set requires batteries whose total cost is under \$1.75, yet they outlive batteries for conventional portables by a factor of 10 to 1 or more. Over a period of many months, or years, this set should prove much more economical than less expensive sets that consume batteries in a relatively short time. END

**MEASURING COIL
CAPACITANCE**

The formula for frequency is $f = \frac{1}{2\pi\sqrt{LC}}$

6.28√LC.L is the inductance of the tank coil and C is the capacitance across it. This equation is correct if L has negligible capacitance itself. If the coil is closely wound or has many layers, its self-capacitance, C_s, will be considerable. In that case C_s must be added to the capacitance across the coil to make up the total tuning capacitance C.

Probably the easiest way to measure C_s is as follows. Use a calibrated tuning capacitor to resonate the coil at some frequency f and note the tuning capacitance, say C1. Now tune to the second harmonic (2f) and record the new value of capacitance as C2. The basic frequency formula shows that doubling frequency is equivalent to dividing the LC product by 4. When we measured with frequency f, the inductance-capacitance product was L(C_s + C1). When the circuit is tuned to the second harmonic the product L(C_s + C2) is one-fourth the first product.

Therefore we write

$$\frac{L(C_s + C_1)}{4} = L(C_s + C_2)$$

$$C_s + C_1 = 4C_s + 4C_2$$

$$C_1 - 4C_2 = 3C_s$$

$$C_s = \frac{C_1 - 4C_2}{3}$$

Therefore if we know C1 and C2, we can easily determine C_s. END

**INTERNATIONAL
RECTIFIER
CORPORATION**

EL SEGUNDO
CALIFORNIA

**DIRECT
REPLACEMENT**

**RADIO & TV
Selenium Rectifiers**

**UNIVERSAL
MOUNTING**

**WIDER
RANGE**

**NOW AVAILABLE
AT YOUR
FAVORITE
JOBBER**

Write for Bulletin JRP-1

**INTERNATIONAL RECTIFIER
CORPORATION**

1521 E. Grand Ave., El Segundo, Calif - Phone: ORegon 8-6281
CHICAGO: 205 W. Wacker Drive - Phone: Franklin 2-3889
NEW YORK: 501 Madison Avenue - Phone: Plaza 5-8665



COMICAL
* PAT. PEND.



* PAT. PEND.

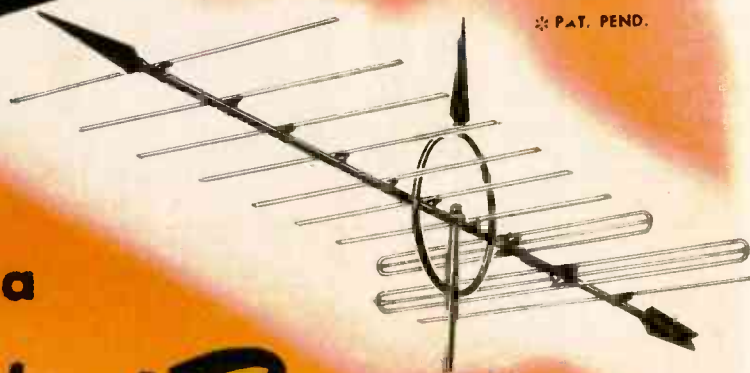

NEW TELE-VANE ANTENNAS BY WARD

backed by a

Power Packed Promotion

Here they are . . . the newest idea in TV antenna design — opening an entirely new field for you with vastly increased profits. Tell the 69 million readers of the Tele-vane national consumer magazine ads that YOU sell Tele-vanes! Use Ward's local tie-in advertising aids . . . all featured and shown in this Tele-vane Kit.

It's yours FREE for the asking.



Complete in one kit, all the dope on window streamers . . . mailing piece . . . newspaper ads and mats . . . full color counter display . . . radio commercials . . . TV slides and announcements.



THE WARD PRODUCTS CORP.

DIVISION OF THE GABRIEL COMPANY

1148 Euclid Ave., Cleveland 15, Ohio

Canadian Distributor: ATLAS RADIO CO. LTD., TORONTO, CANADA



RCP

Portable Radio Repair Shop

"DO-ALL" SERVISHOP...

Compact, convenient service package to meet your AM-FM, audio test needs—in the home and in the shop. Combination of seven individual instruments housed in a portable carrying case provide the test-efficiency of many more. There is nothing that does the complete job as expertly and professionally as the RCP Servishop.

- Tube Tester
 - Vacuum Tube Voltmeter
 - AM Signal Generator
 - FM Signal Generator
 - AF Signal Generator
- Plus a Cathode Ray Tube
Tester and Reactivator

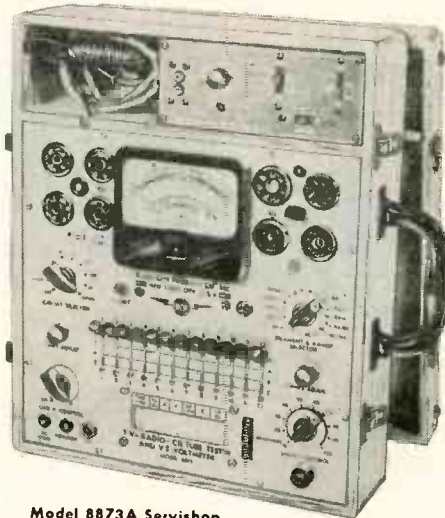

Model 8873A Servishop
Complete with tubes, batteries, leads, etc. in beautifully finished oak, portable case.

\$139⁹⁵ NET

As A Package Buy, The RCP Servishop Means
More Dollar Value For Less Money.

Model 808A
TV-Radio-CR Tube Tester,
Reactivator and VTVM...

\$99⁹⁵ NET

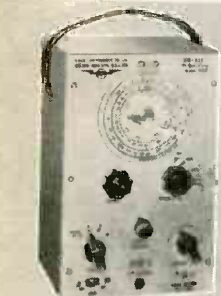

Model 740A
"DO-ALL" Signal,
Marker and Pattern
Generator for VHF
Areas... **\$69⁵⁰** NET



Model 533M
High Sensitivity, Wide
Band Response 3"
Midgetscope. **\$99⁵⁰** NET



Model 453C
20,000 Ohms
per Volt Multi-
Tester for AM-
FM-TV. **\$36⁵⁰** NET



Model 123
Tests Flyback
Transformers
and Yokes
Accurately and
Speedily. **\$39⁷⁵** NET

RCP has a complete line of test instruments to meet the expanding requirements of the service industry. Drop in at your local parts distributor and see "the line that's service-designed."

Write Dept. RE-3 for latest RCP Catalog.

RADIO CITY PRODUCTS CO., INC.

152 WEST 25th STREET • NEW YORK 1, N. Y.



We here at RADIO-ELECTRONICS find it heart-warming to read the many letters of good wishes and encouragement that are written regularly to little Freddie Thomason, armless and legless son of Herschel Thomason, radio technician of Magnolia, Arkansas. Most of these letters accompany contributions to the Fund, and through the generosity of our readers, the Help-Freddie-Walk-Fund has climbed to over \$11,300.

Mr. Thomason writes in appreciation: "... this is more than we ever dreamed of, and we appreciate every penny of it. Freddie is still going to kindergarten and likes it a lot. All of the kids seem to get a kick out of him coming, and they will do anything for him." He has promised to keep us informed of Freddie's progress.

We would like to make special mention of the following donations:

\$85.00 from W. Austin, and \$10.50 from Van Ferguson, RADIO-ELECTRONICS authors who turned their checks over to the Fund.

\$1.00 from Bruce Tanner, a boy with cerebral palsy, and Mrs. Lois Roberts, the woman who cares for him, who saw the story about Freddie in the Buckboard Review, official paper of "Little Princess" Ranch.

\$19.50 from the Men's Fellowship Class of St. John's Methodist Church, Memphis, Tennessee.

\$6.00 from Carleton C. Long, who writes: "Yesterday my family discussed their own good fortune relative to Freddie's, and as a result, the children gave me, jointly, a dollar to send to Freddie's Fund. To this I am adding \$5.00 of my own..."

For five-year-old Freddie to live a normal and productive life, it will be necessary to fit him with mechanical appliances which will enable him to walk and take care of himself. All these cost money—thousands of dollars. Won't you send in your donation whenever you can? No amount is too small to receive our sincere thanks and acknowledgment by letter. Make all checks, money orders, etc., payable to Herschel Thomason. Address all letters to:

HELP-FREDDIE-WALK FUND
c/o RADIO ELECTRONICS Magazine
25 West Broadway
New York 7, New York

CONTRIBUTIONS	
FAMILY CIRCLE Contributions ..	\$ 602.50
RADIO-ELECTRONICS Balance as of October 20, 1953	10,273.09
Anonymous, Venezuela	145.00
Anonymous, Bluefield, West Virginia	5.00
Anonymous, Buffalo, N. Y.	1.00
W. Austin, Seattle, Wash.	85.00
Mr. & Mrs. Herbert J. Billia, Yonkers, N. Y.	2.00
W. H. Brooks, Oconomowoc, Wisc.	6.50
W. T. Burton, Cranbrook, B. C., Canada	5.00

RADIO-ELECTRONICS

California Radio and Electronics Co., Hollywood, Calif.	10.00
J. Dick, Detroit, Mich.	2.00
Tommy Enloe, Hollywood, Calif.	5.00
Van Ferguson, Tallahassee, Florida	10.50
J. M. Francis, Lakewood, Ohio	5.00
Donald F. Garrett, Jackson, Miss.	1.00
Herbert Goldstein, New York, N. Y.	10.00
John S. Hockman, W4SBK, Middleburg, Virginia	5.00
Wendell B. Isola, Calumet, Mich.	3.00
John A. Kirk, Baltimore, Md.	2.00
John L. Knoerl, Buffalo, N. Y.	2.00
Peter N. Koustas, Harrison, N. J.	2.00
Mary Krull, Passaic, N. J.	10.00
Samuel Kushner, Pittsburgh, Pa.	5.00
Carleton C. Long & Family, Beaver, Pa.	6.00
Wally Lyon, Miami, Florida	10.00
Lee S. Manwill, Salt Lake City, Utah	5.00
Rev. Albert E. Martin, W2BWO, Jersey City, N. J.	1.00
Paul G. Martin, Clinton, Mass.	2.00
Men's Fellowship Class, St. John's Methodist Church, Memphis, Tenn.	19.50
Mgt. Morrissey, Worcester, Mass.	2.00
W. J. Nowok, Niagara Falls, N. Y.	1.00
F. C. Purkeypille, Corvallis, Oregon	20.00
Radio Optical Research Co., Hollywood, Calif.	20.00
Mr. & Mrs. W. J. Raine, Poston, Arizona	5.00
Stephen Sandor, New Brunswick, N. J.	2.00
Frank W. Scott, Robert Wilcox Co., Colon, Republic of Panama	5.00
A/2C Mike M. Serikaku, A.P.O. 953, San Francisco, Calif.	1.00
James S. Sevier, Lindenhurst, N.J.	2.00
Stanley Slavinski, Philadelphia, Pa.	5.00
Mr. & Mrs. F. R. Sterba, Mt. Rainier, Md.	5.00
Bruce Tanner & Mrs. Lois Roberts, Dayton, Ohio	1.00
Arthur E. Toppny, Elk River, Idaho	10.00
Wilbert, a friend from Minnesota...	1.00
YV5DI, Caracas, Venezuela	10.00
Stephen Zolocha, W2ZRG, Sanborn, N. Y.	10.00
TOTAL CONTRIBUTIONS as of January 18, 1954	\$11,341.09

Radio Thirty-Five Years Ago
In Gernsback Publications

HUGO GERNSBACK
Founder

Modern Electrics	1908
Wireless Association of America	1908
Electrical Experimenter	1913
Radio News	1919
Science & Invention	1920
Television	1927
Radio-Craft	1929
Short-Wave Craft	1930
Television News	1931

Some of the larger libraries still have copies of ELECTRICAL EXPERIMENTER on file for interested readers.

MARCH 1920
ELECTRICAL EXPERIMENTER

- Wireless Transmission of Power Now Possible, by Thomas W. Benson
- French Radio Station to Have 13,000-Mile Range
- Gaseous Telephone Transmitters, by Richard A. Engler
- Radio Frequency Currents on Wires, by J. O. Mauborgne, Lieut. Col., Signal Corps, U.S.A.
- Vacuum Tube Amplification, by Pierre H. Boucheron
- Construction of Honeycomb Inductances, by Hilbert R. Moore
- An Experiment with Wave Motion, by L. A. Bartholomew

END

MARCH, 1954

COLOR TV Fully Explained

New

INTRODUCTION TO COLOR TV
by Kaufman & Thomas

Here is the complete story about color television — written in a clear, understandable language without mathematics. It gives the answers to questions asked about color TV... It not only describes the NTSC system but also explains it. The authors explain fully the color processing circuits of the color TV receiver which use the three-gun picture tube and the one-gun picture tube. The most complete book on the subject. Easy to understand! A "must" for all technicians, engineers and students.

Chapters: 1 — Questions and Answers About Color TV, 2 — Fundamentals of Color, 3 — The NTSC Color Television System, 4 — Tri-Color Picture Tubes, 5 — The Color Television Receiver, 6 — Color TV Receiver Adjustments.
Over 140 (5¼ x 8¼") pages, illus..... **\$2.10**

New

HIGHLIGHTS OF COLOR TELEVISION
by J. R. Locke, Jr.

A right-to-the-point explanation of the highlights of the NTSC color television system — such as colorimetry — matrixing — the color sub-carrier — synchronous detection — etc. Written for the technician, the engineer, the student — for a quick grasp of the subject.

Eight chapters cover: Introduction, Colorimetry, The N.T.S.C. Color Signal, The Transmitter, Color Receiver, The Shadow Mask Tri-Color Picture Tube, Some Receiver Details, General comments.
48 (5½ x 8½") pages, illus..... **only \$.99**

New

HOW TO INSTALL AND SERVICE AUTO RECEIVERS
by Jack Darr

An expert gives practical, detailed instructions on how to install and service all types of automobile radios. Shows where to run lead-ins, how to install antennas, eliminate noise and gives methods for vibrator testing. Furnishes a complete list of tools, spare parts and other equipment in addition to business procedures for the setting up of an auto radio shop or service department.

Section 1 — Installing Auto Radios
Section 2 — Servicing Auto Radios
Section 3 — The Auto Radio Service Shop
128 (5½ x 8½") pages, illus..... **\$1.80**

New

SERVICING TV VERTICAL AND HORIZONTAL OUTPUT SYSTEMS
by Harry Thomas

Complete easy-to-understand explanation of how vertical and horizontal output systems function. Discusses all types of circuits used in TV receivers — waveforms encountered, construction of components, component constants, requirements and troubleshooting. For the TV service technician and the student of TV servicing. No other book in print offers equivalent coverage of the subject or explains details as clearly.

Chapters cover: Fundamental Conditions, Basic Vertical And Horizontal Sweep Output Systems, Circuit Functioning of the Vertical Sweep Output System, Horizontal Output System Operation, Variations in Horizontal and Vertical Sweep Output Systems, The Deflection Yoke, Mechanical Features of Sweep Output System Components, Recognition of Faults in Sweep Output Systems.
Over 140 (5½ x 8½") pages, illus..... **\$2.40**

WRITE FOR COMPLETE RIDER CATALOG
Buy these books now from your jobber, bookstore — if not available from these sources, write to:

JOHN F. RIDER

PUBLISHER INC.

480 Canal Street, New York 13, N. Y.

West Coast Office:
4216-20 W. Jefferson Blvd.
Los Angeles, California

Export Agent:
Roburn Agencies, Inc.
38 Warren Street
New York 7, New York

Cable Address:
Roburnage N.Y.

In Canada:
McC. Chas. W. Pointon
1928 Gairard Street, East
Toronto, Ontario

AN R-C BRIDGE TEST UNIT

*Easy-to-build instrument
measures resistance and
capacitance with a high
degree of accuracy*

By ALAN G. SORENSEN

THIS test bridge is an extremely useful instrument for the service bench. It measures the exact values of a wide variety of capacitors and resistors to 1% accuracy. Capacitors of all types can be tested. The operation is quick and simple.

The basic circuit of the resistance section is a Wheatstone bridge, shown in Fig. 1. R_x is the unknown resistor, R_a is the variable resistor (dial), R_s is the resistance standard, and R_r is the range resistor. The generator is an audio transformer that delivers 60-cycle a.c. to the bridge. When the arms are balanced there will be no voltage between points A and B. This is a null condition. On either side of this condition voltage will appear, due to the unbalanced condition of the resistance arms.

A similar arrangement is used to measure capacitance. The bridge circuit of Fig. 2 is almost the same as that of Fig. 1 except that two arms contain capacitors instead of resistors. C_x is the unknown capacitor, C_s is the standard. R_s balances out the resistive component of C_x . These circuits combine nicely since R_a and R_r are the same in both bridges. A d.p.d.t. switch is used to change from one circuit to the other.

The complete schematic is shown in Fig. 3. A 1:3 audio transformer provides the 60-cycle bridge voltage. The secondary is the high-impedance side and provides a voltage step-up. To increase the impedance of this source, resistors R2 and R3 are inserted. Resistor R1 loads the transformer and reduces the no-load voltage to about 200. The source voltage should be poorly regulated so that with a small resistance across the terminals the voltage will be reduced to a safe value. At times there may be as little as 5 ohms in the circuit.

The calibrated dial of R13 serves for both resistance and capacitance measurements. This potentiometer should have a linear taper and should be wire-wound. Another bridge, ohmmeter, or resistors of known accuracy should be used to calibrate the dial directly in ohms. This should be done before R13 is connected into the circuit. The accuracy of the completed bridge is dependent upon this calibration, so every effort should be made to obtain an accurate dial marking.

R4 through R10 are 1% tolerance, 1-watt resistors. In the author's instru-



Front view of R-C test bridge. Main dial must be carefully calibrated.

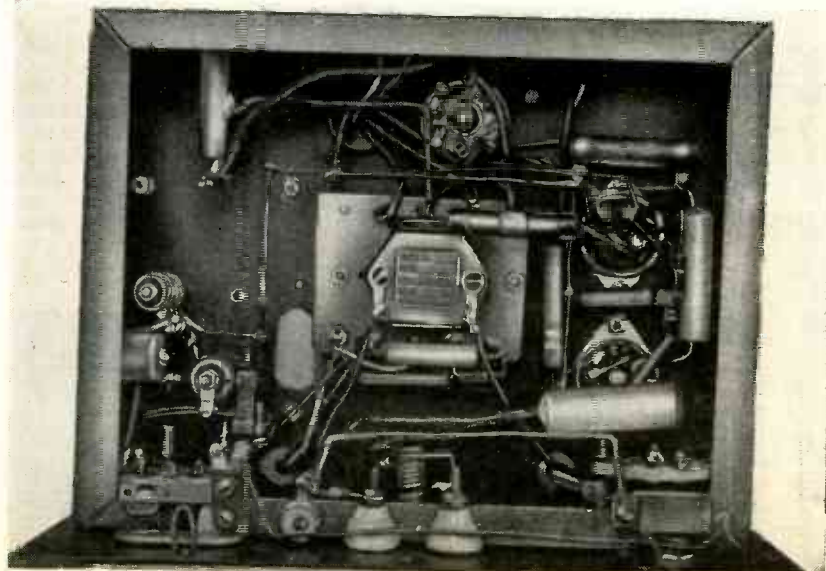
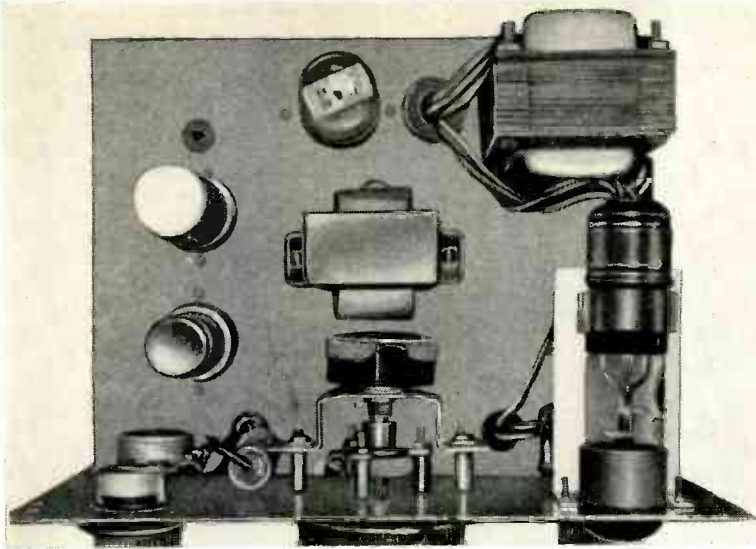

Photo shows underchassis view of bridge. Layout of parts is not critical.



Top view. 6E5 tuning-eye and assembly are conveniently mounted at right.

ment R4 and R5 were IRC *Precistors*. The lower values were wire-wound resistors. R11 is the resistance standard and should also be 1% or better. Capacitor C1 is the capacitance standard and must be within 1%.

R12 is the power balance or power factor control. In most commercial bridges this control is calibrated in power factor percentage. However, for a general-purpose unit, there is no real need for this, and a 0-10 knob was used. If the constructor desires, a dial may be attached and calibrated directly in ohms and the power factor obtained from it.

in parallel with the capacitor under test. These were later replaced with the new General Radio 938 terminals. The stray capacitance across the terminals in the original instrument was 3- μ f. This must be subtracted from the dial reading when measuring small capacitors. The final requirement is to very accurately calibrate the main dial directly from R13 in ohms.

Operation of the completed bridge is quite simple and quick. After a couple of minutes warmup, the null eye glows a bright green, and the instrument is ready.

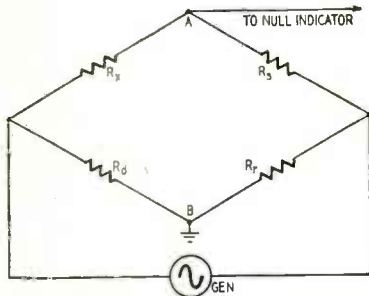

Fig. 1—Diagram of basic Wheatstone bridge used to measure resistance.

A switch and jack were provided so that the amplifier and tuning-eye null indicator might be used with an external inductance bridge.

Construction

The construction is simple and straightforward. A heavy wire should be used for the bridge itself and stray capacitance should be kept to a minimum. Parts placement is relatively unimportant; most any layout could be used. An ICA 3926 grey cabinet, National knobs, and a chrome stripe for decoration (ICA 3513) were used to provide a matching and neat-appearing instrument.

The terminals are small ceramic feed-through insulators to reduce stray capacitance which would otherwise appear

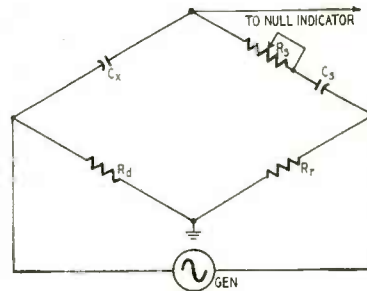

Fig. 2—Diagram of basic Wheatstone bridge used to measure capacitance.

Resistance:

1. Set the function switch to RES.
2. Set the range switch to a range

that will include the resistor under test. If the resistor under test is unknown, try all ranges one by one.

3. Connect the unknown resistor to the instrument terminals. A pair of very short test leads may be used.

4. Advance the AMPLIFIER GAIN control slightly so that the tuning eye will show only a small wedge of black.

5. Slowly turn the main dial and watch for an eye opening. When the eye is at its widest point the bridge is at null. The AMPLIFIER GAIN control may then be adjusted for the sharpest null. By reading the value shown on the main dial and multiplying it by the RANGE switch setting, the value of the resistor under test, in ohms, may be determined.

Capacitance:

1. Set the function switch to CAP.

2. Set the RANGE switch to a range that will include the capacitor under test. If the approximate value is unknown, try all ranges one by one.

3. Connect the unknown capacitor to the instrument terminals. A pair of very short test leads may be used.

4. Advance the AMPLIFIER GAIN control slightly so that the tuning eye will show only a small wedge of black.

5. Slowly turn the main dial and watch for an eye opening. When the eye is at its widest point the bridge is at null.

Materials for Test Bridge

Resistors: 1—1,000, 2—1,200, 1—22,000, 1—270,000, 1—470,000 ohms, 2—1 megohm, 1/2 watt; 1—1, 1—10, 1—100, 2—1,000, 1—10,000, 1—100,000 ohms, 1—1 megohm, 1 watt, 1%; 1—2,500 ohms, 10 watts, 1—15,000 ohms, 10 watts; 1—100,000, 1—500,000 ohms, potentiometer; 1—10,000 ohms, 3 watts, potentiometer.
Capacitors: 1—.01 μ f, 1% mica; 3—0.1 μ f, 400 volts; 1—20-20-20 μ f, 450 volts, electrolytic.
Miscellaneous: 1—power transformer, 500 volts c.t. at 40 ma, 6.3 volts at 2 amp; 1—1:3 step-up audio transformer; 1—6SJ7, 1—6E5, 1—5Y3-GT, tubes; 1—off-on power switch; 1—d.p.d.t. switch; 1—l.s.p.s.t. toggle switch; 1—tuning-eye assembly; 1—pilot light and assembly; 1—1-amp fuse and holder; 2—test terminal (General Radio 938); 1—cabinet 8 x 12 x 8-inches (ICA 3926); 1—chassis 7 x 9 x 2-inches; 1—jack; 1—calibrated dial; knobs; sockets; line cord; hardware, wire, etc.

6. At null, adjust the POWER BALANCE potentiometer to broaden the null and reduce any fuzziness. Readjust the main dial for the sharpest null. The AMPLIFIER GAIN control may have to be re-adjusted.
7. The value of the capacitor may be

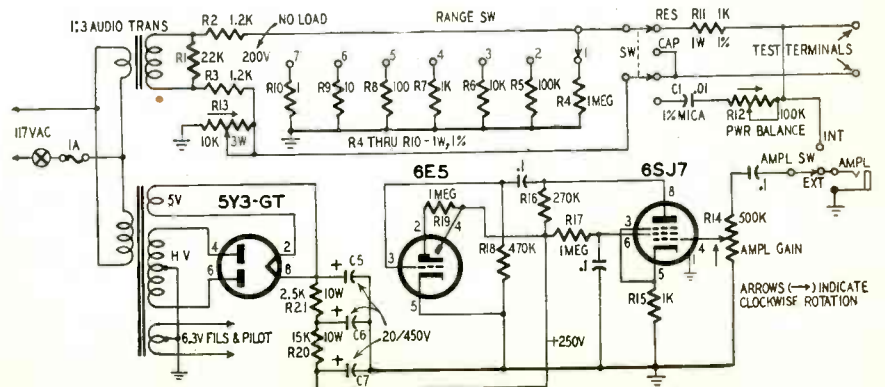

Fig. 3—Diagram of R-C test bridge. Arrows indicate clockwise rotation.

Sangamo Dry Electrolytics

Live many seasons
for heap good
reasons

these wire lead
tubular capacitors
will not deteriorate
with age

Use Sangamo dry tubular electrolytics for trouble-free replacements. You don't have to worry about premature failure. Long life is really built into these capacitors. They have exceptional staying power because:

- 1 A super-seal keeps the electrolyte from evaporating even under the toughest conditions of heat and humidity.
- 2 All these capacitors are aged at 85° C to build a tough dielectric film that will stand up under high heat.
- 3 All aluminum container prevents the "creeping" corrosion that occurs in capacitors when any other metal is permitted to contact the electrolyte.
- 4 Sangamo electrolyte is really pure. Continuous laboratory control of every batch keeps the chlorine ion concentration to less than 10 parts per million. That's 99.999% pure, or better!
- 5 No lead breakage. Sangamo uses a special wire that resists bend fatigue. A specially designed rivet that "cradles" the lead gives additional protection.

P. S. These wire lead tubulars fit those tight corners—Their compact design gives maximum capacity in minimum space. See your Sangamo Distributor for all your capacitor replacement needs.

Those who know



choose Sangamo

SANGAMO ELECTRIC COMPANY

MARION, ILLINOIS

SC54-4

TEST INSTRUMENTS

taken from the main dial and the RANGE switch.

RANGES COVERED BY TEST BRIDGE

Position	Resistance	Capacitance
1	1 ohm to 10 ohms	10 to 100 μf
2	10 ohms to 100 ohms	100 to 1000 μf
3	100 ohms to 1,000 ohms	.001 to .01 μf
4	1,000 ohms to 10,000 ohms	.01 to .1 μf
5	10,000 ohms to 100,000 ohms	.1 to 1.0 μf
6	100,000 ohms to 1 megohm	1.0 to 10 μf
7	1 megohm to 10 megohms	10 to 100 μf

The table shows the ranges covered by the instrument. END

TRANSISTOR LAYOUT BOARD SAVES EXPERIMENTING TIME

When experimenting with transistor circuits you will find that this bread-board layout will save you hours of work. After wasting many hours soldering and unsoldering connections, I figured that there must be an easier way. There is.

Cut a 4-inch square from sheet bakelite, $\frac{3}{16}$ or $\frac{1}{4}$ inch thick. Drill eight holes for the Fahnestock clips and four holes for the mounting feet. The holes for the transistor mounting clips are 120° apart on the circumference of a circle having a radius of $\frac{7}{8}$ inch. Assemble the clips and feet as shown in photograph. This panel provides for

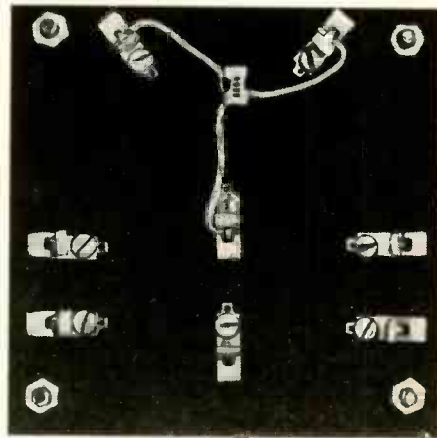

straightforward wiring. In a matter of seconds you can change any part of the wiring. By reorienting the socket you can change the basic circuit from grounded-base to grounded-collector or grounded emitter. Transistor socket leads should be spaced 120 degrees apart so that they will fit directly into the clips. I used General Cement No. 6302 clips, $\frac{3}{4}$ inch long. Fahnestock No. 533 clips are the same size and may be used. If you have larger clips on hand, you can use them on a little larger panel.

If you have ever experimented with different circuit arrangements, you will appreciate this layout. With transistors becoming more available, new applications will be developed requiring experimentation.—J. R. Steen

RADIO-ELECTRONICS

DISPLAY IN ELECTROTHERAPEUTICS

The scope display gives the surgeon immediate visual information

By F. J. G. VAN DEN BOSCH, D. SCI.*

AT THE International Congress of Anesthesiology held in Paris during 1951, there was a discussion on the apparatus for the automatic application of anesthesia developed by Dr. R. G. Bickford at the Mayo Institute. (See "Brain Waves Control Anesthesia" in the November

*Chief of physical and electronic laboratories
Fondation Sheid
Berchem-Antwerp, Belgium

1950, issue of RADIO-ELECTRONICS.) This apparatus is based on the use of the electrical activity of the brain. By this is meant the frequency and amplitude of the electroencephalographical waves. Dr. Bickford's equipment is an important development in the use of the electroencephalograph (EEG) as a powerful instrument for neurologists.

The apparatus described by Dr. Bick-

ford (Fig. 1) consists of a 3-stage capacitance-coupled symmetrical amplifier. Its output is fed into a 6AG5 pentode that is biased to cutoff so it acts as a rectifier and amplifier. Potentiometers in the screen and cathode circuits adjust the cutoff point and one in the grid circuit regulates the amplitude of the input. A 0-1-ma meter in the plate circuit measures the average current and indicates the average electrical level.

When the 6AG5 is conducting, C1 charges until its potential is high enough to unblock the 6SN7-GT one-shot multivibrator. The multivibrator discharges C1 and produces a pulse which fires the 2D21 thyatron. Thus the electrical energy level of the brain is transformed into a series of pulses that increase in frequency as the energy level increases.

When the thyatron fires, it conducts momentarily and produces a pulse in the coil of the stepping relay where it is integrated and shifts a wheel a fraction of a turn. This wheel controls the syringe mechanism used to administer the anesthetic. Since the brain-energy level decreases with the depth of anesthesia, it is possible to regulate the instrument to stabilize anesthesia to the desired level, and keep it there as long as needed.

EEG (electroencephalographic) readings show that before the application of anesthetic, the average brain-wave frequency is about 20 cycles, with a relatively small amplitude; with the onset of anesthesia the amplitude increases while frequency decreases. As anesthesia progresses the frequency settles at about 2 cycles per second and amplitude diminishes gradually with the anesthesia. When a waveform no longer appears on the recorder or scope, it corresponds to a grave inhibition of the brain. It appears that no electrical activity corresponds to death.

When my attention was called to the Mayo and Bickford publications, I was very much interested, as I had already done some work with electronic equipment for operating theaters. Recently I used with considerable success a visual and acoustical aid for display of electrical activity of the heart muscles (electrocardiograms) during a surgical operation. The apparatus was

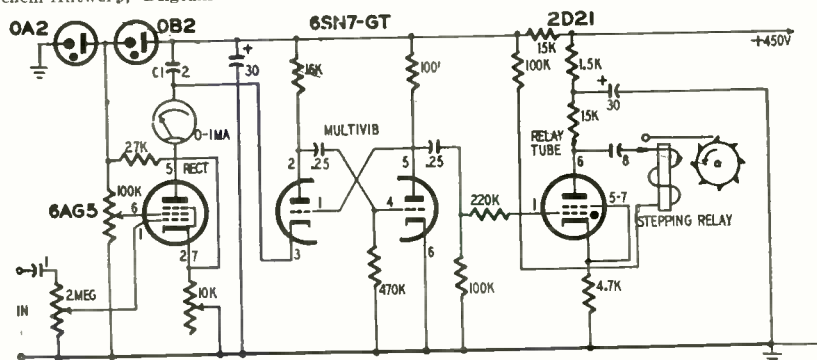

Fig. 1—Control unit for automatic anesthesia. The energy level of the patient's brain waves fires the thyatron periodically and triggers the stepping relay.

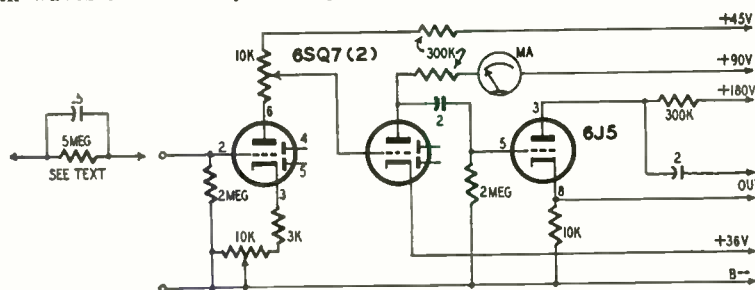

Fig. 2—Preamplifier for feeding electro-encephalographic signals to scope.

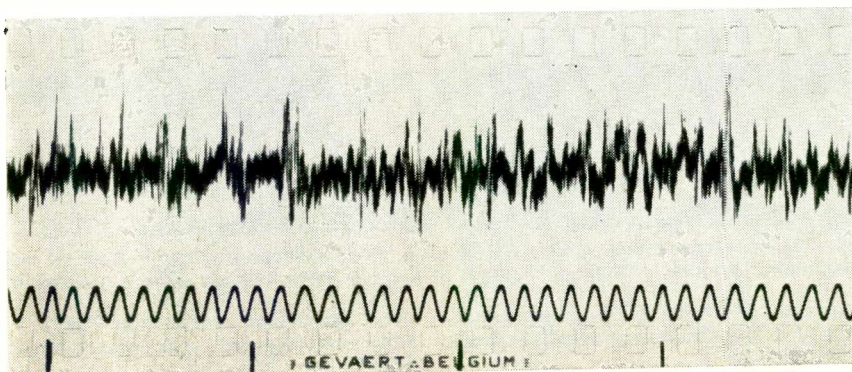

Fig. 3—The upper trace shows a small portion of an electromyogram (record of a muscle's electric activity). A 50-cycle reference marker is shown below.



Model 936HF, \$69.95* list. Model 935HF, (same less metal pan) \$59.95* list.

MORE than ANY other changer...

V-M 939HF

HIGH FIDELITY RECORD CHANGER ATTACHMENT

has Features that give you:

FIDELITY

- Die cast arm
- Laminated, weighted turntable plus 4-pole, 4-COIL motor

CONVENIENCE

- Plug-in heads
- V-M 45 spindle, plus jamproof changer mechanism

RECORD PROTECTION

- Gentle tri-o-matic® spindle plus easy, exact needle pressure adjustment

PLUS MANY OTHER FEATURES!

Made by V-M Corporation, World's largest manufacturer of phonographs and record changers.

V-M Portable high fidelity P-A Package. Model 960 changer, \$64.50* list. Model 160 amplifier and 10" Jensen speaker, \$66.50* list.



*Slightly higher in the west.

UL Approved



PLEASE MAIL COUPON TODAY!

V-M CORPORATION, BENTON HARBOR 10, MICHIGAN
Send full details on the V-M 936HF () and the V-M high fidelity P-A package ()

NAME _____
FIRM _____
ADDRESS _____
CITY _____ STATE _____

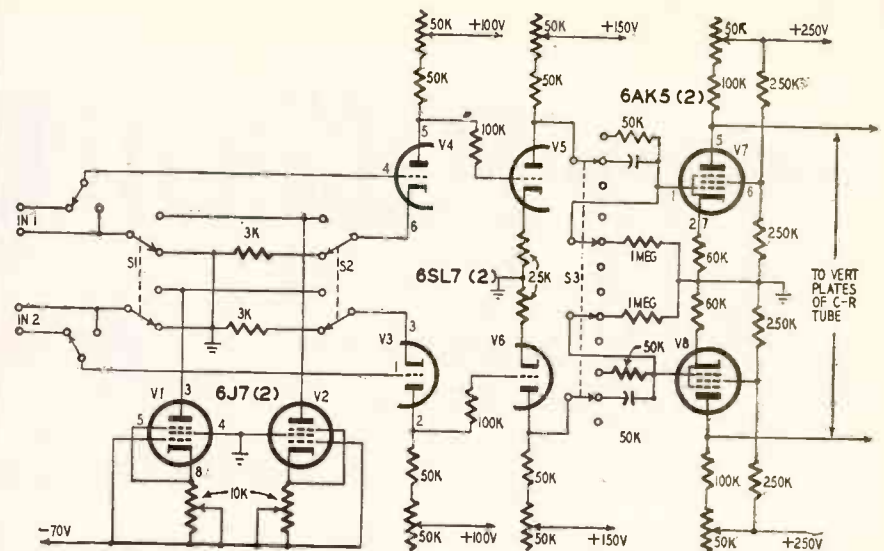

Fig. 4—The schematic diagram shows circuits used in vertical amplifier for a scope for electrocardiograms and electro-encephalographic displays.

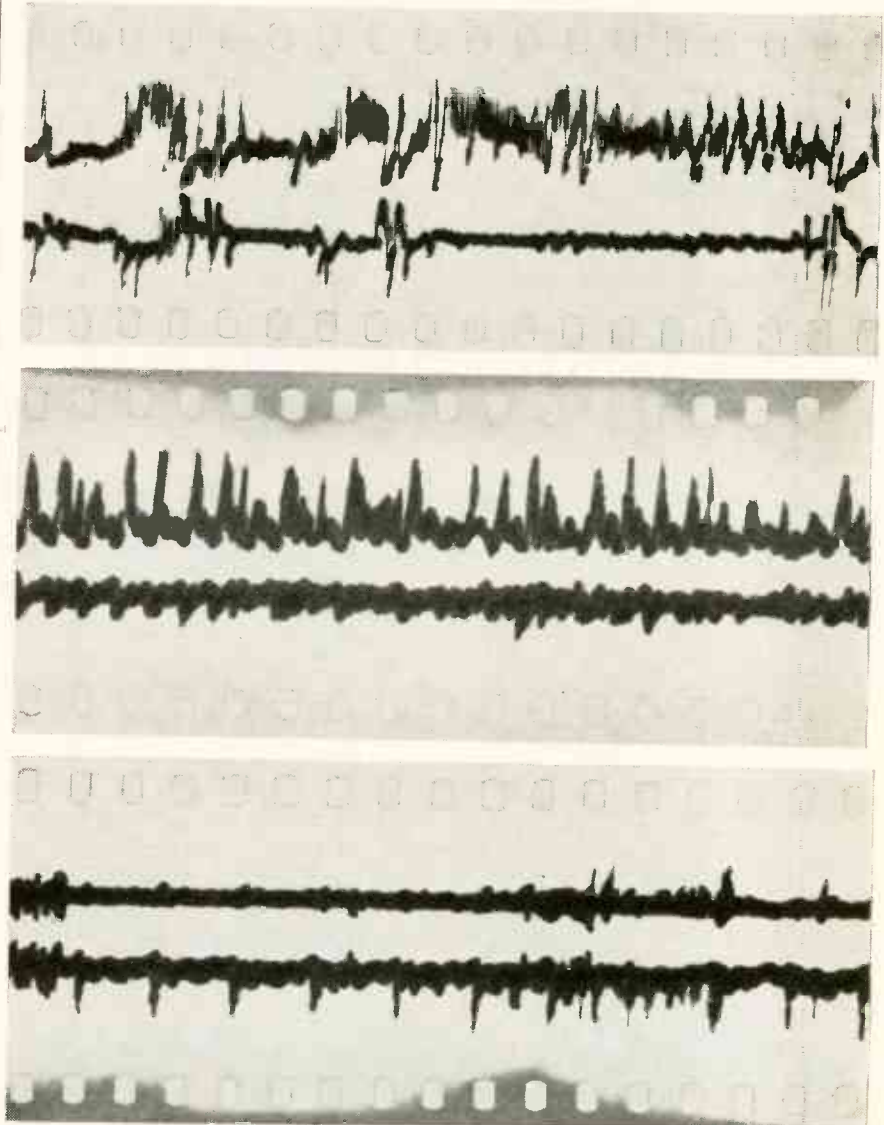

Fig. 5—Electrocardiographic (EKG) and electroencephalographic (EEG) recordings. The EKG traces are shown in the top rows and the EEG's are below.

a Cossor type 1049 oscilloscope paralleled by a low-frequency amplifier with a loudspeaker.

Both these were fed from a pre-amplifier that I designed for the pur-

pose. Its circuit is shown in Fig. 2. The first two stages are direct-coupled 6SQ7's, and the third is R-C coupled and uses a 6J5. When used with the Cossor oscillograph it is advisable to

NOW! Use Your Present Signal Generator

NEW!

For UHF!

PHILCO Signal Generator Adapter

(VHF to UHF)



VHF INPUT
60 MC

UHF OUTPUT
SIGNAL

5" High Gain Oscilloscope Model S-8202.

Gives rugged, general purpose performance. 60 CPS phasing of sweep generator presentations. Wide sweep range (up to 100KC) gives extreme flexibility in sweep circuit trouble shooting.



Individually Calibrated For Extreme Accuracy

Now produce UHF signals for TV receiver tests at a fraction of the cost of a UHF generator. Individual calibration guarantees extreme accuracy of UHF frequency. Any VHF signal generator output at 60 MC is converted by the PHILCO Model G-8000-C to UHF. The VHF sweep or marker signal beats against the UHF oscillator, producing UHF signals with the same characteristics as the VHF input signal. It's economical . . . it's a *PHILCO exclusive!*

Look at These Philco Features . . .

- 1 The VHF signal generator output attenuator controls the UHF output signal level.
- 2 Precision Vernier Dial for accurate re-settings.
- 3 Each unit is hand calibrated.
- 4 Functions as an external UHF converter by connecting UHF antenna transmission line to generator's output terminal and connecting lead to TV receiver tuned to 60 MC Channel 3.
- 5 High UHF levels, excellent stability, no drift.

AVAILABLE THROUGH YOUR PHILCO DISTRIBUTOR
ON A NEW SPECIAL PAYMENT PLAN

Take advantage of the great
SHARE and PROFIT Program

on Philco Receiving Tubes
Parts and Accessories

NOW AT YOUR PHILCO DISTRIBUTOR



MARCH, 1954

better viewing-

better **BUSINESS**

AMPHENOL

UHF/VHF TV antennas

reissue U.S. Pat. 23,273

INLINE* and
STACKED ARRAY

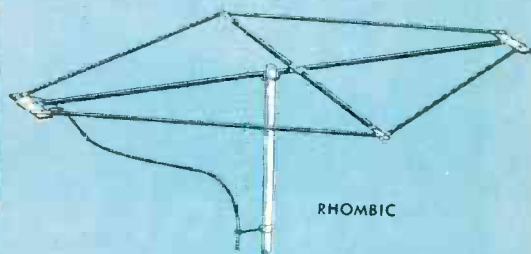

RHOMBIC

Why are AMPHENOL UHF/VHF antennas rapidly becoming the favorite line with distributors, dealers and the public? We think there are two important reasons.

BEST PICTURE—the picture quality of the television set equipped with an AMPHENOL antenna is not just better than others—it is *best*, by any comparison.

LONGER LASTING—AMPHENOL antenna installations last longer, the sturdy antenna stays on the job for years.

There is really a third reason—**CUSTOMER SATISFACTION**—which results from the combination of better electrical and mechanical performance of AMPHENOL antennas. Customer satisfaction with *better viewing* results in *better business* for all.

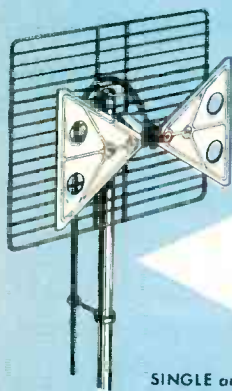

SINGLE and STACKED BO-TY

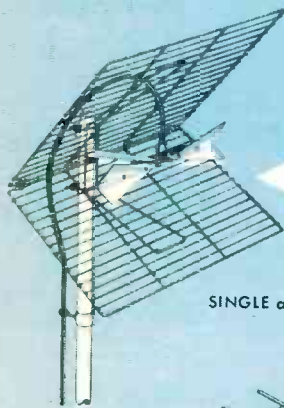

SINGLE and STACKED CORNER REFLECTOR

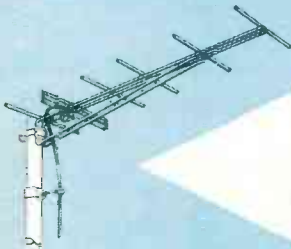

SINGLE and STACKED YAGI

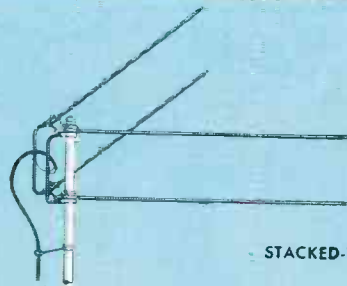
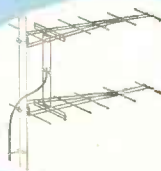

STACKED-V

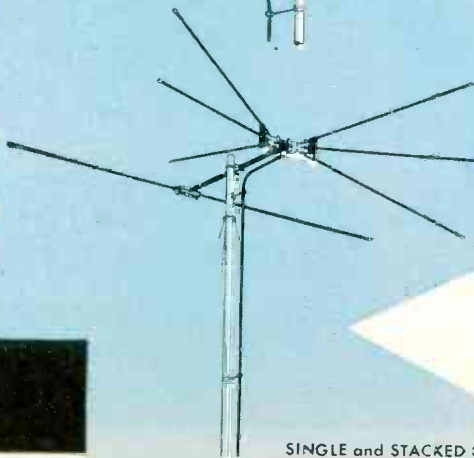

SINGLE and STACKED CONICAL



see your AMPHENOL distributor

use the capacitor shunted by a resistor in the input lead from the electrocardiograph.

Interference and artifacts

I could not see how, in the Bickford apparatus, it would be possible to cut out all the unwanted voltages produced by radiations, bad grounds and noisy power lines. I had been greatly troubled by various types of electrical interference and artifacts during the operations I had assisted in with my equipment. By grounding all apparatus, as well as the operating table, and by using coaxial as input leads. I was able to get trouble-free electrocardiograph recordings *when the patient was at rest and no one was touching him* (that is: before the actual operation began). Fig. 3 is a small portion of an electromyogram (recording of electric muscle activity) taken on a patient before being anesthetized or operated. It was of the left arm muscle. At the bottom appears as a reference marking, the 50-cycle line frequency.

Having experienced interference even with the anesthetist, I applied grounding techniques to him. But when the surgeon started operating, there was a kind of interference that varied according to whether he was only touching the body, shifting organs, or cutting into them. In my view this kind of interference cannot be avoided.

On several occasions during surgical operations I have been able to ascertain that nerves continue to react in a normal manner though the patient is under a heavy anesthetic. It is quite logical that, for example, nerve cells and fibers dealing with pain will continue to act—if situated on a healthy part of the body—and transmit their messages to the brain. There these messages will be detected and the brain—although under anesthesia—must produce some electrical reaction. And this reaction will certainly translate itself on the EEG. This is apart from the fact that the surgeon may manipulate nerve fibers and thus induce spurious voltages whose peaks will certainly drown out the EEG.

With all this in mind I was anxious to see what use we could make of the equipment designed by Dr. R. D. Bickford. The first step was to build a suitable cathode-ray oscilloscope with two equally balanced amplifiers, to enable me to get on one trace the EEG and on the other trace the ECG (electrocardiogram) as a control. The double trace would be obtained with a multivibrator switch.

The circuit of the amplifier is shown in Fig. 4. The first two tubes (V3, V4, V5, V6) are two 6SL7's. They are followed by a 6AK5 on each side. Switches S1 and S2 enable V3 and V4 to have 6J7's as cathode bias resistors. Switch S3 allows insertion of a capacitor to provide the necessary time-constant.

I followed several operations and show in Fig. 5 three of my recordings. These were selected for their interferences, but since the recordings were taken at a rate of 6 cm per minute

new! designed for UHF



model 114-328

actual size



universal

LOW-LOSS LIGHTNING ARRESTOR

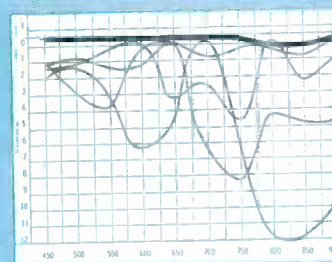

Insertion Characteristics Chart

LOWEST LOSS—The chart above gives the characteristics of the AMPHENOL model 114-328 and four competitive lightning arrestors. The superiority of the AMPHENOL arrester is obvious—negligible losses over UHF frequencies. The same standard measurement procedures applied to four competitive lightning arrestors illustrate the high loss on UHF resulting in poor pictures at the receiver.

FROM THE LABORATORIES OF AMPHENOL COMES a new concept in lightning arrestors, designed not only to protect the television receiver from the hazards of lightning but to give *full protection to the signal strength* as well. This is the new model 114-328 AMPHENOL Lightning Arrester, the result of long months of research by skilled engineers. This Arrester's *low-loss* performance means better picture quality—VHF or UHF. Its unique design assures easy installation—a *sure-grip* of flat, tubular or open-wire lead-in.

AMERICAN PHENOLIC CORPORATION
chicago 50, illinois



A New Champion!

tops in the field of molded tubular capacitors



CORNELL DUBILIER CUB

- * Outperforms all other molded tubulars in humidity tests!
 - * Stands up under temperatures up to 100°C.
 - * You get more for your dollar with this premium tubular designed and built especially for replacement needs, with "better-than-the-original" performance!
 - * Ask your C-D jobber about the special "Cub-Kit"!
- * * * *
- For the name of your C-D distributor, see the yellow pages of your classified phone book. Write for Catalog to: Dept. RC-34, Cornell-Dubilier Electric Corp., South Plainfield, N. J.

CONSISTENTLY DEPENDABLE
CORNELL-DUBILIER

There are more C-D capacitors in use today than any other make.

PLANTS IN SOUTH PLAINFIELD, NEW JERSEY; NEW BEDFORD, WORCESTER AND CAMBRIDGE, MASSACHUSETTS; PROVIDENCE AND HOPE VALLEY, RHODE ISLAND; INDIANAPOLIS, INDIANA; SANFORD AND FUGUAY SPRINGS, NORTH CAROLINA. SUBSIDIARY RADIART CORPORATION, CLEVELAND, OHIO



**OVER 50,000
TECHNICIANS
HAVE LEARNED**

**HOW TO GET
THE MOST OUT
OF BASIC TEST
EQUIPMENT**

for A.M. - F.M. - TV



ONLY 40¢
103 pages. Invaluable information that will help you re-double the value of your basic test equipment.

**'SERVICING BY
SIGNAL SUBSTITUTION'**
A BEST SELLER FOR OVER 12 YEARS!
(NEW, UP-TO-DATE, 12th EDITION)

The Modern, Simplified, Dynamic Approach to Receiver Adjustment & Alignment Problems.

- ★ Nothing complicated to learn
- ★ No extra equipment to purchase
- ★ Universal... non-obsolete
- ★ Employs only Basic Test Instruments

Ask for "S.S.S." at your local Radio Parts Jobber or remit 40¢ in small stamps or coin directly to factory.

PRECISION APPARATUS COMPANY, INC.
92-27 HORACE HARDING BLVD., ELMHURST 4, N. Y.

they involve quite sufficient time for a device like Dr. Bickford's integrator to administer too much anesthesia.

No EEG waves can be seen (the recordings were taken at too low a speed) and only the amplitude is shown as one thick line. Frequency can be followed, however, if displayed visually the same as the variation in amplitude of the EEG, but I made the recording at a very low speed to show the length, continuity and degree of interference which would make it difficult—or impossible—to work any equipment automatically from pure EEG activity during a surgical operation.

What we found however was that we had a very good visual aid to guide the anesthetist in administering anesthesia, just as the electrocardiograph helps the surgeon greatly with its acoustical aid, once he has trained himself to use its various sounds to ascertain not only the cardiac and respiratory condition, but also the traumatic condition of his patient. The EEG displayed on a cathode-ray tube is also a good indication of the patient's narcotic condition.

Friends have suggested that—to reduce interference—I might even "ground" the surgeon. That would present almost unsurmountable difficulties and would not eliminate interference. From my own experience, I fail to see how Dr. Bickford's apparatus—though an ingenious device which certainly has its uses—could be operated efficiently during a surgical operation, since interference (or artifacts, if you prefer the term) would dominate the voltages developed by the EEG. I have come to believe that it would be unwise to try to design automatic electronic devices which work with voltages produced by the patient during surgical operation for use in the operating theater.

Display needed

Indicating electronic devices are sadly lacking and no doubt will render immense service in the future, and in my opinion, research and development in the physical and electronic field should—at this stage—be directed toward indicating instrumentation rather than the operative apparatus.

I am still of the opinion that certain techniques applied by electronics in other fields should be applied to the medical field. For example, in the early days of radar, all the display then considered necessary was a cathode-ray tube as indicator; display had a controlling effect on radar by the end of 1945. Similarly what is required in medicine is display. As a start why not have all the different EEG channels displayed at once on a single C-R tube? That should present no difficulty to a good electronic engineer. With a 10-way electronic switch controlling the tubes which supply the vertical plates (there must be one final tube for each channel) while at the same time controlling the input tubes, it should be possible to present 10 channels simultaneously. This can be achieved with a frequency of about 20

THE #630 TV RECEIVER

remains unmatched for quality and performance • • • RCA designed and developed this set quality-wise not price wise • • • The original 10" set retailed at \$375.00 • • • Subsequent TV sets serve to prove the sacrifice of quality for price • • • what better proof can there be of its superiority than the fact that it is the choice of TV engineers and TV technicians! Herewith we offer you — YOUR BEST BUYS IN TV! — All you pay is the price shown • • • Excise taxes have already been paid by us.

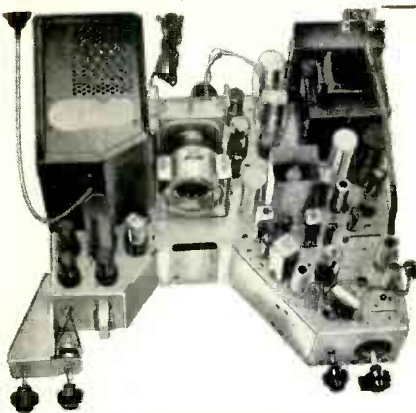

Build your own

**#630
Super Deluxe
TV CHASSIS**

with . . . U. H. F.

With a #630 SUPER DELUXE 31-TUBE TV KIT

including your favorite U.H.F. Station • OPERATES 16" to 24" PICTURE TUBES • Engineered in strict adherence to the genuine RCA #630 plus added features • FULL 4MC BANDWIDTH • CASCADE TUNER • COSINE DEFLECTION YOKE • LARGER POWER TRANSFORMER • KEYED AGC • 12" SPEAKER • UNIVERSAL MOUNTING BRACKETS • CONDENSERS and RESISTORS at rated capacities and tolerances. You receive a COMPLETE SET OF PARTS and TUBES, everything needed is included (less wire & solder). All I.F. Coils and Transformers are factory pre-aligned and tuned. You will enjoy building it with "LIFE-SIZE easy to follow step-by-step ASSEMBLING INSTRUCTIONS" included with each KIT.

NOTHING BETTER AT ANY PRICE!
only . . . **\$119.44** (less CRT)

#630 SUPER DELUXE TV CHASSIS

with U.H.F.—Licensed under RCA patents

COMPLETE READY TO PLUG IN AND PLAY—Similar in characteristics and features to the TV KIT at left • Manufactured especially for us by Regal Electronics Corporation • No efforts or expense have been spared in workmanship or materials, to make this #630 SUPER DELUXE TV CHASSIS the Best obtainable for fringe areas, clarity and all-around-performance, regardless of price. Customers report reception better than 200 miles • Each Set is factory aligned and air-tested • All parts carry the RMA three month guarantee • Our mass volume of business on this CHASSIS (numbering thousands of pleased customers) now makes it possible for us to reduce the price to

only **\$157.97** (less CRT)

OTHER LEADING BRAND #630 TYPES

COMPLETE READY TO PLUG IN AND PLAY (less CRT)

TECHMASTER #C30 TV CHASSIS	\$149.50
#1930 TV CHASSIS	\$179.50
#2430-9 TV CHASSIS 90° for 24" & 27" CRT	\$262.50
VIDEO #K4C TV CHASSIS for 16" to 21" CRT's	\$149.50
#K90 TV CHASSIS for 24" and 27" CRT's	\$198.50

STANDARD BRAND PICTURE TUBES

NEW in Factory Sealed Cartons—With a Full Year Guarantee

17"—#17BP4A	\$29.63
20"—#20CP4A	39.74
21"—#21EP4A—Aluminized	44.68
24"—#24CP4A—90° Aluminized	58.26
27"—#27NP4A 90° Aluminized	82.57

CUSTOM-BUILT CABINETS FOR #630 AND ALL OTHER TV SETS — from FACTORY to YOU

5 LEADING STYLES in genuine mahogany or walnut (blond 10% extra) • Ready drilled for any #630 TV chassis and cutout for any 14", 17", 19", 20" or 21" picture tube at no extras in price • Also supplied with undrilled knob panel for any other TV set • EVERYTHING NECESSARY for an easy perfect assembly is included • Each cabinet is delivered complete as pictured with mask, safety glass, mounting brackets, backboard, backcup, hardware and assembling instructions • Each cabinet is shipped in on air cushioned carton from FACTORY to YOU!

The VOGUE
Most Popular
Table Model



H-25", W-26", D-22"

\$39.89

The MANHATTAN
Style, Quality, Price



H-41", W-25", D-23"

\$59.37

MANHATTAN for 24" or 27" CRT
H-46½", W-27¾", D-24" **\$86.22**

The MAYFAIR
Exquisitely modern, with an elegance of simplicity in styling.



H-40", W-26", D-25"

\$98.56

The PLYMOUTH

Choice of interior Decorators, truly superb in every detail.



H-40", W-27", D-23"

\$105.48

The TOWN & COUNTRY

Patterned after the popular credenza. Available for all size picture tubes 14" to 27"



H-42", W-36", D-24"

For 14", 16", 17", 19", 20", 21", 24" or 27" C.R.T.'s **\$109.62**

PARTS FOR #630 TV SETS

TV WIRE & SOLDER KIT, for any Set	\$ 1.49
630-KIT, screws, nuts, rivets, washers, etc.	1.69
PUNCHED CHASSIS PAN, cadmium plated	4.87
UNIVERSAL CRT MOUNTING BRACKETS	6.97
STANDARD CASCADE TUNER, incl. tubes	22.49
POWER TRANSFORMER, 295ma. 201T6	9.97
VERTICAL OUTPUT TRANS. 204T2	2.69
VERTICAL BLOCKING TRANS. 208T2	1.32
HORIZONTAL OUTPUT TRANS. 211T5	3.98
FOCUS COIL, 470 ohms. 202D2	3.42
DEFLECTION YOKE, Cosine 70°	3.98
COMPLETE SET OF KNOBS, incl. decals	1.34
SOUND DISCRIMINATOR TRANS. 203K1	1.12
1st PIX I.F. TRANSFORMER, 202K2	1.08
2nd PIX I.F. TRANSFORMER, 202K3	1.08
1st or 2nd SOUND I.F. TRANS. 201K1	1.02
HORIZONTAL DISCRIM. TRANS. 208T8	1.49
FILTER CHOKE, 62 ohms	1.47
CATHODE TRAP COIL, 202K4	1.08
WIDTH CONTROL COIL, keyed AGC IR4AG79
ION TRAP BEAM BENDER, double 203D398
ION TRAP BEAM BENDER, single 203D179

STANDARD CASCADE TUNER

Complete with tubes, and Brooks CAS-CODE MANUAL with step-by-step instructions and all extra parts needed. **\$22.94**

PULSE KEYED AGC KIT

Finest, most accurate and the easiest Kit to install in a #630 or in any other make TV receiver. Improves performance, and insures a steady picture on all channels.

COMPLETE SET OF PARTS \$4.59
Including 8AUG tube & Instructions

#630 PARTS & COMPLETE SETS

TV WIRE & SOLDER KIT, for any Set	\$1.49
VIDEO AND I.F. KIT, 19 items	7.84
VARIABLE CONTROL KIT, 9 controls	5.83
CARBON RESISTOR KIT, 107 resistors	6.98
WIREWOUND RESISTOR KIT, 4 resistors	2.31
BRACKET AND SHIELD KIT, 18 items	8.63
ELECTROLYTIC CONDENSER KIT, 6 cond.	7.37
TUBULAR CONDENSER KIT, 38 condensers	4.28

AM SUPER RADIO FOR #630 or other TV

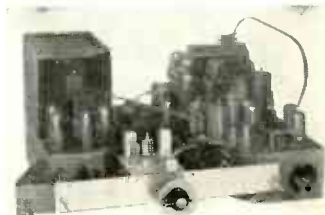

Complete ready to install including tubes & instructions (lists for \$24.95)

only **\$7.89**

Brooks LIFE-SIZE TV INSTRUCTIONS \$2.49
for building any #630 Receiver. Postpaid

HINTS FOR BETTER PERFORMANCE \$1.00
on your #630 TV receiver. Postpaid

Brooks CASCADE MANUAL, how to install Cascade Tuner in any make TV set. Postpaid 50¢

BROOKS RADIO & TV CORP., 84 Vesey St., Dept. A, New York 7, N. Y.

OUTSTANDING for HIGH FIDELITY!
COLLINS TUNERS and RECEIVERS
 AUDIO PRODUCTS CO.

BUY DIRECT AND SAVE

'PRE-FAB'

Two ALL NEW Complete Kits for Every High-Fidelity Need

Collins Audio Products Co., 41 W. 100th St., Philadelphia, Pa. 19136
 Affiliated with Collins Radio Co.

Each Collins Tuner Kit is complete with punched chassis, tubes, power transformer, power supply components, hardware, dial assembly, tuning eye, knobs, wire, etc., as well as the completed sub-assemblies: FM tuning units, AM tuning units, IF amplifiers, etc., where applicable. All sub-assemblies wired, tested and aligned at the factory make Collins Pre-Fab Kits easy to assemble even without technical knowledge. The end result is a fine, high quality, high fidelity instrument at often less than half the cost—because you helped make it and bought it direct from the factory.

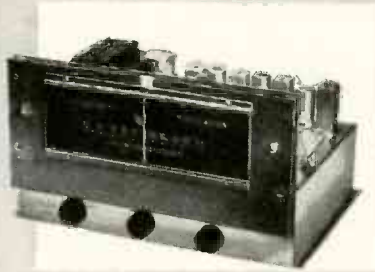

FM Tuner Kit

\$55

The FM-11 tuner is available in kit form with the IF Amplifier mounted in the chassis, wired and tested by us. You mount the completed RF Tuning Unit and power supply, then after some simple wiring, it's all set to operate. 11 tubes: 6J6 RF amp, 6AG5 converter, 6C4 oscillator, 6BA6 1st IF, (2) 6AU6 2nd and 3rd IF, (2) 6AU6 limiters, 6AL5 discriminator, 6AL7-GT double tuning eye, 5Y3-GT rectifier. Sensitivity 6 to 10 microvolts, less than 1/2 of 1% distortion, 20 to 20,000 cycle response with 2DB variation. Chassis dimensions: 12 1/2" wide, 8" deep, 7" high. Illustrated manual supplied. Shipping weight 14 lbs.

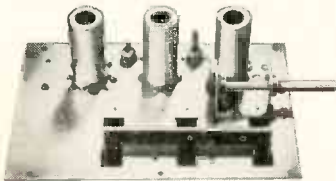

FMF-3 Tuning Unit

\$1525

The best for FM. The most sensitive and most selective type of "front end" on the market. 6 to 10 microvolts sensitivity. Image ratio 500 to 1. 6J6 tuned RF stage, 6AG5 converter, 6C4 oscillator. Permeability tuned, stable and drift-free. Chassis plate measures 6 1/2" x 4 1/2". In combination with the IF-6 amplifier, the highest order of sensitivity on FM can be attained. Tubes included as well as schematic and instructions. Draws 30 ma. Shipping weight FMF-3: 2 1/2 lbs. Dial available @ \$3.85.



IF-6 Amplifier

\$1975

A remarkable value! 6 tubes are used in the IF amplifier: 6BA6 1st IF, (2) 6AU6 2nd and 3rd IF's, (2) 6AU6 limiters and 6AL5 discriminator. High gain, wide-band response (200 KC) for highest fidelity. 20 to 20,000 cycles. Distortion less than 1/2 of 1%. Draws 40 ma @ 220 volts. Chassis plate dimensions: 11 1/8" x 2 1/2". Shipping weight: 3 lbs.

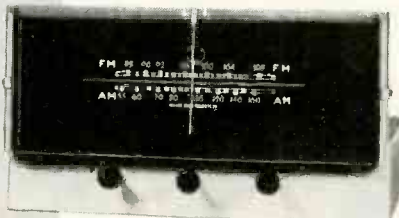

FM/AM Tuner Kit

\$7750

The original 15 tube deluxe FM/AM pre-fab kit redesigned on a smaller chassis. The tuner now measures 14" wide by 12" deep by 7 1/2" high. This attractive new front and dial assembly opens up new applications where space is at a premium. Kit includes everything necessary to put it into operation—punched chassis, tubes, wired and aligned components, power supply, hardware, etc. Kit comprises FMF-3 tuning unit, IF-6 amplifier, AM-4 AM tuning unit, magic eye assembly and complete instructions. All tubes included. Shipping weight 19 lbs.

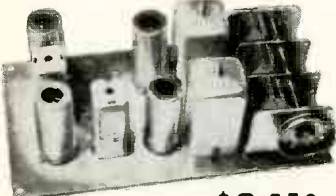

AM-4 Tuning Unit

\$2450

Tops in AM superhet performance! A 3-gang tuning condenser gives 3 tuned stages with high sensitivity and selectivity. Assembly is completely wired, tested and aligned ready for immediate use. Frequency coverage 540 KC to 1650 KC at a sensitivity of 5 microvolts. Tubes 6BA6 RF amplifier, 6BE6 converter, 6BA6 IF amplifier and 6AT6 detector. Draws 30 ma @ 220 volts. Mounts on a chassis plate measuring 4" x 7 3/8". Shipping weight 2 1/2 lbs. Dial available at \$3.85.

MAIL COUPON TODAY

To: Collins Audio Products Co. Inc. RE-3
 P.O. Box 368, Westfield, N. J.
 Tel. Westfield 2-4390

FM Tuner Kit FM/AM Tuner Kit Slide Rule Dial Assembly
 FMF-3 Tuning Unit IF-6 Amplifier AM-4 Tuning Unit

NAME.....
 ADDRESS.....
 CITY..... STATE.....
 Amount for Kit \$..... See weights, add shipping cost \$.....
 Total amount enclosed \$..... Check Money Order

WHEN YOU THINK OF TUNERS, THINK OF COLLINS AUDIO PRODUCTS

kilocycles on the electronic switch. All the electrocardiograph channels should be displayed simultaneously on another C-R tube screen, and on a third screen several independent channels of electromyograms should be displayed. A fourth scope should display various and appropriate gland-action potentials. The neurologist would then have an "electrical activity" picture of the patient before him. This would certainly facilitate diagnosis. I am convinced that the day physicians are able to present a complete and correct physical picture and interpretation of the central nervous system, medical science will enter a new era where guesses will be unknown.

It is essential that medical men should obtain the services of an experienced physicist in the early stages, to get acquainted with the various waveforms displayed and the interpretation of all possible artifacts. And to those who would enter the field of medical electronics: remember that medical men as a group regard electronic devices with suspicion. Their training has left them without sufficient equipment to enable them to grasp even the meaning of electronic apparatus. Clinicians are too much inclined to look upon electronic and physical apparatus to confirm their diagnosis rather than to use it with an open mind; and without prejudice to look at such pieces of equipment as they mostly are: *perfect indicators!*

The medical profession as a whole is beginning to recognize the importance of electronics, and electronic engineers or physicists are gradually being added to the medical staff in most important institutions. Electronic engineers thus engaged should always bear in mind that, while in industrial electronics mistakes will affect only relative production, in medical electronics one deals with human lives. The responsibility is very much greater indeed, and the greatest possible care and caution is therefore recommended.

Finally permit me to express my gratitude to my numerous medical friends who so kindly assisted me with their advice and help, as well as to Gevaert Photo-Products, Ltd., of Antwerp, who kindly assisted me on the photographic side. **END**

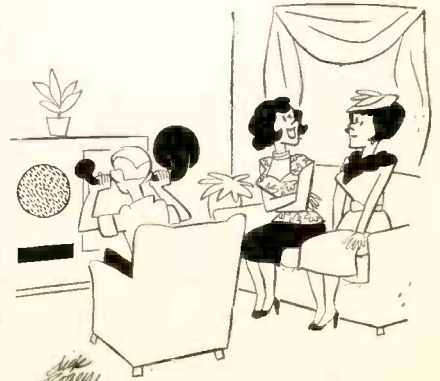

"Gramps getting interested in binaural sound. He bought another ear trumpet."

"BEST FREQUENCY • STABILITY • ACCURACY"

SUMS UP ALL FIELD COMMENT ON THIS LATEST HICKOK TELEVISION ALIGNMENT EQUIPMENT



Model 690

Marker Generator

Crystal controlled. High 25 volt R.F. output. Provides dual markers with any TV sweep generator. This unit features another HICKOK First by incorporating a Non-Parallax shadow type dial. In conventional type dials, error generally is introduced in setting frequencies since the hairline or indicator is at a slight distance from the scale. This distance, however slight, can introduce error if the scale is not viewed directly at right angles.

In alignment of any type of receiver, the marker generator is the unit that is to be relied upon and must therefore be consistently accurate in frequency settings. The Hickok Non-Parallax dial can be viewed from any angle without introducing error. The 45 inches of dial can be self calibrated to within crystal accuracy (.05%) since the unit includes a self contained crystal calibrator.

Leading features of this unit are:

- (1) The simple and time saving method employed in calibration of the dial—there is no counting of beats—no interpolation—no remembering of frequencies.
- (2) Provision for calibrating any other signal generator to crystal accuracy.
- (3) Complete R.F. coverage up to and including channel 83. All channels have picture and sound settings marked directly on the scale—this eliminates checking on these values when they become applicable.
- (4) The marker can be modulated by a self contained 400 cycle signal. This is especially valuable in stage-by-stage alignment and eliminates the introduction of another instrument.
- (5) Position for adding two other crystals is provided in addition to the 2.5 Mc crystal which is included.
- (6) It is possible to view two markers at once on the response curve. This will include the main marker and a marker corresponding to the crystal value selected. For instance, a 4.5 Mc crystal may be used to obtain two markers with a 4.5 Mc separation. This will greatly speed up alignment procedures since it is not necessary to re-set dials to check response curve width.
- (7) Both an electronic-eye tube and a headphone jack are available for either visual or audible indications of zero beat.
- (8) Attenuation is controlled by both a step attenuator and vernier to attain complete regulation of output.
- (9) The unit is completely double shielded to assure a minimum of leakage.
- (10) All frequencies are covered on fundamentals with the exception of U.H.F. channels. There are no spurious

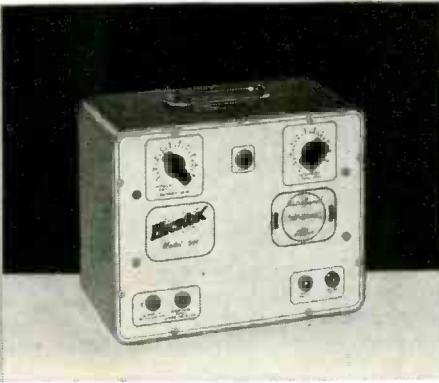

This entirely new and advanced alignment equipment represents the latest HICKOK achievement in offering a complete, fast and accurate solution to TV alignment.

Many leading TV engineers have tested this new equipment and highly compliment its practical design for individual unit use or compatible set use.

The stability frequency and accuracy of this new equipment plus its ease of use make the 690 - 691 - 695 today's best tools for a more profitable TV service business.

or confusing beats or frequencies generated by the unit. It is an all around instrument in view of its very complete R.F. coverage. 3.57 mc crystal is available. (Frequency of color burst)

Model 691

Heterodyned Marker Adder

This unit, in conjunction with the Model 695 Sweep Generator and Model 690 Marker Generator provides the utmost in television alignment techniques. It takes the guesswork out of receiver alignment and eliminates any errors previously introduced by overloading due to markers.

The 691 provides a marker visible at all times (including trap points) and will not change in amplitude or distort the response curve what-so-ever. This feature, in addition to the accuracy and minimum leakage of the other units (690 - 695), will greatly simplify any alignment.

The outputs of the sweep generator and marker generator are heterodyned and applied to an oscilloscope in such a manner that the marker signal will never pass through the receiver itself—therefore cannot cause overloading.

In short, we can say that we are calibrating the oscilloscope with a marker which is visible at all times—even on the base line.

The 691 is specifically designed as a companion to the HICKOK 690 Marker and 695 Sweep Generator; however, it will work well with any of your present equipment that has an output of 50,000 microvolts or more.

Many leading TV engineers have tested this new Hickok equipment and highly compliment its frequency, stability and ease of use in offering today's fastest, most complete and accurate solution to TV alignment tasks. See your jobber today or write factory direct for complete technical information.



Model 695

Sweep Generator

This is a completely new electronic sweep generator that will exactly fill top requirements of the professional TV serviceman or lab. There are no moving parts to produce vibration or to wear out. This unit, although moderately priced, features a sweep signal that is absolutely linear and without amplitude modulations.

This unit has technical advantages over other sweep generators because:

- (1) The unit is completely triple shielded to insure that there is as little leakage from the unit as is engineeringly possible. It is possible to attenuate the signal down to 3 microvolts, and the unit has a maximum output of 300,000 microvolts.
- (2) A bias voltage, variable from 0 to 12 volts, and metered directly by the voltmeter on the front panel, eliminates the usual time-consuming method of obtaining bias voltage from dry cells. Since this bias voltage is variable with continuous tuning, one can determine more accurately the effects of bias on the overall response curve and can align sets to more sensitive for "fringe area" reception or align them to prevent "overloading" when the station signal is very powerful.
- (3) Three RF oscillators provide complete VHF coverage (Channels 2 - 13) on fundamentals and heterodyned output IF frequencies 0 - 50 Mc. This assures a strong signal necessary for aligning "front ends."
- (4) Continuous tuning and an easy-to-read scale marked off in channels literally provides the serviceman with a fool-proof method of alignment.
- (5) An internal method of "retrace blanking" provides a reference base line and eliminates confusion sometimes brought about by retrace curves.
- (6) Even though the sweep width is varied, it will not be necessary to readjust the phasing control.
- (7) As is common to all Hickok Signal generators, a Standby position is incorporated in which the plate voltage is removed from all the tubes leaving filament voltage alone to keep the unit at a constant temperature and ready to operate the moment the Range Selector Switch is rotated.
- (8) The instruction manual accompanying the unit gives complete, detailed and easy-to-follow instructions on correct alignment procedures, uses of the instrument, and a thorough understanding of alignment.

All of these features have been developed with the TV serviceman in mind.

THE HICKOK ELECTRICAL INSTRUMENT COMPANY

10531 Dupont Avenue • Cleveland 8, Ohio

See your parts jobber or write direct for technical details.



Come Again



Radio - Electronic Men!

Just as you have been coming since 1945 to the IRE National Convention and Radio Engineering Show—coming by the thousands, 35,642 in '53—so come again to see and hear all that is new in the engineering advances of your industry.

- ▲ **Fifty-four in '54!**—243 scientific and engineering papers will be presented, skillfully grouped by related interests into 54 technical sessions. More than half these sessions are organized by IRE Professional Groups, thus making the IRE National a federation of 21 conferences in one. The whole provides a practical summary of radio-electronic progress.
- ▲ **600 Exhibitors "spotlight the new!"**—A mile and a half of exhibits line the avenue of this show, intriguingly named for the elements of radio—such as "Instruments," "Components," "Airborne," "Radar," "Transistor," "Audio," "Microwave," etc., filling the four acres of the great Kingsbridge Armory to capacity. An expanding radio industry shows why it is growing by proving how engineering research pays out in new products. The exhibits themselves are an education, condensed to one place—reviewed in four days.
- ▲ **Kingsbridge is the solution!** Only the combined facilities of the Waldorf-Astoria Hotel, plus the three great halls in the Kingsbridge Armory, seating 906, 720, and 500 respectively, are able to keep pace with the increased technical papers program of the IRE Convention. The show had to move because the U. S. Treasury took over Grand Central Palace. The immense Kingsbridge Armory, connected to the very satisfactory Lexington Avenue Hotel area by direct express subway, serves well to expand the already outgrown exhibit facilities of

the Palace and provide space for 200 new firms to exhibit, as well as seat greater audiences at the high-interest sessions. In addition to the subway, free busses leave the Waldorf every ten minutes in which you may travel in the congenial company of fellow engineers, direct to Kingsbridge.

▲ **Admission by registration only!** Registration serves for the four day period. It is \$1. for IRE members, \$3. for non-members, covering sessions and exhibits. Social events priced separately.

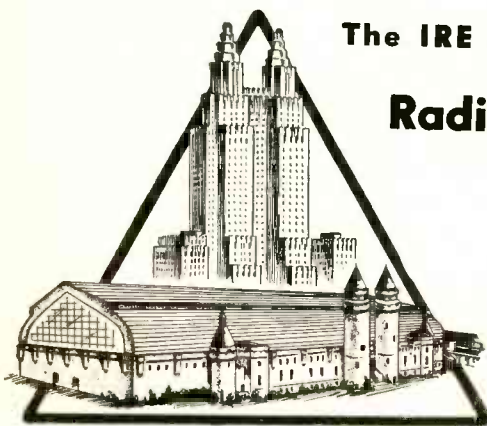

Waldorf-Astoria and Kingsbridge Armory

The IRE National Convention and Radio Engineering Show

March 22-25, 1954

THE INSTITUTE OF
RADIO ENGINEERS

1 East 79th Street, New York City

HELP WANTED

This established radio & television manufacturing firm in Western New York has openings for:

Test Engineers
Technicians

Trouble Shooters
Aligners

Applications should contain details of past experience. Write to

Personnel Manager, H. E. Dudley

STROMBERG-CARLSON COMPANY, Rochester 3, N. Y.

ELECTRONICS

SMALLEST X-RAY TUBE

Probably the smallest X-ray tube ever made, the KT, is now being used for superficial therapy and biological

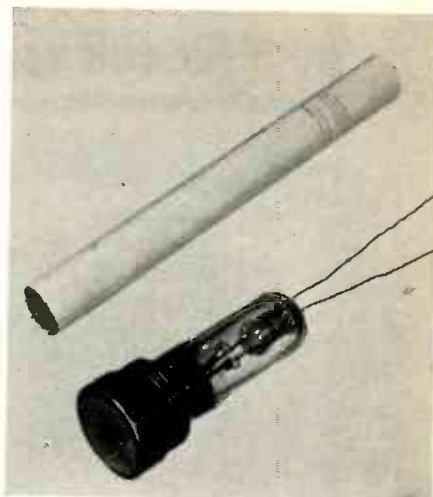

Courtesy Philips Technical Review

Photo shows size of midget KT tube.

research. The KT tube is so small, it can easily be held between two fingers of one hand. The maximum tube voltage is 25,000 and maximum current is 200 μ a. The plate can dissipate 2.5 watts continuously.

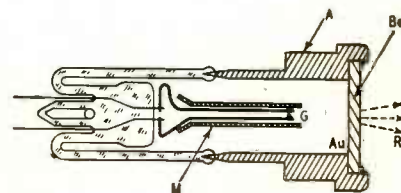

Cross-section of the KT tube (approximately $\frac{3}{8}$ x $1\frac{1}{4}$ inches). A—anode can; Be—beryllium plate; Au—gold layer; G—filament; M—metal cylinder; R—effective X-ray beam.

The KT can be used for making radiographs for research and teaching purposes, where a very soft radiation is required and extremely small power is sufficient. At present, the KT tube is finding much use in therapeutic irradiation.

END



"and is that husband of yours still tinkering around with electronics?"

RADIO-ELECTRONICS

Here's your Opportunity

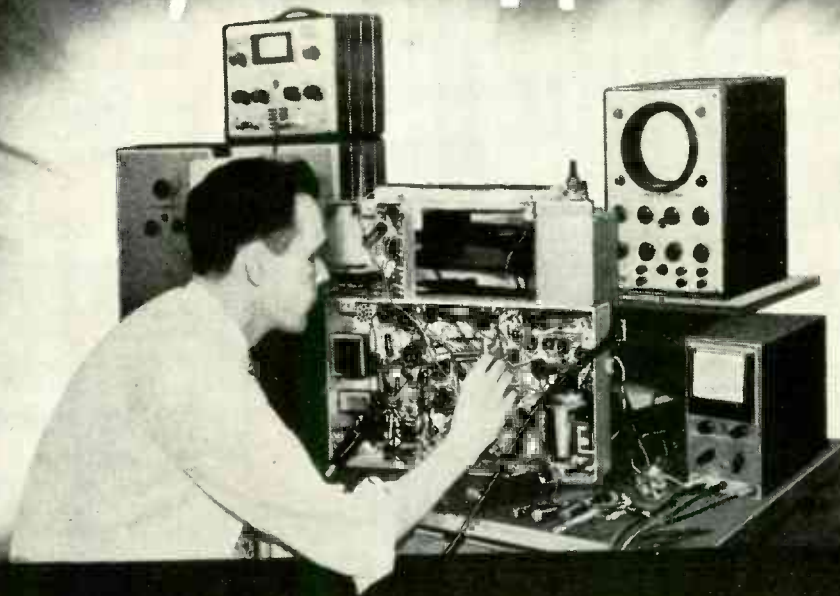

**to prepare for a good job or a business
of your own in TV SERVICING**

ARE YOU SATISFIED with the position you now hold? Do you feel you're worth more money? Are you pleased with yourself, your work, your associates . . . and your future? What does the next year hold for you . . . and the year after that?

Are you content merely to plod along through the best years of your life . . . or do you want to get into more pleasant work . . . hold a well-paid job . . . perhaps establish your own business?

If you are looking for a REAL opportunity . . . If you want to GROW with a GROWING INDUSTRY . . . If you want to grasp the success that should be yours, then we say to you, study TV Servicing.

Everyone knows that Television is the fastest growing industry today. Opportunities are going begging for men who have

the training and ability to grasp them. *Now is the time to start on the road to success in TV Servicing.*

Study at Home in your spare time

The RCA Institutes Home Study Course in TV Servicing is easy to learn. You progress rapidly, step by step, as you learn the procedure of servicing and trouble-shooting TV receivers and installing TV antennas. Hundreds of pictures and diagrams help you understand the how-it-works information and the how-to-do-it techniques.

A Service of

Radio Corporation of America

The RCA Institutes TV Servicing course was written and planned by instructors with years of specialized experience in training men. You get up-to-the-minute information, too, because you study right at the source

of the latest developments in Television. Your lessons are carefully examined and accurately graded by competent teachers who are interested in helping YOU to succeed.

RCA Institutes is licensed by the University of the State of New York . . . an affiliate member of the American Society for Engineering Education . . . approved by leading Radio-TV Service Organizations . . . approved by Veterans Administration.

It costs so little to gain so much

RCA Institutes makes it easy for you to take advantage of the big opportunities in TV Servicing. The cost of the TV Servicing Home Study Course has been cut to a minimum. You pay for the course on a pay-as-you-learn unit lesson basis. *No other home study course in TV Servicing offers so much for so little cost to you.*

RCA Institutes conducts a resident school in New York City offering day and evening courses in Radio and TV Servicing, Radio Code and Radio Operating, Radio Broadcasting, Advanced Technology. Write for free catalog on resident courses.



RCA INSTITUTES, INC.
A SERVICE OF RADIO CORPORATION OF AMERICA
350 WEST FOURTH STREET, NEW YORK 14, N.Y.

MARCH, 1954

SEND FOR FREE BOOKLET—Mail the coupon—today. Get complete information on the RCA INSTITUTES Home Study Course in Television Servicing. Booklet gives you a general outline of the course by units. See how this practical home study course trains you quickly, easily. Mail coupon in envelope or paste on postal card.



MAIL COUPON NOW!

RCA INSTITUTES, INC., Home Study Dept. RE354
350 West Fourth Street, New York 14, N. Y.

Without obligation on my part, please send me copy of booklet "RCA INSTITUTES Home Study Course in TELEVISION SERVICING." (No salesman will call.)

Name _____ (please print)

Address _____

City _____ Zone _____ State _____

WE SPECIALIZE EXCLUSIVELY IN TUBES RECEIVING—TRANSMITTING SPECIAL PURPOSE

The only thing we handle is—TUBES—of every kind and description—serving the industry for years. Thus, we can give you a more comprehensive selection of types and the advantage of more competitive prices. All our tubes are fully guaranteed. From amongst the 3000 different types we have in stock, for immediate delivery, we list here only a few of the common types. These are but a sampling of our immense variety—therefore we urge you to order any other unlisted types. Minimum order \$10. Please include 25% deposit with order.

082	.74	605	.55	6SD7GT	.35	7Z4	.49	12SC7	.69	31	.39
024	.48	606	.55	6SG7GT	.40	10Y	.69	12SF5	.49	32	.39
1A4P	.39	608G	.85	6SH7GT	.45	12G6	.59	12SF7GT	.45	32 7GT	.87
1A5GT	.39	6AB7	.75	6CB6	.45	6SJ7	.49	12AH7	.79	34	.39
1A6	.37	6AC7	.79	6CD6	1.08	6SJ7GT	.59	12AT6	.49	35C5	.37
1A85	.39	6AF4	.88	6DB6	.57	6SL7GT	.45	12AT7	.59	35W4	.33
1AX2	.59	6AF6	.75	6DB6G	.98	6SN7GT	.49	12AUG	.45	35Y4	.53
1B3	.49	6AG5	.40	6F5	.45	6SR7	.45	12AU7	.58	35Z3	.49
1B5	.26	6AG7	.95	6F6G	.32	6SS7	.45	12AV7	.85	36	.39
1C5GT	.34	6AJ5	1.49	6F7	.89	6ST7	.49	12AX4GT	.69	39 44	.25
1C6	.35	6AK5	.55	6F8G	.79	6T7G	.79	12AX7	.65	41	.41
1C7G	.39	6AL5	.36	6H6	.49	6T8	.65	12AY7	1.79	42	.42
1D5GP	.44	6AQ5	.37	6J5	.49	6U7G	.39	12BA6	.49	43	.43
1D7G	.39	6AS5	.50	6J5GT	.39	6U8	.56	12BA7	.59	45Z3	.39
1D7GT	.39	6AT6	.35	6J6	.49	6V6GT	.39	12BE6	.49	46	.46
1D8GT	.77	6AU6	.39	6J7	.69	6X4	.35	12BH7	.65	49	.49
1E4	.29	6AV6	.35	6J7GT	.39	6X8	.69	12B7	.75	50B8GT	.39
1E7GP	.35	6AX4GT	.53	6J7GT	.52	6Y7G	.69	12BZ7	.59	50K6	.64
1F4	.34	6B5	.77	6J8G	.95	6Z7G	.75	12C6	.39	50Y6GT	.59
1F5G	.34	6B8	.72	6K7	.43	7A6	.69	12C6G	.49	50Z6GT	.59
1G4GT	.34	6B8G	.49	6K7G	.39	7AD7	.95	12C8	.49	50Z6GT	.59
1G6GT	.25	6BA6	.39	6K8G	.65	7AG7	.55	12C8G	.39	50Z6GT	.59
1H5G	.48	6BA7	.56	6L5G	.79	7BA	.49	12D6	.58	50Z6GT	.59
1H6GT	.38	6BB6	.44	6L6G	.69	7BE	.59	12E6	.55	50Z6GT	.59
1J6G	.59	6BG6	1.09	6L7	.79	7C4	.49	12K8	.69	50Z6GT	.59
1J6GT	.62	6BH6	.45	6L7G	.59	7C5	.59	12K8GT	.75	50Z6GT	.59
1L4	.43	6BV6	.69	6N7	.72	7D7	.73	12L6	1.30	50Z6GT	.59
1LA4	.79	6BN6	.79	6N7G	.62	7H7	.59	12Q7G	.55	50Z6GT	.59
1L5	.39	6BQ6	.79	6R7G	.55	7L7	.79	12Q7GT	.59	50Z6GT	.59
1L5G	.62	6BZ7A	.78	6S7	.42	7S7	.85	12S8GT	.61	50Z6GT	.59
1U4	.44	6C4	.37	6S7G	.59	7W7	.85	12SA7	.56	50Z6GT	.59
1U5	.45	6C4	.37	6S8	.59	7Y4	.44	12SA7GT	.56	50Z6GT	.59
1X2A	.57										
2A3	.95										
2A4G	.59										
2A5	.39										
2A6	.49										
2A7	.64										
2B7	.62										
3A4	.44										
3A5	.83										
3A8	.60										
3B7	.39										
3D6	.39										
3Q4	.63										
3S4	.44										
3V4	.44										
5T4	1.28										
5Y3GT	.29										

ADDITIONAL DISCOUNTS: On orders for \$25 or more, deduct 3%. Prices subject to change without notice. All prices F.O.B. our warehouse, New York City. All tubes individually boxed.

FREE: Send for our latest listing.

LECTRON TUBE WHOLESALERS, INC.

RECEIVING • TRANSMITTING • SPECIAL PURPOSE

140 DUANE STREET • NEW YORK 13, N. Y. • Phone: BArlay 7-7616

RADIO-ELECTRONICS will be happy to print future contributions similar to the ones below, giving personal experiences of radio and television technicians. We shall pay \$10 for each contribution used by this department. The contribution may be either serious or humorous, but should be an actual experience encountered by a service technician.

Address all contributions to:
 Editor, THE SERVICE RUNAROUND
 % RADIO-ELECTRONICS
 25 West Broadway
 New York 7, New York

A DOCTOR'S APPOINTMENT

Our doctor-customer was angered by the nonperformance of his video set and was too busy to make an appointment so that a service technician could see the set. He berated us and the receiver was running out and we didn't want to be put in a position where we might be suspected of delaying repairs till a set was out of warranty.

Finally we had one of our men, who was unknown to the doctor, call him up as a patient and make an appointment. When the repairman got to see the medic, he told him he was there to look at the set, and asked him how much time he allotted a patient and what his office fee was.

The doctor said he generally figured on 20 minutes to a patient, so our technician went to work and luckily spotted the trouble in the allotted time. He handed the doc the regular fee, but the doctor handed it back with a smile and complimented our man on his novel approach.—Harvey Muller

CATHODE RAY	
3EP1	5.50
5BP1	3.95
5BP4	5.95
5CP1	5.95
7BP7	7.45
12DP7	19.50
16HP4A	24.95
16DP4	24.95



XCELITE Hand Tools
PREFERRED BY THE EXPERTS

AND! It's Now Available with Detachable Reamer! Tops in shops, and "out" on gobs of jobs, the "99" has all it takes! Contains 13 quick-change nut drivers and regular and Phillips screwdrivers, all fitting that husky, man-sized Xcelite handle.

(Now more useful than ever with the new Xcelite super-hard reamer!)—and a complete "tool chest" you CAN take with you—a real buy at only \$11.95, less your discount.

See your Xcelite Dealer NOW!

XCELITE, INCORPORATED
(Formerly Park Metalware Co., Inc.)
Department J Orchard Park, N. Y.

TO "LICK" THAT NEXT JOB MAKE SURE YOU'VE GOT WHAT IT TAKES!

XCELITE PR "99"

Multi-Purpose Kit



For Originality
LOOK TO XCELITE

OPPORTUNITY ADLETS

Rates—45¢ per word (including name, address and initials). Minimum ad 10 words. Cash must accompany all ads except those placed by accredited agencies. Discount 10% for 12 consecutive issues. Misleading or objectionable ads not accepted. Copy for May issue must reach us before March 21, 1954.

Radio Electronics, 25 W. Broadway, New York 7, N. Y.

SPEAKERS REPAIRED at wholesale prices. Guaranteed workmanship. Jobbers wanted. Amprite Speakers Service 70 Vesey St., New York 7, N. Y.

DIAGRAMS. RADIO \$1.00 TELEVISION \$2.00. Give make and model. Diagram Service, Box 672-RE, Hartford, Conn.

TUBEN-TV, RADIO, TRANSMITTING, AND SPECIAL PURPOSE TYPES BOUGHT, SOLD AND EXCHANGED. Send details to B. N. Genster W2LNL, 136 Liberty, N. Y. 6, N. Y.

ALL MAKES OF ELECTRICAL INSTRUMENTS AND TESTING equipment repaired. Write for free catalogue on new and used instruments at a savings. Hazelton Instrument Co., 128 Liberty Street, New York, N. Y.

WANTED—SURPLUS SELSYNS, SYNCHROS, TORQUE Units, Autosyns, Amplidydes, Aircraft Radio Equipment, Tubes, Etc. Highest Prices. Electronic Research, 715 Arch St., Philadelphia, Pennsylvania.

WANTED: AN/APR-4, other "APR", "TS", "IE", "ARC-1, ARC-3, ART-13, RC-348, etc. Microwave Equipment, Everything Surplus. Special tubes, Tee Manuals, Lab Quality Equipment, Meters. Fast Action. Fair Treatment. Top Dollar! Little, Fairhills Box 26, Dayton 9, Ohio.

BUY WHOLESALE—25,000 ITEMS CATALOG 25¢. Matthews, 1172-P6, Broadway, N. Y. C. 36.

INSTRUCTION BOOKLET FOR NEW TWIN CRYSTAL set and crystal set with signal strength meter 50¢. Potential Radio Company, 446 Crown Street, Brooklyn, N. Y.

ALUMINUM TUBING, ANGLE AND CHANNEL Plain and perforated sheet. Willard Radcliff, Postoria, Ohio.

AMATEUR RADIO IS FUN. FIFTY PAGES, EASY TO understand, code and theory Novice Class license \$1.00. Satisfaction guaranteed. Radiographic, 3246 North Orange, Chicago, Illinois.

COMPLETE TELEVISION SETS \$30 UP. W4API. 1420 South Randolph, Arlington 4, Virginia.

TV FM ANTENNAS. ALL TYPES INCLUDING UHF Mounts, accessories. Lowest prices. Wholesale Supply Co., Lunenburg 2, Mass.

When the repairman got to see the medic, he told him he was there to look at the set, and asked him how much time he allotted a patient and what his office fee was.

The doctor said he generally figured on 20 minutes to a patient, so our technician went to work and luckily spotted the trouble in the allotted time. He handed the doc the regular fee, but the doctor handed it back with a smile and complimented our man on his novel approach.—Harvey Muller

RUNNING WATER

This opus could be called "The Case of The Running Water." It happened in the East End of Montreal.

During the freezing months of winter we received a call from a customer. Our repairman who answered their plea for assistance was one of our more highly skilled technicians, as the customer's home was some distance from the shop and we didn't particularly relish a return engagement, nor was it practicable at that time. Upon arrival, the technician inquired of the trouble and was told the set "hissed" (which we thought was not unusual, considering the programs it was receiving), but try as he might, the thing just would not hiss and he left. Several days later the hissing returned and there came another complaint.

The set was under guarantee but the expiration date was close at hand and we thought it possible that the customer was conjuring up faults as a device to have his set thoroughly checked. But he had never been a nuisance before and we couldn't falsely accuse, so we trod our way back through another snow-storm. Of course, upon arrival the cupboard was bare. No hissing, no boiling, no nothing. Just a clear, sweet picture. "But it hissed at eight o'clock last night," he protested, "and it did it the

Now a

COLOR

TELEVISION HOME STUDY COURSE

by RCA Institutes



"Color Television is here—not around the corner, or in the developmental labs, but here! The big question now is . . . Are You ready for Color TV?"

"You may now have a successful TV servicing business. When color sets come to your bench for servicing, will you be able to handle them?"

"Color Television is a vast new field, embodying entirely new concepts . . . principles of light and vision, radically new circuitry."

First Home Study Course in Color TV

Now is the time to prepare. Now, for the first time, you can train yourself for the

opportunities in this brand-new field. The just-announced RCA Institutes Home Study Course is the *first* home study course covering all phases of color television. Offered only to those already experienced in radio-television servicing, it explains the "why" of basic theory, as well as the "how-to-do-it" of servicing techniques.

Planned and written by RCA instructors, the entire course is based on the practical experience of RCA engineers—the men who have pioneered in the research and development of color television since the very first color experiments, many years ago.

Remember when black-and-white television first became a reality? Overnight, the demand for men who knew television grew. Even now, a shortage of qualified servicemen exists. Think, then—of the even greater demand for servicemen who will understand the many additional problems of color reception!

Costs so little to gain so much

RCA Institutes makes it easy for you to prepare yourself now for color television. Not only is the cost of the home study course for qualified servicemen extremely low, but you pay for the course on a pay-as-you-learn basis.

RCA Institutes conducts a resident school in New York City offering day and evening courses in Radio and TV Servicing, Radio Code and Radio Operating, Radio Broadcasting, Advanced Technology. Write for free catalog on resident courses.

Send for **FREE Booklet**—Mail the coupon, today. Get complete information on the RCA INSTITUTES Home Study Course in Color Television. Booklet gives you a general outline of the course lesson by lesson. See how thoroughly you can learn Color TV. Mail coupon in envelope or paste on postal card.



MAIL COUPON NOW!

RCA INSTITUTES, INC., Home Study Dept. RE-354
350 West Fourth Street, New York 14, N. Y.

Without obligation on my part, please send me copy of booklet "RCA INSTITUTES Home Study Course in COLOR TELEVISION." (No salesman will call.)

Name _____ (please print)

Address _____

City _____ Zone _____ State _____

RCA INSTITUTES, INC.
A SERVICE OF RADIO CORPORATION of AMERICA
350 WEST FOURTH STREET, NEW YORK 14, N. Y.

ORDER NOW THIS SENSATIONAL VALUE!

\$2.88
COMPLETE WITH TUBES AND CABINET

99c
FOR CHASSIS AND PARTS

- 1—115 V-6.3 V., 1 AMP FIL. TRANSFORMER
- 1—S.P.S.T. SENSITIVE PLATE RELAY
- 1—S.P.S.T. SWITCH
- 1—ELECTROLYTIC CONDENSER
- 1—POTENTIOMETER
- 6—CARBON INSULATED RESISTORS
- 7—WIRE-WOUND RESISTORS
- 3—TUBE SOCKETS
- 4—PAPER TUBULAR CONDENSERS
- 1—CHASSIS AND HARDWARE

Here is a list of parts useful for many, many applications. Which if furnished individually would regularly cost many times the Crazy Low Price we show. Originally intended as Thyatron Remote Controls for Electric Blankets . . . but now available at a mere fraction of original cost because the maker had more controls than he could make blankets. Comes completely assembled—can be modified for various remote control uses or easily taken apart for the high quality parts alone.

Others offer these identical units as Big Bargains, and truly so, at up to double our prices. Order from B-A Now while they last at the Ridiculous Low Prices below.

Complete Assembly, including 1—6SL7GT, 1—6SN7GT, 1—GL5662 and Plastic Cabinet as pictured.

No. 18B53 Special Each **\$2.88** 10 Lots Each **\$2.50**

*No. 18B48 as above, except less tubes and cabinets. Special Each **99c** 10 Lots Each **89c**

BURSTEIN-APPLEBEE CO.

1012-14 McGee St., Kansas City 6, Mo.

Send Free B-A Catalog No. 541

My order attached for items in this ad.

\$..... enclosed.

Name.....

Address.....

City..... State.....

FREE! WRITE US IF YOU DON'T HAVE B-A'S 1954 CATALOG LOG NO. 541.

night before!" We decided to remain until eight o'clock, nine o'clock, ten o'clock . . . and then came eleven o'clock. No hiss tonight.

We became rather fond of the customer (he always served beer during our visits). We felt if the set really were hissing, then to maintain our professional reputation the trouble must be eliminated.

We therefore removed the set, installed it on the test bench in the shop and instructed the shop personnel . . . "Make this set hiss!" We neglected to ask our customer if he could somehow represent the sound of the hiss, either with his mouth or some instrument. So we amended our foolish error by telephoning him and asking that question. Yes, if we would turn the water tap open and let the water run slowly, then we would have an exact reproduction. We turned on several taps, and finally found one that sounded like a perfect corona discharge. "O.K., boys, look for a corona discharge," we said. But sad to relate, no corona.

We crossed our fingers, and without calling for an appointment drove to the customer's home with the set. (We may as well mention it was again snowing.) When we arrived his wife apologized for the condition of the kitchen where the set was normally installed. "Just cannot dry in the snow you know . . . gotta dry all the kid's diapers in the kitchen . . ."

"Ha, ha! So your television set has been hissing, eh?" we asked. "Well lady, you can grow orchids in your kitchen with this humidity . . ."

And so ends our tale. It was so hot and humid that the insulation broke down within the set and caused a perfect corona. Naturally it didn't hiss while we were there; she was proud and didn't want us to see diapers strung all over the kitchen, so she refrained from washing at the times of our service calls. Hence no humidity.—J. S. Bremner

MERRY CHRISTMAS

During the Christmas season a customer phoned and complained that the set was going on and off. I went out on the call and sure enough, just like the tick of a clock, the set went on and off. I suspected a bad connection and listened carefully for peculiar sounds like intermittent arcing. I did not detect anything unusual, so I connected an a.c. voltmeter across the a.c. interlock socket. Sure enough, up and down went the meter pointer. This was a new one on me.

I had been admiring the flashing ornamental lights on the Christmas tree when I suddenly noticed that they flashed on and off *with the receiver*. Then it hit me! I checked the set's line cord and found that it was plugged into the light flasher! We had a good laugh, then I cleared up the trouble and left.—Harold F. Palmer

A MEATY ONE

During World War II, a lot of old receivers with 24-A's were dragged out

Editors and Engineers
PUBLICATIONS



Giant Thirteenth Edition

RADIO HANDBOOK

THE GREAT ONE-VOLUME LIBRARY OF RADIO INFORMATION

734 PAGES!

RADIO HANDBOOK, GIANT 13TH EDITION. A one-volume library of radio information with extensive, simplified theory. Detailed how-to-build-it data on dozens of items of practical radio equipment. Book No. E&E-RH13...\$6.00*

SURPLUS RADIO CONVERSION MANUAL, VOL. 1. Practical conversions. Write for list of contents. Book No. E&E-SM1...\$2.50*

SURPLUS RADIO CONVERSION MANUAL, VOL. 2. Companion to Volume 1. Book No. E&E-SM2...\$2.50*

BETTER TV RECEPTION (in fringe and low-signal areas). **NEW SECOND EDITION.** The standard guide for installation technicians. A popular text for TV enthusiasts. Book No. E&E-TR2...\$2.50*

RADIOTELEPHONE LICENSE MANUAL. Typical study questions with concise answers for any commercial U.S.A. radiotelephone operators license. Book No. E&E-RL1...\$3.75*

WORLD'S RADIO TUBES (BRANS' VADE MECUM). **NEW 9TH EDITION.** Lists over 15,000 tubes from every tube making country. Printed in 16 languages. Book No. E&E-VM9...\$5.00*

*Plus any tax.

BUY FROM YOUR DISTRIBUTOR

ADD 10% ON DIRECT MAIL ORDER TO EDITORS AND ENGINEERS, 1012-14 MCGEE ST., KANSAS CITY 6, MO. B.O.# 889 SANTA BARBARA, CALIF. Bookstores and News BAKER & TAYLOR, MINN. & N.Y.

FASTER EASIER more PROFITABLE operation

RADIO'S MASTER

NEW! 1954 EDITION

- 1370 pages
- Over 85,000 items
- Over 8,000 illus.
- Completely indexed

GET INTO THE MASTER HABIT!

\$1.95 at your parts distributor. Publisher's price \$6.50

Have complete access to the many thousands of products vital to your daily sales and service operations. In the customer's home, across the counter or on the bench, you'll value the Master's thoroughly complete descriptions, specs, illustrations and prices . . . all systematically organized in 18 big sections for instant reference. Increase your sales . . . sell directly from the Master. Facilitate your stock problem . . . use the Master for jiffy comparison of all electronic products. The Master is the only Official Buying Guide for the TV-Radio-Electronics industry. It contains unabridged catalog data direct from the manufacturers. For buying and selling—the Master gives you all the needed facts in a single volume.

Over 100,000 in active daily use. Get into the Master habit. Order your copy today!

Just a few of the products included: Tubes — Test Equipment — Tools — Transformers — Capacitors — Resistors — Relays — Coils — Antennas — Recording & PA Systems — Hardware — Transmitters — Receivers — Kits — Wire — Cable . . . and thousands of allied products!



UNITED CATALOG PUB., INC.
LAFAYETTE ST. NEW YORK 13, N. Y.

JFD JeTOMIC

Produces brilliant deep fringe UHF performance—plus. Produces heretofore unachieved gain of:
 Stacked* UHF Rhombic on Channels 14 to 83.
 Stacked JeT conical on every VHF Channel 2 to 13.
 Featuring exclusive no-loss isolation network—Only 1 lead to set.

Model JeT 454 Single \$16.50 list
 Model JeT 454 S* Stacked 34.50 list

* complete with stacking transformers

Guaranteed to out-perform any other VHF or UHF-VHF antenna. Both units factory pre-assembled with renowned Jet-action all-aluminum construction. Write for Forms 230 and 241.

the most powerful **1-2** *punch*

Channels	14	21	28	35	42	49	56	63	70	77	83	DB GAIN
Competitor A Conical with Bowtie (2 stack)	4.0	3.25	2.0	1.0	1.0	0.75	0.5	0.7	0.9	0.75	0.3	
Competitor B Bedspring with UHF	0.75	0.75	0.9	1.0	0.8	1.0	1.5	1.6	1.25	1.25	1.0	
Competitor C Conical with V (2 stack)	3.0	3.3	4.0	4.6	4.9	5.0	4.8	4.5	4.25	4.0	3.75	
Competitor D Filter type 2.0 with attached "V"	2.0	2.5	2.75	2.9	2.9	2.4	2.2	2.0	1.3	1.0		
JFD JeT 454 S	7.0	7.25	7.4	8.5	9.0	9.5	10.25	10.25	10.25	10.0	9.75	

JFD SUPER-JeT

Delivers Spectacular Deep fringe VHF performance—plus. Packs Unprecedented gain of:
 Single 10-Element VHF Yagi on each channel from 2 to 13.
 Stacked UHF Bowtie—Reflector off side lobes on Channels 14 to 83.

Model JeT 213 Single \$20.75 list
 Model JeT 213 S* Stacked 42.50 list

* complete with stacking transformers



Burton Browne Advertising

JFD Manufacturing Company
 Brooklyn 4, N. Y.

in antenna history!

CHANNELS	2	3	4	5	6	7	8	9	10	11	12	13	DB GAIN
Competitor A Mattress (4 Stack)	4.0	5.0	7.0	6.25	5.0	5.25	6.0	5.25	7.25	9.25	6.5	7.0	
Competitor B Radar Screen Type A	0.0	3.0	4.0	3.25	3.0	4.5	7.0	7.0	8.0	10.0	10.0	9.0	
Competitor C Radar Screen Type B	0.75	3.25	4.5	3.5	3.5	6.0	7.0	6.5	7.75	8.0	7.5	6.0	
Competitor D CHS 2-13 YAGI	4.50	5.00	5.75	3.00	2.50	3.50	1.00	0.0	.875	.875	.50	.75	
JFD JeT 213 S	6.0	7.5	8.75	7.75	6.75	10.0	9.0	7.0	9.0	10.0	11.0	9.75	

	1" Square Crossarm	Completely Preassembled	LIST PRICE
Competitor A	NO	YES	\$55.00
Competitor B	NO	NO	\$34.95
Competitor C	NO	NO	\$47.50
Competitor D (2 STACK)	NO	NO	\$65.90
JFD JeT 213 S	YES	YES	\$42.50

World's largest manufacturers of TV antennas and accessories.



HOW CAN I,
← A Dealer
 GET TO THE BOTTOM
 OF THIS BIG CONTROVERSY
 OF "WHOSE ALL-CHANNEL
 ANTENNA OUTPERFORMS
 WHOSE?"

DO AS THOUSANDS OF OTHER DEALERS ARE DOING...

Test the super "KATYS" Yourself!

It's a fact...

The amazing, "long-distance", photo-clear reception performance of the KAY-TOWNES SUPER "KATYS" makes all other all-channel antenna designs as obsolete as the 7-inch screen!

THE SUPER "KATYS" WILL PROVE . . .

Find out for yourself, in your own area, why KAY-TOWNES can honestly guarantee that a super "KATY" will outperform any other all-channel TV antenna on the market today!

If we were in your shoes, with a local Dealer-Service reputation to protect . . . and add to . . . we would do exactly as you should do! WE WOULD RUN OUR OWN PERFORMANCE TESTS ON THE SUPER "KATYS"!

In the next few months, many of our competitors are going to attempt to copy the "KATYS" . . . just as they did our "BIG JACK". We have already taken the necessary steps to stop them . . . and to protect our dealers. This is the price forced upon us, because of our recognized leadership in the field of "fringe area" antenna design.

When you stop to think, it is easy to understand why KAY-TOWNES is so far ahead of the pack. While the others have been busy "commercializing" strictly on production

to satisfy the huge demand, KAY-TOWNES has been working toward the "reception perfection" demanded by today's more cautious buyers of Television!

4½ YEARS OF DEVELOPMENT, with our resources and energies trained upon the objective of designing and engineering the world's finest TV antenna, has produced the SUPER "KATYS". What the SUPER "KATYS" will do toward the betterment of Television enjoyment is a foregone conclusion.

Look for KAY-TOWNES' big consumer ads appearing in *Life Magazine . . . Country Gentleman . . . Progressive Farmer . . .* and many other of the leading home publications!

The combined readership of all these publications will add up to more than 30,000,000 individual readers in the most productive "fringe areas" in America! Think what this means in terms of selling help for you!

THE BEST SET IS ONLY AS GOOD AS ITS ANTENNA!

WHO CAN I BELIEVE

Who IS TELLING THE TRUTH ABOUT TV ANTENNA PERFORMANCE... *and who isn't!*

WE CAN ONLY ANSWER FOR OUR OWN ANTENNAS . . .
AND THEN LEAVE THE ENTIRE QUESTION UP TO YOUR OWN
GOOD, QUALIFIED JUDGMENT!

THE NEW, KAY-TOWNES SUPER "KATYS" ARE POSITIVELY
GUARANTEED TO OUTPERFORM ANY OTHER ALL-CHANNEL
ANTENNA ON THE MARKET TODAY!

This is an absolute fact, and not simply an advertising statement! In our search for a perfect All-Channel Antenna design we have, in the past 4½ years, developed countless arrays with ability to perform as well and often better than any competitive design available. We didn't stop there!

The more we probed into the secrets of TV reception, the more convinced we became that with the *right research and study, the right engineering and experimentation* we could finally develop a truly amazing and outstanding TV Antenna. We didn't stop until we did just that!

We've crossed and recrossed our engineering trails many times. We've made every test and check possible. We stake our reputation and future on the positive GUARANTEE we make for the KAY-TOWNES SUPER "KATYS"!

What does this Guarantee mean to You... a Dealer?

First of all, it means that we are absolutely sincere with you! It means that we are willing to stand behind the Super "KATYS" with all the resources at our command. It means that you can finally SELL an All-Channel TV Antenna you can depend on to do the best possible receiving job for any installation!

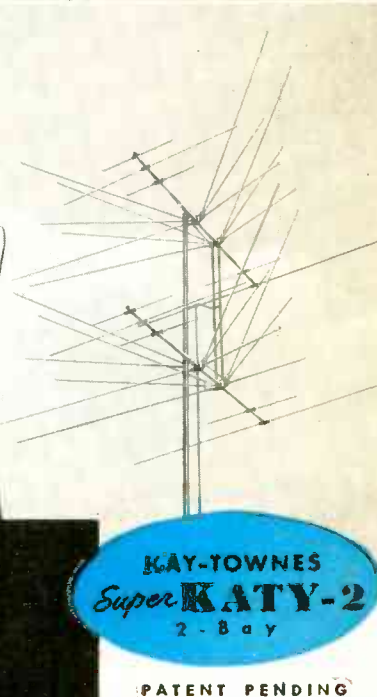
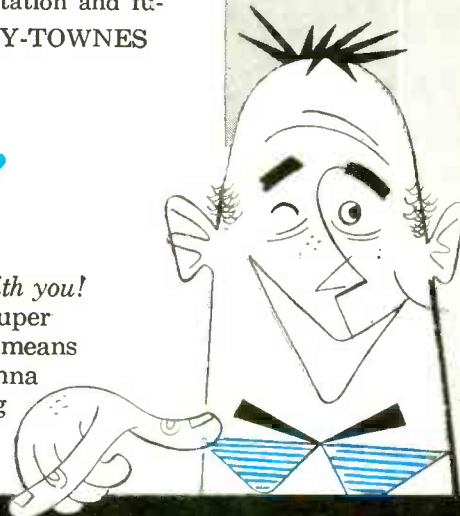

KAY-TOWNES
ANTENNA COMPANY
ROME, GEORGIA

Recognized leaders in the field of fringe area antenna design

CBS-COLUMBIA
 GENERAL ELECTRIC
 PHILHARMONIC
 WESTINGHOUSE
 MOTOROLA
 SYLVANIA
 HOFFMAN
 EMERSON
 PHILCO
 ADMIRAL
 MUNTZ
 RCA

Designed for quick, simple installation, these Stancor flybacks save your time. There are no holes to drill, no leads to splice. Terminal board layouts duplicate the original units—even include choke coils, resistors, tube sockets and any other components that are on the original.

**STANCOR HAS EXACT
 REPLACEMENT FLYBACKS
 FOR ALL THESE TV
 MANUFACTURERS' SETS...and
 others will be available soon**



Stancor TV replacements are listed in Sams' Photofact Index, Counterfacts, Rider Manuals and Tek-Files

**CHICAGO STANDARD
 TRANSFORMER CORPORATION**
 3592 ELSTON AVE., CHICAGO 18, ILL.

EXPORT SALES: Roburn Agencies, Inc.
 39 Warren Street • New York 7, New York



SCALA SUPER-MARKER INJECTOR mixer-amplifier unit mixes small sample of sweep voltage with small sample of marker voltage (from external sweep-marker generator). Injects a large, stable pip into scope being used for alignment of TV receiver. Marker pip is always same size—from base line to top of curve. Pip does not affect pattern on scope, even at resonance peaks. **Greatly speeds up and simplifies alignment jobs.** Separate video and marker gain controls. May be used with any standard marker generator, sweep generator, and scope. Five tubes and Germanium diode. Size, 10x8x7". Cables and instructions supplied. For operation from 110-120 volts, 60 cycle AC. Net, at leading jobbers, \$67.50.

SCALA TEST PROBES—

—May be accurately used with all oscilloscopes—

BZ-1 Signal Tracing Probe for individual check of IF stages, calibrating marker generator, checking output of sweep generator, etc. Low C, Hi-Z demodulator range, non-resonant to 225 mc; useful to 1000 mc. Cables supplied. Net, at leading jobbers, \$9.75.

BZ-2 Low Capacity Probe permits tracing waveforms through Hi-Z circuits without distortion from circuit loading. Cuts effective input capacity of scope, attenuation 10 to 1. Net, at leading jobbers, \$9.75.

BZ-3 Voltage Divider Probe for checking horizontal sweep waveforms and voltages at plates of horizontal output or damper tubes. Does not distort waveform. Net, at leading jobbers, \$9.75.

BZ-4 Voltage Doubler Probe provides virtually double deflection on a scope screen compared to half-wave probes. Dual low C Hi-Z demodulators useful to 150 mc. Net, at leading jobbers, \$10.75.

SCALA RADIO COMPANY, 2814—19th Street, San Francisco 10, Calif.

THE SERVICE RUNAROUND

and put back into service. These tubes (remember?) had large, conspicuous grid caps.

One day I got a call from a woman who complained that her radio was very weak. Also she noticed that by putting her finger on the grid cap she could increase the volume. This she said, was very tiresome while trying to listen to her favorite programs.

When our technician arrived he found that her inventive genius had gone into action and she had removed about two pounds of sirloin steak from the refrigerator and wired it to the grid cap! Only after she found that the meat somehow did not attract the radio waves did she decide to have the set repaired.

—Ralph C. Lippert

BATH-NIGHT BREAKDOWN

The customer who had bought one of our best television receivers called to complain that *every time someone took a bath*, his set went out completely. (The set was not in the bathroom.)

We checked every component to no avail; then the antenna and lead-in came in for a microscopic examination.

Sure enough, the plastic 300-ohm lead was almost rubbed bare of insulation from close contact with the hot-water pipe that ran from the boiler. The pipe was copper and when a continuous stream of hot water ran through it for a time, it expanded just enough to short out the wires in the worn plastic!

—Henry Josephs

OPPORTUNITY KNOCKS

Street and house numbers in our area are being changed, and this has led to considerable confusion, especially since many street signs and house markers have already been painted out pending the assignment of the new numbers.

When I called at a house recently to deliver a repaired radio, the lady who answered the door-bell turned out to be the wrong one on the wrong street. But this gave me an opportunity to identify myself and tell about our service, and not only did I get two radios for repair, but she promised to come in to see our line of television receivers.—Harry J. Miller

END

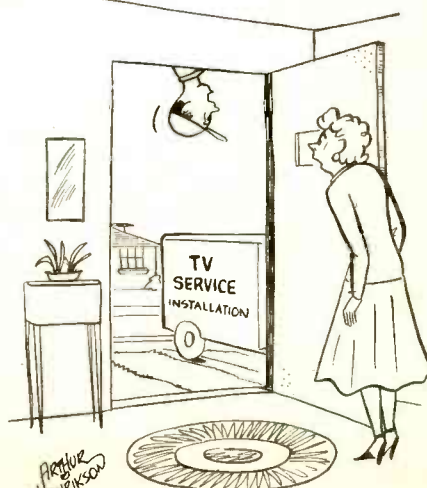

"Would you mind trying channel 9 now?"

Buy on our radically new

NO INTEREST!! **Time Payment Plan** **NO CARRYING CHARGES!!**



Superior's new
Model 670-A

SUPER METER

A COMBINATION VOLT-OHM MILLIAMMETER PLUS CAPACITY REACTANCE INDUCTANCE AND DECIBEL MEASUREMENTS

SPECIFICATIONS:

D.C. VOLTS: 0 to 7.5/15/75/150/750/1,500/7,500 Volts
 A.C. VOLTS: 0 to 15/30/150/300/1,500/3,000 Volts
 OUTPUT VOLTS: 0 to 15/30/150/300/1,500/3,000 Volts
 D.C. CURRENT: 0 to 1.5/15/150 Ma. 0 to 1.5/15 Amperes
 RESISTANCE: 0 to 1,000/100,000 Ohms 0 to 10 Megohms
 CAPACITY: .001 to 1 Mfd. 1 to 50 Mfd. (Quality test for electrolytics)
 REACTANCE: 50 to 2,500 Ohms 2,500 Ohms to 2.5 Megohms
 INDUCTANCE: .15 to 7 Henries 7 to 7,000 Henries
 DECIBELS: -6 to +18 +14 to +38 +34 to +58

ADDED FEATURE:

The Model 670-A includes a special **GOOD-BAD** scale for checking the quality of electrolytic condensers at a test potential of 150 Volts.

The Model 670-A comes housed in a rugged, crackle-finished steel cabinet complete with test leads and operating instructions.

\$28⁴⁰
NET



Superior's new
Model TV-11

TUBE TESTER

SPECIFICATIONS:

- ★ Tests all tubes including 4, 5, 6, 7, Octal, Lock-in, Peanut, Bantam, Hearing Aid, Thyatron, Miniatures, Sub-miniatures, Novals, Sub-minars, Proximity fuse types, etc.
- ★ Uses the new self-cleaning Lever Action Switches for individual element testing. Because all elements are numbered according to pin-number in the RMA base numbering system, the user can instantly identify which element is under test. Tubes having tapped filaments and tubes with filaments terminating in more than one pin are truly tested with the Model TV-11 as any of the pins may be placed in the neutral position when necessary.
- ★ The Model TV-11 does not use any combination type sockets. Instead individual sockets are used for each type of tube. Thus it is impossible

to damage a tube by inserting it in the wrong socket.

- ★ Free-moving built-in roll chart provides complete data for all tubes.
- ★ Newly designed Line Voltage Control compensates for variation of any Line Voltage between 105 Volts and 130 Volts.
- ★ **NOISE TEST:** Phono-jack on front panel for plugging in either phones or external amplifier will detect microphonic tubes or noise due to faulty elements and loose internal connections.

The Model TV-11 operates on 105-130 Volt 60 Cycles A.C. Comes housed in a beautiful hand-rubbed oak cabinet complete with portable cover

\$47⁵⁰
NET

EXTRA SERVICE—The Model TV-11 may be used as an extremely sensitive Condenser Leakage Checker. A relaxation type oscillator incorporated in this model will detect leakages even when the frequency is one per minute.

Superior's New Model 660-A AN AC OPERATED

SIGNAL GENERATOR

PROVIDES COMPLETE COVERAGE for AM-FM & TV Alignment

SPECIFICATIONS:

• Generates Radio Frequencies from 100 Kilocycles to 60 Megacycles on fundamentals and from 60 Megacycles to 220 Megacycles on powerful harmonics. • Accuracy and Stability are assured by the use of permeability trimmed HI-Q colls. • R.F. available separately or modulated by the internal audio oscillator. — Built in 400 cycle sine wave audio oscillator used to modulate the R.F. signal also available separately for audio testing of receivers, amplifiers, hard of hearing aids, etc. • R.F. Oscillator Circuit: A high transconductance heptode is used as an R.F. oscillator, mixer and amplifier. Modulation is effected by electron coupling in the mixer section thus isolating the oscillator from load changes and affording high stability. • A.F. Oscillator Circuit: A high transconductance heptode connected as a high-mu triode is used as an audio oscillator in a High-C Colpitts Circuit. The output (over 1 Volt) is nearly pure sine wave. • Attenuator: A 5 step ladder type of attenuator is used.

• Generates Radio Frequencies from 100 Kilocycles to 60 Megacycles on fundamentals and from 60 Megacycles to 220 Megacycles on powerful harmonics. • Accuracy and Stability are assured by the use of permeability trimmed HI-Q colls. • R.F. available separately or modulated by the internal audio oscillator. — Built in 400 cycle sine wave audio oscillator used to modulate the R.F. signal also available separately for audio testing of receivers, amplifiers, hard of hearing aids, etc. • R.F. Oscillator Circuit: A high transconductance heptode is used as an R.F. oscillator, mixer and amplifier. Modulation is effected by electron coupling in the mixer section thus isolating the oscillator from load changes and affording high stability. • A.F. Oscillator Circuit: A high transconductance heptode connected as a high-mu triode is used as an audio oscillator in a High-C Colpitts Circuit. The output (over 1 Volt) is nearly pure sine wave. • Attenuator: A 5 step ladder type of attenuator is used.

TUBES USED:

- 1—68E6 as R.F. Oscillator, mixer and amplifier.
- 1—6BE6 as Audio Oscillator.
- 1—6H6 as Power Rectifier.

The Model 660-A comes complete with coaxial cable test lead and instructions.

\$42⁹⁵
NET



MOSS ELECTRONIC DISTRIBUTING CO., INC.
Dept. B-94, 3849 Tenth Ave., New York 34, N. Y.

Please send me the units checked. I am enclosing the down payment with order and agree to pay the monthly balance as shown. It is understood there will be no carrying interest or any other charges, provided I send my monthly payments when due. It is further understood that should I fail to make payment when due, the full unpaid balance shall become immediately due and payable.

Name.....
 Address.....
 City.....Zone.....State.....

- MODEL 670-A Total Price \$28.40 \$7.40 down payment. Balance \$3.50 monthly for 6 months.
- MODEL TV-11 Total Price \$47.50 \$11.50 down payment. Balance \$6.00 monthly for 6 months.
- MODEL 660-A Total Price \$42.95 \$12.95 down payment. Balance \$5.00 monthly for 6 months.
- I enclose \$..... as down payment.
- Ship C.O.D. for the down payment.

If you want professional sound quality

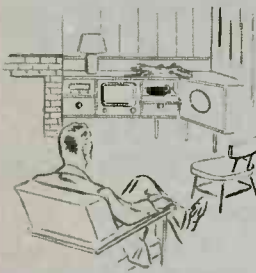

Sound engineers know that the selection of a fine amplifier, pickup and speaker system is only part of the story; that unless the turntable is of equal quality, music reproduction must suffer. That is why they insist on such high standards for turntable performance.

do as the professionals do...



Rek-O-Kut precision turntables are made to conform to the highest standards in the professional field, and they certainly represent the finest you can use in the home. A Rek-O-Kut turntable will make all the difference in the world. The finer your present system, the more apparent the improvement will be. Whether you select the deluxe T-12H or the standard LP-743, the entire performance of your sound system will become a new and thrilling experience.

use a

REK-O-KUT

precision turntable



Rek-O-Kut Precision Turntables are priced from \$59.50. Write for specifications and descriptive literature to Dept. J-13

The REK-O-KUT COMPANY

Manufacturers of Professional Disc Recorders and Specialized Sound Systems.

38-01 Queens Boulevard, Long Island City 1, New York
Export Division 458 Broadway, New York, U.S.A. Cables: Morhanex
In Canada: Atlas Radio Corp., Ltd., 560 King Street, W., Toronto 2B

JOINT SERVICE PROJECT

Philadelphia's WFIL and WFIL-TV are joining with the Council of Radio and TV Service Dealers and Service Technicians' Associations to conduct an intensive public service campaign stressing proper care and maintenance of home radio and television receivers.

David Krantz, chairman of the Industry Relations Committee for the Council, announced that more than 2,500 service technicians from Eastern Pennsylvania, New Jersey, and Delaware will participate in this campaign. Through interviews conducted on programs over WFIL and WFIL-TV, and spot announcements throughout the stations' schedule, listeners and viewers will be constantly alerted to the need for expert care and service for their sets.

In announcing the stations' participation in the public service campaign, general manager Roger W. Clipp said, "Along with constant efforts to improve programs, we cannot lose sight of the millions at home who receive these programs and of the qualified service technicians who keep their sets operating at a high level of efficiency. This campaign, undertaken in co-operation with the Council of Radio and Television Service Associations, will familiarize our audience with the objectives and Code of Ethics of the group, and help our listeners and viewers to keep their sets in good working order."

NATESA ISSUES AWARDS

Joining with other branches of the electronics industry and with the mayor and Chamber of Commerce of Indianapolis, the National Alliance of Television and Electronic Service Associations honored Howard W. Sams with its "Friend of Service Management" award, January 7. Chief speakers at the event were Mayor Clark, of Indianapolis, and Frank Moch, president of NATESA, who stated that the award was presented to Sams for his efforts in behalf of the service business and his contributions to the training of service personnel.

A similar award was presented to John T. Thompson of General Electric's tube department, in which the G-E tube department was cited for the second year, "for outstanding service to television service management in creating better customer relations." A wreath was voted to Sylvania, to be added to the plaque previously awarded that company.

MOCH AGAIN HEADS TISA

Frank J. Moch was re-elected president of the Television Installation Service Association, Chicago. Also re-elected were John Cecich as vice-president, Jerome Mann as treasurer, and Rubin Saxner as secretary. Newly elected officers are Ralph Friedman, second vice-president, and Russ Havill, sergeant-at-arms.

TISA's membership is stated to have gained approximately 20% during the past year, and now numbers about 75 service companies.

arkay HI-FI AUDIO kit

10 Watt high-fidelity amplifier. Separate tone controls for bass and treble through inverse feedback circuit; 10 watt output or 32 db. less than 3% distortion; frequency response ± 1 db. from 20 to 20,000 cps. Tone controls produce maximum bass boost ± 8 db. @ 100 cps. Treble controls produce maximum treble boost ± 10 db. @ 10,000 cps. Hum: 70 db. below rated output.



Model A10 21.95
Write for new catalog of the complete ARKAY line of radio, TV, phonograph and test equipment kits.

arkay
BE 3-6686

RADIO KITS, INC.
120 CEDAR STREET
NEW YORK 6, N. Y.

HEADSET SALE!

HS-33\$4.50 each
HS-23\$4.00 each

Plug PL68 Western Electric on cord50c each

BRAND NEW

TALLEN CO., Inc., Dept. RE
159 Carlton Ave., Brooklyn 5, New York

FACTS

NOT JUST CLAIMS

**FACT- 53 CLAIMS GRANTED
IN 5 UNITED STATES PATENTS -**

#2,585,670; 2,609,503; 2,625,655; 2,644,091; 2,661,423, others pending.

FACT- These antennas positively receive **ALL** channels 2-83 from **ALL** directions without a rotor motor.

FACT- These antennas have consistently **OUT-GAINED** and **OUT-PERFORMED** all others in actual public demonstrations.

FACT- These antennas will unquestionably **OUT-PERFORM** all others, on **YOUR** roof, with **YOUR** set, or **YOUR** money back.

FACT- **SAVES YOU MONEY.** Eliminates rotor motor, uses only **ONE** transmission line, uses only **ONE** antenna for both UHF & VHF—and only **ONE** simple, quick installation.

FACT- Perfect pictures have consistently been received as far as 3 times the guaranteed distances.

FACT- **ONLY** one antenna, **ONLY** one transmission line, **ONLY** one installation. You solve once and for all your **PRESENT** and **FUTURE** antenna problems.

MONEY BACK GUARANTEED TO RECEIVE *All* CHANNELS 2-83 FROM *All* DIRECTIONS AND POSITIVELY OUTPERFORM *All* OTHER ANTENNAS WITH OR WITHOUT A ROTORMOTOR

Guaranteed
60 mi UHF
60 mi VHF



SUPER 60

LIST PRICE
\$36.75
SEE YOUR
JOBBER

Guaranteed
100 mi VHF
30 mi UHF



ULTRA 150

LIST PRICE
\$43.50
SEE YOUR
JOBBER

**9 POSITION
ELECTRONIC
ORIENTATION
SWITCH**



PRICE INCLUDES

Antenna arrays - necessary stacking bars - 9 position switch - switch-to-set coupler - necessary hook-up harness - 7 1/2" stand-offs - individually boxed in mailable carton.

**NEW POLYMICALENE
4 CONDUCTOR TRANSMISSION LINE**

- Low Loss External Air Dielectric
- Matched Impedance
- Eliminates End Sealing
- Eliminates Condensation
- Up to 50% Less Loss Than Tubular When Wet
- Easily Spiraled
- No Breaking or Shorting
- Patents Pending - T. M. Reg.

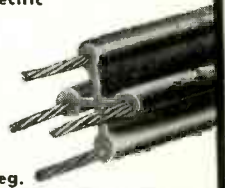

ALL CHANNEL ANTENNA CORP.,

70-07 Queens Blvd., Woodside 77, N. Y. Hickory 6-2304

An outstanding design for EVERY application

CORNELL-DUBILIER

UHF AND VHF TV ANTENNAS

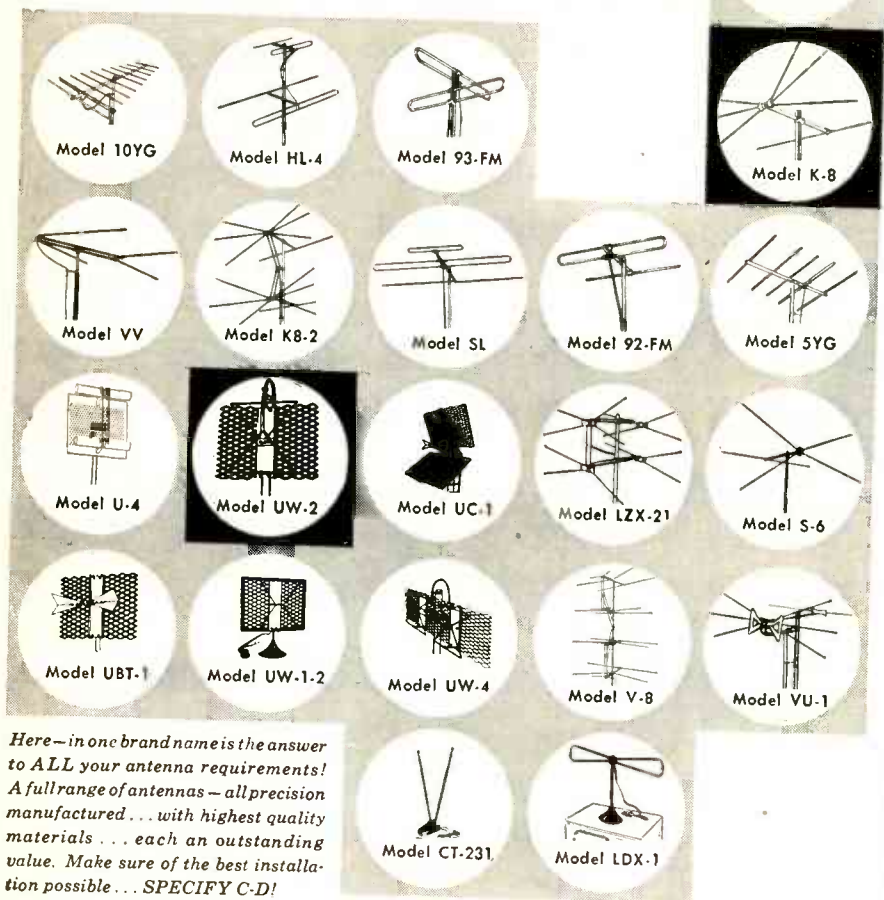

Here—in one brand name is the answer to ALL your antenna requirements! A full range of antennas—all precision manufactured... with highest quality materials... each an outstanding value. Make sure of the best installation possible... SPECIFY C-D!



CONSISTENTLY DEPENDABLE

CORNELL-DUBILIER

SOUTH PLAINFIELD, NEW JERSEY



ROTORS • CAPACITORS • VIBRATORS • ANTENNAS • CONVERTERS

TELEVISION

Big demand for graduates

B.S. DEGREE IN 27 MONTHS in radio including TV engineering—VHF, UHF, AM and FM. Students use over \$100,000 worth of equipment including 2 large commercial type transmitters in new TV lab. Intense specialized course includes strong basis in mathematics, science and advanced design in radio and TV.

Hundreds of young men each year are earning engineering degrees in this recognized institution. Start any quarter. Many earn a major part of expense in this industrial center. Low tuition. Competent instruction. Thorough, intense, practical program.

Also B.S. DEGREE IN 27 MO. in Aeronautical, Chemical, Civil, Electrical and Mechanical Engineering. G.I. Gov't approved. Enter March, June, Sept., Dec. Free catalog. ENROLL NOW.

INDIANA TECHNICAL COLLEGE
1734 E. Washington Blvd., Fort Wayne 2, Indiana

PRES-PROBE CONDENSER TESTER



Finds Intermittent Condensers Instantly

Pres-probe's sliding tip with variable resistance prevents condenser heating. Tests with power on. Requires no adjustment. Stops guesswork. Saves time. Convenient probe size (7/8" long). Satisfaction guaranteed.

See Your Dist. or Order Direct

PRES-PROBE CO.

4034 N. Sixth St., Milwaukee 12, Wis.



WITH THE TECHNICIAN

COLOR ON LONG ISLAND

The Long Island Television and Radio Technicians Guild is sponsoring a Color Forum, in which the fundamentals of color theory and servicing will be discussed. At the introductory session held at the American Legion Hall, Williston, L. I., attendance broke all records. Approximately 250 service technicians turned out to learn about color TV.

Murray Barlowe led the discussion, stressing the complexity of color TV circuitry and the necessity of additional knowledge and new shop equipment to handle color problems. He stated that the screwdriver technician—already given a near-fatal blow by television—is now entirely through, and that, with color, servicing becomes an industry which will require highly specialized skill, complete knowledge of the subject, and—considerably better compensation.

COUNCIL ELECTS HAAS

The Philadelphia Council of Radio-Television Associations has elected Albert M. Haas of the Television Contractors Association (TCA) as its 1954 chairman. Ray Cherrill, of the Northeast Television Service Dealers Association, was elected vice-president, and William Wile, Jr., of the Television Service Dealers Association, secretary. Dave Krantz was appointed chairman of the broadcast and public relations committee.

A TECHNICIAN'S LOT

The inspirational little piece below is reprinted from ARTS'NY News, by special permission of that organization. Its authorship is attributed to Seymour Weinberg of the Associated Radio-TV Service Technicians:

When a television set starts acting crazy,
When the picture rolls and horizontally runs,
When the video and sound are weak and hazy,
A technician's lot is not a happy one.
When a customer starts hollering for service
And you have some other jobs that must be done,
When his visits and his phone calls get you nervous,
A technician's lot is not a happy one.
When your wife complains you're never home to take her
When all your friends go out to have some fun,
When your customers call you a gyp and a faker,
A technician's lot is not a happy one.
What good is all your fussin' and your fumin':
Alone you'll never get a darn thing done.
You must make the public realize you're human
If you want to make your lot a happy one.
So why not get behind us at ARTS'NY:
We're working hard for our place in the sun.
Now's the time for all good men to join the party—
Make the technician's lot a happy one!

NEW ORLEANS OFFICERS

The Radio, Television and Appliance Association of New Orleans elected Robert V. Schumert president; Stanley B. Reinherz, vice-president; Wesley P. Massey, secretary; and Leonard Estorge, treasurer of the organization for 1954.

A silver plaque was presented to the retiring president, Robert J. Magoni, "in recognition of outstanding service" to the association. The presentation was made by Morris Warnick, a past president of RTAA.

END

Watch for the April issue of
RADIO-ELECTRONICS
on the newsstands March 24

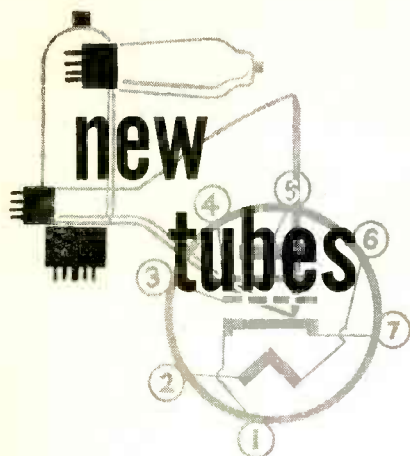

G-E has announced development of its first receiving tube type intended primarily for use in color TV receivers.

The tube, type 6BJ7, is a miniature triple diode. Its primary use is as the d.c. restorer for the three signal channels of color receivers. The electrical characteristics of each section of the 6BJ7 are similar to those of each section of the 6AL5 twin triode.

Maximum ratings for the 6BJ7 are: peak inverse plate voltage, 330; peak plate current per plate, 10 ma; d.c. output current per plate, 1 ma; heater-cathode voltage (heater positive with respect to cathode), 100; (heater negative with respect to cathode), 330.

G-E has announced two new 21-inch picture tubes of the 90° deflection type. They are about 3 inches shorter than corresponding narrower-deflection types. The tubes, types 21ACP4 and 21-ACP4-A (aluminized), are of all-glass, rectangular construction.

Both tubes are 20 inches in over-all length. The 90° feature provides an increase up to 7% in screen area over tubes with narrower deflection angles. The tubes have an external conductive coating which acts as a filter capacitor when grounded.

Typical operating conditions for the 21ACP4 and the 21ACP4-A are: anode voltage, 16,000; grid 2 voltage, 300; grid 1 voltage, -28 to -72; ion trap intensity, approximately 40 gauss.

RCA has announced two new tube types: the 6BY6 and 6197.

The 6BY6 is a pentagrid amplifier of the 7-pin miniature type. It is intended for use as a gated amplifier in television receivers, where it may be used as a combined sync separator and sync clipper.

The 6BY6 has separate base-pin terminals for grids 1 and 3. Each of these grids can be used independently as a control electrode, and has a sharp-cutoff characteristic. The sharp cutoff permits good sync clipping and noise cancellation with relatively low input signals. Furthermore, grid 3 is processed to minimize secondary emission and the resultant possibility of blocking.

An important feature of the 6BY6 is its favorable current ratio of plate current to grids 2 and 4 current. With this ratio, the output signal can be



"Boy... Have I Got the Lines!"

You, too, can have the lines—that meet your exact leadline conditions — whether you are a TV Set Dealer or Service Organization making the finest television reception installations, or a TV fan that demands sharp, "SNOW-FREE" pictures.

We specialize in the manufacture of television transmission lines — built with only one idea in mind: "THE FINEST TELEVISION RECEPTION!"

For UHF and VHF

"SHEATH-LEED" — the all-weather leadline for the toughest conditions: Salt spray in coastal areas; hot, humid weather, or for frosty, icy, wintry wind-whipping conditions which impose a severe tax... Pure Polyethylene Tubing encasing Standard GOODLINE AIRLEAD.



"GOODLINE" AIRLEAD—standard of leadline excellence —with 80% of the loss producing web removed. Correct impedance for sharp, "snow-free" pictures. Of pure polyethylene with flexible stranded copper-clad conductors. MANY IMPORTANT FEATURES.

NEW FULL-WEB "SHEATH-LEED" — the pure polyethylene of "SHEATH-LEED" and full characteristics of GOODLINE AIRLEAD — but NO PERFORATED WEB. No 20 (7 strand 28) copperweld wire in pure electronic golden clear polyethylene — with a pure silver-gray polyethylene sheath overall — for Maximum Weather Protection.

Don Good, INC.

SOLD BY LEADING JOBBERS & DEALERS

Send coupon NOW!
Get samples "in your hands"
—you'll realize why
Don Good Products make
the finest television
reception possible.

DON GOOD, INC. 1-14
1014 Fair Oaks Ave., 5th, Pasadena, Calif.
Please rush Samples and Complete Information covering Don Good Products.

Name _____
Street _____
City _____ State _____

Acrosound **Ultra-Linear Output Transformers**

SOUND BEST

- ✓ SMOOTH NATURAL SOUND
- ✓ CRISP WELL-DEFINED TRANSIENTS
- ✓ CLEAN SEPARATION OF INSTRUMENTS
- ✓ SOLID BASS—SILKY TREBLE

TEST BEST

- ✓ RESPONSE ±1 db 10 cps to 100 kc
- ✓ UNDISTORTED POWER 20 cps to 20 kc
- ✓ UNSURPASSED SQUARE WAVE PERFORMANCE
- ✓ PERMIT UP TO 30 db FEEDBACK

TO-300—20 watts for KT-66, **TO-310**—10 watts for 6V6 **TO-330**—50 watts for pp par
807, 5881 tubes...\$24.75* tubes.....\$18.75* KT66, etc.....\$39.75*

*Slightly higher in West

Descriptive Literature and High Fidelity Amplifier Schematics and Data Available on Request.

ACRO PRODUCTS CO., 369 SHURS LANE, PHILADELPHIA 28, PA.



**TEST EQUIPMENT
for AM, FM, and TV**

HARVEY
ALWAYS HAS IT... IN STOCK
for IMMEDIATE DELIVERY

**New
EICO Instruments
BAR GENERATOR**

Easy to use. Connects to antenna terminals of TV set. Tests picture linearity, picture size, and vertical and horizontal synch circuit stability.

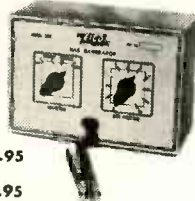

Model 352-K
Complete Kit \$14.95
Model 352
Factory Wired 19.95

- Operates on channels 3, 4 or 5
- Provides 16 vertical and 12 horizontal bars
- Switch permits selection of 'vertical', 'horizontal' or 'stand-by'
- Output Voltage: 100,000 microvolts
- Dimensions: 7 1/2 x 5 x 4 1/2"
- Weight: 6 lbs.

CATHODE RAY TUBE CHECKER



An easy, fast and fully reliable instrument for testing oscilloscope and TV picture tubes without removing from the scope or the set.

Model 630-K Complete Kit \$17.95
Model 630 Factory Wired 24.95

- Provides bridge measurement of peak beam current
- Indicates shorts and open elements in electronic gun
- Tests sockets and cables used with picture tubes
- 2 1/2-foot cables permit testing of tube directly in set or in carton.



**Sine & Square Wave
AUDIO
GENERATOR**

An extremely useful instrument for the audio enthusiast. A reliable test for high fidelity performance of preamplifier, amplifier, speaker, and other components.

Model 377-K Complete Kit \$31.95
Model 377 Factory Wired 49.95

- Wien Bridge circuit — 1% precision resistors
- Sine Waves: 20 to 200,000 cycles
- Square Waves: 60 to 50,000 cycles
- Response: ±1.5 db from 60 to 150,000 cycles
- Cathode follower output
- Output level control.

Prices Net, F.O.B. N. Y. C. Subject to change without notice. *PAT. APP. FOR

**5-inch PUSH-PULL
OSCILLOSCOPE**

A laboratory precision instrument at lowest cost. Has extra sensitivity, range, and other plus features for fast accurate servicing. Steel chassis and cabinet minimize external interference.

Model 425-K
Complete Kit... \$44.95

Model 425
Factory Wired... 79.95

- Push-pull vertical and horizontal amplifiers
- Vertical sensitivity: .05 to .1 rms volts/inch
- Useful response from 5 cps to 500 kc
- TV-type multivibrator sweep generator
- Stable, accurate sweep range: 15 cps to 75 kc
- Direct connection terminals to CRT plates for measuring % modulation and voltage amplitude
- Dual controls for positioning trace on screen
- Dimensions: 8 1/2 x 17 x 13", Ship. Wgt. 29 lbs.

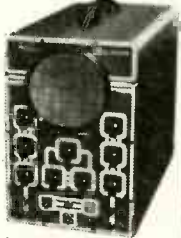

New EICO PROBES*

SCOPE DEMODULATOR PROBE

Model PSD
Complete Kit \$3.75
Factory Wired 5.75

LOW CAPACITY PROBE

Model PLC
Complete Kit \$3.75
Factory Wired 5.75

DIRECT PROBE Model PD

Complete Kit \$2.75
Factory Wired 3.95

SPECIAL

**ALL 3
SCOPE
PROBES**

Kit ... \$9.95
Wired \$14.95

VTVM RF PROBES

Model PRF-11 or 25
For any 11 or 25 megohm VTVM
Complete Kit \$3.75
Factory Wired 4.95

PEAK-to-PEAK PROBES

Model PTP-11 or 25
For any 11 or 25 megohm VTVM
Complete Kit \$4.95
Factory Wired 6.95



SENSATIONAL HIGH VOLTAGE PROBE

Model HVP-2
Factory Wired Only \$4.95

Prices Net, F.O.B. N. Y. C. Subject to change without notice. *PAT. APP. FOR

HARVEY RADIO CO., INC.

103 W. 43rd Street, New York 36, N. Y. • JUdson 2-1500

obtained with relatively low-power input to grids 2 and 4.

The 6197 is a 9-pin miniature sharp-cutoff pentode having very high transconductance. It is designed for frequency-divider and pulse-amplifier circuits in electronic computers and other on-off controls involving long periods of operation under cutoff conditions.

The stable cutoff characteristic of the 6197 permits a consistent cutoff bias to be maintained, and eliminates control-grid emission.

Among the features of the 6197 are radiating fins on grid 2 to increase its dissipation capabilities, a getter shield to minimize interelectrode leakage, and a pure tungsten heater to give long life under conditions of frequent on-off switching. Grid 3 and cathode have separate base-pin connections.

RCA also announces manufacture of germanium point-contact type sealed-in-glass crystal diodes, including: the



1N34-A, the well-known general-purpose diode for use in low-power rectification; the 1N38-A, a large-signal type with a peak inverse voltage rating of 100; the 1N54-A, a high-back-resistance type for use

in clipping circuits, high-impedance high-voltage probes, d.c. restorer circuits, and high-impedance detector circuits; the 1N55-A, a large-signal type with a high peak inverse voltage rating of 150; the 1N56-A, a high-conduction type featuring an exceptionally low



dynamic impedance; the 1N58-A, similar to type 1N55-A but with a lower peak inverse voltage rating.

Sylvania has announced the 6AM8, a diode-pentode. The new tube is similar to a 6CB6 plus one-half of a 6AL5.

The pentode section of this 9-pin tube type has a transconductance of 5,800, and is intended for use as the last video i.f. amplifier in television receivers. The addition of the diode

EASY TO LEARN CODE

It is easy to learn or increase speed with an instructograph Code Teacher. Affords the quickest and most practical method yet developed. For beginners or advanced students. Available tapes for beginner's alphabet to typical messages on all subjects. Speed ranges 5 to 40 WPM. Always ready—no QRM.



ENDORSED BY THOUSANDS!

The Instructograph Code Teacher literally takes the place of an operator-instructor and enables anyone to learn and master code without further assistance. Thousands of successful operators have "acquired the code" with the Instructograph System. Write today for convenient rental and purchase plans.

INSTRUCTOGRAPH COMPANY

4701 Sheridan Rd., Dept. RC, Chicago 40, Ill.

TEST EQUIPMENT REPAIRED

Contractors to U.S. Government

Repairs and calibration by skilled craftsmen on all makes of meters, Testers, Sig. Gens., V.T.V.M's, Scopes, etc. Prompt service. All work guaranteed. For immediate estimate send instrument by P.P. Ins. to

DOUGLAS INSTRUMENT LABORATORY

Electronic Instrument Repairers

176a NORFOLK AVENUE BOSTON 19, MASS.

FREE LEARN TV
C T LOG of TV KITS

Assemble a TRANSVISION TV KIT in easy stages. Pay as you wire—only \$39 for Starting Package #1. Learn while building a superb 17" to 21" screen TV Set with latest features. Ideal for Fringe Areas, adaptable to UHF. No technical knowledge required. Catalog describes 6 great TV KITS.

Write today to Educational Dept. at—
TRANSVISION, INC., Dept. AE, NEW ROCHELLE, N. Y.

allows the tube to be a combined i.f. amplifier and video detector, thus aiding in the reduction of tubes used in TV receivers.

A new mirror-back picture tube—the 21FP4C, has been announced by CBS-Hytron.

This tube, which may be used to replace the 21FP4, is aluminized, with low-voltage electrostatic focus. Using electromagnetic deflection, it has an all-glass, rectangular-bulb, cylindrical face-plate that gives greater contrast and a reflection-free viewing surface.

The aluminum-backed screen reinforces light output and provides brighter, sharper pictures, without additional demands on the other components of the set.

The 21FP4C has an electron gun designed for use with a single-field, external ion-trap magnet. Its outer conductive coating, when grounded, acts as a high-voltage filter capacitor.

The mirror-back (aluminized) screen reflects light output to the viewer that would otherwise be lost to the rear of the screen.

An addition to its line of twin-tetrode tubes has been announced by Amperex. The tube, type 6360, is a miniature twin-tetrode having an over-all length of $3\frac{1}{16}$ inches, and a diameter of $\frac{7}{8}$ inch.

The tube is particularly useful in low-drain, mobile transmitters and multiplier chains where its ability to increase the power level quickly and produce a balanced output make it ideal for driving higher-power and higher-frequency push-pull stages.

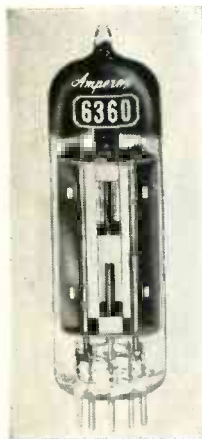

The 6360 is designed for use as a class C amplifier and oscillator, frequency multiplier, and modulator for frequencies up to 200 mc at maximum ratings. It can deliver 16 watts at 200 mc under ICAS conditions. As a frequency tripler from 67 mc to 200 mc, it can deliver 5 watts under ICAS conditions. **END**

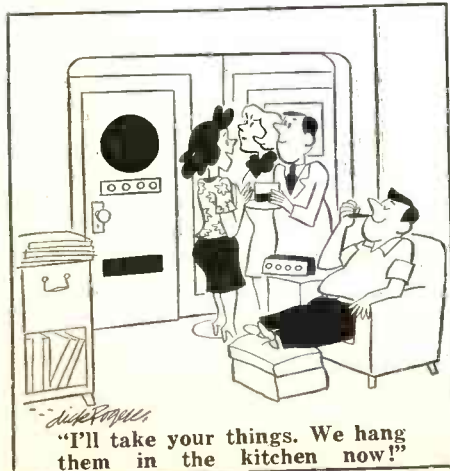

QUAM

the Quality line

When you specify Quam products you are assured of components that are carefully checked and tested for top performance and dependability . . . delivered when you need them . . . at the right price.

manufacturers of

QUAM Adjust-a-Cone® Speakers for television, radio, high fidelity, public address, outdoor use, replacement and many other applications.

QUAM Focalizer Units for TV picture tube focusing . . . use Alnico V permanent magnets . . . eliminate troubles inherent to wire-wound focusing devices.

QUAM Ion Traps for any size or type of TV picture tube.

QUAM Tru-Match Output Transformers, designed to get the best performance from your speaker.

QUAM-NICHOLS CO.
 Marquette Road and Prairie Avenue
 Chicago 37, Illinois

OSCIL-O-PEN

Extremely convenient test oscillator for all radio servicing; alignment • Small as a pen • Self powered • Range from 700 cycles audio to over 600 megacycles u.h.f. • Output from zero to 125 v. • Low in cost • Used by Signal Corps

Write for information.
GENERAL TEST EQUIPMENT
 38 Argyle Ave. Buffalo 9, N. Y.

REVOLUTIONARY
 NEW TYPE TV ANTENNA WINS!
THE OCTO-TENNA

proves superior against all competition in 97 out of 100 comparison tests in difficult signal areas.

DEALERS: This is IT!
 contact **C. R. DERR CO.**
 1018 Taylor Ave., Vallejo, California

Please mention
RADIO-ELECTRONICS
 when answering advertisements

CORONA RADIO KITS

EASY TO BUILD • EDUCATIONAL
EXCELLENT RECEPTION

BROADCAST SUPERHET KIT

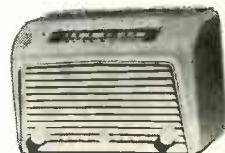

\$14.75

Rocket 115K—Latest Single Band superhet circuit for ultimate in sensitive reception and tonal quality. Kit includes all necessary parts, punched chassis, attractive bakelite mahogany cabinet, built-in loop antenna, iron core IFs, big 5" Alnico V spkr.; tubes: 12SK7, 12SA7, 12SQ7, 50L6, 35Z5. Automatic vol. control, beam power output. Tunes 540 to 1700 Kc. Simple step-by-step instructions included.

Plaza 812K 2-Band AC-DC Super Kit... net **\$20.75**
 Globemaster 814K 3-Band Super Kit... net **\$24.75**

All kits supplied less wire and solder. Please include 25% deposit with C.O.D. Orders. Dept. E-3

CORONA RADIO & TV CO.
 132 LIBERTY ST., NEW YORK 6, N. Y.

Compare... prove EMC superiority

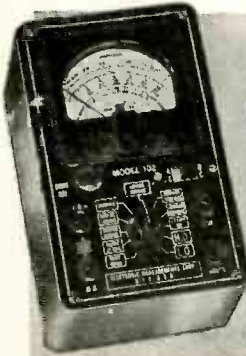

model 102

(1000 ohms per volt meter) • 3" SQUARE METER • 3 AC CURRENT RANGES (0-30/150/600 ma.) • Same zero adjustment for both resistance ranges 0-1000 ohms, 0-1 megohms) • 5 DC & 5 AC Voltage Ranges to 3,000 volts • Also 4 DC Current Ranges **\$14.90**



model 103

(1000 ohms per volt meter) • 4 1/2" SQUARE METER • 3 AC CURRENT RANGES (0-30/150/600 ma.) • Same zero adjustment for both resistance ranges (0-1000 ohms, 0-1 megohms) • Same Ranges as Model 102 • Also 5 DB Ranges **\$18.75**
Model 103-S with plastic carrying strap..... **\$19.25**



model 104

(20,000 ohms per volt meter) • 4 1/2" SQUARE METER (50 micro-amperes-Alnico magnet) • Includes carrying strap • 5 DC Voltage Ranges at 20,000 ohms volt to 3,000 V. • 3 AC Voltage Ranges to 20 megs • Also 3 AC & DC Current Ranges • 5 DB Ranges **\$26.95**
HVT 30,000 Volt Probe for Model 104 **\$7.95**

— See them at your Jobbers —

EMC

Write Dept. RE-3 for Free Complete Catalogue of these and other Instruments.

ELECTRONIC MEASUREMENTS CORPORATION
280 LAFAYETTE STREET • NEW YORK 12, N. Y.

EXPORT DEPARTMENT 136 LIBERTY STREET, N. Y. C. • N. Y.

ENCLOSURE KITS

G & H Wood Products Co., 75 N. 11th St., Brooklyn 11, N. Y., has announced a kit series based upon the Klipsch corner horn enclosure design by Cabintart for 12 and 15 inch speakers.

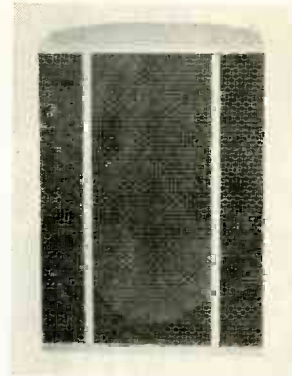

THE K-12 and K-15 embody all the features found in the finished units. Large-enclosure performance is maintained by "backloading to increase the path length and to provide better reproduction of the lows. Unique cabinet design makes for easy accessibility to speaker and simplifies external installation. Dual port arrangement provides for the use of two speakers in varying combinations.

The units are available in unfinished birch, and can be finished in style and color desired. They are packaged complete, from hardware to precut baffle. Easy-to-follow assembly and finishing instructions also are included.

C-R TUBE CHECKER

Eico (Electronic Instrument Co., Inc.), 84 Withers St., Brooklyn 11, N. Y., has produced the new model 630 C-R tube checker in kit and wired form.

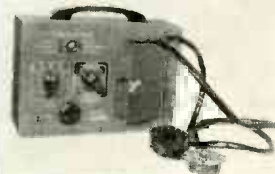

The model 630 indicates shorted or open elements in the electron gun, using a sensitive neon lamp. Bridge measurement of peak beam current (proportional to screen brightness) is made using a neon lamp as a balance indicator. Balancing control is calibrated directly in terms of tube condition. Test sockets and cables are provided for picture tubes with either duodecal or diheptal sockets to cover practically all modern tubes. An a.c. socket is provided so adapters can be plugged in for tubes with other bases. TV picture tubes can be tested right in the TV set or carton, using the test sockets connected to the tester by 2 1/2-foot cables.

D.C. POWER SUPPLY

Electro Products Laboratories, 4501 Ravenswood Ave., Chicago 40, Ill., has announced a low-cost d.c. power supply unit that supplies up to 16 volts d.c.

Its output is continuously variable from 0-8 and 0-16 volts d.c.; maximum continuous current rating is 10 amperes for all voltages up to 12 with intermittent current rating of 20 amperes. Other features are: low ripple; choke input-type filter; conduction cooling and selenium rectifiers; on-off switch and 8- and 16-volt switch; fused input on front panel; heavy-duty transformer and choke.



Ratings are: 110-120 volt, 50-60-cycle a.c. input, 250 watts with an 8-ampere 12-volt d.c. load.

Model D-612 is housed in an 18-gauge steel cabinet finished in blue hammerloid. It weighs 20 pounds and measures 12 x 7 x 8 1/2 inches.

POWER RESISTORS

International Resistance Co., 401 N. Broad St., Philadelphia 8, Pa., has introduced two new high-temperature resistors, types PW-7 and PW-10.

Wire elements are wound on glass fiber cores with axial leads 1 1/2 inches long and .036 inch in diameter. Body dimensions of PW-7 are 1 25/64 x 3/8 x 1 1/2 inches; of PW-10, 1 7/8 x 3/8 x 1 1/2 inches. These element-lead assemblies are sealed into a ceramic case with a cement which provides a mechanical

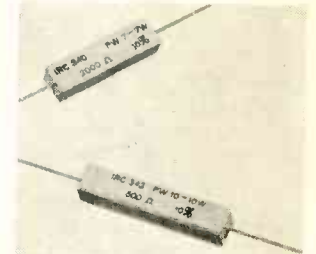

protective bond between the resistive element, the terminals, and the case. Type PW-7 is available from 0.51 to 5100 ohms; type PW-10 ranges from 1 to 8,200 ohms. Both are available in ± 5% and ± 10% tolerance.

Types PW-7 and PW-10 are recommended for circuits where a stable resistor is required with an actual wattage dissipation of 7 or 10 watts or less.

COLOR TV RECTIFIERS

International Rectifier Corp., 1521 E. Grand Ave., El Segundo, Calif., has announced a series of selenium rectifier stacks for color TV sets. The rectifiers in this series are designed for capacitive loads of 600, 700, and 750 ma and are produced for maximum input voltage ratings of 130, 172, and 195 volts r.m.s.

A bellows type spring contactor affords a lower forward drop, lower temperature rise, and longer life. The 2 x 3-inch plate size allows wider

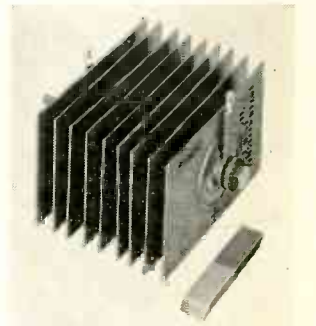

latitude in chassis layout. The photo shows a type RS609S rectifier stack, rated for 195 volts r.m.s. input and 600 ma output.

HIGH PASS FILTER

Service Instruments Co., 422 S. Dearborn St., Chicago, Ill., has designed a u.h.f. high-pass filter, the HP2, to pass ultra-high frequencies with less



than 1 db rejection and to reject all v.h.f. with an attenuation of from 45 to 50 db.

According to the company, the HP2 filter eliminates FM interference on u.h.f., airport interference on strips, and i.f. feed-through, and it prevents channel 5 or 6 from interfering on dual-conversion, all-channel tuners.

MIKE STAND

Atlas Sound Corp., 1451 39th St., Brooklyn 18, N. Y., has announced the model MS-25 microphone stand with an "air-cushioned" telescoping sec-

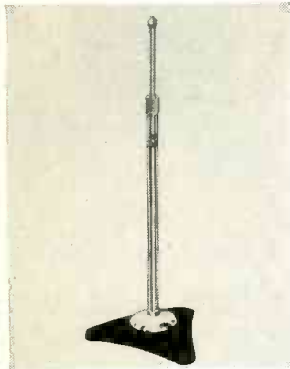

tion. The safety mechanism prevents the stand from crashing down and blasting sound into the amplifier.

The MS-25 has a height adjustment of from 37 to 66 inches and a base diameter of 17 inches. Tube finish is full chrome; base finish is chrome and gray shivel. The tube terminates in a 3/8-inch-27 carefully machined thread. The stand weighs 24 pounds.

UHF TV GENERATOR

Industrial Television, Inc., 369 Lexington Ave., Clifton, N. J., has announced a u.h.f. TV generator. This device uses the signal from any v.h.f. station and translates it into a u.h.f. signal on any channel.

The LI-130R can be used as a source of u.h.f. signals for demonstrating receiving equipment on all channels. It is also useful as a laboratory test instrument.



WIRE-WOUND CONTROLS

Clarostat Mfg. Co., Inc., Dover, N. H., has announced an improved version of its 1 1/2-inch diameter wire-wound potentiometer or rheostat, series 43c.

An improved wiper arm contact and end termination allows higher resolution, more intricate tapers, and tighter tolerances in over-all resistance and linearity. Terminals are fastened directly to winding, insuring low contact resistance. Collector and terminal are now in one piece, eliminating rivets as mechanical fasteners and current conductors. Stop is integral with base instead of in the cover, insuring a more positive stop, and leaving no holes in cover for dust, moisture, or oil to enter.

Series 43c controls are available in resistance from 1 ohm to 10,000 ohms, 2 watts rating. Taps and various tapers are available. Controls come with or without switch in single, dual, and triple assemblies.

MICROPHONES

Shure Brothers, Inc., 225 W. Huron St., Chicago 10, Ill., has announced the

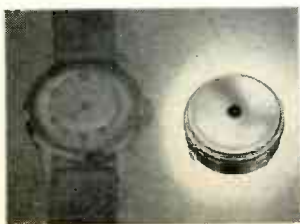

MC series of magnetic microphones. These controlled-reluctance mikes are only 1 inch (25.4 mm) in diameter and are immune to varying conditions of heat and humidity.

Models MC10 and MC11 are similar, but MC11 has a mu-metal shield ring for reducing hum pickup. They were specifically designed for use with transistor circuits, but are applicable to other devices.

TEMPERATURE-COEFFICIENT SLIDE RULE

Sprague Products Co., 81 Marshall St., North Adams, Mass., has introduced a new capacitor temperature-coefficient slide-rule which speeds and simplifies ceramic capacitor installation problems.

Values of stock N750 and NPO type ceramic capacitors which are to be connected in parallel to equal a capacitor of intermediate temperature coefficient of the required capacitance can easily be found with the C-753 slide-rule. The rule need only be set to the desired temperature coefficient and the value of the required N750 capacitor can then be read directly from the scales without consulting charts or tables. Values of the required NPO capacitor may be determined by subtraction.

The back of the rule is a key to ceramic capacitor color codes. Color bands and dots and their positions on each capacitor type are indicated for temperature coefficient, capacitance, tolerances, and voltage.



PHONO CARTRIDGE

Astatic Corp., Conneaut, Ohio, has introduced a new ceramic-element phonograph cartridge, the GCD. It is a turnover-needle cartridge, in which the cartridge remains stationary in the pickup arm, while the double-tipped needle rotates in switching back and forth to play both narrow- and wide-groove records.

Output is listed at 1 volt. Frequency range is 50-10,000 c.p.s., with 6 grams required as minimum needle pressure. No preamplifier or equalizer is required.

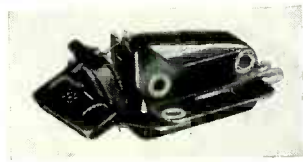

TUBE CADDY

Windsor Electronic Tube Co., 1515 Sheepshead Bay Rd., Brooklyn 35, N. Y., has announced the Tube Caddy, a portable carry-all for holding tubes, meters, tools, and other equipment for on-the-spot servicing.

NEW AMPLIFIER

Video Corporation of America, 229 W. 28th St., New York 1, N. Y., has announced the VC-6 amplifier, designed for use with radios, phonographs, or TV receivers. The unit supplies a push-pull power output of 6 watts and has a frequency response of 50-30,000 c.p.s. It has a bass or treble boost of 6 db from a single control.

The amplifier has a self-contained power supply rated at 110 volts, 60-cycle a.c. Impedance is 8 ohms. The unit is 1 3/8 x 3 1/8 x 11 inches long.

10-WATT AMPLIFIER

Brook Electronics, Inc., 34 DeHart Pl., Elizabeth, N. J., has announced the addition of a new 10-watt amplifier, model 22A, to their line of high-quality audio amplifiers.

SELENIUM RECTIFIERS

Federal Telephone and Radio Co., 100 Kingsland Road, Clifton, N. J., has introduced the Universal line of selenium rectifiers for replacement purposes. These units are of eyelet construction and came equipped with mounting hardware for simplified installation into the radio or television chassis.

Code numbers and ratings of the new selenium rectifiers making up the line are: 1236A, rated at 300 ma; 1238A, rated at 350 ma; 1241A, rated at 400 ma; and the 1237A, rated at 500 ma.

UHF ANTENNA

TV Products Co., 145 228th St., Springfield Gardens 13, N. Y., has introduced a single-bay u.h.f. corner antenna, model 706. This all-channel antenna was designed for use in fringe areas. The 706 has a gain of 14.8 db.

DRAWER CABINETS

General Industries Co., 5738 N. Elston Ave., Chicago 30, Ill., has announced a complete line of See-Thru drawer cabinets for small-parts filing and storage in factories, offices, school shops, home workshops, and garages.

Model J-20, pictured here, consists

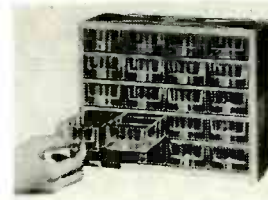

of 20 clear plastic drawers, 5 7/8 x 2 3/4 x 1-7/16-inches in a welded all-steel cabinet.

Other units now include models ranging from 8 to 128 drawers, models with larger size or metal drawers, and portable models with carrying handles.

NEW AM-FM-TUNER

Fisher Radio Corp., 42-41 Van Dam St., Long Island City 1, N. Y., announces the new model 50-RT FM-AM tuner and audio control unit. It includes bass and treble controls with 15 db boost and cut at 50 and 10,000 cycles, a phono preamplifier with inputs for magnetic and high-impedance cartridges, adjustable equalization, for AES, LP, NARTB, and ortho recordings, separate AM and FM front ends, and a d.c. supply for all audio-tube heaters. Response is ±1 db from the FM and audio circuits and ±2 db from the AM circuit in the broad position.

The Armstrong-type FM system has separate inputs for 72- and 300-ohm antennas, a cascade r.f. amplifier, two i.f. stages, dual limiters, and variable a.f.c. with a cut-out switch. Sensitivity on the 72-ohm input is 1 1/2 µv for 20 db quieting and 3 µv at the 300-ohm input.

The AM circuit has a tuned r.f. stage, and two variable-bandwidth i.f. stages. Sensitivity is less than 1 µv for 1 volt output. It has dual antenna inputs and a 10-kc filter.

Audio distortion is less than 0.04% for 1 volt and 0.8% for 10 volts output. There are two cathode-follower output circuits. One is ahead of the tone controls for output to a recorder.

There are separate continuously variable bass and treble controls, a loudness control switched in and out from the panel, a 9-position channel and equalization selector, and volume and tuning controls, a total of six.

Tubes are: 2-6BQ7A, 1-6CB6, 1-6BE6, 3-6BA6, 2-6AU6, 1-6AL5, 1-12AU7, 1-12AX7, 1-6AV6, 1-SY3, and 1-6U5. The over-all dimensions of the 50-RT are 14 3/4 inches wide, 8 1/2 inches high, and 9 1/4 inches deep. Weight, 19 pounds.

AUDIO UNITS

Stromberg-Carlson Co., Rochester 3, N. Y., has added a new combined radio receiver and amplifier, and a 15-inch coaxial loudspeaker to its custom 400 line.

The combined receiver-amplifier, the SR-405, unites in one chassis a high-fidelity tuner and 10-watt amplifier. It provides radio reception throughout both standard AM and FM broadcasting bands, plus faithful amplification of the entire sound spectrum, from 20 to 20,000 cycles.

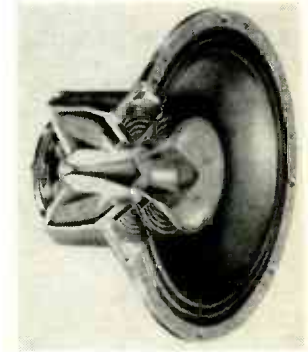
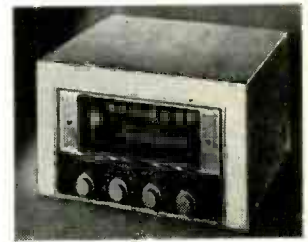

The SR-405 gives a power output of 10 watts with less than 1% of total harmonic content. It has separate bass and treble controls of extreme sensitivity, and the volume control is tone-compensated. Input terminals and controls are provided for microphone, television, magnetic recorder, or crystal phono pickup.

The 15-inch coaxial loudspeaker, RF-475, has a 10 1/2-pound permanent magnet of Alnico V metal.

SIGNAL GENERATOR

RCA Victor Division, RCA, Harrison, N.J., has announced the new WR-49A radio-frequency signal generator, useful as a TV and radio signal tracer as well as an alignment oscillator and marker designed for a wide range of AM or FM radio, and TV service operations and other applications which require a continuous wave or modulated r.f. sine-wave signal from 85 kc to 30 mc.

An important feature of the generator is the built-in blocking capacitors connected in series with the r.f. and a.f. cable connectors. The capacitors provide d.c. isolation of the attenuator circuits and prevent damage should the output cable be connected to a test circuit containing d.c. voltage. This feature eliminates the necessity of stringing d.c. blocking capacitors to the tip of the instrument probes each time the test operation involves direct current.

Other operating conveniences include: a separate range switch for the quick selection of one of the instrument's six tuning ranges; a fine-tuning control to facilitate precise setting of the output frequency, and a special dial and tuning assembly which makes possible rapid tuning and reading of the exact frequency setting.

CONICAL YAGI

RMS (Radio Merchandise Sales), 2016 Bronxdale Ave., New York 62, N. Y., has announced a new conical Yagi antenna for v.h.f. the Mugwump.

This antenna, model CY-1, is a single-bay unit said to offer the characteristic gain of a Yagi, together with the broad-band response of a conical. The antenna also comes in a 2-bay array, model CY-11.

BUILD 15 RADIOS

ONLY

AT HOME \$19.95

With the New Improved 1954

Progressive Radio "EDU-KIT"

NOW INCLUDES
SIGNAL TRACER
and
CODE OSCILLATOR

- ATTRACTIVELY GIFT PACKED
- FREE TOOLS WITH KIT
- ABSOLUTELY NO KNOWLEDGE OF RADIO NECESSARY
- NO ADDITIONAL PARTS NEEDED
- EXCELLENT BACKGROUND FOR TV
- 10 DAY MONEY-BACK GUARANTEE
- SCHOOL INQUIRIES INVITED



WHAT THE PROGRESSIVE RADIO "EDU-KIT" OFFERS YOU

The Progressive Radio "Edu-Kit" offers you a home study course at a rock bottom price. Our Kit is designed to train Radio Technicians, with the basic facts of Radio Theory and Construction Practice expressed simply and clearly. You will gain a knowledge of basic Radio Principles involved in Radio Reception, Radio Transmission and Audio Amplification.

You will learn how to identify Radio Symbols and Diagrams; how to build radios, using regular radio circuit schematics; how to mount various radio parts; Receivers, Transmitters, and Audio Amplifiers. You will learn how to service and troubleshoot radios. You will learn code. You will receive training for F.C.C. license.

In brief, you will receive a basic education in Radio exactly like the kind you would expect to receive in a Radio Course costing several hundreds of dollars.

THE KIT FOR EVERYONE

The Progressive Radio "Edu-Kit" was specifically prepared for any person who has a desire to learn Radio. The kit has been used successfully by young and old in all parts of the world. It is not necessary that you have even the slightest background in science or radio.

The Progressive Radio "Edu-Kit" is used by many Radio Schools and Clubs in this country and abroad. It is used for training and rehabilitation of Armed Forces Personnel and Veterans throughout the world.

The Progressive Radio "Edu-Kit" requires no instructor. All instructions are included. All parts are individually boxed, and identified by name, photograph and diagram. Every step involved in building these sets is carefully explained. You cannot make a mistake.

PROGRESSIVE TEACHING METHOD

The Progressive Radio "Edu-Kit" comes complete with instructions. These instructions are arranged in a clear, simple, progressive manner. The theory of Radio Transmission, Radio Reception, Audio Amplification and servicing by Signal Tracer is explained. Every part is identified by photograph and diagram. You will learn the function and theory of every part used.

The Progressive Radio "Edu-Kit" uses the principle of "Learn by Doing". Therefore you will build radios, perform jobs, and conduct experiments to illustrate the principles which you learn. These radios are designed in a modern manner, according to the best principles of present-day educational practice. You begin by building a simple radio. The next set that you build is slightly more advanced. Gradually, in a progressive manner, you will find yourself constructing Radio Technician. Altogether you will build fifteen radios, including Receivers, Transmitters, Amplifiers, Code Oscillator and Signal Tracer. These sets operate on 105-125 V. AC/DC.

THE PROGRESSIVE RADIO "EDU-KIT" IS COMPLETE

You will receive every part necessary to build 15 different radio sets. Our kits contain tubes, tube sockets, variable capacitors, electrolytic condensers, mica condensers, paper condensers, resistors, line cords, selenium rectifiers, tie strips, coils, hardware, tubing, etc.

Every part that you need is included. These parts are individually packaged, so that you can easily identify every item. Tools are included, as well as an Electrical and Radio Tester. Complete, easy-to-follow instructions are provided.

In addition, the "Edu-Kit" now contains lessons for servicing with the Progressive Signal Tracer, F.C.C. instructions, quizzes. The "Edu-Kit" is a complete radio course, down to the smallest detail.

TROUBLE-SHOOTING LESSONS

Trouble-shooting and servicing are included. You will be taught to recognize and repair troubles. You will build and learn to operate a Professional Signal Tracer. You receive an Electrical and Radio Tester, and learn to use it for radio repairs. While you are learning in this practical way, you will be able to do far exceed the cost of the neighbors and friends, and charge fees which will quickly and easily, and have others pay for it. Our Consultation Service will help you with any technical problems which you may have.

FREE EXTRAS

- ELECTRICAL & RADIO TESTER • ELECTRIC SOLDERING IRON • TV BOOK • RADIO TROUBLE-SHOOTING GUIDE • MEMBERSHIP IN RADIO-TV CLUB • CONSULTATION SERVICE • QUIZZES • F.C.C. TRAINING

Progressive "Edu-Kits" Inc.

497 Union Ave., Dept. RE 81, Brooklyn 11, N. Y.

MAIL TODAY—Order shipped same day received.

10-Day Money-Back Guarantee. Include ALL FREE EXTRAS.

- Send "Edu-Kit" Postpaid. I enclose full payment of \$19.95 (U.S.A. only).
- Send "Edu-Kit" Postpaid. I enclose full payment of \$20.95 (Outside U.S.A.).
- Send "Edu-Kit" C.O.D. I will pay postage (U.S.A. only).
- I wish additional information describing "Edu-Kit". No Obligation.
- Send me FREE Radio-TV Servicing Literature.

Name.....

Address.....

PROGRESSIVE "EDU-KITS" INC.

497 UNION AVE., Dept. RE-81, Brooklyn 11, N. Y.

NEW DEVICES

V.H.F. COLLINEAR YAGI

Technical Appliance Corp., Sherburne, N. Y., has developed an all-changel v.h.f. collinear Yagi antenna, the *Trapper*.

This antenna, model 1880, has a forward director and two tuned driven elements with auto-match stubs, one tuned high-band reflector and one low-band reflector.



For fringe and ultra-fringe installations, two standard Trapper antennas are used with the associated stacking equipment supplied.

not fall out or shake loose from the sockets designed for them. Separate sockets (type 9221-1, made by Cinch Manufacturing Co., of Chicago, Ill.) are used for each lug since spacing between them is determined by the rectifier size.

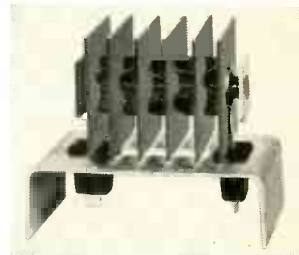

UHF ANTENNA

JFD Manufacturing Co., Inc., 6101 16th Ave., Brooklyn 4, N. Y., has added a corner reflector for fringe reception to its u.h.f. line. The model UHF15 *Golden Rig* features 4-way bracing for elimination of ghost-producing vibration.

This antenna has gold-colored anti-corrosion plating.

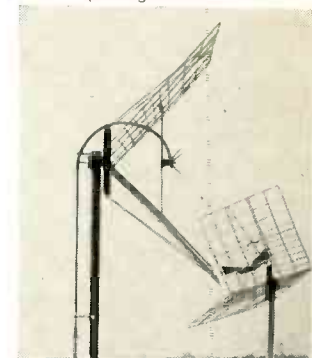

DEFLECTION COMPONENTS

RCA Victor Division, RCA, Harrison, N. J., has developed three 90-degree TV deflection components.

The RCA 220D1 is a de luxe, 90-degree, ferrite-core, deflecting yoke, similar to the RCA 219D1. Major differences include smaller size, lighter weight, molded-vinyl insulation, and a molded-bakelite terminal frame. The 220D1 provides good side-and-corner resolution and freedom from pincushion distortion substantially equal to that obtained with 70-degree systems.

The RCA 238T1 is a de luxe 18-kv, ferrite-core, horizontal output (fly-back) transformer for use with the RCA 220D1 yoke. It will provide full scan of a 90-degree kinescope when driven by an RCA-6CD6-G operating at only 250 volts, and a cathode current of 115 ma.

The new RCA 239T1 is a low-cost equivalent to the 238T1 in performance and life expectancy. It is quite similar electrically and mechanically.

PORTABLE RECORDER

Magnemite Division, Amplifier Corp. of America, 398 Broadway, New York 13, N. Y., has announced a compact 8-pound weather-tight magnetic tape recorder, the *Flyweight Magnemite*, designed for rugged field use.

The unit employs a fly-ball governor-controlled triply shielded electric motor with built-in noise suppressor which assures constant speed and freedom from hash during the full life of the motor batteries. A built-in indicator shows when motor batteries should be replaced.



The recorder uses nonmicrophonic sub-miniature tubes and rewinds a full reel of tape in less than two minutes. It is powered by dry batteries. By powering the low-drain recording-playback amplifier independently of the motor, a supplementary set of inexpensive batteries will last 100 operating hours. Motor battery life is 4 hours.

Three different models are available, playing up to 4 hours on a standard 600-foot roll of 1/4-inch tape on a 5-inch reel.

PLUG-IN SELENIUM RECTIFIER

Sarkes-Tarjian, Inc., Rectifier Division, 415 North College Ave., Bloomington, Ind. announces that the *Centre-Cooled* line of selenium rectifiers is being converted to a plug-in type. The lugs are polarized (the positive lug has a 90° twist) for correct circuit connection. They are designed so the rectifier will

SWEEP GENERATOR

Hickok Electrical Instrument Co., 10531 Dupont Ave., Cleveland 8, Ohio, has announced a u.h.f. sweep alignment generator, model 697. The equipment has an all-electronic sweep that features no moving parts. Model 697 provides fundamental output on channels 14-83 with 0.5-volt r.f. output.



STANDOFF INSULATOR

The Insulin Corp. of America, 36-02 35th Ave., Long Island City, N. Y., has announced a new strap type standoff insulator that accommodates all standard television transmission lines.

A low-loss polyethylene grommet in the eye of the device securely holds flat twin-lead ribbon, tubular twin-lead, oval-tubular lead, or coaxial cable.

An adjustable steel strap permits the insulator to be used on any pipe from 3/4 inch to 1 1/2 inches in diameter. The assembly is tightened by a captive tension nut through which the threaded end of the insulator screw eye passes. All metal surfaces are heavily zinc-plated.

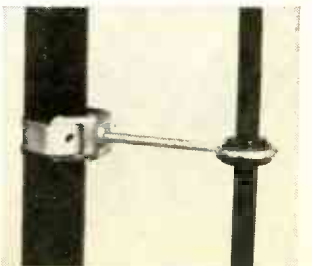

through their anode coils. At the same time, less current flows through the anode coils of B and C. These conditions are reversed during the next half audio cycle. Currents in the T2 primary are no longer cancelled out, and audio power is transferred to the loudspeaker.

The third winding on each core is for biasing the core magnetism. P is adjusted to bias the cores for linear response and high gain. C1 and C2 are used to bypass any carrier current that may remain. Although the fundamental carrier frequency is largely eliminated due to balancing and bypassing, some harmonics may be present. The network LCR is added to eliminate them.

A stage like the one shown here can amplify a.f. over a range of 200-2500 cycles. The carrier should be about 10,000 cycles.

SELECTIVE CIRCUIT

Patent No. 2,653,194
Walter Lyons, Flushing, N. Y.
(assigned to Radio Corp. of America)

This patent has as its objective, a means of obtaining high selectivity without the use of multiple heterodyne circuits and filter arrangements.

Quartz crystals, having a very high Q, are sharply selective. In filter networks, crystals produce high loss so amplification is generally needed. This circuit combines sharp selectivity and high gain. It passes a very narrow band: 100 cycles at a carrier frequency of 50 kc.

The pentodes are in push-pull and each crystal feeds one of the tubes. One crystal is ground for a frequency slightly above the applied carrier frequency. The other resonates at a frequency slightly below the carrier. Due to the push-pull connection, the circuit can have no output if the grids are fed with identical (in phase) signals. If the applied signals are dissimilar (out of phase), output does exist.

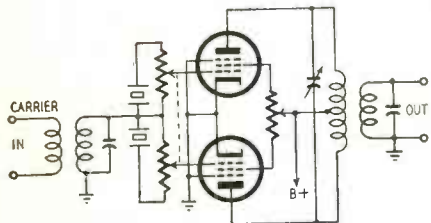

At frequencies far from the carrier, each crystal transmits an identical signal. For example, assume a 50-kc carrier. At 48 kc, the crystals may be assumed identical, for their resonance points are very close to 50 kc. Thus we get no output at 48 kc or any other frequency far from the carrier. Within the pass-band (that is, between the crystal frequencies), the story is different. Here, one crystal acts like an inductance because it is being operated above its resonant frequency. The other crystal acts like a capacitance since it is operating below its resonant frequency. Each tube receives a signal that differs in phase from that of the other. Thus, output exists only within the very narrow range of frequencies between the resonant frequencies of the crystals.

A ganged pair of resistors shunts the crystals. They control damping and bandwidth. The adjustable screen resistance permits balancing of the tubes for zero output when the grid signals are identical.

RELAY CONTROL CIRCUIT

Patent No. 2,622,195
John W. Smith, Cedar Rapids, Iowa. (assigned to Collins Radio Co., Cedar Rapids, Iowa)

Using an ordinary relay, this circuit provides a slow release. The relay is energized quickly; the release time is long.

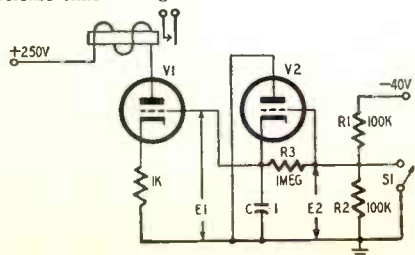

**WHEN WILD WINDS HIT...
PERMA-TUBE STAYS UP**
... and so does your reputation!

**Here's why PERMA-TUBE
backs up quality service:**

- PERMA-TUBE IS STURDY . . .** it's made of special, high-strength J&L Steel.
- PERMA-TUBE IS CORROSION-PROOF . . .** it's treated with vinsynite—then coated inside and outside with a metallic vinyl resin base.
- PERMA-TUBE IS EASILY INSTALLED . . .** it's the only mast with both ends of the joint machine fitted.

Here's proof of Perma-Tube's superior strength. Ordinary masts and Perma-Tube were subjected to regular deflection and permanent set tests with the following results:

TV Mast Tested	Size and B W Gauge	Bending Force To Produce 2 1/2 lbs Set
Mast A	1 1/4" OD x 20 Ga.	1870 inch pounds
Mast B	1 1/4" OD x 18 Ga.	2740 inch pounds
Mast C	1.65" OD x 17 Ga.	2780 inch pounds
Perma-Tube Mast C	1 1/4" OD x 18 Ga.	2930 inch pounds
Mast E	1 1/4" OD x 15 Ga.	4370 inch pounds
Mast F	1 1/4" OD x 16 Ga.	4560 inch pounds
Perma-Tube Mast F	1 1/4" OD x 16 Ga.	5950 inch pounds

CHECK THE 500 HOUR MINIMUM SALT SPRAY TEST RATING OF YOUR TELEVISION MASTS (Am. Soc. of Testing Materials—Spec. 5117-49T). Remember Perma-Tube passes this test . . . remains corrosion-proof.

J&L STEEL
Jones & Laughlin
STEEL CORPORATION — Pittsburgh

Windsor TUBES

RADIO & TV RECEIVING

TESTED and GUARANTEED for **PEAK PERFORMANCE**

WHAT EVERY SERVICEMAN SHOULD KNOW . . . No tube checker reading of "Good" can positively insure that a specific tube will function perfectly in a TV set . . . only a substitution test in an actual set will do that! This is particularly true of tubes used in power and sweep circuits, deflection amplifiers, oscillators, reactance modulators, etc.

YOU PLAY IT SAFE when you buy Windsor tubes—because every tube we ship has been carefully pre-tested in a radio or TV set for **PEAK PERFORMANCE** under actual operating conditions. So we unconditionally guarantee every Windsor tube in accordance with the Standard Warranty: full replacement of any defective tube within 90 days of purchase, excepting only burnouts and breakages. Each tube is attractively packaged in individual carton.

BUY—AND SELL—WINDSOR TUBES, WITH CONFIDENCE

Type	Each	Type	Each	Type	Each	Type	Each
1A7GT	\$.67	3V4	1.00	6BD3GT	\$.98	6Q7GT	\$.55
1B3GT	\$.69	5R4GY	1.00	6BD6	\$.54	6S4	\$.51
1H5GT	\$.51	5U4G	\$.44	6BE6	\$.51	6SRGT	\$.75
1J6	\$.63	5Y4G	\$.83	6BF5	\$.66	6SA7GT	\$.57
1L4	\$.93	5Y3G	\$.37	6BF6	\$.43	6SC7	\$.63
1L6	\$.66	5Y3GT	\$.32	6BG6G	1.47	6SD7	\$.55
1LA4	\$.82	5Y4G	\$.43	6BH6	\$.63	6SF5GT	\$.52
1LAS	\$.80	6A8GT	\$.68	6BJ6	\$.53	6SH7GT	\$.66
1LB4	\$.82	6A8A	\$.51	6BK5	\$.57	6SJ7GT	\$.52
1LC5	\$.80	6AC5GT	\$.82	6BK7	\$.97	6SK7GT	\$.55
1LC6	\$.80	6AG5	\$.59	6BL7GT	\$.94	6SL7GT	\$.68
1LD5	\$.80	6AH4	\$.68	6BN6	\$.98	6SN7GT	\$.59
1LE3	\$.80	6AH6	\$.89	6BQ6GT	\$.98	6SQ7GT	\$.46
1LG5	\$.80	6AL5	1.05	6BQ7	\$.92	6T8	\$.85
1LH4	\$.80	6AL5	1.05	6BZ7	1.09	6U4GT	\$.60
1LN5	\$.80	6AQ5	\$.51	6C4	\$.41	6U8	\$.86
1NSGT	\$.85	6AQ6	\$.47	6C5GT	\$.60	6V3	1.09
1R4	\$.65	6AQ7	\$.75	6C6B	\$.58	6V6GT	\$.51
1R5	\$.62	6AR5	\$.42	6CD6G	2.00	6W4GT	\$.50
1S4	\$.67	6AS5	\$.55	6D6	\$.63	6W6GT	\$.63
1S5	\$.52	6AT6	\$.42	6E5	\$.72	6X4	\$.37
1T4	\$.62	6AUSGT	\$.85	6F5GT	\$.54	6X5GT	\$.37
1U4	\$.61	6AU6	\$.47	6HG6T	\$.55	6Y6G	\$.64
1U5	\$.51	6AV3	\$.85	6J5GT	\$.44	7A4/XXL	\$.57
1X2A	\$.74	6AV6	\$.41	6J6	\$.68	7A5	\$.70
2X2	1.43	6AX4	\$.72	6J7	\$.70	7A6	\$.57
3LF4	\$.76	6B8G	\$.93	6K6GT	\$.45	7A7	\$.58
3D4	\$.86	6BA6	\$.50	6K7	\$.70	7A8	\$.56
3Q5GT	\$.72	6BA7	\$.86	6L6G	\$.88	7AD7	1.05
3S4	\$.61	6BC5	\$.58	6L6GA	\$.88	7AF7	\$.63

Type	Each	Type	Each
7A6T	\$.65	12B7	\$.77
7A7	\$.65	12J5GT	\$.48
7A7	\$.70	12SA7GT	\$.57
7B4	\$.54	12SH7GT	\$.67
7B5	\$.51	12SK7GT	\$.55
7B6	\$.52	12SL7GT	\$.67
7B7	\$.58	12SN7GT	\$.59
7C4	1.05	12SQ7GT	\$.46
7C5	\$.56	14A7	\$.58
7C6	\$.50	14AF7	\$.68
7C7	\$.58	14B6	\$.50
7E5	\$.85	14C5	\$.85
7E6	\$.85	14C7	\$.70
7E7	\$.89	14E6	\$.70
7F7	\$.89	14E7	\$.85
7F8	\$.97	14F7	\$.69
7G7	\$.81	14F8	\$.99
7H7	\$.85	14J7	\$.85
7J7	\$.85	14N7	\$.75
7K7	\$.85	14Q7	\$.62
7L7	\$.85	14R7	\$.85
7N7	\$.82	14S7	\$.80
7Q7	\$.62	15B6G	1.53
7R7	\$.70	25B6GT	\$.98
7S7	\$.90	25L6GT	\$.53
7T7	\$.92	25W4GT	\$.53
7U7	\$.99	25Z6GT	\$.46
7X6	\$.87	35A5	\$.55
7Y4	\$.45	35B5	\$.53
7Y4	\$.45	35C5	\$.53
7Z4	\$.50	35L6GT	\$.52
12A7	\$.53	35W4	\$.33
12A7	\$.75	35Z5GT	\$.33
12A7	\$.47	50A5	\$.55
12A7	\$.58	50B5	\$.52
12A7	\$.41	50C5	\$.52
12A7	\$.87	50L6GT	\$.52
12A7	\$.72	50M5	\$.43
12A7	\$.67	11Z23	\$.43
12A7	2.15	11Z26GT	\$.75
12B4	\$.66		
12BA6	\$.50		
12BA7	\$.66		
12BD6	\$.51		
12BE6	\$.52		
12BH7	\$.69		

FREE! WINDSOR TUBE CADDY



The most practical Service-Aid ever designed for the radio and TV repairman. This ideal television carry-all now offered free with every purchase of \$10.00 or accumulated purchases totaling \$150.00 within 90 days. (You get credit memo with each purchase.) Windsor Tube Caddy may also be purchased outright for \$14.95.

- Carries approximately 125 tubes, including meters and tools.
- 16 3/4 inches long x 8 1/4 inches wide x 1 3/4 inches high.
- Weighs only nine pounds.
- Ruggedly constructed with heavy leatherette covering, strong plastic handle, nickel plated hardware and reinforced with metal clamps.

DON'T MISS THIS SENSATIONAL OFFER!

Windsor ELECTRONIC TUBE CO.
1515-C SHEEPSHEAD BAY ROAD, BROOKLYN 35, N. Y.

25% Deposit with Order. All merchandise F.O.B. NYC. For orders less than \$10. Add \$1 handling cost. Deduct 2% if full remittance accompanies order. All merchandise subject to prior sale and price changes without notice.

WRITE FOR ADDITIONAL TUBE TYPES AND PRICES. We also stock Special Purpose and Transmitting Tubes at similar savings! Dept. C-3

RECORDING TAPE (Plastic Base) 40% OFF (NEW)

WASHINGTON, D.C. WHERE ELSE WOULD THERE BE MORE RED ^ TAPE? Magnetic

- 1200 ft. plastic tape with plastic reel included.
- Each reel individually boxed.
- Choice of nationally famous top quality brands such as: Webcor (2806) 3.20; Reeves (SPN-12) 3.20; Audio (1251) 3.23; Scotch (111-A) 3.25; Panacoustic (711-A) 3.25; Irish, Professional grade (211 RPA) 3.30.
- FREE—7.95 Penton tape carrying case included with purchase of 12 new tapes.

USED RECORDING TAPE (PLASTIC BASE)

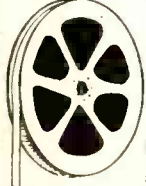

1.99 for 7"-1200 foot
.99 for 5"-600 foot
.59 for 4"-300 foot
.29 for 3"-150 foot
Plastic reels included with all above sizes

New empty plastic reels in boxes for easy labeling, 3" 19c; 4" 22c; 5" 24c; 7" 29c; 7" Professional reel (2 1/2" hub) 39c ea. EMPTY BOXES: 3c; 3c; 4c; 5c; 5c; 7c; 10c ea.

We carry all brands of new tape, recording blanks, tape recorders, etc., at low prices. PLEASE INCLUDE SUFFICIENT POSTAGE.

COMMISSIONED ELECTRONICS CO.
2503 Champlain St. N.W., Washington 9, D. C.

HI-GAIN TUNER-BOOSTER

LESS TUNES WITH DIAL

\$4.75 COMPLETE WITH TUBES
\$6.00

Solve poor TV reception with a Hi-Gain Booster. Banish weak fringe areas, reduce snow. This unit comes to you as a highly serviceable High-Gain Tuner. Uses 6J6 Tubes in very efficient Hi-Q Circuit. Has 8 tuned circuits using pure silver inductances and individual compensation providing high gain on all channels. Built in 5:1 Vernier Drive.

All necessary parts and instr. included makes highest gain booster on the market reg. of price.

100 ASSORTED RESISTORS
Carbon insulated. New in current RMA Values 5%, 10% and 20% in 1/2, 1 and 2 watt

\$100

Shipments sent postpaid when full payment is enclosed. 25% deposit on C.O.D. Send for our new bulletin. NO C.O.D.'S TO CANADA.

FRANK W. DECRAY & ASSOC.
11842 W. Jefferson Blvd. Culver City, Calif.

If switch S1 is open, E₂ is -20 volts due to voltage divider R1, R2. Current flows through R3 into C. If the switch is left open for any length of time, C becomes charged. The grid bias of V2 drops to almost zero, but due to low plate voltage (20 volts) the tube passes little current. A large negative voltage E₁ blocks V1.

When S1 is closed, it grounds the grid of V2, making it 20 volts positive with respect to the cathode. V2 will then pass considerable current and discharges C. With E₁ down to nearly zero volts, V1 conducts and energizes its relay. All this takes place quickly.

If S1 is opened momentarily, V2 blocks at once because E₂ goes back to -20 volts. V1 continues to pass current because it takes time to charge C. With the values shown, 2 or 3 seconds are needed. The time constant C-R3 determines the interval. Thus, if S1 is opened for very short periods, the relay is not energized. It is actuated immediately, however, when S1 is closed.

MINIATURE METER

Patent No. 2,650,349
Francis X. Lamb, East Orange, N. J.
(Assigned to Weston Electrical Instrument Corp.)

This patent relates to small sized meter instruments, for example the 1-inch size. They use a permanent-magnet core within the coil winding, rather than the horseshoe magnet of large meters. As shown, the cylindrical core is flattened slightly at its north pole (N). The shaded region is a soft-iron yoke which provides the return path for magnetic flux. It also acts as shield for the coil. A bolt holds the core and yoke in place. As usual, a pointer moves with the coil.

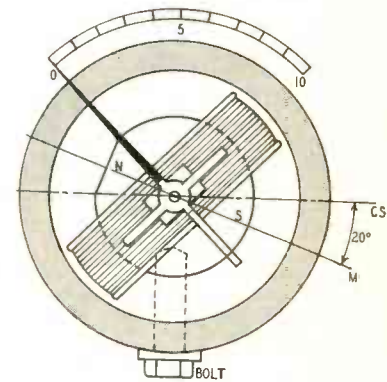

The big problem with miniature meters has been scale linearity. This invention permits a nearly uniform scale without adding to the cost of the meter. The north pole of the core should be flattened until the diameter through N-S is 5% of the original diameter. Furthermore, N-S diameter (M) should make a 20° angle with the center-scale axis (CS).

TRANSISTOR TRIGGER

Patent No. 2,604,496
Lloyd P. Hunter, Pittsburgh, Pa.
(Assigned to Westinghouse Electric Corp.)

This circuit can be triggered by a positive pulse of about a volt. Triggering is extremely rapid, requiring only about 0.1 microsecond. Reset time is a few microseconds. The transistor may be N-type with a small P region surrounding the collector. See Fig. 1.

P1 and P2 adjust the emitter and collector voltages. The output characteristic of the point-contact transistor is shown in Fig. 2. The lowest portion AB shows positive resistance. At higher currents there is a kink in the curve indicated by

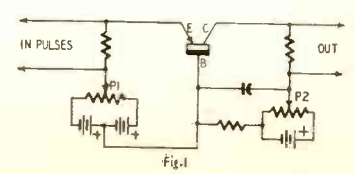

CONTACT RESTORER

Electronic Chemical Corp., 813 Communipaw Ave., Jersey City 4, N. J., has introduced its No Noise volume control and contact restorer in a new spillproof, easy-to-use, 6-oz. spray can. The product is also available in 2- and 8-ounce bottles and quart cans.



SIGNAL EQUALIZER

Tele-Matic Industries, Inc., 1 Joralemon St., Brooklyn, N. Y., has intro-



duced an automatic signal equalizer designed for use in locations where the signals from the low-frequency channels cause overloading and where the high-frequency channels are not strong enough to tolerate any attenuation.

The equalizer, model AT-25, provides maximum attenuation on the low-frequency channel and minimum attenuation on the high-frequency channel without upsetting the impedance of the TV receiver.

REPLACEMENT FLYBACKS

Chicago Standard Transformer Corp., Standard Division, Addison and Elston, Chicago 18, Ill., has added three replacement flybacks for Sylvania to its line. These flybacks, A-8227, A-8228, and A-8229, are usable in 90% of all Sylvania receivers made up to 1953. They are supplied as coil and core for easy installation on the original



brackets which are a permanent part of the chassis. New filament leads are packed with each transformer. END
All specifications given on these pages are from manufacturers' data.

RICHARDSON-ALLEN
CORPORATION
RECTIFIER SPECIALISTS

Mr. Julian Loebenstein, Sales Manager
Selenium and Germanium Division
Radio Receptor Company
251 West 19th Street
New York 11, N. Y.

Seven years a SELETRON CUSTOMER!

Naturally we guard our reputation as manufacturers of power supplies carefully and, therefore, all components used must rank tops in their class — with special attention to the rectifier stacks — since the performance of our equipment depends so largely on them.

For the past seven years your Seletron selenium rectifiers have done a splendid job for us in applications for low voltage electroplating, and for power supplies of 110/220 volts. Both types of use involve individual jobs running into many kilowatts.

We take the best care of our customers.

SELETRON RECTIFIERS

When the problem is industrial rectification, specialists such as Richardson-Allen Corp. look to SELETRON to do a lasting, dependable job. Need we amplify? The record speaks for itself.

SELETRON Rectifiers are available in Radio and TV type as well as large power stacks. Write today for information . . . and study our catalog in Sweet's Product Design File. We also manufacture germanium diodes and transistors.

Seletron
& Germanium
Division

RADIO RECEPTOR COMPANY, INC.
In Radio & Electronics Since 1922
SALES DEPARTMENT
251 West 19th Street, New York 11, N. Y.
WA 4-3633 • Factories in Brooklyn, N. Y.

Just Out

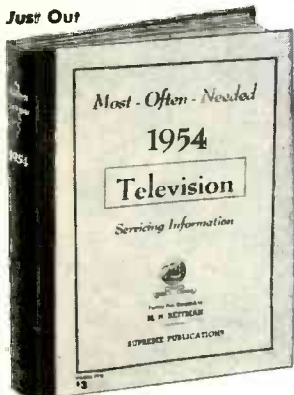

This newest giant volume of the Supreme TV manuals covers 1954 factory data on all popular television sets of all makes. There are explanations of new circuits, 192 pages of alignment procedure, test patterns, response curves, pages of waveforms, voltage charts, service hints, production changes, and dozens of double-spread circuit diagrams. Manual-style binding (opens flat). Special price, only . . . \$3

New SUPREME 1954 TV Manual

FULL YEAR'S TV MATERIAL IN A GIANT VOLUME — \$3

COVERS ALL POPULAR SETS

This new Supreme 1954 TV manual has all the required service material on every popular television set of every important manufacturer. Here is helpful, practical, factory-prepared data that will really make TV servicing and adjustment easy for you. More pages, more diagrams, more service data per dollar of cost. This new giant TV manual and previous volumes for other years have complete circuits, alignment facts, test patterns, response curves, service hints, recommended changes, voltage charts, waveforms, and many double-page diagram blueprints. Here is your TV service material to help you do more expert work quicker; and priced at only \$3 and \$2 per manual covering a whole year of material. See coupon below for complete list of all eight TV volumes, from 1947 to 1954, and the 1953 UHF Converters manual. Order for a 10-day trial.

AMAZING BARGAIN OFFER

The new 1954 TV manual is the most remarkable value offered by Supreme Publications in their 20 years of business. This mammoth television servicing manual at only \$3, or the TV manuals for previous years for only \$3 and \$2 each, are amazing bargains and defy competition. There is nothing else like them. Each manual is a virtual treatise on practical television repairs. By normal standards, each such large manual packed as it is with practical facts, hundreds of illustrations, diagrams, charts, photographs, and expensive extra-large blueprints, should sell for \$10—but as SUPREME special values they are priced at \$3 and \$2 each. Only a publisher who sold over one million TV and radio manuals can offer such bargains based on tremendous volume-sales. Be ready to repair any TV set by having in your shop all eight Television Manuals listed in coupon. Or try the new 1954 TV manual to see what an amazing bargain you get for only \$3. Send trial coupon or ask your jobber.

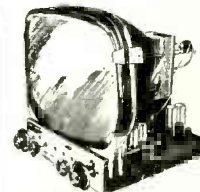

The repair of any television set is really simple with Supreme TV service manuals. Every set is covered in a practical manner that will simplify troubleshooting and repair. This is the help you need to find toughest faults in a jiffy. Each \$3 volume covers a whole year of material. Be wise, buy Supreme Manuals only once each year instead of spending dollars every week for not needed data.

Ne west



RADIO DIAGRAMS

Here is your complete source of all needed RADIO diagrams and service data. Covers everything from most recent radios to pre-war old-timers; home radios, auto sets, combinations, changers, and portables. Sensational values. Still sold at pre-Korean prices. Only \$2 for most volumes. Every Radio manual contains large schematics, all needed alignment facts, parts lists, voltage values, trimmers, dial stringing, and helpful service hints. All volumes are large in size, 8 1/2 x 11 inches, about 102 pages. See coupon at right for a complete list of these low-priced manuals.

NO-RISK TRIAL ORDER COUPON

SUPREME PUBLICATIONS, 1760 Balsam Rd., Highland Park, ILL.

Radio Diagram Manuals

- New 1953 Manual, \$2.50
- 1952 Radio
- 1951 Diagrams
- 1950 Manual
- 1949 Radio
- 1948
- 1947
- 1946
- 1942
- 1941
- 1940
- 1939
- 1926-1938 Manual, \$2.50
- Master INDEX only 25¢

EACH
\$2.50
PRICED AT ONLY \$2 EACH

Send TV manuals checked below and Radio manuals at left. Satisfaction guaranteed or your money back.

- New 1954 Television Servicing Manual, only . . . \$3.
- 1953 TV Manual, \$3. 1953 UHF Units, \$1.50
- 1952 Television Manual, \$3. 1951 TV, \$3.
- 1950 Television Manual, \$3. 1949 TV, \$3.
- 1948 TV, \$3. 1947 TV & FM, only \$2.

- I am enclosing \$ Send postpaid.
- Send C.O.D. I am enclosing \$ deposit.

Name:

Address:

Supreme Publications

Available from Leading Parts Jobbers

Your customers...
and your cash register...
will tell you...

hallicrafters

SHORT WAVE RECEIVERS

are the finest—fastest selling
on the market!

FOR twenty years hams all over the world have agreed that Hallicrafters receivers—dollar for dollar—are the finest on the market. They are in a class by themselves. Your own customers know this. They talk about it—on the air and off. They will tell you—so will your cash register—Hallicrafters is the fastest moving, most profitable line you can handle!

Stock—Feature—
Display Hallicrafters—IT PAYS!

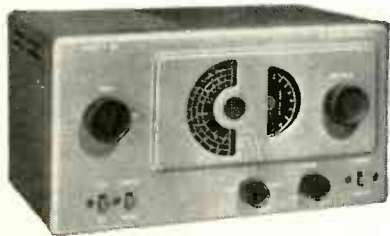

Finest buy in SW—the S-38C

The 38-C is the finest buy in all short-wave. 540 kc to 32 mc in four bands. Broadcast reception that far exceeds ordinary sets. Maximum sensitivity per tube. Built-in speaker. Has band-spread control. 4 tubes plus rectifier. Operates on 115 V AC or DC. . . . \$49.95



Amateur's favorite—the S-40B

Electrical band-spread tuning to separate crowded stations. Switches for automatic noise limiter, code reception, three position tone control. One r-f, two i-f stages. Broadcast plus three short-wave bands, 1680 kc to 44 mc. Built-in speaker \$119.95

hallicrafters

The Name is Famous
4401 West Fifth Avenue
Chicago 24, Illinois
Radio • Television • High Fidelity

PERIODIC BLINKING

Patent No. 2,647,222
Robert T. Nieset, New Orleans, La.
(Assigned to Bierre Associates, Inc.,
New Orleans, La.)

This simple circuit controls flashing gaseous lamps. The inventor describes it in connection with toys. Two lamps are set to light alternately. Among other applications, the blinking lights may be placed at the wing tips of a toy plane or may illuminate the eyes of a teddy bear. The circuit is drawn with recommended component values.

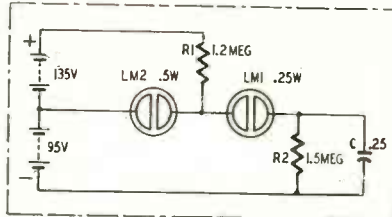

When first connected, LM1 will break down because it is across the entire battery voltage. A voltage drop appears across R1 so LM2 cannot flash. As C charges (through LM1) it opposes the battery voltage. Finally, there is insufficient current through LM1 and it goes out. At this moment LM2 breaks down, even though its potential difference is only 40 volts.

C discharges through R2 until there is sufficient voltage to break down LM1 again. The drop across R1 reduces the available voltage for LM2 and this lamp goes dark, completing the cycle.

MAGNETIC A.F. AMPLIFIER

Patent No. 2,657,281
Walter C. Kluz, Yonkers, N. Y.
(Assigned to Word Leonard Electric Co.)

This amplifier operates at audio frequencies, and is capable of a power gain of about 10. It needs no attention and has nothing to wear out.

The four ring-type reactors A, B, C, D, have laminated, saturable cores. Each has three windings as shown, the top of each being an anode or exciting coil. Rectified a.c. from a carrier source flows through the anode coils and magnetizes the cores in the same direction. The carrier voltage should be at least four times greater than the peak audio voltage to be amplified. It may be about 250 volts.

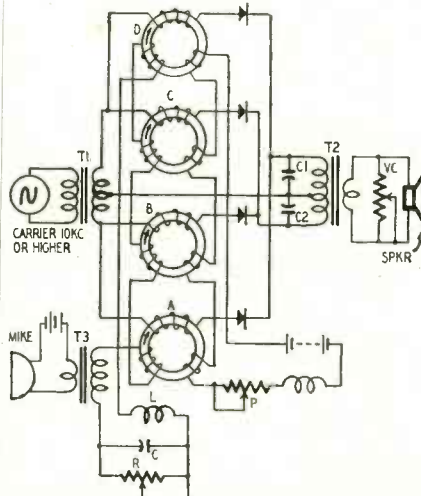

During half of each carrier cycle, current flows through D and the T2 primary. At the same time current flows through C and the other half of the primary. Since these currents are opposite and equal, they cancel each other out. Likewise, during the next half of the carrier cycle, currents through A and B cancel out in the T2 primary.

On the left side of each core are modulating windings. They are fed from a mike through matching transformer T3. Coils A and D are polarized in one direction, B and C in the other. During one-half of each audio cycle, the flux in A and D is strengthened while the flux in B and C is weakened. Thus, cores A and D go deeper into saturation and more current can flow

Resistors Galore!



THE GREATEST SPECIAL
EVER OFFERED...

Values from 10 Ohm. to 10 Meg.
Ohms. Wire wound and carbond.
All plainly marked. Tolerance of
5%-10%-20% with wattage from
1/2-1-2-5-10 Watt.

300 RESISTORS, ASSORTED...

ALL
BRAND NEW
AND
GUARANTEED
PERFECT

ONLY
299*
POSTPAID
U.S.A.

A CARTON OF 1000... only \$8.95

*When Money Accompanies Order

ELMHURST RADIO & TV

4608 Sand Point Road
FORT WAYNE, INDIANA

CONCORD'S BUY OF THE MONTH

Sensational
SELF POWERED
2 WAY
PHONE SYSTEM



\$4.50
PAIR

Sensitive 2 way phone system Operate with telephone like clarity over distances of up to one mile. Phones made of rugged, shockproof Dow Styron with self-contained 1 1/2 volt flashlight battery. Has full size carbon mike 24 carat gold plated. Complete with push to talk switch, spring clips leads and wall brackets. Without a doubt, one of the most sensational service, office or home items ever offered. Complete with batteries. \$4.50
Two conductor twisted pair weatherproof wire for above. 2¢ per ft 100 ft. \$1.50

FREE! NEW 1954 CATALOG!

A complete, comprehensive listing of all your electronic requirements. Bursting with SPECIAL VALUES



CONCORD RADIO, 54 Vesey St., N. Y. 7, Dept. C3

- Please send . . . sets of phones at \$4.50 ea.
- Enclosed find \$ in complete payment. Minimum 20% deposit with C.O.D.
- Send new 1954 CONCORD CATALOG!

NAME _____

ADDRESS _____

CITY _____ ZONE _____ STATE _____

CONCORD RADIO • 54 VESEY ST.
NEW YORK 7, N. Y. • DIgby 9-1132

BC. This portion has negative resistance. Thereafter, the resistance goes positive again (CD). The peak B varies with emitter bias. A more positive emitter reduces the peak, for example from B to H.

The collector load line is shown as L. It intersects the curve at 3 points: E, F, G. Since F lies on an unstable portion of the curve, there are only two permissible operating points. For this trigger application, E is chosen.

If a positive pulse arrives at the emitter, B

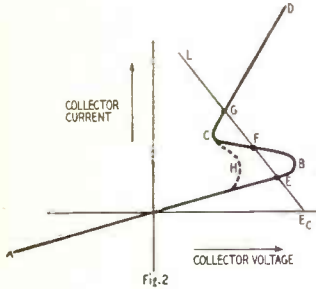

Fig. 2

is momentarily reduced to H. This leaves only one intersection (G) between load line and characteristic curve. The circuit is instantly tripped to this point, the collector current rising from about 1 ma to 10 ma. This output pulse lowers the collector voltage for an instant and the operating point returns to E.

HIGH-FIDELITY AMPLIFIER

British Patent No. 688,273

A problem frequently encountered in electronic circuit design is the transfer of power from a relatively high impedance such as a vacuum tube, to a low impedance load. This problem is most pronounced in audio amplifier circuitry where the transfer of power can take place over an impedance ratio of 1,000 to 1, or more. The output transformer used for this transfer of power is a heavy and expensive component. Numerous attempts have been made to devise means for coupling a speaker load directly to an amplifier without the use of output transformers. This patent covers an audio amplifier that can be connected for direct coupling to a low-impedance load.

An output of more than 8 watts into 150 ohms is claimed for a single 6AS7-G tube. Fidelity is said to be at least as good as that of a Williamson amplifier. From the diagram, the circuit appears similar to—or identical with—the arrangement known here as the Sinclair, or single-ended push-pull, amplifier.

Output tubes V2 and V3 are in series across the B supply. They are in parallel with respect to the load. Therefore the output impedance is very low. The tube grids are fed out of phase. During one half-cycle of audio, current flows from ground through the load and into V2. During the next half-cycle, current flow is through V3, the load and ground.

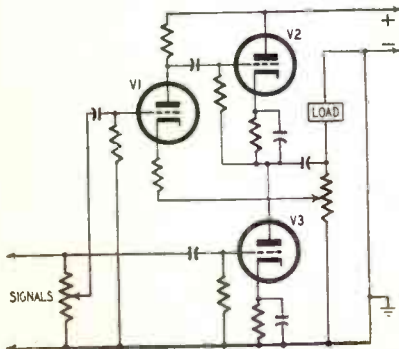

V3 constitutes a large resistance in series with the cathode of V2. This would cause much degeneration and low gain. To cancel its effect, the cathode of V1 is fed by a portion of the output voltage. When correctly adjusted, this cathode voltage is equal to the feedback voltage at its grid. Besides eliminating degeneration, V1 is also a phase inverter for V2. END

Now! HANDLE TELEVISION SERVICE THIS NEW "SHORT CUT" WAY!

Spot TV troubles at a glance . . . Fix 'em twice as fast!



NEW! PIX-O-FIX No. 2 JUST OUT!

Users of PIX-O-FIX No. 1 were so enthusiastic about it that No. 2 has now been issued to include 23 TV receiver troubles not previously covered. Get both at bargain price of only \$2 . . . a saving of 50¢!

HANDLE 90% OF TV TROUBLES BY EASY PICTURE ANALYSIS!

Cut TV testing time to minutes! Usually, the component likely to be faulty is specified. Just turn the dial of the Ghir-tests to apply to it are explained ardi PIX-O-FIX. When the TV—or parts substitution recom-screen image in the PIX-O-FIXmended where this is the best "window" matches the image on procedure. the step you're repairing. The two PIX-O-FIX units cover you've got your clue as to what is wrong! PIX-O-FIX then gives 47 different kinds of TV trouble— you all causes of this particular just about anything you're ever trouble plus the section of the likely to be called on to fix. receiver in which it has prob-Operation is simple and easily happened. Next you get Our money-back guarantee step by step repair instructions.ects you fully.

PIX-O-FIX TV TROUBLE FINDING GUIDES

by Ghirardi & Middleton

The looks of the picture on a bad TV receiver can tell you at a glance what is wrong. PIX-O-FIX not only make this easy—but also shows how and where to make repairs.

PIX-O-FIX No. 1—Identifies 24 common troubles by actual TV screen photos. Gives 192 causes and 253 remedies for these troubles. Price separately, \$1.25

PIX-O-FIX No. 2 (New)—Covers 23 additional troubles not included in No. 1. Together, the 2 volumes are a comprehensive guide to easy "picture analysis" servicing of any TV set. Price separately, \$1.25.

SPECIAL! Get both PIX-O-FIX No. 1 and No. 2 for only \$2. Use coupon.

10-DAY MONEY-BACK GUARANTEE

Dept. RE-34, Rinehart & Company, Inc. 232 Madison Ave., New York 16, N. Y.

Enclosed find \$..... for which please rush the following:

- PIX-O-FIX No. 1 (\$1.25) PIX-O-FIX No. 2 (\$1.25)
- BOTH PIX-O-FIX No. 1 and No. 2 at the special price of only \$2.00 for two plus postage

If not satisfactory, I will return PIX-O-FIX postpaid in 10 days and you guarantee to refund the purchase price.

Name.....

Street.....

City, Zone, State.....

OUTSIDE U.S.A. \$1.50 each, \$2.50 for both.
Same return privilege.

Bargain in Broadcast Quality TAPE RECORDER MECHANISM 38.75

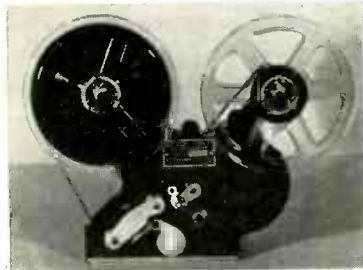

Model 90 "Ultra-Audio" tape transport mechanism complete with high quality record-erase-playback dual track head, 110 volt, 60 cycle induction motor, rewind, accessories and hi-quality plastic base recording tape.

USE WITH ANY HI-GAIN AMPLIFIER

The "Ultra-Audio" tape transport mechanism comes complete with convenient terminals and full instructions which permit its application to your present amplifier, phono-radio, or other audio unit, for the making, reproduction and erase of tapes, just as any standard tape recorder. This machine is ideal for the hi-fi enthusiast, the experimenter, the radio ham, or commercial user. It is identical to that provided for our commercial outlets. Little experience is required to follow simple instructions and comprehensive circuit diagrams to connect to almost any radio or audio unit for full life-like performance.

Records—Reproduces—Erases, At Two Speeds

Simple change over parts furnished permit operation at either 7½ or 3¾ inches per second speeds. A number of circuit diagrams with clear instructions are provided to enable even the novice to construct special amplifiers, etc., at minimum cost to obtain results comparable to that of recorders selling for many hundreds of dollars. Machine will operate with any amplifier capable of being excited by crystal mike or magnetic phono, and with most radios. Unit comes complete, ready to connect and use. Provided with convenient mounting lugs. The fine professional appearance of this unit will make any user proud to display his "Ultra-Audio" Model 90. Money Back Guarantee.

The Model 90 tape transport mechanism was initially developed by the engineers of the Ultra-Audio Broadcasting System for our own use to provide an extremely rugged and simple unit with sufficient mechanical stability to meet commercial and broadcast requirements. It was felt that such design could be achieved by following a careful program of simplicity and removing many of the "frills" at a cost much lower than we were compelled to pay for so-called "professional" units and eliminate a great deal of the constant servicing, repair, and adjustment expense of such units as were available to us.

Available at no cost to the purchasers and users of Ultra-Audio Broadcasting System equipment are the full facilities and services of our engineering staff.

FIRST COME—FIRST SERVED

ORDER FROM
Equipment-Service Division
ULTRA-AUDIO BROADCASTING SYSTEM

Box 243, San Diego (12), California

(Shipped pre-paid on cash with order —otherwise charges collect. ½ cash with order on all C.O.D.'s.)

All orders subject to possible two weeks' delay.

It's a snap!



to convert controls to switch-types— with

FASTATCH*
Switches

Three popular styles: SPST, SPDT, universal DPST. Rated at 5 amps.-125 v.a.c.; 1/2 amp.-125 v.d.c.; 12 amps.-12 v.d.c. Underwriters' approval



In just seconds, Type KB Fastatch converts any plain-type control with blue-and-white label to a TV-AM-FM switch-type. *Snap* — and it's on. No ears to bend, no loose parts.

Your Centralab distributor can furnish Fastatch switches from stock. He also has Centralab Blue Shaft Controls from 500 ohms to 10 megs in a wide variety of tapped units. See him soon.

Send for Catalog 28

A complete, 32-page index to America's most complete line of ceramic capacitors, controls, switches, and Printed Electronic Circuits. * Mail coupon.



Centralab

*Trademark

CENTRALAB, A Division of Globe-Union Inc. 914C E. Keefe Avenue, Milwaukee 1, Wisconsin Send me Centralab Catalog 28.

Name.....
Company.....
Address.....
City..... Zone..... State.....

P-1854

SENSITIVE ALL-WAVE REGENERATIVE SET

After experimenting with a number of simple receiver circuits, I now have a set that is more stable and easier to tune and adjust than any set of its type that I have ever seen. Its sensitivity is good and I hear lots of dx on it with a 15-foot indoor antenna.

values of capacitance may be used. Many SWL's hesitate to use a regenerative receiver because they are afraid that it will reradiate and cause interference. With this set, reradiation could not be detected on a receiver in the next room when it was operated

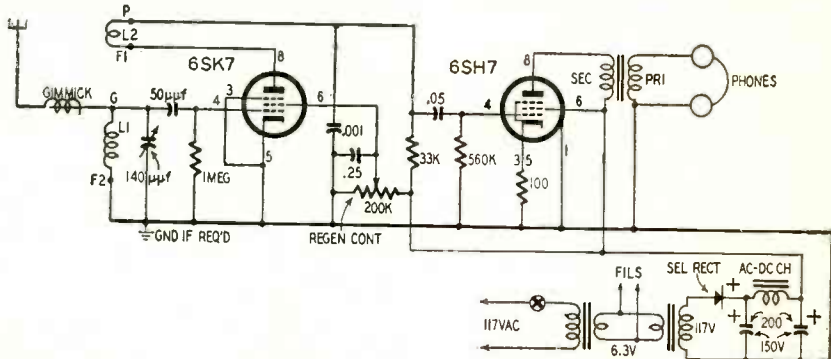

The set uses a 6SK7 detector with the regeneration control in the screen circuit. The relatively small grid resistor and the use of a remote-cutoff tube tend to eliminate squegging and pulling. A set of all-wave plug-in coils are used for short-wave reception. If the set is to be used for broadcast only, use a standard broadcast r.f. coil and tuning capacitor. It is a good idea to use a straight-line frequency capacitor such as the National SE or SEH series. A good high-ratio vernier tuning dial such as the National *Velvet Vernier* is essential for short-wave tuning and very helpful when using the set on the broadcast band.

just beyond the point of oscillation (the normal operating point for c.w. reception). Radiation could be detected only when the regeneration control was advanced almost to the end of travel. However, this setting results in a marked reduction in volume so it is unlikely that the set will be operated in this manner. When operated properly, this set is no more of an offender than the average a.c.-d.c. superhet.

This set is not in the HRO class but it is perfect for those who want a lot of receiver for a little money.—Charles Erwin Cohn

(Winding details for coils for 10 to

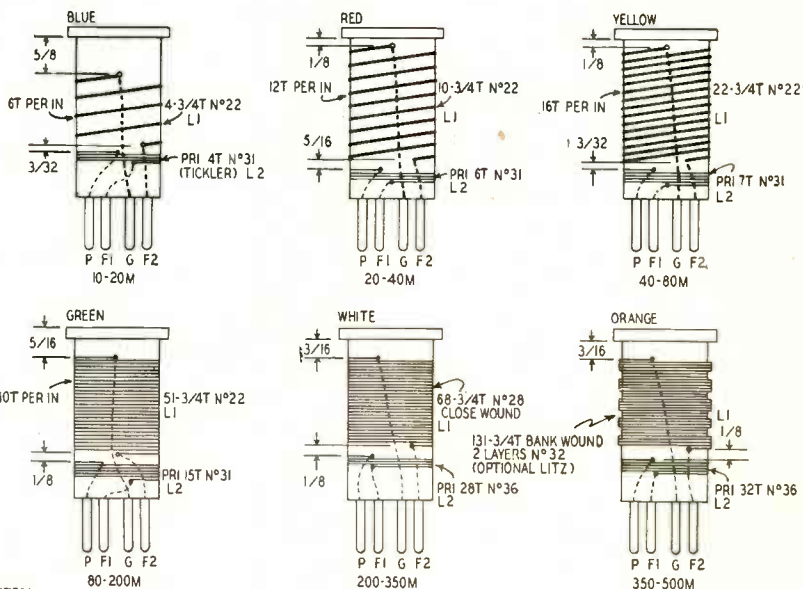

NOTES:— ALL WIRE DSC; ALL PRIMARIES CLOSE WOUND; TUNE:140µF CAPACITOR; DIMENSIONS IN INCHES; ALL FORMS 2-1/8" LONG, 1-1/4" DIA

The a.f. amplifier is a 6SH7 with a standard interstage a.f. transformer connected in reverse and used as the output coupling unit. The transformer is not essential but it provides a better impedance match and higher gain, eliminates d.c. through the phones, and puts the phones at ground potential.

The power supply is a half-wave type using two filament transformers connected back-to-back. The dual 200-µF filter capacitor was on hand. Smaller

500 meters is shown above. In all cases, the tickler (L2) should be wound below grid coil L1 and should have the smallest number of turns which permits the detector to oscillate over the entire band. If the detector suddenly clicks or pops into oscillation as the regeneration control is advanced, try using a larger or smaller grid resistor and cut down on the number of turns on L2. In any receiver, the smoothest control of regeneration is obtained

when the grid leak resistance and the number of tickler turns are optimum for a given operating voltage. Even if you use commercial plug-in coils, you may still find it necessary to experiment with the circuit for best performance.—*Editor*)

PARTS FOR ALL-WAVE REGENERATOR

Resistors: 1—1-megohm; 1—560,000, 1—33,000, 1—100 ohms, 1/2 watt; 1—200,000 ohms, 2-watt potentiometer.
Capacitors: (Paper) 1—0.25, 1—.05 μ f, 400 volts. (Ceramic or mica) 1—.001 μ f; 1—50 μ f, (air-spaced variable) 1—140- μ f, straight-line frequency. (Electrolytic) 1—200 μ f, 150 volts, dual.
Inductors: 2—filament transformers, 6.3 volts, 1.5 amp; 1—Audio interstage transformer to match single plate to single grid; 1—a.c.-d.c. type filter choke; 1—set of all-wave plug-in coils (or six 4-prong plug-in coil forms and wire).
Miscellaneous: 1—selenium rectifier, 130 volts, 50 ma; chassis, dial, headphones, wire, hardware.

I.F. SELECTIVITY SWITCH

The i.f. circuits in many superhet receivers tune too sharply to provide high-quality output on local stations. Sideband cutting can be reduced by installing the selectivity switch described in *Radio Constructor* (England).

The diagram shows how the selectivity switch is added to a receiver with a single i.f. stage. In small a.c.-d.c. sets,

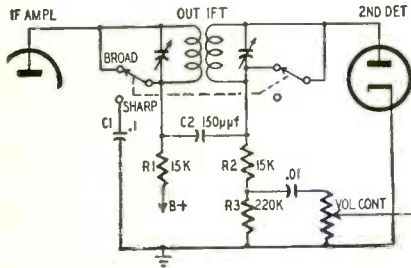

C1 and R1 would probably have to be added to the circuit. In larger sets these components may already be present as the decoupling network for the i.f. amplifier. C2 is the r.f. bypass capacitor for the detector load consisting of R2 and R3. Lift C2 off ground and connect it to the B plus side of the transformer primary as shown. Connect a d.p.d.t. switch so it shorts the transformer windings when in the BROAD position. In this position, R1 becomes the i.f. amplifier plate-load resistor and C2 the coupling capacitor. Throwing the switch to SHARP restores the selectivity provided by the tuned windings of the transformer. C2 now returns to ground through capacitor C1.

The volume will drop when the switch is thrown to BROAD. You can compensate for some reduction in gain by increasing the value of R1.

TV TEST PROBES

The need for special probes for TV servicing was discussed at length in the articles on TV signal tracing in the April, May, June, and October, 1953, issues of this magazine. Demodulator or detector probes are simply high-frequency rectifiers which convert TV carrier and i.f. signals into voltages which can be faithfully displayed on the screen of a scope. When pulses and video waveforms are to be studied, a special compensated probe must be used

EDLIE says

"SAVE WITH CONFIDENCE"

TERRIFIC BUYS—KITS AND WIRED UNITS

3-TUBE PHONO AMPLIFIER

Not a Kit

An assembled unit ready for installation using tone and volume control, with 6 ft. rubber cord. With complete set of tubes... **\$2.95** (less tubes) **\$3.95**

PHONO OSCILLATOR

New Savings! Not a Kit!

Wireless phono oscillator transmits recording for crystal pickups or voice from carbon mike through radio without wires. Can also be used as an intercom by using PM speaker as mike. **\$2.95** (less tubes) **\$3.95**

With complete set of tubes...

PRECISION RESISTOR KIT

Consists of 50—1% Wilkor carbonfilm resistors of 50 different ohmages, housed in a transparent plastic box. May be combined in series or parallel to produce almost any desired ohmage. Each resistor retails for about 85¢. Kit of 50 only... **\$2.45**

SIGNAL GENERATOR BROADCAST BAND

Completely Wired — New, simplified circuit provides the following switch tuned, tone modulated frequencies:

- 455 KC — Intermediate IF frequency
- 1500 KC — Hi freq. of broadcast band
- 600 KC — Lo freq. of broadcast band
- Audio tone for audio amplifier trouble shooting
- Attenuator control is included for adjustment of the output signal strength. Housed in small, black bakelite cabinet, 6"x6"x3 1/2". Excellent for alignment of all Broadcast Band Radio receivers. Completely Wired... **\$7.95** —only

5-TUBE AC/DC SUPERHET KIT

Kit #1: 5-tube superhet kit, AC/DC includes all quality components required to construct this latest design, highly sensitive superhet broadcast receiver, complete with black, glistening bakelite cabinet (excludes wire & solder).

Kit of 5 tubes, 12AT6, 2/12BA6, 12BE6, 35W4, 50B5. **Write for our new LOW PRICES**

NEW SUPERSENSITIVE 2 STATION INTERCOMMUNICATION SYSTEM

This fine unit is suitable for use in home, office, factory, nursery, or sick room. So sensitive it will pick up baby's whimper. Operates from 115 V. AC/DC. Both stations housed in compact, handsome, plastic cabinets: 6" x 6" x 3 1/2". Requires only 2 wires to connect for quick installation. Complete with 50 ft. of twin conductor wire. Model D-1910 Special Price... **\$16.95**

6-TUBE RADIO KIT

Kit #2: Low priced 6-tube kit designed for extra high sensitivity, excellent selectivity and good, rich tone quality. Uses 25L6, 25Z6, 6SQ7, 6SA7, 2/6SK7 in an easily constructed circuit. Includes all parts: punched chassis, resistors, condensers, coils, sockets, PM speaker, hardware, etc. Special close-out price. (Less tubes & cabinet)... **\$6.55**

Matched set of 6 tubes... **\$3.25**

for kit...

SPECIAL TUBE OFFERINGS

STANDARD MAKES GUARANTEED FIRST GRADE

0A2	\$.75
202195
3A455
5Z375
5Z475
6-4B15
6AG565
6AJ575
6AV525
6AQ545
6BB35
6BA655
6C445
6F645
6J555
14E655
6K745
6L745
6B465
6SC745
6SQ745
6V6GT55
12AU765
12K835
12SG765
14E645
28D795
3065
39/4475
RK3475
VR9095
VR10535
8945
21145
958A55
162675
163245
163365
164445
165095
565475
5670	2.95
5686	1.95
CK570275
CK5787	1.15
14E645
6095 (6AQ5)45
6096 (6AK5)55
6097 (6AL5)45
6101 (6A6)55

EDLIE Electronics 154 Greenwich St. DI 9-3143 New York 6, N.Y.

HERE IT IS! The tool that takes the work out of dial-cord stringing!

DOC'S STRING-AID

Perfect for looping cord over pulleys—hooking and shaping springs—working in close places. Made in U.S.A.

Any dial job a breeze! All steel. A five-inch length. Insulated, easy-to-grip shank.

ORDER FROM THIS AD! Money Back Guarantee

DOC'S RADIO TOOLS 509 EISK AVE. BROWNWOOD, TEXAS

75¢

ENJOY 3 COLOR TELEVISION FILTER SCREEN NOW

Changes dull eye-straining black and white pictures into beautiful color tones. Seconds to attach. No tools used. Helps eliminate glare and snow in fringe areas. Order direct. Send \$2 for screen size up to 16". \$4.25 size 17". \$4.50 size 20". \$2 size 21". \$2.50 size 24". \$3 size 27". (Also available are single solid color screens in blue, green, or amber.) Prices on color screens in blue, green, or amber are 10% less. We pay postage except on C.O.D. orders. Satisfaction guaranteed. Inquiries from dealers also welcomed.

Zingo Products, Johnstown 13, New York

Coils & Kits for THEREMIN

described in Jan. issue of *Radio & T.V. News* (Reprint upon request)

Pretested coil assemblies: Pitch Control Coil \$2.95, Volume Control Coil \$2.95, Fixed Oscillator Coil \$2.50, R.F. Transformer (T1) \$1.50, or all 4 for **ONLY \$8.95**. (Plus 1 lb. postage. We refund overpayments.)

Kit containing all parts for construction of the Therman. Chassis comes completely punched. Complete step-by-step wiring instructions and large, easy-to-read diagrams are included. Shipping wt. 25 lbs. **OUR PRICE \$59.95** (less cabinet) plus postage.

Completely assembled and tested Therman housed in a beautiful hand polished mahogany cabinet. 25 lbs. **OUR PRICE \$87.95**.

ONE YEAR GUARANTEE.

R. A. MOOG Co. 51-09 Parsons Blvd. FLUSHING, NEW YORK

THE TEST OF TIME

Has proven
ROHN TOWERS
Superior!

IN CONSTRUCTION

Rohn Towers are built of heavy duty tubular steel electrically welded throughout by skilled workmen exactly to specifications. Proof of Rohn construction lies in the fact that thousands of towers have been sold in the past several years and have successfully withstood the rigors of time in all climates and under the severest of conditions!

IN PERFORMANCE

Rohn Towers assure you of trouble-free performance and once installed give unquestioned satisfaction year in and year out! You are free of complaints because over the years Rohn Towers have proved themselves from the serviceman, dealer and customer point of view!

IN SALES

Sales acceptance has been phenomenal — thousands have been sold coast-to-coast — and the design has been one which has withstood every test known! Why "experiment" with an unproved tower design when you can sell Rohn?

So we ask you, "Why take chances with an untried tower? Be sure — sell Rohn — the only tower of its kind to withstand every test!"

Rohn Fold-Over Tower only one of its kind exclusive with Rohn — patent pending.

Rohn Telescoping Mast — complete line in a proven structural design in 20' — 30' — 40' — 50' models.



3 Self Supporting Rohn Towers To Fit Your Every Need

The No. 5 — The self-supporting tower for use up to 40', or guyed to 80'. An economical, yet sturdy, permanent tower!

The No. 10 — The standard 12' design that is self-supporting to 50' and can be installed to 120' when guyed!

The No. 20 — The heavy duty Rohn Tower, ideal for communication and where great height is required — self-supporting to 60', or guyed to 150'!

All Rohn Towers are in 10' sections — easily erected, transported and stored!

A COMPLETE LINE OF TOWER ACCESSORIES AND HARDWARE

A full line of Superior Design Tower accessories is available including guying brackets, house brackets, wall mounts for towers and masts, special tower bases such as peak and flat roof mounts, etc.

Contact your Rohn authorized representative or your distributor for **FREE CATALOG** or write . . .

ROHN MANUFACTURING CO.
DEPT. RE 116 LIMESTONE BELLEVUE
PEORIA, ILL.

to minimize high-frequency losses caused by capacitance of the cable and input capacitance of the scope. Voltage-divider probes are used when viewing high-amplitude waveforms.

The TV test probes shown in Figs. 1, 2, and 3 are described here through

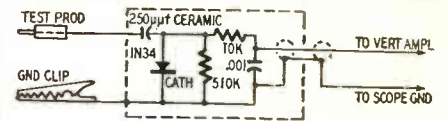

Fig. 1

courtesy of the Cornell-Dubilier Electric Corp. Fig. 1 is the diagram of a detector probe which may be used in servicing AM and TV receivers. The output of the 1N34 detector is filtered and applied to the input of the scope to show the modulation envelope.

Fig. 2 is a compensated probe for picking up video and complex pulse

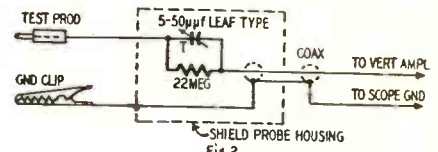

Fig. 2

waveforms and applying them to a wideband scope without distortion. The 22-megohm resistor and 5-50-µF trimmer are in a shielded probe connected to the scope by low-capacitance coax such as RG-59/U. Keep the cable length below 3 feet to reduce shunt capacitance. Adjust the trimmer so its capacitance equals the sum of the cable and scope input capacitances.

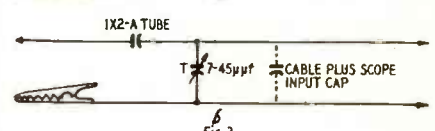
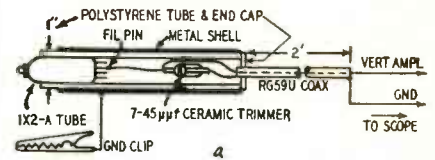

Fig. 3

The capacitive-divider probe in Fig. 3-a is used to observe pulses and waveforms too high to be applied to the scope's vertical amplifier. Fig. 3-b shows the schematic of the probe. The voltage applied to the input divides across the capacitors in inverse proportion to their capacitance. Thus, if C1 (the plate-to-filament capacitance of the 1X2-A) is 1 µf, and C2 and C3 total 100 µf, the voltage ratio will be 100 to 1.

Cement the 1X2-A in one end of a 1-inch (outside diameter) polystyrene tube with its plate cap protruding to serve as a test prod. Slip a metal casing over the plastic tubing to serve as a shield. Insulate the casing to protect the operator against accidental shock. Drill a hole through the wall of the probe casing so the trimmer capacitor can be adjusted with a small screwdriver. Set the trimmer so the total output capacitance (the sum of the trimmer, cable, and scope input capacitances) equals 100 µf.

END

TRAIN AT HOME FOR COLOR-TV and

TELEVISION SERVICING

Learn practical, professional type TV Servicing without leaving your present job. Included are money-making extras, such as set conversion, master antenna installation, UHF-TV, NTSC Color System, field servicing short cuts. You can start earning Television money after first few lessons. You learn to test, trouble shoot and repair all types of TV sets.

HERE'S HOW YOU GET EXPERIENCE!

You train on a large screen, modern TV receiver, furnished with the course and yours to keep! As an optional feature you can get two weeks actual experience with Chicago's largest independent servicing organization. You learn by doing! Age is no barrier. Many students are over 40! ACT NOW! Send for FREE Catalog and SAMPLE LESSON today!

TV COMMUNICATIONS INST.
605 W. Washington Blvd., Dept. RE-27
Chicago 6, Ill.

VETERANS!
T.C.I. is approved for G.I. training. Under Public Law 703. Check coupon.



MAIL NOW FOR FREE BOOKLET

MILTON S. KIVER, President
TELEVISION COMMUNICATIONS INST.
605 W. Washington Blvd., Dept. RE-27, Chicago 6, Ill.
Rush FREE Catalog and Sample Lesson. I am not obligated. Salesman will not call.

Name..... VETERANS: Check here
Address.....
City..... Zone..... State.....
 BEGINNERS check here for Basic TV Course.

OUTPUT-METER ADAPTER

This simple hook-on type transformer makes it possible to connect an output meter quickly to the voice-coil circuit of a receiver. Furthermore, it isolates the meter and leads from any voltages on the receiver chassis. It can be used to detect a.c. and pulsating d.c. flowing in a lead without breaking it or contacting its terminals. The adapter operates as a current transformer. Its construction and layout is shown in Fig. 1-a.

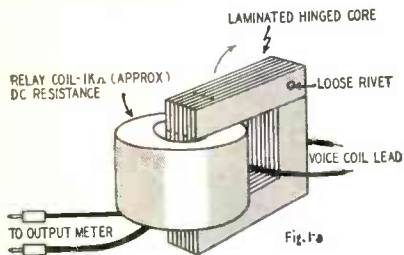

The 1,000-ohm (d.c. resistance) coil came off an old relay. The core was fashioned from laminations removed from a small transformer or choke. To use the unit, connect the coil leads to the output meter and then hook the hinged core around an insulated voice-

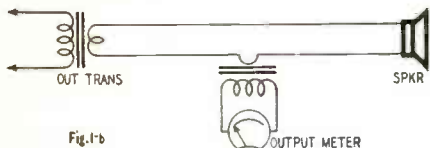

coil lead and close it. Current flowing in the half-turn primary produces an indication on the output meter. The hookup is shown schematically in Fig. 1-b. If the voice coil lead is long enough, more than one turn can be used. Just divide the reading by the number of turns. The more turns used, the greater the sensitivity.—G. L. Garvin

ANCHOR FOR MIKE CABLE

Microphone cables should be anchored near the base of the stand to prevent the hazard of a person tripping over the loop hanging from the mike, and also to give a neater appearance by having the cable lay along the floor right up to the base of the stand.

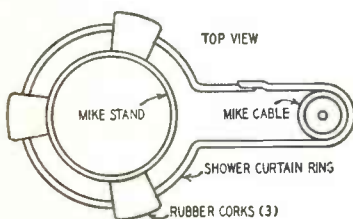

A suitable anchor must be easy to release when the mike is removed and must be firm enough that it won't scratch the stand. By slipping little rubber blocks, or corks, over a shower curtain ring as shown in the illustration, a very handy anchor can be quickly made. Let the clip lie against the base of the mike stand so the cable hugs the upright and the floor as closely as possible.—Hugh Lineback

NOW-GREAT precise TWO OSCILLOSCOPES
(IN KIT OR WIRED FORM)

THE NEWEST, THE ONLY ONE OF ITS KIND!

8½" OSCILLOSCOPE: PRECISE MODEL #308

Now another great Precise Oscilloscope! The only 8½" Oscilloscope on the Commercial Market... in Kit or Wired Form... at an unbelievably low price. Designed to bring you true TV picture clarity and laboratory tested accuracy.

ALL THE OUTSTANDING FEATURES OF THE MODEL 300 as shown below, PLUS:

- ★ INTENSIFIER ANODE
- ★ HI-LOW-NORMAL SYNCH. (A Precise First)
- ★ 8½ INCH TUBE (A Precise First)
- ★ VOLTAGE REGULATION (A Precise First)

"Seeing is Believing"—Go and See! your nearest jobber

308K—kit form..... **\$129.50**

SPECIFICATIONS, PRECISE MODEL 300 OSCILLOSCOPE
VERTICAL—Vertical-flat (3db) DC through 5 megacycles with sensitivity of greater than 10 millivolts push-pull (3.94 Millivolts/cm); Constant Resistance; Push-pull input immediately converted to single-ended normal or reverse phase by shorting bar at inputs 1 and 2; Frequency compensated vertical stepping attenuator selects AC or DC inputs; Push-pull DC amplifiers from input through output; Internal electronic mixing through inputs 1 and 2; five-way binding posts.
POSITIONING—Bridge type positioning on vertical and horizontal does not vary tube characteristics.
HORIZONTAL—Frequency compensated stepping attenuator in horizontal amplifier; Push-pull Horizontal out.
BLANKING—Internal (return trace blanked), external (return trace not blanked), 60 cycle or 120 cycle Blanking through Blanking amplifier circuit.
SYNCHRONIZATION—External, Internal Positive, Internal Negative, Internal 60 cycle or Internal 120 cycle synchronization.
SWEEP RATE—Driven or non-driven linear sweeps from 1 cycle to 80KC in five ranges (1-10 cycles uses external C circuit); Trigger potentiometer.
MAGNIFIER—Electronic magnifier and magnifier positioner allows any part of a signal to be magnified up to ten times (equivalent to 70 inches of horizontal deflection).
CALIBRATION—Internal square wave calibrator and potentiometer for using oscilloscope at a VIVM on Peak to Peak measurements.
CALIBRATION SCREEN—Edge-illuminated scale and graticule may be turned on or off; filtered screen.
OUTPUTS ON FRONT PANEL—Plus Gate output; Sawtooth output; 60 cycle phasing output; 60 cycle unphased output; Calibration output.
FOCUSING—Astigmatism, focus and intensity control.
CRT—NEW 7" Tube, normally supplied is medium persistency type 7J1 (oscilloscope green trace)—high persistency types available at additional cost.
DIRECT—Deflection plates available from rear of cabinet.
INTENSITY MODULATION—Z modulation through modulation amplifier.
GENERAL—Low loss components; Over-designed fused power supply for additional circuitry. Deeply etched aluminum panel; New parts from original manufacturers—(NO SURPLUS); Steel cabinet; 11" x 14" x 17"; complete instruction book and all components; Accessories: Model 912(MM) Demodulator Probe and Model 960 Capacity Attenuator Probe available at extra cost—please see specifications on following pages.
 There are many additional features and circuits in kit form, which may be added to the Model 300. Please write us for descriptive literature.

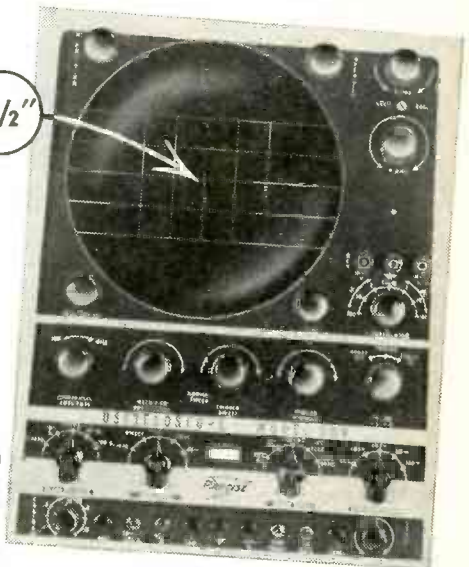

300K—kit form **\$94.95**
 300W—factory wired **\$199.50**

<p>MODEL 630K RF-AF-TV & MARK. GEN. \$33.95</p>	<p>MODEL 610K RF SIG. GEN. \$23.95</p>	<p>MODEL 960 10-1 C.A. PROBE \$5.95</p>	<p>MODEL 912 RF PROBE \$4.25</p>
<p>MODEL 909K VAC. TUBE VOLTMETER \$25.98</p>	<p>MODEL 907K DELUXE VAC. TUBE VOLTMETER \$38.98</p>	<p>MODEL 635K UNIV. AF + LINE. SQ & PULSE GEN. \$33.50</p>	<p>MODEL 999 HI-VOLTAGE PROBE \$6.98</p>
<p>MODEL 468K RES. DECADE BOX \$18.95</p>	<p>Prices slightly higher in the West. Prices and specifications subject to change without notice.</p>		

precise
DEVELOPMENT CORP.
 OCEANSIDE, NEW YORK

Dept. RE 27
 999 LONG BEACH ROAD • OCEANSIDE, L. I., NEW YORK

GENTLEMEN: Without any obligation on my part, kindly send me the following:

PRECISE CATALOG
 NAME OF DISTRIBUTOR NEAREST ME

NAME _____
 ADDRESS _____
 CITY _____ ZONE _____ STATE _____

COMPLETE TRAINING

FOR BETTER RADIO-TV SERVICE JOBS



Let these two great new Ghirardi training books teach you to handle all types of AM, FM and TV service jobs by approved professional methods—and watch your efficiency and earnings soar!

Completely modern, profusely illustrated and written so you can easily understand every word, these books pave the way to fast, accurate service on any type of home radio-TV electronic equipment ever made. Each book is brand new. Each contains the latest data on the latest methods and equipment—NOT a re-hash of old, out-of-date material. Each is co-authored by A. A. Ghirardi whose famous RADIO PHYSICS COURSE and MODERN RADIO SERVICE were, for 20 years, more widely used for military, school and home study training than any other books of their type!

THE NEW Ghirardi

RADIO-TV SERVICE LIBRARY

Almost 1500 pages and over 800 clear illustrations show step-by-step how to handle every phase of modern troubleshooting and servicing.

1—Radio and Television Receiver TROUBLESHOOTING & REPAIR

A complete guide to profitable professional methods. For the novice, it is a comprehensive training course. For the experienced serviceman, it is a quick way to "brush up" on specific jobs, to develop improved techniques or to find fast answers to puzzling service problems. Includes invaluable "step-by-step" service charts. 820 pages, 417 illus., price \$6.75 separately.

2—Radio and Television Receiver CIRCUITRY AND OPERATION

This 689-page volume is the ideal guide for servicemen who realize it pays to know what really makes modern radio-TV receivers "tick" and why. Gives a complete understanding of basic circuits and circuit variations; how to recognize them at a glance; how to eliminate guesswork and useless testing in servicing them. 417 illus. Price separately \$6.50.

New low price . . . You Save \$1.25!

If broken into lesson form and sent to you as a "course," you'd regard these two great books as a bargain at \$50 or more! Together, they form a complete modern servicing library to help you work faster, more efficiently and more profitably.

Under this new offer, you save \$1.25 on the price of the two books—and have the privilege of paying in easy installments while you use them!

10-DAY FREE TRIAL

Dept. RE-34, RINEHART & CO., Inc.
232 Madison Ave., New York 16, N. Y.

Send books below for 10-day FREE EXAMINATION. In 10 days, I will either remit price indicated or return books postpaid and owe you nothing.

- Radio & TV Receiver CIRCUITRY & OPERATION (Price \$6.50 separately)
 Radio & TV Receiver TROUBLESHOOTING & REPAIR (Price \$6.75 separately)
 Check here for MONEY-SAVING COMBINATION OFFER . . . Save \$1.25

Send both of above big books at special price of only \$12.00 for the two. (Regular price \$13.25 . . . you save \$1.25.) Payable at rate of \$3 after 10 days if you decide to keep books and \$3 a month for 3 months until the total of \$12 has been paid.

Name

Address

City, Zone, State

Outside U.S.A.—\$7.25 for TROUBLESHOOTING & REPAIR; \$7.00 for CIRCUITRY & OPERATION; \$13.00 for both books. Cash with order, but money refunded if you return books in 10 days.

HANDY CONSTRUCTION KINK

Model airplane dope is a handy item for the constructor to keep on hand. When constructing or converting a piece of rather complex apparatus, I put a small dab of bright-colored dope on each nut or bolt as soon as it is tightened and a drop of color on each soldered joint. This simplifies the task of checking all joints for a soldered connection. Ground lugs and other bolted connections which have loosened and cause trouble can be located quickly by looking for spots where the dope has flaked off. This method has been successfully used in radio factories for many years. It results in a great saving of time.—Harold J. Weber

DIAL-CORD DRESSING

For a good, nonslip dial-cord dressing, mix powdered rosin and amyl acetate to the desired consistency and apply liberally. Store in an airtight bottle.—A. von Zook

A TUBE AND PARTS SHIELD

Do you need a tube shield for that 870, 1625, 6BG6-G, or similar tube? If so, don't overlook the instant-coffee metal container with the twist-lock cover. It is ideal for shielding tubes with ST-16 and smaller bulbs.

To adapt it for shielding, first remove the bottom with a can opener—the kind which leaves a smooth, rolled edge. Locate the tube socket and its mounting holes on the cover of the can, then centerpunch and drill. The metal is very thin, so take care not to bend or tear it. Punch the socket hole, and if necessary enlarge it with a round file to clear the socket which is to be mounted on the chassis.

Next, fasten the cover to the top of the chassis, threaded side up, using the bolts which secure the socket flange to the underside of the chassis. The cover now becomes the base for the shield, and it is necessary only to insert the tube in the socket, slip the shield over the tube, and twist to lock in the base.

An unaltered container of this type may also be used to shield small plug-in or fixed coils, transformers, or other parts requiring shielding as well as ready access for removal or inspection. These cans are also useful to house high-pass filters for TVI elimination and simple low-pass filters for mobile or low-power ham transmitters.

The containers may be painted to match any color scheme for decorative purposes and rust prevention.—George Rulfs, Jr., W2CJY

WARPED SPEAKER CONES

Frequently we get small table-model receivers that have warped speaker cones. Much of this trouble is caused by excessive heat radiated from a rectifier or power-amplifier tube mounted close by. After repairing the speaker, we prevent an early recurrence of the trouble by placing an asbestos shield between the offending tube and speaker.

—Robert E. Riddle

WORLD'S LARGEST MANUFACTURER
OF CUSTOM BUILT TELEVISION

MATTISON

SILVER ROCKET 630 CHASSIS

Featuring Syncromatic Tuning
NO DRIFT UHF-VHF-DX

ONLY THE MATTISON 630 ELIMINATES DRIFTING APART OF PICTURE AND SOUND ON UHF, VHF AND DX RECEPTION. SELECT YOUR CHANNEL . . . SOUND IS AUTOMATIC. (Syncromatic tuning is an exclusive Mattison 630 Circuit)

Tube Complement: 29 tubes, 3 rectifiers, 1 CRT
SILVER ROCKET 630 Chassis with built in UHF Tuner

33

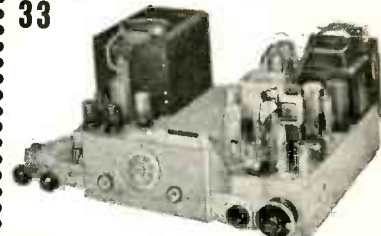

All Channel UHF Tuner

UHF Cascode I.F. amplifier adds additional I.F. stage. Very important because UHF transmitters operate with moderate power and RECEIVER must be sensitive to give top notch UHF performance.

SILVER ROCKET 630 CHASSIS

• with TUNEABLE •

BUILT-IN BOOSTER for Better DX Reception

Tube Complement: 28 tubes, 3 rectifiers, 1 CRT
Select Your Channel . . . SOUND IS AUTOMATIC!

32

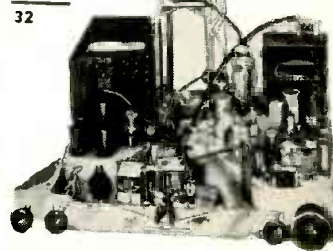

All Channel Booster

Broad band single knob control pre-amplifier built in to eliminate long leads which may cause regeneration and attenuation of signal.

ONLY THE MATTISON 630 CHASSIS HAS AN ALL CHANNEL TUNEABLE BUILT-IN BOOSTER THAT INCREASES SIGNAL STRENGTH UP TO 10 TIMES.

ALL CABINETS MADE IN MATTISON'S OWN CABINET FACTORY. AVAILABLE IN EVERY FINISH AND STYLE. WRITE FOR COMPLETE CATALOG.

DEALERS! SERVICE DEALERS! Here is your opportunity to become the "important" TV Dealer in your area for THE FINEST CUSTOM-BUILT LINE OF TV RECEIVERS. FREE! Write for Mattison's merchandising portfolio explaining the "UNASSEMBLED PLAN" and "\$1,000,000 FLOOR PLAN."



Manufactured with integrity

Mattison Television & Radio Corp.

10 West 181st St., Dept. RE, N.Y. 53, N.Y.

SHORTENING LINE CORDS

For quick setups of equipment where there is danger that excess line cord may cause a person to stumble—such as a temporary PA installation in a crowded place—here is a neat way to handle the extra wire. It may take a few tries before you can build up speed, but it is well worth the effort. In addition to preventing injuries, it also safeguards equipment which might be thrown to the floor in the course of an accident.

Make a series of loose hitches as illustrated in the photo. You'll find the motions just sort of come naturally, so don't try to figure out the loops in the picture.

The drawing shows how to start—then you just keep going, and stick the

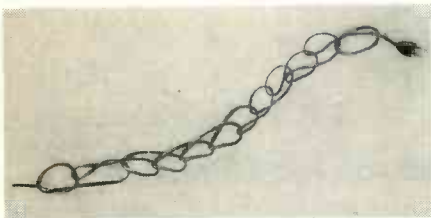
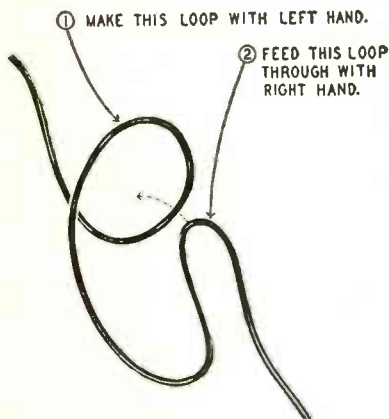

plug through the final loop to lock the chain. To get the line back to its original length you just draw the plug back through the last loop, and zip—the whole string of loops vanishes quick as a wink!—Hugh Lineback

SWITCHING DUAL SPEAKERS

On page 150 of the October, 1953, issue, Mr. Howlett describes a speaker-selector switch which maintains the correct match across the output trans-

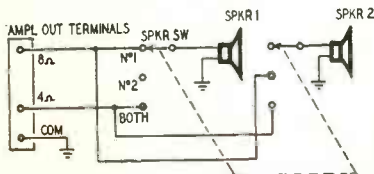

former. The diagram here shows a simplified circuit which permits the use of a 2-pole, 3-position switch to be used instead of the 4-pole, 3-position type specified in the original item.

At the first two positions, the 8-ohm speakers are connected singly; at the third position, in parallel.—Jack Palmer END

MARCH, 1954

NEW

Electro

ELECTRONIC EQUIPMENT

completely assembled

6 and 12 volt

DC POWER SUPPLY

at a comparable KIT PRICE

only \$39⁹⁵ Net

MODEL D-612

UNMATCHED PERFORMANCE

0 to 8, 0 to 16v. completely variable.
0 to 10 amps at 12 v. continuous.

This unbeatable combination of unequalled performance, low price and quality makes the D-612 a must for service technicians. Backed by Electro's reputation for high quality products.

CHECK! COMPARE! More uses for you!

- Operates all auto radios. For relays, phone circuits, low voltage devices, electroplating and battery charging.
- Less than 5% ripple over rated ranges.
- Patented EPL conduction cooling.
- Withstands high overloads for long service.
- Same top quality as other EPL models.

See Your Jobber

... or contact factory for details and literature. You can't afford to be without the D-612, it's everything you need in a DC Power Supply.

Rush FREE Bulletin DCS-123, giving detailed specifications

ELECTRO PRODUCTS LABORATORIES

4501-Rd North Ravenswood Avenue — Chicago 40, Illinois

Manufacturers of Battery Eliminators and Power Supplies Since 1936



... FIRST CHOICE with servicemen because Fenwire is BEST by TEST



*FENTUBE-AIRSPACED and *TWISTUBE are outstanding for high performance—low loss—stable characteristics under all atmospheric conditions—reduced interference pick up—reasonable price.

Write Dept. RE-3 for literature on complete FENWIRE line including "TUF-GUY" ... finest guywire made.

(Sold through jobbers only.)
*U.S. & British Pat. Pending

FENTON COMPANY • 15 Moore Street, N. Y. 4, N. Y. Tel. BOWling Green 9-3445

PRIZE CONTEST!

Name our newest TV service book
WIN VALUABLE CASH PRIZE!

Many other prizes, including cash, test instruments, TV magazine subscriptions, etc.

We want best name. Absolutely **NO OBLIGATION to enter contest.**

Full contest particulars included with your order.

NEW! 1954 TV Consultant TV Serviceman's Silent Partner



New, easy-to-use way to solve toughest TV troubles. UHF sect. includes conversions, installations and servicing. Modern alignment methods shown by pictures, diagrams and simple directions, tell exactly what to do and how to do it. Practical pointers on use of all TV Test Instruments. Over 300 pix, raster and sound symptoms. Detailed directions tell where and how to find faulty parts. Over 135 **RAPID CHECKS**, many using pix tube as trouble locator. 125 illustr. of scope wave forms, diagrams, station patterns, show various defects—take mystery out of TV servicing. **NO THEORY—NO MATH—NO FORMULAS**—just practical service info. covering all types of TV sets.

Only \$2

NEW! 1954 TV Tube Locator All Pix Tubes Listed!

Money-making Time Saver tells which tubes to replace to cure every type of tube trouble. Over 135 such TV troubles listed with clear charts for quickly locating the faulty tubes. Copyrighted **TROUBLE INDICATING TUBE LOCATION GUIDES** for over 3000 most popular models from Admiral to Zenith plus **PIX TUBES** used in each model! 1947 to 1953 models. A storehouse of valuable TV servicing info. priced very low for large volume sales.



Only \$1

NEW! Trouble Shooting PIX GUIDE incl. TV TERMS Explained



Sec. 1 is a fully illustrated **GUIDE** to oft-recurring pix faults. Causes and cures explained. Copyrighted 'Trouble indicating illustrated chart tells where troubles start in typical TV set—illustrations show resulting faulty TV pictures. Sec. 2 explains hundreds of TV terms in non-technical language. **SPEEDS UP TV SERVICING—HELPS YOU DO A BETTER JOB FASTER!**

Only \$1

NEW! TV Trouble Tracer

VOL'S 1 & 2 NOW READY! 70 Common TV troubles traced to source and cured. Copyrighted trouble indicating tube location guides covering over 1200 most popular TV models. Many models different from those shown in **TV TUBE LOCATOR**. Each contains over 70 illustrations and tube location guides. Forty most common picture troubles illustrated, with symptoms described, causes given and remedies prescribed.



Vol. 1 only 50c Vol. 2 only 50c

H. G. CISIN, PUBLISHER

Order from your Jobber today, or if not stocked, write to

Harry G. Cisin, Dept. E-26
Amagansett, New York

Enclosed find \$ Send

- TV Consultant TV Locator
- TV Pix Guide TV Tracer Vol. 1
- TV Tracer Vol. 2

Include with order full particulars about **PRIZE CONTEST!**

Name

Address

City Zone State

QUESTION BOX

DUPLEX POWER SUPPLY FOR HAM TRANSMITTER

? I purchased a 3,000-volt center-tapped transformer rated at 800 ma. The dealer told me that I could use it to supply power to the final and modulator of a 1-kw phone transmitter. I would like to run the final at 2,500 to 3,000 volts but I cannot get more than 1,475 volts d.c. out. Please show me how I can get more than this out of the supply so that I can run the rated input to my final.—Wm. L., Florence, S. C.

A. The bridge-type supply shown in the diagram provides two independent output voltages. One is approximately equal to the full a.c. voltage across the secondary winding and the other is about one-half this value. For your purpose, V1, V2, V3, and V4 should be 872's. You can use 866's for a total current drain of 500 ma, or 816's or similar tubes if the drain does not ex-

ceed 250 ma. The phone-c.w. switch is included to open the low-voltage circuit and shut off the modulators when tuning up or working c.w.

This circuit can be used whenever it is desirable to obtain separate output voltages from a transformer whose full secondary voltage is equal to the highest voltage. For example, an 800-volt center-tapped transformer can be used in this circuit to supply 400 volts d.c. to a driver and 800 volts to a booster amplifier in a high power PA system. In this case, a single 83, 5U4-G, 5R4-GY or similar tube can be substituted for V1 and V2. Separate tubes of the same type with the plates strapped together can be used for V3 and V4.

In this circuit, the total current drawn by the supply should not exceed the maximum d.c. load current rating given by the rectifier manufacturer.

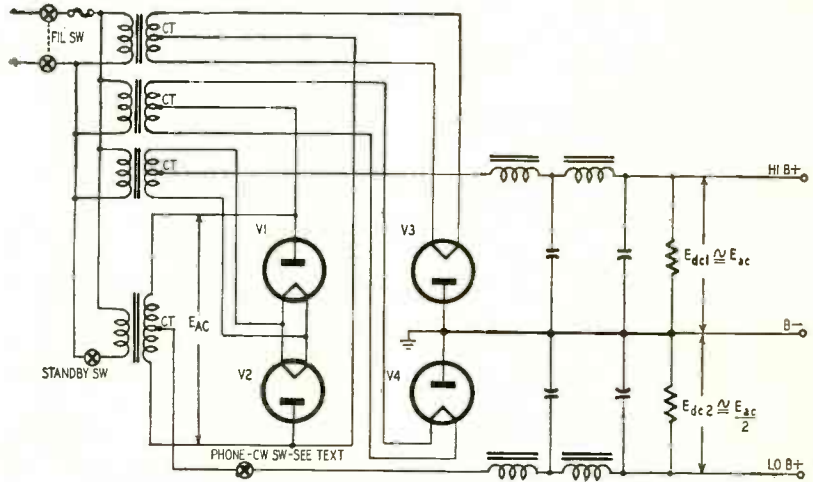

V-R PREAMP AND EQUALIZER FOR PHONO AMPLIFIER

? Please print a diagram of a pre-amplifier and tone control which will permit me to use a variable-reluctance pickup with the phono amplifier described in the December, 1952, issue.—S. F. R., Timmonsville, S. C.

A. The diagram shows a 2-tube pre-amplifier-equalizer which can be used between a V-R pickup and any conventional amplifier which does not have these circuits built in. If you do not require an elaborate tone control, you

can omit the 12AU7 and its components and feed the 6SC7 output directly into the amplifier through the .05- μ f blocking capacitor. Add the switch and .002- μ f shown in the section enclosed by the dashed lines. If you use the 12AU7 equalizer circuit, omit the switch and the .002- μ f capacitor.

All wiring should be short and direct. Heater leads should be twisted and dressed into the corners of the chassis well away from signal leads to minimize hum pickup.

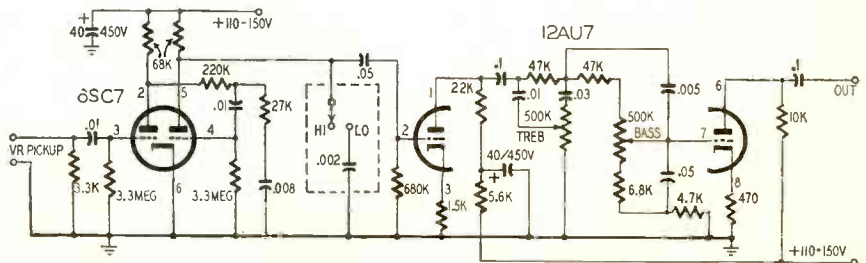

MODIFYING TV ANTENNAS

? I have a 10-element channel 5 Yagi that I would like to cut down for operation on channel 6. Please give me the dimensions for a channel 6 Yagi.—J. T., Thief River Falls, Minn.

A. The dimensions of the elements and the spacing between them is determined by the desired bandwidth and the forward gain or back-to-front ratio. In commercial practice, the spacing and

the length of the elements may vary according to the manufacturers' standards for bandwidth, gain, and front-to-back ratio.

To cut your antenna for a higher frequency while retaining its present characteristics, measure the length and spacing of all elements and record these on paper. Now, multiply each dimension in inches by the lowest frequency of the channel for which the antenna was originally designed. The products of each set of figures gives a constant which is used in determining the length of the corresponding dimension in the new antenna.

Take each of these constants and divide it by the lowest frequency of the new channel for which the antenna is to be cut. This gives the new dimension in inches. For example, suppose that you measure the channel 5 radiator and find it to be 73 inches long. The lowest frequency in channel 5 is 76 mc. The product of the radiator length and the channel frequency gives 5,548 as the constant for the new radiator, regardless of its frequency. Now, divide the constant (5,548) by the lowest frequency in channel 6 (82 mc). The resultant gives 67.6 inches as the length of a channel 6 radiator.

SHOPLIFTER ALARM

? I have not been able to prevent shoplifters from removing electrical tools and appliances from the display counters in my store. At present, I am using a relay and alarm circuit which is completed through a loop of flexible hookup wire which passes through the handle or holes in the frames of the different appliances as shown in the diagram. This is far from foolproof. For example, if the wire is stripped at A-A and then twisted together, the tools can be removed without sounding the alarm simply by cutting the wire at B.

Can you devise a protective setup which might work? I want to use a system in which the appliances are all plugged into receptacles as they would be when in use. I don't care to have control current flowing through the line cords because all switches would have to be on and the voltage would have to be very low to prevent the tools from operating under all conditions.—E. J. L., Chicago, Ill.

A. Many 3-way portable receivers have power change-over switches which resemble a standard power-line receptacle. Plugging the set's line cord into the receptacle on the chassis operates

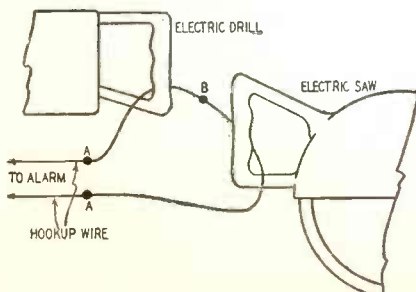

ALL RADIO AND TV TYPES

**CLOSE OUT
SET MANUFACTURERS'
INVENTORY**

TUBES

Standard Brand Warranty • BRANDED • Bulk or Individually Boxed

0A4G . . . \$.50	6AB769	6C5GT41	6U869	19T861
0Z449	6AC768	6C649	6V6GT41	25AV5GT . 1.05
1B3GT59	6AG546	6CB642	6W4GT41	25BQ6GT . .79
1B24 4.95	6AH688	6CD6G . . . 1.08	6W6GT41	25L6GT . . .42
1L447	6AK579	6E576	6X449	25Z6GT . . .49
1R546	6AL534	6F6GT54	6X5GT43	3329
1S452	6AQ538	6H649	7R759	3429
1S538	6AQ649	6H6GT . . .49	12A639	35B546
1T446	6AS562	6J499	12A731	35C546
1U446	6AT636	6J5GT . . .34	12A7T57	35L6GT . . .42
1U538	6AU636	6J651	12A7T34	35W432
1X2A52	6AV5GT . . .79	6J7G49	12AU652	35Z5GT . . .33
2E22 1.45	6AV636	6K6GT . . .36	12AU788	50B546
2X2A33	6AV636	6K7G49	12AV772	50C546
3A833	6BA633	6L6GA . . .99	12AY752	50L6GT . . .42
3B24W . . . 2.95	6BA776	6SA759	12BA652	117Z349
3D625	6BC546	6SA7GT . .61	12BE653	801A19
3B26 1.95	6BE649	6SC781	12BH749	8032.95
3Q469	6BF569	6SF558	12H649	8142.95
3Q5GT55	6BG6G . . 1.16	6SG759	12J729	832A 4.95
3S446	6BH646	6SH765	12SA7GT . .59	8362.95
4C35 24.95	6BJ646	6SJ754	12SG761	866A 1.49
5FP14 9.95	6BL776	6SK769	12SH749	5670 1.45
5U4G49	6BN672	6SK7GT . .69	12SK7GT . .49	5718 4.95
5Y3G36	6BQ676	6SL7GT . .59	12SN7GT . .46	6101CT . . 4.95
6A635	6BQ776	6SN7GT . .46	12SQ7GT . .49	9003 1.10
	6C431	6SR749	12Z339	
	6C541	6T861	19B6G6 . . 1.49	
		6U749		

More than 400 types in stock—Include all your needs when ordering.

MINIMUM ORDER: \$10.00. Terms: 25% with order, balance C.O.D. Please include postage. All prices subject to change without notice. F.O.B. New York City, mail order division.

TRANSAMERICA ELECTRONICS CORP.

120 LIBERTY STREET NEW YORK 6, N. Y.

for like - new performance

replace with original ROGERS full-focus deflection yokes

“the eye tells why”

packaged individually—attractively

ROGERS ELECTRONIC CORP. 43-49 Bleecker St. New York 12, N. Y.

FREE: Send for new catalog “A,” listing TV set models and ROGERS Yoke and Flyback replacements, or see your jobber.

\$3.00 FOR CARTOON IDEAS

RADIO-ELECTRONICS prints several radio cartoons every month. Readers are invited to contribute humorous radio ideas which can be used in cartoon form. It is not necessary that you draw a sketch, unless you wish.

Address
RADIO-CARTOONS, RADIO-ELECTRONICS
25 West Broadway New York 7, N. Y.

Positive connections every time

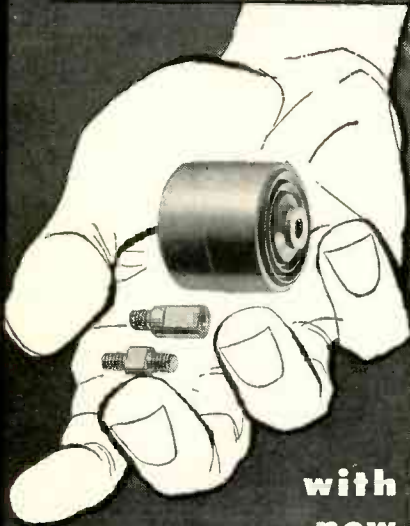

with new **Centralab Precision**

Attachable Terminal HI-VO-KAPS®

When it comes to high-voltage capacitors, you just can't beat CRL Precision Attachable Terminal Hi-Vo-Kaps for dependability. Here's why:

They are 100% factory-tested at twice rated working voltage — withstand continuous overload up to 40,000 v.d.c.

Terminals and taps have heavy 8-32 thread—cannot strip or break off, when terminals are tightened.

Terminals seat flat at bottom of tap. No gaps between terminals and capacitor body — no possibility of corona.

Positive mechanical bond between stub terminals and internal electrodes prevents loosening, when terminals are attached.

Keep a stock of CRL Precision Attachable Terminal Hi-Vo-Kaps on hand. Separate packaging of terminals and capacitor body lets you buy only the terminals you need. See your Centralab distributor.

Send coupon for bulletin 28-2 on CRL Precision Attachable Terminal Hi-Vo-Kaps.

Centralab

CENTRALAB, A Division of Globe-Union Inc. 922C E. Keefe Avenue, Milwaukee 1, Wisconsin
Send bulletin 28-2 on CRL Precision Attachable Terminal Hi-Vo-Kaps.

Name.....

Company.....

Address.....

City..... Zone..... State.....

D-1954

a multipole double-throw switch which sets up the circuit for battery operation.

Most of these switches operate through pressure of the prongs on the line plug. There is no control voltage on the line cord or plug. You can install a number of these switches on a panel and wire the switch contacts to sound the alarm if any of the appliance plugs are removed from the receptacle.

CHECKING VIDEO AMPLIFIERS

? I want to use my square-wave generator to check the response of the video amplifiers in TV sets. To what frequency should I tune the oscillator for this test?—V. R., Martins Creek, Pa.

A. There are different opinions as to the relationship between the frequency of the square wave and the bandpass of the amplifier under test. Some engineers maintain that when an amplifier passes a square wave without distortion, it is flat from $f/10$ to $10f$, where f is the square-wave frequency. Others work between 3-db (cutoff) points. To check low-frequency response, they set the generator to 10 times the amplifier response at 3 db and watch for an undistorted wave on the scope. For the high-frequency check, they set the generator to a frequency whose 21st harmonic is the same as the amplifier response at the high-frequency cutoff point. In any case, it takes practice and familiarity with one's scope and generator to get the best results from a square-wave test.

A video amplifier is designed for a given bandwidth with predetermined input and output impedances and known values of stray-wiring and shunt capacitances. When any test instrument is connected directly across the input or output of a video amplifier, it will upset the normal operating conditions and cause misleading observations. Long test leads to the scope and generator will increase the stray capacitance of the circuit. The amplifier must work from and into the proper load impedances.

In TV broadcasting, special buffer amplifiers, probes, and other adapters are used with the scope and generator to prevent disturbing the inherent response characteristics of the circuit under test. You will not be able to rely on any square-wave response measurements that you make unless you can be sure that the frequency-determining constants of the circuit have not been altered by connections to the test instruments.

POWER SUPPLIES

? I would appreciate having diagrams of two power supplies which operate from a 6-volt d.c. supply. The output of one supply should be high enough to give a bright flash from a NE-20 or NE-51 neon bulb. The other should deliver 25 volts d.c. at 15 amp.—W. M. W., San Francisco, Calif.

A. If the neon lamp is the only drain on the first supply, it would be more

Mr. Serviceman check these items for... Value!



See your local Parts Jobber

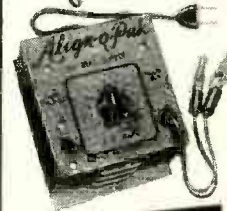

Align-o-Pak

Model BE2

Eliminates TV Alignment Bias Batteries. Provides voltages recommended by all TV manufacturers. Quickly diagnoses AGC trouble.

\$7.85

UHF HI-PASS FILTER



Model HP2

Passes UHF, rejects VHF up to 50 DB without tuning. Eliminates FM, Airport, Taxi cab interference, etc.

\$2.37



Up-Down VOLTAGE BOOSTER

Model LB2

Adds or subtracts 10 volts line voltage with heavy, safe toggle switches for any TV set. Line restored to normal when turned off.

\$5.97

for additional information, clip out coupon and mail TODAY to:

SERVICE INSTRUMENTS CO.
422 So. Dearborn—Chicago 5

I am interested in:

- ALIGN-O-PAK
- HI-PASS FILTER
- UP-DOWN VOLTAGE BOOSTER

NAME:.....

ADDRESS:.....

TO THE
E. E.
 OR
PHYSICS
GRADUATE
 WITH EXPERIENCE IN
RADAR
 OR
ELECTRONICS

HUGHES RESEARCH AND DEVELOPMENT LABORATORIES ARE ENGAGED IN A CONTINUING PROGRAM FOR DESIGN AND MANUFACTURE OF ADVANCED RADAR AND FIRE CONTROL SYSTEMS IN MILITARY ALL-WEATHER FIGHTERS AND INTERCEPTORS.

YOU WILL serve as technical advisor in the field to companies and government agencies using Hughes equipment.

TO BROADEN your field of experience in radar and electronics you will receive additional training at full pay in the Laboratories to become thoroughly familiar with Hughes radar and fire control equipment.

AFTER TRAINING you will be the Hughes representative at a company where our equipment is installed; or you will direct operation of Hughes equipment at a military base.

THE GREATEST advancements in electronics are being made in this sphere because of military emphasis. Men now under 35 years of age will find this activity can fit them for future application of highly advanced electronic equipment.

HUGHES

RESEARCH AND DEVELOPMENT LABORATORIES

SCIENTIFIC AND ENGINEERING STAFF

Culver City, Los Angeles County, Calif.

Assurance is required that relocation of the applicant will not cause disruption of an urgent military project.

economical to use a pair of small 67½-volt portable radio batteries in series. The useful life of the batteries will be about equal to their normal shelf life in this application. On the other hand, you can use a conventional vibrator-type supply which delivers about 120 volts. In this instance, the drain of the vibrator alone may make this type of supply impractical.

For the 28-volt, 15-ampere supply, you will need a motor-generator set or dynamotor. The output power is 420 watts. Assuming that the dynamotor or motor-generator set is 65% efficient—a fair figure for small units—the input power will be 567 watts, or nearly 95 amperes at 6 volts. This drain is excessive for a standard vehicular storage battery. You will probably have to look around for another solution to this problem.

It may be that you are planning to install a piece of 28-volt surplus radio equipment in an automobile equipped with a 6-volt lighting and ignition system. If this is the case, your best bet is to convert the equipment to operate from a 6-volt supply. This would increase the over-all efficiency of the power-supply system and may make the equipment more practical to install and operate.

If the equipment is to be operated in a vehicle and you must have 28 volts d.c., then we recommend that you get a surplus 28-volt aircraft generator and hook it up to a small gasoline engine or drive it from the automobile motor as described in the article "75-Meter Mobile, California Style," in the January, 1952, issue of *QST*.

FOLDOVER IN WESTINGHOUSE

? A Westinghouse 605-T-13 receiver has developed a bad case of horizontal foldover. I made a complete examination of the horizontal circuits, checking the grid-coupling capacitor to the horizontal output tubes, the damper tube and its associated components, the horizontal output tubes, and the bypass capacitors in this circuit. I checked all voltages, but still to no avail. What else could I possibly check that might cause this condition? L. Y., Roanoke, Va.

A. In this model the foldover may be caused by a change in values of the two 220,000-ohm resistors and 330-µf capacitor all in series and feeding pins 5 and 7 of the 6AL5 horizontal automatic frequency control tube from the horizontal output. Check for off-value parts and replace if incorrect by more than 5%.

Check all components in the 6AL5 phase detector circuit and try a new 6AL5. Finally, make the following changes as recommended by the manufacturer for foldover not caused by normally defective parts: Change the grid resistor of the 7A5 horizontal output tubes from 470,000 to 100,000 ohms. Also change the capacitor which shunts the resistor, from 470 to 270 µf. This R-C combination is fairly critical, so at least 5% values should be used. END

Federated

OFFERS

precise

KIT AND WIRED
INSTRUMENTS

NOW
 IN
 STOCK

EXCLUSIVE...

precise

MODEL #308

8½"

SCOPE

KIT \$129.50

#308W \$229.50

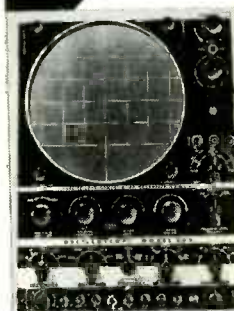

No other oscilloscope, at any price, can meet all the specifications of this electronic masterpiece

- VERTICAL FREQ. RESPONSE—Flat ± 1½ db DC thru 5 MC.
- SENSITIVITY—Greater than 10 millivolts push-pull (3.9 Millivolts/CM)
- BLANKING—60 cycle or 120 cycle Blanking through Blanking amplifier circuit.
- SWEEP RATE—Linear sweeps from 1 cycle to 80 KC in 5 ranges. (1-10 uses Ext. C.) DRIVEN and RECURRENT sweeps.
- MAGNIFIER—Expands and magnifies signal up to 10 times.
- PUSH-PULL—Output in both amplifiers.
- CRT—The latest type 8½" NEW tube a PRECISE EXCLUSIVE.
- VOLTAGE REGULATED.
- ANODE INTENSIFIER—a PRECISE FIRST
- INTERNAL CALIBRATOR

NEW 7" OSCILLOSCOPE

MODEL #300K \$94.95
 MODEL #300W \$199.50

LOWEST PRICED IN ITS FIELD

**NEW MODEL #909
 VACUUM TUBE VOLTMETER**

FACTORY \$375.00
 WIRED

Model 909 Vacuum Tube Voltmeter. 1% Ceramic precision Resistors; Coax DC connector; FM zero alignment scale; burn-out proof circuit; DC input 25 Meg. Rugged oversize 4½" meter.
 MODEL #909 KIT. \$25.98



IN STOCK AT ANY OF OUR OUTLETS

Federated Purchaser

66 Dey Street New York 7, N. Y. Dlgby 9-3050

- Newark, N. J., 114 Hudson St.
- Allentown, Pa., 1115 Hamilton St.
- Easton, Pa., 925 Northampton St.
- Los Angeles 15, Cal., 911 So. Grand Ave.

TRANSVISION FIELD STRENGTH METER

*Finest
at
Any Price*



For 110V AC,
and BATTERY
OPERATION

**SAVES 50% OF
INSTALLATION COST**

Works from antenna
(no TV set needed)

FINEST because: Each Meter is individually calibrated in microvolts on every channel. Widest range—10-50,000 microvolts. 12 channel selector. Multiplier switch for weak signal areas.

Pays for itself on 3 or 4 jobs. Measures relative picture signal strengths directly from antenna. Determines best antenna system and orientation. Checks receiver re-radiation (local oscillator.) Identifies signals—TV, FM, TVI. Easy to operate. Light, rugged. Many other exclusive features.

*Model FSM-4, for 110V AC only. Complete with tubes. Wt. 13 lbs. net \$69.

Model FSM-4B, for Battery Operation and 110V AC. Wt. 13 lbs. net \$89.

**TRANSVISION, INC.
NEW ROCHELLE, N.Y.**

**\$69
NET***

**A MUST IN
FRINGE AREAS**

**UHF
OR
VHF**

10 DAY TRIAL: Try these fine instruments for 10 DAYS. Then, if you return them, your cost less 10% (our cost of re-packaging) will be refunded.

Test & Repair CRTs

Make BIG PROFITS this EASY way:

Every Service Shop needs these Transvision Instruments. Can be used white picture tubes are in sets or cartons. Choice of 4 types:

TESTER-REACTIVATOR-SPARKER: 3 instruments in 1: Measures cathode emission; locates shorts between elements; locates high resistance shorts (leakage) as high as 3 megohms. Gives rapid check of gas condition of tube. Reactivates dim tubes—renews brightness and detail. Sparks out electrical leakage. net \$34.95

TESTER-REACTIVATOR: 2 instruments in 1: Similar to the above but without the sparking function. net \$19.95

TESTER-SPARKER: 2 instruments in 1: Sparks out electrical leakage between elements—saves many picture tubes and small tubes. Provides a variable 8,000-14,000V D.C. supply; useful for analyzing hard-to-solve deflection problems. net \$25.95

SPARKER: Eliminates leakage between elements in C.R.T.s and small tubes. net \$18.95



Transvision, Inc., New Rochelle, N. Y., Dept. E3

- Send me _____
- Enclosed find \$_____ deposit. Balance C.O.D.
- My JOBBER is _____

I accept your 10 Day Trial terms.

Name _____
Address _____
City _____ State _____

JOBBER INQUIRIES INVITED

TROUBLE IN G-E 803

After replacing the horizontal output transformer, the picture distorted when the brightness or contrast control was advanced. The trouble was finally traced to the lead which runs from terminal 4 on the transformer to damper-tube pins 2 and 5. This lead ran too close to the lead between transformer terminal 5 and the blue side of the width coil.

The trouble was eliminated by dressing the lead from terminal 4 along the top of the chassis.—*Geo. R. Anglado*

SELECTING A TV MAST

Before mounting a TV or FM antenna above a bright-colored sloping roof, make sure that the mast tubing you use is rustproofed inside and out. The fact that rust weakens the mast so it must be replaced in a few years may not be nearly as important to many home owners as the fact that the rust may cause unsightly, hard-to-remove stains on the roof. Most homeowners will appreciate your thoughtfulness and will be glad to pay the slight increase in the cost of using a more expensive type of mast.

If you are not sure that the tubing is rustproof on the inside, plug the top end with a large cork and then wrap the end with several layers of plastic electrician's tape to be sure that water will not get in.—*Henry O. Maxwell*

UNUSUAL HUM PROBLEM

An a.c.-d.c. type 3-tube portable record player was brought in with a bad case of hum. The usual checks of tubes and filters did not eliminate the trouble nor shed any light on its cause, so we settled down to examine the circuit layout.

We found that the volume control was mounted on the cabinet away from the chassis. The audio ground lead was used to carry a.c. from the switch on the control to the chassis. There was enough a.c. voltage drop in just the few inches of this ground lead to introduce an abnormal hum in the amplifier. The hum level was brought down to normal by running a separate lead from the switch to the chassis and clipping the original connection between the switch and the cold lead of the volume control. As a general rule, it is not a good idea to have the same wire carry both a.c. power and the signal. There is bound to be some hum pickup.—*Wayne Miller*

PACKARD BELL 2710 CHASSIS

The 0.25-amp fuse in this TV set would blow intermittently. A voltmeter connected to the cathode of the damper tube showed that the d.c. voltage dropped sharply just before the fuse blew. A complete check showed that the horizontal linearity transformer was intermittently shorting to ground. The trouble cleared up when the short was eliminated.—*Manuel E. Silva*

the sensational

ADAPHONE

... it's a remote control
SILENT LISTENER

... it's a Hi-Fi extension
HEARING AID

At last . . . a precision instrument that brings radio and TV listening pleasure to the hard of hearing, without raising the normal loudspeaker volume. And perfect for normal hearing folks who want to watch TV or listen to radio without any sound to annoy others. List Price \$19.95 complete. Write Dept. RE-3 for illustrated literature.

ADAPHONE is easily attached to any TV or radio set. Enables the hard of hearing to hear programs perfectly without disturbance to other listeners.

FENTON COMPANY
15 Moore Street • New York 4, N. Y.

LEARN

Television-Radio Electricity

REFRIGERATION-ELECTRONICS

IN THE GREAT
SHOPS OF **COYNE**

**TRAIN QUICKLY! OLDEST, BEST
EQUIPPED SCHOOL OF ITS KIND IN U.S.**

Come to the Great Shops of Coyne in Chicago. Get practical training in opportunity fields—TELEVISION-RADIO—ELECTRICITY—ELECTRONICS—vital in Defense Program. Prepare now for a better job in industry or better service rating.

Approved for Veterans

Finance Plan—Enroll now, pay most of tuition later. If you need part-time work to help out with living expenses while at Coyne, we'll help you get it. Special tuition plan for men of Draft Age.

FREE BOOK Clip coupon for Big Free Illustrated Book. No salesman will call. Act NOW.

B. W. Cooke, President
COYNE (SCHOOL)
A TECHNICAL TRADE INSTITUTE CHARTERED NOT FOR PROFIT Established 1899
500 S. Paulina, Chicago

**ELECTRICITY ★ TELEVISION
RADIO ★ REFRIGERATION ★ ELECTRONICS**

B. W. COOKE, Pres.
COYNE School
500 S. Paulina St., Chicago 12, Ill. Dept. 34-81H

Send FREE BOOK and full details on:

TELEVISION-RADIO ELECTRICITY

NAME _____

ADDRESS _____

CITY _____ STATE _____

RADIO-ELECTRONICS

SOUND POWERED HEAD AND CHEST SET
 Navy Type—No Batteries Required—Ideal for TV Antenna Installations and many other uses. 20 Ft. Cord. Used Tested: \$5.95 EA.



TELEPHONE WIRE FOR THE ABOVE
 COMBAT TYPE—2 Cond. Twisted, Rubber Covered, Medium Weight, W-130 @ .01¢ per Ft.
 FIELD WIRE—2 Cond. Twisted, Weather-proof, Heavy Duty, W-110—525 Ft. Roll \$4.75
 COPPER WELD WIRE—Weatherproofed, 2 Cond. Solid. 1200 Ft. Roll, \$10.00. Per Ft. @ .01¢ per Ft.

TG-34A KEYS
 PORTABLE—115 or 230 V. @ 50 to 60 cycles—KEYER TG-34A is an automatic unit for reproducing audible code practice signals previously recorded in ink on paper tape. By use of the self contained speaker, the unit will provide code practice signals to one or more people or provide a keying oscillator for use with a hand key. The unit is compact, in portable carrying case, and complete with tubes, photo cell, and operating manual. Size: 10 1/4" x 10 1/2" x 15 1/16". Shipping weight: 45 lbs. BRAND NEW \$14.95—In original Box: NEW: \$24.95—USED:

AERIAL WIRE—Phosphor Bronze #16 Stranded, 200 lb. test. Weatherproof, 150 Feet on Reel. RL-3 with Clips. \$1.50

COAXIAL CABLES:
RG-8/U (SPECIAL) 51.5 ohms. Same size as RG-8/U. Prices: 1 to 100 ft. @ 8¢ per ft.—100 to 500 ft. @ 7 1/2¢ per ft.—500 to 1000 ft. @ 7¢ per ft.—1000 ft. Rolls @ 6 1/2¢ per ft.
RG-34/U—71 ohms, 145 ft. length. \$15.00

FREE CATALOG
 LISTING HUNDREDS OF TRULY EXCEPTIONAL "BUYS"!—WRITE FOR YOUR FREE COPY NOW!

Address Dept. RE • Minimum Order \$5.00
 Prices F. O. B. Lima, U. 25% Deposit on C. O. D. Orders

FAIR RADIO SALES
 132 SOUTH MAIN ST. • LIMA, OHIO

SAVE MONEY ON INSTRUMENTS!

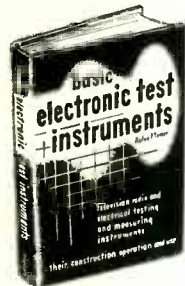

Test with fewer instruments . . .
 Use old instruments in new ways . . .
 Avoid buying types you don't really need . . .
 Learn to evaluate instrument readings and put them to practical use.

BASIC ELECTRONIC TEST INSTRUMENTS

by Rufus P. Turner

254 pages, 171 illus., Price \$4.00

Written especially for servicemen, amateurs and experimenters, this new book is a complete training course in instruments. Over 60 instruments—from the most modern TV pattern generators to grid-dip oscillators and special-purpose bridges—are fully explained. Work-saving short cuts are outlined. You learn how to put your old instruments to new uses and thus avoid buying costly new ones. Tells all about current and voltage meters; ohm-meters and V-O-M's; V-T voltmeters; power meters; oscilloscopes; r-f test oscillators; signal tracers; tube testers; TV linearity pattern generators and dozens more. Helps you get more work out of old instruments . . . avoid the purchase of new ones you don't really need!

READ IT 10 DAYS . . . at our risk

Dept. RE-34, RINEHART & CO., Inc.,
 232 Madison Ave., New York 16, N.Y.
 Send Turner's BASIC ELECTRONIC TEST INSTRUMENTS for 10-day examination. If I decide to keep book, I will then remit \$4.00 plus postage in full payment. Otherwise, I will return book postpaid and owe you nothing.
 Name.....
 Address.....
 City, Zone, State.....

SENTINEL MODELS 454 TO 457
 Tearing and rolling on strong signals may be caused by overloading of the third i.f. amplifier if it is not caused by the area control being in the wrong position (in the weak- or medium-signal positions in a strong-signal area). Overloading of the third i.f. amplifier occurs in early production runs of these models because its plate voltage is too low to permit it to handle strong signals. This trouble can be eliminated by transferring the plate lead of the 6CB6 third i.f. amplifier from the 150-volt to the 265-volt line. Use the following procedure:

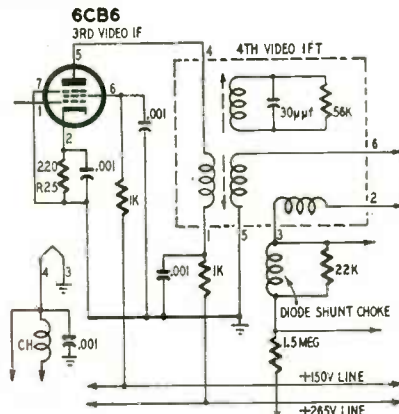

1. Change the third i.f. cathode resistor (R25) from 82 to 220 ohms, 1/2 watt.
 2. Remove the connecting lead between the screen (pin 6) of the 6CB6 and terminal 1 of the fourth video i.f. transformer.
 3. Connect a 1,000-ohm, 1/2-watt resistor between terminal 1 of the transformer and the 265-volt B plus line.
 4. Add a .001-µf, 500-volt capacitor between chassis ground and terminal 1 on the i.f. transformer.
- The diagram shows the revised circuit.—Sentinel Service Department

ADJUSTING U.H.F. STRIPS

Types Q and R u.h.f. strips for tuners in Sentinel TV receivers are prealigned at the factory for the specified channel. But, if you feel that further alignment is needed after checking the u.h.f. antenna and ascertaining that signal strength is adequate at the receiving location, a slight re-adjustment of the oscillator slug may be all that is necessary. Center the fine-tuning control for this operation. If this does not produce a sufficient improvement, try the following:

1. Turn the chassis on its side with the tuner at top left as shown in the drawing. Remove the tuner shield, rotate the channel selector to the de-

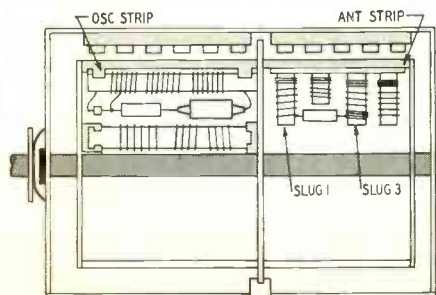

TRANSVISION

makes this greatest of TV offers—backed by **MONEY-BACK GUARANTEE:**

\$88 TV SERVICE \$39.95 INSTRUMENT VALUE FOR—

NEW TV Component Tester performs functions you've always wanted. Look what you get:
 FLYBACK TESTER, value \$39.
 SELENIUM RECTIFIER TESTER, value 29.
 CRT TESTER and REACTIVATOR, value 20.
 Total Instrumentation, value 88.
 ALL 4 In 1 great instrument, net 39.95

SELENIUM RECTIFIER TESTER

FLYBACK TESTER



PIC. TUBE TESTER

PIC. TUBE REACTIVATOR

NEVER BEFORE SUCH GREAT VALUE. For only \$39.95 you get 4 testing-and-repair instruments all in one! Compact, weighs only 3 lbs. Does things never been done before. Pays for itself quickly. Prove it yourself—

TRY IT for 10 DAYS on Money-Back Guarantee:

10 DAY TRIAL: Try this Transvision TV COMPONENT TESTER for 10 days. Then, if you are not 100% satisfied, you may return it. Your purchase price, less 10% (our cost of handling and repacking) will be promptly refunded.

TRANSVISION, INC. • NEW ROCHELLE, N. Y.

RUSH THIS COUPON NOW
 TRANSVISION, INC.
 DEPT. RE-34 NEW ROCHELLE, N. Y.
 () Send _____ TV COMPONENT TESTERS @ \$39.95
 () Enclosed find \$_____ deposit. Balance C.O.D.
 () Enclosed find \$_____ in full.
 I accept your 10 Day Trial terms.
 Name.....
 Address.....
 City..... State.....
 My Jobber is.....

JOBBER INQUIRIES INVITED



you're on easy street
with **PHOTOFACT**
SCHEMATICS

Standard symbols, standard layout—uniform in EVERY PHOTOFACT SCHEMATIC

Clear, easy-to-read Schematics—all parts keyed to chassis photos and parts lists...

NOW—voltages on ALL Schematics, wave forms on all TV Schematics

NOW—transformer color coding & transformer resistances on all Schematics

20 other exclusive features consistently in every PHOTOFACT Folder—the world's best data for faster, more profitable servicing...

NOW! GET THE PROOF FOR YOURSELF!

FREE We'll send you a Free Photofact TV Folder—just ask us for it!

Learn for yourself how PHOTOFACT pays for itself by earning bigger profits for you! We'll send you the proof—a FREE specimen PHOTOFACT TV Folder that shows all the features found consistently and exclusively ONLY in PHOTOFACT. Send for your FREE specimen TV Folder now. Examine it. Compare it. You'll see why PHOTOFACT belongs in your shop! And you'll want to ask your parts distributor about the pay-as-you-earn-plan. Only \$25 down brings you the entire PHOTOFACT Library. Write for FREE specimen TV Folder—learn now how to earn more!

HOWARD W. SAMS & CO., INC.
2205 E. 46th St., Indianapolis 5, Ind.

HOWARD W. SAMS & CO., INC.

sired channel, and remove the four antenna strips that are removable with the tuner in this position.

2. Insert the screwdriver edge of a plastic aligning tool into the bottom of slug 1 and notice if its presence affects the picture. If picture strength increases, turn the slug clockwise about 1/8th turn or until the picture and sound improve to the best possible extent. Advance the slug a little further to compensate for removing the tool from the coil.

3. If the picture strength does not change when the plastic tool is inserted in slug 1, turn the slug counterclockwise 1/8th turn or until best picture and sound are received.

4. Turn slug 3 in the same amount and in the same direction as slug 1 was turned for the best picture.—*Sentinel Service Bulletin*

BARKHAUSEN OSCILLATIONS

Barkhausen oscillations (one or more black vertical lines on the left side of the screen) in the Stromberg-Carlson 421 and 521 series receivers may be cleared up by adjusting the horizontal drive control or by replacing the horizontal output tube.—*Stromberg-Carlson Current Flashes*

PHILCO 51-T1875

This receiver was brought in with an intermittent hum that could be stopped temporarily by jarring the cabinet. By carefully tapping various components, we localized the trouble in the aluminum can type electrolytic capacitor mounted above the chassis. The twist-type lugs were not tight enough to maintain a good electrical connection between the can and the chassis.

The situation cleared up when a capacitor mounting bracket was clamped over the electrolytic and bolted firmly to the chassis.—*Peter Bedrosian*

PHILCO 645

After several of these models had come in for various repairs and tube replacements, I noticed that all seemed to have a moderate amount of nonlinear distortion in the audio section. A check with an audio oscillator and scope failed to show up any nonlinearity. Since the distortion was most noticeable on strong signals, I decided that it was probably due to blocking or plate-current cut-off in one of the stages.

After checking the r.f., mixer, and i.f. stages, the trouble was traced to nonlinearity in the second detector. It was distorting on positive signal peaks.

I cleared the trouble by replacing the original 330,000-ohm diode load resistor with a 100,000-ohm unit. This resulted in perfect linearity. A potentiometer was used to determine the correct value.—*G. P. Oberto*

CROSLLEY 56TG

Check the a.v.c. voltage if reception is weak. If it is abnormally high, remove the a.v.c. leads from pin 2 on the 35W4 socket and install a separate tie point. Excessive a.v.c. voltage is due to leakage to unconnected pins within the tube.—*Geo. R. Anglado* END

6 NEW TRIAD FLYBACKS



As evidence of Triad's continuing efforts to meet your TV replacement needs—exactly and completely—6 new flybacks have been added to the line. A total of 19 are now available, with more being added all the time. These flybacks are precisely engineered for specific replacements and carefully constructed of the finest materials. Their resulting high performance and long life insures satisfied customers and helps you build and hold your service business.

Type No.	List Price	Description
D-31	\$11.00	Universal type. Universal mounting. Replaces RCA 231-T1
D-32	11.00	Has AGC tapped winding. Matches all yokes.
D-33	11.00	Universal type. Universal mounting. Has AGC tapped winding similar to D-32, but low impedance secondaries.
D-35	11.00	Universal type. Universal mounting. Replaces RCA 223-T1, 224-T1, 230-T1 and 232-T1.
DA-36	5.50	Coil only. Replaces coil in Zenith Part No. S-18567.
DA-37	5.50	Coil only. Replaces coil in Zenith Part No. S-19032.

Available from stock. See your jobber for these—and all of your TV replacements.

Write for Catalogs TR-54B and TV-54B

TRIAD
TRANSFORMER CORP.

4055 Redwood Ave., Venice, Calif.

Now! RAD-TEL Tubes & Parts At Savings!

Water Rotary Switch Kit
A choice combination of single, double, etc. from 2 to 8 positions. Special kit of 10



\$1.39

Smashing Reductions on FP CONDENSERS
All famous makes. Save plenty on these top quality FP condensers. Made by leading manufacturers. You can't miss—these values are hits you look at them!

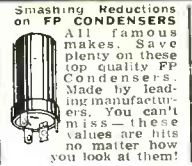

CERAMICON KIT
1 kit of 50 assorted ceramic discs, biphases, tubular condensers, all condensers popular sizes, used in T.V. and F.M. sets. **MUST kit List price \$10.00 \$1.99**



Hi-Watt RESISTOR KIT
Consisting of 5, 10, 15 and 20 Watt vitreous type resistors by W.T.O., I.R.C., etc. A top-flight buy! \$1.95



FILTER CONDENSER 20-20 Mfd. 450 V.
Color-coded leads. Ideal for use where impossible to use metal cans. For top performance at a give-away price. List price \$2.40. **49c**

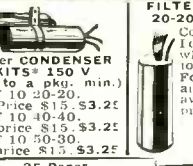

BIAS CONDENSERS
Famous Brands 500 mfd. 12 V List Pr. \$2.35 ea. Plug of 10. \$2.95 Super-Special 4-50 mfd. 8-100 VDC Kit of 7—\$1.29

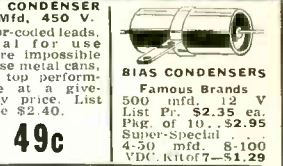

CAN ELECTROLYTICS

Capacity	DC Working Voltage	Price
40-40-40	450-450-25	.49
250-1000	10-6	.49
40	450	.49
60-10-10-20	450-450-450-150	.89
80-40-10	450-450-450	.99
20-8-8-8	450-450-450-250	.59
15	500	.79
80-15-20	450-450-25	.59
40-10-100	450-450-200	.79
10-20	450-25 F.P.	.39
10-8-8-8	450-450-450-150	.49

PHILCO TV BOOSTER
Made by Philco, famed for quality and precision communications equipment. Completely self-contained, including 2 tubes, 1 for High Channel and 1 for Low Channels and selenium rectifier. In factory-sealed cartons. **\$10.95**



25 Paper BY-PASS CONDENSERS
An assortment of 25 by-pass condensers, made by leading manufacturers. Top quality. Most popular sizes and voltages. Values .002 to .2 MFD 200 V. 1000 VDC. Kit of 25 **99c**



Hi-Voltage POWER SUPPLY
4500 VOLTS 5 MA. 12AU7 oscillator 1B3 rectifier. Completely wired, enclosed in shielded metal case, removable cover. Improve performance of your scope; use as R.F. high voltage supply. **BRAND NEW! \$2.95**

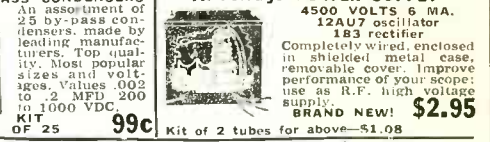

Kit of 10 assorted Electrolytic Condensers
Consists of singles, doubles, triples and quadruples, all of popular voltages and capacities—all standard popular brands. **\$2.39**

FLYBACK TESTER
A MUST For Every Serviceman!
Fast, sure horizontal trouble-shooting. Responsive to as small a defect as a 1-turn error. Tested while in receiver! Tests continuity on yokes, coils, speakers, switches, etc. **\$39.95**

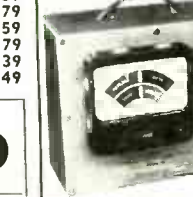

Variable Condensers
Manufactured by Philco, Radio Condenser, etc. 2 Gang AM and FM contains 2 separate sections for AM and 2 for FM with padded condensers. Attached a slug tuned high frequency coil whose plunger is geared to condenser shaft. Pulley type drive wheel. 89c



Kit of Wafer Sockets
Assortment of 6, 7, 8 and 9 pin sockets. These are brand new, standard manufacture. **Kit of 50 \$1.49**

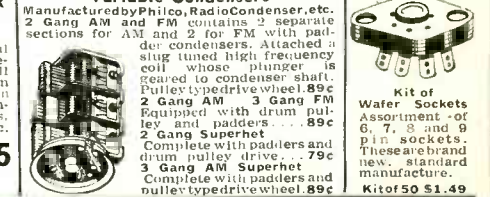

ALL BRAND NEW PARTS!

TRIMMER KIT
Compression type mica for radio, F.M., T.V. Very few duplications. Don't let this chance pass you by! **25 FOR . . . 99c**



FILAMENT ISOLATION TRANSFORMER
6.3 V @ 1.2 A
For damper use with 6W4, etc. High voltage insulation between primary and secondary to withstand high voltage surge. Can be used for general replacement. **79c**



RCA Type FLYBACK TRANSFORMER
Type 215T1
Lowest net price elsewhere—\$4.70
At this give-away price, order in quantity while they are available. Each . . . 95c

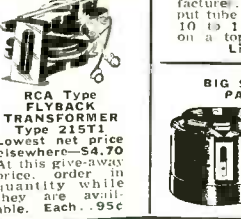

Vertical OUTPUT TRANSFORMER
Very popular, used in most T.V. sets. Well-known manufacturer. Matches vertical output tube to the deflection yoke, 10 to 1 ratio. A terrific buy on a top performer. . . . 95c
List price—\$4.50



BIG SAVINGS YOU CAN'T PASS BY! YOKE
Mfd. by Todd, Sickle, and other leading mfrs. Very good value, makes conversion profitable and simple. **\$1.95**
List price—\$7.50
55" Yoke . . . 99c

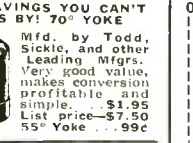

70% to 90% OFF ON TUBES!

All Tubes Individually Boxed! Same Day Service!
Check this list for Fully 1-Year Guaranteed Tubes.

Type	Price	Type	Price	Type	Price
OA2	.74	6BL7GT	.83	12AY7	.99
OB2	.82	6BN6	.59	12BA6	.38
OC3	.72	6BQ6GT	.79	12BA7	.60
OD3	.70	6BZ7	.90	12BD6	.45
024M	.55	6C4	.37	12BE0	.39
IA5	.40	6C5	.39	12BF6	.59
IA7GT	.68	6C6	.58	12BH7	.63
IAX2	.62	6C6B	.44	12BY7	.65
IB3GT	.68	6C6C	.44	12BZ7	.65
IB7	.43	6C6D	.44	12C8M	.34
IC5	.30	6E5	.48	12SC7M	.63
IE7	.29	6E5GT	.48	12S15GT	.42
IG6	.30	6F6	.59	12T8	.59
IH4	.46	6F6B	.52	12Q7	.62
IH5GT	.46	6H6GT	.51	12S8GT	.62
IL4	.49	6J5GT	.43	12SA7GT	.65
IL6	.59	6K5	.47	12SF5	.50
ILA4	.59	6K6GT	.37	12S15GT	.67
ILC5	.59	6K7	.44	12SK7GT	.63
ILE3	.59	6L6	.64	12SL7GT	.47
ILN5	.59	6L6B	.64	12SN7GT	.52
IN5GT	.67	6L7M	.68	12SQ7GT	.56
IP5GT	.57	6Q7	.68	12SR7M	.49
IQ5GT	.58	6R5	.49	12V6GT	.46
IR5	.59	6S7	.35	12X4	.38
IS4	.59	6S7M	.39	12Y6	.54
IS5	.49	6SRGT	.53	14A7	.59
IT4	.49	6SA7GT	.43	14H7	.59
IU4	.49	6SD7GT	.41	14J7	.30
IU5	.43	6SF5GT	.46	14W7	.30
IV	.53	6SG7GT	.49	19B6	.95
IX2A	.63	6SH7GT	.49	19C7	.70
2A3	.30	6SI7GT	.41	19T9	.79
2A4G	.38	6SK7GT	.41	19V8	.79
2W3	.59	6SL7GT	.48	24A	.39
2X2	.45	6SN7GT	.52	25A5GT	.83
3A4	.45	6SQ7GT	.37	25B06GT	.79
3E5	.48	6SR7GT	.45	25L6GT	.39
3Q4	.48	6SG7GT	.42	25V6GT	.66
3Q5GT	.49	6T4	.99	25Z5	.66
3S4	.51	6T8	.56	26	.45
3V4	.50	6U4	.60	27	.39
5U4G	.50	6U5	.44	35	.58
5Y3GT	.37	6U6	.69	35B5	.40
5Z4	.59	6U8	.39	35C5	.39
6A4	.44	6V6GT	.39	35L6GT	.39
6A4B	.44	6W4GT	.44	35W4	.37
6AC7M	.86	6W6GT	.44	35Z3	.59
6AF4	.90	6X4	.37	35Z4	.47
6AG5	.48	6X5GT	.37	35Z5GT	.47
6AH4	.99	6X8	.75	36	.39
6AH6	.57	6Y6G	.48	41	.42
6AJ5	.65	7A4	.47	42	.42
6AK5	.55	7A5	.59	43	.55
6AL5	.38	7A6	.69	45	.55
6AQ5	.39	7A7	.69	45Z3	.44
6AR5	.37	7B4	.53	45Z5	.49
6AS5	.50	7B6	.44	50B5	.43
6AT6	.37	7B6	.69	50C5	.69
6AU4GT	.68	7C4	.59	50L6GT	.61
6AU5GT	.82	7C5	.69	50V7	.50
6AU6	.38	7E5	.59	53	.24
6AV6GT	.82	7E6	.30	55	.49
6AV6	.57	7E7	.59	58	.60
6AX4GT	.53	7L7	.59	70L7GT	.97
6B4	.64	7X7	.70	76	.47
6BA6	.39	7Y4	.69	77	.57
6BA7	.57	7Z4	.59	78	.47
6BC5	.49	12AB6T	.37	83V	.68
6BD6	.45	12AL5	.37	85	.59
6BE6	.39	12AQ5	.52	85	.59
6BF5	.41	12AT6	.37	11Z7	.99
6BF6	.37	12AT7	.66	11Z7Z	.39
6BG6G	.25	12AU6	.38	807	.99
6BH6	.45	12AV6	.54	866A	.39
6BIB	.48	12AX6	.39	1274	.30
6BK7	.80	12AX4	.56	2050	.99
		12AX7	.56	1000FM	.59

Horizontal Output TRANSFORMER
Type 204T1
A horizontal Output Transformer designed for deflection circuits employing rf-operated high-voltage supplies. Intended for 50° magnetic-deflection kinescopes. Used with RCA Deflecting Yokes 201D1, 201D2, 201D3 or 201D12. **\$2.95**
List price—\$13.95

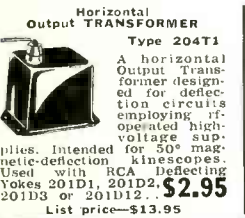

HI-PO TV rectifier tube—replaces the 5U4 tube directly! Makes pictures bigger, brighter, larger and increases the gain in TV receivers. HI-PO 567 **\$1.39**

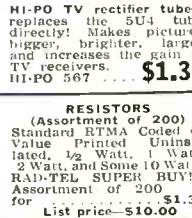

Kit of 50 MICA CONDENSERS
All popular sizes of mica condensers. In regular and silver construction. For TV use. **\$1.95**

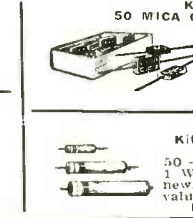

American Makes Kit of 100 Color-Related RESISTORS
50 - 1/2 and 1/4 watt, 25 - 1 Watt, 25 - 1/2 Watt. All new, all clean. Good value. **\$2.65**
List price—\$15.00



Hi-Voltage T.V. CONDENSERS
500 mmfd 10KV. \$.39 ea.
500 mmfd 15KV. .49 ea.
500 mmfd 20KV. .49 ea.
500 mmfd 30KV. 1.59 ea.

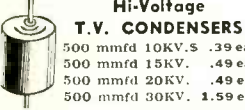

.. OLD FASHIONED SAVINGS!
Cathode Ray TUBE REJUVENATOR
Fits all makes of picture tubes. Completely automatic. Easy to install, no tools needed. For A.C. parallel circuits. (Available for all sets). **\$1.39**
List price—\$5.95
Everyone is a potential user—10 for \$12.90

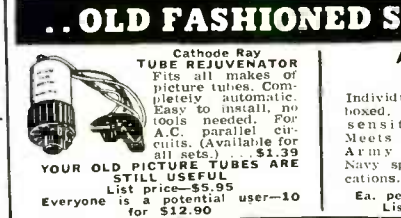

Army - Navy HEADSETS
Individually boxed. Very sensitive. Meets both Army and Navy specifications. **\$2.95**
List price—\$16.00



Volume Control Kit
Kit of 10 includes 3 wire-wound, 2 dual post, 5 carbon. The price of one (1) for the quantity of ten (10). Short and long shaft. **PRK KIT . . . \$1.79**



SPEAKERS—All Standard Brands, Dynamic

Size	Ohms	Price	Size	Ohms	Price
3"	1000	79c	6.5"	38	1.49
4"	1800	79c			
5"	1800	79c			
6"	2500	99c			
10"	2500	1.49			
4 x 6	2750	99c			
5 x 7	1000	99c			
5 x 7	1800	99c			
5 x 7	1800	99c			
5 x 7	90	1.49			
	(with 6K6 output transformer)				
	680	1.95			
	(with 6V6 output trans.)				

Knob Kit (Choice Groups!)
Assortment of home, auto, and T.V. knobs. All colors—plastic, wood and bakelite knobs. Bag of 50 Super Bag of 100 extra val. 1.95 Sells from 12c to 18c each.

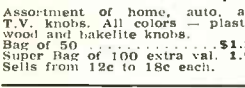

Kit of BATTERY PLUGS
Polarized, 3, 4, 5, etc. **\$1.69**



TERMS: A 25% deposit must accompany all orders—balance C.O.D. All shipments F.O.B. Irvington warehouse. Orders under \$10—\$1.00 Handling Charge. Subject to prior sale.

SOLDER LUG STRIPS
Kit of 48—very usable assortment of solder lug terminal strips. Brand new. Unusually fine value! Comp. Kit of 48 **89c**
List price—\$4.00

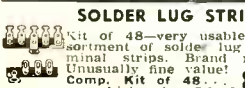

T.V. RADIO, and F.M. COIL KITS
Kit for television service; men and experimenter consisting of 4.5 m.c. peak-to-peak coil, 4.5 m.c. ratio detector, and 21.9 m.c. IF coil. TV. Standard kit of ten 99c
Broadcast and short-wave, midget to multi-band replacement coils. BC. Standard kit of ten (10) 99c
BC. Super value; not duplicated. Kit of 25 \$1.85
Kit of 25 include RF, Osc., IF, and detector coils.



Please send full remittance. A law for postage and save C.O.D. charges! We refund all unused monies. Send For Free Parts Catalog



TERMINAL STRIPS
Assortment of 50 terminal strips (screw type). Kit contains wire selection kit to meet every design. Kit of 50 **89c**
2, 3, 4 and 5 screw strips.

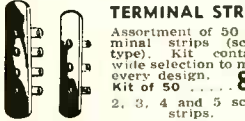

RAD-TEL TUBE CO.

Ph: Essex 5-2947. Dept. RE-3, 115 Coit St., Irvington 11, N. J.

BARGAINS · BARGAINS · BARGAINS

BARGAINS · BARGAINS · BARGAINS

Standard Brands

TUBES

All Brand New Individually Boxed Far Below Wholesale Cost

024	66	6AC7	1.29	6BG6	1.99	6SL7	.96	12AV7	1.14	35Z5	.53
1A7	.87	6AG5	.89	6BH6	.89	6SN7	.86	12AX7	1.06	50B5	.84
1B3	.99	6AG7	1.24	6BK7	1.26	6SQ7	.63	12AZ7	1.59	50C5	.84
1H5	.73	6AH6	1.39	6BL7	1.14	6T8	1.09	12BA6	.72	50L6	.71
1NS	.82	6AK5	1.44	6BU8	1.35	6U8	1.14	12BE6	.78	50Y6	.79
1R5	.79	6AK6	.93	6BQ7	1.49	6V6GT	.71	12BH7	.98	70L7	1.59
1S5	.79	6AL5	.71	6BN6	1.14	6W4	.73	12SA7	.83	80	.59
1T5	.77	6AQ5	.79	6CZ7	1.59	6W6	.91	12SK7	.79	117N7	1.59
1U5	.78	6AQ6	.89	6C87	.86	6X4	.62	12SL7	.99	117P7	1.59
1V2	.99	6AS5	.83	6CB6	2.59	6X5	.63	12SN7	.91	117Z3	.64
1X2A	1.02	6AT6	.72	6CH6	.71	6X8	1.09	12SQ7	.69	117Z6	.96
3Q4	.89	6AV5	1.04	6J5	.63	7F7	.71	19T8	1.29		
3Q5	.99	6AV6	.71	6J6	.99	7N7	.87	25B6	1.29		
3S4	.77	6AV5	1.09	6K6	.71	7Y4	.69	25W4	.75		
3V4	.82	6AV6	.63	6L6GA	1.39	12AH7	1.18	25Z6	.57		
5V4	.65	6BA6	.82	6SA7	.73	12AL5	.71	35B5	.79		
5V4	.99	6BA7	.99	6SC7	.84	12AT6	.62	35C5	.79		
5Y3	.49	6BC5	.86	6SH7	.86	12AT7	1.07	35L6	.73		
6AB4	.79	6BC7	1.04	6SJ7	.66	12AU6	.77	35W4	.73		
6AB7	.99	6RE6	.74	6SK7	.72	12AU7	.94	35V4	.74		

BARGAINS · BARGAINS · BARGAINS

INTERCOM SPECIAL

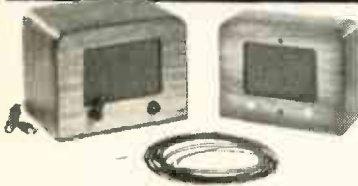

Now you can own an intercom that has a thousand uses at a price you would normally pay for a kit. This intercom comes housed in wooden cabinets completely wired and ready to operate. Outfit consists of one master, one sub station and fifty feet of two wire cable. Ideal for home as baby sitter. Perfect for office or factory. Order now as quantities are limited.

Your Cost **\$16.65**
Complete only

CASCADE TUNER

\$16.99 Lots of 3
\$17.95 each
Factory aligned ready to use. Complete with tubes and instructions.

THREE-SPEED PORTABLE RECORD CHANGER

Now for the first time at this low, low price a 3 speed V.M. Changer complete with 3 tube high quality amplifier. This unit uses the newest type V.M. Changer with automatic shut-off. Changer intermixes 10" and 12" records at any speed. Turnover crystal cartridge with 2 permanent needles. Amplifier has tone and volume control. When last record has played changer and amplifier automatically shut off. Unit comes housed in beautiful rich maroon leatherette carrying case with white beading. Plays 10-12" and 12-10" AC only. Shipped Railway Express only. 22 lbs. shipping wt. **\$46.99**
List Price \$89.95. YOUR COST



WEN ELECTRONIC SOLDERING GUN

250 Watts. Choice of red, green, black. Lots of 3 **\$9.71** each
\$8.64

STEVE-EL ELECTRONICS CORP.

Dept. RE-3 61 Reade St., New York 7, N. Y. COrtland 7-0086

NOW COYNE TRAINS YOU IN SPARE TIME AT HOME

TELEVISION RADIO-ELECTRONICS

Only from famous COYNE do you get this modern up-to-the minute TV Home Training. Easy to follow, Step-by-Step instructions—fully illustrated with 2150 photos and diagrams. Not an old Radio Course with Television tacked on. Personal guidance by Coyne Staff. So practical you can quickly EARN MONEY IN A TV-RADIO SALES AND SERVICE BUSINESS—part time or full time. Not only FINEST TRAINING but COSTS MUCH LESS—pay only for training—no costly extras.

SEND COUPON FOR DETAILS FREE
SEND COUPON BELOW for Picture Folder and full details including EASY PAYMENT PLAN. NO COST OR OBLIGATION—NO SALESMAN WILL CALL.

B. W. COOKE, Pres. **COYNE** FOUNDED 1899
ELECTRICAL SCHOOL

A TECHNICAL TRADE INSTITUTE CHARTERED NOT FOR PROFIT
500 S. Paulina Dept. 34-H74 Chicago 12, Illinois

B. W. COOKE, President
COYNE ELECTRICAL SCHOOL
500 S. Paulina St., Chicago 12, Ill., Dept. 34-H74

Send FREE Picture Folder and details of your Television-Radio-Electronics Home Training offer.

Name: _____
Address: _____
City: _____ State: _____

PLEASE MENTION RADIO-ELECTRONICS when answering advertisements

THE NEW TV DYNATRACER

ONLY \$4.95
Pd. or C.O.D. + Chgs.

- TRACES TV SIGNALS AND VOLTAGES
- LOCATES DEFECTIVE COMPONENTS
- REQUIRES NO ADDITIONAL EQUIPMENT

This sensationally new piece of test equipment is ideal for trouble-shooting television sets in the home, or in the shop. The "DYNATRACER" will outperform more expensive testers and should pay for itself on the very first repair.

A Must For Every TV Technician
SPECIFICATIONS: The "DYNATRACER" is a self-powered quality test instrument designed to trace TV signals through any Video, Sound, Sync, AFC, Horizontal or Vertical Sweep Circuit—will isolate trouble to a stage or component.

ADDED FEATURE: The "DYNATRACER" will also trace voltages (50/500 V. AC/DC) and instantly locate open, shorted, intermittent or leaky (up to 20 MEGOHMS) condensers, resistors, coils, X-Formers, etc.

Instruction and Trouble-Shooting Book Enclosed
10 DAY MONEY-BACK GUARANTEE

Cut out advertisement, attach name and address with \$5.00 bill, check or money order and mail to

Century ELECTRONICS CO.

8509-21st Ave., Dept. 111 Brooklyn 14, N. Y.

RADIO-ELECTRONICS is paying good rates on acceptance for original and unusual articles on audio, television, FM and AM servicing, as well as articles on industrial electronic equipment and applications. Send for a copy of our Authors' Guide. Address:

THE EDITOR RADIO-ELECTRONICS
25 West Broadway, New York 7, N. Y.

Charles F. Stromeier was promoted to executive vice-president of CBS-Hytron, Danvers, Mass. With the company since 1942, he was most recently vice-president in charge of manufacturing and engineering.



C. F. Stromeier

D. W. Gunn was appointed general sales manager of Electronic Products, Sylvania Electric Products, New York,



Left—D. W. Gunn Above—H. P. Gilpin

N.Y. He was formerly assistant general sales manager of the Electronic Products Sales Division. In his new position, he succeeds Harold P. Gilpin who retired after 21 years of service with the company.

G. Richard Fryling and W. Henry Fryling, president and vice-president respectively, of Erie Resistor Corp., Erie, Pa., were presented with a testimonial



W. H. Fryling, center, and G. R. Fryling, right, receiving presentation.

of appreciation by employees at the company's recent 25th Anniversary Staff and Long Service Dinner.

Joseph H. Quick was elected president of the National Co., Malden, Mass. He has been a director and member of the



Executive Committee of National and was formerly president of Harrington & Richardson Arms Co. He has also been associated with RCA, Philco and Sylvania.

A. Melvin Skellett and Lawrence L. Hardin, Jr. were named to the posts of vice-president in charge of manufacturing and engineering, and director of the Research Division, respectively, of the National Union Radio Corp., Hatboro, Pa. Both are long-time employees of the

company. Skellett was also elected to the Board of Directors.

G. W. DeSousa, formerly manager of the General Electric Tube Department marketing administration, was named to succeed G. L. Roark as manager of equipment tube sales. Roark was recently upped to department marketing manager. M. J. Strehle, previously manager of intra-company sales for the department, succeeds DeSousa



G. W. DeSousa



Clifford Shearer

Clifford Shearer joined RMS (Radio Merchandise Sales), New York City, as advertising manager. He was formerly with a leading catalog publishing firm in the electronics field.

Gardiner G. Greene, has become president and principal stock holder of Browning Laboratories, Winchester, Mass. He is the founder of Workshop Associates and became director and vice-president of the Electronics Division of Gabriel Co. when Workshop merged with it. Dr. Glenn H. Browning former president of Browning Laboratories, becomes chairman of the Board.

Joe Chapman Lane, Jr. was promoted to manager of Advertising and Sales Promotion for the Westinghouse Electronic Tube Div., Elmira, N. Y. In his new position he will be responsible for trade magazine advertising and sales promotion.



J. C. Lane, Jr.

Obituaries

Sylvan A. Wolin, pioneer sales and advertising executive in the capacitor industry, died suddenly from a heart attack at his home in Englewood, N.J. He was 42.

Herman H. Smith, pioneer manufacturer of electronic hardware, died suddenly at his home in Brooklyn, N.Y., recently.

Ernest B. Loveman, a member of the executive staff of Philco Corp., Philadelphia, collapsed and died of a heart attack in the reception room of the company's main plant.

Personnel Notes

... Joseph B. Elliott, W. Walter Watts, Dr. Elmer W. Engstrom and Charles M. Odorizzi, RCA vice-presidents, were promoted to executive vice-presidents in charge of their respective operations in an organizational realignment by the Radio Corporation of America. Joseph

QUARTZ CRYSTALS

FT-243-.093" PIN DIA.—.486" PIN SPC
FOR HAM OR GENERAL USE

4035 5437	6800 7610 7900	1015 3840 6473 7100 8025 8475
4080 5485 5973 6806 7625 7906	1110 3885 6475 7125 8050 8500	1915 3940 6500 7140 8073 8525
4165 5500 6240 6825 7640 7925	1930 3955 6506 7150 8075 8550	1940 3980 6550 7175 8100 8575
4190 5660 6260 6850 7641 7940	1950 3990 6573 7200 8125 8600	2065 6025 6575 7250 8140 8625
4280 5675 6273 6875 7650 7950	2125 6050 6600 7300 8150 8650	2537 6075 6606 7306 8173 8700
4300 5700 6275 6900 7673 7973	2840 6100 6625 7325 8175 8733	3500 6125 6640 7340 8200
4330 5706 6300 6925 7675 7975	3640 6140 6650 7350 8340	3680 6150 7000 7375 8350
4397 5725 6325 6930 7700 8206	3720 6175 7025 7400 8380	3735 6200 7050 7425 8400
4490 5740 6350 6975 7708 8223	3760 6440	3760 6440
4485 5750 6373 7450 7720 8250	3800 6450 7075 8000 8450	
4535 5773 6375 7473 7725 8273		
4735 5780 6400 7475 7740 8275		
4840 5808 6406 7500 7750 8300		
4930 5840 6425 7506 7773 8323		
4950 5852 6873 7525 7775 8630		
4980 5873 6675 7540 7800 8663		
5030 5875 6700 7550 7825 8690		
5205 5880 6708 7573 7940		
5300 5906 6725 7575 7850		
5385 5923 6740 7600 7973		
5379 5940 6775 7606 7975		

49¢ each—10 for \$4.00

99¢ each—10 for \$8.00

BC-746 TUNING UNITS—
Foundation coils and condensers for 80 meter VFO or exciter—Less stals.... 98¢

Low Frequency—FT-241A for 558. Lattice Filter etc., .093" Pins. .486" SPC material. 75° Channel Nos. 0 to 79. 54th Harmonic and 270 to 389. 72nd Harmonic. Listed below by Fundamental Frequencies. Fractions omitted.	CR-1A SCR 1 1/2" p 1/2" x 5	FT-171B BC-810 2 Banana Sugs 3 1/2" SPC
--	-----------------------------	---

370 393 414 436 498 520	400 459 5910	2030 2300 3185
372 394 415 437 501 522	440 461 6370	2045 2305 3202
374 395 416 438 502 523	441 462 6450	2052 2320 3215
375 396 418 481 503 525	442 463 6470	2065 2360 3232
376 397 419 483 504 526	444 464 6497	2082 2390 3237
377 398 420 484 505 527	445 465 6522	2105 2415 3250
379 401 422 485 506 529	446 466 6547	2125 2435 3322
380 402 423 486 507 530	447 468 6610	2131 2442 3510
381 403 424 487 508 531	448 469 7350	2145 2532 3520
383 404 425 488 509 533	450 470 7380	2155 2545 3550
384 405 426 490 511 534	451 472 7390	2220 2537 3570
385 406 427 491 512 536	452 473 7490	2258 2660 3580
386 407 429 492 513 537	453 474 7590	2290 2940 2945
387 408 430 493 514 538	454 475 7810	2290 3035 3953
388 409 431 494 515	455 476 7930	2282 3120 3970
390 411 433 495 516	456 477	2290 3150 3995
391 412 434 496 516	457 478	
392 413 435 497 519	458 480	

49¢ each—10 for \$4.00

99¢ each—10 for \$8.00

Add 20¢ postage for every 10 crystals or less

SUN
PARTS DISTRIBUTORS, LTD.

520 Tenth St. N.W.—Wash. D.C., Dept. R

The Magneraser*
Perfect Magnetic Tape Eraser



100% Erasure Guaranteed WITHOUT REWINDING

You no longer need a cumbersome and costly tape demagnetizer. The Magneraser* has all the features necessary for quick, efficient and absolute erasure of any recorded reel of tape. No matter what tape recorder you are using, or how severely the tape is overloaded, the Magneraser* is guaranteed to eliminate completely all recorded signal and bring the background noise level 3 to 6 db. below that of new unused tape.

You can carry the Magneraser* from room to room and use it wherever you have an AC outlet. To operate, simply place the Magneraser* on top of the reel of tape and move it once around. Within seconds, the complete reel is wiped perfectly clean.

Size 4" dia., 2 1/2" high; Weight 2 1/2 lbs.; Operating current 90 to 130 volts, 25 to 60 cycles; Power consumption 60 watts. Furnished with 8 ft. cord, molded rubber plug, and operating instructions. See your local dealer or write directly to factory. Net Price.....\$18.00

AMPLIFIER CORP. of AMERICA
397 Broadway, N. Y. 13, N. Y.
*T.M. Reg. U.S. Pat. Off.

...most sensitive all-channel antenna...

What can you believe in Antenna Claims?

Every claim for all-channel antenna performance should be supported by facts—not "sales talk." Facts are what you get from DAVIS... proof furnished by Microwave Engineering Company, of Los Angeles, who are recognized experts on antenna research and testing.

Write for this data. It's actually certified... data you can count on.

Remember, it's the picture that pays off in customer satisfaction. A DAVIS picture must please you—it's guaranteed to please or your money is refunded by the factory.

Send the coupon for facts on the DAVIS antenna.

"22 DB GAIN

"OUTPERFORMS ALL OTHERS"

"Guaranteed reception"

"...most sensitive all-channel antenna"

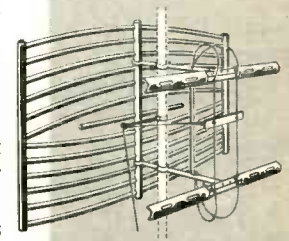

MAIL THIS COUPON TODAY:

DAVIS ELECTRONICS, Box 1247, Burbank, Calif.

Gentlemen... send me the following:

Technical data and complete information on the new SUPER-VISION ANTENNA

Name and address of NEAREST JOBBER

COMPANY NAME _____

MY NAME _____

ADDRESS _____

CITY _____ STATE _____

DAVIS ELECTRONICS
P. O. BOX 1247 • BURBANK • CALIF.
Factories in: BURBANK, CALIF., CHICAGO, ILL., SILVER SPRINGS, MD.

NEW PROBES!

FOR VTVM'S & SCOPES

- FULLY SHIELDED
- SHOCK-MOUNTED TERMINAL BOARD
- SWIVEL ACTION
- ALL PARTS ACCESSIBLE
- COLOR CODED

Only EICO Probes Have All These Features!

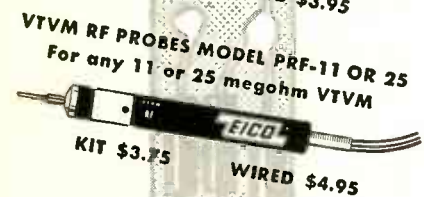

See these amazing probe values at your jobber today. Write now for free catalog PC-3. Turn to our full-page ad on page 5 of this magazine.

EICO® All Above Probes Pat. App. For
ELECTRONIC INSTRUMENT CO., Inc.
84 WITHERS STREET, BROOKLYN, NEW YORK

B. Elliott heads the Consumer Products Div.; W. Walter Watts, the Electronic Products Div.; Dr. Engstrom, the RCA Laboratories Div.; and Charles M. Odorizzi, a newly consolidated corporate staff serving all units and subsidiaries of RCA. Elliott, Watts and Odorizzi will make their headquarters in New York and Dr. Engstrom, in Princeton, N.J.

... Joseph Schlig, assistant to the sales manager of the Electronic Tube Division of Westinghouse Electric Corp., Elmira, N.Y., was selected as one of the 15 men whom the company is sending to the Harvard Graduate School of Business Administration to take a special 16-month management course.

... Paul P. Wickman was named merchandising manager of dealer products in the creation of a new communications link between the General Electric Tube Department's replacement sales organization and its distributors and dealers. Wickman was formerly Boston district sales manager for Tube Department replacement sales.

... E. L. Lee, B. E. Barnes, M. L. Jones and W. E. Vande Kieft were appointed regional electronic sales engineers for United Motors Service, Division of General Motors, Detroit. They will work with Delco electronic parts distributors in the Eastern, Southern, Central and Western regions, respectively.

... Bob Middleton joined the Sales-Engineering Div. of Simpson Electric Co., Chicago. He will conduct lectures for service technicians throughout the country. Middleton was formerly with RCA and Precision Apparatus.

... Dean L. Nordquist was promoted to assistant advertising manager of Electro-Voice, Inc., Buchanan, Mich. He joined the company in 1952.

... Dick O. Klein, vice president and general manager of Raytheon Distributors, Inc., was appointed director of marketing for the Television and Radio Division of Raytheon Manufacturing Co., Chicago, and at the same time named assistant vice-president of the parent company.

... Jerome V. (Jerry) Deevy rejoined National Union Radio Corp., Hatboro, Pa., as director of industrial relations. He had been with the company ten years prior to 1953, when he resigned to become an independent consultant.

... Ralph R. Stubbe was promoted to chief engineer of General Instrument Corp., Elizabeth, N.J.

... Frank M. Folsom, president of Radio Corp. of America, was presented with a gold clock and weather vane by Brig. Gen. David Sarnoff, RCA Board chairman, on behalf of the company's 65,000 employees, on Folsom's 10th anniversary with the company.

... Gordon LeMay joined Tele-Matic Industries, Brooklyn, N.Y., as assistant sales manager. He had been with Terminal Radio Corp., N.Y.C. END

The RADELCO

CORNER REFLECTOR UHF Model US-151

IS MADE FOR UHF AREAS WHERE GHOSTS ARE VIOLENT AND INTERFERENCE IS ROUGH!

- ★ EASY TO INSTALL!
- ★ OPENS LIKE A BOOK!
- ★ MOUNTS IN FRONT OF MAST, NOT BEHIND IT!

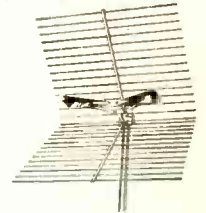

ASSURES CLEARER, SHARPER TELEVISION PICTURES!

- It's a superb high gain, extremely directive, broad band antenna with ample ability to banish ghosts and reject interference. Covers all UHF channels.

SENSATIONALLY LOW PRICED

ORDER FROM YOUR NEAREST PARTS JOBBER **\$7⁴⁵** LIST

OSCILLOSCOPES

ARE "GOLD MINES"!



... if you learn how to use them fully on all types of service jobs!

Learn to handle the oscilloscope fully on all types of AM, FM and TV service work—and watch your efficiency and earnings soar!

MODERN OSCILLOSCOPES AND THEIR USES, a fact-jammed 326-page book by Jacob H. Rutter, Jr., of the Allen B. Dumont Laboratories, contains exactly the help you need—written in a way you can clearly understand. It shows you how to use your scope for fast accurate work on all types of jobs from troubleshooting to realigning; how to make connections; how to adjust circuit components; how to set controls and how to analyze patterns fast and accurately. 370 helpful illustrations including dozens of pattern photos make things doubly clear.

No other type of specific service training stands to mean so much to you in terms of being able to do better, faster, and more profitable work!

- ✓ When, where, why and exactly how to use oscilloscopes
- ✓ How to interpret oscilloscope patterns
- ✓ How to handle tough jobs in less time

PRACTICE 10 DAYS FREE!

Dept. RE-34, RINEHART & COMPANY, Inc., 232 Madison Ave., New York 16, N. Y.

Send MODERN OSCILLOSCOPES AND THEIR USES for 10-DAY EXAMINATION. If I decide to keep the book, I will then remit \$6.00 plus a few cents postage in full payment. If not, I will return book postpaid and owe you nothing.

Name.....

Address.....

City, Zone, State.....

Employer's Name & Address.....

OUTSIDE U.S.A.—Price \$6.50 cash only. Money back in 10 days if book is returned.

RADIO-ELECTRONICS

Any or all of these catalogs, bulletins, or periodicals are available to you on request direct to the manufacturers, whose addresses are listed at the end of each item. Use your letterhead—do not use postcards. To facilitate identification, mention the issue and page of RADIO-ELECTRONICS on which the item appears. All literature offers void after six months.

AUDIO HANDBOOK

Arrow's 1954 *Audio Handbook* is a well-illustrated 104-page catalog. The first 33 pages are devoted to "audio facts," featuring 4 pages on binaural sound reproduction, 14 pages on loudspeakers with construction details for cabinets, a 4-page excerpt from Weiler's *High-Fidelity Simplified* entitled "The How, What, Why, and Where of High Fidelity," and a 10-page reprint of Weil's "Phono Facts" (74 pointers for the person selecting phonograph equipment).

The remaining 71 pages illustrate and give specifications for amplifiers, tuners, speakers and speaker cabinets, and associated audio equipment.

Write to Arrow Electronics Inc., 82 Cortlandt St., New York 7, N. Y. for free copy.

ANTENNA BOOKLET

RMS has published a 32-page catalog illustrating and describing its line of TV antennas and accessories. The booklet is indexed by product groupings and includes a gain reference chart for v.h.f. antennas.

Free from RMS (Radio Merchandise Sales, Inc.), 2016 Bronxdale Ave., New York 62, N. Y.

GOVERNMENT PUBLICATIONS

A list of 17 government publications on electricity, electronics, radar, radio, and television has been issued by the Superintendent of Documents. Subjects covered range from basic reference works on electricity to advances in printed-circuit techniques, and prices run from 5¢ to \$1.25. The highest-priced publications are two books on radar fundamentals, one of 474 pages and one of 394 pages.

Write the Superintendent of Documents, Government Printing Office, Washington 25, D. C., for the list, "Electronics, Radar, Electricity, Radio and TV," which gives catalog numbers (necessary for ordering), along with prices and descriptions.

RECORDER-HEAD DATA

Sound Talk Bulletin No. 27 discusses the problems of tape-recorder head alignment and head wear. The 3-page bulletin covers azimuth alignment and tape skewing, importance of head contact, and the effects of head wear on magnetic tape recording and reproduction. In addition, it includes an 8-step check list for locating high-frequency response loss caused by head problems.

Available free upon request from Minnesota Mining and Manufacturing Co., 900 Fauquier St., St. Paul 6, Minn.

TECH-MASTER High Fidelity Amplifier and Preamplifier KITS

- Tech Master audio amplifier kits are made with the same "custom-quality" attention that has made Tech-Master the first name in TV chassis. They are built to a standard, not to the price. There have been no compromises . . . every component is the finest obtainable . . . workmanship is meticulous.

UL* WILLIAMSON TYPE AMPLIFIER KIT:

(with power supply.) Famous Williamson circuit with modifications for increased, undistorted power output. Uses specially wound quality output transformer.

Model TM-15A, Kit of Parts . . . Net Price . . . \$49.95

Model TMD-15A, DELUXE KIT: Factory assembled, all major components mounted, ready to wire. Net Price . . . \$59.95

*Ultra linear operation through use of screen-tapped primary output transformer

4 CHANNEL PREAMPLIFIER-EQUALIZER KIT:

Provides complete equalization for virtually all recording characteristics now employed. Extra flexibility provided by independent bass and treble boost and attenuation controls.

Model TM-15P, Kit of Parts . . . Net Price . . . \$19.95

Model TMD-15P, DELUXE KIT: Factory assembled, all major components mounted, ready to wire. Net Price . . . \$29.65

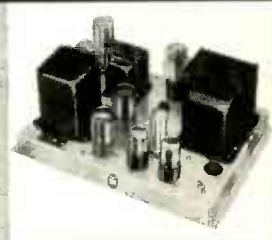

AT ALL LEADING RADIO PARTS DISTRIBUTORS



TECH-MASTER CORPORATION
443-445 BROADWAY, NEW YORK 13, N. Y.

TECH-MASTER, MAKERS OF CUSTOM-BUILT TV CHASSIS, QUALITY TV KITS & HIGH FIDELITY AUDIO EQUIPMENT.

I.R.E. Booth No.
121 Military Ave.

Dealers, Servicemen—Attention Tremendous Bargain

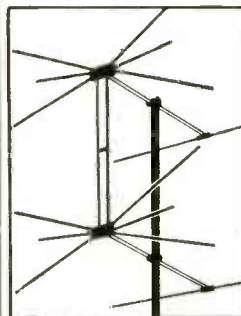

CONICALS 2-BAY 16-ELEMENT CONICAL ARRAY

With Hi-Bond Adapters
Sturdy 3/8" Element
\$4.99 Each

In Lots of Three
Single Lots \$5.30

Never before has National Electronics had a BARGAIN like this. We made a special purchase in order to get these sensational prices. And this array has everything. This conical 2-bay 16-element array provides ultra-fine fringe reception. Includes sixteen 3/8 inch airplane type aluminum elements, including hi-bond adapters for greater gain on the high channels and is complete with one pair of stacking bars to each array. These are packed in cartons of three 16-element arrays per carton, with tie rods, at \$14.95 per carton. When purchased in single 16-element arrays, separately boxed—your cost is \$ 5.30 each
3 Two-Bay Arrays per carton without Tie Rods \$13.50 carton
4 Bay Ultra-Fringe Stacking Assembly for Above—Model 4B \$1.95 set

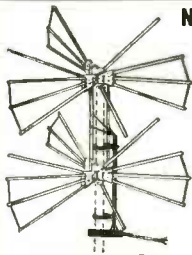

NEW SUPER FRINGE MOTORLESS DIRECTRONIC VHF-UHF

Channels 2-83 Reception From All Directions No Motors Needed

New Super Directronic Is Electronically beamed in all directions by directronic selector switch at receiver. Hi-gain 24-element array eliminates need for motors. Kit complete with 75' tubular Tri-X cable, Directronic Switch, Matched Stacking Bars and Universal U-Clamp.

Model AX-524
ONLY \$23.50
YOU SAVE 50% ON AVERAGE INSTALLATION

ROCKET BROAD BAND YAGIS

- SENSATIONAL GAIN
- SENSATIONAL PICTURES IN FRINGE AND ULTRA FRINGE AREAS

Switch to Yagi Broad Band Hi-Gain Antennas! These new Yagis give you Yagi reception on the 5 low-band and 7 hi-band channels—no restriction to one single channel. A two-bay array will out-perform even a 10 or 12-element single channel Yagi. Price is sensationally low. Complete serviceman's array includes 1 double reflector, 2 folded dipoles, 3 directors, Universal mast clamp. Easy-to-assemble quick rig construction.
Model RB 26—Ch. 2 thru 6—7-element . . . \$10.95 ea.
Model RB 713—Ch. 7 thru 13—9-element . . . 5.95 ea.
Matched Stacking Bars 1.25 ea.

FAMOUS ROCKET ZOOM-UP TOWERS

- Sturdy • Reliable • Easiest Installation
- Economize with Rocket Zoom-up Towers. Offers quickest, easiest way to make an installation up to 30'. Each section telescopes inside the other—to erect, simply slide out each section in its turn—insert bolt thru section below—tighten to keep mast from turning. Each tower complete with guy rings, bolts, and mounting base suitable for peak or flat roof. Handsome and sturdy. Rocket Zoom-ups offer you economy and long life. Order by size.
- | | |
|-----------------------|-----------------------|
| 20' \$ 9.95 | 30' \$15.95 |
| 40' 19.95 | 50' 29.95 |

UHF STRIPS—Now available for Standard Coil tuners. To order, specify channel No. and series designated by letter, such as F, G, Q, etc., stamped on each strip of your present tuner. (Set consists of osc. & ant.) **\$7.50 Ea.**

NEW SPRING CATALOG AVAILABLE
Includes Sensational Profit Sharing Point Plan

HI-GAIN BOW-TIE REFLECTOR

For UHF \$1.95 Each
High gain at low cost. Completely pre-assembled. Easily stacked for fringe use.
2 bay with tie rods \$4.40
4 bays with stacking harness . . 9.95
Lots of 6—individually cartoned 10.95

ALL PRICES F.O.B. CLEVELAND, OHIO
Do not remit more than complete purchase price. Pay shipping charges on receipt of goods. 25% deposit on all C.O.D. orders, please. Money-back guarantee. Prices Subject to Change Without Notice

National Electronics OF CLEVELAND

THE HOUSE OF TV VALUES
203 Delco Building Cleveland 3, Ohio

NOW-STEP AHEAD FASTER! AS AN INDUSTRIAL ELECTRONICS TECHNICIAN

Turn your experience into a big, new better-paying career!

Day by day industrial plants are adding more electronic devices — for sorting, counting, checking, almost any control job you can name. Cash in on industry's great need for men who can keep these devices in top working order. Make more money, feel more secure, doing work that is second nature to you. With what you already know about electronics you have a long head start in a field just beginning to boom. GET INTO IT RIGHT NOW with the help of

PRACTICAL INDUSTRIAL ELECTRONICS LIBRARY

4 Volumes
1390 pages
1050 illus.

\$22.50
EASY
TERMS

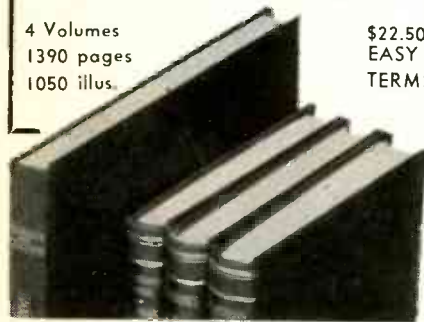

Here's the practical kind of information these 4 volumes give you:

- How to keep the plant's electronic equipment performing as it should
- How to locate and correct tube and circuit troubles quickly and easily
- How to install, service, and maintain even brand new equipment without being stumped by new circuits

No long sessions on math or theory! Instead you get: Clear explanations of how tubes and tube-operated circuits work in motor controls, welding controls, heat controls, etc. A complete manual that covers all maintenance procedures. A handbook of 433 industrial electronic circuits with each fully described. Troubleshooting charts, tested working methods, step-by-step directions—everything you need to start right now is here.

- Contains**
- Chute's *Electronics in Industry*
 - Miller's *Maintenance Manual of Electronic Control*
 - Markus & Zeluff's *Handbook of Industrial Electronics Circuits*
 - Henney & Fahnestock's *Electron Tubes in Industry*
- Shows facts such as:
- How to operate the vacuum-tube voltmeter
 - How to correct ignitor misfire
 - How to maintain light sources for photoelectric control
 - How to protect circuits of welding machines
 - How tubes serve in conveyor synchronization, color measurement, etc. and hundreds more

FREE TRIAL—EASY TERMS

McGraw-Hill Book Co., Dept. RE-3, 327 W. 41 St., NYC 36

Send me the Practical Industrial Electronics Library for 10 days' examination on approval. In 10 days I will send \$2.50, then \$4.00 a month until \$22.50 is paid. (A saving of \$3.50 under the regular price of \$26.00.) Otherwise I will return books postpaid. (Print)

Name _____

Address _____

City _____ Zone _____ State _____

Employed by _____ RE-3

This offer applies in U.S. only.

HIGH-FIDELITY

Lafayette's new 48-page high-fidelity catalog illustrates and describes hundreds of music system components ranging from tuners to binaural records.

Request catalog No. 454 from Lafayette Radio, 100 Sixth Ave., New York 13, N. Y.

TUBE DATA BOOKLET

Amperex's twin-tetrode tube, type 5894/AX-9903, is described in a new 26-page booklet. Included are detailed data, application notes, typical performance curves, special features, and a description of the construction of this tube.

Available without charge from Amperex Electronic Corp., 230 Duffy Ave., Hicksville, L. I., N. Y.

WALL CATALOG

Sprague's C-452 wall catalog consists of five pages tabbed for the popular service types of electrolytic, ceramic, and molded-paper tubular capacitors, as well as printed networks. Listings include capacitance, voltage rating, dimensions, catalog number, and list price of each of the units.

Available free from Sprague Products Co., 81 Marshall St., North Adams, Mass.

UNITIZING EQUIPMENT

The 1954 edition of the Alden handbook, *Ideas—Techniques—Designs* describes new standard components for unitizing electronic equipment. It provides new data and planning sheets on plug-in packages and basic chassis for unitizing equipment and giving it rapid interchangeability. Also improvements and components for indicating and monitoring operation of electronic equipment with tiny tell-tales are described. New models of connectors and interconnecting systems that allow color-coding for easy circuit tracing have been added.

The booklet is available to manufacturers and designers writing on their letterhead to Department HB, Alden Products Co., Brockton, Mass.

OSCILLOGRAPH BULLETIN

General Electric has issued a 12-page bulletin on the features and operation of the general-purpose oscillograph PM-10, used in investigation work, design, and testing. The oscillograph permits simultaneous records to be made of voltage, current, time, speed, pressure, strain, and sound.

Write for Bulletin GEC-449B. *Gratis* from the General Electric Co., Apparatus Sales Div., Schenectady 5, N. Y.

TEST EQUIPMENT

Cal-Tronics has released a 12-page bulletin, *Electronic Test Equipment*, illustrating and describing a synchronizer test unit, electronic control amplifier test unit, computer systems test unit, and signal data converter test unit.

Copies may be had by writing Cal-Tronics Corp., 11305 Hindry Ave., Los Angeles 45, Calif. END

STAN-BURN E-P-A-R-K-E

CATHODE RAY TUBE SPECIALS

ONE YEAR GUARANTEE		STAN-BURN	
G.E.			
7JP4	\$17.10	10BP	\$10.50
10BP4A	19.25	12LP4	12.50
12KP4A	24.00	12LP4A	14.50
12LP4A	27.10	12P4	12.50
12LP4A/B1014	21.70	12P4A	15.00
Dumont	21.00	14CP4	11.95 M Ft.
12UP4B	28.75	15DP4	17.00
14CP4	24.50	16KP4	18.50
15DP4/B1014	24.50	16P4 or A	18.50
Dumont	23.75	16P4 or A	18.50
16AP4A	30.95	16P4A	18.50
16P4A (N.U.)	25.25	16P4A	18.50
16P4 or B	31.25	16P4A	18.50
16KP4/16RP4	24.20	16P4A	19.00
16KP4A	28.75	16P4A	23.00
(Aluminum)	25.25	16P4A	19.00
16JP4A (N.U.)	25.25	16P4A	19.50
16LP4A	28.50	16P4 or A	21.00
16GP4B	26.50	17BP4	19.50
17BP4A	31.25	17CP4A	22.60
17BP4A	24.00	17GP4B	21.60
17CP4	23.90	19FP4	23.00
17GP4B	28.50	19FP4A	24.00
(Aluminum)	20.00	19AP4	23.90
19AP4A	41.50	19AP4A	24.90
20P4	34.50	20CP4	26.00
21AP4	42.00	21P4	26.50
21EP4A	36.35	21AP4	26.50
24AP4A	78.50	24AP4	26.50
		24AP4	49.00

QUANTITY CRT USERS

We will give you DUD allowances if you ship them to us Prepaid. 10 CRT's minimum shipment. WRITE FOR DETAILS.

ANTENNAE SPECIALS

RED DOUBLE "V" Antenna	1.19	6 or more	1.98
10 ELEMENT CONICAL Doweled Inserts	2.98		2.79
Folded Hi Straight Low Quick Rig 1/2" elements	4.25		3.25
WINDOW CONICALS 5 FOOT SWEGGED	4.95		3.75
MASTS 10 FOOT PLAIN	1.39		1.29
NEPCO MASTS 42 Mil	1.69		1.49
TV WIRE 55 Mil. 300 OHM		59.95 M Ft.	
72 OHM COAXIAL		35.00 M Ft.	
CHASSIS 630 TECHMASTER Model C-30 with Cascade Tuner		\$149.50	
OPEN FACE CABINET		\$42.00	

TAPE RECORDERS IN STOCK

PENTRON—Model 9T3C—2-speed Tape Recorder		Write for Price.
RADIO CRAFTSMAN Model C400—Hi Fi Amplifier	Net \$42.90	
Model C10—All-EM Tuner	Net \$31.50	
Model C500—Williamson Amplifier	Net \$99.50	
We also carry MASCO—BOGEN—PILOT, etc. Amplifiers—Pro-Amps. FM Tuners and WEBSTER Tape Recorders.		
6"x9" PM SPEAKER	53.98	
7" PM SPEAKER	3.98	
70° Yoke	1.98	
630 Vert. Output Upright	1.98	
630 Vert. Output Potted	1.29	
630 Vert. Blocking Osc. Xform.	89	
CASCADE TUNERS	17.95	
DUMONT 21.25 mc	14.95	
Famous INPUTUNER	10.00	
TV Permanent Magnet Focus Assembly	1.98	

CONVERSION SPECIAL

21EP4 American Standard Tube—21" Beveled Mask—Rain Conversion Kit. (When set to be converted)

ALL FOR ONLY \$43.50

- AUTHORIZED DISTRIBUTORS for: General Electric, Kenrad, Tung-Sol, National Union, De Wald, Regal, Automatic and General Motors.
- AUTOMATIC CUSTOM-BUILT RADIOS for Plymouth, Ford, Chevrolet and many others—always in stock.
- We carry a complete stock of HI-FIDELITY and SOUND EQUIPMENT. Send us your requests. We also carry a complete line of popular makes of Radio parts and equipment at lowest prices. Send us a list of your requirements for prompt quotations.
- Terms: 20% with order. Balance COD. All prices FOB, NEW YORK Warehouse. Minimum order \$5.00. Write for our latest price list and Hi-Fi Catalog to Dept. RE-3.

STAN-BURN RADIO and ELECTRONICS CO.

(C.B.S. THEATRE BLDG.)
1697 BROADWAY • NEW YORK 19, N.Y.

Now Ready! New Sprayberry Book! "HOW TO CONVERT TV SETS for LARGER PICTURE TUBES"



Covers Step-By-Step Method for Converting any TV Receiver

This new book opens exceptional extra money opportunity for the alert serviceman converting older small screen TV sets to modern, large screen 17", 21" or 24" receivers. Fully illustrated with diagrams, charts and pictures. Covers every step: planning, wiring, final adjustment. Special introductory price, 50c. Mail coin (no stamps please) today.

SEND ONLY 50c

SPRAYBERRY ACADEMY OF RADIO
111 N. Canal St., Dept. 89-G, Chicago 6, Ill.
RADIO-ELECTRONICS

KITS!! KITS!! KITS!!
A BARGAIN FOR EVERYONE!!!

- RADIO-TV BUILDERS LIBRARY** for Students, Hams, Servicemen... 25 asstd. schematics incl. Photofacts... \$.98
- KNOB**... wood plate, Kit 29 asstd... \$.98
- RF-ANTENNA-OSCILL-COILS**... stand, broadcast & S.W. incl. shielded, Kit of 10 asstd... \$.98
- TUBE SOCKETS**... water, 1 to 8 pin, 12 asstd... \$ 1.49
- POTENTIOMETERS**... 1/4" shafts, Kit of 6 asstd... \$ 1.75
- ROTARY SELECTOR SWITCHES**... incl. multi-contact, multi-deck 1/4" shafts, Kit 6 asstd... \$ 2.49
- RELAYS**... incl. multi-contact & midgey keying relays, WHITE TUBE LAST!... 5 asstd... \$ 1.98
- EXPERIMENTAL TUBES**... for Test, Research, Schools, Fil. Tested, Kit 40 asstd; revg. types \$ 2.49
- MOULDED BAKELITE CONDENSERS**... 50mmf -2 mfd. 200-600V. Micamold, Kit 50 asstd... \$ 1.98
- ELECTROLYTICS**... Can & tubular, 8 asstd... \$ 1.49
- OIL CONDENSERS**... incl. multi-sect, 5 asstd... \$.98

KING SIZE

That's the New **JUMBO RADIO-ELECTRONICS PARTS KIT!** Loaded with: COILS, SOCKETS, WIRE, HARDWARE, RESISTORS, CONDENSERS, PHOTOFACTS, TV PARTS, & DIAGRAMS. PLUS MUCH, MUCH MORE!

Shpg. wt. 20 lbs. **\$3.95**



- DIAL SCALES**... incl. AM-FM, acetate & glass... Kit of 12 asstd... \$.98
- ESCUTCHEONS**... airplane & slide-rule, 8 asstd... \$.98
- DIAL WINDOWS**... acetate & glass, Kit 12 asstd... \$ 1.29
- RADIO HARDWARE TREASURE**... FULL LB. CAN of Nuts, Screws, LugS, Washers, etc... \$.89
- TV MASKS**... sizes to 20", Open type, 6 asstd... \$ 3.95

SAVE \$\$\$... REPAIR YOUR OWN SPEAKERS!!

SPEAKER REPLACEMENT CONES... Popular sizes 4" to 12", incl. oval, Less voice coils, 12 asstd... \$.98

SPEAKER REPAIR KIT... Professional assortment of Voice Coil forms, Rings, Spiders, felt, Chamolite Leather, Shim Kit, Cement & Instructions... \$ 2.49

SPECIAL!—Both CONE & REPAIR KITS for ONLY \$ 3.95

Precision CONE & COIL ASSEMBLIES
 Complete with Spider, Leads & Instructs. (Send complete specs. or old cone)
 Any 4" or 5" asbly...\$1.10 Any 6" asbly...\$1.50
 Any 4"x8" asbly...\$1.50 Any 6"x8" asbly...\$1.80
 (We can supply replacement parts for EVERY TYPE OF SPEAKER)

"DIRECT FACTORY SPEAKER REPAIRS SINCE 1927"
 Min. Order \$3.00. 20% deposit req. on all C.O.D.'s.
 Please add sufficient postage—excess refunded.

LEITONE RADIO CORP.
 67 Dey Street
 New York 7, N. Y.

STOP VOLUME CONTROL NOISE!

"NO NOISE"

New 6 oz. spray can
 Net to Service-men **\$2.25**

Contains Amazing New **PERMA-FILM**

- ★ **Cleans!** dirt and oxidation immediately on contact.
- ★ **Lubricates!** One drop eliminates scratch, hum, and noise.
- ★ **Protects!** assures continued top performance.

Perfect Contact Restorer—cleans & restores volume controls, band switches, push button assemblies, electrical contacts. **NO NOISE** is not a carbon pot solution.

2 oz. bottle
 Net to Service-men **\$1.00**

Available in 8 oz. bottles and quart cans.

Nearest distributor... or write
ELECTRONIC CHEMICAL CORP.
 813 Communipaw Ave., Jersey City 4, N. J.



HIGH-FIDELITY TECHNIQUES, by John H. Newitt. Published by the Technical Division, Rinehart Books Inc., 232 Madison Ave., New York, N. Y. 6 1/2 x 9 inches, 494 pages. Price \$7.50.

Written primarily for the "practicing engineer, home constructor, radio service technician, recording studio or sound system operators, and professional audio technician," this work can be read with profit by any music lover whose knowledge of electronics is enough to permit him to read a schematic.

The author devotes a short first chapter to defining the term "high fidelity," then follows with one on sound and hearing. The various components of a high-fidelity system—speakers, enclosures, crossover networks, and amplifiers—are then covered in chapters interspersed with a discussion of distortion and of high-fidelity circuits. High-fidelity radio receivers, records and record players, and magnetic recording each receive a chapter.

The longest chapter in the book is entitled "Custom Installation of High-Fidelity Equipment," and covers technical, subjective, business and mechanical angles. Several plans and photographs of custom installations are included.

Though aimed at the professional man, there is much fundamental information for the less technical reader, as well as for the electronic technician whose experience in audio has been limited. Though the book has a few weaknesses and unbalances (test records, for instance, are dismissed in two paragraphs while speaker enclosures receive 60 pages) there is more information in this book than the reviewer has seen in any other on the subject. —FS

PRINCIPLES OF TRANSISTOR CIRCUITS, Richard F. Shea. Editor. Published by John Wiley and Sons, Inc., 440 Fourth Avenue, New York 16, N. Y. 6 x 9 1/4 inches, 535 pages. Price \$11.00

This is the first of a long series of books which will compete for the attention of engineers specializing in electronic circuit and design work. It is an important book because it gathers much of the desired information on the characteristics and applications of transistors into one text for the first time. The hundreds of illustrative schematic diagrams cover the applications of transistors adequately. Before this the engineer has had to content himself with the information made available in technical journals.

All the authors are engineers at the General Electric Electronics Park Laboratories at Syracuse, N. Y.

Rather than to the service technician, this book is directed to the graduate student and the practicing engineer. Transistors came into the industry at a time when many practicing circuit-design and applications engineers had completed their formal training. Thus for the most part the individuals who will be most likely to profit from this

POST
BUSINESS WEEK
U.S. News & World Report
TIME
OVER 24,974,906*
 have heard about **ANACONDA** "FOAM-LINE"

THE UHF-VHF Line for "all-channel, all-weather reception"

Sell Them!

They're waiting to Buy!

Advertisements in these leading national publications are making consumers aware of the need for ANACONDA "FOAM-LINE" . . . has all the fine features you want, PLUS the CONSUMER DEMAND. *Compiled multiple figures

Write for samples and complete descriptive literature . . .
 SOLD THROUGH JOBBERS ONLY . . .

"National distributors and warehouse for ANACONDA desheath television and radio wires and cables"

Columbia WIRE & SUPPLY CO.
 2850 Irving Park Road • Chicago 18, Ill.



NOW!...a complete guide to Wire & Tape Recording



for **HIGH-FIDELITY RESULTS**

There's more to this fascinating subject than you may suspect!

MAGNETIC RECORDING

By S. J. Begun

242 pages, 130 illustrations. Price \$5.00

- for
- HOME ENTERTAINMENT
- MOVIES
- BROADCASTING
- AMATEUR RADIO
- SECRET COMMUNICATIONS
- SPEECH SCRAMBLING
- PROFESSIONAL RECORDING
- TRANSCRIPTIONS
- TELEGRAPHY and TELEPHONY
- AUTOMATIC ANNOUNCING
- MAGNETIC "MEMORIES"
- RECORDING TRANSIENTS
- CHRONOSCOPES

... and many other uses that make this one of the fastest-growing phases of the electronic industry.

Here's your "Open, Sesame!" to a fast-growing branch of electronics in which far too few have specialized to date! Whether recording is your hobby or your business, this book will pave your way to better results, new techniques and effects.

From simple wire or tape recorders for home entertainment to complicated equipment and processes used in secret services, movies, industry and elsewhere, **MAGNETIC RECORDING** brings you complete, how-to-do-it data. From basic circuits to components; from commercial and home built equipment to its operating and service problems, you get the latest information and expert guidance.

And, chances are, you'll be amazed at the opportunities for recording specialists in this steadily expanding field.

Starting with the fundamentals of magnetism and acoustics you progress rapidly to the advanced phases of the art. Biasing methods, distortion, reproducing heads, erasing, artificial reverberation (echoes), amplification, instrumentation and measurements and helpful analyses of modern commercial recording equipment, are but a few of the subjects covered. Dozens of schematics, block diagrams, cross-sections and under-chassis photos make things easy to understand and are invaluable guides in selecting new equipment or building your own.

type of text are the younger men in the industry and those who have been keeping up with the phenomenal developments in this new field. But it would be a mistake for any of the older practicing engineers to bypass this book. It is hardly likely that any engineer can afford to be without some first-hand knowledge of transistors and their applications.

There are three main sections, treating low frequency, high frequency, and nonlinear applications. The low-frequency section considers such important topics as small and large signal applications, audio, d.c. and ultra-sonic amplifiers. Since transistors are limited in their frequency response this is the most important part of this text at the present time. However, since the frequency limitation is being moved forward almost daily, there is ample treatment of the basic principles of high-frequency operation and design considerations for high-frequency circuits with special consideration for video amplifiers.

The book is replete with circuit data on oscillators, i.f., r.f., and audio amplifiers, as well as flip-flops, multi-vibrators and pulse amplifiers. The chapter on feedback will be of especial interest to those engineers interested mainly in the audio applications of transistors.—DA

RADIO DATA CHARTS. By R. T. Beatty. Revised by J. McG. Sowerby. Published by Wireless World, London. Distributed by British Books Centre, 420 W. 45th St., New York 36, N. Y. 8 1/4 x 10 1/2 inches, 91 pages. Price \$2.00.

First appearing more than 20 years ago, this new fifth edition contains a series of 43 nomograms (or abacs as the British say) providing essential data required in receiver design. Each chart is accompanied by a page of illustrated text supplying pertinent radio theory. Use of the charts is demonstrated with clear examples.

All you need is a ruler. If you know all the quantities of a problem (except one), the abac, plus ruler, will give the answer. It is a time saver for those whose work includes design computations.—MC

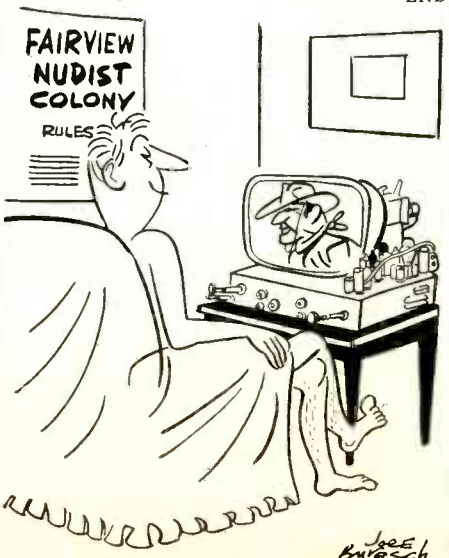

READ IT 10 DAYS ... at our risk!

Dept. RE-34, RINEHART & CO., Inc.
232 Madison Ave., New York 16, N. Y.
Send **MAGNETIC RECORDING** for 10-DAY FREE EXAMINATION. If book is O.K., I will then promptly remit \$5.00 in full payment. If not, I will return it postpaid and owe you nothing.

Name

Address

City, Zone, State

Price outside U.S.A. \$5.50—cash only.
Money back in 10 days if you return book.

ATLAS PROJECTORS

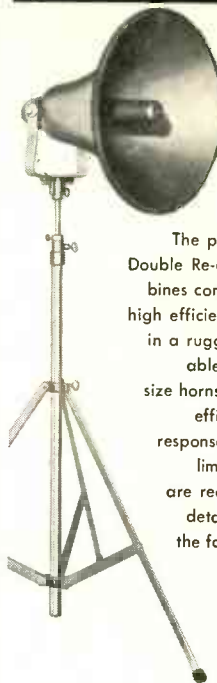

9 models to choose from for EVERY application

The performance-proved ATLAS Double Re-entrant ('DR') design combines compactness with unequalled high efficiency and uniform response in a rugged, stormproof, demountable construction. The larger size horns are excellent for greatest efficiency and low-frequency response. Where space and cost limits exist, the smaller horns are recommended. For complete details on 'DR' Projectors and the famous ATLAS line of Public Address and Microphone Stand equipment...

WRITE NOW for FREE Catalog 553

ATLAS SOUND CORP.
1443 39th St., Brooklyn 18, N. Y.
In Canada: Atlas Radio Corp., Ltd., Toronto, Ont.

AUDELS TV-RADIO SERVICE LIBRARY

HERE IS LATE INFORMATION IN A HANDY FORM FOR RADIO AND TELEVISION REPAIRMEN, SERVICEMEN AND STUDENTS

2 VOLS. \$6 COMPLETE \$1 A MO. PAY ONLY 1 MO.
AUDELS T.V.-RADIO SERVICE LIBRARY—Highly Endorsed—1001 Facts—Over 1552 Pages—625 Illustrations, Diagrams of Parts. Presents Important Subjects of Modern Radio, Television, Industrial Electronics, F.M., Public Address Systems, Auto, Marine & Aircraft Radio, Phonograph Pick-Ups, etc.

IT PAYS TO KNOW!
The Basic Principles—Construction—Installation—Operation—Repairs—Trouble Shooting. Shows How to get Sharp, Clear T.V. Pictures. Install Aerials—How to Test. Explains Color Systems, Methods of Conversion, Terms, etc. Includes Ultra High Frequency (U.H.F.)—Valuable for Quick Ready Reference & Home Study. Tells How to Solve T.V. & Radio Troubles—Answers Your Questions.

Get this Information for Yourself. 7 DAY TEST—ASK TO SEE IT!

MAIL ORDER

AUDEL, Publishers, 49 W. 23 St., N.Y. 10, N.Y.
Mail AUDELS T.V. RADIO SERVICE LIBRARY 2 Vols. \$6 on 7 days free trial. If O.K. I will remit \$1 in 7 days and \$1 monthly until \$6 is paid. Otherwise I will return them.

Name

Address

Occupation

Employed by RE

RADIO SCHOOL DIRECTORY

BECOME AN ELECTRICAL ENGINEER



Bachelor of Science Degree in 36 months.

Major in Electronics or Power. Now, prepare for a career in these rapidly expanding fields.

This school will prepare you to become an engineer, technician or service man. Previous military, academic or practical training may be evaluated for advanced credit.

Enter Both Radio and Television

In 12 months you can attain the Radio-Technician's certificate. An added 6 months course qualifies you for the Radio-TV Technician's certificate and the Degree of "Associate in Applied Science." The Technician's course is the first third of the program leading to a Bachelor of Science Degree in Electrical Engineering with a major in Electronics.

Also offered: 12-month Radio-TV service course; 12-month Electronics or Electro Technician Courses; 6-month Electrical Service Course and 3-month refresher and general preparatory classes.

Terms Open April, July, Sept, January.

Famous for its Concentric Curriculum. Faculty of specialists. 50,000 former students. Annual enrolment from 48 states and 23 overseas countries. Non-profit. 51st year. Courses approved for Veterans. Residence courses only.



MILWAUKEE SCHOOL OF ENGINEERING

MILWAUKEE SCHOOL OF ENGINEERING
Dept. RE-354, 1025 N. Milwaukee
Milwaukee 1, Wisconsin

Send: Free 45-page "Your Career" booklet describing Electrical Engineering Courses; Booklet on Careers in Radio-TV.

I am interested in _____ name of course

Name _____ Age _____

Address _____

City _____ Zone _____ State _____

If veteran, indicate date of discharge _____

MORE JOBS than graduates

Electronic Engineers
Excellent opportunity for professional growth and advancement in an interesting and dynamic field.

Demand for our engineering graduates exceeds supply. Effective placement. Study in this world-famed college established 1884. Quarters start March, June, Sept., Jan. Approved for Korean Vets.

Bach. Sc. degree in 27 months

Complete Radio Eng. courses . . . TV, UHF and FM. Also Mech., Civil, Elec., Chem., Aero. and Adm. Eng.; Bus. Adm., Acct. Small classes. Well-equipped labs. Modest costs. Prep. courses. Write Jean McCarthy, Director of Admissions, for Catalog and Campus View Book.

TRI-STATE COLLEGE
2434 College Avenue, Angola, Indiana

GET INTO ELECTRONICS

You can enter this uncrowded, interesting field. Increase expansion, new developments demand trained specialists. Study all phases radio & electronics theory and practice: TV; FM; broadcasting; servicing; aviation, marine, police radio. 18-month course. Graduates in demand by major companies. H.S. or equivalent required. Begin Jan., March, June, Sept. Campus life. Write for catalog.

VALPARAISO TECHNICAL INSTITUTE
Dept. C Valparaiso, Ind.

RADIO ENGINEERING DEGREE IN 27 MONTHS

Intensive, specialized course including strong basis in mathematics and electrical engineering, advanced radio theory and design, television. Modern lab. Low tuition. Self-help opportunities. Also B.S. degree in 27 months in Aeronautical, Chemical, Civil, Electrical, and Mechanical Engineering. G.I. Gov't approved. Enter March, June, September, December. Catalog.

INDIANA TECHNICAL COLLEGE
153 E. Washington Blvd., Fort Wayne 2, Indiana

RADIO-TV ELECTRONICS

CREI graduates in big demand. Accredited by Engineers Council for Professional Development. New classes start every month. Free placement service for grads. Courses offered—Radio Engineering, Broadcast or TV Engineering, TV, FM, AM Servicing. Write for free catalog. Approved for Vets.

CAPITOL RADIO ENGINEERING INSTITUTE
Dept. RE, 3224—16th St., N.W., Washington 10, D. C.

TV REPAIRMEN MAKE TOP MONEY!

In just 39 weeks, you can get complete TV service training! Streamlined course gives you all essentials for a good job as service technician. Graduates in great demand; jobs are plentiful in this growing field. Other courses in electronics, radio operation and maintenance. Day or evening classes; modern equipment. Opportunity for employment in local industry.

Write for Catalog 111 Today

INDIANAPOLIS ELECTRONIC SCHOOL
312 E. Washington, Indianapolis 4, Ind.

When answering advertisements please mention RADIO-ELECTRONICS

RCA INSTITUTES, INC.
A service of Radio Corporation of America
350 West 4th St., New York 14, N. Y.

OFFERS COURSES IN ALL TECHNICAL PHASES OF RADIO, TELEVISION, ELECTRONICS

Approved for Veterans
Write Dept. RC-54 for Catalog

CODE SENDING SPEED

Be a "key" man. Learn how to send and receive messages in code by telegraph and radio. Commerce needs thousands of men for jobs. Good pay, adventure, interesting work. Learn at home quickly through famous Candler System. Quality for Amateur or Commercial License. Write for FREE BOOK.

CANDLER SYSTEM CO.
Dept. 3-C, Box 928, Denver 1, Colo. U.S.A.

Get Your F.C.C. LICENSE Quickly!

Correspondence or residence preparation for F.C.C. examinations. Results guaranteed.

An FCC commercial operator license means greater opportunities and higher pay. We are specialists in preparing you, in a MINIMUM OF TIME, to pass FCC examinations for all classes of licenses. Beginners get 2nd class license in 5 weeks and 1st class in 3 additional weeks. Write for free booklet.

GRANTHAM SCHOOL OF ELECTRONICS
Dept. 101, 6064 Hollywood Blvd., Hollywood 28, Calif.

EARN MORE MONEY—BE A PROFESSIONAL TELEVISION SERVICE TECHNICIAN

STEP INTO THE TOP PAY \$5,000—\$10,000 A YEAR CLASS. 7 MONTHS' SHOP TRAINING QUALIFIES YOU.

How to be a Successful Television Technician

If you want to reach your goal as a Successful Service Technician you will need plenty of "KNOW HOW" to qualify for the better servicing jobs or profitable shop ownership.

SEND FOR FREE BOOK TODAY!

WESTERN TV offers real experience on live equipment in our **BIG SHOPS AND LABORATORIES** in the shortest practical time under expert instructors. Graduates are in big demand because they have the "field experience" necessary for immediate "bench" or supervisory positions. You learn every phase of Radio and TV servicing (AM, FM, VHF, UHF). WTI men win fast promotion . . . can demand better pay . . . develop highly profitable businesses of their own with the latest and most **PRACTICAL PERSONALIZED TRAINING BEHIND THEM.** You concentrate all your time on being a **PROFESSIONAL TV SERVICE TECHNICIAN**—non-essential math and engineering theory omitted. YOU CAN EARN WHILE YOU LEARN. Special Finance Plan. **APPROVED FOR VETERANS.** Find out how you can get into the **TOP PAY GROUP**—Send for this fact-packed book NOW!

WESTERN TELEVISION INSTITUTE America's Leading Television Servicing School

Western Television Institute Dept. E-3-4
341 W. 18th St., Los Angeles 15, Calif.
Without obligation, please send FREE fully illustrated booklet. (No salesman will call.)

NAME _____ AGE _____
ADDRESS _____
CITY _____ ZONE _____ STATE _____

Sensational Saving For STANDARD BRAND users

- OF THE 5 TOP-LEADING TUBE MANUFACTURERS
- FULLY GUARANTEED
- INDIVIDUALLY BOXED
- FIRST QUALITY

NO SECONDS OR REHASHED "BARGAINS," YOU CAN PLACE YOUR CONFIDENCE IN OUR DEPENDABLE NEW TUBES.

Tube Orders Over \$25.00, with full remittance, PREPAID to you in U.S.A.

Type	Net	Type	Net	Type	Net
0A2	.90	6BA6	.60	12BD6	.75
0B2	.80	6BC5	.69	12BE6	.64
0C3/VR105	.91	6BE6	.63	12BH7	.85
0D3/VR150	.89	6BG6G	1.79	12BY7	1.05
0Z4	.50	6BH6	.80	12S27	1.10
1A7GT	.77	6BJ6	.85	12SA7	.64
1B3GT	.85	6BK7	1.10	12SF5	.70
1B27	1.50	6BL7GT	1.00	12SG7	.80
1H5GT	.77	6BN6	1.20	12SH7	.63
1L4	.60	6BQ6GT	1.17	12SJ7	.55
1L6	.50	6C07A	1.23	12SK7	.61
1LA6	1.10	6BY5G	1.35	12SL7GT	.55
1LB4	1.10	6BZ7	1.28	12SN7GT	.70
1LN5	1.10	6C4	.50	12SQ7GT	.55
1NSGT	.95	6C6	.50	12SR	.69
1N21B	1.80	6CB6	.65	12SX7GT	1.10
1N23B	2.25	6CD6G	1.80	14F7	.75
1N34B	.75	6CU6	2.10	19B6G6	2.05
1N48A	.50	6D6	.75	25BQ6GT	1.25
1N54	.75	6F4	3.50	25L6GT	.62
1R4	.59	6F5	.68	25W4GT	.65
1R5	.75	6F5GT	.68	25Z5	.70
1S5	.70	6F6	.70	25Z6GT	.59
1T4	.75	6G	.80	28D7	1.55
1U4	.50	6FG	.85	35A5	.62
1U5	.70	6GG6	.85	50B5	.60
1V	1.03	6H6	.52	35C5	.62
1V2	.90	6J4 (RCA)	5.10	35L6GT	.65
1X2A	.85	6J5	.50	35W4	.45
1Z2	3.25	6J6	.75	35Z3	.70
2C51	3.90	6J7	.75	35Z5GT	.48
2E26	3.40	6K4 (Sylv)	2.25	50A5	.75
2E30 (Hyt)	2.05	6K4A	2.25	50B5	.65
2J39	7.95	6K6GT	.59	50C5	.65
2J61	37.50	6K7	.60	50L6GT	.65
2J82	33.00	3L6G	1.10	80	.66
2K28	27.55	6L6A	1.10	81	.75
2X2	.45	6L6M	1.25	83V	1.15
3A4	.59	6L7	.80	84/824	.65
3BP11	9.00	6N7M	.70	117Z3	.75
3B7	.39	6Q7GT	.80	117Z6	.98
3B28	4.25	6S4	.58	211/VT4C	.98
3C23 (GE)	8.50	6S7M	.98	304TH	7.75
3C24/24G	1.15	6S7	.88	310A (WE)	3.50
3Q4	.89	6SD7GT	.80	407A (WE)	3.50
3Q5GT	.90	6SG7	.66	408A (WE)	2.50
3S4	.75	6SH7	.98	803	3.25
3L4	.90	6SK7	.65	805	2.95
3V4	.75	6SK7	.61	807	1.50
4B24	4.50	6SL7GT	.65	809	2.95
4D22	18.50	6SN7GT	.73	812A	2.60
5AW4	1.55	6S07	.58	816	1.20
5D21	11.95	6T8	.89	830B	2.75
5R4GY	1.50	6U8	.90	866A (JAN)	1.25
5U4G	.56	6V3	1.15	866A (CBS)	1.75
5W4G	.80	6V6GT	.59		
5X4G	.75	6W4GT	.59		
5Y3GT	.44	6W6GT	.50		
6A8GT	1.10	6X5GT	.50		
6A84	.65	6X8	.85		
6A87	.95	7A7	.75		
6AC7	1.04	7A8	.69		
6AF4	1.39	7B6	.75	955	.42
6AG5	.71	7B7	.76	991/NE16	.50
6AG7	1.10	7B8	.78	CK1005	.75
6AH4GT	.80	7C4	.29	1616	.88
6AH6	.88	7C5	.69	1622/6L6M	1.95
6AJ5	1.30	7C30	85.00	1625	.35
6AK5	.79	7E5	.39	1626	.18
6AK6	.98	7F7	.85	1629	.25
6AL5	.55	7F8G	1.55	2050	1.40
6AN4	1.50	7H7	.70	5516 (Hyt)	7.25
6AQ5	.55	7N7	1.20	5528/C6L	5.00
6AQ6	.73	7Q7	.98	5654	2.25
6AS5	.70	12A7	.50	5656	10.00
6AS6	1.95	12A7	.89	5670	3.25
6AS7G	3.75	12A07	.79	5687	2.95
6AT6	.48	12AV6	.50	5691	7.60
6AU6	.59	12AV7	.90	5693	6.25
6AV5GT	1.10	12AW6	.88	5814	1.95
6AV6	.48	12AX7	.70	9002	.75
6AX4GT	.72	12AY7	1.90	9003	1.10
6AX5GT	.80	12B4	.98	9004	.35
6B8	.75	12BA6	.65	9006	.29

LARGE QUANTITY R72A (G.E.) \$3.25 10 for \$29.50

Above is only a partial listing of our huge stock. Types not listed may be ordered at approx. the same savings. Many new special purpose types in stock.

FOR RUSH ORDERS OF \$75 OR MORE.

AUTHORIZED DISTRIBUTORS

CBS-HYTRON EIMAC WESTINGHOUSE

KARLSON SPEAKER ENCLOSURES

In Stock - Home - Mail - Order - Models - Available - Write for Special Prices.

ORDER MODELS AVAILABLE, WRITE FOR SPECIAL PRICES.

TUBE CARTONS

Two-Colored Cartons With New Safety Partitions . . . Prevents Tube Breakage. Thick Super-Gloss Red and Black Carton is the Most Distinctive Box Available Today.

SIZE

Miniature . . . (6AU6, 6AL5, etc.) . . . EACH \$0.1

GT . . . (6SN7, 6W4, etc.) . . . \$0.125

LARGE GT . . . (1B3, 6BQ6GT, etc.) . . . \$0.15

LARGE G . . . (5U4G, 6BQ6G, etc.) . . . \$0.2

Minimum - 100 any one size.

Quantity prices on request.

FREE SAMPLES, if requested on your letterhead.

BARRY ELECTRONICS CORP.

136B Liberty Street, N. Y. 6, N. Y. Rector 2-2562

Terms: 25% with order, balance C.O.D. All merchandise guaranteed. F.O.B. N.Y.C.

ADVERTISING INDEX

Radio-Electronics does not assume responsibility for any errors appearing in the index below.

Acro Products	119
All Channel Antenna Corp.	117
Allied Radio Corp.	11
American Phenolic Corp.	100, 101
Amplifier Corporation of America	145
Arkay Radio Kits, Inc.	116
Astatic Corp.	16
Atlas Sound Corp.	150
Audel Publishers	150
Barry Electronics	152
Bell Telephone Labs.	14
Blonder-Tongue Labs.	18
Brooks Radio & TV Corp.	103
Burstein-Appelbee Co.	110
CBS Hytron (Division of Columbia Broadcasting System)	17
Capitol Radio Engineering Institute	25
Centralab Div. of Globe Union	90, 130, 225
Century Electronics Co.	144
Channel Master Corp.	20, 21
Chicago Standard Transformer Corp.	114
Cisin, H. G.	136
Cleveland Institute of Radio Electronics	9
Collins Audio Products	104
Columbia Wire Supply Co.	149
Commissioned Electronics	128
Concord Radio	126
Cornell-Dubilier Electric Corp.	102, 118
Corona Radio	121
Coyne Electrical & TV Radio School	23, 140, 144
Davis Electronics	145
Derr Co., C. R.	121
DeVry Technical Institute	7
DeCray & Associates, Frank W.	128
Doc's Radio Tools	121
Douglas Instrument Co.	120
Dumont Labs., Allen B.	Inside Front Cover
Edlie Electronics	131
Editors & Engineers	110
Electro Products Labs.	135
Electro-Voice, Inc.	146
Electron Tube Wholesalers, Inc.	108
Electronic Chemical Corp.	149
Electronic Instrument Co.	30, 146
Electronic Measurements Corp.	122
Eimhurst Radio & TV Service	126
Fair Radio Sales	119
Federated Purchaser	139
Fenton Co.	135, 140
General Test Equipment	121
Gond, Inc., Don	119
Hallcrafters Co.	126
Harvey Radio Co., Inc.	120
Heath Co.	66-77 inclusive
Hickok Electrical Instrument Co.	105
Hunbes Research & Development Labs	139
Indiana Technical College	118
Institute of Radio Engineers, The	106
Instructograph Co.	120
International Correspondence Schools	93
International Rectifier Corp.	109
JFD Manufacturing Co., Inc.	111
Jones & Laughlin Steel Corp.	127
Kay-Townes Antenna Co.	112, 113
Krylon	80
Leader Electronics	149
Leotone Radio Corp.	83
Mallory & Co., Inc., P. R.	Inside Back Cover
Mattison Television & Radio Corp.	134
McGraw-Hill Book Co.	148
Mood, R. A.	131
Mosley Electronics	152
National Electronic Distributing Co.	115
National Electronics of Cleveland	147
National Radio Institute	3
National School	13
Ohmite Manufacturing Co.	87
Opportunity Adlets	108
Perma-Power Co.	82
Philco Corp.	99
Precision Development Corp.	133
Precision Apparatus Co., Inc.	102
Pres-Probe Co.	118
Progressive Edu-Kits, Inc.	121
Quam-Nichols Co.	121
RCA Institute, Inc.	107, 109
RCA Victor Division (Radio Corporation of America)	Back Cover
Rad Tel Tube Co.	143
Radco Manufacturing Co.	92
Padiart Corp.	28, 29
Radio City Products	92
Radio Receptor, Inc.	125

RADIO SCHOOL DIRECTORY PAGE 151

Candler System Co.	
Capitol Radio Engineering Institute	
Grantham School of Electronics	
Indiana Technical College	
Indianapolis Electronic School	
Milwaukee School of Engineering	
RCA Institutes, Inc.	
Tri-State College	
Valparaiso Technical Institute	
Western Television Institute	

Radio-Television Training Ass'n.	15
Raytheon Manufacturing Co.	12
Rek-O-Kut Co.	116
Rider, Inc., John F.	93
Rinehart Books, Inc.	81, 129, 134, 141, 146, 150
Rogers Electronics Corp.	137
Rohn Manufacturing Co.	132
Sams & Co., Inc., R. W.	26, 142
Sangamo Electric Co.	96
Scala Radio Co.	114
Service Instruments Co.	138
Shure Bros., Inc.	26
Sprague Products	85
Sprayberry Academy of Radio	65, 148
Stan-Burr Radio & Electronics	143
Steve-EI Electronics Corp.	144
Stromberg-Carlson Co.	106
Sun Parts Distributors Ltd.	145
Superior Instrument Co.	88, 89
Supreme Publications	125
Sylvania Electric Products	145
Tab	154
Tallen Co., Inc.	116
Tech-Master Products	147
Television Communications Institute	132
Television Hardware Manufacturing Co.	19
Transamerica Electronics Corp.	137
Transvision, Inc.	120, 140, 141
Triad Transformer Corp.	142
Tung-Sol Electric Co.	10
Turner Co.	23
Ultra Audio Broadcasting System	129
United Catalog Publishers	110
University Loudspeakers	145
V-M Corporation	98
Waisco Electronics Corp.	27
Ward Products Corp.	95
Webster Electric Corp.	24
Wheatland Co., Inc.	128
Windsor Electric Tube Co.	86
Winpower Manufacturing Co.	108
Xcelite, Inc.	131
Zingo Products	131

NO BROKEN LEADS

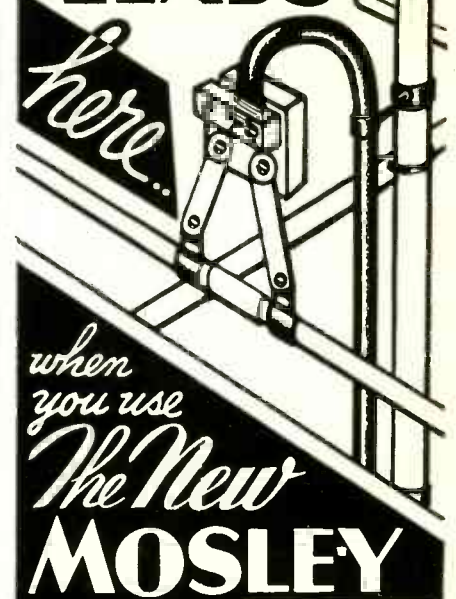

when you use The New MOSLEY "Y-Ty"

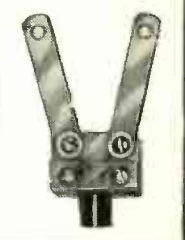

LIST PRICE \$.80

PATENT APPLIED FOR

- Low Loss, Permanent Connections Of Transmission Line and Phasing Strips To TV Antenna Elements!
- For UHF and VHF Antennas!
- For All Types Transmission Line!
- Eliminates Roof-top Soldering Jobs!
- Quick - Easy to Install!
- Available In Two Sizes To Fit All Antennas!

CATALOG 263-S For all UHF Antennas and most VHF Yagis, Conicals, Inline, and other type antennas where distances between terminals is 4" or less.

CATALOG 263-L For TRIO Zig-Zag, and other antennas where distance between terminals is 6" or less.

Your reputation hangs on fine threads of copper. Use the MOSLEY "Y-TY" on Every Installation Job To Stop Antenna Call-backs!

The NEW MOSLEY "Y-TY" now available at Radio and Television Parts Distributors - Coast-to-Coast!



WRITE FOR FREE COPY OF THIS CATALOG

Mosley Electronics, Inc.
8622 ST. CHARLES ROCK ROAD
ST. LOUIS 14, MISSOURI

the new GERNSBACK LIBRARY

top technical information at low cost

TV Repair Techniques—No. 50.

Top technician-writers tell how to recognize, find and correct quickly, the tricky TV servicing problems which stump even the experts. A few minutes reading this book can save you hours of servicing time. 128 Pages. Over 100 Illustrations. \$1.50



Radio & TV Test Instruments—No. 49.

How to build just about every instrument required for modern TV-radio servicing. Plus chapters on constructing a practical servicing bench and carrying case. 128 Pages. Over 100 Illustrations. \$1.50

High-Fidelity — Design, Construction, Measurements—No. 48.

An audio man's audio book. How to get top performance from a high-fidelity system. New 3-way approach. 21 top audio men wrote this book. 128 Pages. Over 100 Illustrations. \$1.50



Radio & TV Hints—No. 47.

Offers over 300 sure-fire hints, gimmicks, and short cuts on radio, TV and audio. Gathered from the hard-earned experience of experts. Grouped in seven sections. 112 Pages. 132 Illustrations. \$1.00

Television Technotes—No. 46.

Cut routine trouble shooting to the bone in TV servicing. Here are the symptoms, causes and cures of over 600 troubles which occur in scores of sets made by leading manufacturers. 128 Pages. \$1.50



Basic Radio Course—No. 44.

John T. Frye's classic on fundamentals! For the practical man who wants to learn theory. Covers everything from Ohm's Law to advanced servicing in a style which makes learning fun. 176 Pages. Cloth cover. \$2.25

Best sellers on Radio and Audio

Radio Tube Fundamentals—No. 45

How and why tubes behave as they do in modern radio circuits. Written for the technician. 96 Pages. \$1.00

Model Control By Radio—No. 43

Remote control of model planes, boats and trains. Theory and construction details. 112 Pages. 114 Illustrations. \$1.00

High-Fidelity Techniques—No. 42

One of the best written and most informative high-fidelity books published—at any price. By James R. Langham. 112 Pages. \$1.00

Public-Address Guide—No. 41

Covers every phase of PA installation and maintenance plus construction details. 80 Pages. Illustrated. 75¢

Practical Disc Recording—No. 39

Covers theory and practical techniques. A full chapter for each important recording component. 96 Pages. 75¢

The quality of the technical writing, the scope of the contents and the low price, make the Gernsback Library books on TV, radio and high-fidelity a unique value in the field.

From the publishers of
RADIO-ELECTRONICS

See your distributor—or mail this coupon

GERNSBACK PUBLICATIONS, INC., Dept. 34
25 West Broadway
New York 7, N.Y.

Enclosed is my remittance of \$ _____
Please send me the following books postpaid.

- 39 41 42 43 44
 45 46 47 48 49 50

Name _____
(Please print clearly)

Street _____

City _____ Zone _____ State _____

SOLVE your hi-fidelity problems with
University
CONE SPEAKERS
**-HIGHEST QUALITY!
-LOWEST COST!**



MODEL 6201 — COAXIAL SPEAKER SYSTEM. Now generally acknowledged to be industry's finest value in a high quality 12" speaker. TRUE coaxial dual range system comprising clean sounding woofer with heavy exclusive Alnico 5W magnet, DRIVER TYPE tweeter with "Reciprocating flares" wide angle horn, and BUILT-IN crossover network complete with "Balance" control.

DIFFUSICONE-12 — WIDE RANGE WIDE ANGLE 12" SPEAKER. Exclusive "diffusicone" design utilizes the benefits of dual-horn loading, radial projection and diffraction principles to achieve unsurpassed quality and sound distribution from a single unit speaker. Enjoy full fidelity ANYWHERE in the room . . . at a surprisingly reasonable cost.



DIFFUSICONE-8 — WIDE ANGLE 8" SPEAKER. Same as the Diffusicone-12 except in 8" size. Remarkable fidelity and exceptional sensitivity and power handling capacity make this a truly outstanding eight. Ideal for use where space is limited, and is also a perfect selection for a mid-range speaker in 3-way systems.

MODEL 6200—EXTENDED RANGE 12" SPEAKER. Designed for general applications, capable of highly efficient FULL-BODIED response throughout the operating spectrum. May be used with equal facility to improve commercial radio, TV, phono sets, high quality sound re-inforcement in night clubs, churches, schools, etc., or as a woofer. The 6200 must be heard to be appreciated.



MODEL C-15W—DUAL IMPEDANCE RANGE 15" WOOFER. Brand new low frequency reproducer embodying many exclusive advance features. Its superior response and acoustic output is due, in part, to a newly University-developed cone and voice coil suspension system permitting the greatest axial movement ever achieved. The incredibly low distortion results from a new magnet assembly.

There is a UNIVERSITY Tweeter for every application and pocketbook. Write for descriptive illustrated literature. Address Desk H-12

University
LOUDSPEAKERS INC
80 SO. KENSICO AVE., WHITE PLAINS, N. Y.

FIRST
... in
more ways
than one!

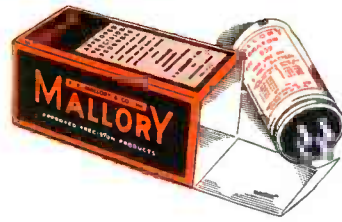

First On The Market . . . more than 20 years ago Mallory produced the first commercial Vibrators.

First As Original Equipment . . . today Mallory produces more Vibrators for set manufacturers than all other makes combined.

First With Servicemen . . . surveys show that Mallory Vibrators are preferred and used by 5 out of 6 servicemen.

Your Work Is Right The First Time when you use Mallory Vibrators. The patented, tuned mechanism assures completely dependable performance... always. Ask for Mallory Vibrators by name.

**Cover 75% of Your Replacement Needs
with just 6 Mallory Vibrators!**

Ask your Distributor about Mallory Deal 2448 which includes these 6 fast moving Vibrators.

And be sure you have a copy of the current Mallory Vibrator Guide. It is a complete cross reference listing and service guide—the most recent edition of a publication serving servicemen for nearly 25 years.

P. R. MALLORY & CO. Inc.
MALLORY

CAPACITORS • CONTROLS • VIBRATORS • SWITCHES • RESISTORS
RECTIFIERS • POWER SUPPLIES • FILTERS • MERCURY BATTERIES
APPROVED PRECISION PRODUCTS

P. R. MALLORY & CO. Inc., INDIANAPOLIS 6, INDIANA

\$50,000 "TELL & SELL" CONTEST

For Dealers and Servicemen* who use RCA Tubes



1954 DeSoto Automatic "Hard-Top"—170-H.P. Fire Dome V8 engine, Power-Flite Transmission, Power Steering . . . completely equipped, including radio and heater.

1954 Dodge Deluxe 1/2-Ton Panel Truck—complete with "Truck-o-matic transmission," radio, heater and accessories . . . plus a full set of RCA Test Equipment, aluminum ladder, and winner's business name and address on truck panel.

Here's all you do—

Get an entry blank from your RCA Tube Distributor Salesman. Complete the following sentence in 25 additional words or less:—

"I use and recommend RCA Tubes because"
It's as easy as that . . . and you may enter as often as you like, but each entry must be on an official entry blank.

Hints to help you win

See your RCA Distributor Salesman right away. He has a copy of the "clue book" waiting for you. This book contains full details on the whole exciting "Tell and Sell"

Campaign, including contest rules.

You may win first prize . . . so don't waste a moment. Contest closes April 30, 1954.

*Your RCA Distributor Salesman will be glad to help you . . . because if you win, he wins a duplicate prize!



400 FABULOUS PRIZES

including:

- * TV sets
- * Watches
- * Cameras
- * Air Conditioners
- * Test Equipment
- * Radios
- * Ranges

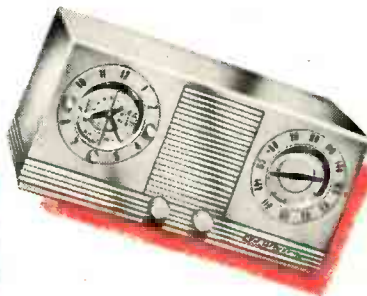

RADIO CORPORATION of AMERICA
ELECTRON TUBES

HARRISON, N. J.