

DECEMBER 1953

RADIO - ELECTRONICS

TELEVISION SERVICING HIGH FIDELITY

HUGO GERNSBACH, Editor

In this issue:

Automatic Gain
Control

•

Miniature Transistor
Hearing Aid

•

Attenuator Design

•

Servicing TV With
a Wattmeter



30¢

U. S. and
CANADA

Merry Christmas!

Look at the Selling Power

of the RCA Radio Battery Package

SMART RCA package design means faster sales, greater inventory turnover for radio dealers and servicemen selling RCA Radio Batteries. This outstanding package styling is another example of the powerful sales appeal of the *Radio Battery for the Radio Trade*.

Call your RCA Battery
Distributor for fast, reliable
service. Stock, sell and
promote RCA Batteries—
*the Radio Battery
for the Radio Trade.*



STEEL-ENCASED (certain types only)

Special steel casings on RCA Battery types VS216, VS236, VS036, VS035, VS084, VS085, and VS086 protect their contents—control bothersome swelling, resist leakage, and damage from shock. This important feature will help you sell more of these RCA Battery types



FAMOUS RCA MONOGRAM

Consumers everywhere recognize RCA as the "greatest name in radio." The RCA trademark stands for experience in the marketing of quality products for radio. It is your assurance of immediate customer acceptance



REPLACEMENT AID

You see, at a glance on the side of the RCA Battery carton, which portable battery types of other manufacturers it will replace. This is another way RCA Batteries help you turn every customer inquiry into a battery sale



REPEAT BUSINESS PROMOTION

Space is provided right on the RCA Battery carton for you to stamp your name and address. In this way you can advertise your own store . . . remind the battery user to come back to you for fresh replacements



SMART DESIGN

RCA Radio Batteries are colorfully styled to catch the customer's eye when displayed in store windows, on counters, in merchandisers, and on shelves. You can use this valuable design in reminding customers to buy RCA Radio Batteries



RADIO CORPORATION of AMERICA
RADIO BATTERIES
HARRISON, N. J.

ADVANCE! Raise your earning power—learn RADIO-TELEVISION-ELECTRONICS by SHOP-METHOD HOME TRAINING

GOOD JOBS AWAIT THE TRAINED RADIO-TV TECHNICIAN

There is a place for *you* in the great Radio-Television-Electronics industry when you are trained as National Schools will train you at home!

Trained technicians are in growing demand at good pay—in manufacturing, broadcasting, television, communications, radar, research laboratories, home Radio-TV service, and other branches of the field. National Schools Master Shop-Method Home Training, with newly added lessons and equipment, trains you in your spare time, right in your own home, for these fascinating opportunities. **OUR METHOD IS PROVED BY THE SUCCESS OF NATIONAL SCHOOLS TRAINED MEN, ALL OVER THE WORLD, SINCE 1905.**

EARN WHILE YOU LEARN

Many National students pay for all or part of their training with spare time earnings. We'll show you how you can do the same! Early in your training, you receive "Spare-time Work" Lessons which will enable you to earn extra money servicing neighbors' and friends' Radio and Television receivers, appliances, etc.



Signal Generator

Audio Oscillator

T. R. F. Receiver

National Schools Training is All-Embracing
National Schools prepares you for your choice of many job opportunities. Thousands of home, portable, and auto radios are being sold daily—more than ever before. Television is sweeping the country, too. Co-axial cables are now bringing Television to more cities, towns, and farms every day! National Schools' *complete* training program qualifies you in all fields. Read this partial list of opportunities for trained technicians:

- Business of Your Own • Broadcasting
- Radio Manufacturing, Sales, Service • Telecasting
- Television Manufacturing, Sales, Service
- Laboratories: Installation, Maintenance of Electronic Equipment
- Electrolysis, Call Systems
- Garages: Auto Radio Sales, Service
- Sound Systems and Telephone Companies, Engineering Firms
- Theatre Sound Systems, Police Radio
- And scores of other good jobs in many related fields.

TELEVISION TRAINING

You get a complete series of up-to-the-minute lessons covering all phases of repairing, servicing and construction. The same lesson texts used by resident students in our modern and complete Television broadcast studios, laboratories and classrooms!



MASTER ALL PHASES!

Get Master Shop-Method Home Training from an Established Practical Resident School with its own Training — almost 50 Years of Successful Experience in Training Ambitious Men.



We Bring National Schools To You!

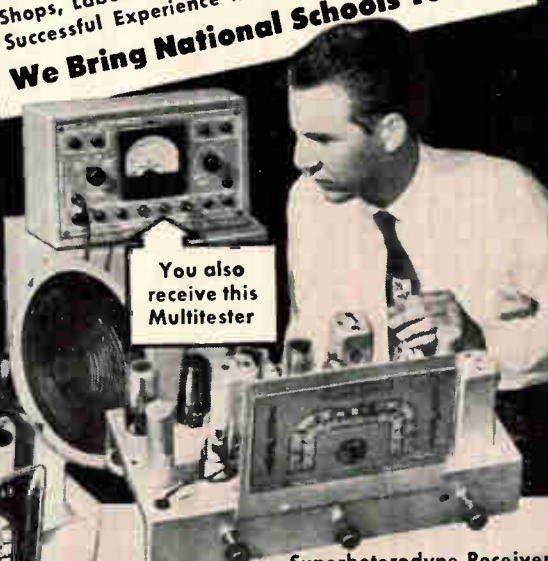

You also receive this Multitester

Superheterodyne Receiver

FREE! RADIO-TV BOOK AND SAMPLE LESSON!

Send today for National Schools' new, illustrated Book of Opportunity in Radio-Television-Electronics, and an actual Sample Lesson. No cost—no obligation. Use the coupon now—we'll answer by return airmail.

This course also offered in Spanish and Portuguese

APPROVED FOR VETERANS AND NON-VETERANS
Check coupon below

Both Resident and Home Study Courses Offered!

NATIONAL SCHOOLS

LOS ANGELES 37, CALIFORNIA • ESTABLISHED 1905
IN CANADA: 193 E. HASTINGS STREET, VANCOUVER, B.C.



GET FACTS FASTEST! MAIL TO OFFICE NEAREST YOU!

(mail in envelope or paste on postal card)

NATIONAL SCHOOLS, Dept. RG-123

4000 S. Figueroa Street Los Angeles 37, Calif. or 323 West Polk Street Chicago 7, Ill.

Send FREE Radio-TV Electronics book and FREE sample lesson. No obligation, no salesman will call.

NAME _____ BIRTHDAY _____ 19__

ADDRESS _____

CITY _____ ZONE _____ STATE _____

Check here if interested in Resident School Training at Los Angeles.
VETERANS: Give Date of Discharge _____

RADIO - ELECTRONICS

Formerly RADIO-CRAFT • Incorporating SHORT WAVE CRAFT • TELEVISION NEWS • RADIO & TELEVISION

Hugo Gernsback
Editor and Publisher

M. Harvey Gernsback
Editorial Director

Fred Shunaman
Managing Editor

Robert F. Scott
W2PWG, Technical Editor

Jerome Kass
Associate Editor

I. Queen
Editorial Associate

Matthew Mandl
Television Consultant

Charles A. Phelps
Copy Editor

Angie Pascale
Production Manager

Wm. Lyon McLaughlin
Tech. Illustration Director

Sol Ehrlich
Art Director

Lee Robinson
General Manager

John J. Lamson
Sales Manager

G. Aliquo
Circulation Manager

Adam J. Smith
Director, Newsstand Sales

Robert Fallath
Promotion Manager



Member
Magazine Publishers
Association

THE COVER:
Color original by Habershaw Studios; radio and TV equipment shown in photo furnished courtesy Terminal Radio Corporation, New York, N. Y.

CONTENTS

DECEMBER, 1953

RADIO-ELECTRONICS Index Volume XXIV		
January through December 1953		127
Editorial (Page 29)		
Electronics vs. Atomic Bombs	by Hugo Gernsback	29
Audio—High Fidelity (Pages 30-43)		
Budget Remote Line Amplifier	by George L. Augspurger	30
High-Quality Audio, Part IV—The Phonograph Pickup by Richard H. Dorf		33
Attenuator Design	by Norman H. Crowhurst	36
Miniature Hearing Aid	by David T. Armstrong	40
Build an IM Analyzer	by William Austin	42
Television (Pages 44-53)		
Radiation Problems	by E. D. Lucas	44
TV DX in December		46
Servicing TV With a Wattmeter	by John B. Ledbetter	47
Television—It's a Cinch (Seventh conversation, second half: Multivibrator Sweep Circuits)	by E. Aisberg	48
TV Service Clinic	Conducted by Matthew Mandl	50
Circuit Shorts (More A.G.C. Circuits)	by Robert F. Scott	52
A Broad-Band V.H.F. Antenna		53
Test Instruments (Pages 54-58)		
Instrument Output Indicator	by Louis E. Garner, Jr.	54
Intermittent Recorder	by Joseph Racker	57
Practical Impedance Checker	by Albert L. Sohl	58
Electronics (Pages 59-96)		
Project Tinkertoy	by Steven Michaels	59
Simple Tubeless Photo Timer	by Kai M. Klømm	74
The Ionic Oscillator	by Thomas E. Fairbairn	76
Magnetostrictive and Electrostrictive Industrial Ultrasonic Apparatus	by Neil Clark, Jr., Robert Quint and Robert Roske	82
Adfojet, Mark II	by Ed Bukstein	96
Radio (Pages 98-101)		
Rating Power Transformers	by Darwin H. Harris	98
Improved TV and FM Alignment Procedure	by John Van Dormolen	101
New Design (Pages 103-105)		
New Tubes		103
Departments		
The Radio Month	8	Technotes 113
Radio Business	16	Try This One .. 115
With the		Radio-Electronic .. 117
Technician .. 106		Circuits 120
New Patents .. 108		Question Box .. 120
New Devices .. 110		People 124
		Miscellany 126
		Communications .. 138
		Electronic .. 140
		Literature .. 142
		Book Reviews .. 142



MEMBER Audit Bureau of Circulations

Vol. XXIV, No. 12

Average Paid Circulation over 173,000

RADIO-ELECTRONICS, December 1953, Vol. XXIV, No. 12. Published monthly at Erie Ave., F to G Sts., Philadelphia 32, Pa., Gernsback Publications, Inc., Entered as Second Class matter September 27, 1948, at the Post Office at Philadelphia, Pa., under the Act of March 3, 1879.
SUBSCRIPTION RATES: In U. S. and Canada, and in U. S. possessions, \$3.50 for one year; \$6.00 for two years; \$8.00 for three years; single copies 30¢. All other foreign countries \$4.50 a year, \$8.00 for two years; \$11.00 for three years.
EXECUTIVE, EDITORIAL and ADVERTISING OFFICES: 25 West Broadway, New York 7, N. Y. Telephone REctor 2-8630. Gernsback Publications, Inc. Hugo Gernsback, President; M. Harvey Gernsback, Vice-President; G. Aliquo, Secretary.
SUBSCRIPTIONS: Address correspondence to Radio-Electronics, Subscription Dept., Erie Avenue, F to G Sts., Philadelphia 32, Pa., or 25 West Broadway, New York 7, N. Y. When ordering a change please furnish an address stencil impression from a recent wrapper. Allow one month for change of address.
BRANCH ADVERTISING OFFICES: Chicago: 7522 North Sheridan Road, Tel. Rogers Park 4-8000. Los Angeles: Ralph W. Harker and Associates, 1127 Wilshire Blvd., Tel. Madison 6-1271. San Francisco: Ralph W. Harker and Associates, 582 Market St., Tel. GArfield 1-2481. **FOREIGN AGENTS:** Great Britain: Atlas Publishing and Distributing Co., Ltd., London E.C.1. Australia: McGill's Agency, Melbourne. France: Brentano's, Paris 2e. Belgium: Agence et Messageries de la Presse, Brussels, Holland: Trilectron, Heemstede, Greece: International Book & News Agency, Athens. So. Africa: Central News Agency Ltd., Johannesburg; Capetown, Durban, Natal. Universal Book Agency, Johannesburg. Middle East: Steimatzky Middle East Agency, Jerusalem. India: Broadway News Centre, Dadar, Bombay #14. Pakistan: Paradise Book Stall, Karachi 3. Copyright 1953 by Gernsback Publications, Inc. Text and illustrations must not be reproduced without permission of copyright owners. **POSTMASTER:** If undeliverable send form 3578 to RADIO-ELECTRONICS, 25 West Broadway, New York 7, N. Y. *Trademark registered U.S. Patent Office.

All Electronic Parts
YOURS TO KEEP!

Now!
Work over
300
practical projects
WITH THESE
PARTS...



MULTIMETER



5 INCH
"SCOPE"

...TO
HELP YOU LEARN

TELEVISION

RADIO-ELECTRONICS Now... at home in spare time you can get BOTH the very training and subsequent Employment Service you need to help you start earning real money in America's thrilling, multi-billion dollar opportunity field of Television-Radio-Electronics. Now that Television is coming to almost every community, here is a chance of a lifetime to prepare to cash in on one of Television's great expansions.

D.T.I.'s amazingly practical home method enables you to set up your own HOME LABORATORY. You get many Electronic parts which you mount on individual bases with spring clip connectors. Tops for experimenting! Add or remove parts in a jiffy. No wasted hours of soldering and unsoldering for each project. You spend minimum time to get maximum knowledge of important circuits that really work. In fact, you get exactly the same type of basic training equipment used in our Chicago training laboratory—one of the nation's finest.

Build and KEEP This VALUABLE TEST EQUIPMENT

Your home laboratory projects also include building and keeping a versatile 5 inch Oscilloscope and precision Jewel Bearing Multi-Meter. These quality commercial test instruments help you EARN WHILE YOU LEARN and will prove mighty valuable, should you later decide to start your own full time TV-Radio service business. You also build and keep a quality 21 inch TV SET.

D.T.I. Provides EVERYTHING YOU NEED to master TELEVISION

In addition to your home laboratory and easy-to-read lessons, you even use HOME MOVIES—a wonderfully effective and exclusive D.T.I. training advantage. You watch hidden actions... see electrons on the march. Important fundamentals... become "movie clear," helping you learn faster... easier... better.

Full time Residential training in D.T.I.'s great Chicago laboratories also available. MAIL COUPON TODAY for all facts. (If subject to Military Service, you'll especially welcome the information we have for you.)



89 WAYS TO EARN MONEY

MAIL COUPON TODAY!

21 INCH

Build and keep this BIG DTI Engineered TV set—easily converted to U.H.F. (DTI offers another home training, but without the TV set.)

"ONE OF AMERICA'S FOREMOST TELEVISION TRAINING CENTERS"
— Established 1931 —



DEFOREST'S TRAINING, INC.
AFFILIATED WITH
DEVRY Technical INSTITUTE
CHICAGO 14, ILLINOIS

DeForest's Training, Inc., Dept. — RE-12-J
2533 N. Ashland Ave., Chicago 14, Ill.

I would like your valuable information-packed publication showing how I can get started toward a good job or my own business in Television-Radio-Electronics.

Name _____ Age _____
Street _____ Apt. _____
City _____ Zone _____ State _____

It takes the **WORLD'S Newest PICTURE TUBE PLANT...**

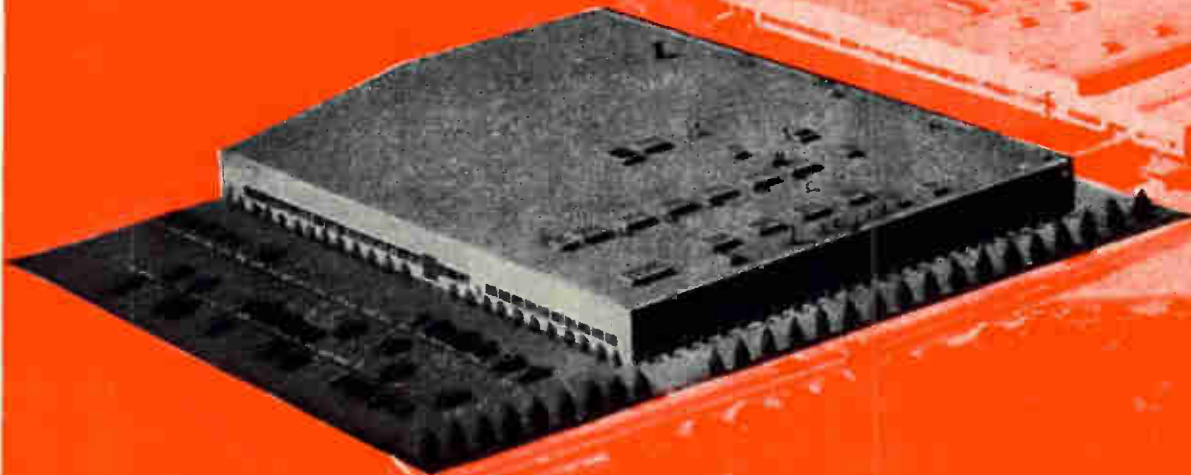

Equipped with the **WORLD'S LARGEST SETTLING MACHINE...**



A BAKE OVEN
as Big as They Come...



And the **WORLD'S LARGEST EXHAUST MACHINE...**



to make the **WORLD'S Finest TELEVISION PICTURE TUBES...**

RAYTHEON  **PICTURE TUBES**

The only way to make large screen (21", 24" and 27") TV Picture Tubes of unsurpassed quality is to make them with equipment especially designed to handle and produce them. That's why Raytheon built and has in operation this miracle of a picture tube plant, which houses the world's finest, largest and most advanced equipment and methods for making large size Picture Tubes. This magnificent new plant is one more indication of Raytheon's dedication to a single ideal — to continue to supply you with the finest quality Television and Radio Tubes the world has ever known.



RAYTHEON MANUFACTURING COMPANY

Excellence in Electronics

Receiving Tube Division
Newton, Mass., Chicago, Ill., Atlanta, Ga., Los Angeles, Cal.

RAYTHEON MAKES ALL THESE

RECEIVING AND PICTURE TUBES • RELIABLE SUBMINIATURE AND MINIATURE TUBES • GERMANIUM DIODES AND TRANSISTORS • NUCLEAR TUBES • MICROWAVE TUBES

RADIO-ELECTRONICS

FREE

MONEY MAKING
FCC
 Commercial-Radio Operator
LICENSE

TELLS HOW -

WE GUARANTEE
 TO TRAIN AND COACH YOU AT HOME
 IN SPARE TIME UNTIL YOU GET

**YOUR FCC
 LICENSE**

If you have had any practical experience — Amateur, Army, Navy, radio repair, or experimenting.

Here is your guarantee

If you fail to pass your Commercial License exam after completing our course, we guarantee to continue your training without additional cost of any kind, until you successfully obtain your Commercial license, provided you first sit for this examination within 90 days after completing your course.

TV Engineering

INFORMATION

INCLUDED IN OUR
 TRAINING AND
 COACHING

TELLS HOW -

OUR AMAZINGLY EFFECTIVE JOB-FINDING SERVICE HELPS CIRE STUDENTS GET BETTER JOBS. HERE ARE JUST A FEW RECENT EXAMPLES OF JOB-FINDING RESULTS:

GETS CIVIL SERVICE JOB

"Thanks to your course I obtained my 2nd phone license, and am now employed by Civil Service at Great Lakes Naval Training Station as an Equipment Specialist."
 Kenneth R. Leiser, Fair Oaks, Md. Del., McHenry, Ill.

GETS STATE POLICE JOB

"I have obtained my 1st class ticket (thanks to your school) and since receiving same I have held good jobs at all times. I am now Chief Radio Operator with the Kentucky State Police."
 Edwin Healy, 264 E. 3rd St., London, Ky.

GETS BROADCAST JOB

"I wish to thank your Job-Finding Service for the help in securing for me the position of transmitter operator here at WCAE, in Pittsburgh."
 Walter Koschik, 1442 Ridge Ave., N. Braddock, Pa.

GETS AIRLINES JOB

"Due to your Job-Finding Service, I have been getting many offers from all over the country, and I have taken a job with Capital Airlines in Chicago, as a Radio Mechanic."
 Harry Clare, 4537 S. Drexel Blvd., Chicago, Ill.

TELLS HOW -

EMPLOYERS MAKE JOB OFFERS LIKE THESE TO OUR GRADUATES EVERY MONTH!

Letter from nationally-known Airlines, "We would also appreciate if you would place the following additional advertisement in your bulletin—Wanted—Superintendent of Communications . . . Salary \$666.66 per month."

Letter from nationally known airplane manufacturer, "We need men with electronic training or experience in radar maintenance to perform operational check-out of radar and other electronics systems . . . starting salary . . . amounting to \$329.33 per month."

Letter from nationally-known Airlines, "We are contemplating placing . . . an Airline Ground Radio Engineer." Starting salary \$385 per month.

These are just a few of the examples of the job offers that come to our office periodically. Some licensed radioman filled each of these jobs; it might have been you!

Ours is the only home study course which supplies FCC-type examinations with all lessons and final tests.

ACT NOW!

Get ALL 3 FREE

Your FCC ticket is Recognized in All Radio Fields as Proof of Your Technical Ability.

HERE'S PROOF FCC LICENSES ARE OFTEN SECURED IN A FEW HOURS OF STUDY WITH OUR COACHING AT HOME IN SPARE TIME:

Name and Address	License	Lessons
Lee Worthy, 2210 1/2 Wilshire St., Bakersfield, Cal.	2nd Phone	16
Clifford E. Vogt, Box 1016, Dania, Fla.	1st Phone	20
Francis X. Foerch, 38 Beucler Pl., Bergenfield, N. J.	1st Phone	38
S/Sgt. Ben H. Davis, 317 North Roosevelt, Lebonon, Ill.	1st Phone	28
Albert Schoell, 110 West 11th St., Escondido, Cal.	2nd Phone	23

CARL E. SMITH, E.E. Consulting Engineer, President

CLEVELAND INSTITUTE OF RADIO ELECTRONICS

Desk RE-59, 4900 Euclid Bldg., Cleveland 3, Ohio

MAIL COUPON NOW!



Cleveland Institute of Radio Electronics
 Desk RE-59—4900 Euclid Bldg., Cleveland 3, Ohio
 (Address to Desk No. to avoid delay)

B I want to know how I can get my FCC Ticket in a minimum of time. Send me your FREE booklet, "How to Pass FCC License Examinations" (does not cover exams for Amateur License), as well as a sample FCC-type exam and the amazing new booklet, "Money-Making FCC License information."

Be sure to tell me about your Television Engineering Course.

Name.....
 City..... Zone..... State.....
 Address.....

Paste on 2 cent postcard or send air mail.

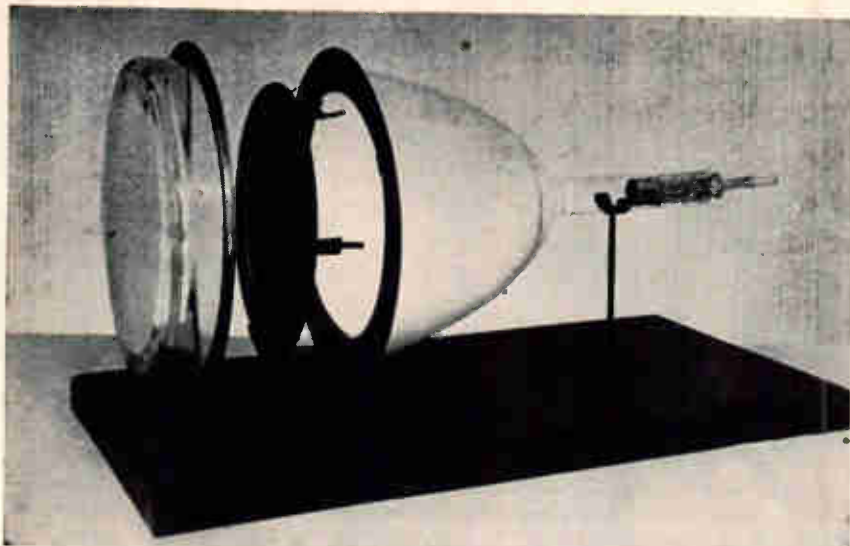

Sectional view, showing parts for the CBS-Hytron Colortron TV picture tube.

A NEW TV COLOR TUBE, the *CBS-Colortron*, was demonstrated at Danvers, Mass., October 5. The new tube is based on the familiar shadow-mask principle, in which the red, green and blue beams are channelled into the right paths by a perforated sheet placed behind the fluorescent screen. The new tube features a greatly simplified method of mounting the mask and fabricating the tube, which the manufacturer believes will eventually bring the price of color tubes down to about 30% higher than black-and-white. Full technical data on the new tube appears in the *New Tubes* article, page 103.

A few days later, a large press corps watched the first major CBS Television Network color program under the NTSC standards, on receivers installed in the Waldorf-Astoria Hotel, New York City. The same show was viewed in black-and-white on home receivers throughout the nation.

The first public demonstration was disappointing in some respects, especially when compared with the earlier one at Danvers, but shortcomings were charged off by CBS spokesmen to transmission difficulties inevitable in a new system. In a second demonstration, at the FCC color hearings held a few days later, the tube gave an excellent account of itself.

The original CBS demonstration, used field-sequential cameras. Their outputs were combined in a device called the Chromacoder, a piece of equipment developed by the CBS under the direction of Dr. Peter Goldmark. The Chromacoder translated the picture signal received from the cameras into the standard NTSC signals, which were then supplied to the transmitter.

AUDIO CONVENTION held by the Audio Engineering Society in New York City October 14, 15, 16 and 17 was the largest to date. During the four days of the convention, members heard 29 papers, presented in seven half-day sessions. The subjects ranged from music in the home through multi-channel or stereophonic music to the

design of loudspeakers, including a paper on an electrostatic tweeter.

At the Audio Fair, held concurrently with, but independently of, the convention, more than 25,000 people registered, to view the displays of 144 exhibitors, occupying four floors of the Hotel New Yorker. As in last year's exhibition, binaural and stereophonic music made a strong bid for attention. Other significant features were the increasing importance of tape, manifested by the large number of tape and tape recorder exhibits; and the development of high fidelity toward the needs of the home; indicated by the wide variety of equipment. Speaker systems alone varied over a price range of almost 30 to 1, and appeared in sizes varying from furnished-room to concert-hall types.

NAVY JET PILOTS can now depend on a new electronic device to determine whether or not they are approaching a carrier at a safe speed for landing. The new radar speed-measuring equipment, apparently an adaption of the Doppler radar principle, was developed by the Raytheon Manufacturing Co. It is installed on a carrier and "watches" the approach of a plane coming down for a landing. It then warns the landing officer if the aircraft's speed is too fast or too slow. The officer then signals his orders to the pilot, either guiding him down to a landing or waving him off for another try.

AN ALL-TRANSISTOR hearing aid which operates for one month on a 15-cent battery has been reintroduced by the Zenith Radio Corp.

The company had started production of an all-transistor hearing aid last December, but soon stopped production. While the transistors had performed satisfactorily in the laboratory, company spokesmen reported, some of them did not hold up under field tests and failed after a few days of use.

Transistors used in the current hearing aid are said to be "many times as resistant to failure" as those produced during the company's early field tests.



NEW! THE ONLY
COMPLETE BOOK ON
TELECASTING!
covers every phase

"Principles & Practices of
**TELECASTING
OPERATIONS**"

by HAROLD E. ENNES

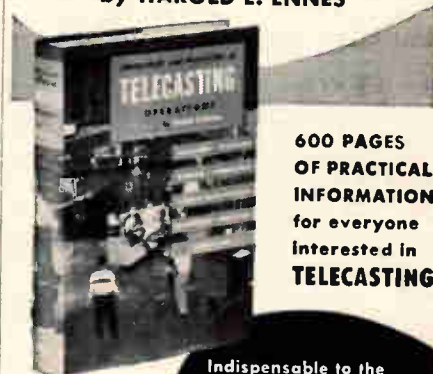

600 PAGES
OF PRACTICAL
INFORMATION
for everyone
interested in
TELECASTING

top reference
on Telecasting

Indispensable to the
Engineer, Production Man,
Director, Technician, and
to all Students of
the Video-Audio Art

CONTENTS:

A Partial List of Authoritative Chapters:
Basic Telecasting Equipment; The TV Camera; The TV Control Room; Fundamentals of TV Studio Lighting and Equipment; Network Program Relay Systems; TV Operational and Maintenance Practices; Technical Production of TV Shows; Field Equipment and Micro-Wave Relays; Analysis of Video and Audio Transmitting Plants; Technical Definitions—**PLUS HUNDREDS OF OTHER SUBJECTS**

Here, in one complete, easy-to-understand volume is the whole fascinating story of Telecasting operations. Whether you are a Chief Engineer, Production Director or Technical Director; if you are now working in or planning to work in TV, or if you are simply interested in Telecasting, this book is *meant* for you. Here is practical, useful information that makes you familiar with the equipment and techniques used in Telecasting, tells you *everything*—answers all your questions about TV production and transmission. If you work or are interested in Telecasting, you'll want this vast wealth of reliable information—you'll want this book in your library. Order your copy today!

600 Pages, 450 Illustrations
6" x 9"
Hard Covers **\$7.95**

**ORDER
TODAY!**

Order from your electronic parts distributor or bookstore, or write direct to Howard W. Sams & Co., Inc. 2205 E. 46th St., Indianapolis 5, Ind.

My (check) (money order) for \$..... enclosed. Send the following:.....copy(ies) of "Telecasting Operations" (\$7.95 per copy).

Name.....

Address.....

City..... State.....

Again proving
tube-design
leadership...

40% OF 1952'S NEW RECEIVING TUBES WERE G-E DEVELOPMENTS... TWICE ANY OTHER MAKE

FOURTEEN out of thirty-five registered *new* receiving-tube designs—40%—were G-E, in the last calendar year, 1952. As still further proof of leadership... new G-E types numbered more than twice those of any other manufacturer!

Outstanding research and development by General Electric have given to the TV-radio industry its newest, most advanced tubes. You can be sure, when servicing latest-model receivers, that G-E tubes are available for every need—that G-E leadership

in tube development brings you the finest obtainable product. Every working day, you will receive extra dividends in superior performance and reliability.

You can expect more new and improved tubes from General Electric in the months ahead—types that will make your work easier and cut call-backs. Keep in touch with your G-E tube distributor for forthcoming new-tube announcements, each with a profit message for you! Tube Dept., General Electric Co., Schenectady 5, N.Y.

SHOWN BELOW: a few of the many new G-E tubes that are making money for service dealers.



You can put your confidence in—

GENERAL  ELECTRIC

161-1A9

... put this
PROOF

right into your
customer's
hand!



**BE SURE TO
ENTER THE
CQS CONTEST**



If you are using the CBS-Hytron *Certified Quality Service Kit*, you are eligible to enter. You simply tell in 25 words or less why you like the CQS Plan. As an eligible entrant, you get a famous CBS-Hytron Soldering Aid free. And you have a chance to win one of these 10 BIG prizes:

- FIRST PRIZE:
FORD PANEL TRUCK**
- Second Prize: \$1000 in Savings Bonds
 - Third Prize: 600 in Savings Bonds
 - Fourth Prize: 500 in Savings Bonds
 - Fifth Prize: 400 in Savings Bonds
 - Sixth Prize: 300 in Savings Bonds
 - Seventh Prize: 200 in Savings Bonds
 - Eighth Prize: 100 in Savings Bonds
 - Ninth Prize: 50 in Savings Bonds
 - Tenth Prize: 25 in Savings Bonds

Remember, your CBS-Hytron distributor's salesman can also win other big prizes. Be sure to write his name, too, on your Contest entry. Entry blanks are available in your CQS Kit . . . or from your CBS-Hytron distributor. Beat the closing date, Dec. 15, 1953.

PROVE to your customer he can put his confidence in you.

Lay all the facts before him. Hand him this *Certified Quality Service Tag*. The Tag he has been reading about in LIFE-POST ads sponsored for you by CBS-Hytron. The same ads (and there'll be more) that are prompting him to ask where he can find you, his *Certified Quality Service* dealer.

With this simple, easy-to-use Tag, *do what your customer wants*. *Certify* that your itemized charges are fair. *Certify* that your service . . . your ability . . . and your equipment guarantee him dependable, top-quality TV and radio repairs. Give your customer *tangible proof* that you are giving him his money's worth. Win *his* confidence. And *you* will gain more business . . . more profits. Put *your* convincing *Certified Quality Service* Tags to work right away.

GO A STEP FURTHER

Tie in with the whole *Certified Quality Service Plan* as advertised in LIFE and the POST.



Use your decal.



Use your window streamer.



Use your LIFE-POST display.

They are all part of the *Certified Quality Service Kit*. This Kit, including 250 CQS Tags imprinted with *your* name and address, is available on a special offer from your CBS-Hytron distributor. Or you can write for details on how to order direct. You can order more CQS Tags from your distributor, whenever you need them.

GO STILL FURTHER

Keep in close touch with your CBS-Hytron distributor. Watch soon for additional supporting material to identify you as a *Certified Quality Service* dealer:

1. CQS illuminated window sign
2. CQS metal flange sign
3. CQS direct-mail postal cards
4. CQS newspaper mats, etc.

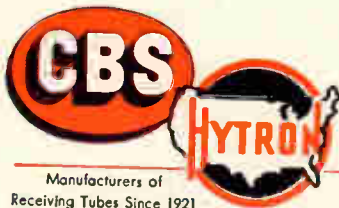

Manufacturers of
Receiving Tubes Since 1921

CBS-HYTRON, Main Office: Danvers, Mass.

A Division of Columbia Broadcasting System, Inc.

A member of the CBS family . . . CBS Radio • CBS Television
Columbia Records, Inc. • CBS Laboratories • CBS-Columbia, Inc. • and CBS-Hytron

RECEIVING . . . TRANSMITTING . . . SPECIAL-PURPOSE AND TV PICTURE TUBES • GERMANIUM DIODES AND TRANSISTORS
RADIO-ELECTRONICS

Here comes opportunity

...ready or not!

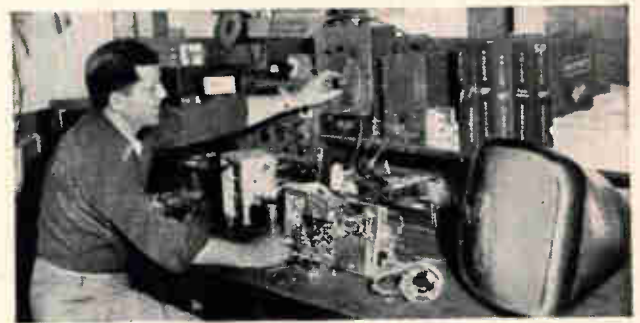

• Prepare now for the new Radio-TV-Electronics boom. Get in on VHF and UHF . . . aviation and mobile radio . . . color TV . . . binaural sound! The International Correspondence Schools can help you!

If you've ever thought about Radio or Television as a career . . . if you have the interest, but not the training . . . if you're waiting for a good time to start . . . NOW'S THE TIME!

No matter what your previous background, I.C.S. can help you. If Radio-TV servicing is your hobby, I.C.S. can make it your own profitable business. If you're interested in the new developments in Electronics, I.C.S. can give you the basic courses of training you need. If you have the job but want faster progress, I.C.S. can qualify you for promotions and pay raises.

I.C.S. training is *success-proved* training. Hundreds of I.C.S. graduates hold top jobs with top firms like R.C.A., G.E., DUMONT, I.T.&T. Hundreds of others have high ratings in military and civil service. Still others have successful businesses of their own.

With I.C.S., you get the rock-bottom basics and theory as well as the all-important bench practice and experimentation. You learn in your spare time—no interference with business or social life. You set your own pace—progress as rapidly as you wish.

Free career guidance: Send today for the two free success books, the 36-page "How to Succeed" and the informative catalog on the course you check below. No obligation. Just mark and mail the coupon. With so much at stake, you owe it to yourself to act—and act fast!

CHECK THESE SEVEN
FAMOUS I. C. S. COURSES
—ONE FOR YOU!

..... I.C.S.—the lifetime Christmas gift

I. C. S., Scranton 9, Penna.

- PRACTICAL RADIO-TELEVISION ENGINEERING**—Foundation course for radio-television career. Basic principles plus advanced training. Radio, Sound, TV.
- TELEVISION TECHNICIAN**—To qualify you for high-level technical positions in television. Camera, studio, transmitter techniques. Manufacture, sale and installation of TV equipment.
- TELEVISION RECEIVER SERVICING**—Installation, servicing, conversion. Dealership. For the man who knows about radio and wants TV training.
- RADIO & TELEVISION SERVICING**—Designed to start you repairing, installing and servicing radio and television receivers soon after starting the course.
- RADIO & TELEVISION SERVICING WITH TRAINING EQUIPMENT**—Same as above but with addition of high-grade radio servicing equipment and tools.
- RADIO OPERATING COURSE**—Special course to help you pass the Government examination for operator's licenses. Code. TV, FM. Radio regulations.
- INDUSTRIAL ELECTRONICS**—Broad, solid background course devoted to the electron tube and to its many applications.

INTERNATIONAL CORRESPONDENCE SCHOOLS

ICS

BOX 2882-J, SCRANTON 9, PENNA.

Without cost or obligation, send me "HOW TO SUCCEED" and the booklet about the course BEFORE which I have marked X:

<p>ART</p> <ul style="list-style-type: none"> <input type="checkbox"/> Commercial Art <input type="checkbox"/> Magazine Illustrating <input type="checkbox"/> Fashion Illustrating <input type="checkbox"/> Cartooning <input type="checkbox"/> Sketching and Painting <input type="checkbox"/> Show Card and Sign Lettering <p>AUTOMOTIVE</p> <ul style="list-style-type: none"> <input type="checkbox"/> Automobile, Mechanic <input type="checkbox"/> Auto Elec. Technician <input type="checkbox"/> Auto Body Rebuilding and Refinishing <input type="checkbox"/> Diesel—Gas Engines <p>AVIATION</p> <ul style="list-style-type: none"> <input type="checkbox"/> Aeronautical Engineering Jr. <input type="checkbox"/> Aircraft Engine Mechanic <input type="checkbox"/> Airplane Drafting <p>BUILDING</p> <ul style="list-style-type: none"> <input type="checkbox"/> Architecture <input type="checkbox"/> Arch. Drafting <input type="checkbox"/> Building Contractor <input type="checkbox"/> Estimating <input type="checkbox"/> Carpenter and Mill Work <input type="checkbox"/> Carpenter Foreman <input type="checkbox"/> Reading Blueprints <input type="checkbox"/> House Planning <input type="checkbox"/> Plumbing 	<ul style="list-style-type: none"> <input type="checkbox"/> Heating <input type="checkbox"/> Painting Contractor <input type="checkbox"/> Air Conditioning <input type="checkbox"/> Electrician <p>BUSINESS</p> <ul style="list-style-type: none"> <input type="checkbox"/> Business Administration <input type="checkbox"/> Certified Public Accountant <input type="checkbox"/> Bookkeeping and Accounting <input type="checkbox"/> Office Management <input type="checkbox"/> Stenography and Typing <input type="checkbox"/> Secretarial <input type="checkbox"/> Federal Tax <input type="checkbox"/> Business Correspondence <input type="checkbox"/> Letter-writing Improvement <input type="checkbox"/> Personnel and Labor Relations <input type="checkbox"/> Advertising <input type="checkbox"/> Retail Business Management <input type="checkbox"/> Managing Small Business <input type="checkbox"/> Ocean Navigation <input type="checkbox"/> Sales Management <input type="checkbox"/> Short Story Writing <input type="checkbox"/> Creative Salesmanship <input type="checkbox"/> Traffic Management <p>CHEMISTRY</p> <ul style="list-style-type: none"> <input type="checkbox"/> Chemical Engineering <input type="checkbox"/> Chemistry <input type="checkbox"/> Analytical Chemistry 	<ul style="list-style-type: none"> <input type="checkbox"/> Petroleum—Nat'l Gas <input type="checkbox"/> Pulp and Paper Making <input type="checkbox"/> Plastics <p>CIVIL, STRUCTURAL ENGINEERING</p> <ul style="list-style-type: none"> <input type="checkbox"/> Civil Engineering <input type="checkbox"/> Structural Engineering <input type="checkbox"/> Surveying and Mapping <input type="checkbox"/> Structural Drafting <input type="checkbox"/> Highway Engineering <input type="checkbox"/> Reading Blueprints <input type="checkbox"/> Construction Engineering <input type="checkbox"/> Sanitary Engineering <p>DRAFTING</p> <ul style="list-style-type: none"> <input type="checkbox"/> Aircraft Drafting <input type="checkbox"/> Architectural Drafting <input type="checkbox"/> Electrical Drafting <input type="checkbox"/> Mechanical Drafting <input type="checkbox"/> Structural Drafting <input type="checkbox"/> Sheet Metal Drafting <input type="checkbox"/> Ship Drafting <input type="checkbox"/> Mine Surveying and Drafting <p>ELECTRICAL</p> <ul style="list-style-type: none"> <input type="checkbox"/> Electrical Engineering <input type="checkbox"/> Electrician <input type="checkbox"/> Electrical Maintenance 	<ul style="list-style-type: none"> <input type="checkbox"/> Electrical Drafting <input type="checkbox"/> Electric Power and Light <input type="checkbox"/> Lineman <p>HIGH SCHOOL</p> <ul style="list-style-type: none"> <input type="checkbox"/> High School Subjects <input type="checkbox"/> Mathematics <input type="checkbox"/> Commercial <input type="checkbox"/> Good English <p>MECHANICAL AND SHOP</p> <ul style="list-style-type: none"> <input type="checkbox"/> Mechanical Engineering <input type="checkbox"/> Industrial Engineering <input type="checkbox"/> Industrial Supervision <input type="checkbox"/> Foremanship <input type="checkbox"/> Mechanical Drafting <input type="checkbox"/> Machine Design-Drafting <input type="checkbox"/> Machine Shop Practice <input type="checkbox"/> Tool Design <input type="checkbox"/> Industrial Instrumentation <input type="checkbox"/> Machine Shop Inspection <input type="checkbox"/> Reading Blueprints <input type="checkbox"/> Toolmaking <input type="checkbox"/> Gas—Electric Welding <input type="checkbox"/> Heat Treatment—Metallurgy <input type="checkbox"/> Sheet Metal Work <input type="checkbox"/> Sheet Metal Pattern Drafting <input type="checkbox"/> Refrigeration 	<p>POWER</p> <ul style="list-style-type: none"> <input type="checkbox"/> Combustion Engineering <input type="checkbox"/> Diesel—Electric <input type="checkbox"/> Electric Light and Power <input type="checkbox"/> Stationary Steam Engineering <input type="checkbox"/> Stationary Fireman <p>RADIO TELEVISION COMMUNICATIONS</p> <ul style="list-style-type: none"> <input type="checkbox"/> Practical Radio—TV Eng'ing <input type="checkbox"/> Radio Operating <input type="checkbox"/> Radio and TV Servicing <input type="checkbox"/> Television—Technician <input type="checkbox"/> Electronics <input type="checkbox"/> Telephone Work <p>RAILROAD</p> <ul style="list-style-type: none"> <input type="checkbox"/> Locomotive Engineer <input type="checkbox"/> Diesel Locomotive <input type="checkbox"/> Air Brakes <input type="checkbox"/> Car Inspector <input type="checkbox"/> Railroad Administration <p>TEXTILE</p> <ul style="list-style-type: none"> <input type="checkbox"/> Textile Engineering <input type="checkbox"/> Cotton, Rayon, Woolen Mfg. <input type="checkbox"/> Carding and Spinning <input type="checkbox"/> Warping and Weaving <input type="checkbox"/> Loom Fixing <input type="checkbox"/> Finishing and Dyeing <input type="checkbox"/> Textile Designing
--	---	--	---	---

Name _____ Age _____ Home Address _____

City _____ Zone _____ State _____ Working Hours _____ A.M. to P.M. _____

Occupation _____

Canadian residents send coupon to International Correspondence Schools Canadian, Ltd., Montreal, Canada. . . . Special tuition rates to members of the U. S. Armed Forces.

MERIT HOLLYWOOD, HOLLYWOOD AND CHICAGO!

East coast, West coast or the middle of the country, Merit's plants are where you need them . . . for, Merit is the only independent coil and transformer manufacturer devoted exclusively to the serviceman's TV problems. Take advantage of MERIT'S faster service. Find Merit's complete line, Tape Marked,* listed in John Rider's Tek-File and Howard Sam's Photofacts and Counter Facts to help you. And! Be sure to get Merit's latest complete Replacement Guide. Forty pages of replacement data and schematics, including IF-RF coils, an exclusive Merit feature.



MERIT COIL AND TRANSFORMER CORPORATION

4425 NORTH CLARK STREET
CHICAGO 40 • LO 1-6311

SEVENTY-ONE NEW TV stations have gone on the air between our last report in this column and October 10.

KAFY-TV	Bakersfield, Calif.	29
KCCO-TV	Sacramento, Calif.	40
KCMO-TV	Kansas City, Mo.	5
KEDD-TV	Wichita, Kansas	16
KERO-TV	Bakersfield, Calif.	10
KETX	Tyler, Texas	19
KEYT	Santa Barbara, Calif.	3
KFAZ	Monroe, La.	48
KFEQ-TV	St. Joseph, Mo.	2
KFSD-TV	San Diego, Calif.	10
KGBS-TV	Harlingen, Tex.	4
KGGM-TV	Albuquerque, N. M.	18
KHQA-TV	Hannibal, Mo.	7
KHSL-TV	Chico, Calif.	12
KIEM-TV	Eureka, Calif.	3
KIYA	Yuma, Arizona	11
KJEO	Fresno, Calif.	47
KMBC-TV	Kansas City, Mo.	9
KMBY-TV	(Shares time with WHB-TV) Monterey, Calif.	8
KNOE-TV	(Shares time with KSBW-TV) Monroe, La.	8
KOAT-TV	Albuquerque, N. M.	7
KOIN-TV	Portland, Oregon	6
KOPR-TV	Butte, Mont.	4
KRBC-TV	Abilene, Texas	9
KRDO-TV	Colorado Springs, Colo.	18
KSBW-TV	(Shares time with KMBY-TV) Salinas, Calif.	8
KVOA-TV	Tucson, Ariz.	4
KXLF-TV	Butte, Mont.	6
KYTV	Springfield, Mo.	3
KZTV	Reno, Nevada	8
WACH	Newport News, Va.	33
WATR-TV	Waterbury, Conn.	53
WBES-TV	Buffalo, N. Y.	59
WBUF-TV	Buffalo, N. Y.	17
WCAN-TV	Milwaukee, Wis.	25
WCHA-TV	Chambersburg, Pa.	46
WDAK-TV	Columbus, Ga.	28
WEAR-TV	Pensacola, Fla.	3
WECT-TV	Elmira, N. Y.	18
WEHT	Henderson, Ky.	50
WENS	Pittsburgh, Pa.	16
WGEM-TV	Quincy, Ill.	10
WHB-TV	Kansas City, Mo.	9
WHBQ-TV	(Shares time with KMBC-TV) Memphis, Tenn.	13
WICA-TV	Ashtabula, Ohio	15
WICS	Springfield, Ill.	20
WIFE	Dayton, O.	22
WILK-TV	Wilkes-Barre, Pa.	34
WILS-TV	Lansing, Mich.	54
WIRK-TV	W. Palm Beach, Fla.	21
WJBF-TV	Augusta, Ga.	6
WKLO-TV	Louisville, Ky.	21
WKNA-TV	Charleston, W. Va.	49
WMAZ-TV	Macon, Ga.	13
WMIN-TV	(Shares time with WTCN-TV) St. Paul, Minn.	11
WMT-TV	Cedar Rapids, Ia.	2
WNOK-TV	Columbia, S. C.	87
WOKY-TV	Milwaukee, Wis.	19
WPMT	Portland, Me.	53
WREK-TV	Rockford, Ill.	13
WROL-TV	Knoxville, Tenn.	6
WSJS-TV	Winston-Salem, N. C.	12
WSVA-TV	Harrisonburg, Va.	3
WTAO-TV	Parkbridge, Mass.	56
WTAP	Parkersburg, W. Va.	15
WTCN-TV	(Shares time with WMIN-TV) Minneapolis, Minn.	11
WTOB-TV	Winston-Salem, N. C.	26
WTOK-TV	Meridian, Miss.	31
WTSK	Knoxville, Tenn.	26
WTVH-TV	Peoria, Ill.	19
WVEC-TV	Hampton-Norfolk, Va.	15

KFXD-TV Nampa, Idaho (Channel 6) has discontinued operations.

As of October 10, there were 284 television stations—196 v.h.f., 88 u.h.f.—in operating in the U.S.)

BING CROSBY ENTERPRISES may be forced to release their VTR (Video Tape Recorder) system to the television industry by early 1954 due to demands by the Government, plus competition from other firms. RCA, for example, announced a demonstration of their tape recording system for December 1.

Frank Healey, executive director of the electronic division of BCE, said that various federal agencies are interested in VTR for radar, moving target and guided missile programs, and are pressing for quick development.

He said GE, Magnacord, RCA, Armour Research Labs, and Ampex are working on video tape recording, but that BCE hopes to be first.

TWO FM PROGRAMS on a single channel are made possible by an invention demonstrated by Major Edwin H. Armstrong and John Bose at Columbia University recently. The system provides for at least two high-quality FM programs on an existing FM channel. The second, or side, channel operates as a subcarrier of 27.5 kc, which is frequency-modulated ± 5 kc, by the second program. The 27.5-kc subcarrier in its turn modulates the main carrier ± 20 kc. The frequency range of the second channel is 8,000 cycles, and the 15,000-cycle range of the main channel is unimpaired. The signal-to-noise ratio of the side channel is 10 to 20 db poorer than that of the main channel, but still meets the FCC specifications for a normal FM broadcast station. Interference between the two channels was virtually inaudible.

Four to six extra tubes are needed in the receiver to extract and demodulate the side carrier. These follow the regular discriminator and comprise a 27.5-kc i.f. system followed by another discriminator. A separate audio amplifier must be used of course. The additional equipment may be attached to an existing FM set, though Major Armstrong pointed out that only receivers with excellent noise discrimination characteristics could be used.

The new transmission system immediately suggests the possibility of binaural broadcasting without the cumbersome two-station setups now required. Major Armstrong suggested other uses, which he said might be the means of putting FM on a paying basis. Since the side channel can carry a program entirely different from the main one, it might provide a special news, sports or other service, to a specialized audience, while the main channel could be used for high-fidelity music or other type of general program. Revenues from the special program would offset costs of the general one.

RADIO HOMES outnumber those with electricity, the census bureau reports. The bureau discovered that 95.7% of all homes have radios, with only 94% having electricity. The difference indicates battery sets in use.

The report points out the rapid increase of radios in the home, from 40% in 1930 to 83% in 1940 to almost one or more in every home by 1950. Television in the home was still relatively new in 1950, the bureau said, adding that the census showed about 5,000,000 sets, mostly in urban homes.

TOKYO TV STATION TOK, the first television station in Japan, has begun broadcasting. The Tokyo unit is the anchor station of a very extensive telecommunication plan, by which all forms of communications will be transmitted by single radio-relay system using microwave stations situated on mountain top locations.

The equipment used in the Tokyo station was bought from RCA and is fully paid for. The entire network is expected to cost about \$15,000,000 in combined currencies.

END

NEW HOME OF ALLIED RADIO

ultra-modern facilities TO SERVE YOU BEST



FREE!

get your value-packed

1954 ALLIED

268-PAGE CATALOG

The World's Largest Stocks

- TV and Radio Parts
- Test Instruments
- High-Fidelity Equipment
- Custom TV Chassis
- AM, FM Tuners and Radios
- Recorders and Supplies
- P. A. Systems, Accessories
- Amateur Station Gear
- Builders' Kits, Supplies
- Equipment for Industry

Fastest Service in Electronic Supply

the only **COMPLETE** catalog for everything in **TV, Radio and Industrial Electronics**



Send for it today!



You'll want the *one* complete Buying Guide to *Everything in Electronics*—268 pages packed with the world's largest selection of quality equipment at lowest, money-saving prices. See all the latest releases in custom TV chassis, TV antennas and accessories; AM and FM tuners and radios; *everything* in High-Fidelity custom components; latest P.A. Systems and accessories; recorders and supplies; Amateur receivers, transmitters and station gear; specialized industrial electronic equipment; test instruments; builders' kits; huge listings of parts, tubes, tools, books—your choice of the world's *most complete stocks* of quality equipment. ALLIED gives you *every* buying advantage: speedy shipment, expert personal help, lowest prices, liberal terms, assured satisfaction. Get the 1954 ALLIED Catalog. Keep it handy—and save time and money. Send for your **FREE** copy today.

SAVE ON EVERYTHING IN ELECTRONICS

SEND FOR THE LEADING ELECTRONIC BUYING GUIDE

free

ALLIED RADIO

World's Largest Electronic Supply House

EASY-PAY TERMS

Use ALLIED'S liberal Easy Payment Plan—only 10% down, 12 months to pay—no carrying charge if you pay in 60 days. Available on Hi-Fi and P. A. units, recorders, TV chassis, test instruments, Amateur gear, etc.

TV and HI-FI SPECIALISTS

To keep up with developments in High-Fidelity and TV, look to ALLIED. Count on us for all the latest releases and largest stocks of equipment in these important fields. If it's anything in High-Fidelity or Television—we have it in stock!

ALLIED RADIO CORP., Dept. 2-M-3
100 N. Western Ave., Chicago 80, Illinois

Send FREE 268-Page 1954 ALLIED Catalog.

Name _____

Address _____

City _____ Zone _____ State _____

CUSTOMERS EVERYWHERE KNOW
SYLVANIA TUBES JUST
CAN'T BE BEAT FOR **QUALITY!**



WHY SYLVANIA PRODUCTS MEAN BETTER BUSINESS!

YOU'RE really on board the *better-profit* special when you feature Sylvania Picture Tubes and Receiving Tubes.

Your customers know Sylvania as a pioneer in the development of fine radio and television products. From the very beginning, the name Sylvania has stood for the highest possible quality. And, as the industry has progressed and expanded, Sylvania has taken great care to maintain its recognized leadership.

Now, due to advanced manufacturing techniques and precision testing methods, Sylvania tubes can point to outstanding records, both in long life and fine performance. Today 7 of the 10 leading set manufacturers use Sylvania Picture Tubes and Receiving Tubes.

So, if you want *recognized quality* working on your side . . . *sell Sylvania!* Call your local Sylvania Distributor for the latest fall prices and money-making promotion offers, or write to: Sylvania Electric Products Inc., Dept. 3R-1712, 1740 Broadway, New York 19, N. Y.

**Television keeps telling
about Sylvania quality**



Sylvania's popular nation-wide television show "Beat the Clock" continues to tell millions of your customers week after week, all through the year, about the unbeatable quality of Sylvania products.

SYLVANIA



LIGHTING • RADIO • ELECTRONICS • TELEVISION

In Canada: Sylvania Electric (Canada) Ltd.
University Tower Bldg., St. Catherine Street, Montreal, P. Q.

RADIO-ELECTRONICS

CREI prepares you quickly for success in

The future is in your hands!

The signs are plain as to the future of the trained men in the electronics industry. It is a tremendous industry, and—at the *present time* there are more jobs than there are trained men to fill them. But—when there's a choice between a trained and untrained applicant, the trained man will get the job. Your biggest problem is to decide on—and begin the best possible training program.

CREI Home Study . . . The Quick Way to Get There.



Since 1927, CREI has given thousands of ambitious young men the technical knowledge that leads to more money and security. The time-tested CREI procedure can help *you*, too—if you really want to be helped. CREI lessons are prepared by experts in easy-to-understand form. There is a course of instruction geared to the field in which you want to specialize. You study at *your* convenience, at *your* rate of speed. Your CREI instructors guide you carefully through the material, and grade your written work personally (not by machine).

Industry Recognizes CREI Training.

CREI courses are prepared, and taught with an eye to the needs and demands of industry, so your CREI diploma can open many doors for you. Countless CREI graduates now enjoy important,

good-paying positions with America's most important companies. Many famous organizations have arranged CREI group training for their radio-electronics-television personnel. To name a few: All America Cables and Radio, Inc.; Canadian Aviation Electronics, Ltd.; Canadian Broadcasting Corporation; Columbia Broadcasting System; Canadian Marconi Company; Hoffman Radio Corporation; Machlett Laboratories; Glenn L. Martin Company; Magnavox Company; Pan American Airways, Atlantic Division; Radio Corporation of America, RCA Victor Division; Technical Appliance Corporation; Trans-Canada Air Lines; United Air Lines. Their choice for training of their own personnel is a good cue for *your* choice of a school.



**Benefits Felt
Right Away.**

Almost immediately, you feel the benefits of CREI training. Your employer, when informed of your step toward advancement (only at your request), is certain to take new interest in you and in your future. What you learn in CREI Home Study can start helping you do a better job immediately.

- BROADCASTING
- TELEVISION
- MANUFACTURING
- COMMUNICATIONS
- SERVICING
- AERONAUTICAL ELECTRONICS



CREI also offers Resident Instruction

at the same high technical level—day or night, in Washington, D. C. New classes start once a month. If this instruction meets your requirements, check the coupon for Residence School catalog.

INFORMATION FOR VETERANS

If you were discharged after June 27, 1950—let the new G. I. Bill of Rights help you obtain resident instruction. Check the coupon for full information.

Get this fact-packed booklet today. It's free.

Called "Your Future in the New World of Electronics," this free illustrated booklet gives you the latest picture of the growth and future of the gigantic electronics world. It includes a complete outline of the courses CREI offers (except Television and FM Servicing) together with all the facts you need to judge and compare. Take 2 minutes to send for this booklet right now. We'll promptly send your copy. The rest—your future—is up to you.



CAPITOL RADIO ENGINEERING INSTITUTE

An Accredited Technical Institute • Founded in 1927

3224 16th Street, N.W.

Washington 10, D.C.

MAIL COUPON TODAY

CAPITOL RADIO ENGINEERING INSTITUTE
Dept. 1412 3224 16th St., N.W., Washington 10, D.C.

Send booklet "Your Future in the New World of Electronics" and course outline.

CHECK FIELD OF GREATEST INTEREST TV, FM & Advanced AM Servicing Aeronautical Radio Engineering Practical Radio Engineering Broadcast Radio Engineering (AM, FM, TV) Practical Television Engineering

Name.....

Street.....

City..... Zone..... State.....

Check— Residence School Veteran

E-V

for PA LIKE ON TV

636 Slimair DYNAMIC MICROPHONE

Gives you features similar to those in the famous E-V Slim-Trim TV Microphones. That's why it is so outstanding for Public Address, Recording and other general-purpose use.
List Price \$70

SMOOTH RESPONSE
60-13,000 CPS
HIGH OUTPUT
OMNIDIRECTIONAL
ACOUSTALLOY
DIAPHRAGM
BUILT-IN
BLAST FILTER

Can be used in the hand, on a stand, or overhead

SEND FOR BULLETIN

Electro-Voice
421 CARROLL ST. • BUCHANAN, MICH.
Export: 13 E. 40th St., N. Y. 16, U. S. A.



BAROMETER of the PARTS INDUSTRY

During October, 82 of the leading 400 manufacturers of Radio-Electronic-Television parts and equipment made changes in their lines. There was an increase in "change activity" as compared to September.

In price revisions by the number of manufacturers and products affected, the following summary illustrates the comparative trend for the months of September and October.

	No. of Manufacturers	
	September	October
Increased prices	19	24
Decreased prices	9	24

	No. of Products	
	September	October
Increased prices	789	1,874
Decreased prices	40	184

For a summary of the most active product categories, see the following tables:

Product Group	Increased Prices		Decreased Prices		New Products		Discontinued Products	
	No. of Mfrs.	No. of Products	No. of Mfrs.	No. of Products	No. of Mfrs.	No. of Products	No. of Mfrs.	No. of Products
Antennas & Access.	4	9**	7	22*	17	94*	8	203*
Capacitors	0	0**	3	41*	2	8*	0	0**
Controls & Resistors	2	48*	1	3*	2	9**	0	0
Sound & Audio	6	15**	3	3**	15	37**	13	35*
Test Equipment	3	615*	1	31*	5	21**	3	93*
Transformer	2	291*	1	18*	2	101*	1	2**
Tubes	7	896*	6	58*	9	64**	4	42*
Wire & Cable	0	0	2	8**	2	4*	0	0**

* Increase over September
** Decrease from September

Comment: The total number of manufacturers making changes in their lines has increased since last month's report. Among these manufacturers reporting changes, the emphasis continues to be placed on price changes, a trend that has been evident for the last three months.

This data is prepared by the staff of United Catalog Publishers, Inc., 110 Lafayette Street, New York, publishers of Radio's Master, the Official Buying Guide of the Parts Industry.

Merchandising and Promotion

United Motors Service Division of General Motors, Detroit, has inaugurated a series of electronics service classes for United Motors electronic distributors and the service personnel of their dealer accounts. The first classes



will be held in the new Detroit Training Center, the first of 35 such training schools to be built across the country.

Erie Resistor Corp., Erie, Pa., devised a new method of packaging its style



413 high-voltage ceramicons. Six ceramicons and sixteen terminals of five dif-

ferent types are packed in a cardboard box for convenient stocking.

CBS-Hytron, Danvers, Mass., developed a new Certified Quality Service Plan built around a service tag attached to the consumer's TV set. In connection with the new plan, CBS-Hytron is sponsoring a contest for radio and TV service technicians and for distributor salesmen. First prize for technicians is a Ford panel truck. The contest closes December 15.



Sprague Electric, North Adams, Mass., designed a new jumbo dummy capacitor carton as a point-of-sale display for its distributors. The company also announced that reprints of its "Beware the Service Bargain" ad are available
(CONTINUED ON PAGE 18)

MY GRADUATES ARE EARNING GOOD PAY!



"I'll always be grateful to your training which helped me get my present fine position as Assistant Parts Manager."
—Norman Weston



"Thanks to your training, I qualified for a good job as a Receiver Tester."
—Paul Frank Seier



"Your excellent instruction helped me get my present job as an airport radio mechanic."
—Eugene E. Basko



"I'm making good money in my own business, repairing and installing radio and TV sets — thanks to your training."
—Irwin Polansky



L. C. Lane, B.S., M.A.
President: Radio-Television Training Association
Executive Director: Pierce School of Radio & Television

YOU, TOO, CAN MAKE BIG PAY IN TELEVISION NO EXPERIENCE NECESSARY

ENOUGH EQUIPMENT TO SET UP YOUR HOME LABORATORY! As part of your training, I give you ALL the above equipment you need and more to prepare for a BETTER PAY TV job. You build and keep a professional **GIANT SCREEN TV RECEIVER** complete with big picture tube, takes any size up to 21-inch... also a Super-Het Radio Receiver, RF Signal Generator, Combination Voltmeter-Ammeter, Ohmmeter, C-W Telephone Transmitter, Public Address System, AC-DC Power Supply. Everything supplied including all tubes!

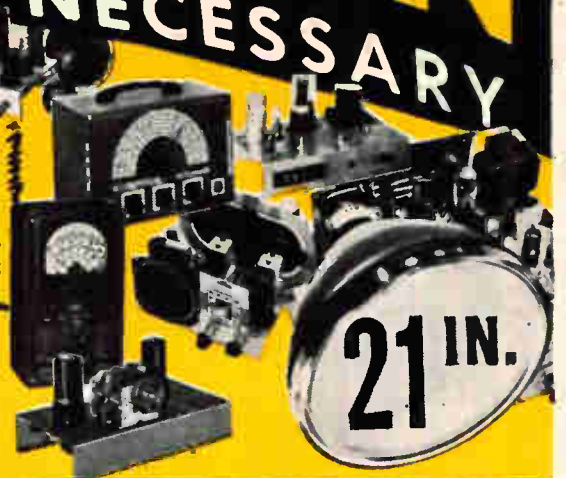

MORE MONEY AND A CAREER ARE WAITING FOR YOU HERE!

GOOD SPARE TIME EARNINGS! At most from the very start you can earn extra money while learning, repairing Radio-TV sets for friends and neighbors. Many of my students earn up to \$25 a week... pay their entire training from spare time earnings... start their own profitable service business. *Act now!*

EXPERT FM-TV TECHNICIAN TRAINING! SAVE VALUABLE TIME! My FM-TV Technician Course can save you months of training if you have previous Armed Forces or civilian radio experience! Train at home with kits of parts, plus equipment to build **BIG SCREEN TV RECEIVER**, and **FREE FCC Coaching Course!** ALL FURNISHED AT **NO EXTRA COST!**

OPTIONAL: TWO WEEKS TRAINING IN NEW YORK CITY AT NO EXTRA COST! You get two weeks, 50 hours, of intensive Laboratory work on modern electronic equipment at our associated school in New York City —Pierce School of Radio and Television. And I give you all this AT **NO EXTRA COST** whatsoever, after you finish your home study training in the Radio-FM-TV Technician course and FM-TV Technician Course.

FREE FCC COACHING COURSE! Important for **BETTER PAY JOBS** requiring FCC License. You get this training **AT HOME** and **AT NO EXTRA COST** Top TV jobs go to FCC licensed technicians.

NEW! PRACTICAL TV CAMERAMAN & STUDIO COURSE! (For men with previous radio and TV training) I train you at home for a big pay job as the man behind the TV camera. Work with TV stars in TV studios or "on location" at remote pick-ups! A special one-week course of practical work on TV studio equipment at Pierce School of Radio & TV, our associated resident school in New York City, is offered upon your graduation.

CIVILIANS! VETERANS! PREPARE FOR A BRIGHTER FUTURE AS A TRAINED TV TECHNICIAN! Thousands of new jobs in TV are opening up in every state as new stations go on the air. You too can take your place in America's booming **TELEVISION** and Electronics industries... enjoy the success and happiness you always wanted. Keep your present job while I prepare you at home for a life-time career as a trained TV Technician. You "learn-by-doing" with the actual parts and equipment I send you... the same successful methods that have helped hundreds of men—many with no more than grammar school training—master television!

LEARN ALL ABOUT COLOR TV. I give you the latest principles and practical training in TV **COLOR!**



MAIL COUPON FOR 4 FREE AIDS! NO OBLIGATION WHATSOEVER!

NO SALESMAN WILL CALL!

VETERANS!

My schools fully approved to train veterans under new G.I. Bill! If discharged after June 27, 1950 — **CHECK COUPON!** Also approved for **RESIDENT TRAINING** in New York City at Pierce School of Radio and Television... qualifies you for full subsistence allowance up to \$160 per month. Write for details.

Dept. R-12A
Mr. Leonard C. Lane, President
RADIO-TELEVISION TRAINING ASSOCIATION
52 East 19th Street, New York 3, N. Y.

Dear Mr. Lane: Mail me your **NEW FREE BOOK, FREE SAMPLE LESSON**, and **FREE** aids that will show me how I can make **BIG MONEY IN TELEVISION**. I understand I am under no obligation and no salesman will call.
(PLEASE PRINT PLAINLY)

NAME _____ AGE _____
ADDRESS _____
CITY _____ ZONE _____ STATE _____

- I AM INTERESTED IN:
- Radio-FM-TV Technician Course
 - FM-TV Technician Course
 - TV Cameraman & Studio Course
- VETERANS!** Check here for Training under **NEW G.I. Bill**

RADIO-TELEVISION TRAINING ASSOCIATION
52 EAST 19th STREET, NEW YORK 3, N. Y.
Licensed by the State of New York Approved by the VA

THE *American* IDEA

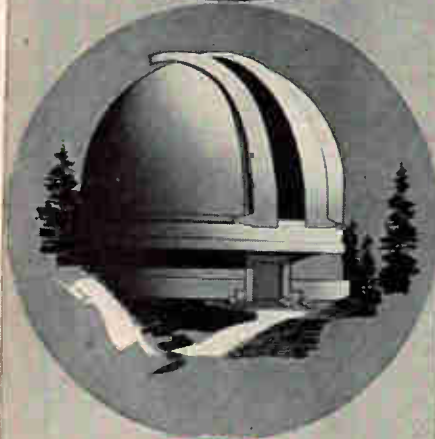

"To find and follow the better way"... Out of the vision of Dr. George Ellery Hale came the great "American Idea" that resulted in the creation of the "Glass Giant of Palomar"—world's largest telescope—to gather new light from the farthest stars for the searching eye of science.

With us, the "American Idea" is, by directed effort and applied know-how, to continue to lead in bringing you electronic products of the highest quality.



INSIST ON
AMERICAN
MICROPHONES
D-33 Broadcast
D-22 Public Address

Send for FREE catalog 46

American microphone co.

370 South Fair Oaks Ave. • Pasadena, 1, Calif.

able to service technicians at a nominal cost. Jumbo window posters of the ad are available to jobbers for distribution to their service technician customers.

Blonder-Tongue Laboratories, Westfield, N. J., is using an attractive yel-



low and black display easel as a point-of-sale display in its current sales promotion program. The easel provides for the mounting of one of the company's *Ultraverter* u.h.f. converters.

The General Electric Tube Department awarded \$2,500 as the first prize in its recent "Write Your Own Ticket" contest for radio and TV service technicians, to George Champlin, Centralia, Wash. A. L. Champigny, advertising and sales promotion manager for the Tube Department, said that this year's entries far exceeded those received in the first contest held in 1952.

Brach Manufacturing Co., Division of General Bronze Corp., Newark, N. J.,



announced a new 3D advertising program to introduce its new line of TV products, according to Ira Kamen, Brach vice-president.

Raytheon Manufacturing, Newton, Mass., held another of its "How to Interpret What You See in U.H.F." meetings in Chicago recently cosponsored by Allied Radio Corp., Raytheon Television Distributors, and the Television Installation and Service Association.

Rauland Corp., Chicago, produced a documentary film portraying the manufacture of TV picture tubes. It is available through Rauland's representatives for distributor meetings.

I.D.E.A., Inc., Indianapolis, held a special U.H.F. Technical Forum in Norfolk, Va., a new u.h.f. territory, under the direction of J. Gordon Dougherty, field representative for the company's Regency Division.

Duotone, Keyport, N. J., is including a free 50-power hand microscope in its dealer-serviceman kit. The device per-

mits the service technician to check phonograph needles right in the machine.

Recoton Corp., New York City, announced plans for one of the biggest advertising campaigns in its history on its complete line of phonograph needles.

Production and Sales

RETMA reported that TV production of 4,754,285 TV sets during the first eight months of 1953 was at the highest level on record for that period. 8,932,638 radio sets were produced as against only 6,558,303 for the 1952 period

New Plants and Expansions

Aerovox Corp., New Bedford, Mass., merged its Wilkor resistor manufacturing operation with the ceramic capacitor operation of the Hi-Q Division. Wilkor moved from Cleveland to the three Hi-Q plants at Olean and Franklinville, N. Y., and Myrtle Beach, S. C. The combined operation will be known as the Hi-Q Division of Aerovox, but the Wilkor name will continue to be used on all resistor products.

Pyramid Electric, North Bergen, N. J., capacitor manufacturer will open a new plant in Gastonia, N. C., which will provide 160,000 square feet of additional space.

Channel Master Corp., Ellenville, N. Y., marked its sixth year of operation by opening a \$1,500,000 manufacturing plant and a \$500,000 aluminum extrusion mill.

General Electric Electronics Division established a new Commercial Equipment Department. William J. Morlock, general manager for commercial equipment activities, was appointed general manager of the new department.

Leader Electronics, Inc., manufacturer of the *Superotor* rotator, moved to new larger quarters at 2925 East 55th St., Cleveland, Ohio.

Pioneer Electronics Corp. formally opened its new West Angeles plant with ceremonies attended by civic and industrial leaders. The company plans to produce 1,000 picture tubes per day.

Audio Devices, New York City, acquired the assets and good-will of Advance Recording Products, Long Island City, N. Y.

Cal-Tronics Corp., Los Angeles test equipment designer and manufacturer moved to a new plant in the Imperial Industrial District at 11307 Hindry Avenue.

Precise Development Corp., Ocean-side, N. Y., acquired an additional building in that community.

Arcturus Electronics, Newark, N. J., plans to begin the manufacture of television picture tubes at a newly acquired plant in Easton, Pa.

Radio Condenser Co. has begun operations in part of its new 90,000-square-foot manufacturing plant in Camden, N. J.

The RCA Victor Tube Department acquired a new warehouse in Dallas, Texas, to speed service to distributors of RCA tubes, parts, and batteries in the Southwest. The new warehouse will be under the managership of John Cavallaro.

END

I Will Train You at Home

For Good Pay Jobs, Success in

RADIO-TELEVISION

J. E. SMITH
 President
 National Radio
 Institute
 Washington, D. C.
 40 years of success
 training men at
 home in spare time.



Practice Broadcasting with Equipment I Send

As part of my Communications Course I send you kits of parts to build the low-power Broadcasting Transmitter shown at the left. You use it to get practical experience putting a station "on the air," performing procedures demanded of Broadcasting Station Operators. An FCC Commercial Operator's License can be your ticket to a better job and a bright future; my Communications Course gives you the training you need to get your license. Mail card below and see in my book other valuable equipment you build.



Practice Servicing with Equipment I Send

Nothing takes the place of **PRAC-TICAL EXPERIENCE**. That's why **NRI** training is based on **LEARN-ING BY DOING**. You use parts I furnish to build many circuits common to Radio and Television. With my Servicing Course you build a modern Radio (shown at right). You build a Multitester which you use to help fix sets while training. Many students make \$10, \$15 a week extra fixing sets in spare time starting a few months after enrolling. All equipment is yours to keep. Card below will bring book showing other equipment you build.

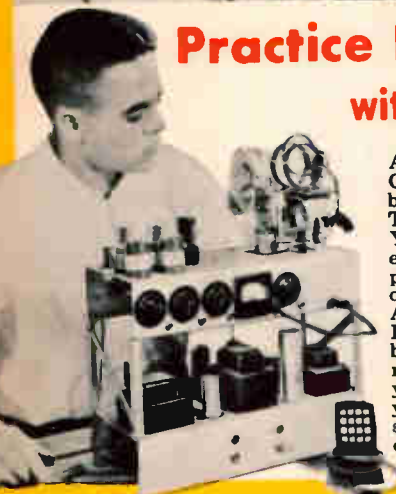

Television is Growing Fast Making New Jobs, Prosperity

More than 25 million homes now have Television sets and thousands more are being sold every week. Well trained men are needed to make, install, service TV sets. About 200 television stations on the air with hundreds more being built. Think of the good job opportunities here for qualified technicians, operators, etc. If you're looking for opportunity get started now learning Radio-Television at home in spare time. Cut out and mail postage free card. J. E. Smith, President, National Radio Institute, Washington, D. C. OUR 40TH YEAR.

AVAILABLE TO
VETERANS
 UNDER G.I. BILL

Good Jobs, Good Pay, Success
 in Radio-TV! SEE OTHER SIDE

CUT OUT AND MAIL THIS CARD NOW

Sample Lesson & 64-Page Book
Both FREE

This card entitles you to Actual Lesson on Servicing, shows how you learn Radio-Television at home. You'll also receive my 64-Page Book, "How to Be a Success in Radio-Television." Mail card now!

NO STAMP NEEDED! WE PAY POSTAGE

Mr. J. E. SMITH, President,
 National Radio Institute, Washington 9, D. C.
 Mail me Lesson and Book, "How to Be a Success in Radio-Television." (No Salesman will call. Please write plainly.)

NAME AGE

ADDRESS

CITY ZONE STATE

VETS write in date of discharge

B C D E F

The ABC's of
SERVICING

How to Be a
Success
 in **RADIO-TELEVISION**



Train at Home to Jump Your Pay as a RADIO-TV Technician



J. E. Smith, President
National Radio Institute

The men whose messages are published below were not born successful. Not so long ago they were doing exactly as you are now... reading my ad! They decided they should KNOW MORE... so they could EARN MORE... so they acted! Mail card below now.

Get a Better Job—Be Ready for a Brighter Future in America's Fast Growing Industry

Training PLUS opportunity is the PERFECT COMBINATION for job security, good pay, advancement. When times are good, the trained man makes the BETTER PAY, GETS PROMOTED. When jobs are scarce, the trained man enjoys GREATER SECURITY. NRI training can help assure you and your family more of the better things of life.

Radio-Television is today's opportunity field. Even without Television, Radio is bigger than ever before. Over 3,000 Radio Broadcasting Stations on the air; more than 115 million home and Automobile Radios are in use. Then add Television. Television Broadcast Stations extend from coast to coast now with over 25 million Television sets already in use. There are channels for 1,800 more Television Stations. Use of

Aviation and Police Radio, Micro-Wave Relay, Two-way Radio communication for buses, taxis, trucks, etc. is expanding. New uses for Radio-Television principles coming in Industry, Government, Communications and Homes.

My Training is Up-to-Date You Learn by Practicing

Get the benefit of my 40 years experience training men. My well-illustrated lessons give you the basic principles you must have to assure continued success. Skillfully developed kits of parts I furnish "bring to life" the principles you learn from my lessons. Read more about equipment you get on other side of this page.

Naturally, my training includes Television. I have, over the years, added more and more Television information to my courses. The equipment I furnish students gives experience on circuits common to BOTH Radio and Television.

Find Out About the Tested Way to Better Pay

Read at the right how just a few of my students made out who acted to get the better things of life. Read how NRI students earn \$10, \$15 a week extra fixing Radios in spare time starting soon after enrolling. Read how my graduates start their own businesses. Then take the next step—mail card below.

You take absolutely no risk. I even pay postage. I want to put an Actual Lesson in your hands to prove NRI home training is practical, thorough. I want you to see my 64-page book, "How to Be a Success in Radio-Television" because it tells you about my 40 years of training men and important facts about present and future Radio-Television job opportunities. You can take NRI training for as little as \$5 a month. Many graduates make more than the total cost of my training in two weeks. Mailing postage free card can be an important step in making your future successful. J. E. Smith, President, National Radio Institute, Washington 9, D. C. OUR 40TH YEAR.

I TRAINED THESE MEN



Handicapped but Successful

"I am now Chief Engineer at WHAW. My left hand is off at the wrist. A man can do... if he wants to." R. J. Halley, Weston, W. Va.



\$10 a Week In Spare Time

"Before finishing, I earned as much as \$10 a week in Radio servicing, in my spare time. I recommend NRI." S. J. Petruff, Miami, Fla.



Control Operator, Station WEAN

"I received my license and worked on ships. Now with WEAN as control operator, NRI course is complete." R. Arnold, Rumford, R. I.



Has Own Radio-Television Shop

"Doing Radio and Television servicing full time. Have my own shop. I owe my success to NRI." Curtis Stath, Fort Madison, Iowa.



Has Growing Business

"Am becoming expert Teletriecian as well as Radiotriecian. Without your course this would be impossible." P. Brogan, Louisville, Ky.



Got First Job Thru NRI

"My first job was with KDLR. Now Chief Engr. of Radio Equipment for Police and Fire Dept." T. Norton, Hamilton, Ohio.

NRI Training Leads to Jobs Like These

BROADCASTING
Chief Technician
Chief Operator
Power Monitor
Recording Operator
Remote Control Operator

SERVICING
Home and Auto Radios
P. A. Systems
Television Receivers
Electronic Controls
FM Radios

IN RADIO PLANTS
Design Assistant
Transmitter Design Technician
Service Manager
Tester
Serviceman
Research Assistant

SHIP AND HARBOR RADIO
Chief Operator
Assistant Operator
Radiotelephone Operator

GOVERNMENT RADIO
Operator in Army, Navy, Marine Corps, Coast Guard
Forestry Service
Dispatcher
Airways Radio Operator

AVIATION RADIO
Plane Radio Operator
Transmitter Technician
Receiver Technician
Airport Transmitter Operator

TELEVISION
Pick-up Operator
Voice Transmitter Operator
Television Technician
Remote Control Operator
Service and Maintenance Technician

POLICE RADIO
Transmitter Operator
Receiver Serviceman

FIRST CLASS

Permit No. 20-R

(Sec. 34.9, P.L. & R.)

Washington, D.C.

BUSINESS REPLY CARD

No Postage Stamp Necessary If Mailed In The United States

POSTAGE WILL BE PAID BY

NATIONAL RADIO INSTITUTE

16th and U Sts., N.W.

Washington 9, D. C.

Find Out What RADIO-TV Offers You



SAMPLE LESSON and 64-PAGE BOOK Both FREE

Cut out and mail postage-free card today!

Start Soon to Make \$10, \$15 a Week Extra Fixing Sets

Keep your job while training. Many NRI students make \$10, \$15 and more a week extra fixing neighbors' Radios in spare time starting a few months after enrolling. I start sending you special booklets that show you how to fix sets the day you enroll. The multimeter you build with parts I furnish helps discover and correct troubles.



Do You Want Your Own Business?

Many NRI trained men start their own successful Radio-Television sales and service business with capital earned fixing Radios in spare time. My book tells how you can be your own boss. Joe Travers, a graduate of mine, in Asbury Park, N. J., writes: "I've come a long way in Radio and Television since graduating. Have my own business on Main Street."



ASTRON SM* CAPACITORS

These SAFETY MARGIN capacitors offer the assurance of greater all-around built-in dependability because of the most exacting engineering specifications. To you, as it does to thousands of other service men, SM* means absolute customer satisfaction.

ASTRON SM* TWIST PRONG

dry electrolytics are individually tested and guaranteed. They have earned wide acceptance by original equipment manufacturers. For quality replacement, you can rely on Astron's high standards of quality manufacture. Your jobber stocks all popular replacement ratings. Catalog AC-3A lists all available SM twist prong ratings.

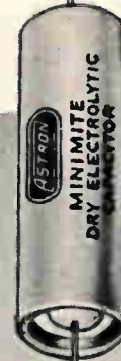

ASTRON SM* BLUE-POINT*

fabulous new member of the Astron line, offers the "tightest seal and toughest shell" in molded plastic paper capacitors. They give outstanding performance under the most adverse temperature and moisture conditions. Look for the eye-catching yellow jacket with the easy-to-spot Blue-Point end seal. Write for Bulletin AB-20A for the complete story.

*Trade Mark

PATENT
PENDING



DEPEND ON—INSIST ON

ASTRON

Manufacturers of a complete line of capacitors and filters for every television, radio and electronic application.

ASTRON CORPORATION 255 GRANT AVE., EAST NEWARK,



NEW JERSEY

In Canada: Charles W. Pointon, 1926 Gerrard St. East, Toronto



CHANNEL MASTER

introduces a

basically **new type**

of VHF antenna

CHAMPION*

the highest gain
all-channel VHF antenna
ever developed!

Featuring the unique new "Tri-Pole"

TRIPLE-POWERED DIPOLE

The "Tri-Pole" is a new antenna system in which the Low Band folded dipole also functions as three folded dipoles tied together in phase on the High Band. This is the heart of the Champion, the secret of its phenomenal performance on all 12 VHF channels.

the **CHAMPION** is the most sensitive all-channel VHF antenna ever designed!

Stacked **CHAMPION** provides:
11-13 D B High Band gain
6½-7½ D B Low Band gain

Here is a totally NEW kind of antenna, completely different — in principal and performance — from any VHF antenna you've ever seen! Since the lifting of the TV freeze means a gradual disappearance of the single-channel VHF area, the VHF antenna of the future will be a multi-channel antenna. Prepare now for outstanding reception on all VHF channels — present and future — with Channel Master's super-sensitive **CHAMPION**! Outperforms every all-channel VHF antenna made today — and many Yagis, too!

COMPARE these features with the antenna you are now using:

- Folded dipoles throughout — give close to 300 ohms impedance across the entire band.
- Screen-type reflector provides high uniform gain on every channel, 2 through 13. Not frequency sensitive — this reflector provides more than twice as much extra gain as straight bar reflectors.
- Phase-correcting harness is built-in and fully assembled; the only wiring you do is to attach the lead-in.
- All-aluminum construction . . . lightweight, durable, non-corrosive.

MARVEL OF PRE-ASSEMBLY

assembles faster than a
5-element yagi!

Collapsed "Pop-Up" screen opens instantly — no loose rods, elements or hardware. "Tri-Pole" assembly features automatic Spring Lock Action — all dipoles snap permanently into place without wing nuts or any other hardware.

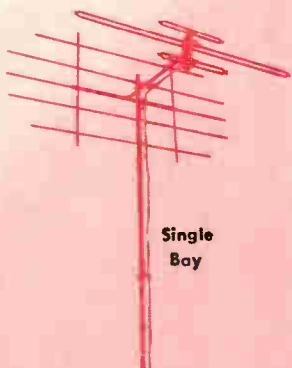

Single
Bay

It's a **CHAMPION** in any area!

- 1-bay—local areas
- 2-bay—secondary and fringe areas
- 4-bay—super-fringe areas

THIS ANTENNA...

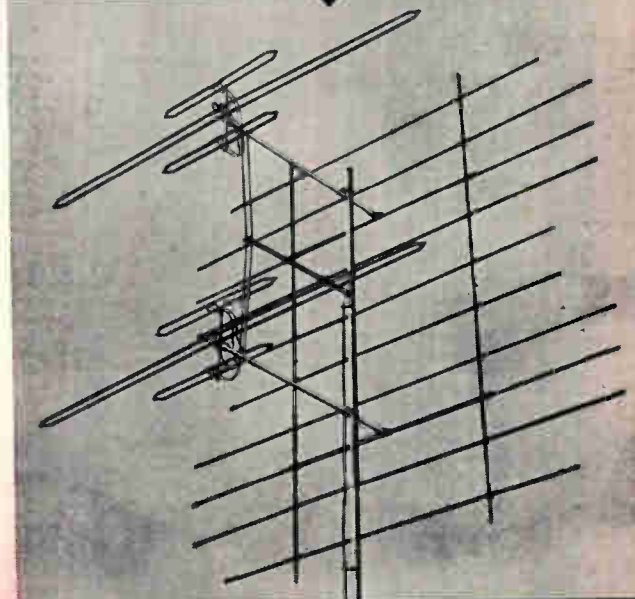

OUT-PERFORMS:

this ...



this ...

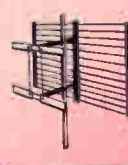

this ...



or this ...



The 2-Bay **CHAMPION** actually gives you the performance of:

- Separate 5-element Yagis for every Low Band channel!
- Separate 10-element Yagis for every High Band channel!

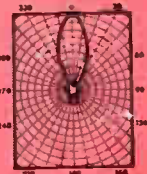
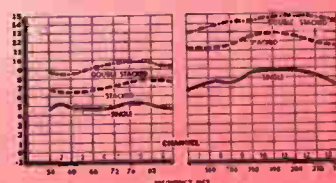

Model No.		List Price
325	Single Bay	\$20.83
325-2	2-Bay	\$42.36
325-4	4-Bay	\$88.89
Separate Stacking Harness		
325-3	2-Bay Harness	\$ 2.08
325-5	4-Bay Harness	\$ 4.15

Send for complete technical literature.

CHANNEL MASTER CORP.

ELLENVILLE, N. Y.





How silent is the night?

Watching the serenity of Christmas skies, we are conscious of deep silence. Yet the stars are talking to us all the while—talking in radio waves that are full of meaning to scientists probing the depths of space.

The important discovery that some stars produce radio waves was made by a Bell Laboratories scientist while exploring atmospheric disturbances which might interfere with transoceanic telephone service.

His discovery marked the birth of the fast-growing science of radio astronomy. It is telling us of mysterious lightless stars that broadcast radio waves, and it promises new and exciting revelations about the vast regions of space concealed by clouds of cosmic dust.

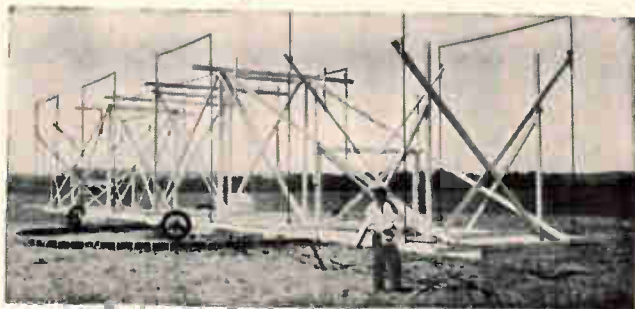

Directional radio antenna used by Karl G. Jansky, in the discovery of stellar radio signals at the Holmdel, New Jersey, branch of Bell Telephone Laboratories. In 1932 he detected waves of 14.6 meters coming from the direction of Sagittarius in the Milky Way.

It is another example of how Bell Telephone Laboratories scientists make broad and important discoveries as they seek ways to make your telephone serve you better.



BELL TELEPHONE LABORATORIES

EXPLORING AND INVENTING, DEVISING AND PERFECTING, FOR CONTINUED IMPROVEMENTS AND ECONOMIES IN TELEPHONE SERVICE,
RADIO-ELECTRONICS

For opportunities within your reach

See what the RCA TV Servicing Course offers you

Good-pay jobs. A business of your own.

OPPORTUNITIES FOR GOOD-PAY JOBS in Television are within your reach when you study TV Servicing by the RCA Institutes Home Study Method. Or perhaps you would like to start a TV Service business of your own.

If you are not satisfied with the way your future now stacks up, see how easily

you can change the course of your career. RCA Institutes Home Study Course in TV Servicing is helping thousands of other people to better jobs. It can help you. Right now thousands of opportunities are going begging. There is a critical shortage of trained TV servicemen. This is *your* big opportunity.

One of the leading and oldest Radio-Television training schools



Founded in 1909, RCA Institutes, Inc. has been in continuous operation for the past 44 years. Its

wide experience and extensive educational facilities give students, just like you, unsurpassed technical training in the highly specialized field of radio-television-electronics.

RCA Institutes is licensed by the University of the State of New York . . . an affiliate member of the American Society for Engineering Education . . . approved by the Veterans Administration . . . approved by leading Radio-Television Service Organizations.

Easy-to-understand, illustrated lessons



The entire course is divided into ten units of several individual lessons. You study them at home in your spare time.

Lesson-by-lesson you learn the theory and step-by-step procedures of installing TV antennas, of servicing and trouble-shooting TV receivers. Hundreds of pictures and diagrams help you understand the how-it-works information and the how-to-do-it techniques. You will be amazed how easily you absorb the knowledge of each lesson, how quickly you train yourself to become an experienced technician.

Experienced engineers and faculty prepared the course, grade your lessons



The RCA Institutes course was written and planned by instructors with years of specialized experience in training men by home-study and resident-school methods. The course embodies RCA's background of television experience plus knowledge gained in training several thousand technicians. A study of the course parallels an apprentice's training. Your lessons are carefully examined and accurately graded by friendly teachers who are interested in helping you to succeed.

It costs so little to gain so much

RCA Institutes makes it easy for you to take advantage of the big opportunities in TV Servicing. The cost of the TV Servicing Home Study Course has been cut to a minimum. You pay for the course on a pay-as-you-learn unit lesson basis. No other home study course in TV Servicing offers so much for so little cost to you.

RCA Institutes conducts a resident school in New York City offering day and evening courses in Radio and TV Servicing, Radio Code and Radio Operating, Radio Broadcasting, Advanced Technology. Write for free catalog on resident courses.

SEND FOR FREE BOOKLET—Mail the coupon—today. Get complete information on the RCA INSTITUTES Home Study Course in Television Servicing. Booklet gives you a general outline of the course by units. See how this practical home study course trains you quickly, easily. Mail coupon in envelope or paste on postal card.



MAIL COUPON NOW!

RCA INSTITUTES, INC., Home Study Dept. RE-1253
350 West Fourth Street, New York 14, N.Y.

Without obligation on my part, please send me copy of booklet "RCA INSTITUTES Home Study Course in TELEVISION SERVICING." (No salesman will call.)

Name _____ (please print)

Address _____

City _____ Zone _____ State _____



RCA INSTITUTES, INC.
A SERVICE OF RADIO CORPORATION of AMERICA
350 WEST FOURTH STREET, NEW YORK 14, N.Y.

Coming Next Month

7th ANNUAL TELEVISION ISSUE

A record 191,835 copies sold last year!

FEATURING

- Pages of schematics of the most popular 1953 TV sets.
- The How and Why of Color TV
- A complete series of TV servicing articles
- C-R Tube Replacements and other guides and charts
- UHF servicing, equipment and problems
- Plus many other articles and features on TV
- And a balance of first-rate articles on audio-high fidelity, radio and electronics.

Watch for this distinctive cover — on sale at parts distributors and newsstands December 24th. 50¢ per copy.

If you are not a subscriber to RADIO-ELECTRONICS, an immediate subscription will include the **January Television Issue** at regular rates. You can save up to \$3.40 over newsstand prices, on a 3-year subscription.

1 Year \$3.50 2 Years \$6.00 3 Years \$8.00



JETOMIC AGE

For the era of all-channel reception—model JeT454, the JFD JeTOMIC.

TWO broadband antennas in ONE revolutionary pre-assembled UHF-VHF array for channels 2-83.

The JFD JeTOMIC combines for greater gain the most highly directive UHF antenna design—the rhombic—and the JeTenna conical—acknowledged classic of VHF performance.

ONE LEAD-IN—NO LOSSY COUPLER
BRILLIANT UHF-VHF RECEPTION!

Send for form No. 241

JFD MFG. CO. Brooklyn 4, N.Y. *World's largest manufacturer of TV antennas and accessories*

FACTS TALK! COMPARE FOR YOURSELF

Channels	14	21	28	35	42	49	56	63	70	77	83
Competitor A Conical with Bowtie (2 stack)	4.0	3.25	2.0	1.0	1.0	0.75	0.5	0.7	0.9	0.75	0.3
Competitor B Bedspring with UHF	0.75	0.75	0.9	1.0	0.8	1.0	1.5	1.6	1.5	1.25	1.0
Competitor C Conical with V (2 stack)	3.0	3.3	4.0	4.6	4.9	5.0	4.8	4.5	4.25	4.0	3.75
Competitor D Filter type with attached "V"	2.0	2.0	2.5	2.75	2.9	2.9	2.4	2.2	2.0	1.3	1.0
JFD JeT 454S	7.0	7.25	7.4	8.5	9.0	9.5	10.25	10.25	10.25	10.0	9.75



Model JeT454S

stacked* • \$34.50 list

Model JeT454 • single \$16.50 list

*Complete with stacking transformer

NEW! 7 INCH PUSH-PULL OSCILLOSCOPE

Only EICO Has All These Features:

- VERTICAL FREQ. RESPONSE: ± 2 db 10 cps - 1 mc
- VERTICAL SENS.: .01 volts / inch
- HORIZONTAL FREQ. RESP.: flat ± 0 db / cps - 200 kc, -4 db at 500 kc
- HORIZONTAL SENS.: .3 volts rms / inch
- DEEP RANGE: 15 cps-100 kc
- STEP FREQ.-COMPENSATED ATTENUATOR eliminates freq. distortion, overloading.
- CATHODE FOLLOWER inputs to tube amplifiers
- PUSH-PULL outputs in both amplifiers
- TURN TRACE BLANKING
- VOLTAGE CALIBRATOR
- HORIZONTAL TRACE EXPANSION & CENTERING: Full screen without distortion.
- DIRECT CONNECTION to vert. CRT plates. KIT \$79.95. WIRED \$129.50.
- PHASING CONTROL of internal 60 cps sine wave sweep.

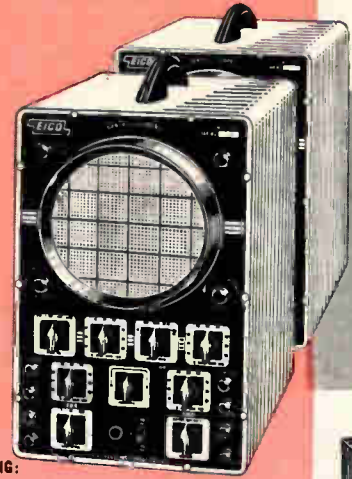

MODEL 470K
KIT \$79.95. WIRED \$129.50.

FRONT PANEL: Intensity mod. input; 60 cps, sawtooth outputs.
FAMOUS EICO AMAZING FEATURE-PACKED ECONOMY-PRICED
425K 5" PUSH-PULL SCOPE KIT \$44.95. WIRED \$79.95.

- AC & DC volts: 0-5, 10, 100, 500, 1000 V (30 KV with HVP-1 probe). ● 5 ohm ranges from .2 ohm to 1000 megs.
- DC input Z 26 megs. ● 4 1/2" meter movement in can't-burn-out circuit.
- 1% mult. resistors.



221K VTVM KIT \$25.95. WIRED \$49.95.

- HIGH VOLTAGE PROBE \$6.95
- Extends range of VTVMs & voltmeters to 30 KV.



PIX TUBE ADAPTER for Tube Testers \$4.50. Checks TV picture tubes white in set.

- Continuous coverage of all TV & FM freqs. from 500 kc to 228 mc.
- Sweep width variable 0-30 mc.
- Crystal marker oscillator, variable amplitude.



360K SWEEP GEN. KIT \$34.95. WIRED \$49.95.



- Large 7 1/2" meter, can't-burn-out circuit.
- AC/DC volts: 0-5, 10, 100, 500, 1000 (30 KV with HV Probe).
- 5 ohms ranges from .2 ohm to 1000 megs.
- DC input Z 26 megs.
- 1% mult. resistors.

214K VTVM KIT \$34.95. WIRED \$54.95.



625K TUBE TESTER KIT \$34.95. WIRED \$49.95.

COUNTER CABINET for above: add \$10.00 to Kit or Wired Prices.

- Illum. gear-driven "Speed Rolchart."
- New lever-action switches for individual testing of every element.
- Tests all conventional & TV tubes.



950A-K R-C BRIDGE & R-C-L COMP. KIT \$19.95. WIRED \$29.95.

- Measures & tests all resistors; 5 ohm to 500 megohms.
- Every type condenser, 10 mmf to 5000 mfd.
- 0-500 DC voltage source for capacitor leakage testing.

NOW! ONLY EICO -

the largest manufacturer of its kind in the world - gives you LIFETIME SERVICE & CALIBRATION GUARANTEE*
... the Industry's greatest protection for your test equipment investment!

* at less than our cost of handling (see the EICO Guarantee Card enclosed with each Kit and Instrument).



- NEW!
- SCOPE VOLTAGE CALIBRATOR KIT 495K KIT \$12.95. WIRED \$17.95.
- Sq. wave output at power-line freq. with full-scale readings of .1, 1, 10 or 100 V. peak-to-peak.
 - Accuracy $\pm 5\%$ of full-scale on each range.



- Audibly signal traces all IF, RF, Video & Audio circuits from ANT to SPKR or CRT in all TV, FM, AM, etc. without switching.
- Germanium crystal diode probe responsive to over 200 mc.
- Integral test speaker.

145K SIG. TRACER KIT \$19.95. WIRED \$28.95.



- Fundamentals 150 kc to 34 mc, harmonics to 102 mc.
- 5-step band switching.
- Colpitts audio oscillator generates 400 cps pure sine wave voltage.
- Permits pure RF, modulated RF, or pure AF.

320K SIG. GEN. KIT \$19.95. WIRED \$29.95.
322K SIG. GEN. KIT \$23.95. WIRED \$34.95.



- 1000 Ω /V; 31 ranges
- DC/AC volts: Zero to 1, 5, 10, 50, 100, 500, 5000.
- DC/AC Current: 0-1, 10 ma; 0.1, 1 A.
- Ohms: 0-500, 100 K, 1 meg.

536K MULTIMETER KIT \$12.90. WIRED \$14.90.
526K MULTIMETER KIT \$13.90. WIRED \$16.90.



- Complete sine wave coverage, 20-200,000 cps in 4 direct-reading ranges.
- Complete square wave coverage, 60-50,000 cps.
- Cathode follower output circuit.

377K SINE & SQUARE WAVE AUDIO GEN. KIT \$31.95. WIRED \$49.95.



- Resistance values from 0 to 99,999 ohms with 0.5% precision.
- All resistors have 0.5% accuracy.

1171K RES. DECADE BOX KIT \$19.95. WIRED \$24.95.



- NEW!
- DECADE CONDENSER BOX KIT 1180K KIT \$14.95. WIRED \$19.95.
- All capacitors precision silver mica, accuracy $\pm 1\%$.
 - Range from 100 mmf - 0.111 mfd in steps of 100 mmf.
 - Smooth-action positive detent ceramic switches

Prices 5% higher on West Coast. Specifications and prices subject to change without notice.



- 20,000 Ω /V; 31 ranges.
- DC/AC/Output volts: 0-2.5, 10, 50, 250, 1000, 5000.
- DC Current: 0-100 μ a; 10, 100, 500 ma; 10 A.
- Ohms: 0-2K, 200K, 20 meg.

565K MULTIMETER KIT \$24.95. WIRED \$29.95.
555K MULTIMETER KIT \$29.95. WIRED \$34.95. (1% precision resistors)



- Covers range of 75 kc to 150 mc.
- 7 calibrated scales: accuracy better than 1%.
- Bandsread vernier tuning.
- 4-step RF shielded output multiplier: constant output Z.

315K DELUXE SIG. GEN. KIT \$39.95. WIRED \$59.95.

EICO

Write NOW for FREE latest Catalog C-12

You build EICO Kits in one evening, but . . . they last a lifetime!
And you SAVE OVER 50%! See the famous EICO line TODAY, in stock at your local jobber.

ELECTRONICS vs. ATOMIC BOMBS

... The atomic threat will be countered by electronics ...

By HUGO GERNSBACK

THE greatest weakness of any atomic bomb lies in its delivery." This obvious axiom is frequently lost sight of now when our country is becoming frantic in elaborate defense measures and where there is little agreement upon the most effective means to use. Let us therefore consider the means now at our disposal.

RADAR Radar is only of limited use as a warning agency. Unless it is far removed from our vital centers, it becomes useless. That means a permanent radar chain installation high up North in the polar regions if we are to have the necessary several hours warning to alert our interceptor planes. Obviously we can have no such chains in the North Atlantic and Pacific unless we use hundreds of radar-equipped ships. Such ships, however, are cumbersome and the cost is high.

In 1950, the writer proposed *Stratoradar* planes. These are huge planes circling at great heights, scanning the horizon 24 hours a day. We need only 6 *stratoradar* planes to cover a line of 3,000 miles, each plane scanning 500 miles. Such a scheme is now seriously considered for the so-called "D.E.W." (Distant Early Warning).

HOMING GUIDED WEAPONS These can be used either from the ground or from the air. They can be fired from antiaircraft guns, from the ground, or from interceptor planes. The guiding is done electronically by the missile itself.

Yet imagine the highly complex situation when an enemy fleet numbering hundreds of bombers should appear over our country. Even with long distance warning and all our present available radar and other defenses, not every guided missile can possibly make an effective hit on an enemy bomber.

We would need tens of thousands of interceptor fighters to wipe out such an attacking air armada. And we must not forget that the enemy bombing planes are armed too—and conceivably will have guided weapons against our own defending planes.

This was the case over England and over Germany during World War II. The unpleasant fact remains that *at best*, according to our informed military experts, we can only hope at present to shoot down 70% of the attacking aircraft. Thus, out of 300 planes, 90 will get to the target. To be sure, not all the attacking planes would carry atom bombs. Let us say only 10% do. Nine attacking planes, therefore, would finish their mission. Ponder also the fact that one solitary H-Bomb could wipe out not only a city the size of New York, but severely damage all surrounding cities over a radius of 100 miles.

But that isn't the whole story. Consider also the destroyed enemy aircraft. Heretofore these were only casualties to the enemy. *Today, if an H-Bomb carrier is shot down even 20 miles from a large city, that city*

may be destroyed as completely as if it had been bombed by the enemy.

To be sure, the enemy is aware of all these possibilities, and realizes that if he attacks us we will repay him in kind, plus interest. Nevertheless, the stark reality remains that if we are successfully attacked, dozens of our large cities will be completely wiped out with fatalities and casualties running between 10 and 40 million persons.

From these facts—dozens of others could be cited—it should become obvious that our vital needs are:

1. Far-flung and numerous bases and abundant air-power to attack the enemy with overwhelming blows as a powerful deterrent. Fortunately, this gigantic arm is now in the making.

2. A comprehensive and well-equipped D.E.W. (Distant Early Warning) system that will be efficient. Present day radar is so poor due to technical limitations that—according to the scientists at McGill University who worked out the Canadian Arctic radar interception system—at best only 80% of attacking enemy planes could be detected. This calls for vast new research in radar improvement. It also means complete reorientation of radar itself.

3. New electronic interception and *direct electronic combatting means*. It is here our most powerful and effective future defense lies. History has always recorded that every new weapon sooner or later forces a successful counter. The attacking H-bomber—or for that matter the transoceanic guided missile—will be check-mated in time. And you may be sure it will be by electronic means.

Electronic guided atom or H weapons will envelop and destroy clouds of hundreds of enemy attacker planes in the stratosphere.

Thermic-Radar will burn and explode enemy aircraft—and in the more distant future—track and destroy even transcontinental guided missiles. We have already made a modest beginning in the use of thermic radar as reported first in our August 1953 issue. We reprint only one passage from that article, entitled "Radar Hazards":

Photoflash bulbs were fired (by microwave Radar) at a distance of 323 feet. At 300 feet audible and visible sparking was apparent when metallic chips were shaken in a paper bag. With high power radar, these and other spectacular effects can be duplicated at even greater distances.

It would appear from the few facts cited here that our entire future defense and our survival as a nation may well rest on electronic means. Our electronic engineers, our physicists and scientists will come up with the right answers at the right time. They always have in the past.

The Editors and Staff of Radio-Electronics
Wish You a Merry Christmas and a Prosperous New Year.

BUDGET REMOTE LINE AMPLIFIER

This tried and tested low-cost amplifier is ideal for schools or semiprofessional use



The low-cost remote line amplifier with power transformer.

By **GEORGE L. AUGSPURGER**

WE HAVE often pointed out that the slogan "something for nothing" belongs among the "famous last words" as far as audio work is concerned. Yet, we have to admit that few persons or institutions can afford to buy equipment on a "price is no object" basis. Schools especially are plagued with the necessity of trying to stretch scanty budgets for broadcast or recording studios.

Arizona State College at Tempe recently installed a wired-wireless radio station. While the transmitter is no more than a glorified phono oscillator, the school has managed to set up fairly complete studio and control facilities. In such a college radio setup a great deal of work consists of remote broadcasts from the gymnasium, auditorium, chapel and similar points. One day when we were inspecting the KASC facilities, the station engineer, Tom Voss, re-

marked that he would like to have a miniature remote amplifier capable of reasonable fidelity that could easily be carried to remote locations and operated by student members of the radio staff.

We told him that it would be possible to build such an item in a small, light case for about \$50, and to prove our point we sketched a schematic of a simple three-stage circuit.

"Will that do the job?" asked Tom. We assured him that it would.

"Will it have enough gain?"

We did some quick mental calculating and replied that it wouldn't have any to spare, but that it should have *enough*. (Mistake number one!)

"And a single-ended output will be able to send plenty of signal into the line?" inquired Tom dubiously.

"Oh, yes," we said, "After all, you don't need extreme fidelity and we can

slap in a little feedback if we have to." (Mistake number two!)

"All right," said Tom. "One of our engineers is looking for a special project in an electronics course. I'll have him build it."

Preliminary problems

The engineer looking for a special project turned out to be a pleasant fellow named Mark Sexton. In about a week he had collected all the parts needed for the circuit. We checked them over and discovered that he had purchased a steel chassis. "Couldn't you get an aluminum one?" we asked. "This is bound to induce hum if we try to mount the power transformers on the same chassis as the amplifier."

Mark answered that he had tried to get an aluminum chassis, but the wholesale house was unfortunately out of them at the moment and he was anxious to get started on the project. We chewed our fingernails and said all right, the hum could probably be licked by orienting the transformers. (Mistake number three!)

Tom was anxious to have the unit built too. Did we think that Mark would have any trouble wiring it? "If he just follows the schematic and avoids ground loops, he won't have a bit of trouble," I assured Tom. (Mistake number four!)

Another week went by and Mark had finished the job. We plugged in a pair of headphones and turned it on. Loud hum! We rotated the input transformer. Still loud hum. We adjusted the filament balancing pot. Still loud hum. "I wired it just like you said," said Mark hopefully.

An hour later we discovered that Mark *had* wired it just the way we had drawn the schematic, but due to certain things we had forgotten, such as

RADIO-ELECTRONICS

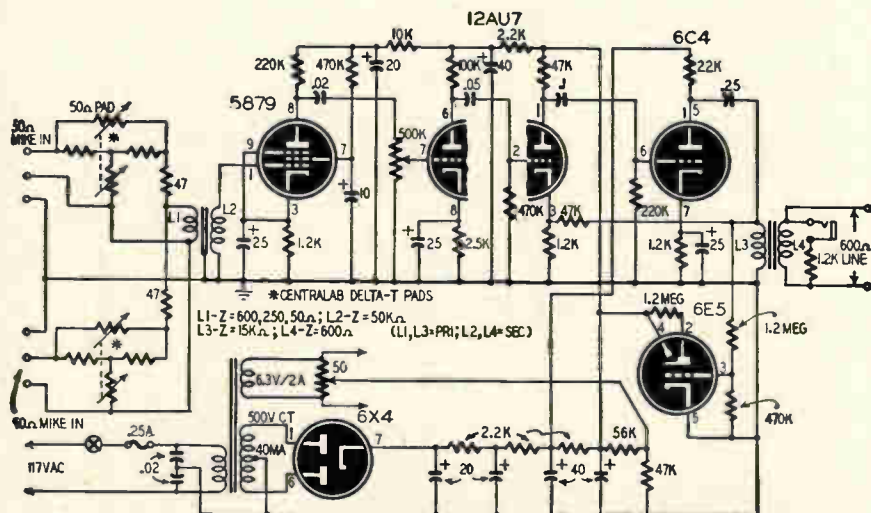
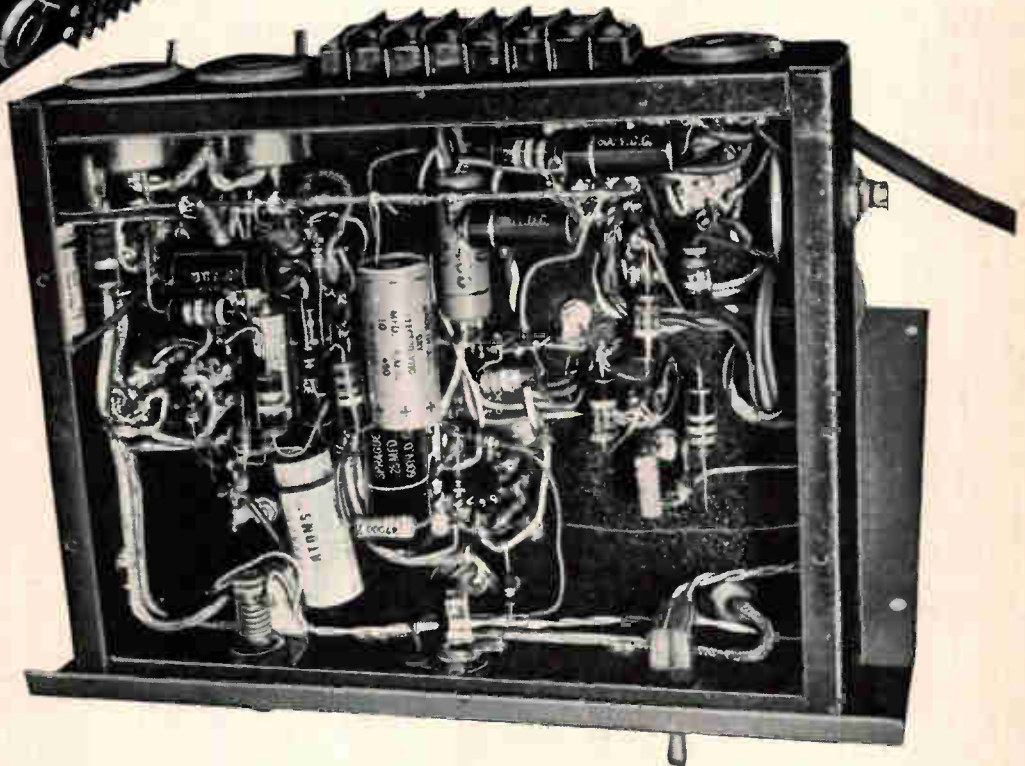

Fig. 1—Schematic of the final revision of the budget remote line preamplifier.



Left. Top view of remote amplifier. Ample room provides for neat layout.

Below. Underside view of amplifier. Barrier strip makes good terminal.



transformer case grounds, he had managed to wire in three ground loops. Once these were removed, the hum was down about 10 decibels, but it was still too high. Another hour's experiment showed that the power transformer was inducing hum both into the chassis and into the electrolytic capacitors sitting next to it. If we tried to put the power supply on a separate chassis there would still be the capacitor induction problem.

We finally solved the difficulty by attaching a 24-inch cable directly to the transformer itself. The case was removed and connections were made inside the shell. With a plug on the other end of the cord this gave us an auxiliary unit much smaller and easier to handle than the conventional separate power supply as well as completely isolating the transformer from all possible hum pickup. The transformer hooks on to the rear of the cabinet when it is being carried about.

Mark took the amplifier down to the electronics lab to run some tests. He came back with a neat set of charts that showed 15% distortion at 6 milliwatts output and a noise level only 30 db below the zero db output! "We'll have to put in a little feedback," we muttered.

About two days and several testing sessions later we had the hum and noise down about 35 db and had compromised on a 1 volt output at 4% distortion. Tom tried it out the next evening and reported that with all the controls full open it still didn't have enough output. "You must have used a defective microphone," we suggested. Of course, we were wrong again—the microphone was perfectly all right. The fact was simply that the amplifier didn't have enough gain.

This time we had sense enough to

take the diagram home and work on it a little more carefully before we made any suggestions. We finally calculated that by adding one more tube, it would be possible to incorporate plenty of feedback and still have gain to spare.

Mark took our revised diagram and within the space of two days had not only added the extra stage but had replaced a noisy volume control and rearranged all the wiring so that it was neat and orderly.

This time it only took us about an hour to find two more concealed ground loops and discover that the power transformer case was not grounded; then we took the little monster down to the lab and made some last adjustments. The final circuit is shown in Fig. 1. It meets our original specifications of being flat within 3 db from 50 to 15,000 cycles at less than 3% distortion at zero db output. Tom tried it again and was pleased this time with its performance, so we wisely kept our mouths shut and just smiled and staggered

away. However, for the benefit of the reader, it might be a good idea to discuss the amplifier a little further from the standpoint of criticism and evaluation.

Mixing systems

Since high-quality transformers are the most expensive components in such an amplifier, it was decided to try low-impedance mixing with both microphones feeding into a common input transformer. This system, while the most economical possible, has two serious drawbacks. It has an insertion loss of 6 db between the microphone and the first amplifier stage, and it places the mixer controls ahead of all stages of amplification. Hum and noise is automatically higher than it would be with electronic mixing. In this particular



Fig. 2—Response curve of amplifier

case, hum was reduced to a very low value due to the filament balancing control and the use of a 5879 in the first stage. However, tube hiss and noise could not be reduced more than about 36 db below rated output.

The first stage is a conventional pentode-connected 5879, which is about the least expensive and most reliable of the low-noise type tubes. Two-watt carbon resistors are employed in the first two stages to reduce resistor noise without the expense of noninductive wirewound types. Even so, tube and resistor hiss could have been lowered even more had lower values of plate and screen resistors been used in the first stage of the amplifier.

The volume control is located at the grid of the second stage as a remnant of the original design. Since the amplifier introduces almost no noise or hum after the 5879, there seemed to be no point in moving the control back another stage when the 6C4 was added to the amplifier.

In the final stage a 6C4 feeds the output transformer through a 0.25- μ f capacitor. Feedback is taken directly from the transformer primary to the cathode of the third stage. This, of course, sends a fractional bit of direct current through the transformer winding, but it does not seem to be enough to have any serious effect.

A headphone jack is connected to the secondary of the transformer through a 1,200-ohm series resistor to prevent any possibility of something being plugged in which would unduly load the line. A tuning-eye tube is used in place of the conventional meter, since a meter would have cost too much for this project and an electron-ray tube

can't have its pin bent by an inexperienced operator.

The amplifier is not able to drive a line at more than 6 milliwatts. This is not a deterrent at the college since all remote lines are relatively short and additional amplification is always available at the other end of the line, should it be needed.

The photographs show clearly the compact arrangement of parts on the sloping front cabinet and the location of components underneath the chassis. No attempt was made to use resistor strips or cabled wiring, but Mark's final job is extremely neat, efficient, and easy to service.

A glance at Fig. 2 shows that the response of the unit slopes down slightly from 5,000 cycles and then takes a sudden plunge at about 100 cycles. Probably with more generous bypass and coupling capacitors, and with a more carefully chosen value for the shunt-feed capacitor, the response curve could be extended considerably in the low range.

Distortion figures are given in the table, and shown at several points over the audio range. The maximum distortion occurs at 100 cycles and still is only 2.25% at full output. This figure is not at all bad for a single-ended stage driven almost to its maximum output. What distortion does occur is mostly nonsymmetrical and could be eliminated by using push-pull output, but this would mean another output tube and a phase inverter. These two items would increase size and cost more than would be justified in a small all-purpose unit such as this one, although we readily admit that for highest quality a push-pull output stage is a

Table I—Audio harmonic distortion.

Frequency	%
50	2.1
100	2.25
1,000	2.1
10,000	1.25

necessity.

As can be seen, the microphone input is to Centralab delta-T pads. This was not done because of convenience of parts, but for a very special reason. The ear does not hear equally as well at all volume levels. As volume increases or decreases from about the center of the hearing range, the ear hears less and less of the very low or very high notes in relation to the medium notes. This is especially true and more noticeable at the low frequencies. This effect is usually called the Fletcher-Munson effect.

The delta pad is a volume control and special printed electronic circuit network designed to better reproduce the bass and treble response of the amplifier when the volume is at a low level. The pad is thus a true "low loss" control that would not induce a noticeable signal loss into a piece of equipment.

Since the budget remote line amplifier is essentially a low current device, the power supply is entirely adequate. The power supply filter may seem unnecessarily elaborate, but the RC filtering assures a minimum of ripple frequency finding its way into the various circuits.

Modifications

After reviewing the performance of the unit, it seems reasonable that the only two changes we might make if a

HIGH-FIDELITY STANDARDS

In a letter to Edward F. Howery, chairman of the Federal Trade Commission, John S. Meck, president of Scott Radio Laboratories has asked the FTC to "provide a standard for high-fidelity performance and take the necessary steps to protect the public from pseudo products." He continued:

"As the chairman of an organization that has done such an excellent job of protecting the buying public, you will be interested to know that the term 'high-fidelity' is being employed in the promotion of many instruments that in no way provide the components or performance of minimum high-fidelity standards."

The Scott president says he considers the following points as *minimum* high-fidelity essentials:

1. A pickup on the tone arm that preserves the true waveform at all frequencies, with particular reference to high notes and overtones.

2. A large and ample amplifier of the push-pull type with 6L6 or equivalent tubes, having a maximum output

of 25 watts or more, of which 5 to 6 watts will be utilized under optimum range.

3. A wide-frequency-range coaxial speaker, with a separate cone for the low notes having a resonance point near 50 cycles per second; a second coaxially mounted speaker unit that faithfully reproduces the high notes to well above 15,000 cycles per second; and a crossover network to remove the highs from the low-frequency speaker unit and the lows from the high-frequency speaker unit.

At a meeting of RETMA's high-fidelity equipment section, a draft of standards was agreed upon. These proposed high-fidelity standards are: Wide-range loudspeakers, minimum range of 60-10,000 cycles per second; tuners, sensitivity on FM, minimum standard of 30 db of signal, with 25 microvolts into antenna; amplifiers, minimum frequency response, plus or minus 3 db from 30-15,000 cycles at no less than 10 watts, with maximum of 5% intermodulation distortion. END

Materials for amplifier

Resistors: 2-47, 4-1,200, 4-2,200, 1-2,500, 1-10,000, 1-22,000, 3-47,000, 1-56,000, 1-100,000, 2-220,000, 3-470,000 ohms; 2-1.2 megohm. (The author used 2-watt resistors for lower noise, though 1-watt resistors might be used in all but low-level stages. See text.)

2-Centralab Delta-T pads or equivalent, 50 ohms; 1-50-ohm wirewound variable resistor; 1-500,000-ohm potentiometer.

Capacitors: 3-.02, 1-.05, 1-0.1, 1-0.25 μ f, 600 volt, paper or mica; 1-10, 3-20, 3-40 μ f, electrolytic, 450 volts; 3-25 μ f, 25-volt electrolytics.

Tubes: 1-5879, 1-12AU7, 1-6C4, 1-6E5, 1-6X4. Transformers: power, Triod R-4A or equivalent; input, Triod J0-1 or equivalent; output, UTC A-24 or equivalent.

Miscellaneous: open-circuit phone jack; 2 microphone-input jacks; 1/4-ampere fuse, sockets, chassis, wire, switch, hardware, etc.

second one were built would be to lower the value of the plate and screen resistors in the first stage and try to select components to give a slightly extended bass range.

With the exception of the possible two modifications just mentioned, the circuit seems to be a most satisfactory design according to the original goals established. The total cost of parts was almost exactly \$50. For this amount of money and a little careful work, a unit can be constructed which will provide flat response at low distortion from 50 to 15,000 cycles. As a compact, lightweight, easy-to-operate remote line pre-amplifier, it fills a definite need for a low-budget semiprofessional unit. END

HIGH-QUALITY AUDIO

Part IV—The phonograph pickup is the decoder of recorded music; the beginning of the sound reproduction process

By RICHARD H. DORF*

THE main source of pleasure through the high-quality home music system is reproduction of phonograph records. Even in a city like New York, which is almost unique in having three FM stations broadcasting almost nothing but serious music, the majority of music system owners listen more often to records than to radio music. That being so, it is worth while to look at the subject of phonograph records and the pickups, with more than passing interest.

Sound itself is simply a series of compressions and rarefactions of the air. Striking the ear, the air pressure variations have a physiological effect on certain membranes and small hairs, which effect the brain interprets as hearing. Only air pressure variations which occur at rates between about 12 and 15,000 times per second have

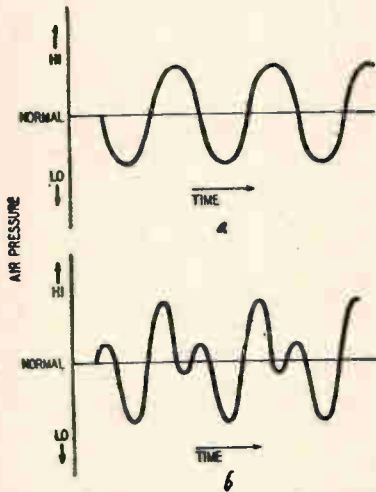

Fig. 1—Simple and composite waves.

this effect; faster and slower variations are either ignored by the brain or interpreted in ways other than sound.

The number of times per second the air pressure varies (that is, its frequency) determines what we call pitch; the faster the variations (the higher the frequency), the higher the pitch. When, for example, the air pressure varies at a rate of 440 times per second, we hear the pitch that is referred to in music as A above middle C.

The greater the pressure variations (that is, the greater the difference between maximum and minimum pressure) the greater is the apparent volume or loudness of the sound.



Fig. 2—Two forces acting on one object. The net acting force is the difference.

Thus we have two basic characteristics of sound: pitch or frequency (which we will use interchangeably for the moment), determined by the number of pressure variations per second; and volume, loudness, or amplitude (same comment), determined by the extent of the pressure variations.

We can draw a graph of a sound wave, which tells the entire story. Fig. 1-a is such a graph or picture of the sound wave produced by a tuning fork. This fork was tuned to A (440 cycles), and the graph shows a short section of time during which the air pressure started at its normal value, was compressed, returned to normal, became rarified then returned again to normal.

This pattern—normal, maximum, normal, minimum—is repeated again and again. It is a complete cycle. Since the fork was tuned to 440 cycles per second, this one cycle must have taken place in 1/440 of a second.

Fig. 1-b shows what happens when we take two tuning forks, one at 440 cycles and a second at twice that frequency, 880 cycles. We strike both equally hard and they have equal effects on air pressure. The sound pressure now varies in a different pattern, since it contains two frequencies. But, there are not two separate waves. The pressure variations caused by the two

forks combine and produce a single pattern of compression, which is a composite picture of the two. This is to be expected, since the same air particles could hardly be in two places at the same instant.

This is important in audio, so let us illustrate it. Fig. 2 shows Jack and Hal, each pulling on a rope wound around a rock. Jack is pulling with a force of 10 pounds, Hal with a force of 8 pounds. Obviously the rock cannot move simultaneously toward Hal and Jack. So, it must combine both forces and undergo a single movement which is a composite of the two. And since Jack is pulling 2 pounds harder than Hal, the rock will move toward Jack.

It is easy to see what would happen if there were four men—or seven, or any number—all pulling on the rock from different directions with different forces. Since the rock can move in only one direction at a time, it would have to make a calculation that takes into account all the forces and directions and take the one path that is the resultant.

Air is just as clever as rocks. When many different frequencies, each at a different amplitude, exist in a source of sound, the air makes the right calculation at every instant and compresses or rarifies to an extent and at a

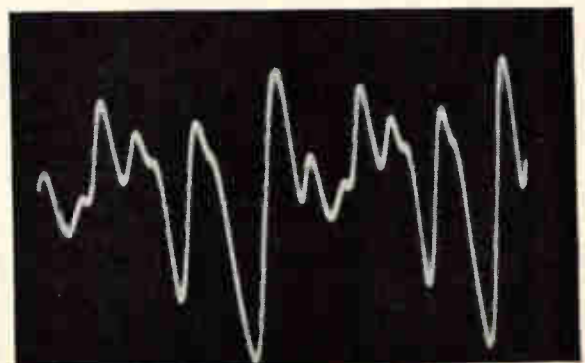

Fig. 3—Wave containing many frequencies.

* Audio Consultant, New York

rate which takes into account *all* the acoustic forces. That is what has happened with the two frequencies in Fig. 1-b. Fig. 3 is a picture of a sound wave with a great many frequency components, more typical of what the usual musical instrument or orchestra really produces. All the frequencies are contained in a single pattern of air movement (two cycles of it are shown); but when all this reaches the ear, the brain will automatically break down the pattern to its original components, each of which will be heard as separately as transmitted.

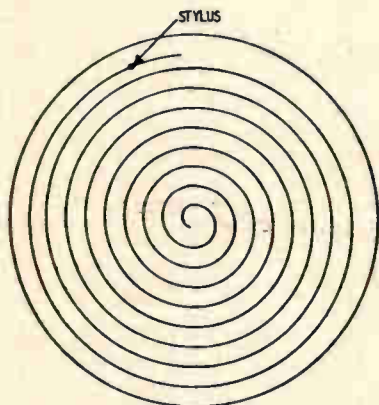

Fig. 4—Path of stylus-spiral groove.

Preserving sound

We have already recorded sound in Figs. 1 and 3. They *are* records of sound just as surely as "antidisestablishmentarianism" is a record of a word. However, they are records of only a very short period of sound—a small fraction of a second. To record even a few minutes would require many thousand inches of drawing, and it would be an almost impossible job for the draftsman if the sound were constantly changing, as it would in a musical composition. We need a device which will automatically translate air pressure variations into a permanent record. The record may be a drawn line on paper, variations in density of a film, variations in the magnetism of a strip of tape, or variations in the path of a spiral groove in a disc. The latter is what we are interested in at the moment.

The writer's book *Practical Disc Recording* (Gernsback Library) gives a good grounding in the how of making records, which we will not attempt to reproduce here. All we have to know is that the pattern of air pressure variations is translated by a microphone and amplifier into an exactly similar pattern (we hope) of variations in electric power. By a recording machine the electric power variations are engraved into a rotating disc as variations in the path of a spiral groove. Then, many exact (again, we hope) duplicates are made of this master record by various factory processes known as pressing.

Fig. 4 represents a phonograph record. The much exaggerated spiral line represents the shallow groove engraved in it. The record rotates in the direc-

tion of the arrow. If we place a stylus in the groove and keep it from rotating with the record, the stylus will ride through the entire groove. The stylus (we used to call it a needle) will end up near the center of the record, where the spiral groove ends.

Fig. 5 shows the real nature of the groove. It is an exaggerated picture of a small section of the spiral. The groove is not a perfect spiral; instead, it wiggles from side to side. The wiggles are the sound pattern in Fig. 5, representing a sound very much like that of Fig. 1-a. Where the pattern of sound is more complex (Fig. 3) the wiggles of Fig. 5 would also be more complex. In fact, if the spiral were straightened out, the wiggles would be a replica of a graph of the original air pressure variations.

How pickups pick up

A phonograph pickup consists of two main parts. The first is the stylus, which fits into the record groove, and the second is the element, which translates stylus movements into an electrical voltage which can then be fed into an audio amplifier.

Obviously, therefore, the stylus must move *with relation to the element*. It would do no good if both stylus and element moved together in response to the wiggles of the record groove, for the stylus must move some part of the element in order to create a voltage. A good analogy is winding up the spring motor of a toy automobile. You must turn the winding key with relation to

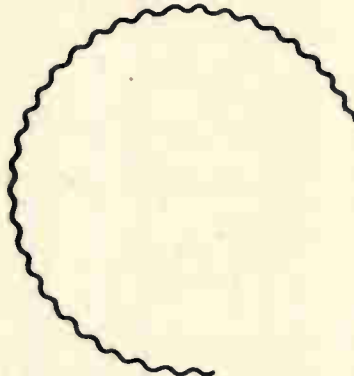

Fig. 5—Groove with signal recorded.

the car—and you do it by holding the car steady in one hand and turning the key with the other.

The reason this point is brought up is that some people are puzzled (with good reason) about the pickup. If the wiggles in the groove cause the stylus to wiggle back and forth, they also cause the whole pickup to wiggle, since it is mounted in a pivoted arm. Now, how can the stylus move *with relation to the element*?

It's simple. The element (combined with the case of the cartridge and the arm) has much greater mass or weight than the little stylus. The stylus is mounted to the cartridge in such a way that it is very free to move. It is *compliant*. The groove wiggles are very small and very fast. Therefore, while

they can vibrate a small lightweight thing like the stylus, they simply haven't the power to vibrate a relatively big heavy assembly like the rest of the pickup, at so high a rate of speed. You can prove this. Hold a pencil in your hand and see how fast you can vibrate it back and forth. Now hold a heavy bar of steel and see how fast you can vibrate that! It is easy to see that if you pivoted the bar of steel at one end like a phonograph arm and attached the pencil to the other end with a light spring, you could do a lot of pencil wiggling without getting a move out of the bar.

If you slow down the rate of wiggling, you will find some low speed at which moving the pencil will also move the bar. At this and lower speeds, the relative movement between pencil and bar will become less and less until, at some very slow speed, there will be none.

The same is true of the stylus and element. At some frequency of groove wiggle, the movement rate will be slow enough to allow the pickup and arm to move right along with the stylus—and there will be no electrical output from the pickup. The frequency at which this begins to take effect depends on the mass of pickup and arm, the stiffness of the arm, and the compliance (relative freedom of movement) of the stylus.

Ideally, the normal kind of arm would not be used. Instead, the pickup would be firmly clamped to a stationary mount, with only the stylus free to move. This would cause much mechanical difficulty, however, especially with the necessity for the whole assembly to move inward slowly with the groove spiral, therefore it is never done. Instead, high-quality audio systems use pickup arms which have the proper characteristics to move the critical frequency down so low it is out of the audio range.

Resonance is another important arm factor. Any piece of metal (or any other substance) has a mechanically resonant frequency. The prime example is the metal tube which is struck by a hammer for carillon or chime effects. A pickup arm also has resonance, the frequency depending on its mass, length, and stiffness. The arm is very easy to move at its resonant frequency. If some groove wiggles make the stylus move at this frequency, the arm starts swinging all over the place (don't try to see it—it's still too small a movement for that). This creates a great deal of relative movement between stylus and pickup element, and tones at the resonant frequency are greatly accentuated in volume. The listener hears a "boom-boom" effect, which is far from the high-quality sound we are after.

The arm designer has many problems. The arm must be light enough to avoid excess stylus pressure on delicate grooves, but heavy enough to give a low resonant frequency. It must be very stiff, yet the weight of bracing cannot be added. Fig. 6 shows a well-



Fig. 6—Pickup is damped with a viscous liquid like a hydraulic shock absorber.

made arm which, in addition to having low basic resonance, is actually damped with a viscous liquid like a hydraulic shock absorber. This positively prevents audio-frequency arm movements and also prevents the arm from dropping on the record with enough force to damage stylus or disc.

Because we are talking about high-quality audio and not department-store or public address machines, this question of the mechanics of grooves and vibrating styli and arms is an important one. Nothing is more true in high-quality audio than the old saw about the weakest link in the chain. A poor arm and a noncompliant stylus mounting in a pickup definitely mean poor quality. When you buy pickups and arms, remember what we have said in this article and make sure you consult salesmen and manufacturers' ratings to get the best you can afford—the arm with the lowest resonant frequency and a pickup with high stylus compliance. Unfortunately you have not a wide choice of arms when it comes to record changers, but even here changer makers are now paying more attention to arm resonance. If you fail to heed, not only will you have juke-box bass—with every bass note sounding like the same pitch (the resonant pitch of the arm)—but your records, especially the plastic LP's, will die an early death.

The war of the speeds

Until 1948 all records sold to the public were supposed to rotate at 78.26 r.p.m. and the spiral was pitched at between 96 and 110 lines per radial inch of disc.

In 1948 Columbia brought out the 33 1/2-r.p.m. microgroove LP, which extended the amount of music on a single disc, a laudable accomplishment which has given new life to the record industry.

For a complete symphony only one record need be manufactured, handled, and sold, instead of as many as six. This saving is passed to the user. And—at last—there is almost no surface noise, or "needle scratch." The plastic vinylite is expensive compared to the old shellac compound with its gritty filler, but LP makers can afford to use it. No longer does the stylus move at random several thousand times per second due to irregularities in record material surface. Vinylite is glassy-smooth

by comparison and the stylus moves only in response to purposeful groove wiggles—or dust particles.

There are two main differences between slow-speed records and the older fast (78-r.p.m.) types. The size of the groove is made smaller because the spiral is tighter—250 to 350 grooves per radial inch—though occupying the same size disc.

Each cycle of the groove wiggles which hold the music is shorter in length for a given frequency. The frequency of a reproduced tone depends on how long it takes for each cycle of groove wiggles to pass under the stylus.

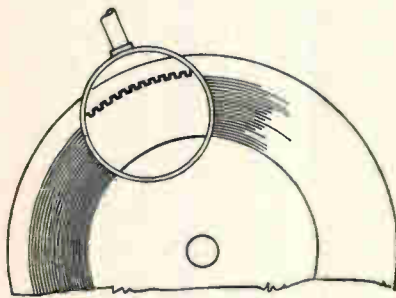

Fig. 7—View of square-wave modulation.

INEXPENSIVE SOLUTION TO REMOTE AUDIO PICKUP PROBLEM

In high-quality music installations, the tuner, record player, or other signal source may be a considerable distance from the control amplifier or the main amplifier. Since most components in a custom installation are designed to operate from and into high impedances, it is often difficult to make a satisfactory installation with the major components widely separated. Hum and feedback may occur if the audio signal leads are not shielded. If they are shielded, the highs may be attenuated by the capacitance between the conductor and its grounded shield. Wide-band

line-matching transformers may be used but they are susceptible to inductive hum pickup and are also likely to introduce distortion into the system.

A simple, inexpensive solution to the problem is described in an article in *Radio Constructor* (London, England). The a.f. signal source feeds into a cathode follower (V1 on the diagram) at the remote point. V1 feeds into a grounded-grid amplifier at the input to the control unit or main amplifier.

The cathodes of V1 and V2 are tied together through a conductor in the cable and are returned to ground through a common cathode resistor (R1). R1 is half the value required for a single tube of the same type used for V1 and V2. The impedance of the line between the cathode follower and grounded-grid amplifier is 500 ohms.

V1 may get its heater voltage from the control unit or main amplifier through an extra conductor in the cable or it may be powered by a separate filament transformer.

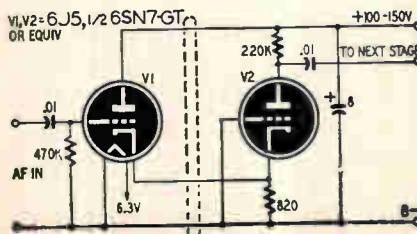

ATTENUATOR DESIGN

By NORMAN H. CROWHURST

The design of attenuators is not complicated. Each shape has its own characteristics and can be easily computed

CALIBRATED attenuators, giving any desired degree of attenuation in definite steps can be bought ready-made, or assembled from kits complete with the necessary close-tolerance resistors. But often, in both audio and radio work, we need an attenuator pad between the output of one piece of equipment and the input to another, to avoid overloading the latter and so we can operate the gain controls in a normal way, instead of at the "bottom end." Attenuators are occasionally needed for television, to prevent the overloading of certain stages in the receiver, which causes the well-known "soot-and-whitewash" picture.

An attenuator can be designed with comparatively simple formulas. But even those of us who are mathematically inclined may doubt our own accuracy, feeling safer if we get the answer from a ready-made chart.

The six basic types of attenuator network in common use are known—from their configurations—as T, π , lattice, bridged-T, and the two types of L (according to whether the shunt arm of the L is at the input or output end). These are illustrated at a to j in Fig. 1.

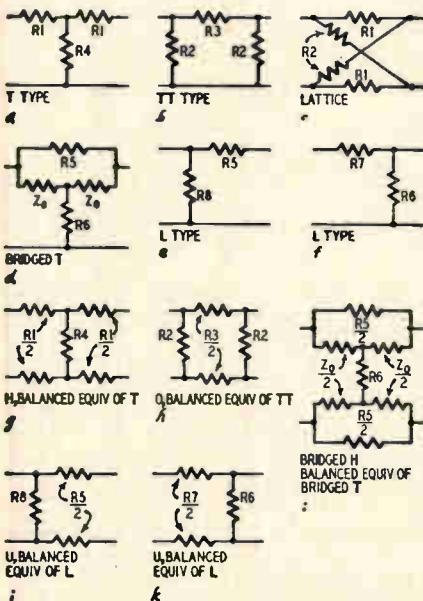

Fig. 1—Most frequently used attenuator configurations. All resistors are coded.

Only one of these—the lattice—is for balanced circuits. The others are all single-ended in their basic form. However, each of these can be rearranged in balanced form by splitting the series resistor components, giving the corresponding types shown at g to k in Fig. 1. If the balanced attenuators are to have a grounded center point, the shunt resistor elements will also require center-tapping.

Such a variety of circuits can be confusing. Which one should we choose for a particular job? The balanced and single-ended variations need little explaining: if a circuit has one side grounded, then single-ended attenuators are necessary; if both lines of a circuit are above ground (have signal voltages on them), a balanced type must be used. After this selection, the choice depends upon a number of factors, chief of which are the working impedance (high or low) and the amount of attenuation required; also whether constant impedance is needed both ways. The advantage of constant impedance both ways is that it can be inserted in any circuit of the correct impedance without interfering with the existing circuit either before or after the point of insertion. This is particularly advantageous where an attenuator is patched in with equalizers and other components, as between a preamplifier and the main amplifier.

For this purpose, the T, π , lattice, and bridged-T types, with their balanced counterparts, are suited. Among these, the T is best suited for medium-impedance circuits (500 or 600 ohms), because it uses the most reasonable values in resistors, while the π networks are better for low-impedance circuits, for the same reason. Along with convenience in resistor values, possible stray pickup also dictates a similar choice. The lattice variety is good for small values of attenuation (balanced circuits only), which can be achieved with good accuracy, but is poor for large attenuations, because the resistor values become very critical. The bridged-T is more complicated as a straightforward attenuator, but is better suited for a variable attenuator of the constant-resistance type, because it requires only two variable elements as

against at least three for the others.

Where it is important for constant resistance to be held only one way, the L types will serve. As shown, both are designed to maintain constant resistance at the input end, which is usual. If for any reason the opposite is required, the network may be reversed. The choice of which end the shunt element goes at will be seen better from the examples. As with the choice between T and π , it is a matter of getting convenient resistor values.

The formulas for the various resistors, using the coding given in Fig. 1, are as follows:

$$\text{db attenuation} = 20 \log_{10} K$$

$$K = \frac{E_{in}}{E_{out}}$$

$\frac{R1}{Z_0} = \frac{K-1}{K+1}$	$\frac{R5}{Z_0} = \frac{K-1}{K+1}$
$\frac{R2}{Z_0} = \frac{K+1}{K-1}$	$\frac{R6}{Z_0} = \frac{1}{K-1}$
$\frac{R3}{Z_0} = \frac{K^2-1}{2K}$	$\frac{R7}{Z_0} = \frac{K-1}{K}$
$\frac{R4}{Z_0} = \frac{2K}{K^2-1}$	$\frac{R8}{Z_0} = \frac{K}{K-1}$

A number of different ways of presenting this simple design information have been derived. Probably the first stage was a simple graph giving resistance values against attenuation for some fixed working impedance. This results in curves of the form shown in Fig. 2. Here all the values are given as R divided by the operating impedance. This means the factor obtained from the graph must be multiplied by the working impedance to find the correct resistor values. The popularity of the abac (alignment chart or nomogram) led to applying the same information by means of contact curves, producing the arrangement shown in Fig. 3.

This uses the same information as in Fig. 2, but the reading is obtained by laying a straightedge from the required decibel attenuation scale at the left to a point just touching the desired curve. This will give a reading on the right-hand scale that is identical to that given by the graph of Fig. 2. (These charts give factors. A more common practice is to give actual resistor values for just one particular impedance, say 10 ohms.)

Each of these presentations requires eight curves to cover all the possible attenuator configurations. The resistor values are given either for one working impedance only or as a factor relative to the working impedance (as shown in Figs. 2 and 3). So we have to do some arithmetic—or use a slide-rule—to get

the resistor values for the actual working impedance.

The decibel scale used has been linear. By adjusting the db scale spacing appropriately, any one of the curves can be converted into a straight line. Further, by plotting working impedance horizontally and resistor values vertically, a chart (Fig. 4) using irregularly spaced decibel rulings can give one of the resistor values in an attenuator for the actual working impedance required. Here the chart has been drawn to cover a decade of working impedances from 100 to 1,000 ohms, and the values are read off directly for any impedance in this range. Outside this range the value does not call for a slide-rule, but merely the addition or removal of some ciphers.

Fig. 4 is the chart for values of R3. The disadvantage of this presentation is that, to cover all the configurations of attenuators, eight charts are required, each with spacing between the db rulings to correspond with the individual formula. This is cumbersome. By applying the same method to the nomogram construction, the number can be reduced to two, because each reference line can be used to carry two different scales, one on each side. Notice that, in the eight formulas for resistor values, four are reciprocals of the other four. This means that the same set of decibel rulings can be used for a pair of resistors using reciprocal formulas by inverting the R and Z scales on the appropriate reference lines. This was used in the presentation of Fig. 3 to reduce the number of contact curves necessary to four. The decibel reference line can also have a scale on each side, enabling two pairs of reciprocal formulas to be accommodated on one chart. This turns out to be quite convenient, because any one configuration uses only two resistor values, selected from one group of four in the list of formulas. By using a separate chart for each group of four, only one chart is necessary for the design of any particular attenuator.

Chart 1 (page 39) deals with T, π , and lattice attenuators and can be used of course for the balanced equivalents of T (H) and π (O) types, while Chart 2 (page 39) deals with bridged-T and L types and their balanced counterparts.

You may wonder why so many types of attenuator networks are used—why not just stick to one? Several factors contribute to the answer to this question. It is largely a matter of relative values, and depends partly on the amount of attenuation required and partly on the working impedance. This will be made clearer by some examples: **Example 1.**

To design a T type attenuator to give 20 db attenuation at an impedance of 600 ohms:

As shown in the top key for Chart 1, the scales for R and Z are both on the left-hand side of the R and Z reference lines; the db scale for R1 is on the left-hand side and that for R4 is on the right-hand side of the db reference line.

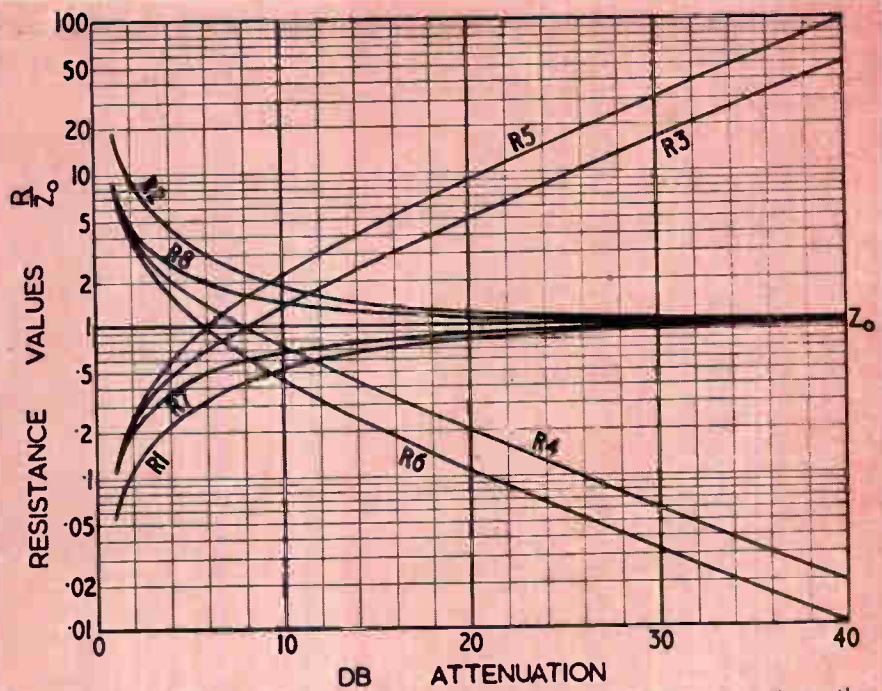

Fig. 2—Graph shows plot of formulas. Resistance values vs. attenuation.

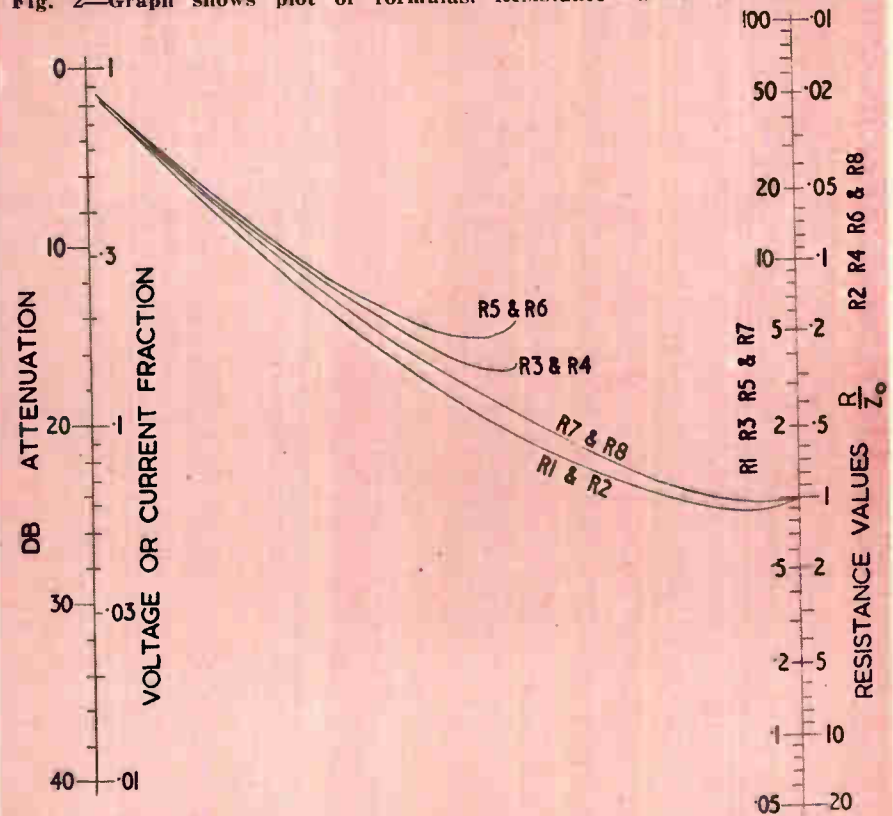

Fig. 3—A method of converting Fig. 2 information into an alignment chart.

Using the chart in this way, R1 is 480 ohms and R4 is 120 ohms. For an H pad, the series arms each would be half of 480 ohms, or 240 ohms.

Example 2.

To design a π type attenuator for the same job as example 1:

The middle key on Chart 1 shows that the right-hand scales for resistance and impedance are used, with one db scale on either side of the reference line as for the T pad. Using these positions, R2 is 750 ohms and R3 is 3,000 ohms.

Notice here that R1 and R2, for values of 20 db attenuation and upward, approach the same value as the working impedance. For the T pad R4 goes much lower and for the π pad R3 goes much higher. For smaller degrees of attenuation, the distribution of relative resistance values is bound to be somewhat different.

Example 3.

An attenuator required to give 10 db attenuation at an impedance of 100 ohms: using the π configuration R2 is

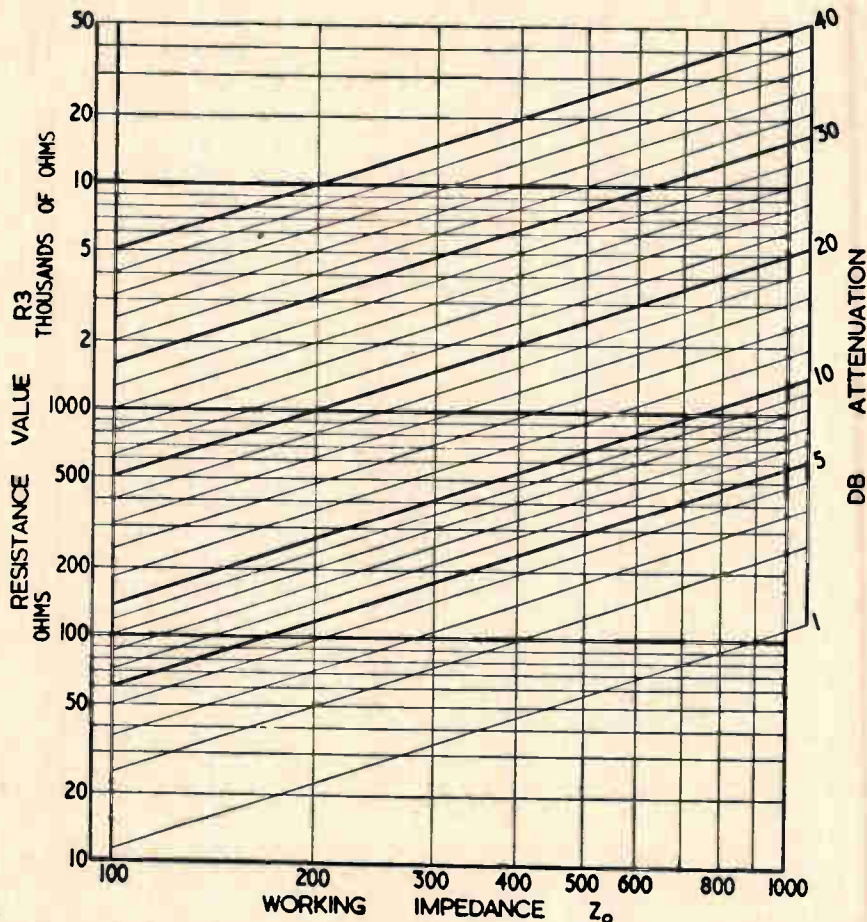

Fig. 4—Graph enables values to be given for a variety of working impedances.

190 ohms and R3 140 ohms. For the T configuration, the opposite sides of the resistor and impedance scales are used again (for 100 ohms this is the same point on the impedance scale), giving R1 52 ohms and R4 70 ohms.

Notice here that the resistor values are all somewhere near the working impedance.

Example 4.

A lattice attenuator is required for 6 db at a working impedance of 250 ohms.

For lattice type attenuators, as shown in the bottom key on Chart 1, the left-hand db scale is used for both values, the left-hand resistance and impedance scales being used for one resistor and the right-hand scales for the other. Using these positions for a working impedance of 250 ohms, the required resistances are R1 85 ohms and R2 760 ohms.

Example 5.

A lattice attenuator is required for 20 db attenuation at 500 ohms. This gives R1 as 410 ohms and R2 as 610 ohms.

The point to notice with lattice attenuators is that as attenuation rises both resistors approach the working impedance closely, so that resistance tolerances have a much greater effect on the amount of attenuation. It is obvious from Example 5 that a comparatively small change in any resistor

would result in a relatively large change in attenuation. On the other hand, for low degrees of attenuation, the lattice attenuator gives greater precision without necessity for strict tolerance on resistor values.

Example 6.

To design a bridged-T attenuator for an attenuation of 26 db at 1,000 ohms:

In the bridged-T type attenuators, two of the resistors have the same value as the working impedance; in the balanced counterpart there are four resistors having half the value of the working impedance. The remaining values, R5 and R6, are found by using Chart 2, as Chart 1 is used for lattice attenuators. For this example R5 is 19,000 and R6 is 52.5 ohms.

Whatever attenuation is required, the working impedance is a geometric mean between the values of R5 and R6. For small degrees of attenuation R5 is very low and R6 is very high. As attenuation increases, the values of R5 and R6 change over, so R5 is high and R6 is low. The widespread decibel scale for R5 and R6 indicates that a strict tolerance on resistor values is not so vital with bridged-T and bridged-H type attenuators as it is with the other types.

Example 7.

To design an L type attenuator, with the shunt arm at the output end, for an attenuation of 14 db and an impedance of 50 ohms:

As shown in the middle key on Chart 2, the working impedance and resistor values both are on left-hand scales, while the db scales are on opposite sides of the db reference line, for R5 and R8. For the example specified R5 is 200 ohms and R8 is 62.5 ohms.

Example 8.

For comparison with the previous example we will design an attenuator for the same purpose with the shunt arm at the input end.

As shown in the key at the bottom of Chart 2, the references for R and Z_0 are on the right-hand side of their respective scales in this case. R6 is 12.5 ohms and R7 is 40 ohms.

Notice the difference in values for the same operating impedance and attenuation, as compared with Example 7.

The foregoing indicate why different attenuator configurations suit different cases.

The L types are much simpler than any of the others. They save one or more resistors but do not have constant resistance in both directions, as indicated in the configuration diagrams on Chart 2. When terminated at the right-hand, or output, end with Z_0 , the resistance measured at the input end is also Z_0 , but this is not true in the opposite direction. For many purposes an attenuator of this simple type is quite adequate. Often the source impedance preceding an attenuator is not the same as the output impedance into which it is working, so two-way matching is unnecessary anyway.

In the other types of attenuators, if the source impedance is Z_0 , the source impedance measured at the output end of the attenuator will also be Z_0 , giving two-way matching. An attenuator of this type is always desirable for really high-quality work, but to get the benefit of it, the impedances between which it is connected must be true values, and do not themselves deviate from the nominal working impedance.

I have often heard the opinion expressed about attenuators, similar to that about filters, that when resistances obtained from the required formulas are put into a circuit, the circuit possesses "magical" properties. An impedance of 500 or 600 ohms has been shown to be an ideal line impedance. This has been interpreted to mean that attenuators designed to work at this impedance will smooth out any discrepancies. That, for example, a 20-db 600-ohm attenuator will give an attenuation of 20 db and present terminal impedances of 600 ohms, regardless of what is connected to the other end of it! *This is definitely not true.*

Attenuators do what they are designed to do only when the correct impedances are connected to them.

Sometimes, however, an output of one impedance requires that it be connected, via an attenuator, to an input of a different impedance. Then comes the puzzle of how to correct for this change of impedance. This will be dealt with in a succeeding article. **END**

Charts 1 and 2 on facing page →

Chart 1—For T, Pi, H, O, and lattice type attenuators.

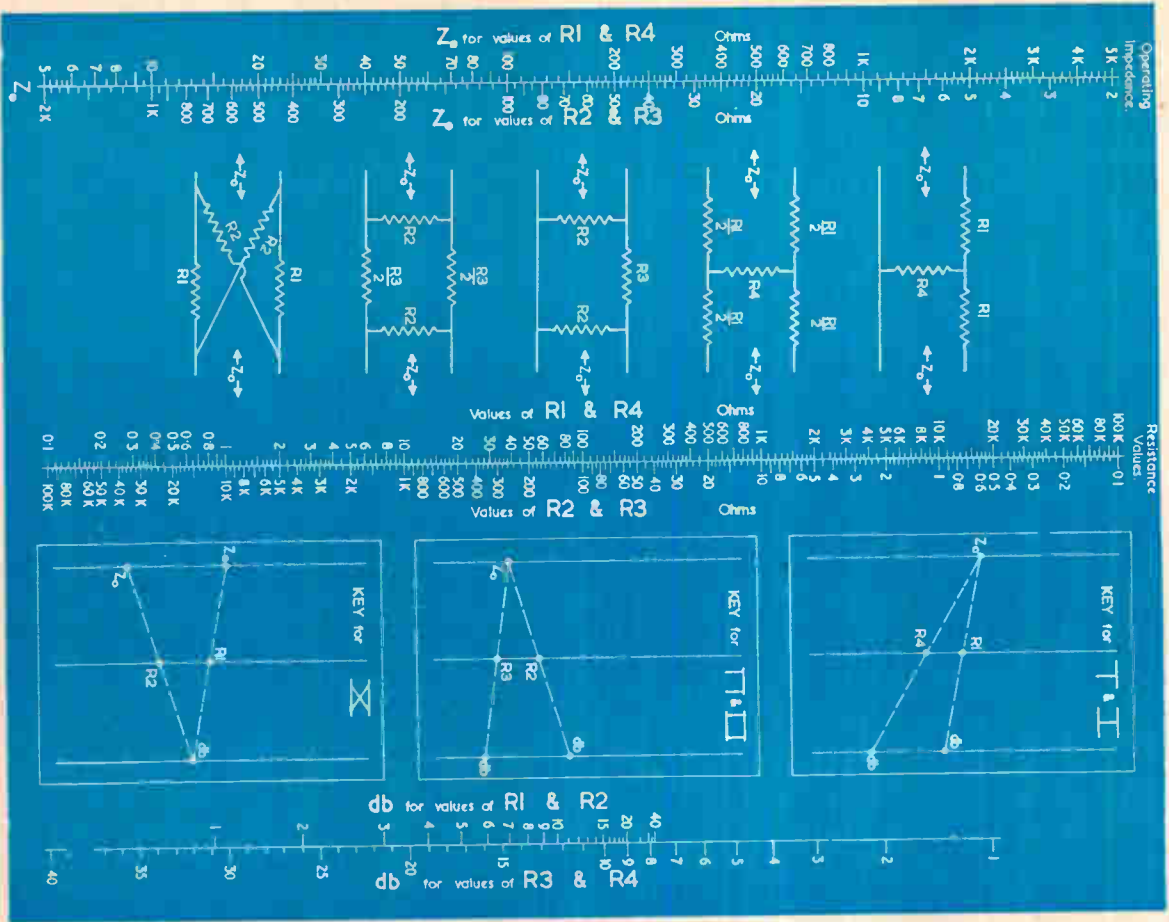
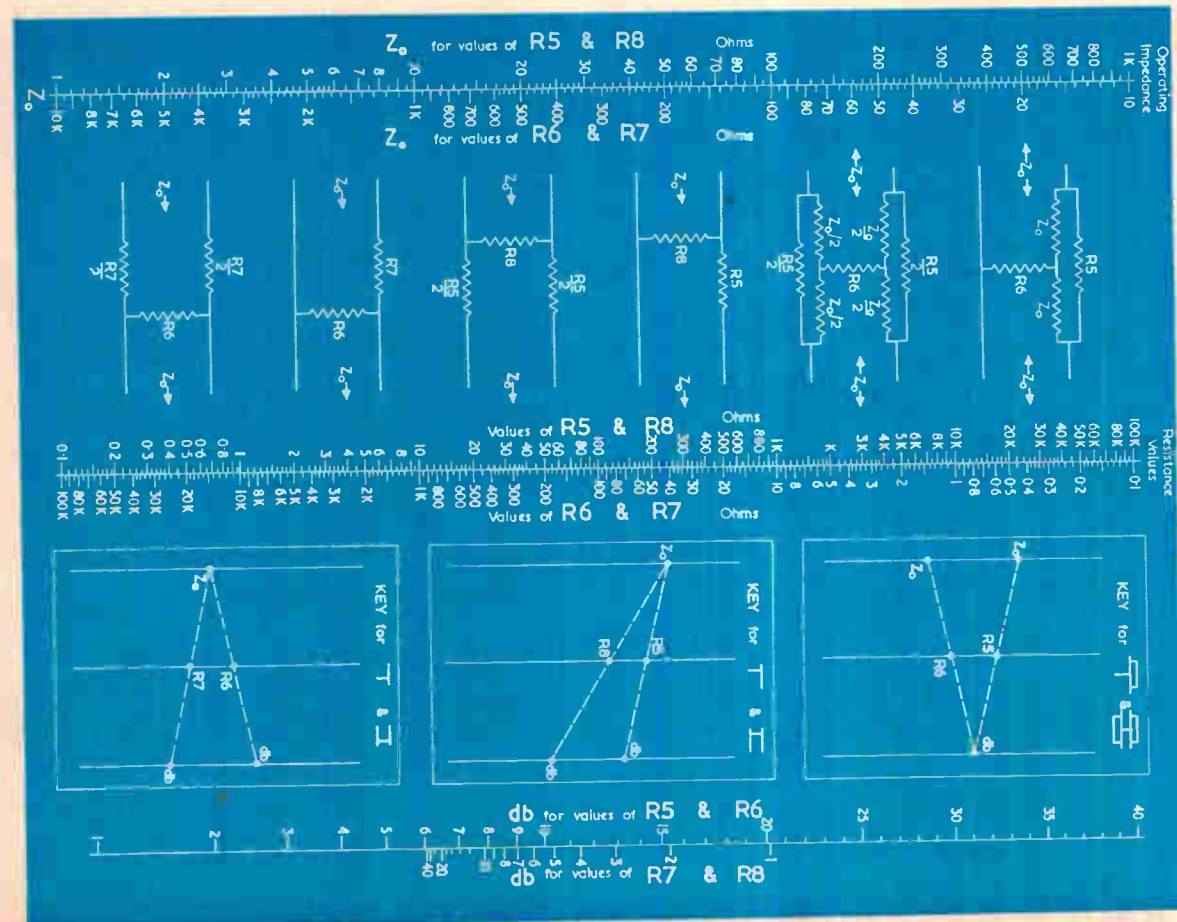

Chart 2—For bridged T, H, L, and U type attenuators.



Miniature Transistor Hearing Aid

The trend in hearing aids which has been toward compactness has been given a boost with the introduction of the transistor.

By DAVID T. ARMSTRONG

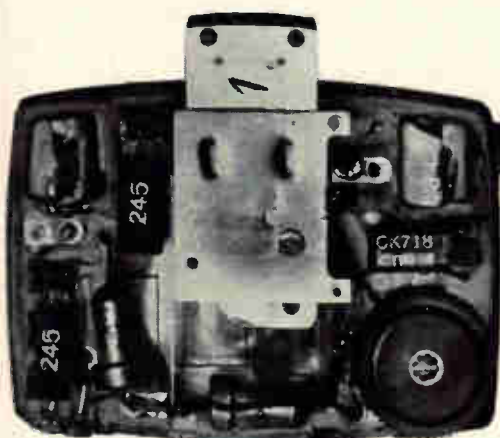

Photo of Transist-Ear chassis. Compartment on top houses small energy capsule.

TRANSISTORIZED hearing aids are appearing on the market in quantity. The high efficiency of the transistor and its low power consumption give it a decided edge over vacuum tubes. Battery power is still required, but the drain is cut to such a tiny figure that the life of a battery is extended many times. The entire absence of an A battery in any all-transistor type hearing aid makes possible a unit small enough to be worn on the wrist or hidden in a woman's hair. These are real applications, not just theoretical possibilities. There has been a great deal of controversy over the merits of transistors in hearing aids. Like anything else that is new, certain obstacles must be overcome before final success is reached. One company actually stopped their production of transistor hearing aids, but with technical improvements, they have resumed.

Miniaturization has been achieved by using subminiature components for resistors, capacitors, and transformers, and by redesigning the microphone and receiver into magnetic types. By using miniature components and lightweight metals, Maico has produced the *Transist-Ear* using three Raytheon CK718 transistors. The instrument weighs a little over 2 ounces and its over-all

dimensions are $2\frac{5}{8} \times 1\frac{7}{8} \times 1\frac{3}{16}$ inches.

The engineers responsible for this all-transistor hearing aid did not attempt to convert vacuum tube circuits to transistor applications by what is becoming known in the art as the "duality" technique. Rather, they started from scratch and designed circuits on the basis of which the associated components were specifically selected, for use in an all-transistor hearing aid. In this way they were able to balance the gain for the three stages and secure the greatest gain where it would produce the minimum accompanying noise. Hence this device is not any more noisy than a comparable type vacuum-tube hearing aid.

The circuit diagram of the Transist-Ear is shown in Fig. 1. Transformer coupling is used for the three grounded-emitter transistor amplifier stages. The bias resistor in each stage was selected to provide a predetermined collector current. In the present state of transistor manufacture there is wide variation in the characteristics of the individual CK718 Raytheon transistors used with this instrument; thus it is important to match the bias resistor with the individual transistor used in a particular stage.

The resistors R1 and R2 were selected to give 0.35 to 0.5 ma collector current;

R3 was selected to give 1.7 to 2.1 ma collector current. These individual transistors vary considerably in gain and noise as well as in impedance. As part of the quality-control program established for the manufacture of these hearing aids, each transistor is checked in the laboratory and marked as a first-stage, second-stage, or output-stage transistor.

The grounded-emitter circuit has been found to be superior for this type of transistor application, partly because the input resistance is completely independent of transistor parameters. Current design practice uses the grounded emitter almost exclusively for all but the output stage of amplifiers. In the output stage, a grounded-base circuit is found to be better for some applications. It provides a wider swing of collector voltage with linear operation, and hence greater efficiency. In this circuit, however, the output stage is a grounded-emitter type to control the gain and attenuate the noise.

The audio-frequency field is ideal for transistor applications because of the high gain, low noise, and high efficiency obtainable. The limitation on how weak a signal can be handled is noise. Noise is much lower for junction-type transistors than for point-contact types. A transistor with a noise figure of 15 db at 1,000 cycles for a 1-cycle bandwidth has an equivalent noise input power of approximately 10^{-15} watts. A signal

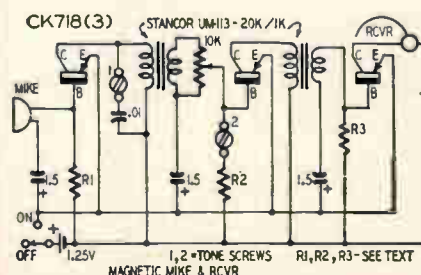

Fig. 1—Schematic of the Transist-Ear.



From Trumpet to Transist-Ear. 15 years of progress in hearing aid development.

input of one micromicrowatt will have a 30 db signal-to-noise ratio.

The frequency response of this instrument is adjustable and can be fitted to the hearing loss of the user by adjusting tone screws 1 and 2 shown in the circuit diagram of Fig. 1. Normal response is obtained with screw 2 in and screw 1 out. Thus insertion or removal of the screws emphasizes tones for which the user's loss is most severe or attenuates those tones for which the user's hearing is nearly normal.

When screw 1 is in, the .01-uf capacitor is connected to the circuit. When screw 2 is in, the resistor R2 is connected to the circuit.

Subminiature tantalum capacitors, hermetically sealed in silver cans, were used because it is believed they have an extremely long life. The low operating voltages permit use of small-size, low-voltage capacitors. The energy capsule is a mercury cell (illustrated in photo). This is 5/8 inch in diameter and 1/4 inch thick. This energy capsule is housed in a drawer. This tiny energy capsule will supply power for operating this hearing aid for 70 to 90 hours.

All-transistor type hearing aids are not low priced. They cost more than comparable vacuum tube models. However, the operating costs are low and transistors do not require replacement as tubes do.

The low cost and high operating efficiency of the *Transist-Ear* are among its most remarkable features. The total battery drain of the three transistors is 30 ma at 1.3 volts, or 3.9 milliwatts. Dividing the electrical output delivered to the receiver, 1 milliwatt, by the total battery drain, indicates an efficiency of approximately 25%. This all-transistor circuit is eight times as efficient as a conventional vacuum-tube hearing aid.

The three transistors are immune to damage from shock or vibration, and

they are designed to retain their original operating characteristics over a long period of time. When these transistors are properly hermetically sealed (this is extremely important) by the encapsulating plastic they are impervious to moisture. This is emphasized in view of some recent experiences with hearing-aid devices not properly hermetically sealed. These were found to be affected by the moisture and body temperature of the user.

Table I. Characteristics of the Stancor Ultraminiature Transistor Transformers

Part Number	Application	Primary impedance (ohms)	Secondary impedance (ohms)	Primary d.c. resistance (ohms)	Secondary d.c. resistance (ohms)
UM-110	Interstage	20,000	1,000	1,675	285
UM-111	Output or matching	1,000	50/60	120	9.0
UM-112	High impedance microphone input	200,000	1,000	4,000	195
UM-113	Interstage	20,000	1,000	1,350	205
UM-114	Output or matching	500	50/60	70	9.0

The estimated life of transistors is about 100,000 hours, which would be equivalent to 20 years of use; compare this with the 5,000-hour life of a vacuum tube. (The switching of a transistor on and off may have some effect on its useful life.)

The magnetic microphone is much sturdier than the crystal microphone formerly used, and is far less likely to be affected by high humidity. The microphone is mounted on a soft floating rubber cushion to reduce to a minimum the noise created by friction of the case and the clothing. Compartmentalization design techniques were utilized to place the components in special snug-fitting niches in a nylon

chassis. This design feature was adopted because it is expected to contribute to long life by reducing the possibility of damage through shock or vibration.

The interstage audio transformers are triumphs of miniaturization. They measure a 3/8-inch cube, and were specifically designed for such applications by Chicago Standard Transformer Corp., as their ultraminiature transistor transformers. They are the tiniest iron-core audio transformers currently available. They weigh less than 1/10 ounce and are no larger than the transistors they power. They are constructed of extremely fine wire, wound on molded nylon bobbins, with special nickel alloy steel transformer core laminations. They have a useful range below the 1-milliwatt level.

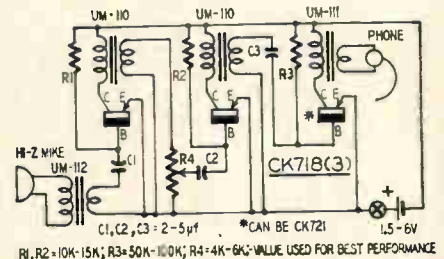

Fig. 2—Transistor audio amplifier.

For comparison purposes the Stancor suggested circuit is given in Fig. 2, with the recommended values of the associated components. The available transistor ultraminiature transformers and their design characteristics are given in Table I.

There is no a.v.c. in this circuit. Further, the distortion in the output is related to the output power level. Special circuits involving response-shaping networks and volume compression circuits are desirable in a hearing aid, but these are usually available only for custom built units.

A desirable accessory for a hearing aid is a telephone pickup coil which will enable the user to hear telephone conversations without the distortion introduced by transducing the signals from the telephone ear-piece to the hearing-aid magnetic microphone.

Practically no heat is generated by a transistor hearing aid; hence there is no problem of heat dissipation. END



Front view of intermodulation analyzer.

Build an IM Analyzer

By WILLIAM AUSTIN

ALWAYS increasing emphasis on reproduction quality in audio equipment has led to efforts to reduce intermodulation distortion effects; therefore this practical IM analyzer.

An instrument to measure intermodulation distortion can be built by the experimenter at surprisingly low cost compared with the array of equipment needed for complete harmonic analysis. (The instrument can be used also as a very sensitive electronic voltmeter.)

Circuit Description

Fig. 1 shows the schematic. The 60-cycle a.c. from the power transformer filament windings supplies the low frequency. This is mixed, in a resistance network, with the output of a 7-kc Hartley oscillator. The mixed signal is applied to the input of an amplifier under test. The amplifier output is fed through a gain control into a cathode follower and from there to the 6AH6 containing 7-kc resonant circuits in both grid and plate circuits. These circuits remove the 60-cycle component and also most of the hum and noise, so the signal at the 6AH6 plate is a pure 7-kc note, containing only the modulation to be measured. This signal is demodulated by half of the 12AT7 connected as an infinite-impedance type detector. The 12AT7 had the most linear output with respect to modulation percentage of several tubes tried. Any modulation in the carrier is present at the cathode of this stage. A large portion of the carrier is also present here, but is removed by L3, a 5-henry inductor, connected in a low-pass filter circuit. This filter has a flat bandpass up to about 600 cycles with cutoff above 700 cycles. S1 provides a means of comparing the average carrier amplitude with the output of the filter. Thus, if some carrier amplitude reference point is chosen, we can measure the percentage of modulation.

The circuit from here on is a sensitive a.c. v.t.v.m. with a range of 10 mv to 100 volts full scale and an input resistance of 1 megohm. The voltmeter may be used separately by turning S1 to V. A meter of this kind is useful for measuring very small voltages. Feedback is used, giving flat response from 10 cycles to 50 kc and linearizing the meter deflection. It is this linear characteristic

which makes it possible to measure voltage or intermodulation (IM) percentage on the original 0-1 millimeter scale without any additional meter calibration.

Construction

The wiring and layout are not critical except for the location of the coils, particularly L3. It is important that coupling between these components and the power transformer be kept to a minimum. L2, L3, and L4 should be mounted with their axes at 90° to the axis of the power transformer windings and close to a plane passing through the center of the power transformer at 90° to its winding axis (see photo). An exact location can be found by connecting a high-gain scope, or other sensitive indicating device, across the coil. With the power transformer in operation, move the coil around until a spot is found where there is a null in the induced voltage. L1 is followed by the resonant plate circuit of the 6AH6, so is not as susceptible to 60-cycle pickup, but there is a tendency for this coil to pick up 7-kc radiation from the oscillator coil. For this reason, L1 should be mounted as far from the oscillator as possible with its axis at 90° to the axis of the oscillator coil.

L1 and L2 each consist of 1,600 turns of No. 30 enameled wire, layer-wound, on a 3/8-inch diameter slug-tuned coil form, with a winding length of 3/4 inch. L4 is the same, except for a tap at 500 turns. A layer of Scotch tape between each winding layer prevents the possibility of shorts. The inductor used for L3 is a 5-henry unit.

The entire instrument is built on the panel of a standard 12 x 7 x 6-inch metal utility box. The double-deck construction provides good separation of critical components and makes a compact assembly, which takes up a minimum of bench space. The two shelves are made of 16-gauge aluminum and are held to the panel by the bushings of the potentiometers and switches.

Adjustment

After the wiring is completed and checked, the v.t.v.m. section should be calibrated by applying a known a.c. voltage to the input, as measured with an accurate meter. The IM output and input controls should be turned down to prevent any possible 7-kc radiation from affecting the v.t.v.m. The 50-ohm calibrating potentiometer is adjusted for agreement between the meters. Cal-

ibration is necessary on only one range. The use of precision resistors in the range decade will make the others take care of themselves.

To calibrate the IM section, a scope is necessary. Connect the circuit of Fig. 2. A vacuum-tube diode may be substituted for the crystal. Set the ratio on 4:1, S1 to V, turn output and input controls up about halfway, and adjust the slugs of L1 and L2 to resonance as indicated by maximum vertical deflection. The oscillator slug should be set for output in the vicinity of 7 kc. As resonance is approached, back the input control down and make the final adjustments with it as low as possible. With the scope sweep on 120 c.p.s., it should be possible to get a pattern similar to that of Fig. 3. This looks very much like the standard textbook picture of a modulated carrier, which is exactly what it is. The diode introduces nonlinearity, which causes the 7-kc signal to become modulated by the 60-cycle signal in the same manner it would occur in a nonlinear amplifier. The percentage of modulation can be varied with the series resistor from near 0 to about 80%. Fig. 3 represents 50% modulation. The percentage for any pattern on the screen can be calculated by the formula: $m = \frac{a-b}{a} \times 100$,

where a and b are the dimensions shown in Fig. 3. Measurements on the screen are best made by using the ruled grid supplied with most scopes. Set up a 50% pattern as closely as possible. Set the range switch to 0-10 volts and S1 to the IM 2 position. Adjust the input gain until the meter reads exactly half scale. Change S1 to the IM 1 position and adjust the IM calibrate control until exactly half scale is again indicated. When the switch is again placed in the IM 2 position, the meter will read ".5" or 50% modulation. 20% and lower modulation values can now be set up and the meter should indicate them quite closely. For each measurement, the switch should be placed in the IM 1 position and the input gain set for a half-scale reading. Full-scale, or any other reference point, could be used and the calibrate control set accordingly, but half-scale is most convenient. To read values below 10%, move the range switch to the 1-VOLT position. This will give an IM range of 0-10%. To read very low values, use the .1 v position. This will read full-scale on 1% IM. On this low range, circuit noises cause a meter deflection

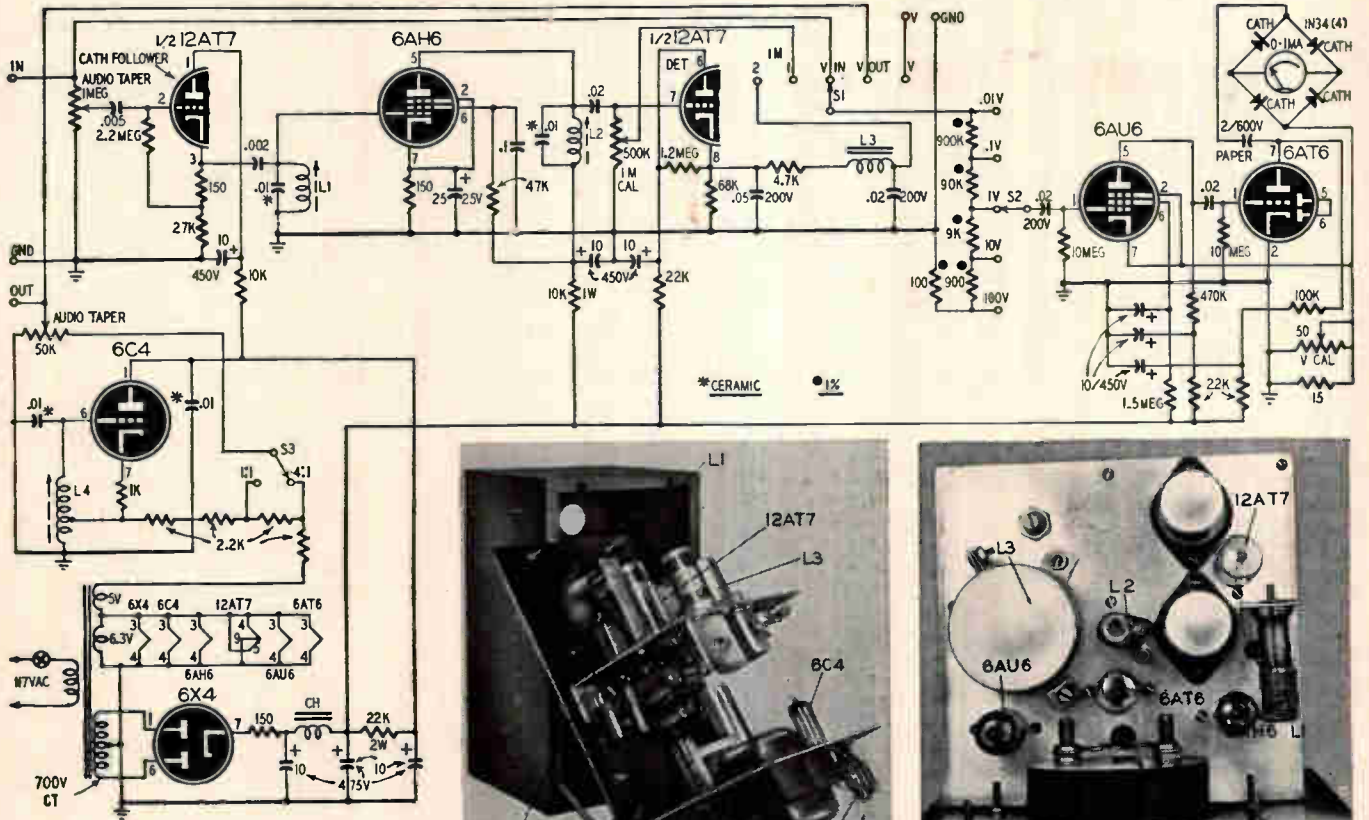
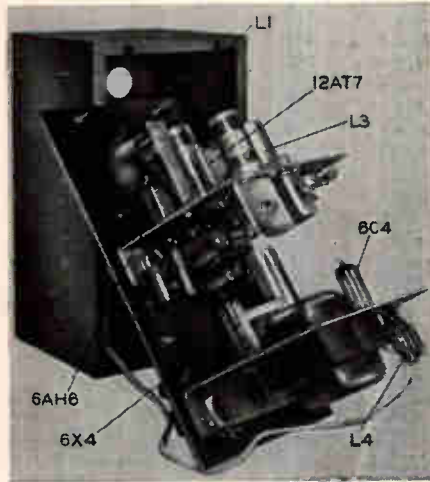
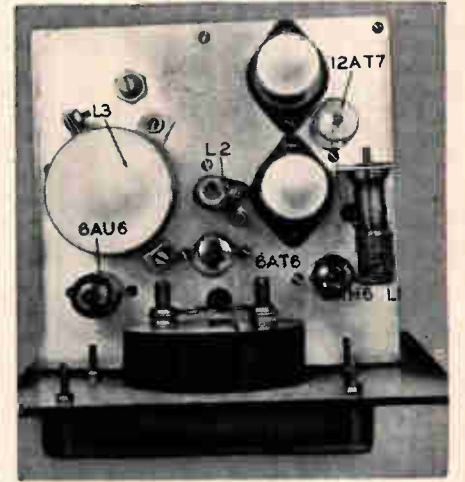

Fig. 1—Diagram of intermodulation analyzer. 60 cycles and 7 kc are used.



Side view. L1 and L4 widely separated.



Top view. Analyzer contains v.t.v.m.

of about .08% of this figure from the meter reading.

To measure the intermodulation in an amplifier, connect the IM output to the amplifier input and set the ratio on 4:1. Terminate the amplifier in a high-wattage resistor with a value equal to the nominal output impedance of the amplifier. Connect the amplifier output to the input terminals of the analyzer. Set S1 to V IN and advance the output control until the desired amplifier power output at which the measurement is to be made is obtained. To do this, a correction must be applied to the meter reading. The voltage is a mixture of two frequencies and has a higher peak to r.m.s. ratio than a sine wave. The meter reading would correctly indicate the average power dissipated in the load

resistor (E^2/R), but distortion would occur at a seemingly low power output because of the high amplitude peaks. If the meter indication is multiplied by a factor of 1.3 at the 4:1 ratio and 1.6 at 1:1, the resulting figure will be the r.m.s. value of a sine wave having a peak amplitude equal to that of our complex wave and will give a true measure of amplifier power capability. For example: To set up a test at 10 watts into 8 ohms with a 4:1 ratio: E (meter) $\sqrt{WR/1.3}$ or $9/1.3=6.9$ volts, which the meter should read for an equivalent power of 10 watts. If another meter of the peak-responsive type is available, the same result can be obtained directly. (Most d.c. and a.c. v.t.v.m.'s are of this type.) The meter voltage should be corrected also when making IM tests on voltage amplifiers. Multiply the meter reading by 1.3 or 1.6, depending on the ratio, to obtain the equivalent sine wave r.m.s. voltage. Adjust the input gain to the half-scale reference point and shift S1 to V 2 to read the intermodulation. The average good-quality amplifier will show 5% or 6% at close to the full rated output, with a rapid rise above this point. 10% or over at any substantial power output is getting out of the high-fidelity class. A very high-quality amplifier, such as the Williamson, will show from 1/2% to 1%. Usually, distortion occurs first at low frequencies. For this reason, the 4:1 ratio will usually show a somewhat higher percentage than 1:1. This

is why the 4:1 ratio is usually used for amplifier measurement. Occasionally an amplifier will have more distortion at high frequencies. In this case, the 1:1 ratio will indicate the fact by showing a higher IM value.

The minimum input signal required

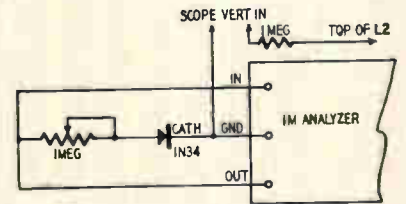

Fig. 2—Circuit used for calibration.

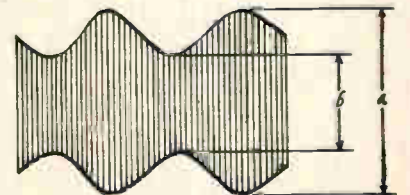

Fig. 3—50% modulation—7 kc by 60 c.p.s.

by the instrument for IM measurements is 0.8 volt at the 4:1 ratio and 0.2 volt at 1:1. This is enough sensitivity to easily permit measurements over a single stage, or on low-level amplifiers, such as phonograph preamplifiers. END

Materials for IM analyzer.

- Resistors: 1—15, 3—150, 1—1,000, 4—2,200, 1—10,000, 2—22,000, 1—27,000, 1—17,000, 1—68,000, 1—100,000, 1—470,000 ohms, 1—1 megohm, 1—1.5, 1—2.2, 2—10 megohms, all 1/2 watt; 1—10,000 ohms, 1 watt; 1—22,000 ohms, 2 watts; 1—900,000, 1—90,000, 1—9,000, 1—900, 1—100 ohms, 1% precision resistors, available at TAB, 111 Liberty St., N. Y. 6, N. Y.
- Potentiometers: 1—50, carbon (Ohmite CU5001); 1—50,000 ohms, audio taper; 1—500,000 ohms, linear taper; 1—1 megohm, audio taper.
- Capacitors: (Paper) 1—.002, 1—.005, 4—.02, 1—.05, 1—0.1 μ f, 400 volts; 1—2 μ f, 600 volts. (Ceramic) 4—.01 μ f. (Electrolytic) 1—25 μ f, 25 volts, 2—10-10, 10 μ f, 450 volts; 1—10-10, 10 μ f, 475 volts.
- Miscellaneous: 1—power transformer, 650 volts c.t. at 40 ma, 5 volts at 2 amp, 6.3 volts at 2 amp (Stanor PC8406); 1—5-h filter choke (primary of small speaker output transformer can be used); 1—5-h choke, potted (5 ma or less); 3-3/8-inch-diameter slug-tuned coil forms; 1—6X4, 1—6A4, 1—6AU6, 1—6C4, 1—6AH6, 1—12A7; tubes; 1—12 x 7 x 6-inch metal utility box; 1—0-1 milliammeter (preferably 4 inches or larger); 4—IN34 crystal diodes; 5—binding posts; assorted hardware, wire, etc.

RADIATION

PROBLEMS

By E. D. LUCAS*

FEDERAL Communications Commission has not yet taken official jurisdiction over community TV systems. However, it has been compelled to take an active interest in the radiation problems created by them.

Many community installations have been made in fringe areas where TV set owners have invested substantial sums in individual antenna towers, antenna arrays, rotors, and boosters. A home owner who has spent up to \$500 for his antenna installation may be reluctant to connect to the cable of a community system, even though the latter will provide better pictures. If there is radiation from the amplifiers, a.c. power lines, connectors, tap-off units or cable of the community TV system, the radiated signals may be strong enough to cause annoying interference with direct pickup by individual antennas.

Interference caused by radiation from a community system is of two principal types. One is the ghosting which results from co-channel time-delay interference. The community system distributes certain channels by means of amplifiers, cable and other equipment. If set owners in the same community are able to receive these channels directly, and if these signals are weak, while the wired community TV system is radiating strongly, ghost images are inevitable. This is because the set owner with an antenna on his roof receives a picture from channel 2, for instance, first by direct pickup from the transmitter and then—a second, delayed picture—resulting from a closely adjoining section of the community system. The few microseconds delay in receiving the re-radiated signal is caused by the electronic equipment and cable through which this signal must travel before radiating to the set owner's antenna.

A second type of interference caused by radiation occurs when the community TV system is distributing channels adjacent to those received directly in a fringe area. For example, the community system may distribute channels 2, 4, and 6. Set owners within the same community, who have their

own antennas, receive a weak signal from channel 3 transmitted 80 miles away. If there is strong radiation of channels 2 and 4 from the community system, adjacent-channel interference will annoy set owners tuned to channel 3.

Radiation is a double-edged problem. If a community TV installation radiates a strong enough signal to cause interference, it will certainly lose money. In many community systems, set owners have achieved good reception without either the formality or expense of a legitimate connection to the cable. I have seen simple dipole antennas placed close to a radiating cable—and the set owners happy with fair pictures obtained without paying \$185 (or whatever the cable connection charge might be) to the community system. The system operators refer bitterly to this practice as "bootlegging" and generally take prompt steps to try to eliminate this charitable distribution of free signals.

Thus radiation is a serious problem for operators of a community TV system. With radiation, the wired system causes interference and complaints from the owners of individual antenna installations. These complaints, as their volume mounts, result in a visit from a polite but firm representative of the FCC, who says the radiation problem must be solved. Even more annoying is the fact that a radiating wired system invites "bootleggers" and endangers the substantial investment of the community system's owners.

Solving the problem

The more modern community TV installations have solved their radiation problems by recognizing that each signal-carrying element must be correctly designed. Any part of the system may be troublesome if it is not engineered so that radiation is reduced to a safe level, say 20 microvolts per meter at a distance of 20 feet.

This approach requires the design of each piece of electronic equipment and each type of cable with radiation in mind.

The antenna site is the first logical step. Often radiation is of no conse-

Community installations have created unique radiation problems: interference ranging from bootlegging to ghosting

quence here, if the site is on an isolated hilltop as in many community installations. Occasionally—as in the case of a new system now under way to serve sections of Burbank and Glendale, California—the best site for the master antenna installation is in a heavily populated area. In such a location, it is obviously important that the head-end amplifiers, power supplies, and power lines are properly radiation-proofed. One easy way is to mount the amplifiers and other equipment in a sheet-metal shack which acts as a shield against radiation. If this is impractical, place all electronic equipment including connectors in metal cabinets. The a.c. power line should be brought in through a low-pass filter, which should be in the shack or one of the cabinets. Such a filter, available commercially, prevents r.f. leakage back into the power lead and consequent radiation.

After taking these precautions, it is desirable to make tests with a simple dipole antenna and TV receiver placed a few feet away from the head-end equipment installed at the antenna site, to see whether objectionable radiation is still present. If so, more careful shielding of the amplifiers, power supplies, and connectors will be necessary. It also may be necessary to reduce the output level of the amplifiers. Some of the early amplifiers designed for community TV boasted an output of as high as 3 volts, and behaved like miniature transmitters. Modern design calls for an output level generally not exceeding 0.5 volt from the individual-channel strip amplifiers with associated a.g.c. used at community antenna sites.

In the distribution system of a community installation, where the electronic equipment and cables are installed in populated areas, radiation must be eliminated. The problem is most easily solved by designing each element of the system to reduce its potentialities as a radiator.

Line amplifiers—the term used to describe r.f. amplifiers utilized to boost TV signals along the main trunk cables and feeder lines—are an obvious source of radiation. As in the case of head-end equipment, the answer is good shielding and correct output level.

* Pres. Best Electronics Corp., Los Angeles, Calif.

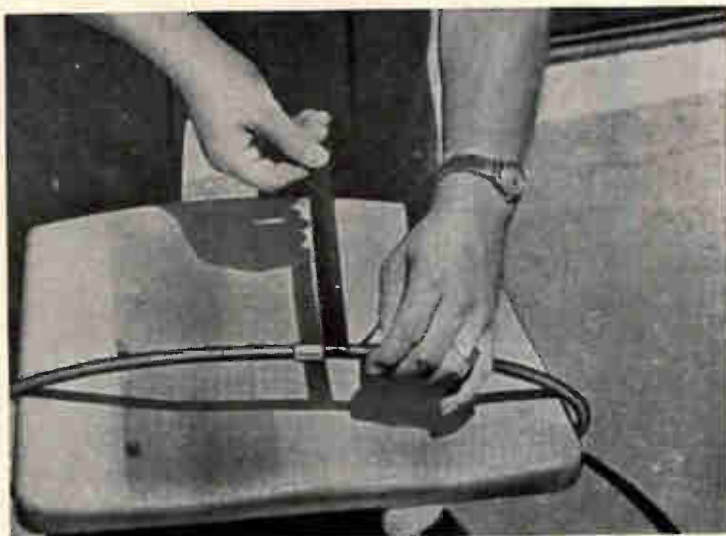

Splicing RG-11/U cable. Aluminum foil is wrapped around the braid and then taped.

Mount the amplifier in a metal cabinet. This box should be large enough to contain the amplifier, its power supply, and such associated equipment as a power-line filter (to prevent r.f. leakage to the a.c. line, as noted above); the equalizer, used with broad-band amplifiers to compensate for variations in attenuation of the signal by the cable when distributing several TV channels and at very high radio frequencies; fine splitter, directional coupler, or distribution amplifier, for branching feeder lines from the main cable; any short lengths of cable used as matching sections to balance impedances; and connections to the distribution cables, whether made with connectors or soldered splices.

This list of equipment at a line-amplifier station may seem impressive. However, except for the amplifier and associated power supply, most of it is small. The metal cabinet shielding all this equipment may easily be mounted on a double crossarm installed on a telephone or power pole, or may be attached directly to the pole. Utility companies prefer crossarm mounting, since a metal cabinet on a pole reduces the climbing space available to their linemen and thus presents a possible hazard as well as an inconvenience.

Another important antiradiation precaution is to keep the line amplifier's output level fairly low. Modern practice is not to exceed 0.2 volts per channel. Then, at the antenna site, test for radiation with a dipole and TV receiver placed about 30 feet from a typical line-amplifier installation.

A troublesome source of radiation has been connectors or splices in community TV cables. While working as an engineer on the Palm Springs community TV installation of International Telemeter Corporation, I found a simple and inexpensive way to make such connections radiation-proof. Merely wrap aluminum foil around the connector or splice, and then apply an outer weather-proofing of plastic tape and paint.

Isolation units, or tap-off devices, inserted in feeder cables to transfer TV signals from the cable to the drop feeding one or more TV sets in a subscriber's home, are another possible source of radiation. A tap-off unit should be

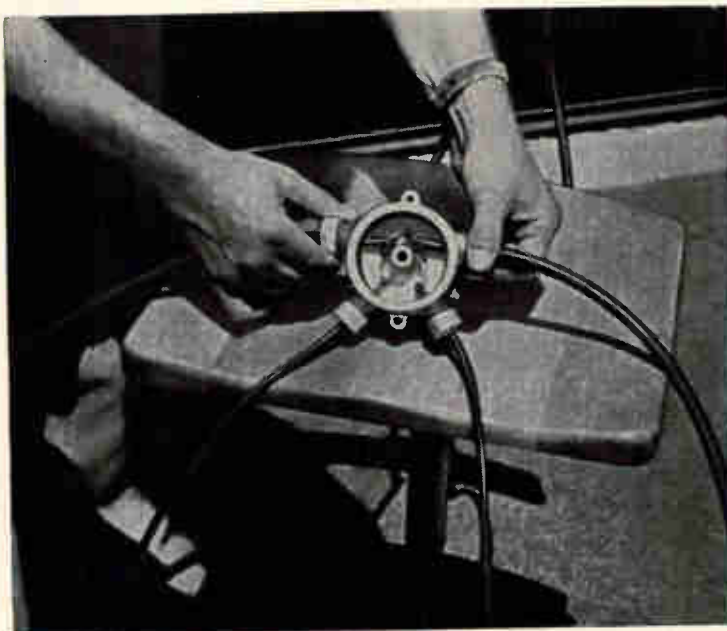

One type of tap-off unit for distribution of the community TV signal.

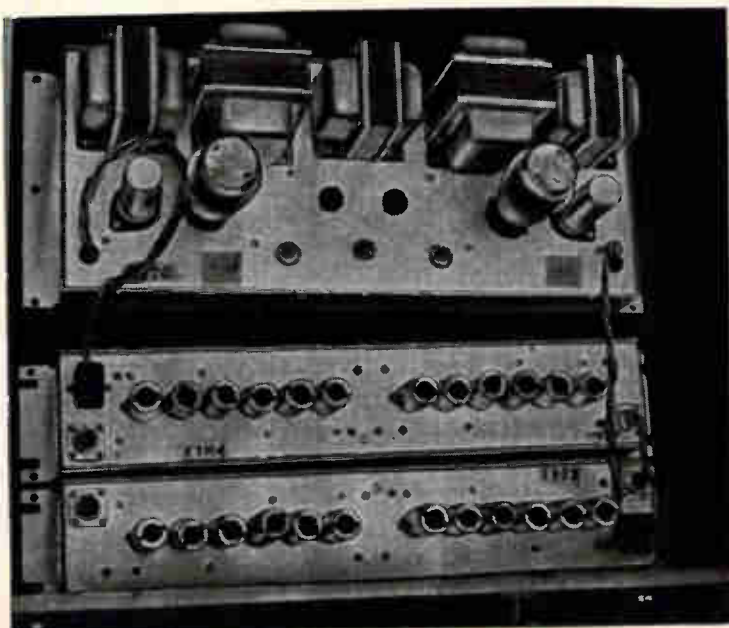

Community TV line amplifier. A filter prevents leakage to power line.

adequately shielded. It usually contains either a resistor or capacitor connecting the center conductors of the feeder cable and the individual drop line. Such a tap-off device should be treated like a cable connector, and weatherproofed with plastic tape and paint. A wet tap-off has been known to act like a detector and radiate unrestrainedly. Here again, a little aluminum foil wrapped around the unit before taping and painting is a good precaution if the device is not well shielded.

Selecting coaxial cable

A major cause of radiation in community TV systems has been the coaxial cables used for distributing signals to subscribers. Variation has been wide in the quality of the copper-braid outer conductor or shield used in even such a popular cable type as RG-11/U. Some manufacturers produce a finely woven braid that makes a satisfactory shield. Other makes are obviously inferior, as you can easily see if you strip off a few inches of the outer vinyl jacket and observe the braid.

Since cable requires the most trouble and expense to install of all the elements in a community system, and can cause the worst grief by radiating, it is well worthwhile to specify and select cable types carefully. From experience, it is best to use such low-loss cable as K-14 (Federal) or 21-125 (Amphenol) or the new aluminum-sheathed *Styroflex* (Phelps-Dodge) for long cable runs. Such long runs may include the line from the antenna site to the community and the main trunk lines in town. Radiation from K-14 or 21-125 cable is not troublesome if the amplifier output level is kept at or below 0.2 volt per channel. *Styroflex*, with its solid aluminum sheath, obviously will not radiate signal.

The coaxial cable most widely used for signal distribution in community TV systems is RG-11/U. Where line-amplifier output is maintained at 0.2 volt per channel or higher—to permit economical spacing of amplifier stations—there has frequently been troublesome radiation from this line, usually near an amplifier station because there the signal level in the cable is by far, the highest.

To solve this problem, cable manufacturers have developed a coaxial cable identical in attenuation characteristics with RG-11/U but providing two copper-braid shields instead of one. This double-shielded cable is designated as SP-75 by Federal and as "tri-axial" 21-529 by Amphenol, and is definitely superior to RG-11/U where radiation is a problem. Tests conducted by California Electronic Services Company, Los Angeles, a firm specializing in measurements of radiation and electrical noise, indicate the following:

1. At 200 mc, the double-shielded cable has a radiation level 50 db below that of RG-11/U.

2. At 60 mc, the radiation level of SF-75 or 21-529 double-shielded coaxial is 37 db below that of RG-11/U.

Thus, although the double-shielded

cable is approximately 50% higher in cost than RG-11/U, its use is now being recommended by engineers designing modern community TV installations as a safeguard against radiation from transmission lines.

Drops from this double-shielded feeder cable to the homes of individual subscribers are generally made with RG-59/U cable, where the run is not longer than 150 feet, or where the tap-off is reasonably near the line amplifier. Where the signal level is relatively low, the drop to the home should be made with RG-11/U because its attenuation is about half that of RG-59/U at v.h.f. television frequencies. For the same reason, RG-11/U is used for drops where the distance from tap-off unit to subscriber's TV set is longer than 150 feet.

Radiation is usually not a serious problem so far as such drops are concerned because of the reduction in signal level by the tap-off unit. However, should a drop cable be found to be radiating, the answer is to use double-shielded cable of either the SP-75 type or SP-76, a twin-shielded version of RG-59/U.

Grounding the system

One of the most important requirements of a community TV system is satisfactory grounding throughout the system. This is necessary not only as a safety measure (required by the utility companies whose poles are used) but also as an effective aid in reducing radiation. The antenna masts or towers are usually of steel and are set deep enough into the earth for adequate grounding. At certain sites, however, large wooden poles are used to support antennas, and occasionally preamplifier equipment. Here a heavy cable should be run from the antenna clamps and preamplifier cabinet down to a ground rod.

At each line-amplifier station, all chassis and cable shields within the metal weather-resistant cabinet should be securely grounded to the inside of the cabinet, and the cabinet itself *must* be grounded. This is done by running a cable from the cabinet to a ground rod at the foot of the pole. If this is impractical at a given location, the cabinet should be grounded to the steel messenger line to which the community TV coaxial cable is lashed.

Telephone company standards call for keeping the outer conductor of TV cables and the messenger strand electrically continuous throughout the system. The messenger strand supporting community coaxial should also be bonded to the light strand used for supporting drops to subscribers' homes where such drops are supported. Also TV cable strand (messenger) is bonded to telephone company strand at every 10th pole, or at every 8th pole on thoroughfares having trolley feeders or contact wires. The outer conductor of a drop to the home should be grounded, preferable to a water-pipe system, close to the point of entry into the building. Such grounding, like shielding,



EVERY year about this time, after going for several months with little or no dx reception, many TV dx-ers take it for granted that it's all over until next summer, and they stop looking for other than local signals. This is a big mistake. Though the period from May to August is the big one, there is another good stretch of dx due every December.

The two periods are centered around the longest and shortest days of the year. The summer one lasts about three months, and the winter one perhaps no more than three weeks. Otherwise, dx conditions are very similar. The same low-band stations come through, from about the same distances, and usually with about the same signal levels. The essential difference seems to be that there is seldom any sign of "double-hop" propagation during the winter dx season, so 600 to 1,200 miles is the most likely dx range.

Tropospheric propagation will be generally poor in December and the following cold months, except when there is warm rain, or snow turning to rain, imminent. Then, for an evening, reception over the usual fringe-area distances will be almost equal to the best that summer and early fall had to offer. Low-band stations will be affected most by such winter breaks. It is unlikely that there will be any of the 500-mile high-band stuff reported by several observers during September and October.

U.h.f. reception can be expected to continue at a low level during most of the winter months, though our experience in this region is too meager to be certain. This is where your reports can be of considerable help. Observations comparing v.h.f. with u.h.f. reception for *all* seasons are needed. Your past reports have been greatly appreciated and we hope for many more in the future. END

helps to prevent harmful and annoying radiation.

To summarize, radiation from a community TV system can annoy non-subscribers who have their own antennas, by causing interference, and may permit other nonsubscribers to obtain signals without paying for them. To eliminate such undesirable radiation requires proper shielding of all parts of the system where the signal level is high, and makes it desirable to operate amplifiers at an output level below 0.5 volt per channel. A little shielding in the right places goes a long way in curing radiation problems. END

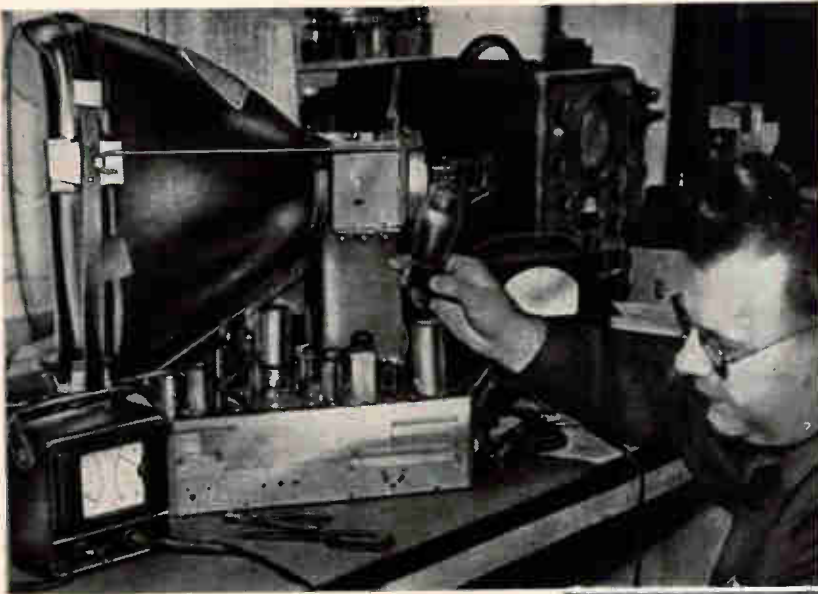
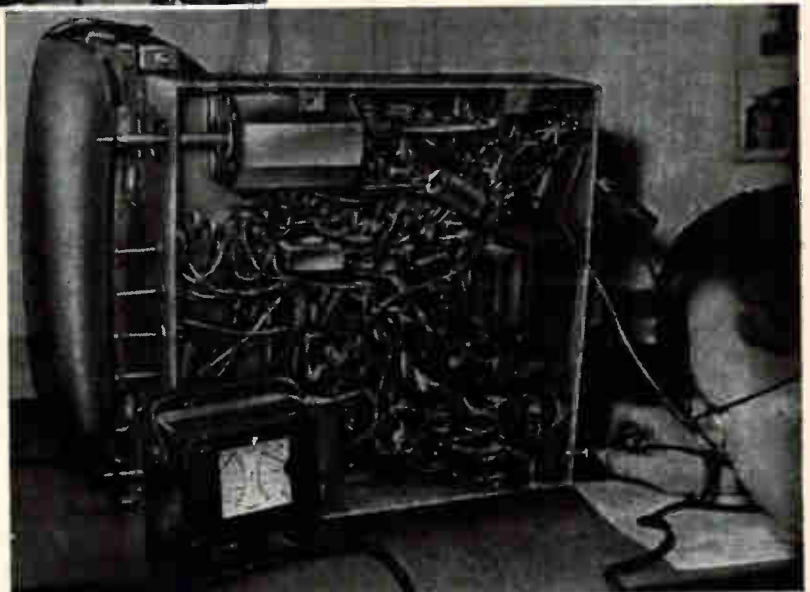

Fig. 1—Rectifier tube is removed to check power-transformer current drain.

Fig. 2—Filter capacitor is short-circuited to check rectifier capabilities.



Photos courtesy Triplett Instrument Co.

By JOHN B. LEDBETTER*

UNLESS you have actually used a wattmeter, you may have no idea of the time, trouble, and money it can save you in helping to check a TV receiver. (The wattmeter is not limited to the television set—it is equally helpful on AM receivers, PA equipment, or any electronic device which operates from a.c., including auto receivers.)

Suppose the set you are checking has weak picture and weak sound. From past experience you may judge the trouble to be a weak low-voltage rectifier, or, if the brightness seems to be normal, a weak tube in the video i.f. or front end. Checking these points takes time, and you may end up finding that the trouble comes from another source. Suppose the trouble is due to a leaky filter capacitor or an internal short (however slight) in the power transformer. This could take several minutes (or longer) to locate. Here is how the same thing can be done with the wattmeter:

First, plug the wattmeter into the a.c. socket and plug the receiver line cord

into the wattmeter receptacle. From the moment the receiver is turned on, the wattmeter gives a constant indication of current drain. As the current continues to increase, past experience or the manufacturer's rating will tell you if the current drain is normal. If the current indicated on the wattmeter is within tolerance for that particular receiver, you will know (without having made any check at all) that the power transformer is O.K. The trouble then may be found to lie in a weak rectifier tube, weak filter capacitor, or some point beyond.

Suppose, however, that the current drain indicated on the wattmeter is excessive. The next step is to remove the low-voltage rectifier tube (see Fig. 1) and observe the current reading. If it has fallen to approximately normal, the trouble is a defective filter or bypass capacitor at the output of the power supply, a gassy rectifier, or possibly a short in the focus coil bleeder resistor or filter choke.

A quick check of the filter capacitor is then made. The filter is disconnected from the circuit and the difference in current drain is noted on the meter. If

noticeable drain is indicated, replace the capacitor. This method of checking often will disclose capacitor trouble which would not be indicated on a capacitor checker.

In making the first test, suppose the current drain had remained abnormally high with the rectifier tube out of its socket. This would have indicated an internal short in the power transformer and would have eliminated the need for further checking.

In a similar manner, the cause of low current drain can be quickly established. In Fig. 2, the B plus circuit (at the filter-capacitor output) is being shorted to ground. An excessively high drain under these conditions would be normal, while a low value would indicate a weak or gassy rectifier tube or a possible defect in the power transformer.

The wattmeter can be used in similar setups to check leakage factor of new filter capacitors, power factor of transformers, etc. Once you have become accustomed to having this instrument around the shop, you will find yourself creating other new and time-saving uses for it.

END

From the original "La Télévision? . . . Mais c'est très simple!" Translated from the French by Fred Shunaman. All North American rights reserved. No extract may be printed without the permission of RADIO-ELECTRONICS and the author.

TELEVISION... it's a cinch!

By E. AISBERG

*Seventh conversation, second half:
Sawtooth waves with multivibrators.*

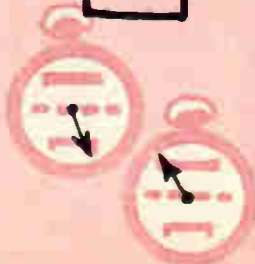
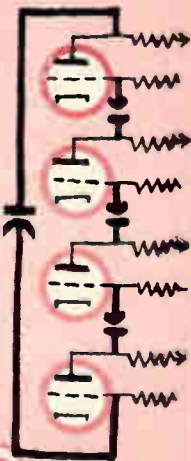
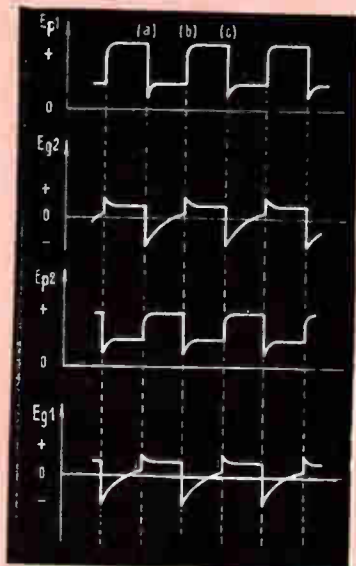
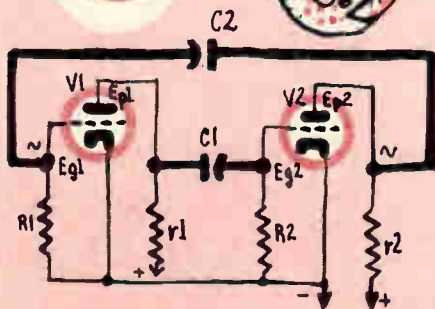
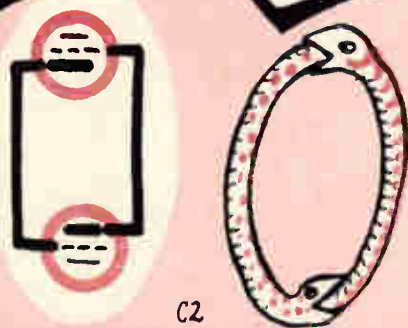
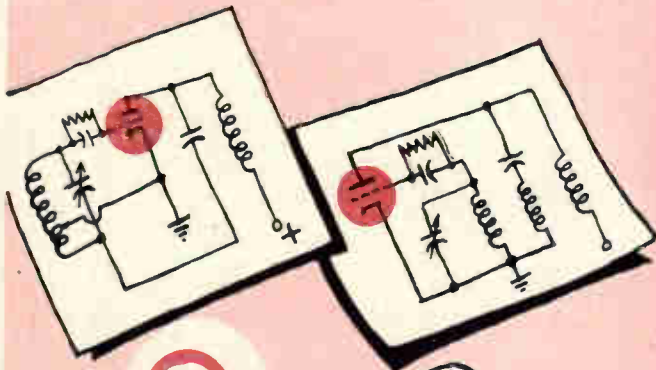

WILL—Isn't it possible to develop other pulse circuits than the one we've just been looking at? There are so many sine-wave generator circuits: Hartley, Reinartz, Colpitts . . .

KEN—Sure, you *could* use such circuits, but they would only bring in unnecessary complications. But, you can abandon coils altogether and get the feedback you need for oscillations by using a second tube whose voltages will be opposite in phase from the first, then reinjecting these voltages back into the input to maintain the oscillations.

WILL—That explanation doesn't seem very clear.

KEN—Let's try it another way. Imagine a two-tube, resistance-capacitance coupled amplifier. Connect the output back to the input. What do you get?

WILL—Something like two snakes eating each other tail first!

KEN—We haven't done too well with examples from the zoo so far—let's cut them out! Now, how about analyzing just what *does* happen in such a circuit?

WILL—Well, suppose I try to reason it out the way you'd do. Let the plate current of V1 be increasing. Then the voltage drop across plate resistance r_1 increases, reducing the plate voltage E_{p1} on the first tube. This—acting through coupling capacitor C1—reduces the voltage E_{g2} on the grid of V2. As it becomes more negative, the plate current of V2 drops. Therefore, there is less voltage drop across r_2 , and the plate voltage E_{p2} increases, increasing E_{g1} through coupling capacitor C2. That, of course, makes V1 draw more current.

KEN—Of course, you understand that all these things are happening at the same time. What is important is to note that the voltage at the output is in such a direction that it *helps out* the things that are happening at the input. The output and input voltages are *in phase*. And we should expect it. You've learned long ago that a stage of amplification reverses the phase; when the grid becomes more positive, the plate becomes less positive, and *vice versa*. So, with two stages, we get back into phase again.

WILL—Then you could use four tubes? Or six? Or eight?

KEN—You could. But are you a tube manufacturer's agent?

WILL—It seems to me our explanation didn't finish. Can the current in V1 keep on increasing indefinitely?

KEN—Certainly not—the house fuses would blow sooner or later! The rapid increase of current in V1, by making the grid of V2 more negative, reduces its plate current to zero (instant *a* in the curves E_{p1} , E_{g1} , E_{p2} , E_{g2}). With no further increase in E_{p2} , there will be no increase in the voltage E_{g1} . So the plate current of V1 remains high and its plate voltage low. Now C1, which is charged negatively, begins to discharge through R2 (instant *a-b* on the curve E_{g2}).

WILL—I'm having trouble following so many things at the same time!

KEN—These curves should give you some help.

WILL—As capacitor C2 discharges, plate current flows in V2 and starts to increase.

KEN—That's right. And (at instant *b* on the curves) V2 finds itself in the same condition as V1 at instant *a*.

WILL—In other words, the voltage E_{p2} drops; C2 passes that drop in voltage to the grid of V1, reducing its plate current and increasing its voltage. And that makes the grid of V2 still more positive.

KEN—O.K., you can stop now, Will, because the *multivibrator* will keep right on going. This oscillator with the long name produces regular voltages with an irregular shape. The two tubes repeat—every half-cycle—everything it has taken us so long to trace out with the curves' help.

WILL—But this multivibrator won't give us sawtooth waves!

KEN—Well, no. Their plate circuits produce something more like square waves. These have plenty of applications in television—and in the whole field of electronics. The duration of their positive and negative alternations is identical if all the equivalent components in the two stages have the same values. But if they differ, we destroy the symmetry. By changing them intentionally we can get short impulses separated by relatively long periods. So we get our sync pulses.

Return of the Sawteeth

WILL—Couldn't we replace our two tubes with a double triode?

KEN—We can and we do. And further, if we have a single-cathode tube, or tie the two cathodes together, we can use the coupling through the common resistance *R* to replace one of our coupling capacitors.

WILL—I don't see just how you can make a resistor replace a capacitor.

KEN—It's not hard to figure out. Remember that each increase of plate current through one of the triodes increases the current through *R*, which makes the grid of the other tube more negative, since the voltage drop across *R* makes the end to which the grids are tied negative as compared to the cathode end. The capacitor on the other multivibrator produced the same effect.

WILL—I see. And you apply your sync pulses through a capacitor to the grid of V1, in the usual style.

KEN—Yes, and I find it simple to synchronize the circuit because the multivibrator is a very easy circuit to pull into step with a synchronizing frequency.

WILL—The multivibrator seems to have a lot of virtues. But since we are supposed to be talking about sawtooth generators, what good are they if it won't make a sawtooth wave?

KEN—If you must have sawteeth, we'll give you sawteeth! Just put the capacitor *C* (look at the dotted lines) between one of the plates and *B* minus. Then make the plate resistor (*r2*) of that tube considerably larger than that (*r1*) of the other tube. And you have sawtooth voltages across *r2*!

WILL—Is this our old charging circuit, with *r2* playing the part of *R*?

KEN—Exactly. Because of the high resistance of *r2*, we start with no current in V2. The voltage across *C* has to rise to a fairly high value before the capacitor starts to discharge across the anode-cathode space of the tube. But then we have an avalanche! For, as current starts in V2, the voltage across the cathode resistor rises, making the grid of V1 relatively more negative with regard to the cathode. Its current drops, and its plate voltage rises, charging V2's grid *more* positive through C1, accelerating the discharge. This quick discharge, followed by a slower charge limited by the constants of *C* and *r1*—when the current through V2 is cut off—gives us a typical sawtooth wave.

WILL—So now I know all the ways of making sawtooth waves!

KEN—Sorry to disillusion you, Will; there are plenty of others! But with the thyatron, the blocking oscillator and the multivibrator, you know the principal types. The others are all based on ideas we already know. So you won't have any trouble analyzing any new ones you may run into. And—next time we get together—we can forget about time-bases and talk about more cheerful subjects.

(TO BE CONTINUED)

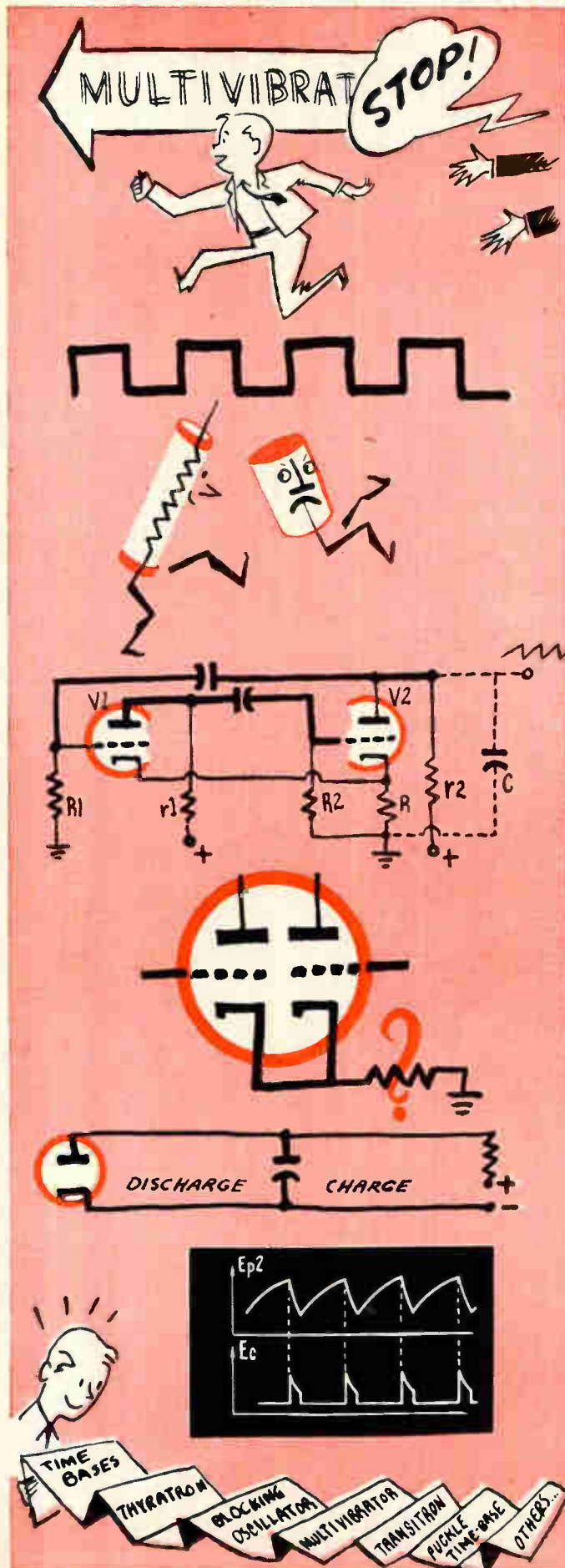

TV SERVICE CLINIC

Conducted by
MATTHEW MANDL*



Vertical sync is critical.

DURING our vacation we spent a postman's holiday for a few days, inspecting several u.h.f. antenna installations. We were quite surprised to find that many of them had no lightning protection. Many used a lightning arrester but failed to install it to give proper protection against lightning. (I must hasten to add that the greatest percentage of poor installations were found where the set owner himself had added a u.h.f. antenna to his existing v.h.f. installation.) The smaller dimensions of the u.h.f. antennas, plus the presence of the v.h.f. mast, tempts the set owner into trying the job himself.

The unprotected u.h.f. installation can suffer costly damage if lightning should strike. Also, a poor installation by the television technician can lead to lawsuits, particularly if it can be proved that the resultant damage was caused by the technician's negligence to provide adequate lightning protection.

Several methods can be used for installing the u.h.f. antenna. One consists of installing a separate mast and u.h.f. antenna with the new lead-in connecting to the u.h.f. converter or a double-pole switch where a v.h.f. antenna is also used and the converter has no v.h.f. antenna terminals. For the new u.h.f. antenna and mast, the best lightning protection consists of grounding the mast and also using a lightning arrester for the transmission line. Some technicians prefer to mount the lightning arrester directly to the mast below the antenna. This method is not practical unless the mast is grounded. The grounding wire should be large (No. 6 or larger). The ground wire should be bolted to the bottom of the mast and run to a ground rod (available at most jobbers) (Fig. 1-a). If no ground rod is available, a ½- or ¾-inch pipe can be driven into the ground. A 6-foot length will usually be long enough. Drive about four feet into the ground, leaving two feet above for attaching the ground wire.

A direct ground wire run as shown in Fig. 1 is preferred, though this is not possible unless the antenna is mounted at the side of the house. Where

the antenna is mounted near the center of the roof, the ground wire would have to run along the roof to the edge before it can be run down to the ground rod. Lightning seeks the most direct path to earth, so the straight run from the mast directly down to the rod is best. With such an installation, particularly where the antenna is some 10 feet or more above the roof, the home is actually protected better against lightning than if no antenna were present.

The lightning arrester can be placed down on the lead-in to the point where it enters the house as shown at Fig. 1-a and connected to the ground rod. It can also be used indoors by fastening it to a water pipe (never a gas pipe). A second choice would be as shown in Fig. 1-b, where the arrester is placed at the lower section of the mast. Here, the lead-in below the arrester is not protected against a direct hit, but when the ground wire is used, it is unlikely that the lightning would take the higher-resistance path afforded by the lead-in when it has the direct path available with the straight run of low resistance ground wire.

When the u.h.f. antenna is fastened to the same mast as the v.h.f. antenna, use an additional lightning arrester if the u.h.f. antenna uses a separate transmission line. Even with a grounded mast, a separate arrester always should be used for each lead-in employed. The exception, of course, is where a u.h.f.-v.h.f. crossover coupling unit is used. Since this device permits using the u.h.f. and v.h.f. antenna on a single transmission line, a single arrester will do.

Do not use the radio type of lightning arrester. They have considerable losses at v.h.f. and u.h.f. The television types have low loss gaps and some also use resistors for discharge of static. Some lightning arresters originally designed for v.h.f. may introduce losses at u.h.f. because of excessive shunt capacitance. Check the reception without the lightning arrester and note the difference if any on the weaker stations when it is connected. If losses are introduced try an arrester by a different manufacturer. Always make your installation and test it before installing the

arrester, then note any difference in reception.

A good lightning arrester will dissipate static charges and afford a fair measure of protection against lightning. But there is no use deluding ourselves with the idea that it is the perfect answer to a direct heavy strike. When the mast is grounded, however, using heavy wire and good solid connections, neither the customer nor you have much to worry about.

Interlace loss

I am servicing a Raytheon model C-173-1A receiver which developed a blurring of the picture that cannot be corrected with the focus-control magnet. The scanning lines seem to appear in sets of two instead of one and they are not stable. When the vertical hold control is moved to a point just before the picture rolls, the scanning lines seem to try to come back to normal and the picture clears up, but this point is not stable. Please advise what defective part to look for. F. M., New York, N. Y.

In normal operation, interlace is upset only when the hold control is adjusted near the point where sync is about to be lost. Line structure is upset and interlace is lost. As shown in photo, the horizontal wedge of the test pattern has a lacy *moiré* effect. Interlace is lost also when the picture rolls. In the receiver you mentioned, a defective component has upset this condition to the point where the setting for interlace is too critical to maintain good sync stability.

Try a new vertical oscillator tube. If this does not help, check the resistor-capacitor network which feeds the oscillator grid and check other resistors and capacitors in the oscillator circuit. Since this model has had some cases of vertical oscillator transformer leakage, replace the transformer if the foregoing suggestions do not help, this should stabilize the picture.

Vertical troubles

I have been unable to locate the cause of what appears to be foldover across the top of the picture in a Motorola 17T5D receiver. I also get a double picture from top to bottom. The hori-

* Author: Mandl's Television Servicing

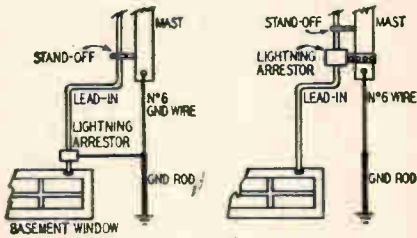
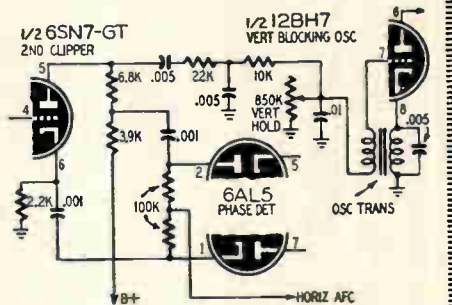

Fig. 1—Use of lightning arrester and ground wire for lightning protection.

Fig. 2—Schematic shows 2nd sync clipper feeding vertical and horizontal circuits.



zontal sync is slightly unstable and at times drifts from right to left, showing the vertical blanking bar with the picture signal. How can I correct these troubles? V. H., Kansas City, Mo.

The double vertical image indicates improper vertical sweep frequency in the oscillator, while the crowding at the top is foldover as you suspected. Both are caused by a defective part in the R-C network associated with the vertical hold control. But first try a new 12BH7 vertical oscillator tube as well as a new 6SN7-GT sync clipper.

As shown in Fig. 2, the second sync clipper feeds sync pulses to both the vertical and horizontal circuits. A defective part in the vertical system will change the load on the horizontal a.f.c. input and produce the tendency toward instability in the horizontal sweep.

Intermittent cut-off

I have for repair a Philco 51-PT1207 with an intermittent condition. Sometimes it will go for hours and work well, then it will cut off completely. During cutoff, the a.g.c. bus goes highly negative. I have changed all tubes in the tuner and i.f. strip, as well as the detector, the a.g.c. rectifier, and others. I've also checked capacitors and resistors. I suspect the second i.f. amplifier, since this seems to be the critical stage. During cutoff, the picture can be restored by touching any lead in the second video i.f. amplifier transformer. I have checked this unit but found nothing wrong. What would cause the a.g.c. to develop an excessive voltage? E. N., Shiloh, N. J.

Several conditions could cause this, the most common being a stage which develops oscillations. When the latter occurs the grid draws current and charges the grid capacitor to form a high negative bias. Since the grid is tied to the a.g.c. line, the a.g.c. voltage is increased to a higher negative value than normal.

The fact that the defective part is sufficiently critical to become normal when the circuit is touched would seem to indicate a defective capacitor. Capacitors often act in this fashion when intermittent. Such an intermittent component is difficult to localize since the

application of any test probes would restore the circuit to normal before the defective part was found.

Technicians often place the receiver on an unused portion of the bench and wait until the breakdown is more permanent. You can hasten the process by enclosing the receiver in a cardboard carton so that lack of ventilation will overheat parts.

We suggest you use a capacitor checker and test each capacitor in the second video i.f. amplifier stage by disconnecting it from the circuit. The full voltage rating of the capacitor can then be applied to cause an immediate breakdown of the weak one.

Low high voltage

I'm working on a Tech-Master model 5016 which at present has only 7,200 volts output.

I have substituted all tubes and capacitors from the video amplifiers and sync separator up to and including the damper section. I have also changed the flyback transformer. I still get the same results. Since this receiver uses a 14-inch picture tube there should be at least 10,500 to 11,000 volts. Can you suggest additional tests? R. F., Tulsa, Okla.

Insufficient high voltage can be caused by a low signal output from the oscillator or horizontal output stage. A decline in waveform amplitude can be caused by defective tubes, capacitors, or resistors, or by insufficient plate and screen voltages.

Try a new 470,000-ohm high-voltage resistor in the high-voltage lead from the 1X2 tube. If this doesn't help, check the low-voltage rectifier as well as the filter capacitors. In particular, check the resistors in the horizontal output system and replace any that are off by more than 10%. You should also recheck the coupling capacitor to the horizontal output tube grid, and also the screen bypass capacitor.

It is unfortunate that the peak-to-peak voltages of the waveforms in the horizontal system are not given in the service notes. This would help localize the trouble by use of an oscilloscope. The only method for making this check would be on another similar model

which is in working order. The waveform amplitudes can then be ascertained and compared with those of the defective receiver.

16AP4 to 16AP4A

Recently I found it necessary to replace the picture tube in a Magnavox model CT-232 receiver. The original tube was a 16AP4, but I could not get this when needed, so I used a 16AP4A, assuming they were interchangeable. However, the new tube gives a dark picture even with the brightness control full on.

I have checked the voltages concerned with the brightness control and found nothing wrong, so I assume the dark-face tube is the root of the trouble. Are alterations of the brightness-control circuit necessary when using the 16AP4A? If not, what else can I check? T. H., Springdale, Conn.

The 16AP4 has a clear face while the 16AP4A has a gray face plate. Except for this, these tubes are identical in all electrical characteristics. Evidently the brightness was low initially in this receiver and the difference is now noticeable with the gray-face tube.

Either tube requires a double-magnet ion trap, and you should check the adjustments of the trap to make sure it is set for maximum brilliancy. Do not use the trap to eliminate corner shadows. The focus assembly is the one to use for this purpose. If trap settings do not help, try a new horizontal output tube and a new horizontal oscillator tube. Also check the B voltages in the horizontal system, and try a new damper and high-voltage rectifier.

If this does not increase brightness, check all parts associated with the horizontal oscillator and output stages. No alterations of the brightness circuit are necessary for the 16AP4A tube, and the latter should work satisfactorily in place of the 16AP4. END

Note: When writing, give full details and be sure to include the model and chassis number of the receiver. Send a self-addressed, stamped envelope. We prefer the 4" x 9½" size envelope, because we often send data sheets with our answers.

circuit shorts

more AGC circuits

By ROBERT F. SCOTT
TECHNICAL EDITOR

A FEW months ago, we described a few of the circuits which manufacturers are using to delay the application of a.g.c. voltage and to set the minimum operating bias for cascode-type television tuners. While discussing some of these circuits with friends and TV service technicians, I found that most of them were a bit uncertain as to actually how keyed a.g.c. circuits work and that they were unable to follow the description of the tuner delay circuits. For this

reason, we are reviewing the operation of the basic keyed a.g.c. circuit and the delay network as used in the Du Mont RA-171 chassis. The simplified circuit is shown in Fig. 1. The complete circuit was shown in Fig. 1 in this column in the July, 1953, issue, page 35.

The 6AU6 is the a.g.c. amplifier or a.g.c. keyer tube. R1 and R2 form the a.g.c. load resistor across which the full a.g.c. voltage is developed. The 6AU6 control grid is direct-coupled to the output of the video amplifier. A composite video signal is applied to the 6AU6 grid circuit from the video circuit. The cathode of the keyer tube is returned to a B plus line which is high enough to bias the tube to cutoff, so that only the sync pulses are strong enough to drive the tube to conduction. Now, unlike most amplifiers, which operate with a fixed d.c. plate voltage, the a.g.c. keyer plate voltage takes the form of high-amplitude pulses which are fed to the plate from a tap or winding on the horizontal output transformer. (In some sets, the flyback pulse is obtained from a second winding on the width coil.) The pulses on the 6AU6 plate occur at the same time the positive sync pulses reach the control grid, so the tube conducts and causes plate current to flow to ground through R2 and R1 as indicated by the dashed arrows.

$\times 247,000$ ohms) negative with respect to ground. However, this calculation is made without regard to the bleeder current which flows from ground through R1, R2, R3, and R4 to the plus 270-volt line.

Note that the bleeder current, shown by the solid arrows, flows in a direction opposite to that produced by the a.g.c. keyer tube. R1, R2, R3, and R4 total 2,667,000 ohms, so the current produced by the 270-volt line would be $270/2,667,000$, or approximately $100 \mu\text{a}$ (.0001 amp).

With the $100\text{-}\mu\text{a}$ bucking current, produced by the 270-volt line, the current through R1 and R2 drops to $125 \mu\text{a}$ ($225-100$) and the voltage at the plate of the 6AU6 is only 31 volts instead of 55, as it was before we considered the effects of the bucking current. The a.g.c. voltage for the i.f. amplifier strip is tapped off at the junction of R1 and R2, which is approximately 5.9 volts negative. Since the left-hand end of R3 is 31 volts negative and the right-hand end of R4 is 270 volts positive, there is a total drop of 301 volts ($31+270$) across R3 and R4. There is a drop of approximately 27 volts across R3, which makes the junction of R3 and R4 27 volts positive with respect to the 6AU6 plate and 4 volts negative with respect to ground.

In the Du Mont *Service News* the following example is used to explain the operation of the delay circuit. Assume that when the 6AU6 conducts, a current of $225 \mu\text{a}$ flows through R1 and R2. This makes the plate 55 volts (.000225 amp

Looking into the voltage divider from the 270-volt line, there is a drop of 274 volts across R4 which makes the junction of R3 and R4 274 volts negative with respect to the 270-volt line, or 4 volts negative with respect to ground.

When the strength of the incoming signal drops, the 6AU6 conducts less heavily and its plate becomes less negative. When the voltage drops to minus 27, the junction of R3 and R4 (the tuner a.g.c. take-off point) becomes zero. The current through R1 and R2 drops to $109 \mu\text{a}$ and the i.f. a.g.c. take-off point drops to approximately 5.2 volts. Thus, when the total a.g.c. voltage drops 4 volts (from 31 to 27) the tuner a.g.c. voltage also drops 4 volts (from minus 4 to zero) while the drop on the i.f. a.g.c. line is about 0.7 volt.

A minimum bias of about minus 0.5 volt must be maintained on the cascode r.f. amplifier to prevent it from drawing excessive plate current. This voltage is obtained in a number of ways. In the RA-171 it is obtained by using the con-

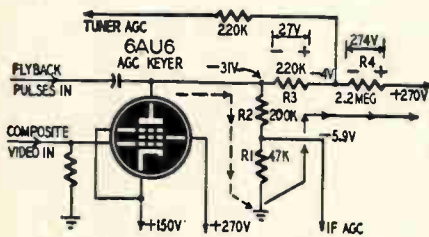

Fig. 1—Keyed a.g.c. circuit and delay network in the Du Mont RA-171 chassis.

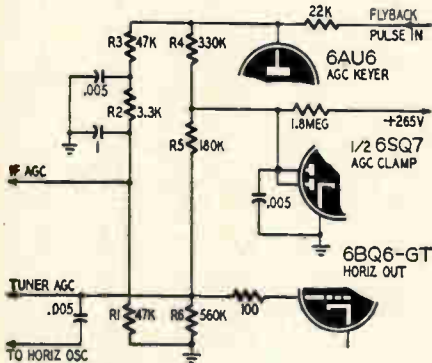
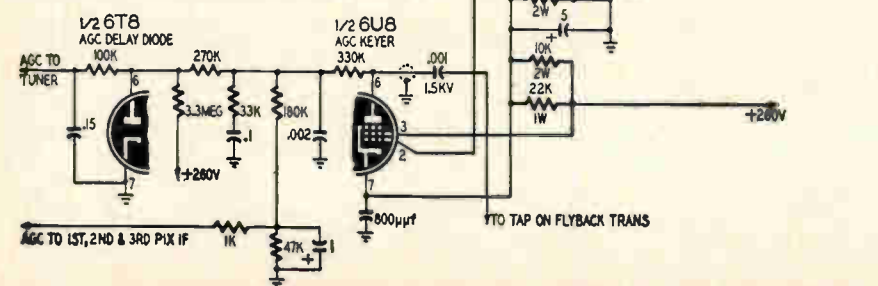

Fig. 2, above—The keyed a.g.c. circuit and delay network in the Hoffman 190B and 191B television receivers.

Fig. 3, right and below—The G-E model 21C255 uses a 6U8 tube as keyer.



tact bias potential developed by a diode connected between the tuner a.g.c. line and ground.

If the total a.g.c. voltage across R1 and R2 drops below 27, the tuner a.g.c. line would tend to go positive. This is prevented by connecting the plate of a diode clamp tube to the junction of R3 and R4 and connecting the cathode to ground. When the diode plate goes positive, the tube conducts and reduces the left-hand end of R4 to the contact bias potential of -0.5 volts.

The bucking voltage from a B plus source is used in almost all cases where a keyed a.g.c. circuit is used in sets which use cascode tuners.

Hoffman a.g.c. circuit

The keyed a.g.c. circuit and delay network in the Hoffman 190B and 191B TV chassis is shown in Fig. 2. In these sets, the 6AU6 develops its full a.g.c. voltage across two parallel-connected voltage dividers. One is composed of R1, R2, and R3 and the other consists of R4, R5, and R6. The bucking current for the delay voltage is obtained from the 265-volt B plus line and is applied to the junction of R4 and R5 through the 1.8-megohm resistor.

When the signal level is low, a minimum bias of approximately 0.5 volt is applied to the tuner a.g.c. line. This voltage is obtained from a tap on the 6BQ6-GT grid resistor (which consists of the 100-ohm resistor and R6 in series). The diodes of the 6SQ7 a.f. amplifier are strapped together and are used as the a.g.c. clamp, which prevents the positive voltage on the 265-volt line from being applied to the tuner a.g.c. line and the 6BQ6-GT grid when the r.f. signal is low.

G-E 6U8 a.g.c. keyer

Most TV design engineers seem to have settled on the 6AU6 as the tube most suitable for use as an a.g.c. keyer, so the 6U8 keyer attracts especial attention in the G-E 21C255 receivers. The diagram is shown in Fig. 3.

The keyer tube cathode is biased highly positive by its connection to a tap on the 260-volt B plus voltage divider. The high bias holds the keyer at cutoff until its grid and plate are driven positive simultaneously by the positive-going sync pulses and the pulse which occurs at the end of each horizontal sweep cycle. The tube conducts and develops a voltage drop across the 330,000-, 180,000-, and 47,000-ohm resistors connected between plate and ground. As in the other keyed a.g.c. circuits which we have discussed in this column, the voltage is most negative at the plate end of the resistor string. A.g.c. bias voltage for the first three video i.f. amplifiers is tapped off at the top of the 47,000-ohm resistor.

The a.g.c. line for the r.f. amplifier in the tuner is tapped off at a higher point on the a.g.c. load resistance. Delay bias for the tuner is obtained by making the 180,000- and 47,000-ohm resistors a part of a B plus voltage divider across the 260-volt line. **END**

A BROADBAND V.H.F. ANTENNA



Fig. 1—Antenna current distribution.

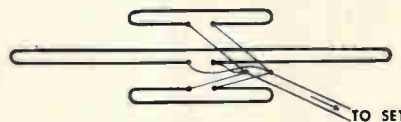

Fig. 2—Complete dipole assembly.

THE Champion antenna, developed by Dr. Yuen T. Lo, project engineer, and Harry Greenberg, chief engineer of the Channel Master Antenna Development Laboratories, is an attempt to produce a v.h.f. dipole system that would function with maximum efficiency on both the high and low bands.

Since the size of a dipole varies inversely with the frequency, a low-band dipole is approximately three times the size of a high-band dipole. However, the voltage that a dipole picks up is proportional to its length, and a high-band dipole will pick up only one-third the energy of a low-band dipole. The low-band dipole can thus be considered as three high-band dipoles tied together. (Fig. 1 dipoles B-A-C). The center dipole is 180° out-of-phase with the two outside dipoles. This results in an undesirable field distribution pattern.

The goal of antenna engineers has been to develop a system in which the low-band dipole performs as three *in-phase* dipoles on the high band, while performing as a fully efficient ½-wave dipole on the low band.

Keeping in mind that the low-band dipole is really three high-band dipoles tied together, Dr. Lo successfully reversed the phase of the center dipole by adding two new dipoles to the system (Fig. 1 dipoles D-E). These dipoles are so connected that the net result produced an antenna which gave the performance of three individual antennas on the high band and yet functioned with peak efficiency on the low band (Fig. 2). Adding all the currents together we see that dipoles A and B cancel each other out and dipoles B, C, and

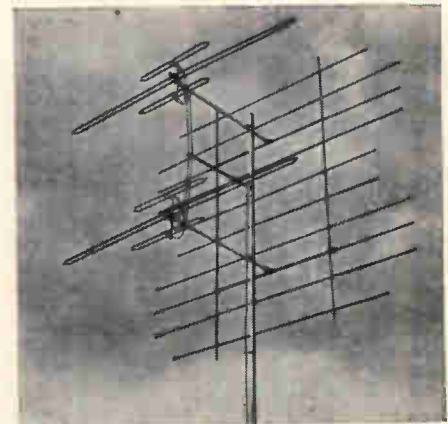

The Channel Master
2-Bay Champion Antenna



Fig. 3—Result of current addition.

E are in-phase. The resulting current distribution is shown in Fig. 3.

The impedance of each of the two small phase-reversing dipoles was well below 300 ohms, due to mutual impedance and coupling. Special one-fourth-wave transformer lines had to be designed to transform these low impedances to sufficiently high values, so that the total impedance of the three dipoles in parallel stayed in the vicinity of 300 ohms (see photo).

A screen-type reflector, rather than a straight bar parasitic reflector, was selected for the system. The maximum potential gain of a straight bar reflector is approximately 3 db and can be achieved only at one frequency. A straight bar parasitic reflector could not function effectively on both the high and low band. However, a screen type reflector has an optimum gain of approximately 7 db and is non-resonant.

A further advantage of the antenna is its versatility. It may be used in one-bay, two-bay, or four-bay arrays, providing optimum reception in any kind of television area. A high degree of stacking efficiency is maintained by the specially designed stacking harnesses. It is the first v.h.f. antenna ever developed which uses two-stage stacking transformers. The two-bay version provides gain of over 11 db across the entire high band. **END**



Front view. Eye is shaded from glare.

INSTRUMENT OUTPUT INDICATOR

*To measure relative signal level, and
wherever actual voltage is not important,
this indicator replaces an a.c. voltmeter*

By LOUIS E. GARNER, JR.

TO plot the frequency response of an amplifier, a crossover network, or a filter circuit, the usual technique is to apply sine-wave signals of various frequencies to the input of the circuit to be checked, keeping the input amplitude constant, and checking the output signal amplitude at each frequency used. Since few audio oscillators or sine-wave generators have a flat output (except for the more expensive laboratory instruments), it is necessary to keep a constant check both on the output of the signal source (input to circuit) and the output of the circuit being tested.

One solution is to use an a.c. voltmeter to check both the input and output signal amplitudes at each test frequency, switching the instrument connections back and forth as necessary. This has several disadvantages: It is time-consuming, and is likely to introduce errors due to the changes in loading as the voltmeter leads are connected and removed, as well as to the general confusion invariably involved in such a process.

A better technique is to use two a.c. voltmeters or one voltmeter and an oscilloscope. One instrument is connected to the input of the circuit being checked, while the other is connected to the output. In this way, a running check on the input signal amplitude is possible, permitting it to be kept constant. This technique introduces its own disadvantages, however.

In many instances, two a.c. voltmeters may not be readily available to the technician. Even if available, this solution means that two fairly expen-

sive instruments will be tied up while a series of measurements are carried out, preventing their use in other tests or measurements that may be necessary at the same time.

If an oscilloscope and an a.c. voltmeter are used, two valuable instruments are again tied up at the same time. In addition, the use of a scope may mean unnecessary bulkiness and excessive space requirements for an otherwise compact and simple equipment layout.

To overcome these difficulties, the instrument shown was designed and built. Although quite compact (case size is only 4 x 5 x 6 inches), this instrument is basically an uncalibrated a.c. v.t.v.m. It serves to indicate the *relative* level of signals applied to its input allowing any changes in signal level, whether an increase or decrease in amplitude, to be readily observed, thus permitting a readjustment back to a predetermined amplitude. The frequency response is essentially flat well past 100 kc, permitting tests on hi-fi as well as conventional amplifiers. Both a frequency-compensated step attenuator and a continuously variable sensitivity control are incorporated in the circuit design, thus allowing the user to make tests with signal amplitudes ranging from a fraction of a volt to well over 100 volts.

A further advantage of the instrument is its light weight and small physical size. This permits its use in an equipment layout without increasing the bench space requirements. It may be easily placed on top of the case of an audio oscillator or sine-wave generator

which is used for making the measurements of frequency response.

Circuit description

The complete schematic diagram is given in Fig.1. The circuit is quite straightforward and conventional. No complicated "trick" circuits are used.

Any signal applied to the SIGNAL (input) terminals is coupled through capacitor C1 to the step attenuator or MULTIPLIER circuit, consisting of R1, R2, R3, R4, C2, C3, C4, C5, and S1. C1 serves primarily as a blocking capacitor, permitting a.c. to pass, but blocking the flow of d.c. to the circuit. This permits the instrument to be used to indicate relative signal levels in circuits where both a.c. and d.c. may be present, as in the plate circuit of an amplifier tube.

Using both resistors and capacitors in the MULTIPLIER circuit provides frequency-compensation, so that the input signal level may be reduced without affecting the over-all frequency response of the instrument. This switch permits a straight-through feed to the grid of the amplifier tube, or reductions of 10:1 or 100:1 in signal strength, corresponding to the 100X, 10X, and 1X positions in the photograph.

The signal is applied to the grid of V1 ($\frac{1}{2}$ of a 12AT7) and amplified, with the amplified signal appearing across plate-load resistor R6. This resistor is kept fairly low in value to permit a wide frequency response. Bias for V1 is obtained by a conventional cathode resistor R5, together with its bypass capacitor C6.

The amplified signal appearing across

R6 is applied through blocking capacitor C7 to the cathode of a diode-connected triode V2 (second half of the 12AT7), where rectification occurs, with a d.c. voltage proportional to the a.c. signal amplitude appearing across R8.

Since the d.c. voltage across R8 contains an a.c. component, a simple R-C filter circuit is used to serve as a ripple filter, permitting essentially d.c. to be applied to the sensitivity control R10. The filter circuit consists of R9 and C8.

A portion of the d.c. voltage across R10 is applied to the grid of V3 a sensitive tuning-eye tube. The amount of eye closure obtained depends on the amount of d.c. voltage applied to the grid of this tube, and thus serves as an indication of the relative signal level applied to the input terminals. R11 is the plate-load resistor for V3.

D.c. operating voltages for the circuit are obtained from a conventional half-wave rectifier circuit using a selenium rectifier and a half-wave power transformer which also supplies filament voltage for the tubes. An R-C pi-type filter consisting of C9, R12, and C10, is used in the power supply circuit. R13 prevents damage to the rectifier during the charging of C9.

Since the power requirements for the instrument are small, it was not thought necessary to provide an on-off switch in

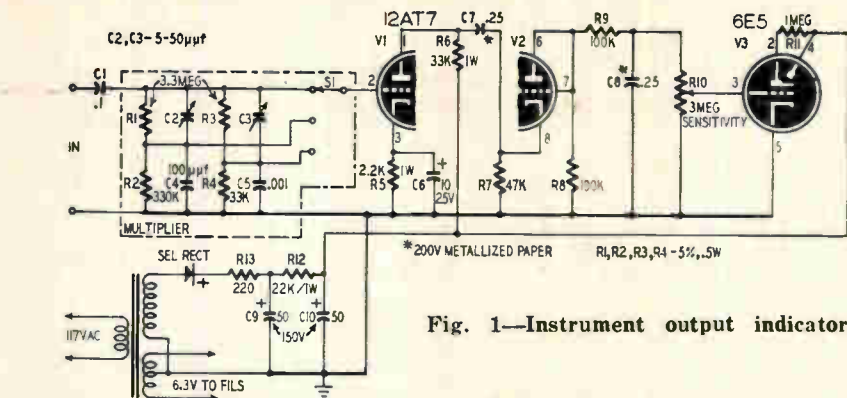

Fig. 1—Instrument output indicator.

the primary circuit. The instrument may be left connected while measurements are being carried out, and turned off simply by removing the plug from the power receptacle.

Construction hints

The layout of major parts is apparent from the exterior and interior photographs of the instrument. The circuit is not critical and a different layout may be used without difficulty if desired by the builder. Two precautions should be followed: A.c. signal leads should be kept as short and direct as possible. The input terminals and multiplier circuit should be well separated from other circuits to minimize dis-

tributed capacitances to ground.

Construction is simplified by using a small subchassis on which is mounted the amplifier tube, the power transformer, and other parts; and by using an Amphenol tuning-eye assembly. The Amphenol assembly provides the mounting bracket for the 6E5 tube, the front escutcheon, and a wired socket (including R11).

The MULTIPLIER and SENSITIVITY controls are mounted on the front panel of the Bud Minibox used as a cabinet. The carrying handle is optional and may be purchased from a dime store or hardware store.

Bud Miniboxes may be obtained in either etched aluminum or gray Ham-

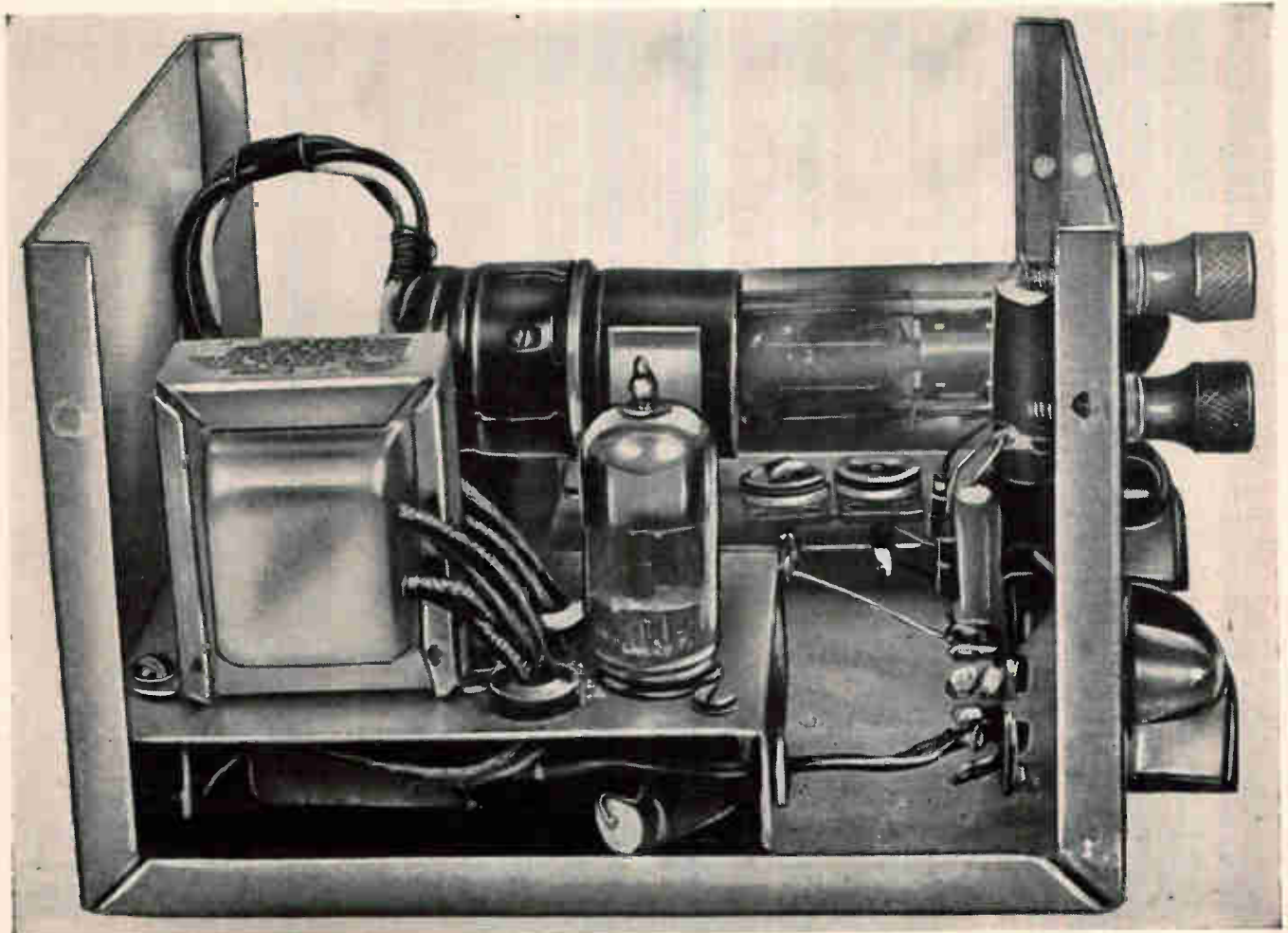

Photo shows interior view of instrument output indicator. Trimmer capacitors are conveniently located for adjustment.

merloid finish (like the model shown). If the builder plans to use some other type of finish, such as gloss enamel or wrinkle varnish, he should obtain a box with a plain aluminum finish, applying the paint after drilling and punching, but before mounting parts.

Controls and terminals may be identified—using standard name-plates or decals. If a light finish is used, the new black decals have an attractive appearance (see photo).

The trimmer capacitors C2 and C3 in the multiplier assembly should be rigidly mounted in such a position that adjustment is easy after the wiring is completed.

Adjustment

Once the wiring is completed and checked, the tubes should be placed in their respective sockets and the unit plugged in. After a warmup period, the tuning eye should glow normally. The eye should then be rotated until the opening faces downward.

The operation of the instrument may next be checked by applying an a.c. signal of from 1 to 6 volts to the input terminal and adjusting the MULTIPLIER and SENSITIVITY controls. The eye should close or overlap (depending on the input signal level).

If the eye does not glow green after a reasonable warmup period, first check and make sure the 6E5 is in good condition and that its filament is lit. If the tube filaments light, but a glow is still not obtained, check the wiring for errors and make sure B plus is available from the power supply.

Should the eye tube glow properly, but not close when a reasonable level a.c. signal is applied to the input and the controls adjusted, check for opens or shorts in the signal circuits. Also make sure that R11 is not open.

Once the unit is operating normally, the trimmers in the multiplier circuit should be adjusted to obtain proper frequency compensation. To do this, connect the vertical input terminals of an oscilloscope to the output of the amplifier stage (between the plate of V1 and ground). Connect a square-wave generator to the input terminals of the instrument.

Using a 10-kc square-wave signal, turn the MULTIPLIER to the 10X posi-

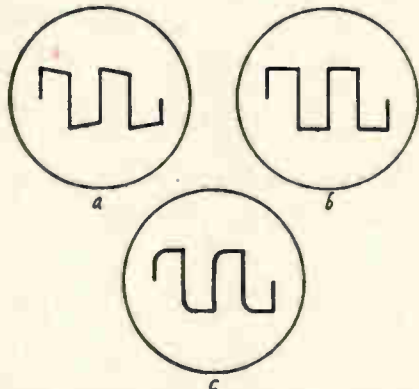

Fig. 2—Patterns for adjusting indicator.

tion and adjust C2 until the square-wave signal observed on the screen of the scope is flat with square corners, as shown in Fig. 2-b).

A slant like that shown in Fig. 2-a indicates that the trimmer capacitance is too high, while a slant in the opposite direction or a "rounding" of the leading edge (Fig. 2-c) indicates that it is too low.

After properly adjusting C2 in this fashion, switch to the next position of the multiplier switch and adjust C3 similarly. It may be found that adjustment of the scope gain controls or the output of the square-wave generator may be necessary to obtain a reasonable signal level.

Applications

The output indicator may be used in place of an a.c. voltmeter wherever the actual voltage is not important and where a relative signal level may be indicated. Such applications include the use of the instrument as an output indicator when aligning radio receivers, as a null indicator when working with impedance bridge circuits, and as a level indicator when plotting frequency response curves. As can be seen, the instrument is quite versatile and may be used in a number of different applications, the only limit being the ingenuity of the user.

A basic setup for using the instrument output indicator when obtaining the frequency-response curve of an audio amplifier is illustrated in Fig. 3.

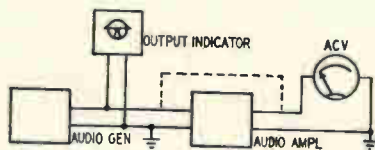

Fig. 3—Obtaining amplifier response.

In this case it is used in conjunction with an audio generator and an a.c. voltmeter.

First, connect the a.c. voltmeter and the output indicator in parallel with the output of the audio generator. Adjust the output control of the generator to give the desired voltage, as indicated on the a.c. voltmeter. Set the MULTIPLIER and SENSITIVITY controls of the instrument output indicator so that the tuning eye just closes, as shown in Fig. 4-b.

Next connect the a.c. voltmeter leads to the output of the amplifier and leave them connected here during the remainder of the tests (the preliminary connection during the initial adjustment of the audio generator and output indicator is shown by the dotted line in Fig. 3).

Then adjust the audio generator to supply signals of different frequencies to the audio amplifier, and the output reading obtained on the a.c. voltmeter is noted.

If the signal from the audio generator decreases in amplitude as different frequencies are used, the tuning eye will tend to open (Fig. 4-a). If the

signal increases in amplitude, the eye will overlap, as shown in Fig. 4-c.

In either case, readjust the output control of the audio generator until the eye is again just closed, as in Fig. 4-b. This insures maintaining a constant input signal to the audio amplifier.

Do not readjust the MULTIPLIER or SENSITIVITY controls of the output indicator during the tests after the initial adjustment.

A slightly different technique is to connect the instrument output indicator to the output of the circuit under test, connecting the a.c. voltmeter in parallel with the output of the audio generator. In this case, the output signal level is kept constant (as indicated by the closed tuning eye) and the input signal voltage required to just close the tuning eye at each of the different frequencies is noted.



Fig. 4—Eye indicates signal amplitude.

In cases where a low-level signal must be supplied to the circuit under test, so that it is not possible to completely close the eye, the setup shown in Fig. 5 may be employed. The instrument output indicator is connected to the output of the audio generator, and a frequency-compensated attenuator is used between the audio generator and the circuit be-

Output indicator parts list.

Resistors: 1—220 ohms, 1—33,000 ohms (5%), 1—47,000 ohms, 2—100,000 ohms, 1—330,000 ohms (5%), 2—3.3 megohms (5%), 1/2 watt, carbon; 1—2,200 ohms, 1—22,000 ohms, 1—33,000 ohms, 1 watt, carbon; 1—3 megohms, potentiometer, carbon, linear taper; 1—1 megohm, 1/2 watt, carbon (in MEA-6 assembly).
Capacitors: 1—0.1, μ f, 600 volts, paper; 2—0.25 μ f, 200 volts, metalized paper tubular; 1—0.001 μ f, 100 μ f, ceramic; 2—5-50 μ f, ceramic trimmers; 1—10 μ f, 25 volts, electrolytic; 2—50 μ f, 150 volts, electrolytic (may be dual capacitor).
Miscellaneous: 1—1-pole, 3-position switch (Molly 3223J—use one section); 1—20-ma selenium rectifier; 1—12AT7 tube; 1—6E5 tube; 1—power transformer, 150 volts at 25 ma, 6.3 volts at 0.5 ma (Merit P-3046); 1—Bud Minibox, 4x5x6 inches; 1—Amphenol MEA-6 tuning eye assembly, 1—small chassis (Bud C.J. 1617); 1—line cord; 1—9 pin miniature socket; 2—Banana plug type binding posts; 2—pointer knobs; 1—handle; wire, solder, and hardware.

ing tested to reduce the input signal level to the point desired. In this way, ample signal is supplied to the output indicator, yet a low-level signal is supplied to the circuit being checked.

Although the instrument output indicator is quite inexpensive and easy to assemble, it may often be used to replace much more expensive instruments for some types of measurements.

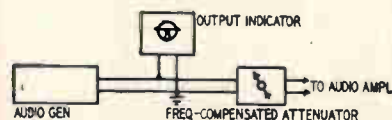

Fig. 5—Low-level signal arrangement.

The average technician should have no difficulty in wiring the unit in from six to eight hours. Once it is completed and adjusted, only a few minutes experimenting will familiarize the user with its operation and application. END

twin diode, providing a d.c. voltage across the 2-megohm potentiometer. For d.c. signals the 6AL5 is removed from the circuit. The 2-megohm zero-set potentiometer is adjusted for a zero reading on the meter. With the circuit zeroed, both halves of the 12AX7 draw equal currents and no voltage difference exists between the two plates.

When a voltage change of sufficient amplitude occurs, the 12AX7 becomes unbalanced and a voltage difference exists between the two plates. This causes one of the two halves of the 6AL5 coupling diode (to the 2D21) to conduct. The half that conducts depends upon the polarity of the voltage change. With the 6AL5 conducting, a positive voltage is placed at the grid of the 2D21, causing this thyatron to fire. In the plate circuit of the 2D21 is the actuating relay which lights the appropriate lamp and sounds the buzzer. Even if the voltage change disappears, the thyatron continues to conduct, since once such a tube is fired it cannot be cut off until the plate voltage is removed. Plate voltage is cut off only when the reset button is pressed.

The method of balancing the circuit for zero reading on the meter is unusual for a v.t.v.m. circuit of this type. One grid (pin 7) of the 12AX7 is grounded, so the other grid (pin 2) would also have to be at ground potential (zero volts) for the circuit to balance. Since the alarm is operated by the voltage across a portion of the potentiometer in the input circuit, a 1.5-volt cell is placed in series with the grid to buck the voltage developed at the arm of the potentiometer. The circuit balances when the voltage on the arm of the potentiometer equals the voltage supplied to the grid by the battery. The input selector switch reverses battery polarity so it bucks the voltage applied to the input.

The circuit in Fig. 1 must operate on voltages as low as 0.5, so the cell voltage is reduced by the 3-1 divider consisting of the 100,000- and 47,000-ohm resistors in series with the cell. The bucking voltage for the grid is tapped off the smaller of the two resistors. In the 3- and 15-volt circuits the cell connects across a 150,000-ohm resistor in series with the grid.

The inputs to the 3- and 15-volt circuits have controls as parts of fixed voltage dividers. The 3-volt input has a 2-1 divider consisting of a 1-megohm resistor in series with a 1-megohm potentiometer. The 15-volt circuit has a 10-1 divider consisting of a 2-megohm resistor in series with a 200,000-ohm potentiometer.

The recorder can be operated by d.c. or a.c. voltages at any convenient point in an electronic circuit. When the input probe is connected directly to the plate of an amplifier, it operates with changes in the average voltage when the applied voltage consists of d.c. with superimposed a.c. By using a blocking capacitor in series with the probe, the circuit operates from changes in the a.c. signal alone. END

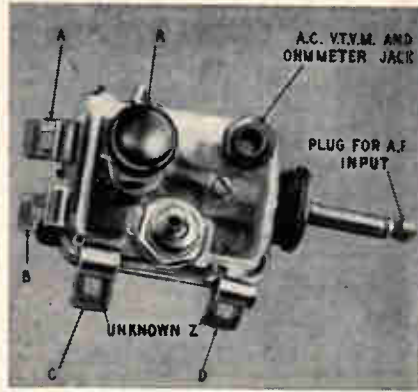

Front view of impedance checker. Jack, without bakelite cover mounted on right.

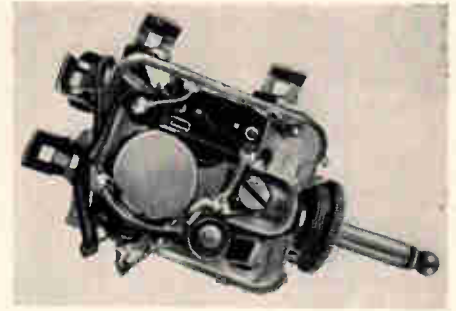

Rear closeup view of impedance checker. Very few parts make construction easy.

Checker is mounted on insulating panel material. The phone plug is screwed on.

PRACTICAL IMPEDANCE CHECKER

By ALBERT L. SOHL

COMPACTNESS and simplicity keynote this unit which takes up no more space than a pack of cigarettes. The checker is based upon a substitution method (Fig. 1) using easily obtainable components.

I used a plastic thread and thimble box measuring 1 3/4 x 2 inches obtained in a 5-and-10-cent store. Any insulating panel material with approximately the same dimensions will serve as a mount for the few items involved. A phone plug with the bakelite shell removed has one terminal screwed directly on the panel. This plug is connected directly into the output jack of the test audio oscillator.

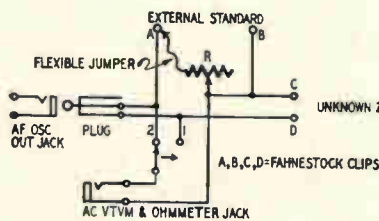

Fig. 1—Schematic of impedance checker.

The known resistance R (a 1 megohm midget potentiometer, in this case), is attached between Fahnestock clips A and B. If other or more critical values of the known resistance are required, the mounted potentiometer can be eliminated and the new resistance substituted.

To operate, set the test oscillator at 1,000 cycles and plug the a.c. v.t.v.m. into the output jack of the impedance checker. Place the unknown impedance between Fahnestock clips C and D, and plug the checker into the oscillator output. When the toggle switch is at position 2, the v.t.v.m. will measure the voltage across R; on position 1, it will measure the voltage across the unknown impedance. Now move toggle

switch back and forth while varying the potentiometer until the meter readings are the same at both switch positions. When both readings are identical remove unit from oscillator and check resistance of R with an ohmmeter. Ohmmeter check can be made by moving switch to position 2 and adjusting v.t.v.m. to read resistance. The value of the resistance will be the impedance of the unknown L, C, or R.

Determining L, C, R

If the unknown impedance is a resistor, its value will be equal to R. If the unknown impedance is an inductance or a capacitance, some simple formula substitution must be used. If it is an inductance, the value of R is approxi-

Materials for checker:

Resistors: 1—1 megohm potentiometer, midget.
Miscellaneous: 4—Fahnestock clips; 1—single-circuit jack; 1—phone plug with bakelite shell removed; 1—single-pole double-throw toggle switch; 1—plastic panel; 1—box, 1 3/4 x 2 inches.

mately equal to its inductive reactance

$$(X_L). \text{ The formula } L = \frac{X_L}{6.28 \times f}$$

can then be used to find L. If the unknown impedance is a capacitance, the value of R is equal to its X_C . The

$$\text{formula } C = \frac{1}{6.28 \times f \times X_C}$$

can then be used to find C. For those allergic to formulas, nomographs or reactance tables can be used.

Any test frequency can be used. As an added refinement for this unit, the mounted potentiometer can be calibrated for direct reading.

The beautiful part of this impedance checker is, that the voltage output of the audio oscillator is unimportant. There is no need to adjust attenuators or monitor voltages, because we are interested only in the relative distribution of the voltage, and not the exact voltage. END

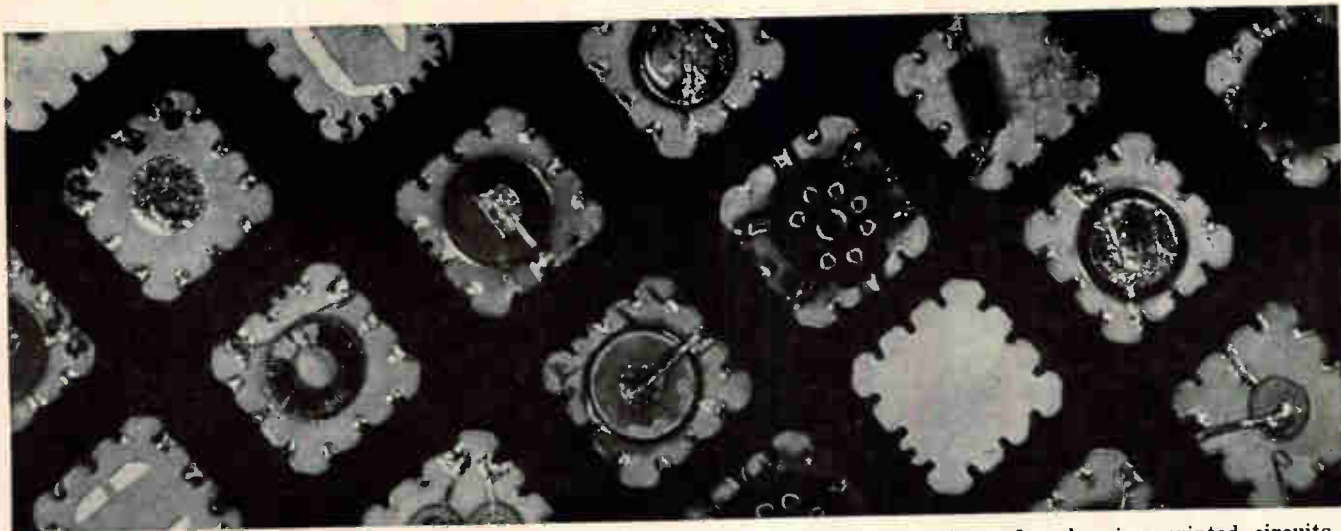

Geometric arrangement of Tinkertoy parts-mounted wafers. Modules have four to six wafers bearing printed circuits.

project TINKERTOY

An automatic production line for the manufacture of electronic products

By STEVEN MICHAELS

MACHINES instead of men can now do the biggest part in producing desperately needed electronic equipment for the armed forces during manpower scarcities.

The Navy Bureau of Aeronautics and the National Bureau of Standards jointly announced that they had pushed automatic mass production of electronic devices so far that the most refined skill and something that closely resembles intelligence has been transferred to machines. This revolutionary system is code-named "Project Tinkertoy."

At the present moment, the Navy is especially interested in such electronic devices as guided missiles, radar sets, proximity fuses, electronic fire control and communication methods. Project Tinkertoy was developed primarily to make the parts and circuits required for such military equipment.

Starting with raw or semi-processed materials, machines automatically manufacture ceramic materials and adhesive carbon resistors, print conducting circuits, and mount resistors, capacitors, and other miniaturized component parts on standard uniform steatite wafers. The wafers are stacked very much like building blocks to form a module (building block) that performs all the functions of one or more electronic stages. Automatic inspection machines check physical and electrical characteristics of the parts mounted on the wafers at numerous stations along the production line. The completed module is a standardized, interchangeable subassembly combining all of the requirements of an electronic circuit with ruggedness, reliability, and extreme compactness.

MDE design system

The key to the automatic, mechanized production of electronic equipment in Project Tinkertoy is the design system developed by the National Bureau of Standards, called MDE—for Modular Design of Electronics. The system establishes a series of mechanically standardized and uniform modules producible with a wide range of electrical characteristics.

Each module consists usually of four to six thin ceramic wafers, bearing various circuits associated with an electronic stage. A number of individual modules are combined to form a larger subassembly.

Since electronic assemblies consist largely of electronic tubes and groups of simple parts (like resistors and capacitors) which account for the mass of the individual parts and are also responsible for most of the manual labor in conventional production, they have been the chief target for redesign in the MDE system.

The MDE system does away with the conventional circuit diagram of the tested electronic model and places all necessary production programming information on an MDE work sheet. Each work sheet contains the front and back outlines of six wafers with numbering to identify each notch in the wafer, each riser wire, and the electronic piece that is to be placed on the wafer. The engineer translates his conventional wiring diagram to an MDE diagram. He indicates the position of the piece and its proper value and tolerances. Lines are drawn to indicate how the circuits between wafers are to be connected.

The engineer's MDE work sheet becomes the basic document from which a draftsman makes an ink drawing that may be reproduced in large numbers. The draftsman also prepares a larger version of the work sheet to be photographed and used subsequently to make stencils for the circuit printing machines. The numbers of wafers and the tube sockets listed on the MDE sheets indicate the quantity of raw ceramic materials that must be mixed. The number and value of resistors marked on the work sheets determine the production required for tape resistors.

The MDE work sheet is also used to establish the inspection procedure. Current paths on each wafer are marked on specially prepared punch cards. These cards accompany the wafers through all the standard modules or counterparts employed in the final testing and inspection of the module assembly.

MPE production system

Modules and assemblies, designed in the MDE system, are produced and inspected mechanically in Project Tinkertoy. The production system is called MPE—Mechanized Production of Electronics. MPE uses non-critical raw materials. The ceramic wafers— $\frac{3}{8}$ -inch square by $\frac{1}{16}$ -inch thick—are produced directly in quantity from the raw materials. Ceramic capacitors are made the same way. Another part of the line produces adhesive tape resistors.

These and other basic parts are fed into the production line. The proper circuits are printed by automatic

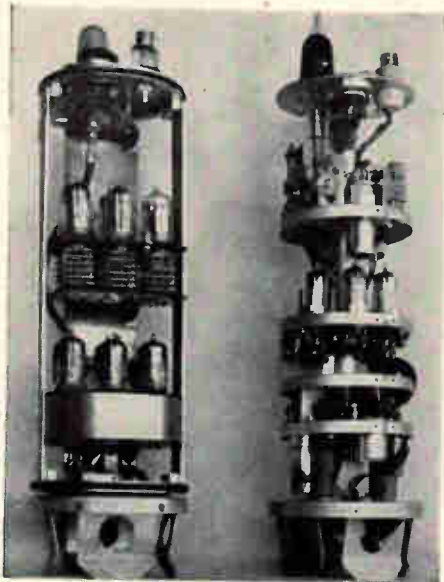

machines. Interconnection between any number of modular units is simple.

Modular design

In a series of metallizing operations, sections of the wafer or capacitor body are silver-painted. During these stages, circuits are printed on the wafers, the notches are coated, the conducting surfaces and leads are applied to capacitors, the bodies are cured in a furnace, and the circuits are inspected.

Once the wafers and components have been made and metallized, the next step is joining them. Machines are used to apply up to two capacitors to each side of a wafer. Other machines apply either one or two resistors to each side of a wafer. Rolls of resistor tape are mounted on a machine that automatically cuts the tape into one-half-inch strips, presses it between printed electrodes on a wafer, applies pressure, and ejects the completed piece. Tube sockets are also mounted on their appropriate wafers so that the pins will connect with suitable notches.

After many of the steps in the components assembly process, parts or circuit lines must be soldered or tinned. This is done automatically by induction heating and dip tinning.

Uniform wafer-mounted component parts, including wafer-mounted coils, toroids, potentiometers, and crystals are now ready for assembly. The module is completely assembled in a single machine. Six feeders issue the wafers to a loading device that holds them upright between specially designed jaws. A chain drive carries the jig to a soldering position at which six riser wires are guided into appropriate notches, three on a side. The mechanism then solders the wires to the notches. Another mechanism next turns the unit 90°, and the chain drive carries it to another soldering position where six more wires are bonded to the module. The final operations on an assembled module consist of clipping the riser wires automatically at specified positions and testing the completed units.

Upper left: Equipment on left made by Tinkertoy process.

Upper right: Two typical Tinkertoy modules and wafer.

Lower right: Equipment at right produced by Tinkertoy.

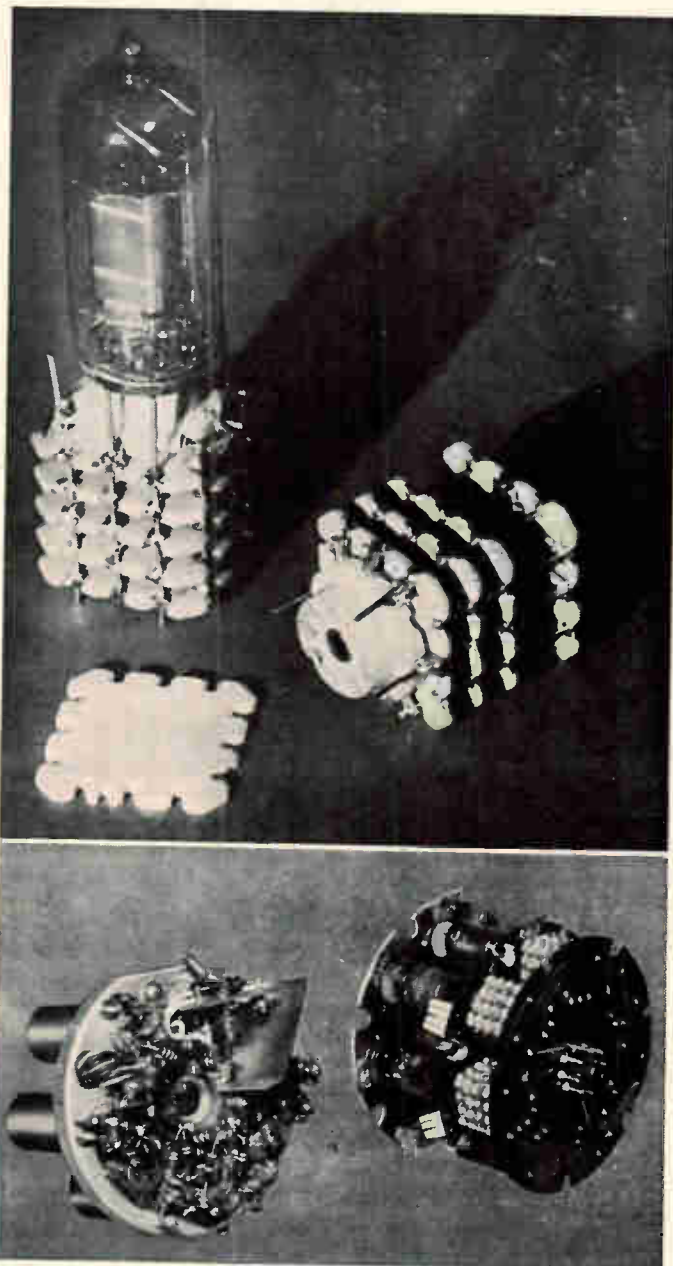

Inspection and assembly

During each stage in the mechanized production of electronics, provision is made for 100% automatic inspection. This is both a physical gauging and an electrical comparison. Printed circuits, resistors, and capacitors are compared with their electronic equivalents both before and after assembly. This is done with electronic computers, bridge circuits, and other comparison devices. The inspection "code" is contained on the punched cards which were prepared by the design engineer and have accompanied the wafers all through the production process. After the final assembly of the module the whole circuit is again tested to see that it meets specifications.

The final assembly operation need not necessarily be considered a part of the Mechanized Production of Electronics. Normally, a set of modules

(as many as ten) are mounted on or between copper-clad base plates. Circuits have been etched into the copper surface and connect the riser wires of the several modules to form a complete electronic circuit. Several such plate assemblies may form a single piece of equipment. One base plate with six modules, for instance, contains all the necessary circuits to make a six-tube radio receiver function properly.

Project Tinkertoy makes possible a rapid conversion from civilian to military products (and back again) on short notice and, concurrently, allows a greatly expanded production capacity. Tinkertoy speeds up the output beyond anything that could be done through pep talks or incentives to workers. A small pilot shop now in operation is rated to produce 1,000 modular subassemblies every hour. Depending on human hands, you'd need a huge factory to equal that pace.

END



**I Send You
18 BIG
KITS
OF RADIO-
TELEVISION
EQUIPMENT**

I'll Train **YOU** at Home in Your Spare Hours for Big Pay Job • Your Own Business • Exceptional Opportunity in **RADIO-TELEVISION** ON *New* **NO-OBLIGATION PLAN!**

You Have NO MONTHLY PAYMENT CONTRACT

to sign . . . you pay for your training as you learn and earn... **ENROLL NOW!**
Be Ready in Little as 10 MONTHS!

Now you can get into Radio-Television, today's fastest growing big money opportunity field, in months instead of years! My completely new "package unit" training plan prepares you to qualify as a Radio-Television Technician in as short a time as 10 months, or even less! I offer you my training with no monthly payment contract to sign—thus **NO RISK** and **NO OBLIGATION** for you! This is America's finest, most modern and really practical training. Includes FM . . . UHF Television and all the most recent developments. My training gets you ready to handle any practical job in the booming Radio-Television industry. Start your own profitable Radio-Television Service Shop . . . or accept a fine paying job. I have trained hundreds of successful Radio-Television technicians—and I can train you regardless of lack of previous experience. Mail coupon and get all the facts—**FREE!**

VALUABLE EQUIPMENT INCLUDED WITH TRAINING

Much of your Sprayberry Training is actual construction, demonstration and experimentation. You get priceless practical experience this way. You build the 6 tube Sprayberry Short Wave and Broadcast Training Radio Receiver, the Sprayberry Television set, multi-range test meter, signal generator, signal tracer, cathode ray oscilloscope and many other projects. All this equipment is yours to keep. You have practically everything you need to set up your own profitable Radio-Television shop. All lessons and books I send you remain your own property.

OUR 21st YEAR TRAINING MEN FOR RADIO-TELEVISION

Earn Extra Money While You Learn

All your Sprayberry Training is given **IN YOUR OWN HOME** during your free time. Keep on with your present job and income while learning Radio-Television. With each Sprayberry "Package Training Unit" I include money-making plans and special "Business Builders" for spare time Radio-Television service jobs. New Television stations opening everywhere open big money opportunity for men to install UHF antennas—I tell you how! If you expect to be in the Armed Forces later, there is no better preparation than Radio-Television. Mail coupon below . . . get facts **FREE**. *No salesman will call.*

FREE TO YOU 3 BIG RADIO-TELEVISION BOOKS

I invite you to get all the facts—

I want you to have **ALL** the facts—without cost! Rush coupon for my three big Radio-Television books! "How to Make Money in Radio-Television" PLUS my new illustrated Television Bulletin PLUS an actual sample Sprayberry Lesson—**ALL FREE**. No obligation and no salesman will call. Mail coupon **NOW!**

SPRAYBERRY ACADEMY OF RADIO

111 NORTH CANAL STREET, DEPT. 20-D
CHICAGO 6, ILLINOIS

**Mail
Coupon
Today!**

**NO OBLIGATION
No Salesman
Will Call**

SPRAYBERRY ACADEMY OF RADIO, Dept. 20-D
111 North Canal St., Chicago 6, Illinois
Please rush to me all information on your 10-MONTH Radio-Television Training Plan. I understand this does not obligate me and that no salesman will call upon me. Be sure to include 3 books FREE.

Name.....Age.....
Address.....
City.....Zone.....State.....
 Are you Experienced? No Experience

Approved for
Veterans Under
the G. I. Bill

**IF YOU ARE
EXPERIENCED IN RADIO**

Men already in Radio who seek a short intensive 100% TELEVISION Training with **FULL EQUIPMENT INCLUDED** are invited to check and mail the coupon at the right.

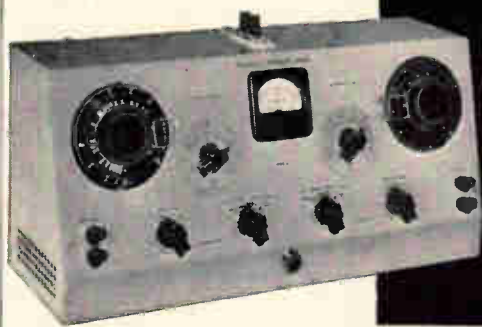

Heathkit IMPEDANCE BRIDGE KIT

MODEL IB-2

\$59⁵⁰

SHIPPING WT.
15 LBS.

Features

- Simpson 100-0-100 microampere meter.
- Completely AC operated.
- Built-in phase shift generator and amplifier.
- Battery type tubes, no warm-up required.
- Newly designed two section CRL dial.
- Single knob D, Q, and DQ functions.
- Special impedance matching transformer.
- New modern cabinet styling.
- ½% precision resistors and silver mica condensers.

Another new, outstanding instrument design so typically characteristic of Heathkit operation in producing high quality instrument kits at the lowest possible price. A new, improved model Impedance Bridge kit featuring modern cabinet styling, with slanted panel for convenience of operation and interpretation of scales at a \$10.00 price reduction over the preceding model. Built-in adjustable phase shift oscillator and amplifier with all tubes of the battery operated type completely eliminates warm-up time. The instrument is entirely AC line operated. No bothersome battery replacements.

The Heathkit IB-2 Impedance Bridge Kit actually represents four instruments in one compact unit. The Wheatstone Bridge for resistance measurements, the Capacity Comparison Bridge for capacity measurements, Maxwell Bridge for low Q, and Hay Bridge for high Q inductance measurements. Read Q, D, DQ all on one dial thereby eliminating possible confusion due to the incorrect dial reference or adjustment. Only one set of instrument terminals nec-

essary for any measurement function. Panel provisions provided for external generator use.

A newly designed two section CRL dial provides ten separate "units" switch settings with an accuracy of .5%. Fractions of units are read on a continuously variable calibrated wire-wound control. A special minimum capacity, shielded, balanced impedance matching transformer between the generator and the bridge. The correct impedance match is automatically switch selected to provide constant load operation of the generator circuit. The instrument uses ½% precision resistors and condensers in all measurement circuits.

The new Heathkit IB-2 provides outstanding design features not found in any other kit instrument. The single low price includes the power supply, generator, and amplifier stages. No need to purchase separate instrument accessories in order to obtain the type of operation desired.

Heathkit AUDIO WATTMETER KIT



MODEL AW-1

\$29⁵⁰

SHIPPING WT.
6 LBS.

A new Heathkit design for the audio engineer, serious hi fi enthusiast, recording studio, or broadcast station; the Heathkit Audio Wattmeter Kit. This specialized instrument instantly indicates the output level of the equipment under test without requiring the use of external load resistors. All readings are taken directly from the calibrated scales of a 4½" 200 microampere Simpson meter.

The Heathkit Audio Wattmeter features five full scale power measurement ranges from 5 milliwatts up to 50 watts with db ranges of -15 db to +48 db. The instrument has a power measurement rating of 25 watts continuous and 50 watts maximum for intermittent operation. Non-inductive resistance load impedances of 4, 8, 16, and 600 ohms are provided through a panel impedance selector switch. Frequency effect is negligible from 10 cycles to 250 kc. A conventional VTVM circuit utilizes a 12AU7 twin triode tube. The meter bridge circuit uses four germanium diodes for good linearity.

With the Heathkit AW-1 desired information can be obtained instantly and conveniently without bothering with the irksome setups and calculations usually required. Useful for power curve measurements, frequency response checks, monitoring indicator, etc. Convenient calibration directly from 110 volt AC line source. This new instrument will help to supply the answers to your audio operating or power output problems.

Heathkit LABORATORY GENERATOR KIT

MODEL LG-1

\$39⁵⁰

SHIP. WT.
16 LBS.

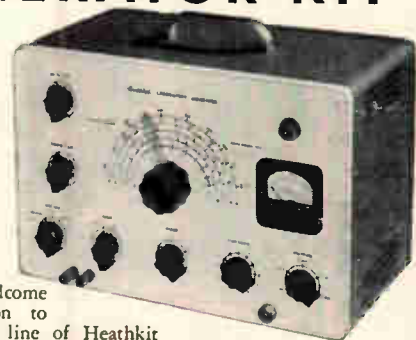

Another welcome new addition to the popular line of Heathkit instruments, the Heathkit Laboratory Generator. Specifically designed for flexibility of operation, accuracy and versatility beyond the performance level provided by the conventional service type generator. Frequency coverage of the Colpitts oscillator is 150kc to 30mc in five convenient ranges with provisions for internal or external modulation up to 50%, and .1 volt RF output throughout the frequency range. Panel mounted 200 microampere Simpson meter for RF "set reference level" to provide relative indication of RF output. Individually shielded oscillator and shielded variable and step attenuator provide flexible control of RF output.

The circuit features a 6AF4 high frequency oscillator, a 6AV5 amplifier with grid modulation, 12AU7 400 cycle oscillator and modulator, OB2 voltage regulator tube, and a selenium rectifier for the transformer operated power supply. The smart professional instrument appearance and over-all flexibility of operation will prove a decided asset to any industrial or educational laboratory. The Heathkit Laboratory Generator sets a new level of operation, far superior to any instrument in this price classification.

HEATH COMPANY • Benton Harbor 20, Mich.

CHECK THESE *Features*

- ✓ New 5U1 CR tube
- ✓ Re-trace blanking
- ✓ Voltage regulation
- ✓ Extended band width
- ✓ Peak-to-peak calibrating provisions
- ✓ Good square wave response
- ✓ Astigmatism control
- ✓ New heavy duty shielded power transformer

NEW 5" *Heathkit*
**OSCILLOSCOPE
KIT**

MODEL O-9

\$59⁵⁰

SHIPPING
WT. 28 LBS.



Announcing the latest addition to a brilliant series of Heathkit Oscilloscopes, the new Model O-9. This outstanding instrument incorporates all of the features developed and proven in the production of well over 50,000 kits, in addition to a host of many new design features for truly outstanding performance. This new scope features a brand new (no surplus) commercially available 5U1P1 cathode ray tube for fine focusing, high intensity, and freedom from halation. The 5" CR tube is the standard size for design and industrial laboratories, development engineers, and service men. The only size CR tube offering a wide range of types, colors, phosphors, and persistence. The answer to good oscilloscope performance lies in improved basic design and operating characteristics, and not in the use of larger CR tubes.

VERTICAL AMPLIFIER — New extended band width vertical amplifier with sensitivity of .025 volts per inch, down 3 db at 2 mc, down only 5½ db at 3 mc. Three step vertical input attenuator, quality ceramic variable capacitors for proper input compensation, provisions for calibrated 1 volt peak-to-peak reference, with calibrated screen for direct reading of TV pulses.

HORIZONTAL AMPLIFIER — New input selector switch provides choice of horizontal input, 60 cycle sweep input, line sync, internal sync, and external sync. Expanded horizontal sweep produces sweep width several times the cathode ray tube diameter. New blanking amplifier for complete retrace blanking and new phasing control.

POWER SUPPLY — New high voltage power supply and filtering circuit for really fine hairline focusing. New heavy duty power transformer with adequate operating reserve. Voltage regulated supply for both vertical and horizontal amplifiers for absolutely rock steady traces and complete freedom from bounce and jitter due to line variations.

The acid test of any oscilloscope operation is the ability to reproduce high frequency square waves and the new Heathkit O-9 will faithfully reproduce square waves up to 500 kc. This is the ideal all around, general purpose oscilloscope for educational and industrial use, radio and TV servicing, and any other type of work requiring the instantaneous reproduction and observation of actual wave forms and other electrical phenomena.

Heathkit **LOW CAPACITY
PROBE KIT**



NO. 342
\$3⁵⁰ SHIP. WT.
1 LB.

Oscilloscope investigation of high frequency, high impedance, or broad bandwidth circuits encountered in television work requires the use of a low capacity probe to prevent loss of gain, distortion, or false service information. The Heathkit Low Capacity Probe features a variable capacitor to provide the necessary degree of instrument impedance matching. New probe styling with bright polished aluminum housing and polystyrene probe ends.



NO. 337-B
\$3⁵⁰
SHIP. WT. 1 LB.

Heathkit
**SCOPE DEMODULATOR
PROBE KIT**

In applications such as trouble shooting or aligning TV, RF, IF, and video stages, the frequency ranges encountered require demodulation of signals before oscilloscope presentation. The newly-styled Heathkit Demodulator Probe in polished aluminum housing will fulfill this function and readily prove its value as an oscilloscope service accessory. Detailed assembly sheet provided, including instructions for probe operation.

Heathkit
VOLTAGE CALIBRATOR KIT

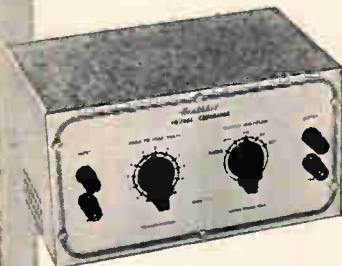

MODEL VC-2
\$11⁵⁰
SHIPPING WT.
4 LBS.

The Heathkit Voltage Calibrator provides a convenient method of making peak-to-peak voltage measurements with an oscilloscope by establishing a relationship on a comparison basis between the amplitude of an unknown wave shape and the known output of the voltage calibrator. Peak-to-peak voltage values are read directly on the calibrated panel scales. To offset line voltage supply irregularities, the instrument features a voltage regulator tube.

With the Heathkit Voltage Calibrator, it is possible to measure all types of complex wave forms within a voltage range of .01 to 100 volts peak-to-peak. A convenient "signal" position on the panel switch by-passes the calibrator completely and the signal is applied to the oscilloscope input thereby eliminating the necessity for transferring test leads.

Heathkit
**ELECTRONIC SWITCH
KIT**



MODEL S-2
\$23⁵⁰
SHIP. WT. 11 LBS.

The basic function of the Heathkit S-2 Electronic Switch Kit is to permit simultaneous oscilloscope observation of two separate traces which can be either separated or superimposed for individual study. A typical example would be observation of a signal as it appears at both the input and output stages of an amplifier. It will also serve as a square wave generator over the range of switching frequencies often providing the necessary wave form response information without incurring the expense of an additional instrument.

Continuously variable switching rates in three ranges from less than 10 cps to over 2,000 cps. Individual controls for each input channel and a positioning control. The five tube transformer operated circuit utilizes two 6SJ7, two 6SN7, and one 6X5 tubes. Buy this kit and enjoy increased versatility of operation from your oscilloscope.

HEATH COMPANY • Benton Harbor 20, Mich.



Heathkit
VACUUM TUBE
VOLTMETER
KIT
MODEL V-6
\$24⁵⁰

SHIPPING WT. 6 LBS.

The beautiful Heathkit Model V-6 VTVM, the world's largest selling kit instrument, now offers many outstanding new features in addition to retaining all of the refinements developed and proven in the production of over 100,000 VTVM's. This is the basic measuring instrument for every branch of electronics. Easily meets all requirements for accuracy, stability, sensitivity, convenience of ranges, meter readability, and modern styling. It will accurately measure DC voltages, AC voltages, offers tremendous ohmmeter range coverage, and a complete db scale for a total of 35 meter ranges.

New 1½ volt full scale low range provides well over 2¼" of scale length per volt. Upper DC scale limit 1,500 volts. DC ranges 0-1.5, 5, 15, 50, 150, 500, 1,500 volts full scale. AC ranges 0-1.5, 5, 15, 50, 150, 500, 1,500 (1,000 volts maximum). Seven ohm-

meter ranges from .1 ohm to 1,000 megohms. For added convenience a DC polarity reversing switch and a center scale zero adjustment for FM alignment.

The smartly styled, compact, sturdy, formed aluminum cabinet is finished in an attractive gray crackle exterior. The beautiful two-color, durable, infra-red, baked enamel panel further adds to the over-all professional appearance.

Top quality components used throughout. 1% precision resistors — silver contact range and selector switches — selenium rectifier — transformer operated power supply. Individual calibration on both AC and DC for maximum accuracy. DB scale printed in red for easy identification, all other scales a sharp, crisp black for easy reading. A variety of accessory probes shown on this page still add further to over-all instrument usefulness.

Features

- ✓ New 1½ volt full scale low range
- ✓ 1,500 volt upper limit DC range
- ✓ Increased accuracy through 50% greater scale coverage
- ✓ High impedance 11 megohm input
- ✓ Center scale zero adjust
- ✓ Polarity reversal switch
- ✓ 1% precision resistors
- ✓ Clearly marked db scales

Heathkit 30,000 VOLT DC
PROBE KIT

For TV service work or any similar application where the measurement of high DC voltage is required, the Heathkit Model 336 High Voltage Probe Kit will prove invaluable. A precision multiplier resistor mounted inside the two-color, sleek, plastic probe body provides a multiplication factor of 100 on the DC ranges of the Heathkit 11 megohm VTVM. The entire kit includes precision resistor, two-color plastic probe, tip connector spring, test lead, phone plug panel connector, and complete assembly instructions.



No. 336

\$4⁵⁰

SHIP. WT.
2 LBS.

Heathkit AC VACUUM TUBE
VOLTMETER KIT

MODEL AV-2

\$29⁵⁰

SHIPPING WT.
5 LBS.



The new Heathkit AC VTVM that makes possible those sensitive AC measurements required by laboratories, audio enthusiasts, and experimenters. Especially useful for hum investigation, sensitive null detection, phono pick-up output measure-

ments, making frequency response runs, gain measurements, ripple voltage checks, etc. Low level measurements are easy to make because of the complete voltage coverage of the instrument and the one knob operation.

The large 200 microampere Simpson meter has clearly marked and easy to read meter scales. Ten voltage ranges covering from .01 rms full scale to 300 volts rms full scale, with frequency response ± 1 db from 20 cycles to 50,000 cycles. Instrument input impedance 1 megohm, ten db ranges from -52 db to +52 db. For stability and good linearity characteristics the meter bridge circuit features 4 germanium diodes. Attractive instrument styling, a companion piece for the popular Heathkit VTVM and the new AW-1 Audio Wattmeter.

No. 338-B

Heathkit PEAK-TO-PEAK
PROBE KIT

Now read peak-to-peak voltages on the DC scales of the Heathkit 11 megohm VTVM. Readings can be directly made from the VTVM scale without involved calculations. Measurements over the frequency range of 5 kc to 5 mc. Use this probe to extend the usefulness of your VTVM in radio and TV service work. The Peak-to-Peak Probe Kit features the new polished aluminum housing with two-color polystyrene probe ends. Detailed assembly sheet including instructions for probe operation.



\$5⁵⁰

SHIP. WT. 2 LBS.

Heathkit RF
PROBE KIT

The Heathkit RF Probe used in conjunction with any 11 megohm VTVM will permit RF measurements up to 250 mc, ± 10%. A useful, convenient accessory for those occasions when RF measurements are desired. The RF probe body is housed in the new, smartly-styled polished aluminum probe body featuring two-color polystyrene probe ends and a low capacity flexible shielded test lead. The kit is complete with all necessary material and a detailed assembly sheet as well as instructions for probe operation.



No. 309-B

\$3⁵⁰

SHIP. WT. 2 LBS.

HEATH COMPANY • Benton Harbor 20, Mich.

CHECK THESE *Features*

- ✓ 20,000 ohms per volt DC sensitivity, 5,000 ohms per volt on AC
- ✓ Polarity reversal switch
- ✓ 1% precision multiplier resistors
- ✓ 50 microampere 4½" Simpson meter
- ✓ Meter ranges for service convenience
- ✓ New resistor ring-switch assembly
- ✓ Total of 35 meter ranges
- ✓ New Modern cabinet styling

NEW *Heathkit* MULTIMETER KIT

MODEL MM-1

\$26.50

SHIPPING WT. 6 LBS.



The most important Heathkit announcement of the year, the new 20,000 ohms per volt Heathkit Multimeter, Model MM-1. The universal service measuring instrument, accurate, sensitive, portable, and completely independent of AC line supply. Particularly designed for service use incorporating many desirable features for the convenience of the service man. Full 20,000 ohms per volt sensitivity on DC ranges — 5,000 ohms per volt sensitivity on AC — polarity reversal switch, no bothersome transferring of test leads — 1% precision multiplier resistors — large 4½" recessed non-glare 50 microampere Simpson meter — conveniently slanted control panel — recessed safety type banana jacks — standard universally available batteries — rugged practical sized cabinet with plastic carrying handle, and a total of 35 calibrated meter ranges.

RANGES

Voltage ranges selected entirely for service convenience. For example 1½ volt full scale low range for measuring portable radio filament voltages, bias voltages, etc., 150 volt full scale range for AC-DC service work, 500 volt full scale range for conventional transformer operated power supply systems. Complete voltage ranges AC and DC, 0-1.5—5—50—150—500—1,500—5,000 volts. DC current ranges, 0-150 microamperes—15 milliamperes—150 milliamperes—500 milliamperes—15 amperes. Resistance measurements from .2 ohms to 20 meg-

ohms x 1 x 1,000 x 10,000.
DB coverage from -10 db
to +65 db.

CONSTRUCTION

Entirely new design permits assembly, mounting and wiring of precision resistors on a ring-switch assembly unit. The major portion of instrument wiring is completed before mounting the ring-switch assembly to the panel. No calibration procedure is required, all precision resistors readily accessible in event of replacement.

CABINET

Strikingly modern cabinet styling featuring two piece construction, durable black Bakelite cabinet, with easy to read panel designations. Cabinet size 5½" wide x 4" deep x 7½" high. Good cabinet physical stability when operated in vertical position.

The Heathkit MM-1 represents a terrific instrument value for a high quality 20,000 ohms per volt unit using all 1% deposited carbon type precision resistors. Here is quality, performance, functional design, and attractive appearance, all combined in one low priced package.

Heathkit BATTERY TESTER KIT



MODEL BT-1
\$8.50
SHIP. WT.
2 LBS.

The Heathkit Battery Tester measures all types of dry batteries between 1½ volts and 150 volts under actual load conditions. Readings are made directly on a three color Good-Weak-Replace scale. Operation is extremely simple and merely requires that the test leads be connected to the battery under test. Only one control to adjust in addition to a panel switch for "A" or "B" battery types. The Heathkit Battery Tester features compact assembly, accurate meter movement, and a three deck wire-wound control, all mounted in a portable rugged plastic cabinet. Checks portable radio batteries, hearing aid batteries, lantern batteries, etc.

Heathkit HANDITESTER KIT



MODEL M-1
\$14.50
SHIPPING WT.
3 LBS.

The Heathkit Model M-1 Handitester readily fulfills major requirements for a compact, portable volt ohm milliammeter. Despite its compact size, the Handitester is packed with every desirable feature required in an instrument of this type. AC or DC voltage ranges full scale, 0-10—30—300—1,000—5,000 volts. Two ohmmeter ranges, 0-3,000 and 0-300,000. Two DC current measurement ranges, 0-10 milliamperes and 0-100 milliamperes. The instrument uses a Simpson 400 microampere meter movement, which is shunted with resistors to provide a uniform 1 milliamper load on both AC and DC ranges. Special type, easily accessible, battery mounting bracket — 1% deposited carbon type precision resistors — hearing aid type ohms adjust control. The Handitester is easily assembled from complete instructions and pictorial diagrams. Necessary test leads are included in the price of this popular kit.

HEATH COMPANY • Benton Harbor 20, Mich.

New *Heathkit* 12 Volt BATTERY ELIMINATOR KIT



MODEL BE-4

\$31⁵⁰SHIPPING WT.
18 LBS.

CHECK THESE *Features*

- ✓ Either 6 or 12 volt operation
- ✓ Continuously variable voltage output
- ✓ Constant ammeter and voltmeter monitoring
- ✓ Automatic overload relay — self-resetting
- ✓ Two 10,000 mf condensers
- ✓ New 18 disc split type heavy duty rectifier unit
- ✓ Fuse protection

Here is the new Heathkit Battery Eliminator necessary for modern, up-to-date operation of your service shop. The Heathkit Model BE-4 furnishes either 6 volts or 12 volts output which can be selected at the flick of a panel switch. Use the BE-4 to service the new 12 volt car radios in addition to the conventional 6 volt radios.

This new Battery Eliminator provides two continuously variable output ranges, 0-8 volts DC at 10 amperes continuously, or 15 amperes maximum intermittent; 0-16 volts DC at 5 amperes continuously or 7.5 amperes maximum intermittent. The output voltage is clean and well filtered as the circuit uses two 10,000 mf condensers. The continuously variable voltage output feature is a definite aid in determining the starting point of vibrators, the voltage operating range of oscillator circuits, etc. Panel mounted meters constantly monitor voltage and cur-

rent output and will quickly indicate the presence of a major circuit fault in the equipment under test. The power transformer primary winding is fuse protected and for additional safety an automatic relay of the self-resetting type is incorporated in the DC output circuit. The heavy duty rectifier is a split type 18 plate magnesium copper sulfide unit used either as a full wave rectifier or voltage doubler according to the position of the panel range switch.

Here is the ideal battery eliminator for all of your service problems and as an additional feature, it can also be used as a battery charger. Another new application for the Heathkit Battery Eliminator is a variable source of DC filament supply in audio development and research. More than adequate variable voltage and current range for normal applications.

Heathkit VIBRATOR TESTER KIT

Your repair time is valuable, and service use of the Heathkit Vibrator Tester will save you many hours of work. This tester will instantly tell you the condition of the vibrator being checked. Checks vibrators for proper starting and the easy to read meter indicates quality of output on a large Bad-?-Good scale. The Heathkit VT-1 checks both interrupter and self rectifier types of vibrators. Five different sockets for checking hundreds of vibrator types.

The Heathkit Vibrator Tester operates from any battery eliminator capable of delivering continuously variable voltage from 4 to 6 volts DC at 4 amperes. The new Heathkit Model BE-4 Battery Eliminator would be an ideal source of supply.

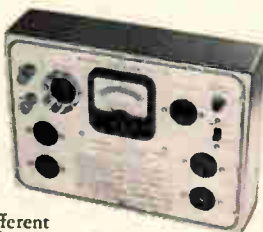

MODEL VT-1

\$14⁵⁰SHIPPING WT.
6 LBS.

NEW *Heathkit* VARIABLE VOLTAGE ISOLATION TRANSFORMER KIT

The new Heathkit Isolation Transformer Kit provides line isolation for AC-DC radios (not an auto transformer), thereby eliminating shock hazard, hum problems, alignment difficulties, etc. The output voltage is variable from 90 to 130 volts AC and is constantly monitored by a panel mounted AC volt meter. Use it to increase AC supply voltage in order to induce breakdown of faulty components in circuits thereby saving service time. Use it also to simulate varying line voltage conditions and to determine the line voltage level at which oscillator circuits cease functioning, particularly in three-way portable radios. Rated at 100 watts continuous operation and up to 200 watts maximum intermittent operation. A useful radio and TV service tool.



MODEL IT-1

\$16⁵⁰

SHIP. WT. 9 LBS.

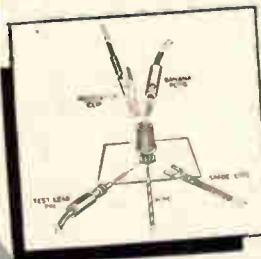

Heathkit BINDING POST

Binding post kit now available so that standardization of all instrument connectors is possible. This new, five-way binding post will accommodate an alligator clip, banana plug, test lead pin, spade lug, or hook-up wire. Sold in units of 20 binding post assemblies. Each assembly includes binding post, flat and shoulder fiber washers, solder lug, and nut. 120 pieces in all. Kit 362, \$4.00.



Heathkit TECHNICAL

APPLICATION BULLETINS

An exclusive Heathkit service. Technical application bulletins prepared by recognized instrument authorities outlining various combinations of instrument applications. Available now with 40 four-page illustrated bulletins and an attractive flexible loose-leaf binder. Only \$2.00. (No c.o.d. on this item, please.)

HEATH COMPANY • Benton Harbor 20, Mich.

CHECK THESE *Features*

- ✓ INCREDUCTOR controllable inductor sweep
- ✓ TV and IF sweep deviation 12-30 mc
- ✓ 4 mc- 220 mc continuous frequency coverage
- ✓ Oscillator operation entirely on fundamentals
- ✓ Output in excess of 100,000 microvolts
- ✓ Automatic amplitude circuit
- ✓ Voltage regulation
- ✓ Simplified operation

NEW *Heathkit*
**TV ALIGNMENT
 GENERATOR
 KIT**

MODEL TS-3

\$44.50SHIPPING WEIGHT
18 POUNDS

Proudly announcing an entirely new, advanced model TV and FM Sweep Generator, the Heathkit Model TS-3. This new design provides features and combinations of functions not found in any other service type instrument. Every design consideration has been given to the requirements of the TV service man to provide a flexible, variable sweep source with more than adequate RF output and complete frequency coverage throughout the TV and FM spectrum.

The frequency range of the TS-3 is from 4 mc to 220 mc in four switch selected ranges. All frequency ranges are overlapping for complete coverage. A particularly important feature of the instrument is that the oscillator operates entirely on fundamentals, thereby providing complete freedom from spurious oscillation and parasitics normally encountered in beat frequency type oscillators. This circuitry assures a much higher total RF output level and simplifies attenuation problems.

The new TS-3 features an entirely new principle of sweep operation. Sweep action is entirely electronic with no moving parts or electro-mechanical devices so commonly used. The heart of the sweep system is a newly-developed INCREDUCTOR controllable inductor. With this system, the value of inductance of each oscil-

lator coil is electrically varied with an AC control current, and the inductance variation is achieved by a change in the magnetic state of the core on which the oscillator coils are wound. This system provides a sweep deviation of not less than 12 mc on all TV frequencies, and up to a maximum of 30 mc on TV IF frequencies. The high RF output level throughout the instrument frequency range overcomes the most common complaint of the older type sweep generators. A new, automatic amplitude control circuit maintains the output level flat to ± 2 db throughout the instrument range. For convenience of operation a low impedance 50 ohm output is used.

Operation of the instrument has been simplified through the reduction of panel controls and separate panel terminals provide for external synchronization if desired. The circuit uses a voltage regulator tube to maintain stable instrument operation. A built-in variable oscillator marker further adds to flexibility of instrument operation. Provisions are also made for the use of an external marker, such as your service type signal generator, if desired. Use the Heathkit TS-3 for rapid, accurate TV alignment work, and let it help you solve those time consuming, irksome problems so frequently encountered.

NEW *Heathkit*
SIGNAL GENERATOR KIT

MODEL SG-8

\$19.50SHIPPING WEIGHT
8 POUNDS

Announcing the new Heathkit Model SG-8 service type Signal Generator, incorporating many design features not usually found in an instrument in this price range. The RF

output is from 160 kc to 100 mc in five ranges, all on fundamentals, with useful harmonics up to 200 mc. The RF output level is in excess of 100,000 microvolts throughout the frequency range.

The oscillator circuit consists of a 12AT7 twin triode tube. One half is used as a Colpitts oscillator, and the other half as a cathode follower output which acts as a buffer between the oscillator and external load. This circuitry eliminates oscillator frequency shift usually caused by external circuit loading.

All coils are factory wound and adjusted, thereby completely eliminating the need for calibration and the use of additional calibrating equipment. The stable low impedance output features a step and variable attenuator for complete control of RF level. A 6C4 triode acts as a 400 cycle sine wave oscillator and a panel switching system permits a choice of either external or internal modulation.

The transformer operated circuit is easy to assemble, requires no calibration, and meets every service requirement for an adjustable level variable frequency signal source, either modulated or un-modulated.

NEW *Heathkit*
BAR GENERATOR KIT

MODEL BG-1

\$14.50SHIPPING WEIGHT
6 POUNDS

The Heathkit BG-1 Bar Generator represents another welcome addition to the fast growing line of popular Heathkits. The

station transmitted test pattern is rapidly disappearing, and the bar generator is the logical answer to the TV service man's problem in obtaining quick, accurate adjustment information without waiting for test patterns.

The Heathkit BG-1 produces a series of horizontal or vertical bars on a TV screen. Since these bars are equally spaced, they will quickly indicate picture linearity of the receiver under test. Panel switch provides "stand-by position" — "horizontal position" — "vertical position." The oscillator unit utilizes a 12AT7 twin triode for the RF oscillator and video carrier frequencies. A neon relaxation oscillator provides low frequency for vertical linearity tests. The instrument will not only produce bar patterns but will also provide an indication of horizontal and vertical sync circuit stability, as well as overall picture size.

Instrument operation is extremely simple, and merely requires connection to the TV receiver antenna terminal. The unit is transformer operated for safety when used in conjunction with universal or transformerless type TV circuits.

HEATH COMPANY • Benton Harbor 20, Mich.



NEW *Heathkit* TUBE CHECKER KIT

MODEL TC-2

\$295.00

SHIP. WT. 12 LBS.

The new Model TC-2 Heathkit Tube Checker features many circuit improvements, simplified wiring, new roll chart drive and illumination of roll chart. This instrument is primarily designed for the convenience of the radio and TV service man and will check the operating quality of tubes commonly encountered in this type of work. Test set-up procedure is simplified, rapid, and flexible. Panel sockets accommodate 4, 5, 6, and 7 pin tubes, octal and loctal, 7 and 9 pin miniatures, 5 pin Hytron and a blank socket for new tubes. Built-in neon short indicator, individual three-position lever switch for each tube element, spring return test switch, 14 filament voltage ranges, and line set control to compensate for supply voltage variations, all represent important design features of the TC-2. Results of tube tests are read directly from a large 4½" Simpson three-color meter, calibrated in terms of Bad?-Good. Information that your customer can readily understand. Checks emission, shorted elements, open elements, and continuity.

The use of closer tolerance resistors in critical circuits assures correct test information and eliminates the possibility of inaccurate test interpretation. Improvement has been made in the mechanical roll chart drive system, completely eliminating diagonal running, erratic operation, and backlash. The thumb wheel gear driven action is smooth, positive, and free running. As an additional feature, the roll chart is illuminated for easier reading, particularly when the tube checker is used on radio or TV home service calls.

Wiring procedure has been simplified through the extended use of multi-colored, color coded wires, providing a harness type installation between tube sockets and lever switches. This procedure insures standard assembly and imparts that "factory built" appearance to instrument construction. Completely detailed information is furnished in the new step-by-step construction manual, regarding the set-up procedure for testing of new or unlisted tube types. No delay necessary for release of factory data.

The new Heathkit Tube Checker will prove its value in building service prestige through usefulness—simplified operation—attractive professional appearance. Don't overlook the fact that the kit price represents a savings of \$40.00 to \$50.00 over the price of a comparable commercially built instrument. At this low price, no service man need be without the advantages offered by the Heathkit Tube Checker.

CHECK THESE NEW *Features*

- ✓ Simplified harness wiring
- ✓ Improved, smooth, anti-backlash roll chart action
- ✓ Optional roll chart illumination
- ✓ Individual element switches
- ✓ Portable or counter style cabinet
- ✓ Spare blank socket
- ✓ Contact type pilot light test socket
- ✓ Simplified test set-up procedure
- ✓ Line adjust control
- ✓ 4½" three-color meter

New

HEATHKIT PORTABLE TUBE CHECKER KIT

MODEL TC-2P

\$345.00

SHIP. WT. 14 LBS.



The portable model is supplied with a strikingly attractive two-tone cabinet finished in rich maroon, proxylin impregnated, fabric covering with a contrasting gray on the inside cover. Detachable cover, brass-plated hardware, sturdy plastic handle help to impart a truly professional appearance to the instrument.

PORTABLE TUBE CHECKER CABINET as described above will fit all earlier Heathkit TC-1 Tube Checkers. Shipping weight 7 lbs. Cabinet only, 91-8, \$75.00.



No. 355 **\$45.00**
Ship. Wt. 1 lb.

Heathkit TV PICTURE TUBE TEST ADAPTER

The Heathkit TV Picture Tube Test Adapter used with the Heathkit Tube Checker will quickly check for emission, shorts, etc., and determine picture tube quality. Consists of standard 12 pin TV tube socket, four feet of cable, octal socket connector, and data sheet.

Heathkit POWER SUPPLY KIT



MODEL PS-2

\$335.00SHIPPING WT.
17 LBS.

The Heathkit Laboratory Power Supply features continuously variable, regulated voltage output with good stability under wide load variations. A 4½" Simpson plastic enclosed panel mounted meter provides accurate meter output information of voltage or current. All panel terminals completely isolated from the cabinet. Separate 6.3 volt AC supply at 4 amperes for filament requirements. Ripple component exceptionally low, stand-by switch provided to eliminate warm-up time of the five tube circuit.



LABORATORY AND SERVICE SHOP BOOKLETS

"Planning Your Service Business" by John T. Frye, and "Establishing the Industrial Electronics Laboratory" by Louis B. Garner, Jr., are booklets available to Heathkit customers at no charge. These booklets, written by nationally recognized authorities, outline the various requirements and considerations for establishing your own service business or for setting up an industrial electronics laboratory. Full attention is given to various details that are frequently overlooked when projects of this nature are undertaken. Just write in to the Heath Company requesting your free copy, or attach a memo to your next order.

HEATH COMPANY • Benton Harbor 20, Mich.

CHECK THESE *Features*

- ✓ Visual and aural signal tracing
- ✓ Two channel input
- ✓ High RF sensitivity
- ✓ Unique noise locator circuit
- ✓ Calibrated wattmeter
- ✓ Substitution test speaker
- ✓ Utility amplifier
- ✓ RF, audio probes and test leads included

Heathkit VISUAL-AURAL SIGNAL TRACER KIT

MODEL T-3

\$23⁵⁰SHIPPING WEIGHT
10 POUNDS

An entirely new type of signal tracer incorporating a combination of features not found in any other instrument. Designed expressly for the radio and TV service man, particularly for the servicing of AM, FM, and TV circuits. Here in a five tube, transformer operated instrument are all of the useful functions so necessary for speedy, accurate isolation of service difficulty.

This new signal tracer features a special high gain RF input channel, used in conjunction with a newly-designed wide frequency range demodulator probe. High RF sensitivity permits signal tracing at the receiver antenna input. A separate low gain channel and probe available for audio circuit exploration. Both input channels are constantly monitored by an electron ray beam indicator, so that visual as well as aural signal indications may be observed. The instrument can also be used for comparative estimation of gain per stage.

A decidedly unusual feature is a noise localizer circuit in conjunction with the audio probe. With this system, a DC potential is applied to a suspected circuit component and the action of the

voltage in the component can be seen as well as heard. Invaluable for ferreting out noisy or intermittent condensers, noisy resistors, controls, coils, IF and power transformers, etc. A built-in calibrated wattmeter circuit is very useful for a quick preliminary check of the total wattage consumption of the equipment under test. Separate panel terminals provide external use of the speaker or output transformer for substitution purposes. Saves valuable service time by eliminating the necessity for speaker removal on every service job. The terminals also permit the utilization of other shop equipment, such as your oscilloscope or VTVM. The T-3 Signal Tracer can be used as a high gain amplifier for checking tuners, record changers, microphones, phono crystals, etc.

Don't overlook the interesting service possibilities provided through the use of this new instrument and let it work for you by saving time and money. The kit is supplied complete with all tubes, circuit components, demodulator probe, audio probe, and additional test leads.



Heathkit DECADE RESISTANCE KIT

MODEL DR-1

\$19⁵⁰SHIP. WT.
4 LBS.

The Decade Resistance Kit provides individual switch selection of resistance values using twenty 1% resistors providing a choice of 1 to 99,999 ohms in 1 ohm steps. Ceramic wafer switches, silver-plated contacts, smooth, positive detent action, baked enamel panel, and handsome, polished birch cabinet.

Heathkit DECADE CONDENSER KIT

The Heathkit Decade Condenser Kit features silver mica, precision condensers with a rated accuracy of $\pm 1\%$. Capacity values are arranged in three decades from 100 mmf to .111 mf in steps of 100 mmf. Ceramic wafer switches with silver-plated contacts and smooth detent action. Useful in laboratory work, for circuit development.

MODEL DC-1

\$16⁵⁰SHIP WT
4 LBS.

Heathkit RESISTANCE SUBSTITUTION BOX KIT

MODEL RS-1

\$5⁵⁰SHIP. WT.
2 LBS.

The Heathkit Resistance Substitution Box provides individual switch selection of any one of 36 RTMA 1 watt 10% standard value resistors, ranging from 15 ohms to 10 megohms. Many applications in circuit development work, and also in radio and TV service work. Ideal for experimentally determining resistance values and for quickly altering circuit operating characteristics. Entire unit housed in attractive Bakelite cabinet, featuring the new universal type Heathkit binding posts to simplify circuit connections.



Heathkit CONDENSER CHECKER KIT

MODEL C-3

\$19⁵⁰SHIPPING WT.
8 POUNDS

Use the Heathkit C-3 Condenser Checker to quickly and accurately measure those unknown condenser and resistor values. All readings are taken directly from the calibrated panel scales without requiring any involved calculation. Capacity measurements in four ranges from .00001 mf to 1,000 mf. Checks paper, mica, ceramic, and electrolytic condensers. A power factor control is available for accurate indication of electrolytic condenser measurements. A leakage test switch with switch selection of five polarizing voltages, 25 volts to 450 volts DC, will indicate condenser operating quality under actual load condition. The spring return leakage test switch automatically discharges the condenser under test and eliminates shock hazard to the operator.

Resistance measurements can be made in the range from 100 ohms to 5 megohms. Here again all values are read directly on the calibrated scale. Increased circuit sensitivity coupled with an electron beam null indicator increases overall instrument usefulness.

For safety of operation the circuit is entirely transformer operated and the instrument is housed in the attractive, newly-styled Heathkit cabinet, featuring rounded corners, and drawn aluminum panel. The outstanding low kit price for this surprisingly accurate instrument includes necessary test leads. Good service shop operation requires the use of this specialized instrument, designed for the express purpose of determining unknown condenser values and operating characteristics.

HEATH COMPANY • Benton Harbor 20, Mich.



Heathkit AMATEUR TRANSMITTER KIT

MODEL AT-1
\$29.50

SHIPPING WEIGHT
16 POUNDS

CHECK THESE NEW Features

- ✓ Single knob band switching
- ✓ Pre-wound coils
- ✓ Metered operation
- ✓ 52 ohm coaxial output
- ✓ Crystal or VFO excitation
- ✓ Built-in power supply
- ✓ Rugged, clean construction

Here is the latest Heathkit addition to the ham radio field, the AT-1 Transmitter Kit, incorporating many desirable design features at the lowest possible dollar-per-watts price. Panel mounted crystal socket, stand-by switch, key click filter, AC line filtering, good shielding, etc. VFO or crystal excitation — up to 35 watts input. Built-in power supply provides 425 volts at 100 ma.

This kit features pre-wound coils, single knob band switching, 52 ohm coaxial output, plug in chassis provisions for VFO or modulator and rugged clean construction. Frequency range 80, 40, 20,

15, 11, and 10 meters. Tube line-up 6AG7 oscillator-multiplier, 6L6 amplifier-doubler, 5U4G rectifier. Physical dimensions 8 1/8" high x 13 1/8" wide x 7" deep.

This amazingly low kit price includes all circuit components, tubes, cabinet, punched chassis, and detailed construction manual. The ideal kit for the novice just breaking into ham radio. It can be used later on as a stand-by rig or an all band exciter for higher powered transmitter.

NEW Heathkit ANTENNA COUPLER KIT

New Heathkit Antenna Coupler, specially designed for the Heathkit AT-1 Transmitter. The Antenna Coupler can be used with any 52 ohm coaxial input — up to 75 watts power. Low pass filter with cut-off frequency of approximately 36 mc — L section tuning network — neon tuning indicator — rugged, compact construction — transmitter type variable condenser, and high Q coil are all outstanding features. The AC-1 has both inductance and capacity tuning for maximum operating versatility. Dimensions 8 1/8" wide x 4 3/8" high x 4 7/8" deep.



MODEL AC-1

\$14.50 SHIP. WT. 3 LBS.

Heathkit ANTENNA IMPEDANCE METER

Use the Heathkit Antenna Impedance Meter for measuring antenna impedance for line matching purposes — adjustment of beam antennas — phone monitor, etc. It will determine antenna resistance at resonance, match transmission line for minimum SWR, determine receiver input impedance, and provide a rough indication of SWR. Precision resistors, germanium diode, 100 micro-ampere Simpson meter. Dial calibrated from 0-500 ohms. Shielded aluminum cabinet, 7" long x 2 1/2" wide x 3 1/4" deep.



MODEL AM-1

\$14.50

SHIP. WT. 3 LBS.

Heathkit COMMUNICATIONS RECEIVER KIT

MODEL AR-2

\$25.50 SHIP. WT. 12 LBS.



Here is the new receiver kit you have repeatedly asked for, the Heathkit Communications Receiver. The perfect companion piece for the AT-1 Transmitter kit. Many outstandingly desirable features have been incorporated in the design of the AR-2; such as, electrical bandspread

for logging and tuning convenience — high gain miniature tubes — IF transformers for high sensitivity and good signal to noise ratio — separate RF gain control with optional automatic volume control or manual volume control, in addition to the conventional audio gain control. Noise limiter — stand-by switch — stable BFO oscillator circuit — headphone jack — transformer operation, etc., all contribute to a high performance standard.

Frequency coverage is continuous from 535 kc to 35 mc in four ranges. For added convenience, various ham bands have been separately identified in respect to their relative placement on the slide rule tuning scale. A chassis mounted, 5 1/2" PM speaker is included with this kit. Tube line up 12BE6 mixer oscillator, 12BA6 IF amplifier, 12AV6 detector AVC audio, 12BA6 BFO oscillator, 12A6 beam power output, 5Y3GT rectifier.

RECEIVER CABINET

Proxilyn impregnated, fabric covered, plywood cabinet with aluminum panel designed expressly for the AR-2 Receiver. Part 91-10, shipping weight 5 lbs., \$4.50.

IMPROVED Heathkit GRID DIP METER KIT

\$19.50 SHIP. WT. 4 LBS.



MODEL GD-1B

The invaluable instrument for service men, hams, and experimenters. Useful in TV service work for alignment of traps, filters, IF stages,

peaking compensation networks, etc. Locates spurious oscillation, provides a relative indication of power in transmitter stages, use it for neutralization, locating parasitics, correcting TVI, measuring C, L, and Q of components, and determining RF circuit resonant frequencies. With oscillator energized, useful for finding resonant frequency of tuned circuits. With the oscillator not energized, the instrument acts as an absorption wave meter. Variable meter sensitivity control, head phone jack, 500 microampere Simpson meter. Continuous frequency coverage from 2 mc to 250 mc. Pre-wound coil kit and rack, new three prong coil mounting, 6AF4 high frequency triode.

Two additional plug-in coils are available and provide continuous extension of low frequency coverage down to 355 kc. Dial correlation curves included. Shipping weight 1 lb., kit 341, \$3.00.



HEATH COMPANY • Benton Harbor 20, Mich.

CHECK THESE *Features*

- ✓ First popular priced Q Meter
- ✓ Reads Q directly on calibrated scale
- ✓ Oscillator supplies RF frequencies of 150 kc to 18 mc
- ✓ Calibrate capacitor with range of 40 mmf to 450 mmf with vernier of ± 3 mmf
- ✓ Measures Q of condensers, RF resistance, and distributed capacity of coils
- ✓ Many applications in design and development work
- ✓ Useful in TV service work for checking deflection yokes, coils, chokes, etc.

Heathkit "Q" METER KIT

MODEL QM-1

\$44.50

SHIPPING WT. 14 POUNDS

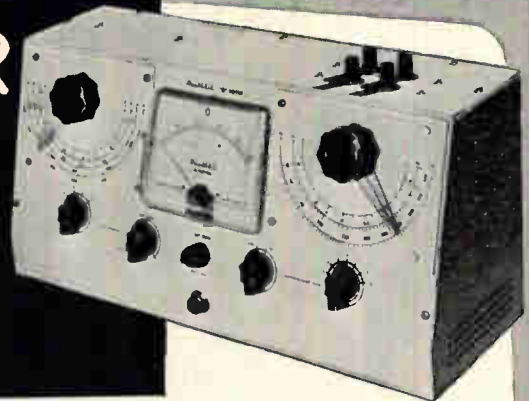

Another outstanding example of successful Heathkit engineering effort in producing a Q Meter Kit within the price range of TV service men, schools, laboratories, and experimenters. This Q Meter meets RF design requirements for rapid, accurate measurement of capacity, inductance, and Q at the operating frequency and all indications of value can be read directly on the meter calibrated scales. Oscillator section supplies RF fre-

quencies of 150 kc to 18 mc. Calibrate capacitor with range of 40 mmf to 450 mmf, with vernier of ± 3 mmf.

Particularly useful in TV service work for checking peaking coils, wave traps, chokes, deflection coils, width and linearity coils, etc. At this low kit price research laboratory facilities are within the range of service shops, schools, and experimenters.

Heathkit INTERMODULATION ANALYZER KIT



MODEL IM-1

\$39.50SHIPPING WT.
17 POUNDS

The Heathkit IM-1 is an extremely versatile instrument specifically designed for measuring the degree of inter-action between two signals in any portion of an audio chain. It is primarily intended for making tests of audio amplifiers, but may be used in other applications, such as checking microphones, records, recording equipment, phonograph pick-ups, and loud-speakers. High and low test frequency source, intermodulation unit, power supply, and AC vacuum tube volt meter all in one complete instrument. Per cent intermodulation is directly read on the calibrated scales, 30%, 10%, and 3% full scale. Both 4:1 and 1:1 ratios of low to high frequency easily set up. With this instrument the performance level of present equipment, or newly developed equipment can be easily and accurately checked. At this low price, you can now enjoy the benefits of intermodulation analysis for accurate audio interpretation.

Heathkit AUDIO GENERATOR KIT

A Heathkit Audio Generator with frequency coverage from 20 cycles to 1 mc. Response flat ± 1 db from 20 cycles to 400 kc, down 3 db at 600 kc, and down only 8 db at 1 mc. Calibrated, continuously variable, and step attenuator output controls provide convenient reference output level. Distortion is less than .4% from 100 cps through the audible range. The ideal controllable extended frequency sine wave source for audio circuit investigation and development.

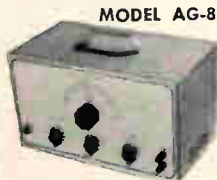
**\$29.50**

SHIP. WT. 11 LBS.

Heathkit AUDIO OSCILLATOR KIT

Sine or square wave coverage from 20 to 20,000 cycles in three ranges at a controllable output level up to 10 volts. Low distortion, 1% precision resistors in multiplier circuits, high level output across entire frequency range, etc., readily qualify this instrument for audio experimentation and development work. Special circuit design consideration features thermistor operation for good control of linearity.



MODEL AO-1

\$24.50

SHIP. WT. 11 LBS.

Heathkit AUDIO FREQUENCY METER KIT



MODEL AF-1

\$34.50

SHIP. WT. 12 LBS.

The Heathkit Audio Frequency Meter provides a simple and convenient means of checking unknown audio frequencies from 10 cycles to 100 kc at any voltage level between 3 and 300 volts rms with any non-critical wave shape.

Instrument operation is entirely electronic. Just set the range switch, feed an unknown frequency into the instrument, and read the frequency directly on the calibrated scale of the Simpson $4\frac{1}{2}$ " meter.

Heathkit SQUARE WAVE GENERATOR KIT



MODEL SQ-1

\$29.50

SHIP. WT. 12 LBS.

The Heathkit Square Wave Generator provides an excellent square wave frequency source with completely variable coverage from 10 cycles to 100 kc. This generator features low output impedance of 600 ohms and the output voltage is continuously variable between 0 and 20 volts, thereby providing the necessary degree of operating flexibility. An invaluable instrument for those specialized circuit investigations requiring a good, stable, variable square wave source.

HEATH COMPANY • Benton Harbor 20, Mich.



Heathkit WILLIAMSON TYPE AMPLIFIER KIT

MODEL W-2

Particularly designed for custom installations, featuring separate cable connected units for simplicity of installation. Sheet metal work finished in attractive gray hammer-tone for smart appearance. All control shafts of the adjustable length break-off type.

\$69.50

PRICES OF COMBINATIONS

W-2 Amplifier Kit including main amplifier, power supply, and WA-P1 Preamplifier Kit. Shipping Weight 37 lbs. Shipped Express only. **\$69.50**

W-2M Amplifier Kit includes main amplifier and power supply. Shipping Weight 29 lbs. Shipped Express only. **\$49.75**

WA-P1 Preamplifier Kit only. Shipping Weight 6 lbs. Shipped Express or Parcel Post. **\$19.75**

When selecting an amplifier for the heart of your high fidelity audio system, investigate the outstanding advantages offered by the Heathkit Williamson Type Amplifier. Meets every high fidelity audio requirement and makes listening to recorded music a thrilling new experience.

This outstanding amplifier is offered with optional output transformer

operation, providing either the conventional triode output circuit or the new extended power circuitry in which the screen supply voltage is obtained from separate transformer primary taps. Frequency response within ± 1 db from 10 cycles to 100 kc. Tube complement — 6SN7 cascade amplifier and phase splitter, 6SN7 push pull driver, two 5881 push pull power amplifiers, one 5Y4G cathode type rectifier.

Matching preamplifier available providing three switch selected inputs, correct compensation, and individual bass and treble tone controls. Uses 12AY7 (or 12AX7) preamplifier — 12AU7 tone control amplifier.

Particularly designed for the novice kit builder and requires no specialized knowledge or equipment for successful assembly and operation.

NEW Heathkit 20 WATT High Fidelity AMPLIFIER KIT

MODEL A-9A



\$35.50

SHIP. WT. 18 LBS.

A new 20 watt high fidelity amplifier, designed especially for custom audio installations demanding clean reproduction, adequate power, and flexibility to meet individual requirements. Separate treble and bass tone controls provide up to 15 db boost or cut. Four switch selected inputs, each with the necessary compensation for the service desired. Output transformer impedances of 4, 8, and 16 ohms.

Preamplifier, tone control, and phase splitter circuits utilize 9 pin twin triode miniature tubes for low hum and noise level. Two 6L6 push pull power output tubes provide full 20 watts power. Frequency response ± 1 db, 20-20,000 cycles. Total harmonic distortion 1% (at 3 db below rated output). Tube line-up: 12AX7 preamplifier, 12AU7 voltage amplifier and tone control, 12AU7 voltage amplifier and phase splitter, two 6L6 push pull pentode power output, 5U4G rectifier. Truly outstanding amplifier performance coupled with low cost.

Heathkit ECONOMY 6 WATT AMPLIFIER KIT



MODEL A-7B

\$15.50

SHIP. WT. 10 LBS.

The new Heathkit Model A-7B Amplifier offers many unusually fine features not normally expected in this low price range. Either of the two input circuits may be individually switch selected for phono or tuner operation. Separate bass and treble tone controls. Output impedances of 4, 8, and 15 ohms. Push pull beam power output stage for balanced reproduction. Excellent voltage gain characteristics, good frequency response, and full 6 watts power output. 12J5 amplifier, 12SL7 second amplifier and phase splitter, two 12A6 beam power output, one 5Y5 GT rectifier.

A-7C incorporates preamplifier stage with special compensated network to provide necessary gain for operation with variable reluctance or low output level phono cartridge. Circuit is properly compensated for microphone operation. \$17.50.

NEW Heathkit BROADCAST BAND RECEIVER KIT

Another new Heathkit for the student, beginner, or hobbyist. If you have ever had the urge to build your own radio receiver, this kit warrants your attention.

New high gain miniature tubes and IF transformers provide excellent sensitivity and good signal to noise ratio. A built-in ferrite core rod type antenna has been provided. A chassis mounted $5\frac{1}{2}$ " PM speaker provides excellent tone and volume. Convenient phono input. Can be operated either as a receiver or tuner. Simplified construction manual outlines circuit theory. Ideal for students. Tube line-up: 12BE6 mixer oscillator, 12BA6 IF amplifier, 12AV6 detector-AVC-first audio, 12A6 beam power output, 5Y3GT rectifier.



MODEL BR-2

\$17.50 SHIP. WT. 11 LBS.

CABINET — Proxylin impregnated fabric covered plywood cabinet. Shipping weight 5 lbs. Part number 91-9, \$4.50.

Heathkit FM TUNER KIT

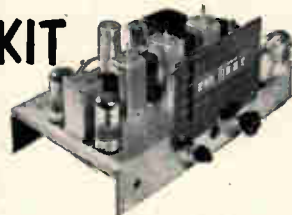

MODEL FM-2

\$22.50

SHIP. WT. 9 LBS.

The Heathkit FM-2 Tuner was specifically designed for simplified kit construction. Can be operated through the "phono" portion of your radio or with a separate amplifier. The kit features a pre-assembled and adjusted tuning unit, three double tuned IF transformers, and a discriminator transformer in an 8 tube AC operated circuit. Frequency coverage 88 to 108 mc. Experience the thrill of building your own FM tuner and at the same time enjoy all of the advantages of true FM reception.

Free CATALOG

Write for free catalog containing latest price information, schematics, specifications, and descriptions of all Heathkits.

HEATH COMPANY • Benton Harbor 20, Mich.

Simple Tubeless Photo Timer

With no critical parts involved, this timer is both durable and accurate

By KAI M. KLEMM

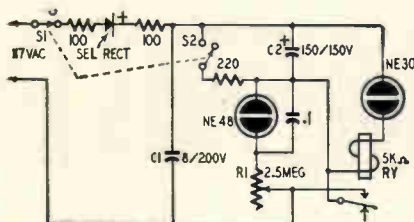

Above schematic shows electrical layout of simple tubeless photo timer at right.

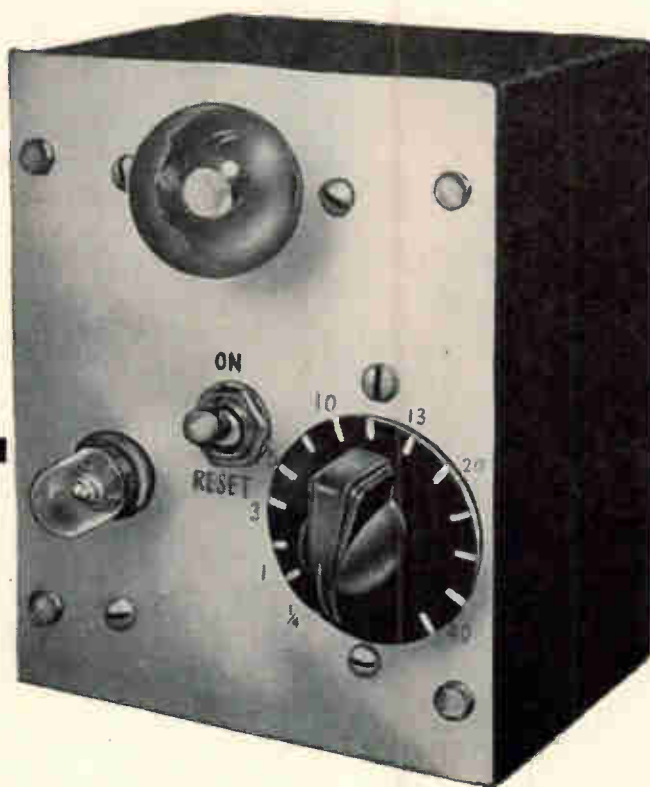

A TIMER of one sort or another has always been a useful piece of equipment in the darkroom, on the experimenter's workbench, or even in the XYL's kitchen. Mechanical timers have always had the disadvantage of having to be wound up for each new timing period. Most electronic timers use 117-volt dual-purpose tubes with some kind of capacitor charging system in the grid circuit, and a plate relay in the plate circuit. The disadvantage of these timers is that the tubes are expensive and operate rather hot. So, if used in a small case, the life of the tubes and components is very much shortened.

With those points in mind I wondered if it would be possible to build a timer using as the heart of the unit a 1-watt neon bulb. A neon bulb is an open circuit until its ionizing voltage is reached. Then it conducts. After many trials and errors the circuit above was developed. The operation of the circuit is:

Switch S1 and S2 is a double-pole double-throw switch wired so that S1 is closed and S2 is open when the switch is thrown in one direction and S1 is open and S2 is closed when thrown the other way. When S1 is closed, 117 volts a.c. is

applied to the selenium rectifier. C1 is an 8- μ f, 200-volt, electrolytic capacitor which filters the half-wave d.c. C2 is a 150- μ f, 150-volt, electrolytic capacitor. (I used a 3-section 50-50-50- μ f capacitor, tying its three sections together) which is charged through a $\frac{1}{4}$ -watt neon bulb and variable resistor R1. When C2 is charged to about 80-85 volts the neon bulbs across which it is connected will conduct. The 5,000-ohm relay in series with the 1-watt neon bulb will close for a brief instant due to the current flowing through the neon bulb, and will automatically connect the neon bulb and itself across the full output of the power supply. To repeat the timing cycle the switch is merely thrown the other way for a second, opening S1 and closing S2. This discharges C2 through the 220-ohm resistor. The longest time period is determined by R1. Originally, a 2.5-megohm volume control was used which gave a maximum of about $\frac{1}{2}$ hour. To get a longer period, the resistance of the control may be increased. Since the $\frac{1}{4}$ -watt neon bulb glows very faintly when such high resistance is used, it is advisable to connect a capacitor of about 0.1- μ f across it. The $\frac{1}{4}$ -watt neon bulb is mounted on the

panel to show when the timer is in operation. The capacitor will make the bulb flash brightly every few seconds, showing that the instrument is on. The minimum interval is about 15 seconds. By removing the $\frac{1}{4}$ -watt neon bulb this can be decreased to a minimum of about 1 second. However, the upward range cannot then be made so high. The whole apparatus can be built into a utility box 4 x 5 x 3 inches, and the 1-watt neon bulb should be mounted in a conspicuous place. The on-off reset switch should be mounted in an easily accessible place.

Materials for photo timer

Resistors: 2—100, 1—220, $\frac{1}{2}$ -watt; 1— $2\frac{1}{2}$ megohms, potentiometer (linear).
Capacitors: 1—0.1 μ f, 200 volts, paper; 1—8 μ f, 200 volts, electrolytic; 1—150 μ f, 150 volts, electrolytic.
Miscellaneous: 1—50-mo selenium rectifier; 1—5,000-ohm relay (Kurman-2221/90Y); 1—d.p.d.t. switch; 1— $\frac{1}{4}$ -watt neon bulb, NE 48; 1—1-watt neon bulb, NE 30; cabinet; sockets; hardware; solder; and hookup wire

The timer should not be very expensive to build, especially if you have any of the parts in the junk box. The relay, the major item in cost, is a Kurman 2221/90Y which can be had on the war-surplus market for around 75 cents or ordered from Kurman Electric Co., 35-18 37th St., Long Island City, N. Y. at list price.

END

Sparkling Beauty

for the housetops

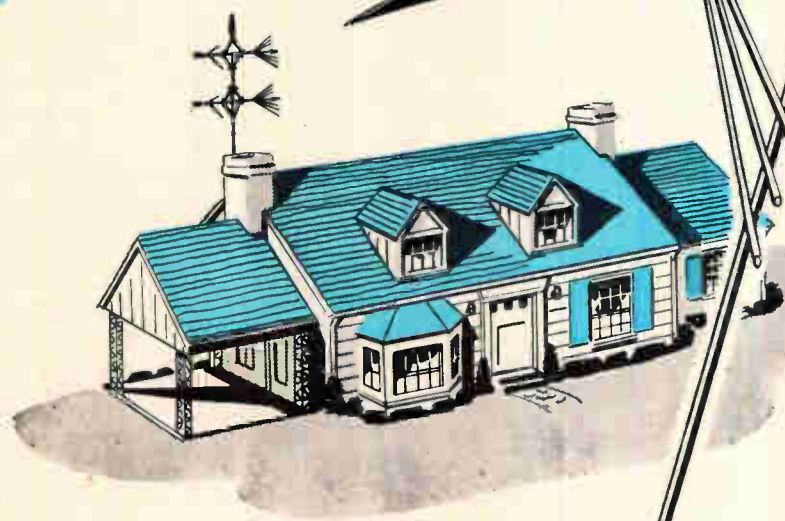

WARD'S
DYMON-VANE
CONICAL

another in the Tele-vane Series

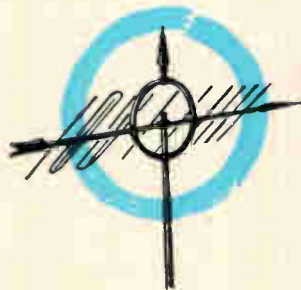

The Circle-vane . . .
first of Tele-vane
series for Channels
2 - 6 VHF.



Dave Chapman, S. I. D.
Famous designer of
the Ward Tele-vane
series of TV Antennas.

Ward flashes again with the handsome Dymon-vane, the second model in its new series of Tele-vane TV antennas. Reflecting the modern trend and decor the beautiful new Dymon-vane enhances any home and becomes a valuable prized addition. Clean cut in design, a flawless performer, the Dymon-vane stands out as a glittering solitaire among all other TV antennas. A conical antenna with aluminum elements and black permatube cross arm with wrought adornments, the Dymon-vane is designed for complete coverage of VHF Channels 2 - 13 in metropolitan, suburban and fringe areas.

The New Dymon-vane comes in single bay or two bay stacked models . . . folded and pre-assembled ready for easy installation.

THE WARD PRODUCTS CORP.

DIVISION OF THE GABRIEL COMPANY

1148 Euclid Avenue, Cleveland 15, Ohio

In Canada: Atlas Radio Co., Ltd., Toronto, Ont.



THE IONIC OSCILLATOR

By THOMAS E. FAIRBAIRN

A patent* was issued August 19, 1952, on a new form of gas-tube oscillator which contains no resistive, capacitive, or inductive time-constants, and needs no external or internal resonant circuits or cavities. This new *ionic oscillator* can deliver high output at audio or radio frequencies and has good stability over long periods of time. This is the simplest electronic oscillator known, and operates on as little as 2 milliamperes from a plate supply of 22½ volts or less. Fig. 1 shows the ionic oscillator's simple circuit.

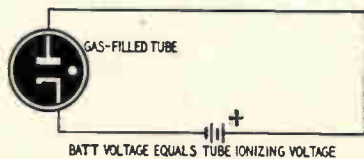

Fig. 1—The utter simplicity of the ionic-oscillator circuit. The battery voltage is made equal to the normal ionization drop across the gas tube.

The U.S. Naval Research Laboratory in Washington found that when a certain critical voltage is applied between the plate and cathode in an inert-gas or vapor-discharge tube, the ionized gas generates oscillations in the audio- or radio-frequency range. This is something like the oscillations in a resonating crystal—but with the added advantage of much higher output.

A very simple experiment convinced the Navy and patent men that the oscillations were generated in the ionized gas of the tube and not in any external circuits. Fig. 2 shows the basic circuit

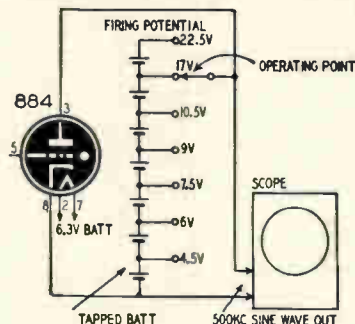

Fig. 2—Circuit used in original ionic-oscillator experiments. The full 22½ volts is applied first to fire the 884; then the voltage is reduced to the optimum value for stable sine-wave oscillations.

used in the experiment—nothing but an 884 thyratron, a 6-volt filament battery (a.c. can be used as well), a tapped 22½-volt B battery, and an oscilloscope connected across the plate-cathode circuit to show the output waveform. The

physical setup is shown in the photograph. If you check the settings of the scope controls you can see that the frequency of oscillation of the 884 is about 500 kc.

This experiment showed that any gas-filled tube (except certain neon bulbs) will oscillate when you apply a d.c. voltage across its plate and cathode equal to the voltage drop of the tube when ionized, and it will generate an almost perfect sine wave (not a sawtooth as in other gas-tube oscillators). Many gas tubes besides the 884 were tested in the same circuit and they all oscillated in the same way, except that each tube had its own fundamental frequency of oscillation just as crystals have.

The ionic oscillator in this experiment put out enough r.f. to be picked up on a home receiver at distances of 10 feet or more—without an antenna.

The ionic oscillator can be tuned over a limited range by changing the plate-cathode voltage in diode types, or by inserting a variable resistor between plate and grid in triodes and adjusting it for the desired output frequency.

Some of the gas tubes tested and their fundamental single-frequency outputs are as follows: 884—500 kc, tunable from 400 to 1,000 kc; 6Q5—1,000 kc tunable from 500 kc to 1,500 kc; 2050—15,000 cycles tunable from about 1 cycle to 20,000 cycles; 0C3/VR105—1,400 kc tunable from 900 to 1,900 kc. The Navy SN7 stroboscope tube has an output of about 1,000 cycles tunable over the entire audio range. Neon bulbs have no frequency of oscillation as yet discovered. Fluorescent lights oscillate over a very broad frequency band and can be detected almost anywhere on the dial, but have definite peaks at certain frequencies. Some large thyratrons used in high-current circuits were found to have outputs as low as 8 cycles per minute, with current changes of up to 1 ampere. Many other types of gas tubes were tested and frequencies as high as 9 megacycles were noted.

Modulation

Either frequency modulation or amplitude modulation may be applied, depending upon whether the modulating voltage is inserted in series with the plate or in parallel with the grid and cathode. A .01-volt a.c. signal applied between the grid and cathode of a triode-type gas tube as shown in Fig. 3 will modulate the output of the ionic oscillator from zero to well over 100 percent. (With over 100 percent modulation you get a pulse-modulated carrier.) A $\pm .01$ -volt input to the grid will

produce as much as 1.5 volts change in the output carrier. This represents an a.c. amplification factor of 150, and also shows that grid control is possible with gas oscillators.

When a sound-powered or crystal microphone was connected between grid and cathode of the thyratron (Fig. 3) the voice-modulated output could be heard clearly on a radio receiver tuned to the fundamental frequency of the ionic oscillator.

When two ionic oscillators with different fundamental frequencies were connected in series as shown in Fig. 4 the result was a frequency-modulated carrier with an output of at least 1½ volts r.f. The percentage modulation of this series circuit could be varied with the 50,000-ohm control of the upper triode.

Advantages

Now let's look at the differences between this ionic oscillator and other more familiar oscillators. First we'll compare the ionic oscillator with the relaxation oscillator which also uses a thyratron (or a gas diode) and may confuse a person who is not up on his electronics. The relaxation oscillator

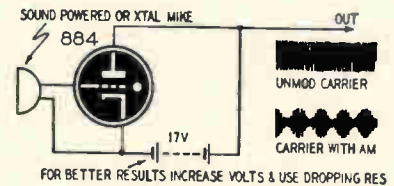

Fig. 3—Circuit of a voice-modulated ionic oscillator. The carrier frequency with an 884 is approximately 550 kc; with a 6Q5, approximately 1 mc.

gives out a sawtooth waveform, whereas the ionic oscillator gives out a sine wave. The relaxation oscillator has a top frequency limit of about 50 kc because of the electron transit time between the plate and cathode elements and the ionization and deionization time of the gas. The ionic oscillator has an upper limit of over 1,500 kc. In the relaxation oscillator an external R-C time-constant network sets the frequency of oscillation; but an ionic oscillator using the same tube type has nothing but a battery in the external circuit.

In the gas-tube relaxation oscillator the grid loses control over the output waveform once the oscillation starts, but in the ionic oscillator the grid maintains control at all times. This is proved by the voice-modulation circuit shown in Fig. 3. In addition, the ionic oscillator works at a voltage equal to the plate-cathode voltage drop of the

* U.S. patent No. 2,607,897



the C·D·R Rotor

sells faster...sells easier

because.....

The best line of TV Rotors money can buy

It is the complete line of quality rotors, with a model and type to best serve 'most every type application.

TV Spot Campaign

To reach the buying public, an intensive campaign on Television in key markets pre-selling CDR ROTORS for you.

Newspaper Advertisements

Also directed at the consumer, a supporting campaign in key city newspapers exploiting the advantages of the CDR ROTOR.

Moving Displays

It's causing excitement everywhere, this display that is an eye and traffic stopper, a silent salesman for the CDR ROTOR.

Envelope Stuffers

Here's another selling tool that may be mailed directly to your customers, selling them the CDR ROTOR in their home.

Newspaper Mats

A full set of completely prepared advertisements for dealers and distributors to capture extra CDR ROTOR business.

Window Streamers

They let everybody going into and by your-store know that you have the CDR ROTORS, a colorful and eye-catching streamer.



TR-12



TR-11



TR-2



THE **RADIART** CORPORATION
CLEVELAND 13, OHIO



CORNELL-DUBILIER ELEC. CORP.
SOUTH PLAINFIELD, NEW JERSEY

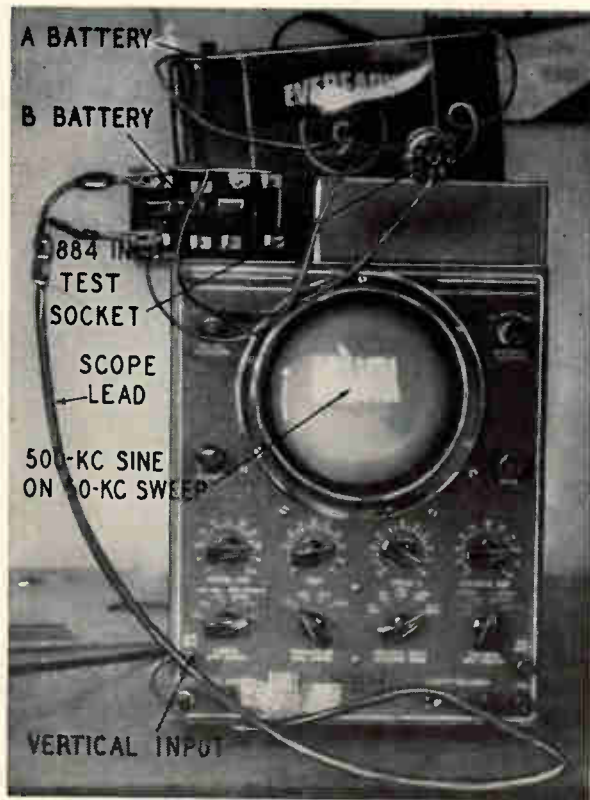

The physical setup of the circuit shown in Fig. 2. Sweep-control settings show the sine-wave oscillations have a frequency of approximately 500 kc.

ionized gas tube used, but the relaxation oscillator must have a much higher B supply due to the voltage drop in the external R-C network.

In comparing the ionic oscillator with the inductance-capacitance tuned-tank oscillator or the crystal oscillator, the ionic oscillator can be loaded very heavily; it needs no coupling circuit, and will transfer almost as much of its output to a low-impedance load as to a high-impedance load. In the L-C oscillator the resonant-tank circuit determines the frequency of oscillation, whereas in the ionic oscillator, the ionized gas itself determines the resonant frequency regardless of the external circuit.

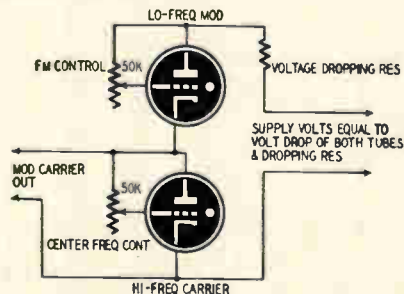

Fig. 4—An ionic-oscillator adapted to direct frequency-modulation.

One further advantage: An L-C oscillator can be detuned or killed by hand capacitance. The ionic oscillator is not affected at all.

In tuning an ionic oscillator the plate-cathode voltage is adjusted so that a small plate current flows. This current is fairly critical over a limited region for single-frequency operation. (With larger plate currents, the ionized

gas oscillates erratically at random frequencies.)

A circuit for general experimental work is given in Fig. 5. Either an 884 or 6Q5 thyatron can be used. R1 is a variable voltage-dropping resistor, and R2 is a variable grid resistor for tuning. The battery is 140 volts, and the 6.3-volt filament supply may be either a.c. or d.c. A current of about 10 ma should produce a good sine wave at about 1,000 kc with a 6Q5, and at about 550 kc with an 884. This oscillator can be modulated with a crystal phono pickup or microphone connected between grid and cathode, and the modulation should be heard clearly in a nearby radio.

Other applications

What uses can this oscillator be put to? Well, the ionic oscillator will drive an 807 r.f. power amplifier directly. No elaborate modulator circuit is needed for phone operation, as modulation can be applied to the oscillator itself.

The circuit of this transmitter is shown in Fig. 6. Here the ionic oscillator is used as the master oscillator for the 807. (Remember—this is an experiment only and keep F.C.C. regulations in mind!) At 500 kc the power output of the 807 is enough to light a 40-watt fluorescent tube. The bandwidth is no more than 10 kc on any conventional receiver.

The 807 is set up as a conventional class-A amplifier except for the fact that there is no grid tank circuit. The plate tank circuit was designed only to prove a point and not to stand up on any breakdown test. The tank coil

was a four-pie 1-mh r.f. choke and the tank capacitor was a midget 144- μ f variable. A 450- to 500-volt d.c. power source supplied the plate and screen voltages, and a dropping resistor supplied the ionic oscillator plate voltage. The ionic oscillator and the r.f. amplifier were coupled through a .05- μ f 200-volt capacitor. (This may be varied for optimum drive to the 807; the cut-and-try method will give the best results.)

The ionic oscillator is adjusted till it oscillates best. Then the amplifier is turned on and the plate tank is tuned till the fluorescent tube lights with maximum brilliance when touched to the plate of the 807. Those who know tank circuit design and are licensed to operate on 160 meters or higher frequencies can operate the 807 as a doubler. Those who do not have a license are advised not to try this experiment, as this simple transmitter will radiate quite a distance.

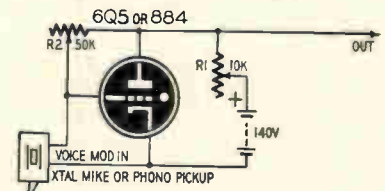

Fig. 5—A circuit for general experimental work with the ionic oscillator.

The ionic oscillator has been used also in audio signal generators, photo-cell amplifiers, radio receivers, pulse generators, special waveform generators, frequency- and amplitude-modulated oscillators, control circuits, and other special devices.

Other Characteristics

For those who are more interested in the experimental value of the ionic oscillator the following data were recorded during actual experiments:

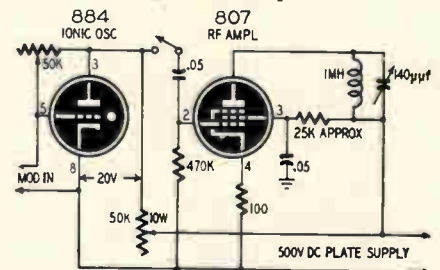

Fig. 6—A 40-watt 500-kc transmitter with an ionic master oscillator. Values are for experimental work only with all precautions taken to prevent radiation in violation of FCC regulations.

It was found that an OC3/VR105 voltage-regulator tube will oscillate at as many as five different modes. These modes can be produced by opening and shutting the plate-current circuit. Each mode will follow the other in sequence as the plate circuit is interrupted. At the same time a spot of blue light can be seen switching up and down the cathode as each mode is reached. These modes or frequencies will always be the same for the same position of the

IMPACT IN UHF

FINCO

series 500

Great UHF ANTENNAS

IMPACT Through Advertising

LOCAL NEWSPAPERS

LIFE

FARM MAGAZINES

RADIO

TELEVISION

**FINCO IS A NAME
YOUR CUSTOMERS
KNOW BECAUSE OF
THIS POWERFUL
NATIONAL ADVERTISING
PROGRAM!**

**THE
FINNEY COMPANY**

Dept. RE-312, 4612 St. Clair Ave., Cleveland 3, O.

This great series once again reaffirms Finco leadership! Model 502 is a 2-bay unit of the colateral* type with a "snap-out" screen for instantaneous installation. Model 504 is the 4-bay version, highly effective in super fringe areas where ultra high gain is consistently required. Both models feature high front to back ratio and excellent impedance match to 300 OHM line for low signal fringe areas. Completely preassembled — corrosion proof aluminum throughout (including screen) — one antenna, one transmission line!

Both Units available in 3 models which peak on channel ranges shown below and maintain high gain on balance of frequencies:

#502A — channels 14-32
#502B — channels 29-55
#502C — channels 53-83

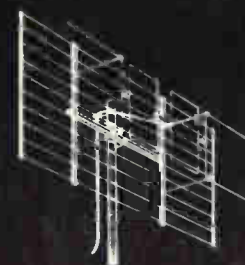

#504A — channels 14-32
#504B — channels 29-55
#504C — channels 53-83

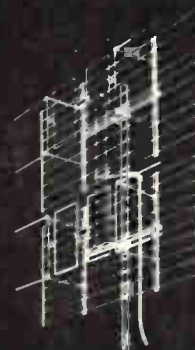

Patent No. 2,566,287
*Reg. U.S. Pat. Off.



Turret-type 3-speed
record-changer
phonomotor

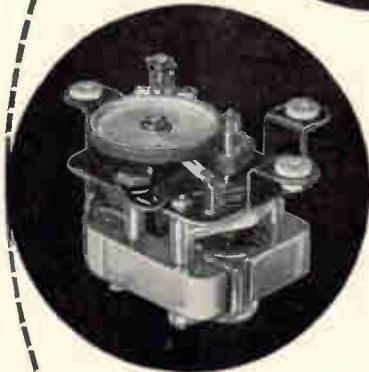

Single belt-type
3-speed
record-changer
phonomotor

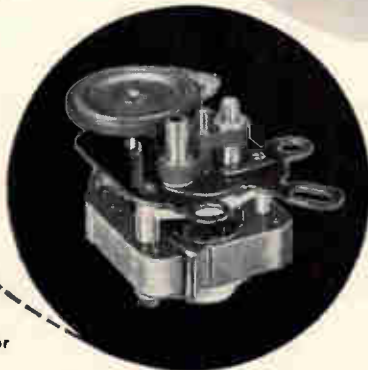

Double belt-type
3-speed record-
changer phonomotor

AMERICA'S
LEADING
RECORD-CHANGER
MANUFACTURERS
USE
GENERAL
INDUSTRIES'
3-SPEED
PHONOMOTORS

Each of the above 3-speed record-changer phonomotors was designed and engineered by General Industries to meet the specific requirements of a leading national manufacturer. These and countless companion GI phonomotors of all types and sizes—are the evidence on which General Industries bases its claim of phonomotor leadership.



THE GENERAL INDUSTRIES CO.
DEPARTMENT ME • ELYRIA, OHIO

OVER 50,000
TECHNICIANS
HAVE LEARNED

HOW TO GET
THE MOST OUT
OF BASIC TEST
EQUIPMENT

for A.M. - F.M. - TV



ONLY **40¢**
103 pages. Invaluable information that will help you re-double the value of your basic test equipment.

**'SERVICING BY
SIGNAL SUBSTITUTION'**

A BEST SELLER FOR OVER 12 YEARS!
(NEW, UP-TO-DATE, 12TH EDITION)

The Modern, Simplified, Dynamic Approach to Receiver Adjustment & Alignment Problems.

- ★ Nothing complicated to learn
- ★ No extra equipment to purchase
- ★ Universal... non-obsolete
- ★ Employs only Basic Test Instruments

Ask for "S.S.S." at your local Radio Parts Jobber or remit 40¢ in small stamps or coin directly to factory.

PRECISION APPARATUS COMPANY, INC.

92-27 HORACE HARDING BLVD. ELMHURST 4, N. Y.

blue cathode spot. This same shifting of frequency can be accomplished by beating one variable-frequency ionic oscillator against another.

It was also noted that if a d.c. or a.c. arc is made on a hard metal surface any ionic oscillator in the vicinity will shift frequency. Arcs on soft metal will not produce this effect. When a Navy type-SN7 stroboscope gas tube is hooked up as an ionic oscillator and placed in the beam of another stroboscopic light source, alternate light and dark bands can be seen moving slowly toward the plate from the cathode. If one pole of a magnet is brought near the column of ionized gas in the SN7 the frequency of this ionic oscillation will decrease as the bands move farther apart.

When an SN7 stroboscope tube is working as an ionic oscillator at about 5,000 cycles, the high-pitched audio note can be heard clearly coming from the tube elements.

If a variable resistor is connected between cathode and grid of a 6Q5 ionic oscillator, the oscillator will continue to work, even after the filament voltage has been removed, when a certain resistance has been reached.

If the grid of a triode-type ionic oscillator is driven very hard by an audio signal generator, the output carrier frequency will increase from about 1,000 kc to 9 mc. There will also be many different waveforms and pulsed radio- or audio-frequency combinations.

A tetrode gas tube such as the 2050 used as an ionic oscillator can have two separate control signals—one applied to the control grid and the other to the screen grid. These two signals can gate the tube to work only when both are present or when one or the other is present. In some tubes fixed a.c. modulating waveforms may be used for switching the ionic oscillations on and off.

In summary, the ionic oscillator is unique in that it is a high-frequency gaseous tube oscillator. In addition, it is a stable oscillator whose frequency and voltage output is constant for wide variations in load impedance. All this is done with extreme simplicity of construction.

Prior to the ionic oscillator, all oscillators using gaseous discharge tubes had the frequency determined by a tuned tank circuit connected to the output of the tube or by the charging time of an external capacitor as in a relaxation oscillator. The upper limit of most gaseous tube oscillators is generally no more than 50 kc because of the on-off process which has a definite minimum time limit. However, the ionized gas in a discharge tube normally oscillates within the tube at a frequency between 500 and 1,500 kc at low orders of ionization, the frequency being dependent on certain of the external circuit constants.

It should be clear to the reader that this is truly a new and unusual electronic invention that has many possibilities. Data will have to be compiled and checked before practical applications can be made.

END

“Meet The Family...”

THE NAME IS

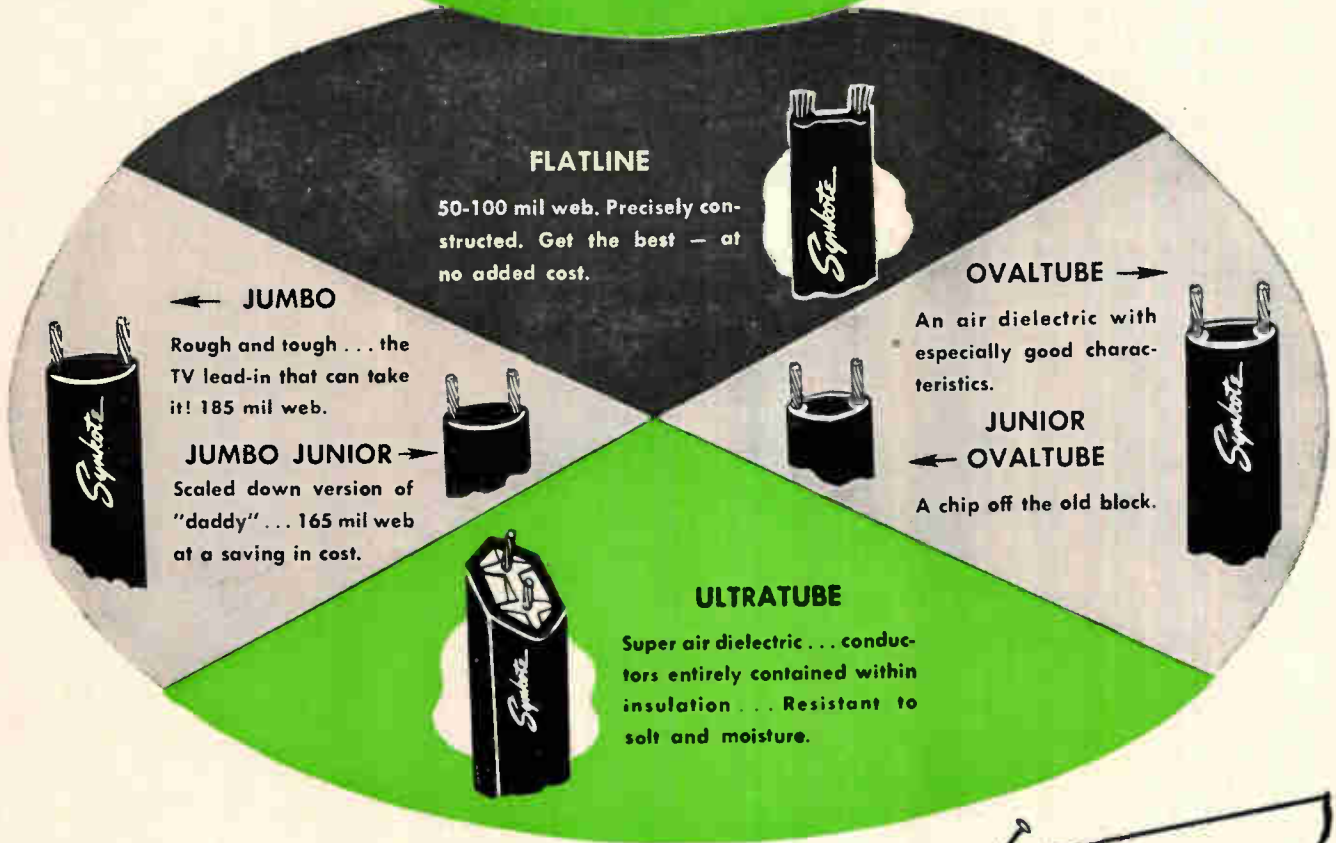
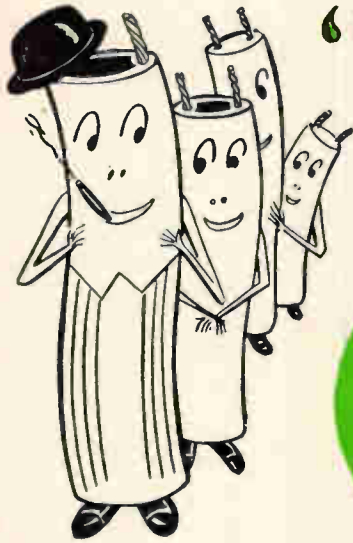

... And the rest of the SYNKOTE family SYNKOTE Perforated, Shielded, flat and round rotor cable, regular and junior coaxial.

CALL your PLASTOID representative and tell him you want to MEET THE SYNKOTE FAMILY... TODAY!

PLASTOID
Corporation

42-61 24th St., Long Island City, N.Y.

... Our Latest Addition...

FOAMLINE

Newest principle of cellular construction using millions of tiny, foamlke air chambers to repel moisture, biggest enemy of good reception.

Synkote DEPENDABLE WIRE and CABLE "Manufactured by the mils - tested by the inch"

Train IN
Great COYNE shops
for big pay jobs

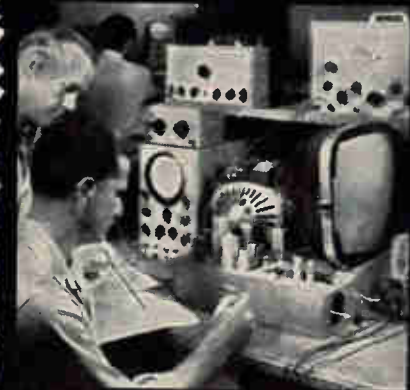

IN Television
-Radio



OR
Electricity
-ELECTRONICS

Learn on REAL EQUIPMENT!
In Best Equipped School of its
kind in U. S.

Prepare for your future NOW! Come to the Great Shops of Coyne. Get practical training in opportunity fields—TELEVISION-RADIO-ELECTRICITY-ELECTRONICS. Prepare for a better job in Industry or better service rating if drafted.

WE TRAIN YOU IN CHICAGO

At Coyne you learn on real, full-size equipment. Trained instructors show you how, then you do shop jobs yourself. No previous experience or advanced education needed.

Approved for Veterans

Finance Plan—Enroll now, pay most of tuition later. If you need part-time work to help out with living expenses while at Coyne, we'll help you get it. Special tuition plan for men of draft age.

FREE BOOK Clip coupon for Big Free Illustrated Book. No salesman will call. Act NOW.

COYNE
SCHOOL

500 S. Paulina St., Dept. 93-81H
Established 1899
APPROVED for VETERANS

B. W. COOKE, Pres.

COYNE School

500 S. Paulina St., Chicago 12, Ill., Dept. 93-81H

Send FREE BOOK and full details on:

TELEVISION-RADIO ELECTRICITY

NAME

ADDRESS

CITY..... STATE.....



Magnetostrictive and Electrostrictive Industrial Ultrasonic Apparatus

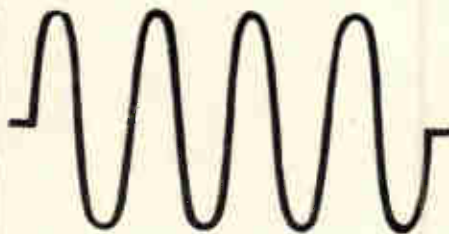

By NEIL CLARK, JR.,
ROBERT QUINT, and
ROBERT ROSKE*

THE industrial uses of high-intensity sound waves far above audible frequencies are finding new practical applications. The 50-year-old field of ultrasonics has produced a great deal of theory but, to date, very few commercially useful devices. Sonar is the outstanding military application, and much know-how has been locked up in Government laboratories.

This article describes three ultrasonic devices of known commercial utility. These devices will do jobs which are either impossible or impractical to do with conventional equipment. The 10-ke magnetostrictive oscillator can clean small complicated mechanical parts such as precision ball bearings more thoroughly, and faster, than ever before. An ultrasonic machine tool provides a device for machining complicated forms in the super metals and ceramics without using the critically short-supply and expensive diamond dust. For a new chemical catalyst, and medical therapy, the 1-mc electrostrictive equipment closes the gap a little further between the theoretical and the practical application of ultrasonics.

A magnetostrictive oscillator

The Raytheon 200-watt 10-ke magnetostrictive oscillator, model DF-101, was designed as a research tool primarily for the science laboratory and may be used to vibrate a sample of liquid at a frequency of approximately 10 kilocycles. However, it is finding application in industry for cleaning small parts.

The magnetostrictive oscillator con-

sists of a driver unit and a treatment unit, Fig. 1. The treatment unit consists of a covered cup for holding samples. A vibrating diaphragm serves as the bottom of the cup. A laminated nickel rod is attached to the bottom of the diaphragm, and the field coil for magnetizing the rod is encased in a stand which is also used to hold the rod and cup.

The driver unit generates the ultrasonic electrical power which is fed to the field coil in the stand. A special push-pull electron-coupled oscillator is used to eliminate oscillator detuning due to changes in the load. The a.c. oscillations developed in the grid circuits of the oscillator tubes are coupled to the low-impedance load in the plate circuit with a step-down transformer. Because of the push-pull arrangement, core losses and second harmonic distortion are considerably decreased over single-tube operation. Maximum trans-



Fig. 1—10-ke magnetostriction oscillator.
RADIO-ELECTRONICS

*Research Division, Raytheon Mfg. Co., Waltham, Mass.

With double
lock stop...

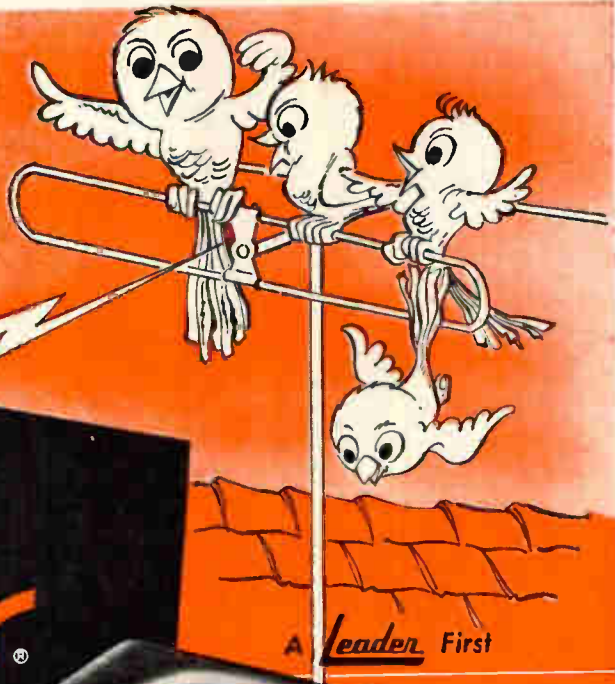

Only Superotor®

OFFERS VP Tuning



VP means Vernier Precision — sharpest tuning ever possible with any antenna rotator! With the exclusive double lock stop, and "telegraph key" fingertip action, Superotor can be rotated in increments of less than 1/2-degree, permitting highly critical orientation of antenna which automatically locks in position. In addition, Superotor's advanced design permits reading the antenna position without moving the antenna!



Compare All The Features, And You'll Join The Big Switch To Superotor



A
Leader
First



A
Leader
First



A
Leader
First



A
Leader
First



● Quick Detachable Drive Unit

● Built-in Chimney Mount

● Double Lock Stop Prevents Drift & Coast

● Steel-Reinforced Construction



2925 EAST 55TH STREET • CLEVELAND 27, OHIO

LEADING THE WAY TO BETTER PRODUCTS

Save TV
Alignment Time
 with the EAZY to use
Align-O-Pak
 TV alignment Bias
 Battery Eliminator



★ Quickly determines
 AGC troubles

Think of the time wasted connecting batteries in series... The Align-O-Pak provides all the voltages recommended by these leading TV manufacturers:
 • ADMIRAL 1½-4½v
 • MOTOROLA 3v • PHILCO 7½v
 • RCA 1v • ZENITH 2v Variable.

- ★ Forget messy Bias Batteries
- ★ Fix only TWO AGC troubles and your Align-O-Pak is paid for
- ★ Just Plug it In...
- ★ Provides from 0 to 10 Volts BIAS Instantly
- ★ Completely isolated from Power Line and Case

Only 785
 DEALER NET

INSTRUCTIONS
FOR ALIGNMENT: Plug Align-O-Pak in and turn unit on. Connect black lead to the Receiver AGC buss and red lead to 8 minus (usually chassis). Set Align-O-Pak knob to voltage recommended by TV manufacturer.
FOR AGC TROUBLE SHOOTING: With Align-O-Pak connected as described above, turn control knob slowly from 0 to 10. If normal picture appears, AGC is defective.

Carried by leading jobbers!

SI SERVICE INSTRUMENTS COMPANY
 422 South Dearborn Street, Chicago 5, Illinois

fer of power to the field coil is effected by means of a filter circuit which balances out the reactive component of the load. The a.c. signal from the electrical oscillator is then superimposed upon a d.c. polarizing current supplied from a rectifier and together they are passed through the energizing coil in the stand.

A magnetostrictive motion

When a d.c. magnetic field is set up in a bar of magnetostrictive material, it expands or contracts parallel to the axis of the magnetic field. The permalloys expand while pure nickel contracts. With flux densities of a few thousand

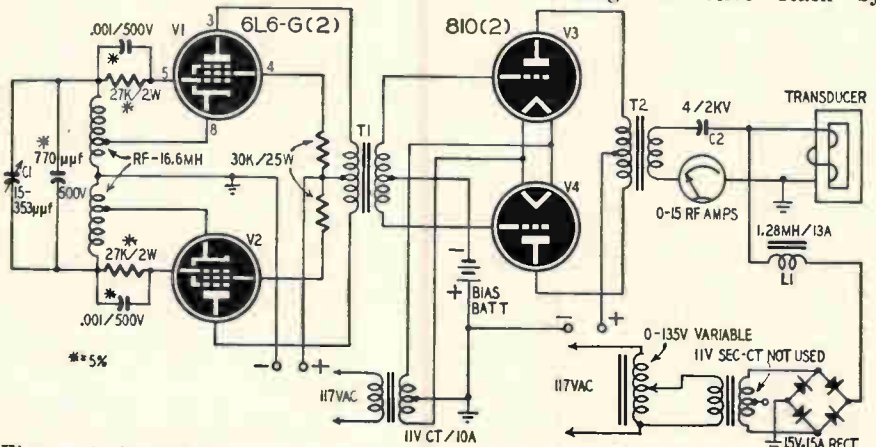

Fig. 2—A simplified schematic diagram of electronic driver and control equipment.

gausses, this contraction or strain in the material is about 10^6 , or 1 part in 100,000. When, in addition, an a.c. signal is passed through the same coil of wire, the resulting alternating magnetic field causes the bar to periodically shorten and expand about the contracted length whose value is determined by the polarizing current. If the frequency of the alternating current is equal to the resonant frequency of the bar, its resultant motion is also a resonance phenomenon and the d.c. strain of 10^6 may be multiplied 10 or 100 times depending on the effective Q of the material. Laminations are used to cut down the eddy-current losses which are proportional to the square of the frequency, flux density, and the thickness of the individual core laminations. Besides a magnetic hysteresis loss which is common to all magnetic materials, there is also an elastic hysteresis loss. In other words, a material which is subjected to alternate expansion and contraction exhibits a stress-strain loop similar to the familiar hysteresis loop.

The nickel laminations are used in producing the oscillations, for the following reasons: (1) A-type nickel, properly heat treated, has as high an electromechanical coupling factor (a figure of merit which relates the amount of electrical energy converted into mechanical energy) as any known magnetostrictive material. (2) Nickel is as rugged as the other materials and a lot easier to work with from an annealing as well as machining point.

The motion or amplitude developed at the end of the laminated nickel rod is coupled to a specially designed dia-

phragm which drives the liquid to be treated. As long as the diameter of the diaphragm is less than the wavelength of sound, as it is in the 10-kc unit, the sound waves spread out uniformly in all directions from the sound source so that the intensity in the direction normal to the axis of motion is only slightly less than the intensity along the axis. In other words, the action is essentially nondirective. The liquid is contained in a special cup which is adapted to maintain the temperature of the treated liquid relatively constant by means of a water jack. After flowing through the jacket the water serves to cool the magnetostrictive stack by

spraying inside the enclosed stand. Since the magnetic properties of nickel deteriorate with increasing temperature, this water spray is necessary for best operation. A cap prevents the escape of any liquid when subjected to violent agitation and decreases the intensity of the sound radiated to the air.

The generation of cavitation

From a physical point of view, a major use of the 10-kc oscillator is its ability to cavitate liquids. The phenomenon of cavitation, which has long been one of the unknown quantities in engineering, is being attacked theoretically as well as experimentally by a number of laboratories. Present results indicate that when high-amplitude sound waves are transmitted to a fluid, the mechanical strain in the liquid becomes so great that the liquid is torn apart. Under steady-state conditions, light liquids filled with air cavitate when the negative acoustic pressure reaches the atmospheric pressure. In terms of power density transmitted by the diaphragm to the fluid, the power required to cavitate liquid at atmospheric pressure is only ½ of a watt per square centimeter. Power densities of the order of 25-50 watts per square centimeter are available from the 10-kc unit. Cavitation point depends on frequency. For a fixed amplitude of sound, it is easier to cavitate at low frequencies.

Major uses of the 10-kc equipment to date have been in the cleaning of small metal parts, bacteria disintegration, and the emulsification of immiscible liquids. The vibrating diaphragm may be coupled to a tank or container of any

(CONTINUED ON PAGE 88)



Symbol of superior speaker performance

RCA Speakers—quality engineered for superior performance—are now clearly identified by this distinctive gold label. It is your assurance that these speakers represent the superior technical "know-how" and manufacturing techniques that

have made RCA the accepted name for high-quality products.

Look for the gold label—symbol of superior speaker performance—and be sure of using only genuine RCA Speakers for your replacement needs.

For complete information on RCA Speakers, see your RCA Distributor.



RADIO CORPORATION of AMERICA
ELECTRONIC COMPONENTS

HARRISON, N. J.

ATTENUATOR SWITCH eliminates "cut and try" methods for better TV reception

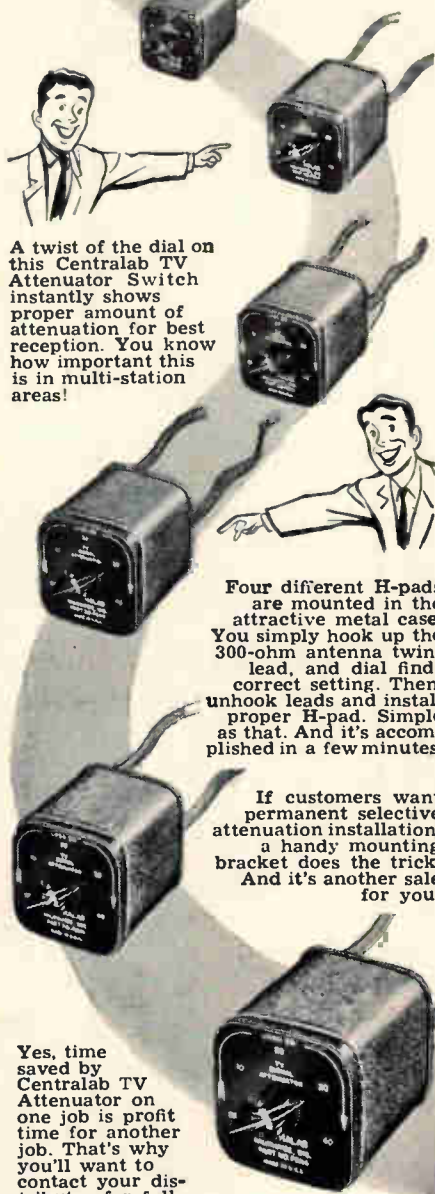

A twist of the dial on this Centralab TV Attenuator Switch instantly shows proper amount of attenuation for best reception. You know how important this is in multi-station areas!

Four different H-pads are mounted in the attractive metal case. You simply hook up the 300-ohm antenna twin-lead, and dial finds correct setting. Then, unhook leads and install proper H-pad. Simple as that. And it's accomplished in a few minutes.

If customers want permanent selective attenuation installation, a handy mounting bracket does the trick. And it's another sale for you!

Yes, time saved by Centralab TV Attenuator on one job is profit time for another job. That's why you'll want to contact your distributor for full details.

Centralab

CENTRALAB, A Division of Globe-Union Inc. 922-L E. Keefe Ave., Milwaukee 1, Wis.

Please send additional technical data on Centralab's TV Attenuator and H-pads.

Name.....
 Firm.....
 Address.....
 City.....Zone.....State.....

size or shape instead of the cup, thus facilitating the treatment of larger parts or the installation of continuous-flow apparatus. The standard cup supplied will hold about 150 cc.

An ultrasonic machine tool

Another magnetostrictive device is the Raytheon ultrasonic machine tool which utilizes electronics and ultrasonics in a combination providing a unique machine tool capable of many operations which have in the past been impractical. The essential parts of the apparatus are the electronic driver and control unit, the transducer which converts electrical into mechanical energy, and the work-holding and positioning mechanism. Even though carbides and ceramics may be machined, the cutting tools may be made from cold-rolled steel or brass and are attached to the transducer so that they vibrate normal to the work surface. An abrasive suspended in water flows between the vibrating tool and the work piece. The

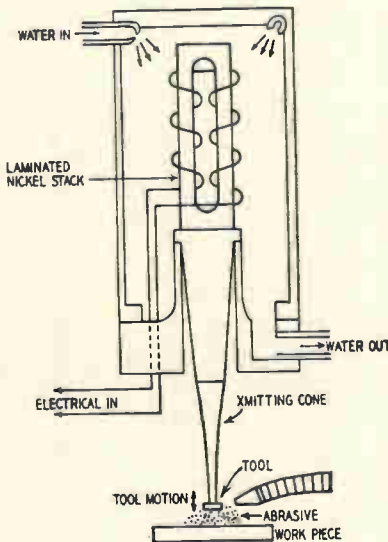

Fig. 3—Electromechanical transducer.

up-and-down motion of the tool drives the abrasive particles into the work, chipping it away. The work surface is worn away an almost negligible amount with each cycle of the tool motion, but the repetition rate of 26,000 per second produces a very significant rate of material removal.

Electronic equipment

A simplified schematic diagram of the electronic driver and control equipment is shown in Fig. 2. It consists essentially of a master-oscillator-power-amplifier utilizing two 6L6 tubes (V1 and V2) as a push-pull electron-coupled oscillator. The capacitance of C1 is varied to tune the driver to the transducer operating frequency. An untuned transformer T1 couples the m.o.p.a. to the class-B power amplifier, utilizing push-pull 810's (V3 and V4) with approximately 500 watts output. A special output transformer T2 matches the 810's to the transducer load. An isolating network composed of C2 and L1 (CONTINUED ON PAGE 91)

New Flyweight Magnemite*

Electric-Motor Battery-Operated Portable Recorder

The ideal recorder for newspaper reporting, recording lectures, telephone monitoring, field reports traveling secretary, on-the-spot interviews, reference recording, customer interviews, salesmen reports and secret recordings. Combines, for the first time, ease and efficiency of operation with maximum reduction of weight. Performs anywhere, producing professional results under adverse conditions. Fly-ball governor-controlled electric motor plus triple shielding assures constant speed and freedom from hash. Weather-tight, satin-finished, aluminum alloy case gives complete protection to recorder. Three models available in speeds of 15/16, 1 1/8 and 3/4 ips.

- Check these unusual features:
- ★ Records for 4 full hours (Model 310-A)
 - ★ Operates from self-contained dry cells
 - ★ Immediate playback
 - ★ Size: 5 1/2 x 9 x 12 inches
 - ★ Weight: only 8 pounds

Write for complete technical literature and direct factory prices to Dept. RE



AMPLIFIER CORP. of AMERICA
 398 Broadway, N. Y. 13, N. Y.
 *T.M. Reg. U.S. Pat. Off.

EASY TO LEARN CODE

It is easy to learn or increase speed with an Instructograph Code Teacher. Affords the quickest and most practical method yet developed. For beginners or advanced students. Available tapes for beginner's alphabet to typical messages on all subjects. Speed ranges 5 to 40 WPM. Always ready—no QRM.



ENDORSED BY THOUSANDS!

The Instructograph Code Teacher literally takes the place of an operator-instructor and enables anyone to learn and master code without further assistance. Thousands of successful operators have "acquired the code" with the Instructograph System. Write today for convenient rental and purchase plans.

INSTRUCTOGRAPH COMPANY

4701 Sheridan Rd., Dept. RC, Chicago 40, Ill.

WANTED

WE NEED YOUR SURPLUS ELECTRONIC EQUIPMENT

WE PAY TOP \$\$\$ FOR:

★ RADIO RECEIVERS	★ PLUGS
★ TRANSMITTERS	★ CORDS
★ ART-1	★ RELAYS
★ ARC-3	★ TELEPHONE MATERIALS
★ ART-13	★ AN CONNECTORS
★ CONTROL BOXES	★ WE BUY ANYTHING!
★ INDICATORS	
★ CLAMPS	

Write, Wire today! Tell us what you have.

TALLEN CO., Inc., Dept. RE
 159 Carlton Ave., Brooklyn 5, N. Y.

PLEASE MENTION RADIO-ELECTRONICS WHEN ANSWERING ADVERTISEMENTS



Symbol of superior speaker performance

RCA Speakers—quality engineered for superior performance—are now clearly identified by this distinctive gold label. It is your assurance that these speakers represent the superior technical “know-how” and manufacturing techniques that

have made RCA the accepted name for high-quality products.

Look for the gold label—symbol of superior speaker performance—and be sure of using only genuine RCA Speakers for your replacement needs.

For complete information on RCA Speakers, see your RCA Distributor.



RADIO CORPORATION of AMERICA
ELECTRONIC COMPONENTS

HARRISON, N. J.

BRIDGE

the V-O-M with the BIG dial

SIMPSON'S NEW MODEL 269 VOLT-OHM-MICROAMMETER!

100,000 OHMS PER VOLT

Never before available commercially a Volt-Ohm-Microammeter with this sensitivity . 7 inch dial in 7 inch case . Read 33 Ranges direct on the dial . The biggest dial in the smallest possible case . It is ideal for voltage measurements in high resistance circuits . May be used in place of Vacuum Tube Volt Meter for many voltage and resistance measurements . Complete with Operator's Manual, pair of test leads with removable alligator clips, 4000 volt DC probe extension . . . only \$88.00

RANGES FOR MODEL 269

DC Voltage

- 0-1.6 volts
- 0-8 volts
- 0-40 volts
- 0-160 volts
- 0-400 volts
- 0-1600 volts
- 0-4000 volts

} 100,000 ohms per volt sensitivity

AC Voltage

- 0-3 volts
- 0-8 volts
- 0-40 volts
- 0-160 volts
- 0-800 volts

} 5,000 ohms per volt sensitivity

AF Output Voltage

- 0-3 volts
- 0-8 volts
- 0-40 volts
- 0-160 volts

} 0.1 microfarad internal series capacitor

DC Resistance

- 0-2,000 ohms (18 ohms center)
- 0-20,000 ohms (180 ohms center)
- 0-200,000 ohms (1800 ohms center)
- 0-2 megohms (18,000 ohms center)
- 0-20 megohms (180,000 ohms center)
- 0-200 megohms (1.8 megohms center)

DC Current

- 0-16 microamperes
- 0-160 microamperes
- 0-1.6 milliamperes
- 0-16 milliamperes
- 0-160 milliamperes
- 0-1.6 amperes
- 0-16 amperes

} 267 millivolts maximum drop

Volume Level in Decibels

- 12 to +11 decibels
- 3.5 to +19.5 decibels
- +10.5 to +33.5 decibels
- +22.5 to +45.5 decibels

} Zero DB Power Level .001 watt in 600 ohms

ALSO, SIMPSON'S NEW MODEL 262 VOLT-OHM-MILLIAMMETER!

20,000 OHMS PER VOLT SENSITIVITY \$68.00

SIMPSON ELECTRIC COMPANY 5200 W. Kinzie Street Chicago 44, Illinois Estebrook 9-1121

In Canada: Bach-Simpson, Ltd., London, Ontario

100,000 Ohms per Volt sensitivity



Simpson

ATTENUATOR SWITCH eliminates "cut and try" methods for better TV reception



A twist of the dial on this Centralab TV Attenuator Switch instantly shows proper amount of attenuation for best reception. You know how important this is in multi-station areas!

Four different H-pads are mounted in the attractive metal case. You simply hook up the 300-ohm antenna twin-lead, and dial finds correct setting. Then, unhook leads and install proper H-pad. Simple as that. And it's accomplished in a few minutes.

If customers want permanent selective attenuation installation, a handy mounting bracket does the trick. And it's another sale for you!

Yes, time saved by Centralab TV Attenuator on one job is profit time for another job. That's why you'll want to contact your distributor for full details.

Centralab

CENTRALAB, A Division of Globe-Union Inc. 922-L E. Keefe Ave., Milwaukee 1, Wis.

Please send additional technical data on Centralab's TV Attenuator and H-pads.

Name.....
 Firm.....
 Address.....
 City..... Zone..... State.....

size or shape instead of the cup, thus facilitating the treatment of larger parts or the installation of continuous-flow apparatus. The standard cup supplied will hold about 150 cc.

An ultrasonic machine tool

Another magnetostrictive device is the Raytheon ultrasonic machine tool which utilizes electronics and ultrasonics in a combination providing a unique machine tool capable of many operations which have in the past been impractical. The essential parts of the apparatus are the electronic driver and control unit, the transducer which converts electrical into mechanical energy, and the work-holding and positioning mechanism. Even though carbides and ceramics may be machined, the cutting tools may be made from cold-rolled steel or brass and are attached to the transducer so that they vibrate normal to the work surface. An abrasive suspended in water flows between the vibrating tool and the work piece. The

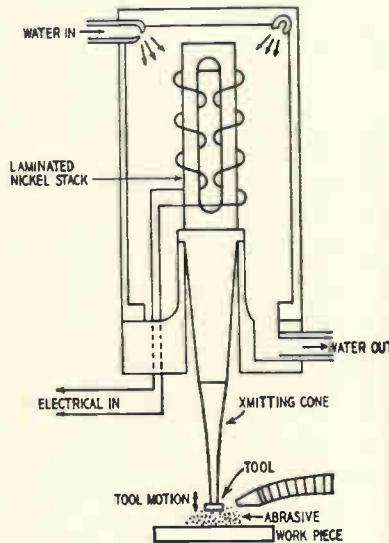

Fig. 3—Electromechanical transducer.

up-and-down motion of the tool drives the abrasive particles into the work, chipping it away. The work surface is worn away an almost negligible amount with each cycle of the tool motion, but the repetition rate of 26,000 per second produces a very significant rate of material removal.

Electronic equipment

A simplified schematic diagram of the electronic driver and control equipment is shown in Fig. 2. It consists essentially of a master-oscillator-power-amplifier utilizing two 6L6 tubes (V1 and V2) as a push-pull electron-coupled oscillator. The capacitance of C1 is varied to tune the driver to the transducer operating frequency. An untuned transformer T1 couples the m.o.p.a. to the class-B power amplifier, utilizing push-pull 810's (V3 and V4) with approximately 500 watts output. A special output transformer T2 matches the 810's to the transducer load. An isolating network composed of C2 and L1

(CONTINUED ON PAGE 91)

New Flyweight Magnemite*

Electric-Motor Battery-Operated Portable Recorder

The ideal recorder for newspaper reporting, recording lectures, telephone monitoring, field reports traveling secretary, on-the-spot interviews, reference recording, customer interviews, salesmen reports and secret recordings. Combines, for the first time, ease and efficiency of operation with maximum reduction of weight. Performs anywhere, producing professional results under adverse conditions. Fly-ball governor-controlled electric motor plus triple shielding assures constant speed and freedom from hash. Weather-tight, satin-finished, aluminum alloy case gives complete protection to recorder. Three models available in speeds of 15/16, 1 1/8 and 3/4 ips.

- Check these unusual features:
- ★ Records for 4 full hours (Model 310-A)
 - ★ Operates from self-contained dry cells
 - ★ Immediate playback
 - ★ Size: 5 1/2 x 9 x 12 inches
 - ★ Weight: only 8 pounds

Write for complete technical literature and direct factory prices to Dept. RE



AMPLIFIER CORP. of AMERICA
 398 Broadway, N. Y. 13, N. Y.
 *T.M., Reg. U.S. Pat. Off.

EASY TO LEARN CODE

It is easy to learn or increase speed with an Instructograph Code Teacher. Affords the quickest and most practical method yet developed. For beginners or advanced students. Available tapes for beginner's alphabet to typical messages on all subjects. Speed ranges 5 to 40 WPM. Always ready—no QRM.



ENDORSED BY THOUSANDS!

The Instructograph Code Teacher literally takes the place of an operator-instructor and enables anyone to learn and master code without further assistance. Thousands of successful operators have "acquired the code" with the Instructograph System. Write today for convenient rental and purchase plans.

INSTRUCTOGRAPH COMPANY

4701 Sheridan Rd., Dept. RC, Chicago 40, Ill.

WANTED

WE NEED YOUR SURPLUS ELECTRONIC EQUIPMENT

WE PAY TOP \$\$\$ FOR:

- | | |
|-------------------|-----------------------|
| ★ RADIO RECEIVERS | ★ PLUGS |
| ★ TRANSMITTERS | ★ CDRS |
| ★ ARC-3 | ★ RELAYS |
| ★ ARC-13 | ★ TELEPHONE MATERIALS |
| ★ CONTROL BOXES | ★ AN CONNECTORS |
| ★ INDICATORS | ★ WE BUY ANYTHING! |
| ★ CLAMPS | |

Write, Wire today! Tell us what you have.

TALLEN CO., Inc., Dept. RE
 159 Carlton Ave., Brooklyn 5, N. Y.

PLEASE MENTION RADIO-ELECTRONICS WHEN ANSWERING ADVERTISEMENTS

AN ALL-CHANNEL UHF

CONVERTER



MODEL NO. RC-5
Patent Pending

\$ 1995

Regency

Div. I. D. E. A., Inc.
7900 Pendelton Pike
Indianapolis 26, Indiana
Telephone: Cherry 2466

you're ready for

COLOR TELEVISION

with an AMPHENOL **INLINE***

Color television is fast becoming a reality! Sets are expected to be available the first part of next year and stations are purchasing the necessary transmitting equipment. Initial costs, unfortunately, will be high but as improvements in design and production are achieved the price of color television will become within everyone's reach.

The consumer is concerned with the problems presented by television in color. He has read reports on prices and availability; all have been conflicting. He knows, however, that his set will have to be replaced or converted. What he does not know is that if he has an AMPHENOL INLINE*, there will be no extra expense in antenna or installation! AMPHENOL engineers provided for color in the original design of the INLINE*.

Every dealer, distributor and installer will want to acquaint their customers with this reassuring information. The color television market is potentially tremendous. It certainly will prove of benefit if the consumer can be reassured on one part of the cost of conversion to color.

The fact that AMPHENOL INLINES are able to receive color television so well reflects favorably upon the engineering ability of AMPHENOL. For in ordinary black and white television the same level-gain design has proved valuable. Set owners know, now, that their AMPHENOL INLINE* is providing them with the best black and white picture their sets can deliver.

*Reissue U.S. Pat. No. 23,273

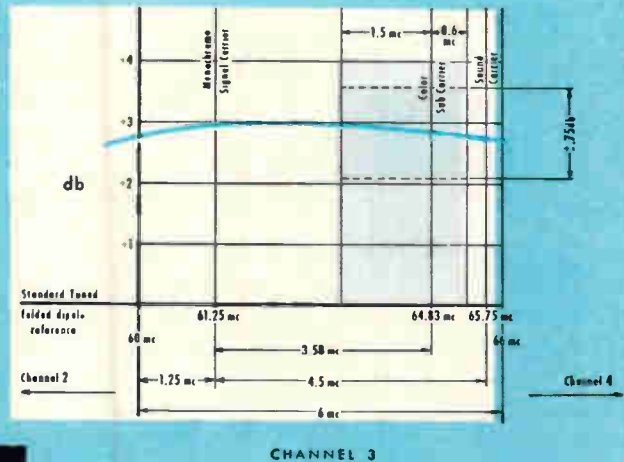

Antenna Electrical Requirements for COLOR TELEVISION

Information now available on color television has made it clear that the receiving antenna must have these characteristics:

- 1 Antenna gain must be flat, no gain or loss greater than one db, within 1.5 mc below and 0.6 mc above the color sub-carrier* (a width of 2.1 mc).
- 2 Antenna gain must be held down across the FM frequencies. Rejection of FM signals is much more important in color than in black and white television.

*Channel frequency widths are at present divided between the monochrome amplitude modulation picture carrier and the frequency modulation sound carrier. The addition of the color sub-carrier is made at 3.58 mc above the monochrome carrier.

The AMPHENOL INLINE* fully meets the two conditions listed above. Besides being engineered to reject FM signals, from 88 mc to 108 mc, the INLINE provides very level gain across all channels, particularly over the color sub-carrier. Typical of the INLINE's performance on all channels is the gain chart† illustrated above for channel 3.

†Measured in accordance with proposed RETMA standards.

AMERICAN PHENOLIC CORPORATION
chicago 50, illinois

AMPHENOL

permits application of a variable polarizing current to the transducer. Variation of this current enables the operator to control the ultrasonic power.

The polarizing current is a direct current applied to the transducer to permit operation on the most efficient part of the magnetization curve. It is applied through L1 which offers a high impedance to 26 kc and thus isolates the polarizing current power supply from the 500 watts of 26 kc power applied to the transducer. The capacitor C2 has a low impedance at 26 kc, allowing passage of the 500 watts, but prevents the d.c. polarizing current from flowing in the secondary of T2.

The transducer

The heart of this machine tool is the ultrasonic transducer which converts electrical energy into mechanical energy of vibration or motion. A cross-section sketch of the transducer used on the first model of this equipment is shown in Fig. 3. In addition to the direct polarizing current, 26-kc electrical energy at approximately 80 volts and 6 amperes is fed into the coil wound around a stack of nickel laminations. For each ampere of current increase, the magnetic flux setup in the 4-inch nickel stack causes it to mechanically contract about one hundred thousandth of an inch. A decrease in current causes it to expand an equal amount in the manner previously described for the 10-kc oscillator. A sinusoidal change of current in the transducer coils will cause a sinusoidal variation in mechan-

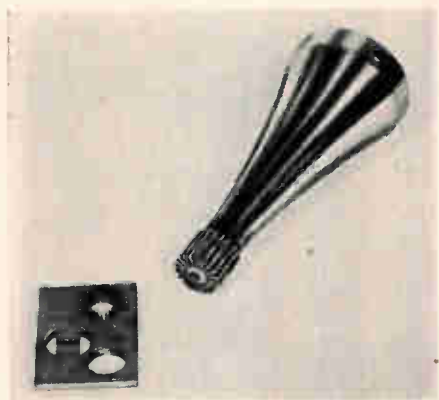

Fig. 4—Sample of complicated machining on tungsten carbide, and tool used.

ical length of the nickel stack. At the mechanical resonant frequency of 26 kc, the length changes about .001 inch.

Attached to the lower end of the nickel stack is a metal cone designed to transmit the vibrational energy to the tool. The cone is designed to increase the amplitude of vibration and provide a closer match or more efficient energy coupling between the tool and work piece. A good analogy is the tapered electrical transmission line in which the capacitance and inductance per unit length are varied to change its characteristic impedance. The mass and stiffness per unit length are changed so that the nickel stack is matched at one end of the cone, and the tool at the other end more closely matches the load



Standardize on

WEBSTER ELECTRIC
Featheride[®]
**REPLACEMENT
CARTRIDGES**

When you stock these five models of Featheride Replacement Cartridges, you can handle virtually all replacement needs—regardless of make of record player or changer—quickly, easily, profitably, and with a minimum inventory investment.

Mail the coupon for free copy of our handy new Replacement Chart YF-2, showing how you can most profitably fill your replacement needs.

these 5 models are all you need!

Model WS • A versatile unit capable of replacing the majority of 78 RPM Cartridges in the field.

Model AX • A complete unit for three-speed application, furnished with a removable twist mechanism.

Model BX • Designed primarily for RCA Automatic record changers and Columbia players. Unusually high fidelity.

Model CX • May be used with a three-mil needle for 78 RPM or two-mil needle for three-speed application.

Model FX • A two-needle twist cartridge, delivering high or low output.



**THIS NEW DISPENSER
WILL INCREASE YOUR SALES**

• This attractive Featheride Replacement Cartridge Dispenser on your counter or wall will boost your sales and profits. It comes with a basic stock of 10 each of the 5 models shown above—each cartridge packaged with all needed fittings, instructions and data, all in individual transparent plastic box. Replacement chart included in back of dispenser.

Send coupon for details of our Special Dispenser Offer, whereby you save \$10 if you order promptly.

WEBSTER ELECTRIC
RACINE WISCONSIN

"Where Quality is a Responsibility and Fair Dealing an Obligation"
WEBSTER ELECTRIC COMPANY, RACINE, WISCONSIN • EST. 1909

Webster Electric Co., Dept. RE-12, Racine, Wisconsin
Send me, without obligation, the items checked below:
 Free Featheride Replacement Chart YF-2
 Details of Special Dispenser Offer, whereby we can save \$10.00

Ordered by _____
Company _____
Address _____
City _____ State _____ Zone _____



PAMPER

YOUR TV AND RADIO SETS

WITH DEPENDABLE **OHMITE**[®] REPLACEMENTS

Little Devil[®] COMPOSITION RESISTORS



Tiny, yes... but what dependability, ruggedness, and stability! And they provide an extra margin of safety—being rated at 70C rather than 40C. Completely sealed and insulated by molded plastic, they meet all JAN-R-11 requirements... are available in 1/2, 1, and 2-watt sizes in all RTMA values.

TYPE AB NOISE-FREE POTENTIOMETERS

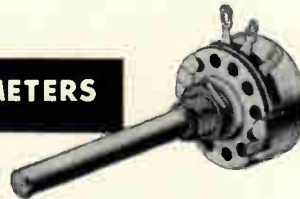

Because the resistance material in these units is solid-molded—not sprayed or painted on—continued use has practically no effect on the resistance. Often, the noise-level decreases with use... and they provide exceptionally long, trouble-free service. Rated at 2 watts, with a good safety factor.

BROWN DEVIL[®] AND DIVIDOHM[®] RESISTORS



BROWN DEVIL fixed resistors and DIVIDOHM adjustable resistors are favorite vitreous-enameled units! DIVIDOHM resistors are available in 10 to 200-watt sizes; BROWN DEVILS in 5, 10, and 20-watt sizes.



WRITE FOR
STOCK
CATALOG

OHMITE MFG. CO.
3646 W. Howard St.
Skokie, Illinois
(Suburb of Chicago)

Be Right With...
OHMITE

RHEOSTATS • RESISTORS • TAP SWITCHES

placed on it by the cutting action.

Tool cutting action

Although the maximum movement of the tool is only 0.004 inch, the acceleration is about $1.5 \times 10^{12} g$ ($g = 32 \text{ ft./sec.}^2$). This means that an object, the size and weight of a penny, when mounted on the end of the transmitting cone would exert a force of about one-half ton on the cone end. With the tremendous forces in play at the tip of the tool, it is not surprising that the abrasive and tool will eat their way into the work piece. The high acceleration given the abrasive particles is probably responsible for the cutting. Their extreme small motion gives a good surface finish and high accuracies.

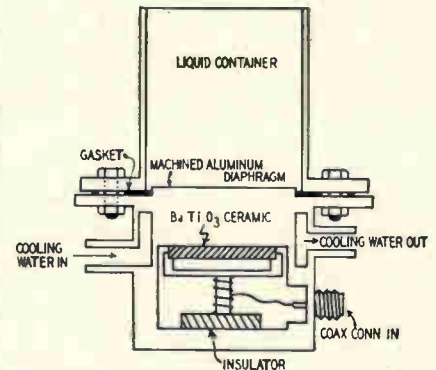

Fig. 5—Ceramic transducer for propagation of ultrasonic energy into liquids.

Even though the tool material is cold-rolled steel or brass, the machine readily cuts tungsten carbide, glass, quartz, and many other hard and brittle materials. The operations it can perform are unique in the machine-tool field. It can be mounted to drill holes of complicated cross-section as illustrated in Fig. 4. The ultrasonic machine tool is finding application in die-making, and other fields where the use of expensive diamond dust has before been the only method of machining.

High-frequency ultrasonics

The practical physical dimensions of magnetostrictive materials limits the high frequencies at which a transducer made of this material can operate. It is therefore necessary to use either crystals or ceramics to obtain higher frequencies. In the study of propagation and absorption phenomena, frequencies in the order of 15 mc are commonly used. One megacycle is very good, since most liquids absorb large amounts of energy at that frequency. A 1-megacycle liquid treatment unit is now being developed which has as the transducer, an electrostrictive barium titanate ceramic. The equipment consists of a treatment cup, a barium titanate transducer, and an electronic driver.

The barium titanate transducer

Barium titanate is a polycrystalline ceramic which exhibits ferroelectric properties below its Curie temperature analogous in the electrical case to magnetic properties which are known to exist in magnetostrictive materials. In its original state the ceramic is not

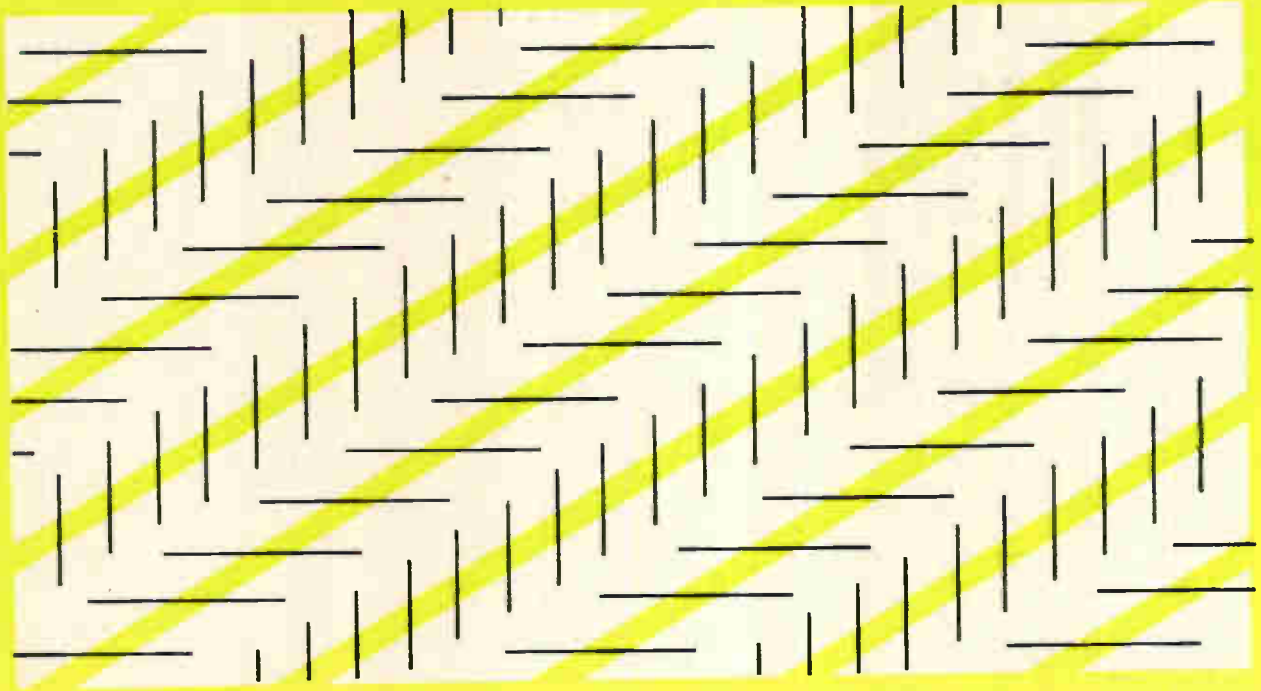

THINGS ARE **NOT** AS THEY SEEM...

The long lines are strictly parallel—that they appear otherwise is an optical illusion.

This fuse merely has the metal caps cemented to the glass.

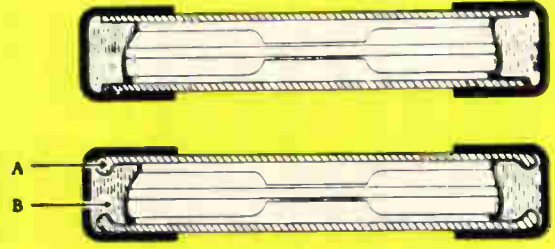

The difference between these two fuses is no illusion...

This Littelfuse has the caps locked to glass like this. The ends of the glass are formed^A. The solder which is bonded in a separate operation to the cap reflows through the small aperture and spreads out to form a permanent collar-button lock^B between cap and glass—impervious to moisture and vibration. The exclusive Littelfuse feature eliminates fuse failure due to loose caps.

LITTELFUSE

DES PLAINES, ILLINOIS

Littelfuse leads all other fuse manufacturers in design patents on fuses. Lock-cap assembly patent no. 1922642

Trav-Electric

DC to AC

CURRENT CONVERTERS

for Land...Sea...Air

JUST PLUG INTO CIGAR LIGHTER ON DASH
Change 6 or 12 Volt D.C.
to 110 Volt A.C., 60 Cycle



Operates Test Equipment,
All Electric Shavers

SIZE: 2"x2"x3 1/2"

Trav-Electric MIDGET

Model 6-11160, 60 Cycle, 10-15 Watts

\$11⁹⁵
List



OPERATES

- Test Equipment
- Turntables
- Lights
- Short, Long Wave Radios
- Portable Phonographs
- Electric Shavers, etc.

SIZE: 2 1/2"x2 1/2"x4 1/2"

Trav-Electric SENIOR

Model 6-1160, 60 Cycle, 35-40 Watts

\$15⁹⁵
List



OPERATES

- Curling Irons
- Radios
- Turntables
- Small Dictating Machines
- Test Equipment,
- Electric Shaver
- Portable Phonographs

SIZE: 4"x5"x6"

Trav-Electric MASTER

Model 6-51160, 60 Cycle, 40-50 Watts

\$24⁹⁵
List



OPERATES

- Wire Recorders
- Amplifiers
- Soldering Iron
- Radios
- Dictating Machines
- Turntables
- Small Electric Drill
- Electric Shaver

SIZE: 4"x5"x6"

Trav-Electric SUPER

Model 6-71160, 60 Cycle, 60-75 Watts

\$37⁹⁵
List

FULLY GUARANTEED
See your Jobber or Dealer

Terado COMPANY

ST. PAUL 14, MINNESOTA

In Canada Write: Atlas Radio Corp., Ltd.
560 King St. West, Toronto 28, Ont.

Export Sales Division: Scheel International, Inc.
4237 N. Lincoln Ave., Chicago 18, Ill. U.S.A.

Cable Address—Harshell

piezoelectric. The piezoelectric behavior is introduced by applying a d.c. bias of 30,000 volts per centimeter with the directions of the electrical and mechanical axes depending on the direction of the polarizing field. When the d.c. field is removed there remains a residue polarization which may be as high as 90% of the saturation polarization. Therefore, there is no need for maintaining a fixed electric biasing field on the ceramic during operation.

Even though the ceramic can withstand high temperatures without changing its physical properties, the piezoelectric polarization is reduced at temperatures around 90°C, and becomes completely depolarized above the Curie temperature which is about 120°C. It is therefore necessary when using barium titanate as a transducer to have some form of cooling system that will keep the ceramic below 90°C.

Applying a small alternating voltage to the barium titanate will cause the ceramic to mechanically vibrate. If the frequency of the applied alternating voltage approximates a frequency at which mechanical resonance can exist in the ceramic, the amplitude of vibration is considerably larger. Since the ultrasonic intensity of a sound wave is directly proportional to the square of the amplitude, vibrating the ceramic at resonance will give a large ultrasonic intensity output.

The electromechanical coupling factor of barium titanate is much greater than that of quartz. The electromechanical coupling factor is the same as described for the magnetostrictive transducer. It represents the percentage of the total electrical energy applied to the crystal or ceramic which is stored in mechanical form. For quartz the electromechanical coupling factor is about 1.1%, whereas in barium titanate it may run as high as 30%.

One advantage barium titanate has over quartz is the low impedance of the ceramic which allows it to operate at low driving voltages. Another advantage that barium titanate has over quartz when being used as a transducer is that the transducer can be made to any desired size or shape. The ceramic can be molded in the shape of a focusing radiator which will concentrate ultrasonic energy in a given region.

A one-megacycle treatment unit

Fig. 5 shows the liquid treatment unit with the ceramic transducer mounted against an aluminum diaphragm. The ceramic is 2 inches in diameter and has a thickness of 0.100 inch. The diaphragm is designed to couple a maximum of ultrasonic energy to the liquid. This is accomplished by making the diaphragm an integral number of half waves thick. For aluminum at 1 mc a half wavelength is 0.32 cm or 0.126 inch. The diaphragm in the present liquid treatment unit is two wavelengths thick or 0.504 inches. This thickness gives the diaphragm sufficient cooling surface to keep the ceramic from overheating while in operation. A special

grease is used to bond the ceramic to the diaphragm, with enough pressure being applied by a spring to keep the ceramic in contact with the diaphragm. A metal contact which supplies the alternating voltage to the transducer is made so that the ceramic is constrained as little as possible while vibrating, and at the same time prevents the ceramic from slipping. The water cooling system serves to keep the diaphragm, which is in contact with the ceramic, at a temperature low enough to prevent the ceramic from becoming depolarized. The liquid treatment unit is at ground potential with the high potential lead connected to the ceramic as shown in Fig. 5.

As was mentioned before, the low impedance of the ceramic permits 60 ultrasonic watts output with only 100 to 130 volts drive. Intensities of 3 watts per square centimeter are easily obtained. The unit shown in Fig. 5 can easily be adapted to continuous flow treatment or larger tank by bolting the transducer on the side or bottom of any large container. In this manner the transducer may be adapted to any liquid in almost any container. A great deal of information has been published on successful ultrasonic treatment of many liquids. In the field of chemistry, success has been obtained in the degassing of various types of liquids, vaporization of liquids, and the transformation of chemical compounds. A few biological effects are the destruction of protozoa and bacteria, loss of reproduction power to yeast cells, and loss of luminosity to luminous bacteria.

Since sound is such an integral part of sonar and similar underwater detection, it is highly probable that magnetostrictive oscillators will become increasingly important in depth sounding devices such as fathometers, and for military applications.

Many surprising and interesting effects are produced by high-intensity ultrasonic waves, but there yet remains a vast field of undiscovered phenomena of intrinsic value to society. It will pay to keep an eye on this field for new developments which are sure to come.

END



THE BEST SET IS ONLY AS GOOD AS ITS ANTENNA!

The KAY-TOWNES "BIG JACK" IS *not* A NEW ANTENNA

The "BIG JACK", recognized even by competitive manufacturers as the best performing VHF antenna design ever developed HAS BEEN ON THE MARKET FOR MORE THAN 1½ YEARS!

**WE
CHALLENGE**

any other manufacturer
who claims this design
as his original
idea!

**HIGH GAIN ON ALL VHF CHANNELS
PREASSEMBLED**

1" HEAVY ALUMINUM BOOM

**CRIMPED & DOWEL REINFORCED
HEAVY (7/16" O.D.) ALUMINUM
TUBING**

**"SURE-GRIP" CAST ALUMINUM MAST
CLAMP WILL NOT SPREAD, BEND OR
COLLAPSE.**

Kay-Townes Antennas and Accessories are sold only through selected wholesale outlets . . . Contact your jobber or write for name of nearest distributor.

Copyright 1953

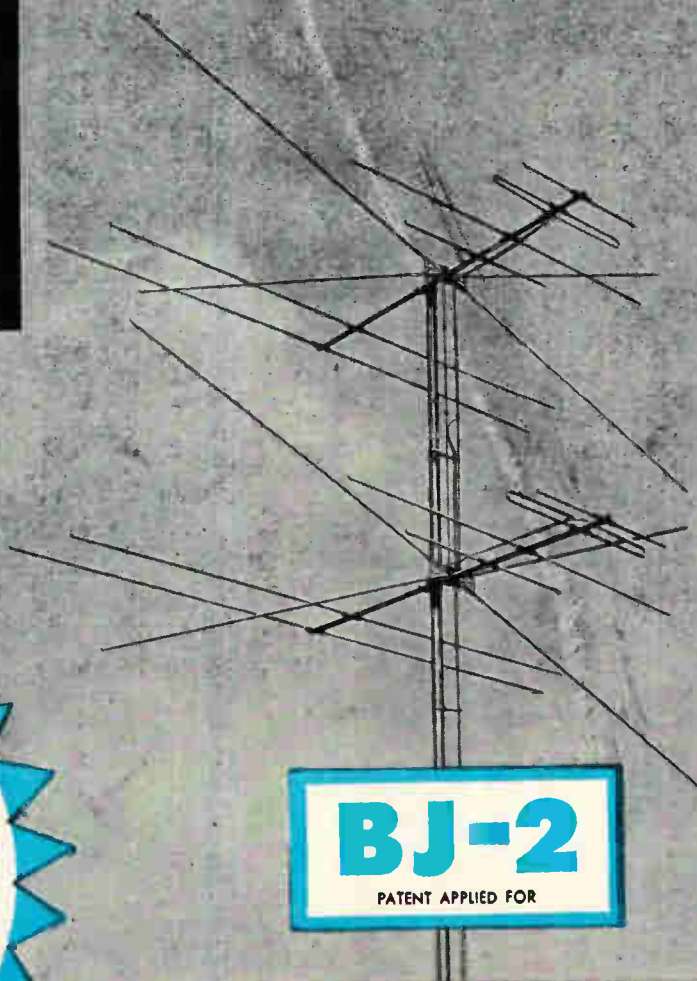

KAY-TOWNES' "BIG JACK" ANTENNAS PERFORM WITH OUTSTANDING SUCCESS WHERE OTHERS FAIL!

Kay-Townes technical experience and engineering details plus careful manufacture, all combine to make "BIG JACK" the most advanced antenna on the market today. As a matter of fact, certain other manufacturers who have failed to come up with matching performance in antennas of their own design, have attempted to copy the "BIG JACK" design, with questionable results.

HUNDREDS OF STATEMENTS LIKE THE ONE REPRODUCED HERE, PROVE "BIG JACK'S" SUPERIORITY!

Dear Sirs:

I have one of your BJ-2 "Big Jack" Antennas, which was installed approximately 2 months ago. It has consistently proved vastly superior to any other antenna in this locality. I have nothing but praise for this well made, expertly designed antenna. We receive WSB-TV, Atlanta, channel 2, 165 miles away better than everyone else around here. WAGA-TV, Atlanta, channel 5, and WBTV, Charlotte, channel 3, also come in clear and sharp.

James R. Rule
Oak Ridge, Tennessee

KAY-TOWNES ANTENNA CO. ROME, GEORGIA

Recognized leaders in the field of fringe area antenna design

ADFOJET

Mark II

Electronic equipment has a relatively short life under the best of conditions. Juniors' interest could hasten electronic oblivion

By **ED BUKSTEIN**

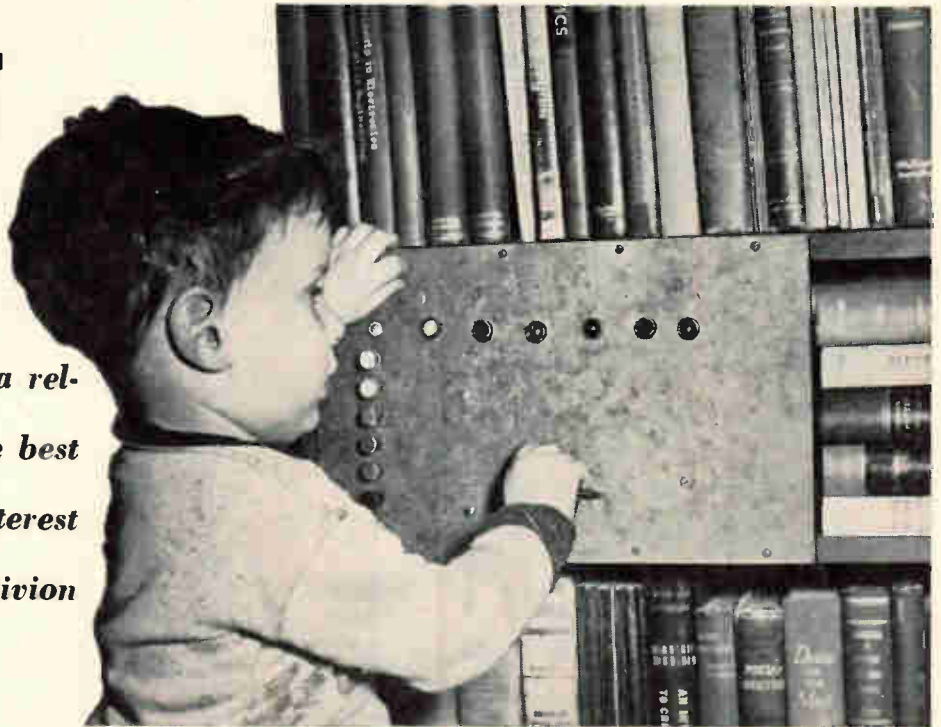

Author's child at the controls of ADFOJET. Textbooks are now free from fear.

TO A TWO-YEAR-OLD boy, the radioman's home or shop is a paradise of fascinating gadgets. Standard toys like blocks, rubber balls, and miniature automobiles lose their appeal and become unattractive in the presence of such attention-catchers as a signal generator and oscilloscope. The two-year-old is an indefatigable knob-twister and switch-thrower, and an instrument panel provides an ideal outlet for his natural and insatiable curiosity. The complexity of the problem is further increased by the fact that the pages of a Rider's Manual are ideal in size and weight for making paper airplanes, and that a slide rule equipped with a rubber band can be used as a cross-bow type of weapon.

Fathers who subscribe to the old adage, "Spare the rod and spoil the child", probably have well-behaved children; but these are dull, unimaginative children deprived of curiosity and self-confidence. Equally unfortunate is the child whose father follows the newer philosophy of letting the child express himself even if this self-expression takes the form of drilling holes in the floor. The ideal solution to the problem lies in diverting the child's attentions into nondestructive channels while still providing him with ample opportunity to exercise his imagination and curiosity.

It was after the discovery that several reference books had taken on a coating of jam, and that an assortment of broom straws, match sticks and pencil leads had been pushed into the pin-jacks of the audio generator, that I seriously directed my attention to this problem. This led to the development of ADFOJET (Attention Diverter For Junior Electronic Technicians).

The first ADFOJET unit consisted of

a masonite panel with six pilot-light assemblies mounted in a horizontal row. Each assembly had a different color jewel (white, yellow, blue, orange, green, and red). It took several trips to

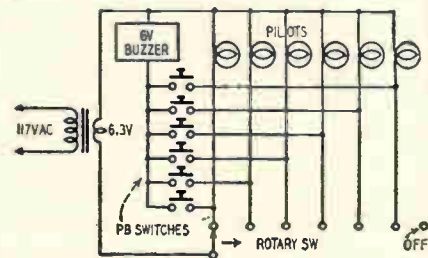

Fig. 1—Schematic of ADFOJET model 2.

different supply houses to get the six different colors, but the effort later proved to be more than justified. A 6.3-volt filament transformer, mounted on the back of the panel, served as a power source for the pilot lights. A 6-position rotary switch provided the means for lighting up any of the six colors. This was ADFOJET Mark I. It served its purpose by captivating the attention of my son. It also proved to be educational in that it taught the boy to recognize the colors by name and to pronounce the names correctly. After the novelty wore off, the ADFOJET no longer performed its prescribed function. This turn of events led to the development of Mark II (Fig. 1).

A set of push-buttons from an old receiver was mounted on this unit. The six push-buttons were painted to correspond to the colors of the lights. In addition, a 6-volt buzzer was mounted on the back of the masonite panel. As before, the selector switch serves to light up any of the six colors. To make

the buzzer ring, it is necessary to depress the push-button of the same color. To preserve the peace and tranquility of the household, spacers were placed under each push-button. This permits the button to be pushed in far enough to make contact, but not far enough to lock. The unit was mounted in a bookshelf where it has been serving its purpose admirably ever since. It has proved to be an excellent teacher of logical thinking, cause and effect reasoning, etc.

Should the novelty of Mark II wear off, several modifications are being held in reserve. For example, the unit could be used to teach a child to identify objects by their names. This would involve pasting pictures of the objects over the lights, and printing the names alongside the corresponding push-buttons.

Also, by marking the lights 1 times 9, 2 times 9, 3 times 9, 4 times 9, etc., and marking the pushbuttons 9, 18, 27, 36, etc., the unit could be used to teach the multiplication tables. In each case, the sound of the buzzer indicates a correct answer.

The tension has gone now, and everyone has relaxed. The vacuum tube voltmeter looks out defiantly from its shelf, and the reference books stand brave and unmolested. Peace has returned to our household.

END



NO INTEREST!!

Buy on our radically new
Time Payment Plan

NO CARRYING CHARGES!!



Superior's new
Model 670-A

SUPER METER

A COMBINATION VOLT-OHM MILLIAMMETER PLUS
CAPACITY REACTANCE INDUCTANCE AND DECIBEL MEASUREMENTS

SPECIFICATIONS:

D.C. VOLTS: 0 to 7.5/15/75/150/750/1,500/7,500 Volts
A.C. VOLTS: 0 to 15/30/150/300/1,500/3,000 Volts
OUTPUT VOLTS: 0 to 15/30/150/300/1,500/3,000 Volts
D.C. CURRENT: 0 to 1.5/15/150 Ma. 0 to 1.5/15 Amperes
RESISTANCE: 0 to 1,000/100,000 Ohms 0 to 10 Megohms
CAPACITY: .001 to 1 Mfd. 1 to 50 Mfd. (Quality test for electrolytics)
REACTANCE: 50 to 2,500 Ohms 2,500 Ohms to 2.5 Megohms
INDUCTANCE: .15 to 7 Henries 7 to 7,000 Henries
DECIBELS: -6 to +18 +14 to +38 +34 to +58

ADDED FEATURE:

The Model 670-A includes a special **GOOD-BAD** scale for checking the quality of electrolytic condensers at a test potential of 150 Volts.

The Model 670-A comes housed in a rugged, crackle-finished steel cabinet complete with test leads and operating instructions.

\$28⁴⁰ NET



Superior's new
Model TV-11

TUBE TESTER

SPECIFICATIONS:

- ★ Tests all tubes including 4, 5, 6, 7, Octal, Lock-in, Peanut, Bantam, Hearing Aid, Thyatron, Miniatures, Sub-miniatures, Novals, Sub-minars, Proximity fuse types, etc.
- ★ Uses the new self-cleaning Lever Action Switches for individual element testing. Because all elements are numbered according to pin-number in the RMA base numbering system, the user can instantly identify which element is under test. Tubes having tapped filaments and tubes with filaments terminating in more than one pin are truly tested with the Model TV-11 as any of the pins may be placed in the neutral position when necessary.
- ★ The Model TV-11 does not use any combination type sockets. Instead individual sockets are used for each type of tube. Thus it is impossible

to damage a tube by inserting it in the wrong socket.

- ★ Free-moving built-in roll chart provides complete data for all tubes.
- ★ Newly designed Line Voltage Control compensates for variation of any Line Voltage between 105 Volts and 130 Volts.
- ★ **NOISE TEST:** Phono-jack on front panel for plugging in either phones or external amplifier will detect microphonic tubes or noise due to faulty elements and loose internal connections.

The model TV-11 operates on 105-130 Volt 60 Cycles A.C. Comes housed in a beautiful hand-rubbed oak cabinet complete with portable cover.

\$47⁵⁰ NET

EXTRA SERVICE—The Model TV-11 may be used as an extremely sensitive Condenser Leakage Checker. A relaxation

type oscillator incorporated in this model will detect leakages even when the frequency is one per minute.



Superior's New Model 660-A AN AC OPERATED

SIGNAL GENERATOR

PROVIDES COMPLETE COVERAGE for AM-FM & TV Alignment

SPECIFICATIONS:

• Generates Radio Frequencies from 100 Kilocycles to 60 Megacycles on fundamentals and from 60 Megacycles to 220 Megacycles on powerful harmonics. • Accuracy and Stability are assured by the use of permeability trimmed Hi-Q coils. • R.F. available separately or modulated by the internal audio oscillator. — Built in 400 cycle sine wave audio oscillator used to modulate the R.F. signal also available separately for audio testing of receivers, amplifiers, hard of hearing aids, etc. • R.F. Oscillator Circuit: A high transconductance hep-

tode is used as an R.F. oscillator, mixer and amplifier. Modulation is effected by electron coupling in the mixer section thus isolating the oscillator from load changes and affording high stability. • A.F. Oscillator Circuit: A high transconductance heptode connected as a high-mu triode is used as an audio oscillator in a High-C Colpitts Circuit. The output (over 1 Volt) is nearly pure sine wave. • Attenuator: A 5 step ladder type of attenuator is used.

Tubes used: 1—6BE6 as R.F. Oscillator, mixer and amplifier. 1—6BE6 as Audio Oscillator. 1—6H6 as Power Rectifier.

\$42⁹⁵ NET

The Model 660-A comes complete with coaxial cable test lead and instructions.

MOSS ELECTRONIC DISTRIBUTING CO., INC.
Dept. B-88, 38 Murray Street, New York 7, N. Y.

Please send me the units checked. I am enclosing the down payment with order and agree to pay the monthly balance as shown. It is understood there will be no carrying, interest or any other charges, provided I send my monthly payments when due. It is further understood that should I fail to make payment when due, the full unpaid balance shall become immediately due and payable.

Name.....

Address.....

City.....Zone.....State.....

- MODEL 670-A Total Price \$28.40 \$7.40 down payment. Balance \$3.50 monthly for 6 months.
- MODEL TV-11 Total Price \$47.50 \$11.50 down payment. Balance \$6.00 monthly for 6 months.
- MODEL 660-A Total Price \$42.95 \$12.95 down payment. Balance \$5.00 monthly for 6 months.
- I enclose \$..... as down payment.
- Ship C.O.D. for the down payment.

"HOW TO" BOOKS

Simple and Practical



HOW TO TROUBLESHOOT A TV RECEIVER

by J. R. Johnson

A step-by-step guide for newcomers to rapid systematic troubleshooting. Read this book and start out on the right foot!

Over 120 (5 1/4 x 8 1/4") pp..... \$1.80

HOW TO USE SIGNAL AND SWEEP GENERATORS

by J. R. Johnson

First book on all types of signal and sweep generators. Gives test uses and discusses problems and their solutions in using this equipment. Applications of all signal and sweep generators in AM, FM radio and TV servicing.

Over 140 (5 1/2 x 8 1/2") pages..... \$2.10

POSITIVE CURES FOR TV TROUBLES

TV MANUFACTURERS' RECEIVER TROUBLE CURES VOL. 1, VOL. 2, VOL. 3 and VOL. 4

Positive cures for TV troubles! Gives you exact directions for correcting TV receiver performance "bugs". Each cure is official, factory-authorized, direct from the receiver's manufacturer. Listings by manufacturer and model or chassis number. Helps correct the most difficult faults—picture jitter, hum instability, buzz, tearing, etc.

Vol. 1, 115 pages (5 1/4 x 8 1/4")..... \$1.80

Covers 12 brands, Admiral through Dumont

Vol. 2, 117 pages (5 1/4 x 8 1/4")..... \$1.80

Covers 11 brands, Emerson through Jackson

Vol. 3, 119 pages (5 1/4 x 8 1/4")..... \$1.80

Covers 16 brands, Kaye-Halbert through Philco

Vol. 4, Over 115 pages (5 1/4 x 8 1/4")..... \$1.80

Covers 10 brands, Philharmonic through Shaw TV

VOLUME 5 COMING SOON!

Prominent manufacturers not in first 4 volumes

One Service Job Will More Than Pay

The Cost of This Series of Books!

UHF TELEVISION ANTENNAS AND CONVERTERS

by A. Lytel

Latest information on all types of converters, antennas, transmission lines. Valuable for UHF installation techniques.

Over 128 (5 1/4 x 8 1/4") pp..... \$1.80

GUIDE TO AUDIO REPRODUCTION

by David Fidelman

A to Z explanation of the reproduction of sound, design, construction, assembly and testing of sound systems and their components. Valuable for service technicians, engineers, amateurs.

Over 250 (5 1/2 x 8 1/2") pp., illus..... \$3.50

OBTAINING AND INTERPRETING TEST SCOPE TRACES

by J. F. Rider

Over 500 actual photographs of test scope traces. Shows how to use scopes and what traces mean. Valuable for servicing TV receivers, FM and AM radio receivers, audio systems and test equipment. Specific test equipment set-ups shown with each application. No other book like it! Over 140 pages..... Only \$2.40

TV SWEEP ALIGNMENT TECHNIQUES

by Art Liebscher, Test Equipment Specialist

Never before has there been a book such as this on TV sweep alignment! An expert gives you accurate time-saving methods—and tells you how they work. Introduces the new Supermark method. Chock-full of sweep curve pictures. Valuable for servicing in UHF signal areas. 123 (5 1/2 x 8 1/2") pp., illus..... \$2.10

Write for complete RIDER catalog

Buy these books now from your jobber... bookstore

... If not available from these sources, write to:

JOHN F. RIDER

PUBLISHER, INC.
480 Canal Street, New York 13, N. Y.

Dept. RE-12

RATING POWER TRANSFORMERS

By DARWIN H. HARRIS

USUALLY, the most important rating of a power transformer is the maximum B plus current it can supply. Here is a simple yet reliable method for measuring that current. It is especially useful for checking surplus transformers, which are often rated optimistically, to say the least; or for checking those beautiful hermetically sealed military-surplus jobs which most of us find irresistible, and then wonder what to do with, because no one seems to know their specifications.

The first step is to measure the resistance of the high-voltage secondary winding. (One side of a center-tapped winding is enough, but it's a good idea to check both sides to make sure you don't have an open winding.) Then, with all secondaries unloaded, connect the primary across the power line and measure the voltage (be careful!) across the half-secondary. If the transformer is already installed and wired into a piece of equipment, remove all the tubes, and take resistance and voltage readings at one of the plate pins of the rectifier socket.

Divide the open-circuit voltage by the measured resistance. This gives a figure (called here the V/O ratio) which is the formula for current; however as used in this case, it is meaningless. (If we wished to apply Ohm's law, we would use V/Z.) To get the figure we want, multiply the V/O ratio by the factor 25 for a capacitor-input filter, or by the factor 35 for a choke-input filter. The answer is the current capacity in milliamperes.

The principle is simple: The resistance of the secondary is a function of the size and length of the wire in its winding, while the voltage is a function of the length of wire alone. The V/O ratio is then a function of the size of wire only, and this is a measure of the allowable current. Of course, a number of other factors contribute to the development of heat, which is the basic limitation to the current drawn; all such characteristics that are a part of the transformer are assumed to be of average value, that is, their net effect is considered constant.

This would not be true over a wide range of transformer sizes. The factors given are known to apply to small and medium sizes, up to about 200-ma ratings. The author has had little experience with larger units, and the application of this method in that range is uncertain.

It is important to take account of the difference in load resulting from the type of filter input used, by employing the appropriate factor.

Here are three examples showing how to use this rating method:

BLAK-RAY SELF-FILTERING ULTRA-VIOLET LAMP



BLAK-RAY 4-watt lamp, model X-4, complete with U-V tube. This lamp gives long-wave ultra-violet radiation having a wave-length of 3654 to 4000 angstrom units. Some of the substances made to fluoresce visibly when illuminated by U-V light are certain woods, oils, minerals, milkstone, cloth, paints, plastics, yarn, drugs, crayons, etc. This lamp is self-filtering and the invisible U-V rays are harmless to the eyes and skin. Equipped with spectral-finish aluminum reflector. Consumes only 4 watts and can be plugged into any 110 volt 50-60 cycle A.C. outlet. Will give 2000 to 3000 hours of service. It weighs but 1 1/4 lbs. Approved by the Underwriters Laboratories and has a built-in transformer so that it may be safely used for long periods when necessary. Extra U-V tubes are available.

Shp. wt. 4 lbs.
ITEM NO. 125
UNUSUAL BUY..... \$16.75

POWERFUL ALL PURPOSE MOTOR

Sturdy shaded pole A.C. Induction motor. 15 watts, 3000 rpm. 3"x2"x1 3/4"; 4 mounting studs; 7/8" shaft, 3/16" diameter; 110-120 volts, 50-60 cycles. A.C. only. When geared down, this unit can operate an 18" turntable with a 200 lb. dead weight. Use it for fans, displays, timers and other purposes. Ship wt. 2 lbs.

ITEM NO. 147
UNUSUAL BUY \$2.45

WATTHOUR METER

Leading makes—reconditioned. Ideal for trailer parks. 100-110 volts, 60 cycles, 2-wire A.C. 5 amp. Heavy metal case 8 1/2" x 6 1/4" x 5". Easy to install. Ship. wt. 14 lbs.

ITEM NO. 83
NOW ONLY \$4.50

WESTERN ELECTRIC BREAST MIKE

Lightweight 1 lb. carbon microphone. Aircraft type. Breastplate mounting, adjustable 2-way swivel. Easily fastened straps. For home broadcasts, communications etc. Complete with 6 foot cord, hard rubber plug. Sheradized plate, non-rusting finish. Ship. wt. 2 lbs.

ITEM NO. 152
NEW LOW PRICE \$2.25

AMAZING BLACK LIGHT

250-watt ultra-violet light source. Makes fluorescent articles glow in the dark. Fits any lamp socket. For experimenting, entertaining, unusual lighting effects. Ship. wt. 2 lbs.

ITEM NO. 87
A SAVING AT \$2.45

250 POWER TELESCOPE LENS KIT

Make your own high powered 6 ft. telescope. Kit contains 2" diam., 75" focal length, ground and polished objective lens and necessary eye pieces. Magnifies 50x to 250x. Full instructions. Ship. wt. 1 lb.

ITEM NO. 123
YOU SAVE AT \$2.95

HUDSON SPECIALTIES CO.
25 West Broadway, Dept. RE-12-53
New York 7, N. Y.

I am enclosing full remittance for items circled below. (Be sure to include shipping charges.)

OR, my deposit of \$..... Ship balance C.O.D.

MINIMUM C.O.D. ORDER \$5.00.

C.O.D. ORDERS ACCEPTED ONLY WITH 20% DEPOSIT

INCLUDE SHIPPING CHARGES.

Circle Items Wanted

87 147 33 152 125 123

Name..... Please Print Clearly

Address.....

City..... Zone..... State.....



**YOUR ELECTRONIC
EQUIPMENT**

Demands Highly Specialized

WIRE

THE MANUFACTURERS
AND SERVICE MEN
WHO SERVE BEST

Specify

Belden

WIREMAKER FOR INDUSTRY

Follow this path to faster, more profitable repair service

If you're like thousands of other busy Service Engineers, you can't afford to sacrifice profit time — hunting for repair parts. That's why it pays to have your Centralab controls on hand when you need 'em — in one of these 3 handy Blue Shaft Control kits. Assortments contain *exact* replacement values you use every day, in plain or switch types, for popular radio and TV sets!



Kit deal B-A
contains 22 controls (8 types) in $\frac{1}{2}$ and 1 megohm. All units C₂ audio taper. Standard full-length fluted mill and split-knurled shafts.



Kit deal B-B
newest, revised. Has 22 controls (15 C₂ types, —1000 ohms to 5 megs) plus 4 Fastatch* type KB line switches.



Handy Plastic-Paks
of 12 controls each in 10 fast moving assortments. You pay for parts only — no charge for metal or plastic containers.

And remember . . . switches are factory-attached and tested for immediate installation. Your Centralab distributor has plenty of Blue Shafts on hand to keep kits well-stocked. Order kits from him NOW.

*Trademark

Centralab

CENTRALAB
A Division of Globe-Union Inc.
922L E. Keefe Ave., Milwaukee 1, Wis.
Please send me Catalog 28 with complete details on Centralab Radio-TV control kits.

Name _____

Firm _____

Address _____

City _____ Zone _____ State _____

1. A small replacement type transformer is rated "700 volts c.t. at 50 ma." The secondary measured 650 ohms and 840 volts open-circuit. The V/O ratio is 1.3; 25 times 1.3 equals 33 ma for capacitor input, and 35 times 1.3 equals 46 ma for choke input. It appears that the advertised rating applies only to choke input, and the high secondary voltage confirms this. The extrapolated regulation line would intersect zero current at roughly 560 volts d.c. (half secondary unloaded r.m.s. voltage times 1.33) and assuming purposely poor regulation of 2,000 ohms, voltage at the filter output with a 50-ma load would be 460 volts (560—2,000 × .05) approximately. With choke input, assuming 1,000 ohms regulation and a 50-ma load, the corresponding voltages would be about 380 and 330 respectively.

2. A husky-looking good-quality surplus transformer was rated by the seller at 125 ma. This was wired into a circuit without checking the current rating (before this method of checking was adopted), and the transformer ran

very hot when operated at the supposedly conservative load of 50 ma. Later measurements of the secondary gave 550 ohms and 550 volts. The V/O ratio is 1.0, and ratings become 25 ma and 35 ma for the respective inputs. This is an extreme example of mis-rating; usually surplus transformers turn out close to the listed current figure.

3. The power transformer in my oscilloscope was running hot and I was interested in comparing the actual current with the V/O rating. The secondary readings were 1,300 ohms and 850 volts. This gave a V/O ratio of 0.65. The filter is capacitor input, so the rating is 17 ma. The measured current also showed exactly 17 ma—a rather surprising agreement. The overheating was due to inadequate ventilation. This was remedied by punching ventilating holes in the case and by covering the bright aluminum interior with flat black paint, resulting in a markedly cooler ambient temperature. This system may not be foolproof, but it's a step in the right direction. END

IMPROVED TV AND FM ALIGNMENT PROCEDURE

By JOHN VAN DORMOLEN

FOR your own satisfaction as well as for the customer's benefit, you should check the alignment of every TV set that you repair. Do this after you have fixed the other troubles and the set is in operating condition.

Most technicians think of a careful TV-i.f. alignment as a long-drawn-out operation that involves the following procedure:

1—Set up the TV receiver for picture-i.f. over-all response check, with sweep generator, marker generator, dummy antenna, and oscilloscope connected according to set manufacturer's instructions (See Fig. 1).

2—If the response is too far out to be corrected by minor adjustments, disconnect the oscilloscope and replace with a v.t.v.m.; disconnect the sweep generator and hook up the marker generator alone.

3—Set the marker generator to each trap frequency in turn, and adjust the corresponding traps for *minimum* output on the v.t.v.m.

4—Set the marker generator to each i.f. alignment frequency in turn and adjust the corresponding i.f. windings for *maximum* output on the v.t.v.m.

5—Disconnect v.t.v.m. and replace with oscilloscope; disconnect marker generator from receiver and replace with original sweep-generator-marker-generator hookup.

6—Check over-all response and make

any adjustments needed to get the correct curve.

I get the same results in much less time with the following method:

1—Hook up the sweep generator, marker generator, dummy antenna, and scope, and check the i.f. response as before. If realignment is necessary turn the sweep-width or deviation control on the sweep generator to zero; throw the sweep center-frequency dial or band-selector switch out of the i.f. band.

3—Turn on 400-cycle modulation in the marker generator (modulated r.f.).

4—Using the height of the 400-cycle waves on scope screen as an indicator, tune traps for *minimum* output, and i.f. windings for *maximum* output at specified marker frequencies, as before.

5—To check the over-all response merely reset the sweep-width or deviation control to its original setting, and put the sweep center frequency back in the i.f. pass-band.

A little practice with this procedure will give you speed and confidence, and some of your most valuable test equipment will stop collecting dust.

The same method can be used for aligning the TV sound section or any FM receiver. It speeds up discriminator or ratio-detector alignment, since all three instruments are hooked up at all times, and *only one connection*—the hot scope lead—has to be changed for any checks or adjustments. END

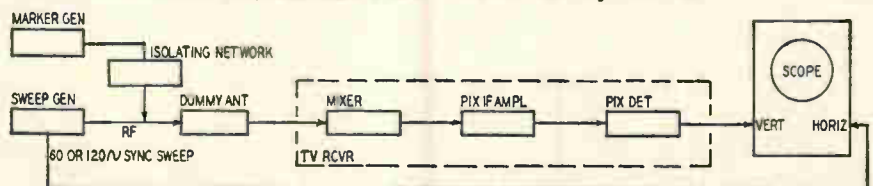

Fig. 1—Block diagram of typical setup for checking TV-i.f. over-all response.

Now! RAD-TEL Tubes & Parts At Savings!

HI-VOLTAGE F. COIL
4500 Volts RF Transformer
List Price \$7.50
Ideal for T.V. and Oscilloscope power supplies, using 5" x 7" tubes. This buy is too BIG to be beaten!



79c

Smashing Reductions on F.P. CONDENSERS
All famous makes. Save plenty on these top quality FP Condensers. Made by leading manufacturers. You can't miss—these values are hits no matter how you look at them!



CERAMICON KIT
1 kit of 50 assorted ceramic disc plates, tubular condensers. All condensers used in T.V. and P.M. sets. A MUST kit.
List price—\$10.00
\$1.99

DRY ELECTROLYTIC CAPACITORS
10 Mfd 500 WV 600 Peak
A higher rated capacitor at a lower price. Box of ten (10).
List price \$27.50
... OUR price is **\$2.95**



FILTER CONDENSER KITS 150 V. (#10 To A Pkg. Minimum)
At this price you'll be ordering in quantities. Kit of 10 20-20... \$2.95
Kit of 10 40-40... 3.25
Kit of 10 50-30... 3.25
List Price \$15... 3.25



FILTER CONDENSER 20-20 Mfd. 450 V.
Color-coded leads. Ideal for use where impossible to use metal cans. For top performance at give-away price. List price \$2.40.
49c



BIAS CONDENSERS 500 Mfd 12 V. Famous name manufacturer. Maximum value, minimum price.
List price \$2.00
Package of ten (10) \$2.95
35c each



CAN ELECTROLYTICS

Capacity	DC Working Voltage	Price
40-10-10-100	450-450-450-200 Bendix	.89
40-40	450-450	.99
250-1000	10-6	.49
40	450 Standard Brand	.89
60-10-10-20	450-450-450-150	.89
20-8-8-8	450-450-450 Standard Brand	.99
30-30-20	450-450-450-250	.99
80	450-450-25 Standard Brand	.79
35	500 Standard Brand	.79
15-15-20	450 Standard Brand	.49
40-10-100	450-25 Standard Brand	.59
40-40	450-450-200	.79
15	450-50 Standard Brand	.59
10	450 Standard Brand	.39
10-20	450-25 F.P.	.39
10-8-8-8	450-450-450-150	.49

RESISTORS
(Assortment of 200) Standard RTMA Coded or Value Printed, Uninsulated, 1/2 Watt, 1/4 Watt, and Some 10 Watt. RAD-TEL SUPER BUY!! Assortment of 20 for **\$1.39**
List price—\$10.00



National Turret T.V. BOOSTER
Made by National, famed for quality and precision communications equipment. Turret selects each channel. Completely self-contained including tube and selenium rectifier for A.C. operation. Housed in metal cabinet. In factory-sealed cartons with complete instructions.
List price \$39.95
\$9.95



25 Paper BY-PASS CONDENSERS
An assortment of 25 by-pass condensers, made by leading manufacturing companies. Top quality. Most popular sizes and voltages. Values .002 to 2 MFD 200 to 1000 VDC.
Kit of 25 **\$9.95**



ANODE CAPS Fit all TV sets. Phonbor metal plus wick number insulator and high voltage 1/2 inch. Seize this buy NOW!
List price—\$1.95
19c each



ALL BRAND NEW PARTS!

FILAMENT TRANSFORMER 6.3V @ 1.2 A
For damper use with 6W4, etc. High voltage insulation between primary and secondary to withstand high voltage surge. Can be used for general replacement.
List price—\$1.75
79c



Kit of 50 MICA CONDENSERS
All popular sizes of mica condensers. In regular and silver construction. For FM and TV use.
List price—\$12.50
\$1.95



AMERICAN MAKES KIT OF 100 RESISTORS
50 1/2 and 1/4 Watt, 25 - 1/2 Watt, 25 - 2 Watt. All new, all clean. Good value.
List price—\$15.00
\$2.65



RCA Type FLYBACK TRANSFORMER Type 21ST1
Lowest net price elsewhere—\$4.70
At this give away price, order in quantity while they are available.
95c each



LOWER PRICES THAN EVER BEFORE!
Famous Standard Coil CASCADE TUNER
Famous standard tuner T.V. front end. Double the gain with a great reduction in noise. A MUST for fringe area replacement. Includes tubes 6BK7 or 6BQ7 and GJ8.
List price \$34.50
\$18.95



Hi-Watt RESISTOR KIT
Consisting of 5, 10, 15 and 20 Watt vitreous tube resistors by Ward, L.R.C., etc. A top-tenant buy!
Assorted Kit of 20 **\$1.95**



Hi-Voltage SUPPLY 4500 Volts 6 MA. 12A7 oscillator 1B3 rectifier
Complete 10' wired enclosure in shielded metal case, removable cover. Improve performance of your scope, use as R.F. high voltage supply.
Kit of 2 tubes for \$1.08
\$2.95



Horizontal TRANSFORMER Type 204T1
A horizontal Output Transformer designed for deflection circuits employing re-energated high-voltage supplies. Intended for 50" magnetic-deflection kinescopes. Used with RCA Deflecting Yokes 201D1, 201D2, 201D3 or 201D12.
List price—\$13.95
\$2.95



Kit of BATTERY PLUGS Polarized, 3, 4, 5, etc. 50 For **\$1.69**



Cathode Ray TUBE REJUVENATOR
Fits all makes of picture tubes. Completely automatic. Easy to install, no tools needed. For A.C. parallel circuits. (Available for all sets.)
Your Old Picture Tubes Are Still Useful!
List price—\$5.95
Everyone is a potential user—10 for **\$1.59**



FOCUS COIL EM-PM
Heavy alnico magnet. Uses less power. Found in GE etc. TV sets. Unbeatable quality!
List price \$7.50.
99c each



Hi-Watt RESISTOR KIT
Very good value, makes conversion profitable and simple. Get 'em while they're still around!
List price—\$7.50
\$1.95

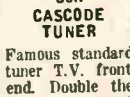

Complete 10' wired enclosure in shielded metal case, removable cover. Improve performance of your scope, use as R.F. high voltage supply.
Kit of 2 tubes for \$1.08
\$2.95



Kit of 2 tubes for \$1.08
\$2.95



.. OLD FASHIONED SAVINGS!

Hi-Voltage T.V. CONDENSERS

Capacity	Price
500mmfd. .10KV. .5	.39
500mmfd. .15KV. .49	.49
500mmfd. .20KV. .49	.49
500mmfd. .30KV. 1.59	1.59

4 x 6 Inch Well-Known P.M. SPEAKER
Alnico 5 Field. Lowest price oval speaker ever offered. Can be used in almost every table model television set. Exceptional high and high quality.
List price—\$4.75
\$1.95



12" Magnavox P.M. SPEAKER
Heavy Magnet. Delivers high volume and clear tone. Ideal for radio and P.A. use, and replacement of small speakers —for better tone.
List price—\$15.00
\$5.95



70% to 90% OFF ON TUBES!

All Tubes Individually Boxed! Same Day Service! Check this list for Fully 1-Year Guaranteed Tubes.

Type	Price	Type	Price	Type	Price	Type	Price
0A2	.37	6AR5	.37	6E5	.42	12X7GT	.52
0C3	.72	6AT6	.37	6T8	.56	12SR7	.49
0D3	.70	6AU4	.68	6U4	.60	12V6GT	.46
0Z4	.58	6B6	.62	6U6	.64	144T	.44
1ASG7	.30	6AV5	.83	6U6	.64	144T	.44
1A7GT	.47	6AV6	.37	6U8	.61	147	.30
1AX2	.62	6AX4	.64	6V6GT	.44	147	.30
1B3	.68	6B4C	.64	6V6GT	.44	148CG	.95
1B7GT	.30	6BA6	.39	6V6GT	.44	148CG	.95
1C5GT	.43	6B7	.62	6V8	.37	19T8	.69
1E5GT	.29	6BC5	.49	6X5GT	.37	19T8	.69
1G6	.24	6BD5GT	.49	6X8	.47	25A5V	.83
1M4G	.30	6BD6	.74	6X8	.47	25B06	.79
1M5GT	.40	6BE6	.39	7A7	.69	25B06	.79
1L4	.48	6BF5	.47	7A7	.69	25L5GT	.39
1L5	.49	6BF6	.37	7AF7	.53	22Z5	.66
1N5	.57	6BG6	1.25	7B4	.44	26	.45
1P5	.57	6BH6	.43	7B6	.39	26	.45
1Q5	.58	6BK6	.43	7C5	.69	35	.58
1R5	.49	6BQ6GT	.79	7C6	.40	35B5	.40
1S4	.79	6BQ7A	.90	7E6	.30	35C5	.39
1S5	.43	6BQ7B	.90	7F7	.46	35L6GT	.41
1T4	.49	6C4	.37	7X7	.70	35W4	.37
1T5	.53	6CSGT	.39	7Y4	.70	35W4	.37
1U5	.49	6C6	.58	7Z8	.61	35Z5GT	.47
1V5	.43	6CB6	.41	12AL5	.37	38	.39
1V	.53	6CD6C	1.11	12AT6	.37	41	.49
1X2A	.83	6C6	.45	12AT7	.66	42	.42
2A3	.30	6E5	.48	12AU4	.38	43	.55
2A4G	.24	6F5GT	.39	12AV7	.54	45	.85
2W3	.59	6G6	.59	12AV7	.39	45Z3	.44
2X2	.59	6G6G	.52	12AV7	.63	45Z5	.49
3A4	.45	6H6GT	.41	12AX4	.56	50A5	.79
3E5	.48	6H6GT	.43	12AX7	.56	50B5	.43
3Q4	.48	6J6	.52	12AY7	.59	50C5	.39
3Q5GT	.49	6J7G	.43	12B6A	.60	50C5GT	.61
3A5	.58	6K6	.47	12B6A	.60	50Y7	.50
3V4	.51	6K6GT	.37	12BD6	.45	50Z3	.24
5U4G	.50	6K7G	.44	12BE6	.45	50Z3	.24
5V4	.43	6L6	.64	12BE6	.39	57	.58
5Y3GT	.37	6Q7G	.45	12BH7	.39	58	.58
5V4G	.35	6Q7G	.45	12BH7	.39	58	.58
5Z3	.52	6Q7G	.45	12BK7	.65	71A	.60
6A8	.62	6S47GT	.43	12C6	.44	76	.44
6AB4	.64	6S47GT	.43	12C6	.44	76	.44
6AF4	.64	6S47GT	.43	12C6	.44	76	.44
6AG5	.48	6S47GT	.43	12C6	.44	76	.44
6AG7	.59	6S47GT	.43	12C6	.44	76	.44
6AM4	.65	6S47GT	.43	12C6	.44	76	.44
6AJ5	.65	6S47GT	.43	12C6	.44	76	.44
6AK5	.65	6S47GT	.43	12C6	.44	76	.44
6AL5	.65	6S47GT	.43	12C6	.44	76	.44
6AQ5	.39	6S47GT	.43	12C6	.44	76	.44
6A06	.37	6S47GT	.43	12C6	.44	76	.44

5" Utah AUTO SPEAKER 3 OHM FIELD
Exceptional price for a standard well-known speaker. Designed for auto radio use.
List price—\$5.05
79c



VOLUME CONTROL KIT
Kit of 10 includes 3 wire-wound 2 dual pots. 5 carbon
The price of one (1) for the quantity of ten (10). Short and long shaft.
PER KIT **\$1.79**

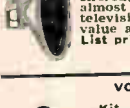

AUTO VIBRATORS (Kit of 5)
Sync. and non-sync. Mfd. by Oak Mfg. Electronic others. Four (4) and seven (7) prong.
\$1.95



KNOB KIT (Choice Groups)
Assortment of home, auto, and T.V. knobs. All colors—plastic, wood and bakelite knobs.
Bag of 50 \$1.29
Super Bag of 100 extra val. \$1.95
Bells from 12c to 18c each



Kit of LOOP ANTENNAS
Stamped high efficiency type. Can be used with most sets. For Emerson, Hallicrafter, Sentinel, etc.
Kit of ten **\$1.29**



Order Today .. Save Plenty!

T.V. RADIO, and F.M. COIL KITS
Kit for television servicemen and experimenter consisting of width coil, peaking coil, 4.5 m.c. ratio detector, and 4.5 m.c. IF coil.
TV. Standard kit of ten (10) **.99c**
TV. Super value; not duplicated **25 — \$1.85**
Broadcast and short-wave, midgeet to multi-band replacement coils. Kit each **.99c**
BC. Standard kit of ten (10). **.99c**
BC. Super value; not duplicated. **25 — \$1.85**
BC kits include RF, Osc., IF and detector coils.



Kit of WAFER SOCKETS
Assortment of 6, 7, 8, and 9 pin sockets. These are brand new, standard manufacturer.
Kit of 50 **\$1.49**



Vertical OUTPUT TRANSFORMER
Very popular, used in most T.V. sets. Well-known manufacturer. Matches vertical output tube to the deflection yoke. 10 to 1 ratio. A terrific buy on a top performer.
List price—\$4.50
95c



SOLDER LUG STRIPS
Kit of 48—very usable assortment of solder lug terminal strips. Brand new. Unusually fine work.
Kit of 48 **98c**
List price—\$4.00



TERMINAL STRIPS
Assortment of 50 terminal strips (new design). Kit contains wide selection to meet every design.
Kit of 50 **89c**
2, 3, 4 and 5 screw strips



TERMS: A 25% deposit must accompany all orders—balance C.O.D. All shipments F.O.B. Irvington warehouse. Orders under \$10—\$1.00 Handling Charge. Subject to prior sale.

RAD-TEL TUBE CO.

"Integrity Is Our Chief Asset"
Phone: Essex 5-2947 115 Colt Street
Dept. RE-12 Irvington 11, N. J.

THE #630 TV RECEIVER remains unmatched for quality and performance • RCA designed and developed this set quality-wise not price-wise • The original 10" set retailed at \$375.00 • Subsequent TV sets serve to prove the sacrifice of quality for price • What better proof can there be of its superiority than the fact that it is the choice of TV engineers and TV technicians! Herewith we offer you—YOUR BEST BUYS IN TV! All you pay is the price shown • • • Excise taxes have already been paid by us.

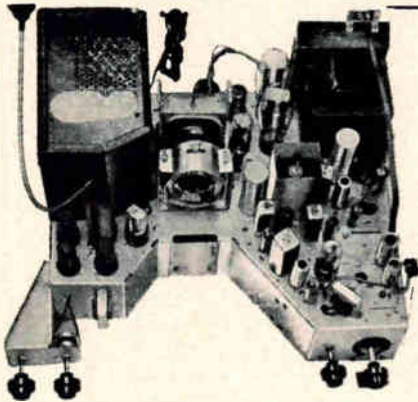

Build your own
#630
Super Deluxe
TV CHASSIS
 with . . . U. H. F.

With a #630 SUPER DELUXE 31-TUBE TV KIT including your favorite U.H.F. Station • OPERATES 16" TO 24" P.C-TUBE TUBES • Engineered in strict adherence to the genuine RCA #630 plus added features • FULL 4MC BANDWIDTH • CAS-CODE TUNER • COSINE DEFECTION YOKE • LARGER POWER TRANSFORMER • KEYED AGC • 12" SPEAKER • UNIVERSAL MOUNTING BRACKETS • CONDENSERS and RESISTORS at rated capacities and tolerances. You receive a COMPLETE SET OF PARTS and TUBES, everything needed is included (less wire & solder). All I.F. Coils and Transformers are factory pre-aligned and tuned. You will enjoy building it with "LIFE-SIZE easy to follow step-by-step ASSEMBLING INSTRUCTIONS" included with each KIT.

NOTHING BETTER AT ANY PRICE!
 only . . . **\$119.44**

#630 SUPER DELUXE TV CHASSIS

with U.H.F.—Licensed under RCA patents
COMPLETE READY TO PLUG IN AND PLAY—Similar in characteristics and features to the TV KIT at left • Manufactured especially for us by Regal Electronics Corporation • No efforts or expense have been spared in workmanship or materials, to make this #630 SUPER DELUXE TV CHASSIS the Best obtainable for fringe areas, clarity and all-around-performance, regardless of price. Customers report reception better than 200 miles • Each Set is factory aligned and air-tested • All parts carry the RMA three month guarantee • Our mass volume of business on this CHASSIS (numbering thousands of pleased customers) now makes it possible for us to reduce the price to . . . only **\$157.97** (less CRT)

2-#630 TV SPECIALS BY TECH-MASTER

both with U.H.F.
TECH-MASTER Model C-30 TV CHASSIS. This Model has retained the outstanding characteristics of the RCA-630 circuitry, namely the four-stage, full bandwidth picture IF strip and the three-stage FM sound section • In addition, the latest innovations in synchronization and sweep circuits have been incorporated to produce a custom-quality receiver assuring outstanding performance • 30 tubes, 12" speaker.

Complete Ready to Plug in and Play—Special at **\$149.50** (less CRT)

TECH-MASTER Gold Medal Model 2430-9 TV CHASSIS, 90° deflection, operates all 24" or 27" rectangular and 30" round picture tubes. The last word in TV achievement • Ideal for wall or custom-cabinet mounting • Detailed technical data mailed on request, however with the knowledge that this CHASSIS is a 30-tube #630 with both TECH-MASTER'S and OUR guarantee, you need not hesitate sending your order in now.

Complete Ready to Plug in and Play—Special at **\$262.50** (less CRT)

FINEST STANDARD GUARANTEED PICTURE TUBES

MOST desirable 5 sizes—ALL RECTANGULAR • • • BRAND NEW in Factory Sealed Cartons—With a Full Year Guarantee

17" #17BP4A	\$29.63	20" #20CP4A	\$39.74	21" #21EP4A	\$44.68	24" 90° #24CP4A	\$58.26	27" 90° #27NP4A	\$82.57
-------------	---------	-------------	---------	-------------	---------	-----------------	---------	-----------------	---------

CUSTOM-BUILT CABINETS FOR #630 AND ALL OTHER TV SETS—FROM FACTORY TO YOU

5 LEADING STYLES in genuine mahogany or walnut (blond 10% extra). • • • Ready drilled for any #630 TV chassis and cutout for any 14", 17", 19", 20" or 21" picture tube at no extras in price. • • • Also supplied with undrilled knob panel for any other TV set. • • • EVERYTHING NECESSARY for an easy perfect assembly is included. Each cabinet is delivered complete as pictured with mask, safety glass, mounting brackets, backboard, backcup, hardware and assembling instructions. • • • Each cabinet is shipped in an air cushioned carton from FACTORY to YOU.

The **VOGUE**
 Most Popular
 Table Model



H-25", W-26", D-22"

\$39.89

The **MANHATTAN**
 Style, Quality, Price

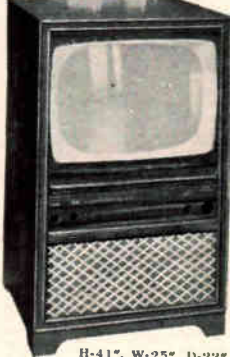

H-41", W-25", D-23"

\$59.37

MANHATTAN for 24" or 27" CRT
 H-46 1/2", W-27 3/4", D-24" **\$86.22**

The **MAYFAIR**
 Exquisitely modern, with an elegance of simplicity in styling.



H-40", W-26", D-25"

\$98.56

The **PLYMOUTH**
 Choice of interior Decorators,
 truly superb in every detail.



H-40", W-27", D-23"

\$105.48

The **TOWN & COUNTRY**
 Patterned after the popular credenza,
 Available for all size picture tubes 14" to 27"

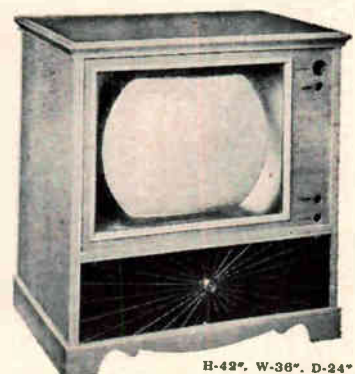

H-42", W-36", D-24"

For 14", 16", 17", 19", 20", 21", 24" or 27" C.R.T.'s **\$109.62**

#630 PARTS & COMPLETE SETS

TV WIRE & SOLDER KIT, for any Set. . . .	\$1.49
#630-KIT, screws, nuts, rivets, washers, etc.	1.69
UNIVERSAL CRT MOUNTING BRACKETS	6.97
VIDEO AND I.F. KIT, 19 items	7.84
VARIABLE CONTROL KIT, 9 controls	5.83
CARBON RESISTOR KIT, 107 resistors. . . .	6.98
WIREWOUND RESISTOR KIT, 4 resistors. . .	2.31
BRACKET AND SHIELD KIT, 18 items. . . .	8.63
ELECTROLYTIC CONDENSER KIT, & cond	7.37
TUBULAR CONDENSER KIT, 38 condensers	4.28
CERAMIC CONDENSER KIT, 28 condensers	3.37
MICA CONDENSER KIT, 11 condensers. . .	1.38

Modernize a #630 or any TV Set
 with a
STANDARD CASCODE TUNER
 For better all around performance

Complete with tubes, and Brooks CAS-CODE MANUAL with step-by-step instructions and all extra parts needed.

\$22.49

Brooks CASCODE MANUAL, how to install Cascode Tuner in any make TV Set. Postpaid **50¢**

PULSE KEYED AGC KIT
 Finest, most accurate and the easiest Kit to install in a #630 or in any other make TV receiver. Improves performance, and insures a steady picture on all channels.

COMPLETE SET OF PARTS **\$4.59**
 Including 6AU6 tube & Instructions

Brooks LIFE-SIZE TV Instructions, for building any #630 TV Receiver. Postpaid **\$2.49**

HINTS FOR BETTER PERFORMANCE, on your #630 TV receiver. Postpaid **\$1.00**

BROOKS RADIO & TV CORP., 84 Vesey St., Dept. A, New York 7, N. Y.

RADIO-ELECTRONICS

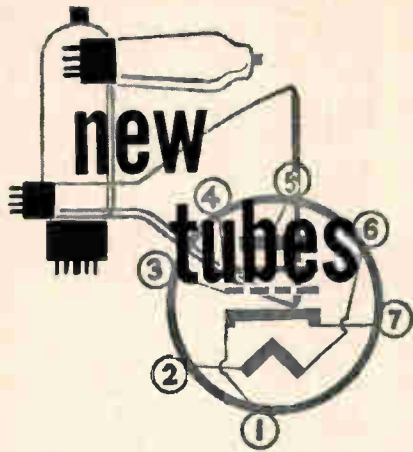

THE CBS-Colortron, an aluminized, direct-view, tricolor picture tube designed for use in color-television receivers, has been announced by CBS-Hytron. Electromagnetically deflected and electrostatically focused, the *Colortron* (HD-187) has a deflection angle of 45°, and an over-all length of 26½-inches. It provides a choice of full-color or black-and-white pictures on a screen area of approximately 104 square inches.

It is an all-glass tube with a 15-inch envelope, and uses a unique mask-and-screen assembly (see photo in *Radio Month*). It is interchangeable with the RCA 15-inch glass color tube.

The electron-gun assembly contains three matched, electrostatic-focus elec-

tron guns, each similar to the gun used in the 5TP4 projection-type black-and-white tube. The phosphor screen of the *Colortron* contains some 250,000 phosphor dots of each primary color, a total of 750,000. These dots are arranged in 250,000 triangular groups, or triads. Each triad contains one red, one blue, and one green phosphor dot.

Typical operating voltages for the HD-187 are: Anode 20,000; grid 4 (convergence) 9,300; grid 3 (focus) 3,100; with grid 2 of each gun at 200 volts, grid 1 of each gun -45 to -100; with grid 1 of each gun at -75; grid 2 of each gun 240 volts.

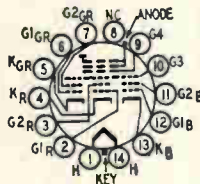

Base diagram of CBS-Colortron HD-187. Pin (1) heater; (2, 3) grids 1 and 2 of red gun; (4, 5) cathodes of red-and-green gun; (6, 7) grids 1 and 2 of green gun; (8) no connection; (9, 10) grids 4 and 3; (11, 12) grids 2 and 1 of blue gun; (13) cathode of blue gun; (14) heater; metal flange—**anode**.

CBS-Hytron also plans to mass-produce a 21-inch rectangular color tube late next year.

RCA has announced production of three new tube types, the 12X4, 6101, and 6293.

The 12X4 is a full-wave 7-pin miniature vacuum type rectifier tube intended especially for use in vibrator type power supplies of automobile radio receivers operating from a 12-volt storage battery.

Rated to withstand a maximum peak inverse plate voltage of 1,250, the 12X4 can supply a maximum peak plate current per plate of 210 milliamperes. When operated in a full-wave circuit with capacitor input to filter, and an a.c. plate-to-plate supply voltage of 650, the 12AX4 can deliver about 300 volts d.c. to the filter at a load current of 70 milliamperes. With choke-input filter and an a.c. plate-to-plate supply voltage of 900, it can deliver approximately 370 volts d.c. to the filter at a load current of 70 milliamperes.

The 6101 is a "premium" medium-mu twin triode of the 7-pin miniature type. It was designed for use as a class A amplifier and control tube in mobile and aircraft equipment, where dependable performance under shock and vibration is a fundamental consideration. It is constructed and processed to meet military requirements.

Developed from the type 6J6, the 6101 has many unique structural features. These features include additional mica insulators to keep the mount rigid and to lock the tube parts firmly in place, and an embossed cathode which is stitched to the top mica insulator and securely anchored to minimize cathode shift.

The 6293 is a small, sturdy beam-

100 ASSORTED TUBULAR CONDENSERS
All are Standard Brands & Desirable Sizes \$4.69
\$15.00 Value Only

100— ASSORTED 1/2 WATT RESISTORS \$3.97

15— Asst. Radio Electrolytic CONDENSERS \$4.74

15— Assorted TV Electrolytic CONDENSERS \$6.88

100— ASSORTED MICA CONDENSERS \$4.99

100— ASSORTED CERAMIC CONDENSERS \$4.99

100— ASSORTED 1 WATT RESISTORS \$5.86

100— ASST. PILOT LIGHTS \$4.83
#44, 46, 47, & 51

100— ASSORTED SOCKETS \$3.92
Octal, Lactal & Miniature

100— ASSORTED KNOBS \$3.97
SCREW & PUSH-ON

10— VOLUME CONTROLS \$2.94
ASSORTED, WITH SWITCH
1/4, 1/2, 1, 2 meg. and others

10— VOLUME CONTROLS \$1.94
ASSORTED, LESS SWITCH
1/4, 1/2, 1, 2 meg. and others

TV SAFETY GLASS in POPULAR SIZES
13 3/8" x 16 1/4" \$2.96 16" x 22" \$4.29
15 7/8" x 20 1/4" 3.72 22 3/4" x 25 3/8" 6.47
17 3/8" x 23 3/8" 5.24 21 1/2" x 27" 6.98

RADIO & TV TUBES
STANDARD TOP KNOWN BRANDS

At 14¢ each — 37, 38, 39/44, 77.

At 39¢ each — 35Z5, 35W4, 5Y3, 6AL5, 43, 80, 6H6, 6SQ7, 12SJ7, 6F5, 7C5, 7F5.

At 59¢ each — 1LD5, 0Z4, 5U4, 6AT6, 6K6, 6SA7, 6SK7, 7F7, 11Z3, 45Z5.

At 69¢ each — 1H5, 1Q5, 1T4, 1T5, 6C4, 6C5, 6AB4, 6AU6, 6BE6, 12AL5, 12SK7, 12SA7, 50L6, 6BA6, 6AG5, 6CB6, 6SN7, 7A8, 6AB7, 35L6, 50B5, 12SG7, 12AT6, 7V7.

At 72¢ each — 1LE3, 1R5, 1S4, 3Q4, 3Q5, 354, 12AT7, 12AU7, 12BE6, 35Y4, 14A7.

At 98¢ each — 1A7, 1B3, 1LB4, 5V4, 6AC7, 6AH6, 6AK5, 6J6, 6SH7, 6T8, 6SD7, 7F8, 25A6, 35A5, 50A5, 11Z76.

TUBE CARTONS in Lots of 100
(10% extra discount in lots of 1000)

SMALL PEANUT 1"x1"x2 1/8" \$.89

LARGE PEANUT 1"x1"x2 3/4" .98

GT TYPE 1 1/4"x1 1/4"x3 3/8" 1.06

SMALL G 1 1/2"x1 1/2"x4 1/2" 1.39

LARGE G 2"x2"x5" 1.59

EXTRA LARGE 2 1/4"x2 1/4"x6 1/2" 2.97

TV PLASTIC OPEN MASKS

Used in conjunction with safety glass
17" — Rect. 14 1/8" x 17 1/2" \$1.87
21" — Rect. 18" x 22 3/4" 3.36
24" — Round 20" x 27" 6.74
27" — Rect. 21 1/2" x 27" 7.23

MISCELLANEOUS ITEMS

- ONE POUND ROSIN CORE SOLDER.....\$.59
- UNIVERSAL OUTPUT TRANS. (any tube).. .89
- 6 FOOT LINE CORD, molded plug..... .16
- VARIABLE CONDENSER, 2 gang, super..... .59
- I. F. TRANSFORMER, 456 kc..... .49
- I. F. TRANSFORMER, FM 10.7 mc..... .58
- VOLUME CONTROL L/S 1/4, 1/2, 1 or 2 meg .24
- VOLUME CONTROL W/S 1/4, 1/2, 1 or 2 meg .47
- FAMOUS MAKE CRYSTAL PICKUP..... 2.44
- CRYSTAL CARTRIDGE, fits most pickups.. 1.42
- UNIVERSAL PICKUP, 78, 45, 33 rpm..... 4.63
- PHONO MOTOR, 78, 45, 33 rpm..... 4.97
- PHONO AMPLIFIER, incl. 3 tubes..... 4.87
- HYTRON PROBING TWEEZERS..... .35
- HYTRON TUBE PULLER..... .75
- HYTRON SOLDERING AID..... .49
- HYTRON TUBE LIFTER..... .15
- HYTRON PICK-UP STICK..... .05
- HYTRON 7-PIN STRAIGHTENER..... .55
- HYTRON 9-PIN STRAIGHTENER..... .55
- HYTRON AUTO RADIO TOOL..... .24
- SPRAYWAY PLASTIC SPRAY..... .98
- SPRAYWAY ALUMINUM ENAMEL..... .98
- TV HIGH VOLTAGE PROBE..... .49
- TV BACK CUP, recesses C.R.T.59

TV CRYSTAL-CLEAR LUCITE MASKS

Framed in Rich Gold Leaf Finish

Tube Size	Overall Dimensions	Price
17"	Rect. 13 1/2" x 17"	\$5.97
21"	Rect. 15 3/4" x 20 3/8"	8.84
24"	Round 20 1/2" x 26 1/4"	14.65
27"	Rect. 21 1/2" x 27"	15.48

(Including Set of Rosettes)

Resistor & condenser code charts FREE with each order

BROOKS RADIO & TV CORP., 84 Vesey St., Dept. A, New York 7, N.Y.

What the well-dressed window is wearing

Radio Supplies, Inc.



It's all up and down the street—the new Craftsmen CA-1 "ASSEMBLY" High Fidelity Home Music System and its eye-catching, sales-building window display. An unbeatable combination of Craftsmen quality and visual appeal that's paying off in big sales (and satisfied music lovers) everywhere!

high fidelity by **craftsmen**[®] means distinctly better listening

The Radio Craftsmen, Inc., 4401 N. Ravenswood Ave., Chicago 40, Ill.

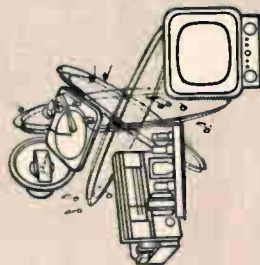

developed Automatic Frequency Control. High sensitivity for fringe areas.
4. C400 Amplifier offers exceptional performance at low cost. Frequency response: 15-20,000 cps, less than 1% distortion.
5. C30 Three-speed Record Player features chrome face plate, dual-sapphire variable-reluctance pickup. Specially designed.

1. Six-piece window display in color, die-cut for attention value. Small note cards can be used individually (available for all products) on counter shelf or window.
2. C20 Coaxial Speaker, specially designed to Craftsmen specifications, 12" woofer and horn tweeter, self-contained crossover network.
3. C10 FM-AM Tuner features Craftsmen-

power-amplifier tube intended for pulse modulator service in both fixed and mobile equipment.

Rated for service with duty factors up to 1.0 together with a maximum averaging time of 10,000 microseconds in any interval, the 6293 offers the equipment designer a wide choice of operating conditions involving different combinations of pulse lengths and repetition rates. For example, the 6293 can deliver a peak plate current of 3 amperes during a pulse length of 30 microseconds under conditions with duty factor of 0.003 and plate-supply volt-

at high line conditions, and increased ruggedness to withstand momentary overloads.

Amperex Electronic Corporation announces the addition of a new tube, type 6252, to its line of twin tetrodes. It is a lower-power version of Amperex type 5894 AX9903. Its maximum plate dissipation rating is 20 watts under ICAS conditions and it works efficiently with a power output of 12 watts at 600 mc. It has been successfully operated as a frequency multiplier over the entire u.h.f. television band. The tube is particularly suitable for low-drain mobile transmitters and multiplier chains.

Rounding out a wide selection of new tubes this month, RCA announces production of the 5ABP1, 5ABP7, and the 5ABP11, a new series of 5-inch, flat-face, C-R tubes utilizing electrostatic focus, electrostatic deflection, and post-deflection acceleration. They differ from each other only in the spectral-energy emission and persistence characteristics of their respective phosphors, P1, P7, and P11.

The 5AB types have exceptionally high sensitivity and low capacitance electrodes provided for vertical deflection. These electrodes are especially suited for operation from wide-band amplifiers, the high sensitivity making up for the low signal output of such amplifiers, and the low capacitance providing the type of load into which such amplifiers work best. The horizontal deflecting electrodes have higher sensitivity than previous similar electrostatic types while retaining full screen deflection.

Another feature of these new types is the small size and high brilliance of the fluorescent spot, characteristics which make it possible to "see" more, even with high-speed phenomena. The 5AB types can generally be substituted for the corresponding older 5C types to give improved performance. END

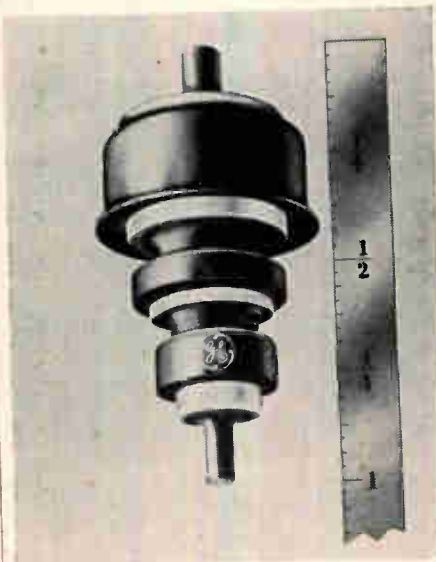

Type GL-6299 is a coplanar triode.

age of 2,000; or a peak plate current of 1.4 amperes during a pulse length of 200 microseconds under conditions with duty factor of 0.02 and plate-supply voltage of 3,500.

General Electric is producing a new metal-and-ceramic receiving tube with a noise figure of 8.5 decibels or better and a power gain of 16 decibels at 1,200 megacycles.

The tube, type GL-6299, was developed to offer a solution to some of the military u.h.f. designer's high noise-level problems in lower frequency radar equipment.

The GL-6299 is a coplanar triode designed specifically for use as a low-level class A r.f. amplifier operating at frequencies as high as 3,000 megacycles. It is 1 inch long, weighs 1/8 ounce, and is gold-plated to improve conductivity and resist corrosion.

CBS-Hytron has announced production of a beam-power tube designed for use as a horizontal deflection amplifier in television receivers, the 6CU6. Completely new in design, the 6CU6 is a rugged replacement for the popular 6BQ6-GT and is engineered to meet the demands of C-R tubes with deflection angles up to 70°. The 6CU6 features a larger bulb and a larger plate area that permit greater heat dissipation. Its specially designed micas and plate suspension provide arc-free performance. The 6CU6, interchangeable in all sets designed for the 6BQ6-GT, has an increased peak positive plate voltage (6,000 absolute maximum), longer life

STATEMENT OF THE OWNERSHIP, MANAGEMENT, AND CIRCULATION REQUIRED BY THE ACT OF CONGRESS OF AUGUST 24, 1912, AS AMENDED BY THE ACTS OF MARCH 3, 1933, AND JULY 2, 1946 (Title 39, United States Code, Section 233) of RADIO-ELECTRONICS, published monthly at Philadelphia, Pa., for October 1, 1953.

1. The names and addresses of the publisher, editor, managing editor, and business managers are: Publisher, Gernsback Publications, Inc., 25 West Broadway, New York 7, N. Y.; Editor, Hugo Gernsback, 25 West Broadway, New York 7, N. Y.; Managing Editor, Fred Shunaman, 25 West Broadway, New York 7, N. Y. Business Manager, none.

2. The owner is: Gernsback Publications, Inc., 25 West Broadway, New York 7, N. Y.; H. Gernsback, 25 West Broadway, New York 7, N. Y.

3. The known bondholders, mortgagees, and other security holders owning or holding 1 percent or more of total amount of bonds, mortgages, or other securities are: None.

4. Paragraphs 2 and 3 include, in cases where the stockholder or security holder appears upon the books of the company as trustee or in any other fiduciary relation, the name of the person or corporation for whom such trustee is acting: the affiant's full knowledge and belief as to the circumstances and conditions under which stockholders and security holders who do not appear upon the books of the company as trustees, hold stock and securities in a capacity other than that of a bona fide owner.

H. GERNSBACK, Publisher.

Sworn to and subscribed before me this 28th day of September, 1953. (Seal) Maurice Coyne, Notary Public. (My commission expires March 30, 1954.)

HANDLE *any* TELEVISION or RADIO SERVICE JOB



**easier, better
...and faster!**

**Get Ghirardi's big
PROFESSIONAL SERVICE
TRAINING LIBRARY**

**...at the special money-saving
combination price!**

TRAIN FOR BETTER JOBS... BIGGER PAY!

Here's the biggest one-two punch in modern service training—and at the lowest price! Let these two, up-to-the-minute Ghirardi training books teach you to handle ALL types of AM, FM and Television service work by approved modern methods. Learn to handle jobs faster, with less testing. Follow the fast, accurate professional service procedures that are so clearly explained—and watch both your service efficiency and your earnings soar! If broken into lesson form and sent to you as a "course" you'd regard this new Ghirardi training as a bargain at \$100 or more. Instead, you buy both big books for the bargain price of only \$12 (you save \$1.25!).

Written so you can understand every word, these two great books train you to service any type of home radio-TV-electronic equipment ever made. Almost 1500 pages and over 800 clear illustrations show step by step how to locate troubles faster and then repair them in a fraction of the usual time. Each book is profusely illustrated. Each contains the latest data on the most modern methods and equipment. Together, they provide complete service training and they're ideally suited for every day, on-the-job reference to help you solve puzzling service problems in a jiffy. **Read them for 10 full days at our risk. You be the judge!**

1 Radio & Television Receiver CIRCUITRY and OPERATION by Ghirardi and Johnson 669 pages, 417 helpful illustrations

It's lots easier to repair ANY radio or television set when you know all about its circuits and just why and how each one works. You locate troubles in much less time and with less testing. You repair them faster, better—and more profitably! That's why Radio & Television Receiver CIRCUITRY AND OPERATION is invaluable to servicemen who want to be well equipped to handle today's complicated receivers! First it gives a complete understanding of all basic circuits and their variations. It teaches you

to recognize each one quickly. Then it shows how to eliminate useless testing and guesswork in making repairs. Throughout, this book gives you the kind of above-average training that takes the "headaches" out of servicing—the kind that fits you for the better-paid jobs. Covers all basic circuits used in modern TV and radio receivers as well as phono pick-ups and record players.

Sold separately for \$6.50—or see big MONEY-SAVING COMBINATION OFFER below!

2 Radio & Television Receiver TROUBLESHOOTING and REPAIR by Ghirardi and Johnson 822 pages, 417 clear illustrations

This big book is designed to make the tough service jobs easy—and the easy ones a "cinch."

Throughout its 822 pages, Radio & Television Receiver TROUBLESHOOTING AND REPAIR is a complete, how-to-do-it guide to professional service methods of the sort that help you handle jobs a whale of a lot faster and make more money doing it! For beginners, it is a complete, easily understood course in every phase of the work. For busy servicemen, it is a quick way to "brush up" on specific jobs; to develop faster troubleshooting methods and short cuts; or to find fast answers to tough service problems.

Modern test methods are clearly explained—from "static" tests to dynamic signal tracing and all the rest. Special problems in hard-to-fix troubles are explained. Step-by-step charts demonstrate professional procedures almost at a glance. An outstandingly clear television section brings you up-to-the-minute training on everything from general troubleshooting, pattern analysis and repairs to what to do about fading or handling troublesome intermittents—and dozens of other subjects.

Sold separately for \$6.75—but save money by ordering the MONEY-SAVING COMBINATION OFFER below. Send coupon today!

SAVE \$125! 10-DAY FREE EXAMINATION

Dept. RE-123, Rinehart Books, Inc., Technical Division, 232 Madison Ave., New York 16, N. Y. Send books checked below for 10-day FREE EXAMINATION. In 10 days, I will either remit price as indicated or return books postpaid and owe you nothing.

- Check here to order books singly:
- Radio & TV Receiver CIRCUITRY & OPERATION (Price \$6.50 separately)
 - Radio & TV Receiver TROUBLESHOOTING & REPAIR (Price \$6.75 separately)
 - Check here for MONEY-SAVING COMBINATION—Save \$1.25! Both of the above big books at the special price of only \$12.00 for the two. (Regular price \$12.75—you save \$1.25.) Payable at the rate of \$3 after 10 days if you decide to keep books and \$3 a month thereafter until the total of \$12 has been paid.

Name.....

Address.....

City, Zone, State.....

OUTSIDE U.S.A.—\$7.25 for TROUBLESHOOTING & REPAIR book; \$7.00 for CIRCUITRY & OPERATION; \$13.00 for both books. Cash with order only. Money refunded if you return books in 10 days.

Make your service training library complete... have the data you need at your fingertips—WHEN YOU NEED IT! Check SPECIAL COMBINATION OFFER in coupon.

NATESA HOLDS CONVENTION

Nearly 700 service dealers and technicians from 35 areas from Texas to Ontario convened in Chicago October 9, 10, and 11 at the Fourth Annual Convention of the National Alliance of Television and Electronic Service Associations. The records indicate 659 registrations during the three days of the convention. In addition, some 30 companies rented booth space for exhibits of items of interest to the service profession.

The October 9 sessions were devoted to the subject of business promotion. Highlight of the day was the talk by Professor J. H. Hazlehurst of Northwestern University: "Are You Training Your Competition?" Professor Hazlehurst pointed out that most TV technicians are trained on the job, and that it costs time and money to train them. He suggested means for making the greatest use of that training and retaining the employee, instead of handing it over, along with the employee, to a competitive organization.

The second day witnessed possibly the most brilliant collection of papers ever read before a service convention. Opening with a talk on u.h.f. and u.h.f. antennas by John Spack of Amphenol, the program continued with the now famous talk "How To Interpret What You See," by Bill Ashby, Raytheon field engineer. Dan Creato, vice-president of RCA Service Co., spoke briefly on training for color TV, and introduced E. R. Klingman, who unveiled RCA's new Color TV Dynamic Demonstrator. This is a complete color receiver, mounted on a somewhat larger board than the older and now well-known black-and-white Dynamic Demonstrator. Constructed under the supervision of Merrill Gander, chief engineer of RCA Service Co., it operates as well as a more conventionally wired color receiver. With all its 540 parts and 1,180 soldered connections out in sight, it offers an opportunity to demonstrate the correct adjustment of a color set as well as adjustment of many forms of possible malfunctioning.

A Sunday crowd of visitors inspected the exhibits on the third day of the convention. An informal demonstration and discussion on color television occupied the earlier part of the afternoon. Later there was an excellent fundamental talk on transistors by C. E. Walters of RCA Service Co., following which Howard Sams and Bill Renner of the Sams Photofact Service discussed u.h.f. problems.

The whole slate of NATESA officers was re-elected for the next year. They are Frank Moch, Chicago, president; J. B. McDowell, Kansas City, secretary general; John Hemak, Minneapolis, treasurer; Bertram Lewis, Rochester, N. Y., Eastern vice-president; Harold (Dusty) Rhodes, Paterson, N. J., Eastern secretary; Fred Colton, Columbus, Ohio, East-Central vice-president; Francis Fingado, Denver, Colo., Western vice-president; Homer Mauer, Cheyenne, Wyo., Western secretary; and Vincent Lutz, St. Louis, Mo., West-Central vice-president.

BETTER BUSINESS

The Better Business Bureau of Columbus, Ohio, recently paid a telling tribute to organized service enterprises. Speaking through its publication "For the Home Folks," the Bureau stated: "The Columbus BBB is happy to report that it has never had a complaint against any member of the Associated Radio and Television Service Dealers" (the local service association), and goes on to point out that ARTSD is living up to its insignia: "Certified Radio and TV Service."

ARTSD has also solved a very important topical problem in modern servicing, namely, the correct definition of a high-fidelity enthusiast. According to ARTSD Service News, "A true high-fidelity fellow is one who, when he hears a girl singing in the bath, puts his ear to the keyhole!"

RETMA SPONSORS COURSE

The Radio-Electronics-Television Manufacturers Association September 21 opened a pilot course for training radio-TV service technicians in New York City. The course is open to practicing technicians with three or more years experience. Both classroom and laboratory instruction in advanced serv-

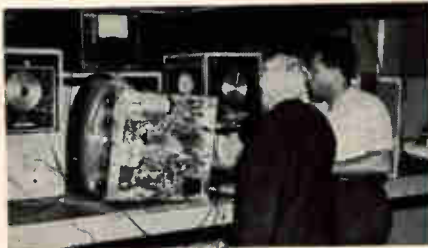

ice techniques are included in the program. RETMA member companies donated 15 benches of test equipment as well as TV receivers, components, antennas, and printed instructional material. The photo shows one of the test benches, with students at work.

NOW IT'S FTRSAP

The Pennsylvania State Federation, at a meeting held in the Sheraton Hotel, Pittsburgh, decided to take final action to change the present chartered title of the organization to *The Federation of Television Radio Service Associations of Pennsylvania*. Action was to be effective with the October meeting.

A panel discussion was held on the effect of Pennsylvania's newly enacted Consumers' Sales Tax Law and its application to the service industry in the State. A number of delegates felt that tax registration would more clearly define the margin between a wholesaler and retailer, since the latter also requires a State registration number.

NEW GROUPS JOIN NATESA

Three new radio-TV associations have joined NATESA, Frank Moch reported at that organization's annual meeting in Chicago. The new groups are: Association of Television Service Companies, Cincinnati, Ohio; Association of Western New York, Buffalo; and Rhode Island Radio and Businessmen's Association, Providence. **END**

EDLIE says "Save with confidence"
The Lowest Priced Kits on the Market



LOWEST PRICED SIGNAL GENERATOR, BROADCAST BAND

New simplified circuit provides the following switch tuned, tone modulated frequencies:
1. 455 K.C.—Intermediate I.F. frequency
2. 1500 K.C.—High frequency of Broadcast Band
3. 600 K.C.—Low frequency of Broadcast Band
4. Audio tone—for audio amplifier trouble shooting
5. An attenuator control is included for adjustment of the output signal strength
Housed in small black bakelite cabinet size 6"x6"x3 1/2". Can be useful for alignment of all Broadcast Band radio receivers. **Completely Wired. \$7.95**

INTRODUCTORY OFFER
Deduct \$1.00 if ordered with Kit #1 or #2

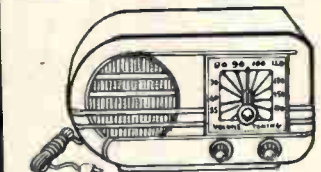

5 TUBE AC-DC SUPERHET KIT

Kit #1—Five Tube superheterodyne kit, A.C.-D.C. contains all components required to construct this latest design, highly sensitive superheterodyne broadcast receiver, complete with black bakelite cabinet (excludes wire and solder) **Only \$7.95**
Kit of 5 tubes (12AT6, 12BA6, 12BE6, 35W4, 50C5). Only \$32.25.

D 1273 INSULATED RESISTOR KIT

Contains 100 resistors 1/2, 1/2, 1 & 2 watts from 5% to 20% tolerance. Housed in a transparent plastic box. Price complete **\$1.65**

D 1278 PAPER TUBULAR BY-PASS CONDENSER KIT

Contains 50 by-pass condensers ranging in capacity from .005 mfd. to .5 mfd. and at voltages from 200 to 1600, housed in a plastic transparent cabinet, size 7" x 3 1/2" x 1 1/8". Price \$2.95 per kit.

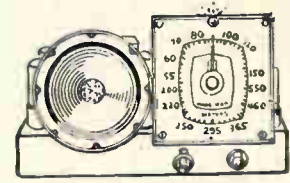

6-TUBE RADIO KIT

Kit #2—A low-priced 6 TUBE KIT designed for high sensitivity, excellent selectivity and good tone quality. Uses 25L6, 25Z6, 6SQ7, 6SA7, 6SK7, 6SK7 in an easily constructed circuit. The 6 Tube Kit is shipped with all parts, including punched chassis, resistors, condensers, coils, sockets, PM Speaker, hardware, etc.
And at a closeout price of only (less tubes and cabinet) **\$6.95**
Matched set of six tubes **\$3.25** for kit

PHONO OSCILLATOR

Not a Kit!
Wireless phono oscillator transmits recording for crystal pickups or voice from carbon mike through radio without wires. Can also be used as an intercomm by using P.M. speaker as mike. Price (excluding tubes) **\$2.95**
With Complete Set of Tubes **\$3.95**



1910 SUPERSENSITIVE TWO STATION INTERCOMMUNICATION SYSTEM.

The unit is suitable for use in home, office, factory, nursery or sick room. So sensitive it will pick up a baby's cry at a reasonable distance. Operates from 115 volts AC/DC. Both stations housed in compact plastic cabinets (6"x6"x3 1/2"), and requires only 2 wires to connect. Furnished with 50 ft of twin conductor wire. Price **\$16.95**

D 1279 DISC CONDENSER KIT

Contains an assortment of 50 Erie type disc ceramics, includes the following capacities 001, 2 x .001, .0015, 2 x .0015, 2 x .004, .0047, .005, 2 x .005, .01, 2 x .01 and 10 assorted printed circuited capacitors, housed in a transparent plastic box. Price **\$2.95** per kit.

Electronic Code Practice Oscillator & Blinker Kit

AC/DC or Battery Operated!
Kit #3—One of the most practical Code Practice Oscillators ever designed, yet one of the simplest to build and operate. Can be used with any number of headphones. Adjustable Pitch Control—Any type of headphone can be used. No warmup time—ready to operate instantly. Simple and safe to operate. Operates anywhere—with AC or DC power, or from a 90 volt Miniature Battery. Learn Blinker Code with flashing light. Blinker can be used as signaling device. International Morse Code included. Kit **\$1.95** Assem. **\$2.95** each Med

3-TUBE PHONO AMPLIFIER

Not a Kit!
An assembled unit ready for installation using tone and volume control and six feet of rubber cord (Not including Tubes) **\$2.95**

With Complete Set of Tubes **\$3.95**

D 1275 Ceramic Condenser Kit

Contains 50 assorted ceramics ranging from 0.5 mmfd to 2000 mmfd, housed in a transparent plastic box. Price **\$1.95** per kit.

Terms: All merchandise shipped F.O.B. New York City. Prices are subject to change without notice. Include 20% deposit for C.O.D.'s.
WRITE FOR NEW CATALOG—Free!

EDLIE Electronics 154 Greenwich St. DI 9-3143 New York 6, N. Y.

----- BARGAINS YOU'VE NEVER SEEN BEFORE! -----

GROUND PLANE ANTENNAS: 10-20-40 Meters
—casily made with our painted-copper-plated WHIPS
—threaded tapered sections—16 ft.—\$2.45; 32 ft.—\$5.25

Capacity	1 Amp	2 A.	5 A.	10 A.	20 A.
2- 18 Volts	\$1.35	\$ 2.20	\$ 4.50	\$ 6.75	\$13.25
24- 36 Volts	2.15	3.60	8.50	12.75	25.50
90-130 Volts	7.50	10.50	29.75	44.95	79.50

NEW SELENIUM RECTIFIERS—Bridge Type

Capacity	1 Amp	2 A.	5 A.	10 A.	20 A.
2- 18 Volts	\$1.35	\$ 2.20	\$ 4.50	\$ 6.75	\$13.25
24- 36 Volts	2.15	3.60	8.50	12.75	25.50
90-130 Volts	7.50	10.50	29.75	44.95	79.50

METAL CABINET—13 1/2"x9 3/4"x6"—less front panel. \$ 7.75
JUKEBOX CHROME SPEAKER ENCLOSURE with 5" Speaker (Table Model) **1.95**
METERS—2: 0-1 Ma.—\$3.75; 500 microA.—\$ 8.85
CRYSTAL—27.255 Mc.—Petersen Z9A **4.75**
SPECIAL—Guaranteed TUBES
RK-61 **\$3.45** XFG-1 **\$3.35** 3D6 **\$9.95**

RADIO CONTROL EQUIPMENT
TRANSMITTER & RECEIVER KIT—License Free. \$9.95
All parts & diagrams (less tubes & crystal) to build 3 Watt Transmitter Unit & 2 Tube lightweight Receiver, including SIGMA 10,000 ohm Relay.
COMPLETE RADIO CONTROL OUTFIT—Aristol TRANS-MITTER, Boomerang RECEIVER & ESCAPEMENT (less Battery) for model planes or boats **\$7.50**

RELAYS
SIGMA 4F: 8,000 ohms; 1 Ma. **4.50**
KURMAN BK-35: 1,000 ohm; 1/2 Ma. SPDT **4.25**
SIGMA 5F: Cased—dual 130 ohms; 1 1/2-6 Volts. **4.25**
Western Electric POLAR Relay—D183119A—SPDT—**8.95**
LEACH 1025-SN: 24 Volt, heavy duty DPST-NC. **1.85**
GM—Volt dual coil, Heavy contact SPST **4.95**
GM—10,000 ohm coil, Heavy DPDT—SPST **2.75**
GM—Dual coil 85 ohms, Heavy 2 Brk. + 1 Mk. **4.95**
STRUTHERS type-5000 ohm coil—2D1 + SPST **1.95**

KITS—All Kits include Diagram
MULTIMETER KIT—Basic parts to Build (less case) 3
D.C. 0-60, 600 Volts & Continuity **2.15**
R.F. PROBE KIT—For Scope, Sig. Tracer, V.T.M. **2.45**
VIBRATOR TRANSFORMER—Standard 0 Volt type **.95**

CASED TRANSFORMERS
Pri 115V/Sec 600 CT, 175 Ma, 5V/3A, 6.3V/4 1/2A **\$5.95**
Pri 216-224V/50-60 cycle/Sec 5V CT/224A Amps **6.95**
Pri 220V/50-60 cycle/Sec—10.2V/10A; 10.2V/5A; 1234V/28A; 1234V/7A **8.45**
CASED FILTER CHOKES—10 HEMO 2A 10 Ohm **3.25**
10 Henry Imp-11 Ohm **\$9.95** 10H-125 Ma. **1.95**
DYNAMOTORS—6V input 300 Volts AC @ 165 Ma, 8.50
6V input 180V-100 Ma.—\$7.95; 12V imp/600V-200 Ma. **9.50**

STORAGE BATTERIES—2 Volt: 3"x4"x5 1/2" **2.75**
MINIATURE 6 Volt—Willard NT8—2 1/2"x1 1/2"x3 1/2" **2.45**
BATTERY CHARGER: 2-6 Volt/6 A; with Indicator **7.95**
CHARGER—FOR HEAR, AID & Port. 1 1/2-90 Volts. **6.50**
1/6 HP MOTOR—12/24 Volts DC-0 K for 0 double **5.25**
1 1/2 Volt Tiny MOTOR, 6000 RPM with double shaft **1.75**
ABOVE MOTOR—VARIABLE speed GEARBOX **3.45**
GEAR BOX—600:1 Ratio 2 1/2" D. by 2" **1.45**
DC GENERATOR: 12/24 Volts to 12 Amps. (requires 5-25) **5.25**
1/6 HP or larger motor w/ pulleys **24 Volts—Operates 115V AC with series condenser—5RPH **1.25****
ALLEN-BRADLEY 1/2 POT: 5 assorted sizes for **1.49**
POWER POTENTIOMETERS: 25000 ohms—4 Watt **1.75**
50 Watt Ward Leonard 7000 ohm POT—with knob **.95**
D.P.D.T. TELEPHONE type SWITCH **1.75**
FILTRITE—TUBE 12G, 3 Amperes, 95 C for **2.45**
OIL CAPACITOR—CP-26A1; 1/2 MF/200V Tubular. **.29**

FULL STOCK OF JAN-C-25 CAPACITORS—IMMEDIATE DELIVERY. Tremendous stock of oil and transmitting mica capacitors at rock bottom prices. Send requirements. All Material Guaranteed. Free Catalog. **FREE—**with order of \$10.00 or more choice of Sensitive 10,000 ohm Relay, new BC-366 or Ball Pen.

GYRO ELECTRONICS CO.
325 Canal St., New York 13, N. Y.
WO 6-1290

NOW-TWO GREAT precise OSCILLOSCOPES

(IN KIT OR WIRED FORM)

THE NEWEST, THE ONLY ONE OF ITS KIND!

8½" OSCILLOSCOPE: PRECISE MODEL #308

Now another great Precise Oscilloscope! The only 8½" Oscilloscope on the Commercial Market... in Kit or Wired Form... at an unbelievably low price. Designed to bring you true TV picture clarity and laboratory tested accuracy.

ALL THE OUTSTANDING FEATURES OF THE MODEL 300 as shown below, PLUS:

- ★ INTENSIFIER ANODE
- ★ HI-LOW-NORMAL SYNCH. (A Precise First)
- ★ 8½ INCH TUBE (A Precise First)
- ★ VOLTAGE REGULATION (A Precise First)

"Seeing is Believing"—Go and See! your nearest jobber

308K—kit form **\$129.50**

SPECIFICATIONS: PRECISE MODEL 300 OSCILLOSCOPE
 VERTICAL — Vertical flat (3db) DC through 5 megacycles with sensitivity of greater than 10 millivolts push-pull (3.94 Millivolts cm). Constant Resistance; Push-pull input immediately converted to single-ended normal or reverse phase by shorting bar at inputs 1 and 2. Frequency compensated vertical stepping attenuator selects AC or DC inputs. Push-pull DC amplifiers from input through output. Internal electronic mixing through inputs 1 and 2; five-way binding posts.

POSITIONING — Bridge type positioning on vertical and horizontal does not vary tube characteristics.

HORIZONTAL — Frequency compensated stepping attenuator in horizontal amplifier. Push-pull horizontal out.

BLANKING — Internal (return trace blanked), external (return trace not blanked), 60 cycle or 120 cycle Blanking through Blanking amplifier circuit.

SYNCHRONIZATION — External, Internal Positive, Internal Negative, Internal 60 cycle or Internal 120 cycle synchronization.

SWEEP RATE — Driven or non-driven linear sweeps from 1 cycle to 80KC in five ranges (1-10 cycles uses external C circuit). Trigger potentiometer.

MAGNIFIER — Electronic magnifier and magnifier positioner allows any part of a signal to be magnified up to ten times (equivalent to 70 inches of horizontal deflection).

CALIBRATION — Internal square wave calibrator and potentiometer for using oscilloscope as a VTVM on Peak to Peak measurements.

CALIBRATION SCREEN — Edge-illuminated scale and graticule may be turned on or off; filtered screen.

OUTPUTS ON FRONT PANEL — Plus Gate output; Sawtooth output; 60 cycle phasing output; 60 cycle unphased output; Calibration output.

FOCUSING — Astigmatism, focus and intensity control.

CRT — NEW 7" Tube, normally supplied is medium persistence type 7JP1 (oscilloscope green trace) — high persistence types available at additional cost.

DIRECT — Deflection plates available from rear of cabinet.

INTENSITY MODULATION — Z modulation through modulation amplifier.

GENERAL — Low loss components; Over-designed fused power supply for additional circuitry. Deeply etched aluminum panel. New parts from original manufacturers — NO SURPLUS. Steel cabinet; 11" x 14" x 17"; complete with instruction book and all components; Accessories: Model 912(MM) Demodulator Probe and Model 960 Capacity Attenuator Probe available at extra cost — please see specifications on following pages.

There are many additional features and circuits in kit form, which may be added to the Model 300. Please write us for descriptive literature.

300K—kit form **\$94.95**

300W—factory wired **\$199.50**

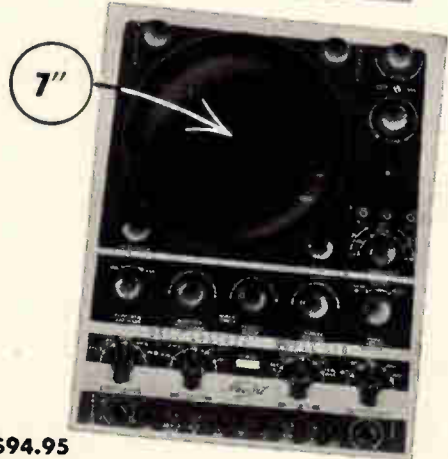
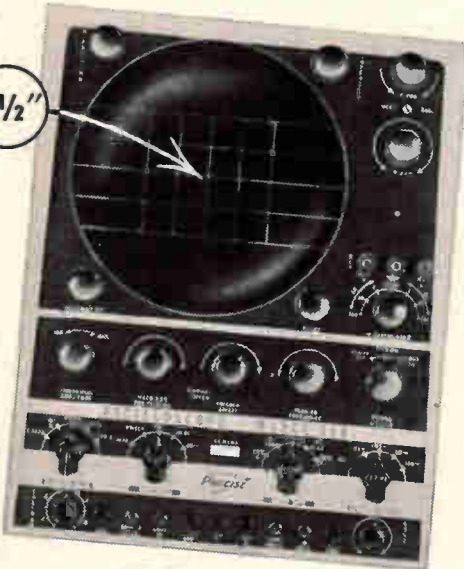

- MODEL 960 10-1 C.A. PROBE **\$5.95**
- MODEL 912 RF PROBE **\$4.25**
- MODEL 630K RF AF-TV & MARK GEN. **\$33.95**
- MODEL 610K RF SIG. GEN. **\$23.95**
- MODEL 635K UNIV AF SINE, SQ & PULSE GEN **\$33.50**
- MODEL 468K RES. DECADE BOX **\$18.95**
- MODEL 999 HI-VOLTAGE PROBE **\$6.98**
- MODEL 909K VAC. TUBE VOLTMETER **\$25.98**
- MODEL 907N DELUXE VAC TUBE VOLTMETER **\$38.98**

Prices slightly higher in the West. Prices and specifications subject to change without notice.

PRECISE DEVELOPMENT CORP. Dept. RE 24
 999 LONG BEACH ROAD • OCEANSIDE, L. I., NEW YORK
 GENTLEMEN: Without any obligation on my part, kindly send me the following:
 PRECISE CATALOG
 NAME OF DISTRIBUTOR NEAREST ME
 NAME _____
 ADDRESS _____
 CITY _____ ZONE _____ STATE _____

CONTRAST CONTROL

Patent No. 2,641,649

Robert H. Pierce, Palatine, Ill.

(Assigned to Radio Corp. of America)

TV circuits, like radio, suffer from limited dynamic or contrast range. The original TV signals must be compressed for transmission through video channels. For best contrast, it may be desirable to compress voltages representing light areas, and to expand those representing dark ones, while reducing the over-all range. This control network is instantly adjustable, and maintains constant impedance. It uses four rectifiers (1N34) and two 1,000-ohm ganged potentiometers. The output impedance is about 350 ohms.

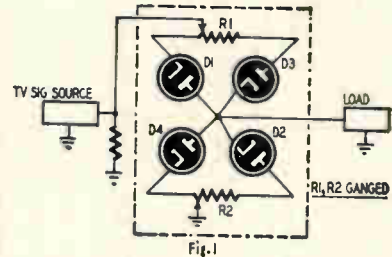

Assume that the movable arms are at the left of each potentiometer (see Fig. 1). If the video input is negative, its path is through D1, D2, and the potentiometers. R1 is minimum and R2 is maximum. The network becomes a voltage divider that passes most of the signal to the load. The greater the negative voltage, the better the conduction through D1, and the higher the percentage of signal transmitted. In other words, negative signals are expanded. See curve A in Fig. 2.

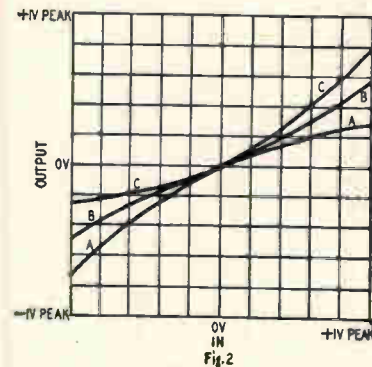

Positive signals pass through D3, D4, and the potentiometers. In this case, R1 is maximum and R2 is minimum. Less than half the input is transmitted. The greater the positive signal, the greater the conduction through D4, and the smaller the percentage of voltage passed on to the load. Thus, positive signals are compressed as shown by curve A.

When the potentiometer arms are both moved to the right, conditions are reversed. The positive signals are expanded, the negative signals are compressed. This is shown by curve C.

With the potentiometer arms set to mid-point, there is practically no compression or expansion, and the contrast remains unchanged (curve B).

SPACE CHARGE CONTROL TUBE

Patent No. 2,607,861

Herbert M. Wagner, Asbury Park, N. J.
 (Assigned to the United States of America as represented by the Secretary of the Army)

Billions of grid-controlled tubes are used for communication, computation, and control. Their performance is best at low and medium frequencies. At very high frequencies, efficiency drops off. This is due primarily to inductive and capacitive effects. This inventor suggests the use of an electron cloud for a grid. In this way the frequency range can be greatly extended.

The space-charge tube is shown in diagram. Its electron gun appears at the left of the tube. Cathode K1 emits electrons which pass through grid G toward the plate P1. They must travel over a relatively long path, so they remain within the tube for a considerable time. Thus a space charge is built up. The main tube discharge occurs between cathode K2 and plate P2, and is aided by accelerating grids A1, A2. Output cur-

precise
DEVELOPMENT CORP.
 OCEANSIDE, NEW YORK

rent flows through the load and high-voltage supply.

When G goes more positive, it passes more electrons and the space charge grows. The charge is negative so it opposes emission from K2. For example, if G is driven beyond cutoff, there is no space charge at all. Output current would then be maximum. Thus the input signal modulates tube output at all times.

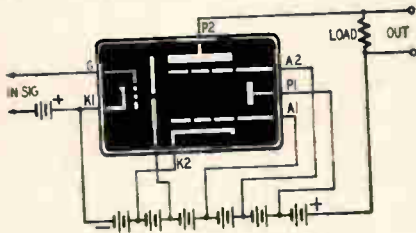

Absence of a metallic grid reduces the input capacitance and means a far greater input impedance. A space-charge tube of this type has possibilities for both control and amplification. For high gain K2 should be a much larger element than K1.

DIRECTIONAL TV ANTENNA WITHOUT MOTORS

Patent No. 2,585,670

Marvin P. Middlemark, Woodside, N. Y.

This is a directivity control for TV antennas. The antenna may be a crossed-dipole affair as shown. Leads from its four conductors end at a 9-position switch located near the receiver. The viewer turns the switch as required for maximum signal and minimum ghost.

The switch has two sections, X and Y. Each has seven fixed contacts, one of them a common terminal. Also, each section has two movable contacts (shown shaded). The smaller contacts (one on each section) are strapped together. The antenna conductors, 1 to 4, connect to certain

switch contacts as marked. For example, 3X indicates an X terminal to which 3 is tied. Note there are two of them.

In the position shown, conductors 2 and 3 feed the TV receiver through the common terminals. Also, 1 and 4 are shorted through the small movable contacts. Response is maximum from a direction midway between the effective conductors, that is from the east. As the switch is rotated from one position to another, the directional pattern changes. The table lists various positions (counting clockwise) and results obtained.

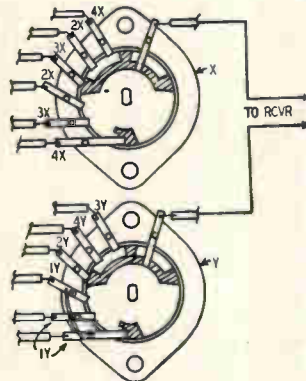
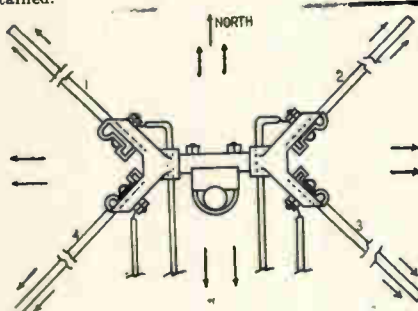

Position	X Ties to	Y Ties to	Shorted	Max. Pickup from
1	3	2	1, 4	E
2	2	4	3, 1	SE NW
3	4	3	2, 1	S
4	3	2	3, 2	SW
5	2	1	2, 4	SW NE
6	4	3	4, 3	N
7	3, 4	1, 2		NW
8	2, 3	1, 4		N
9	2, 4	1, 3		NE NW
				SE SW

PUSH-PULL TRANSISTOR AMPLIFIER

Patent No. 2,644,859

Loy E. Barton, Princeton, N. J.
(Assigned to Radio Corp. of America)

A point transistor amplifier may be connected either with grounded base or grounded emitter. The first is more stable, the second permits more gain. This circuit feeds the transistor in push-pull. Neither base nor emitter is grounded. A ground tap is placed on the input coil between the emitter and base terminals.

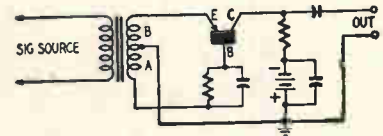

The turns ratio between windings A, B, are determined as follows. The ratio between base and emitter impedances must be known. The base input resistance will be negative. If, for example, the base resistance is 10,000 ohms and the emitter has a positive resistance of 500 ohms, this is a ratio of 20 to 1. An impedance ratio of 20 means a turns ratio of $\sqrt{20}$ or 4.5 to 1. Thus A should have 4.5 times as many turns as B. A turns ratio of 4.5 to 1 is typical. Since the turns ratio varies as the square root of the impedance ratio, it will not vary greatly. R and C form a bias network for the emitter. **END**

Get This Valuable Book

Just for Examining COYNE'S New 6-Volume Set

FREE



Applied Practical Radio-Television

ON 7 DAY FREE TRIAL!



Yes, you get this big, brand new book, "150 Radio-Television Picture Patterns and Diagrams Explained", absolutely FREE! Just off the press! Gives complete wiring circuits and diagrams on the latest Radio and Television Sets. Easy-to-read, large 8 1/2 x 11" pages, with full instructions on how to read and use the diagrams. A "must" in every Radio and Television service-man's repair kit. You get this valuable book as a FREE Gift for asking to see Coyne's great new 6-book set, "Applied Practical Radio-Television"!

Here's "Know-How" That Makes You Worth More!

Coyne's great new 6-volume set gives you all the answers to servicing problems—quickly! For basic "know-how" that is easy to understand, you'll find everything you want in volumes 1 to 5 which contain over 5000 practical facts and data. They cover every step from principles to installing, servicing, trouble-shooting and aligning all types of radio and TV sets. So up-to-date it includes COLOR TV and UHF, adaptors and converters. Also covers very latest information on TRANSISTORS.

802-Page Television Cyclopedia Included

And then, for speedy on-the-job use, you get volume 6—the famous Coyne TELEVISION CYCLOPEDIA. It answers today's television problems on servicing, alignment, installation and others. In easy-to-find ABC order, cross indexed. Use this 6 volume TV-RADIO LIBRARY free for 7 days; get the valuable Servicing Book ABSOLUTELY FREE!

SEND NO MONEY! Just mail coupon for 6-volume set on 7 days free trial. We'll include book of 150 TV-Radio Patterns & Diagrams. If you keep the set, pay \$2 in 7 days and \$2 per month until \$22.50 plus postage is paid. (Cash price \$20.95). Or you can return the library at our expense in 7 days and owe nothing. **YOU BE THE JUDGE.** Either way, the book of TV-Radio Patterns is yours FREE to keep! Offer is limited. Act NOW!

FREE BOOK—FREE TRIAL COUPON!

COYNE ELECTRICAL & TELEVISION-RADIO SCHOOL, Dept. C3-T1
500 S. Paulina St., Chicago 12, Ill.

YES! Send 6-volume "Applied Practical Radio-Television" for 7 days FREE TRIAL per your offer. Include TV-Radio Patterns & Diagram Book FREE.

Name..... Age.....

Address.....

City..... Zone..... State.....

Where Employed.....

() Check here if you want library sent COD. You pay postman \$20.95 plus COD postage on delivery. 7-day money-back guarantee.

COYNE ELECTRICAL & TELEVISION-RADIO SCHOOL
500 S. Paulina St., Dept. C3-T1 Chicago 12, Ill.

Compare...

prove EMC superiority



model 102

(1000 ohms per volt meter) • 3" SQUARE METER • 3 AC CURRENT RANGES (0-30/150/600 ma.) • Same zero adjustment for both resistance ranges 0-1000 ohms, 0-1 megohms) • 5 DC & 5 AC Voltage Ranges to 3,000 volts • Also 4 DC Current Ranges **\$14.90**



model 103

(1000 ohms per volt meter) 4 1/2" SQUARE METER • 3 AC CURRENT RANGES (0-30/150/600 ma.) • Same zero adjustment for both resistance ranges (0-1000 ohms, 0-1 megohms) • Same Ranges as Model 102 • Also 5 DB Ranges **\$18.75**
Model 103-S with plastic carrying strap **\$19.25**



model 104

(20,000 ohms per volt meter) 4 1/2" SQUARE METER (50 micro-amperes-Alnico magnet) • Includes carrying strap • 5 DC Voltage Ranges at 20,000 ohms volt to 3,000 V.; 5 AC Voltage Ranges to 3,000 V. • 3 Resistance Ranges to 20 megs • Also 3 AC & DC Current Ranges • 5 DB Ranges **\$26.95**
HVT 30,000 Volt Probe for Model 104 **\$7.95**

— See them at your Jobbers —

EMC

ELECTRONIC MEASUREMENTS CORPORATION
280 LAFAYETTE STREET • NEW YORK 12 N. Y.

EXPORT DEPARTMENT 136 LIBERTY STREET, N. Y. N. Y.

Write Dept. RE-12
for Free Complete
Catalogue of these
and other Instru-
ments.

NEW DEVICES

FRINGE ANTENNA

JFD Manufacturing Co., 6101 Sixteenth Ave., Brooklyn 4, N. Y., has announced a v.h.f. antenna for fringe-area reception, the JeT213.

It has a flat gain curve for channels 2-6, due to the dual reflector action. The high-channel section consists of two driven elements and two directors spaced and phased to present a reasonably flat response on channels 7-13.

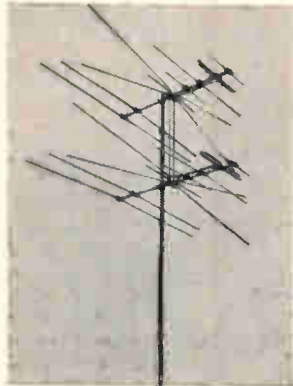

Among outstanding advantages of the JeT213 are its excellent directivity and the absence of side lobes.

ROTATOR CONNECTORS

Mosley Electronics, Inc., 8622 St. Charles, St. Louis 14, Mo., has announced a new series of plugs and sockets for connecting 4-, 5-, and 8-wire rotator cables.

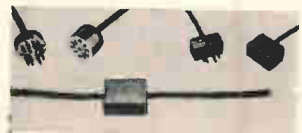

Consisting of a complete series of line plugs, line sockets, base sockets, and flush sockets, the connectors are precision-molded of polystyrene and have phosphor bronze contact strips. Plug pins are plated brass. All the connectors are solderless.

Base sockets may be mounted on wood or metal. Connectors are designed for either flat or round multi-wire cable.

CONNECTOR SERIES

Cannon Electric Co., 420 West Ave. 33, Los Angeles 31, Calif., has announced a series of sealed power connectors manufactured to Signal Corps specifications for power units of audio equipment.

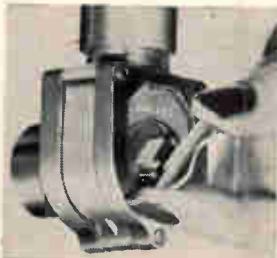

Signal Corps identifications of these connectors range from U-112/U to U-117/U. All plugs are the angle 90° type with wing-blade handle which operates a screw for easy engagement and disengagement under conditions in which operator's hand would be gloved. Receptacles are round, with a lock ring for panel mounting. Contact arrangements are four No. 16, twelve No. 16, and twenty-nine No. 16 contacts having 2,500 volts a.c. r.m.s. flashover values.

PLASTIC-COATED TUBING

Jones & Laughlin Steel Corp., Gateway Center, Pittsburgh, has announced

Perma-Tube, a plastic-coated electric-welded steel tubing which resists the corrosive effects of salt water.

Subjected to a standard ASTM weatherometer test, which reproduces weather conditions such as exposure to the sun's rays, heat, humidity, and rain, the Perma-Tube does not deteriorate. After a period equivalent to more than five years of actual service, the plastic-coated tubing shows no signs of corrosion. A test simulating cold-temperature conditions produces no bad effects on the coated test pieces. Perma-Tube is available in 5- and 10-foot lengths and in wall thicknesses of 16 and 18 gauge.

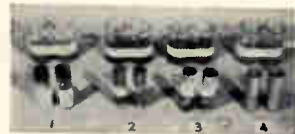

Test samples after 40-day corrosion test are shown in the illustration. Samples 1 and 2 are mechanical tubing, electrogalvanized and painted; 3 is plain galvanized mechanical tubing. No. 4 is Perma-Tube, electric-welded steel tubing, coated inside and out with plastic. All these samples were immersed for 40 days in 3.3% salt solution in the jars.

HI-FI SPEAKERS

Permoflux Corp., 4900 W. Grand Ave., Chicago 39, Ill., has announced the Super Royal line of high-fidelity speakers. The line includes 8-, 12-, and 15-inch models, all of which feature a



slotted, treated cone for low resonance and superior low-frequency response.

Model 15 x 81, illustrated here, has a frequency response of 30 to 11,000 c.p.s.; power rating of 25 watts, 8 ohms voice coil impedance, and magnet weight of 14.5 oz.

REPLACEMENT PARTS

Chicago Standard Transformer Corp., Standard Division, Addison St. and Elston Ave., Chicago 18, Ill., has added four new replacement flyback transformers to its line.

A-8220 replaces Philco part No. 32-8565, used in 14 models and chassis; A-8221 replaces 32-8555 in 29 models and chassis; A-8222 replaces 32-8533 and 32-8534 in 38 sets; and A-8223 replaces 32-8572 in 15 sets. All models involved are from 1952 and 1953 production. These units are accurate duplicates of the original Philco parts they are designed to replace. They include the choke coils, resistors, and capa-

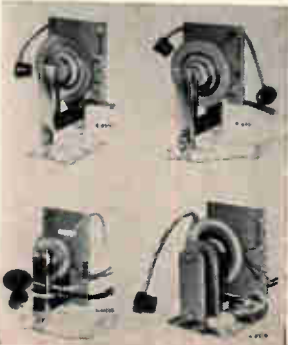

RADIO-ELECTRONICS

citers already wired to the terminal boards.
A special mounting tab arrangement on A-8220, A-8221, and A-8222, allows the technician to re-use the base plate of the replaced flyback. A-8223 has mounting centers that duplicate the original unit.

NEW ANTENNAS

Best Electronics Corp., 11368 W. Olympic Blvd., Los Angeles 64, Calif., has announced a v.h.f. and three u.h.f. v.h.f. antennas in their Double-Diamond line.

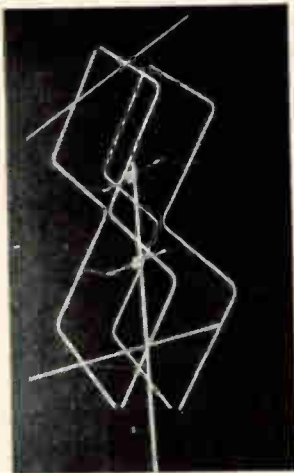

The v.h.f. model 213 averages 10 db over the low band and from 12 to 15 db over dipoles cut for channels 7 to 13. Horizontal lobe width between 3 db points is about 30°, and corresponding vertical lobe width is 20°. Average impedance is 450 ohms. The model 213 measures 7 feet high, 5 feet 8 inches wide, and 17 inches deep.
The u.h.f. v.h.f. antennas are similar in shape to the model 213 but are smaller and need no cross-arms. Model 1440 covers channels 14-40, model 3570, channels 35-70, and model 6083, channels 60-83.

REPLACEMENT PARTS

International Rectifier Corp., 1521 E. Grand Ave., El Segundo, Calif., has announced a series of miniaturized selenium rectifiers for use in the production of TV boosters and u.h.f. converters. These units are also ideal for replacement purposes in servicing boosters, converters, and other electronic equipment requiring relatively low current drain.



The CR series selenium rectifiers consist of a number of cells assembled within a cylindrical aluminum tubing and provided with pigtail copper leads for easy wiring into crowded spaces. The smallest unit, type CR-15, is 0.5-inch in diameter and 0.6-inch long, while the largest unit has a diameter of 0.75-inch and is 0.6-inch long.
These miniature selenium rectifiers are rated for maximum r.m.s. input voltages of 130 and 160 for operation into a capacitive load.

LEAD-IN WEATHERHEAD



Javex, Inc., Redlands, Calif., has announced a TV lead-in weatherhead of molded acrylic resin, the *Tenna Shingle*. This fits under shingles on a roof or under siding, and covers the small hole required for the lead-in. It is transparent and accommodates standard 300-ohm line.

ANTENNA ROTATOR

Leader Electronics, Inc., 2925 E. 55th St., Cleveland 27, Ohio, has announced a new antenna rotator, the *Superrotar*. Among the unit's features are a detachable drive unit, a double lock-stop, built-in chimney-mount design, steel-reinforced construction, and vernier precision tuning.
The rotator's speed is 1 r.p.m. and it can be operated at more than 350 feet from the control box. Over-all size is 16½ x 7 x 4½ inches. It is rated at 60-75 watts input, 117 volts, 60 cycles a.c.



PIN STRAIGHTENER

CBS-Hytron, Danvers, Mass., has developed a twin pin-straightener for 7- and 9-pin miniature tubes. The tool is vest-pocket size and is made of steel.



RADIO INVERTERS

American Television & Radio Co., 300 E. Fourth St., St. Paul, Minn., has announced new inverter models for operation from 6- or 12-volt storage batteries in automobiles, buses, and trucks.
The new ATR inverters provide 110-volt a.c. 60-cycle output in various wattage capacities for dictating machines, recorders, radio sets, and other electrical or electronic apparatus. Models are also available for operation from 6 volts to 220 volts d.c.



Attention!!

• EXECUTIVES • SALESMEN • PUBLIC OFFICIALS
• POLICEMEN • FIREMEN • OUTDOOR MEN
REPORTERS • FIELD INSPECTORS • DOCTORS • LAWYERS, ETC.

Dictate in your CAR

with **ATR**

INVERTERS

for changing your battery current to
A.C. Household CURRENT
Anywhere . . .
in your own car!!

ATR INVERTERS . . . especially designed for operating standard 110 volt A.C. Tape Recorders, Wire Recorders, Dictating Machines and Electric Razors IN YOUR CAR.

EASY TO INSTALL
EASY TO OPERATE

A VALUABLE TIME SAVER FOR:

- **TRAVELLING SALESMEN**—Dictate reports in your own car. Send your dictated reports in daily to your home office or sales manager.
- **FIELD INSPECTORS & INVESTIGATORS**—Dictate your field inspection reports in the field—on the spot. Give the complete story factually and completely. Include your clients' recordings also.
- **DOCTORS**—Dictate and record your hour calls on the completion of your call while awaiting a fresh in your mind. Have these records for transcription by your office girl.
- **LAWYERS**—Record evidence in the field at your client's premises. Obtain factual and complete witness reports, etc.
- **EXECUTIVES**—Dictate in your car all business matters while on trips for pleasure or business.
- **PUBLIC OFFICIALS**—Dictate complete field reports in your car. Obtain recorded opinions and expressions of Mr. Public in the field. Dictate your business reports while travelling.
- **POLICE SQUAD CARS**—Dictate accident reports right on the scene complete and factual. Include witness recordings at the same time. Have the complete story available by dictation.
- **FIRE TRUCKS**—Dictate your fire reports factually and complete on the scene and include witness reports. Have the complete story.
- **AMBULANCES**—Dictate complete reports of your ambulance run. Include witness recordings, etc.
- **ADVERTISING AGENCIES**—Use AC operated animated or illuminated displays in or on the car.
- **FISHERMEN & HUNTERS**—Use your electric razor on camping trips, operating in your car. Also small home radios and other electrical or electronic items.
- **CAMPERS**—Make your camping and outing trips more exciting using mis-masters, tape recorders, or wire recorders operating from your car battery.
- **WAREHOUSE & MATERIAL HANDLERS**—Dictate your inventory and material handling reports on the scene, in the warehouse, yard, or wherever you may be.

FREE !! ATR INVERTER!
... given away every 30 days to lucky registrant of preceding month. Mail a postcard as your registration request today!

TYPE	Input DC Volts	AC Output 60 Cycles	Output Wattage Intermittent	Output Wattage Continuous	List Price	RECOMMENDED APPLICATIONS
6-LIF	6	110 volts	40	35	\$25.55	For operating small low-power AC motors, electric razors, small radios and small portable dictating machines having wattage consumption less than 35 watts.
12-LIF	12	110 volts	50	35	25.55	
6-RSD	6	110 volts	85	75	39.25	Recommended for operating small AC motors, Radio Sets, PA Systems, Amplifiers, and Radio Test Equipment having input wattage consumption within continuous output wattage ratings indicated.
12-RSD	12	110 volts	125	100	39.25	
6-ISQ-F	6	110 volts	85	75	49.95	Especially recommended for operating dictating machines, wire recorders, tape recorders, and small AC motors and electronic or electrical apparatus having input wattage consumption within continuous output wattage ratings indicated.
12-ISQ-F	12	110 volts	125	100	49.95	
6T-HSG	6	110 volts	175	150	96.45	For operating large tape recorders, wire recorders, PA Systems, amplifiers, and small TV sets having input wattage consumption within the continuous output wattage ratings indicated.
12T-HSG	12	110 volts	250	200	96.45	

See your jobber or write factory ✓ NEW MODELS ✓ NEW DESIGNS ✓ NEW LITERATURE
"A" Battery Eliminators, DC-AC Inverters, Auto Radio Vibrators

ATR

AMERICAN TELEVISION & RADIO Co.
Quality Products Since 1931
SAINT PAUL 1, MINNESOTA—U. S. A.

DECEMBER, 1953

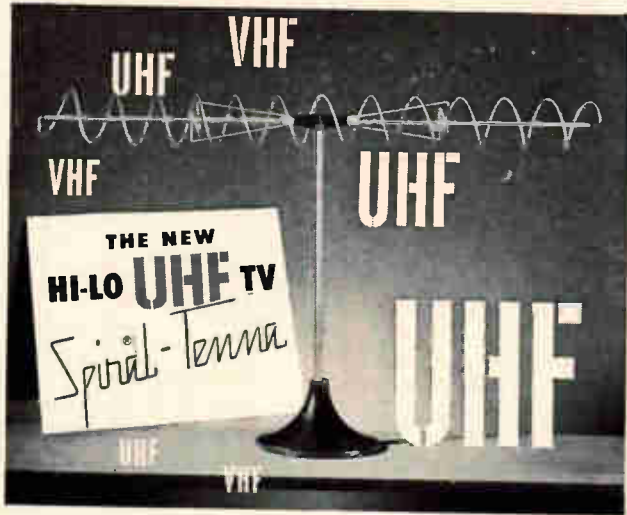

Peak Performance for Indoor UHF and VHF Television Reception Model 202 U-V

Now — the nationally advertised, consumer accepted HI-LO TV Indoor Spiral-Tenna is applicable for both VHF and UHF with our exclusive UHF antenna adapter from channels 2-83. But, you still get the volume by selling at the same low, low price.

The Hi-Lo UHF antenna adapter is available separately for all previous HI-LO antennas. List Price \$2.00.

Sold by recognized jobbers

at the same low list price!

U. S. Patent No. 2,495,579 Canadian patents 1951 — other patents pending

ORDER HI-LO UHF-VHF TV Spiral-Tenna TODAY!

Hi-Lo TV ANTENNA CORP.
3540 N. Ravenswood • Chicago 13, Illinois

\$9.95 LIST PRICE

WANTED

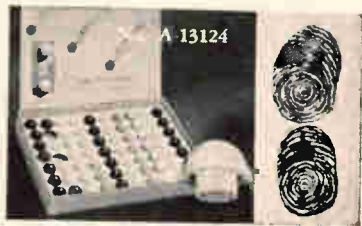

By DEALERS, SERVICEMEN and others.

Suspected of willfully aiding and abetting them in saving time and satisfying customers.

Name . . . **WALDOM'S AUTO KNOB ASSORTMENT**

Description . . . 70 CRONAME tenite knobs in assorted colors. Knobs are 7/8" in diameter and will fit 3/16" flatted shaft. Set screws included. Housed in attractive display box. Answers to No. A-13124

SPECIAL BULLETIN

Knob Assortments answering to above charge and description have been apprehended by your local parts distributor, assisted by Waldom Electronics Inc., 911 N. Larabee St., Chicago 10, Illinois.

UHF-VHF ANTENNA

All Channel Antenna Corp., 70-07 Queens Blvd., Woodside 77, N. Y., has developed an all-direction, all-channel antenna, the Super 60. This antenna features the same relative high gains as the AD 2-8 with only 10-inch spacing between bays to improve the ultra-high frequencies, low-loss phenolic insulators, and a redesigned low-loss switch.

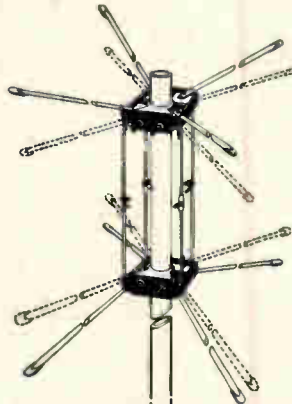

5 NEW PRODUCTS

United Technical Laboratories, Morristown, N. J., has five new products for radio and TV: a TV crossover network which permits the use of u.h.f. and v.h.f. antennas with a single lead-in and elimination of antenna controls for all-channel reception; an interference filter for use between the transmission line and a TV receiver; a coupler for operating two TV receivers from a single antenna; a variable inductance kit consisting of eight permeability-tuned coils; and Klipzon points for panel mounting.

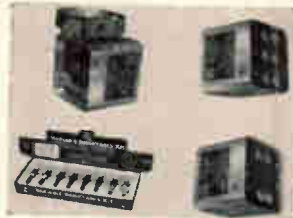

UHF ANTENNAS

Television Hardware Manufacturing Co., a division of General Cement Manufacturing Co., 919 Taylor Ave., Rockford, Ill., has announced their new Wishbone antenna line for u.h.f. The Butterfly, No. 8965 has one stacking bar and weighs 2 3/4 pounds. The Corner-Tenna, No. 8984, is a reflector type that weighs 5 pounds.

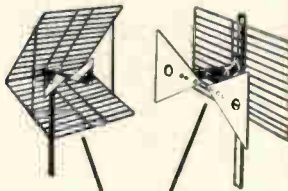

These antennas feature the Wishbone insulator, which provides a free air space to prevent shorting out.

UHF ANTENNAS

Finney Co., 4612 St. Clair Ave., Cleve-

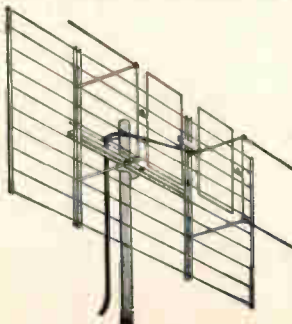

land 3, Ohio, has introduced its series 500 antennas, designed specifically for u.h.f. and constructed on the basic co-lateral design. Model 502, the 2-bay unit, and model 504, the 4-bay unit, both feature a snap-out type screen reflector which locks securely in place for ease of installation.

Each model is available in 3 variations—502 and 504 A, B, and C. The A-B-C variations are designed to peak on the following channel range: A: channel 14 through 32; B: channel 29 through 55; C: channel 53 through 83.

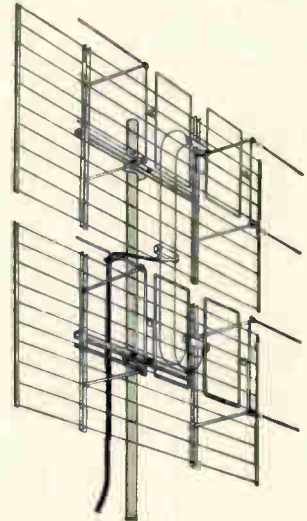

A stacking arrangement is also available for double-stacking the 2-bay 502 unit to make a 4-bay unit.

MATCHED CABINETS

G & H Wood Products Co., 75 N. 11th St., Brooklyn 11, N. Y., has introduced a pair of matched cabinets designed to house all equipment necessary for a complete high-fidelity system. They are models 21 and 22.

The equipment housing handles a record changer, tuner, and amplifier in its frame 35 inches high, 23 1/2 inches wide and 17 1/2 inches deep. The companion speaker cabinet has the same over-all dimensions as the equipment end. Its baffle area is 6 1/2 cubic feet, measuring 22 x 31 x 16 inches. An individual speaker cutout is available.

The cabinets, part of the company's Cabinart line, are modern in design, and are of hand-rubbed woods finished in French mahogany, limed oak, honey walnut, and black lacquer.



SPEAKER SYSTEM

Jensen Manufacturing Co., 6601 S. Laramie Ave., Chicago 38, Ill., has announced the Duette, a 2-way high-fidelity reproducer which can be placed on a book shelf, end table, desk or table. The unit contains a heavy-duty

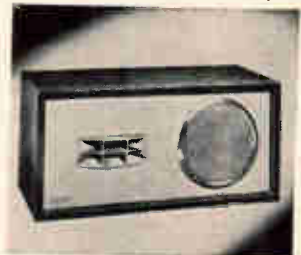

8-inch woofer, a multicell horn tweeter, and has impedances of 4 and 8 ohms with a 20 watt power rating. It is 11 x 10 x 23 1/4 inches. END

All specifications given on these pages are from manufacturers' data.

DU MONT RA-160, RA-162

Loss of horizontal size with all horizontal sweep components checking O.K. may be noted in the Du Mont RA-160, -162, and -162B TV chassis.

The trouble is probably caused by an increase in the series resistance of the 4- μ f cathode bypass capacitor (C314) in the horizontal output circuit. (See partial schematic.) The increase in resistance causes degeneration.

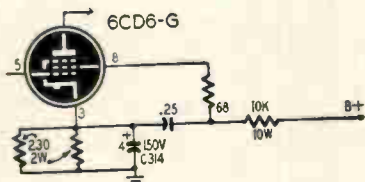

This reduces the amplitude of the horizontal sweep voltage and causes shrinking.

To remedy the situation, replace C314 with a Du Mont part 03 013 670 or 03 122 480.—*Du Mont Service News*

CROSLLEY TV CIRCUIT CHANGE

A circuit change was made early in the production of 1954 Crosley TV receivers to improve picture contrast and shading. All 1953 21-inch sets and 1954 sets which do not incorporate the

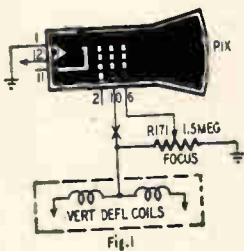

change may be modified in the field. Fig. 1 shows the circuit before modification and Fig. 2 shows it after modification.

The change lowers the voltage on grid 2 (pin 10) of the picture tube. Grid 2 is disconnected from the top of the focus control and is connected to a

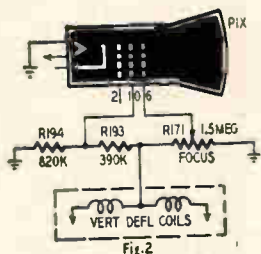

point on a voltage divider (R193 and R194) which is added to the circuit.

Focus control R171 is not used in 1954 21-inch sets because they use magnetically focused tubes.—*Crosley Service Department*

6BQ7'S IN CASCADE TUNERS

A number of sets using 6BQ7's in cascade tuners have come in with complete loss of sound and video. Performance has been restored to normal although the old tube checks good in a tube tester. To minimize callbacks because of a recurrence of the same

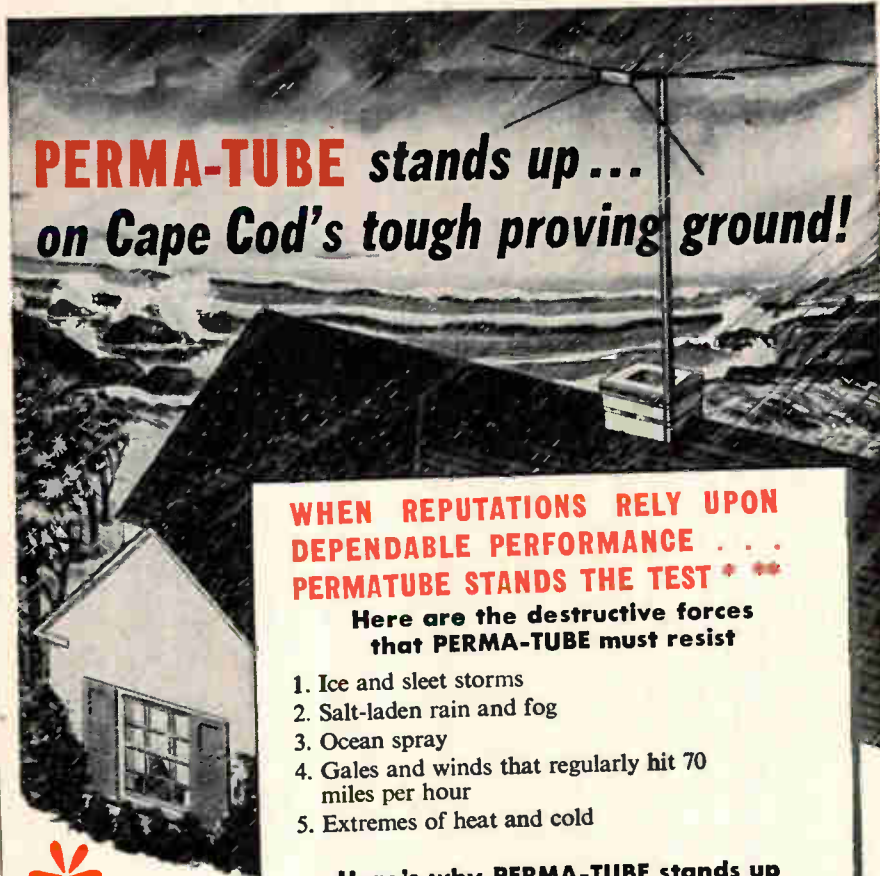

PERMA-TUBE stands up... on Cape Cod's tough proving ground!

WHEN REPUTATIONS RELY UPON DEPENDABLE PERFORMANCE . . . PERMATUBE STANDS THE TEST * * *

Here are the destructive forces that PERMA-TUBE must resist

1. Ice and sleet storms
2. Salt-laden rain and fog
3. Ocean spray
4. Gales and winds that regularly hit 70 miles per hour
5. Extremes of heat and cold

Here's why PERMA-TUBE stands up under the most severe conditions

1. PERMA-TUBE is STURDY . . . it's made of special, high-strength, J&L steel.
2. PERMA-TUBE IS CORROSION-PROOF . . . it's treated with vinsynite—then coated inside and outside with a metallic vinyl resin base.
3. PERMA-TUBE IS MECHANICALLY SOUND . . . it's the only mast with both ends of the joint machine fitted.



*From the records of Ware Radio Supply Company of Brockton, Massachusetts . . . over 500,000 feet of PERMA-TUBE used on Cape Cod installations—and not a single complaint.

**From the records of Bill Perry—Cape Cod radio and television sales and service expert . . . over 1000 installations of PERMA-TUBE in three years—and not one single mast failure.

Here's proof of how Perma-Tube resists corrosion



Section of ordinary conduit tubing used for TV masts after 96 hours in a salt spray test (A.S.T.M. Designation B-117-49T) to accelerate corrosion. Extensive rust inside the mast has reduced strength—caused rusty water to drain onto the owner's home.

Section of PERMA-TUBE after 500 hours salt spray test shows no evidence of corrosion. Strength has been retained and the chance of rust streaks on owner's home is eliminated. Note sturdier wall thickness of PERMA-TUBE sample.

PERMA-TUBE IS AVAILABLE IN STANDARD LENGTHS . . . DIAMETERS . . . WALL THICKNESSES. FOR COMPLETE INFORMATION MAIL THIS COUPON.



Jones & Loughlin Steel Corporation
496 Getaway Center, Pittsburgh 30, Pa.

Without charge Name of nearest distributor
please send me Complete information on PERMA-TUBE

Name _____
Company _____
Address _____

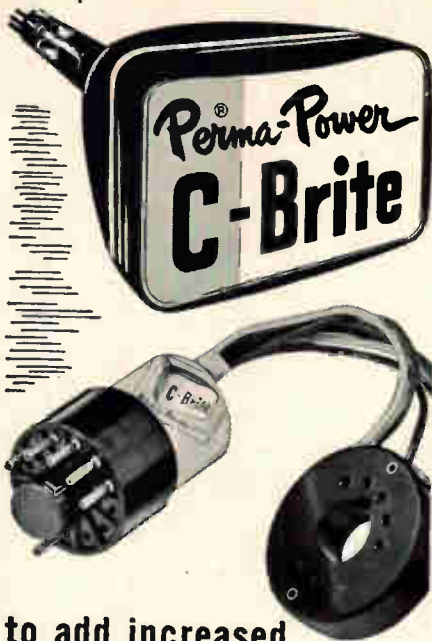

to add increased
brilliance to any
TV PICTURE TUBE

manufactured by
Perma-Power COMPANY
Chicago 25, Illinois

Manufacturers of Electronic Equipment Since 1928

\$3.00 FOR CARTOON IDEAS
RADIO-ELECTRONICS prints several radio cartoons every month. Readers are invited to contribute humorous radio ideas which can be used in cartoon form. It is not necessary that you draw a sketch, unless you wish.
Address
RADIO-CARTOONS, RADIO-ELECTRONICS
25 West Broadway, New York 7, N. Y.

trouble, I insert a 3-ohm resistor in series with one side of the 6BQ7 heater.
—Willard Rickard

(Tube manufacturers have found that 6BQ7's used in cascode circuits often develop "heater growth" which eventually causes the heater to short to the cathode or some other tube element. In circuits where the cathode is 135 volts or so positive with respect to the heater, there is a strong electrostatic attraction between these two elements. Thermal expansion of the heater combines with the attraction to gradually force the heater up to the point where it protrudes from the cathode sheath. It is this growth (displacement) of the heater that is the most common cause of heater-cathode shorts in 6BQ7's. This can be minimized by substituting a 6BQ7-A.—Editor)

PRE-WAR PHILCO SETS

Static-like crackling on the short-wave bands of the Philco 645 and others made between 1934 and 1938 has finally been traced to trouble in the speaker. There is friction between the voice coil and the floating speaker frame. Grounding the speaker frame to the chassis will cure the trouble in most cases. If it doesn't, try grounding one side of the voice coil to the speaker frame and the other side to the chassis.—G. P. Oberto

TELE-KING MODEL 116

A Tele-King model 116 had insufficient height. A preliminary check showed cathode voltages on the 6W4-GT damper and 5U4-G low-voltage rectifier were 100 and 50 volts low, respectively. All possible sources of leakage and excessive B plus drain were checked and new tubes were substituted without improvement. New power and

flyback transformers were tried without success.

Voltages returned to normal and more than sufficient height was obtained by modifying the low-voltage power supply to use two 5U4's connected as

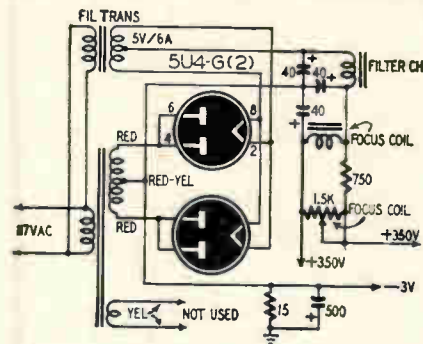

half-wave rectifiers as shown in the diagram. The original 5U4-G rectifier was disconnected from the 5-volt filament winding on the power transformer and the filaments of both 5U4-G's were paralleled across a 5-volt, 6-amp filament transformer.—Kenneth S. Ferrin

DU MONT VOLTAGE CALIBRATOR

Take care with the Du Mont 264-B voltage calibrator when the signal amplitude is 50 volts or more or when the applied signal is superimposed on a high B plus voltage. Throwing the shorting-type OUTPUT MULTIPLIER switch from the OUTPUT position momentarily places the input signal across the 110-ohm resistor at the bottom of the attenuator string. This resistor may be damaged or burned out if the input signal is high enough, therefore high-amplitude signals should be disconnected from the SIGNAL INPUT terminals before operating the switch. Isolate B plus voltages with an external blocking capacitor.—Charles Erwin Cohn.

END

NEW JFD "3-in-one" LIGHTNING ARRESTER



one for all... all for one

1. for UHF or VHF tubular twin lead
2. for VHF flat twin lead
3. for VHF or UHF open wire

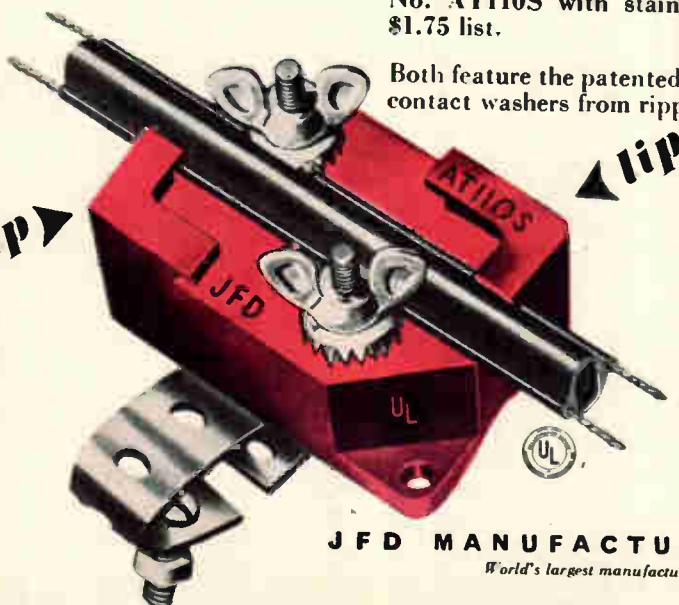

No. AT110 with hardware for wall or window sill mounting, \$1.50, list.

No. AT110S with stainless steel strap for pipe mounting, \$1.75 list.

Both feature the patented JFD strain-relief lips which prevent contact washers from ripping the lead-in wires apart!



Burton Browner Advertising

JFD MANUFACTURING COMPANY, INC.
World's largest manufacturer of tv antennas and accessories; Brooklyn 4, New York

Engineering

WRITERS

ENGINEERS, E. E. or PHYSICS GRADUATES, for preparation of technical manuals...

HUGHES RESEARCH AND DEVELOPMENT LABORATORIES' expanding program for production of radar, electronic digital computers, guided missiles and other military advanced electronic systems and devices requires the following:

1 ELECTRICAL ENGINEERING AND PHYSICS GRADUATES to prepare operating, servicing and overhauling instructions for complex electronic equipment. Those with previous maintenance experience on military equipment preferred. Writers will participate in a three-month program in our technical training school to become familiar with the latest Hughes equipment prior to writing assignments.

2 ENGINEERS EXPERIENCED in the writing and preparation of maintenance manuals for electronic equipment or guided missiles. These specialists will work step-by-step with the people designing, developing and manufacturing the products involved. Experience in the writing of engineering reports is of value.

HOW TO APPLY

Write full details of your qualifications to

HUGHES

Research and Development Laboratories

SCIENTIFIC AND ENGINEERING STAFF

Culver City, Los Angeles County California

Assurance is required that relocation of the applicant will not cause disruption of an urgent military project.

HANDY TEST ADAPTER

It is easy to measure voltages at the pins of miniature tubes without removing the set from the cabinet when you use this simple adapter. Similarly, when aligning a set using miniature tubes, the adapter makes it easy to connect the output meter to the plate of the output tube.



The drawing shows the construction of the adapter. A wafer-type miniature socket provides the connector for the tube pin. Pry one of the lugs loose from the wafer socket and flatten it with pliers. Solder the lug to a length of flexible test lead and then cement a piece of tight-fitting spaghetti over it so only the tiny socket is exposed. Place a phone tip or banana plug on the other end of the lead and you have an adapter which saves time and increases your efficiency when checking and aligning sets using miniature tubes.—Jack Lipiner

TUNING EYE FOR TV SETS

With the a.g.c. systems included in present TV sets, the picture contrast changes very little for large changes in input signal. Therefore, it is hard to adjust indoor antennas, rotators, or boosters, for best results, and it is also hard for dx fans to estimate the relative strength of signals. An electron-ray tuning indicator, easily added to any set, can change this situation.

The method of connecting the indicator depends on whether the set is of the intercarrier or separate-sound type. For the intercarrier type, connect the grid lead of the indicator tube directly to the a.g.c. line. In such a case the indicator should not be used for tuning, as it will give misleading results when so used.

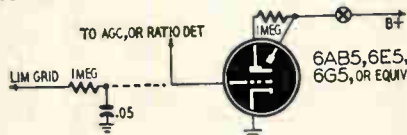

However, for split-sound sets the situation is different, as the indicator is connected in the sound channel. If the set uses a ratio detector, connect the grid of the indicator to the negative end of the electrolytic capacitor in the ratio-detector circuit. If the set uses a limiter-discriminator circuit, the grid of the indicator should go to the grid of the first limiter through a filter network as shown in the diagram. Here the indicator serves well for tuning, as minimum shadow will indicate that the sound is properly tuned in. However, if there are two positions of minimum shadow close together, this means that the sound i.f. is overcoupled, and then the correct tuning position is in between the two minima. In any case, if the glow of the eye tube is objectionable during normal viewing, a switch can be placed in the B plus lead to shut it off when it is not being used.—Charles Erwin Cohn

NEW! 4 P.E.C.* KITS

Right now there are 100,000,000 radio and TV sets — 4 or more years old — in everyday use. These sets do not have P.E.C.'s. You'll save service time and parts investment — have greater confidence in your service jobs if you replace old-style components with P.E.C.'s. Centralab P.E.C. kits are your best supply source!



PCK-18

18 P.E.C. units. Replace 42 old-style resistors and 52 old-style capacitors. Net - - - \$9.00



PCK-110

110 P.E.C. units. Replace 255 old-style resistors and 52 old-style capacitors. Net - - - \$55.80



PCK-220

220 P.E.C. units. Replace 525 old-style resistors and 620 old-style capacitors. Net - - - \$115.80



PCK-45

45 P.E.C. units. Replace 106 old-style resistors and 133 old-style capacitors. Net - - - \$24.00



This P.E.C. Guide No. 2 (included with each kit) tells you how and when to use P.E.C.'s. Shows cross indexing — schematics — tells you how to test P.E.C.'s. Get complete details from your CRL distributor or use coupon below.

Centralab

*Trademark — Printed Electronic Circuits

CENTRALAB
A Division of Globe-Union Inc.
922-L E. Keefe Ave., Milwaukee 1, Wis.

Please send name of distributor stocking P.E.C. Kits, also additional technical data.

Name _____

Firm _____

Address _____

City _____ Zone _____ State _____

If You Want SPEAKERS

ORDER OXFORD

World's Largest Producer of Speakers



Used by more manufacturers for original equipment than any other brand



OXFORD ELECTRIC CORP. 3911 South Michigan Avenue, Chicago 15, Illinois

OXFORD ELECTRIC CORP. Export: Roburn Agencies, New York City

In Canada: Atlas Radio Corp., Ltd., Toronto



TRY THIS ONE

TURN COUNTING AID

If you wind your own coils or transformers, don't throw away broken or discarded plastic dial covers. Take any fair-sized piece and cut it to the general shape of a guitar pick as shown in the drawing. Then sand the pointed end down to a sharp thin edge to make a useful aid for counting the turns on your coil.

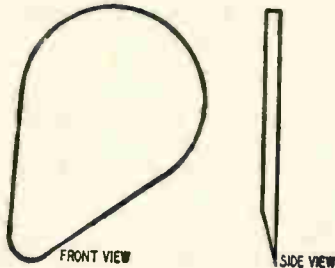

Just pull the thin edge of the device slowly over the winding and you will hear a single sharp click for each turn in the coil. It is perfect for coils wound with bare or enameled wire. To use it on plastic- or cloth-insulated wire, use less pressure and count the slight ups and downs you feel in your fingers as the tip passes over each turn.—*Thomas Oda Miller.*

HIGH-VOLTAGE TESTER

The neon tube contained in a discarded fluorescent starter can be used as a simple, quick, and safe means of determining whether or not the high-voltage circuit in a TV set is operating. The neon bulb is attached to the inside of the bakelite base or terminal board. Remove the terminal board and invert it so the neon lamp is on the outside and then reinstall it on the metal container. If there is a capacitor shunting the lamp, remove it.

This simple voltage indicator may be used also to check r.f.-type power supplies in oscilloscopes, TV sets, and other devices requiring high voltage at low current.

To use the indicator, hold it about an inch and a half from the plate of the horizontal output tube, high-voltage rectifier, or the high-voltage contacts on the flyback transformer. The bulb glows when voltage is present. The strength of the voltage can be estimated by the brightness of the glow and the distance from the test point. A few minutes experimenting with sets which are developing normal high voltage will enable you to quickly determine whether sufficient voltage is being developed in the set under test.—*Abraham Jacobowitz*

CHECKING TV LEAD-INS

To quickly check continuity of a lead-in connected to a folded dipole radiator, disconnect the lead from the set and unscrew the bottom from a flashlight. Touch one side of the lead to the bottom of the exposed battery and the other to the metal shell of the flashlight. The bulb will light if the lead is not broken. It will flicker or will not light at all if the lead and antenna are not continuous.—*Arthur Hellman*

END

REVOLUTIONARY NEW Mogne-Pulse

intermittent recorder

GREATEST TIME SAVER Ever Developed for Television Servicemen!
IN STOCK at TERMINAL



Automatically Locates Intermittents

The most troublesome and time-consuming job in TV servicing . . . locating intermittents NOW made easy and practically automatic with the sensational Mogne-Pulse Recorder. Performs the work of 3 VTVM's. Reduces intermittent servicing time to virtually zero. Easy to operate, simply connect three Recorder leads to three points in TV set, and zero set meter. You set it and forget it.

WHEN TROUBLE OCCURS, BUZZER SOUNDS, LIGHT INDICATES EXACTLY WHERE INTERMITTENT OCCURRED.

Most important, light remains lit indicating defective circuit . . . other circuits immediately locked out to avoid indicating side effects. It's foolproof simplifies repairs . . . saves time and money. Fully described in this issue (see article). Complete with all test leads — ready to use. 115 Volt—60 Cycle—Dealer Net

\$199.50

Write for Literature

Radio • Audio • Video • Electronic Equipment
Phone: WOrth 4-3311

Terminal

RADIO CORP.

85 Cortlandt St. • New York 7, N. Y.

RADELCO

LIGHTNING ARRESTOR

MODEL R-116

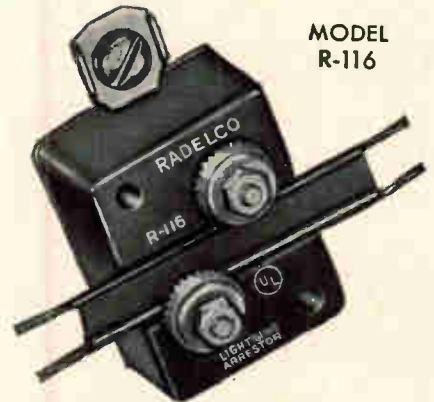

IT'S THE LOWEST PRICE UNDERWRITERS' LISTED ARRESTOR ON THE MARKET

ORDER FROM YOUR NEAREST PARTS JOBBER

LIST PRICE **90¢**

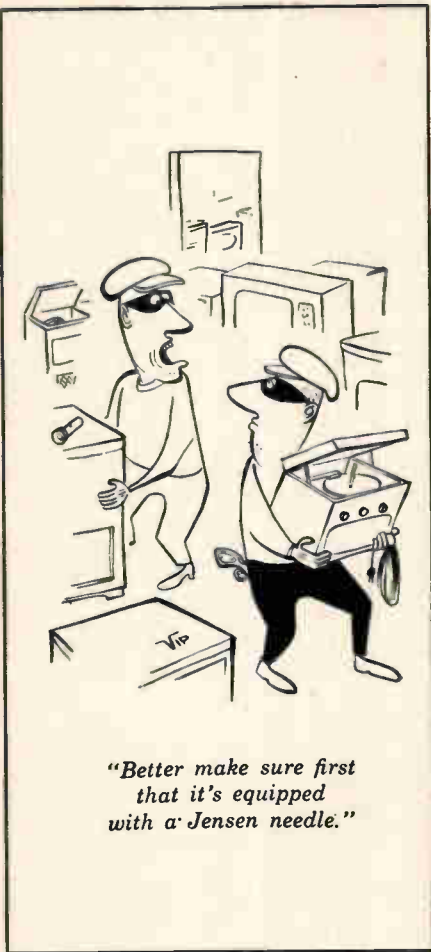

"Better make sure first that it's equipped with a Jensen needle."

MORE QUIETROLE
TRADE MARK REG. U.S. PAT. OFF.
is purchased by
MORE USERS
than ever before...

Because it does more for the user than any other product of its kind. It is the original non-conductive, non-inflammable liquid that works magic on noisy TV and radio controls and switches. The choice of those who want the best, the standard since 1947. Keeps customers happy, puts money in your pocket.



Carried by leading jobbers everywhere!



manufactured by
QUIETROLE COMPANY
Spartanburg, South Carolina

DECEMBER, 1953

PHOTO SLIDE TRIPPER

In many instances, teachers, lecturers, field service engineers, and sales personnel use photographic slides to illustrate their talks. If the same speech must be delivered a number of times, it is often convenient and advantageous to record the talk on magnetic tape. Since a projector operator is not always available or if available may not be familiar with the material, I have developed a method of cuing the tape so that slides are changed automatically at the correct instant. The setup is shown in Figs. 1 and 2.

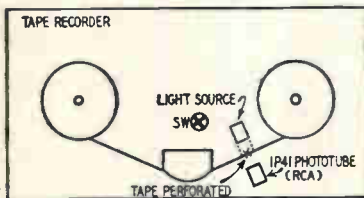

Fig. 1

A standard tape recorder is fitted with a miniature phototube and a 6.3-volt light source as shown in Fig. 1. The tape is cued by perforating it so that light passes through it and causes the projector to release the next slide.

Fig. 2 shows the diagram of the phototube relay which operates the slide-trip mechanism on the projector. This circuit operates with an increase in light. It was taken from the RCA manual on phototubes.

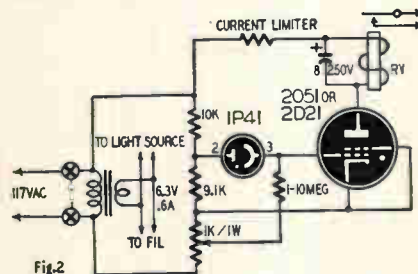
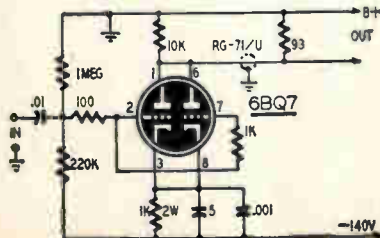

Fig. 2

The current limiting resistor in series with the relay and the plate of the 2050 depends on the resistance of the relay coil. The total resistance in the plate circuit should be at least 1,200 ohms to limit the plate current. This resistor may be omitted if the relay coil resistance is 1,500 ohms or higher. The relay should operate on 25 ma or less.—Robert P. Kraig

DRIVER FOR COAX CABLE

Cathode followers are widely used to drive low-impedance lines carrying low-level high-frequency signals from one remote point to another. When the signals must be reproduced faithfully, the cable must be terminated in a resistive load equal to its nominal impedance. In the article "A Coaxial Cable



GRANCO UHF

for superior performance

the only complete
all-channel
UHF converter line



"STAR"

MODEL LCU—Proven all-channel performance everywhere. Coaxial tuning at a new low price!



ALL-NEW "SUPER"

MODEL MTU—Coaxial tuning for unmatched performance... especially in difficult reception areas.



"HIDEAWAY"

MODEL HT-5—At last, a front-end tuner that answers the problem of concealed installation for all-channel reception. Coaxial tuned!

Sold by leading jobbers everywhere!

Write today for free bulletin to Dept. S

GRANCO PRODUCTS, INC.

36-17 20th Avenue
Long Island City 5, N. Y.



Just a few minutes reading this
New Gernsback Library Book
can save you hours of servicing work



128 Pages
Over 100 Illustrations
\$1.50

**TV Repair
Techniques—No. 50**

The most timely, the most needed,
the most valuable low-price book
on TV servicing yet published!

**A QUICK GLIMPSE OF SOME
OF THE CONTENTS**

- Unusual TV Troubles
- Servicing Procedure
- TV Signal Tracing
- Servicing TV in the Home
- TV Control Troubles
- High-Voltage Headaches
- Servicing Picture Tube Circuits
- Brightness Troubles
- Correction of Picture Distortion
- Servicing Horizontal Locks
- Curing Intercarrier Buzz
- Vertical Sweep Problems
- Television Interference

TV REPAIR TECHNIQUES assumes you understand theory and know what tubes to check. It goes right to work in analyzing the tricky bugs which are enough to stump the experts. It concentrates on the circuits in which they occur and tells you how to recognize, find and correct them in jig time. It offers you the experience of some of the top technician-writers in the field today. The hints they give you can save you hours of sweating out a tough one. Look over the partial list of contents. Compare the price. Then order your copy today.

Why not give books for Christmas?

Radio & TV Test Instruments—No. 49

How to build just about every instrument required for modern TV-radio servicing. 128 Pages. **\$1.50**

Radio & TV Hints—No. 47

Over 300 hints, gimmicks and short cuts on radio, TV and Audio. Seven sections. 112 Pages. **\$1.00**

Radio Tube Fundamentals—No. 45

How and why tubes act as they do in modern radio circuits. Written for the service technician. 90 Pages. 74 Illustrations. **\$1.00**

Model Control By Radio—No. 43

Remote control of model planes, boats and trains. Theory and construction details. 112 Pages. 114 Illustrations. **\$1.00**

Public-Address Guide No.—41

Covers every phase of PA installation and maintenance plus construction details on an all around system. 80 Pages. Illustrated. **75¢**

Practical Disc Recording—No. 39

Covers theory and practical techniques. A full chapter for each important recording component. 96 Pages. Illustrated. **75¢**

Published by Gernsback Publications, Inc.
Publishers of
RADIO-ELECTRONICS

**High-Fidelity—Design, Construction,
Measurements—No. 48**

New 3-way approach on how to get top performance from a high-fidelity system. 128 Pages. **\$1.50**

Television Technotes—No. 46

Cuts routine trouble shooting time. Causes and cures of over 600 specific troubles. 128 Pages. **\$1.50**

Basic Radio Course—No. 44

John T. Frye's classic on fundamentals makes learning theory fun—from Ohm's Law to advanced techniques. 176 Pages. Cloth cover. **\$2.25**

High-Fidelity Techniques—No. 42

One of the best written and most informative books on high-fidelity written at any price. By James R. Langham. 128 Pages. Illustrated. **\$1.00**

See your distributor—or mail this coupon

GERNSBACK PUBLICATIONS, INC., Dept. 123
25 West Broadway
New York 7, N. Y.

Enclosed is my remittance of \$ _____
Please send me the following books postpaid.

- 50 TV REPAIR TECHNIQUES
- 49 48 47 46 45
- 44 43 42 41 39

Name _____
(Please print clearly)
Street _____
City _____ Zone _____ State _____

Driver with Gain" in *The Review of Scientific Instruments*, Kurt Enslein, of the University of Rochester (New York), describes a grounded-cathode circuit with a gain of about 2.4 over a cathode follower designed to work into the same 93-ohm line. The circuit is shown.

A negative power supply is used to keep the coaxial conductors at ground potential without using prohibitively large blocking capacitors. The 1,000-ohm resistor between the grids prevents the amplifier from oscillating. The linearity of the circuit is not as good as that of a cathode follower but it is better than 1% with r.m.s. signal inputs between .01 and 0.1 volt.

WIDE-BAND VIDEO AMPLIFIER

Wide-band amplifiers are often required for TV, pulse, radar, and oscillographic applications. An interesting video amplifier having a gain of 100 and response substantially flat from 15 cycles to 5 mc is described here through the courtesy of *Electronic Engineering* (London, England). The amplifier was designed to boost the output of a signal generator from 50 mv to 5 volts and has also been used as a preamplifier for a v.t.v.m. and a number of other applications. Its input-output curve is linear for signal input voltages up to 0.5 volt r.m.s. Distortion sets in above this level.

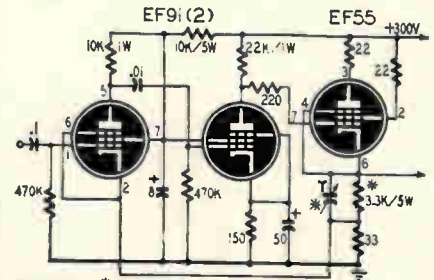

The amplifier uses a pair of EF91's connected as a feedback pair working into an EF55 cathode follower. The output impedance is 10 ohms or less for signals between 50 cycles and 500 kc and rises to 1/gm at the extreme ends of the pass-band.

The frequency response of the amplifier is adjusted with the compensating trimmer capacitor across the 3,300-ohm, 5-watt resistor (three 10,000-ohm, 2-watt resistors in parallel) in the cathode circuit of the EF55. The trimmer should be set to about 21 μf for best results in a typical amplifier constructed according to good video engineering techniques. The coupling capacitors between the EF91's should be suspended away from the chassis to reduce stray capacitance. Leads on the 33-ohm resistor should be as short as practical to reduce the inductance in the cathode circuit of the input stage.

The EF91 and EF55 are European types. The former is directly replaceable by a 6AM6. The EF55 is similar to a 6AC7, but the two types are not directly interchangeable. These and most other European types can be obtained through North American Philips, 100 E. 42nd St., New York, N. Y.

The First Practical, Understandable Book About TRANSISTORS

distributed by
HOWARD W. SAMS & CO., INC.

NEW COYNE PUBLICATION

"TRANSISTORS AND THEIR APPLICATIONS IN TELEVISION-RADIO-ELECTRONICS"

by Louis E. Garner, Jr.

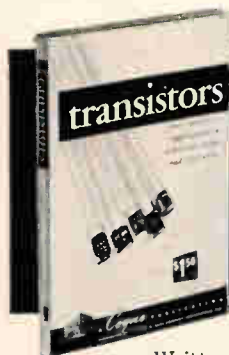

The "inside story" of Transistors for Service-men, Engineers, Amateurs and Experimenters

Written by an authority on the subject. Explains in easy-to-understand language the theory and practical applications of Transistors. Clears up common misconceptions; clarifies Transistor circuitry, installation, testing techniques, theory and servicing. An important book for everyone in Electronics.

CONTENTS

Chapt. 1: History of Transistor development and its implications for the electronic industry. Chapt. 2: Non-mathematical explanation of how Transistors work; description of basic types. Chapt. 3: Physical and electrical properties of transistors. Chapt. 4: Transistor amplifier circuits. Chapt. 5: Transistor oscillator circuits. Chapt. 6: Special Transistor circuits (D.C. amp., R.F. det., Clippers, Phase Inverters, etc.). Chapt. 7: Transistor Components (sub-miniature parts and power supplies). Chapt. 8: Care and servicing of Transistors. Chapt. 9: Practical Transistor circuits (experimental circuits with parts values; audio and r.f. circuits). Chapt. 10: Reference data; commercially available Transistors and their characteristics, etc.

Have ALL the latest information on Transistors in this authoritative, low cost book—it's a "must" for your library.

100 PAGES. 5½ x 8½" **\$1.50**
ORDER CTB-7. Only....

ORDER TODAY

HOWARD W. SAMS & CO., INC.

Order from your Parts Jobber today, or write direct to Howard W. Sams & Co., Inc. 2205 East 46th St., Indianapolis 5, Ind.

My (check) (money order) for \$..... enclosed. Send.....copy(ies) of "Transistors" (CTB-7) at \$1.50 per copy.

Name.....
Address.....
City..... Zone... State.....

LOW-COST MAGNETIZER

This simple, low-cost magnetizer for permanent magnets was constructed at the National Bureau of Standards and described in the Bureau's *Technical News Bulletin*. The magnetizer operates by discharging a very large capacitor through the magnetizing coil. The simplicity of the unit is evident from the diagram.

The 6,500- μ f capacitor is charged to about 125 volts d.c. available from the 400-ma selenium rectifier. The 1-1 transformer isolates the unit from the power line. Pressing the push-button switch operates the heavy-duty 24-volt d.c., 70-amp motor-starting relay which connects the magnetizing coil across the capacitor bank. The relay coil is excited by the voltage across the capacitor so the contacts open shortly before the capacitor fully discharges. Since the contacts open at a time when the current is low, they need not be designed for interrupting high currents.

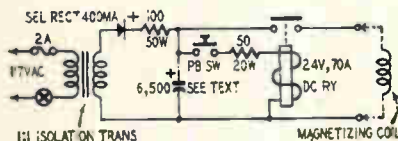

The storage capacitor was made from 10 surplus 650- μ f, 80-volt d.c. capacitors which were found to operate satisfactorily at 125 volts after being formed. The power consumed by the magnetizer varies from 70 watts with the capacitor discharged, to about 10 watts when it is fully charged. At a normal rate of magnet charging—one pulse each 15 seconds—the average power drain is not more than 30 watts.

The size and shape of the magnetizing coil depends on the object to be magnetized. Usually, the coils have 150 to 200 turns, an inside diameter no larger than necessary to accommodate the piece to be magnetized, and a d.c. resistance of 0.3 to 1.0 ohm. In a typical operation, the peak current of about 150 amps has a duration of 2 milliseconds.

In some cases, it will be necessary to slowly withdraw the object to be magnetized, from the coil. Keeping it there may leave it only slightly magnetized by the final pulsation. END

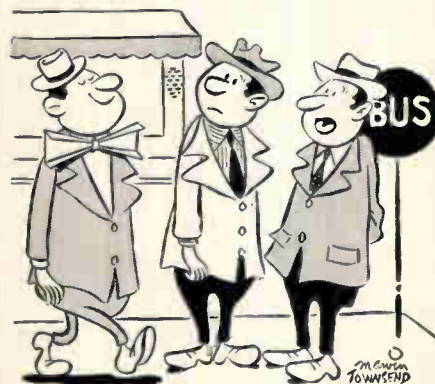

"He's the owner of our new UHF station."

AIREX'S 1954 Co-Channel

630 FA-2A With Genuine FM Armstrong Sound System

3 MONTHS RMA GUAR. ON ALL PARTS

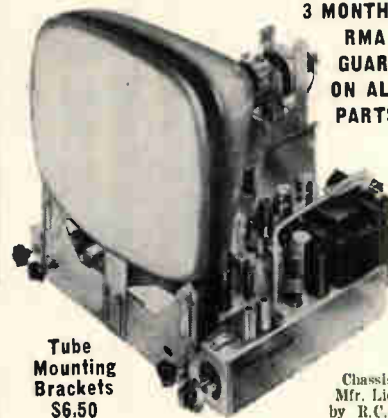

Tube Mounting Brackets **\$6.50**

Chassis Mfr. Lic. by R.C.A.

Here is the most powerful fringe area chassis on the market today... the one TV engineers and servicemen are buying for themselves. Clear, sharp, exceptional reception up to 200 miles.

CHECK THESE EXCLUSIVE FEATURES

- 10 WATT push-pull audio output. Frequency range from 40 to 12,000 cycles • 3 position fringe area switch • Delayed gated AGC system • Standard Coil Cascade Tuner prevents radiation • Retrace Blanking Circuit allows you to raise the brightness without the annoying vertical retrace lines • Heavy duty front focus control • Automatic gain control potentiometer allows you to adjust the threshold sensitivity as low as 4 microvolts & still keep the full 4 MC band width • Improved sync amplifier • Improved automatic brightness control • Set aligned for 21.9 MC. New Ham band will not interfere • Improved fused high voltage power supply gives full 14.5 KV under load. Will handle all picture tubes up to 24 inch with full sweep • Improved video amplifier has a gain of 40 • All moulded plastic condensers give long life & trouble-free operation • Easily adapted to new UHF stations in 2 minutes by just changing a strip in the tuner • Extra heavy duty power transformer with large safety factor • 6CB6 tubes in Video IF to give full gain • Extra filtering in power supply for hum & ripple-free operation • Phono Connection & switch on chassis allows you to play your phonograph or tuner through the built-in 10 watt hi-fidelity amplifier • Extra heavy duty focus coil, which runs cool • Full focus cosine yoke.

THE ONLY CHASSIS WITH 10 WATT PUSH-PULL AUDIO OUTPUT AT

\$169⁹⁵

Fed. Tax Included Less C.R. Tube and Brackets

Complete with 12" ROLA Hi-Fi Speaker With UHF Converter—\$211.90 Detailed Service Manual & Schematic—\$1

TV PICTURE TUBE SALE

- Standard Brands. Factory New. Guaranteed 1 year.
- 17" Tube \$27.95
 - 20" Tube \$34.95
 - 21" Tube \$39.95
 - 24" Tube (Guar. 6 Mos.) \$79.95
 - 27" Tube. Guar. 1 yr. \$79.95
 - Ring and Sleeve for 24" \$ 7.50

630 CHASSIS FOR 24 & 27 INCH OPERATION \$229⁹⁵

TV GOLD PLASTIC MASKS

- 16" and 17" \$ 4.95
- 20" and 21" \$ 7.95
- 24" \$14.95

UHF SLUGS \$7.95

BARGAIN CABINET BUY

Beautiful mahogany console/ta Cabinet cut for 630 FA-2A Chassis. Complete with mask, glass & tube mounting brackets... **\$499⁹⁵**

In Blond \$59.95

Send for complete cabinet brochure

FREE—New TV—Hi-Fi PARTS CATALOG

All merchandise brand new, factory fresh, guaranteed. Mail & phone orders filled upon receipt of certified check or money order for \$25 as deposit on TV chassis, 20% on other items. Balance C.O.D., F.O.B. N. Y. Prices & specifications subject to change without notice. NO FED. TAXES TO PAY.

AIREX RADIO CORP.

SHOWROOM: 171 Washington St., N. Y. 7 Gramercy 7-9243
MAIL ORDER: 400 Lafayette St., N. Y. 3

Now! A COMPLETE GUIDE TO HIGH FIDELITY!



... for listeners
... builders
... experimenters
... service technicians

JUST OUT! HIGH FIDELITY TECHNIQUES

by John H. Newitt
D.I.C. Staff Member,
Dept. of Electrical Engineering,
Massachusetts Institute of Technology
494 pages, 203 clear illustrations,
6 x 9 size
Price \$7.50

ANSWERS YOUR QUESTIONS ABOUT "HI FI"—Guides you every step of the way!

Here are just a few of the subjects covered: What to look for in high-fidelity equipment—what to avoid • Getting reproduction to suit your taste • Some unusual "hi-fi" combinations • Hi-fi vs. P.A. type speakers • Matching the reproducer to its environment • Loudspeaker construction and performance • Adjusting bass-reflex cabinets • Controlling distortion • A novel horn system • Baffles • Getting rid of "overhang" • The best reproducer enclosure • Selecting a woofer-tweeter combination • Sound-proofing materials • How grillwork affects attenuation • Special hi-fi circuits • Proper crossover frequencies for dual-channel amplifier systems • Do's and don't's of volume expansion • Ways to suppress noise • A good tone control system • Negative feedback and how to use it • Pre-amps and equalizers • Amplifier construction hints • Commercial amplifiers and how to judge them • F-M tuners and how they work • Minimizing tuner distortion • Avoiding chatter and crosstalk • Limiter-discriminator vs. ratio detector FM circuits • All about records and record players • A comprehensive course in magnetic recording • Pick-up resonance, its cause and cure • Choosing a recorder • Tips for custom builders • Custom-building technical problems and solutions • Special installation problems • Typical "hi-fi" installations • Bass-reflex calculations and design charts • Acoustical horn design data . . . and dozens of other subjects. Read it for 10 days AT OUR RISK! Use coupon.

10-Day Free Examination

Dept. RE-123, Rinehart Books, Inc.,
Technical Division,
232 Madison Ave., New York 16, N. Y.

Send HIGH FIDELITY TECHNIQUES by Newitt for 10-day FREE examination. If I decide to keep the book, I will then remit \$7.50 plus postage. Otherwise, I will return book postpaid promptly and owe you nothing. (If you send cash with order, we pay postage—same return privilege with money refunded.)

Name

Address

City, Zone, State

OUTSIDE U.S.A.—Price \$8.00 cash only. Money back if book is returned postpaid in 10 days.

SCREEN-MODULATING THE SCR-274-N

? I have a set of SCR-274-N command transmitters complete with control box, BC-456 modulator, and DM-33 dynamotor. Reports indicate that when operating this equipment on the amateur phone bands, the percentage of modulation is low. I tried doubling the screen voltage on the final amplifier without any improvement. Is there any way that I can raise the modulation percentage while using the BC-456?—J. F. O., Klamath Falls, Ore.

A. For 100% modulation when using screen-grid modulation, the plate current should drop to zero when the

should be about one-half of the value used for c.w. Use a scope or modulation meter to check the modulation. If it is low, check the operating voltages on the final and then check tubes and components and make corrections necessary to bring the operating voltages up to normal for screen modulation.

It may be that the BC-456 modulator was designed for close talking in a loud voice. In this case, for ordinary ham-station use you will need more gain between the mike and modulator to bring the audio up to the required level for full modulation.

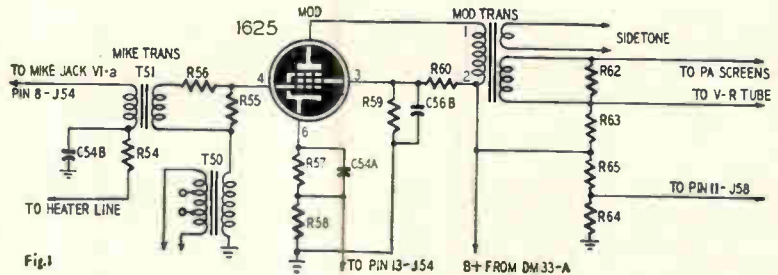

Fig. 1

screen voltage is driven to zero. With most pentodes, the screen must be driven *negative* to cut off plate current and output. About 80% modulation is the maximum that can be obtained without producing intolerable distortion.

The peak a.c. signal delivered to the screen by the modulator must be about 15% greater than the d.c. screen voltage—which, for screen modulation,

Fig. 1 shows a simplified partial schematic of the modulator. Since m.c.w. (tone modulation) is not used in the amateur bands covered by this equipment, you can remove the 12J5 tone oscillator (not shown) and rewire its circuit as a speech amplifier. Disconnect all leads from pins 5, 3, and 8 of the 12J5 and from pin 4 of the 1625 modulator and rewire the circuit as shown in Fig. 2.

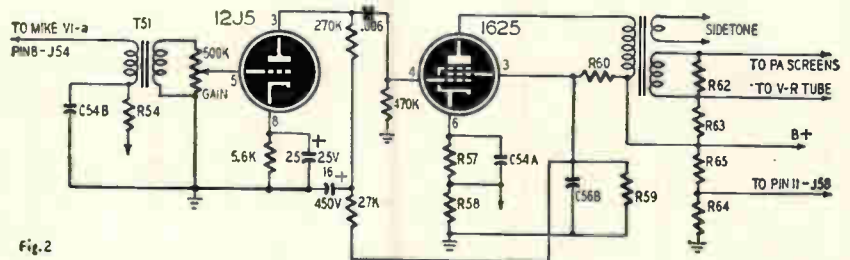
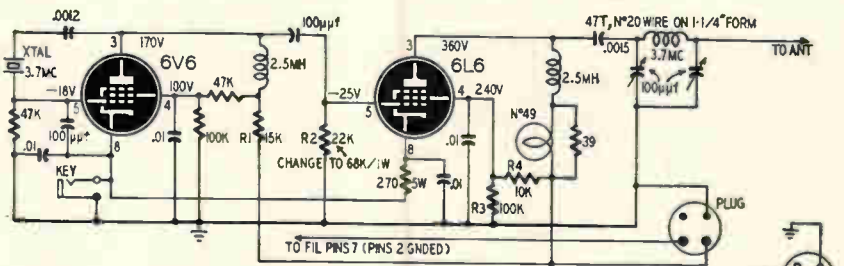

Fig. 2

ADDING POWER AMPLIFIER TO 80-METER TRANSMITTER

? I am enclosing the circuit of my 2-tube 80-meter c.w. transmitter. If practical, I would like to have a diagram for adding an 807 power amplifier and power supply to it. I want to

use a π network in the plate of the final.—J. T., Chicago, Ill.



use a π network in the plate of the final.—J. T., Chicago, Ill.

A. There is almost no need to add an 807 after the 6L6 unless you plan to use the latter as a buffer or multiplier when the rig is used on higher fre-

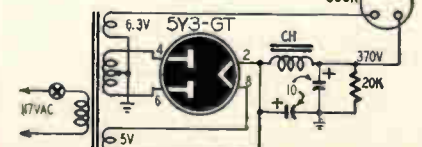



GUARANTEED PERFORMANCE

MONEY BACK GUARANTEED TO RECEIVE *All* UHF and *All* VHF STATIONS IN *All* DIRECTIONS FOR 60 MILES WITHOUT A ROTORMOTOR OF ANY KIND!!

**SO NEW! SO DIFFERENT!
IT'S PATENTED!**

#2,585,670

#2,609,503

#2,625,655

#2,644,091

OTHERS PENDING

WORLD'S MOST POWERFUL UHF-VHF TELEVISION ANTENNA

While antenna reception is guaranteed for 60 miles, perfect pictures have been consistently received as far as 160 miles from stations.

NEW

POLYMICALENE 4 CONDUCTOR TRANSMISSION LINE

- Low Loss External - Air Dielectric
- Matched Impedance
- Eliminates End Sealing
- Eliminates Condensation
- Up to 50% Less Loss Than Tubular When Wet
- Easily Spiraled
- No Breaking or Shorting
- Patents Pending - T. M. Reg.



All NEW DESIGN FOR '54

- LOW-LOSS SWITCH
- LOW-LOSS PHENOLIC INSULATORS
- USES NEW 4-CONDUCTOR MATCHED IMPEDANCE LINE
- ONLY 10 INCH SPACING BETWEEN ANTENNA BAYS

The 9 position selector switch electronically rotates the antenna in a stationary position.



LIST PRICE

\$36⁷⁵

SEE YOUR LOCAL JOBBER

PRICE INCLUDES

Complete stacked array • 4 stacking bars • 9 position switch • Switch-to-set coupler • 2 - 7 1/2" stand offs • Individually boxed in mailable carton

Money Back Guarantee
IN ALL LOCATIONS **IN EVERY AREA**
WITH STATIONS IN ALL DIRECTIONS

The new All Channel Model Super 60 is guaranteed to bring in, immediately on installation, every UHF and every VHF station within 60 miles in any direction, giving clearer and sharper pictures than any antenna or combination of antennas with or without rotor motors.

If, immediately on installation, it fails to do this, we agree to refund to the jobber to whom we sold and shipped it, his full purchase price.

ALL CHANNEL ANTENNA CORP.

70-07 Queens Blvd., Woodside 77, N. Y.

Hickory 6-2304

NEW!



LIGHTNING ARRESTOR



HOLDS EVERY COMMON TYPE OF TRANSMISSION LINE

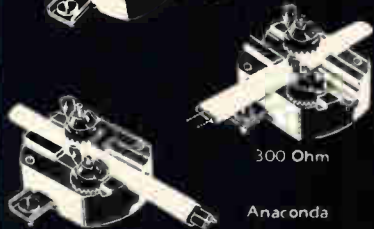
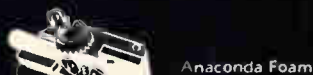

Now! No stripping of insulation, no straps or ears to break off, no signal loss—and no "misses". This new Lightning Arrester by iE reduces your installation problems—and inventory, too! Easily installed indoors or outdoors.

Model 4000 for walls and windows, etc. List \$1.25
Model 4005 with stainless steel strap for pipe mounting List \$1.50

Write for details and new iE catalog.
325 N. HOYNE AVE.
CHICAGO 12, ILL.

a new medium-shell 5-pin socket for the octal socket used for the 6L6.

The maximum power input to the 807 will depend on the power supply you use. For a reasonable increase in power input over that of the 6L6, the plate voltage should be at least 500 and not more than 750. Maximum plate current is 100 ma regardless of the voltage.

If you want to use a separate supply for the 807 plate, dropping resistors R1, R3 and R4 need not be changed. But if you want to operate the entire transmitter from the new supply, you will have to change the values of these resistors.

Adjust the value of R1 for 170 to 300 volts on the plate of the 6V6 with adequate drive on the 807 grid. The bias between grid and cathode should be 45 volts. With a 600-volt supply, change R3 and R4 to 35,000 and 20,000 ohms, respectively.

With a 500-volt or higher supply, substitute a 5R4-GY for the 5Y3-GT and reduce the input filter capacitor to not more than 4 μ f.

RHOMBIC FOR CHANNEL 2

? Please print a layout for a 6-wavelength rhombic antenna for channel 2. —H. E. O., Hemmingford, Neb.

A. A rhombic antenna provides maximum signal when its terminated end points along the great-circle route to the transmitting antenna and when the incoming signal strikes it at a small angle above the horizon. This angle—called the *wave angle*—is a fairly

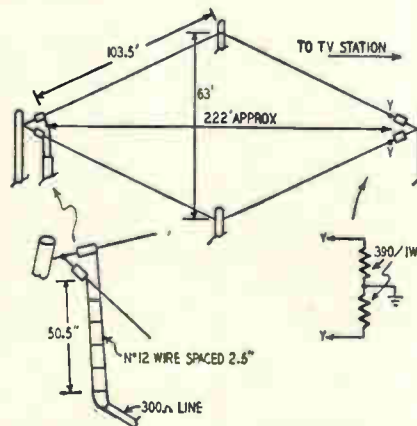

critical one which varies with frequency, the seasons, and with the distance between the receiving and transmitting antennas.

The diagram shows the layout of a typical 6-wavelength rhombic for channel 2. Although exact measurements are shown in the drawing, the dimensions are not critical as long as you keep each leg several wavelengths long. To adjust the antenna to the optimum wave angle, try it at different heights between about 17 and 35 feet and note the effects of height on performance. Make the adjustments for maximum signal strength with the antenna legs as nearly horizontal as practical.

The 800-ohm antenna is matched to a 300-ohm transmission line by a quarter-wavelength section of 490-ohm line consisting of two No. 12 wires spaced 2 1/2 inches apart. END

Build Your Own Interior-Styled Cabinets

KITS

by Cabinet

presenting the

paul klipsch-designed REBEL IV . . .



Now you can build your own Klipsch Corner Horn Enclosure — and save money — identical in acoustic design to assembled units and easily put together with a minimum of tools. Priced for the home-builder in unfinished birch.

\$36.00* Net for 12" model

\$42.00* Net for 15" model

BASS REFLEX and EQUIPMENT CABINETS

Ideal housing for hi-fi components — removable panels make future changes easier. Loudspeaker cabinet acoustically-designed for either 12" or 15" speaker.

Overall dimensions: 33 1/2", 23", 16". Tuner Compartment: 20" H., 21 3/4" W. (inside dimensions). 15 3/4" Deep. Baffle volume: 6 cubic feet.



All kits include 3/4" white pine plywood cut to size, baffle pre-cut for 12" or 15" speaker. Saran Plastic Acoustcloth, Kim-sul Acoustic Insulation, Assembly and Finishing Instructions, hardware, plastic wood, sandpaper and glue.

No. 80 ..\$27.00 *
(Equipment Kit)

No. 8112 ..\$18.00 *
(12" speaker)

No. 8115 ..\$18.00 *
(15" speaker)

CORNER FOLDED HORN ENCLOSURES

Reproduces a quality of bass heretofore only possible through the use of far more expensive designs.

No. 61 (12" speaker) ..\$19.95 *

No. 63 (15" speaker) ..\$23.95 *

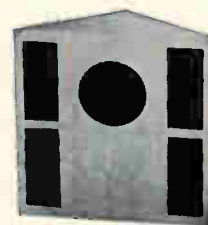

* Prices higher West and South.
Write for free catalog and nearest distributor
Pioneers in radio furniture for high fidelity equipment

G & H WOOD PRODUCTS COMPANY
75 NORTH 11th STREET
BROOKLYN 11, N. Y.

FREE EXTRAS:

- ELECTRICAL AND RADIO TESTER • ELECTRIC SOLDERING IRON • BOOK ON TELEVISION • RADIO TROUBLE-SHOOTING GUIDE • MEMBERSHIP IN RADIO-TELEVISION CLUB • CONSULTATION SERVICE • QUIZZES • TRAINING FOR F.C.C. LICENSE.



Build 15 RADIOS AT HOME

WITH THE NEW
IMPROVED 1954
PROGRESSIVE RADIO "EDU-KIT"
ONLY \$ **19.95**

- NOW INCLUDES SIGNAL TRACER
AND CODE OSCILLATOR
- FREE TOOLS WITH KIT
 - NO ADDITIONAL PARTS NEEDED
 - ABSOLUTELY NO KNOWLEDGE
OF RADIO NECESSARY

10-DAY MONEY BACK GUARANTEE

Excellent Background
For Television

BECOME A RADIO AMATEUR



GET A WELL-PAYING JOB



GO INTO A PROFITABLE BUSINESS



DECEMBER, 1953

WHAT THE PROGRESSIVE RADIO "EDU-KIT" OFFERS YOU

The Progressive Radio "Edu-Kit" offers you a home study course at a rock bottom price. Our Kit is designed to train Radio Technicians, with the basic facts of Radio Theory and Construction Practice expressed simply and clearly. You will gain a knowledge of basic Radio Principles involved in Radio Reception, Radio Transmission and Audio Amplification.

You will learn how to identify Radio Symbols and Diagrams; how to build radios, using regular radio circuit schematics; how to mount various radio parts; how to wire and solder in a professional manner. You will learn how to operate Receivers, Transmitters, and Audio Amplifiers. You will learn how to service and trouble-shoot radios. You will learn code. You will receive training for F.C.C. license.

In brief, you will receive a basic education in Radio exactly like the kind you would expect to receive in a Radio Course costing several hundreds of dollars.

THE KIT FOR EVERYONE

The Progressive Radio "Edu-Kit" was specifically prepared for any person who has a desire to learn Radio. The Kit has been used successfully by young and old in all parts of the world. It is not necessary that you have even the slightest background in science or radio.

The Progressive Radio "Edu-Kit" is used by many Radio Schools and Clubs in this country and abroad. It is used for training and rehabilitation of Armed Forces Personnel and Veterans throughout the world.

The Progressive Radio "Edu-Kit" requires no instructor. All instructions are included. All parts are individually boxed, and identified by name, photograph and diagram. Every step involved in building these sets is carefully explained. You cannot make a mistake.

PROGRESSIVE TEACHING METHOD

The Progressive Radio "Edu-Kit" comes complete with instructions. These instructions are arranged in a clear, simple and progressive manner. The theory of Radio Transmission, Radio Reception, Audio Amplification and servicing by Signal Tracing is clearly explained. Every part is identified by photograph and diagram. You will

learn the function and theory of every part used.

The Progressive Radio "Edu-Kit" uses the principle of "Learn by Doing". Therefore you will build radios to illustrate the principles which you learn. These radios are designed in a modern manner, according to the best principles of present-day educational practice. You begin by building a simple radio. The next set that you build is slightly more advanced. Gradually, in a progressive manner, you will find yourself constructing still more advanced multi-tube radio sets, and doing work like a professional Radio Technician. Altogether you will build fifteen radios, including Receivers, Transmitters, Amplifiers, Code Oscillator and Signal Tracer. These sets operate on 105-125 V. AC/DC.

THE PROGRESSIVE RADIO "EDU-KIT" IS COMPLETE

You will receive every part necessary to build 15 different radio sets. Our kits contain tubes, tube sockets, chassis, variable condensers, electrolytic condensers, mica condensers, paper condensers, resistors, line cords, selenium rectifiers, tie strips, coils, hardware, tubing, hook-up wire, solder, etc.

Every part that you need is included. These parts are individually packaged, so that you can easily identify every item. Tools are included, as well as an Electrical and Radio Tester. Complete, easy-to-follow instructions are provided.

In addition, the "Edu-Kit" now contains lessons for servicing with the Progressive Signal Tracer, F.C.C. instructions, quizzes. The "Edu-Kit" is a complete radio course, down to the smallest detail.

TROUBLE-SHOOTING LESSONS

Trouble-shooting and servicing are included. You will be taught to recognize and repair troubles. You will build and learn to operate a professional Signal Tracer. You receive an Electrical and Radio Tester, and learn to use it for radio repairs. While you are learning in this practical way, you will be able to do many a repair job for your neighbors and friends, and charge fees which will far exceed the cost of the "Edu-Kit". Here is your opportunity to learn radio quickly and easily, and have others pay for it. Our Consultation Service will help you with any technical problems which you may have.

**MAIL
TODAY**
YOUR ORDER
SHIPPED SAME
DAY RECEIVED

Send me the "Edu-Kit" with 10 Day Money-Back Guarantee—include All FREE extras.

Send further information.

Check or M.O. enclosed—postage prepaid

C.O.D. (U. S. Only)—I will pay postage

NAME _____

ADDRESS _____

Outside U.S.A.—no C.O.D.'s; send check on U.S. bank or international M.O. for \$19.95. Postage prepaid. "Edu-Kit" for 210-250 V. AC/DC \$22.45.

PROGRESSIVE "EDU-KITS" INC.

497 UNION AVE., Dept. RE-78, Brooklyn 11, N. Y.

Learn to Use Instruments MORE EFFECTIVELY!



THE INSTRUMENT GUIDE WRITTEN ESPECIALLY FOR Servicemen, Amateurs, Experimenters

- ★ Learn new uses for old instruments
- ★ Learn to do better faster testing with fewer instruments
- ★ Avoid buying unnecessary instruments
- ★ Learn how to evaluate instrument readings and put them to practical use

BASIC ELECTRONIC TEST INSTRUMENTS

by Rufus P. Turner
254 pages, 171 illus., Price \$4

How well you work—how fast you work, and how much money you make depends to a big extent on how much you know about instruments. **BASIC ELECTRONIC TEST INSTRUMENTS** is a down-to-earth guide that can help you in dozens of ways—from showing new uses for old instruments to guiding your instrument purchases and avoiding costly types that aren't really necessary. Over 60 types—from the latest TV pattern generators to special-purpose bridges, general-purpose instruments and all the old standbys—are clearly described. Work-saving testing short cuts are outlined.

SAVE MONEY ON INSTRUMENTS!

In addition to all "standard" instruments from simple meters to capacitance checkers, oscillators, oscilloscopes and dozens more, you get complete training in the newer ones such as grid-dip oscillators; TV sweep and marker generators; TV linearity pattern generators; square-wave generators, distortion meters and many others. You are shown new uses for VOM'S, oscilloscopes, signal generators and other familiar types. You learn easy ways to extend the ranges of old instruments; how to make an accurate bridge from old instruments; how to use power drain measurements for fast TV troubleshooting; how to calculate shunts and multipliers; how to measure r-f impedance with a simple T-network; how to measure inductance and capacitance with a grid-dip oscillator—and scores of other money-saving tips.

Use coupon today!



Dept. RE-123, RINEHART BOOKS, Inc.
Technical Division, 232 Madison Ave.,
New York 16, N. Y.

Send Turner's **BASIC ELECTRONIC TEST INSTRUMENTS** for 10-day **FREE EXAMINATION**. If I decide to keep book, I will then remit \$4.00 plus postage. Otherwise I will return book postpaid promptly and owe you nothing.

Name.....

Address.....

City, Zone, State.....

OUTSIDE U.S.A.—Price \$4.50, cash only. Money back if book is returned postpaid in 10 days.



H. C. Roemer

Henry C. Roemer, former president of Federal Telephone and Radio Co., Clifton, N.J., has been designated vice-president in charge of the administration of the Domestic Divisions of the International Tele-

phone and Telegraph Corp. Raymond S. Perry, vice-president and general sales manager of Federal, succeeds Mr. Roemer as president.

Charles B. Denton was appointed marketing manager of Weston Electrical Instrument Corp., Newark, N. J. In this newly created post, he retains direction of the Advertising Department and also assumes responsibility for the sale of all retail and distributor products.



C. B. Denton

William J. Slawson joined Pyramid Electric Co., North Bergen, N. J., capacitor manufacturer, as assistant sales manager, Jobber Division. He was formerly with Federal Telephone and Radio Corp. and John F. Rider Publisher, Inc.



W. J. Slawson

Bea Jones joined I.D.E.A., Inc., Indianapolis, as assistant advertising manager of the Regency Division. She was



formerly an executive with Spencer Curtiss, industrial advertising agency.



R. J. Mueller

Robert J. Mueller was promoted to sales manager of Walsco Electronics Corp., Los Angeles. During the past four years with the company he has worked in practically every department, and was most

recently assistant sales manager.



M. L. Finneburgh

M. L. Finneburgh joined Finney Co., Cleveland antenna manufacturer, as vice-president. He was formerly general sales manager of the Liquid Carbonic Corp., Chicago. He joins his brother and son in the Finney Co.

Harry E. Moon was appointed executive vice-president for both the Mechanical and Plastic Divisions of General Industries Co., Elyria, Ohio. He was formerly vice-president in charge of sales of the Mechanical Division. Mr. Moon has spent his entire 30-year business career with General Industries.



Fabian Bachrach
H. E. Moon

Obituaries

Walter M. Skillman, manager of marketing administration of the Radio and Television Department of the General Electric Electronics Division, died after a brief illness.

Joseph Webber, pioneer in radio engineering, and at one time chief engineer of Warwick Manufacturing Co., Chicago, died from a heart attack at his home in Santa Monica, Calif.

Personnel Notes

... **Elwood W. Schafer** joined CBS-Hytron, Danvers, Mass., as assistant to Charles F. Stromeyer, vice-president in charge of manufacturing and engineering. He was formerly a vice-president of National Union Radio Corp.

... **Robert A. Elliot** was appointed manager of the Distributor Sales Division of Erie Resistor Corp., Erie, Pa. He was previously with Pioneer Electric and Research Corp., Standard Coil Products, and RCA.

... **K. L. Bishop** was named to the new position of general sales manager of the V-M Corp., Benton Harbor, Mich. He had been industrial and export sales manager for the company.

... **Max F. Balcom**, Sylvania Electric Products, was elected chairman of the new Radio-Television Industry Committee of the RETMA, and F. R. Lack, Western Electric, was elected Chairman of the Electronics Industry Committee.

... **C. L. Orcutt**, joined P. R. Mallory & Co., Indianapolis, as assistant to the president. He was formerly with Sylvania Electric Products.

... **Louis W. Selsor** is now handling distributor sales for Jensen Manufacturing Co., Chicago. He has been with the company for over a year. **Philip B. Williams**, an 11-year veteran with Jensen, has been named chief engineer.

... **David Gnessin** was appointed educational director of Transvision, Inc., New Rochelle, N. Y. He is the editor of *Television Notes*, the company's house organ.



TELEVISION

Big demand for graduates

B.S. DEGREE IN 27 MONTHS in radio including TV engineering—VHF, UHF, AM and FM. Students use over \$100,000 worth of equipment including 2 large commercial type transmitters in new TV lab. Intense specialized course includes strong basis in mathematics, science and advanced design in radio and TV.

Hundreds of young men each year are earning engineering degrees in this recognized institution. Start any quarter. Many earn a major part of expense in this industrial center. Low tuition. Competent instruction. Thorough, intense, practical program.

Also **B.S. DEGREE IN 27 MO.** in Aeronautical, Chemical, Civil, Electrical and Mechanical Engineering. G.I. Gov't approved. Enter Dec., March, June, Sept. Free catalog. **ENROLL NOW.**

INDIANA TECHNICAL COLLEGE
17123 E. Washington Blvd., Fort Wayne 2, Indiana

COAST ELECTRONICS has the

NEW precise MODEL 308 K 8 1/2" OSCILLOSCOPE

THE GREATEST OSCILLOSCOPE FROM COAST TO COAST

ALL THE FEATURES OF THE FAMOUS MODEL #300 PLUS:

- ★ INTENSIFIER ANODE
- ★ HI-LOW-NORMAL SYNCH. (A Precise First)
- ★ 8 1/2 INCH TUBE (A Precise First)
- ★ VOLTAGE REGULATION (A Precise First)

See Precise Ad Page 108



The only 8 1/2" Oscilloscope on the commercial market today. We have this Precise "scope" for you . . .

NEW 7" Oscilloscope Kit \$ 94.95
LATEST 8 1/2" Oscilloscope Kit \$129.50

OTHER PRECISE KITS AVAILABLE:

MODEL 909K—VACUUM TUBE VOLTMETER	\$25.98
MODEL 630KA—RF-AF TV & MARKER GENERATOR (pre-assembled head)	\$38.95
MODEL 610KA—RF SIGNAL GENERATOR (pre-assembled head)	\$28.95
MODEL 635K—UNIV. AF SINE, SQ. & PULSE GEN.	\$33.50

Terms: All merchandise shipped FOB Alhambra, California. Prices slightly higher in the West. Prices and specifications subject to change without notice. Include 20% deposit for C.O.D.'s. WRITE FOR NEW CATALOG—FREE!

COAST ELECTRONICS SUPPLY CO. Dept. P3
527 W. Main Street • Alhambra, Calif.

Send me _____
 Enclosed find \$ _____ deposit. Balance COD
 Enclosed find \$ _____ in full.
 NAME _____
 ADDRESS _____
 CITY _____ ZONE _____ STATE _____

. . . Douglas J. Sullivan was appointed to the newly created post of manager of personnel development for the Marketing Section of the General Electric Tube Department, Schenectady, N. Y. He had been manager of employee and plant community relations for the department.

. . . Edward Schulz joined the RCA Laboratories Division, Princeton, N. J., as director of personnel. He was a former associate professor of management and industrial relations at New York University School of Business.

. . . Ashley A. Farrar was promoted to assistant vice president of Raytheon Manufacturing Co., Waltham, Mass. He was previously manager of Government Contracts for the Equipment Division of Raytheon.

. . . Merton W. Whitney joined the sales staff of Simpson Electric, Chicago. He was formerly with Cook Electric.

. . . Robert D. Hallock joined American Microphone Co., Pasadena, Calif., as plant manager. He has had wide experience in the electronics field.

. . . P. N. Cook, Chicago-Standard Transformer Co. was named chairman of the Social Committee of the Association of Electronic Parts & Equipment Manufacturers. Other committee chairmen include: E. Van Deveer, Jensen Manufacturing, Credit; O. D. Jester, Standard Coil, Publicity; Roy S. Laird, Ohmite, Educational; Theodore Rossman, Pen-tron, Industry Relation; Wilfred Larson, Switchcraft, Membership and Attendance; and Ben Boldt, Amphenol, Merchandising Problem Analysis.

. . . Hank Gropper is now with Tech-Master Products, New York City, as assistant to Paul Witte, sales manager. He had been with United Transformer Co.

. . . Major William J. Schoenberger, recently released from active duty with the Air Force, joined Insuline Corp. of America, Long Island City, N. Y., as assistant to Samuel H. Spector, president of the firm. He will be in charge of the Contracts Division.

. . . Isadore Waber joined C-B-C Electronics, Philadelphia, as vice-president in charge of sales. He was formerly with Radio Electric Service Co.

. . . Ray Murphy was named manager of the Electronics Division of Industrial Engineering Corp., Tampa, Fla.

. . . Marshall T. McGuineas was appointed advertising manager of The Hallcrafters Co.'s branches in Chicago, Kansas City, and Milwaukee.

. . . Jerry B. Minter, vice-president of Measurements Corp., Boonton, N. J., and president of Components Corp., Denville, N. J., was elected president of the Audio Engineering Society.

. . . Albert E. Hylas and Walter V. Tyminski joined the engineering staff of Industrial Television, Inc., Clifton, N. J. Both were formerly with the Research Division of Allen B. Du Mont Laboratories.

. . . Miryam Simpson, of Mark Simpson Manufacturing Co., Long Island City, N. Y., was awarded an associate membership to the American Institute of Management. END

MANNFRED PROUDLY PRESENTS

NEW! EICO 7 INCH PUSH-PULL SCOPE



MODEL 470

KIT \$79.95 Factory Wired \$129.50

- VERTICAL FREQ. RESPONSE: flat ± 2 db 10 cps—1 mc.
- VERTICAL SENS.: .01 volts rms/inch.
- HOR. FREQ. RESP.: flat ± 0 db 10 cps—200 kc, —4 db at 500 kc.
- HOR. SENS.: .3 volts rms/inch.
- SWEEP RANGE: 15 cps—100 kc.
- 3-STEP FREQ.-COMPENSATED ATTENUATOR eliminates freq. distortion, overloading.
- CATHODE FOLLOWER inputs to both amplifiers.
- PUSH-PULL outputs in both amplifiers.
- RETURN TRACE BLANKING
- INT. VOLTAGE CALIBRATOR
- V & H TRACE EXPANSION & CENTERING: 1.5X full screen without distortion.
- DIRECT CONNECTION to vert. CRT plates.
- PHASING CONTROL of internal 60 cps sine wave sweep.
- AT FRONT PANEL: intensity mod. input; 60 cps, sawtooth outputs.

Famous EICO amazing value-packed economy-priced 425K 5" Push-Pull Scope KIT \$44.95. Wired \$79.95.

EICO VTVM

221K VTVM KIT \$25.95. WIRED \$49.95.

- AC & DC volts: 0-5, 10, 100, 500, 1000 V (30 KV with HVP-1 probe).
- 5 ohm ranges from .2 ohm to 1000 megohms.
- DC input Z 26 megohms.
- 4 1/2" meter movement in can't-burn-out circuit.
- 1% mult. resistors.



Send for our new 1953 MANNFRED CATALOG!

FREE! A complete, comprehensive listing of all your electronic requirements. Bursting with those SPECIAL VALUES that only MANNFRED can present.



MANNFRED ELECTRONICS CORPORATION
21-26 36th Ave., Long Island City, N. Y.

- Send me at once your new 1953 catalog
- Send complete information and technical data on NEW EICO Model 470
- Please send EICO Model Enclosed find \$ 20% deposit with C.O.D. required. Pre-paid if remittance in full.

Name
Street
City State

MANNFRED
Electronics Corporation

21-26 36th Ave., Long Island City, N. Y.

Most Sensational Bargain
National Electronics Has Ever Offered
Clear, Sharp Fringe Area Reception

ON ALL CHANNELS
UHF and VHF
TV Antenna Kit

Everything Needed
For A Perfect
Installation
\$19.95

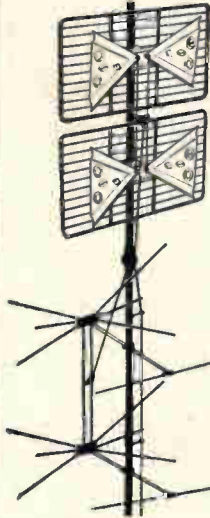

A complete hi-gain UHF-VHF antenna system designed for fringe area reception. Includes everything needed for the complete installation. Just think! A powerful fringe-type 2-bay 16-element conical and a hi-gain two-bay Row-Tie Reflector for UHF—with complete mounting kit containing everything you need for installation. A Terrific Value!
Model UV-1 .. \$19.95
Model UV-2 .. \$21.45

Look at what you get with Model UV-1 Two-Bay UHF Row-Tie Reflector, 2-bay 16-element conical, 1 UHF-VHF antenna matching transformer, 75" UHF tubular twin-lead, 3 UHF mast insulators, 6 UHF screw insulators, 1 arrester, mast, chimney mount and lead-in tube. Model UV-2 Same as above, but with flat or peak roof mount, guy rings, guy wires and hardware.

1-10' mast, 1 self-coupling 5' mast, chimney mount and lead-in tube. Model UV-2 Same as above, but with flat or peak roof mount, guy rings, guy wires and hardware.

UHF STRIPS—Now available for Standard Com tuners. To order specify channel No. and series designated by letter such as F, G, Q, etc. stamped on each strip of your present tuner. (Set consists of one, & ant.) **\$7.50 EACH**

Save With Rocket 35 Foot Mast Kits
Economy mast kit contains 3 self-coupling 10' seamless TRI-COATED 1 1/4" O.D. masts, one 5' mast, 300 feet of 6/20 galvanized steel guy wire, and everything else needed including guy rings, insulators, cable clamps, guy hooks, and swivel mounting base.
35 foot Mast Kit **\$15.95** 25 foot Mast Kit **\$11.95**

ALL PRICES F.O.B. CLEVELAND, OHIO
Do not remit more than complete purchase price. Pay shipping charges on receipt of goods. 25¢ deposit on all C.O.D. orders. Please, Money-back guarantee. Prices Subject to Change Without Notice

Perfect Pictures in Fringe Areas
Rocket Super Fringe
All Channel Antenna

This truly sensational TV antenna is THE ANSWER to super-fringe area reception. Twenty-four driven elements provides a balanced all channel db gain that produces astounding results at 100 or more miles from transmitter. Also provides crystal-clear UHF pictures in primary or near-fringe areas. We strongly recommend this powerful antenna as the "Finest All-Channel TV Antenna On The Market Today."

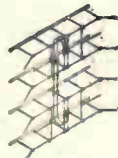

- Series "J" .. \$24.95 each
Lots of 3 .. \$29.25 each
- 9 Anodized Aluminum Elements (guaranteed against staining or tarnishing)
 - Solid Cast-Aluminum Back-up Blocks
 - Plexi-glass Hi-dielectric Insulators
 - Aluminum Washers and Stand-offs
 - Cadmium-plated Nuts & Bolts
 - 3/16" Dowel Pins
 - Light Weight—no thrust bearing required on rotor
- LOOK AT THESE AMAZING FEATURES
- Clear pictures up to 100 miles and more from station—plus UHF near-fringe reception
 - 12 driven elements on high VHF!
 - 12 driven elements on low band!
 - High gain—low noise ratio!
 - One transmission line!



Radiart Telerator

WITH DIRECTION INDICATOR
Streamlined, waterproof, sturdy, 12 heavy duty ball bearings. Heavily reinforced die-cut housing. Precision gears. Positive stop at end of rotation. Heavy duty motor reverses instantly. Mast, tower or platform mounting. Factory lubricated for life. Perfect pattern dial gives immediate indication of antenna position.
Requires 8 Cond. Cable
8 Conductor Wire \$98 ft.

\$29.37

UHF TELEVISION CONVERTER

Sutco UHF television converter with built-in booster. Continuously variable for channels 14 thru 83. Built-in wide band VHF booster for channels 2 thru 13. Self-powered for 110 volt, 60 cycle AC operation. Selector switch gives choice of VHF or UHF antenna. VHF antenna may be fed thru the broad band booster or direct to the TV set. Stock No. 22B shipping weight 7 lbs.



\$34.95

National Electronics
OF CLEVELAND
THE HOUSE OF TV VALUES
212 Delco Building Cleveland 3, Ohio

EDISON RADIO AWARD

A nation-wide search for the amateur radio operator who performed the outstanding public service of 1953 has been announced by the General Electric Company Tube Department. The winner will receive the Edison Radio Award. His name will be announced on February 11, 1954, Thomas A. Edison's 107th birthday anniversary. The 1953 eligibility rules are as follows:

Nominations may be made by any individual or group familiar with the service performed.

The service must have been performed during 1953 while the candidate was pursuing his hobby as an amateur within the continental limits of the United States.

Candidates must hold an amateur radio license issued by the Federal Communications Commission.

Nominations must be postmarked not later than January 3, 1954, and must include the name of the candidate, his call letters and address, and a full description of the service performed.

Decisions of the judges will be based upon (1) the greatest benefit to an individual or group and (2) the amount of ingenuity and sacrifice displayed in performing the service.

No employee of the General Electric Company is eligible to receive the award.

Nominations should be addressed to the Edison Award Committee, Tube Department, General Electric Company, Schenectady 5, N. Y.

Last year, the Edison Award went to 20-year-old Don L. Mullican, Searcy, Ark. He stuck to his shortwave set for more than five days—almost without relief—to bring emergency aid to tornado victims in two nearby towns.

PAPER THAT TALKS

A dictating-transcribing machine, the Pentron Dictorel, recently placed on the market by Pentron Industries, uses magnetic coated paper called Talkaform, which can be used and reused over 2,000 times without loss of fidelity. The machine electronically erases the paper so completely, while re-recording, that not even a whisper of previous recordings remains, even at full volume.



The paper can be written upon, folded, and filed. It feeds into the Pentron Dictorel like a typewriter, rotating around a drum to form a cylinder. As the drum rotates, the record-erase carriage moves slowly along its length so that the recording track is helical.

No Choice

By Jeanne DeGood

"A new method of control for television sets... 'breath control.' It enables the viewer to change stations or turn the volume off or on by puffing into the appropriate opening of the control."—RADIO-ELECTRONICS May, 1953.

I settled in my chair tonight
And puffed my set to watch a fight.
It ended, and I puffed again
To twist the knob to Channel Ten.
A cooking show—I puffed once more
To try the fare on Channel Four.
I puffed and puffed, but didn't see
A single show that suited me...
For me, TV has met its death,
For I'm completely out of breath.

NOW! New TELEVISION SPECIALTIES



TYPE V-2

CALIBRATED VARIABLE INDUCTANCE KIT

8 Permeability Tuned Coils

FEATURING

- WIDE INDUCTANCE RANGE 1 to 1000 μ Hy.
- INDIVIDUAL INDUCTANCE CURVE SHEET FOR EACH COIL.
- COMPLETE DATA ON Lmin., Lmax., SELF RESONANT FREQUENCY, Q, R & C.
- ACCURATE UNIVERSAL AND SOLENOID WINDINGS. Q-MAX impregnation.
- Video Peaking • IF Circuits
- Radio or TV Tuning • RF Choke

\$4.50 per box

for UNIVERSAL DESIGN-CONSTRUCTION and REPLACEMENT PURPOSES

A HANDY KIT for any LAB or SERVICE SHOP

IMPORTANT! TELEVISION ANTENNA ACCESSORIES



TYPE F-1 for 300 Ω

TELEVISION INTERFERENCE FILTER

Highly efficient 3-section high pass type. Attenuates all frequencies up to 50MC. Eliminates amateur, xray, diathermy, auto and aircraft interference.

LIST \$5.90



TYPE T-1

UHF...VHF CROSS-OVER NETWORK

Adopts UHF-VHF antenna to single transmission line.

Eliminates antenna switches and duplex lead-ins. Saves time and money on installation work.

LIST \$4.75



TYPE R-1 for 300 Ω

TWO-RECEIVER TV COUPLER

Allows use of two TV receivers on one antenna.

No adjustments or switches.

No effect on transmission line impedance.

LIST \$3.85

Ask about these NEW ITEMS at your local distributor, or write for FREE BULLETIN, giving distributor's name and address.

Engineers **UNITED TECHNICAL LABORATORIES** Manufacturers
MORRISTOWN, N. J.

RADIO-ELECTRONICS Annual Index
 Volume XXIV January - December 1953
 (Key to abbreviations on pg. 136)

	DATE	PAGE
A		
AMATEUR		
Adapting Relays to Special Uses (Garner)	May	100
Heterodyne Frequency Meter Uses Pair of Transistors (Turner)	Oct.	88
Low-Down on the BC-422-A (Frye)	Apr.	80
Moon and Back, The (R.M.)	Apr.	16
IN34 NB FM-PM Modulator (Maki)	June	66
Oscillators		
Beginner's Code Oscillator (Welz—R.E.C.)	Feb.	104
Code Oscillator (Q.B.)	Oct.	153
Improving Oscillator and A.V.C. Operation (Sareda)	Jan.	130
Two-Band V.F.O. (Queen)	May	96
Receivers, communications		
Novice 2-Tube Superhet (Graham)	July	51
Short-Wave Converter (Graham)	Jan.	122
Short-Wave Preselector (R.E.C.)	Jan.	146
Short-Wave Regenerator	Feb.	88
Television interference—See Television Transmitters		
Adding Power Amplifier to 80-Meter Transmitter (Q.B.)	Dec.	120
Economical Novice Transmitter (Graham)	Sept.	108
Modulating SCR-274-N Rigs (Q.B.)	June	105
Screen-Modulating The SCR-274-N (Q.B.)	Dec.	120
Two-Tube, 360-Watt Rig (Q.B.)	Apr.	128
Transmitter-receivers		
One-Tube Tranceiver (R.E.C.)	June	96
AMPLIFIERS—See also Audio, TV		
Stable D.C. Amplifier (Patent)	Oct.	138
Trigger Circuit Relay Amplifier (Trent)	May	90
ANTENNAS		
AM-FM Antenna Switching (Trauffer—T.T.O.)	Jan.	152
TV antennas—See Television		
APRIL FOOL STORY		
New Kit Solves TV Problems	Apr.	49
AUDIO		
Amplifiers		
Amplifier Metering Set (R.E.C.)	Aug.	87
Budget Remote Line Amplifier (Augsburger)	Dec.	30
Crystal Pickup Equalizer (Q.B.)	Aug.	99
Dual-Channel Remote Amplifier (Jordan)	Feb.	58
Experimental Subminiature Amplifier (Parker)	Sept.	40
Extending Amplifier Bandwidth (Marshall): Pt. I Sept. 42; Pt. II Oct.	Oct.	40
Gas-Tube Amplifier (Patent)	Mar.	113
Gas-Tube Amplifier (Patent)	June	93
High-Quality Circuits Pt. I (Comm. on above)	Sept.	33
(Frieborn) Pt. II	Dec.	138
	Oct.	42
Importance of Balance in Push-Pull Amplifiers (Marshall)	July	28
Junior Golden Ear Amplifier (Marshall)	Nov.	55
Low-Hum Amplifiers (Simon)	Mar.	40
Multipurpose Audio Amplifier (Hantz)	Feb.	64
Novel Tone Control	Apr.	126
Oscilloscope Patterns and Amplifier Diagnosis (Crowhurst)	Oct.	34
Phase Inverter Circuit (R.E.C.)	Apr.	122
Push-Pull Drivers (Fletcher-Cooper): Pt. II Jan. 96; Pt. III Feb. 60; Pt. IV Mar.	Mar.	38
Signal-Tracing Amplifier (Lederer)	May	64
3Q5-GT A.F. Amplifier (Q.B.)	Mar.	126

RCP VTVM

Model 655

READS PEAK-TO-PEAK VOLTAGES DIRECTLY

ACCURATE MEASUREMENT OF COMPLEX WAVESHAPES

SINE WAVE
 RMS or Peak-To-Peak... Useful and Necessary—Read Directly With Model 655

PEAKED SAWTOOTH WAVE
 TV Horizontal Signal... Peak-To-Peak Reading Required—Easily Done Directly with the Model 655.

PULSE WAVE
 TV Horizontal Deflection... Peak-To-Peak Measurements Needed—Read It Directly on the Scale—Model 655.

COMPOSITE VIDEO WAVE
 Video Amplifier... Peak-To-Peak Measurements A Must—Do It Directly With The Model 655.



Quickly... Accurately

DO-ALL Model 655.

ONLY \$59.50

... gives a true reading measurement of complex and sinusoidal voltages with necessary peak-to-peak or RMS value read directly, for the analysis of waveforms in video, sync and deflection circuits.

service as the manufacturers say—the peak-to-peak way. The combination of this P. to P. meter and service notes to match, take the guesswork out of service and speed up your service operation.

Versatility of measurement, built into each Model 655, serves a variety of industrial applications in the service of vibrator power supplies, AC generators and all equipment utilizing any type of waveform or DC.

Match the Model 655 with any peak-to-peak VTVM—You will find that comparable performance can only be found in much higher priced instruments.

Comes complete with new "RCP SOLDERLESS TEST LEADS" for operation on 105 to 125 V AC.

- FOR TELEVISION SERVICE AND INDUSTRIAL MAINTENANCE**
- PEAK-TO-PEAK AC measurements of from .2V to 4200V on 7 ranges.
 - AC RMS measurements of .1V to 1500V on 7 ranges.
 - DC measurements of from .02V to 1500V on 7 ranges.
 - RESISTANCE measurements of from .2 ohms to 1000 Megohms on 7 ranges.

See Your Local Parts Distributor or Write For RCP Catalog RE 12.

RADIO CITY PRODUCTS CO., INC.
 152 WEST 25th ST • NEW YORK 1, N. Y.

SAVE MONEY! SAVE SERVICE CALLS!
CHECK ALL TV, RADIO & PICTURE TUBES
 with this **VISULITE TV TUBE CHECKER**

NO TECHNICAL KNOWLEDGE REQUIRED
 Simple Instructions Furnished
SAFE—QUICK—FOOLPROOF

Most Radio set failures are due to burned out tubes. Just plug tube into socket provided and Neon Lamp indicates this condition instantly. Operates on 110 Volt AC or DC.

Performs 1001 Electrical Checks!
 Checks continuity of resistors, appliances, motors or any Electrical device. Sturdily built for long life of trouble shooting. Test Leads included—Nothing else to buy.

SOLD ON 10 DAY MONEY BACK GUARANTEE. See it at your distributor today. If he can't supply, order direct from factory. \$3.95 Postpaid anywhere in the U. S.

VISULITE CO., Dept. RE12 423 Broome St., New York 13, N. Y.

PRES-PROBE CONDENSER TESTER

Finds Intermittent Condensers Instantly

Pres-probe's sliding tip with variable resistance prevents condenser heating. Tests with power on. Requires no adjustment. Stops guesswork. Saves time. Convenient probe size (7/8" long). Satisfaction guaranteed.

795
 Postpaid U. S. A.

See Your Dist. or Order Direct

PRES-PROBE CO.
 4034 N. Sixth St., Milwaukee 12, Wisc.

ALL WELDED —

ALL ALUMINUM!

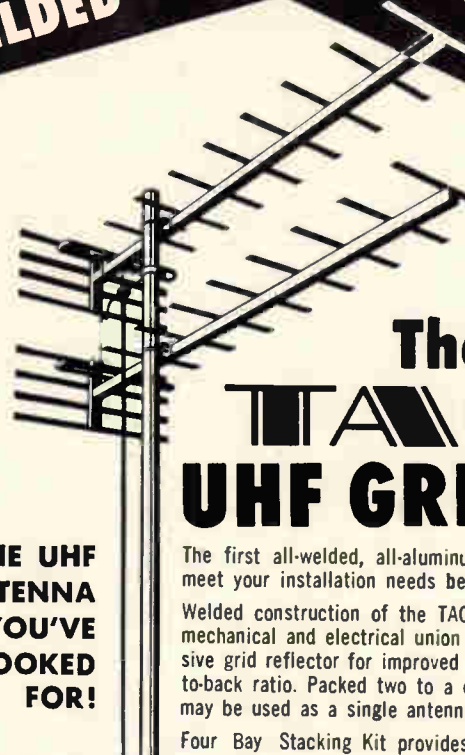

The TACO UHF GRID YAGI

The first all-welded, all-aluminum UHF yagi — designed to meet your installation needs better.

Welded construction of the TACO Grid Yagi assures perfect mechanical and electrical union between all elements. Exclusive grid reflector for improved directivity and highest front-to-back ratio. Packed two to a carton, with stacking lines — may be used as a single antenna or two-stack array.

Four Bay Stacking Kit provides added gain and directivity.

★ **THE UHF ANTENNA YOU'VE LOOKED FOR!**

★ **ASK YOUR JOBBER FOR COMPLETE INFORMATION**
TECHNICAL APPLIANCE CORPORATION, SHERBURNE, N. Y.
 In Canada: Hackbusch Electronics, Ltd., Toronto 4, Ont.

IT'S READY NOW!

SEND FOR YOUR GIANT NEW
Concord Catalog

1954 EDITION



IT'S GOT EVERYTHING!

- Standard Lines
- Special Buys

IT'S FREE!

Concord Radio
 55 Vesey Street, New York 7, N. Y.
 Phone DLgby 9-1132

SENSATIONAL XMAS GIFT VALUE!



SETCHEL CARLSON DE LUXE TABLE RADIO

\$29.50

- POWERFUL 6 TUBE CIRCUIT
- 10" PM SPEAKER
- THREE BANDS

Offers all the advantages of a large size console set in minimum space and for very moderate cost. Features include: 3 bands, 540-1600 kc, 2.4-6.6 Mc, 6-17.6 Mc. Well-designed five tube plus rectifier circuit. Tubes: 2-12BA6, 12BE6, 12AT6, 6V6, 6X4. Power output is 3 watts undistorted to 10" high quality PM speaker. Has provisions for external antenna, phono pickup, and power to phono AC only. Extra plug for use on 220 volts AC (export). Handsome cabinet-maker's hand finished genuine Mahogany veneer cabinet 21½ L x 11½ H x 6½ D. Available in Blonde or Mahogany finish. Shpg. Wt. 19 lbs.

Stock No. F-5130M Mahogany Net \$29.50
 Stock No. F-5130B Blonde Net \$32.50

CONCORD RADIO, 55 Vesey St., New York 7, N. Y. Dept. C-12

Send Giant New FREE Concord Catalog at once to:

Name _____
 Address _____
 City _____ Zone _____ State _____

	DATE	PAGE
Volume Expanders and Compressors (Scott)	Mar.	41
Why Feed Back So Far? (Crowhurst)	Sept.	36
Audio Hum Check List (Coriell)	May	65
Bookshelf Enclosure for Good Bass	July	27
British Audio Circuits (Crowhurst)	Nov.	74
Filters		
Attenuation Problem (Wald)	Oct.	86
Attenuator Design (Crowhurst)	Dec.	36
More About Filters (Crowhurst): Pt. I Apr. 64; Pt. II May	62	
Hearing Aids		
Build This Transistor Hearing Aid (Turner)	Sept.	38
Miniature Hearing Aid (Armstrong)	Dec.	40
Transistor-Equipped Hearing Aid (R.M.)	Mar.	16
High Quality—See Also Individual Heads		
High-Quality Audia (Dorf): Pt. I Sept. 30; Pt. II Oct. 37; Pt. III Nov. 58; Pt. IV Dec. 33		
Loudness Controls		
Bridged-T Audio Control (Austin)	June	45
High-Quality Circuits (Frieborn)	Oct.	42
Loudness Controls (O'Leary) (Schjelderup-Comms.)	Aug.	48
	Nov.	148
Loudspeakers		
Electrostatic Speaker (Dieffenbach)	Apr.	66
Extension Loudspeaker (Q.B.)	Oct.	155
Handy Remote Speaker from "Useless" Dynamic (Dunscombe)	Nov.	88
PM Dynamic Speakers (R.M.)	Feb.	14
Speaker Phasing and Dissociation Effect (Crowhurst)	Feb.	55
Musical Instruments, electronic		
Amplifying the Reed Organ (Shinn)	Apr.	62
Electronic Organ (Patent)	Sept.	140
Electronic Music (Fostenaeckels): Pt. II Jan. 102		
How to Build a Theremin (Hansen)	Nov.	84
Oscillators, phono		
Phono Oscillator (Kaness)	Oct.	106
Simple Phono Oscillator (Anglado—R.E.C.)	Mar.	117
Phonographs		
High-Quality Record Player in Kit Form (Kass)	Nov.	53
Individual Phonograph (Iwanivsky)	Jan.	135
Public address		
Overcoming P.A. Hookup Problems (Crowhurst)	June	46
Rapid Remote Microphone Control (Crowhurst)	Mar.	34
Preamplifiers		
Audio Preamplifier (Hantz—R.E.C.)	Apr.	121
Heathkit Preamp Modification (Q.B.)	Nov.	143
Powering Audio Preamps (McMath)	May	33
Transistor Preamp (Turner)	Feb.	54
Reactance Charts (French)	July	24
Record Changers		
Servicing Record Changers (Lettner): Pt. I Aug. 34; Pt. II Sept. 62		
Recording		
Learning Tape Recording (Carlson—Comms.)	Apr.	139
Magnetic Film Recording (Queen)	Aug.	52
Signal Generators		
New Phase-Shift Oscillator with Wide Frequency Range (Maxwell—R.E.C.)	Feb.	107
Reliable Wide-Range Audio Oscillator	Apr.	68

	DATE	PAGE
Simple Signal Generator (R.E.C.)	Apr.	122
Velocity Microphone (Brizendine)	Nov.	78

B

BATTERY CHARGERS

Charging Dry Batteries (Vidden—T.T.O.)	Mar.	123
Simple Battery Charger (R.E.C.)	July	96

BROADCASTING AND COMMUNICATIONS

Best Wave for Urban Use (Queen)	Nov.	98
Broadcasters to Meet Defense Emergencies	July	66
Experimental Communication with Light Beams (Leslie)	Oct.	46
Simple Instrument Measures Frequency Deviation	Nov.	94
Statistical TV Transmission	May	113
Where Antennas Go Down, Not Up (Klein)	May	106
Citizens Band Transmitter (R.E.C.)	Aug.	88

C

CONSTRUCTION—See Individual heads, Receivers, etc.

E

EDITORIALS (H. Gernsback)

Closed-Circuit Television	June	27
Electronics vs. Atomic Bombs	Dec.	29
Guided Missiles	July	23
Miniradios	Nov.	29
New Television Trends	Jan.	29
Radar Hazards	Aug.	25
Radio Astronomy	Mar.	33
Radio-Electronics Digest	May	29
Service Digest	Sept.	29
Transistor Transition	Feb.	29
Transoceanic Television	Apr.	29
Wanted: Inertialess Speakers	Oct.	33

ELECTRONICS—See also Industrial electronics

General

Automatic Headlamp Control	Feb.	78
Automatic Headlight Dimmer (Marley)	Oct.	99
Contest Winners	Apr.	48
Electronic Interval Timer (Harnes)	Apr.	84
Ionic Oscillator, The (Fairbairn)	Dec.	76
Phototube Control Circuit	Sept.	117
Scintillation Counter (Bukstein)	Aug.	54
Simple Geiger Counter (Kucharski)	Sept.	119
(Note on above)	Nov.	132
Sonic Delay Lines	Mar.	56
Stanford's Linear Accelerator	May	61

Medical—See also Ultrasonics

Electropsychometer (Gish)	May	58
Psychometer Safety Modification (McCready—Comms.)	Aug.	107

Musical Instruments—See Audio

F

FREQUENCY MODULATION

Adapter Unit Kills FM Commercials (Sheldon)	May	68
Commercial Silencer (Patent)	July	82
Converting GE JFM-90 Tuner to 88-108-Mc Band (Q.B.)	June	104
FM Broadcasting in Western Germany (Nestel)	Mar.	63
FM Receiver from Small-Screen TV	Sept.	122
Long-Distance FM Receiver (Kumm)	Apr.	58
Narrow-Band FM Adapter (R.E.C.)	May	138
Reactance Tube Tuning Vernier (Ives)	May	82

I

INDUSTRIAL ELECTRONICS

Character Tube Has Many Commercial Applications (Milanowski)	Oct.	114
--	------	-----

The Latest and Best in

TV ANTENNAS AND ACCESSORIES

from Admiral

World's Largest Television Manufacturer



Admiral antennas & accessories

Admiral is first with the best and the mostest. Your Admiral distributor now carries the most complete and up-to-the-minute line of TV antennas and accessories. See the Admiral Catalog for high-gain UHF antennas of the most advanced design . . . rotators . . . all-weather transmission line . . . mast and tower equipment for every type of installation.

Now you can get everything needed from one source, at one time . . . no need to waste time shopping around. Quick, close-to-home service. Admiral prices are lowest. And every item conforms to Admiral's high quality standards. Send for your catalog today!

FREE

Mail coupon for

Admiral

CATALOG

.....
Admiral Corporation, Accessories Division
 3800 Cortland St., Chicago 47, Illinois

Please send free catalog.

Name _____

Address _____

City _____ State _____

RE-11

TRAIN AT HOME FOR UHF-TV AND

TELEVISION

SERVICING

Learn practical, professional type TV Servicing without leaving your present job. Included are money-making extras such as set conversion, master antenna installation, UHF-TV, field servicing short cuts. You can start earning Television money after first few lessons. You learn to test, trouble shoot and repair all types of TV sets.

HERE'S HOW YOU GET EXPERIENCE!

You train on a large screen, modern TV receiver, furnished with the course and yours to keep! As an optional feature you can get two weeks actual experience with Chicago's largest independent servicing organization. You learn by doing! Age is no barrier. Many students are over 40! ACT NOW! Send for FREE Catalog and SAMPLE LESSON today!

TV COMMUNICATIONS INST.
 205 W. Wacker Dr., Dept. RE-24
 Chicago 6, Ill.

VETERANS!
 T.C.I. is approved for G.I. training. Under Public Law 550. Check coupon

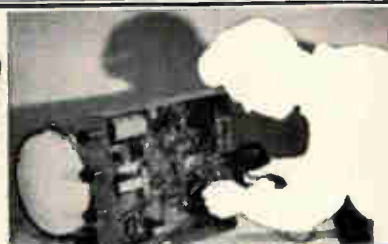

MAIL NOW FOR FREE BOOKLET

MILTON S. KIVER, President
 TELEVISION COMMUNICATIONS INST.
 205 W. Wacker Dr., Dept. RE-24, Chicago 6, Ill.
 Rush FREE Catalog and Sample Lesson. I am not obligated. Salesman will not call.

Name _____ Veterans: Check here

Address _____

City _____ Zone _____ State _____

BEGINNERS check here for Basic TV Course.

assemble your own...



CONTROL: Select the correct carbon control—15/16" or 1-1/8" dia.—to meet requirements.

SWITCH: When required, choose switch in either the SWB or SWA series to meet specifications and attach to the control.

SHAFT: Finally, select any one of 12 different "Pick-A-Shaft" shafts and insert into the control. Note that Clarostat also offers "Pick-A-Shaft" 2, 3, and 4 watt wire-wound controls.

*Trade-Mark

CLAROSTAT

CONTROLS AND RESISTORS

CLAROSTAT MFG. CO., INC. DOVER, NEW HAMPSHIRE

In Canada: Canadian Marconi Co., Ltd., Toronto, Ont.

ASK YOUR JOBBER about these money-, time-, trouble-saving Clarostat "Pick-A-Shaft"* and "Ad-A-Switch"* controls for replacement or for initial-equipment needs. Ask for latest catalog.

for like - new performance

replace with original ROGERS full-focus deflection yokes



Since most of the better TV sets are made with ROGERS Deflection Yokes, this same top quality yoke should be used for replacement. With over 25 years of electronic know-how, ROGERS Precision Engineered Products make TV sets perform like new.

ROGERS Full-Focus Deflection Yoke assures double brilliance with knife-edge sharpness over the entire screen. Each ROGERS yoke—precision tested for perfect focus—is designed for peak performance and extra long life.

"the eye tells why"

packaged individually—attractively

ROGERS ELECTRONIC CORP. 43-49 Bleeker St. New York 12, N. Y.

FREE: Send for new catalog "A," listing TV set models and ROGERS Yoke and Flyback replacements, or see your jobber.

ARKAY

world's finest radio kits

Write for free Brochure

RADIO KITS, INC., 120 Cedar St., N. Y. 6

ELECTRONIC HOBBYISTS

Build and play my latest polyphonic organ without a knowledge of music. Or get blueprints for a miniature electronic brain, and other projects. Send 3¢ stamp for air mail reply.

JIM KIRK, W6JKX

1552 Church St., San Francisco 14, Calif.

MISCELLANY

	DATE	PAGE
Electronic Fishing (Hallows)	Sept.	98
Machine Stenographer Types		
Speech Direct	Sept.	106
Project Tinkertoy (Michaels)	Dec.	59
U.H.F. Treatments to Improve Wines (Lafargue)	Mar.	54
IRE Convention (Shunaman)	June	68

L

LIGHT-BEAM COMMUNICATION

Light-Beam Communication (Leslie)	Oct.	46
Light-Beam Modulator (Patent)	May	130

LOUDSPEAKERS—See Audio

M

MEASUREMENTS AND METERS—

See Test instruments

MOTION PICTURES

Narrow-Gauge Motion Pictures (Lane): Pt. I Apr. 54; Pt. II	May	36
Theater-TV Standards Proposed by Industry	May	50

MUSICAL INSTRUMENTS, ELECTRONIC—See Audio

O

OSCILLATORS—See also Amateur,

Audio		
NBS Transistor Oscillator	May	118
New Phase-Shift Oscillator with Wide Frequency Range (Maxwell)	Feb.	107
Transistor Oscillator Is Powered by Light (Turner)	Aug.	66

P

Phototimers—See Relays

POWER SUPPLIES

Battery Charger-Eliminator (Q.B.)	Oct.	152
Laboratory Type 12-volt Battery Eliminator (Barbee)	Aug.	58
Multiple Voltage Supply (Hardy—R.E.C.)	Sept.	143
Power Supply for Intermittents (Fischer—T.T.O.)	July	90
Scope and Your Power Supply, The (Ennes)	May	30
Voltage-Regulated Screen and Bias Supplies (Scott)	Oct.	44
Voltage Regulators for Hi-Fi Amplifiers (Marshall)	Mar.	36
V-R Tubes in Parallel (R.E.C.)	Feb.	104

PRINTED CIRCUITS

New Printed-Circuit Techniques (R. M.)	Aug.	8
New Printed-Circuit I.F. Amplifier (Leslie)	Sept.	52

RADIO CONTROL

Novel Control Circuit (Phillips—T.T.O.)	Jan.	152
Radio-Controlled Speedboat (Moses)	July	48

R

RECEIVERS—See also Amateur,

Servicing		
Adding Bass and Treble Controls to High-Fidelity Tuner Output	Feb.	57
Auto Radio Conversion (Q.B.)	July	98
Booster for Police Radio (Q.B.)	Aug.	100
High-Fidelity Voltage-Doubling Broadcast Tuner (Chalfin)	May	80
High-Quality AM Tuners (Shields)	Feb.	63
New Feature in Midget Set	Sept.	86

Portable

Converting the G-E 260 for A.C. Operation (Q.B.)	Jan.	157
High-Performance Portable (Cohn)	July	56
Two-Tube Pocket Set Uses Famous		

	DATE	PAGE
Circuits (Tax)	Apr.	94
Selective Crystal Tuner (Dhuru—R.E.C.)	June	97
Some Improvements for Clock-Controlled Receivers	Sept.	94
Variable Selectivity for Superhet	May	143
RELAYS		
Capacitance Relay (Scott)	June	58
Photo Slide Tripper (Kraig—R.E.C.)	Dec.	117
Sensitive Capacitance Relay Circuit (R.E.C.)	Oct.	145
Simple Tubeless Photo Timer (Klemm)	Dec.	74
Transistor Control Relay (Bohr)	July	53
Voltage Amplifiers in Control Circuits (Ives)	Apr.	57

SERVICING

General

Average TV Service Dealer Discussed	Feb.	38
Best Foot Forward (Kirk)	Feb.	48
Canvassing Builds Business (Kirk)	Mar.	58
Communiclip (Lowens)	Mar.	57
Engineering Approach to Audio-TV Service (Kibling)	May	35
Equipment Investment	Jan.	53
Fire Insurance and Your TV (Matsinger)	Feb.	50
Mr. Postal Card Has Selling Power (Welz)	Oct.	61
New TV Areas (Rider)	Jan.	39
110 Million Radios in U.S. (R.M.)	Oct.	22
TV Service Can Be Successful (Drut)	Feb.	30
TV Service Record System (Lowens)	Sept.	57
Who is Liable (Parker)	Feb.	52

Instruments for—See Test instruments

Radio Receivers

Adding a Short-Wave Band to Fada 740 (Q.B.)	Mar.	130
Adding Tuning Indicator Circuit (Q.B.)	Nov.	139
Converting a G-E 260 Portable for A.C. Operation	Jan.	157
Coupling Radios by Their I.F.'s (Welz)	May	94
High-Speed Servicing (Tryon)	Apr.	53
Intermittent Alarm (R.E.C.)	Aug.	87
Midget Portables and Their Problems (Boller)	Oct.	62
Rating Power Transformers (Harris)	Dec.	98
Rewiring Battery Sets for A.C.-D.C. Operation (Laurence)	Apr.	47
Shortcut Service on Radio (F. Tryon)	Oct.	84
S-38-C Noise Limiter (Q.B.)	Nov.	141

Television Receivers—See Television, SIGNAL GENERATORS—See Audio

TAPE RECORDERS—See Audio TELEVISION

Amplifiers

Design Data (Sorensen)		
Pt. I	Mar. 46, II	Apr. 36,
III	May 52, IV	June 31
Driver for Coax Cable (R.E.C.)	Dec.	117

Antennas, General

Antenna Coupler (Frye—T.T.O.)	Oct.	148
Antenna Design (Clinic)	Nov.	42
Antenna Reference Chart	Mar.	51
Broad-band V.H.F. Antenna, A	Dec.	53
Broad-Band Yagi Antennas for V.H.F. and U.H.F. (Mandl and Noll)	Sept.	45
Coaxial lines for (Q.B.)	Oct.	156
Folded-Dipole Type Antennas Can Be De-Iced (Josephs)	Oct.	50
High-Gain Rhombic for TV (Rafford)	May	51
High-Gain Vertical Antenna (Q.B.)	Aug.	99

free
THE BIG B-A
1954 ANNUAL
CATALOG
NUMBER 541

Complete Guide to the Latest Products of Top Makers in Radio, TV, Sound and Recording Fields

BURSTEIN-APPLEBEE CO., 1012-14 MCGEE ST., KANSAS CITY, MO.

156 PAGES OF MONEY-SAVING VALUES!

BURSTEIN-APPLEBEE CO.

1012-14 McGee St., Kansas City 6, Mo.

Send Free B-A Catalog No. 541.

Name.....

Address.....

City..... State.....

BURSTEIN-APPLEBEE CO.

1012-14 MCGEE ST. KANSAS CITY, MO.

RIGHT!

from any angle

A challenging answer to low cost, wide-angle high fidelity reproduction. Diffusicone-12 is a newly engineered speaker with exclusive dual concentric cone design, which diffuses the normally beam-like high frequencies. Results in exceptionally uniform response . . . assures full range reception over the entire listening area.

Write today for Bulletin 62N73 — address inquiries to Desk 62.

THE NEW University DIFFUSICONE-12

An Engineering Achievement of **UNIVERSITY LOUDSPEAKERS INC.**
 80 So. Kensico Ave., White Plains, New York

**COMPARISON PROVES
EICO OFFERS
GREATEST V-O-M values!**



World-renowned **EICO**
VOLT-OHM-MILLIAMMETERS

#536 KIT \$12.90. Wired \$14.90
#526 KIT (with 1% multipliers)
only \$13.90. Wired \$16.90

COMPARE EICO Multi-meters with any others and you'll agree . . . only EICO gives you ALL the features

you want—PLUS 9 new exclusive EXTRAS—at the LOWEST COST in the industry!

COMPARE the PLUS versatility and performance of ALL THESE 9 EXTRA features: • full-scale ranges of 0-1 volt way up to 0-5000 volts on both AC and DC • grand total of 31 full-scale ranges • Current ranges on both AC and DC • large 3" meter • 400 ua sensitivity • 1000 ohms/volt on both AC and DC • minimum battery-drain ohm ranges • dual rectifier with separate low and high voltage calibration on AC ranges • available in both KIT and WIRED form. Just think of the amazing wide and versatility of these 31 different ranges! DC/AC Volts: Zero to 1, 5, 10, 50, 100, 500, and 5000! DC/AC Current: 0-1 ma, 10 ma, 0.1 Amp, 1 Amp. Ohms: 0-500, 100 K, 1 meg. 6 DB ranges:—20 to 69.

Yes, Comparison proves it . . . you get the MOST VERSATILITY—and you really SAVE—only with EICO! See the famous complete EICO line of V-O-Ms, Scopes, VTVMs, generators, tube testers, battery eliminators, bridges, decade boxes, etc. at your jobber today. Write NOW for FREE Catalog MC-12 and name of local jobber.

Prices 5% higher on West Coast.

ELECTRONIC INSTRUMENT CO., Inc.
84 WITHERS STREET, BROOKLYN 11, N. Y.

THE "COQUILLE"

(Pat. pending)

High Fidelity Shell Baffle Made of FIBREGLASS. Three dimensional sound with

ONE SPEAKER!

Here for the first time is a speaker enclosure based on the acoustic principles of the world's great concert halls.



Increases speaker efficiency up to 1/2. Extreme wide angle projection of high frequencies with full bass response. Brings life to your music with concert-hall realism. Ideal for home or auditorium.

For 12" and 15" speakers, size 68" high—40" wide \$74.50
For 8" speakers—size 34" high—20" wide \$44.50
Shipped F.O.B., our plant, ready to assemble. 25% deposit with orders. Balance C.O.D.

MASTER ELECTRONICS CO.

8586-90 Santa Monica Blvd.,
Los Angeles 46, Calif.

Spot TV trouble symptoms at a glance

. . . fix them twice as fast!

**NOW! SAVE HUNDREDS OF DOLLARS
IN TV SERVICING TIME!**



The short cut way of handling up to 90% of your television troubleshooting by the easy PICTURE ANALYSIS METHOD!

**FAST!
EASY TO
USE!**

Just "dial" the new Ghirardi PIX-O-FIX TV TROUBLEFINDER GUIDE until the actual TV screen photo appearing in its "window" matches the screen picture on the defective set you are repairing. The proper Trouble Key Number also appears on the guide. This directs you to the tabulation giving all possible causes of this particular trouble and the stage or section of the receiver in which

Hours of tedious, time-consuming troubleshooting can be cut to minutes. Repairs can be made twice as fast!

it is most likely to occur. But this is only the beginning!

The Pix-O-Fix Guide not only helps you locate the trouble quickly but then shows you exactly how to fix it. Step-by-step repair instructions follow. In most cases, the particular component most likely to be faulty is specified. Quick tests to apply to it are explained. If part substitution is likely to be more effective than an instrument test, this is recommended.

PIX-O-FIX is applicable to all television receivers. Operation is clear and simple. Money-back guarantee if you're not more than satisfied!

NOTE! Ghirardi's PIX-O-FIX is designed and sold as a professional TV service device for servicemen—NOT as a "fix-it-yourself" gadget for use by consumers.

Only \$1. 10 DAY Money back Guarantee

Dept. RE-123, Rinehart Books, Inc., Technical Div.
232 Madison Ave., New York 16, N. Y.

Enclosed is \$1 for which please rush a PIX-O-FIX TROUBLE FINDER GUIDE. If not satisfactory, I will return it postpaid within 10 days and you guarantee to refund my \$1.

Name _____

Street _____

City, Zone, State _____

PRICE OUTSIDE U. S. A. \$1.25 cash—same return privilege.

PIX-O-FIX

**TV TROUBLE
FINDER GUIDE**

By Ghirardi & Middleton

24 COMMON television troubles identified by actual TV screen photos.

190 POSSIBLE causes of these troubles identified and localized to the particular stage of the receiver where they are most likely to occur.

253 DEFINITE, easily understood remedies for these troubles.

4,500 WORDS in CAUSE and REMEDY section to explain step by step what to do.

MISCELLANY

	DATE	PAGE
Indoor Yogi for TV (Manning—T.T.O.)	June	103
Relay Rhombic Brings TV to Shadow Area	Apr.	35
Rhombic Antenna Modification (Q.B.)	Jan.	156
Rhombic for Channel 2 (Q.B.)	Dec.	121
Stacking Bars for Conical (Clinic)	Aug.	47
Tilting Antennas in Ultra-Fringe Areas (Clinic)	July	41
TV Antenna Products Directory	Jan.	60
Yagi Antenna Problem (Q.B.)	Mar.	127
Antennas, Distribution Systems		
Community TV Systems (Lucas, Jr.): Part I	July 37; Pt. II	Aug. 40
Community Antenna Systems (Shapp—Comms.)	Oct.	163
Community Antenna Systems (Lucas—Comms.)	Nov.	148
Community TV Troubles (Comms.)	May	154
Jerrold Community TV (Shapp—Comms.)	July	108
TV Comes Over the Mountain (Stephens)	Mar.	44
TV Distribution Systems (Leslie)	Jan.	34
Antennas, u.h.f.		
Antenna for U.H.F. TV (R.E.C.)	Nov.	136
U.H.F. Antennas and Transmission Lines (Roche)	Apr.	30
U.H.F. Antenna Installations (Clinic)	Dec.	50
U.H.F. Conical (Q.B.)	Oct.	155
U.H.F. Indoor Installations (Kamen)	Sept.	50
U.H.F. Master Antenna Systems (Kamen)	May	39
U.H.F. TV Antennas (Hyman and Sarayiotas)	Oct.	58
U.H.F. Yagi Antenna (R.E.C.)	June	98
Boosters		
Dual Output Booster	Feb.	40
New Boosters From Old Tuners (Marshall)	June	28
TV Booster Characteristics	Jan.	70
Circuitry		
Analyzing the R-C Circuit (Glickstein)	Nov.	47
Antinoise Sync Circuitry (Scott)	Jan.	52
Area Control	Feb.	44
Automatic Contrast-Ratio Control (Dix, Jr.)	Aug.	29
Automatic Width Control (Scott)	Jan.	53
Drive Control (Clinic)	Sept.	60
Improved A.G.C. Systems (Scott)	July	35
Linear Sweep Generator	Jan.	134
Local-Distance Switching (Scott)	Jan.	51
More A.G.C. Circuits (Scott)	Dec.	52
Retrace Blanking Circuits (Scott)	Feb.	44
Retroce Blanking for 630 (De La Mater—R.E.C.)	Sept.	145
Sensitivity Control Switching (Scott)	Jan.	51
Spot Wobbler (Hart, Atkinson, and Martin)	Sept.	48
Color Television		
Color TV (Patent)	Feb.	101
Color TV—The NTSC System (Kronenberg)	Nov.	30
Glossary of Terms for Color TV	Feb.	41
Kine Control for Color TV (Patent)	Nov.	124
NTSC Color TV (Sieminski)	Jan.	42
Dx		
Dx Prospects for U.H.F. TV	Apr.	41
Effect of Sporadic E on TV Reception (Smith)	June	54
TV Dx in 1952 (Tilton)	Jan.	45
European		
European Station List (Martin)	Oct.	60
European TV Network	Jan.	37
Industrial		
Dismantling Bombs by TV (Emery)	Sept.	51
Interference		
Stubs (Dines)	June	52
Correction	Dec.	139
TVI Reduction Kink (R.E.C.)	Jan.	147

Servicing—See also Test instruments	DATE	PAGE
Analyzing the R-C Circuit (Glickstein)	Nov.	47
Antinoise Sync Circuitry (Scott)	Jan.	52
Area Control	Feb.	44
Automatic Contrast-Ratio Control	Aug.	29
Automatic Width Control (Scott)	Jan.	52
Cascade Tuner Installation (Clinic)	Jan.	69
Conversion to 21-inch Tubes (Clinic)	Feb.	42
Critical Components (Clinic)	May	46
Directory of TV Receiver Characteristics	Jan.	72
Drive Control (Clinic)	Sept.	60
Impedance-Matching Stubs (Q.B.)	Feb.	112
Improved TV and FM Alignment Procedures (Van Dormolen)	Dec.	101
Installing Cascade Tuner (Q.B.)	Sept.	148
Kinescope Replacement Chart (Scott)	Jan.	64
Line-Voltage Changes (Clinic)	Oct.	54
Local-Distance Switching (Scott)	Jan.	51
Polarized Power Plugs (Hedge)	Jan.	118
Replacing 12WP4 Tube in Philco (Q.B.)	June	107
Restoring Peak Performance (Waner)	Feb.	32
Retrace Blanking Circuits (Scott)	Feb.	44
Retrace Blanking for 630 (De La Mater—R.E.C.)	Sept.	145
Servicing U.H.F. TV (Kleidon)	Oct.	51
Television Components for Conversion or Repair	Jan.	66
Tone Control for TV Set (Q.B.)	Mar.	126
Trivial Troubles (Clinic)	June	40
Tube Failures in TV Receivers (Ledbetter)	Nov.	34
Tuning Eye for TV Sets (Cohn—T.T.O.)	Dec.	115

TV Chassis Simplified	June	50	
TV Matching Pads (Q.B.)	Mar.	128	
TV Oddities (Burke)	May	41	
TV Signal Tracing (Engineering Staff, Scala Radio):			
Pt. I	Apr. 44;	Pt. II	May 48;
Pt. III	June 34;	Pt. IV	Oct. 48
Various Troubles (Clinic)	Apr.	42	
Voltage-Boost Circuit (Clinic)	Mar.	52	
What About the Ion Trap? (Kaufman)	Apr.	34	
Stations			
Construction Permit List	Aug.	37	
KCJB-TV (Boler)	Nov.	33	
Station List—U.S.	July	44	
Station List—European	Oct.	60	
30 TV Stations to Change Frequencies	Feb.	39	
Theory			
Television—It's a Cinch (Aisberg): Pt. I, I	Jan. 54;	I, 2	Feb. 36;
II	Mar. 48;	III, 1	Apr. 38;
III, 2	May 54;	IV	June 36;
V, 1	July 31;	V, 2	Aug. 44;
VI, 1	Sept. 54;	VI, 2	Oct. 56;
VII, 1	Nov. 36;	VII, 2	Dec. 48
Tuners			
Cascade Type Front Ends (Armstrong): Pt. I	Aug. 38;	Pt. II	Sept. 58
U. h. f.			
Antenna for U.H.F. TV (R.E.C.)	Nov.	136	
Conical on U.H.F. (Q.B.)	Oct.	155	
Dx Prospects for U.H.F. TV	Apr.	41	
Harmonic Generators	May	140	
Model 60 U.H.F. Tuner (Barr)	June	32	
New U.H.F. Channels	Jan.	38	
Report on Pennsylvania U.H.F.	Apr. 56		
Servicing U.H.F. TV (Kleidon)	Oct.	51	
TV Comes to Portland (Bary)	Jan.	62	
Two More U.H.F. Converters			

(King)	Jan.	48
Two New U.H.F. Tuners (Scott)	May	43
U.H.F. Antennas and Transmission Lines (Roche)	Apr.	30
U.H.F. Channel Frequencies Made Easy (Hatfield)	Aug.	31
U.H.F. Circuitry	Jan.	57
U.H.F. Growing Pains Mark First Year of Unfreeze (Leslie)	July	43
U.H.F. Indoor Installations (Kamen)	Sept.	50
U.H.F. Master Antenna Systems (Kamen)	May	39
U.H.F. Opens Up (Guy)	Jan.	30
U.H.F. TV Antenna (Hyman and Sarayiotis)	Oct.	58
U.H.F. Yagi Antenna (R.E.C.)	June	98

TEST INSTRUMENTS AND TESTS—

See also Audio signal generators,

Oscillators, etc.

Advanced Scope Techniques (Garner)	July	45
Amplifier Metering Set (Lederer—R.E.C.)	Aug.	87
Band-Edge Crystal Marker	Jan.	148
Build an IM Analyzer (Austin)	Dec.	42
Capacitance and the Ratio Detector (Glickstein)	Oct.	78
Capacitor Checkers (La Mantia—T.T.O.)	Feb.	115
Modification of above (Wilkinson)	Oct.	150
C-R Tube Checker Adapter (Herman—T.T.O.)	June	101
Crystal-Diode Tester (R.E.C.)	Mar.	117
Crystal Markers for Sweep Generators (Morrissette)	Jan.	106
Field Strength Meter (Clinic)	Aug.	46
Field Strength Meter for TV Measurements (Q.B.)	Jan.	157

Tele Sound CORPORATION

Custom Built TV CABINETS

WHY PAY MORE?

Don't be misled! Other cabinets may look the same, but they are NOT similar in QUALITY. Our cabinets are massively constructed, fully reinforced, smartly styled in the modern manner, and offered to you at today's LOWEST PRICES. Buy with confidence. All cabinets illustrated available in Mahogany. Add 10% for Blonde Korina and Lined Oak. Complete catalog an request.



Model 500
H 25" W 25" D 21 1/2"
17" to 21" \$42.00
24" & 27" 59.50



Model 1200
H 35" W 40"
D 23"
\$130.00



Model 250
H 40 1/2" W 25"
D 22"
\$57.50

Standard Brand	
PIX TUBES—1 YR. GUARANTEE	
17" 17BP4A	\$28.90
20" 20CP4A	38.05
21" 21EP4A	40.25
24" 24PB4	76.00
27" 27QP4 (electro-magnetic)	90.00

TV CHASSIS SPECIAL VALUES

all less picture tube
 VIDEO 530 DX Chassis \$139.50 TECHMASTER C-30-TV Chassis \$149.50
 VIDEO 630 Super-Deluxe 149.50 TECHMASTER 1930 TV Chassis 179.50
 VIDEO 630-DX Chassis 159.50 TECHMASTER 2431-P TV Chassis 199.50
 Please include 25% deposit with orders, balance C.O.D. All shipments F.O.B., NYC. Prices subject to change without notice.

Save Money with TELE SOUND "Package Deals"!
 Order the Tele Sound Cabinet you want combined with Vide 530 DX Chassis, 12" speaker and picture tube, at these terrific low prices:

CABINET STYLE	17" CRT	20" CRT	21" CRT	24" CRT	27" CRT
250	\$218.81	227.73	229.87
500	204.09	213.01	215.15	266.63	329.03*
1200	287.69	296.61	298.75	333.61	396.01*

* For other TV chassis add: Video 630, \$5; Video 630-DX, \$10; Techmaster C-30, \$5; 1930, \$30; 2431-P, \$50. These models equipped with Video 530-DXC-27 chassis.

Tele Sound CORPORATION
 "Designers and Manufacturers of Custom TV and Radio Furniture"
 431 West 28th Street New York 1, N. Y.
 Phone: WI 7-0719

"HIGH FIDELITY Simplified"

by
H. D. WEILER



Here is the complete story of high fidelity—clearly told, easily understood. This brand new, practical book covers everything from 'what high fidelity is' to the actual selection, purchase and installation of the proper high fidelity equipment. You'll find page after page of detailed, illustrated information concerning record players and changers, amplifiers, loudspeakers and tape recorders... it answers your questions on what to buy and do to obtain perfect results. Learn how you can enjoy the most lifelike musical reproduction possible. Order your copy of this valuable, new first edition today at your local bookstore... or simply send \$2.50 to—

John F. Rider, Publisher, Inc.
Dep't. RE-12, 480 Canal Street
New York 13, N. Y.

BE A TV EXPERT!



TV TROUBLESHOOTING AND REPAIR GUIDE BOOK, VOL 1—R. G. Middleton

Finest practical book to make TV servicing easy. Spot your TV receiver troubles fast! 204 (8½ x 11") pp. \$3.90

ENCYCLOPEDIA ON CATHODE-RAY OSCILLOSCOPES AND THEIR USES—Rider & Usland

Most complete 'scope book! Cloth cover. 992 (8½ x 11") pp., 3,000 illus. \$9.00

RECEIVING TUBE SUBSTITUTION GUIDE BOOK—H. A. Middleton

Answers all tube problems by listing 2,500 radio-television tube substitutions in numerical sequence with accompanying wiring instructions, original and substitute tube socket illustrations. 224 (8½ x 11") pp. \$3.00

FIRST SUPPLEMENT, RECEIVING TUBE SUBSTITUTION GUIDE BOOK

750 completely new and different radio-TV tube substitutions not listed in the first edition. Special section on substitutions tubes in television receivers. 48 (8½ x 11") pp. \$9.99

Write for complete Rider catalog.

Buy these books now from your jobber, local bookstore or, if unavailable from these sources, write to:

JOHN F. RIDER PUBLISHER, INC.
480 Canal Street, New York 13, N. Y.

	DATE	PAGE
How to Test Your Signal Generator (Garner)	Feb.	46
Inductance Meter Uses Heterodyne Principle	Oct.	96
Instrument Output Indicator (Garner)	Dec.	54
Intermittent Alarm (R.E.C.)	Aug.	87
Intermittent Recorder (Racker)	Dec.	57
Low-Range Ohmmeter (Stratmoen)	Aug.	30
Making Meter Scales (Halmbacher)	Mar.	59
Measuring Field-Strength for TV (Engineering Staff—Scala Radio)	Nov.	39
Modern Watch-Rate Recorders (Maxwell)	Aug.	26
New Volt-Ohm-Microammeter	Sept.	80
Novel Capacitor Checker (Gold)	Mar.	118
Novel V.T. Voltmeter (R.E.C.)	Sept.	144
Peak-to-Peak Calibration (Row)	Apr.	46
Practical Impedance Checker (Sohl)	Dec.	53
Quick Capacitor Checker (Kelly)	Jan.	114
R.F. Circuit Tester (Queen)	Mar.	62
Servicing TV with a Wattmeter (Ledbetter)	Dec.	47
Signal-Tracing Amplifier (Lederer)	May	64
Simplified Meter Shunts (R.E.C.)	Mar.	120
Simplify Frequency Ratio Checking (Henry)	May	34
Scope and Your Power Supply, The (Ennes)	May	30
Scope Measures D.C. (Queen)	May	119
Subminiature Tube-Tester Design (Sandretto)	Mar.	60
Test Crystals With Your Signal-Generator (Ives)	July	47
Transistor Microammeter (Rhita)	June	49
Tube-Filament Checker (Showers)	July	91
Correction for above	Nov.	155
Tube-Heater Checker (Arslan—T.T.O.)	May	132
TV Linearity Checker (R.E.C.)	Jan.	148
Versatile Grid-Dip Probe (Queen)	Oct.	111
Versatile Neon Tube (Haviland)	Apr.	50
Versatile Scope You Can Build (Hust)	Nov.	49
Z-Axis for Your Scope (Ives)	Nov.	44
THEORY AND ENGINEERING, See also Electronics		
Artificial Delay Lines (Paine)	Mar.	92
Atomic Dry Cell (R.M.)	July	12
Bridged-T Network Makes Ideal Phase Shifter	Apr.	100
Detector-Amplifier With Germanium Diodes (Gottlieb)	Mar.	86
Electricity From Atoms (Secor)	Feb.	66
Electronic Flame (Conant—Comms.)	Feb.	123
Understanding Mechanical Filters (Burns)	Oct.	120
TOYS		
Adfojet, Mark II (Bukstein)	Dec.	96
TRANSISTORS—See also Tubes and Transistors		
All-Transistor TV Receiver Shown by RCA	Feb.	51
Build This Transistor Hearing Aid (Turner)	Sept.	38
4-Terminal Transistor (Patent)	Aug.	86
Heterodyne Frequency Meter Uses Pair of Transistors (Turner)	Oct.	88
Junction Transistors (R.M.)	Feb.	12
Miniature Hearing Aid (Armstrong)	Dec.	40
NBS Transistor Oscillator	May	118
New RCA Transistors (R.M.)	Sept.	12
Phototransistor Control Unit (Patent)	Nov.	118
RCA Shows Transistor Progress (R.M.)	Jan.	12
Test Techniques for Transistors		

ATLAS PROJECTORS

9 models to choose from for EVERY application



The performance-proved ATLAS Double Re-entrant ('DR') design combines compactness with unequalled high efficiency and uniform response in a rugged, stormproof, demountable construction. The larger size horns are excellent for greatest efficiency and low-frequency response. Where space and cost limits exist, the smaller horns are recommended. For complete details on 'DR' Projectors and the famous ATLAS line of Public Address and Microphone Stand equipment...

WRITE NOW for FREE Catalog 553

ATLAS SOUND CORP.

1443 39th St., Brooklyn 18, N. Y.
In Canada: Atlas Radio Corp., Ltd., Toronto, Ont.

PHILCO TV TURRET TUNER (Pt. #78-3109, less coil strips). For '48 & '49 models... \$1.49
PHILCO TUNER with 3 socket wired R.F. strip... \$1.98
PHILCO 3 MIN. SOCKET R.F. STRIP containing over \$4.00 worth of Resistors, Condensers, Etc. \$9

ROTARY BALL-BEARING SWIVEL ASSEMBLY... Designed for TV TABLE SETS; used also for HEAVY CHASSIS SERVICING & ROTARY DISPLAY WORK. Rugged hardware mtd. between 18" O.D. Masonite plates... \$5.95

EXPERIMENTAL TUBES for Test, Research, etc. Fil. tested, Kit of 40 asstd. reev. types... 1.98
GD-60 (G-E) RADIO DIAL STRIPS. Tune & Vol. **BLACK HARD RUBBER PANELS**. 5/32" thick 12"x12"-.15; 12"x18"-\$1.65; 12"x24"-\$2.15; 9"x12"-.89; 18"x18"-\$2.39; 18"x24"-\$2.98
FADA BALLAST TUBES. 115, 12, 13, 58, 79, 100, 101, 110, 124, 133 each... .89

MOTOR SPECIALS!! 1/17 H.P. G-E MOTOR (Type SD), 1725 RPM, 110V DC, 7 and 9/16" shaft, O.D. 4 3/4"x1 1/2"... 13 lbs. 3.95
6V. DC MOTOR (Deleo). Fully cased, dustproof, 1 1/2" shaft, 1500 RPM, 2 3/4"x4" (shpr. wt. 4 lbs.)... 2.95
1 40 H.P. AC MOTOR (Robins & Myers), 1350 RPM, 1650 RPM. With capacitor & switch (6 lbs.)... 4.95

ELECTRICAL RUBBER TAPE... 3/8"x15 ft. (TL-192)... .99
FL-192... .99
FL-192... .99
13V PILOT BULBS (1813) min. bay. ea. 12c 10/98c
DPDT BAT TOGGLE SWITCH (C-H #8715K2)... .79
Luminous tip, 20A 125V. Spring return... .98
DPDT RELAY (Allied 2452-1128) 230 ohms, 24V. 3A. contacts. 2"x1 1/2"x3/4"... ea. 79c 6/3.98
60° TV DEFECTION YOKE for 12" & 16" tubes 1.29

BARGAIN PARTS ASSORTMENTS!!
OIL CONDENSERS, incl. multi-section. Kit of 10 1.98
ROTA SELECTOR SWITCHES, incl. multi-deck... 1.75
MOULDED BAKELITE CONDENSERS—20mmf to .2mfd, 200-600V. (Micamole). Kit of 50 asstd. 1.98
CARBON RESISTORS, 1/4 to 2W. Kit of 100... 1.98
RADIO HARDWARE TREASURE... FULL LB. CAN OP: Nuts, Screws, Washers, Lugs, etc. 89c
WAFER TUBE SOCKETS, 4 to 8 pin. 12 asstd. .49
ELECTROLYTICS, can & tubular. 8 asstd. 1.98
WIRE-WOUND RESISTORS: 3-20 watt, 10 asstd. .98
POTENTIOMETERS... all 1/4" shafts, 6 asstd. 1.49

!! HIT THE RADIO-ELECTRONICS-TV PARTS JACKPOT !! with the new "JUMBO RADIO-ELECTRONICS PARTS KIT"!! SWITCHES, SOCKETS, WIRE RESISTORS, CONDENSERS, PHOTOFACTS & TV DIAGRAMS & PARTS, ETC. ETC. Shpr. \$3.95 wt. 20 lbs.

"DIRECT FACTORY SPEAKER REPAIRS SINCE 1927"
 Min. Order \$3.00. 20% deposit req. on all C.O.D.'s.
 Please add sufficient postage—excess refunded

LEOTONE RADIO CORP.
 67 Oey Street
 New York 7, N. Y.

RADIO-ELECTRONICS

Concord Radio presents the world's most powerful UHF-VHF-FM antenna!



MONEY BACK GUARANTEED

TO RECEIVE *All* UHF and *All* VHF STATIONS IN *All* DIRECTIONS FOR 60 MILES WITHOUT A ROTORMOTOR OF ANY KIND!!

While antenna reception is guaranteed for 60 miles, perfect pictures have been consistently received as far as 160 miles from stations.

All **NEW DESIGN FOR '54**

- LOW-LOSS SWITCH
- LOW-LOSS PHENOLIC INSULATORS
- USES NEW 4-CONDUCTOR MATCHED IMPEDANCE LINE
- ONLY 10 INCH SPACING BETWEEN ANTENNA BAYS

MODEL SUPER 60

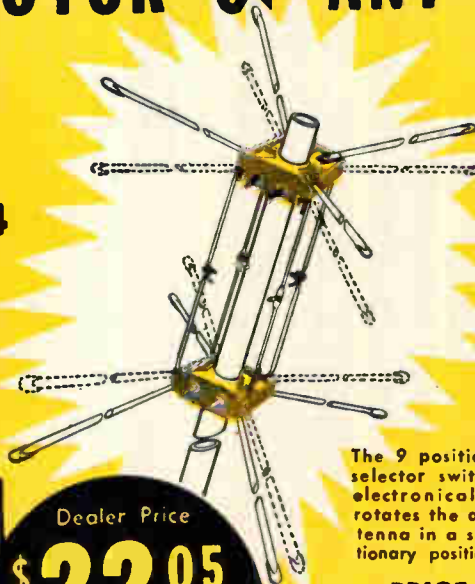

The 9 position selector switch electronically rotates the antenna in a stationary position.



NEW! POLYMICALENE 4 CONDUCTOR Matched Impedance TRANSMISSION LINE

Improves Both UHF and VHF Performance of any ALL-CHANNEL Antenna

100 Ft.	\$8.90
150 Ft.	\$13.90
200 Ft.	\$17.50

Minimum quantity 100 ft.

Dealer Price

\$22.05

LIST PRICE

\$36.75

PRICE INCLUDES
 Complete stacked array • 4 stacking bars • 9 position switch • Switch-to-set coupler • 3-7½" stand offs • Individually boxed in mailable carton

Mfg. solely by
ALL CHANNEL ANTENNA CORP.
 New York N. Y.
 under license Pat. No's 2,585,670.
 2,609,503. 2,625,655. 2,644,091.
 others pending.

WRITE FOR FREE CATALOG
Concord Radio
 54 Vesey Street, New York 7, N. Y. • Digby 9-1132

CONCORD RADIO 54 Vesey Street, New York 7, N. Y.

Please send me amount of \$36.75 list price.

Please send me amount of \$22.05 dealer net.
 Dealers order on letterhead.

Please send me feet of 4 conductor Polymicalene

Name _____

Address _____

City _____ State _____

Check Enclosed Money Order Enclosed

C.O.D. enclosed please find 25% of total purchase price....check....

Money Order. Send Giant New FREE Concord Catalog at once

Please put my name on your "Special Bargain" mailing list

() Enclosed find \$_____ in full. Send prepaid.



YOUR HIGH-PAYING
interesting career in
TELEVISION
starts here!

Complete, Easy-to-Learn
HOME STUDY COURSE
with one of America's
LARGEST schools

There's a place for YOU in the tremendous, billion-dollar Television, Radio & Electronics industry! It's so easy to get started with the famous **CRESCENT SCHOOL** course. Learn at home, in your spare time. Illustrated, simplified lessons and kits to practice on. No previous training needed. Send for **FREE** sample lesson . . . make this day the day you started on your way to a brilliant profitable career!

APPROVED FOR KOREAN VETS
Also Day & Eve. Classes
Trained at Our School



CRESCENT SCHOOL
"One of the Largest of its kind"

SEND COUPON TODAY!

CRESCENT SCHOOL Dept. E-12
500 Pacific Street, Bklyn. 17, N.Y.

Sirs: Rush your **FREE** sample lesson and full details about the **CRESCENT SCHOOL** Course—at no obligation to me!

Home Study Course Residential Course

NAME _____
ADDRESS _____
CITY _____ ZONE _____ STATE _____

CORONA RADIO KITS

• Easy Assembly • Excellent Reception

SINGLE BAND SUPER Rocket 135K—Latest superhet circuit for ultimate in sensitive reception and tonal quality. Kit includes all necessary parts, punched chassis, attractive bakelite mahogany cabinet, built-in loop antenna, iron core IFs, big 5" Audio Y speaker tubes, 12SK7, 12SA7, 12SQ7, 50L6.

3525. Automatic vol. control, beam power out. Tuner 540 to 1700 Kc. Simple step-by-step instructions included.Net **\$14.75**

2 BAND AC-DC SUPER Plaza 812K—Excellent sensitivity. Tuner standard Broadcast 535 to 1800 Kc. foreign shortwave 6 to 18 Mc (10.6 to 50 meters). Features iron core IFs, bass-treble tone control, 5" Audio FM Spkr., phono jack. Handsome bakelite mahogany cabinet. 11 1/2" x 8 1/2" x 7 1/2". Tuner: 12SK7, 12SA7, 12SQ7, 50L6, 3525. All parts, punched chassis, easy step-by-step instructions included.Net **\$20.75**

3-BAND SUPER Globemaster 814K Complete Kit.Net **\$24.75**
All kits supplied lease wire and solder. Please include 25% deposit with C.O.D. Orders. Dept. E-12

CORONA RADIO & TV CO.
136 LIBERTY ST. NEW YORK 6, N. Y.

	DATE	PAGE
(Turner)	Mar.	78
Transistor Amplifier (Patent)	Dec.	109
Transistor Control Relay (Bohr)	July	53
Transistor-Equipped Hearing Aid (R.M.)	Mar.	16
Transistor Fundamentals (Pierce)	June	42
Transistor Microammeter (Rhita)	June	49
Transistor Modulator (Patent)	Nov.	118
Transistor Oscillator Is Powered by Light (Turner)	Aug.	66
Transistor Preamp (Turner)	Feb.	54
Transistor Receiver Operates Loudspeaker (Grace)	Mar.	99
Transistor Transmitter (R.M.)	Mar.	14
Transistor Trigger (Patent)	July	85

TUBES AND TRANSISTORS
Feb. 82; Apr. 103; May 127; June 79; July 68; Aug. 71; Sept. 135; Nov. 105; Dec. 103

U

ULTRASONICS

Magnetostrictive and Electrostrictive Industrial Ultrasonic Apparatus (Clark, Quint, Raske)	Dec.	82
Stimulation of Plant Growth by Ultrasonic Waves (Obolensky)	July	76
Ultrasonic Therapy Unit (Milanowski)	May	57

KEY TO ABBREVIATIONS

Clinic	Television Clinic
Comms.	Communications
Q.B.	Question Box
R.E.C.	Radio-Electronic Circuits
R.M.	Radio Month
T.T.O.	Try This One

Items so marked appeared in monthly departments of RADIO-ELECTRONICS. Since these departments could not be fully indexed because of space limitations, a selection was made on basis of most common interest and value. Other regular departments not indexed here are Radio Business, With the Technician, New Devices, Technotes, People, Electronic Literature, Book Reviews, and TV Dx Reports. In most of the other entries the last name of the author is included parenthetically.

Radio Thirty-Five Years Ago
In Gernsback Publications

HUGO GERNSBACK
Founder

Modern Electrics	1908
Wireless Association of America	1908
Electrical Experimenter	1913
Radio News	1919
Science & Invention	1920
Television	1927
Radio-Craft	1929
Short-Wave Craft	1930
Television News	1931

Some of the larger libraries still have copies of **ELECTRICAL EXPERIMENTER** on file for interested readers.

December 1919

ELECTRICAL EXPERIMENTER

Ships Guided by Electrified Cable Speaking Crystals, by A. McL. Nicolson
Carnavon Radio Station
Locating Submarines by Audio Syphoning, by Edward T. Jones, A.M.I.R.E.E.
Modern American Radio Apparatus
Radio Guides Ships Thru Fog
Mica Condensers for Radio Sets



HICKOK
Model 605A

DYNAMIC MUTUAL CONDUCTANCE

Tube Tester
Handy Size Portable

- Popular—Accurate—Dependable.
- Large 5" easy-to-read meter.
- Accurately tests tubes in micromhos.
- Built-in 20,000 ohms per volt DC millimeter measures capacitance, inductance, volts, current and decibels.
- Write for technical details . . .

THE HICKOK ELECTRICAL INSTRUMENT CO.
10531 DUPONT AVE. CLEVELAND 8, O.

QUARTZ CRYSTALS
PT-243-.093" PIN DIA.—.406" PIN SPC
FOR HAM AND GENERAL USE

494 EACH—10 FOR \$4.00	994 EACH—10 FOR \$8.00
4035 3500 3930 6706 7306 7825	1013 2603 3993 6573 7240 8173
4080 5673 5973 6723 7323 7840	1110 2738 6000 6575 7273 8175
4110 5677 5975 6740 7340 7850	1150 2785 6025 6600 7275 8200
4163 5700 6225 6750 7350 7873	1523 2895 6050 6606 7300 8340
4190 5706 6240 6773 7373 7893	1818 2940 6073 6623 7306 8390
4235 5728 6250 6778 7378 7900	1930 3005 6075 6640 7325 8375
4280 5740 6255 6800 7400 7926	1940 3010 6100 6650 7340 8380
4300 5750 6273 6806 7406 7925	1950 3020 6106 7000 7350 8400
4397 5760 6275 6823 7410 7940	2065 3215 6128 7006 7375 8425
4450 5773 6300 6840 7423 7950	2105 3237 6140 7025 7400 8450
4490 5778 6306 6850 7440 7973	2118 3245 6150 7040 7425 8450
4495 5800 6323 6873 7441 7975	2125 3250 6173 7050 7440 8460
4750 5806 6335 6878 7450 8006	2140 3450 6178 7075 8000 8475
4845 5825 6340 6900 7473 8225	2145 3500 6200 7078 8006 8483
4930 5840 6350 6906 7475 8240	2305 3540 6440 7100 8025 8500
5030 5850 6373 6925 7500 8260	2320 3590 6450 7106 8040 8525
5205 5852 6378 6940 7506 8273	2390 3640 6473 7125 8050 8550
5235 5873 6400 6950 7520 8273	2415 3680 6475 7140 8073 8575
5250 5875 6406 6973 7523 8300	2430 3720 6500 7150 8075 8583
5300 5880 6425 6975 7540 8306	2442 3735 6506 7173 8100 8600
5305 5900 6675 7450 7570 8325	2460 3740 6525 7175 8106 8625
5333 5906 6675 7473 7573 8330	2532 3800 6540 7200 8128 8650
5385 5925 6700 7475 7575 8345	3840 6550 7208 8140 8700
5485 5940	7500 7800 8600 2537 3885 7225 8150 8733

Low Frequency—PT-241A—for 59B.
Lattice Filter etc.—093" Pins.
.406" SPC. Marked as Channel.
None—0 to 75—84th Harmonic &
& 70 to 38—2nd Harmonic—labeled
Below by Fundamental Frequencies—Fractions Omitted.

494 EACH—10 FOR \$4.00	994 EACH—10 FOR \$8.00
370 393 414 436 498 520	400 459 5918 2030 2300 3155
372 394 416 438 501 522	440 461 6370 2045 2305 3202
374 395 418 438 502 523	441 462 6450 2052 2320 3215
375 396 418 461 503 523	442 463 6470 2065 2360 3232
376 397 420 463 504 526	444 464 6497 2082 2390 3237
377 398 420 465 505 527	446 465 6522 2105 2415 3250
379 401 422 465 506 529	446 466 6547 2125 2435 3322
380 402 423 466 507 530	447 468 6610 2131 2442 3310
381 403 424 467 508 531	448 469 7380 2145 2532 3510
383 404 425 468 509 533	450 471 7380 2155 2545 3530
384 405 426 490 511 534	451 472 7390 2220 2537 3570
385 406 427 491 512 538	452 473 7480 2258 2660 3580
386 407 429 492 513 537	453 474 7850 2260 2940 2945
387 408 430 493 514 534	454 475 7810 2280 3035 3955
388 409 431 494 518	455 476 7930 2282 3120 3978
389 41 435 495 516	456 477
391 412 354 518	457
392 413 435 497 518	458 480

Special—200 Kc or 400 Kc in PT-241A Held—S-1-0-B ea.

SUN
add 20¢ postage for every 10 crystals. for less!

PARTS DISTRIBUTORS, LTD.
520 TENTH ST., N.W. - WASHINGTON, D.C.

RADIO-ELECTRONICS

ANOTHER OUTSTANDING JOBBER

NIDISCO

713 Newark Ave.
Jersey City, N. J.

55 State St.
Hackensack, N. J.

658 Anderson Ave.
Cliffside, N. J.

294 Passaic St.
Passaic, N. J.

126 So. Warren St.
Trenton, N. J.



\$12.95

HAS THE SENSATIONAL NEW

EICO 495-K SCOPE VOLTAGE CALIBRATOR KIT

IN STOCK!

OPPORTUNITY ADLETS

Rates—45¢ per word (including name, address and initials). Minimum ad 10 words. Cash must accompany all ads except those placed by accredited agencies. Discount, 10% for 12 issues. Misleading or objectionable ads not accepted. Copy for February issue must reach us before December 21, 1953.

Radio-Electronics, 25 W. Broadway, New York 7, N. Y.

SPEAKERS REPAIRED at wholesale prices. Guaranteed workmanship. Fast service. Amprite Speakers Service, 70 Vesey St., New York 7, N. Y.

OUT OF BUSINESS. SACRIFICE television service inventory. Test equipment, tubes, etc. James Donnelly, Waverly, Ohio.

TEST EQUIPMENT REPAIRED AND CALIBRATED by factory staff. All makes. Solar, Simpson, Triplet, Heath, etc. Immediate service. Douglas Instrument Laboratory, 178a Norfolk Avenue, Boston 19, Mass.

WHAT IS EKERADIO? SUBMINIATURE RADIO, BROADCAST AND shortwave, story carried by the Associated Press national magazines. This powerful Ekeradio, headset, antenna, batteries, ready to play only \$29.95. (Dealers needed in every state.) Send your order now. Ekeradio, Box 247M, Pasadena, California. Watch a national front cover for another Eker development.

TUBES-TV, RADIO, TRANSMITTING, AND SPECIAL PURPOSE TYPES BOUGHT, SOLD AND EXCHANGED. Send details to B. N. Gensler W2LNI, 136 Liberty, N. Y. 6, N. Y.

WANTED: AN APR-4, other "APR-", "TS-", "IE-", ARC-1, ARC-3, ART-13, RC-348, etc. Microwave Equipment, everything Surplus. Special tubes, Test Manuals, Lab Quality Equipment, Meters, Fast Action, Fair Treatment. Top Dollar! Littell, Fairhills Box 26, Dayton 9, Ohio.

BUY WHOLESALE—25,000 ITEMS—CATALOG 25¢. Matthews, 1473-P3, Broadway, N. Y. C. 36.

ALUMINUM TUBING, ANGLE AND CHANNEL. Plain and perforated sheet. Willard Radcliff, Fostoria, Ohio.

AUTO RADIOS—ALL MODELS, BEST BRANDS. Wholesale. Free Catalog. Radio Frank, 14456 Michigan, Dearborn, Michigan.

USED TELEVISION \$30 UP. W4API, 1420 South Randolph, Arlington, Virginia.

TV FM ANTENNAS, ALL TYPES INCLUDING UHF. Mounts, accessories. Lowest prices. Wholesale Supply Co., Lunenburg 2, Mass.

Now Ready! New Sprayberry Book!

"HOW TO CONVERT TV SETS for LARGER PICTURE TUBES"



Covers Step-By-Step Method for Converting any TV Receiver

This new book opens exceptional extra money opportunity for the alert serviceman... converting older small screen TV sets to modern, large screen 17", 21" or 24" receivers. Fully illustrated with diagrams, charts and pictures. Covers every step: planning, wiring, final adjustment. Special introductory price, 50¢. Mail coin (no stamps please) today.

SEND ONLY 50c

SPRAYBERRY ACADEMY OF RADIO
111 N. Canal St., Dept. 89-C, Chicago 6, Ill.

THE FUND REACHES \$10,875.59



HELP-FREDDIE-WALK FUND

The *Help-Freddie-Walk Fund* has received the following letter from Herschel Thomason, radio technician of Magnolia, Arkansas, the father of five-year-old Freddie Thomason, who was born without arms or legs.

"Freddie started to kindergarden a few days ago and he seems to enjoy it a lot. He will be ready for regular schooling in one more year and we don't know yet if he can go to a public school, but we want him to go to one if at all possible. We feel that it is better for him to mix with a crowd than to stay to himself. Thanks very much for the checks. We truly appreciate all that you are doing for us."

To help the Fund give Freddie and his parents not only financial but moral support as well, we ask that each and every reader send in his contribution as often as possible. No amount is too small; none too large. Each donation is acknowledged with sincere thanks by our office, and is then forwarded direct to the Thomasons. *Make all checks, money orders, etc., payable to Herschel Thomason.* Address all letters to:

HELP-FREDDIE-WALK FUND
c/o RADIO-ELECTRONICS Magazine
25 West Broadway
New York 7, N. Y.

CONTRIBUTIONS

FAMILY CIRCLE Contributions	\$ 602.50
RADIO-ELECTRONICS Balance as of September 18, 1953	10,221.09
Anonymous, Agawam, Massachusetts	1.00
Mr. & Mrs. Frank Benevides, Somerset, Mass.	2.00
Romie Callino, Columbus, Ohio	1.00
Detect-O-Ray Co., Chicago, Ill.	10.00
S/Sgt. M. Giberson, A.P.O. 919, San Francisco Calif.	3.00
Mrs. Michael Iwanon, Los Angeles, Calif.	2.00
Mrs. A. D. Jansson, Hyattsville, Maryland, on behalf of self and friends	5.00
C. A. Mitchell, Newark, Ohio	2.00
Mrs. Adele Palo, New Westminster, B. C.	2.00
Mr. & Mrs. William Powell, Vancouver, B. C.	3.00
Radar & Wireless Section, #6 Coy. R.C.E.M.E., Halifax, N. S.	10.00
Michael Rosenberg, Bronx, New York	2.00
James T. Smith, Bronx, New York	3.00
Mr. & Mrs. Thomas Larsen, St. Paul, Minn.	1.00
Eleanor Wilson, W1QON, Walpole, Mass.	1.00
John J. Winer & Son, Buffalo, N. Y.	4.00

TOTAL CONTRIBUTIONS as of October 20, 1953 . . . \$10,875.59

THE *New* SUPER-ROYAL



High Fidelity Speakers

BY *Permoflux*

WITH THE **Famous Treated Slotted Cone FOR LOW RESONANCE**

This exclusive Permoflux feature, plus New design in magnetic structure, utilizing heavy Alnico 5 ring magnet, results in extended distortion free, low frequency response.

The specially designed single cone radiator reproduces both high and low frequencies with exceptional clearness, and avoids the inherent distortion of coaxial or 2 way systems.

See and hear the Super Royal at your High Fidelity Dealer

Available in 3 sizes 8, 12 and 15 inch.

For descriptive literature write to . . .

Permoflux CORPORATION
4912 Grand Ave., Chicago 36, Ill.
West Coast Plant
236 S. Verdugo Rd., Glendale 5, Cal.

Windsor TUBES

RADIO & TV RECEIVING

TO MERIT YOUR CONFIDENCE—to insure your satisfaction—Every tube we ship has been tested in a radio or TV set for **PEAK PERFORMANCE**. Each tube is attractively packaged in individual carton—and, **EACH WINDSOR Tube** you buy carries the full RTMA GUARANTEE!

TESTED and GUARANTEED for **PEAK PERFORMANCE**



Type	Each	Type	Each	Type	Each	Type	Each	Type	Each
1A7GT	\$.67	3Q5GT	.72	68G6G	1.47	65Q7GT	.46	7J7	.85
1B3GT	.69	354	.61	68H6	.63	6T8	.85	7K7	.85
1C6	1.06	3V4	.62	68J6	.53	6UB	.86	7L7	.85
1E7GT	1.09	5R4GY	1.00	68K5	.76	6Y3	1.09	7N7	.62
1H5GT	.51	5U4G	.44	68K7	.97	6V6GT	.51	7Q7	.62
1H6	.93	5V4G	.83	68L7GT	.94	6W4GT	.50	7R7	.70
1J6	.93	5Y3G	.37	68N6	.98	6W6GT	.63	7S7	.90
1L4	.63	5Y3GT	.32	68O6GT	.98	6X4	.37	7V7	.92
1L6	.66	5Y4G	.43	68Q7	.92	6X5GT	.36	7X6	.62
1LA4	.82	6ABGT	.68	68Z7	1.09	6Y6G	.64	7Y4	.45
1LA6	.80	6AB4	.51	6C4	.41	7A4/XXL	.57	7Z4	.50
1LB4	.82	6ACS5GT	.82	6CB6	.58	7A5	.70	12A7	.75
1LC5	.80	6AG5	.59	6CD6G	2.04	7A6	.57	12A7	.75
1LC6	.80	6AH4	.68	6D6	.63	7A7	.58	12A7	.75
1LD5	.80	6AK5	1.05	6E5	.72	7A8	.56	12A7	.75
1LE3	.80	6AL5	.44	6F5GT	.54	7AD7	1.05	12A7	.75
1LG5	.80	6AQ5	.51	6J5GT	.44	7AF7	.63	12A7	.75
1LH4	.80	6AO6	.47	6J6	.68	7AG7	.65	12A7	.75
1LN5	.80	6AO7	.75	6J7	.70	7AH7	.65	12A7	.75
1N5GT	.63	6AR5	.42	6K6GT	.45	7AJ7	.70	12A7	.75
1P5	.76	6AS5	.55	6K7	.70	7B4	.54	12A7	.75
1O5	.72	6AT6	.42	6L6G	.88	7B5	.51	12A7	.75
1R4	.85	6AU5GT	.85	6L6GA	.88	7B6	.52	12A7	.75
1R5	.62	6AU6	.47	6Q7GT	.55	7B7	.58	12A7	.75
1S4	.67	6AV6	.41	6S4	.51	7C4	1.05	12A7	.75
1S5	.52	6AX4	.72	6SBGT	.75	7C5	.56	12A7	.75
1T4	.62	6BBG	.93	6SA7GT	.57	7C6	.50	12A7	.75
1T5GT	.78	6BA6	.50	6SC7	.63	7C7	.58	12A7	.75
1U4	.61	6BA7	.66	6SD7	.55	7E5	.85	12A7	.75
1U5	.51	6BC5	.58	6SF5GT	.66	7E6	.65	12A7	.75
1X2A	.74	6BD5GT	.98	6SH7GT	.52	7E7	.85	12A7	.75
2A7	.74	6BD6	.54	6SJ7GT	.52	7F7	.69	12A7	.75
2X2	1.43	6BE6	.51	6SK7GT	.55	7F8	.97	12A7	.75
3LF4	.76	6BF5	.66	6SL7GT	.68	7G7	.85	12A7	.75
3Q4	.66	6BF6	.43	6SN7GT	.59	7H7	.61	12A7	.75

WRITE FOR ADDITIONAL TUBE TYPES AND PRICES. We also stock Special Purpose and Transmitting Tubes at similar savings! 25% Deposit with Order. All merchandise F.O.B. NYC. For orders less than \$10, add \$1 handling cost. Deduct 2% if full remittance accompanies order. All merchandise subject to prior sale and price change without notice. Dept. C-12.

Windsor ELECTRONIC TUBE CO.
1515-C SHEEPSHEAD BAY ROAD, BROOKLYN 35, N. Y.

JUNIOR GENIUS AT WORK

Dear Editor:

During the fall of 1952 I built the scope whose circuit appeared in the Question Box department of the June, 1952, issue. It cost me a total of \$10, since most of the parts came from old radios and a TV set. With it I won the first prize of \$25 in the Eighth-Grade Physics division of the New York Science Fair.

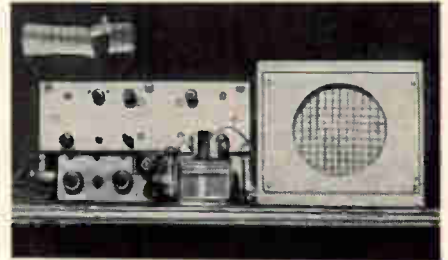

Enclosed is a picture of the scope. The cathode-ray tube is mounted in a separate case. In front of the main scope chassis is a preamplifier unit. A total of 10 tubes are used. The inset shows a video signal as viewed on the scope with the sweep set at 60 cycles.

I find your magazine very interesting and hope you will publish more articles about designing and building electronic circuits and test equipment.

STEPHEN ADLER (Age 13)

Bayside, N. Y.

HIGH-QUALITY CIRCUITS

Dear Editor:

The article "High-Quality Circuits" by John K. Frieborn in the September issue of RADIO-ELECTRONICS brought up some points that were not completely clear. I would like to mention some of the features of Ultra-linear circuits which were not brought out.

Frieborn indicates that Williamson regards partially cathode loaded stages as a greater improvement over triode operation than the Ultra-Linear circuit. This is not an accurate interpretation of Williamson's statements. In the article "Amplifiers and Superlatives," to which Frieborn refers, Williamson compares several circuit arrangements, and points out that the partially cathode loaded stage has the additional advantage over other arrangements in that it impresses a feedback voltage on the tube. This of course has all the attendant advantages of feedback but also has its attendant disadvantage. The sensitivity of the output stage is decreased, and the preceding stage has a more difficult job of supplying undistorted-drive voltage to the output, just as happens with plate-to-grid feedback.

If the same proportion of the output winding which is used in the screen circuit in Ultra-Linear connection is placed in the cathode circuit (or on the grid), the drive requirement to the output stage is more than doubled. In addition there will be inherent problems of coupling the extra winding in the output transformers which do not occur in the Ultra-Linear circuit.

The Ultra-Linear circuit permits lin-

a prize package!

SKYLINE UHF-VHF

It's the greatest! This Christmas package offers better pictures and sound the year 'round, for years to come!

One Skyline and one lead-in, get all channels, all frequencies, (VHF to 200 miles, UHF to 50 miles). It's pre-assembled, all aluminum, is quick to rig, and lasts a lifetime without weakening or blanking out, because the elements are integral.

SKYLINE MFG. CO.

1652 ROCKWELL, CLEVELAND 14, OHIO

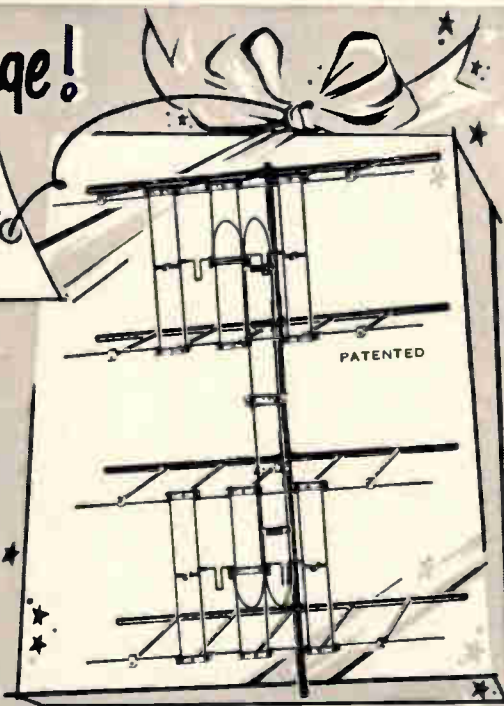

Free!
Get More Service Calls with **EICO DECALS**
For Store Windows & Cars.
Write EICO

Brooklyn 11, N.Y. Dept. DE-1

ENJOY 3 COLOR TELEVISION FILTER SCREEN NOW

Changes dull eye-straining black and white pictures into beautiful color tones. Seconds to attach. No tools used. Helps eliminate glare and snow in fringe areas. Order direct. Send \$1 for screen size up to 16". \$1.25 size 17". \$1.50 size 20". \$2 size 21". \$2.50 size 24". \$3 size 27". (Also available are single solid color screens in blue, green, or amber.) Prices on solid color screens are 10% less. We pay postage except on C.G.D. orders. Satisfaction guaranteed. Inquiries from dealers also welcomed.

Zingo Products, Johnstown 13, New York

earization of the tube characteristic without loss of sensitivity and without the disadvantages of extra transformer windings.

Both Williamson and Frieborn incorrectly refer to the Ultra-Linear circuit as a feedback arrangement. This is not correct, and it is simple to show why. In a feedback circuit the reduction in distortion and the reduction in internal impedance can never be greater than the reduction in gain. However, in the Ultra-Linear circuit there is practically no reduction of gain, but there is a significant reduction in distortion and internal impedance. Thus, there is a definite advantage to the Ultra-Linear circuit since, as Williamson puts it, "you get something for nothing," and distortion can be made lower than for either triode or tetrode operation of the output tubes.

DAVID HAFLER

Acro Products Co.
Philadelphia, Pa.

POWER LINE TROUBLES

Dear Editor:

While looking over the August issue of RADIO-ELECTRONICS, I noticed the article entitled "Power Line Troubles" (Page 108).

Having worked for power companies and consumers alike, I have seen the voltage-regulation problem handled from both ends. Mr. C. L. L. may have a solution, but 90% of the time poor regulation is the trouble. I have seen voltage fluctuation like Mr. J. T. K. writes about. Correcting these troubles is an expense to the power company. Therefore, occasionally nothing is done even though repeated complaints are received.

The solution to this problem is to make one complaint to the power company and then make a recording of the voltage. Have the chart signed by one or two witnesses and present it to the Public Service Commission having jurisdiction over the company in question. The chart should cover a seven-day period with time of day and date indications at the margin. I have never seen this method fail to bring about voltage stability. In making your readings, be certain that you are using a reliable instrument; if possible, checked by the local power company.

THOMAS L. BARTHOLOMEW
Clarksburg, W. Va.

CORRECTION

The italicized statement beginning with the tenth line on the second page of "Stubs" in the June issue is erroneous.

Open quarter-wavelength stubs attenuate all odd harmonics (the 1st, 3rd, 5th, and so on) when they are connected across the signal source or transmission line. Even harmonics are not attenuated. A shorted half-wave stub will attenuate the fundamental and all harmonics.

Our thanks to Robert A. Sadilek of Anchorage, Alaska, for spotting this error and reporting it to us. END

this
protection
pays!

**RMS
LIGHTNING ARRESTORS**

ALL *Completely* UNIVERSAL!
for twin, tubular lead and open line

ALL  APPROVED!
for indoor and outdoor

ALL QUICK-MOUNTING!

Available from your local jobber!



RMS

2016 BRONXDALE AVENUE
NEW YORK 60, N. Y.



for UHF
model LA-UH3
\$1.48 list

for VHF
model LA-3
\$1.00 list

for VHF and UHF
JUMBO model LA-4
Porcelain body with ground-lug
... plus 4 ft. ground wire.
\$1.65 list

Now...

**multi-moded, all channel
tele-beam antenna**

For UHF or VHF or both... close-in or fringe... under any receiving conditions, the TELE-BEAM MULTI-MODED ANTENNA will guarantee your customers top reception on all channels.

Basic single Sabre Comet unit can be built up to meet any need: Add snorkel for an increase on VHF highs, stack these for more on all VHF channels; use diamond stacking bars for increase VHF and UHF gain; add UHF reflectors to increase the UHF gain and directivity.



tele-beam INDUSTRIES

Write for complete information

SIXTH AND SOSCOL STS.
NAPA, CALIFORNIA

OSCIL-O-PEN

Extremely convenient test oscillator for all radio servicing; alignment • Small as a pen • Self powered • Range from 700 cycles audio to over 600 megacycles u.h.f. • Output from zero to 125 v. • Low in cost • Used by Signal Corps • Write for information.

GENERAL TEST EQUIPMENT
38 Argyle Ave. Buffalo 9, N. Y.

WE ARE QUICK & CASH BUYERS

We're looking for surplus inventories of all types of electronic parts—receiving, transmitting and special-purpose Tubes. Anything in the Radio-TV and electronic field.

**SMALL or LARGE QUANTITIES—
SEND US YOUR LIST**

Submit samples where possible, amount of each item and prices. **NAT ADELMAN**
168 Washington St., New York 6, N. Y.

L. Veltri, busy service-dealer of Westchester, N. Y., reports

I SAVED \$940*
by making a \$69 INVESTMENT
in a Transvision
FIELD STRENGTH METER

* Says Mr. Veltri: "... The way I figure, in the last 6 months I saved that much money in installation time alone ..."



FIELD STRENGTH METER
Saves 50% of Installation Cost
Pays for itself on 3 or 4 jobs

NO TV SET NEEDED

Works from antenna ... Measures actual picture signal strength directly from antenna. Shows antenna orientation maxima. Compares gain of antenna systems. Measures TVI on all channels. Checks receiver re-radiation (local oscillator). Permits one man antenna installation.



Eliminate variables, insure accuracy with direct meter readings on the FSM.

PREVENT WASTE OF SERVICING TIME! By checking antenna performance with the Field Strength Meter, the serviceman can determine whether the TV set or antenna, or both, are the source of trouble. Call backs are eliminated.



Don't lug sets. The Transvision FSM makes installation easy.

Wide range: Measures field strength from 10-50,000 microvolts. Has Fringe Area Switch for weak signal areas. 13 channel selector. Individually calibrated on every channel.

ADAPTABLE for UHF

Model **FSM-4**, for 110V AC only. Complete with tubes. Wt. 13 lbs. **net \$69.**

Model **FSM-4B**, for 110V AC and Battery Operation (case and cables included; batteries extra). Wt. 22 lbs. **net \$89.**

Order from your Jobber or from factory:

TRANSVISION INC., NEW ROCHELLE, N. Y.

Jobber Inquiries Invited



10 DAY TRIAL

Buy and try this fine instrument for 10 DAYS. Then, if you wish, you may return it. Your purchase price less 10% (our cost of handling and re-packaging) will be promptly refunded.

TRANSVISION, INC.
DEPT. RE-12F NEW ROCHELLE, N. Y.

() Send me _____ Model FSM-4; _____ FSM-4B
() Enclosed find \$_____ deposit. Balance C.O.D.
() My **JOBBER** is _____
I accept your 10 Day Trial terms.

Name _____
Address _____
City _____ State _____

Any or all of these catalogs, bulletins, or periodicals are available to you on request direct to the manufacturers, whose addresses are listed at the end of each item. Use your letterhead—do not use postcards. To facilitate identification, mention the issue and page of RADIO-ELECTRONICS on which the item appears. All literature offers void after six months.

INDEX TO DIAGRAMS

The 1953 edition of *Master Index to Supreme Publications Most-Often-Needed Radio and Television Servicing Information* has just been released. It presents complete information for quickly finding diagrams and servicing data in the 13 *Most-Often-Needed Radio Diagrams* manuals covering radio receivers from 1926 to the present day, the seven manuals of TV service data, and the u.h.f. manual. Names of set manufacturers are listed alphabetically with models and chassis listed numerically under each. Opposite each model is an entry indicating volume and page number where the service data will be found.

A copy can be obtained from *Supreme Publications, 3727 W. 13th St., Chicago 23, Ill.,* by mentioning **RADIO-ELECTRONICS** and enclosing 4¢ for postage.

U.H.F. TUBES

Sylvania has issued a 15-page report on their u.h.f. tubes 6AN4 and 6T4. Ratings and characteristics are given in great detail. The booklet contains circuits showing the use of these tubes.

Gratis from *Sylvania Electric Products, Inc., 1740 Broadway, New York, N. Y.*

TV-AM-FM COILS

Stanwyck's 22-page coil catalog is a well-illustrated, indexed booklet covering almost every conceivable coil for TV, AM, and FM use. Five pages of wiring diagrams are included.

Obtainable free from *Stanwyck Wind-ing Co., Newburgh, N. Y.*

DEFLECTION YOKES

Syntronic's newest catalog page describes three new deflection yokes for military and oscilloscope applications. Technical information given includes dimensional drawing, electrical and mechanical data, and complete tables of push-pull and single-ended deflection coil data.

Free on request to *Syntronic Instru-ments, Inc., 100 Industrial Road, Ad-dison, Ill.*

TV ANTENNA FOLIO

Amphenol has issued an attractive booklet: *TV Antenna Folio*. Looseleaf sheets illustrating and giving specifications on three v.h.f., four u.h.f. and one all-channel antenna, and a sheet on TV accessories, are contained in a folder. The folder describes basic factors of antenna performance and basic antenna types. Colorful shots from an Amphenol film point up the descriptions.

Gratis from the *American Phenolic Corp., 1830 South 54th Ave., Chicago 50, Ill.*

Mandl's
Television Servicing

THE FAMOUS SERVICE GUIDE THAT

with **NEW DATA**

• pinpoints the trouble for you

• shows you how to correct it quickly and accurately

THE NEW REPRINT of this widely used service guide includes new data on the cascade tuner, servicing of newer types of i.f. systems, automatically focused tubes, UHF station listings and antenna calculations, transistors and other recent developments. Everything you need to know for quick, efficient servicing is given here in the most practical, useful way. You'll learn simple signal tracing procedures, how to improve reception in fringe areas, how to use all test equipment, and many trade tricks for diagnosing troubles accurately and in minimum time. All faults likely to occur, including those hard-to-find troubles, are dealt with; there are hundreds of helpful illustrations, and a complete master trouble chart to help you pin point the cause of trouble from the symptoms and turn quickly to the specific directions for correcting it.

Solve your problems with ease and accuracy
Turn to

Fischer's
Radio & Television Mathematics

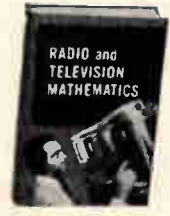

"A book for the place of honor beside its natural partner, the slide rule," says *Radio-Electronics*. You'll find, conveniently arranged under radio topics such as antenna power, plate-to-plate voltage, and 400 hundred others, the formulas to use, the numerical values to substitute, and the step-by-step solutions to 721 problems. If you want to convert polar to j-notation, find the impedance and length of a matching stub between a TV antenna and its transmission line, or get quick, accurate answers to innumerable other problems involving mathematics, **HERE IS YOUR BOOK.**

SEE THEM ON APPROVAL

The Macmillan Company, 60 Fifth Ave., N. Y. 11

Please send me the book(s) checked below. I will either remit the full price plus small delivery charge, or return the book(s) in 10 days. (Save: Enclose check or money order and we pay delivery charge).

- Mandl's TV Servicing, \$5.50
- Radio & TV Math. \$4.75

Signed _____

Address _____

This offer good only within continental limits of U.S.A.

NEEDLE HINTS

Jensen's new 2-color pocket-sized booklet on the care of records, needles, pickups, and cartridges is a consumer publication available for dealer distribution. It illustrates needle wear and contains information on phonograph care. A chart shows the exact Jensen diamond needle replacement for specific record players.

Available without charge from Jensen Industries, Inc., 320 S. Wood, Chicago, Ill.

ACCESSORY CATALOG

Electronic accessories for TV, PA systems, radio, amateur radio and audio are listed in Javex's Catalog No. 252. Among items listed in the 8-page booklet are outlet wall plates, high voltage probes, plugs, sockets, and connectors. Free from Javex, Redlands, Calif.

WHEELCO CATALOG

Wheelco's new 42-page data book and catalog, Bulletin TC-10, lists a complete line of thermocouples, radiation detectors, and resistance bulbs. Information on sensing units, protection tubes, lead wire and other accessories for use with indicating, controlling, and recording instruments is also included.

Available on request to Wheelco Instruments Div., Barber-Colman Co., Rockford, Ill.

OSCILLOGRAPHS

Du Mont has issued bulletins on their Type 322-A dual-beam and Type 301-A miniaturized wide-band, cathode-ray oscillographs.

Gratis from Technical Sales Dept., Allen B. Du Mont Laboratories, Inc., 760 Bloomfield Ave., Clifton, N. J.

TRANSFORMER BULLETIN

Stancor's bulletin No. 469, TV Replacement Transformer Popularity Tables lists the number of TV models that use each Stancor replacement transformer. About 55 major set manufacturers are listed.

Copies free on request to Chicago Standard Transformer Corp., Standard Division, Addison and Elston, Chicago 18, Ill.

HIGH FIDELITY

Temples of Tone is a 16-page illustrated brochure issued by Electro-Voice, and describing components needed for high-quality reproduction. Brief discussions of how the human ear hears, the limits of ordinary reproducing equipment, distortion, and choosing components for an audio system make it interesting to all music lovers and service technicians.

Write to Electro-Voice, Buchanan, Mich., for this one, gratis.

SOUND CATALOG

Shure's 12-page general catalog gives technical data and replacement information on components used for sound reproduction. Included are microphones, microphone parts and accessories, phono cartridges and pickups, and recording heads.

Request Catalog No. 44A from Shure Brothers, Inc., 225 West Huron St., Chicago 10, Ill. END

BARGAINS · BARGAINS · BARGAINS
Standard Brands **TUBES** All Brand New Individually Boxed Far Below Wholesale Cost

02A	.86	6AC7	1.29	6BQ6	1.99	6SL7	.96	12AV7	1.14	35Z5	.53
1A7	.87	6AG5	.89	6BM6	1.89	6SN7	.86	12AX7	1.06	50B5	.84
1B3	.99	6AG7	1.24	6BD6	1.26	6X4	.83	12AZ7	1.59	50C5	.84
1M5	.73	6AM6	1.39	6BL7	1.14	6T8	1.09	12BB6	.72	50L6	.71
1N5	.82	6AK5	1.44	6BQ6	1.35	6U8	1.14	12BE6	.78	50Y6	.79
1R5	.79	6AR5	.93	6BZ7	1.49	6V6GT	.71	12BK7	.98	70L7	1.39
1S5	.79	6AL5	.71	6BN6	1.14	6W4	.73	12CA7	.83	80	.59
1T4	.77	6AQ5	.79	6BZ7	1.39	6W6	.71	12CK7	.79	117N7	1.35
1U4	.79	6A06	.89	6C4	.86	6X4	.82	12DL7	.99	117P7	1.39
1U5	.78	6AR5	.73	6CB6	.87	6X5	.83	12EN7	.91	117Z3	.84
1V2	.99	6AS5	.71	6CD6	2.59	6X8	1.04	12G7	.89	117Z6	.98
1X2A	1.02	6AT5	.72	6CH6	.71	7C5	.71	12HT	1.29		
3Q4	.89	6AU5	1.14	6J5	.63	7F7	.89	25BQ6	1.34		
3Q5	.89	6AU6	.71	6J6	.69	7H7	.87	25L6	.73		
3R5	.77	6AV6	1.03	6K6	.71	7Y4	.89	25M6	.73		
3V4	.82	6AV6	.63	6L6GA	1.39	12AM7	1.18	25Z6	.67		
5U4	.85	6BA6	.82	6SA7	.73	12AL5	.71	35B5	.79		
5V4	.99	6B7	.93	6SC7	.84	12AL5	.81	35C5	.79		
5Y3	.49	6BC5	.86	6SH7	.86	12AT7	1.07	35L6	.73		
6AB4	.79	6BC7	1.04	6S7	.86	12AU6	.77	35W4	.53		
6AB7	.99	6BE6	.74	6SK7	.72	12AU	.84	35W4	.74		

SPECIAL DISCOUNTS
50 Asst. \$5%
100 \$10%

IDEAL XMAS GIFTS FOR THE ENTIRE FAMILY!

THREE-SPEED PORTABLE RECORD CHANGER

Now for the first time at this low, low price a 3 speed V.M. Changer complete with 3 tube high quality amplifier. This unit uses the newest type V.M. Changer with automatic shut-off. Changer intermixes 10" and 12" records at any speed. Turnover crystal cartridge with 2 permanent needles. Amplifier has tone and volume control. When last record has played changer and amplifier automatically shut off. Unit comes housed in beautiful rich maroon leatherette carrying case with white beading. Plays 10-12". AC only. Shipped Railway Express only. 22 lbs. shipping wt. List Price \$89.95 YOUR COST \$46.99



Sensational HIGH FIDELITY

3 Speed Portable PHONOGRAPH WITH GE RELUCTANCE CARTRIDGE

Housed in handsome carrying case. Complete with high quality 4-Tube Amplifier, large 6x9" Alnico V Speaker, G.E. Variable Reluctance Cartridge. Plays all speed records, 78, 45, 33 1/3 RPM. Cartridge comes complete with long life needles. Unit has compensating control and volume control. A.C. only.



List Price \$79.95 YOUR COST \$37.85

Shipped Railway Express only. 20 lbs. shpg. wt.

MINIMUM ORDER \$5.00
STEVE-EL now carries full line of Eico, E.M.C., Pilot, Tech-Master, Pentron, Wen Products, Burgess, Shure, etc. Write for free catalog.

STEVE-EL ELECTRONICS CORP.

Dept. RE-12 61 Reade St., New York 7, N. Y. COrtland 7-0086

OSCILLOSCOPES ARE "GOLD MINES"!

... if you learn how to use them fully on all types of service jobs!



Learn to handle the oscilloscope fully on all types of AM, FM and TV service work—and watch your efficiency and earnings soar!

MODERN OSCILLOSCOPES AND THEIR USES, a fact-jammed 326-page book by Jacob H. Ruitter, Jr., of the Allen B. DuMont Laboratories, contains exactly the help you need—written in a way you can clearly understand. It shows you how to use your 'scope for fast accurate work on all types of jobs from troubleshooting to realigning; how to make connections; how to adjust circuit components; how to set controls and how to analyze patterns fast and accurately. 370 helpful illustrations including dozens of pattern photos make things doubly clear.

No other type of specific service training stands to mean so much to you in terms of being able to work better, faster, more profitably.

- ✓ When, where, why and exactly how to use your oscilloscope
- ✓ How to interpret patterns
- ✓ How to handle tough jobs in less time

MAIL ORDER 10-DAY FREE EXAMINATION

Dept. RE-123, RINEHART BOOKS, Inc. Technical Division, 232 Madison Ave., New York 16, N. Y. Send MODERN OSCILLOSCOPES AND THEIR USES for 10-DAY EXAMINATION. If I decide to keep the book, I will then remit \$6.00 plus a few cents postage in full payment. If not, I will return book post-paid and owe you nothing.

Name _____
Address _____
City, Zone, State _____
Employer's Name & Address _____
OUTSIDE U.S.A.—Price \$8.50, cash only. Money back if book is returned in 10 days.

Let me show you how EASY it is to **LEARN TV** the practical way—

ASSEMBLE A TRANSVISION TV KIT

Pay as You Wire \$39 Down Payment

I WILL HELP YOU to start learning TV the practical way — by assembling a TRANSVISION TV KIT in EASY STAGES. For only \$39 you get PACKAGE #1 (standard first pkg. for all of our kits). This package gives you the BASIC CHASSIS and over 450 TV COMPONENTS with complete Instructions, Drawings, Photos, Service Booklet, and a year's subscription to my "TV and Electronics Notes". When ready, you order the next stage (pkg. #2), etc. Low prices make your complete kit a terrific buy!

FREE CATALOG Shows 6 Great TV Kits: EXCLUSIVE: Only Transvision TV Kits are adaptable to UHF. Ideal for FRINGE AREAS. No Previous Technical Knowledge required. Write now! TRANSVISION, INC., Dept. RE12 NEW ROCHELLE, N. Y.

— MAIL THIS COUPON TODAY —
Mr. D. Gnessin, Educational Director
TRANSVISION, INC., NEW ROCHELLE, N. Y. Dept. RE12
 I'm enclosing \$_____ deposit. Send standard kit PACKAGE #1, with all instruction Material. Balance C.O.D.
 Send FREE copy of your new TV Kit Catalog.
Name _____
Address _____
City _____ State _____

AUDELS TV-RADIO SERVICE LIBRARY

HERE IS LATE INFORMATION IN A HANDY FORM FOR RADIO & TELEVISION REPAIRMEN, SERVICEMEN & STUDENTS

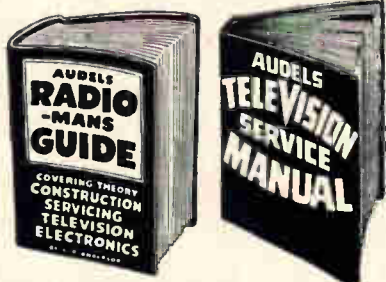

2 VOLS. \$6 COMPLETE \$1.00 PAY ONLY
IT PAYS TO KNOW!

AUDELS T.V.-RADIO SERVICE LIBRARY presents the important subjects of Modern Radio, Television, Industrial Electronics, F.M. Public Address Systems, Auto, Marine & Aircraft Radio, Phonograph Pick-Ups, etc. Covers Basic Principles—Construction—Installation—Operation—Repairs—Trouble Shooting. Shows How to get Sharp, Clear T.V. Pictures. Install Aerials—How to Test. Explains Color Systems & Methods of Conversion. 1001 Facts—Over 1260 Pages—625 Illustrations—Parts & Diagrams—Valuable for Quick Ready Reference & Home Study. Tells How to Solve T.V. & Radio Troubles—Answers T.V. & Radio Questions.

Get this information for Yourself.
7 DAY TEST—ASK TO SEE IT!

MAIL ORDER

AUDELS Publishers, 49 W. 23 St., N.Y. 10
Mail AUDELS T.V. RADIO SERVICE LIBRARY 2 Vols. \$6 on 7 days free trial. If O. K. I will remit \$1 in 7 days and \$1 monthly until \$6 is paid. Otherwise I will return them.

Name _____
Address _____
Occupation _____ RE
Employed by _____

Watch for our January
7th Annual Television Number
On the stands Dec. 24, 1953

Hold the Screw! Drives it too!



Ask for it at your Dealer
Kedman Co., 233 S. 5 W., Salt Lake City, Utah

RECORDING TAPE (Plastic Base) 40% OFF (NEW)

WASHINGTON, D.C. WHERE ELSE WOULD THERE BE MORE MAGNETIC TAPE?

- 1200 ft. plastic tape with plastic reel included. . .
- Each reel individually boxed.
- Choice of nationally famous top quality brands such as:
Weber (2808) 3.20; Reeves (SPN-12 3.20; Audio (1251 3.23; Scotch (111-A) 3.25; Panacoustic (711-A) 3.25; Irish, Professional grade (211 RPA) 3.20.
- Recording studios, schools, radio stations and other large quantity users—write for bulk price.

USED RECORDING TAPE (PLASTIC BASE)



1.99 for 7"—1200 foot
.99 for 5"—800 foot
.59 for 4"—300 foot
.29 for 3"—150 foot
Plastic reels included with all above sizes

New empty plastic reels in boxes for easy labeling. 3" 10c; 4" 22c; 5" 24c; 7" 30c; 7" Professional reel (2 1/2" hub) 45c ea. EMPTY BOXES: 3" 3c; 4" 5c; 5" 5c; 7" 10c ea.

We carry new recorders, recording blanks, tape, tape recorders, etc. at large savings. PLEASE INCLUDE SUFFICIENT POSTAGE.

COMMISSIONED ELECTRONICS CO.
2503 Champlain St. N.W., Washington 9, D. C.

SERVOMECHANISM ANALYSIS, by George J. Thaler and Robert G. Brown. Published by McGraw-Hill Book Co., 330 West 42 St., New York, N.Y. 6 x 9 inches, 414 pages. Price \$7.50.

The main purpose of this text is to present methods for analyzing servomechanisms. There is very little reference to design. The authors first prepare the reader with a thorough discussion on the direct and inverse Laplace transformations. They treat means of setting up the differential equations which define the motion of elementary systems—with some applications to more complex systems—in a general manner.

Having established the necessary mathematical background, they undertake the transient analysis of servomechanisms. Only simple cases are considered, since they illustrate the principles involved without unnecessary mathematical complications, but most of the important variations are treated in detail.

The remainder of the text is devoted to an intensive development of the transfer-function approach, including mechanical procedures in manipulation, mathematical theory, and graphical aids to analysis and design.

While written very clearly, it is on a very high level. For the reader encountering difficulty, the appendix is rich in clear explanations of error detectors, controllers, servomotors, and compensating devices.

This text is written for the senior or graduate engineering student. It is well organized and fundamentally theoretical in intent.—JK

PRINCIPLES and PRACTICES OF TELECASTING OPERATIONS, by Harold E. Ennes. Published by Howard W. Sams & Co., Inc., 2201 E. 46th Street, Indianapolis 5, Ind. 6 x 9 inches, 596 pages. Price \$7.95.

Oddly enough, books on studio operating techniques are rare. This important subject has been treated in the off-hand manner with which one disposes of an unwanted relative. It is refreshing to find that at least one author has the courage to believe that the multimillion dollar TV broadcasting industry is worthy of a book all its own.

This work is authoritative from two viewpoints. The author knows what to say and makes every effort to have the reader understand—a technique often overlooked by writers of engineering texts.

Intended for those making telecasting their vocation, the book covers every phase of television broadcasting. Essentially what you have is a detailed description of the camera chain and the studio control room. This includes the TV camera, lens system, picture tubes, viewfinders, switcher and mixer units, picture and waveform monitors, slide projectors, stabilizing amplifiers, the monoscope, and other equipment.

We hope the author will include a chapter on color telecasting when a new edition is printed. Until then, this is an excellent book if telecasting is your career.—MC

Brand New Set Mfr's SURPLUS

TUBES

STANDARD BRAND WARRANTY

Bulk Packed in Original Mfr's Nested Cartons or Individually Boxed
Every tube meter and chassis tested for top quality... BRANDED

1B3CT54	6AC771	6BH649	6SN7GT49	19BG6C1.19
1L450	6AH664	6BJ649	6T864	19T864
1R549	6AK579	6BL7GT79	6V6CT44	25BQ6CT82
1S455	6AL537	6BQ6GT79	6W4CT44	25L6CT45
1S541	6AQ541	6BQ779	6W6CT44	35B549
1T449	6AC549	6BK771	6X5CT34	35B549
1U449	6AT639	6C434	12AT634	35C549
1U541	6AU639	6C544	12AT760	35L6CT45
1X2A55	6AV639	6CB645	12AU637	35W435
3Q5GT58	6B4C82	6CD6C1.11	12AU755	35Z536
3S449	6AB639	6H641	12BA645	50B549
3V449	6BC549	6J5GT37	12BE645	50C549
5U4C44	6BE641	6J654	12BH756	50L6CT45
5Y3CT39	6BG6C1.19	6K6CT39	12SN7GT49	

More than 400 types in stock, include all your needs when ordering.
Orders less than \$10—add \$1.00 service charge. Terms: 25% with order, balance C.O.D.
Please include postage. All prices subject to change without notice. F.O.B. New York City.

TRANSAMERICA ELECTRONICS CORP.

120 LIBERTY ST., NEW YORK 6, N. Y.

STAN-BURN SPARKS

CATHODE RAY TUBE SPECIALS

ONE YEAR GUARANTEE		STAN-BURN	
★ 6TP4	\$44.95	★ 10RP4	\$11.00
★ 7JP4	17.10	★ 12LP4A	14.20
★ 10FP4A	15.25	★ 14CP4	17.00
★ 10FP4A	24.00	★ 15DP4	19.50
★ 12KP4A	27.10	★ 16AP4	21.60
★ 12LP4A	28.20	★ 16FP4	19.60
★ 12UP4B	28.25	★ 16GP4	21.60
★ 14CP4	24.50	★ 16EP4A	22.80
★ 16AP4A	20.95	★ 16DP/HP4	19.60
★ 16DP4A (N.U.)	28.20	★ 16DP/HP4A	20.60
★ 16GP4	31.25	★ 16KP4	18.50
★ 16KP4/16RP4	28.20	★ 16LP4	20.60
★ 17BP4A	23.90	★ 16LP4A	21.60
★ 17CP4	23.90	★ 17BP4	18.50
★ 19AP4A	39.45	★ 17CP4	21.60
★ 20CP4	25.95	★ 18AP4	23.90
★ 20LP4	37.50	★ 19AP4A	25.90
★ 21EP4A	37.35	★ 20CP4	29.50
★ 24AP4 A	78.50	★ 21EP4	32.50

ANTENNA SPECIALS

★ RED DOUBLE "Y" Antenna	1-5	6 or more
★ 10 ELEMENT CONICAL	2.19	1.99
★ Dowled Inserts	2.98	2.79
★ Folded Wire Straight Low Qick Rod	4.25	3.25
★ WINDOW CONICALS	4.95	3.75
★ MASTS 5 FOOT SWAGED	1.79	.69
★ 10 FOOT PLAIN	1.39	1.29
★ NEPCO MASTS	7.60	1.49
★ TV WIRE 42 Mil	59.95 M Ft.	
★ 55 Mil. 300 OHM	11.95 M Ft.	
★ 72 OHM COAXIAL	35.00 M Ft.	
★ 12" Heavy Slug Speaker	Special \$3.98	

CHASSIS 630 TECH-MASTER

Model E-30 with Cascade Tuner... \$149.50
OPEN FACE CABINET

WIRE RECORDERS IN STOCK

PENTRON—Model 9T3C—2-speed Tape Recorder... Write for Price.
RADIO CRAFTSMAN Model C400—Hi Fi Amplifier... Net \$42.90
Model C10—AM-FM Tuner... Net \$31.50
Model C500—Williams Amplifier... Net \$9.60

★ 6"x9" PM SPEAKER	\$3.98
★ 7" PM SPEAKER	3.98
★ 77J1 G.E. Flyback	1.98
★ 70" Yoke	1.98
★ 630 Vert. Output Upright	1.98
★ 630 Vert. Output Potted	1.29
★ 630 Vert. Blocking Osc. Xform.	.89
★ CASCODE TUNERS	19.95
★ STANDARD TUNERS	17.95
★ DUMONT 21.25mc	14.95

AUTHORIZED DISTRIBUTORS for: General Electric, Kenrad, Tung-Sol, National Union, De Wald, Regal, Automatic and General Motors.

AUTOMATIC CUSTOM-BUILT RADIOS for Plymouth, Ford, Chevrolet and many others, always in stock. We carry complete stock of HI-FIDELITY and SOUND EQUIPMENT. Send us your requests. We also carry a complete line of popular makes of Radio tubes at 50-100% discount. Also many other special purpose and transmitting types, and all electronic parts and equipment at lowest prices. Send us a list of your requirements for prompt quotations.
Terms: 20% with order, balance C.O.D. All prices FOB. NEW YORK Warehouse. Minimum order \$5.00.
Write for our latest price list and Hi-Fi Catalog to Dept. RE-12

STAN-BURN RADIO and ELECTRONICS CO.
(C.B.S. THEATRE BLDG.)
1697 BROADWAY • NEW YORK 19, N.Y.

THE TV DYNATRACER

ONLY \$4.95
Pd. or C.O.D. + Chgs.

- TRACES TV SIGNALS AND VOLTAGES
- LOCATES DEFECTIVE COMPONENTS
- REQUIRES NO ADDITIONAL EQUIPMENT

This sensationally new piece of test equipment is ideal for trouble-shooting television sets in the home or in the shop. The "DYNATRACER" will outperform more expensive testers and should pay for itself on the very first repair.

A Must For Every TV Technician
Specifications: The "Dynatracer" is a self-powered quality test instrument designed to trace TV signals through any Video, Sound, Sync, AFC, Horizontal or Vertical Sweep Circuit—will isolate trouble to a stage or component.

Added Feature: The "DYNATRACER" will also trace voltage (50/500 V. AC/DC) and instantly locate open, shorted, intermittent or leaky (up to 20 MEGOHMS) condensers, resistors, coils, transformers, etc.

Instruction and Trouble-Shooting Book Enclosed
10 DAY MONEY-BACK GUARANTEE
Cut out advertisement, attach name and address with \$5.00 bill, check or money order and mail to

Century ELECTRONICS CO.
8509-21st Ave., Dept. 108, Brooklyn 14, N.Y.

VACUUM TUBE OSCILLATORS, by William A. Edson. Published by John Wiley & Sons, 440 4th Ave., New York, N. Y. 6 x 9 inches, 476 pages. Price \$7.50

A systematic and reasonably complete treatment of the many factors which affect the behavior of vacuum tube oscillators is presented in a thorough, well-connected discussion on the design and operation of these devices. The author treats the subject from the viewpoint of design rather than analysis.

The level of discussion is directed toward a senior or graduate course in electrical engineering, and for practicing engineers. The text is heavy with mathematics, and the reader should have a good working knowledge of the calculus.

The book is generally divided into two main classes—harmonic, and relaxation oscillators. Chapters on general characteristics of transient behaviors of linear systems, negative resistance, nonlinear oscillations, feedback systems and stability criteria, and resonators, form the preparatory material prior to dealing with specific oscillators.

In his chapter on resonators, the author does a remarkably good job on the properties of resonator components. For the mathematically inclined, this textbook is an excellent comprehensive treatment on oscillator design.—JK

CIRCUIT THEORY OF ELECTRON DEVICES, by E. Milton Boone. Published by John Wiley & Sons, Inc., New York, N. Y. 6 x 9 inches, 483 pages. Price \$6.75.

This book is written for college students by a college professor. As its name suggests, it emphasizes circuit theory, especially in terms of equivalent networks. It is clearly written and easy to understand, but the reader must know physics and mathematics through calculus.

The major topics—amplifiers, oscillators, modulators, power supplies—are covered in much detail. Tubes and transistors are treated from the standpoint of equivalent 4-terminal networks. Diagrams and graphs appear often, to illustrate the material. Each chapter ends with numbered problems.—IQ

UHF TELEVISION and VHF TUNERS, by Edward M. Noll. (Also called Notebook No. 7, TTLB series) Published by the Paul H. Wendel Publishing Co., Inc., Indianapolis, Ind. 8 1/2 x 11 inches, 72 pages. Price \$1.00.

This publication is divided into two parts of almost equal length. The first discusses v.h.f. tuners, the second u.h.f. television. It is written in concise, lecture style with numerous schematics, mostly of commercial TV equipment.

Part 1 is about commercial tuners and characteristics, with brief manufacturers' alignment data. Traps, response curves and sweep calibration are also covered briefly. Part 2 is more detailed and describes topics that are relatively new to technicians. Beginning with u.h.f. characteristics, it goes on to various antennas, plug-in strips and converters. Also included is a chart listing u.h.f. channels.—IQ END

NOW! BECOME EXPERT AT RADIO-TELEVISION IN 4 EASY STEPS!

Complete Self-Training Library in RADIO and TV by Famous Experts—Takes You BY SIMPLE STEPS From Basic Theory to Problems of Repair, Installation, Color TV, etc.

NOW you can do ANY Radio-TV installation, service, or repair job like an expert; operate field-testing equipment; understand problems of TV, FM-AM transmission, etc. Step into a good-paying job—or start your own service business. Train yourself AT HOME... IN SPARE TIME... with the McGraw-Hill Radio and Television Servicing Library.

2296 Pages—1611 Illustrations

The men who wrote this complete 4-volume Library are among the outstanding radio and TV instructors in America today. Every detail is clearly explained in over TWO THOUSAND PAGES of step-by-step instruction and over SIXTEEN HUNDRED "how-to-do-it" illustrations, cross-section diagrams, etc. The review questions and answers "nail down" everything you learn. At-a-glance "trouble-shooting" charts show how to diagnose instantly any radio or TV breakdown... and how to repair it expertly and quickly.

The Library will pay for itself many times over. It gives all you need to know for FM and TV in the FCC's 1st-class license exam; gives an experienced technician more confidence and skill.

SEND NO MONEY
Mail coupon below to examine complete four-volume Library FREE for 10 days. No obligation. Or you may examine individual books FREE for 10 days by checking the proper boxes in coupon.

PARTIAL CONTENTS ESSENTIALS OF RADIO.
800 pages, 433 illus.
Circuit Analysis • Vacuum Tubes • Circuits • Detector • Amplifier • Tube Oscillator • Power Supply • Transmitting, Receiving • Etc.

ELEMENTS OF RADIO SERVICING.
475 pages, 375 illus.
Multimeters • AC Power Supply • Speakers • Antennas • Auto Radios • Push-Pull Output Stage

BASIC TELEVISION.
592 pages, 415 illus.
Scanning • Synchronizing • Video Signal • Brightness Control • DC Retraction • Picture • FM Alignment • Picture Tubes • VHF and UHF transmission • Reception

TELEVISION SERVICING.
429 pages, 388 illus.
Antennas • Transmission Lines • Test-pattern and Picture Analysis • Localizing Reception Troubles • Interference Remedies • Deflection Circuits... AND MUCH MORE!

FREE 10-DAY TRIAL COUPON

McGraw-Hill Book Co., Inc., Dept. RE-12
327 West 41st St., New York 36, N.Y.

Send me for 10 day free examination the Radio and TV Servicing Library, 4 Vols. (Regular retail price is \$26.75; Special Course Price only \$21.95 in easy installments.) If not satisfied with Course, I will return it, pay nothing. Otherwise, I'll send \$1.95 plus delivery charges then and only \$4.00 monthly for 5 months.

If you wish to examine any of these books individually, check below the ones you wish us to send you for 10 Days' FREE EXAMINATION:

Essentials of Radio, \$7.50
 Elements of Radio Servicing, \$5.25
 Basic Television, \$7.50
 Television Servicing, \$6.50

For any book I keep, I'll send \$2.00 plus delivery charges in 10 days, balance in easy monthly installments. (Print)

Name.....
Address.....
City..... Zone..... State.....
Employed by..... RE-12

WE PAY FOR DELIVERY if you send first payment of \$1.95 when ordering Library or full price when ordering individual books (prices above). Same return privilege. (This offer applies to U.S. only.)

REAL SALE TUBE WHOLESALE PRICES!

Tube Orders Over \$15.00, with full remittance, PREPAID to you in U.S.A.

Stock up now on these amazing tube values! All tubes are popular brands and fully guaranteed

Type	Net	Type	Net	Type	Net
DA2	.90	6AT6	.55	12BH7	.98
DA3 VR75	1.05	6AU6	.59	12BY7	1.03
DB2	.80	6AV5GT	1.10	12BZ7	1.10
DC3 VR105	.96	6AV6	.55	12SA7	.69
DD3 VR150	.95	6AX4GT	.60	12SF5	.70
DZ4	.55	6AX5GT	.80	12SG7	.80
IA7GT	.77	6B8	.75	12SH7	.63
IAX2	1.15	6BA6	.60	12SJ7	.55
IB3GT	.90	6BC5	.62	12SK7	.60
IBZ7	11.50	6BE6	3.59	12SL7GT	.65
IH5GT	.77	6BG6	1.85	12SN7GT	.75
IL4	.60	6BH6	.80	12SQ7GT	.55
IL6	.95	6BJ6	.85	12SR7	.69
ILA6	1.10	6BN6	1.20	12SX7GT	1.10
ILB4	1.10	6BQ6GT	1.13	14F7	.75
ILN5	1.10	6BQ7A	1.40	19B6GG	2.40
IN5GT	1.95	6C27	1.30	25A7	2.20
IN23A	2.05	6C4	.50	25BQ6GT	1.00
IN23B	2.25	6C6	.50	25L6GT	.62
IN34A	.75	6C8B	.58	25W4GT	.80
IN38	.88	6C06	1.95	25Z5	.70
IN48	.50	6C06	2.10	25Z6GT	.59
IN52	.90	6D6	.75	28D7	1.55
IN54	.79	6F4	3.59	35B5	.55
IN54A	.90	6F5	.68	35C5	.55
IN69	.60	6FS5GT	.68	25L6GT	.60
IN70	1.25	6F6	.70	35Z3	.70
IN81	1.00	6F6G	.80	35T	
IR4/1299	.59	6F8G	.85	(Eimac)	2.75
IR5	.88	6GG6	.85	35Z6GT	.55
IS5	.29	6H6	.52	35Z7	.90
IT4	.85	6J4(RCA)	5.10	50B5	.55
IU4	.55	6J5	.50	50C5	.65
IU5	.77	6J6	.62	50L6GT	.65
IV	1.03	6J7	.75	80	.66
IV2	.70	6K4(Sylv)	2.25	81	.75
IX2A	.90	6K4A	2.25	83	1.15
122	.95	6K6GT	.55	84/6Z4	.65
2C39A	13.75	6K7	.60	11Z23	.75
2C40	6.75	6L6G	1.10	11Z26	.98
2C51	3.90	6L6GA	1.10	211/VT4C	.88
2E30(Hyt)	2.05	6L6M	1.25	250TH	16.95
2J39	7.95	6L7	.80	27A & B	3.00
2J61	37.50	6N7M	.70	30ATH	7.75
2J62	33.00	6P7G	.88	30ATL	4.75
2K28	27.55	6Q7GT	.80	310A(WE)	3.50
2X2	.35	6S7M	.98	371B	.65
3A4	.59	6S7C	.88	407A(WE)	3.50
3BP11	9.00	6S07GT	.80	408A(WE)	2.50
3B7/2291	.39	6S7G	.66	717A	.88
3BZ8	4.25	6S7H	.88	725A	4.70
3C23(GE)	8.50	6S7J	.75	803	3.25
3C24/24G	1.15	6SK7	.57	805	3.35
3D6/1299	.35	6SL7GT	.65	807	1.55
3Q4	.89	6SN7GT	.73	811A	3.55
3Q5GT	.89	6S07	.70	812A	3.60
3S4	.75	6T8	.99	816	1.20
3L4	.90	6V3	.95	829	7.95
3V4	.75	6V6GT	.86	829B	8.95
3X2500		6V8	.99	830B	2.75
A-3	135.00	6W4GT	.55	832A	9.95
4B24	4.50	6W6GT	.75	866A(JAN)	1.25
4D22	18.50	6X5GT	.47	866A(CBS)	1.75
4X150A	29.95	7A7	.75	869B	65.00
5D21(WE)	12.50	7AB	.69	872A	3.25
5R4V	1.50	7B7	.75	931A	4.75
5U4G	.58	7B8	.78	955	.42
5V4G	.95	7C4	.29	991/NE16	.50
5W4G	.80	7C5	.69	CK1005	.75
5X4G	.75	7C6	.69	1616	.88
5Y3GT	.54	7C30	85.00	1622/6L6M	1.95
6ABGT	1.10	7E5	.38	1625	7.95
6AB4	.80	7F7	.85	1626	.18
6AB7	.95	7F8G	1.55	1629	.25
6AC7Jan	.80	7BP7	4.25	2050	1.55
6AC7RCA	1.12	7H7	.70	5516(Hyt)	7.25
6AF4	1.39	7JP4	15.00	5528/6L6	5.00
6AG5	.70	7N7	1.20	55Z7I	57.50
6AG7	1.10	7P7	.98	5654	1.75
6AH4GT	.95	12A4	.98	5656	10.00
6AH6	.88	12AT7	.80	5670	3.50
6AJ5	1.30	12AU7	.70	5687	2.95
6AK5	.75	12AV7	1.10	5691	7.60
6AK6	.98	12AW6	.88	5693	6.25
6AL5	.83	12AX7	.75	5814	2.20
6AN4	1.50	12AY7	1.90	9002	.75
6AQ5	.48	12B4	.98	9003	1.10
6AQ6	.73	12BA6	.60	9004	.35
6AS5	.70	12BD6	.75	9006	.29
6AS6	1.95	12BE6	.60		

Above is only a partial listing of our huge stock. Types not listed may be ordered at approx. the same savings. Many new special purpose types in stock. AUTHORIZED DISTRIBUTORS: CBS-HYTRON WESTINGHOUSE

ODDS & ENDS

ERCO MARINE TRANSMITTER-RCVR.
4 channels, 12 V. DC operation. FCC approved. New, complete (less crystals). Regularly over \$300.00 **SPECIAL \$179.50**

BRAND NEW VIBRAPACKS
12 V. DC input. 300 V. DC @ 125 ma. output. Complete with vibrator. \$9.95

TRIMM FEATHERWEIGHT HEADSETS
4000 ohms impedance. New orig. boxes \$3.75

W.E. STEEL RACK PANELS
10 1/2 x 19 x 1/4". Commercial grey. Brand new. Regularly \$4.92 **SPECIAL \$4.00**

BARRY ELECTRONICS CORP.

136B Liberty Street, N. Y. 6, N. Y. Rector 2-2562

Terms: 25% with order, balance C.O.D. All merchandise guaranteed. F.O.B. N.Y.C.

ADVERTISING INDEX

Radio-Electronics does not assume responsibility for any errors appearing in above index.

Adelman, Nat	139
Admiral Corporation	129
Airex Co.	119
All Channel Antenna Corp.	121
Allied Radio Corp.	13
American Microphone Co.	18
American Phenolic Corp.	90
American Television & Radio Co.	111
Amplifier Corporation of America	88
Arkay Radio Kits, Inc.	130
Astron Corp.	21
Atlas Sound Corp.	134
Audel Publishers	142
Barry Electronics	146
Belden Manufacturing Co.	99
Bell Telephone Labs	24
Brooks Radio & TV Corp.	102, 103
Burstein Applebee Co.	131
CBS Hytron (Division of Columbia Broadcasting System)	10
Capitol Radio Engineering Institute	15
Centralab—Div. of Globe Union	88, 100, 115
Century Electronics Co.	143
Channel Master Corp.	22, 23
Clarostat Manufacturing Co., Inc.	130
Cleveland Institute of Radio Electronics	7
Coast Electronics	125
Columbia Wire & Supply Co.	146
Commissioned Electronics	142
Concord Radio	128, 135
Corona Radio	136
Coyne Electrical & TV Radio School	82, 109
Creasant School	136
DeForest's Training, Inc.	5
Edlie Electronics	107
Electro-Vox Inc.	16
Electronic Instrument Co., Inc.	28, 125, 132, 138
Electronic Measurements Corp.	110
Finney Co.	79
G & H Wood Products Co.	122
General Electric Co.	9
General Industries Co.	65
General Test Equipment	139
Gernsback Publications	26, 118
Granco Products, Inc.	117
Gyro Products	107
Heath Co.	62-73 inclusive
Hickok Electrical Instrument Co.	136
Hi-Lo TV Antenna Corp.	112
Hudson Specialties	98
Hughes Research & Development Labs	115
IE Manufacturing Co.	122
Indiana Technical College	88
Instructograph Co.	88
International Correspondence Schools	27, 114
JFD Manufacturing Co., Inc.	117
Jensen Industries	113
Jones & Laughlin Steel Corp.	95
Kay-Townes Antenna Co.	142
Kedman Co.	130
Kirk, Jim	83
Leader Electronics	134
Leatone Radio Corp.	93
Littelfuse, Inc.	140
Macmillan Co., The	90
Mallory & Co., Inc., P. R.	Inside Back Cover
Mannfred Electronics	125
Master Electronics Co.	132
McGraw-Hill Book Co.	143
Merit Coil & Transformer Co.	12
Moss Electronic Distributing Co.	97
National Electronics of Cleveland	126
National Radio Institute	19, 20
National Schools	3
Nidisco	137
Ohmite Manufacturing Co.	92
Opportunity Adlets	137
Oxford Electric Corp.	116
Permotlux Corp.	137
Perma-Power Co.	114
Plastoid Corp.	81
Precision Development Corp.	108
Precision Apparatus Co., Inc.	80
Pres-Probe Co.	127
Progressive Electronics	123
Quietrol Co.	117
RCA Institutes, Inc.	25
RCA Victor Division (Radio Corporation of America)	Inside Front Cover, 85, Back Cover
Rad-Tel Tube Co.	101
Radelco Manufacturing Co.	116
Radjart Corp.	77
Radio City Products	127
Radio Craftsmen	104, 105
Radio Merchandise Sales	139
American Electronics Co.	
Candler System Co.	
Grantham School of Electronics	
Indiana Technical College	
Indianapolis Electronic School	
Milwaukee School of Engineering	
RCA Institutes, Inc.	
Tri-State College	
Valparaiso Technical Institute	
Western Television Institute	
Radio-Television Training Ass'n	17
Raytheon Manufacturing Co.	6
Regency Div. (I.D.E.A., Inc.)	89

RADIO SCHOOL DIRECTORY

Page 147

NEW!

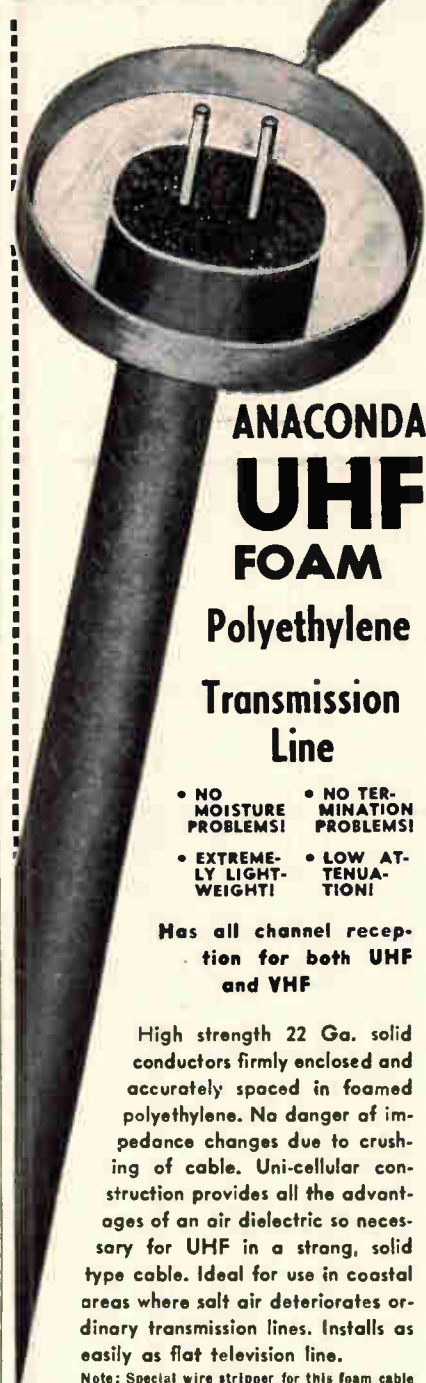

ANACONDA UHF FOAM Polyethylene Transmission Line

- NO MOISTURE PROBLEMS!
- NO TERMINATION PROBLEMS!
- EXTREMELY LIGHT-WEIGHT!
- LOW ATTENUATION!

Has all channel reception for both UHF and VHF

High strength 22 Ga. solid conductors firmly enclosed and accurately spaced in foamed polyethylene. No danger of impedance changes due to crushing of cable. Uni-cellular construction provides all the advantages of an air dielectric so necessary for UHF in a strong, solid type cable. Ideal for use in coastal areas where salt air deteriorates ordinary transmission lines. Installs as easily as flat television line.

Note: Special wire stripper for this foam cable is available

We have a UL approved universal type "Lightning Arrestor" for use with all Anaconda UHF lines & other types of flat or round TV wires.

Write for Samples and New Descriptive Literature. Sold through recognized jobbers only!

"National distributors and warehouse for ANACONDA denshath television and radio wires and cables"

Columbia WIRE & SUPPLY CO.

2850 Irving Park Road • Chicago 18, Ill.

STAN-BURN E-D-A-R-K-E

CATHODE RAY TUBE SPECIALS ONE YEAR GUARANTEE

G.E.		STAN-BURN	
5TP4	\$44.95	10BP4	\$11.00
7JP4	17.10	12LP4A	14.20
10BP4A	19.25	14CP4	17.00
10FP4A	24.00	15DP4	19.50
12KP4A	27.00	16AP4	21.80
12LP4A	21.70	16FP4	19.60
12UP4B	28.25	16GP4	21.80
14CP4	24.50	16HP4A	22.60
16AP4A	30.95	16DP/HP4	19.80
16DP4A (N.U.)	28.20	16DP/HP4A	20.80
16GP4	31.20	16RP4	18.50
16KP4/16RP4	28.20	16LP4	20.80
17BP4A	23.90	16LP4A	21.60
17CP4	23.90	17BP4	18.30
19AP4A	39.45	17CP4	21.60
20CP4	32.50	19AP4	23.90
20LP4	37.50	19AP4A	25.90
21EP4A	37.40	21EP4	29.50
24AP4 A	78.50	21EP4A	12.50

ANTENNAE SPECIALS

RED DOUBLE "V" Antenna...	1-5	6 or more
10 ELEMENT CONICAL Doweled Insulators	2.98	2.79
Folded HI Straight Low Quick Rig 1/2" elements	4.25	3.25
WINDOW CONICALS	4.93	3.75
MASTS 5 FOOT SWEGGED	.79	.69
10 FOOT PLAIN	1.39	1.29
NEPCO MASTS	1.69	1.49

TV WIRE 42 Mil	\$9.95 M FL
55 Mil	11.95 M FL
72 OHM COAXIAL	35.00 M FL
12" Heavy Slug Speaker	Special \$3.98

CHASSIS 630 TECH-MASTER Model C-30 with Cascade Tuner... \$149.50 OPEN FACE CABINET

WIRE RECORDERS IN STOCK

PENTRON—Model 9T3C—2-speed Tape Recorder	Write for Price
RADIO CRAFTSMAN Model C400—Hi-Fi Amplifier	Net \$42.90
Model C10—AM-FM Tuner	Net \$31.50
Model C500—Williamson Amplifier	Net \$9.50

6"x9" PM SPEAKER	\$3.98
7" PM SPEAKER	3.98
77J1 G.E. Flyback	1.98
70" Yoke	1.98
630 Vert. Output Upright	1.98
630 Vert. Output Potted	1.29
630 Vert. Blocking Sec. Xform.	.88
CASCADE TUNERS	19.95
STANDARD TUNERS	17.95
DUMONT 21.25mc	14.95

AUTHORIZED DISTRIBUTORS for: General Electric, Kenrad, Tung-Sol, National Union, De Wald, Regal, Automatic and Custom Motors.

AUTOMATIC CUSTOM-BUILT RADIOS for Plymouth, Ford, Chevrolet and many others, always in stock. We carry a complete stock of HI-FIDELITY and SOUND EQUIPMENT. Send us your requests. We also carry a complete line of popular makes of Radio tubes at 50/10% discount. Also many other special purpose and transistors, tubes, and all electronic parts and equipment at lowest prices. Send us a list of your requirements for prompt quotations.

Terms: 20% with order. Balance C.O.D. All prices FOB. NEW YORK Warehouse. Minimum order \$5.00. Write for our latest price list and HI-FI Catalog to Dept. RE-12

STAN-BURN RADIO and ELECTRONICS CO.
(C.B.S. THEATRE BLDG.)
1697 BROADWAY • NEW YORK 19, N.Y.

THE TV DYNATRACER

ONLY \$4.95 Ppd. or C.O.D. + Chgs.

- TRACES TV SIGNALS AND VOLTAGES
- LOCATES DEFECTIVE COMPONENTS
- REQUIRES NO ADDITIONAL EQUIPMENT

This sensationally new piece of test equipment is ideal for trouble-shooting television sets in the home or in the shop. The "DYNATRACER" will outperform more expensive testers and should pay for itself on the very first repair.

A Must For Every TV Technician

Specifications: The "DYNATRACER" is a self-powered quality test instrument designed to trace TV signals through any Video, Sound, Sync, I.F.C. Horizontal or Vertical Sweep Circuit—will isolate trouble to a stage or component.

Added Feature: The "DYNATRACER" will also trace voltage (50/500 V. AC/DC) and instantly locate open, shorted, intermittent or leaky (up to 20 MEGOHMS) condensers, resistors, coils, transformers, etc.

Instruction and Trouble-Shooting Book Enclosed

10 DAY MONEY-BACK GUARANTEE

Cut out advertisement, attach name and address with \$5.00 bill, check or money order and mail to

Century ELECTRONICS CO.
8509-21st Ave., Dept. 108, Brooklyn 14, N. Y.

VACUUM TUBE OSCILLATORS, by William A. Edson. Published by John Wiley & Sons, 440 4th Ave., New York, N. Y. 6 x 9 inches, 476 pages. Price \$7.50

A systematic and reasonably complete treatment of the many factors which affect the behavior of vacuum tube oscillators is presented in a thorough, well-connected discussion on the design and operation of these devices. The author treats the subject from the viewpoint of design rather than analysis.

The level of discussion is directed toward a senior or graduate course in electrical engineering, and for practicing engineers. The text is heavy with mathematics, and the reader should have a good working knowledge of the calculus.

The book is generally divided into two main classes—harmonic, and relaxation oscillators. Chapters on general characteristics of transient behaviors of linear systems, negative resistance, nonlinear oscillations, feedback systems and stability criteria, and resonators, form the preparatory material prior to dealing with specific oscillators.

In his chapter on resonators, the author does a remarkably good job on the properties of resonator components. For the mathematically inclined, this textbook is an excellent comprehensive treatment on oscillator design.—JK

CIRCUIT THEORY OF ELECTRON DEVICES, by E. Milton Boone. Published by John Wiley & Sons, Inc., New York, N. Y. 6 x 9 inches, 483 pages. Price \$6.75.

This book is written for college students by a college professor. As its name suggests, it emphasizes circuit theory, especially in terms of equivalent networks. It is clearly written and easy to understand, but the reader must know physics and mathematics through calculus.

The major topics—amplifiers, oscillators, modulators, power supplies—are covered in much detail. Tubes and transistors are treated from the standpoint of equivalent 4-terminal networks. Diagrams and graphs appear often, to illustrate the material. Each chapter ends with numbered problems.—IQ

UHF TELEVISION and VHF TUNERS, by Edward M. Noll. (Also called Notebook No. 7, TTLB series) Published by the Paul H. Wendel Publishing Co., Inc., Indianapolis, Ind. 8 1/2 x 11 inches, 72 pages. Price \$1.00.

This publication is divided into two parts of almost equal length. The first discusses v.h.f. tuners, the second u.h.f. television. It is written in concise, lecture style with numerous schematics, mostly of commercial TV equipment.

Part 1 is about commercial tuners and characteristics, with brief manufacturers' alignment data. Traps, response curves and sweep calibration are also covered briefly. Part 2 is more detailed and describes topics that are relatively new to technicians. Beginning with u.h.f. characteristics, it goes on to various antennas, plug-in strips and converters. Also included is a chart listing u.h.f. channels.—IQ

NOW! BECOME EXPERT AT RADIO-TELEVISION IN 4 EASY STEPS!

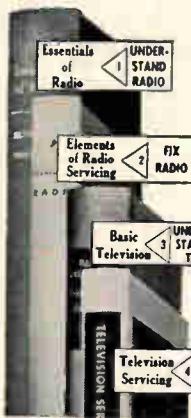

Complete Self-Training Library in RADIO and TV by Famous Experts—Takes You BY SIMPLE STEPS From Basic Theory to Problems of Repair, Installation, Color TV, etc.

NOW you can do ANY Radio-TV installation, service, or repair job like an expert; operate field-testing equipment; understand problems of TV, FM-AM transmission, etc. Step into a good-paying job—or start your own service business. Train yourself AT HOME... IN SPARE TIME... with the McGraw-Hill Radio and Television Servicing Library.

2296 Pages—1611 Illustrations

The men who wrote this complete 4-volume Library are among the outstanding radio and TV instructors in America today. Every detail is clearly explained in over TWO THOUSAND PAGES of step-by-step instruction and over SIXTEEN HUNDRED "how-to-do-it" illustrations, cross-section diagrams, etc. The review questions and answers "nail down" everything you learn. At a glance "trouble-shooting" charts show how to diagnose instantly any radio or TV breakdown... and how to repair it expertly and quickly.

The Library will pay for itself many times over. It gives all you need to know for FM and TV in the FCC's 1st-class license exam; gives an experienced technician more confidence and skill.

SEND NO MONEY
Mail coupon below to examine complete four-volume Library FREE for 10 days. No obligation. Or you may examine individual books FREE for 10 days by checking the proper boxes in coupon.

PARTIAL CONTENTS ESSENTIALS OF RADIO.
800 pages, 433 illus.
Circuit Analysis • Vacuum Tubes • Circuits: Detector • Amplifier • Tube Oscillator • Power Supply • Transmitting, Receiving • Etc.

ELEMENTS OF RADIO SERVICING.
475 pages, 375 illus.
Multimeters • AC Power Supply • Speakers • Antennas • Auto Radios • Push-Pull Output Stage

BASIC TELEVISION.
592 pages, 415 illus.
Scanning • Synchronizing • Video Signal • Brightness Control • DC Reinforcement • Picture Tubes • VHF and UHF transmission • Reception

TELEVISION SERVICING.
429 pages, 368 illus.
Antennas • Transmission Lines • Test-pattern and Picture Analysis • Localizing Reception Troubles • Interference Remedies • Deflection Circuits... AND MUCH MORE!

FREE 10-DAY TRIAL COUPON

McGraw-Hill Book Co., Inc., Dept. RE-12
327 West 41st St., New York 36, N. Y.

Send me for 10 day free examination the Radio and TV Servicing Library, 4 Vols. (Regular retail price is \$26.75; Special Course Price only \$21.95 in easy installments.) If not satisfied with Course, I will return it, pay nothing. Otherwise, I'll send \$1.95 plus delivery charges then and only \$4.00 monthly for 5 months.

If you wish to examine any of these books individually, check below the ones you wish us to send you for 10 Days' FREE EXAMINATION:

<input type="checkbox"/> Essentials of Radio, \$7.50	<input type="checkbox"/> Elements of Radio Servicing, \$5.25
<input type="checkbox"/> Basic Television, \$7.30	<input type="checkbox"/> Television Servicing, \$6.50

For any book I keep, I'll send \$2.00 plus delivery charges in 10 days, balance in easy monthly installments. (Print)

Name.....

Address.....

City..... Zone..... State.....

RE-12

Employed by.....

WE PAY FOR DELIVERY if you send first payment of \$1.95 when ordering Library or full price when ordering individual books (prices above). Same return privilege. (This offer applies to U.S. only.)

TRIO proudly announces



The New ZIG-ZAG

"TWIN-SIX"

(A significant addition to the Zig-Zag line)

... the greatest advance ever made in ALL-CHANNEL antenna design!

Not content to bring out just another all-channel antenna, TRIO studied and tested every other model available. Months of research produced the "Twin-Six", a Zig-Zag that provides all of the desirable features indicated above. Quantitative ratings for antennas are practically meaningless because of some exaggerated claims. For this reason, the "Twin-Six" is announced without the usual gain charts. The new "Twin-Six", however, equals and, in most cases, greatly exceeds the gains of these antennas on every channel. For instance, the "Twin-Six" showed a 2 to 6 db higher gain than a competitive antenna which is advertised as having a 12 db gain.

MINUTE-UP ASSEMBLY

There's no antenna easier to assemble. Shipped with all hardware mounted on the boom. Complete assembly consists of matching elements to color coded insulators and snapping on spring clips. Improper assembly impossible.



Insulators come mounted on boom and are so designed that "shorting-out" is impossible. Antenna elements mounted merely by snapping on the spring clips.

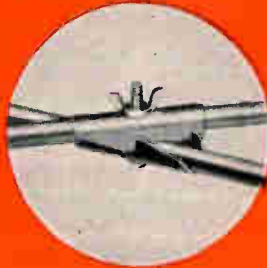

Pre-assembled high channel elements are swung into position and quickly locked by mating brackets.



Team the new Zig-Zag "Twin-Six" with the dependable TRIO rotator for the maximum in TV enjoyment!

NEW ZIG-ZAG "TWIN-SIX" OFFERS:

Measurable Higher Gain On All VHF Channels Than Any Other Single Bay All-Channel Antenna

PLUS

1. One Horizontal Bay Does It All!
2. Single Lead-In Operation!
3. Easy-Up, One Minute Assembly!
4. Rugged Construction Throughout — No Droop, No Sag! Light Weight — Attractive Appearance!
5. UHF Reception For All Primary Areas!
6. Low Standing Wave Ratio!
7. Built and Backed by TRIO — A Name You Can Trust!
8. Competitively Priced!



TRIO

MANUFACTURING CO. GRIGGSVILLE, ILL.

REAL SALE TUBE WHOLESALE PRICES!

Tube Orders Over \$15.00, with full remittance, PREPAID to you in U.S.A.

Stock up now on these amazing tube values! All tubes are popular brands and fully guaranteed.

Type	Net	Type	Net	Type	Net
0A2	.90	6AT6	.55	12BH7	.98
0A3 VR75	1.05	6AU6	.59	12BY7	1.03
0B2	.80	6AV5GT	1.10	12BZ7	1.10
0C3 VR105	.96	6AV6	.55	12SA7	.69
0D3/VR150	.95	6AX4GT	.80	12SF5	.70
0Z4	.55	6AX5GT	.80	12SG7	.63
1A7GT	.77	6B8	.75	12SH7	.80
1AX2	1.15	6BA6	.60	12SJ7	.55
1B3GT	.90	6BC5	.62	12SK7	.60
1B27	11.50	6BE6	.59	12SL7GT	.65
1H5GT	.77	6BG6G	1.85	12SN7GT	.75
1L1	.60	6BH6	.80	12S7GT	.55
1L6	.95	6B16	.85	12SR7	.69
1LA6	1.10	6BN6	1.20	12SX7GT	1.10
1LB4	1.10	6BQ6GT	1.13	14F7	.75
1LN5	1.10	6BQ7A	1.40	19BG6G	2.45
1N5GT	.95	6BZ7	1.20	25A V5	1.20
1N23A	2.95	6C4	.50	25BQ6GT	1.00
1N23B	2.25	6C5	.50	25L6GT	.60
1N34A	.75	6C6B	.58	25W4GT	.80
1N38	.88	6C06	1.95	25Z5	.70
1N48	.50	6C06	2.10	25Z6GT	.59
1N52	.90	6D6	.75	28D7	1.55
1N54	.79	6F4	3.50	35B5	.55
1N54A	.90	6F5	.68	35D5	.55
1N69	.60	6F5GT	.68	25L6GT	.60
1N70	1.25	6F6	.70	35Z3	.70
1N81	1.00	6F6G	.80	35T	.5
1R4/1299	.59	6F8G	.85	(Eimac)	2.75
1R5	.88	6G6G	.85	35Z5GT	.55
1S5	.78	6H6	.52	50A5	.90
1T4	.85	6J4(RCA)	5.10	50B5	.55
1U4	.55	6J5	.50	50C5	.65
1U5	.77	6J6	.62	50L6GT	.65
1V	1.03	6J7	.75	80	.66
1V2	.70	6K4(Sylv)	2.25	81	.75
1X2A	.90	6K4A	2.25	83	1.15
1Z2	3.25	6K6GT	.55	84/6Z4	.65
2C39A	13.75	6K7	.60	11Z23	.75
2C40	6.75	6L6G	1.10	11Z26	.98
2C51	3.90	6L6GA	1.10	211/VT4C	.88
2E30(Hyt)	2.05	6L6M	1.25	250TH	16.95
2I39	7.95	6L7	.80	274A & B	3.00
2I81	37.50	6N7M	.70	304TH	7.75
2I82	33.00	6P7G	.88	304TT	8.75
2K28	27.55	6Q7GT	.80	310A(WE)	3.50
2X2	.35	6S7M	.98	371B	.65
3A4	.59	6S7C	.88	407A(WE)	3.50
3BP11	9.00	6SD7GT	.80	408A(WE)	2.50
3B7/2291	.39	6S67	.66	717A	.88
3B28	4.25	6SH7	.98	725A	4.70
3C23(GE)	6.50	6S17	.65	803	3.25
3C24/24C	1.15	6S7K	.57	805	3.35
3D6/1299	.35	6SL7GT	.65	807	1.55
3Q4	.89	6SN7GT	.73	811A	3.55
3Q5GT	.99	6SQ7	.70	812A	3.60
3S4	.75	6T8	.99	816	1.20
3L4	.90	6V3	.95	829	7.95
3V4	.75	6V6GT	.66	829B	8.95
3X2500-		6V8	.99	830B	2.75
A-3	135.00	6W4GT	.55	832A	9.95
4B24	4.50	6W6GT	.75	866A(JAN)	1.25
4D22	18.50	6X5GT	.47	866A(CBS)	1.75
4X150A	29.95	7A7	.75	869B	65.00
5D21(WE)	12.50	7A7	.69	872A	3.25
5R4Y	1.50	7B7	.75	931A	4.75
5U4G	.58	7B8	.78	955	.42
5V4G	.95	7C4	.29	991/NE16	.50
5W4G	.80	7C5	.69	CK1005	.75
5X4G	.75	7C6	.69	1616	.88
5Y3GT	.54	7C30	.85	1622/6L6M	1.95
6A8GT	1.10	7E5	.39	1825	.35
6AB4	.80	7F7	.85	1626	.18
6AB7	.95	7F8G	1.55	1629	.25
6AC7Jan	.80	7BP7	4.25	2050	1.55
6AC7RCA	1.12	7H7	.70	5516(Hyt)	7.25
6AF4	1.39	7JP4	15.00	5528/C6L	5.00
6AG5	.70	7N7	1.20	5531	.92
6AG7	1.10	7Q7	.98	F6271	57.50
6AH4GT	.95	12A4	.98	5654	1.75
6AH6	.88	12A7	.80	5656	10.00
6AJ5	1.30	12A7	.70	5670	3.50
6AK5	.75	12AV7	1.10	5687	2.95
6AK6	.98	12AW6	.88	5691	7.80
6AL5	.83	12AX7	.75	5693	6.25
6AN4	1.50	12AY7	1.90	5814	2.20
6AQ5	.48	12B4	.98	9002	7.75
6AQ6	.73	12BA6	.60	9003	1.10
6AS5	.70	12BD6	.75	9004	.35
6AS6	1.95	12BE6	.60	9006	.29

Above is only a partial listing of our huge stock. Types not listed may be ordered at approx. the same savings. Many new special purpose types in stock.

AUTHORIZED DISTRIBUTORS
CBS-HYTRON WESTINGHOUSE

ODDS & ENDS

ERCO MARINE TRANSMITTER-RCVR.
4 channels, 12 V. DC operation. FCC approved. New, complete (less crystals). Regularly over \$300.00 SPECIAL...\$179.50

BRAND NEW VIBRAPACKS
12 V. DC input, 300 V. DC @ 125 ma. output. Complete with vibrator...\$9.95

TRIMM FEATHERWEIGHT HEADSETS
4000 ohms impedance. New orig. boxes...\$3.75

W.E. STEEL RACK PANELS
10 1/2 x 19 1/4". Commercial grey. Brand new. Regularly \$4.92 SPECIAL...\$1.00

BARRY ELECTRONICS CORP.

136B Liberty Street, N. Y. 6, N. Y. REctor 2-2562

Terms: 25% with order, balance C.O.D. All merchandise guaranteed. F.O.B. N.Y.C.

ADVERTISING INDEX

Radio-Electronics does not assume responsibility for any errors appearing in above index.

Adelman, Nat	139
Admiral Corporation	129
Airex Co.	119
All Channel Antenna Corp.	121
Allied Radio Corp.	13
American Microphone Co.	18
American Phenolic Corp.	90
American Television & Radio Co.	111
Amplifier Corporation of America	88
Arkoy Radio Kits, Inc.	130
Astron Corp.	21
Atlas Sound Corp.	103
Audel Publishers	142
Barry Electronics	146
Belden Manufacturing Co.	99
Bell Telephone Labs	24
Brooks Radio & TV Corp.	102, 103
Burstein Applebee Co.	131
CBS Hytron (Division of Columbia Broadcasting System)	10
Capital Radio Engineering Institute	15
Centralab-Div. of Globe Union	88, 100, 115
Century Electronics Co.	143
Channel Master Corp.	22, 23
Clarostat Manufacturing Co., Inc.	130
Cleveland Institute of Radio Electronics	7
Coast Electronics	125
Columbia Wire & Supply Co.	146
Commissioned Electronics	142
Concord Radio	128, 135
Corona Radio	136
Coyne Electrical & TV Radio School	82, 109
Crescent School	136
DeForest's Training, Inc.	5
Edie Electronics	107
Electro-Voice Inc.	16
Electronic Instrument Co., Inc.	28, 125, 132, 138
Electronic Measurements Corp.	110
Finney Co.	79
G & H Wood Products Co.	122
General Electric Co.	9
General Industries Co.	80
General Test Equipment	139
Gernsback Publications	26, 118
Granco Products, Inc.	117
Gyro Products	107
Heath Co.	62-73 inclusive
Hickok Electrical Instrument Co.	136
Hi-Lo TV Antenna Corp.	112
Hudson Specialties	98
Hughes Research & Development Labs	115
IE Manufacturing Co.	122
Indiana Technical College	125
Instructograph Co.	88
International Correspondence Schools	11
JFD Manufacturing Co., Inc.	27, 114
Jensen Industries	117
Jones & Laughlin Steel Corp.	113
Kay-Townes Antenna Co.	95
Kedman Co.	142
Kirk, Jim	130
Leader Electronics	83
Leotone Radio Corp.	174
Littelfuse, Inc.	93
Macmillan Co., The	140
Mallory & Co., P. R.	Inside Back Cover
Mannfred Electronics	125
Master Electronics Co.	132
McGraw-Hill Book Co.	143
Merit Coil & Transformer Co.	12
Moss Electronic Distributing Co.	97
National Electronics of Cleveland	126
National Radio Institute	19, 20
National Schools	3
Nidisco	137
Ohmite Manufacturing Co.	92
Opportunity Adlets	137
Oxford Electric Corp.	116
Permoflux Corp.	137
Perma-Power Co.	114
Plastoid Corp.	81
Precise Development Corp.	108
Precision Apparatus Co., Inc.	80
Pres-Probe Co.	127
Progressive Electronics	123
Quietrole Co.	117
RCA Institutes, Inc.	25
RCA Victor Division (Radio Corporation of America)	Inside Front Cover, 85, Back Cover
Rad-Tel Tube Co.	101
Radelco Manufacturing Co.	116
Radiart Corp.	77
Radio City Products	127
Radio Craftsmen	104, 105
Radio Merchandise Sales	139
American Electronics Co.	
Candler System Co.	
Grantham School of Electronics	
Indiana Technical College	
Indianapolis Electronic School	
Milwaukee School of Engineering	
RCA Institutes, Inc.	
Tri-State College	
Valparaiso Technical Institute	
Western Television Institute	
Radio-Television Training Ass'n	17
Raytheon Manufacturing Co.	6
Regency Div. (I.D.E.A., Inc.)	89

NEW!

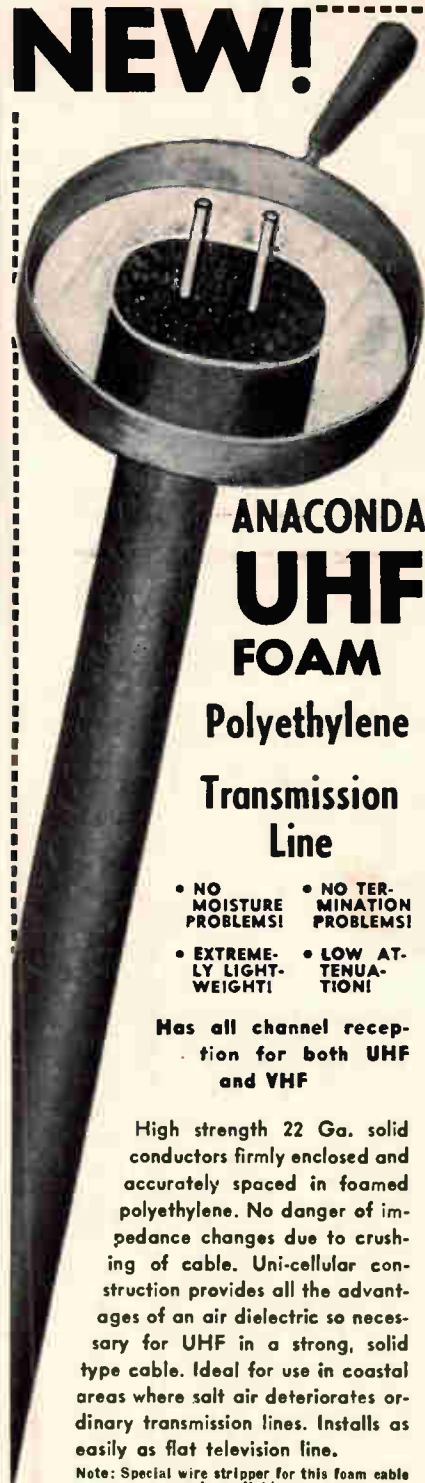

ANACONDA UHF FOAM Polyethylene Transmission Line

- NO MOISTURE PROBLEMS!
- NO TERMINATION PROBLEMS!
- EXTREME LIGHT-WEIGHT!
- LOW ATTENUATION!

Has all channel reception for both UHF and VHF

High strength 22 Ga. solid conductors firmly enclosed and accurately spaced in foamed polyethylene. No danger of impedance changes due to crushing of cable. Uni-cellular construction provides all the advantages of an air dielectric so necessary for UHF in a strong, solid type cable. Ideal for use in coastal areas where salt air deteriorates ordinary transmission lines. Installs as easily as flat television line.

Note: Special wire stripper for this foam cable is available

We have a UL approved universal type "Lightning Arrestor" for use with all Anaconda UHF lines & other types of flat or round TV wires.

Write for Samples and New Descriptive Literature. Sold through recognized jobbers only!

"National distributors and warehouse for ANACONDA denshath television and radio wires and cables"

Columbia
WIRE & SUPPLY CO.
2850 Irving Park Road • Chicago 18, Ill.

RCA INSTITUTES, INC.
 A service of Radio Corporation of America
 350 West 4th St., New York 14, N. Y.
OFFERS COURSES IN ALL TECHNICAL PHASES OF RADIO, TELEVISION, ELECTRONICS
 Approved for Veterans
 Write Dept. RC-53 for Catalog

LEARN WITH "AMECO" COURSES
BECOME A RADIO AMATEUR
 Simple, Low Cost, Home-Study Courses prepare you to pass F.C.C. Code and Theory Examinations for Amateur license and Code for Commercial license.
 An ideal Christmas Gift
 Write for details to
AMERICAN ELECTRONICS CO.
 1203 Bryant Ave., (Dept. RE-12), New York 59, N. Y.

CODE SENDING RECEIVING SPEED
 Be a "key" man. Learn how to send and receive messages in code by telegraph and radio. Commerce needs thousands of men for jobs. Good pay, adventure, interesting work. Learn at home quickly through famous Candler System. Qualify for Amateur or Commercial License. Write for FREE BOOK.
CANDLER SYSTEM CO.
 Dept. 3-O, Box 928, Denver 1, Colo., U.S.A.

TV REPAIRMEN MAKE TOP MONEY!
 In just 39 weeks, you can get complete TV service training! Streamlined course gives you all essentials for a good job as service technician. Graduates in great demand; jobs are plentiful in this growing field. Other courses in electronics, radio operation and maintenance. Day or evening classes; modern equipment. Opportunity for employment in local industry.
 Write for Catalog 111 Today
INDIANAPOLIS ELECTRONIC SCHOOL
 312 E. Washington, Indianapolis 4, Ind.

MAKE \$600 EXTRA EACH MONTH!
F.C.C. LICENSE REQUIRED
 Service 2-way mobile radio systems. Our free booklet tells of opportunities, explains the different types and classes of F.C.C. licenses required, and tells how you can get your license QUICKLY. 2nd class in 5 weeks. 1st class in 3 additional weeks. Both correspondence and residence training available. Write today for free booklet.
GRANTHAM SCHOOL OF ELECTRONICS, DEPT 101
 6064 Hollywood Blvd., Hollywood 28, Calif.

Rider, Inc., John F.	98, 134
Rinehart Books, Inc.	106, 120, 124, 132, 141
Rogers Electronics Corp.	130
Soms & Co., Inc., Howard W.	8, 119
Service Instruments Co.	84
Simpson Electric Co.	86, 87
Skyline Manufacturing Co.	138
Sprayberry Academy of Radio	61, 137
Stan-Burn Radio & Electronics	143
Steve-El Electronics Corp.	141
Sun Radio of Washington	136
Sylvania Electric Products	14
Tab	148
Tallen Co., Inc.	88
Technical Appliance Co.	128
Tele-Beam Industries	139
Telesound Corp.	133
Television Communications Institute	129
Terado Co.	94
Terminal Radio	116
Transamerica Electronics	142
Transvision, Inc.	140, 141
Trio Manufacturing Co.	144, 145
United Technical Labs.	126
University Loudspeakers	131
Visulte Co.	127
Waldom Electronics	112
Ward Products Corp.	75
Webster Electric Corp.	91
Windsor Electric Tube Co.	139
Zingo Products	138

GET INTO ELECTRONICS

You can enter this uncrowded, interesting field. Defense expansion, new developments demand trained specialists. Study all phases radio & electronics theory and practice: TV; FM; broadcasting; servicing; aviation, marine, police radio. 18-month course. Graduates in demand by major companies. U.S. or equivalent required. Begin Jan., March, June, Sept. Campus life. Write for catalog.
VALPARAISO TECHNICAL INSTITUTE
 Dept. C Valparaiso, Ind.

RADIO ENGINEERING DEGREE IN 27 MONTHS

Intensive, specialized course including strong basis in mathematics and electrical engineering, advanced radio theory and design, television. Modern lab. Low tuition. Self-help opportunities. Also B.S. degree in 27 months in Aeronautical, Chemical, Civil, Electrical, and Mechanical Engineering. G.I. Gov't approved. Enter December, March, June, September. Catalog.

INDIANA TECHNICAL COLLEGE
 1512 E. Washington Blvd., Fort Wayne 2, Indiana

Unlimited Opportunities in RADIO ENGINEERING DEGREE IN 27 MONTHS

Complete Radio Engineering course including telev., U. H. F. and F. M. Bachelor of Science Degree also in Mech., Civil, Elect., Chem., and Aero. Eng.; Bus. Adm., Acct. Extensive campus, modern buildings, well equipped labs. Low cost. Prep courses. Personalized practical instruction. Founded 1884. Placement service. Growing shortage of engineers. Prepare now. Approved for Korean vets. Enter January, March, June, September. Write for catalog.

TRI-STATE COLLEGE
 24123 College Ave. ANGOLA, IND.

EARN MORE MONEY— BE A PROFESSIONAL TELEVISION SERVICE TECHNICIAN
 HOW TO BE A SUCCESSFUL TELEVISION TECHNICIAN

STEP INTO THE TOP PAY \$5,000—\$10,000 A YEAR CLASS. 7 MONTHS' SHOP TRAINING QUALIFIES YOU.

If you want to reach your goal as a Successful Service Technician you will need plenty of "KNOW HOW" to qualify for the better servicing jobs or profitable shop ownership.

WESTERN TV offers real experience on live equipment in our BIG SHOPS AND LABORATORIES in the shortest practical time under expert instructors. Graduates are in big demand because they have the "field experience" necessary for immediate "bench" or supervisory positions. You learn every phase of Radio and TV servicing (AM, FM, VHF, UHF). WTI men win fast promotion... can demand better pay... develop highly profitable businesses of their own with the latest and most PRACTICAL PERSONALIZED TRAINING BEHIND THEM. You concentrate all your time on being a PROFESSIONAL TV SERVICE TECHNICIAN — non-essential math and engineering theory omitted. YOU CAN EARN WHILE YOU LEARN. Special Finance Plan. APPROVED FOR VETERANS. Find out how you can get into the TOP PAY GROUP — Send for this fact-packed book NOW!

WESTERN TELEVISION INSTITUTE America's Leading Television Servicing School

Western Television Institute Dept. E-12-3
 341 W. 18th St., Los Angeles 15, Calif.
 Without obligation, please send FREE fully illustrated booklet. (No salesman will call.)

NAME _____ AGE _____
 ADDRESS _____
 CITY _____ ZONE _____ STATE _____

BECOME AN ELECTRICAL ENGINEER

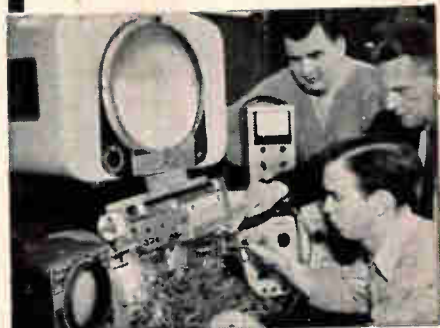

Bachelor of Science Degree in 36 months.
 Major in Electronics or Power. Now, prepare for a career in these rapidly expanding fields.

This school will prepare you to become an engineer, technician or service man. Previous military, academic or practical training may be evaluated for advanced credit.

Enter Both Radio and Television

In 12 months you can attain the Radio-Technician's certificate. An added 6 months course qualifies you for the Radio-TV Technician's certificate and the Degree of "Associate in Applied Science." The Technician's course is the first third of the program leading to a Bachelor of Science Degree in Electrical Engineering with a major in Electronics.

Also offered: 12-month Radio-TV service course; 12-month Electronics or Electro Technician Courses; 6-month Electrical Service Course and 3-month refresher and general preparatory classes.

Terms Open January, March, June, October

Famous for its Concentric Curriculum. Faculty of specialists. 50,000 former students. Annual enrollment from 48 states and 23 overseas countries. Non-profit. 50th year. Courses approved for Veterans. Residence courses only.



MILWAUKEE SCHOOL OF ENGINEERING

MILWAUKEE SCHOOL OF ENGINEERING
 Dept. RE-1253, 1025 N. Milwaukee
 Milwaukee 1, Wisconsin

Send: Free 45-page "Your Career" booklet describing Electrical Engineering Courses; Booklet on Careers in Radio-TV.

I am interested in _____ name of course _____
 Name _____ Age _____
 Address _____
 City _____ Zone _____ State _____
 If veteran, indicate date of discharge _____

DC POWER SUPPLY

0 to 12 VDC/2 Amp. Variable DC supply, un-cased and completely built-in...

FEDERAL "ITT" SELENIUM BATTERY CHARGER RECTIFIER

10-0-10V (CT) 100 Amp. Replace your old inefficient auto rectifier...

SELENIUM RECTIFIERS

Table with columns: Current, Voltage, Price, Qty. Lists various selenium rectifier models and their specifications.

RECTIFIER XFMRs

Table listing transformer models (e.g., 4 Amp, 12 Amp) and their prices.

SELENIUM RECTIFIERS

Table listing various selenium rectifier models and their prices, including full wave rectifiers and transformers.

"TAB" THAT'S A BUY

RECTIFIER CHOKES

Table listing rectifier chokes with specifications like ampere rating and inductance.

POWERSTAT SPECIALS

Table listing Powerstat models and their prices.

RHEOSTAT SALE

Table listing rheostat models and their prices.

CLOCK RADIO

WAKE UP TO MUSIC. Just set the dial and radio automatically turns on.

ODD'S & END'S SALE

DELTA 50K OHM 10 Turn 0.5% 8.95. HELIPOT ATTENUATOR 22K dual.

YOU PICK THEM 39¢

Cracked base or broken key electrically perfect. TESTED & 90 DAY GUARANTEED.

YOU PICK THEM \$1.00 WHILE THEY LAST

KITS AND COMPONENTS. Oil Condensers Ass't. 5 for \$1.25. Electrolytic Condensers Ass't. 5 for \$1.25.

OIL CONDENSERS WAREHOUSE CLEARANCE SALE

5MFD 1500VDC .95¢; 2 for \$1.50. 3MFD 330VAC 1000VDC .45¢; 3 for 1.20.

ONE YEAR GTD PICTURE TUBES

Table listing various picture tube models (70P4, 10BP4, etc.) and their prices.

OIL CONDENSER SPECIAL

10 MFD 600 VDC \$1.75 ea. lots of 3.

INFRARED SNOOPSCOPE

SEE-IN-DARK TUBE. Image-Converter Tube sensitivity simplified design 2" dia. Willite lens.

CONDENSER SPECIAL

2 MFD 1000 VDC 330 VAC "CD" MFR. Lots of 10.

ELECTRIC DRILL 1/4" MODEL 200J

Hi-Torque (800W) UL Hi-Torque 2400 RPM 115V AC/DC motor.

CHROME VANADIUM SPEED DRILLS

29PCS CHROME VANADIUM SPEED STEEL. Top Quality for Machine or all purpose use.

MODEL 200JK UTILITY KIT

The serviceman's workshop. kit includes 200J Jacobs 1/4" drill, ass't drill bits and accessories.

ELECTROLYTIC CONDENSER KIT

POPULAR VALUES 25¢ ea. Here is a handy assortment of 15 condensers for the serviceman.

TELEVISION ANTENNA

VEE CONICAL Broad response all channel. Study cone full for fringe areas.

TV & COAX CABLE

300 Ohm Twlnx. Heavy duty 65 mil all copper TV lead in.

TUBES

*From This Special List We Ship \$10.00 and Up Tube Orders At Our Expense (Post-paid) Within Continental Limits of U.S.A.

Large table listing various vacuum tube models (0A2, 0B2, etc.) and their prices.

TACHOMETER GENERATOR

MARK V STUD MTG. GENERAL ELECTRIC. \$4.98 ea. Write for quantity price.

YOU PICK THEM 59¢ WHILE THEY LAST

LOTS OF 10. Your selection of 10 at 59¢ each or smaller quantity at individual prices.

"TABS" NEW TRANSFORMER STOCK

Table listing transformer models and their prices.

EICO TEST EQUIPMENT

Table listing EICO test equipment models and their prices.

REPAIR KIT #873

All the tools needed for on the spot repair job. Includes 4" interchangeable screw driver blades.

FILAMENT TRANS.

Table listing filament transformer models and their prices.

STORAGE BATTERIES

36 Volt WILLARD MINI-BRAND-New 5 ohm Designed Portable Equip Models 98c; 4 for \$3.

THROAT MIKE

730-V Double Button flat P-20 90-0-90 CV 5K 2B1850V. Brand New 98c.

TRANSFORMERS

Table listing various transformer models and their prices.

866A KIT and XFORMER

2 Tubes, Sects, Xfmr. 115V 60Cz Inpt. output 2.5v/10A/7.

ELECTROLYTIC CONDENSERS

Table listing electrolytic condenser models and their prices.

FILTER CHOKES

Table listing filter choke models and their prices.

HI-FI POWER SUPPLY

SOLA constant voltage power transformer, mounted on chassis with (2) octal rectifier sockets.

THROAT MIKE

730-V Double Button flat P-20 90-0-90 CV 5K 2B1850V. Brand New 98c.

THAT'S "TAB" THAT'S A BUY

Dept. 12RE 111 LIBERTY STREET, NEW YORK 6, N. Y., U.S.A.

THAT'S "TAB" THAT'S A BUY

Dept. 12RE 111 LIBERTY STREET, NEW YORK 6, N. Y., U.S.A.



The Time YOU SAVE ... is ALL PROFIT!

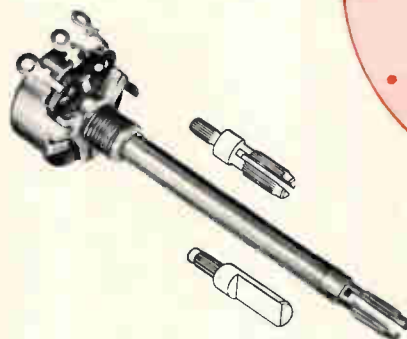

Mallory Dual Control Kits

Three kits of controls and switches, selected to meet varying requirements in different parts of the country, will serve 50 different models of radio and television sets. You pay only for the controls and switches; attractive 3-drawer metal cabinet is free of extra cost. Get details from your Mallory Distributor.

Every job is in a hurry around a busy service shop... and minutes saved add up to more work done and greater profits, to say nothing about satisfied customers.

When you use Mallory Midgetrols®, you'll find them fast and easy to install in any TV or radio set.

Round tubular shafts can be cut accurately and quickly... fit split-knurl or flatted-type knobs.

AC switches can be attached instantly without disassembling the control.

Unique design simplifies inventory problems... makes them quickly available from your distributor.

Midgetrols are engineered to match the electrical characteristics of the original equipment of any TV or radio set. They will give equal, and often better, performance than the original control... your assurance of precision quality on every job.

This will save time, too. Ask your Mallory Distributor for a copy of the Mallory Control Guide. It is a complete cross reference between set manufacturers' part numbers and the equivalent Mallory control.

P. R. MALLORY & CO. Inc.
MALLORY

CAPACITORS • CONTROLS • VIBRATORS • SWITCHES • RESISTORS
RECTIFIERS • POWER SUPPLIES • FILTERS • MERCURY BATTERIES
APPROVED PRECISION PRODUCTS

P. R. MALLORY & CO., Inc., INDIANAPOLIS 6, INDIANA

*Depend on Mallory
for
Approved Precision Quality*

Have you hung up

your shingle?

IT PAYS TO KEEP GOOD COMPANY . . .
and it's good business to advertise the
good company you keep.

Thousands of dealers and servicemen
are using the sales-magic in the RCA name
to instill confidence in their customers.
Identifying *your* name with RCA pays off
in dollars and cents.

And it's so easy to do . . . because RCA's
new Dealer Identification Program pro-
vides you with a handsome "shingle" with
your name on it, that you'll be proud to
display in your shop. When a customer
sees this Dealer Identification Plaque he
knows you are using the best tube products
available.

So, we ask . . . "Have you hung up *your*
shingle yet?" If not, be sure to see your
RCA Tube Distributor today and learn
how *you* can qualify for a Registered
Dealer Plaque at no extra cost.

Unlock the door to bigger profits

Here's *your* key to better business . . . RCA's
dynamic Dealer Identification Program. Ask
your *RCA Tube Distributor* for your copy of the
colorful, 16-page booklet
"A Magic Pass-Key to
Customer Confidence."
It tells you how—for
the first time—you can
become a Registered
Dealer . . . and get
extra sales benefits.

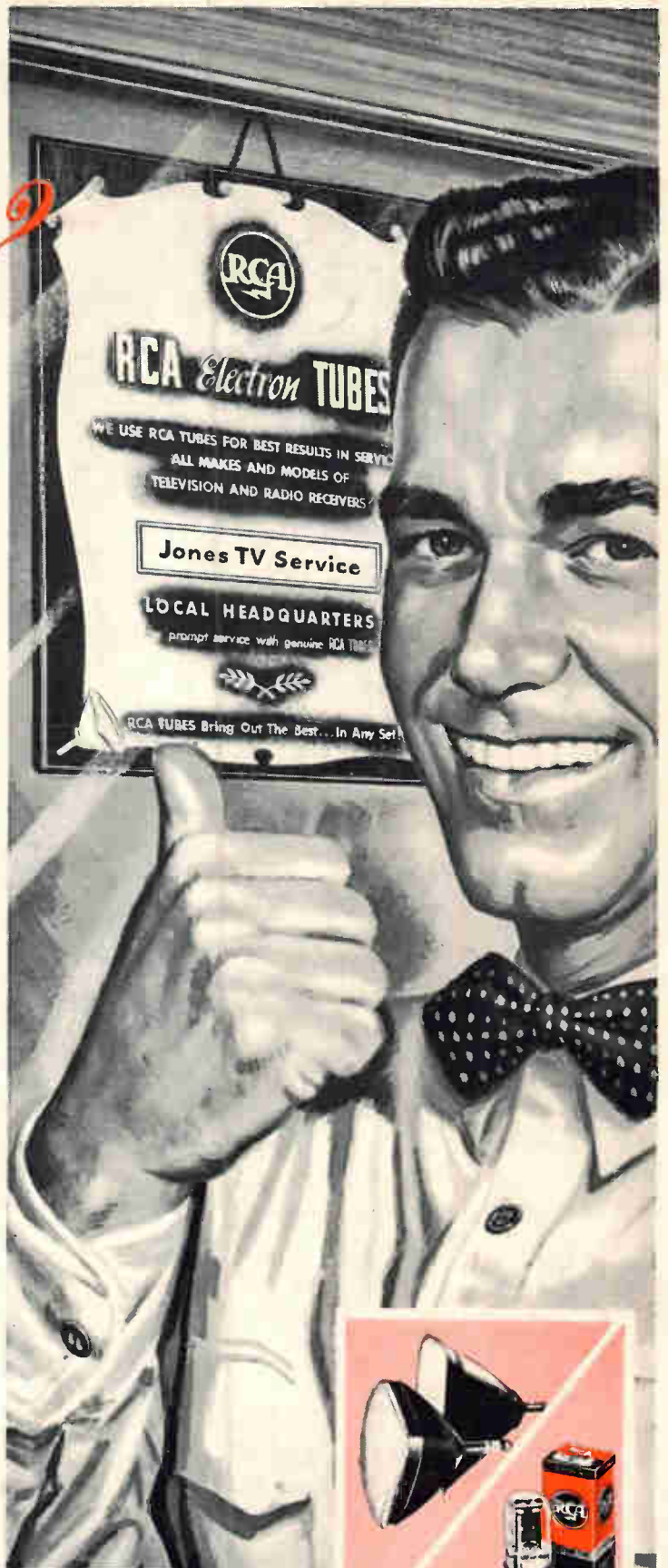

RADIO CORPORATION of AMERICA
ELECTRON TUBES

HARRISON, N. J.