

RADIO - ELECTRONICS

MAY 1952

LATEST IN TELEVISION • SERVICING • AUDIO

HUGO GERNSBACH, Editor

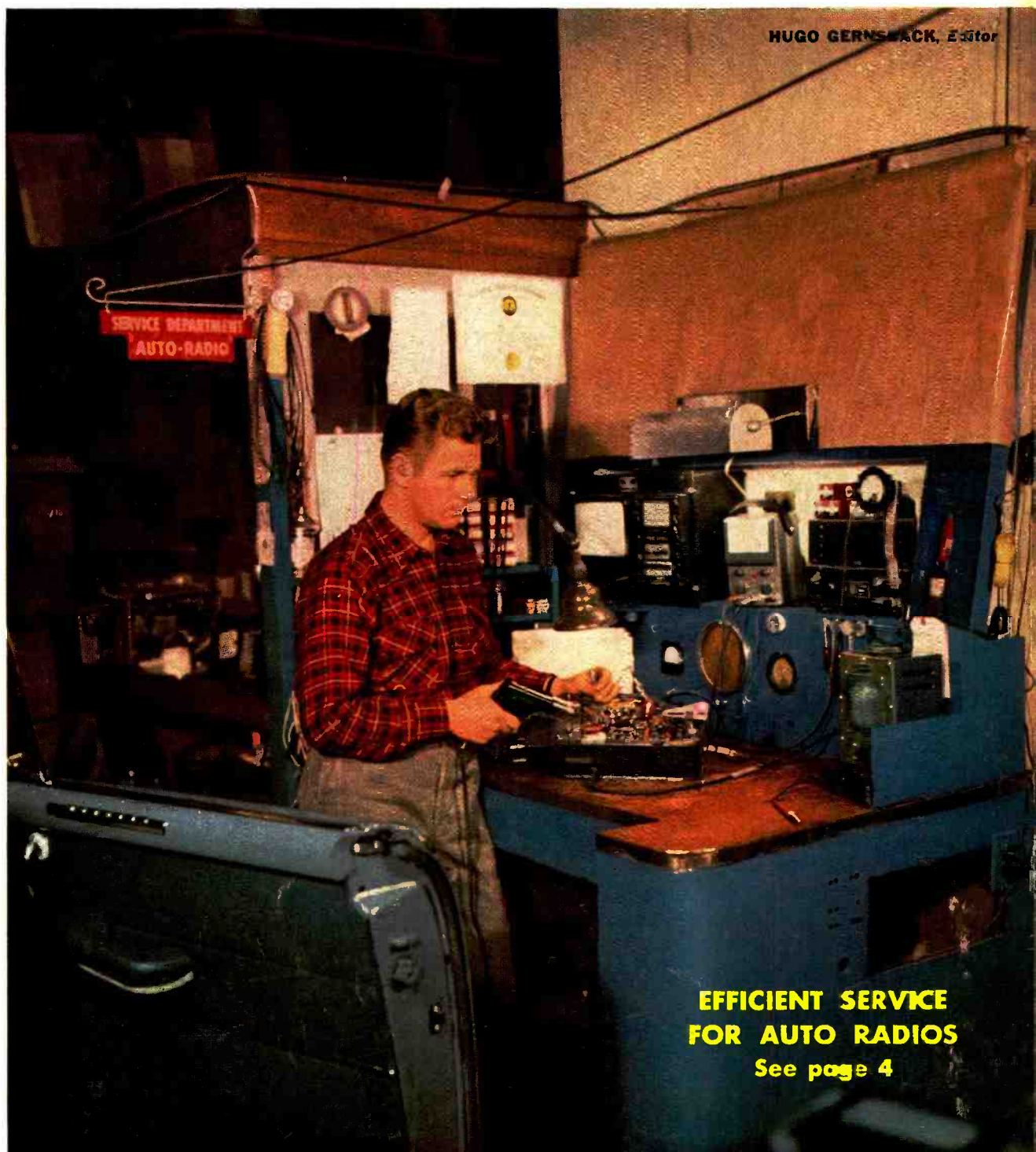

**EFFICIENT SERVICE
FOR AUTO RADIOS**
See page 4

30¢

U. S. and
CANADA

**In this issue: TV Pattern for the Future •
Practical TVI Filters • Converting the 9T-270**

if you use television picture tubes

DU MONT PICTURE TUBE DATA CHART

ELECTROMAGNETIC FOCUS TYPES

Type	Model	Screen	Resolution	Deflection	Power	Weight	Notes
11P10	11P10	10 1/2"	100	100	100	100	Standard
11P12	11P12	12"	120	120	120	120	Standard
11P14	11P14	14"	140	140	140	140	Standard
11P16	11P16	16"	160	160	160	160	Standard
11P18	11P18	18"	180	180	180	180	Standard
11P20	11P20	20"	200	200	200	200	Standard
11P22	11P22	22"	220	220	220	220	Standard
11P24	11P24	24"	240	240	240	240	Standard
11P26	11P26	26"	260	260	260	260	Standard
11P28	11P28	28"	280	280	280	280	Standard
11P30	11P30	30"	300	300	300	300	Standard
11P32	11P32	32"	320	320	320	320	Standard
11P34	11P34	34"	340	340	340	340	Standard
11P36	11P36	36"	360	360	360	360	Standard
11P38	11P38	38"	380	380	380	380	Standard
11P40	11P40	40"	400	400	400	400	Standard
11P42	11P42	42"	420	420	420	420	Standard
11P44	11P44	44"	440	440	440	440	Standard
11P46	11P46	46"	460	460	460	460	Standard
11P48	11P48	48"	480	480	480	480	Standard
11P50	11P50	50"	500	500	500	500	Standard

Using the Data Chart
Look for the model number in the left margin. The first column lists the model number. The second column lists the screen size. The third column lists the resolution. The fourth column lists the deflection. The fifth column lists the power. The sixth column lists the weight. The seventh column lists the notes.

ELECTROSTATIC FOCUS TYPES

Type	Model	Screen	Resolution	Deflection	Power	Weight	Notes
11E10	11E10	10 1/2"	100	100	100	100	Standard
11E12	11E12	12"	120	120	120	120	Standard
11E14	11E14	14"	140	140	140	140	Standard
11E16	11E16	16"	160	160	160	160	Standard
11E18	11E18	18"	180	180	180	180	Standard
11E20	11E20	20"	200	200	200	200	Standard
11E22	11E22	22"	220	220	220	220	Standard
11E24	11E24	24"	240	240	240	240	Standard
11E26	11E26	26"	260	260	260	260	Standard
11E28	11E28	28"	280	280	280	280	Standard
11E30	11E30	30"	300	300	300	300	Standard
11E32	11E32	32"	320	320	320	320	Standard
11E34	11E34	34"	340	340	340	340	Standard
11E36	11E36	36"	360	360	360	360	Standard
11E38	11E38	38"	380	380	380	380	Standard
11E40	11E40	40"	400	400	400	400	Standard
11E42	11E42	42"	420	420	420	420	Standard
11E44	11E44	44"	440	440	440	440	Standard
11E46	11E46	46"	460	460	460	460	Standard
11E48	11E48	48"	480	480	480	480	Standard
11E50	11E50	50"	500	500	500	500	Standard

Electrostatic Focus Tubes
The most important characteristic of an electrostatic focus tube is its ability to focus the electron beam. This is achieved by the use of electrostatic focusing. The electron beam is focused by the electric field of the focusing electrodes. The focusing electrodes are located at the neck of the tube. The focusing electrodes are connected to the focusing voltage. The focusing voltage is applied to the focusing electrodes. The focusing voltage is applied to the focusing electrodes. The focusing voltage is applied to the focusing electrodes.



BULB OUTLINE INFORMATION

Type	Model	Screen	Resolution	Deflection	Power	Weight	Notes
11B10	11B10	10 1/2"	100	100	100	100	Standard
11B12	11B12	12"	120	120	120	120	Standard
11B14	11B14	14"	140	140	140	140	Standard
11B16	11B16	16"	160	160	160	160	Standard
11B18	11B18	18"	180	180	180	180	Standard
11B20	11B20	20"	200	200	200	200	Standard
11B22	11B22	22"	220	220	220	220	Standard
11B24	11B24	24"	240	240	240	240	Standard
11B26	11B26	26"	260	260	260	260	Standard
11B28	11B28	28"	280	280	280	280	Standard
11B30	11B30	30"	300	300	300	300	Standard
11B32	11B32	32"	320	320	320	320	Standard
11B34	11B34	34"	340	340	340	340	Standard
11B36	11B36	36"	360	360	360	360	Standard
11B38	11B38	38"	380	380	380	380	Standard
11B40	11B40	40"	400	400	400	400	Standard
11B42	11B42	42"	420	420	420	420	Standard
11B44	11B44	44"	440	440	440	440	Standard
11B46	11B46	46"	460	460	460	460	Standard
11B48	11B48	48"	480	480	480	480	Standard
11B50	11B50	50"	500	500	500	500	Standard

Teletrons
TELEVISION'S FINEST
PICTURE TUBES

CATHODE-RAY TUBE DIVISION
ALLEN B. DU MONT LABORATORIES, INC.
750 BLOOMFIELD AVENUE
CLIFTON, N. J.

Whether it's for TV receiver design, research, or servicing be sure to have one of these charts handy. At a glance you can see all the electrical and physical characteristics for any modern RTMA-registered TV picture tubes. This is the latest edition of the Du Mont tube chart incorporating the very latest tube types. Ask your local Teletron Distributor, or write...



DU MONT

Teletrons*

First with the Finest in Television Picture Tubes
Cathode-ray Tube Division,
Allen B. Du Mont Laboratories, Inc.
Clifton, N. J. *Trade mark

TRAIN for Security! Good-Paying Jobs!

MAKE THE MONEY YOU'VE ALWAYS DREAMED OF!



LEARN RADIO -TELEVISION

AND ELECTRONICS BY EASY SHOP METHOD TRAINING AT HOME!

You get all the parts—even tubes!— for this modern Superheterodyne Receiver. You learn to build it step by step. And you keep it! Get all the facts. Mail coupon now.

Let **NATIONAL SCHOOLS**—a resident-training school for nearly 50 years—train you at home for today's unlimited opportunities in Radio-Television-Electronics. National Schools is one of the largest schools of its kind. It is located in Los Angeles—the center of Radio and TV world! It has four large buildings of modern shops and labs. Its faculty is considered tops in the business.



You learn from lessons prepared by experienced instructors and engineers. Men who are successful Radio and Television technicians. Men who have trained 1000's of men like YOU!



FREE BOOK TELLS YOU HOW!

Page after page—in color—tells you everything you want to know. Mail the coupon. Get this valuable book today. And if you hurry—YOU GET A FREE SAMPLE LESSON. TOO! Shows how easy National Schools Home Training is. Mail the coupon today.

You Train At Home—In Your Spare Time

National Schools Shop Method Home Training gives you basic and advanced instruction in *all* phases of Radio-TV-Electronics. And remember—your training is based on resident school training principles. You learn *fast!* from hundreds of diagrams and pictures. All instructions are written by experienced technicians who work in Radio and TV every day. All instructions have been developed and tested in National Schools' own labs and studios, which are equipped with the latest RCA equipment. No wonder this National Schools course is so up-to-date, practical, interesting. And so easy to learn! And no wonder it is held in such high regard by leaders of American industry! Approved for eligible Veterans.

We Teach You How To Make Welcome Extra Money—While You Learn!

Many National Schools students—men like you—make plenty of extra dollars each week in spare time! Fixing neighbors' radios, appliances—and other ways we teach you. You start learning and earning from the day you enroll. From the very first lesson!

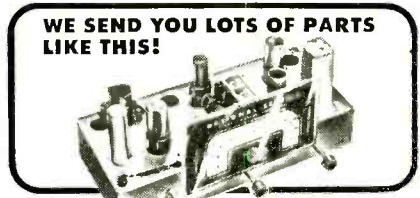

WE SEND YOU LOTS OF PARTS LIKE THIS!

With National Schools Shop Method Home Training, you get basic principles and plenty of *practical* training. You learn *by doing*. No wonder you learn so fast! We send you many parts—all of professional, modern quality. You do lots of practical experiments. You advance day by day, step by step. Until you can even build the modern Superheterodyne Receiver you see above—plus other important testing units. The free book tells you all about it. The free sample lesson shows how easy the training is. Use the coupon. Send today—without fail!

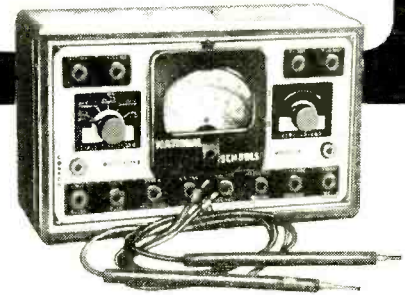

Only National Schools Gives You This Professional Multi-Tester!

You get this amazing, new testing instrument—factory-made and tested—complete—ready to use! Simple to operate. Accurate and dependable. An instrument every Radio-TV man needs. Light enough to carry around—so you can use it at home or on service calls. You'll be proud to own this valuable equipment.

Here are only a few of the Good-Paying Jobs You Can Choose
Radio Station Engineer, District Service Manager, Aircraft Radio Inspector, Own Your Own Repair Shop, Inspector Technician, Service Specialist, Special Government Jobs, Complete TV Service, Sound Truck Operator. Many more!
National Schools graduates have secure, good-paying jobs like these! So don't wait—mail the coupon today. Now—while you're thinking about it!

Today's Shortage of Trained Technicians Creates Chance of a Lifetime For You!

Think of it! With guided missiles, radar, and other electronic devices so important to national defense! With big, new developments in TV. With over 90,000,000 home and auto radios, over 12,000,000 TV sets. With more than 3100 radio stations...over 100 TV stations—and more building every day...yes, imagine the great opportunity you have today! YOU are wanted in Radio-Television-Electronics! America's fastest-growing field. High-pay jobs—the kind you've always wanted—are waiting for YOU!

Job Security! Big Money! For YOU! in Today's Expanding Industries!

Trained Radio and Television technicians really make important money these days. Thousands of National Schools graduates—men just like you—are earning good money all over the country. Why not you? And—National Schools graduates get the personal satisfaction of being highly-skilled technicians. Men people respect. Men who *enjoy* their work—rather than having to drag along in just any old job.

National Schools Has Trained 1000's of Successful Men! Why Not YOU?

In almost every state—and many foreign countries—National Schools graduates are filling big jobs with famous companies. Or running their own successful businesses. What are YOU waiting for? National Schools training is *complete* training. So when you graduate you can take advantage of today's big opportunities in Radio-Television-Electronics—fast.

DON'T PUT IT OFF! GET THE BIG SALARY YOU HAVE ALWAYS WANTED!

Attention! Men Going into Service Soon!

National Schools' course quickly prepares you for many important jobs in the Armed Services. With National Schools Training you have an opportunity to get into *special* service classifications—with higher pay and grade—immediately!

FREE SERVICE FOR GRADUATES

National Schools uses its great influence and prestige to help you find your place in the field of your choice. Don't put it off! Start yourself toward a skilled trade! Get the big pay you've always wanted!

NATIONAL SCHOOLS

LOS ANGELES 37, CALIFORNIA • ESTABLISHED 1905
In Canada: 193 E. Hastings St. Vancouver, B. C.

MAIL THIS COUPON TODAY—WITHOUT FAIL!

NATIONAL SCHOOLS, Dept. GR-52
4000 South Figueroa Street
Los Angeles 37, California

Mail in envelope or paste on penny post card.

Mail me FREE the book mentioned in this ad. Also a free sample lesson. I understand no salesman will call on me.

NAME _____ AGE _____

ADDRESS _____

CITY _____ ZONE _____ STATE _____

Check here if you were released from the Service less than 4 years ago.

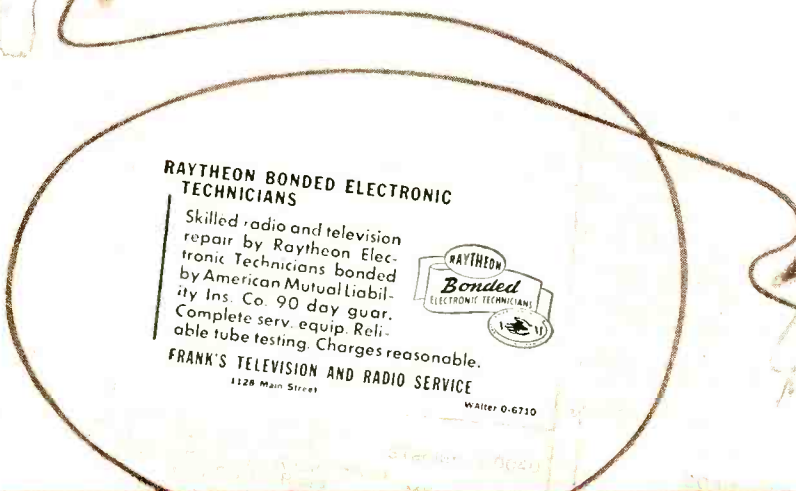

Here's another important way the

RAYTHEON BONDED Electronic Technician Program

builds your business

A receiver fails and an upset customer scans the telephone directory. A sea of unfamiliar names — ah — here's a radio and television service dealer whose guarantee is cash-protected by a Bond. Result: another customer for a *Raytheon Bonded Electronic Technician*.

The Raytheon Bonded Dealer Decal on windows and doors; the Raytheon Creed Display; the Raytheon Bonded Dealer Certificate exert a similar influence on passers-by — wary customers choose you instead of the guy next door.

These are all part and parcel of Raytheon's *Bonded Electronic Technician Program* which costs you nothing yet gives you a mighty important advantage over your competitors.

Better ask your Raytheon Tube Distributor to show you how little it costs to use this exclusive business builder.



RIGHT... FOR SOUND AND SIGHT



RAYTHEON MANUFACTURING COMPANY

Receiving Tube Division

Newton, Mass., Chicago, Ill., Atlanta, Ga., Los Angeles, Calif.

Excellence in Electronics

RECEIVING AND PICTURE TUBES • RELIABLE SUBMINIATURE AND MINIATURE TUBES • GERMANIUM DIODES AND TRANSISTORS • RADIAC TUBES • MICROWAVE TUBES

RADIO-ELECTRONICS

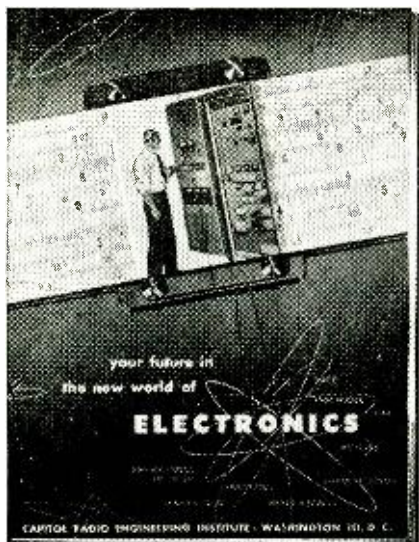

Many a well-paid man
is grateful for this **FREE**
fact-packed booklet, which details

HOW YOU CAN BE SUCCESSFUL IN RADIO-TV-ELECTRONICS

← Send for it today

Every success in Electronics has a story behind it. Sometimes you hear it's "luck." Other times, "contacts."

What do the successful men themselves say? *They give credit to training.* In addition, many men on the way up thank the day they sent for a booklet titled "Your Future in the New World of Electronics."

This is the eye-opening survey of the fast-growing world of Electronics. Many eager, ambitious men started their technical careers with a study of this booklet.

Expansion is phenomenal in this dynamic industry. There are over 100,000,000 radios in use! Experts predicted that by 1954 there would

be 13,000,000 TV sets. That mark was passed a year ago. Today there are 16,184,000. 109 television stations are now in operation, and the lifting of the freeze will send 1500 to 2500 new stations scrambling for trained personnel—so urgently needed in every phase of electronics. That isn't the whole picture. Consider

the tremendous defense orders for electronic installations—consider the fire and police departments, the railroads, the cabs, the aircraft—all using radio. Consider radar. Consider the maritime world with its navigational aids, fathometers, ship-to-shore and ship-to-ship communications. Think of electronic heating, fax and ultra-fax, of electronic medicine, and all the other applications of electronic know-how. Countless positions must be filled—in development, research, design, production, testing, inspection, manufacture, broadcasting, telecasting and servicing. Who can get those positions? You—if you prepare today—if you are alert and have the ambition to advance your knowledge. You—if you take 2 minutes to send for a free copy of "Your Future in the New World of Electronics." This helpful booklet shows you how CREI Home Study leads to greater earnings through the inviting opportunities described above.

CREI, an accredited technical school, does not promise you a "bed-of-roses." You have to translate your willingness to learn into salable technical knowledge—via *study*. Since its founding in 1927, CREI has provided thou-

CREI Resident Instruction (day or night) is offered in Washington, D. C. Here work is done with the latest equipment, in ideal surroundings, under close personal supervision. New classes start once a month. For a CREI Residence School catalog, check the last line of the coupon below.

sands of professional radiomen with technical educations. During World War II, CREI trained thousands for the Armed Services. Leading firms choose CREI courses for group training in electronics at company expense, among them United Air Lines, Canadian Broadcasting Corporation, Trans Canada Airlines, Sears Roebuck & Co., Bendix Products Division, All-American Cables and Radio, Inc., and RCA-Victor Division.

CREI courses are prepared by recognized experts. Assignments are practical and easily-understood. You benefit from the individual supervision of CREI's Staff

of Instructors. This complete training is the reason why CREI graduates find their diplomas keys-to-success in Radio, TV and Electronics. CREI alumni hold top positions in many of America's leading firms.

At your service is the CREI Placement Bureau, which finds positions for students and graduates. Although CREI does not

guarantee jobs, requests for personnel currently exceed supply by far.

Talk to men in the field and check upon CREI's high standing in electronics instruction. Determine for yourself right now that your earnings are going to rise with your knowledge—and that you can get your rightful place in the Age of Electronics. All this CREI can promise you, provided you sincerely want to learn. Fill out the coupon and mail it today. We'll promptly send you your free copy of "Your Future in the New World of Electronics." The rest—your future—is up to you.

MAIL COUPON FOR FREE BOOKLET

CAPITOL RADIO ENGINEERING INSTITUTE

Dept. 145D, 16th & Park Rd., N.W., Washington 10, D. C.

Send booklet "Your Future in the New World of Electronics" and course outline.

CHECK TV, FM & Advanced AM Servicing Aeronautical Radio Engineering

FIELD OF Practical Television Engineering

GREATEST Broadcast Radio Engineering (AM, FM, TV)

INTEREST Practical Radio Engineering

Name.....

Street.....

City..... Zone..... State.....

If residence school in Wash., D. C. preferred, check here

Six quality features of all Tung-Sol Picture Tubes mean better TV receiver operation

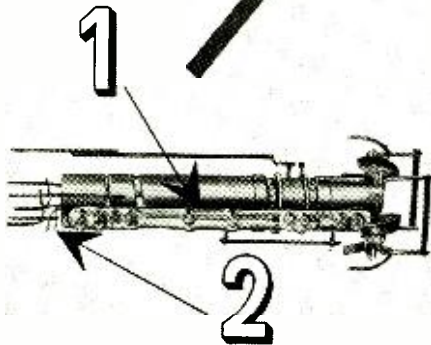

1. Glass bead type assembly is stronger, both mechanically and electrically—gives greater protection against leakages and arcing.

2. Double cathode tab provides double protection against failure in the cathode circuit.

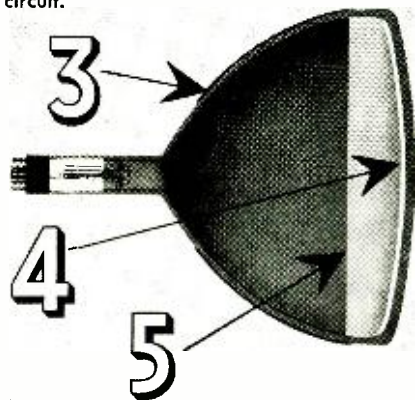

3. Low resistance of outside conductive coating minimizes radiation of horizontal oscillator sweep frequency.

4. Fortified screen composition resists burning (X pattern).

5. Rigid control of internal conductive coating materially improves service reliability.

6. Tung-Sol Picture Tubes can be used with single or double field ion trap designs.

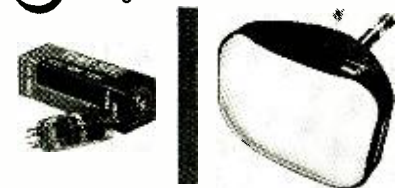

TUNG-SOL®

RADIO, TV TUBES, DIAL LAMPS

TUNG-SOL ELECTRIC INC., Newark 4, N. J.
Sales Offices: Atlanta • Chicago • Culver City (Calif.)
Dallas • Denver • Detroit • Newark

Tung-Sol makes All-Glass Sealed Beam Lamps, Miniature Lamps, Signal Flashers, Picture Tubes, Radio, TV and Special Purpose Electron Tubes.

EXPANSION OF TV NETWORK facilities is being speeded by American Telephone and Telegraph Co. Extension of existing networks to Miami, New Orleans, Houston, Dallas, Fort Worth, and Oklahoma City is now scheduled for completion in time for this year's major political conventions. In addition, the company is seeking more microwave channels for its Chicago-Omaha-San Francisco link.

A MILLION-WATT STATION, the most powerful in the world, is being constructed for the U.S. Navy near Seattle, Washington. Built for worldwide communication with the fleet, the station's 7,200 foot antennas are supported by towers two miles apart.

ARC WELDING OPERATIONS capable of causing radio or TV interference, will be governed temporarily by rules similar to those now covering induction heating equipment, according to the FCC. Final regulations for arc welding equipment will be adopted in about two years.

A RADIO WARNING SERVICE for Alaska and the North Pacific area has been opened by the National Bureau of Standards. Supplementing present long-range forecasts of transmitting conditions, the new service will report transient magnetic disturbances in the arctic auroral zones from several observation points.

SCATTER SOUNDING, a new technique for investigating h.f. propagation characteristics, has been announced by two outstanding radio amateurs, O. G. Villard Jr., and A. M. Peterson, in a release circulated by the American Radio Relay League. Using radar-type pulse transmissions, distances and directions of ground echoes are plotted to determine maximum skip distances. Results indicate the possibility of predicting the most effective frequency for transmission to a given point at any time.

SOUTHWESTERN I.R.E. conference and engineering exhibit will be held Friday and Saturday, May 16-17, in Houston, Texas. Scheduled speakers include Dr. Donald B. Sinclair, I.R.E. president; Commander R. A. M. Craven of Washington; Col. Edwin White of the FCC; and others.

Sectionalized technical sessions will increase time available for coverage of the 48 manufacturers' exhibits planned.

A full program of entertainment for visiting wives has been planned by the wives of Houston I.R.E. members.

This is the fourth southwestern I.R.E. conference.

MORE LIGHT ON V.H.F. propagation over long distances may be provided by a new theory announced by the National Bureau of Standards. Reflection in the upper atmosphere of frequencies above 100 mc may be predictable from a modified analysis of the change in refractive index with

height. The new theory, developed by Dr. J. Feinstein of the NBS staff, indicates the possibility of dependable v.h.f. long-distance communication, and may complicate present plans for the allocation of TV channels by anticipating possible interference. (See "TV Pattern for the Future" elsewhere in this issue.)

THE FLYING TYPEWRITER, an

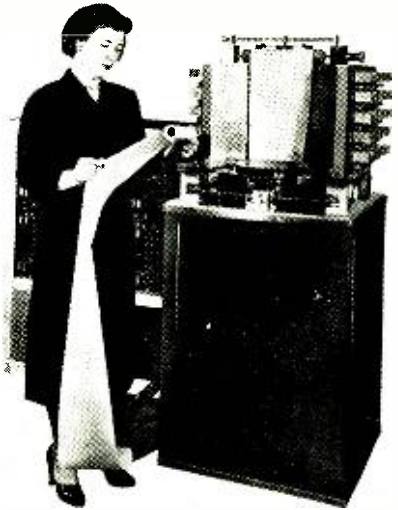

ultra-high-speed electro-mechanical printer which prints a line at a time, was announced recently by the Potter Instrument Company, Inc., of Great Neck, N. Y. Capable of handling 24,000 alphanumeric characters per minute, the Flying Typewriter can serve as an adjunct to a digital computer, or transcribe data directly from radio, wire line, or magnetic tape sources. Printing is on 8-inch wide paper tape, with two carbon copies available. Speeds as high as 900 lines per minute have been achieved.

TEXAN ROBERT T. BARTLEY was sworn in March 9 as a member of the Federal Communications Commission. Bartley, whose practical broadcast experience dates from 1939, was appointed by President Truman to fill the vacancy created by the resignation of FCC Chairman Wayne Coy.

THREE TV CHANNELS for non-commercial educational programs will be assigned to New York State by the FCC, according to Dr. Lewis A. Wilson, New York's State Education Commissioner. Official announcement of the allocations was expected March 25. In anticipation of the allocations, a bill was passed by the state legislature creating a fifteen-member commission to study and develop a program for most effective use of the channels.

The commission's findings, due in February, 1953, will include estimates of station construction and operating costs, and the relative desirability of station control and management by the State, or by private educational institutions.

NOW... GET EVERYTHING YOU NEED TO LEARN AND MASTER TELEVISION RADIO-ELECTRONICS... AT HOME!

Use REAL commercial-type equipment to get practical experience

Your future deserves and needs every advantage you can give it! That's why you owe it to yourself to find out about one of the most COMPLETE, practical and effective ways now available to prepare AT HOME for America's billion dollar opportunity field of TELEVISION-RADIO-ELECTRONICS. See how you may get and keep the same type of basic training equipment used in one of the nation's finest training laboratories... how you may get real STARTING HELP toward a good job or your own business in Television-Radio-Electronics. Mail the coupon today for complete facts — including 89 ways to earn money in this thrilling, newer field.

D.T.I., ALONE, INCLUDES BOTH MOVIES and HOME LABORATORY In addition to easy-to-read lessons, you get the use of HOME MOVIES — an outstanding training advantage — plus 16 big shipments of Electronic parts. Perform over 300 fascinating experiments for practical experience. Build and keep real commercial-type test equipment shown at right

Get BOTH of these information packed publications FREE!

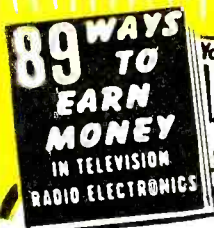

MODERN LABORATORIES

If you prefer, get all your preparation in our new Chicago Training Laboratories—one of the finest of its kind. Ample instructors, modern equipment. Write for details!

MILITARY SERVICE!

If you're subject to military service, the information we have for you should prove very helpful. Mail coupon today.

ACT NOW! MAIL COUPON TODAY!

DE FOREST'S TRAINING, INC, Dept. RE-5-1
2533 N. Ashland Ave., Chicago 14, Ill.

Without obligation, I would like your Opportunity News Bulletin showing "89 Ways to Earn Money in Television-Radio-Electronics"; also, the folder showing how I may prepare to get started in this thrilling field.

Name.....Age.....
Address.....Apt.....
City.....Zone.....State.....



Here's the REAL THING!

SET UP YOUR OWN HOME LABORATORY

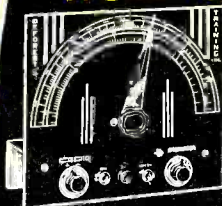

R-F Signal Generator



Oscilloscope

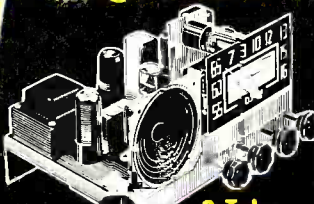

6-Tube Radio

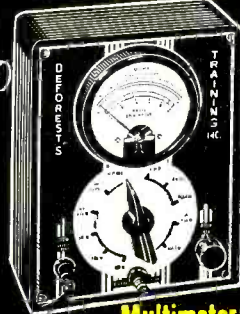

Multimeter

"ONE OF AMERICA'S FOREMOST TELEVISION TRAINING CENTERS"

DeFOREST'S TRAINING, INC.
CHICAGO 14, ILLINOIS
A DeVRY INSTITUTION

HERE'S THE "SECRET!"

Solder-seal construction formerly used only in costly, large metal-encased capacitors.

This exclusive hollow eyelet terminal permits OIL impregnation after the capacitor is molded.

Sprague *dry* molding keeps the high purity paper and foil windings uncontaminated during manufacture.

Enlarged cut-away view of Sprague Telecap.

..... that makes
SPRAGUE TELECAPS®
outperform and outlast
other molded tubulars

Actual, on-the-job performance *proves* the superiority of Sprague "Black Beauties" beyond question. To find the secret that explains just why they're so much better, however, you've got to see inside of a Telecap itself.

The big feature is that every Sprague Telecap is molded into its sturdy Bakelite phenolic shell while its windings are still *dry*. Any chance of contamination by moisture or dust during manufacture is avoided. *After* molding, the capacitor is vacuum-impregnated with mineral oil through a tiny eyelet. The lead is then inserted, the terminal is solder-sealed—and you have a capacitor that has maximum resistance to heat and moisture... extra high insulation resistance and superior capacitance stability. *In short, a capacitor that brings you premium quality at no extra cost!*

... And that's the secret behind the fact that Sprague Telecaps are more widely used by leading television set makers... and why they're first choice of service technicians who value their reputations for good work!

Write for "Telecap" Bulletin. It's free!

SPRAGUE PRODUCTS CO.

Distributors Division of Sprague Electric Co.
81 Marshall Street
NORTH ADAMS MASSACHUSETTS

**BLACK BEAUTY
TELECAPS®**

**TELEVISION'S MOST WIDELY USED
MOLDED TUBULARS**

FELIX EHREHAFT, noted physicist and early investigator of electronic phenomena, died March 4 in Vienna at the age of 73. A United States citizen since 1944, Professor Ehrenhaft fled Nazi persecution in 1939, and returned to Vienna three years ago as Guest Professor at the University's physics institute.

While in the United States, Professor Ehrenhaft attracted a great deal of attention with his statements of the existence of magnetic current and unipolar magnets. This material appeared first in RADIO-CRAFT in March, 1944, and later as papers at various sessions of the American Physical Society. Up to the time of his death he was engaged in studies of the behavior of small particles under the influence of light or other forces, when subjected to the influence of a magnetic field.

NEW CITIZENS BAND RULES became effective March 24. In addition to minor changes in procedure and in the technical requirements for existing Class A and Class B stations, a new class has been created exclusively for radio control of model planes, boats and cars. This new service, called Class C, has been assigned a spot frequency of 27.255 mc, with a power limitation of 5 watts and a maximum bandwidth of 10 kc.

TWENTY-FOUR RADIO BILLS were considered by the New York Legislature in its last session. The largest number were intended to prohibit landlords from charging for, or prohibiting tenants' TV roof antennas. Some of the bills would have required that the tenant pay the cost of any additional insurance that would be incurred because of the antenna's presence, and others wove in various safeguards and provisions around the general idea.

One bill would have deprived educational corporations of their tax exemption if they refused to permit their sports events to be telecast; others would have made the broadcasting of a person's name or picture without the person's consent an "invasion of privacy," and would permit New York City to levy a tax of 5%—collectable from the sponsors—on all radio and TV programs originating in that city. Only one—the Williamson bill banning the telecasting of any trial or proceeding in New York's state courts—was expected to pass, as the session drew to a close in the middle of March.

ULTRASONIC WAVE THERAPY has been successfully applied in Germany to patients suffering from lumbago, rheumatism and arthritis, according to a recent report. Direct applications of 1-mc vibrations through a small transmitter head have relieved pain and promoted healing of the affected areas. The method has also been applied with apparent success to the treatment of open sores and nervous diseases. Ultrasonic equipment is used by 30% of the major German clinics.

—end—

FREE

TELLS HOW —

**WE GUARANTEE
TO TRAIN AND COACH YOU AT HOME
IN SPARE TIME UNTIL YOU GET
YOUR FCC LICENSE**

If you have had any practical experience—Amateur, Army, Navy, radio repair, or experimenting.

TELLS HOW —

OUR AMAZINGLY EFFECTIVE JOB-FINDING SERVICE HELPS CIRE STUDENTS GET BETTER JOBS. HERE ARE JUST A FEW RECENT EXAMPLES OF JOB-FINDING RESULTS:

GETS CIVIL SERVICE JOB

"Thanks to your course I obtained my 2nd phone license, and am now employed by Civil Service at Great Lakes Naval Training Station as an Equipment Specialist."
Kenneth R. Leiser, Fair Oaks, Md. Del., McHenry, Ill.

GETS STATE POLICE JOB

"I have obtained my 1st class ticket (thanks to your school) and since receiving same I have held good jobs at all times. I am now Chief Radio Operator with the Kentucky State Police."
Edwin Healy, 264 E. 3rd St., London, Ky.

GETS BROADCAST JOB

"I wish to thank your Job-Finding Service for the help in securing for me the position of transmitter operator here at WCAE, in Pittsburgh."
Walter Koschik, 1442 Ridge Ave., N. Braddock, Pa.

GETS AIRLINES JOB

"Due to your Job-Finding Service, I have been getting many offers from all over the country, and I have taken a job with Capital Airlines in Chicago, as a Radio Mechanic."
Harry Clare, 4537 S. Drexel Blvd., Chicago, Ill.

HERE'S PROOF FCC LICENSES ARE OFTEN SECURED IN A FEW HOURS OF STUDY WITH OUR COACHING AT HOME IN SPARE TIME:

Name and Address	License	Lessons
Lee Worthy, 2210 1/2 Wilshire St., Bakersfield, Cal.	2nd Phone	16
Clifford E. Vogt, Box 1016, Dania, Fla.	1st Phone	20
Francis X. Foerch, 38 Beucler Pl., Bergenfield, N. J.	1st Phone	38
S/Sgt. Ben H. Davis, 317 North Roosevelt, Lebanon, Ill.	1st Phone	28
Albert Schoell, 110 West 11th St., Escondido, Cal.	2nd Phone	23

CLEVELAND INSTITUTE OF RADIO ELECTRONICS
Desk RE-41, 4900 Euclid Bldg., Cleveland 3, Ohio



**TELLS HOW
YOU CAN GET A FREE TELEVISION
ENGINEERING COURSE**

TELLS HOW —

EMPLOYERS MAKE JOB OFFERS LIKE THESE TO OUR GRADUATES EVERY MONTH!

Letter from Chief Engineer, Broadcast Station, North Carolina. "Need men with radiotelephone 1st class licenses, no experience necessary. Will learn more than at average station for we are equipped with Diesel Electric power, transmitting and studio equipment".

Telegram from Chief Engineer, Broadcast Station, Wyoming. "Please send latest list available first class operators. Have November 10th opening for two combo men".

Letter from Chief Engineer, Broadcast Station, Texas. "Please send list of latest licensed graduates".

These are just a few of the examples of the job offers that come to our office periodically. Some licensed radioman filled each of these jobs; it might have been you!

Ours is the only home study course which supplies FCC-type examinations with all lessons and final tests.

**ACT NOW!
Get All 3 FREE**

Your FCC ticket is Recognized in All Radio Fields as Proof of Your Technical Ability.



MAIL COUPON NOW

Cleveland Institute of Radio Electronics
Desk RE-41—4900 Euclid Bldg., Cleveland 3, Ohio
(Address to Desk No. to avoid delay.)

I want to know how I can get my FCC Ticket in a minimum of time. Send me your FREE booklet, "How to Pass FCC License Examinations" (does not cover exams for Amateur License), as well as a sample FCC-type exam and the amazing new booklet, "Money-Making FCC License information."

Tell me how I can get your Free Television Course.

Name.....
Address.....
City..... Zone..... State.....
Paste on 2 cent postcard or send air mail.

BUILD A BIGGER ON POWERFUL G-E

AMERICA'S BIGGEST MAGAZINES PRESELL G-E TUBES!

● 35,000,000 people read G-E full-page tube ads. 35,000,000 TV owners and enthusiasts see *proof* month after month that General Electric tubes are superior!

● Every message emphatically directs these owners to you—the serviceman with the General Electric tube sign. The ads tell

why patronizing *your* shop means brighter, sharper, more lifelike television pictures in the home.

● Take advantage of the big local market that G-E tube advertising creates for you! Make *real* money by selling G-E tubes to a *presold* television public!

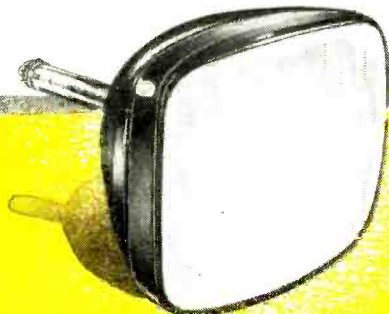

BUSINESS "LIFE" AND "POST" ADS!



We install

Aluminized TV Picture Tubes

"up to 100% brighter"

AS ADVERTISED IN LIFE AND SATURDAY EVENING POST

**THIS SIGN PUTS G-E
NATIONAL ADS
TO WORK FOR YOU!**

EVERY MINUTE of every hour, people who have read G-E tube advertising pass your shop. They want to know where to go for service. Use these colorful gummed streamers to tell them *you* install G-E tubes!

21" WIDE, the streamer is just the right size for your door or window. Blow-ups of LIFE-POST ads, supplied from time to time, can be mounted beneath. For counter giveaway, or for display where space is limited, actual-size ad reprints are available to you regularly.

YOUR G-E TUBE DISTRIBUTOR will be glad to supply you with streamers and reprints. See, phone, or write him today! Get *all* the tube and service business "Up to 100% brighter!" will bring to your door! *Tube Department, General Electric Company, Schenectady 5, New York.*

GENERAL  ELECTRIC

161-1A2

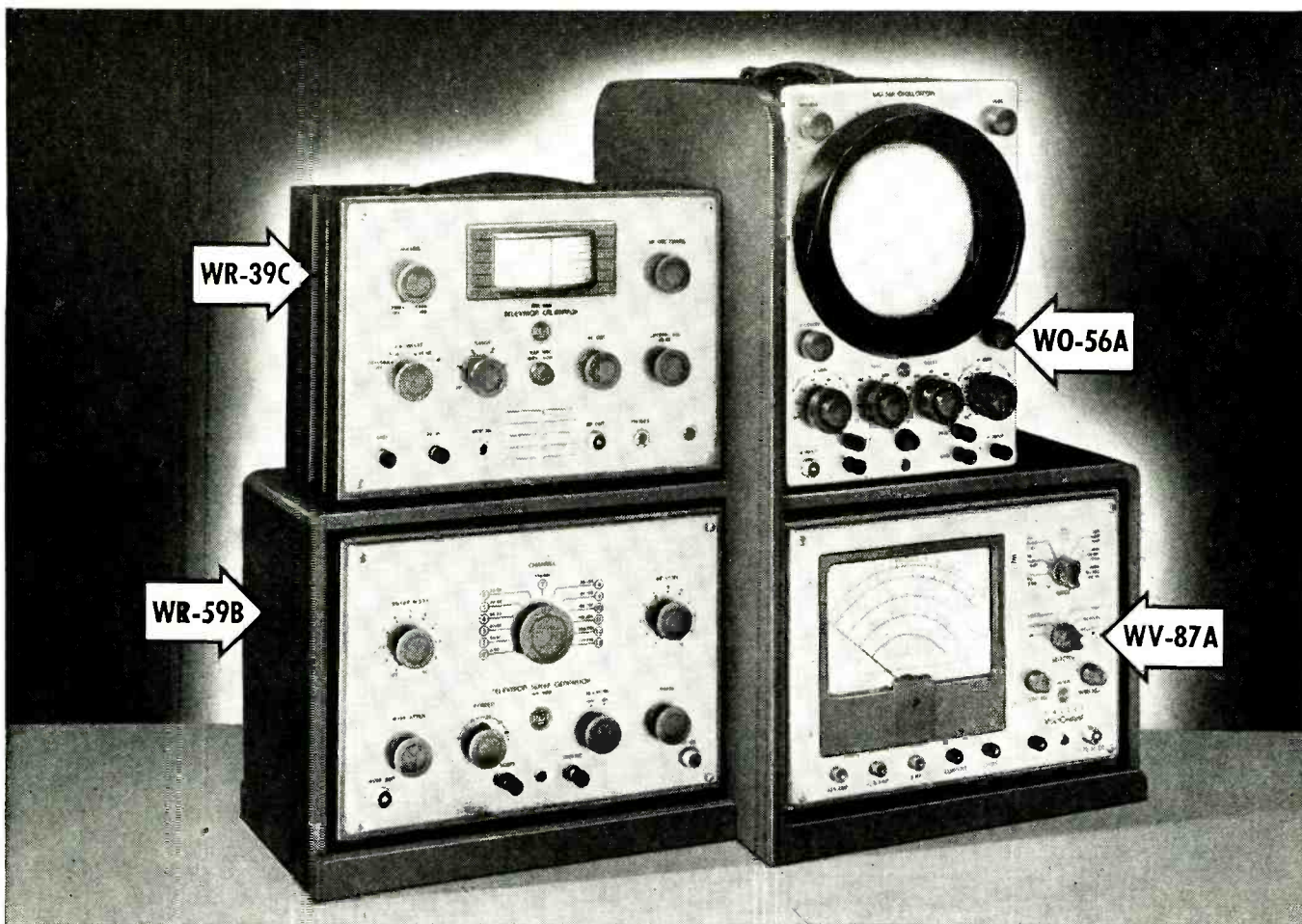

NOW... the RCA ***UNIFIED*** test position

Provides the best in television-servicing facilities

THE new RCA 4-position deluxe rack will add beauty and convenience to your test set-up. You'll like the way this service-engineered rack increases your operating efficiency... you'll be surprised to see how precious bench space is conserved. Furthermore, you'll be amazed how easy it is to get one of these handsome 4-position racks from your RCA Test Equipment Distributor. The rack accommodates four test instruments as illustrated.

WR-39C **Television Calibrator.** Variable-frequency oscillator provides fundamental output over entire range, with crystal-controlled check points at 2.5-Mc and 0.25-Mc intervals. Provides 4.5-Mc crystal-oscillator signal for intercarrier alignment and for dual markers at TV carrier frequencies. The WR-39C is a heterodyne frequency meter, a crystal standard (with 3 crystals supplied), a bar-pattern generator, and a TV re-broadcast transmitter.

WR-59B **Television Sweep Generator.** Covers all TV channels on preset fixed positions. Continuous tuning range from 300 Kc to 50 Mc covers video and intermediate frequencies. High-precision vibrating capacitor provides up to 12-Mc maximum sweep width, flat within ± 1 db, with good linearity. Has dual-piston attenuator for varying output voltage from 0.1 volt to 5 microvolts. Includes blanking for zero-reference line on 'scope.

WO-56A **Television Oscilloscope.** Uses 7" CR tube and direct-coupled, 3-stage, push-pull, vertical and horizontal amplifiers. Dual controls for "coarse" and "fine" adjustments. Frequency-compensated and voltage-calibrated attenuators on both amplifiers. Response flat within -2 db from dc to 500 Kc, within -6 db at 1 Mc. Vertical deflection sensitivity, 10.6 rms millivolts per inch. Magnetic shield on CR tube reduces effects of external fields.

WV-87A **Master VoltOhmyst*:** Has big $8\frac{1}{2}$ " easy-to-read meter. Measures dc voltages accurately in high-impedance circuits, even with ac present. It also reads rms values of sine waves and the *peak-to-peak* values of complex waves or recurrent pulses, even in the presence of dc. Measures resistance from 0.1 ohm to 1000 megohms, current from 10 microamperes to 15 amperes. Features $\pm 1\%$ tolerance multiplier and shunt resistors, a meter movement having an accuracy within $\pm 2\%$ and a tracking error of only $\pm 1\%$, high input resistance, zero-center scale adjustment for discriminator alignment, dc polarity-reversing switch, and sturdy metal case for good rf shielding.

For complete details, see your RCA Test Equipment Distributor, or write Commercial Engineering, Section EX49, Harrison, New Jersey, for descriptive folders on the individual instruments. *Reg. U. S. Pat. Off.



RADIO CORPORATION of AMERICA
TEST EQUIPMENT
HARRISON, N. J.

RADIO-ELECTRONICS

Adds every UHF Channel... to any TV receiver...

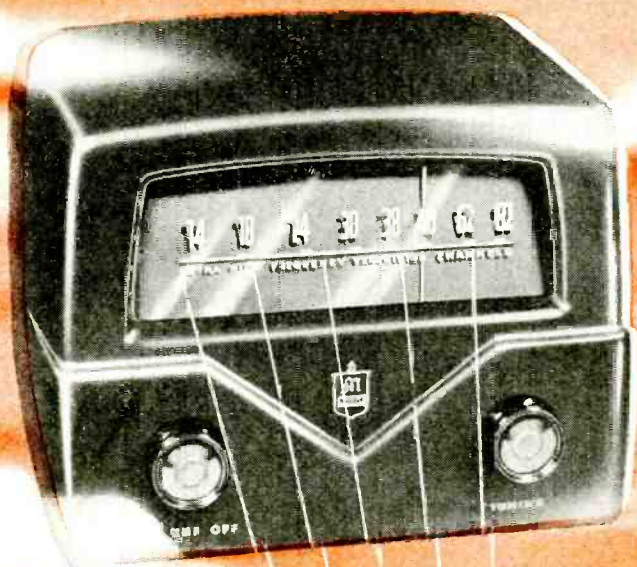

Mallory UHF Converter

THAT'S RIGHT! The Mallory UHF converter adds *all* UHF channels to *any* TV set... in *any* UHF broadcast area. And installation involves only the connection of power lines and antenna leads; no internal adjustments of the receiver are necessary.

Here are the Mallory features that will help you make the most of the new UHF market...

- Reception of *all* UHF channels
- No sacrifice of VHF channels
- Built-in UHF antenna
- High quality picture definition
- Fast, easy installation

The Mallory UHF converter is small, attractive—precision-built to high Mallory standards. For complete information on this versatile converter, contact your Mallory distributor today.



*Make Sure ...
Make it Mallory*

P. R. MALLORY & CO. INC.
MALLORY CAPACITORS... CONTROLS... VIBRATORS...
SWITCHES... RESISTORS... RECTIFIERS...
VIBR-PAK* POWER SUPPLIES... FILTERS
*Reg. U.S. Pat. Off.

APPROVED PRECISION PRODUCTS

P. R. MALLORY & CO., Inc., INDIANAPOLIS 6, INDIANA

INDISPENSABLE!
PHOTOFACT BOOKS



Photofact Television Course. Covers TV principles, operation and practice. 216 pages; profusely illustrated; 8½ x 11". Order **TV-1**.....Only **\$3.00**

Television Antennas. New 2nd edition. Describes all TV antenna types; tells how to select, install, solve troubles. Saves time; helps you earn more. 200 pages; illustrated. Order **TAG-1**.....Only **\$2.00**

Television Tube Location Guide. Volume 2. Accurate diagrams show position and function of all tubes in hundreds of TV sets; helps you diagnose trouble without removing chassis. 224 pages; pocket-size. Order **TGL-2**. Only **\$2.00**

Television Tube Location Guide. Vol. 1. Over 200 pages of TV receiver tube position diagrams on hundreds of models. Order **TGL-1**.....Only **\$1.50**

Making Money in TV Servicing. Tested proved methods of operating a profitable TV service business. Covers all important phases. Authoritative, valuable guide to success. Over 130 pages. Order **MM-1**.....Only **\$1.25**

Servicing TV in the Customer's Home. Shows how to diagnose trouble using capacitor probe and VTVM. Short-cut methods help save time, earn more on outside service calls. Order **TC-1**.....Only **\$1.50**

1949-1950 Record Changer Manual. Vol. 3. Covers 44 models made in 1949, including multi-speed changers and wire and tape recorders. Original data based on actual analysis of equipment. 286 pages; 8½ x 11"; paper-bound. Order **CM-3**.....Only **\$3.00**

1948-1949 Changer Manual. Vol. 2. Covers 45 models made in 1948-49. Paper bound, Order **CM-2**. Only **\$4.95**

1947-1948 Changer Manual. Vol. 1. Covers 40 post-war models up to 1948, Order **CM-1**..... Only **\$3.95**

Recording & Reproduction of Sound. 2nd Edition. New, completely revised and vastly enlarged edition of the outstanding original volume. The most authoritative treatment of all phases of recording and amplification ever written. Over 800 pages. 6 x 9". Order **RR-2**. Only **\$7.95**



Audio Amplifiers. Vol. 3. Clear, uniform, accurate data on 50 important audio amplifiers, plus full coverage of 22 FM and AM tuners, produced during 1950. 362 pages, 8½ x 11". Order **AA-3**.....Only **\$3.95**

Audio Amplifiers. Vol. 2. A complete analysis of 104 well-known audio amplifiers and 12 tuners made 1949-50. 368 pages, 8½ x 11". Order **AA-2**.....Only **\$3.95**

Audio Amplifiers. Vol. 1. 102 amplifiers and FM tuners made through 1948. 352 p. Order **AA-1**.... Only **\$3.95**

Auto Radio Manual. Complete service data on more than 100 post-war auto radio models. Covers over 24 mfrs. 350 pages, 8½ x 11". Order **AR-1**.....Only **\$4.95**

Communications Receiver Manual. Complete analysis of 50 popular communications models. 246 pages, 8½ x 11". Order **CR-1**.....Only **\$3.00**

Radio Receiver Tube Placement Guide. Accurate diagrams show where to replace each tube in 5500 radio models, covering 1938-1947 receivers. 192 pages, pocket-size. Order **TP-1**.....Only **\$1.25**

Dial Cord Stringing Guide. Vol. 2. Covers receivers made from 1947 through 1949. Shows you the one right way to string a dial cord in thousands of models. Pocket-size. Order **DC-2**.....Only **\$1.00**

Dial Cord Guide. Vol. 1. Covers sets produced 1938 through 1946. Order **DC-1**.....Only **\$1.00**

Order from your Parts Jobber or write direct to
HOWARD W. SAMS & CO., INC., 2201 E. 46th St., Indianapolis 5, Indiana
HOWARD W. SAMS & CO., INC.

Merchandising and Promotion

General Electric's Tube Department, Schenectady, N. Y., announced a new tube rack which is available to radio

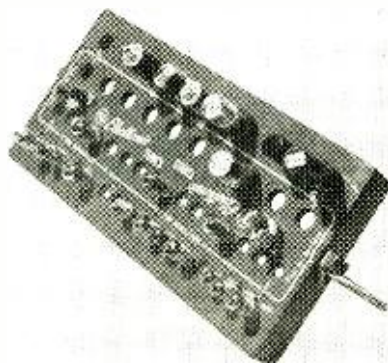

and TV service technicians through G-E tube distributors. Known as the "Tubesaver," it can hold as many as 52 tubes of all standard base types.

Sylvania Electric Products' advertising director Terry P. Cunningham, announced that the company will continue and expand its national promotion on behalf of TV-radio service technicians to the public. National consumer magazines, television programs, and local

dealer displays will be used in the campaign.

Recoton Corp., New York City, released an illustrated cross index containing a breakdown of the phonograph needles used by various cartridge manufacturers. It lists competitive manufacturers' needles as well as those made by Recoton.

American Electrical Heater Co., Detroit, manufacturer of "American Beauty" soldering irons, announced stepped-up promotional plans, extending into 1953, which will include coverage of the electronic, aviation, radio-TV, and telephony fields. The Allman Co., Inc., Detroit, was named as the company's new advertising agency.

RCA Tube Department released a revised edition of its "Triple Pindex" socket manual, a compilation of socket-connection diagrams for more than 660 receiving tubes and kinescopes. It is available from RCA tube distributors and from the Commercial Engineering Division, RCA Tube Department, Harrison, N. J., for 75c.

Electronic Instrument Co., Inc., Brooklyn, N. Y., manufacturer of "Eico" test instruments and kits, released a new direct-mail booklet as a part of its "follow-through" promotion to back up its national advertising.



BAROMETER of the PARTS INDUSTRY

During March, 64 of the leading 375 manufacturers of Radio-Television-Electronic parts and equipment made changes in their lines. Actually there was an increase in "change activity" as compared to February. In price revisions by the number of manufacturers and products affected, the following summary illustrates the comparative trend for February and March.

	No. of Manufacturers		No. of Products	
	Feb.	March	Feb.	March
Increased prices	17	12	451	482
Decreased prices	16	28	166	492

As evident from the above chart, price decreases showed the greatest change. For comparison, these figures are broken down into the following categories:

Product Group	Increased Prices		Decreased Prices		New Products		Discontinued Products	
	No. of Mfrs.	No. of Products	No. of Mfrs.	No. of Products	No. of Mfrs.	No. of Products	No. of Mfrs.	No. of Products
Antennas & Acces.	2	24	6	924	7	1134	2	334
Capacitors	None	None4	None	None	3	2654	None	None
Controls & Resistors	1	404	None	None4	3	224	3	54
Sound & Audio	2	64	5	1394	12	654	7	594
Test Equipment	2	44	1	34	3	114	3	74
Transformers	None	None4	1	704	3	1194	2	1424
Tubes	4	3034	8	1544	3	104	1	24
Wire, Cable, etc. Connectors	None	None4	3	384	3	94	1	64

4 Increase over February
4 Decrease

4 Increase over February
4 Decrease

Comment: Tube prices continue to increase. However, there are fewer manufacturers involved than in February.

Comment: The manufacturers of antennas and audio products continue to be the most active.

This data is prepared by the staff of United Catalog Publishers, Inc., 110 Lafayette Street, N. Y. C., publishers of RADIO'S MASTER.

the only complete catalog
for everything in Radio,
TV & Industrial Electronics

your 1952 **free!**
ALLIED 212-page
value-packed catalog



Send for it today!

Here's the *one* authoritative, complete, up-to-date Buying Guide to TV, Radio and Industrial Electronics. Make your selections from the world's largest stocks of quality equipment at lowest, money-saving prices. See the latest and most complete presentation of electronic apparatus: new TV, AM and FM receivers; High-Fidelity Custom Sound components; latest P.A. Systems and accessories; recorders; fullest selections of Amateur receivers and station gear; specialized industrial electronic equipment; test instruments; builders' kits; huge listings of parts, tubes, tools, books—the world's *most complete stocks* of quality equipment.

ALLIED gives you *every* buying advantage: speedy delivery, expert personal help, lowest prices, liberal time payment terms, assured satisfaction. Get the latest 1952 ALLIED Catalog. Keep it handy—and save time and money. Send for your FREE copy today!

the world's
largest stocks

- Radio Parts Unlimited
- Test Instruments
- Television & Home Radios
- P.A. and Hi-Fi Equipment
- Amateur Station Gear
- Builders' Supplies
- Equipment for Industry

quick, expert service

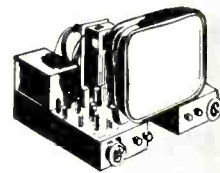

ALLIED IS YOUR TV and HI-FI HEADQUARTERS

TV **HI-FI**

Count on ALLIED for the latest in TV! If it's made—we have it for quick delivery. We specialize, too, in High-Fidelity sound components—everything in amplifiers, speakers, tuners, phono gear and accessories. For TV or Hi-Fi—think of ALLIED!



free

SEND TODAY FOR RADIO'S LEADING BUYING GUIDE

ALLIED RADIO CORP., Dept. 2-E-2
833 W. Jackson Blvd., Chicago 7, Illinois

Send FREE 212-page 1952 ALLIED Catalog No. 127.

Name _____

Address _____

City _____ Zone _____ State _____

ALLIED RADIO

the World's Largest Radio Supply House

EVERYTHING IN ELECTRONICS

MERIT

tv full-line*
components give
universal coverage

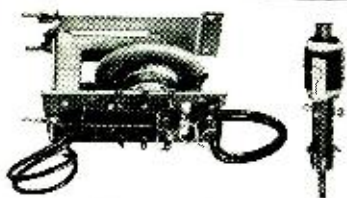

NEW IMPROVED HVO-7 FOR GREATER COVERAGE
Tapped AFC Winding. Covers Admiral Chassis 21-24 Series.
MWC-1 UNIVERSAL WIDTH COIL
(3-27 MH) A Tapped Secondary For AGC or AFC.



IF-RF COILS
Only complete line of TV replacements.



"COSINE" YOKES
Complete with leads & network.

MATCHED FOR DIRECT DRIVE

MDF-30 HVO-8



A-3080 Vert. Mtg.
A-3081 Horiz. Mtg.
Autoformer



KIT NO. 1000
MATCHED SET FOR SPEEDY PROFITABLE SERVICE!

MERIT . . . HQ for PRACTICAL TV Service Aids

MERIT'S 1952 Catalog No. 5211 with new MERIT IF-RF Coils.

Other MERIT service aids:

TV Repl Guide No. 404, 3500 models & chassis.

Cross Ref Data, IF-RF Coils, Form No. 14.

See your Jobber or write: Merit Coil and Transformer Corp., 4425 Clark Street, Chicago 40.



These three MERIT extras help you:
Exclusive: Tapemarked with specs and hook-up data.
Full technical data packed with every item.
Listed in Howard Sams Photo-facts.



*Merit is making the TV improvement, replacement and conversion business with a line as complete as our advance information warrants.

The RTMA released a new membership service brochure describing the association's activities and services. Prepared under the direction of the RTMA Promotion Committee, headed by J. J. Kahn, president of Standard Transformer Corp., it was designed to fully acquaint all RTMA members with the association's services, and to interest nonmembers in joining the RTMA.

Rinehart Books, Inc., New York City, issued two new illustrated circulars describing the first two volumes of the new Ghirardi's *Modern Radio and Television Servicing Library*.

Brach Manufacturing Co., Newark, N. J., is furnishing its distributors and dealers with display cards, posters, and mailing pieces to promote the sale of its new auto antenna line. The line fea-



tures a new patented "Cowl Well" antenna which can be installed from the top by one man.

New Plants and Expansions

LaPointe-Plascomold Corp., Windsor Locks, Conn., manufacturer of "Vee-DX" antennas, boosters, and accessories, announced two major steps in its long-range expansion program. The first was the acquisition of the Press Wireless Mfg. Co., Hicksville, N. Y., and the second, the purchase of the Springfield Mill in Rockville, Conn. The Rockville plant will house the Press Wireless Mfg. Co., which will also maintain a plant in West Newton, Mass.

Standard Coil Products Co., Inc., Chicago, purchased from the Espey Mfg. Co., New York, its Sherold Crystal Division, Kansas City, Kan. Sherold Crystal will become a wholly owned subsidiary of Standard Coil for the manufacture of quartz crystals for civilian and defense use.

Cleveland Graphite Bronze Co. has completed arrangements to buy the Brush Development Co., long established Cleveland research and manufacturing concern.

Motorola, Inc. established its National Defense Division headquarters in its Clybourn Ave. plant in Chicago. The entire plant, plus another plant of 50,000 square feet, will be devoted solely to military production, which is expected to account for 25% of the company's total volume during 1952. Mo-

torola also established a Radio Message Service in Phoenix, Ariz., to permit field testing of its new two-way mobile radio equipment.

Business Briefs

. . . RCA completed arrangements to borrow \$50,000,000 from investment institutions on long-term notes. Proceeds will be used for working capital and for general corporate purposes, including expanded defense production.

. . . The 1952 NEDA Convention and Manufacturers' Conference to be held in Atlantic City, N. J., September 20 to 24, will feature a series of business meetings and an educational program. Completely equipped conference booths will be available to each manufacturer. Cost of the booth will be included in the \$300 participation fee.

. . . RTMA "task force" committee appointed by Dr. W. R. G. Baker, chairman of RTMA's Television Committee, reported that expansion of TV broadcasting to cities not now covered would not be delayed by defense production restrictions. Construction permits for 140 new TV stations should be issued by the FCC by the end of 1952, and 190 more by the end of 1953. Half of these were estimated to be for u.h.f. transmitters, and the balance for v.h.f. The "task force" further predicted that 22 new v.h.f. stations would go on the air in 1952, 21 of them in cities not now covered by TV.

. . . Radio Receptor Co., Inc., Brooklyn, N. Y., was named Licensee No. 1 to manufacture germanium transistors and diodes in an agreement with Western Electric Co. which holds the patents.

THE 1952 ELECTRONIC PARTS SHOW

The 1952 Electronics Parts Show will be held in the Conrad Hilton Hotel, Chicago, from May 19th-22nd. 204 companies will exhibit in 164 booths in Exhibition Hall and in 136 display rooms. The educational program will include a nine-hour course in applied salesmanship plus seminars on topics vital to the distributing industry.

List of Exhibitors

COMPANY	EXHIBITION HALL		DISPLAY ROOM	
	NUMBER ASSIGNED	BOOTH NUMBER	NUMBER ASSIGNED	ROOM NUMBER
Aerovox Corporation	680			
Alliance Manufacturing Co. 322				
Allied Electric Products . . . 201				
Alpha Wire Corporation . . . 412				
Alprocco, Inc.	13			
Altec Lansing Corporation. 592			607	
American Microphone Co. . . 302				
American Phenolic Corp. . . 207			560A-563A	
American Radio Hardware Co. 415				
American Tel. & Radio 308				
Amperite Company	214			
Anchor Radio Corporation. . 123				
Approved Electrical Instruments	113			
Argos Products Co.			500	
Astatic Corporation	416		542A-544A	
Atlas Sound Corporation . . . 213				
Audak Company			547	

Be Sure of Your Installations . . . Use

Aptitude-Tested

MULTIPLE CONDUCTOR

CABLE

● You know what you are doing when you use Belden Multiple Conductor Cables — they're aptitude rated. They are designed to provide desirable electrical characteristics, and rigid control assures constant quality.

Specify Belden Radio Wires.

Belden Manufacturing Co., 4623 W. Van Buren St., Chicago 44, Ill.



To You, Belden's Golden Anniversary Means —product performance that can come only from a "know-how" that has grown through actual service since the inception of Radio.

—an ability to co-operate in pioneering new wires to meet or anticipate industry's growing needs.

In the years that follow

This Belden Program Is—

— TO BE CONTINUED

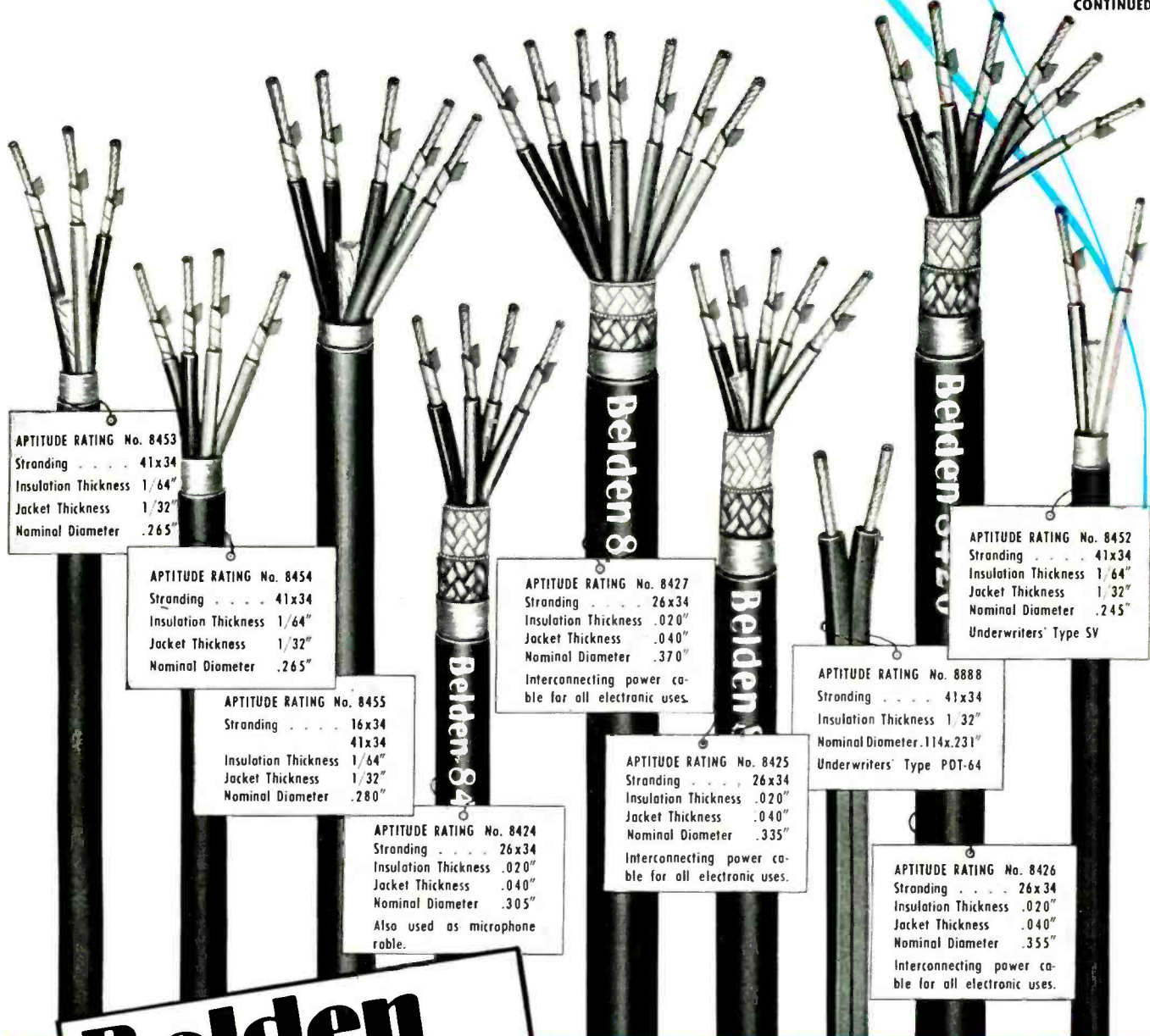

APTITUDE RATING No. 8453
Stranding 41x34
Insulation Thickness 1/64"
Jacket Thickness 1/32"
Nominal Diameter .265"

APTITUDE RATING No. 8454
Stranding 41x34
Insulation Thickness 1/64"
Jacket Thickness 1/32"
Nominal Diameter .265"

APTITUDE RATING No. 8455
Stranding 16x34
 41x34
Insulation Thickness 1/64"
Jacket Thickness 1/32"
Nominal Diameter .280"

APTITUDE RATING No. 8424
Stranding 26x34
Insulation Thickness .020"
Jacket Thickness .040"
Nominal Diameter .305"
Also used as microphone cable.

APTITUDE RATING No. 8427
Stranding 26x34
Insulation Thickness .020"
Jacket Thickness .040"
Nominal Diameter .370"
Interconnecting power cable for all electronic uses.

APTITUDE RATING No. 8425
Stranding 26x34
Insulation Thickness .020"
Jacket Thickness .040"
Nominal Diameter .335"
Interconnecting power cable for all electronic uses.

APTITUDE RATING No. 8888
Stranding 41x34
Insulation Thickness 1/32"
Nominal Diameter .114x.231"
Underwriters' Type PDT-64

APTITUDE RATING No. 8426
Stranding 26x34
Insulation Thickness .020"
Jacket Thickness .040"
Nominal Diameter .355"
Interconnecting power cable for all electronic uses.

APTITUDE RATING No. 8452
Stranding 41x34
Insulation Thickness 1/64"
Jacket Thickness 1/32"
Nominal Diameter .245"
Underwriters' Type SV

Belden
Radio **WIRE**

The *Aptitude-Tested* **LINE**

**NEW • ADVANCED
SUPERIOR IN PERFORMANCE**

**THE
SCANAFAR**



**ASTATIC'S
NEW
TV BOOSTER
MODEL CT-1**

The Scanafar, new Astatic TV Booster development, incorporates improvements that match the forward strides made in newer model TV Receiver front-ends. It stands alone as a working companion with the new receivers, for added picture brilliance and clarity . . . and offers a still higher measure of reception improvement for older style sets. The Scanafar presents a new minimum noise figure with maximum gain. Band width (over seven megacycles on all channels) and picture definition are excellent. A balanced, cascaded circuit is employed, with a neutralized 6J6 tube driving a 6BQ7 (the highly touted "quiet tube"). Both tubes are used over the entire TV frequency range. It all adds up to booster performance that is unparalleled today. Test this new unit yourself . . . at your first opportunity. Be prepared for a new experience in booster aid to TV reception.

SEE ASTATIC'S NEW BOOSTER . . . OTHER NEW ASTATIC DEVELOPMENTS AT THE 1952 ELECTRONIC PARTS SHOW, May 19 to 22, Conrad Hilton Hotel, Chicago. ASTATIC BOOTH NO. 416—DISPLAY ROOMS 542-A and 544-A.

Audio Devices Inc.	321	
Baker Manufacturing Co.	114	
Barker & Williamson, Inc.	225	
Belden Manufacturing Co.	405	
Bell Sound Systems	319	546A-548A 539 & 553
David Bogen Co.		
Blonder-Tongue Labs.	6	
British Industries	301	
Brush Development Co.	678	
Bud Radio, Inc.		637
Burgess Battery Co.	313	
Bussmann Manufacturing Co.	105	
Camburn, Inc.		553A
Centralab Division	685	
Channel Master Corp.		549
Chicago Transformer Div.	684	522 & 520
Clarostat Manufacturing Co.	410	
Clear Beam TV Antennas	26	
Cleveland Electronics	312	658A-659A
Columbia Wire & Supply	587	
Condenser Products Corp.		620
Consolidated Wire & Assoc.	208	
Copperweld Steel Co.	117	
Cornish Wire Co.	683	
Crest Transformer Corp.	108	
Drake Electric Works	222	
Du Kane Corporation		556A-557A 613-614
Allen B. Dumont Laboratories	580	
Duotone Company, Inc.	118	
Eicor, Inc.	8	700-01 658-659
Eldico of New York, Inc.		
Electronic Devices, Inc.	203	
Electronic Instrument	202	
Electronic Measurements	112	
Electro Products Laboratories	414	
Electro-Voice, Inc.	128	550A-551A
Electrovox Company	129	
Erie Resistor Corp.	318	536A
Espey Manufacturing Corp.	673	
Freed Transformer Co.	303	
Fretco Television Co.	126	656
The Gabriel Company	674	612A-613A
Gee-Lar Manufacturing Co.	109	
General Cement Mfg. Co.	419	504A
General Electric Co.	676	537A
General Industries Company	417	521A
General Transformer Co.		629
Grayhill	588	
Guardian Electric Mfg. Co.	212	
Grayburne Corp.		637A
The Halldorson Company	586	
The Hallcrafters Company	574	512A-513A
Hammarlund Mfg. Co.	407	
Hickok Electrical Instr. Co.		528A-530A
Hi-Lo TV Antenna Corp.	3	
Hytron Radio & Electronics	305	
IE Manufacturing Co.	10	632
Illinois Condenser	687	
Illinois Transformer Co.		603A-609A 502
Indiana Steel Products Co.	408	
Industrial Devel. Eng. Assocs.	116	
Insuline Corp. of America	206	523
International Resistance Co.	307	
Jackson Electrical Instru- ment	421	
James Vibrapowr Co.	127	
J-B-T Instruments	576	501A
Jensen Industries, Inc.	577	602
Jensen Manufacturing Co.	404	504-505
Jersey Specialty Company	115	
J. F. D. Manufacturing Co.	578	516
E. F. Johnson Company	133	
Kester Solder Company	122	
LaPointe Plascomold	688	653A
Lenz Electric Mfg. Co.	314	
Littelfuse, Inc.	317	539A
Lowell Manufacturing Co.	120	
P. R. Mallory & Company	573	
Markel Electric Products	24	644
Merit Transformer Corp.	689	
James Millen Mfg. Co.	217	
M. A. Miller Mfg. Co.	585	
Model Engineering & Mfg. Co.	102	
Mosley Electronics	119	
Don McGohan, Inc.	1	616-617
National Carbon Co., Inc.	125	621-622
National Company	575	
National Union Radio Co.	103	

EXPORT DEPARTMENT

401 Broadway, New York 13, N. Y.
Cable Address:
ASTATIC, New York

THE
Astatic
ASTATIC CORPORATION
CONNEAUT, OHIO
IN CANADA CANADIAN ASTATIC LTD, TORONTO, ONTARIO



New CBS-Hytron
cylindricals
17LP4 and 21FP4A low-
voltage electrostatics
17QP4 and 21EP4A
electromagnetics

Facts

YOU'LL WANT TO KNOW ABOUT NEW CBS-HYTRON Cylindricals

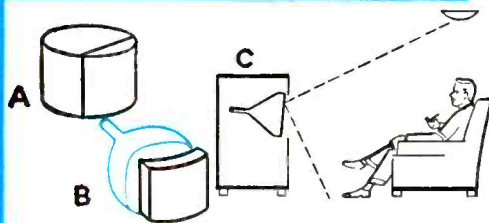

WHY CBS-HYTRON CYLINDRICAL?

To eliminate reflected glare? How? Simple as ABC: A. Imagine a cylinder; slice it vertically. B. You now have the shape of the face plate of a cylindrical tube: curved horizontally; straight, vertically. C. Light falling on this surface at an angle from above is reflected at the same angle... downward. Tilting the tube directs glare downward even more, away from the viewer's eyes.

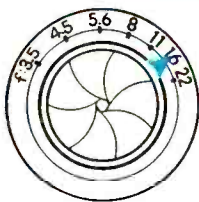

WHY CBS-HYTRON SHIELDED LENS?

With this shielded lens in the electron gun, greater depth of field and better definition are achieved. Just as when you stop down the diaphragm of a large, fast camera lens (f/3.5) to a small aperture (f/16). Distortion caused by interaction of external electrostatic fields used to focus and accelerate the electron beam is avoided. Focusing is easier, less critical. Slight changes in voltages and currents do not cause drift.



WHY CBS-HYTRON BLUE-WHITE SCREEN?

Ever notice how a shirt laundered with bluing appears whiter? With the CBS-Hytron blue-white screen, whites appear whiter; blacks, blacker. Picture definition is crisper. In fringe areas, the expanded gray scale of the blue-white screen gives noticeably clearer pictures. No wonder CBS-Hytron's original blue-white screen is fast becoming the standard preferred by consumers for best definition.



These are just a few reasons why it's smart to demand CBS-Hytron... original studio-matched rectangulars. Try the new CBS-Hytron cylindricals yourself. Discover for yourself why 9 out of 10 leading set manufacturers pick CBS-Hytron.

MAIN OFFICE: SALEM, MASSACHUSETTS

You can't go wrong with a **TURNER** TV **BOOSTER!**



THE TURNER BOOSTER

List Price . . . \$57.50

For television viewing you want the finest possible picture—whatever your receiving conditions. You don't want to compromise for anything less than a bright, clear picture, no matter where you are in the fringe area. And with the Turner Television Booster you don't need to compromise! The Turner Booster gives you the superior picture that's a delight to watch—the crisp, natural sound you've always wanted.

If it's a better picture you're after . . . if it's the finest possible performance you want from your TV set . . . don't settle for less than a Turner Booster!

YOU CAN'T GO WRONG WITH A TURNER TV BOOSTER!

THE TURNER COMPANY

933 17TH STREET N. E.

CEDAR RAPIDS, IOWA

IN CANADA: Canadian Marconi Co., Ltd.

Toronto, Ont., & Branches

EXPORT: Ad. Auriema, Inc.

89 Broad St.

New York 4, New York

For GREATER TV ENJOYMENT . . .

Install a MOSLEY 3-WAY ANTENNA SWITCH

Here's convenience! MOSLEY TV Antenna Switches give instant, easy selection of any one of three antennas. Special rotary type switch, making silver-to-silver contact, assures low loss, constant impedance.

Cat. No. F-10 is Flush Mounted Switch and Lead-in Socket combination for neat, concealed-in-wall installation in standard electrical box. Cat. No. F-20 is enclosed in attractive plastic case for mounting on wall or back of set. If mounting on back of set, attach special extension lever provided and install in position for easy accessibility.

At leading Radio Parts Jobbers everywhere

MOSLEY ELECTRONICS 2125 Lackland Road
Overland, Missouri



Cat. No. F-20
List \$3.75



Cat. No. F-10
List \$3.75

National Video Corporation	533 & 536
Newcomb Audio Products . . . 223	521
Oak Ridge Products 11	
Ohmite Manufacturing Co. . . 210	
Oxford Electric Corporation	309 557
Par-Metal Products Corp. . . 215	
Peerless Products Industries 9	
Penn Boiler & Burner Mfg. Co. 121	657
Penn Television Products . . 124	
Pentron Corporation 107	529
Permoflux Corp. 418	614A-615A
Permo, Inc. 104	
Philmore Manufacturing Co.	533A-534A
Phoenix Electronics 101	635A
Pickering & Company	657A
Potter & Brumfield 591	612
Precise Development Corp. . . 130	
Precision Apparatus Co. . . . 403	501
Premax Products Division . . 135	
Presto Recording Co.	515A
Pyramid Electric Co. 671	
Quam-Nichols Co. 411	601
Racon Electric Co. 111	
Radelco Manufacturing Co. . . 23	
Radiart Corporation 209	610-611
Radio Apparatus Co. 205	
Radio City Products 409	
Radio Corporation of America 21	524A-526A
Radio Craftsmen, Inc.	505A-507A
Radio-Electronics Magazine.	656A
Radio Merchandise Sales . . . 691	
Radio Receptor Co., Inc. 5	
Radion Corporation	616A-617A
Ram Electronics, Inc. 110	
Rauland-Borg Corp. 204	618-619
Rauland Corporation 216	532A
Raytheon Mfg. Co. 422	
Recoton Corporation 590	
Reeves Soundcraft 27	
Rek-O-Kut Company	561
John F. Rider Publisher, Inc.	583
Howard W. Sams & Co. 211	
Sangamo Electric Co. 316	
Walter L. Schott Co. 218	
Shure Brothers, Inc. 581	519A-520A
Simpson Electric Co. 219	509
Mark Simpson Mfg. Co. 679	512-513
Herman H. Smith, Inc. 582	
Snyder Mfg. Company 310	
Sola Electric Co. 413	
Spirling Products	556
Sprague Products 686	
Square Root Manufacturing Co. 14	633A-634A
Standard Transformer Corp. 401	605A-607A
Stromberg-Carlson	618A-619A
Switchcraft, Inc. 672	
Sylvania Electric Products . 681	
Talk-A-Phone Company 221	610A-611A
Tape Master, Inc.	639-640
Tech-Master Products	560
Technical Appliance Corp. . . 22	
Telrex, Inc. 7	
Thomas Electronics	655A
Thordarson-Meissner Division 572	
Triad Transformer Mfg. Co. 402	600-602A
Tricraft Products Co. 677	
Trimm, Inc. 589	
Trio Manufacturing Co. 4	631A-638A
Triplett Electrical Instr. Co. 675	
Tung-Sol Electric Co. 106	517A
Turner Co. 220	
TV Products Co. 131	
Ungar Electric Tools 315	
United Catalog Publishers . 12	
United Transformer Co. 406	604-605
Universal Co.	660-661
University Loudspeakers . . . 304	509A
Utah Radio Products 25	
Vaco Products Co. 311	
Van Cleff Brothers 2	
V-M Corporation 306	507
Waldom Electronics 579	
Ward Leonard Electric 420	
Webster-Chicago Corp. . . . 571	534
Weller Electric Corp. 584	
Wilcox-Gay Corp. 682	
Xcelite, Inc. 320	

—end—

RADIO-ELECTRONICS

Here's your Opportunity

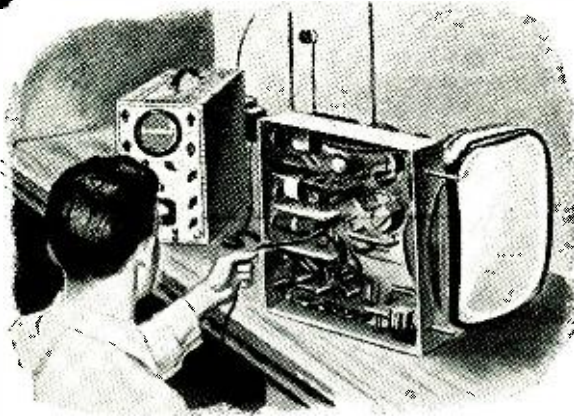

to prepare for a good job or a business of your own in TV SERVICING

There are today more good jobs open in TV Servicing than there are trained and experienced men to fill them. Yes, thousands of opportunities exist now for good-pay jobs offering employment security for years and years to come. Thousands of TV Servicing jobs are going begging. Do you want one of them?

Experts agree, that because of the critical shortage of trained and experienced TV Servicemen, and the tremendous future growth of the industry, no vocational field today offers more opportunities than TV Servicing.

The Big New Industry with a Great Future

Television is just in the beginning stages of its big industrial boom. Look at these amazing facts:

- Lifting the freeze on new TV stations will open many new TV areas and will improve the coverage of existing areas. The result will be an enormous demand for TV receivers.
- Within a few years over 1000 TV stations will be telecasting compared with 108 TV stations now on the air.
- Nearly one-half of all families living within the present TV areas do not yet own TV receivers.
- The new trans-continental video network plus better and more interesting programs plus larger viewing screens and color TV will increase the installation of new receivers, will induce present owners of 12-inch and smaller size viewing screens to buy newer model receivers.
- The power increases of many existing stations and improved reception range of current receivers will result in receivers being installed and serviced in the fringe areas of present stations.
- Under the FCC proposal, over 70 per cent of all communities will be served by UHF channels exclusively. This means TV servicemen must know UHF receivers before the new UHF stations in their area are opened.
- No one yet knows how great the industrial TV market will be.

RCA Institutes Home Study Course prepares you for a Career in TV Servicing

The addition of the RCA Institutes TV Service Training to your present radio-electronics experience will qualify you to step out and grasp the golden opportunities that now exist in television—America's fastest growing industry.

Learn at home—in your spare time—while you study the practical *how-to-do-it* techniques with *how-it-works* information. Easy-to-read and easy-to-understand lessons under the supervision of RCA engineers and experienced instructors quickly train you to qualify for the many good jobs now waiting for trained TV servicemen. Don't pass up this lifetime opportunity for financial security and a bright future in TV. Learn TV Servicing from RCA—pioneers and leaders in radio, television and electronic developments.

RCA Institutes conducts a resident school in New York City offering day and evening courses in Radio and TV Servicing, Radio Code and Radio Operating, Radio Broadcasting, Advanced Technology. Write for free catalog on resident courses.



RCA INSTITUTES, INC.
A SERVICE OF RADIO CORPORATION of AMERICA
350 WEST FOURTH STREET, NEW YORK 14, N. Y.

Send for FREE BOOKLET

Mail the coupon—today. Get complete information on the RCA INSTITUTES Home Study Course in Television Servicing. Booklet gives you a general outline of the course by units. See how this practical home study course trains you quickly, easily. Mail coupon in envelope or paste on postal card.



MAIL COUPON NOW!

RCA INSTITUTES, INC., Home Study Department RE-552
350 West Fourth Street, New York 14, N. Y.

Without obligation on my part, please send me copy of booklet "RCA INSTITUTES Home Study Course in TELEVISION SERVICING." (No salesman will call.)

Name _____ (please print)

Address _____

City _____ Zone _____ State _____

LOOK AT THE BOX

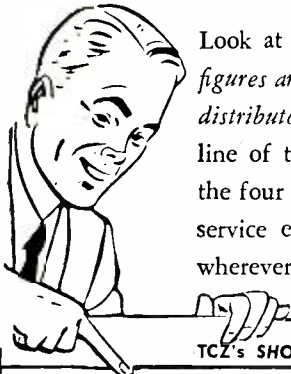

Look at the figures in the charts below. *These figures are taken from current catalogs listing stock distributor items.* Compare Centralab's complete line of temperature compensating capacitors with the four other leading makes. You'll see why more service engineers are standardizing on Centralab wherever capacitors of this type are required.

Remember too — Centralab was the first manufacturer to offer temperature compensating ceramic capacitors to the market.

For r.f. and resonant circuits — where frequency drift is critical — Centralab Temperature Compensating Capacitors are the last word in accurate stabilizing — *safest and best for guaranteed servicing.*

TCZ's SHOW NO CAPACITANCE CHANGE OVER WIDE RANGE OF TEMPERATURE (-20°C to +85°C)

CRL		COMPETITOR A**			COMPETITOR B**			COMPETITOR C**			COMPETITOR D**				
600VDCW		1200VDC			(tubular) 500 VDCW			Disc. 500VDCW — 1000 VDC			(tubular) 500 WVDC				
CRL Part No.	Cap. mmf.	Tolerance	Net Price	Cap. mmf.	Tolerance	Net Price	Cap. mmf.	Tolerance	Net Price	Voltage 500 VDCW			Cap. mmf.	Tolerance	Net Price
										Cap. mmf.	Tolerance	Net Price			
TCZ-.5	.5	± .25 mmf	.45	*			†			†			†		
TCZ-.68	.68	± .25 mmf	.45	*			†			.75	± .1 mmf	.45	†		
TCZ- 1.0	1.0	± .25 mmf	.45	*			†			†			†		
TCZ- 1.5	1.5	± .25 mmf	.45	1.0	± 1 mmf	.30	†			1.5	± .5 mmf	.30	1.5	‡	.30
TCZ- 2.2	2.2	± .25 mmf	.45	*			†			†			†		
TCZ- 3.3	3.3	± .25 mmf	.45	3.0	± 1 mmf	.30	†			3.0	± 1 mmf	.30	3.0	‡	.30
TCZ- 4.7	4.7	± .5 mmf	.36	3.3	± 1 mmf	.30	†			3.3	± .5 mmf	.30	3.3	‡	.30
TCZ- 6.8	6.8	± .5 mmf	.36	4.7	± 1 mmf	.30	†			4.7	± .5 mmf	.30	4.7	‡	.30
TCZ- 10	10	± .5 mmf	.36	5.0	± 1 mmf	.30	†			5.0	± 1 mmf	.30	5.0	‡	.30
TCZ- 12	12	± .5 mmf	.36	6.8	± 1 mmf	.30	†			6.8	± .68 mmf	.30	6.8	‡	.30
TCZ- 15	15	± .5 mmf	.36	8.2	± 1 mmf	.30	†	‡	.30	10	± 1 mmf	.30	8.2	‡	.30
TCZ- 18	18	± .5 mmf	.36	10			†			†			10	‡	.30
TCZ- 20	20	± .5 mmf	.36	*			†			†			†		
TCZ- 22.0	22	± 2½%	.30	*			†	‡	.30	†	± 10%	.30	†	‡	.30
TCZ- 24	24	± 2½%	.30	20	± 10%	.30	†			†			†		
TCZ- 27	27	± 2½%	.30	*			†			†	± 10%	.30	†	‡	.30
TCZ- 30	30	± 2½%	.30	*			†			†			†		
TCZ- 33	33	± 2½%	.30	25	± 10%	.30	†	‡	.30	†	± 10%	.30	†	‡	.30
TCZ- 36	36	± 2½%	.30	*			†			†			†		
TCZ- 39	39	± 2½%	.30	*			†			†			†		
TCZ- 43	43	± 2½%	.30	*			†			†			†		
TCZ- 47	47	± 2½%	.30	*			†	‡	.33	†			†		
TCZ- 51	51	± 2½%	.30	33	± 10%	.30	†			†	± 10%	.30	†	‡	.33
TCZ- 56	56	± 2½%	.30	*			†			†			†		
TCZ- 62	62	± 2½%	.30	*			†			†			†		
TCZ- 68	68	± 2½%	.30	*			†			†			†		
TCZ- 75	75	± 2½%	.30	50	± 10%	.33	†	‡	.33	†	± 10%	.33	†	‡	.33
TCZ- 82	82	± 2½%	.30	*			†			†			†		
TCZ- 91	91	± 2½%	.30	*			†			†			†		
TCZ-100	100	± 2½%	.30	33	± 10%	.33	†	‡	.33	†	± 10%	.33	†	‡	.33
TCZ-110	110	± 5%	.30	*			†			†			†		
TCZ-120	120	± 5%	.30	*			†			†			†		
TCZ-130	130	± 5%	.30	*			†			†			†		
TCZ-150	150	± 5%	.30	150	± 10%	.36	†	‡	.36	†	± 15 mmf	.36	†	‡	.36
TCZ-160	160	± 5%	.30	*			†			†			†		
TCZ-180	180	± 5%	.30	175	± 10%	.36	†			†	± 17.5 mmf	.36	†	‡	.36
TCZ-200	200	± 5%	.30	*			†			†			†		
TCZ-220	220	± 5%	.30	*			†			†			†		
TCZ-240	240	± 5%	.30	*			†			†			†		
TCZ-270	270	± 5%	.30	*			†			†			†		
TCZ-300	300	± 5%	.30	*			†			†			†		

**Name on request.

*Not cataloged item — available on special order.

†Not cataloged

‡Tolerance not listed in literature

SCORE!

... Of the five leading makes of temperature compensating capacitors — Centralab gives you more values to choose from — closer tolerances you can rely on — at prices that are right!

TCN's VARY CAPACITANCE ACCORDING TO TEMPERATURE															
CRL				COMPETITOR A** (tubular)			COMPETITOR B** (disc)			COMPETITOR C** (tubular)			COMPETITOR D**		
CRL Cat. No.	Cap. mmf.	Tolerance	Net Price	Cap. mmf.	Tolerance	Net Price	Cap. mmf.	Tolerance	Net Price	Cap. mmf.	Tolerance	Net Price	Cap. mmf.	Tolerance	Net Price
TCN- 3	3	± .5 mmf	.36	*			†			†			†		
TCN- 5	5	± .5 mmf	.36	5	± 10% or ± 1 mmf	.30	†			5	± 10% or ± 1 mmf	.30	5	‡	.30
TCN- 10	10	± .5 mmf	.36	10	± 10% or ± 1 mmf	.30	10	‡	.30	10	± 10% or ± 1 mmf	.30	10	‡	.30
TCN- 12	12	± .5 mmf	.36	*			†			†			†		
TCN- 15	15	± .5 mmf	.36	*			15	‡	.30	†			†		
TCN- 18	18	± .5 mmf	.36	*			†			†			†		
TCN- 20	20	± .5 mmf	.36	*			†			†			†		
TCN- 22	22	± 2½ %	.30	*			22	‡	.30	†			†		
TCN- 24	24	± 2½ %	.30	*			25	‡	.30	†			†		
TCN- 27	27	± 2½ %	.30	*			†			†			†		
TCN- 30	30	± 2½ %	.30	*			†			†			†		
TCN- 33	33	± 2½ %	.30	*			33	‡	.30	†			†		
TCN- 36	36	± 2½ %	.30	*			†			†			†		
TCN- 39	39	± 2½ %	.30	*			†			†			†		
TCN- 43	43	± 2½ %	.30	*			†			†			†		
TCN- 47	47	± 2½ %	.30	47	± 10%	.30	47	‡	.30	47	± 10%	.30	47	‡	.30
TCN- 51	51	± 2½ %	.30	*			†			†			†		
TCN- 56	56	± 2½ %	.30	*			†			†			†		
TCN- 62	62	± 2½ %	.30	*			†			†			†		
TCN- 68	68	± 2½ %	.30	*			68	‡	.30	†			†		
TCN- 75	75	± 2½ %	.30	75	± 10%	.30	†			75	± 10%	.30	75	‡	.30
TCN- 82	82	± 2½ %	.30	*			†			†			†		
TCN- 91	91	± 2½ %	.30	*			†			†			†		
TCN-100	100	± 2½ %	.30	100	± 10%	.30	100	‡	.30	100	± 10%	.30	100	‡	.30
TCN-110	110	± 5%	.30	†			†			†			†		
TCN-120	120	± 5%	.30	†			†			†			†		
TCN-130	130	± 5%	.30	†			†			†			†		
TCN-150	150	± 5%	.30	†			150	‡	.30	†			†		
TCN-160	160	± 5%	.30	†			†			†			†		
TCN-180	180	± 5%	.30	†			†			†			†		
TCN-200	200	± 5%	.30	†			200	‡	.30	†			†		
TCN-220	220	± 5%	.30	†			220	‡	.30	†			†		
TCN-240	240	± 5%	.30	†			†			†			†		
TCN-270	270	± 5%	.30	†			†			†			†		
TCN-300	300	± 5%	.30	†			†			†			†		
TCN-330	330	± 5%	.30	†			330	‡	.30	†			†		
TCN-360	360	± 5%	.30	†			†			†			†		
TCN-390	390	± 5%	.30	†			†			†			†		
TCN-430	430	± 5%	.30	†			†			†			†		
TCN-470	470	± 5%	.30	†			†			†			†		
TCN-510	510	± 5%	.30	†			†			†			†		
TCN-560	560	± 5%	.30	†			†			†			†		
TCN-620	620	± 5%	.30	†			†			†			†		
TCN-680	680	± 5%	.30	†			†			†			†		
TCN-750	750	± 5%	.30	†			†			†			†		

Centralab Temperature Compensating Capacitors are available in five body sizes, with most values in the smaller dimensions. For more information, see your Centralab Distributor.



Centralab
®
 A Division of Globe-Union Inc.
 922 East Keefe Avenue • Milwaukee 1, Wis.

**Name on request.

Thunder Hunters

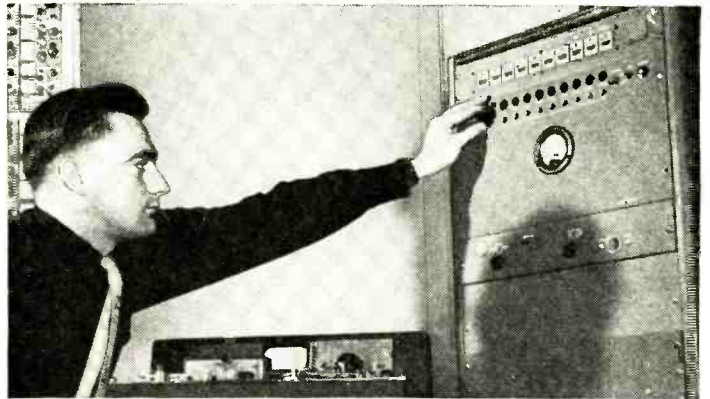

Thunder hunting equipment on location near Madison, Florida. Loop antenna on truck picks up static. The engineer in top picture is watching the indication of a circuit which registers how often the static exceeds a given level.

Many new telephone circuits have two jobs to do—carrying your voice and transmitting signals to operate dial exchanges in distant towns. And an old-fashioned thunderstorm can interfere with both!

“Rolling static” comes from many storms over a wide area and can interfere with clear telephone talk. A nearby lightning flash makes “crack static” which, unchecked, plays hob with dial system signals.

So Bell Laboratories scientists go “Thunder Hunting” in the storm centers of the United States — “capturing” storms by tape recorders. Back in the Laboratories, they recreate the storms, pitting them against their new circuits. This method is more efficient and economical than completing a system and taking it to a storm country for a tryout. It demonstrates again how Bell Telephone Laboratories help keep costs down, while they make your telephone system better each year.

BELL TELEPHONE LABORATORIES



Improving telephone service for America provides careers for creative men in scientific and technical fields.

RADIO-ELECTRONICS

EICO

TEST INSTRUMENTS

guards

Majestic
HIGH STANDARDS OF
TELEVISION PRODUCTION QUALITY

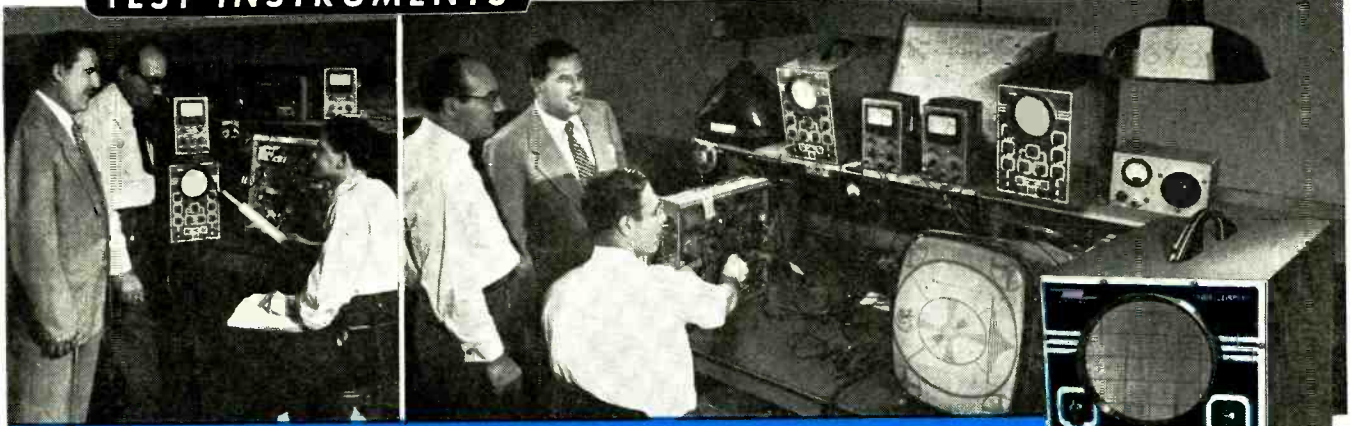

In the Majestic design laboratories, Frank J. Diehl and assistant, Paul Smith, discuss with Harry R. Ashley, some important prototype-circuit measurements just taken with the 425 Oscilloscope, #221 VTVM and #HVP-1 HV Probe.

Frank J. Diehl, Majestic's Chief Engineer, and Harry R. Ashley, President of EICO, inspecting the use of the EICO Model 425 5" Push-Pull Oscilloscope, Model 221 Vacuum Tube Voltmeter and Model HVP-1 High Voltage Probe at the important Final Test Position on the Majestic Television production lines.

KITS - Wired Instruments

For Laboratory Precision at Lowest Cost—
the Leaders Look to **EICO!**

WHY does The Majestic TV Division of The Wilcox-Gay Corp., another one of America's leading TV manufacturers, specify EICO Test Instruments on both its production lines and in its design laboratories?

BECAUSE —like Emerson, Tele-King, Tele-Tone, CBS-Columbia, and many another famous TV manufacturer coast to coast, Majestic knows that **ONLY EICO TEST EQUIPMENT DELIVERS ALL 10 EICONOMICAL FEATURES**

1. Laboratory Precision
2. Lowest Cost
3. Lifetime Dependability
4. Speedy Operation
5. Rugged Construction
6. Quality Components

7. Latest Engineering
8. Super-Simplified Assembly and Use Instructions
9. Laboratory-Styled Appearance
10. Exclusive EICO Make-Good Guarantee

Before You buy any higher-priced equipment, be sure You look at the **EICO** line—in **Wired** as well as **Kit form!** Each EICO product is jam-packed with unbelievable value. **YOU** be the judge—compare, see **EICO instruments today** — in stock at your local jobber — and **SAVE!** Write **NOW** for **FREE** newest Catalog 5-C.

FOLLOW THE LEADERS... INSIST ON EICO!



NEW 555K MULTIMETER
KIT \$29.95 WIRED \$34.95
20,000 ohms/volt

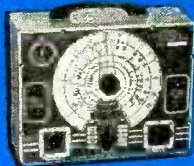

NEW 750K R-C BRIDGE & R-C COMB. KIT \$19.95
WIRED \$29.95



320K SIG. GEN. KIT \$19.95. WIRED \$29.95
NEW 22K SIG. GEN. KIT \$23.95. WIRED \$34.95



NEW 1042K BATTERY ELIM. KIT \$25.95. WIRED \$34.95



511K VOM KIT \$14.95
WIRED \$17.95



NEW 425K TUBE TESTER KIT \$34.95
WIRED \$49.95

NEW 526K MULTIMETER KIT \$13.90 WIRED \$16.90
1000 ohms/volt

NEW 1771K RES. DECADE BOX KIT \$19.95 WIRED \$24.95



NEW 315K DELUXE SIG. GEN. KIT \$39.95
WIRED \$59.95



360K SWEEP GEN. KIT \$34.95
WIRED \$49.95



145K SIG. TRACER KIT \$19.95
WIRED \$28.95



HIGH VOLTAGE PROBE \$6.95



NEW 425K 5" PUSH-PULL SCOPE KIT \$44.95. WIRED \$79.95



NEW 221K VTVM KIT \$25.95 WIRED \$49.95



ELECTRONIC INSTRUMENT CO., INC.
84-86 Withers Street, at Meeker Ave., Brooklyn 11, New York

©1951

Prices 5% higher on West Coast. Due to unstable conditions, prices and specifications are subject to change without notice

MEMBERS OF THE I.R.E.
Electronic Systems Engineers
Controls and Servo Engineers
Designers—Electrical • Mechanical

Career Opportunities In Aviation Electronics

We offer you an unparalleled opportunity to build your career with one of the fastest growing companies in the electronic industry. You'll help produce the advanced developments of the future—the advanced systems and flight simulators, radar, missile guidance, and other systems. You'll work with the most advanced electronic equipment, and you'll be working with the most advanced people in the industry.

Plan To See Us! Telephone PE04530, 4-530 between 9 a. m. and 5 p. m. Monday through Thursday for an interview starting in March 1953 in the EXHIBIT STATE BUILDING, Room 500, 1100 Grand Central Station, New York 17, New York. Open days between 1 p. m. and 5 p. m. Monday through Thursday.

ELECTRONICS DIVISION
631 Central Avenue, Carlstadt, N. J.
CURTISS-WRIGHT CORPORATION

ENGINEERS
Recent Graduates or Experienced Men
PERMANENT CAREERS and **EXCEPTIONAL OPPORTUNITIES**
Await YOU AT
PHILCO
Immediate Challenging Assignments
and Unlimited Future for
ELECTRONIC ENGINEERS
MECHANICAL ENGINEERS
PHYSICISTS

Investigate Now
PHILCO offers you a wide range of opportunities for both permanent and temporary assignments in all phases of its operations.

NEW YORK INTERVIEWS
During I.R.E. Convention, March 3-6
Call MR. W. J. LUKER, Chubbuck 4-5350 for Appointment
Or Communicate With
PHILCO CORPORATION
Engineering Personnel Office
8 & 1100A STREETS PHILADELPHIA 24, PA.

What's in the cards for engineers?
a future in jets...at Republic

ARCHITECT	ELECTRICAL EQUIPMENT
MECHANICAL PRODUCT DESIGN	RAILROAD CAR DESIGN
STRUCTURAL STEEL	SHIP DESIGN

REPUBLIC WILL TRAIN YOU FOR A FUTURE IN AVIATION...
YOU HAVE OPPORTUNITY...
WE'D LIKE TO TALK IT OVER WITH YOU... IN PERSON

REPUBLIC
NATION CORPORATION
Graduate of I.R.E. Convention

engineers • physicists
chemists • metallurgists
GENERAL ELECTRIC

Don Miss A Testing Point In Your Career

MILITARY RADAR AND MISSILE GUIDANCE
ELECTRONIC ENGINEERS
TELEVISION, TEST AND MATERIALS

Representations available for positions in NEW YORK

March 3-4-5
Call Mr. T. De To
Eldorado 5-3000

GENERAL ELECTRIC

SENIOR ELECTRONICS ENGINEERS
THERE ARE SPECIAL OPPORTUNITIES FOR YOU WITH
CONVAIR IN SOUTHERN CALIFORNIA

General (Consolidated Vultee Aircraft Corporation) is now accepting applications for permanent, long-range assignments in its modern, progressive Engineering Department. Positions are open for those specializing in these fields:

- Missile Guidance
- System Coordination
- Avionics
- Microwaves
- Computers
- Antennas
- Technical Writers

WORKING FACTS: You get the highest of a week of 40 hours in working assignments in 3-day week, air travel, salary range, etc. "Senior" engineering department... and working, challenging, interesting assignments of a wide variety... and many other... and many other... and many other...

LIVING FACTS: Southern California with its beautiful scenery and its sunny days and sea-breeze breezes... and many other... and many other... and many other...

PLEASE CONTACT William E. Hunt, Jr. Consolidated Vultee Aircraft Corporation PLAZA 5-7579

ELECTRON TUBE ENGINEERS
Raytheon Manufacturing Company

For an exciting career and a chance to work on the most advanced electronic equipment in the world, you should consider a position in our Electron Tube Division.

RESEARCH AND DESIGN
TESTING AND PRODUCTION
SALES AND SERVICE

Raytheon Manufacturing Company
100 Main Street, Woburn, Massachusetts 01890

IN THE AIR -- IT'S
CONVAIR
(Consolidated Vultee Aircraft Corporation)
YOU ARE INVITED TO SEE OUR BOOTH 500, IRE SHOW, GRAND CENTRAL STATION, NEW YORK 17, N.Y.

ENGINEERS
6 EXCEPTIONAL OPENINGS
OFFER UNLIMITED POSSIBILITIES

FIELD OFFICES AT
PROGRAM CHIEF, ENGINEERING DEPARTMENT
CHIEF, DESIGN DEPARTMENT
CHIEF, TESTING DEPARTMENT
CHIEF, PRODUCTION DEPARTMENT
CHIEF, SALES DEPARTMENT

FOR PERSONAL INTERVIEW
MR. JAMES H. ALLEY
NOR TWP. BUILDING 1040 PM
PA. 5-4000

ENGINEERS
USE YOUR EXPERIENCE
TO BUILD A SOUND
FUTURE AT **SPERRY**

ENJOY MANY ADVANTAGES
ATTENTION: IRE MEMBERS - INTERVIEWS AT
IRE HEADQUARTERS HOTEL, ROOM 953
FROM MONDAY, MARCH 3 TO 6, 11 A.M. TO 5 P.M. FOR APPOINTMENT

QUANTIFY RESUME TO IMPROVEMENT OFFICE
SPERRY CORPORATION, GREAT NECK 1, N.Y.

Welcome... Members of I.R.E.
ENGINEERS
Attending the
Annual Conference
The opportunity of
a lifetime awaits you
in **Missile Guidance
Development at RCA**

Revolutionary engineering enterprise now in progress at RCA

Immediate Openings Exist for
Electronic • Mechanical • Electrical
in the Following Fields:

RESEARCH AND DESIGN
TESTING AND PRODUCTION
SALES AND SERVICE

I.R.E. MEMBERS
sylvania

offers unusual opportunities to men in the following fields:

- Radio & Television
- Control Systems
- Radar Systems
- Transistors
- Military Communications

For further information call
MR. HAROLD CLARK
Eldorado 5-3000
110 E. Washington Street, Room 1302
NEW YORK 17, N.Y.

SYLVANIA ELECTRIC

ELECTRONICS ENGINEERS & PHYSICISTS
FOR
RESEARCH & DEVELOPMENT
AT
CAPEHART FARNSWORTH CORP.
(INDIANA)

IN
GUIDED MISSILES
TUBES
TELEVISION
FIELD ENG.

RADAR
TEST EQUIP.
RADIO
PROCESS ENG.

FOR INFORMATION AND PERSONAL INTERVIEW
TELEPHONE MR. W. J. WHITE
MARCH 1 THROUGH MARCH 6
AT THE
SHELTON HOTEL
NEW YORK CITY

For Personal Interview
Phone: Mr. J. W. HARRITT, Eldorado 5-3000
Monday and Tuesday, March 3 and 4
10:00 a. m. to 5:00 p. m. (For Appointment During IRE Conference)

RCA
RADIO CORPORATION OF AMERICA

“GO ELECTRONIC, YOUNG MAN!”

... *The world's greatest bonanza—radio electronics* ...

By HUGO GERNSBACK

NEARLY 100 years ago, one of the greatest editors of all time, Horace Greeley, in a letter to W. H. Verity, wrote these words of advice: “Go West, young man!” These four words became a household word in this country and soon accelerated the migration—which was in the making—of young men seeking their fortunes in the West. The advice was excellent because Horace Greeley knew what he was talking about. The West, indeed, proved to be a land of unprecedented opportunities, enriching hundreds upon thousands of young men who took the advice.

Today, with technological evolution expanding at an unprecedented rate, we no longer need to migrate from one part of the country to another. There are fabulous, undreamt-of opportunities all around us, making it possible for the young man to stay right at home and progress to a most lucrative future, if he but enter the century's greatest endeavor—radio-electronics. Recently, in our November, 1951, issue, we predicted that “sales of the entire radio-electronic industry by 1960 should reach no less than \$10,000,000,000.” As the months pass, it appears that this figure may even be exceeded. The reason is that the radio-electronic industry today ranks next to steel and aircraft in importance, and may soon exceed both.

The new giant industry has grown at such a breathtaking rate that new records in all directions are set up almost every week. So fast has been its growth that today it is so short of radio and electronic engineers that the various manufacturers are outbidding each other to fill vacancies—most of which cannot be filled for years to come simply because there are not enough trained men to fill the positions. This trend is certain to continue for many years.

To show to what extent the industry is going in its search for available men, we cite a most astonishing event which occurred last March. During the first week of that month, the Institute of Radio Engineers held their annual meeting in New York. In a single issue of *The New York Times*, there appeared over a dozen advertisements using large space in an endeavor to secure radio-electronic engineers. Some of these advertisements cost close to a thousand dollars apiece. A few of them are reproduced on the facing page as a permanent record of what lengths manufacturers are going to, to secure the talent they so badly need. Indeed, the situation will probably get much worse for some years to come before it will improve.

What then is the answer? While it is possible to graduate a small quantity of men from the existing ranks in

the industry, only exceptional men can make the grade without the necessary education that these positions demand. Even radio and TV technicians from the servicing industry are being pulled out and made into “engineers,” helping to cripple the servicing trade in the process. This, then is not the answer for a long term pull.

What we need is to educate parents, grade and high schools, that lucrative positions are now going begging for want of electronic engineers. But an electronic engineer is not made overnight. *It is a long evolutionary and educational process.* It starts with a boy of six or less, making him conscious of radio-electronics, and instilling in him the germ of the future engineer by supplying simple radio-technical literature to the young boy, gradually stepping it up over the years. Parents and educators can help the country's economy and incidentally assure the young man of a worthwhile future in the process.

Grade schools and high schools can do a tremendous service by educating young boys in the intricacies of radio-electronics. This is not as difficult as it sounds, because there is always a large percentage of young boys who are mechanically inclined and radio-minded. By supplying them with tools and a few simple radio appliances a young boy can, in easy stages, be made into a technician.

It is much more difficult to instill the radio-electronics spark into a boy once he has reached puberty. The sooner he begins the quicker he will become proficient in the greatest endeavor the world has ever seen. Moreover, as has been found out by past experience, boys who start young in this endeavor are not likely to land in poolrooms and become public charges later.

There is, perhaps, nothing quite so intriguing to the young mind as radio-electronics today. If the boy is started young and kept interested, he will not have to be pushed on by others. He will push himself ahead and be the better for it in the future.

Nor is it expensive to start a young boy off on this technical path. It does not cost more to supply him with radio-electronic gadgets than with other toys. In the end, it will pay big dividends.

If you who read this know of a young boy who needs coaching, this is the time to get him started. If 100,000 of our readers who read this will pass these two pages on to parents of young boys, the shortage of radio-electronic engineers fifteen years hence will no longer be a matter of concern—and you will be doing the boy—and your country—a tremendous favor.

—end—

REPRINTS OF THIS TWO-PAGE EDITORIAL CAN BE HAD AT
COST FROM THE PUBLISHERS IN SINGLE LOTS OR QUANTITY.

TV PATTERN FOR THE FUTURE

By RAYMOND F. GUY*

Planning a nation-wide television system — An outstanding authority discusses the tremendous technical problems involved, and the methods developed by industry and the FCC for the solution of the difficulties

BASED upon long experience it would seem that the planning and adjustment phases of a radio service never reach a point where they may be considered complete or permanent. Developments follow in endless succession to provide service to more people, or better service, or to crowd more message intelligence into a segment of the frequency spectrum, or to combine such improvements. A clas-

sic example is the compatible color television system, which more effectively utilizes the 6-mc channel to transmit full color programs fully equal in quality and detail to present black-and-white pictures.

A clear thinker aptly remarked that he was interested not in the past or the present, but only in the future, because he expected to spend the rest of his life there. But all our experience, knowledge and ability to rationalize and plan came from the past. We are not always able to plan wisely. Employ-

ment of radio services cannot be postponed until engineers know all there is to know about the behavior of radio waves and the systems which utilize them. Often the pressure of events leaves inadequate time for accumulation of a broad base of experience and knowledge, and we must adjust as required and as the opportunity affords.

The television freeze was imposed because of such a desire to adjust: to minimize TV interference before its growth reached the point of no return. That is our present position. From the

* Manager, Radio and Allocations Engineering, National Broadcasting Company.

Service Areas of Operating and Proposed VHF Television Stations

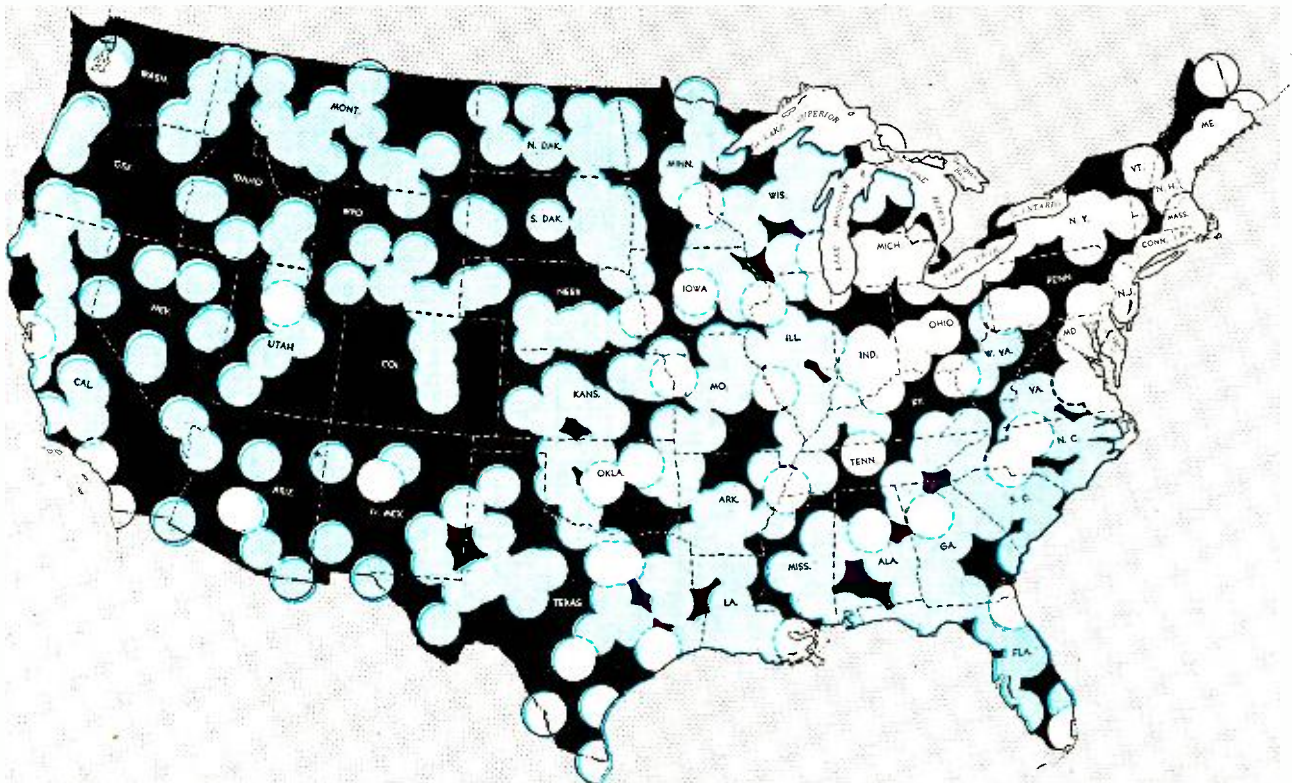

Service Areas of Proposed UHF Television Stations

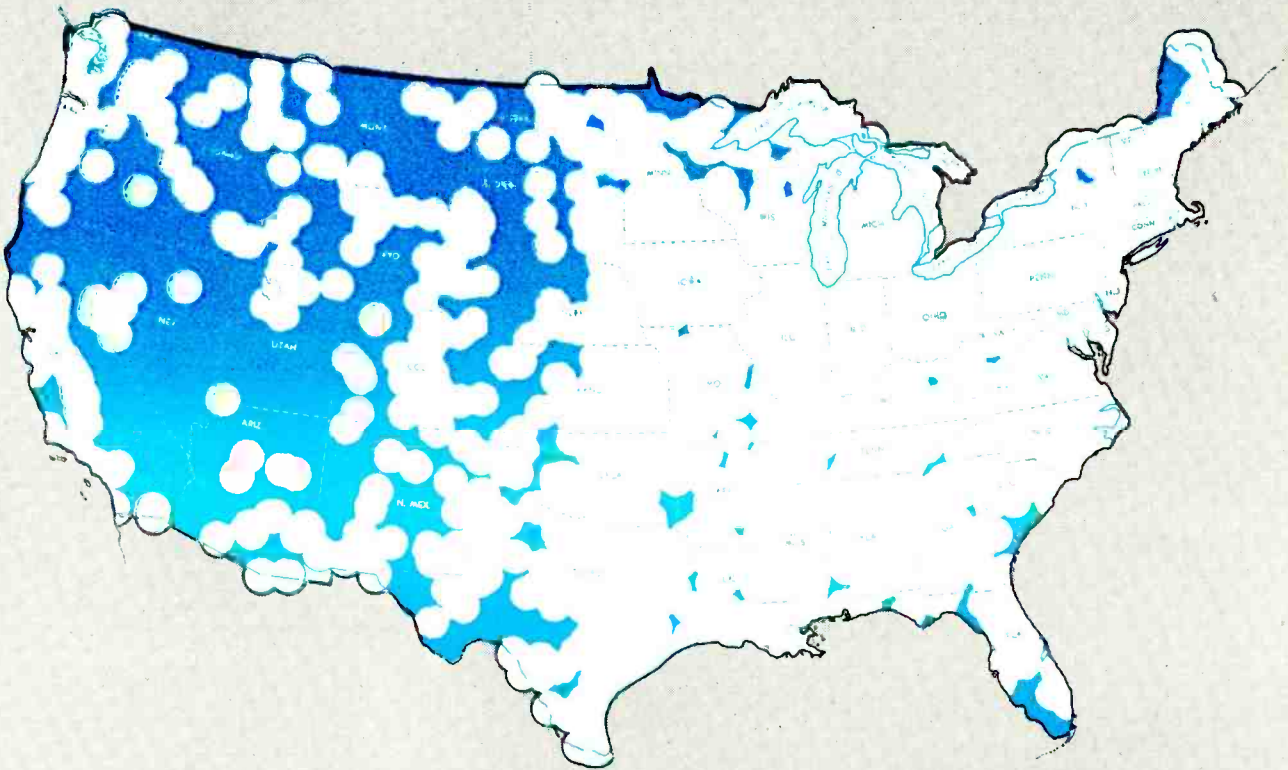

Service Areas of All Operating and Proposed VHF and UHF Television Stations

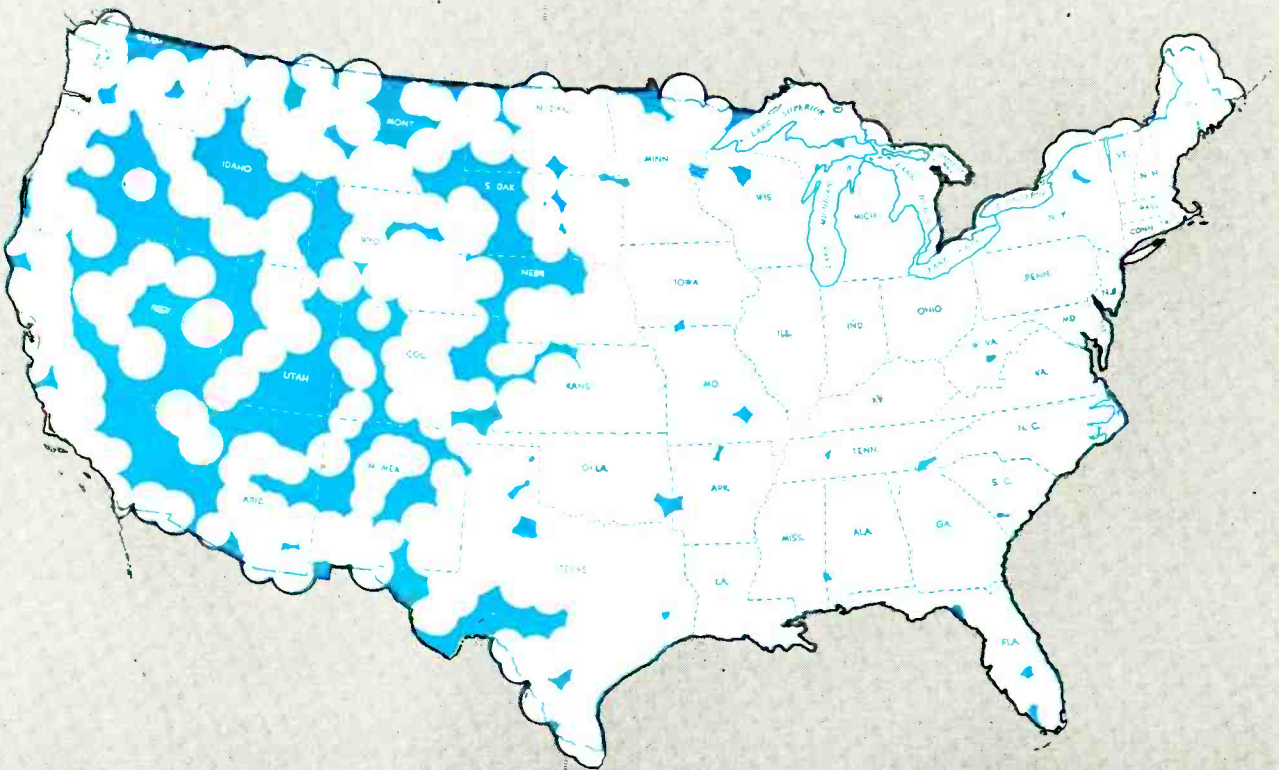

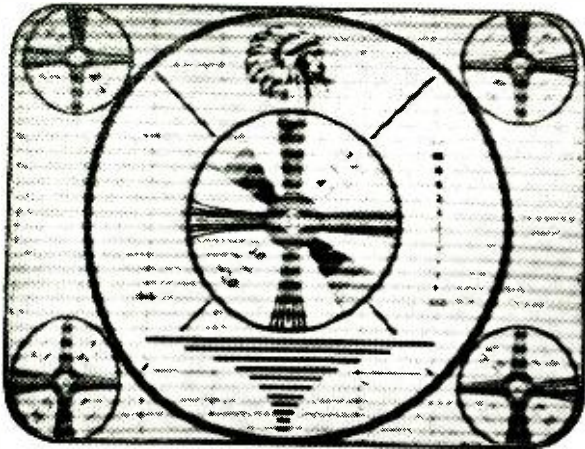

Fig. 1—"Venetian-blind" effect caused by minute frequency differences between carriers of co-channel television stations.

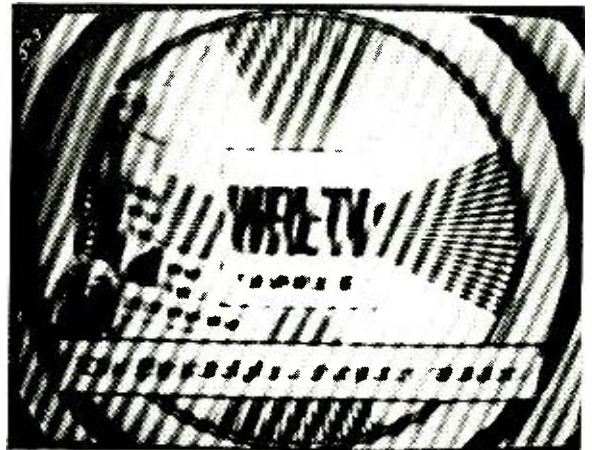

Photo courtesy of Radio Corporation of America
Fig. 2—Typical interference pattern due to pickup of radiation from the local oscillator of another television receiver.

events of the past a pattern is taking shape for the future. It merits display against the background of the past.

Brief history of allocations

In 1928 the author participated in the establishment of station W2XBS in New York, which was probably the world's first television station to go into permanent operation. The Federal Radio Commission then considered visual broadcasting a matter of speculation. In 1929 four 100-ke experimental channels were established between 2 and 3 mc. But RCA and NBC were even then planning the move to 40 mc and to the Empire State Building which was accomplished by 1931.

In 1936 the commission allocated 19 channels to television in the area now used, and by 1939 commercial licenses were being sought. They were denied as premature.

In April 1941 one of the television channels was diverted to FM broadcasting and new rules were adopted for commercial operation. A few weeks later the NBC Empire State station became the world's first commercial television station, and was followed by a half-dozen more before the war stopped construction.

At a postwar hearing television allocations were cut down from 18 to 12 v.h.f. channels and the uncharted u.h.f. spectrum (now 470-890 mc) was earmarked for future expansion.

As a general rule the commission specified a geographical separation of 150 miles between v.h.f. television stations operating on the same channel, but in making assignments these minimum separations could not always be observed. The 150-mile separation was based on inadequate knowledge and consideration of tropospheric propagation, with the result that severe interference became a major problem as new stations were built. Its magnitude was such that the commission felt compelled to call a halt, and imposed the freeze which is now over three years old.

Many issues face the commission with

respect to the formulation of new television rules, standards, and allocations. The rules and standards have as their primary purpose the establishment of a satisfactory foundation upon which to build an allocation structure, and the routines and ground rules by which it may be administered. Our neighboring countries to the north and south either have or are contemplating television service. Our plans must dovetail with theirs if we are to avoid the difficulties experienced in the past in standard broadcasting. In its early years, this service found itself faced with intolerable interference from stations in bordering countries. Through the co-operative efforts of the North American countries an international allocations plan was adopted in the 1930's. To meet the provisions of this agreement scores of stations in the United States alone had to make changes in their operating frequencies, facilities, or both, with much inconvenience, and in some cases, at great expense.

With the experience of the past in mind, the new television-allocation plan will include an agreement with our neighboring countries by which all may have television service through joint use of v.h.f. and u.h.f. channels without conflict.

In order to provide greater freedom from interference among domestic stations, and guard against conflicts with stations in bordering countries, an adjustment has become necessary, consisting of changes in the authorizations of the 31 stations listed to the right.

Offset carrier operation

As a result of observations of television co-channel interference caused to and by its own stations and others, NBC undertook research programs in 1948 and 1949 in co-operation with RCA to develop methods of eliminating or minimizing such interference. The efforts were successful and the technique is now in common use. The interference is caused mainly by tropospheric propagation over distances up to about 300

miles. Differences of up to a few thousand cycles in the carrier frequencies of the desired and undesired stations produced beat notes in receivers. These beat frequencies create horizontal bars on the kinescope similar to venetian blinds, and these lines move in the vertical plane when the carrier frequency of either station changes (See Fig. 1).

Since identical carrier frequencies would produce no beat notes, an automatic synchronizing method was developed in the RCA Laboratories. A receiving station was necessary at a point between the desired and undesired stations with a separate highly-directional antenna directed at each station. These antennas fed individual sharply tuned amplifiers and circuits which extracted the frequency and sense of the beat note. This was transmitted via leased wire lines to one of the stations, where the beat note produced a control voltage which caused the oscillator to hunt for and lock at zero beat automatically. WNBT (New York) and WNBW (Washington) were controlled from a receiving station near Philadelphia and WNBK (Cleveland) and WWJ-TV (Detroit) were controlled from a receiving

Station	City	Present Channel	Proposed Channel
WOI-TV	Ames, Iowa	4	5
WSB-TV	Atlanta	8	11
WRRC-TV	Birmingham	4	6
WTTV	Bloomington, Ind.	10	4
WRKB	Chicago	4	2
WLWT	Cincinnati	4	5
WKRC-TV	Cincinnati	11	12
WCPO-TV	Cincinnati	7	9
WXEL	Cleveland	9	8
WNBK	Cleveland	4	3
WLWC	Columbus	3	4
WLWD	Dayton	5	2
WHIO-TV	Dayton	13	7
WOC-TV	Davenport	5	6
WLAV-TV	Grand Rapids	7	8
WSAZ-TV	Huntington, W. Va.	5	8
WJAC-TV	Johnstown, Pa.	13	6
WGAL-TV	Lancaster	4	8
WAVE-TV	Louisville	5	3
WHAS-TV	Louisville	9	11
WMCT	Memphis	4	5
WTMJ-TV	Milwaukee	3	4
WNHC-TV	New Haven	6	8
WTAR-TV	Norfolk	4	10
WKY-TV	Oklahoma City	4	7
WDTV	Pittsburgh	3	2
WJAR-TV	Providence	11	10
WHAM-TV	Rochester	6	5
WRGB	Schenectady	4	6
WSYR-TV	Syracuse	5	3
WDEL-TV	Wilmington, Del.	7	12

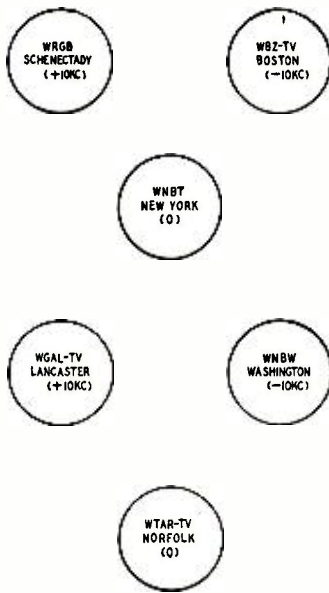

Fig. 3 (left)—Co-channel carrier offset plan proposed by the author and currently in use in northeastern United States.

station near Cleveland. The results were successful and it was planned to synchronize other stations with WNBC. But simultaneously other methods were being investigated, including offsetting the carrier frequency of one of the stations by various controlled amounts.

This method offered the great advantages of simplicity and low cost because it required only a change in the transmitter oscillator of one station, and eliminated the receiving station, wire line, and complex control circuits. It was so successful in laboratory tests that FCC approval was immediately granted for field trials. The laboratory results were duplicated in tests at NBC stations WNBC, WNBW, and WNBK and the carrier-offset system was adopted in 1949, making obsolete the synchronizing method.

The offset frequency schedule proposed by the author, adopted and still used, is shown on Fig. 3.

Fig. 4 shows the approximate relationship of frequency offset and interference reduction. The new FCC proposals contemplate 10-kc offset operation as a standard practice to take advantage of the 17-db reduction in interference provided. In combination with the proposed co-channel geographic separation, the new standards will reduce interference and facilitate increasing transmitter powers to the proposed 100-kw to 200-kw figures, or higher.

Oscillator radiation

The new television allocation plan contemplates other improvements. Service technicians have observed the degradation on some channels from receiver oscillator radiation and are familiar with the causes and effects. (See Fig. 2.) The new plan is based upon the new sound i.f. of 41.25 mc, but also attempts to minimize interference from existing receivers utilizing 21.25 mc without reducing the number of v.h.f. assignments. The u.h.f. allocation plan separates by at least 60 miles those stations 7 channels (42 mc) apart, and thus protects one receiver from the oscillator radiations of others to the same degree

that it would be protected from a co-channel station.

Intermodulation

Very high field intensities from undesired stations may produce intermodulation in receiver circuits, particularly when the channels are not widely spaced in frequency. (The effect of this type of interference is to produce a picture from the unwanted station which apparently swings back and forth behind the picture to which the receiver is tuned.) To minimize or eliminate such effects the u.h.f. allocation plan proposes that stations less than 20 miles from each other shall be at least 6 channels apart.

Image interference

Image problems have not arisen in v.h.f. television reception because the images fall outside the channels. But the large numbers of contiguous channels possible in u.h.f. could lead to very destructive image interference.

To guard against such effects u.h.f. channels separated by twice the picture i.f. (91.5 mc, or 15 channels) are proposed to be separated 75 miles or more. Correspondingly, channels separated by twice the sound i.f. (82.5 mc, or 14 channels) are proposed to be separated by 60 miles or more. These separations also are intended to give each television receiver the same degree of protection as from co-channel stations.

I.F. beat

If two local television stations operate on channels separated in frequency by an amount corresponding to the receiver i.f., the two signals may be received directly in the receiver i.f. circuits. This may occur for separations of 7 or 8 channels when the sound i.f. is 41.25 mc and the picture i.f. 45.75 mc. Since stations separated by 7 channels are proposed to be geographically separated at least 60 miles because of oscillator radiation interference, we must consider only what to do about 8-channel separations. The FCC proposes at least 20 miles minimum geographical

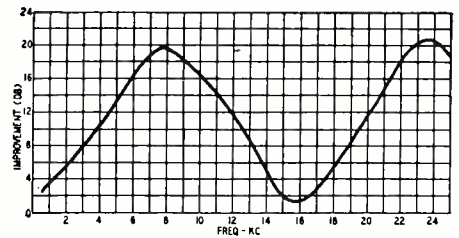

Fig. 4 (above)—Reduction in co-channel interference obtained by offsetting carrier frequencies by controlled amounts.

separation between all such stations.

National coverage

The commission has striven to provide an allocation framework which will as nearly as possible assure television service to all people of the United States and which will also fairly distribute television stations among the states and communities. The implications of this plan are illustrated in the series of maps on pages 30 and 31. In preparing these figures it was assumed that each station would provide its normal coverage to an average distance.

The map on page 30 shows service to be provided by existing and proposed v.h.f. stations. The white discs surround existing stations; the blue discs are centered on proposed ones. The maps on page 31 show service areas of proposed u.h.f. stations, and of all operating and proposed stations. In these maps, white represents service areas and blue, those outside the range of reliable service.

Many have expressed the view that the freeze was unnecessary. This author feels that television of the future will benefit greatly from it. At the time it was imposed no such techniques as carrier synchronism or offset-carrier operation had been demonstrated for television. The full impact of the technical inadequacies in the old standards and rules had not been felt because of the relatively limited number of stations then in operation. But in the Northeastern States the operation of co-channel stations having inadequate protection against interference was causing much concern. In addition, new stations were scheduled to go into operation in such large numbers that the practical difficulties inherent in correcting the shortcomings of the technical standards would have compounded rapidly and perhaps made solution impossible.

Television will become increasingly important in our national life from now on. The commission carries grave responsibility because the pattern established in the present will shape the national service of the future.

—end—

it's the LAW

The record number of regulatory bills introduced in the past year emphasizes TV's influence in our national life, and may vitally affect the technician's future.

By **FRED SHUNAMAN**

IF YOU want to get into jail in the State of Connecticut, just install a TV receiver in your car in such a way that you can see it from the driver's position. It's a fine of "not more than \$100" or jail if you don't pay. It's even easier in New York; simply *operate* a vehicle equipped with a televiser on any public highway in the state. Several states have laws either before their legislatures or already enacted, forbidding installation of a receiver so the driver can see it. These include South Dakota, California, Nebraska, Florida, and Michigan. But New York's law is absolute, and would forbid operating a TV receiver in the back of a Greyhound bus.

The lawmakers devoted a flattering amount of attention to television and radio during 1951. New York leads the list with 22 bills introduced. Massachusetts had a dozen, Pennsylvania five, and a large number of states two or three.

Most popular subject of legislation was the televiser in a motor vehicle. Licensing of radio technicians was next, with bills introduced in Massachusetts, New York, Pennsylvania, and

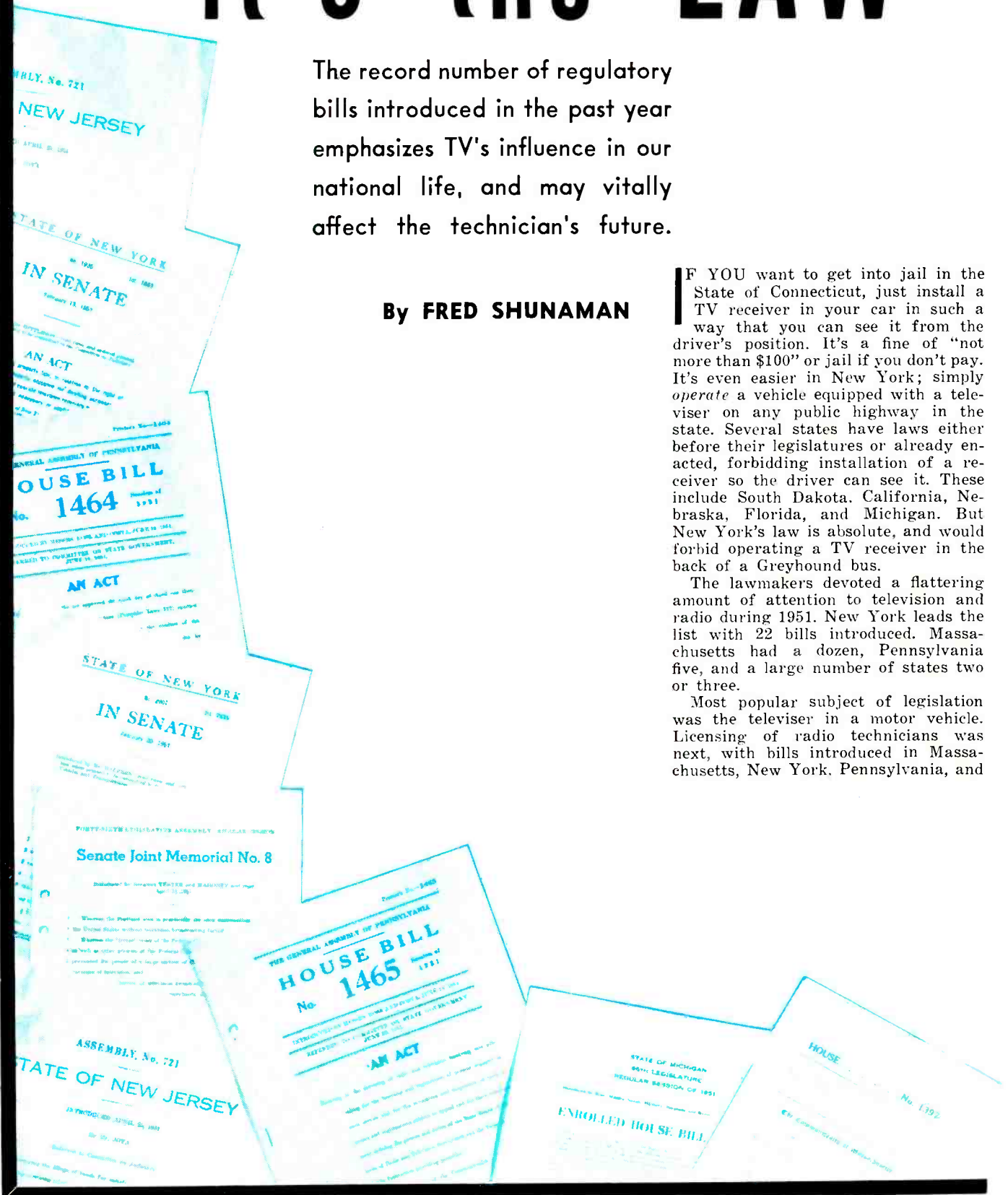

Wisconsin (as well as at least four cities, Los Angeles, Miami, Milwaukee, and New York). Another important subject is protection of moneys paid for TV contracts, either by bonding, escrow, contractor licenses, or a combination. Several states introduced bills requiring colleges receiving state aid to permit their athletic events, or other affairs to be televised, so that the taxpayer who is financing the affair can see it. Other bills relate to the appearance of minors on TV shows, or cover other public-interest angles of the art.

Licensing bills have attracted more attention than any others. Most of them have one feature in common: They propose setting up one or more grades of TV service technicians, and boards of examiners to determine those qualifications. They also provide for license fees. In the Massachusetts, Pennsylvania, and Wisconsin bills (and that proposed for the City of New York) the administrative board would have at least one representative from among the radio technicians. The Pennsylvania bill provides that *three* of the board shall have experience in electrical servicing, including TV, and that the other two have experience in training TV and radio service personnel.

Licensing is still a live issue in Pennsylvania and in the cities of Los Angeles and New York. It is dormant at other points, or has been completely abandoned, as in Milwaukee. A campaign of education and control by dealers and service technicians in that city cut TV service complaints down to a point the local Better Business Bureau considered surprising, and little more was heard of the licensing proposal.

Adherents of licensing believe that an examination and license would give the technician a semiprofessional standing, would assure the customer that the service technician he called would be a real technician and not a high-school boy masquerading as such, and would help the employed technician by making it impossible for service companies to hire cheap, untrained men to do

their work. This, they say, would increase the demand for trained technicians, and thereby raise their living standards.

Opponents of licensing have been equally quick to point out that customers will not be protected from dishonesty, which according to Better Business Bureaus and other authorities, is a more serious cause of complaint than incompetence. They also point out that action can be taken against improper service tactics without first licensing the technician or organization, and point to Los Angeles, where TV repairmen are doing time in the local jail.

Another large number of bills—practically all of which have fallen by the wayside—seek to protect the buyer of a TV service contract. By license, bonding, or escrow arrangements, or a combination of the three, they try to assure that the TV set owner will not be left holding the bag after having bought and paid for his contract. A typical bill is one from Rhode Island, which was before the 1951 session, and has been introduced at this year's sitting. It provides for licenses for all sellers of service contracts, plus a bond of \$2,000 for each licensee. New Jersey had a bill which provided for bonding all persons or firms receiving money under contract for TV servicing. Several similar bills were introduced in the New York Legislature, some calling for bonding, others for deposit of all moneys received as payment for TV contracts in a trust fund, and for making monthly withdrawals.

Education by television was the subject of five of Massachusetts' twelve bills, though the subject was not touched by any other state. Two of the five bills petition the Federal Government to set aside allocations for educational broadcasting. The others would establish a State Television Authority to direct the State Department of Education to establish a program of television education, over the state's own TV station if need be.

Several states were interested in seeing that state institutions supported

by taxes refrain from entering into contracts which might prevent the taxpayer from seeing football games or other events. These ranged from resolutions urging colleges to have their games televised to strongly worded bills directing that no state-owned stadium be used for such events, or that state aid be cut off immediately if televising were restricted. Unlike most TV bills, the majority of these acts were passed by the legislatures in which they were introduced.

A few bills had technical or safety aims. New York added to its law forbidding radio antennas or other wires within 10 feet of a roof, the words "and no radio, television antennae, or other wires shall be attached to any fire escape or to any soil or vent line extending above the roof." Massachusetts had a bill which would have authorized their department of public safety to investigate the necessity of uniform rules and regulations in regard to television sets and antennas, and would have prevented any city or town in the Commonwealth from setting up rules taxing or licensing TV sets or antennas until such study should have been made. New Hampshire enacted a law authorizing the erection of television structures, poles, and underground conduits or cables along or across public highways on the same footing as other utilities.

But perhaps the bill that shows more than any other the position TV has gained in our life is a proposed amendment to a law relating to exemption from execution and attachment. Introduced in the California Assembly, it provides that among the goods exempt from seizure for debt shall be included, together with "household, table, and kitchen furniture . . . beds, bedding," and other bare necessities, "also one radio, one television set and equipment . . ." The TV receiver, in the mind of one California legislator at least, has taken its place with the family bed and table as one of the necessities of which a judgment debtor may not be deprived.

—end—

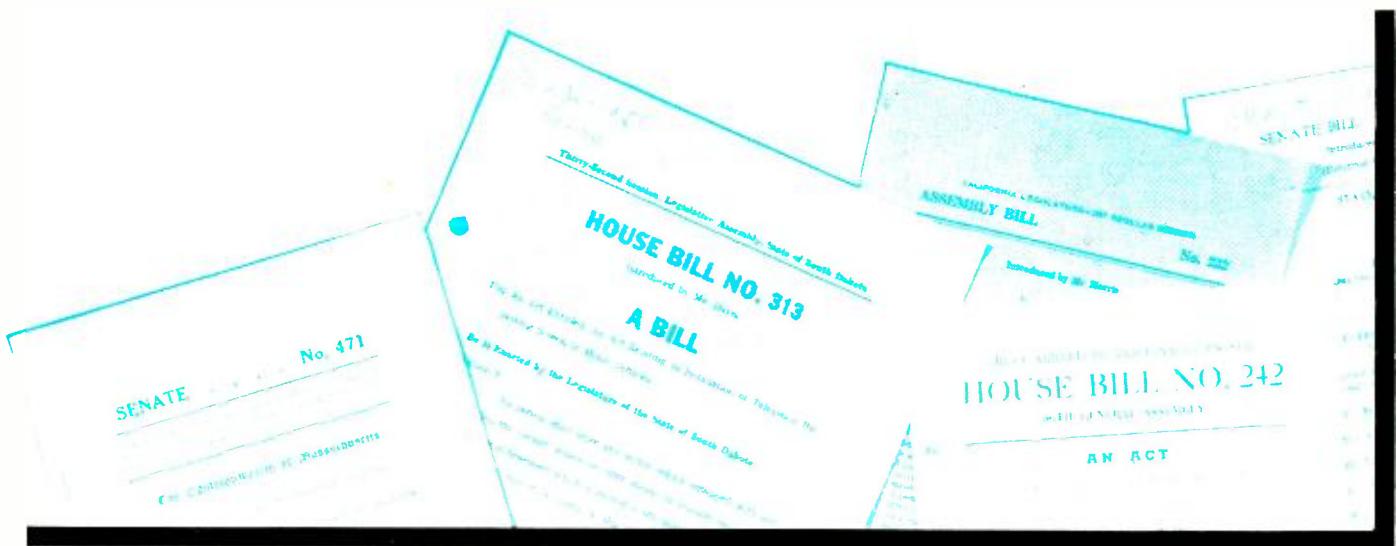

CONVERTING THE RCA 9T-270

A successful conversion of a popular receiver, with a minimum of mechanical and electrical modifications.

By GERALD SHIRLEY

IN THE field of TV conversions more 10-inch sets are converted than any other size, and the great majority of these are probably converted to 14-inch rectangulars. The chief reason for this is that the original cabinet can be used.

A potential field for conversions also exists among 16-inch round-tube sets, since in most cases a 20-inch rectangular will fit into the original cabinet (with some alterations of course). The rear end of the new tube may protrude several inches at the back of the cabinet. This may or may not be a deterrent, depending on where the set is placed in the room or whether the owner objects to having it a little further from the wall. Where a set is placed diagonally in a corner of the room the protruding rear end of the tube is no problem at all.

When a 16GP4 or any other *wide-angle* tube is replaced with a 20-inch rectangular, a perfectly satisfactory picture should be obtained on the new tube without making any electronic changes in the set (assuming, of course, that the set is in first-class operating condition). There may be a temptation to try a few tricks for increasing the high voltage, (such as reconnecting the ground side of the h.v. filter condenser to the hot terminal of the horizontal output transformer, etc). It should be borne in mind that a limitation is imposed on increasing the h.v. by the need for ample picture width and for some reserve sweep power to compensate for tube aging, etc.

The conversion described in this article was done on an RCA 9T-270, a high-definition table model using the long 16AP4. The high-voltage supply uses a doubler circuit which puts out about 12,000 volts. Since this is sufficient for a 20CP4 we decided to try to sweep the new tube with the original deflection circuit, substituting only a

new yoke to avoid neck shadow.

The first step (standard operating procedure in any conversion) was to put the receiver into first-class condition. It should be possible to over-sweep the 16AP4 with both width-selector and horizontal drive controls at reduced settings. Refer to service manual for diagram. A 20-inch tube was then substituted temporarily with no change except for a recessed-cavity type h.v. connector. The original yoke gave some shadow, as had been expected, but surprisingly less than one normally encounters when swinging a 70-degree tube with a 50-degree yoke. It is possible that with painstaking adjustments of the yoke, focus coil and ion trap the original yoke can be used. However, the length of a 50-degree yoke places the focus coil too far back for greatest effectiveness, and too close to the ion trap.

Electrical Changes

Cosine-wound 70-degree yokes are now available from several manufacturers. The inductance of the horizontal windings should be approximately 8 mh. to match the deflection winding of the RCA flyback transformer. We used a Philco yoke (stock No. 32-9644) which required some physical modifications to fit the RCA yoke cradle.

Substituting the Philco yoke for the original RCA yoke, we obtained an excellent, unshadowed picture on the 20CP4. With the width-selector and horizontal drive controls set for maximum picture width, the raster overlapped the tube face and the actual pictures (which are always smaller than the raster) just filled the screen. As stated earlier, a certain amount of reserve sweep should be provided on any conversion job; otherwise, as tubes age and the picture shrinks, it will be necessary to replace such tubes as the horizontal output, its driver, and the

power rectifier much more often.

The method we used to achieve the extra sweep consists of a form of feedback from the horizontal output transformer. The hot secondary tap of the horizontal output transformer (terminal 4) is coupled through a very small capacitor to the grid of the 6BG6-G. Since large amplitude pulses are present in this feedback loop, the capacitor must have a very high voltage rating. We used the inherent capacitance between the two conductors of a length of 300-ohm line, while the plastic insulation between them provides a healthy safety factor against breakdown.

A length of about 2½ feet added over an inch to the sweep width without lowering the 12,000 volt anode supply. This caused slight nonlinearity at the extreme edges. Fig. 1 is a photograph taken after the conversion was completed, showing that the *overall* linearity is very good.

Still more sweep was obtained by lengthening the 300-ohm line to 4 feet, at the expense of noticeable nonlinearity at the edges. Further increases in the feedback capacitance caused a drop in high voltage, poor regulation, and picture blooming.

The 2½ feet of 300-ohm line was rolled up tightly, and taped, and mounted on a porcelain standoff insulator under the chassis near the 6BG6 tube socket. (See Fig. 2) We now had a picture that more than filled the tube with the width selector at its mid-position, and the horizontal drive control 1½ turns from maximum. The over-all focus was excellent, and the picture brightness was very good.

Mechanical Changes

The front of the cabinet was taken off, and the white inner plastic mask was unscrewed from it. The 16AP4

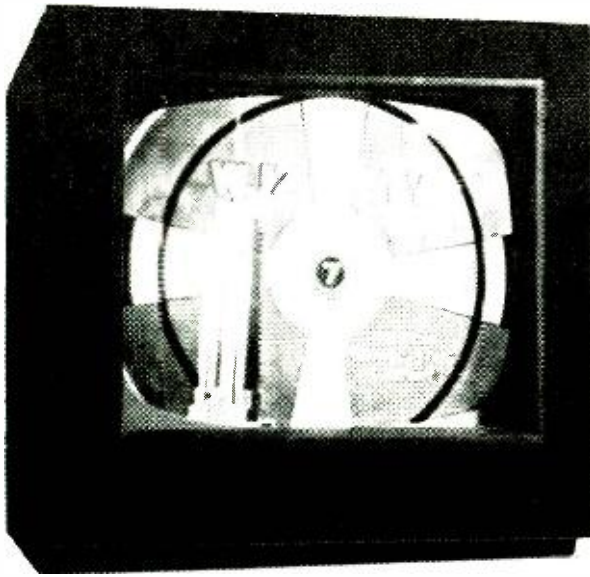

Fig. 1—Picture quality—the test of a successful conversion.

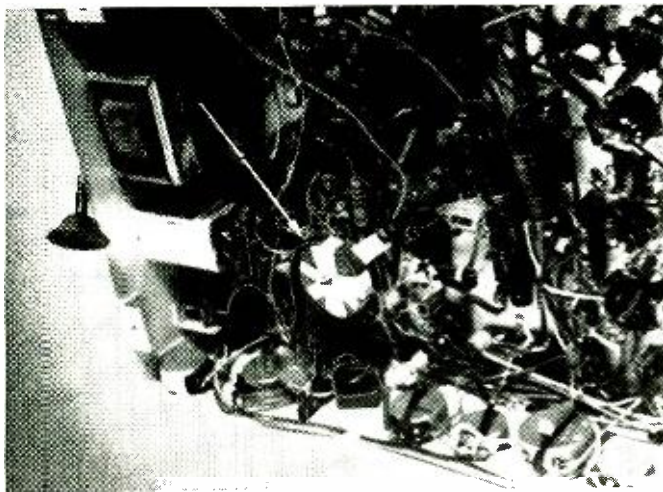

Fig. 2—Location and mounting of the 300-ohm line feedback capacitor.

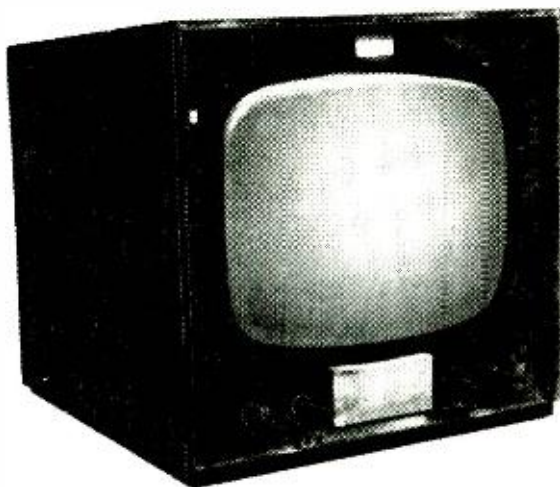

Fig. 3—The front removed from the receiver, showing CRT supports.

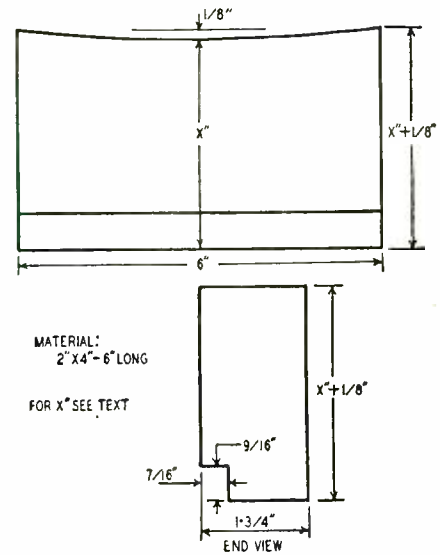

Fig. 4—Details of the lower supporting block for the 20-inch glass picture tube.

was removed and the four plastic tube positioners were unfastened from the inner wooden panel. The cabinet was then placed on the floor, face up, and the 20CP4 was placed in the round opening of the inner wooden panel. (Because of its rectangular shape the 20CP4 will not fall through this opening). The tube was oriented and aligned with the cabinet as accurately as possible. Then with the aid of a small square and an ice-pick, the outline of the tube at its widest points was pricked into the wooden panel below. At the same time, a measurement was taken of the distance from the bottom center of the tube to the cabinet floor. This measurement is used in designing the wooden support block, shown in Fig. 3.

The tube was then removed from the cabinet, and a fresh outline was made on the inner wooden panel $\frac{1}{4}$ inch higher than the first. The new outline was then cut out by drilling a series of closely-spaced $\frac{1}{8}$ -inch holes along the outline and cutting through them with a keyhole saw. An outline drawing of the supporting block is shown in Fig. 4. The block is concave on top to fit the shape of the tube and provide even support for it. The top of the block should be covered with a layer of sponge rubber, $\frac{1}{4}$ inch to $\frac{3}{16}$ inch thick. The height of the block at its midpoint (dimension "x" as shown in Fig. 4) is calculated as follows: add $\frac{1}{4}$ inch to the measurement taken earlier of the distance from the bottom-center of the tube to the cabinet floor, and subtract the thickness of the rubber layer when it is compressed by the weight of the tube. The block is channelled at the bottom as shown in Fig. 4 to clear the front strip on the cabinet floor, and is fastened flush against the strip by two $1\frac{1}{2}$ -inch wood-screws which run up through the cabinet floor.

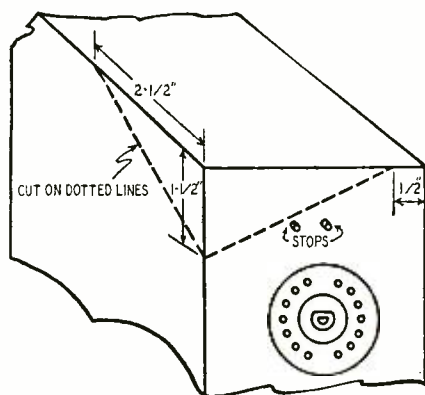

Fig. 5—Sketch of the tuner enclosure, showing material that must be removed.

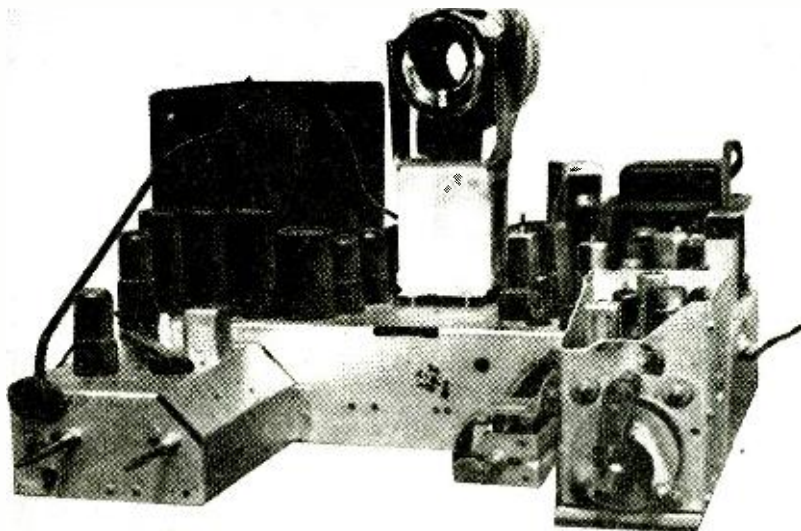

Fig. 6—All necessary mechanical changes are shown in this view.

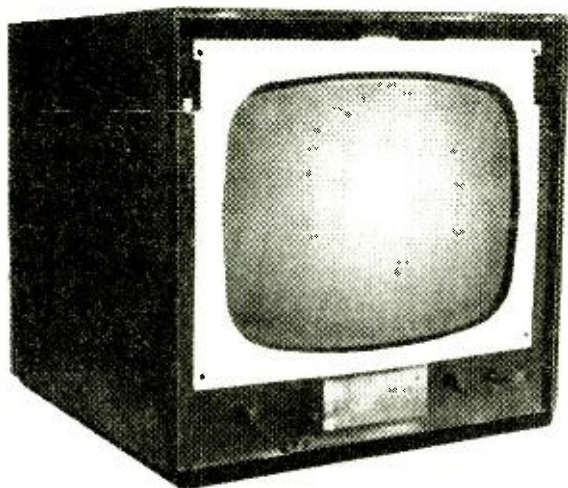

Fig. 7—Installation of the removable picture-tube mask.

Three mechanical changes must be made to the chassis. The upper left-hand corner of the tuner shield must be cut away, one tube moved to a new location, and the yoke mounting bracket must be moved forward and raised. Each of these changes we will discuss in turn.

Fig. 5 shows the portions of the tuner that must be cut down. Be careful to clear the two punched-out mechanical stops for the tuning control. (Before cutting remove the tubes and cover all openings in the tuner so as to keep out metal filings. Fig. 6 shows the front end after it was cut down. We had to saw it three times before we had enough metal off, so it does not look as neat as if we had known in advance how much to remove.) It is necessary, of course, to use care, and to see that the blade at no time strikes the transformer mounted near the front of the tuner.

The 6SN7 on the left "front-porch"

assembly of the chassis had to be moved since its top prevented the picture tube from going all the way in. Rather than go through the headaches of making a hole in the chassis for a new socket, we simply mounted a new socket on two standoffs a short distance away, as shown in Fig. 6. Before mounting it, we soldered on eight wires of equal length whose other ends were soldered into a male octal plug made from the base of a burned-out tube. The whole operation did not take over half an hour, and the performance of the set was in no way affected by moving the tube.

Next, the bracket assembly which holds the yoke and focus coil was moved forward $3/4$ inch by drilling four new mounting holes. Four tubular metal spacers $1/4$ inch high were used to raise the bracket assembly in its new location. The details are shown in Fig. 6.

The chassis was put back in the cab-

inet and bolted in place. The picture tube was inserted, and then the front of the cabinet was put in place temporarily so that the proper location of the picture tube—fore and aft—could be determined. The face of the tube should not quite touch the safety glass insert. With the picture tube properly positioned, the yoke cradle was adjusted to bring the yoke as far forward as possible on the neck of the tube. (Because of the winding configuration of the 70-degree yoke, it may be necessary to remove the original rubber bumpers from the yoke cradle to get the necessary room.)

To bring the focus coil closer to the yoke, it is necessary to shorten the three springs and bolts which hold the focus-coil bracket to the cradle. The springs were cut down to about $1/2$ inch in length, and the bolts to about 1 inch. A new *single-magnet* ion trap was then installed.

To hold the tube more securely in position, we wedged another block of wood—also rubber lined—between the top of the tube and the ceiling of the cabinet. This can be seen in Fig. 3.

For a mask we used a large cream-colored mat of the type available from most camera supply houses. An outline of the useful screen area was made on the mat and then carefully cut out with a single-edge razor blade. This mask was fastened to the inner wooden panel with four screws and washers, as it must be removable. It is shown in Fig. 7. There may be a commercially available open-face mask which can be adapted easily to this conversion. If a solid plexiglass mask is used, it may be necessary to remove the pane of safety-glass which is in the front frame.

RCA made a number of different models using this same chassis. It should be possible to convert any of these other models following the procedure outlined in this article. The same holds true for the 16-inch models in the preceding 8T series.

—end—

HOW TO FIX YOUR OWN TELEVISION SET



Copyright, 1952, New York Herald Tribune Inc.

When Lightning Strikes the Lead-In

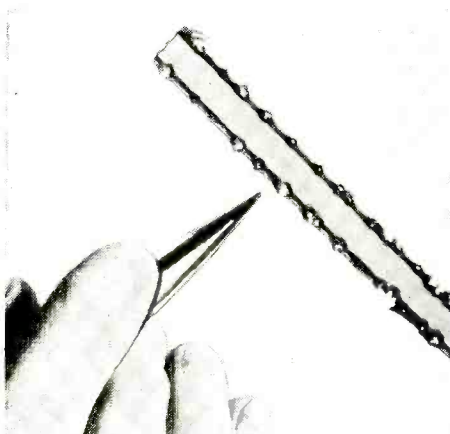

Lightning struck this section of Twin-Lead, and this is what happened. The polyethylene body of the line is relatively untouched, but the copper conductors are completely vaporized, and the insulation covering them is melted.

This is just a mild illustration of what lightning can do. Proper grounding of TV antennas and masts will do much to prevent this and worse damage to antennas, masts, receivers and homes or shops.

TV DX FOR MAY

EVERYONE looks forward to May, and no one more than TV dx enthusiasts and the hams who operate on the v.h.f. bands, for while "spring is busting out all over," so is sporadic-E dx. After dragging through eight months when dx has been infrequent at best, owners of TV sets almost anywhere in North America should be able to bring in strong signals intermittently during late April, and more frequently in May. Generally warmer weather will also have a beneficial effect on local coverage, and fringe-area signals will begin their climb toward the summertime peak.

The most common low-band dx reception will take place over distances between 600 and 1,200 miles, tending toward the higher figure at first, then coming in closer in the latter part of the month. Most dx will be caught in the early evening, though viewers who have an opportunity to make daytime checks will find the morning hours worth watching closely. The low spot of the day will most probably be in the late afternoon, and most evening openings will fade out before 11 pm local time. Channels 2, 3, and 4 will be affected most often.

Exact date and time prediction is still largely in the crystal-gazing category, but the observer himself can make his own predictions for May by recording results in April. If pronounced dx develops in April, look for recurrences 27 to 28 days later. The May recurrence should be longer and more widespread than its April predecessor. Current indications are that a break may occur—at least in Southern states—between April 28 and May 2. There should be a good period around the middle of the month, and probably the best dx so far in 1952 during the last week of May.

As weather gets steadily warmer, tropospheric propagation will improve. Areas that have had snowy reception from distances of 100 miles or more in the winter months will note considerable rise in average signal level on all channels, and there will be the first signs of "ducting" on the high channels, making possible occasional reception over distances up to 500 miles or more on channels 7 to 13. Considerable co-channel interference can be expected in areas where there have been frequency reassignments within 150 miles or less. The cure, of course, is an antenna system of higher directivity to knock down the signal from the unwanted direction.

In locations where there is dense foliage, signal levels may be lower when the leaves make their appearance. Raising the antenna to clear nearby trees may be desirable, but in many instances the improved propagation of the spring season will counterbalance foliage losses.

—end—

Courtesy American Phenolic Corp.

TV SERVICE CLINIC

Conducted By
MATTHEW MANDL*

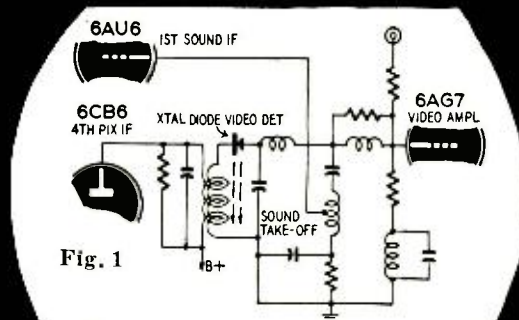

Fig. 1

Picture detector and sound take-off circuits in RCA KCS-66A series.

OFTEN readers of the Television Clinic forward information to us regarding unusual servicing problems. On other occasions they report discovering some little trick which overcame a particularly tough problem. On occasion we will pass these along so that the service technician can make notes of them and try corrective measures such as these when similar conditions are encountered.

A. D. Marikle of New York reports an unusual symptom in the RCA KCS-66A series receivers. He has encountered conditions where the receiver has a normal raster, fair or even good sound, but no picture. Normally this would indicate trouble *after* sound take-off. In three instances, however, he has found this trouble to be a defective 1N60 crystal diode video detector as shown in Fig. 1. This would not ordinarily be suspected, as the sound take-off is *beyond* the detector circuit. Evidently the rectifying action of these crystals can decline considerably but still permit heterodyning of sound and picture signals to secure the necessary 4.5-mc frequency for the sound i.f. stages.

M. Savka of Newark, N. J. found a method for minimizing afterglow effects in the Hallicrafters 600 receiver. In this model, as with many others, the afterglow is centered on the screen after the set is shut off, and remains there while slowly dimming out. Our reader found that a very slight rotation of the ion trap a few degrees in one direction or another altered the afterglow condition. The slight adjustment was sufficient to cause the afterglow to sweep upward and disappear as soon as the set was shut off. There is usually sufficient latitude with regard to a few degrees rotation of the ion trap where brightness is not diminished. This depends on gun structure and circuit design and will not work with all receivers.

J. K. Cross of Greenwich, Connecticut, has found a way to eliminate the foldover which often occurs on the Philco 48-1000 after conversion.

In several instances he has encountered severe foldover after converting these models and tried all normal solutions without help. Eventually he found that these receivers have a very fast inherent flyback time. Ordinary horizontal output transformers having longer retrace cause a portion of the retrace to be unblanked. Our reader found that by using a voltage doubling type of horizontal output transformer, the Q difference permitted the flyback time to be more nearly that required by the receiver.

He used a RCA 218T1 transformer with matching yoke, driving a 20-inch tube. This eliminated the foldover though he found that the drive was rather sensitive. He corrected this by making the 820- μ f capacitor a variable padder. This is in the plate circuit of the horizontal oscillator. With these components he gets sufficient drive for a 6CD6 without instability or overheating. One of these converted sets has been in use for over a year without any trouble.

Pincushion effect

I am running into a severely distorted picture in a Trav-ler 64-R50 receiver. The sides of the picture are bent to resemble pincushion effect. I have checked the focus coil, changed the ion traps, and replaced all tubes.

I have also checked the components in the horizontal and vertical sweep systems without finding the trouble. C. W. B., Marshalltown, Iowa.

The pincushion effect which you are experiencing in the Trav-ler 64-R50 receiver could be caused by a defective deflection yoke. Often shorted turns in a yoke will produce this condition as shown in Fig. 2. Pincushion and barrel effect can also be caused by a mismatch between the horizontal output transformer and the yoke.

You should also check to see that there is no magnetic field too close to the picture tube. Make sure the speaker and the transformers are not creating magnetic fields which would cause picture distortion. (A small pincushion effect is a normal characteristic of

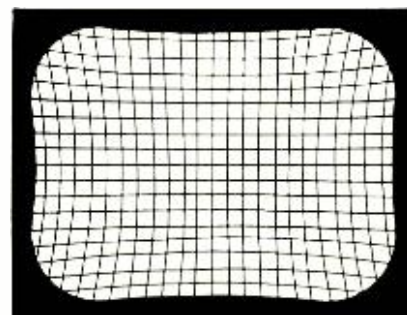

Fig. 2—Cross-hatch pattern showing the "pincushion" effect discussed in the text.

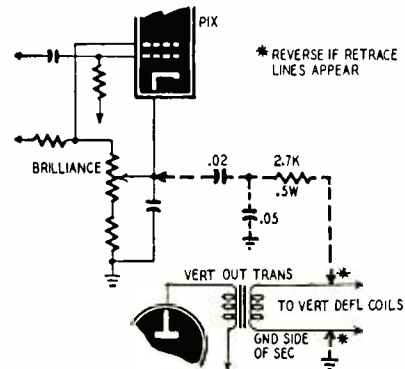

Fig. 3—Vertical retrace-eliminating circuit adaptable to many TV receivers.

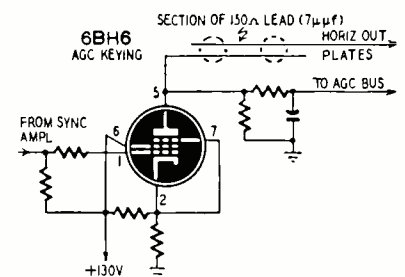

Fig. 4—Schematic of the keyed a.g.c. circuit used in Westinghouse model H609T10.

most high-efficiency 70-degree deflection yokes, especially those with cosine-type windings. The picture size is

*Author: Mandl's Television Servicing.

usually adjusted so that the concave edges are outside the mask.)

You mention changing all tubes and presumably you have tried a new horizontal output tube as well as a new high-voltage rectifier tube. Decreased emission from these tubes can cause some blooming and also picture distortion.

Split-sound buzz

In an RCA 6T54 a hum or buzz is heard which is produced at most of the settings of the fine-tuning control. The adjustment is critical and the buzz can be minimized only at one narrow point. Also the point of best picture reception is not the best point for sound, and this is the case for all stations. H. S., Brooklyn, N. Y.

This seems to indicate improper tracking in the tuner. With the tuner frequency adjusted to favor one segment of the bandpass over the other, the hum or buzz becomes more pronounced. This is not an intercarrier receiver, and therefore the buzz you experienced would be of the tunable type caused by detuning from the correct relationship between picture and sound. You should check the tracking and also the alignment of the receiver with your sweep generator, marker, and scope, against those shown in the schematic for this receiver. Also try a new tube in the local oscillator stage of the tuner, for you may be getting tunable hum. This is caused by a heater-cathode short or leakage in the local oscillator tube.

Retrace elimination

I would like to eliminate the vertical retrace which occasionally appears. The receiver is a Tele-King model 410. D. S. W., Kent, Ohio.

Fig. 3 is a retrace eliminating circuit which can be added to the Tele-King 410. The portion of the schematic in broken lines represents the additions to be made to the present circuit.

Arcing at grounding springs

In a DeWald receiver, the original 10-inch tube has been replaced with a 12LP4 with no other changes. The receiver worked well for a year but suddenly started to arc around the corona ring and between the picture tube graphite coating and the two grounding springs at the yoke. I cleaned the corona ring and changed the 1B3-GT as well as the 6BG6-G without improvement. Inserting insulation between the corona ring and the high-voltage tube socket stopped the arcing there but it still arcs at the grounding springs. The arcing increases as the brightness control is advanced. M. W., Detroit, Mich.

The cause of these symptoms is often poor contact between the grounding springs and the graphite coating of the tube. Sometimes the grounding springs wear away portions of the graphite coating and do not make good contact. A high-voltage charge accumulates on the surface of the tube, and arcing will thus occur. You should check the

graphite coating to see whether it is intact at the grounding springs. If it is worn, replace with graphite dope available at your local distributor. You could also rotate the tube slightly to present an unbroken graphite surface area to the contact springs.

Inasmuch as you have changed associated tubes such as the 1B3-GT and 6BG6-G, the only other condition which might cause this would be a defective picture tube.

Intermittent raster

On an RCA 721 receiver, operation is normal for the first few minutes; then the raster and picture disappear. The sound remains during this condition. Variation of the brightness control restores the picture but focus seems to be affected and if the control is advanced to a greater degree the picture disappears. E. S. S., Hammond, Ind.

The last video amplifier of this receiver is directly coupled to the picture-tube grid. This means that both the grid and the cathode are at a positive d.c. voltage but that the grid must be less positive than the cathode so that the proper negative bias will be established. If this relationship has been upset it could cause the condition you describe. You should check the grid and cathode voltages and related component parts to see that there is proper negative bias between grid and cathode of the picture tube. After warmup, troubles often develop in the tubes, capacitors, etc. The grid should have a 70-volt plus potential on it, while the B+ feed to the brightness control should be 225 volts. Also check the brightness control for defects and check for an intermittent 100,000-ohm resistor from the brightness control to ground.

Also test the 1B3 and 6BG6 tubes. If voltages, tubes, and parts check normal, the trouble could be a defective picture tube.

Transmission line

I have heard that a 300-ohm transmission line can be taped down along the pipe mast of the antenna for a distance to offset automobile ignition and other interference. Does this procedure minimize noise pickup because of the mast acting as a shield? S. F. P., Boynton Beach, Fla.

Taping the transmission line to the pipe mast is not recommended because the shunt capacitance from the line to the mast would cut down the signal strength. The higher the channel frequency the more noticeable the loss would become because the shunt reactance would be reduced.

To reduce noise, give the line a twist every foot or so along its length. This cuts interference pickup from the line by about 30%. Coaxial cable can be used if the signal strength is sufficient to overcome the losses in the coaxial line.

Intermittent channel 2

On an RCA 9TC24T receiver the picture and sound blank out intermittently on channel 2. All other channels function normally. If I turn the selector switch slightly on channel 2 it occasionally restores normal picture and sound though some microphonics are present. I have cleaned the switch contact terminals with carbon tetrachloride but this only restored normal operation for a short time. Can you suggest other procedures? D. P., Red Bank, N. J.

The fact that the cleansing with carbon tetrachloride restored the set to normal operation for a while indicates that you have localized the source of trouble. Carbon tetrachloride will clean the contacts but provides no means of maintaining good electrical connection. Most technicians use one of the several chemical compounds available at wholesalers for this purpose. These contact cleaning fluids leave a slight deposit on the contacts which acts as a combination lubricant and electrical contact element.

Defects in a.g.c.

In a Westinghouse model H-609T10 receiver there is intermittent picture and sound, though the raster remains during this time. After one-half hour of continuous operation the set functions normally, but only for a short time. I checked voltages and they all indicated proper values. When I place a meter from ground to the a.g.c. circuit, both picture and sound reappear but there is loss of vertical and horizontal sweep. Upon removal of the meter, picture and sound again disappear. Tubes check all right but if the keyed-a.g.c. 6BH6 tube is removed, picture and sound come in normally but with poor horizontal and vertical synchronization. What could cause this trouble? H. W. H., St. Louis, Mo.

The fact that both picture and sound reappear when you apply a meter to the a.g.c. circuit would indicate that the resistance of the test equipment is establishing sufficient continuity in the a.g.c. circuit and partially correcting for defects therein. The lack of sync stability under such a condition indicates insufficient bias and overload of the subsequent circuits. The same condition prevails when you remove the a.g.c. tube. You should try a new 6BH6 a.g.c. tube and also check for defective resistors and capacitors in this circuit. This model uses a section of transmission line for coupling the horizontal pulse to the plate of the a.g.c. tube. The transmission line (Fig. 4) is used as a capacitor. Measure the voltage along the a.g.c. bus. Test to see whether the a.g.c. voltage varies as you tune over the different channels. Check at the grids of the r.f. amplifier and picture i.f. tubes. It would appear that the defect is causing excessive bias and cutting off these tubes, thus obliterating both the picture and sound.

—end—

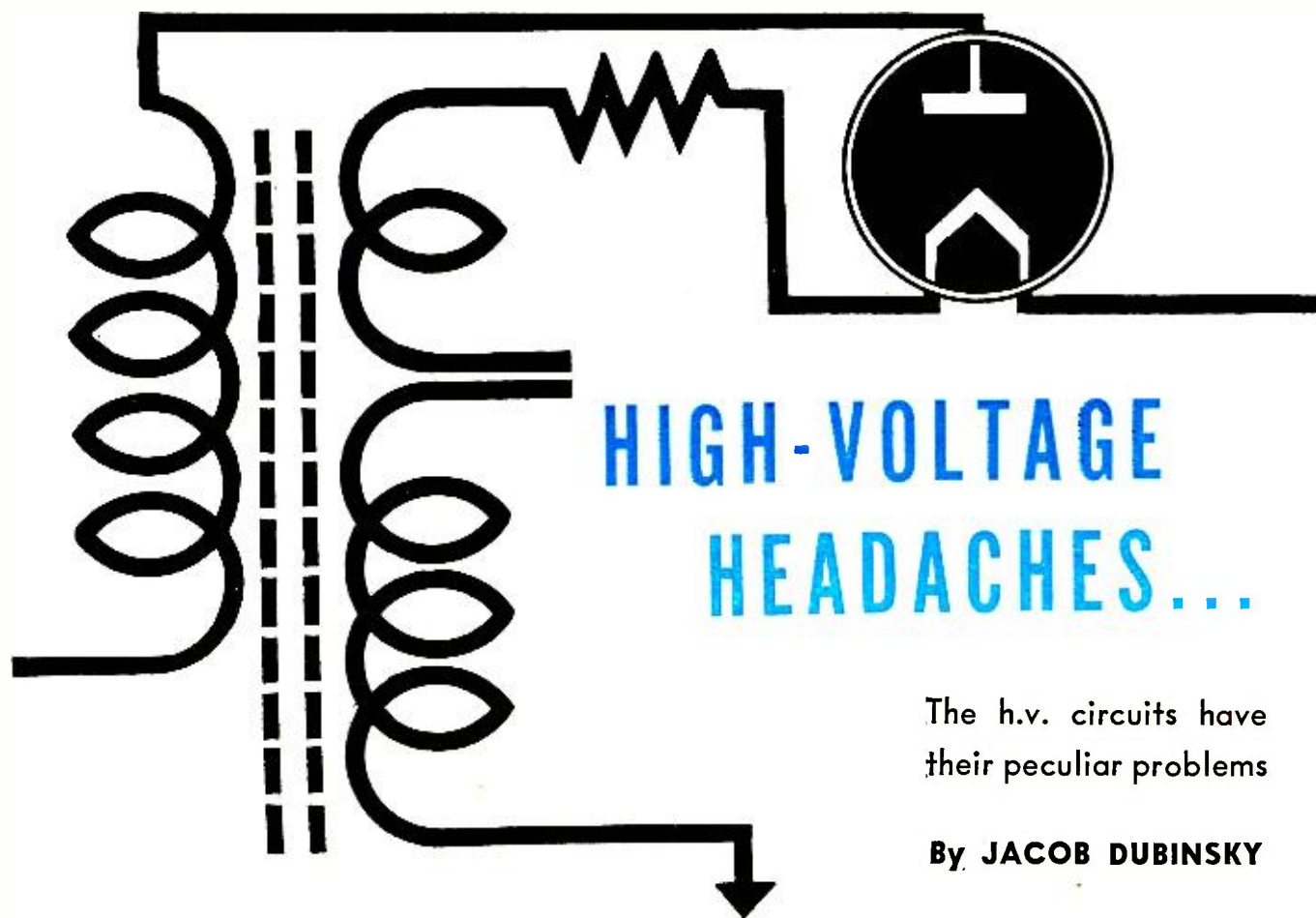

HIGH-VOLTAGE HEADACHES...

The h.v. circuits have their peculiar problems

By JACOB DUBINSKY

HAVING read practically every article and book on the subject of television servicing in the field, I have been struck by the fact that few really gave any hints on how to service a set which shows no picture.

The vast majority of troubles of this kind (high-voltage or otherwise) will be found due to defective, weak, or gassy tubes. Obviously the best set made will not operate with bad tubes, and no competent technician will start ripping a set apart before he has assured himself that the tubes are O.K., either by using a tube checker or by replacement of the suspected tube.

If tube replacement does not solve the problem, the logical procedure is to check for the presence of high voltage at the picture tube, and then work back through all preceding circuits. Typical troubles and their remedies follow:

Shorted high-voltage capacitors: This is rare but does happen, especially in the long plastic capacitors used in Philco, Stromberg-Carlson, and others. Replace, of course.

Defective or changed-value resistors: Usually output is through a 500,000-ohm to 1-megohm filter resistor. Replace with heavier unit or with lower resistance. The filament winding for the rectifier tube often has a 2- or 3-ohm resistor in series with the 1B3-GT. These often change value. These

resistors are also responsible for picture blooming. A common cause of trouble in high-voltage doubler and tripler circuits is the charging resistor running from the filament of one 1B3 to the plate of the other. This resistor, generally 2 megohms, is shown in Fig. 1. An inexpensive and permanent repair is to replace it with three 680,000-ohm, 2-watt resistors in series. Be careful in soldering the resistors together and in making the circuit connections. Make round smooth joints and solder with short leads. Keep the resistors well away from other units and especially from the 6BG6. I have seen them arc over to the 6BG6 and actually burn a hole in the tube.

Here one can be fooled. While servicing a Crosley 12-inch receiver, I did get a heavy spark on the high-voltage lead and still the picture refused to come on. The trouble was a shorted 1X2-A which was feeding a.c. to the picture tube.

Ordinary troubles in the output stage would be:

Blown fuse. The ¼-amp fuse often burns out. Replace with same size fuse. Most service technicians use a clip-on holder and place the new fuse in the holder. I prefer soldering a single fuse holder to the terminals of the blown fuse and replacing the fuse. This makes a permanent job and does not take up the space of the other method.

Cathode resistor of the horizontal output tube often changes value or burns out. This unit should be at least 2 watts. I often use two 2-watt resistors in parallel to make a good heavy-duty 4-watt resistor.

Defective flyback or r.f. coil. An internal short sometimes can be seen by turning off the lights. A tiny pinpoint of white light will give it away.

Shorted or arcing lead. These can be cured by painting with high-voltage dope or by placing additional insulation between the leads.

And now we come to the damper circuit. In most sets, the damper tube actually supplies the primary of the flyback transformer with its plate voltage. Obviously, if the tube is weak or defective the high voltage will be out. An open or grounded linearity coil will also stop the high voltage. I have seen dozens of linearity, width, and ringing coils shorted to the slug. The result is a dead B-plus short with red-hot 5U4's or blown fuses.

Common sources of trouble are the two capacitors across the linearity coil.

If we have tested all these units and replaced them if necessary, we should now have our high voltage. But here again we may still find no picture.

I spent a good many hours on a Capehart 17-inch job in the customer's home, and although everything tested fine, there was no high voltage. Finally I

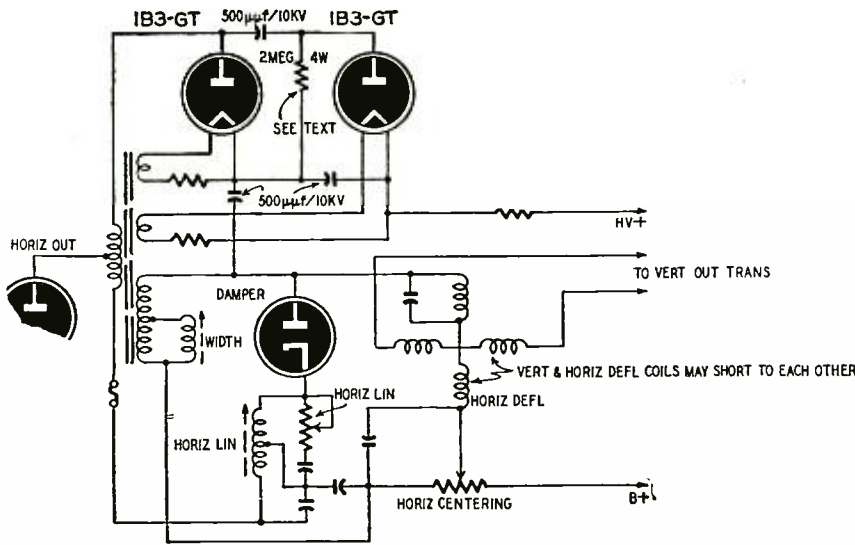
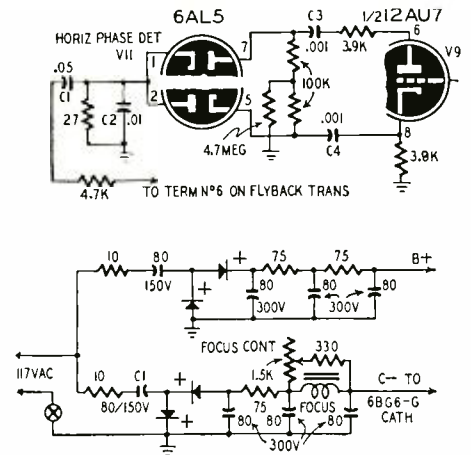

Fig. 1

The resistor marked "See Text" is responsible for many breakdowns.

Fig. 2, top—How "unrelated" circuits can cause trouble. Fig. 3, below—An intermittent with an uncommon cause.



removed the chassis to the shop, leaving the picture tube and deflection coils in the cabinet.

The set was tested and the high voltage was fine. The set was gone over with a fine-tooth comb. No intermittent units could be found. Returned the set and connected it up. Again no high voltage. The trouble was caused by a short in the deflection yoke between the horizontal and vertical coils.

Oscilloscope methods

Tracking down lack of high-voltage sweep in the earlier stages with an oscilloscope is a simple matter. If the sawtooth generator is operating improperly, or not at all, the trouble may be in the Synchrolok coil, the horizontal blocking-oscillator coil, the ringing coil, or any of the various methods used to get the initial sawtooth charge. Of course open or shorted capacitors or changed-value resistors anywhere in those circuits should not be too difficult to track down.

If the oscillator is working, the next step is to check the signal through the coupling capacitors, grid resistors, and input circuits right up to the output tube.

In a Muntz set, lack of horizontal oscillation was traced to a breakdown of the mica in the horizontal drive padding capacitor. The wise technician will always check those horizontal drive

capacitors and circuits as well as horizontal drive variable resistors.

An instance where an apparently unrelated circuit can cause loss of high voltage was found in an Artone. This set is made by Tele King and there are thousands of them about. They are also called the A. & S. Lyrtone. The phase-detector circuit in this set is shown in Fig. 2.

Capacitors C2, C3, and C4 break down often. These immediately kill the high voltage. A breakdown of C1 will burn out the 27,000-ohm resistor, too. Another cause of intermittent high voltage is a 120-µmf capacitor across terminals 4 and 5 of the high-voltage (flyback) transformer.

Servicing high-voltage intermittents can be quite a headache. The real rogue in this picture is the 1B3 or the 1X2-A. The tubes become intermittent and if in doubt, replace same. Don't fool around—replace both high-voltage rectifiers and the horizontal output tube.

Another source of intermittent picture loss is a loose connection at the base of the picture tube. If the tube fails to light, check the socket connections and the tube base. Quite often you can effect permanent cures by resoldering the pins. Lay the set face down on the floor. Use a cushion or a couple of books to protect the cabinet or knobs. Now you can resolder the tube base pins and the solder will run

down and make a very good contact.

One of the writer's unusual experiences was with a 12-inch Emerson model 571. The complaint was intermittent high voltage. On the first call, the 6BG6 and the 1B3 were replaced and the high voltage came on fine. All sorts of checks were made and the set worked fine. Two days later came the same complaint.

The set was removed from the cabinet and voltages were checked against the Emerson Service Manual. The 6BG6 tube voltages were incorrect.

The i.f. and audio circuits all showed proper voltages. The trouble was traced to an open 80-µf, 150-volt electrolytic capacitor (C1 in Fig. 3). This open capacitor cut off the power supply to the sweep circuits without affecting the video and audio circuits.

Narrow pictures that cannot be widened may be caused by shorted turns in the flyback transformer or in the deflection yoke. If in doubt try a good yoke or transformer. On a recent job on a 12-inch Sylvania set with r.f. high-voltage supply the picture could not be widened. I found both the deflection yoke and horizontal output transformer defective. Rather than go to the expense of replacing both these units, I changed the entire high-voltage system to a standard flyback type. The picture worked out fine.

—end—

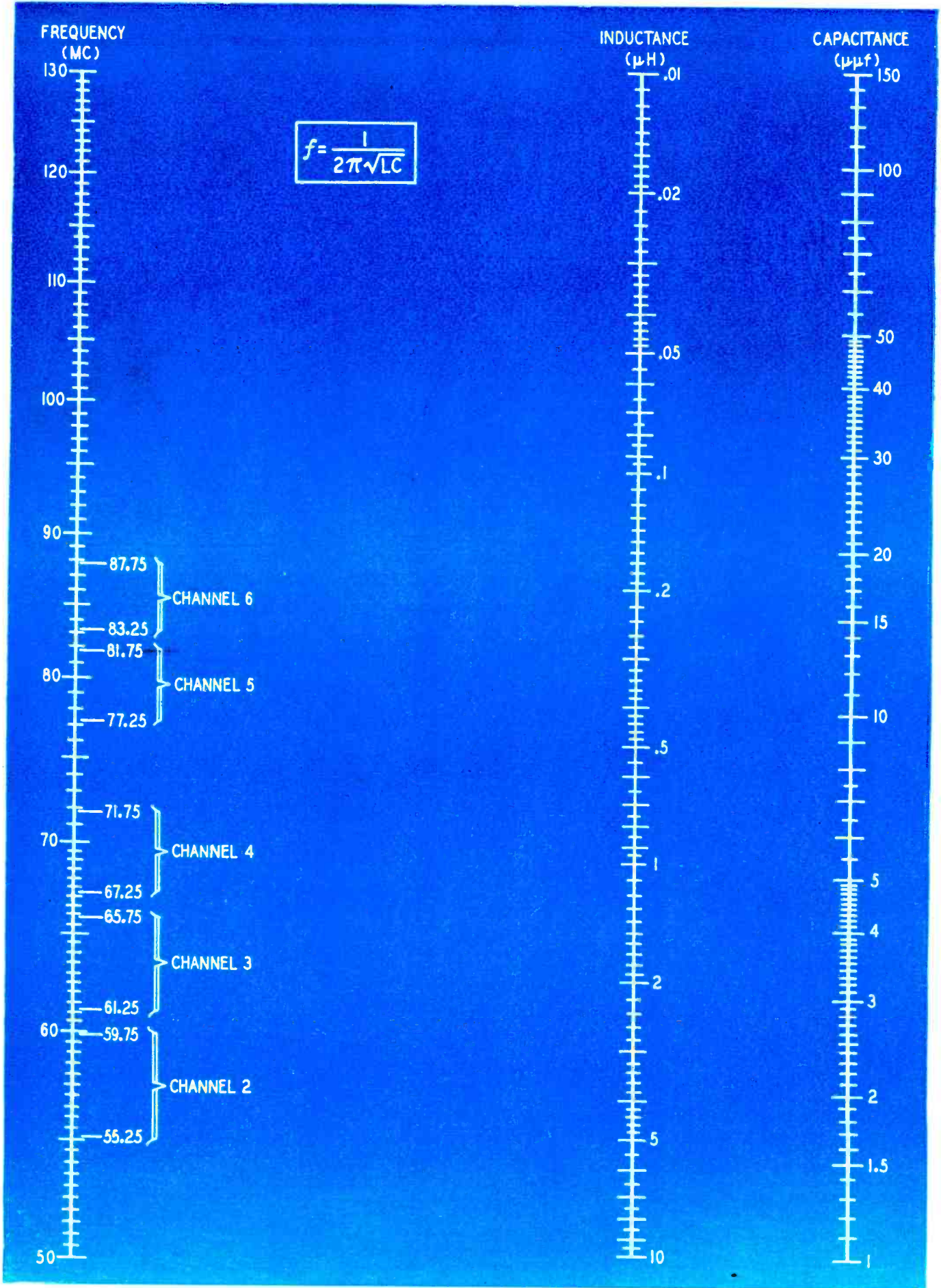

Nomograph for computing TVI filters

Courtesy Radio Corporation of America

RADIO-ELECTRONICS

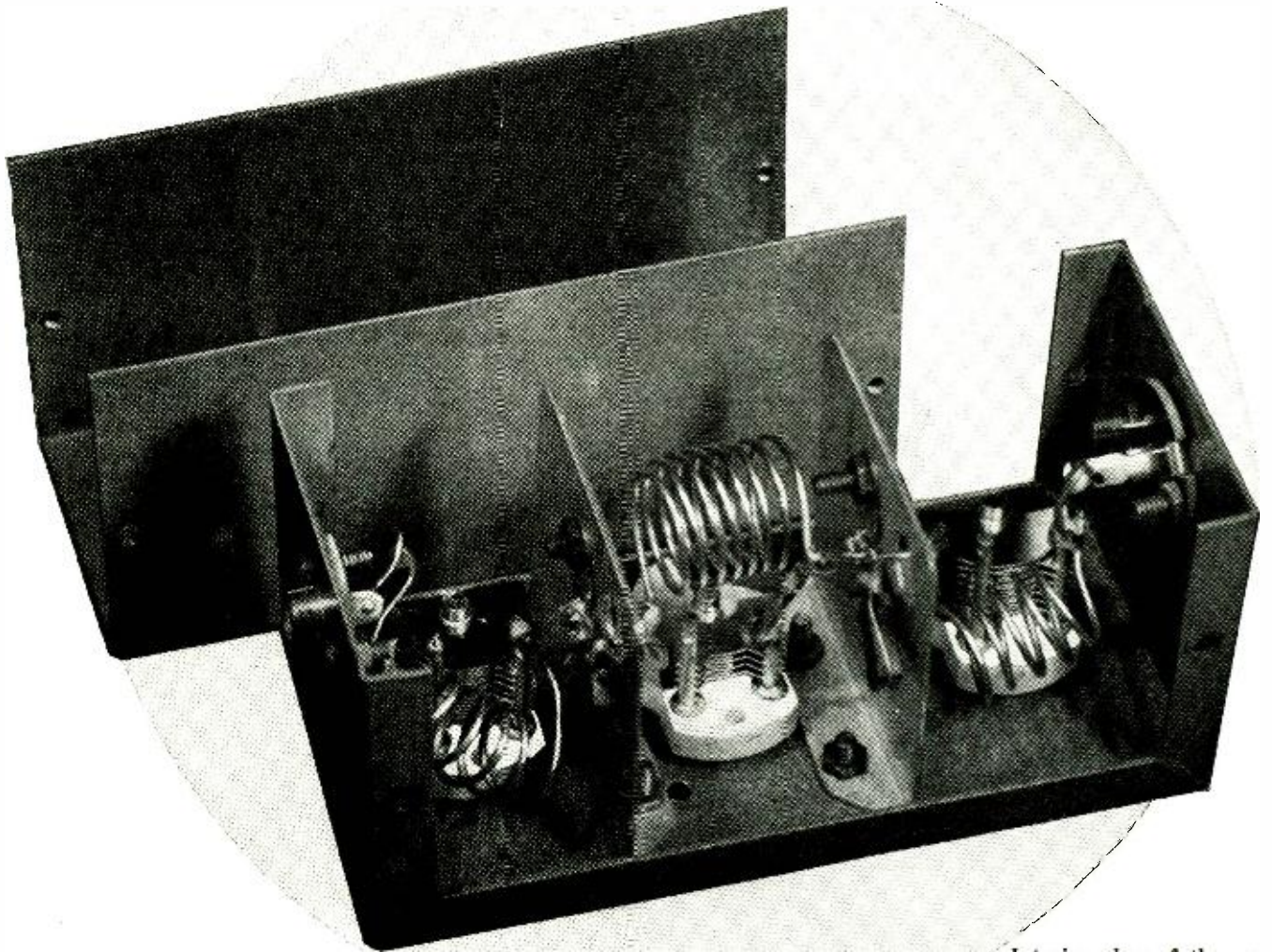

Interior view of the complete TVI harmonic filter.

PRACTICAL TVI FILTER

The XYL's TV set can help you design low-pass filters for your transmitter

By JIM OWENS, W2FTW*

NINE-TENTHS of all the TV interference attributed to amateur operation is the fault of the television receiver itself. Deficient rejection permits signals to ride through on the set's intermediate frequency. In all such cases the FCC will back up the amateur. If he is so operating that a well-engineered TV set within 100 feet of the transmitter

produces a perfect picture on all channels, the owner of the set is advised to install filters to prevent signals on his intermediate frequency from getting through the front end. (See "TV I.F. Interference," RADIO-ELECTRONICS, February, 1952.)

In some cases the amateur is actually radiating harmonics which fall in the television band. In this event, the only remedy is to annihilate the harmonic. A low-pass filter in the feeder is indicated.

The construction of a TVI low-pass filter for your transmitter is simple. All you need to do is to follow the instructions and then line it up with a Q-meter or accurate grid-dip meter. If you don't have either of these expensive pieces of test equipment (each of which costs more than a manufactured TVI low-pass filter) maybe you can borrow one. If you can't borrow one, you are right back where you started, unless you can find some other way to do the job.

*Manager, Test Equipment Renewal Sales Section, Tube Department, Radio Corporation of America, Harrison, N. J.

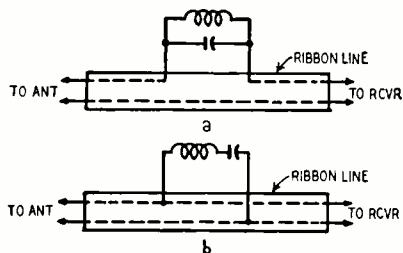

Fig. 1—Circuits for adjusting filter with TV receiver.

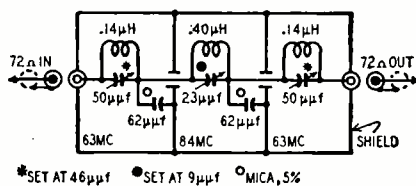

Fig. 2—Schematic diagram of the TVI filter unit.

Now we come to the substance of this article. There is another way—or let us say other equipment—that can be used for the alignment procedure. You simply make use of the XYL's television set.

Tuning to frequency

To start with an example, suppose your calculations call for a resonant circuit composed of an inductor and capacitor, both of nonstandard values (like $0.14 \mu\text{H}$ or $9 \mu\text{mF}$). The capacitor presents no serious problem. You will probably use a variable air capacitor, and will be able to set it close enough to the specified value by estimating the percentage of plate mesh as a percentage of total capacitance. The inductor may present much greater difficulty. Winding a coil to a fairly close approximation of the specified value of inductance in microhenries is not easy. Even if you could get the coil to within say 20% of its proper value, the combined error of both capacitor and inductor could add up to a large figure so that the circuit would be completely ineffective as a TVI low-pass filter.

Fortunately, there is a very simple way to get this filter tuned to the exact frequency. If it happens to be a parallel network, all you have to do is insert it in one side of the transmission line to the TV receiver as in Fig. 1-a. If it's a series resonant circuit, you connect it directly across the TV set antenna transmission line. See Fig. 1-b.

The next step is to set the receiver to the r.f. channel in which the filter is supposed to be resonant. Then you adjust the capacitor to the point where the TV signal is attenuated and the picture rolls or tears. At this point, you will note that the capacitor seems to be meshed too much or too little to provide the specified value of capacitance, so you prune the coil or wind a larger one, then repeat the tuning process. Fine adjustment of the coil inductance can be made by spreading or squeezing the turns of wire.

Incidentally, you can adjust the cir-

cuit to resonate at either the picture-carrier frequency or the sound-carrier frequency. When you tune it to the picture carrier, you can pull the picture out completely; when you tune it to the sound carrier, you can drop the sound level below the noise level.

Using this same procedure, you build and adjust all of the resonant circuits called for in the filter design. Then you mount them on a metal chassis, with shielding plates between each section. If possible, you shield the entire filter so that no radiation can take place. Of course, the mounting and shielding steps have disturbed the tuning of the individual resonant circuits, and some readjustment will be required for best performance. The filter is a shunt-derived low-pass type designed by A. M. Seybold, W2RYI. It is designed for a 72-ohm line and provides peak attenuation of harmonics interfering with channels 3 and 6. Its circuit is shown in Fig. 2.

The unit is constructed in a $5 \times 2\frac{1}{4} \times 2\frac{1}{4}$ -inch Eud Minibox with partition shields added. Refer to the photograph and note carefully the placement of all parts, particularly the two $62\text{-}\mu\text{mF}$ mica capacitors. Input and output connections are made through phono jacks and plugs.

Connect filter to set

The next and final step of the tuning procedure is to connect the complete filter in series with the transmission line to the TV set. If your filter was designed for use in series with a coaxial transmission line, and the TV set happens to be fed with balanced twin-lead, don't let it worry you. Cut the line and connect one of the wires to the ground side of the filter and the other one to the top or hot side of the filter, on both the input and output ends. Now you can tune the receiver to one channel after another and progressively touch up each section of the filter.

The only precaution to be observed in the tuning processes is to eliminate the effects of body capacitance and resistance. Don't touch the filter or filter

sections! Mount them on a piece of dry wood a few inches long to hold in one hand, and use a nonmetallic screwdriver to adjust the variable air capacitors with the other hand.

Adjusting inductors

In some filter designs, inductances which are not part of tuned circuits are specified. These inductors can be built and adjusted to their precise values by adding one additional step to the procedure. By using the nomograph, you can determine the value of capacitance in parallel required to resonate the specified inductance at one of the TV channel frequencies. After the tuning procedure has been completed, the inductor can be disconnected from the test capacitor and then soldered permanently into the circuit. Of course, you have to take care to avoid changing the shape of the inductor during the transfer.

This system of adjusting tuned circuits can be used for other purposes. For example, suppose you want to get additional attenuation of a powerful harmonic that falls right in one of the television channels. You decide to accomplish the objective by "sucking out" the harmonic with a parallel-tuned trap placed near the final amplifier tank coil, or connected in series with the plate lead to the final amplifier tube in the transmitter. This trap can be adjusted as described, by placing it in series with one side of the transmission line to the TV receiver, and tuning it to the sound or picture carrier or to a mid-point between the two, as desired.

Design data on low- and high-pass filters can be found in most radio engineering texts but if you are looking for practical stuff, you will find lots of it in Mack Seybold's articles in the August, 1947, and December, 1949, issues of *QST* and in an article by another author in the November-December, 1949 issue of *G-E Ham Tips*.

The elimination of TVI at the transmitter is not confined solely to the use of low-pass filters. The rig must be free from high-intensity harmonics and subharmonics of the output frequency. Adequate shielding and traps must be used to insure against direct radiation through space and radiation from the power lines.

(In some instances, there may be severe sound interference on all channels without any interference showing up in the picture. This type of BCI—well known to amateurs—is caused by rectifying the fundamental in the grid circuit of the first a.f. stage. The cure is to bypass the grid of this stage to ground with a small mica capacitor.—Editor)

A large number of other articles on television interference elimination have appeared in various technical publications. One book, *Television Interference*, contains reprints of 21 such articles and a bibliography of about 85 other articles and items on the subject. (25¢, Remington Rand Inc., 315 Fourth Ave., New York 10, N. Y., attention Miss Ann Smith.)—Editor

—end—

Small service
benches make for
big business

A BUSINESS BASED ON AUTO RADIO SERVICE

By ERIC LESLIE

OPERATED by a man-and-wife team, Lucien and Marie Merle, the Merle Radio Company of Plainfield, N. J., has followed a number of original lines ever since it started in 1934. The fruition of one of these is the subject of our cover this month. *No bench in Merle Radio has room for more than one man.* Although one of the service benches (used for television) is more than 20 feet long, it is still strictly a one-man working space. The bench shown on the cover is one of two used for auto radio servicing, and there are one each for home broadcast radios and for audio-record changer work.

Another original feature of the organization is that from its beginning it has been oriented primarily toward auto radio servicing. This was one of the factors leading toward the present bench system. In a period where auto radio service was almost universally performed in the mud behind the radio shop, Merle realized very early that "the place where the man works is important." Room was made for several cars *inside* the shop, and Merle had one of the first "drive-in" auto radio service shops in the country.

Once alerted to the value of excellent working surroundings, Merle began to see the disadvantages of the communal bench. Workers encroached on each other's territory. Technical—and other—discussions consumed valuable time. An inconsiderate technician could put the whole bench on edge. The shop still remembers when one man was laid off with a broken finger, due to "borrowing" one tool too many from a bench neighbor who was holding a wrench at the moment.

Nothing of that kind can happen now. With his own tools at hand, and with the "home feeling" of his private bench, each man can turn out more and better work. Specialization of instruments becomes possible, and while there is some necessary duplication, cost of extra instruments is more than offset by time saved, because no one has to wait for a piece of equipment.

When the company started business in 1934, practically all its business was installing and servicing radios for motor car dealers. In those days an installation was a two-man job and required from six to eight hours work. To assure a clean and workmanlike job, work was carefully divided between the installation men. One, the "greasy" partner, did all the under-the-hood work; the "clean" man stayed strictly inside the car. Such neatness and strict attention to good workmanship soon built prestige in a period which saw more than a little "brute-force" auto radio installation.

In those days, the auto radio could be sold to the dealer in whose car it was installed, and profits were made on sales as well as service. In 1935, Philco began making a radio for Ford, and Merle Radio was appointed a Philco factory installation and service station, with four men working on Philco-Ford jobs alone. Sales to car dealers were reduced increasingly through '36 and '37 as more auto manufacturers brought out their "own" radios, but rose again when Motorola brought out an auto radio for sale to radio dealers, independent auto sales or service organizations, or direct to motor car owners.

The war brought a drastic reduction in consumer auto (and other) radio production, together with a severe curtailment of auto travel. With Merle teaching radio for the Army at Rutgers University, Mrs. Merle ran the shop with a staff of two, and sometimes three elderly men. Merle Radio started to service home broadcast receivers for the first time. It was during this period that Mrs. Merle learned to service radios. This she no longer does, but she finds that her knowledge of components and their peculiarities and tolerances gained then is very useful to her as buyer for the shop.

The postwar auto radio boom necessitated keeping a staff of five to six men on installations alone. This happy period lasted until 1948, when the car manufacturers introduced their pres-

ent system, which tends to keep car radio business—both sales and service—in the hands of the factory or its regular dealers. This, Merle believes, was a great mistake, since it tended to disorganize the force of highly skilled auto radio service technicians who had come up with the industry. Few of them found work with the car dealers and auto repair shops—most shifted to other phases of radio work, in which they often earned far less than in their own specialty.

Television was an early interest of the company, and even before the war Merle Radio had a number of installations in taverns and other public places. At present one man is occupied with television service exclusively. Installations are farmed out to an independent organization, another original, but by no means exclusive, idea of the organization.

Success has followed the application of original technical systems and sound business methods. The company is now an authorized service branch and parts distributor for Philco, Motorola, Colonial, and Bendix. It is also the exclusive factory service agency for the Lincoln-Mercury works in nearby Metuchen, repairing all radios found defective in new cars or damaged in installation. The present staff consists of seven, plus the two owners.

The shop occupies a 35 x 90-foot space on Plainfield's Seventh Street, a main auto road, and less than a block from one of the city's main business streets. A little less than half the space is a salesroom devoted largely to television. The rear is the drive-in auto service shop. Television receivers, home radios, and audio equipment, all have their own separate benches in the basement.

Merle has just purchased the local FM station, WXNJ, and has an application for an AM station pending before the FCC. In thus uniting both ends of the chain of broadcast services the organization is certainly original—if not unique.

—end—

TV SERVICE WITH SIMPLE INSTRUMENTS

More procedures and suggestions for fast, efficient trouble shooting in television receiver circuits.

By CHARLES G. BUSCOMBE

THE first installment of this story in last month's RADIO-ELECTRONICS described TV troubles that could be found with the TV Service Aid (RADIO-ELECTRONICS, March, 1952, page 28) or with other simple test equipment. Troubles in the high- and low-voltage supplies and picture-tube circuits were covered. This month we will try to find troubles in the other parts of the TV receiver, beginning with the sweep circuits and working back through the i.f.'s to the front end.

Vertical sweep section. If unable to lock (even momentarily) with hold control, oscillator trouble is indicated. Substitute tube; check socket voltages to localize defective component; look for leaky coupling capacitors and changed resistor values. Where there is complete or partial loss of vertical deflection, determine whether oscillator or amplifier is at fault. One method is to feed 6 volts from heater circuit through a .25- μ f capacitor to amplifier grid. If height increases, amplifier is probably O.K. Presence of sawtooth at amplifier grid can also be determined by an a.c. voltage check or by coupling this point through a blocking capacitor to video or audio amplifier, using picture tube or speaker as an indicator.

If oscillator is at fault, check its components as mentioned above, not neglecting integrator network and coupling capacitor from sync circuits. Where manual control is possible for short intervals, and oscillator tube is O.K., it can be assumed that sync pulses have been lost or attenuated in preceding stages (sync amplifiers, separators, limiters, integrator or even in video stages). Where vertical amplifier is at fault and there is sufficient sawtooth drive on its grid, try tube sub-

stitution. Next check for sawtooth at amplifier plate, and if none, measure socket voltages and look especially for open cathode circuit, shorted cathode bypass, or open output transformer primary. If sawtooth is O.K. at plate, test for break in transformer secondary or vertical deflection yoke. Shorted yoke turns will produce a key-stone raster. In electrostatic sets, most tests are essentially the same except for R-C coupling to the picture tube.

In general, where symptoms are loss of height with sync instability (rolling), the oscillator and integrator circuits may be suspected. Where problem involves height and linearity, the amplifier or its output coupling is probably responsible.

Horizontal sweep section. If unable to lock the horizontal oscillator with hold control or other frequency adjustments, try tube substitution followed by the same socket voltage measurements and component tests mentioned for vertical oscillator troubles. If picture can be locked in but will not hold, or evinces pulling, bending, horizontal shift, jitter or tearing, trouble may lie in a.f.c. circuit or sync stages.

Drive is normally adjusted for maximum raster width and brilliance without vertical overdrive bars on screen. If width is excessive, use width control. If linearity is impaired, correct with linearity control or slight readjustment of drive. If drive adjustment causes loss of sync, correct with hold control.

If r.f. type h.v. supply is used and there is no horizontal deflection, trouble is in horizontal sweep circuit. For same symptom with flyback supply, transformer output winding, damper circuit or horizontal yoke can be

considered responsible.

In electrostatic sets, test horizontal output tube, output coupling capacitors, and load resistors.

Video amplifier and pix detector

Symptoms: Raster O.K., no picture; poor contrast; distorted pictures (smearing or phase reversals). Sound may or may not be impaired, depending on whether set is intercarrier or dual channel. Sync may or may not be unstable.

Start by substituting tubes, then if necessary apply signal tracing, using one or more of following methods:

(1) Inject audio to picture tube input (grid or cathode); attenuate signal and adjust brilliance and contrast controls until developed sound bars appear light gray. Feed signal to preceding points, noting increases or decreases in bar contrast. Continue as far as detector load resistor. Where there is no improvement in contrast between plate and grid of any tube, that stage can be considered at fault.

(2) Follow up by checking socket voltages, continuity of peaking coils, load resistor values, and low-frequency compensating components. Where raster brilliance is consistently too high or too low, and brightness control has negligible effect, look for defective coupling capacitor from video output to picture tube.

(3) With antenna connected and station tuned in, adjust tuner for maximum contrast. With signal tracer follow signal from detector load resistor through amplifier to picture-tube input, noting relative changes in level. Audible indication of this signal is of course the raspy tone commonly referred to as sync buzz.

The signal injection method of tracing can make use of an a.f. generator, neon relaxation oscillators, or sawtooth voltage taken from the vertical sweep oscillator through a blocking capacitor.

Sync circuits

Symptoms: Partial or complete loss of sync as evidenced by rolling, jitter, pulling, or tearing.

Assuming oscillators are running at correct frequencies and are capable of being triggered, determine if pulses are reaching point of sync takeoff by observation of sync and blanking bars on picture tube. This is done by adjusting hold or centering controls. By manipulating brilliance and contrast controls, sync bar should normally appear very dark against the gray background of the blanking bar. If not, a previous stage is responsible for at-

tical jitter or rolling when changing channels. Indications of horizontal stability are where hold control is not particularly critical and pix does not tear when channels are switched.

Picture i.f. amplifier

Possible symptoms (depending whether set is intercarrier or dual-channel): No pix, no sound; sound but no pix; poor pix contrast or resolution; pix smear with sync instability.

(The video amplifier can also be responsible for these symptoms, so it is up to the technician to decide which stage to investigate first.) In intercarrier models try tube substitution in all stages. In dual-channel receivers if sound is O.K. be concerned only with those tubes following sound take-off. The picture i.f. is prone to few troubles other than tube failure or misalignment. Occasionally, however, a

mentioned above. Signal crossover method may be employed by using crystal tracer probe between i.f. test point, and either audio or video amplifier inputs.

Where minor sound misalignment is apparent, a tolerable job of sound i.f. alignment can be done by ear. The procedure is to adjust the fine tuner for the best possible sound, then detune *slightly* in the direction necessary to obtain the best picture. Leaving tuner set on the edge of sound signal, adjust all tuned circuits in sound strip for maximum volume from speaker (not forgetting the sound takeoff trap). Again adjust tuner in direction of best picture, peaking tuned circuits again for loudest sound. Repeat as often as necessary until optimum picture and sound are received at one setting of fine tuner. Next step is to adjust secondary of discriminator transformer for minimum audio distortion and sync buzz. This method cannot be used on intercarrier receivers for the obvious reason that sound is fixed at 4.5 mc and misalignment of this strip will only weaken or distort the sound.

The front end tuner

Symptoms: Raster O.K., no picture, no sound; picture but no sound, or weak distorted sound; poor contrast with excessive snow.

If no sound or picture, particularly on high channels, but considerable interference from FM and auto ignition the oscillator is probably inoperative or badly mistuned. Replace the tube, and adjust oscillator slug or trimmer to bring in sound and picture.

Weak picture and sound and high noise level, may be due to a weak oscillator or defective mixer or r.f. tube. Try substitution. If no improvement, investigate for possible antenna trouble, such as change of orientation, loose or open connections, or a broken transmission line.

These symptoms on only one or two channels may indicate misalignment of r.f.-mixer adjustments. To verify this, try peaking them for improved picture contrast on a troublesome channel. (Final alignment of this section must be done with proper equipment, otherwise picture quality may be impaired.) Picture-sound mistracking cannot always be blamed on the tuner. However, a similar condition may prevail which tuner adjustments will correct. This is where picture is received at one extreme of tuner range and sound is either missing or weak and distorted. The procedure here calls for setting fine tuner at midposition, and adjusting the over-all oscillator slug for best sound and picture on the highest channel. Try all other channels and if necessary adjust their individual oscillator slugs without touching fine tuner. A little extra effort spent on this operation will please the customer, as it saves him the annoyance of having to manipulate the tuner every time a new channel is selected.

—end—

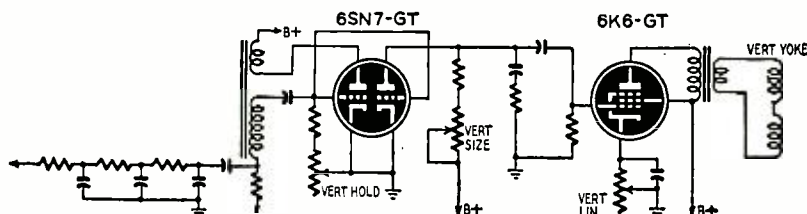

Typical vertical sweep circuit used in electromagnetic television receivers.

tenuation of sync voltage.

Try substitution of all sync-amplifier and separator tubes, including the a.f.c. control tube. Trace pulses from takeoff point up to inputs of vertical or horizontal oscillators. (Some attenuation normally results between input and output of clipper tubes.)

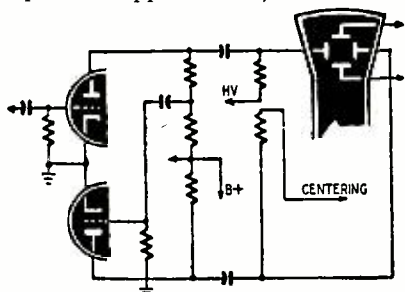

Electrostatic deflection output stage.

If pulses can be traced up to integrator, follow through integrator or a.f.c. (depending on whether vertical or horizontal sync is at fault). Substitution of the integrator is readily accomplished with one of the printed-circuit types. If necessary, check socket voltages of a.f.c. tube, followed by associated component testing. Particularly investigate feedback loop, then make various adjustments required.

Where hum bar appears on raster or in sound, trouble is often due to cathode-heater leakage in a video or sync tube or poor filtering in the low-voltage supply. These are very common causes of sync instability.

(A set should never be considered to have good sync unless the picture locks in abruptly with the vertical hold control and shows no signs of ver-

shorted screen bypass capacitor or a defective decoupling resistor may be responsible. The troublesome stage can be localized by signal tracing with one of following methods: (1) With antenna attached and set tuned to an operating channel, use crystal probe to follow signal from mixer output through various stages, toward detector. Trouble will be found in stage following point where signal was last recorded. (2) Inject a suitable signal into check points in the i.f. amplifier, working back from detector toward front end. An AM or sweep generator may be used for this purpose, or, lacking these, use a noise signal from the vertical sweep amplifier or damper plate with a suitable isolating resistor and capacitor in series with the lead.

Sound i.f. det.—audio

Symptoms (raster and picture O.K.): Sound may be completely lost, weak, or distorted.

If audio amplifier or speaker is suspected, touch hot end of volume control for the usual hum or growl. If not heard, try tube or speaker substitution. Next use signal tracing, employing neon oscillator or noise signal taken from vertical oscillator or damper. Another method is to feed signal through a small capacitor from different points in AF amplifier to the hot end of video detector load resistor. Sound bars on picture tube will indicate where signal is present. If a.f. section is O.K., first make certain that front-end oscillator is not mistuned, then proceed to trouble-shoot sound i.f. strip. This can be done with either a generator or noise signal as

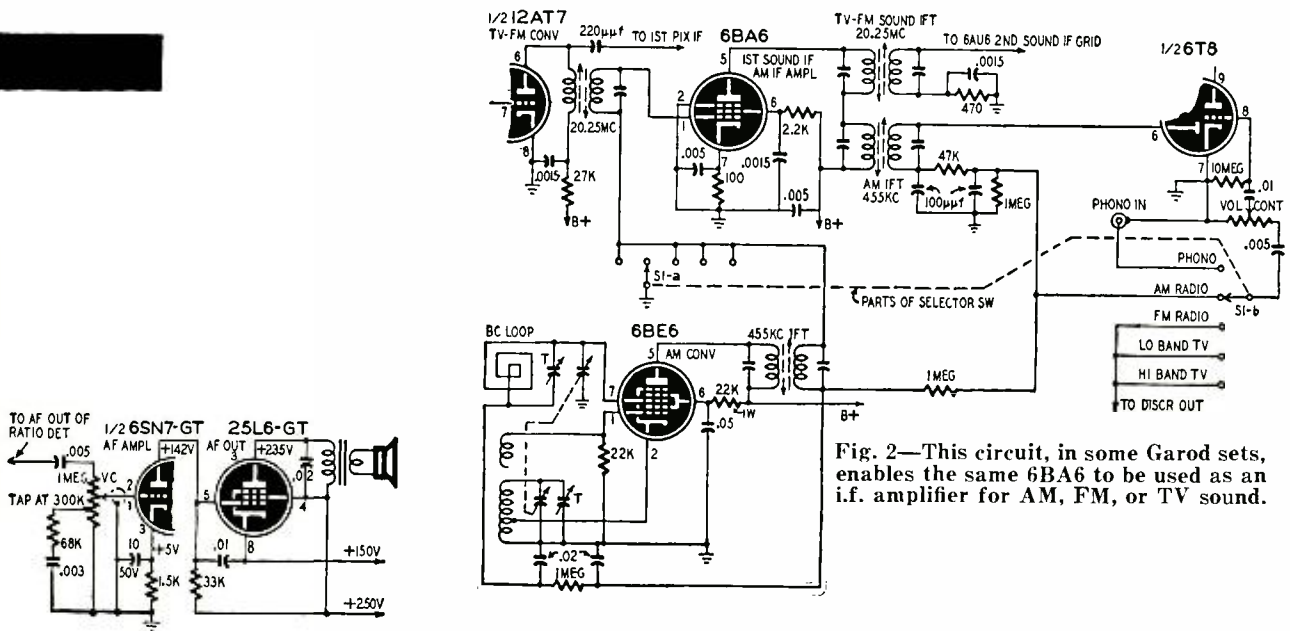

Fig. 1—Motorola direct-coupled audio.

Fig. 2—This circuit, in some Garod sets, enables the same 6BA6 to be used as an i.f. amplifier for AM, FM, or TV sound.

short circuits

By **ROBERT F. SCOTT**

New features in
sound and picture
circuits of current
TV receivers.

IN THE January, 1952, issue, we discussed some of the new and unusual circuits in this year's crop of TV sets. Last month, we covered some of the less familiar features and circuits of the current FM-AM combinations. This month, we have again concentrated on circuits in TV sets and will try to brief you on what to expect in the way of unusual circuitry in some of them.

Some of the old-timers in the service game remember the nights they spent sweating over some of the Loftin-White direct-coupled amplifiers, trying to get them to work as the designers said that they would. They probably recall the relief they felt as the last of those old-time troublemakers faded away into junk boxes, attics, and basements. Well, boys, I have news for you! The ghost of the direct-coupled audio

amplifier has come back to haunt us. But, it looks like the ghost is pretty well tamed now and won't be a bit of trouble. In the January issue, we discussed the direct-coupled circuit in the Bendix long-range chassis. Fig. 1 shows a somewhat similar circuit in the Motorola TS-314 and similar chassis.

The plate and screen grid of the 25L6-GT and the plate of the a.f. amplifier (one-half of a 6SN7-GT) are supplied from a source of 250 volts. The cathode of the 25L6 is returned to plus-150 volts. Under normal conditions, the 6SN7 draws enough current through the 33,000-ohm plate load resistor to bring the plate voltage—and the voltage on the grid of the 25L6—down to 142. Under these conditions, the cathode of the 25L6 is 8 volts positive with respect to the grid, thus providing the required 8 volts of bias.

Garod AM tuner

Whenever AM reception is included in a TV receiver, we usually find at least three extra tubes. In the 10T220, 12T220, and a few other chassis, Garod has worked out a neat trick which gives AM reception with only one extra tube. See Fig. 2. Existing tubes are used for other AM circuit functions.

The secondary of the first 455-kc AM i.f. transformer is in series with the secondary of the TV-FM converter transformer, so the 6BA6 first sound i.f. amplifier (20.25 mc) also functions

as the 455-kc AM i.f. amplifier. The primary of the 455-kc i.f. output transformer is in series with the plate circuit of this stage and develops the signal voltage when a 455-kc signal is fed into the grid. (Since parallel-resonant circuits have maximum impedance at resonance and negligible impedance at frequencies far removed from resonance, the tuned circuit not in use can be ignored.)

The secondary of the second 455-kc i.f. transformer feeds into one of the diodes of the 6T8 TV-FM discriminator and first a.f. amplifier. The output of the diode appears across the 47,000-ohm and 1-megohm resistors in series. The voltage at their junction is tapped off and fed through the volume control to the first a.f. amplifier and through a 1-megohm filter resistor to the a.v.c. line which controls the grids of the 6BE6 converter and the 6BA6 when operating at 455 kc.

When the selector switch is in the PHONO, FM or TV positions, S1-a grounds the control grid of the 6BA6 through the secondary of the TV-FM converter transformer. A separate section of the selector switch (not shown on the diagram) opens the B-plus line to the 6BE6 when receiving TV, FM, or operating the phonograph.

Westinghouse audio circuit

The average service technician takes audio circuits pretty much for granted.

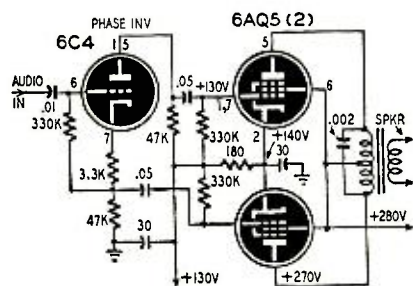

Fig. 3—Westinghouse "floating" audio.

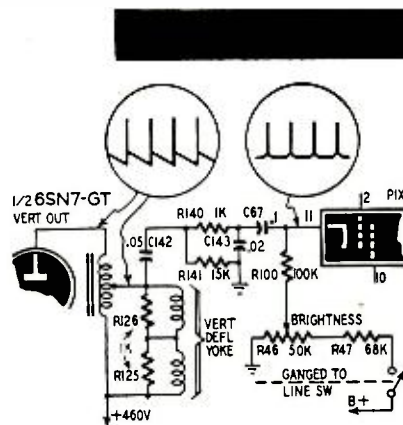

Fig. 4—Raytheon vertical retrace-blanking and h.v. spot-elimination circuits.

For example: In a push-pull cathode-biased stage, we expect the grids to be at ground potential with the cathodes only a few volts above ground (positive). We are so accustomed to the zero- or negative-potential control grid that we almost invariably start replacing coupling capacitors whenever we find a positive voltage there. A study of the audio circuits in some of the latest TV sets shows that the grids of some of the tubes are operated away up in the air, so you had better think first before using the old finger-on-the-grid technique of locating trouble in a dead audio circuit.

In Westinghouse models H-660C17 and H661C17, the push-pull 6AQ5 audio output tubes are used as parallel d.c. dropping resistors to reduce the B-plus voltage from 280 volts to 130 volts (Fig. 3). This lower voltage is for the i.f. and other stages of the receiver. The grid-cathode return point of the output stage is at a positive potential of 130 volts. The cathodes are biased for proper operation by the 10-volt drop developed across the 180-ohm cathode biasing resistor.

Raytheon beam blanking

Raytheon has incorporated into its latest sets two simple innovations which blank out vertical retrace lines and prevent the brilliant spot which normally occurs in the center of the screen shortly after the set is turned

off. These two blanking circuits are shown in Fig. 4.

Up to about a year ago, set manufacturers depended on the blanking signals from the TV station to blank out the vertical retrace lines and prevent them from appearing as light diagonal lines on the TV screen. Under ideal conditions, the blanking pulses from the station do the job rather effectively. But, when the signal level is low or when washed-out, weak film is being televised, or when some types of camera effects are used, retrace lines often appear and spoil what would otherwise be an acceptable picture.

To eliminate this, Raytheon and a number of other manufacturers use the pulse or overshoot which occurs at the end of each vertical sawtooth to blank out the beam during the retrace period. The vertical deflection signal (Fig. 4) is tapped off the vertical deflection yoke and the sawtooth component is removed by a differentiator consisting of C142 and R141. The resulting pulse is cleaned up by passing it through an integrator—R140 and C143—and then fed to the cathode of the picture tube.

This pulse is positive and has sufficient amplitude to bias the picture tube to cutoff during the retrace interval thus preventing the retrace lines from appearing on the picture or the raster.

Bright spot

When a TV set is turned off, the cathode of the picture tube continues to emit electrons for a considerable time until it cools. Since the drain on the high-voltage supply is negligible, its filter capacitor holds a charge for a long period of time. It is this charge which draws the undeflected electron stream to the center of the screen and causes the brilliant circle of light.

To eliminate this occurrence which sometimes burns the phosphor due to over-excitation, Raytheon has ganged a s.p.s.t. switch to the on-off switch on the volume control and connected it in series with the B-plus lead supplying fixed bias to the picture tube cathode.

When the set is operating, the switch is closed and the major portion of the operating bias is developed by the bleeder current flowing through R47 (Fig. 4) and the brightness control so the cathode current is comparatively low. When the switch is opened, the fixed bias is removed from the cathode. The anode current increases greatly and rapidly drains off the charge on the high-voltage filter capacitor. With this source of attraction removed, the electrons are not drawn to the screen.

This feature also provides a measure of protection for the service technician since it automatically discharges the high-voltage capacitor and the coating on the tube, eliminating a shock hazard.

—end—

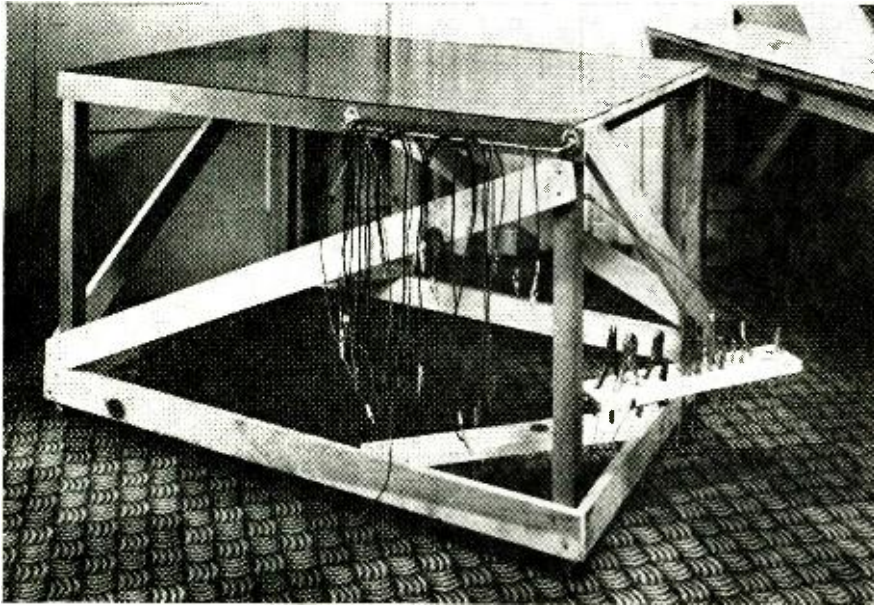

TV SERVICE TABLE

A rolling service table can add flexibility to any shop's workbench arrangements.

ROLLS UP TO BENCH

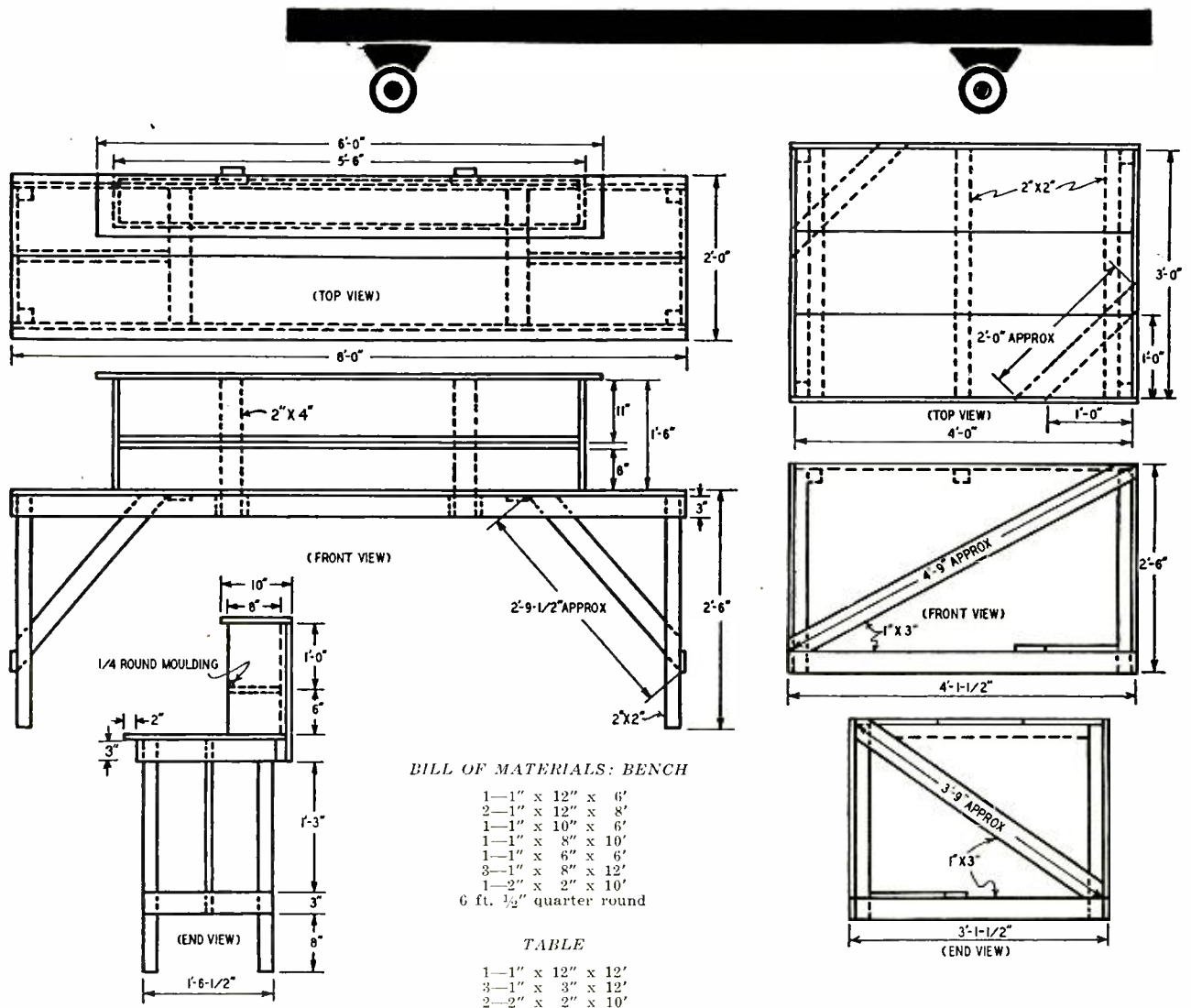

THIS service bench is only two feet deep instead of having the four foot depth found in many other benches. Four feet is an awkward reach when one is seated, and equipment markings are much harder to read at this distance. A two-foot bench will not accommodate a large chassis, but this problem has been solved by the use of the special service table described here.

This table is equipped with casters and can be easily moved to any part of the bench, or rotated when one wants to work on the opposite side of a chassis. Fastened to one of the legs of the table is an easily made swing-away type of tool rack which places tools within easy reach. Also mounted on the table is a towel rack which holds the many test leads used with the equipment.

The bench and table are covered with linoleum. A light pattern gives the bench a cheerful, modern appearance, and small parts are easily located. Small mats cut from excess linoleum are used under chassis to protect the bench and table tops. Waxing the linoleum will improve the appearance and help to protect the surface.

The bench itself is easily wired and is equipped with several surface-type outlets. The master switch is mounted on the bench lip. The advantage of a master switch should be noted. All instruments can be controlled from one point and once you get into the habit of turning this switch off when you leave the bench, you will no longer worry about forgetting to turn off some individual piece of equipment. For safety the wiring is fused for only 10 amperes.

Antenna and ground connections are brought to a barrier-type terminal strip mounted on the front lip of the bench. A television antenna connection is similarly made by means of a special jack.

A 6.3-v filament transformer is mounted under the bench surface which operates a small plug-in trouble light.

A most important factor in service bench design is the placement of test equipment. Items which are used together should be placed near each other. Decide which are your most-used pieces of equipment and place them at central points. By mounting the tube tester on a sloping rack, you will be able to test tubes easily whether you are standing or seated.

Panel mounting of test equipment was ruled out because this would make it difficult to change instrument arrangement when new units are added, and duplicate equipment would be needed for outside work.

Construction details of the bench and table are given in the accompanying drawings. Dimensions can be easily modified to suit individual space requirements.

Lumber may be any good grade desired. The table and bench shown were made of No. 1 Ponderosa Pine.

—end—

OSCILLATOR

AMPLIFIER

FILTER

FREQMETER



4 instruments in 1 package

More than just a gadget—a combination of highly useful functions for the technician.

By I. QUEEN

THIS multipurpose audio instrument, based on an article by Villard in *Electronics*, July, 1949, operates as an oscillator, rejection filter, or selective amplifier, depending on control settings. Readers may remember a number of versions of this circuit—particularly in the amateur press—shortly after the publication of Villard's original article. The novice whose memory does not extend to 1949, and the amateur and audio experimenter who may not have been interested at the time may find it worth their while to examine the equipment again. This one has been in use at W2OUX three years and has become more valuable each succeeding year. For greater usefulness we have added a novel direct-reading indicator to measure frequency. It operates in the range 175 to 6,000 cycles.

The schematic of this instrument is drawn in Fig. 1. The heart of the circuit is its two-stage phase shifter which includes V1 and V2. The shifter advances phase by 180° at the frequency to which it is tuned.

The phase-shifter principle is shown

in Fig. 2. A center-tapped a.f. source is shunted by an R-C network. Resistance is adjustable to equal capacitive reactance at the desired frequency. The vector diagram shows that under this condition the phase of the output (B-D) is advanced 90° compared with the input (A-C). Furthermore, the output amplitude remains constant at half the input at any frequency. This is an important requirement.

Referring back to Fig. 1, note that V1 and V2 have balanced plate and cathode loads. Each triode provides the "center-tapped" a.f. signal required. An identical R-C network is connected across the output of each tube. These triodes and their respective networks comprise the phase shifter. The resistance of each network can be varied to equal the X_c of the capacitor at the desired frequency.

The OSCILLATOR-FILTER switch, S3, combines signals in or out of phase as desired, converting the unit from an oscillator to a rejection circuit.

As an oscillator

Fig. 3-a shows the basic oscillator

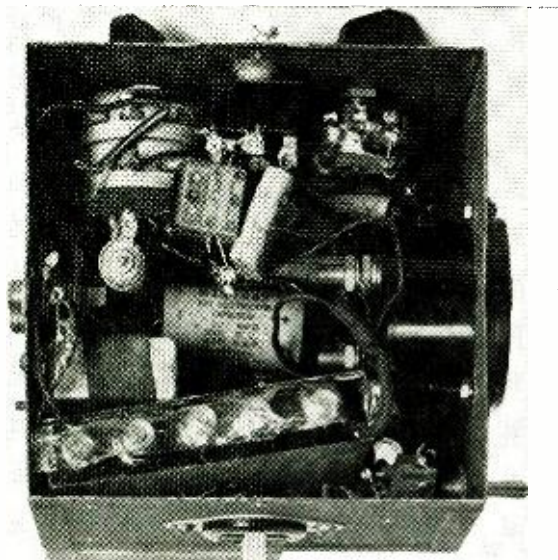

Inside the chassis of the multi-purpose instrument. This degree of compactness is convenient but layout is not critical.

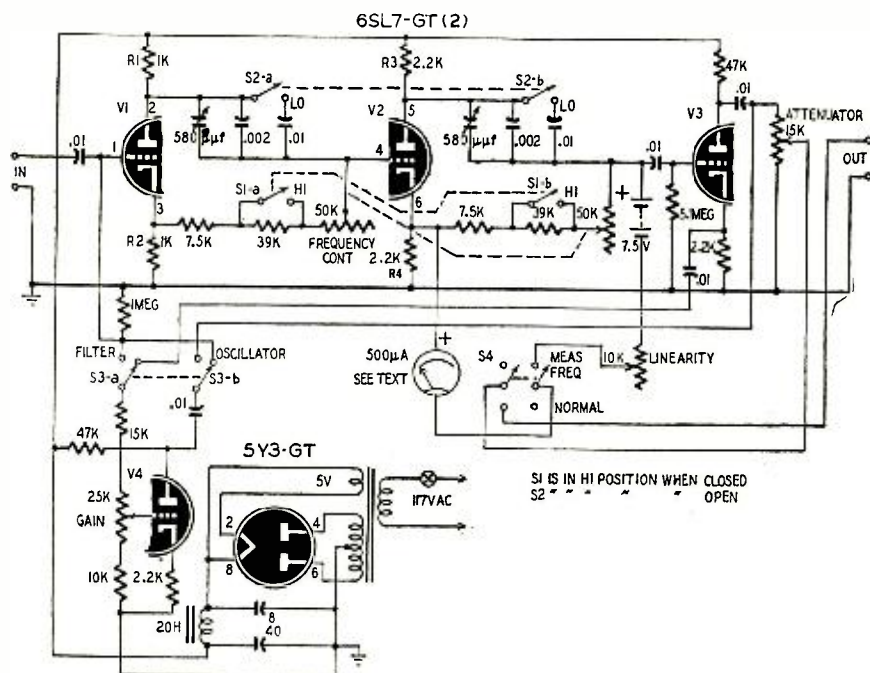

Fig. 1—Schematic of the unit. Certain critical values are discussed in the text.

circuit. The phase shifter feeds an amplifier (V4) which again reverses phase. Therefore the amplifier output is in phase with the shifter input and oscillations can be produced. An isolating stage follows the oscillator.

As an amplifier

Frequency is determined by the shifter adjustment. If the amplifier gain is reduced sufficiently, oscillations cease, but there is still positive feedback, and at the tuned frequency the circuit becomes a highly selective regenerative amplifier. The desired frequency is accentuated above all others.

As a filter

Fig. 3-b is the filter circuit. An input signal feeds the phase shifter and amplifier V4 simultaneously. V4 shifts

phase by 180°. The signal through the shifter-V3 channel is not changed in phase. If these signals are equal they cancel at the output terminals. The null is deeper and sharper than that of a parallel-T network.

The frequency control is a dual 50,000-ohm potentiometer. When set to zero resistance the frequency is maximum. For still higher frequencies the d.p.s.t. switch S1-a and S1-b is closed. S2 is the band switch. The 580-µuf trimmers are adjusted as follows: Set S3 to the oscillator position; set S1 and S2 to HIGH. Tune the oscillator to a frequency of 4 kc. Now throw S2 to LOW, and adjust the two trimmer capacitors for an output of 1 kc, or exactly one-quarter the first frequency. (Keep the trimmers at about the same capacitance during adjustment.)

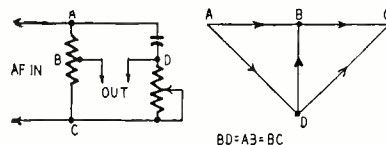

Fig. 2—Simple 90° phase-shift circuit.

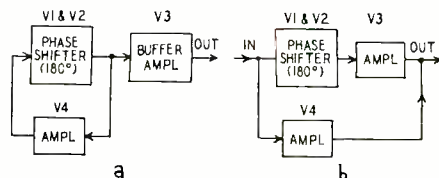

Fig. 3—Basic oscillator and filter schemes.

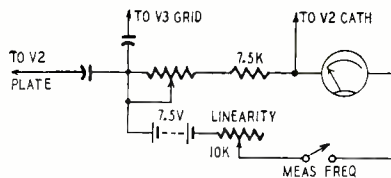

Fig. 4—Frequency meter circuit details.

Frequency ranges are approximately as follows:

- With S2 closed
 - S1 open 175-325 c.p.s.
 - S1 closed 320-1,800 c.p.s.
- With S2 open
 - S1 open 700-1,300 c.p.s.
 - S1 closed 1,280-7,200 c.p.s.

Frequency meter

A meter and battery circuit is used for measurement of frequency. It is in the V2 plate circuit. The principle of operation is shown in Fig. 4. In this circuit the meter indication is approximately inversely proportional to resistance. Since this is the same relationship which exists between frequency and resistance, the meter can be calibrated in cycles. We used a meter with a basic 500 microampere movement. It carries two scales (marked volts) the upper one 0-15 and the lower 0-600. We use the meter to indicate to 1,500 cycles on low range and to 6,000 cycles on the other. The linearity control is used to calibrate the readings near full scale.

Switch S4 is a momentary type. When depressed, frequency is measured and the output is disconnected. When released, the meter is out of the circuit and the oscillator-filter operates normally. Resistors R1, R2, R3, and R4 should be of the precision, wire-wound type.

Output from the oscillator is ample for a.f. testing, bridge supply, low power modulation, and other applications. The filter can be used to eliminate interference, or measure frequency.

Materials For Oscillator-Filter

- Resistors:** 2-2,200, 2-8,200, 1-10,000, 1-15,000, 2-39,000, 2-47,000 ohms, 1-1 meg, 1/2 watt; 2-1,000, 2-2,200 ohm precision type.
- Potentiometers:** 1-10,000, 1-15,000, 1-25,000, 1-dual 50,000 ohms.
- Capacitors:** 2-.002, 7-.01, mica; 2-580 µuf mica trimmers; 1-40, 1-8 µf, 450 volts, electrolytic.
- Switches:** 1-d.p.d.t. momentary, 1-d.p.d.t., 2-d.p.s.t., 1-s.p.s.t.
- Power transformer:** 200-200 V @ 50 ma.
- Miscellaneous:** 1-7.5-v battery, 2 phone jacks, 1-0-500 microammeter, 1 metal box 5x5x3/2, filter choke, line cord, wire, solder, hardware.

—end—

More Notes on TV Troubles

By MICHAEL L. TORTARIELLO

General Electric 802 and 803

Sound and picture normal on channels 2-4-5. No sound, but pictures normal on channels 7, 9, 11, and 13.

Characteristics of 7F8 radio-frequency oscillator tube have changed with age. Replace with new one.

General Electric model 802 (AM-FM-TV combination)

Picture normal; sound on AM normal; no sound on FM or TV.

Resistor R783 (4,700-ohm, 1/2-watt) open. Replace with 4,700-ohm, 1-watt.

Westinghouse model H618T16

Sound normal; video signal and raster present, but no horizontal or vertical synchronization.

Replace 6C4 sync phase inverter tube.

Westinghouse model H605T12

Sound normal; no high voltage.

Resistor R409, 560 ohms, 5 watts, red hot, capacitor C506 (.047 μ f, 400 volts) shorted. Resistor R502 (68 ohms, 1/2 watt), damaged. Replace capacitor with .035- μ f 600-volt unit. Replace resistor R409 with 5-watt, 500-ohm. Replace resistor R502 with 100-ohm, 1-watt unit.

Westinghouse model H626T16

Sound normal; vertical and horizontal sweeps normal; high voltage normal; no video signal at cathode of 16RP4 C-R tube.

Capacitor C315 (.05- μ f, 400 volts) shorted. The shorting of this capacitor also opened up contrast control R319 (1,500 ohms). Replace C315 with .05- μ f, 600-volt unit. Replace R319 with V-9877 assembly, which includes contrast control, volume control, and a.c. on-off switch.

Westinghouse model H600T16

Sound normal; vertical sweep and high voltage present, but raster only 1 inch wide.

Winding of L401 feed choke (supply-

ing B-plus to the three 7A5 horizontal output tubes) shorted to ground. This also burned out R406 (5,000-ohm width

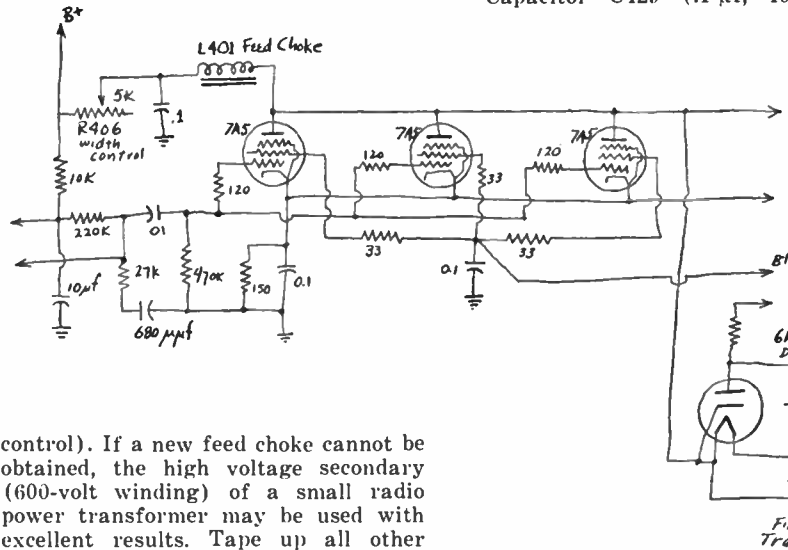

control). If a new feed choke cannot be obtained, the high voltage secondary (600-volt winding) of a small radio power transformer may be used with excellent results. Tape up all other leads and insulate transformer case from chassis. Replace R406.

Sound normal; video signal and raster present, but raster shows a bright white line 2 inches wide from top to bottom of picture tube.

Replace burned-out 6W4 damper tube.

Sound normal; video signal present; raster keystone wide at top, narrow at bottom, very much wrinkled.

Shorted 56- μ f, 1,500 volt capacitor across one half of horizontal deflection coil. Replace with 56- μ f ceramic.

Westinghouse model H627K16

Sound normal; no high voltage; plate of 6AU5 horizontal output tube red. Oscilloscope showed horizontal sawtooth at pin 6 of 12AU7 horizontal multivibrator.

Capacitor C427 (.01- μ f) shorted. This capacitor is rated at 400 volts. Replace with 600-volt unit.

Westinghouse model H630T14

No picture; no high voltage; sound distorted.

Capacitor C429 (.1- μ f, 400 volts)

from pin 8 of horizontal output tube (6AU5) to ground, shorted. Replace this unit with a 0.1- μ f, 600-volt type.

Westinghouse model H619T12

Sound distorted; no high voltage.

Capacitor (0.1 μ f, 400 volts) from pin 5 of horizontal output tube (6AU5) and horizontal deflection coil, shorted. 1,500-ohm width control burned out. Replace 0.1- μ f capacitor with 600-volt unit. Replace width control.

Crosley model 10-421 MU

No horizontal synchronization; rotation of horizontal hold control had no effect on picture. Very loud high-frequency whistle emanating from flyback transformer.

Replace 6SN7 horizontal a.f.c. and oscillator tube, with a brand-new one, as not all 6SN7 tubes will work in this application.

Crosley model 9-407-M-3

Weak sound; no high voltage.

Section A of resistor R-36 rated at 7,000 ohms, reads 2,000 ohms. This resistor is attached to chassis and is enclosed in a metal sleeve. Open end of resistor arcing to ground. Replace with 7,000-ohm 10-watt wire-wound unit.

Admiral model 25A16

Sound normal; no horizontal sweep or high voltage.

C53 capacitor (50 μ f) between pin 4 of 6SN7 (V16B) horizontal oscillator and ground open. Replace C53.

—end—

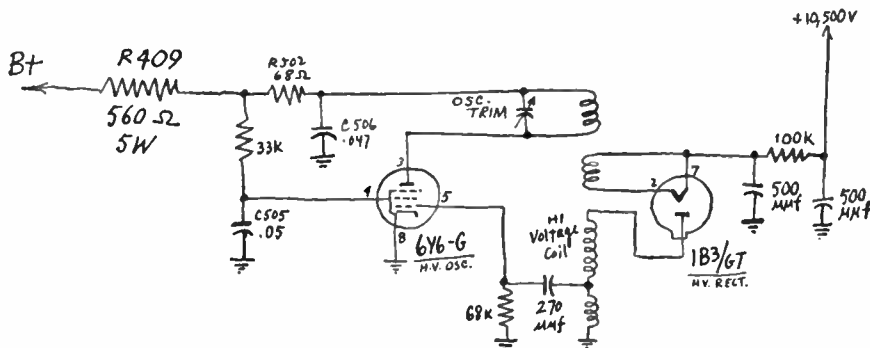

R.f.-type high-voltage circuit used in the Westinghouse model H605T12 receiver.

Electronics and Music

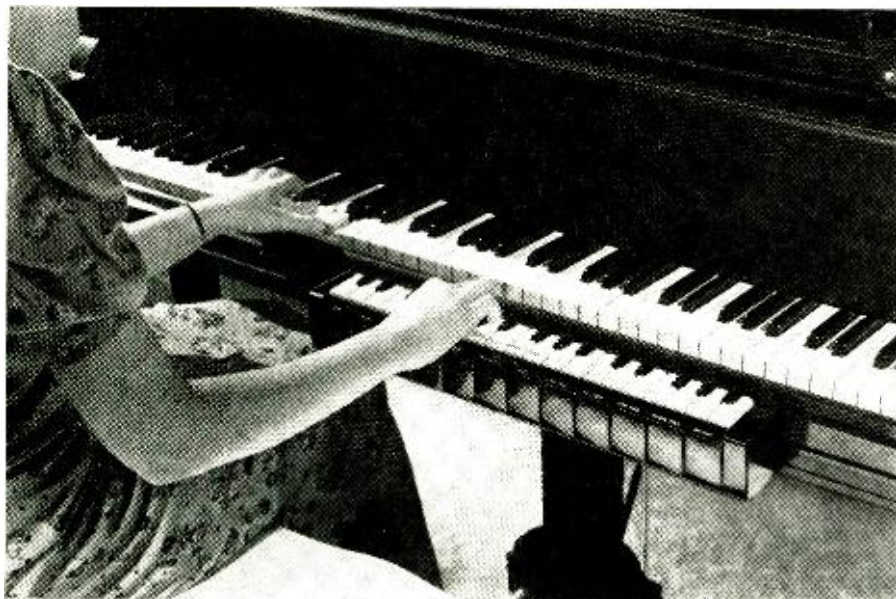

Fig. 1—Typical Hammond Solovox installation. The miniature keyboard fastened to the piano front contains playing keys and all controls.

Part XXIII—The construction and circuit details of the popular Solovox in its new, all-electronic version.

By RICHARD H. DORF

THE Hammond Solovox (Hammond Instrument Company, Chicago, Ill.) is and has been for a number of years the best-known monophonic electronic musical instrument made in this country. While it permits the playing of only a single note at a time, and has neither the types nor variety of tone colors to appeal to most serious musicians, it has found extensive use in popular-music ensembles and particularly in the home among amateurs. It is ordinarily used with the piano—the player's right hand playing the melody on the Solovox and the left hand playing an accompaniment on the piano—where its sustained tones contrast with the percussive effects of the piano to produce pleasing sounds with a minimum of study, effort, and expense.

Unlike the Hammond organ, the Solovox is completely electronic, with no moving parts other than the keys and controls. (To be accurate, the older models J and K had a vibrating-reed vibrato system, but the present model L is electronic in even this respect.) This article describes the model L, which does not differ from the earlier J and K models in principle.

A typical Solovox installation is

shown in Fig. 1. The two principal units are the keyboard and a tone cabinet. The tone cabinet (not shown in the illustration) houses the speaker and all vacuum tubes. The keyboard, attached to the front of the piano, holds the switches which are actuated by the keys, and all control circuits.

Fig. 2 is a block diagram of the Solovox which shows the principal components and their relationships. A master oscillator is tuned through a 3-octave range by the keys, and its frequency may be varied cyclically to produce vibrato. The oscillator synchronizes a frequency divider which produces similar tones one octave lower down. This, in turn, synchronizes a second and third frequency divider.

One output is taken from the oscillator, which operates in the highest three-octave range of the instrument, and one from each of the frequency dividers. In accordance with their pitch ranges the outputs are labelled SOPRANO, CONTRALTO, TENOR, and BASS. Any one or a combination may be switched into a common output bus which goes to a series of five tone filters. Whatever tone qualities are switched on are passed to a preamplifier, thence to a push-pull control stage. In the control

stage the output volume is controlled by a knee lever fastened under the keyboard, and the attack of each note is slowed down by using an extra set of keyboard contacts to remove cutoff bias on the stage at a controlled rate of speed. From here the signal passes to an output stage and loudspeaker.

Master oscillator

The master-oscillator circuit is diagrammed in Fig. 3. It is basically very simple and capable of wide-range operation. The output of V1-a is R-C

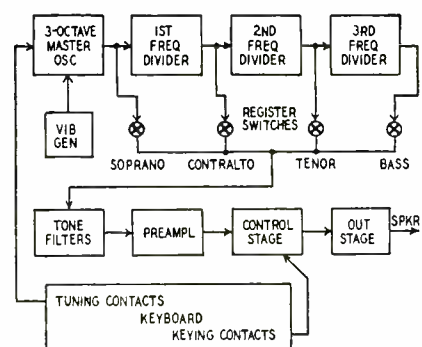

Fig. 2—Block diagram showing the operating circuits of the Hammond Solovox.

coupled to the grid of V2-a. The plate of V2-a is R-C coupled back to the grid of V1-a. Since the circuit is re-entrant and the feedback phase is positive, the combination oscillates. The frequency of oscillation is controlled by capacitance and resistance placed between the grid of V1-a and ground.

Two step-type controls are provided. C1 is the main tuning capacitor, and C2, C3, and C4 are added to give the exact value required for the fixed capacitance. The next bank of six .002- μ f capacitors is so arranged that as the arm labeled ROUGH TUNING is moved upward, it contacts the capacitors one by one and at maximum position all six are across the main tuning capacitors. Six steps of 400 μ f each are available with a similar switching arrangement for the fine-tuning adjustment.

remaining triodes of the 6SN7-GT and 6SL7-GT used in the oscillator. V2-b is the 6-cycle oscillator, a standard phase-shift unit, the output of which is fed to V1-b, a switching tube. The plate-supply potential for V1-b is only 40 volts, obtained from the drop across the frequency-divider cathodes (see Fig. 4). With the low plate potential of 10 volts and zero bias, the comparatively small signal from the vibrato oscillator is sufficient to cut off the switching tube when the signal is in the negative direction.

With the vibrato switch on, paralleled 400- μ f and 800- μ f capacitors (total value of .0012 μ f) are connected from one side of the audio tuned circuit, through the switching tube, to ground. On the half-cycles of vibrato frequency during which the switching tube con-

ducts, the capacitance is across the audio tuned circuit, changing its frequency to some degree. On the half-cycles during which V1-b is cut off, the audio frequency is unchanged. The frequency is thus switched at the vibrato-oscillator rate of 6 cycles per second, giving a vibrato effect.

Frequency dividers

Frequency dividers are very common in electronic musical instruments. In polyphonic instruments there is usually one set of them for each of the 12 notes of the scale and each divider need work at only one frequency. In the Solovox there is only a single set of three dividers, each of which must work over a three-octave range. To fulfill this requirement they are designed to be not particularly frequency-selective and they are of the non-oscillating multi-vibrator type. This means that in the absence of a synchronizing signal they do not oscillate but remain in one or the other of their two stable conditions.

The frequency-divider section of the Solovox appears in Fig. 4. The first tube V3-a is a rectifier which rectifies the output of the master oscillator. The grid is coupled to the oscillator plate through C1. The waveshape of the master oscillator output is roughly symmetrical and contains principally odd harmonics, sounding like a muted instrument, or a woodwind, or stopped pipe. The rectified output from V3-a is no longer symmetrical and contains even harmonics as well as odd ones.

V3-b is a pulse rectifier. Because of the capacitive coupling between V3-a and V3-b, the rectified output of V3-a appears as a.c. on the grid of V3-b. Due to the average plate currents of the tubes in the dividers the cathode of V3-b is 40 volts positive, giving the tube a high negative grid bias. Negative input to the grid therefore has no effect, but positive input increases the plate current and produces negative pulses at the plate.

V4-a and V4-b are the first frequency divider. In the resting condition one of the tubes is cut off and the other is conducting. When the driver V3-b puts out a negative pulse, it passes through C3 and C4 to the divider grids. The negative pulse has no effect on the tube which is cut off, for instance V4-a. However, it causes the tube which is drawing current, V4-b in this case, to put out a positive pulse at its plate. The positive pulse is transferred to the grid of V4-a through the R-C plate network, causing V4-a to conduct and put out a negative pulse of its own. This negative pulse is transferred to the grid of V4-b, adding to the negative input signal. In a very short time V4-b is cut off and V4-a is conducting, the reverse of the original state. At this point the circuit is again stable. However, the

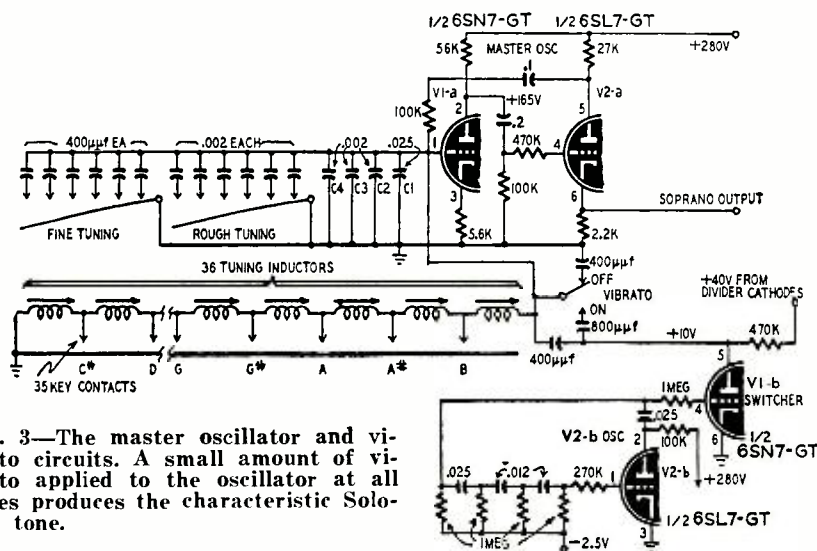

Fig. 3—The master oscillator and vibrato circuits. A small amount of vibrato applied to the oscillator at all times produces the characteristic Solovox tone.

The inductance part of the tuned circuit is used to vary the frequency to give the pitch required for each key over the three-octave range of the oscillator (523 to 3951 cycles). Thirty-six small inductors, each with a movable core for individual adjustment, are wired in series, with a switch contact connected between each adjacent pair. When a key is pressed, the corresponding contact is grounded, decreasing the net inductance between the grid of V1-a and ground. When the lowest C key is pressed, no contact operates—the full value of all the series inductors is in place and the lowest frequency sounds. (Actually this frequency is being generated all the time, even when no key is being pressed. The control tubes, however, block the amplifier until a key is pressed, as described later.) When the topmost key (B of the top octave) is pressed, all inductors but the one nearest the grid are shorted to ground and the remaining inductance is just large enough to tune the circuit to the topmost note. With this arrangement, no spurious notes are heard even when two or more keys are pressed at once by accident; only the uppermost of the notes played is heard.

The vibrato circuit includes the two

ducts, the capacitance is across the audio tuned circuit, changing its frequency to some degree. On the half-cycles during which V1-b is cut off, the audio frequency is unchanged. The frequency is thus switched at the vibrato-oscillator rate of 6 cycles per second, giving a vibrato effect.

With the vibrato switch off, a permanent capacitor of 400 μ f is connected across the tuned circuit. The 400- μ f capacitor between V1-b plate and the audio tuned circuit is still in place and the switching tube is still doing its job. The vibrato effect is therefore still present to a very slight degree. This is desirable, for it is enough to destroy the "perfection" of the electronically generated tones, which would otherwise be so perfectly steady as to lack interest.

This is an interesting point in all electronic instruments—perfection is undesirable! A pipe organ, a wind instrument, a violin—all of them have inherent random irregularities of pitch and volume caused by small variations in the wind supply or slight unsteadiness in the player's control. One of the essential factors in art appreciation by the emotions is variation; monotony is inartistic and unpleasant. Thus the natural slight unsteadiness of acoustic

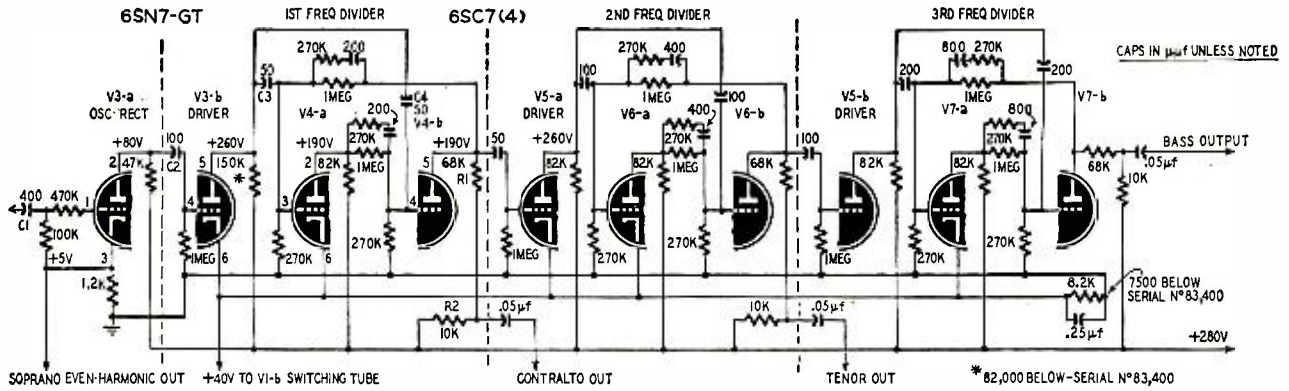

Fig. 4—Schematic of the Solovox frequency-divider chain. Each stage divides by two, reducing the frequency one octave.

next negative pulse to come from the plate of V3-b starts things all over again and in the same manner V4-a now cuts off and V4-b conducts.

In this way, it takes two input pulses from V3-b to make the V4 circuit execute a complete cycle of change, returning to its original condition. Since the frequency of pulses from V3-b is the oscillator frequency, the contralto output taken from the plate circuit of the divider at the junction of R1 and R2 is one-half the oscillator frequency and has a rectangular waveshape.

Each of the two following dividers works in the same way and includes a driver-rectifier triode (V5-a and V5-b) and two multivibrator triodes (V6-a and V6-b, V7-a and V7-b). In each case the input frequency is divided in half, so that there are four outputs from the generating section of the instrument—one from the oscillator and three from the dividers, each output being one octave below the input.

Tone color selection

Two circuits are shown in Fig. 5. The first is the register-control section of the Solovox and the second the tone controls.

The register controls do two jobs. The first and most obvious is the selection of which ranges shall be sounded. The entire instrument covers six octaves. When the soprano switch is closed the three highest octaves are fed to the output bus. When the contralto switch is closed, each note keyed sounds one octave lower, which adds one lower octave to the instrument, and so on down to the bass switch.

The outputs of the frequency dividers are symmetrical in waveform. This is a "muted" tone carrying only odd harmonics. To add even harmonics to the tones of the bass register, a certain amount of tenor output can be added, since the fundamental of the tenor is the second harmonic (one octave above) of the fundamental of the bass. The amplitude of the added tenor must be kept down so that it does not sound to the ear like an additional octave repetition. If, for example, the original bass tone has 1/3 as much third harmonic as fundamental, 1/6 as much fifth harmonic as fundamental, and so on, then

adding a tenor fundamental about 1/2 as loud as the bass fundamental will give a second harmonic to the bass which will simply fill out the harmonic content of the bass in the correct proportion. The effect is to get rid of the muted tone quality.

With the mute switch of Fig. 5 in the off position the bass receives some additional tone for this purpose from tenor; tenor receives some from contralto; and contralto receives some from soprano. Since there is nothing higher than soprano the special oscillator rectifier of Fig. 4 supplies even-harmonic additions for the soprano tone. With the mute switch on, these additions are removed and the muted quality is sounded.

There are five tone-control switches in Fig. 5. All the filters are in series across the register-control output bus. The tone switches are normally closed; when a tone quality is selected the switch is opened. With all but the DEEP TONE switches closed, the tone develops across a highly capacitive load and the high-frequency harmonics are very much reduced. With the FULL TONE switch open, frequency response is almost flat, but with some attenuation of treble to round off the sharp edges of the waveform. FIRST VOICE and SECOND VOICE are roughly 400-cycle and 800-cycle resonant circuits which give brassy and reedy tones, while the BRIL-

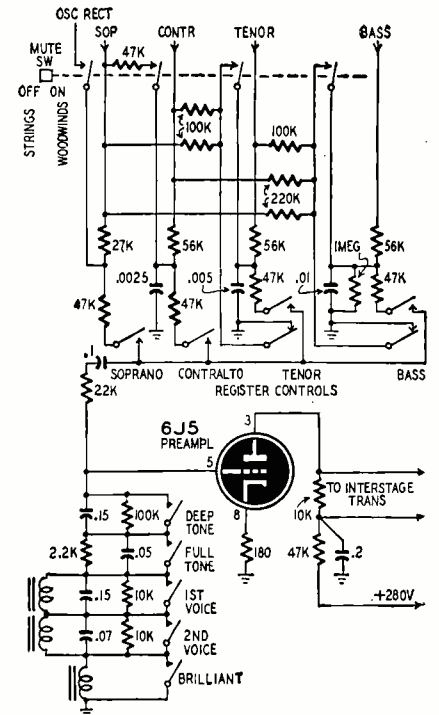

Fig. 5—Register-control and tone color-selection circuits. Instrument tones are produced by harmonic combinations.

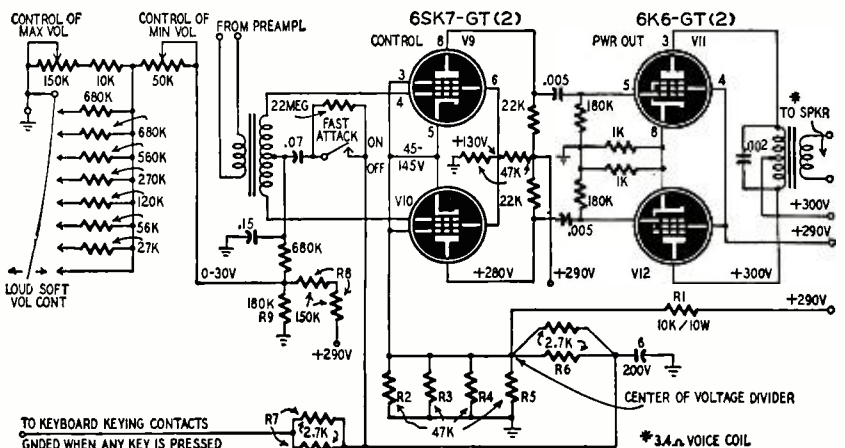

Fig. 6—Control stage slows attacks and varies output volume of the instrument.

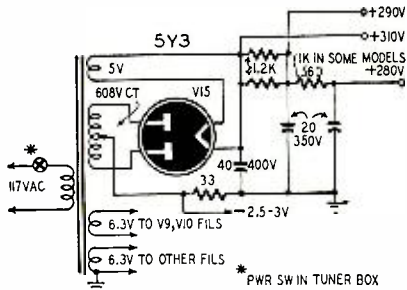

Fig. 7—Supply has four output levels.

LIANT filter is a high-pass filter with a very bright tone. The filters are in the grid circuit of the preamplifier 6J5 the plate of which couples to the control stage through a transformer.

Control and output stages

The control stage, diagrammed in Fig. 6, consists of a pair of push-pull, remote-cutoff 6SK7's. The two cathodes are connected to the center of a voltage divider consisting of R1 as one leg and R2, R3, R4, and R5 in parallel as the second leg. Normal voltage at the cathode tap is 145 because of the connection of plus 290 volts to the input of the voltage divider. The center of the voltage divider is also connected through R6 and R7 to a bus running the length of the keyboard. One of the contacts under each key is permanently grounded. When any key is pressed the bus is grounded, placing R6 and R7 across the lower (cathode) leg of the divider and reducing cathode voltage to about 45. The rate of drop of the voltage is controlled by the 6- μ f capacitor, which causes a time delay.

A second voltage divider is placed across the 290-volt supply, with R8 as its upper leg and R9 as its fixed lower leg. The center of this divider goes to the center-tap of the input transformer and thence to the grids. Shunted across the lower leg of the divider is the network of resistors and the selector switch shown, which varies volume by varying the d.c. grid voltage. At maximum volume the grids are about 30 volts above ground. Since the cathode, when a key is down, is about 45 volts positive, the net grid bias is about 15 volts and the tubes operate normally. As the volume control is closed the lower leg of the grid divider is shunted more and more and the grids become less positive. They therefore become more and more negative with respect to cathode. When no key is pressed the cathodes are about 145 volts positive, enough to cut off the tubes no matter what the position of the volume control.

The fall of grid-cathode voltage when a key is pressed is normally slowed up additionally by the .07- μ f capacitor between transformer center-tap and keying circuit. For faster attack the switch is opened and a 22-megohm resistor is in series with the capacitor.

The output stage is conventional, using a pair of 6K6 tubes. The power supply is shown in Fig. 7.

(To Be Continued)



TRANSFORMER COUPLED PHONO AMPLIFIER

By CHARLES R. AMMERMAN

A GOOD-quality amplifier can be simply and easily built. This amplifier was designed to have a frequency response satisfactory for use with good phonograph records, adequate power output, and a certain degree of versatility. It was considered a foundation unit to which preamplifiers, compensators, and other equipment, could be added. Therefore a flat frequency characteristic was desired. Its primary use was to operate directly from a microgroove crystal pickup. An AM or FM tuner also may be used as a signal source. Occasionally some sort of PA system is handy, so a

mike preamplifier was built in for convenience. The preamplifier frequency response is poor, since it is adapted to the crystal pickup, but for most PA and amateur work the frequency response is of little consequence.

The units delivers about 4½ watts without severe distortion, with 0.88 volt input, at full gain. The frequency response is 3 db down at about 20 and 10,000 cycles. (These frequencies depend almost wholly on the transformers used.) Since feedback was to be avoided in the interests of simplicity, push-pull class A 2A3's were used for low output impedance and low distortion.

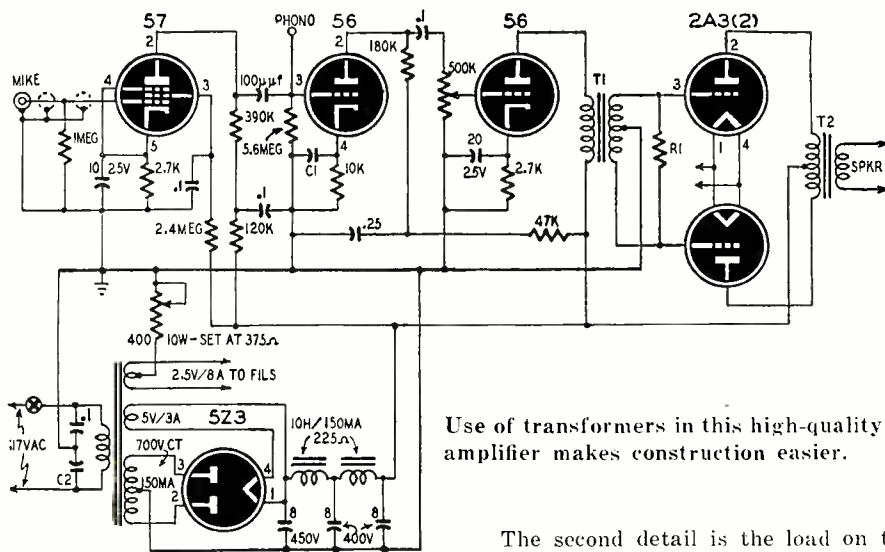

Use of transformers in this high-quality amplifier makes construction easier.

Since 2A3 tubes were used in the output, 2.5-volt tubes were also used in the other stages. There would be no objection to using the 6.3-volt equivalents all the way through, except that 6A3's seem harder to find. The equivalent 6B4-G's or 6A5-G's could also be used, of course. In the other stages two 6C5's or 6J5's (or one 6SN7) and one 6J7 could be substituted. (The first tube may be omitted if a microphone is not to be used.)

Circuit features

There are very few unusual features about this circuit. The performance depends almost entirely upon the transformers T1 and T2. For T2, any push-pull transformer matching the speaker to 4,500 ohms will do the job. *The better the transformer, the better the amplifier frequency response.* Similarly T1 can be almost any single-plate to push-pull grid transformer. This one came from an old but good radio. (Interstage transformers in old sets are often very poor.) Thordarson types T-20A23 and T-22S70 would probably be satisfactory for most applications.

Three details make a slightly better amplifier than might be expected with any given set of transformers. The first is the resistor R1 shunting the interstage transformer. This improves the frequency response at both the high and low ends, and also tends to reduce the Q at the transformer resonance peak. When a square-wave was fed into the amplifier and the output waveform was observed on an oscilloscope, transient oscillations on the square-wave due to transformer T1 ringing were very noticeable when the resistor was not used. The smaller it is made the less ringing is seen. The only disadvantage of small values is that the amplifier gain is reduced. A value of 100,000 ohms was chosen for this amplifier. The experimenter without test equipment should use the smallest resistance consistent with adequate gain (although not lower than about 25,000). High quality transformers will not require shunting resistors.

The second detail is the load on the crystal pickup. The low-frequency output of a crystal is very dependent upon the load resistance, so that the grid resistor of the 56 was made 5.6 megohms. Its coupling capacitor of 100 μ f has very high reactance at low frequencies, hence the low-frequency input impedance is nearly 5 megohms.

Just a general tip: Don't use a volume control in this circuit. The input capacitance of the tube is high, due to Miller effect, and a high-resistance volume control will make the high-frequency response fall off as the volume is decreased.

The third place where frequency response may be improved is in a compensating circuit in the cathode of the first triode. In general, to get good low-frequency response it is necessary to use very large bypass capacitors, and it is better to leave them off if you can stand the loss in gain. Here it was decided not to bypass the first triode's cathode. Then the idea of using this stage to improve high-frequency response came. A *small* capacitor, C1, is used, that starts to bypass at about the same frequency the transformers start to cut off. This will maintain good response to a somewhat higher frequency. Care must be taken that it is not made too large, or a peak will occur near the high-frequency end. In this particular amplifier an optimum value

of 0.003 μ f was found. Further compensation could be added, if desired, by treating the next cathode capacitor the same way, but of course there would be some loss in gain. An audio oscillator or standard frequency record is almost a necessity in determining the proper size capacitor to use. If you don't have either of these it might be safer to omit the cathode capacitor entirely.

Hum should not be excessive and may be treated in common ways. The pre-amplifier should be well shielded, including the grid lead. Do not make the mistake the author did and bring the 117-volt line and phonograph input connections to the same terminal strip. This caused unnecessary grief that was finally cleared up by installing capacitors across the line, and trying various values for C2 until the hum was balanced out. There was one value that worked well—larger or smaller values gave more hum. Start with 0.1, then try larger or smaller values until the proper one is found.

This amplifier will develop all the power needed to enjoy music in the home, and has very good quality. Remember that the speaker is *at least* as important as the amplifier in any installation. A speaker not less than eight inches in diameter, and preferably larger, should be used; best results may be obtained with some sort of woofer-tweeter combination. The speaker will not be at its best unless used in an adequate mounting. Simple mountings that give good results are a large flat baffle, three feet or more on a side, or a large open-back cabinet. Bass-reflex and horn-type enclosures may give somewhat better results.

Materials for amplifier:

Resistors: 1—400 ohms, 10 watts, with slider; 2—2,700, 1—10,000, 1—47,000, 1—120,000, 1—180,000, 1—390,000 ohms, 1/2 watt; 1—1, 1—2.4, 1—5.6 megohms, 1/2 watt; 1—500,000 ohm potentiometer with audio taper. (See text for R1.)

Capacitors: (mica) 1—100 μ f, 500 volts; (paper) 1—0.1 μ f, 600 volts; 3—0.1, 1—0.25 μ f, 400 volts; (electrolytic) 1—10, 1—20 μ f, 25 volts; 3—8 μ f, 450 volts. (See text for C1 and C2.)

Miscellaneous: Tubes: 1—57, 2—56, 1—5Z3, 2—2A3. Sockets: 1—6 prongs, 2—5 prongs, 3—4 prongs. Transformers: 1—700 volts c.t., 150 ma; 5 volts, 3 amp; 2.5 volts c.t., 9 amp; 1—interstage audio, single plate to p-p grids; 1—10-watt output, primary 4,500 ohms plate-to-plate, secondary to match voice coil; 2—chokes, 10 henries, 150 ma, 225 ohms (approx.). Chassis, hookup wire, hardware.

—end—

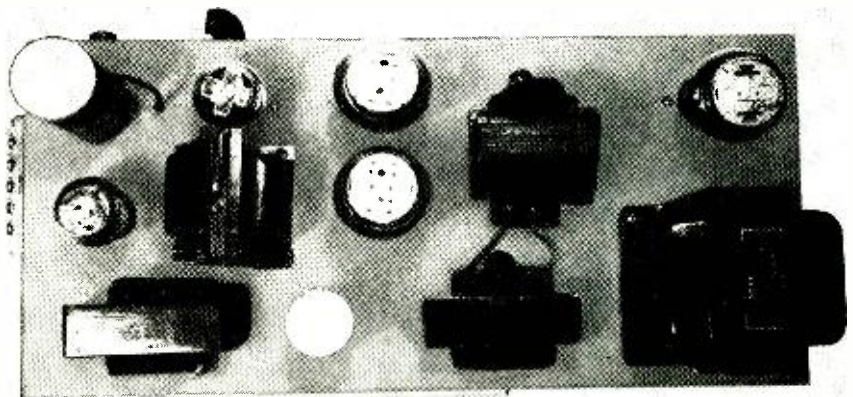

Top view shows layout. The filter chokes are those nearest the power transformer.

"SECRET" TUNING

IN CERTAIN television receivers the horizontal oscillator frequency is controlled by a method which apparently has never been fully explained in data intended for service technicians. Although it is possible to service a receiver without completely understanding it, many technicians want to know, as I did, just what goes on in these receivers and what other applications the same principle may have. Most publishers of information for technicians seem to believe that their readers are unable or unwilling to learn anything more than their day-to-day work forces them to know. If the material published in RADIO-ELECTRONICS reflects the wants of its readers—and of course it has to—those readers know that things which do not seem to have any immediate application in their work today may still be worth reading about, either because they may be needed tomorrow, or simply because they are parts of the field of electronics, which many of us find so interesting that it is not only our business but our hobby.

Ask any radioman how the resonant frequency of a parallel resonant circuit can be changed and he will probably answer something like this: "By changing the inductance or the capacitance, of course; how else?" There is enough truth in this to make it accurate for all practical purposes, but there is enough error in it to hide a principle

which has been used in the design of certain television receivers, but not explained in the service data. Actually there is nothing very complicated about it. (Incidentally, if you have been looking ahead and the mathematical formulas worry you, skip them. You don't need them, except to quote to the fellow who quotes the formula that "everybody knows". These formulas, being longer, should put *him* in his place, so remember where you saw them.)

What is resonance?

One fact which confuses the situation is that there are different definitions for the resonant frequency of a parallel resonant circuit: the frequency at which the inductive and capacitive reactances are equal; that at which the current is minimum and the impedance is maximum; and that at which the current is in phase with the voltage and the impedance is equivalent to a pure resistance. The usual formula

$$F = \frac{1}{2\pi\sqrt{LC}}$$

is correct for the first definition, but in actual circuits the important frequency is usually one of the latter two, the frequency of maximum impedance in a tuned amplifier, and the in-phase-current frequency in an oscillator. These frequencies are affected by the presence of resistance

Frequently used—
but rarely explained—
the technique of
tuning L/C circuits by
resistance control.

By JOHN K. FRIEBORN

in series with either of the legs. The resistance of the coil produces such an effect, but usually a negligible one. Deliberate insertion of a substantial amount of resistance in either or both legs, makes it possible to tune the circuit within certain limits by varying the resistance. Although very little has been published on this type of resistance tuning, it was used in experimental AM receiver designs more than fifteen years ago, in military FM equipment during World War II, and in post-war television receivers.

The tuning effect of the added resistance can be accounted for by considering the resonant frequency of a parallel L-C circuit as that at which the currents through the inductive and capacitive branches are approximately equal in amplitude and opposite in phase, producing a minimum total current and maximum impedance. Inserting resistance in series with one leg will decrease the current through that leg and disturb the resonant condition. We can get back to resonance by increasing the reactance of the other leg to reduce its current. This can be done either by changing the value of the inductance or capacitance or by changing the frequency. For example, inserting resistance in series with the capacitance reduces the leading current in the circuit, requiring an increase in the inductive reactance to reduce the lagging current. By increasing the size

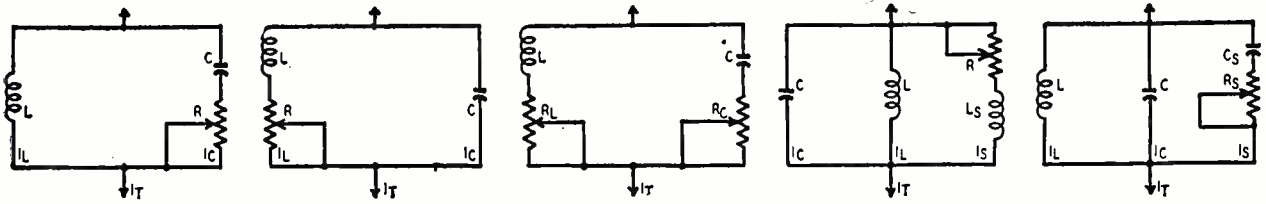

Figs. 1 through 5 (left to right)—Inserting resistance in the branches shown changes the resonant frequency of each circuit.

of the inductance, the same resonant frequency could be restored; if the inductance is unchanged, the resonant frequency would increase. Adding resistance in series with the capacitance as in Fig. 1 reduces the current through the capacitive leg as if the capacitance itself had been decreased; decreasing the capacitance would increase the resonant frequency. Adding resistance in series with the inductance, as in Fig. 2, would of course have the opposite effect.

The mathematics

Anyone interested in exact quantitative results can find mathematical treatments in many standard books.

These books often (probably unintentionally) steer their readers away from the principle which is the subject of this article by remarking that—in the circuits usually used in radio—all three of the definitions of resonance are approximately equivalent. For example, *Mathematics for Electricians and Radiomen*, by Cooke (McGraw-Hill), pages 478-480, gives, for the frequency at which the current is minimum and the impedance is maximum,

$$f = \frac{1}{2\pi} \sqrt{\frac{1}{LC} - \frac{R^2}{2L^2}}$$

and, for the frequency at which the current is in phase with the voltage and the circuit acts like a pure resistance,

$$f = \frac{1}{2\pi} \sqrt{\frac{1}{LC} - \frac{R^2}{L^2}}$$

In both of these, R is the resistance in series with the inductive leg. In either formula, increasing that resistance would decrease the resonant frequency.

Cledo Brunetti and Eric Weiss, in "Theory and Application of Resistance Tuning," *Proceedings of the I.R.E.*, June, 1941, pages 333-344, give a formula for the frequency at which a circuit with resistance in both legs (Fig. 3) acts like a pure resistance:

$$f = \frac{1}{2\pi\sqrt{LC}} \sqrt{\frac{1 - \frac{C}{L} R_L^2}{1 - \frac{C}{L} R_C^2}}$$

This also indicates that increasing R_L would decrease the resonant frequency and increasing R_C would increase the frequency.

As we might expect, there is a disadvantage in this method of changing resonant frequency: adding resistance to the circuit reduces the Q. The more the frequency is changed in this way, the lower the Q becomes.

Terman's *Radio Engineers' Handbook* (McGraw-Hill), pages 145-8, gives a very complete discussion of the effect of resistance on the maximum-impedance and in-phase-current frequencies, including curves which show how adding resistance in series with the inductance not only flattens the peak of the impedance-frequency curve, but changes the frequencies at which maximum impedance and zero phase angle occur.

Resistance tuning may be used for small frequency variations by having only part of the inductive or capacitive current pass through the added resistance, as in Figs. 4 and 5. The change in frequency is smaller and so is the reduction in Q.

A few examples

An early example of resistance tuning was in an experimental circuit for automatic tuning of AM receivers, described by Charles Travis in "Automatic Frequency Control", *Proceedings of the I.R.E.*, October, 1935, pages 1125-41. The circuit is shown in Fig. 6. Capacitor C1 and the plate resistance of the tube V2 form a series circuit in parallel with the tank L-C, so this circuit is of the same form as that in Fig. 5. Changing the plate resistance of the tube by changing the bias changes the amount of signal current through C1 and its effective capacitance, thus changing the frequency of the oscillator. Travis pointed out that this particular circuit is not very suitable for automatic tuning over the wide range of frequencies in the broadcast band (a ratio of about three to one), but similar circuits have been used in receivers with narrower ranges, such as military FM sets.

The chief application of resistance tuning to postwar television receivers has been for control of the horizontal oscillator frequency. Fig. 7 shows the horizontal oscillator circuit of RCA model 630TS. R168 is the manual horizontal frequency control. The series combination of R168, R196, and C172 is in parallel with the oscillator tank. Varying R168 varies the frequency of the oscillator.

Although R168 and R196 form the grid-leak resistance of this oscillator, the principle involved is not the same as that in a blocking oscillator. In the blocking oscillator, the time constant of the grid resistor and capacitor combination determines the length of time the tube remains cut off, that is, the time between cycles of the sine wave oscillations in the grid circuit. In this oscillator, however, there is no break between successive sine-wave cycles. In a blocking oscillator, increasing the resistance increases the length of time between oscillations in the grid circuit, and the length of the sawtooth cycle in the plate circuit. In fewer words, increasing the resistance *reduces* the frequency. But, as already pointed out, increasing resistance in series with capacitance across a parallel L-C circuit *increases* the resonant frequency.

In this circuit, varying R168 will also have other effects on the functioning of the circuit. There will be some variation in the input capacitance of the tube when its bias is changed, due to the Miller effect, but this is a minor matter at the television horizontal scanning frequency. More important is the fact that varying the grid resistor will vary the amplitude and waveform of the oscillations. In fact, extreme variation of the value of the grid resistor in either direction would cause the oscillator to stop. The practical

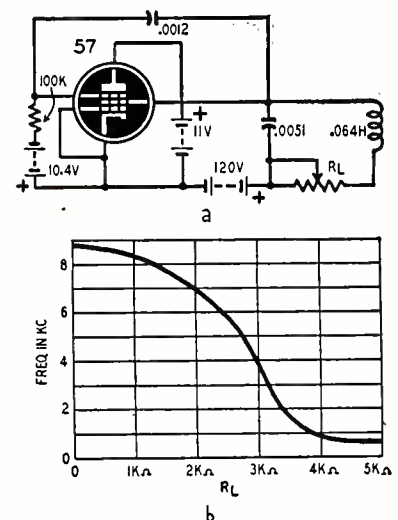
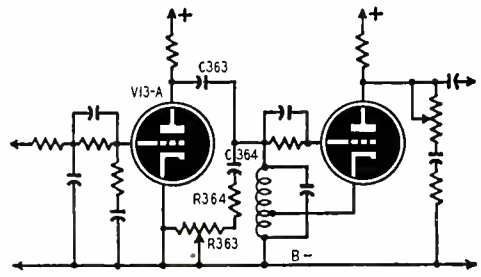
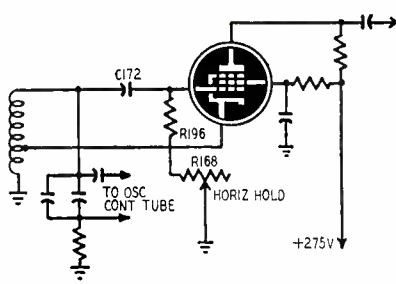
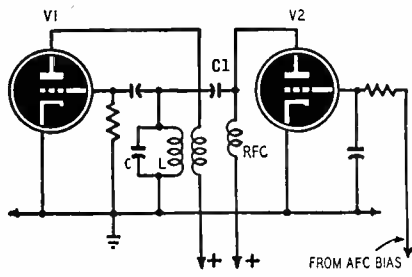

Fig. 9—Circuit for wide frequency range. RADIO-ELECTRONICS



Figs. 6, 7 and 8 (left to right)—Three applications of “secret tuning” to automatic frequency control. Details in text.

range of frequency variation is therefore smaller than it would be if the resistor and capacitor were used only across part of the tank. In this application, this is not a disadvantage, for several reasons: the desired frequency is always approximately the same; the oscillator circuit used is sufficiently stable not to require very large corrections; and the oscillator is used with a system of automatic frequency control for the correction of errors.

An a.f.c. application

The automatic frequency control of the horizontal oscillator in the 630 makes use of a reactance tube, which acts like an inductance in parallel with the tank, so that its effect is equivalent to inductive tuning. However, in some General Electric and Zenith receivers, the frequency of the horizontal oscillator is controlled both manually and automatically by resistance tuning. Fig. 8 shows the horizontal oscillator and control tube circuits of G-E model 16T3. R363, R364, and C364 are the manual frequency control circuit, and C363 and the plate resistance of V13-a are the automatic frequency control, similar to the Travis circuit in Fig. 5. Since this tube functions purely as a resistance, it is not a reactance tube in the usual meaning of the term, although it is sometimes referred to as such.

Unfortunately, giving it a name which immediately calls up a definite image in the mind of the service technician

by no means helps in understanding the actual functioning of the circuits.

Larger variations

Most of the applications of resistance tuning to date seem to have been in circuits where only a small frequency variation is required. However, Brunetti and Weiss showed that a very large frequency variation could be obtained with some sacrifice of Q, and that, with certain circuits, the variation in frequency is approximately proportional to the change in resistance. Figs. 9, 10, and 11, adapted from their paper, give some idea of the possibilities. Fig. 9-a shows a transitron oscillator with a resistance-tuned tank, the resistance being in series with the inductive arm. Fig. 9-b shows the variation of frequency with resistance. Figure 10-a shows a tank for the same oscillator with the resistance in series with the capacitive arm, and Fig. 10-b the resulting frequency variation. Fig. 11-a shows a third tank circuit for the same oscillator, with a potentiometer arranged so that resistance taken from one arm is added to the other. The accompanying graphs in Fig. 11-b show the frequency variations obtained using potentiometers having total resistances of 5,000 ohms and 2,000 ohms, respectively. The first gives a roughly linear variation of frequency with resistance

over a very wide range, while the second gives a frequency variation which is almost perfectly linear over a range of about 1.5 to 1.

Although resistance-tuned L-C circuits used to date seem to have been confined to oscillator tanks, the same principle could of course be applied to other resonant circuits.

Another application

Another application of the principle which apparently has not been mentioned in previous publications, is its use with series resonant circuits. Just as the frequency of a parallel circuit can be changed by inserting resistance in series with one of the arms, so the frequency of a series resonant circuit can be changed by the insertion of resistance in parallel with one of the members. In Fig. 12, resistance in parallel with the capacitance reduces its impedance. For resonance, the impedance of the inductive member must be reduced, either by a decrease in inductance or by a reduction in frequency. The smaller the resistance, the greater the effect. The frequency at which the current is in phase with the voltage is

$$f = \frac{1}{2\pi} \sqrt{\frac{1}{LC} - \frac{1}{C^2R^2}}$$

If this article has revealed any secrets which engineers have been keeping to themselves, it is because I believe it can do no great harm for service technicians to know what goes on in the television receivers they work with.

—end—

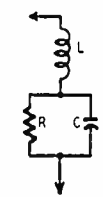
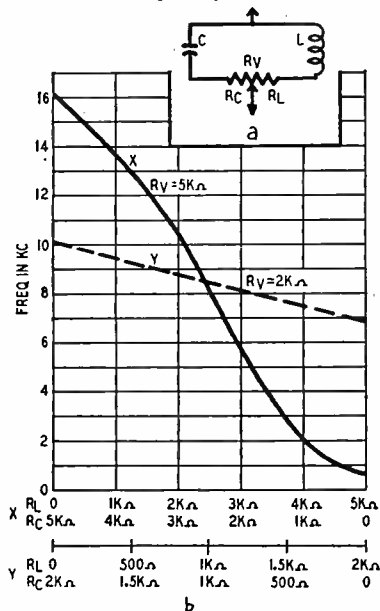
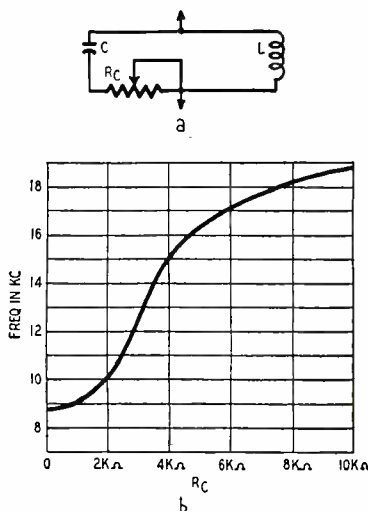

Fig. 10—A modification of Fig. 9 circuit.

Fig. 11—Another modification of Fig. 9.

Fig. 12—“Secret tuning” in series circuit.



A group of easily constructed circuits, using the advantages of this inexpensive thyatron in various control applications.

THE VERSATILE 2050

By ED BUKSTEIN*

INDUSTRIAL electronics could never have reached its present state of development without the thyatron.

This tube has proven invaluable in a great variety of control circuits. It has been used in such diverse applications as centering postage stamps within their perforated boundaries, scaling down the counting rate of radiation counters, measuring the muzzle velocity of guns, and controlling the rotational speed of radar antennas.

The thyatron is a hot-cathode, gas-filled tube containing a control grid. Unlike the *vacuum tube*, small changes in grid voltage do not produce corresponding changes of plate current in the thyatron. The thyatron, like a switch, is either cut off or completely conductive; either the bias is sufficiently negative to prevent the flow of plate current or it is not. Once conduction has started, the grid loses all control; only removal or reduction of the plate voltage will restore the thyatron to the cutoff condition.

The 2050 is a small thyatron available at most radio supply houses and on the war-surplus market. This tube is classified as a shield-grid thyatron or a gas tetrode. The purpose of the second grid is to reduce the value of control grid current and also to permit variations in the firing characteristics of the tube. In most applications, however, the shield-grid is connected to the cathode. The filament of the 2050 is rated at 6.3 volts at 0.6 amp. The peak cathode current is 500 ma and the average cathode current is 100 ma. Some manufacturers recommend that the cathode be preheated at least 10 seconds before anode voltage is applied.

Four control circuits employing the 2050 are described below. These are basic circuits, and variations of the

same principles make these circuits usable in an almost endless variety of control applications.

The diagram of an automatic timing circuit is shown in Fig. 1. This timing circuit is often used when it is desired to apply power to certain apparatus, then have the power automatically disconnected after a given length of time. Resistance welders, enlargers, printers, r.f. heating equipment, and X-ray machines usually have this type of control. Accuracy and efficiency requirements preclude manual control by the operator.

When S1 (Fig. 1) is open and the upper side of the power line is negative, capacitor C charges. The path taken by this charging current is shown by the arrows. This charging current is actually the grid current of the 2050. The charge on capacitor C applies a negative potential to the grid of the 2050 and prevents the tube from conducting.

To start the timing interval, S1 is closed. S1-b now allows current to flow through the normally closed relay contacts, through the controlled device and back to the other side of the power line. Capacitor C begins to discharge through resistor R connected across it. As C discharges, the grid of the 2050 becomes less negative until the tube fires (ionizes). When the gas ionizes, the tube draws sufficient plate current to energize the relay. The normally closed relay contacts now open and disconnect the controlled device from the power lines.

Since the thyatron operates with a.c. plate voltage, the gas deionizes during every negative half-cycle. To prevent the relay from chattering at the line frequency, a capacitor is connected across its winding. This capacitor keeps the relay closed by discharging through it during each negative alternation. The 100-ohm resistor

limits surge currents which might damage the thyatron.

Duration of the timing interval is determined by the values of R and C. A larger resistance will reduce the rate of discharge and therefore increase the timing interval. A larger

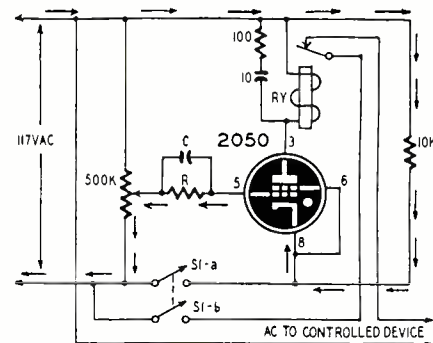

Fig. 1—An a.c.-operated circuit for thyatron control of small timing intervals.

capacitor will also require more time to discharge. The values of R and C are therefore chosen on the basis of the time duration desired. The resistor may be made variable to control the time delay. Several time-ranges can be made available by the use of a selector switch and several different values of capacitance. The potentiometer shown in the grid circuit also provides some control of the timing interval. Moving the slider toward the S1 end will cause C to charge to a greater voltage. More time will then be required to discharge this capacitor.

Photoelectric control

The high sensitivity of the thyatron has been extensively utilized in its application to photoelectric control devices. These circuits have been used for opening garage doors when an automobile approaches, counting objects passing on a conveyor belt, turn-

*Northwestern Vocational Institute, St. Paul, Minnesota.

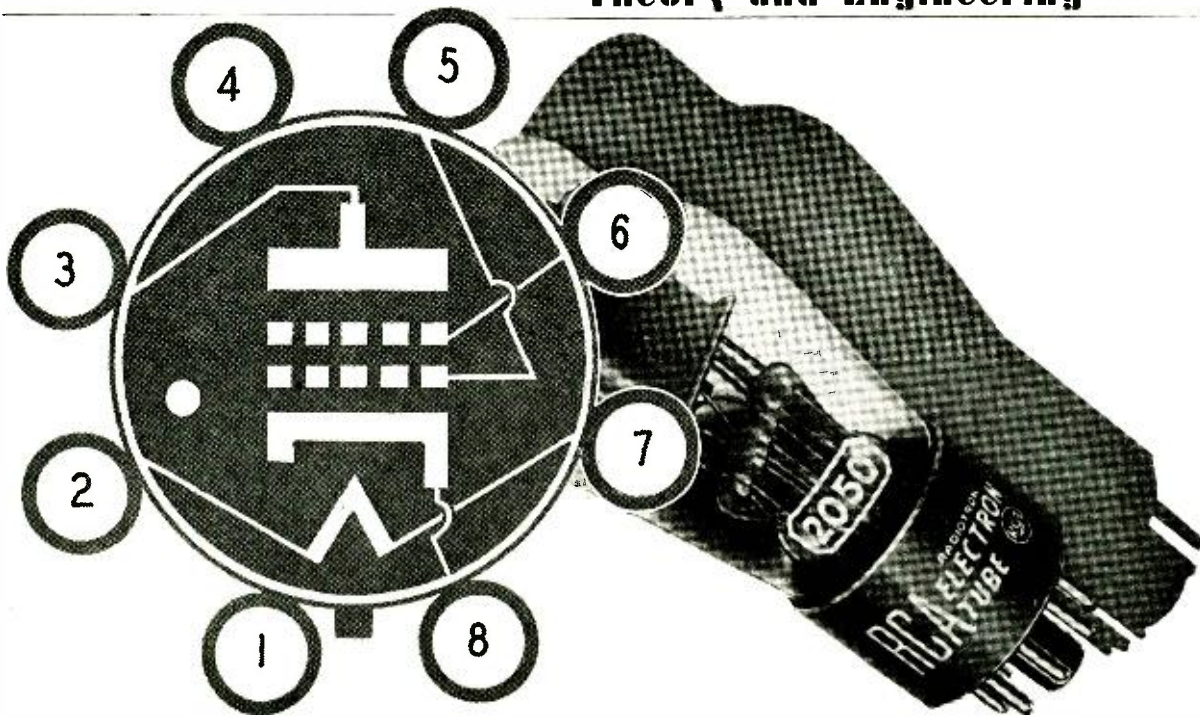

ing on lights at sundown, burglar and fire alarms, traffic surveys, race timers, etc.

Fig. 2 shows the circuit diagram of a photoelectric control which operates directly from the a.c. power line. The transformer is so connected that when

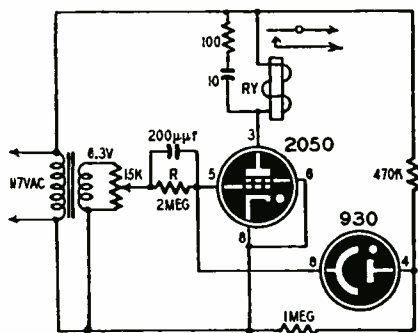

Fig. 2—A simple photoelectric control circuit using the 2050 thyatron tube.

the upper end of the primary is positive, the upper end of the 6-volt secondary is negative. Under these conditions, the thyatron cannot ionize (each time the plate goes positive, a negative bias is applied to the grid). If light is now allowed to strike the phototube, its cathode will emit electrons. This flow of photocurrent through R produces a voltage drop of opposite polarity to the bias. Since this IR drop makes the thyatron grid positive, ionization occurs and the resulting plate current energizes the relay.

The 1-megohm and 470,000-ohm resistors form a voltage divider to cut down the line voltage to a value suitable for the anode of the phototube (90 volts maximum for the 930).

Another photoelectric control is shown in Fig. 3. This circuit is of the type known as *self-latching*; i.e., once the relay has energized, it remains energized even though the amount of light on the phototube is restored to

its original value. This is the type of circuit used for intruder alarms. When the intruder passes in front of the phototube he breaks the light beam. This energizes the relay and turns on an alarm bell. The bell then continues to ring even though the burglar moves

the relay will be energized whenever light strikes the phototube.

The diagram of a thyatron contactor, sometimes known as a contact amplifier, is shown in Fig. 4. Initially, ionization of the thyatron is prevented by the application of negative

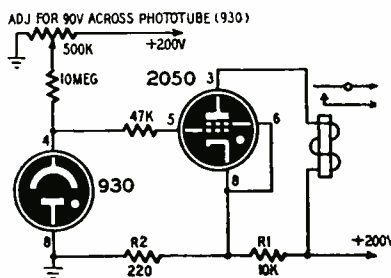

Fig. 3—The 2050 thyatron in a self-latching photoelectric alarm circuit.

away from the phototube.

In the circuit of Fig. 3 R1 and R2 form a voltage divider from B-plus to ground. The positive voltage at the junction of these two resistors is applied to the cathode of the thyatron. This cathode bias is sufficient to prevent ionization.

When the light to the phototube is obstructed, the internal impedance of this tube increases and a greater voltage drop appears across it. This voltage drop makes the thyatron grid positive enough to overcome the cathode bias. The 2050 then ionizes and energizes the relay. After a thyatron has ionized, variations of grid voltage do not change the plate current. This loss of grid control accounts for the self-latching feature of the circuit. To de-energize and release the relay, it is necessary to remove the plate voltage momentarily.

If the positions of the 10-megohm resistor and the phototube are reversed,

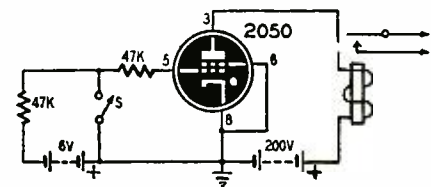

Fig. 4—A sensitive relay circuit, or "contact amplifier," using the 2050 thyatron.

voltage to the control grid. When the switch S is closed, the grid is connected to the cathode. Under this zero-bias condition, the thyatron fires, and its plate current energizes the relay. This circuit will be self-latching; once the thyatron is fired, opening the switch will not deionize it. If this self-latching feature is not desired, transformer windings may be used in place of the batteries shown in Fig. 4. These windings should be so arranged that when the thyatron plate is positive, its grid will be negative.

In practice, the thyatron contactor is used when the switch contacts are too delicate or too small to handle enough current to operate a relay directly. The relay contacts can be used to energize a circuit which will counteract the original increase which closed the switch contacts. In this manner, the quantity being metered can be regulated or held within specified limits.

—end—

ELECTROSTATIC FINISHING

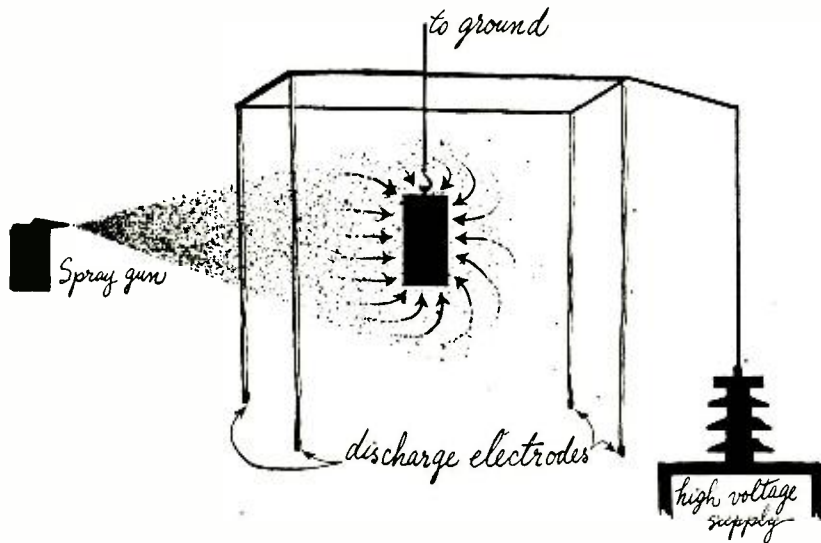

Conventionalized representation of electrostatic painting equipment.

Painting becomes
easy with this
technique in which
the paint seeks out
its object

By JERRY S. ADAMS

ELECTROSTATIC finishing offers the alert service technician a field with many potential applications. Recently introduced, it effects large savings in spray-finishing operations by polarizing the minute particles of paint so that they are attracted to grounded objects by electrostatic force.

The spray is polarized by directing it through a series of fine wires as shown above. The wires (known as discharge electrodes) are charged to a potential of approximately 100,000 volts by a step-up transformer and rectifier operating from the power line. Powerful electrostatic fields exist between these wires and nearby grounded objects.

The spray enters these fields at the high-potential end, the particles become positively charged, and are attracted at high velocity to the grounded object. Dispersion and waste of the finishing material is eliminated and the time required for the operation considerably reduced. Normal current in the high-voltage circuit due to ionization of the air surrounding the wires is approximately 10 ma.

The danger of fires or personnel accidents is relatively slight because there is no tendency to "spark" in an atmosphere laden with coating particles. However, fires can be started by failures in electrical equipment or unpredictable accidents, so two methods of protection are used.

A constant-voltage transformer in the power-line circuit reduces hazards due to possible line-voltage fluctuations; and a special protector unit guards against sparking in the high-voltage circuit. Current is supplied to all operational units through a five-pole magnetic contactor. The holding coil of the contactor is energized

through a thyatron, operated from a small auxiliary power supply. When a dangerous increase occurs in the normal 10-ma current the thyatron fires, opening the holding circuit of the five-pole contactor and energizing a two-pole relay which actuates a warning bell and a signal light on the spray-booth control panel. If a failure should take place in some component of the spark guard, work would be halted the same as if a sparking condition existed; but, when repairs cannot be made in a reasonable time, a locking switch can be utilized to bypass the spark guard, permitting operations to continue on an emergency basis.

Articles which are being electrostatically finished are usually grounded via metallic fixtures or metallic conveyor units, on which they are mounted for movement through the spray booth. In some cases, difficulties have been experienced due to the tendencies of certain nonmetallic articles to resist the influence of a negative charge; and it has occasionally been found that such articles can possess an inherent degree of polarity which will actually repel the sprayed coating particles. As a rule these difficulties can be overcome if nonmetallic articles are reinforced with strong metallic conductors during the finishing process.

Coating materials are usually thinned with solvents to minimize the sizes of sprayed particles, thus facilitating polarization, and to maintain the "wetness" of the particles during the relatively long time interval that may elapse before they are attracted by a grounded surface. Spray guns are carefully regulated for low atomizing pressures (about 15 to 30 pounds per square inch), and are rigidly mounted.

Generally speaking, two or more

spray guns are simultaneously operated in each electrostatic spray booth. Each is positioned at least 12 inches away from a discharge electrode, and aimed so that its output will be almost parallel to the direction of conveyor travel—directly coating articles which are two or three feet distant.

Electrostatically coated articles are usually conveyed past a bank of infrared lamps for rapid drying action. In some cases they may receive a preliminary infra-red heat treatment to remove greases and other fluids which might prevent the adhesion of coating materials.

The normal operations of an electrostatic spray booth are started and stopped by means of a simple push-button switch on the control panel.

A variation of the electrostatic spraying technique is the process known as "electrostatic detearing," recently developed by Ransburg Electro-Coating Corp. It consists of dip-coating and draining an article in a conventional manner, then (by means of a grounded conveyor) passing the article over a high-voltage grid so that electrostatic influences will remove the unsightly "tear drops" which would not ordinarily drain from the lower edges of a dip-coated product.

Several manufacturers are currently reported to be in the process of developing "dry electroplating" techniques, in which pneumatic metallizing guns may be used to atomize molten alloys so that the latter can be sprayed on both metallic and nonmetallic articles via the ionizing wires of a discharge electrode. However, despite the fact that suitable spray guns are known to be available, no accomplishments in this category have yet been announced.

—end—

Learn RADIO TELEVISION

-New Package Unit Plan- PAY AS YOU LEARN NO MONTHLY PAYMENT CONTRACT TO SIGN!

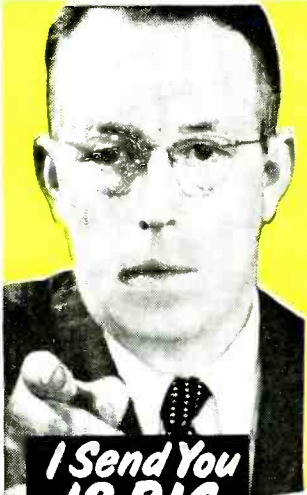

**I Send You
18 BIG
KITS
OF RADIO-
TELEVISION
EQUIPMENT**

TRAIN IN 10 MONTHS OR LESS At Home in Your Spare Hours

Now . . . be ready for Radio-Television's big pay opportunities in a few short MONTHS! Frank L. Sprayberry's completely new "Package" training unit plan prepares you in just 10 MONTHS . . . or even less! Equally important, there is NO monthly payment contract to sign . . . thus NO RISK to you! This is America's finest, most complete, practical training—gets you ready to handle any practical job in the booming Radio-Television industry. In just 10 months you may start your own profitable Radio-Television shop . . . or accept a good paying job in this fascinating expanding field at work you've always wanted to do. Mr. Sprayberry has trained hundreds of successful Radio-Television technicians—and stands ready to train you in less than one year, even if you have no previous experience. You learn by DOING . . . actually working with your hands with equipment of special design to illustrate basic theory instead of relying on books alone.

VALUABLE EQUIPMENT INCLUDED WITH TRAINING:

The new Sprayberry "package" plan includes many big kits of genuine, professional Radio-Television equipment. While training you actually perform over 300 demonstrations, experiments and construction projects. In addition, you build a powerful 6-tube standard and short wave radio set, a multi-range test meter, a signal generator, signal tracer, many other projects. All equipment is yours to keep . . . you have practically everything you need to set up your own service shop. The interesting Sprayberry book-bound lessons and other training materials . . . all are yours to keep.

Learn Extra Money While You Learn!

All your 10 months of training is AT YOUR HOME in spare hours. Keep on with your present job and income while learning . . . and earn EXTRA CASH in addition. With each training "package" unit, you receive extra plans and ideas for spare time Radio-Television jobs. Many students pay for their entire training this way. You get priceless practical experience and earn generous service fees from grateful customers. Just one more reason why the Sprayberry new 10 MONTH-OR-LESS training plan is the best Radio-Television training in America today. If you expect to be in the armed forces later, there is no better preparation than good Radio-Television training.

FREE 3 BIG RADIO-TELEVISION BOOKS

I want you to have ALL the facts about my new 10-MONTH Radio-Television Training—without cost! Act now! Rush the coupon for my three big Radio-Television books: "How to Make Money in Radio-Television," PLUS my new illustrated Television Bulletin PLUS an actual sample Sprayberry Lesson—all FREE with my compliments. No obligation and no salesman will call on you. Send the coupon in an envelope or paste on back of post card. I will rush all three books at once!

SPRAYBERRY ACADEMY OF RADIO
Dept. 20-J, 111 N. Canal St., Chicago 6, Ill.

APPROVED FOR VETERANS UNDER THE G.I. BILL



IF YOU ARE EXPERIENCED IN RADIO

Men already in Radio who seek a short intensive 100% TELEVISION Training with FULL EQUIPMENT INCLUDED are invited to check and mail the coupon at the right.

Mail Coupon Today!

**NO OBLIGATION
No Salesman
Will Call**

SPRAYBERRY ACADEMY OF RADIO, Dept. 20-J
111 North Canal St., Chicago 6, Ill.

Please rush to me all information on your 10-MONTH Radio-Television Training Plan. I understand this does not obligate me and that no salesman will call upon me.

Name..... Age.....

Address.....

City..... Zone..... State.....

Please check Below About Your Experience

Are You Experienced? No Experience

CODETYPER

How computer-type circuits automatically form Morse Code characters.

By NATHANIEL G. A. DORFMAN

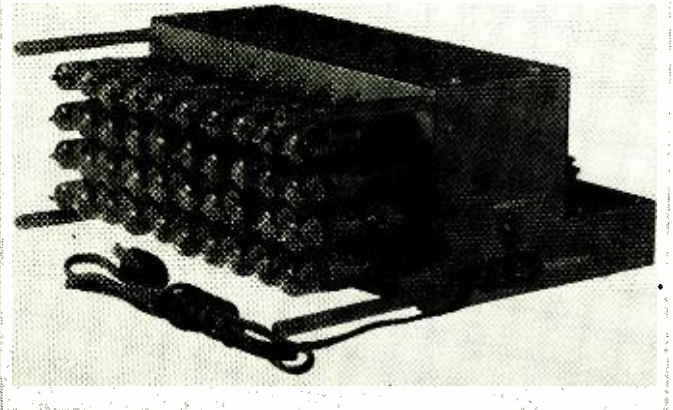
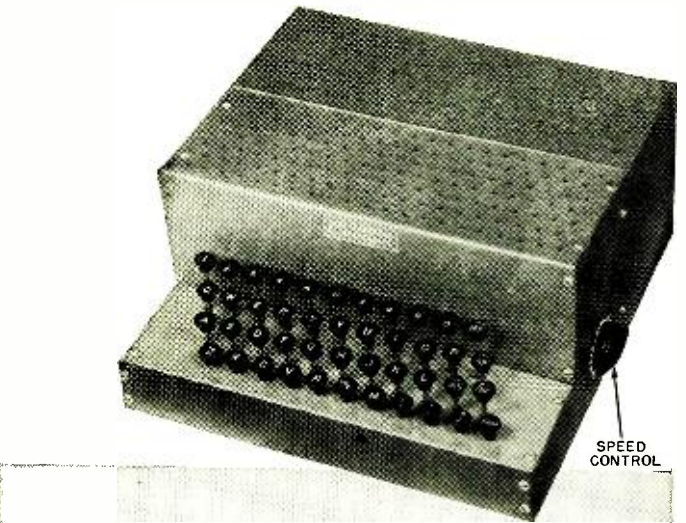
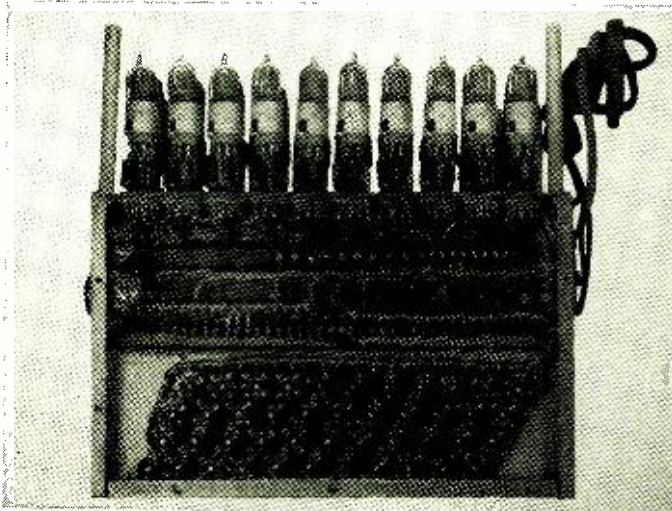

These three views of the Codetyper show its external resemblance to a standard "mill," and some of its unique constructional features. Plug-in cell units for all tube circuits provide complete accessibility and allow instant replacement.

THE dream of every amateur radio operator (and many professionals) —a perfect "fist"—may become a reality with the development of the *Codetyper*. Automatically translating the characters of a standard typewriter keyboard directly into perfectly formed and spaced dots and dashes, it may also benefit commercial circuits. By eliminating personal idiosyncrasies from code transmission it may enable consistent, errorless reception under difficult receiving conditions.

The *Codetyper* incorporates many of the counter and gating circuits used in recent electronic computing devices. Although no larger than a portable typewriter, it contains 40 miniature tubes, power supply, and all wiring and control circuits. (See photographs)

The dots and dashes of the code are formed by a series of on-off switching oscillators called "unigenerators." Each unigenerator is a cathode-coupled multivibrator with one stable state. The schematic of a typical unigenerator stage is shown in Fig. 1-a, and

operating waveforms are shown in Fig. 1-b. V1 and V2 in the discussion below may refer to two separate tubes, or—as in the unigenerators—the two halves of a 6J6 dual-triode.

In the stable condition V2 is made to draw heavy plate current by applying a positive voltage to its grid from the voltage divider R1-R2. The plate of V2 is thus effectively shorted to its cathode. V1 is completely cut off by the large bias voltage developed across the common cathode resistor R4 by the plate current of V2. Thus the plate of V1 is at full B-plus voltage. Capacitor C is charged to the difference in voltage between the plate of V1 and the grid of V2, with the polarities shown in Fig. 1-a.

The unigenerator remains in this condition until a large positive pulse from an external source applied to the grid of V1 overcomes the cutoff bias from the cathode resistor. The resulting flow of plate current in V1 produces several effects simultaneously, shown graphically in Fig. 1-b.

1. The internal resistance of V1 falls to a very low value, effectively shorting its plate and cathode.

2. Capacitor C discharges rapidly through R3, R2, R4 and the low internal resistance of V1.

3. The heavy flow of electrons from the grid end of capacitor C to ground during this discharge is in the opposite direction to the flow of bleeder current through R2, and cancels the positive voltage on the grid of V2.

4. V2 is now cut off by the bias across cathode resistor R4 developed by the plate current of V1, and its plate is at full B-plus voltage.

Normal conditions in the unigenerator are now reversed. It will remain in this state until the grid end of capacitor C again charges to a positive voltage through R2. The instant this positive voltage overcomes the cutoff bias on V2, the unigenerator reverts to its original condition. The time of this recovery depends on the product of R3 and C, and on the positive voltage required. Since R3 and C are fixed, the

A Guiding Beacon For Quality Electronic Parts

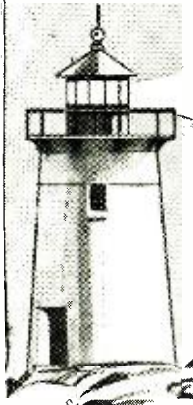

Your Local
RADIART
Distributor



RADIART Sales Offices Across The Nation



These Are The Cities With RADIART Distributors
In Alaska, British Columbia, Idaho, Montana,
Oregon and Washington

ALASKA

ANCHORAGE
FAIRBANKS

BRITISH COLUMBIA

VANCOUVER
VICTORIA

IDAHO

BOISE

MONTANA

BUTTE
GREAT FALLS
MISSOULA

OREGON

EUGENE
KLAMATH FALLS
MEDFORD
PORTLAND

WASHINGTON

BELLINGHAM
EVERETT
SEATTLE
SPOKANE
TACOMA
YAKIMA

BUY OF THE MONTH

NOW—it can be told! After months and months of patient research and development—a NEW RADIART VIBRATOR, as well as a NEW RADIART BOOSTER, is in production! These remarkable electronic developments are the last word in the field—and take up where all others leave off. Superior in performance—advanced in design—they incorporate all the features necessary for maximum TV set performance. See them at your RADIART distributors—or write for literature to us.

FOR NAME OF YOUR NEAREST RADIART DISTRIBUTOR
USE COUPON BELOW

RADIART SALES CO., 819 Thomas Street, Seattle 9, Washington

.....Please send names of the Radiart Distributors in my area stocking the following Radiart products in which I am interested: Tele-Rotors, Vibrators, TV and FM Antennas, "Spee-Dee" Chimney Mounts, Lightning Arresters, Auto Aerials, Power Supplies

.....Please have a Radiart Distributor call on me.

Name.....

Address.....

City..... State.....



THE **RADIART** CORPORATION CLEVELAND 2, OHIO

VIBRATORS • AUTO AERIALS • TV ANTENNAS • ROTATORS • POWER SUPPLIES

no other fan conical

assembles so fast

performs so well!

JETENNA

see the new jfd jetenna at the may radio parts show booth 578 or room 516

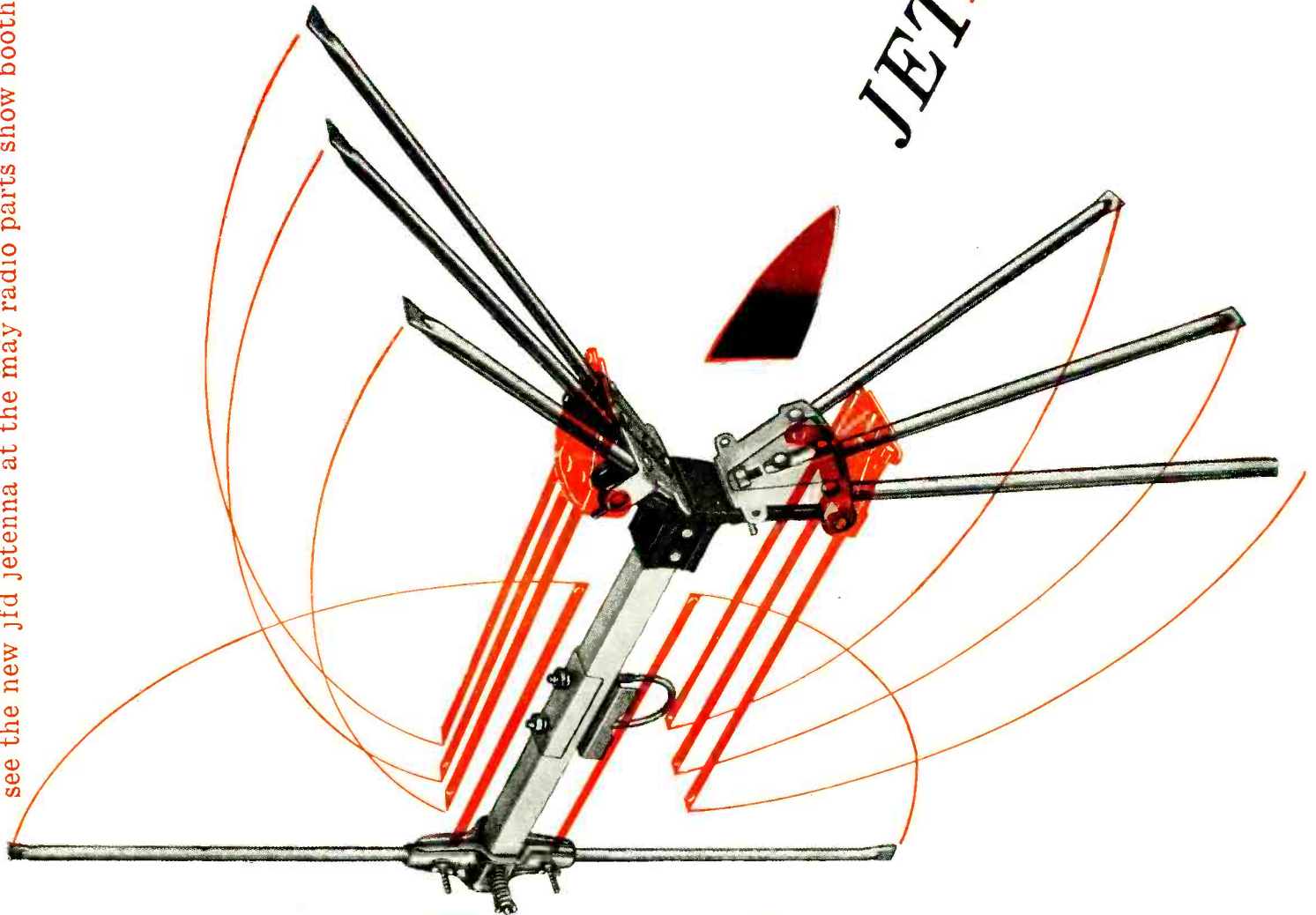

JFD JETENNA, the conical with the jet-action assembly, has absolutely no separate parts to put together—the slowest part is opening the carton! Just swing out the elements, tighten two “T” bolts and two wing nuts and it’s assembled! Front elements automatically fan out as they are swung forward. Reflector elements are spring-loaded to lock into position for tightening. 1” square seamless crossarm, seamless elements and element brackets are of high tensile strength aluminum—unbreakable head is of all weather, high dielectric material. Solid, unbreakable “vibration dampers” do not absorb moisture or swell and will not rot out. SEE YOUR JOBBER OR WRITE FOR FURTHER INFORMATION ABOUT THIS REVOLUTIONARY NEW ANTENNA.



JFD MFG. CO., BROOKLYN 4, N.Y.
BENSONHURST 6-9200

*world's largest manufacturer
of TV antennas and accessories*

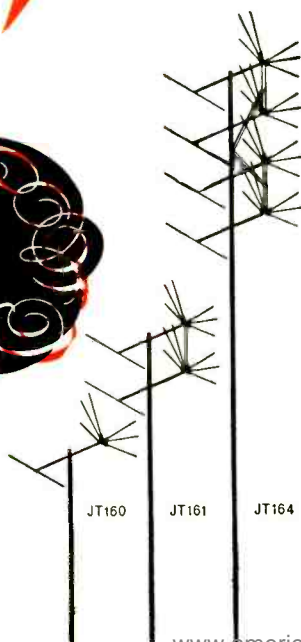

JT160 SINGLE BAY 12.50 LIST
JT161 STACKED 26.40 LIST
JT164 DOUBLE STACKED 56.80 LIST

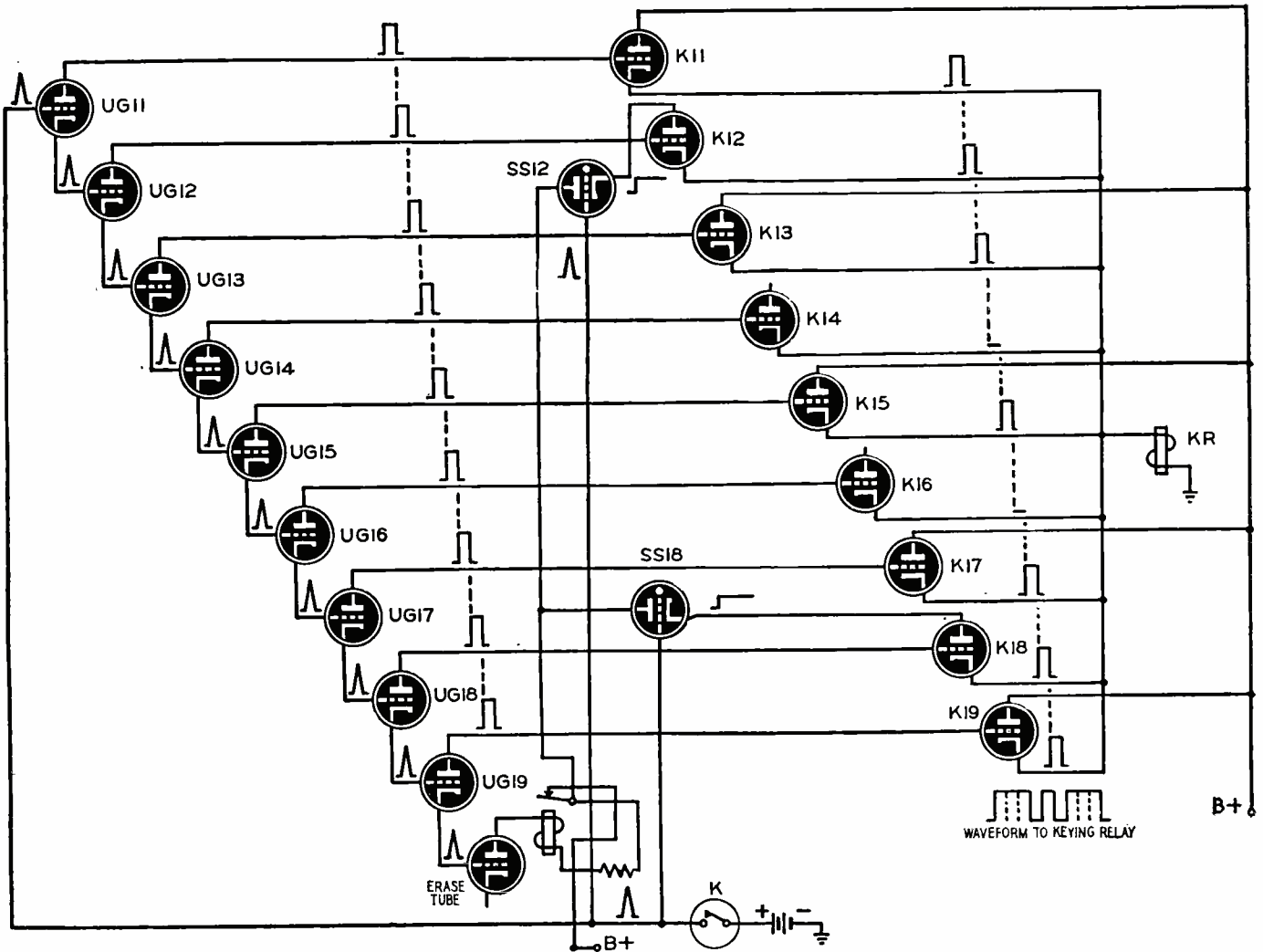

Functional diagram of the Codetyper, showing the components and circuitry involved in automatically transmitting letter "K".

recovery time can be varied by an adjustable positive-bias control (R2).

The waveforms of Fig. 1-b show that a positive square wave appears at the plate of V2 each time a positive pulse is applied to the grid of V1. At the same time a negative square wave appears at the common cathode point, since V1 is adjusted to draw slightly less plate current than V2 when conducting.

Nineteen code components

The Codetyper utilizes a chain of 19 identical unigenerators to produce up to 19 successive square waves. Each succeeding stage is triggered from the cathode of the preceding stage through a differentiator circuit which converts the leading and trailing edges of the square waves to negative and positive pulses. The negative pulse has no effect, since the tube to which it is applied is already biased beyond cut-off. The positive pulse overcomes the bias, and triggers the unigenerator.

If the starting trigger pulse is applied to the input of the first unigenerator in the chain, square waves will appear *in succession* at the outputs of each of the 19 stages. Fewer than 19 successive square waves are obtained

by applying the starting pulse to the input of the appropriate unigenerator stage. Individual compensating adjustments in each stage (not shown in Fig. 1-a) permit equalizing the widths and amplitudes of all 19 outputs. A common adjustable positive bias for all stages controls recovery time (keying speed).

The positive square wave from the output plate of each unigenerator is applied to the grid of its associated *keying tube*. The cathodes of all 19 keying tubes are connected in parallel, and return to B-minus through the coil of the keying relay. The odd-numbered tubes are connected to plus-B and are biased to cutoff, so that the keying relay is not energized without signal. The plate of each even-numbered keying tube is connected to B-plus through a "sequence-selector" thyratron which is normally nonconducting. Thus an odd-numbered keying tube requires only a positive square wave on its grid from its associated unigenerator to make it conduct fully and energize the keying relay. An even-numbered keying tube, however, requires not only the grid square wave but also a conductive sequence-selector to energize the keying relay.

In the International Morse Code the basic timing unit or interval is the duration of one *dot*. A *dash* has a length of three intervals, and the *space* between dots or dashes within a character is equal to one interval. The Codetyper has only two states. It can transmit a dot (marker) or a blank interval (space). If none of the sequence-selectors are activated, a voltage applied to the first unigenerator will cause each alternate keyer tube to act in turn, sending a series of dots separated by spaces. The sequence-selectors cause a space to become a dot, and therefore permit sending three dots with no interval between them. This is a dash. Thus the three elements of the code—dot, dash, and space—become two, and can be handled by an on-off device.

Odd and even intervals

Since dots and dashes represent *odd* numbers of intervals (1 and 3) spaces within a character will always occur on even-numbered intervals. For example, the letter "L" contains a total of 9 intervals:

1	2	3	4	5	6	7	8	9
DOT			DASH			DOT		DOT

JOBBERS . . . See it at BOOTH 414

filtered DC power supply

1%

LESS THAN RIPPLE at TOP LOAD

Continuously Variable, 0-28 Volts up to 15 Amps.

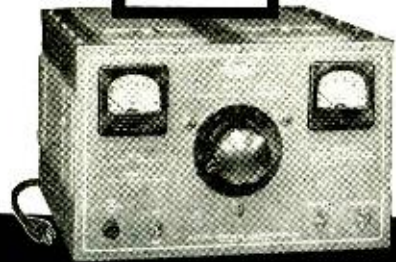

Test, Service DC Equipment from AC Lines Faster . . . at Less Cost!

NEW MODEL "NF" meets most requirements in a DC power supply . . . extremely low AC ripple or hum at this output range . . . low price . . . dependability. One control gives you adjustable output voltage, over its rated range. Exclusive "Electro" application of selenium rectifiers increases rectifier power rating and lowers cost per ampere output. Top quality components and special design withstand high overloads.

NET \$195

For Aircraft, Tank, Marine Electronic Equipment, Laboratory Instruments, Research, Relays, Solenoids, Phone Circuits.

Model "N" 0-28 V., 1-15 Amps., 8% Hum, \$175
 Model "B" 6 V., 1-20 Amps., \$49.80
 Model "BJ" 6 V., 1-12.5 Amps., \$37.50

If Your Jobber Can't Supply, Write to . . .



ELECTRO PRODUCTS LABORATORIES
 4501-Rf Ravenswood Ave. Chicago 40, Ill.
 In Canada ATLAS RADIO CORP., LTD., TORONTO
 PRECISION INSTRUMENTS SINCE 1944

The numeral "5" also contains 9 intervals:

1	2	3	4	5	6	7	8	9
DOT	DOT	DOT	DOT	DOT	DOT	DOT	DOT	DOT

The longest single character (the numeral "zero") contains 19 intervals:

1	2	3	4	5	6	7	8	9	10	11	12	13	14	15	16	17	18	19	
DASH	DASH	DASH	DASH	DASH	DASH	DASH	DASH	DASH	DASH	DASH	DASH	DASH	DASH	DASH	DASH	DASH	DASH	DASH	DASH

A special "error" signal, consisting of 10 dots and 9 spaces, also contains 19 intervals:

1	2	3	4	5	6	7	8	9	10	11	12	13	14	15	16	17	18	19	
DOT	DOT	DOT	DOT	DOT	DOT	DOT	DOT	DOT	DOT	DOT	DOT	DOT	DOT	DOT	DOT	DOT	DOT	DOT	DOT

Thus in transmitting characters consisting only of dots, (E, I, H, S, 5, and the error signal) the even-numbered intervals are not keyed. In transmitting characters containing dashes, only the even-numbered intervals falling in the middle of a dash are keyed. Fig. 2 shows how this principle is utilized in the operation of the Codetyper in transmitting the letter "K".

1	2	3	4	5	6	7	8	9
DASH	DOT	DASH	DASH	DASH	DASH	DASH	DASH	DASH

Since the letter "K" contains 9 intervals, only the last 9 unigeners in the chain of 19 are required. The starting trigger pulse must be applied to the input of unigenerator 11. Thus only keying tubes 11 through 19 will receive positive pulses on their grids, as shown below.

Unigeners/ Keying tubes { 11 12 13 14 15 16 17 18 19
 DASH DOT DASH

Since no keying is necessary for the spaces 14 and 16, only even-numbered keying tubes 12 and 18 are required to conduct through their associated sequence-selector thyratrons. All the units involved are shown below:

Unigeners	11	12	13	14	15	16	17	18	19
Keying tubes	11	12	13	14	15	16	17	18	19
Sequence selectors Conducting		12						18	

Striking the letter "K" on the keyboard closes a switch which applies a positive voltage to the control grids of sequence-selector thyratrons 12 and 18, and to the input grid of unigenerator 11. This part of the equipment, known as the "phantom switch network," is a form of coder (function table, matrix). The principle of these devices is described in the series "How an Electronic Brain Works" (Berkeley and Jensen) Part XII, RADIO-ELECTRONICS, September, 1951. Briefly, a coder is a device with which a single-pole, single-throw switch can actuate a number of circuits, and other similar switches can actuate some of the same circuits together with others, making it possible to have a large number of combinations with a practical number of switches. Thus any one of the combinations described above may be thrown into action by pressing a single key switch on the typewriter-like keyboard.

With the exception that neon lamps are used instead of the rectifiers, the phantom switch network is much like that shown in the article in the September, 1951, RADIO-ELECTRONICS.

Releasing the key removes the voltage placed on the grids, but the following sequence of events has already taken place:

Conduction has started through sequence-selectors 12 and 18, connecting the plates of keying tubes 12 and 18 to B-plus. (Removal of the positive voltage from the thyatron control grids cannot stop conduction.)

The voltage at the output plate of unigenerator 11 has jumped from nearly zero to full B-plus, thus applying a positive pulse through the coupling capacitor to the grid of keying tube 11. The flow of plate current through this keying tube energizes the keying relay. The voltage at the cathode of unigenerator 11 has dropped to a lower value, applying a negative pulse to the input grid of unigenerator 12. This negative pulse, however, has no effect, since the input triode section of unigenerator 12 is completely cut off.

After a recovery time determined by the setting of the speed control, unigenerator 11 reverses, its output plate voltage falls, and its cathode voltage

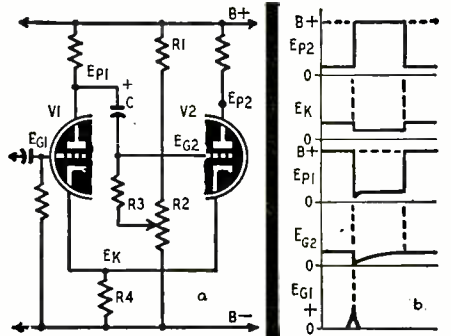

Fig. 1—Basic unigenerator circuit, with waveforms produced by an input trigger.

rises to the original value. The rising cathode voltage transmits a positive pulse through the differentiator circuit to the input of unigenerator 12, overcoming the cut-off bias and triggering this stage in the manner described above. Since there is no appreciable delay between the fall in voltage at the plate of unigenerator 11 and the corresponding rise at the plate of unigenerator 12, keying tube 12 conducts and holds the keying relay closed when keying tube 11 is cut off.

The series of pulses continues successively down the chain, keying tube 13 holding the relay closed when keying tube 12 releases. However, keying tubes 14 and 16 have no B-plus voltage, since their sequence-selector thyratrons were not energized, and the keying relay opens during these intervals.

The final positive pulse from the cathode of unigenerator 19 is applied to the grid of the "erase" tube. The resulting flow of plate current energizes the erase relay, and removes B-plus voltage from the sequence-selector tubes. After a short time delay, controlled by the value of the resistor in series with the erase relay coil, the erase circuit recloses. With B-plus voltage again applied to their plates, the sequence-selector thyratrons are reactivated in preparation for the next character to be transmitted.

—end—

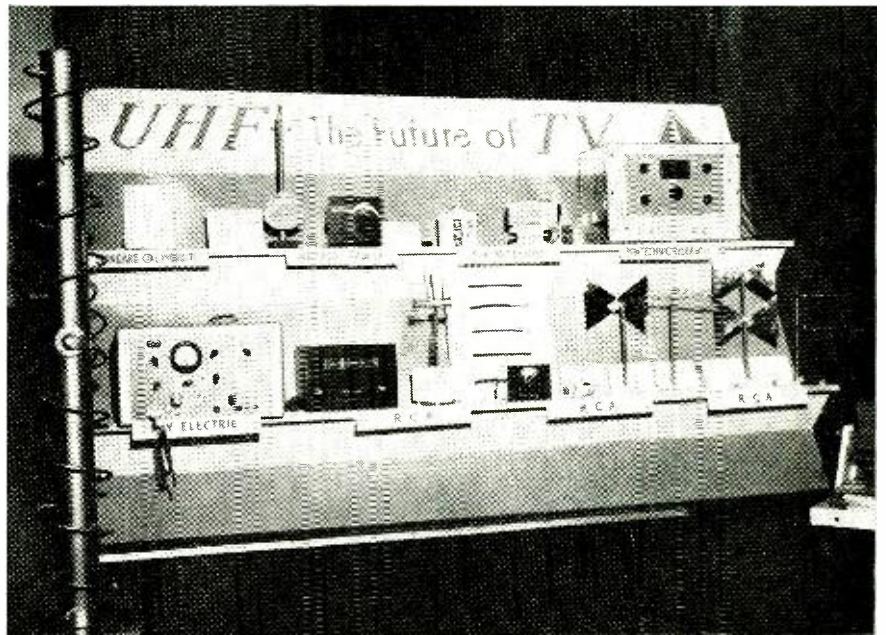

I. R. E.

FACES THE FUTURE

U.h.f. was the dominant feature of this year's I.R.E. meeting

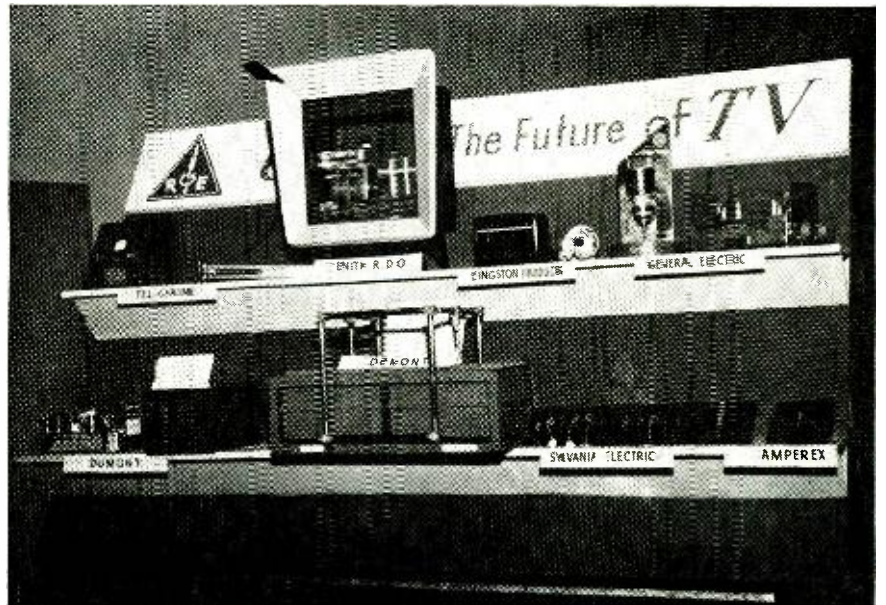

A two-bench display of converters, tuners and other equipment for u.h.f. television.

"I.R.E. Sets the Pace" was the official slogan at the 40th I.R.E. convention, held in New York City March 3-6. Underneath the official slogan, and pervading the whole convention was an unofficial one: "It's u.h.f. again this year—but this time we mean it," which was never put officially into words, but was felt in spirit in most conversations, conferences, papers and displays.

The 40th anniversary convention was the most successful in the history of the Institute. More than 29,000 engineers were registered, as compared

to a little less than 23,000 last year. The Radio Engineering Show which always forms a part of the meeting showed a spectacular increase as well, with 356 exhibits against last year's total of 276. Exhibits, which last year occupied three floors of New York's Grand Central Palace, with plenty of room on the third floor, now crowded four floors—a veritable World's Fair of electronics.

The feeling that the freeze on u.h.f. TV broadcasting was about to be lifted did indeed give a mighty impetus and direction to the proceedings. At the

preconvention press conference the biggest collection of u.h.f. converters and tuners on record was displayed. These will make it possible to receive the new u.h.f. stations on old receivers, and assure that new sets can be built for the high frequencies without further delay, once there are u.h.f. transmitting stations to send out programs.

U.h.f. played a large part in the technical sessions. Two sessions, at which nine papers were read, were devoted to the subject. G-E announced its new GL-6183, a ceramic 1-kilowatt air-cooled tetrode which gives full output

VEE-D-X

proudly presents

THE ALL CHANNEL

Q-TEE



Look for the bright red electronic channel separators, distinguishing mark of the dramatic new Q-TEE.

FEATURING

*PATENTED BUILT-IN

Electronic Channel Separators

for

Super Power All-Channel Performance

VEE-D-X engineers have done it again! Here is the antenna that brings to all-channel reception the brilliant performance and clean design of the famous VEE-D-X single channel arrays, the "JC" and the "Long John". Add the outstanding new feature, patented electronic channel separators, plus amazing newly engineered all-channel power, and it is easy to see why VEE-D-X is proud to present the Q-TEE. With these dramatic developments, the Q-TEE is destined to revolutionize broadband reception, not only in large metropolitan areas, but also in the near fringe and fringe with two and four stacked arrays. Your cue to brilliant TV reception is the Q-TEE.

THE LaPOINTE-PLASCOMOLD CORP., WINDSOR LOCKS, CONNECTICUT

ANOTHER VEE-D-X ORIGINAL—WITH PATENTED FEATURES

* Lic. A.A. K. Pat. 2,422,458; 2,282,292; others pending.

REVOLUTIONARY

Engineering Achievement in Antenna Construction

Q-TEE FEATURES

- All-channel Performance
- Ideal for Primary, Near Fringe and Fringe Areas
- Higher Average Gain Than Other Broadband Antennas
- Smaller, Lighter, Better Looking
- Higher Uniform Gain Over All Channels
- Better Front-to-Back Ratio
- Perfect 300 Ohm Match on Both High and Low Channels
- Lower Standing Wave Ratio Than Any Other Broadband Antenna
- More Easily Installed and Stacked
- VEE-D-X Pre-assembled Construction

EASILY STACKED FOR FRINGE AREAS

SINGLE BAY
for primary areas



2-STACK ARRAY
for near fringe areas provides a gain increase of 40% or better

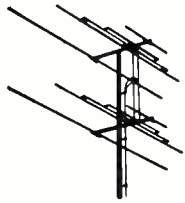

4-STACK ARRAY
for fringe areas provides a gain increase of 100% or better



Q-TEE is shipped pre-assembled and the elements fold open into position. Portions of this antenna are manufactured under license of A.A.K. Patent Nos. 2,282,292 and 2,422,458. Other patents on this antenna pending.

HOW THE Q-TEE FUNCTIONS

by Sydney E. Warner, VEE-D-X Chief Engineer

The Q-TEE is a new engineering approach to the all-channel TV antenna problem. Entirely new in design, this antenna incorporates a revolutionary feature, Electronic Channel Separators. The result is a unique antenna with better gain and directivity, higher front-to-back ratio, greater ease of assembly, increased mechanical strength and better appearance. Figure 1 shows the basic antenna assembly. On the low channels, elements (A-A) form a half-wave dipole, with elements (B-B) as the reflector. On the high channels, elements (C-C) form a full wave dipole with elements (E-E) as a half-wave director.

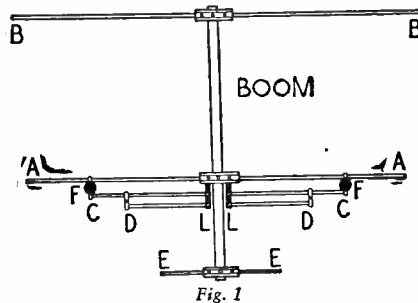

The close proximity of (A-A), (C-C) and (D-D) provides a driven element with very low "Q". This low "Q" in effect represents a driven element of a large electrical diameter and which in turn accounts for the broad (all-channel) frequency characteristics of the antenna.

Figures 2 and 3 show the horizontal directivity pattern of the Q-TEE. Note that the directivity is quite pronounced. The front-to-back ratio on the low channels will run from 6 db to as high as 12 db. This is an important consideration in those areas where co-channel interference problems exist. On the high channels, the front-to-back ratio is as high as 8 db on the center of the band.

Isolation filters (F-F) are anti-resonant at the center of the high channels (195 mc) and isolate the low channel dipole (A-A) from the high channel dipole (C-C). The center matching and phasing section performs a dual function and accounts for the unique operational characteristic of this antenna. In the high channels elements (D-D) are "T" match sections which tap the dipole (C-C) and provide a 300 ohm termination at (L-L). The high channel antenna is, therefore, a full wave antenna "T" matched, with a half-wave director. On the low channels the isolation filters (F-F) have a low impedance (inductive) since they operate below resonance. The high channel dipole (C-C) combined with element (D-D) form a double "T" match which taps dipole (A-A) to provide a 300 ohm termination at (L-L).

The directional characteristics of the antenna give less noise pickup since signals off the side and back are rejected to a much greater degree than they are in a conical type antenna. Conicals designed for good response on the high channels are poor on the lows, while those designed for the low channels are poor on the highs. Q-TEE does not have these limitations.



Mail coupon for full information on the Q-TEE.

Fig. 2

Fig. 3

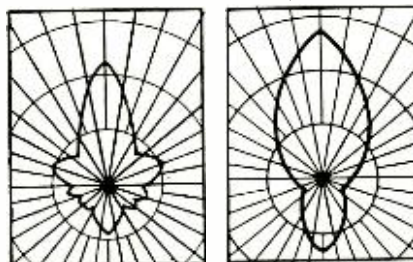

THE LaPOINTE-PLASCOMOLD CORP.
Windsor Locks, Conn.

Gentlemen:
Send me full information on Q-TEE

NAME.....
ADDRESS.....
CITY.....ZONE.....STATE.....

LOOK CLOSELY...

and you'll see why

They outperform all others!

OHMITE *Little Devil*
INSULATED COMPOSITION
RESISTORS

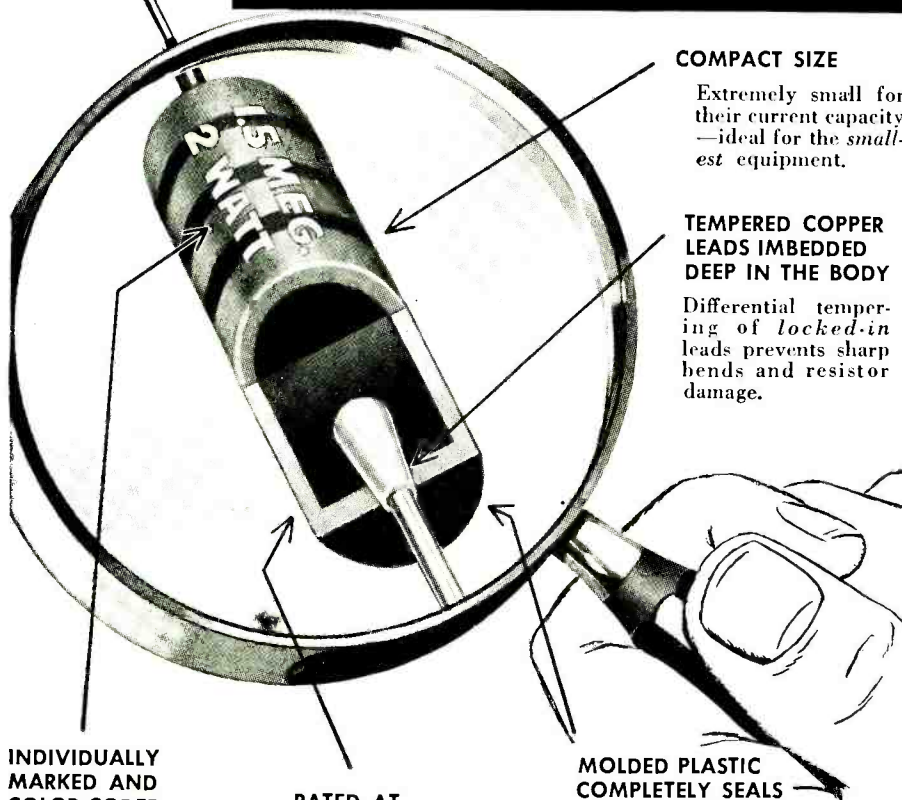

COMPACT SIZE

Extremely small for their current capacity—ideal for the smallest equipment.

TEMPERED COPPER LEADS IMBEDDED DEEP IN THE BODY

Differential tempering of *locked-in* leads prevents sharp bends and resistor damage.

INDIVIDUALLY MARKED AND COLOR-CODED

Quick, positive identification is easy. No guesswork or mistaken identity!

RATED AT 70C (158F)

Withstand extremes of heat, pressure, and humidity without deterioration.

MOLDED PLASTIC COMPLETELY SEALS AND INSULATES

Have high mechanical and insulating strength. Meet JAN-R-11 requirements.



When you use OHMITE *Little Devils* on your repair jobs, you can be sure of dependable resistor performance. That's because these tiny, rugged units are designed and built to high standards unmatched by any other composition resistor. Little Devils come in 1/2-, 1-, and 2-watt sizes in $\pm 5\%$ or $\pm 10\%$ tolerances, in standard RTMA values from 10 ohms to 22 megohms. In the 1-watt size, $\pm 10\%$ tolerance, values as low as 2.7 ohms are available.

OHMITE MANUFACTURING COMPANY

4894 Flournoy Street, Chicago 44, Illinois

WRITE FOR
BULLETIN 135

Be Right with **OHMITE**®

RHEOSTATS • RESISTORS • TAP SWITCHES

at 900 megacycles. This is an air-cooled version of the 6039 introduced last year. RCA reported on an experimental triode with a power output of 5 kilowatts. Other transmitter problems of the ultra-highs were discussed, as well as types of antennas for the spectrum.

A number of completely new classi-

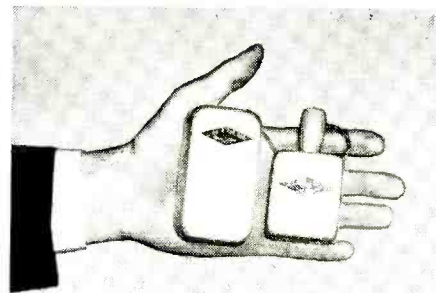

The Stephens Radio Link transmitter.

fications appeared on the program. One of these was the session *Subaudio Instrumentation*. The name was new but the subjects discussed were vibration testing, oil prospecting by underground sound (and subsonic), and other subjects already familiar to the engineer.

A second subject, which had been discussed at previous conventions, occupied two full sessions of this one. The subject was *Information Theory*. Engineers pointed out that by transmitting only those portions of a message—or even a television picture—that could not be predicted in advance, equipment and spectrum space might be used more efficiently. Besides transmitting new material, it would be nec-

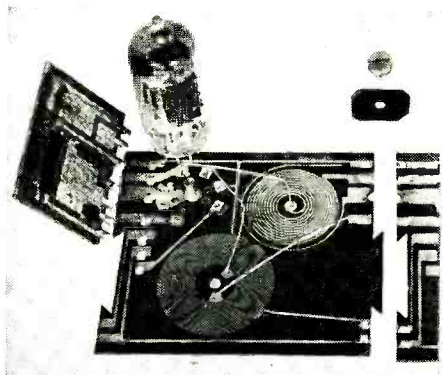

Sylvania applied-circuit unit, with part of second showing snap-in system.

essary to send signals representing the difference between the signal predicted by the receiver and that actually transmitted, when such "error" should occur. This subject borders closely on another important one—that of computers, since a "memory" is necessary to assemble material received and from it to predict what will come.

In spite of the ban on color broadcasting, color was one of the important features of the convention. A complete session and an evening symposium were devoted to it, and the subject was touched on in other papers. One of the most popular exhibits at the show was Columbia's demonstration of an all-electronic CBS color broadcasting sys-

RADIO-ELECTRONICS

The TRIO ROTATOR

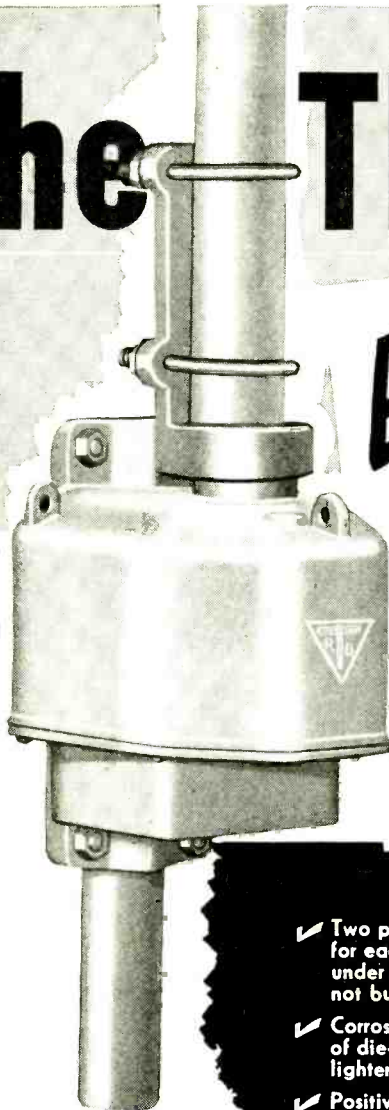

Easy to Sell!

It's easy to sell a product with as many plus features to talk about as the TRIO ROTATOR. In design, in construction, appearance; it is by far the outstanding TV antenna rotator in the market today!

Stays Sold!

In addition to providing a powerful sales story, the features listed below are your assurance of complete customer satisfaction: Assurance that the TRIO ROTATOR will give dependable performance year in and year out — in all kinds of weather!

- ✓ Two powerful 24 volt motors used — one for each direction of rotation. Each motor under load only fraction of time — will not burn out!
- ✓ Corrosion resisting, weatherproof housing of die-cast aluminum for greater strength, lighter weight, perfect alignment of parts!
- ✓ Positive electrical stops at ends of 360° rotation prevent damaging or twisting of leads!
- ✓ Will support heavy TV arrays — even in 80 MPH winds!
- ✓ Permanently lubricated with special grease that functions perfectly in high and low temperature extremes!
- ✓ Ball-bearing end thrusts on all shafts, including motor! Main shaft vertical load carried on large oversized "Oilite" self-lubricating bearing!
- ✓ All motors, shafts and gears mounted on a rugged, one-piece casting for true alignment and longer life!
- ✓ 1 1/16" diameter tool steel main shaft and mast holder will withstand 4500 inch pounds bending moment!
- ✓ Rotator and mast holder fits any pipe size up to 2" OD!
- ✓ Precision built to extremely close tolerances!



Smartly Styled

DIRECTION INDICATOR

The TRIO Direction Indicator is housed in a sturdy plastic cabinet of graceful lines. It is a beautiful instrument that will blend harmoniously with any furniture style.

Utmost ease in selecting the desired antenna direction is provided by a new "finger tip" control that operates at a light touch and the easy-to-read dial face that clearly and instantly indicates the exact antenna position.



**FULLY TESTED
BEFORE
SHIPMENT**

Each TRIO ROTATOR is thoroughly factory tested to the equivalent of 3 months of constant operation. This, plus an additional torque test guarantees each unit to be perfect in every detail of assembly.

The TRIO ROTATOR's sound design and construction has been proven by three years of extensive field testing under every extreme of weather.



TRIO Manufacturing Company
GRIGGSVILLE, ILLINOIS

Now...in the beautiful
New RMS Booster...
 the first real
 contribution to
 Booster Engineering



The TV Booster may be considered a dam of power. In ordinary boosters, this power may spill over, thus overloading the tube and setting up noise or "snow." In an attempt to avoid this, ordinary boosters do not make use of maximum possible gain.



SP-6's easily operated external gain control is like a dam spill-way. It cuts down the tremendous power to the point *just before* overload. Thus, for each channel, the highest practical gain possible brings in a clearer picture than might be obtained with a conventional booster.

EXTERNAL GAIN CONTROL

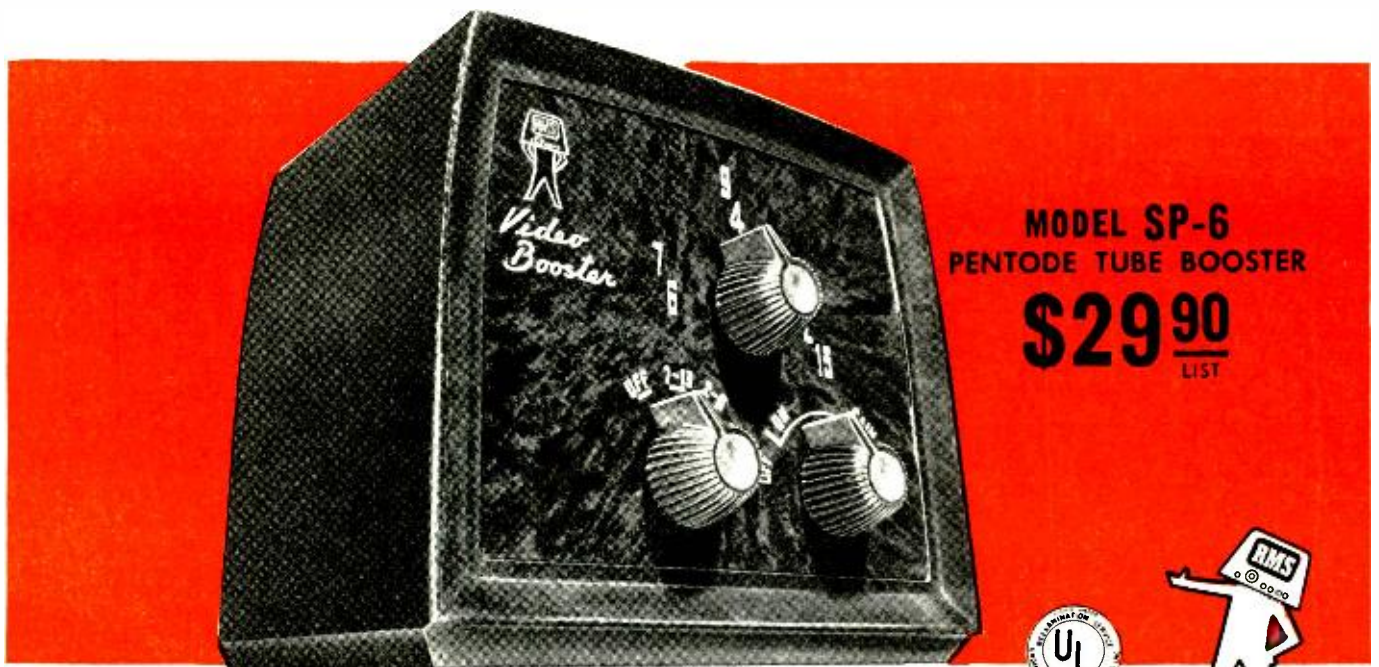

also **A NEW RMS TRIODE TUBE BOOSTER . . . MODEL SP-6J**

America's first and oldest booster manufacturer now offers you a choice in TV Boosters unmatched for their fine performance and tasteful styling. Impressively low noise level in both boosters; each approved by Underwriters Laboratories, each carries a *full year guarantee* with RMA 90-day warranty on parts.

See Your Local RMS Jobber
 Visit our booth at The Chicago Parts Show!

RMS INC. NEW YORK 59, NEW YORK

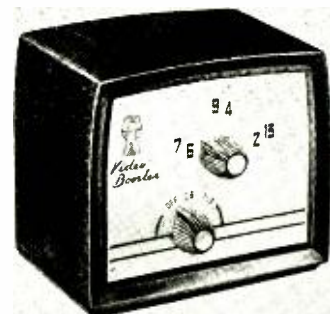

SP-6J TRIODE TUBE BOOSTER \$29.90 LIST

for **Portable**
and **Auto**

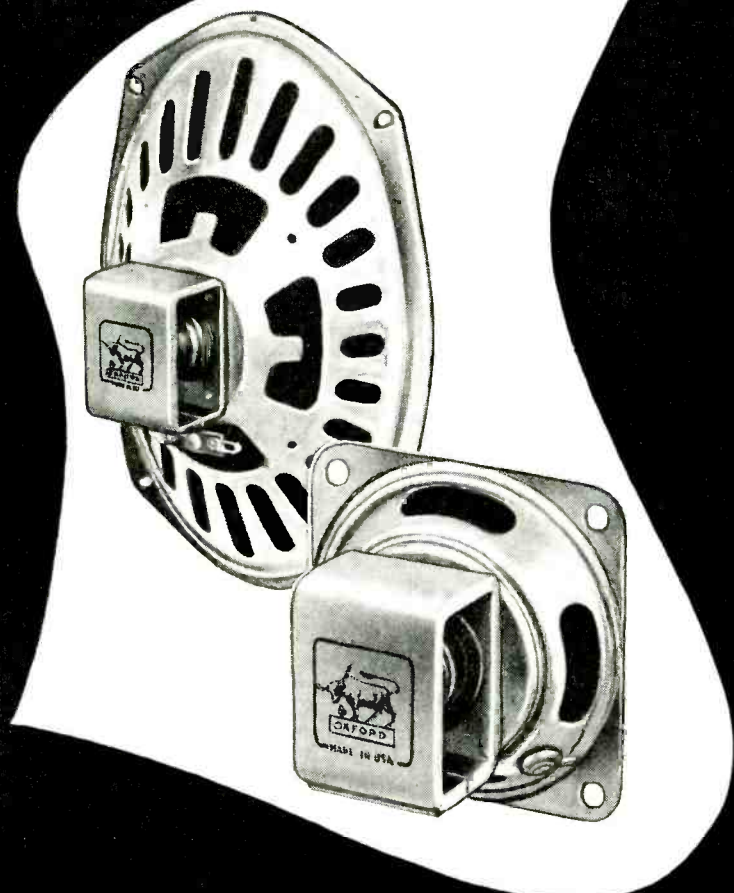
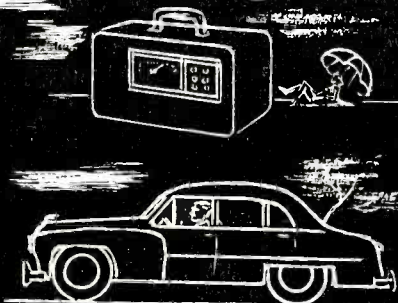

it's
OXFORD
Speakers

Preferred for original equipment
... Proven for replacement!

Other Oxford Speakers for: Radio and Television •
High Fidelity • Intercom • P.A. Systems • Out-
door and Weatherproof Applications

OXFORD
ELECTRIC CORPORATION

3911 S. Michigan Ave. • Chicago 15, Ill.
EXPORT: ROBURN AGENCIES, NEW YORK CITY

A copy of our
latest catalog
will be sent
upon request.

Available at
leading jobbers!

Visit
Booth
#309
Display
Room
#557

MAY PARTS
SHOW
CHICAGO



curved guide is needed, a polystyrene "waveguide" can be bent into the required shape readily.

Another important report by Bell was on work in receiving u.h.f. signals at points far beyond the theoretical line-of-sight. Signals of 500 and 3,700 mc were received *reliably* at a distance of 285 miles. Reliable reception means to a communications engineer that he can be sure of hearing a signal when he turns on the receiver. Weather and frequency seem to have had little effect on reception at these frequencies.

While the signals were very weak, they were very much stronger than predicted by theory. This indicates that our propagation theory is incomplete and that there are factors hitherto unsuspected.

The vest-pocket transmitter came into its own in the Stephens Radio Link, illustrated on page 76. It is an FM transmitter for actors' use on TV or movie stages. Frequency is about 50 mc, and reliable range 30 feet.

Other subjects which received much more attention than at previous conventions were transistors and medical electronics. The latter had a full session devoted to it for the first time. Treatment by microwave diathermy was the subject of one paper. The author pointed out that it is much more easily controlled than ordinary short-wave diathermy. Another paper described the use of color television in connection with ultraviolet microscopy. Since different types of tissues reflect different portions of the ultraviolet spectrum more strongly, the spectrum itself can be divided into three parts, each one of which is assigned a color. Then otherwise barely distinguishable differences show up clearly.

Discussion on transistors was a normal advance on that of previous years, and as such was not dramatic. The crystal diode also received some mention, in a paper describing its action at very low voltages. A paper on a barium titanate amplifier (RADIO-ELECTRONICS, February, 1952, page 92) was read. This device, whose action resembles that of a magnetic amplifier more than of a transistor, is as yet a novelty.

Printed circuits appear to have come into their own. Only one paper on the subject appeared, though some equipment used printed circuits where expedient, without bothering to mention it. The one paper described printed i.f. subassemblies for television. Using both silk-screen and photographic etching, a complete i.f. stage was placed on a card less than two inches square. Some of the resistors and capacitors were appliquéd onto a much smaller card mounted on the edge of the first. The tube was plugged into socket holes in the card, which was so shaped as to snap into preceding and succeeding stages. This system was presented by Sylvania, who, however, have no immediate plans for using it in production models. When that occurs, the service technician's dream of replacing whole defective stages, instead of trying to repair them, will have come true.

—end—

RADIO-ELECTRONICS



ALL RANGES WITH THIS ONE CONTROL

Just *one* knob—extra large—easy to turn—flush with the panel, controls all ranges. This one knob saves your time—minimizes the chances of “burn-outs” because you don’t have to remember to set another control. You can work fast with Model 630 with your eyes as well as your hands. Look at that scale—wide open—easy to read, accurately. Yes, this is a *smooth TV* tester. Fast, safe, no projecting knobs, or jacks, or meter case. Get your hand on that single control and you’ll see why thousands of “Model 630’s” are already in use in almost every kind of electrical testing



**Model
630**

ONLY \$39.50 AT YOUR DISTRIBUTOR

In Canada: Triplett Instruments of Canada, Georgetown, Ontario

FOR THE MAN WHO TAKES PRIDE IN HIS WORK

Triplett

TRIPLETT ELECTRICAL INSTRUMENT COMPANY • BLUFFTON, OHIO, U. S. A.

NEW GLOW LAMP APPLICATIONS

Gas-filled tubes have certain characteristics which make them suitable as pulse counters. Unfortunately, a gas tube with one cathode and one anode can have only two stable states: conducting and nonconducting. Thus a counting decade needs as many as 10 ordinary glow lamps (see RADIO-ELECTRONICS, Dec., 1951, p. 91).

To simplify counter design, tubes are being designed with multiple cathodes (or anodes). Successive pulses trigger the tube from one element to the next. Thus a tube with 10 cathodes does the work of 10 ordinary tubes and can function as a complete decade all by itself. Two promising tubes of this type have been disclosed recently in Patent Office publications.

Fig. 1-a is the basic design of a tube invented by N. B. Wales, Jr.* It has an extended cathode K, a short anode F, and several probe-anodes P. Hydrogen at low pressure is sealed within the glass envelope. R controls the tube current and determines the extent of the cathode glow. Initially, R is adjusted so the glow rises to a height A. Only the KF gap is ionized.

*U.S. Patent No. 2,573,373, assigned to International Business Machines Corp., New York City.

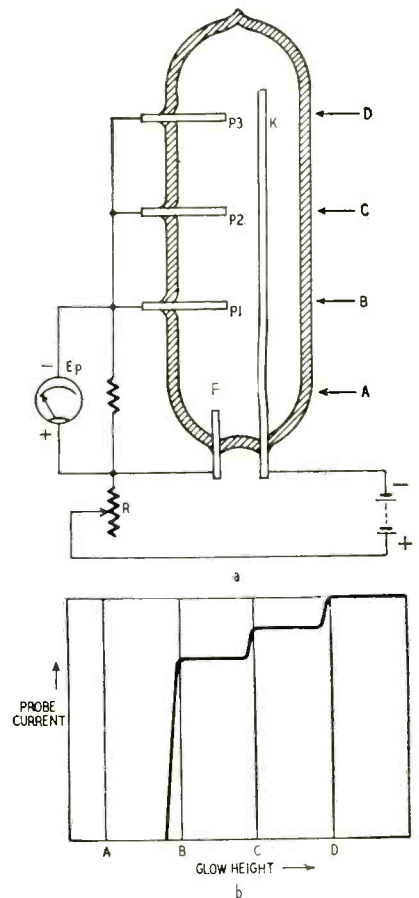

Fig. 1—Multiple-anode lamp and response.

Do You Know?

G-C

MAKES

3,521

SERVICE NEEDS

FOR RADIO TV SERVICING

RADIO - TV CHEMICALS

In the G-C chemical line alone, there are more than 85 different products. Every one's designed to help the serviceman do a better job faster, easier, more profitably.

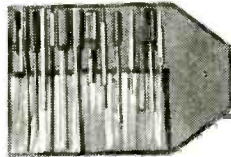

ALIGNMENT TOOLS AND EQUIPMENT

Virtually every type of servicing tool for the bench or on the job is available at G-C, both separately and in kits. "Whatever you need, G-C makes" might well be the G-C motto!



ACCESSORIES AND SERVICE AIDS

There are literally hundreds and hundreds of in-demand items in this G-C category. Switches, terminal strips, knobs, belts, dial drives, cables, recording wire and tape are included.

RADIO HARDWARE

Nuts, bolts, set screws and all the rest of these indispensable items are conveniently packaged by G-C in jars, boxes, envelopes, displays and racks. And the line is both big and complete.



TV ANTENNAS AND HARDWARE

The G-C Master-Line Antenna line-up is America's finest. In addition, there's a matching line of accessories — stand-offs, chimney and wall mounts, connectors, and the rest — to guarantee the success of every installation.

G-C MEANS QUALITY! Though our line is a big one, we've never forgotten that Quality is the first essential of any merchandise. That's why . . . no matter what you need . . . it will pay you to insist on G-C products every time you buy!

FREE! 80-PAGE G-C CATALOG shows every G-C product. Fully illustrated. Write for your copy today!



GENERAL CEMENT MANUFACTURING COMPANY

907 Taylor Avenue Rockford, Illinois

See Us — Booth 419 — Parts Show!

We TELL 'em
 You SELL 'em
PHILCO
Accessory Products



Now Nationally
 Advertised to the Millions
 of Readers of the
**Saturday
 Evening Post**
 and
**Better Homes
 and Gardens**



YES, the fireworks have started! The big guns of Philco national advertising are *booming* for Philco Accessory Products. With ads like these, week after week, month after month, going into the homes of your community—creating tremendous new interest and demand for these Philco products you sell. Now is the time to make this valuable advertising work for you by featuring these Philco Accessory Products in your store—displaying them in your window—suggesting them to your customers at every opportunity. Open up this new gold mine of sales now . . . and ringing up extra profits! Order your stock today.

HIT OF THE MONTH OFFERS

**Extra Profits on Philco
 Parts and Accessories
 NOW AT YOUR
 PHILCO DISTRIBUTOR**

Put across that PERSONALITY

WITH AN **E-V** MIKE



Model 950
CARDAX
Crystal
Cardioid
with Dual
Response
List, \$42.50

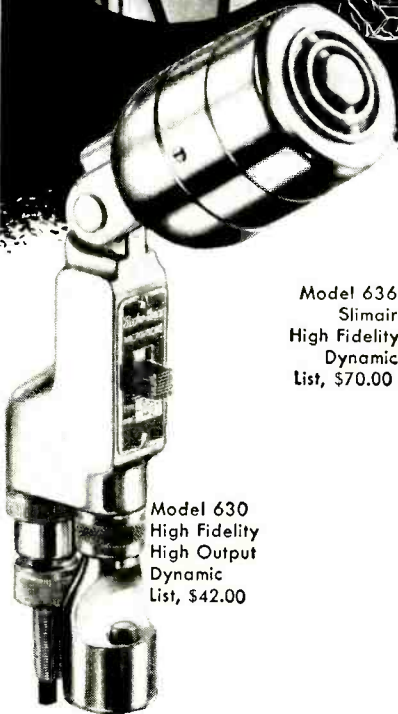

Model 636
Slimair
High Fidelity
Dynamic
List, \$70.00



Authorized
Distributors
Everywhere

Model 630
High Fidelity
High Output
Dynamic
List, \$42.00

REPRODUCE VOICE AND MUSIC... ACCURATELY!

The microphone makes a difference in the sound you hear! As a radio ham, sound specialist, or home recording fan, you are certain to reproduce the individual quality and personality of speech or song or orchestral music... with a *research-engineered* E-V mike! Send today for illustrated bulletin.

NO FINER CHOICE THAN **Electro-Voice**

421 CARROLL STREET • BUCHANAN, MICHIGAN
Export: 13 East 40th St., New York 16, N.Y., U.S.A. Cables: Arlab
MICROPHONES • HI-FI SPEAKERS • TV BOOSTERS • PHONO CARTRIDGES

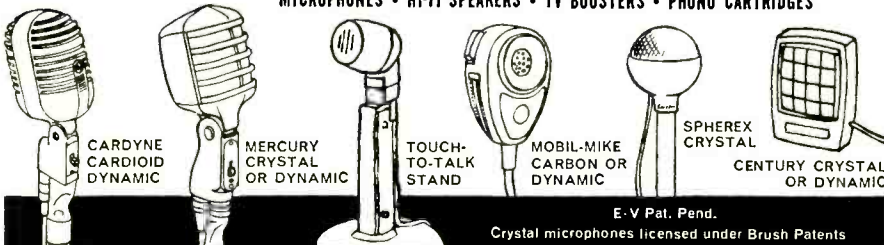

E. V Pat. Pend.

Crystal microphones licensed under Brush Patents

If the resistance of R is reduced, more current flows between cathode and anode F. The glow spreads slowly and gradually. When it is close enough to P1, electrons can leap from the cathode to this probe-anode. Therefore this gap ionizes. The meter registers this probe current. Further decrease of R increases the glow height until it is close to P2. Then another abrupt change occurs. Fig. 1-b shows the variation of glow height vs. probe current. Note the nearly flat plateaus which break sharply near each probe element.

As a decade counter, the tube contains 10 probes. Also, R is replaced by vacuum tubes. See Fig. 2. V1, a pulse amplifier, normally operates near full conduction. V2 is a control tube which is biased near cutoff. The first *negative* input pulse triggers V1 more negative and V2 more positive. The internal resistance of V2 is momentarily reduced. The cathode glow, normally having a height "0," rises to "1." Probe current

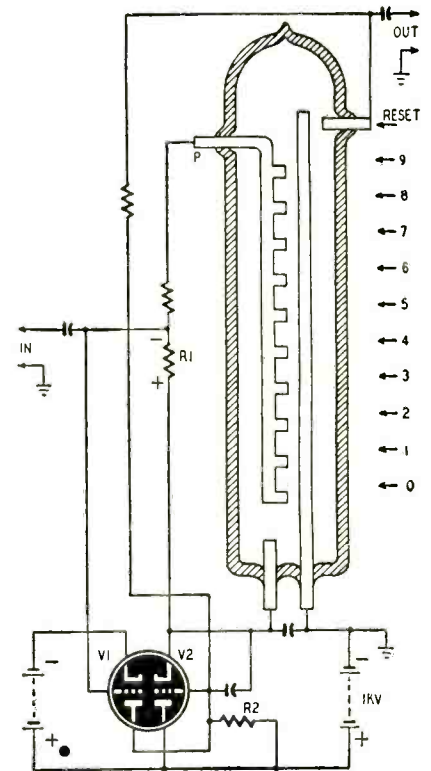

Fig. 2—Typical circuit using multi-anode glow lamp.

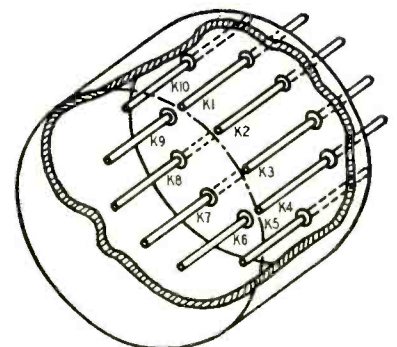

Fig. 3—Multi-cathode type of glow lamp for computer applications.

Now, The Plain Truth about easy tv servicing

Learn how official service data direct from the set manufacturer's own engineering and testing laboratories can solve the most difficult tv repairs, quickly and permanently!

No one knows his receiver better than the manufacturer.

Isn't it common sense that the men who design and build the receiver know the most about it? They are responsible for the receiver's performance and when a weakness is discovered, they are the first to determine the necessary permanent correction. The servicing information issued by the manufacturer's engineering department is certainly the most complete; because it contains not only the whole story on each model but includes *changes* in the receiver which the service technician must know in order to make a permanent repair!

For example: A major set manufacturer found that a capacitor overheated and broke down. A conventional replacement of the defective capacitor would mean repeat calls and customer dissatisfaction because the overheating and eventual breakdown would reoccur. So he developed a permanent cure—rearrangement of the circuit wiring. You couldn't possibly know that by looking at the original schematic. The only way you could repair this manufacturer's set containing this trouble would be to have the *complete* factory data! When faced with these facts, and there are many, many more, isn't it surprising that some servicemen are still not taking advantage of the wealth of data developed by the manufacturer?

How to get this vital information.

There are only two ways to get the complete unabridged manufacturers' servicing data: one way is to write the manufacturers direct. However, by doing this you run the risk of mail delay while your customer's set gathers dust, plus the difficulty of organizing the material once it's received.

The other way—the only practical way—is to buy this data in complete, easy-to-read published form. **THIS MEANS RIDER SERVICING DATA!** For 22 years Rider, and Rider alone, has been the only source for getting the whole story—the complete story, including all manufacturers' production changes—in accurate, organized, un-

edited form. You get large, easy-to-follow schematics . . . explanation of circuits . . . stage by stage alignment curves . . . page after page of trouble-shooting test patterns . . . waveforms . . . *complete* factory parts lists and values . . . clear, enlarged chassis views . . . circuit changes . . . and much, much more, all guaranteed to match the set you're working on. This has made servicing *easy* for countless thousands of service technicians.

Rider servicing data designed to meet your needs.

Whether you are a part-time or full-time service technician — independent or employed — you can afford Rider servicing data; Because it's available two ways:

Rider Manuals.

Volumes 1 through 9.

The greatest collection of manufacturers' servicing data ever published. Each volume covers all production runs for a certain period. The newest Rider Manual (TV9) contains servicing data for sets produced between October 1951 and February 1952. Each Rider manual contains an index listing the contents for all Rider manuals. The average volume contains more than 2000 (8½ x 11") pages bound in a permanent, heavy-duty binder. Perfect for shop use and permanent reference. Price \$24.00 each.

Rider Tek-File.

Packs 1 through 56.

The newest way to get complete Rider servicing data. The *only* difference between Rider manuals and Tek-File is the package. In manuals you buy the data of many manufacturers in one volume. In Tek-File packs you buy the same data—but only for one, two, or a few manufacturers at a time according to your needs. Each numbered Tek-File pack contains standard file folders with all servicing data for the manufacturer's models printed on the pack's

tamper-proof label. These folders are designed for house calls and easy bench use in the shop. Perfect for the specialist on certain brands of receivers . . . the part-time service technician . . . the engineer and the independent or employed serviceman. Price only \$2.00 per pack.

As an additional Tek-File service, many packs contain Tek-File Handies. These are 3 x 5" index cards giving manufacturer-tested trouble cures plus production changes made by the manufacturer's own engineering department . . . Each Tek-File pack contains a coupon, 15 of which, plus a small handling charge, get you a permanent manual binder for Tek-File shelf use.

DON'T BE SWITCHED!

There is only one Rider Tek-File. It is *not* the same as any other publisher's service. If your jobber doesn't carry Rider Tek-File **DON'T BE SWITCHED** . . . write us direct—we'll sell you! Please include your jobber's name.

Combat unfair press . . . combat national ads that say "fix your own set"! You can do this if you use Rider Manuals and Tek-Files because then you can tell your customers that you are using *factory-prepared, official, authorized, complete servicing information.*

TRY A PACK! Once you've tried Rider Tek-File we are convinced you'll never use any other service. Make this simple test. Use Tek-File for seven days—if you're not convinced, return it to us and receive full refund!

Free Rider Tek-File Index.

Rider Tek-File indexes covering all issued packs are available at your jobbers. If your jobber doesn't have Rider Tek-File Indexes—write us direct . . . it's free.

John F. Rider Publisher, Inc. 480 Canal St. New York 13, N. Y. West Coast office: 4216-20 W. Jefferson Blvd. Los Angeles, Calif.

For the **clearest** picture of campaign progress...



Rauland PICTURE TUBES

Man, what a year for TV—and TV service profits! The richest menu of regular attractions ever offered to viewers... PLUS the party conventions, the campaign, the elections and inauguration! When viewers need replacement picture tubes, they'll want them fast—and good.

So remember that Rauland alone

offers these replacement profit advantages:

- The *most complete* line of replacement picture tubes... a far better supplement for your regular tube line than a second line of receiver tubes.
- The faster, *surer* installation adjustment made possible by the patented Indicator Ton Trap.

- The dependable, uniform *extra* quality that so many smart service men depend on for assured customer satisfaction.

Remember, Rauland research has developed more "firsts" in picture tube progress since the war than any other maker. And this leadership pays off... in your customers' satisfaction.

THE RAULAND CORPORATION



Perfection Through Research

4245 N. KNOX AVENUE • CHICAGO 41, ILLINOIS



RADIO-ELECTRONICS

through R1 biases V1 to maintain the glow at height "1." The next input pulse biases V1 further so that the glow reaches height "2," and so on.

The tenth pulse drives the glow to the "reset" element. Current flows through R2 to bias V2 to nearly cutoff. Probe current nearly disappears and causes the glow to slide down to "O." Now the tube is ready for the next decade of pulses.

Another multielement tube was recently invented by G. E. Hagen.** In several ways it appears to have better possibilities than the previous one. This tube has 10 cathodes arranged in a ring as in Fig. 3. The anode (not shown in this figure) is a circular bar adjacent to the cathodes. The tube is filled with helium. The ionizing voltage may be relatively low because the cathode-anode gaps are small and equal.

Each cathode K is associated with a rectifier D, a resistor R, and a capacitor (see Fig. 4). Electrons can pass downward through each rectifier, from its cathode to its anode.

Initially, assume that the glow discharge is between K2 and the anode. Therefore electrons flow through R2 to this cathode. A smaller current flows through R1, D1 to this same element. Still less current flows through R10, D10 and D1 to reach K2. In a typical case, K2 is 100 volts positive. K1 is 90, K10 is 80, and so on around the circle to K3 which is 10 volts above ground.

With application of a negative pulse to the anode, the discharge is interrupted momentarily, and the anode

**U.S. Patent No. 2,575,517, assigned to Northrop Aircraft, Inc., Hawthorne, Calif.

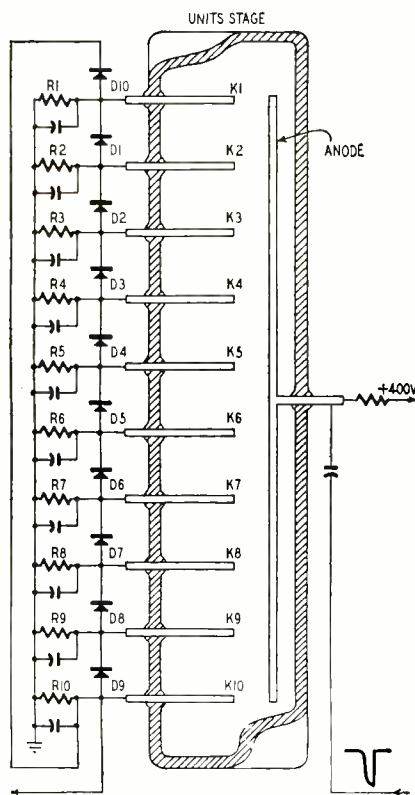
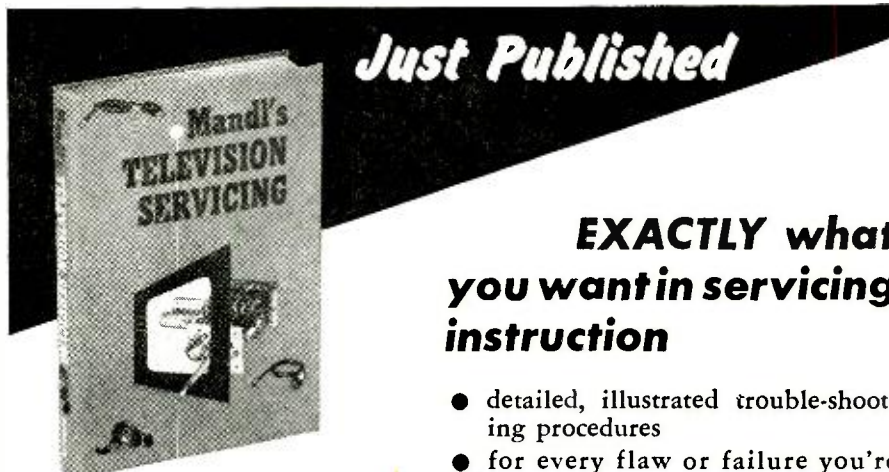

Fig. 4

Fig. 4—Application of multi-cathode lamp to a counter circuit.



EXACTLY what you want in servicing instruction

- detailed, illustrated trouble-shooting procedures
- for every flaw or failure you're likely to encounter in any TV receiver
- completely and clearly indexed for quick reference

You'll find

Handy lists of troubles that may occur in each section of the TV receiver and the exact procedures for correcting each.

Large clear block diagrams of typical commercial circuits for tuners, focus control systems, R-F voltage supply, sync separator systems and all other basic TV receiver circuits.

New original photographs showing actual symptoms of trouble on TV screens to aid identification.

Full explanation of unusual, hard-to-find troubles and how to fix them, as well as all ordinary defects.

Complete instruction on the use of testing equipment, and oscilloscope patterns to facilitate the checking of test results.

Ways of improving overall performance; how to improve gain, reduce ghost reception, minimize interference.

Special servicing instruction for color TV and for VHF and UHF receivers.

Whatever the trouble, in picture or sound, you'll be able to put your finger on it quickly and accurately with the aid of this book. More important, you'll KNOW HOW TO FIX IT, without guesswork or trial and error, and with full assurance that the trouble is REALLY CORRECTED.

A complete master index, in clear, convenient tabular form, lists over 100 trouble symptoms—all the various hums, sound distortions, streaks and bars on picture, focus defects and all others that you're likely to find—with the probable causes of each and the page on which full servicing instruction for that particular fault is given.

You won't have to thumb through batches of manufacturers' notes, never sure that you have the right directions for the latest improvements or changes. Here are the instructions you need for correcting trouble in each circuit in any set, and the CLEAR UNDERSTANDING of each circuit you need in order to BE SURE that the adjustments you make will achieve the desired results.

300 illus.
A handy 421-page,
fact-packed guide

and much more

Are these top-ranking aids on your working reference shelf?



Fischer's RADIO & TV MATHEMATICS

"An extremely useful reference," wrote *Radio News* about this unique book. Here are step-by-step solutions, showing what formulas to use and what numerical values to substitute, for HUNDREDS of typical radio and TV servicing, construction, and operational problems, arranged under radio topics for quick reference.

Noll & Mandl's TELEVISION & FM ANTENNA GUIDE

A basic course on antenna theory combined with a complete handbook on antennas and their installation. Shows how to pick the right antenna for the site, determine the best position for it, install transmission line for maximum efficiency and all other practical details for getting the most out of the antenna system.

Noll's TV FOR RADIOMEN

Explains very clearly and fully all basic principles of television reception, the essentials of TV transmission, and the construction and operation of each part of modern TV receiving systems; and gives step-by-step instruction in installation, adjustment, alignment, and basic trouble-shooting procedures. A basic book for anyone in television servicing, noted for clarity and completeness. Here are all the fundamental why's and how's by a man known throughout the country as a leading authority on the technical aspects of television.

See them ON APPROVAL

Look them over. If you're not entirely satisfied you may return the books without further obligation.

The Macmillan Co., 60 Fifth Ave., New York 11

- Mandl's TV Servicing \$5.50
- TV for Radiomen \$7.75
- Radio & TV Math. \$6.75
- TV & FM Antenna Guide \$6.25

Please send me the books checked at left. I will either remit in full or return the books in 10 days.

Signed

Address

E

THOUSANDS ACCLAIM
"BEST T.V. LEAD MADE"

GOODLINE
AIRLEAD



NEW GOODLINE AIRLEAD has everything you want!

- Sharp, clean, "snow-free" pictures.
- Correct impedance for "ghost-free" reception. Nominal 300 ohms.
- Lower in cost than other leadlines purported to accomplish same results.
- Correct spacing for minimum radiation loss—Less than 1% of operating wave length.
- Fully insulated—approved by safety experts.
- Pure, unadulterated polyethylene insulation—specially treated by our chemists for extreme weather.
- High-efficiency conductors: Flexible, stranded—to insure long life.
- Easily installed—with standard insulators.
- Packaged in convenient lengths: 100', 250', 500', 1,000', 2,500'.
- AT YOUR DEALERS, or Write For Free Samples and Literature.

*Patent Pending *Trade Mark U.S. and Foreign Patents Pending
EXCLUSIVE LICENSEE AND SOLE MANUFACTURER

Don Good, INC.

1014 FAIR OAKS AVENUE
SOUTH PASADENA, CALIFORNIA

OTHER OUTSTANDING GOODLINE PRODUCTS:

VARIABLE TELETRAPS—2: Highly effective for *eliminating interference* from FM STATIONS, and DIATHERMY and AMATEUR SIGNALS within its tuning range.

HI-PASS FILTER: *Eliminates or greatly reduces interference* picked up by I. F. AMPLIFIER or TV RECEIVER—interference arising from strong, local low-frequency fields: X-Ray, Diathermy Equipment, Neon Lights, Etc., Etc.

NEW CONDENSER TESTER



**Finds Intermittent
Condensers Instantly**
NET

Pres-probe's sliding tip with variable resistance prevents condenser heating. Tests with power on. Requires no adjustment. Stops guesswork. Saves time. Convenient probe size (7½" long). Satisfaction guaranteed.

795
Postpaid
U.S.A.

See Your Dist. or Order Direct

PRES-PROBE CO.

4034 N. Sixth St., Milwaukee 12, Wisc.

TELEVISION

Big demand for graduates

B.S. DEGREE IN 27 MONTHS in radio including TV engineering—VHF, UHF, AM and FM. Students use over \$100,000 worth of equipment including 2 large commercial type transmitters in new TV lab. Intense specialized course includes strong basis in mathematics, science and advanced design in radio and TV.

Hundreds of young men each year are earning engineering degrees in this recognized institution. Start any quarter. Many earn a major part of expenses in this industrial center. Low tuition. Competent instruction. Thorough, intense, practical program.

Also **B.S. DEGREE IN 27 MO.** in Aeronautical, Chemical, Civil, Electrical and Mechanical Engineering. G.I. Gov't approved. Enter June, Sept., Dec., March. Free catalog. **ENROLL NOW**

INDIANA TECHNICAL COLLEGE
1752 E. Washington Blvd., Fort Wayne 2, Indiana

voltage starts to rise. The cathode capacitors maintain their charges for a short time. When the anode voltage is high enough, it ionizes the gap to which ever cathode has the lowest potential. At this time it is K3. After firing, the cathode potentials readjust themselves. K3 becomes 100 volts positive; K2, 90; K1, 80; and so on. In the same way, successive pulses fire K4, K5, and so on, in progression.

The ring arrangement of cathodes eliminates need for a reset element. At the tenth pulse K10 fires and transmits a positive pulse to the next (tens) decade. The eleventh pulse fires the K1 gap and the cycle repeats.

—end—

**APRIL FOOL STORY
FOOLED EVERYBODY**

The printer joined in the fun when we published our annual April Fool story last month, with the result that we were fooled and the majority of our subscribers were badly puzzled.

As most of our old readers have already suspected, the last line of the story "Noise Neutralizer" by Mohammed Ulysses Fips on P. 53 of the April issue should have been: April 1. Then it would have followed the model of previous April stories by the same author.

The printer, while trimming some dead matter off the bottom of the page, worked up too far and trimmed off the heavy type at the bottom of the third column, which would have tipped off the reader as to the hoax nature of the story. The error was found and corrected, but only after many of the copies had been printed and shipped out.

Our sincere apologies to any readers who may have been puzzled by the omission. It was just one of those things we couldn't do anything about, as all the proofs were correct up to the very moment the presses began to roll.

CORRECTIONS

Frequency Meter

There is an error in the diagram of the frequency meter in Fig. 1 on page 25 of the February, 1952, issue. There should be a dot indicating a connection between the lead from pin 5 of the 6H6 and the lead between S1-d and the meter. With this connection made, the meter is connected between pin 5 and ground and is shunted by R2-R7, depending on the setting of the range switch.

We thank Mr. John Yannoulis, of Cairo, Egypt, for calling this to our attention.

John E. Pitts, W6CQK

In the article Useful Phone—C. W. Monitor, by John E. Pitts, which appeared in the January, 1952 issue of RADIO-ELECTRONICS, the author's call letters were erroneously given as W6CQP. This call has been assigned to Mr. Raymond Christian, 5543 Gables Street, National City, Calif. Mr. Pitts' correct call letters are W6CQK.

10,000,000* Waiting to be SOLD!

**Perma-Power
TV TUBE
BRITENER**



* Over 10,000,000 television sets were purchased prior to 1951. Each of these has a picture tube which is getting dimmer. 10,000,000 set owners need the "TV TUBE BRITENER."

- Prolongs tube brilliance; fully automatic
- Isolates filament; relieves cathode — filament shorts
- Eliminates nuisance calls
- Protects tube guarantee
- Made to sell; packaged to sell
- Producing sales everywhere



"TV TUBE BRITENER" was designed by engineers to produce sales for television servicemen. Adds brilliance to any picture tube; extends useful life of tube for year or more; adaptable for all tubes with duodecal base.

Write for complete, illustrated literature. SOLD through recognized wholesalers ONLY. ORDER TODAY!

Perma-Power COMPANY

4721 N. Damen Ave., Chicago 25, Ill.

"Manufacturers of electronic equipment since 1928"

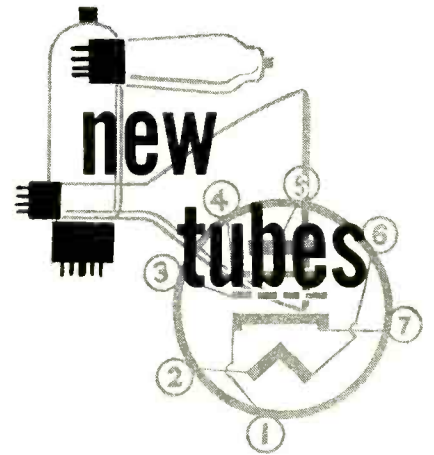

In the field of television picture tubes, both RCA and CBS-Hytron have announced the 17QP4, an all-glass, rectangular, magnetic-focus and deflection type. A cylindrically shaped Filterglass faceplate reduces surface reflections and absorbs much of the light reflected by the phosphor and the interior of the faceplate itself. RCA has also announced the 17LP4, identical to the 17QP4 except for the use of low-voltage electrostatic focusing.

Both types have screens 14 $\frac{3}{8}$ x 10 $\frac{1}{16}$ inches, with slightly curved sides and rounded corners; external conductive coatings; and require a single-gun ion-trap magnet. Maximum voltage ratings are: Ultor, 16,000 volts; grid 2, 500 volts; grid 4 (17LP4 only), 1,000 volts.

In the larger sizes, RCA is producing the 20MP4 and 21MP4 electrostatic focus types. Except for its over-all length and screen size (17 $\frac{1}{4}$ x 13 $\frac{1}{4}$ inches), the 20MP4 is identical in all respects to the 17LP4 described above. The 21MP4 is a metal-shell tube with a screen 18 $\frac{3}{8}$ x 14 inches. Its electrical characteristics are the same as the foregoing types. All four picture tubes have standard RMA basing.

G-E has announced the GL-5QP4, a cathode-ray view-finder tube for high-accuracy focusing in television cameras. Developed for use with the "Eidophor" system of theater projection color television, the GL-5QP4 will also be used in all G-E-made TV studio cameras.

An aluminized screen provides the high brightness and definition required for extremely critical focusing, and increases the life of the tube by reducing ion burns and general screen deterioration.

Receiving types

G-E's new miniature power-output pentode, the 6BK5, is intended for use with the 6BN6 gated-beam limiter-discriminator (December, 1951, RADIO-ELECTRONICS, page 37). Its high power sensitivity and small grid driving volt-

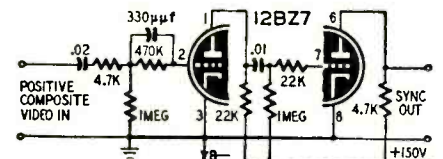

Fig. 1—Sync clipper-amplifier

the most convenient TV tower ever made

THE TEL-A-RAY

SWING-OVER* TOWER

*swings over
to the ground
for servicing . . .*

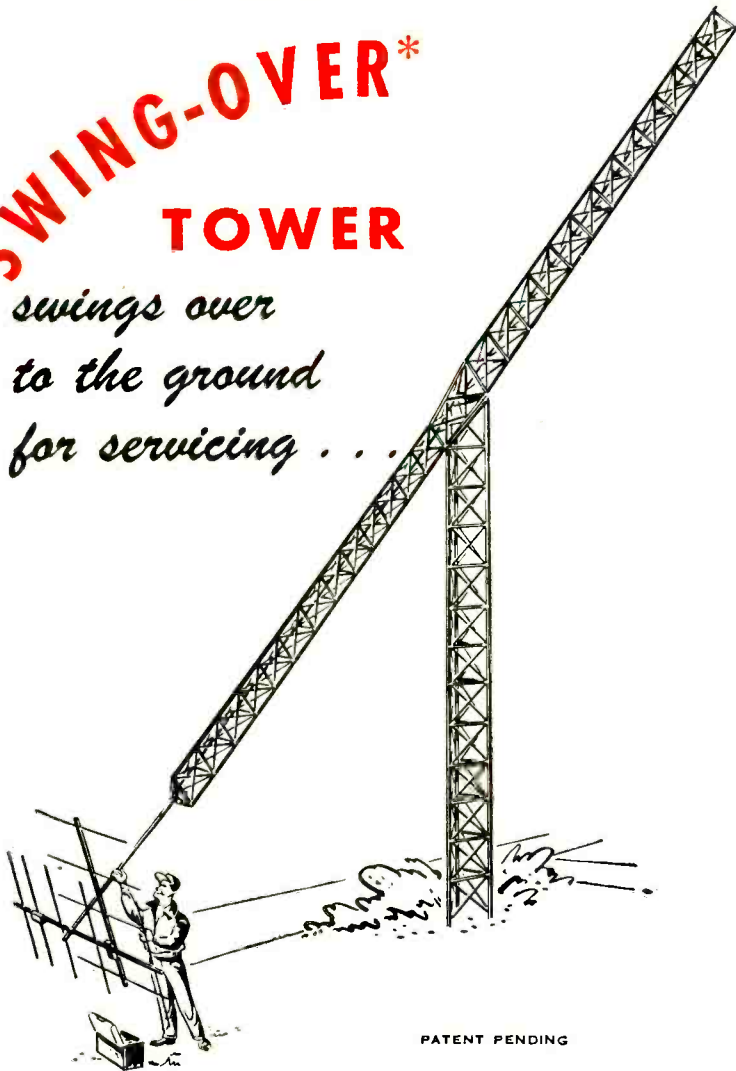

The biggest new idea in television — the Tel-a-Ray Swing-Over Tower* — swings over to the ground for easy servicing! One man can raise or lower this counterbalanced tower in three minutes! Model TT1, for ground installations, is 50 feet high when a recommended 10 feet of water pipe is added — can be quickly erected with no guy wires. Model TT2 is designed for roof tops, reaches up 24 feet with the addition of an eight-foot pipe. Although light in weight, the Swing-Over Tower is ruggedly built with steel angles and welded construction. Simple to assemble . . . no machinery necessary . . . low in price. Write today for information.

MAY, 1952

FOR WONDERFUL
TV RECEPTION
WHEREVER YOU ARE

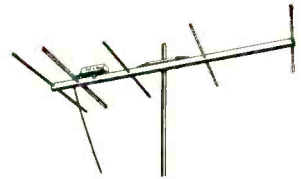

The weatherproof Model T antenna . . . brings in wonderful reception up to 200 miles.

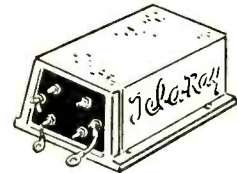

Only low-priced Pre-Amplifier on the market, the TB. Multiplies signal gain . . . holds noise to a minimum.



Butterfly Swivel-Positioned TV and FM antenna . . . designed to give the finest reception in primary areas.

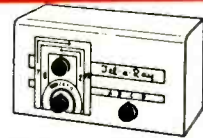

Tel-a-Ray's new Switching Booster (Model PTB1) — one switch changes channels and antennas. Eliminates the need for a separate booster for each antenna . . . for as many as four antennas. Automatic features make this outstanding.

FOR COMPLETE INFORMATION WRITE

Tel-a-Ray

ENTERPRISES, INC.



BOX 332E
HENDERSON, KY.



C-D's Sealpup

"class" will tell!

You don't need a pedigree to know that SEALPUP comes from a long line of winners! It's the finest metallized capacitor made. Just developed by C-D for ultra-compact military and commercial equipment. Hermetically sealed, brass case, glass-to-metal bonded, it's impervious to humidity!

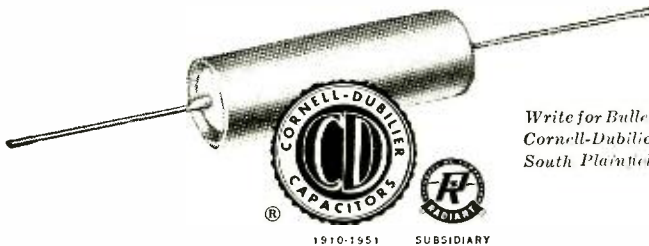

Write for Bulletin NB143 RC-52
Cornell-Dubilier Electric Corp.
South Plainfield, N. J.



CONSISTENTLY DEPENDABLE CORNELL-DUBILIER CAPACITORS

Plants in South Plainfield, N. J., New Bedford, Worcester and Cambridge, Mass.; Providence, R. I.; Indianapolis, Indiana; Fuquoy Springs, North Carolina, and subsidiary, The Radiart Corporation, Cleveland, Ohio.

Over 43,000 Technicians Have Learned
HOW TO GET THE MOST OUT OF BASIC TEST EQUIPMENT
Why Not You, Too?

SERVICING by SIGNAL SUBSTITUTION
A BEST SELLER FOR OVER 9 YEARS! (NEW, UP-TO-DATE, 12TH EDITION)

The Simple, Modern, Dynamic Speed Approach To Receiver Adjustment and Alignment Problems, AM-FM-TV.

- Nothing complex to learn
- Universal — non-obsolete
- No extra equipment to purchase
- Employs Only Basic Test Equipment

Ask for "S.S.S." at your local Radio Parts Jobber or order direct from factory.

only 40¢

100 pages. Invaluable information that will help you re-double the value of your basic test equipment.

PRECISION APPARATUS COMPANY, INC. • 92-27 Horace Harding Blvd., Elmhurst 4, N. Y.

age requirements eliminate the need for a first audio amplifier tube. The 6BK5 can deliver 3.5 watts output with a grid signal of only 5 volts peak.

Another G-E tube is the 6BX7GT, a twin-triode combined vertical-oscillator and amplifier. It provides improved linearity and high output at reduced B-plus voltages.

CBS-Hytron has announced four new miniature tubes for television. The 12A4 is a high-perveance triode vertical deflection amplifier. Operating data: Heater voltage and current: 6.3 v at 0.6 amp (parallel connection); 12.6 v

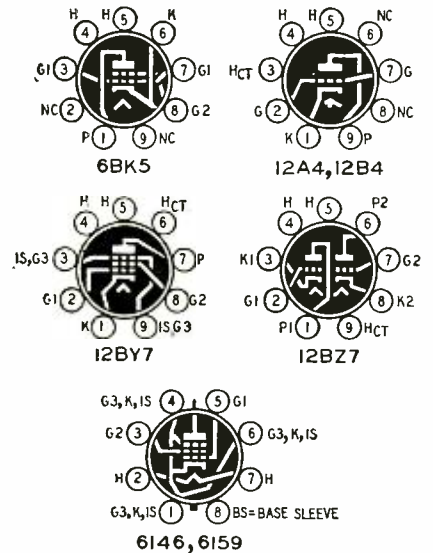

Fig. 2—Basing of tubes described in text.

at 0.3 amp (series connection); plate voltage, 250 v; plate current, 15 ma; cathode bias resistor, 560 ohms; peak-to-peak grid signal, 25 v; peak-to-peak sawtooth current in yoke, 360 ma.

The 12B4 is a triode vertical sweep amplifier with smaller output capabilities than the 12A4.

Type 12BY7 is a high-transconductance pentode video amplifier providing improved contrast linearity. Typical operating conditions for the 12BY7 are: Plate voltage, 250 v; plate current, 24 ma; screen voltage, 180 v; screen current, 5 ma; Gm, 12,000 micromhos; cathode resistor, 100 ohms; suppressor grid connected to cathode at socket. The heater is designed for either series or parallel operation.

Type 12BZ7 is a high-mu dual triode intended for use as a sync separator-amplifier. A typical schematic recommended by the manufacturer for this application is shown in Fig. 1.

Transmitting and special tubes

RCA has announced the 6146 and 6159, improved beam power tubes for low-power v.h.f. transmitting applications. Differing only in heater ratings (6.3 volts for the 6146 and 26.5 volts for the 6159) their ICAS ratings are 90 watts input up to 60 mc, and 60 watts input at 175 mc.

—end—

Industrials



Communications

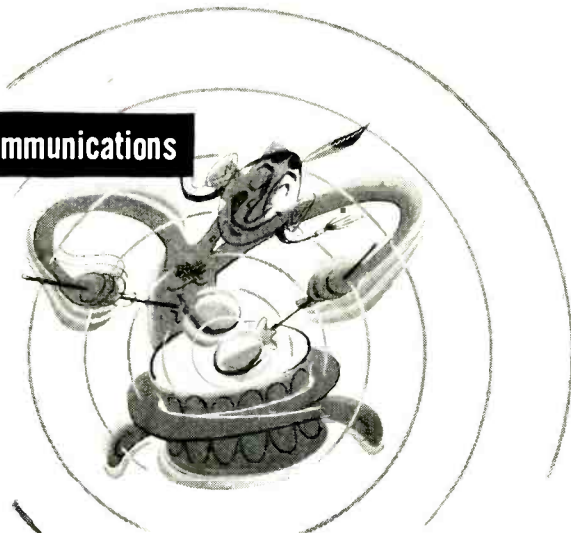

SANGAMO
Capacitors



papers



micas



buttons



electrolytics

Those who know...choose Sangamo
**for every radio and
electronic application**

SANGAMO Capacitors have been the choice of discriminating users for a quarter of a century. Radio servicemen, amateurs, electronic engineers, the Armed Services—all testify to the design, construction, honesty of characteristics, and conservativeness of ratings of Sangamo capacitors.

Television

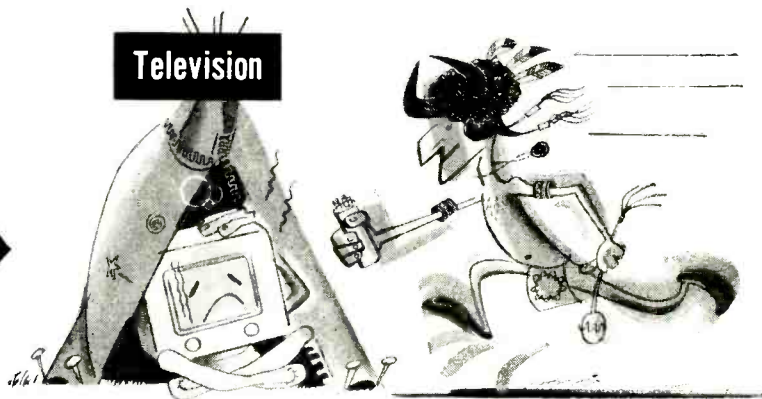

Armed Services



SANGAMO
ELECTRIC COMPANY

MARION, ILLINOIS

IN CANADA

SANGAMO COMPANY LIMITED, LEASIDE, ONTARIO

in WAR or PEACE

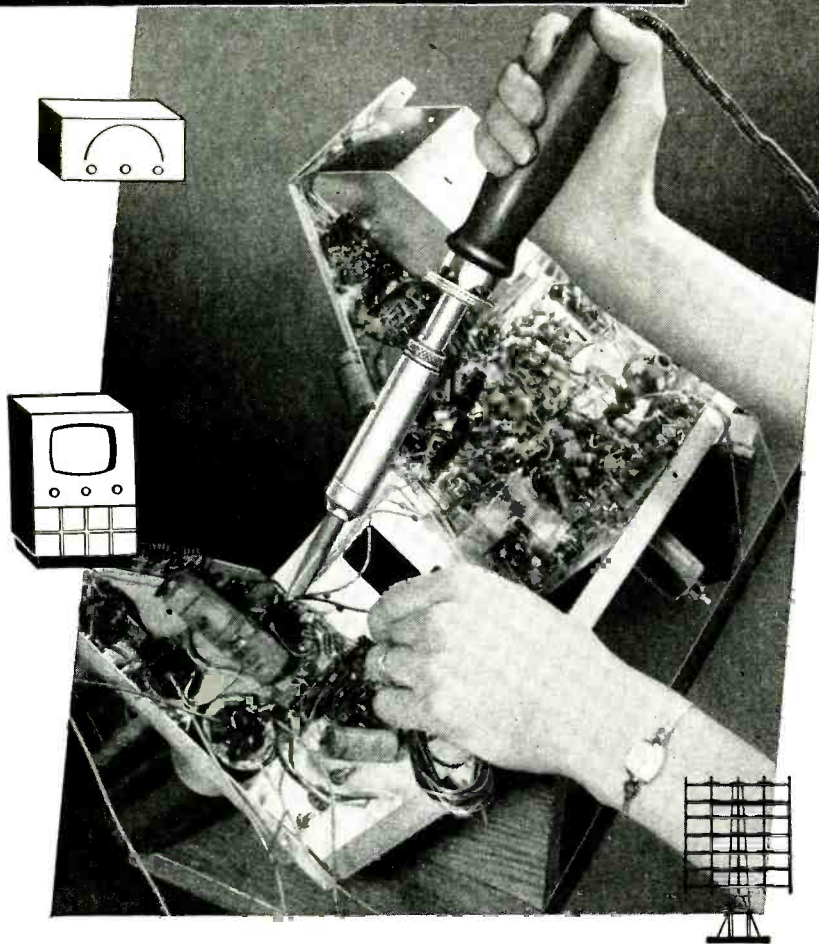

**on RADIO-TV-RADAR
production lines**

**American Beauty
ELECTRIC SOLDERING IRONS**

**DURABLE
DEPENDABLE
EFFICIENT!**

Day after day — shift after shift — American Beauty Electric Soldering Irons are at work on production lines throughout the nation. Faithful performers for America's safety — and enjoyment — for over half a century.

Let American Beauty Electric Soldering Irons prove to YOU their durability — dependability — efficiency.

123

For descriptive catalog pages write Dept. S-3

**AMERICAN ELECTRICAL HEATER CO.
DETROIT 2, MICH.**

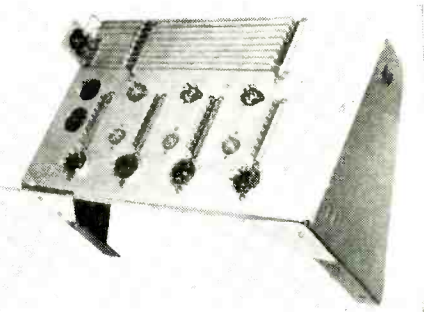

Fig. 1—The assembled breadboard chassis, showing the placement of tube sockets, terminal strips, bus bars, and power connector. The end wings of the aluminum control panel, which is bent outward at an angle of 30°, so that it appears practically invisible in the photo, are seen near the bottom.

**EXPERIMENTER'S
BREADBOARD**

By H. L. REMLEY

A phone call from a friend, asking just what values to use in making a multivibrator with a given pulse width, brought the reply, "Why not set up a simple multivibrator circuit and find out just exactly what you want?" He replied that it would entail a lot of work and he had just wondered if I knew, offhand, the values he sought. At this point he was invited over to see a simple solution to his troubles. We won't go into the multivibrator problem here but will describe one way to make such experimental setups as simple as possible.

Many devices have been described or manufactured to permit rapid assembly of experimental breadboard circuits, but for several reasons they did not appeal to this writer. A survey of recent literature, a search through shelves and junk boxes—and our deluxe breadboard was the result. In its main features, it is a simplified version of a job described in *Electronics* for July, 1949.

The complete breadboard assembly is shown in Fig. 1. The main chassis was made from an 8½ x 12½-inch aluminum panel. A right-angle bend, ¼ inch wide, was made on each edge for rigidity. Two 6½ x 8-inch standard

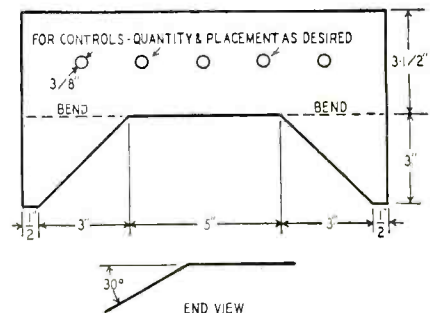

Fig. 2—Details of control panel strip.
RADIO-ELECTRONICS

This Amazing MAGNA-TIP SCREW DRIVER!

4 Screw Drivers in 1

*Yours
FREE!*

...with every 100 Sylvania
Receiving Tubes or 4 Picture Tubes
purchased between April 1st and May 15th

"SAVES HOURS
IN RADIO
AND TV WORK!"

It's the greatest time-saving tool you ever saw! Just slip the right-sized bit in place and a permanent Alnico magnet charges the bit...holds both your bit and screw in place for fast, easy, one-hand operation.

Lifetime quality

Made of fine tool steel, this slim-shaft driver is 8½ inches long. Equipped with 2 Phillips and 2 slotted bits, (3 bits in handle compartment and one in shank). And the shank itself is a power driver for ¼-inch hex-head screws.

You get it FREE when you buy 4 Sylvania TV Picture Tubes or 100 Sylvania receiving tubes. But, better hurry! Offer closes May 15th. Your Sylvania Distributor is the man to see . . . TODAY!

"NEVER LOSES
ITS MAGNETIC
GRIP!"

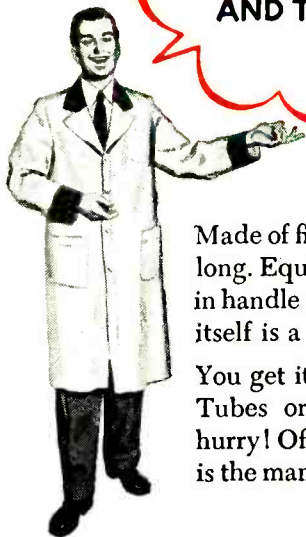

SYLVANIA



RADIO TUBES; TELEVISION PICTURE TUBES; ELECTRONIC PRODUCTS; ELECTRONIC TEST EQUIPMENT; FLUORESCENT TUBES, FIXTURES, SIGN TUBING, WIRING DEVICES; LIGHT BULBS; PHOTOLAMPS; TELEVISION SETS

MAY, 1952

CUSTOM-BUILT TV CABINETS FROM FACTORY TO YOU

Feast Your Eyes on Eleven Leaders in **STYLE . . . QUALITY . . . PRICE**

The **VOGUE**



Most popular table model and the best value ever!
H-24", W-26", D-23" shipping weight 48 lbs.

\$39.89

VOGUE for 24" CRT
H-31", W-27", D-23" shipping weight 60 lbs.
\$62.54

The **STREAMLINER**

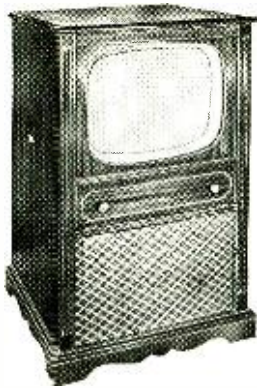

Unique with center drop panel that conceals the tuning knobs.
H-42", W-26", D-24" shipping weight 80 lbs.

\$74.98

The **WINDSOR**

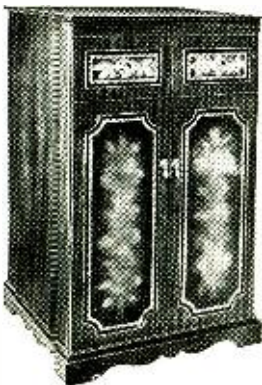

Royal splendour, genuine leather inlay, hand tooled in gold.
H-42", W-26", D-24" shipping weight 100 lbs.

\$117.46

REVOLVING TV TABLE



\$14.97

Adds a new joy to TV pleasure. Top 22" x 25" fits most TV sets. Shipping weight 25 lbs.

The **NEW YORKER**

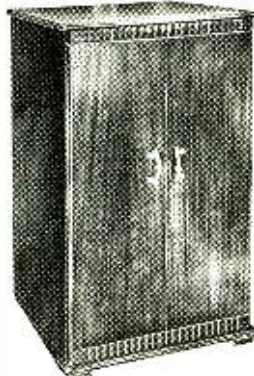

Full door model. Excellent companion-piece to piano in parlor.
H-42", W-26", D-24" shipping weight 100 lbs.

\$96.87

The **MAYFAIR**

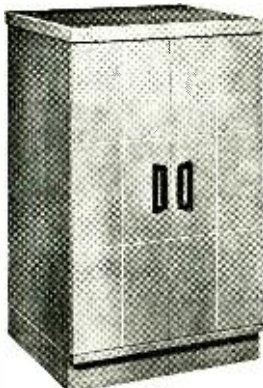

Exquisitely modern, with an elegance of simplicity in styling.
H-40", W-27", D-23" shipping weight 85 lbs.

\$98.56

The **HOLLYWOOD**



Aristocrat of TV, styled to grace the finest home. Optional with PHONO-DRAWER and/or BAR (less liquor). Inside front panel same as cabinet below.
H-41", W-31", D-24" shipping weights 125 to 150 lbs.

(less BAR & PHONO-DRAWER) **\$138.44**

ADD \$19 for PHONO-DRAWER COMBINATION, \$46 for BAR (less liquor), \$26 for 24" (C.R.T. cutout) FIT.

The **TOWN & COUNTRY**



Patterned after the popular credenza. Specially made for the 24" picture tube.
H-42", W-36", D-24" shipping weights 100 to 114 lbs.

\$109.62

With PHONO-DRAWER (shorter grill) . . . \$128.62

The **MANHATTAN**



A best seller with all Mfrs. of TV with a "new look" in styling.
H-41", W-25", D-25" shipping weight 50 lbs.

\$59.37

MANHATTAN for 24" CRT
H-46 1/2", W-27 3/4", D-24" shipping weight 78 lbs.
\$86.22

The **PLYMOUTH**

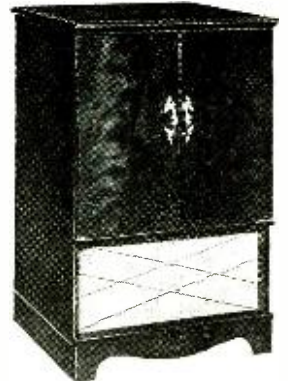

The choice of interior decorators, truly exquisite in every detail.
H-40", W-27", D-23" shipping weight 82 lbs.

\$105.48

The **ORIENTALE**



Work of art. Gold hand painted figures on a black lacquer finish.
H-42", W-26", D-24" shipping weight 100 lbs.

\$118.73

BROOKS RADIO & TV CORP., 84 Vesey St., Dept. A, New York 7, N. Y. TELEPHONE COrtland 7-2359

IF YOU WANT THE BEST . . .

The #630 TV RECEIVER remains unmatched for quality and performance • RCA designed and developed this set quality-wise not price-wise • The original 10" set retailed at \$375.00 • Subsequent TV sets serve to prove the sacrifice of quality for price • What better proof can there be of its superiority than the fact that it is the private choice of TV engineers and TV technicians! • It is adaptable for U.H.F. and color TV.

NOTHING BETTER AT ANY PRICE

#630 SUPER DELUXE 31-TUBE TV CHASSIS... LICENSED BY RCA

Nationally Known Manufacturer — Brochure Sent With Order Or On Request

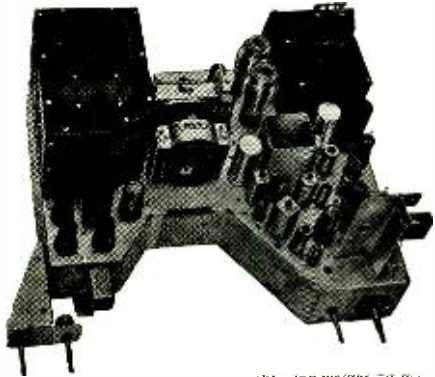

W—22", H—10 1/4", D—17"

shipping weight 72 lbs.

OPERATES ALL **16" TO 24"** PICTURE TUBES

Engineered in strict adherence to the genuine RCA #630, plus added features ★ ★ ★ ★ ★

- Standard Turret Tuner (Cascode) for DX
- Original 630 Synch. Chain for Stability
- 16.5 KV for Clarity and Brilliance
- Peak Sensitivity for Fringe Areas
- 4 Megacycle Bandwidth for Definition
- Fast Action Pulse Keyed AGC
- Large Concert-tone 12" PM Speaker

Complete ready to play with all tubes, hardware, knobs, etc. (less C.R. Tube)

\$167.97

10"	#188P4A	\$22.74
12 1/2"	12LP4A	25.72
14"	14CP4A	28.34
16"	16AP4A	33.97
16"	16DP4A	22.77
18"	18FP4	22.77
18"	18TP4	22.97
17"	17BP4A	34.42
19"	19AP4A	39.74
20"	20CP4	44.34
21"	21EP4A	48.74
24"	24AP4	70.44

FINEST STANDARD GUARANTEED PICTURE TUBES

Most desirable 4 sizes. Choice of DUMONT 6-mos. guaranty or SHELDON blue label 1-yr. guaranty.

17" Rect. \$34.63 shipping weight 23 lbs.	20" Rect. \$44.68 shipping weight 31 lbs.	21" Rect. \$49.74 shipping weight 38 lbs.	24" Round \$79.49 shipping weight 43 lbs.
--	--	--	--

SPECIAL COMBINATION OFFERS - SAVE 10%!

On Any Combined Purchase of a CABINET, CHASSIS and PICTURE TUBE

NOW . . . Our volume in sales makes it possible for us to offer you the **WORLD'S BEST TV SET** — the famous #630 SUPER DELUXE 31-TUBE TV CHASSIS with a CABINET and PICTURE TUBE of your choice at the price that you would pay for an ordinary TV SET. And we bring you this sensational offer at a most opportune time. The PICTURE TUBES are larger . . . the #630 TV CHASSIS with its new Cascode Tuner is better than ever . . . and the full page display of cabinets is really exciting.

PICK any CABINET in the finish to suit your taste. Pick a PICTURE TUBE in the size that you prefer, include the #630 SUPER DELUXE TV CHASSIS, add the total selling price . . . now deduct 10% and you have arrived at your special combination price. (For example — the MANHATTAN CABINET (in mahogany or walnut), CHASSIS & 21" PICTURE TUBE total \$277.08, you deduct 10% and your net price is only \$249.37.)

EACH ITEM — the CHASSIS, CABINET and PICTURE TUBE will reach you in its original factory sealed carton. Assembling is easy, everything has been prefabricated at the factory and all you have to do is slide the CHASSIS and PICTURE TUBE in place and bolt them down. Everything needed is included. Delivery is prompt and each order will receive our special attention.

DOLLAR FOR DOLLAR WE BRING YOU YOUR BEST BUYS IN TV!

WE ARE HEADQUARTERS FOR #630 TELEVISION CHASSIS, KITS & PARTS . . . All Items are STANDARD BRANDS . . . All Prices Are WHOLESALE (FEDERAL TAXES PAID)

Terms: F.O.B. New York, send 20% deposit with order, balance on delivery.

BROOKS RADIO & TV CORP., 84 Vesey St., Dept. A, New York 7, N. Y. TELEPHONE COrtlandt 7-2359

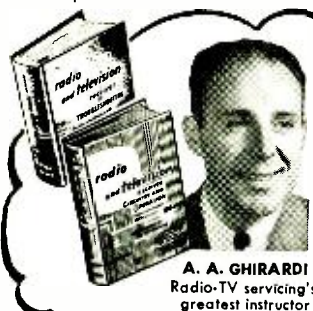

A. A. GHIRARDI
Radio-TV servicing's
greatest instructor

SPECIAL COMBINATION OFFER!

Get these NEW Ghirardi service books at the special price of only \$12.00 for the two (regular price \$12.75)! Have complete, modern service data at your finger tips! Be prepared for faster, more profitable handling of every job! Books contain 1489 pages of helpful, how-to-do-it service data. Use coupon to order SPECIAL COMBINATION OFFER today for 10-day free examination.

Learn to service ANY RADIO OR TV SET EVER MADE!



It pays to know all about circuits when it comes to handling tough jobs in less time! ... only \$6.00

Ghirardi's new Radio & Television Receiver CIRCUITRY & OPERATION

Know modern circuits from A to Z, and you'll be pleasantly surprised how much easier it is to handle even the toughest jobs—how much faster you can go right to the seat of the trouble! Guesswork is eliminated. Laborious testing can be reduced to an absolute minimum—and you won't have to depend on set manufacturer's data and manuals!

Starting with a clear explanation of AM and FM processes, Ghirardi's 669-page Radio and Television Receiver Circuitry and Operation brings you a complete understanding of all basic circuits in today's home equipment. You learn how each one operates; how to recognize it quickly; what troubles to look for; and how to service it.

By making it easy for you to understand each circuit and its relations to other circuits, Mr. Ghirardi helps you locate troubles much faster and with far less effort. You know what to look for—and you know exactly how to go about repairing the troubles when you find them!

A BOOK TO HELP YOU HANDLE SERVICE JOBS FASTER

In the characteristic, easily understood style that has made his books famous throughout the entire world, Mr. Ghirardi not only explains the comparatively few basic circuits in use, but likewise tells all about their many and often complicated variations.

In short, this is a book for servicemen who want to forge ahead—and who know that the best way to earn more is to learn more!

Read it for 10 days at our risk and see for yourself how much it can mean to you!



PASS SERVICE LICENSE EXAMINATIONS

with flying colors!

Even the toughest servicing license examinations now required by many cities won't "stump" you—*not* if you fortify yourself with the knowledge in these great books! Ghirardi service books are recognized throughout the trade as the finest, most complete of their kind!



The complete "know-how" of Radio-TV service by money-making professional methods only \$6.75

Ghirardi's new Radio & Television Receiver TROUBLESHOOTING AND REPAIR

Nowhere else will you find troubleshooting and service procedures explained so clearly, and as completely as in this brand new 820-page Ghirardi book!

Fully modern, profusely illustrated, Radio & Television Receiver TROUBLESHOOTING AND REPAIR shows you how to service all types of radio, television and record-playing equipment—even communications receivers. You learn to locate troubles faster—how to repair them more efficiently in a fraction of the usual time. Best of all, the book teaches you to work *professionally*—not as an underpaid "screwdriver" mechanic!

LET GHIRARDI GIVE YOUR EARNING POWER A BIG BOOST!

Any radio or TV is simply a network of components—and this big book first analyzes each component type individually. From here, you forge ahead rapidly to troubleshooting methods including static and dynamic tests using signal tracing and injection techniques. You learn to interpret data—how to make dozens of invaluable troubleshooting short cuts. The troublesome procedures of realigning TV, AM and FM are made amazingly clear.

Television servicing is explained so simply that even newcomers will find it easy to understand. Parts repair as well as parts replacement are fully covered and there are hundreds of tips on handling difficult service jobs. Unique step-by-step charts show exactly what moves to make in checking specific trouble symptoms. Each subject is covered with the remarkable clarity that, for over 20 years, has made Ghirardi service books the most widely used of their type. Use coupon!

10-DAY EXAMINATION OFFER

Dept. RE-52, Rinehart Books, Inc., Technical Division,
232 Madison Ave., New York 16, N. Y.

Send the following books for 10 day examination. If I like the books, I will then promptly remit the price indicated, plus a few cents postage. Otherwise I will return books postpaid in good condition and owe you nothing.

Ghirardi's Radio & Television Receiver
TROUBLESHOOTING AND REPAIR \$6.75

Ghirardi's Radio & Television Receiver
CIRCUITRY AND OPERATION, \$6.00

SPECIAL COMBINATION OFFER—both of
above big books—1489 pages of helpful service data
—Price only \$12.00 for the two

Name _____

Address _____

City, Zone, State _____

Employer's name & address _____

OUTSIDE U.S.A.—\$7.25 for TROUBLESHOOTING REPAIR; \$6.50 for
CIRCUITRY & OPERATION or \$13.00 for COMBINATION OFFER. Cash
only—money back if you return books in 10 days.

rack mounting chassis brackets formed the ends of our breadboard, supporting the chassis at a convenient angle, with the low side usually in front when working with the breadboard. Another piece of aluminum, cut, bent, and drilled as shown in Fig. 2, is bolted across the back of the chassis between the two mounting brackets. In addition to strengthening the assembly, this backplate is used to mount controls, with their shafts projecting to the rear. If desired, similar control plates may be mounted at the ends of the chassis.

The main chassis was drilled and punched for three types of sockets (in this case four octal, three 7-pin miniatures, and three 9-pin miniatures). Saddle-type octal sockets with four ground lugs were used. Multiple tie-point strips provide plenty of terminals to which parts may be fastened. The eight bus wires are used for supply voltages and voltage-divider networks. External connections are made through the socket at the left. A 5-pin tube socket was used because the contacts fit standard banana plugs where individual connections are desired. The common-ground bus (nearest the front) is connected to the chassis at one point.

Also included on the chassis were two cutouts and mountings for FP type capacitors. These capacitors and all tubes, when used, are inserted from the under side of the chassis.

Obviously, the number and arrangement of sockets, tie points and bus bars may be varied to suit any requirements. More effective use of the available chassis space may be made by providing sockets for plug-in circuit units. Suitable components are available from several manufacturers, such as Millen, National, Alden, and Vector. Vector also manufactures turret-type sockets, which are handy space-savers. The breadboard shown was assembled from parts on hand at the time the author felt the need for the device. —end—

DEFINITE DICTUM

The old term "solenoid" has become a source of some confusion to radio technicians. To the r.f. man it means any cylindrical coil (as opposed to the helix, or pancake coil). To the relay manufacturer it tends to mean a magnet winding with a movable core.

The following definition, worthy of any magazine's "How's That Again" department, should relegate all that confusion to the background. It appeared in the *New York Herald Tribune*, under the head "Primary Magnet Form Bears Term 'Solenoid'."

Solenoid means a primary form of electrical magnet. It consists of a filament which, when inclosed by a spiral-conducting wire properly positioned with its ends brought to the middle, may become a magnet when engaged by a current.

This form of electrical magnet also is called a solenoid magnet.

The whole secret of a successful solenoid, of course, rests in the proper positioning of the wire, with the ends brought to the middle. This is known technically as "ends to a mean."

BUY TEST EQUIPMENT ON THIS RADICALLY NEW TIME PAYMENT PLAN

NO INTEREST!! - NO CARRYING CHARGES!!

USE CONVENIENT TIME PAYMENT ORDER BLANK BELOW

Superior's New JUNIOR SUPER-METER

MOST COMPLETE AND COMPACT MULTI-SERVICE INSTRUMENT EVER DESIGNED



Handsome round cornered molded bakelite case 3 1/2" x 5 7/8" x 2 1/2" complete with all test leads and instructions.

\$21.40
NET

Measures:
 • Voltage • Current • Resistance
 • Capacity • Reactance • Inductance
 • Decibels

Specifications: D.C. Volts: 0-7.5/75/150/750/-1500 Volts. A.C. Volts: 0-15/150/300/1500/3000 Volts. Resistance: 0-10,000/100,000 ohms. 0-10 Megohms. D.C. Current: 0-7.5/75 Ma. 0-7.5 amps. Capacity: .001 Mfd.—.2 Mfd. .1 Mfd.—20 Mfd. Electrolytic Leakage: Reads quality of electrolytics at 150 Volt test potential. Decibels: -10 Db to +18 Db. +10 Db to +38 Db. +38 Db. to +58 Db. Reactance: 15 ohms—25 K ohms 15 K ohms—2.5 Megohms. Inductance: .5 Henry—50 Henries 30 Henries—10 K Henries. Plus Good-Bad scale for checking the quality of electrolytic condensers.

Superior's New Model TV-11 TUBE TESTER



Operates on 105-130 Volt 60 Cycles A.C. Hand-rubbed oak cabinet complete with portable cover

\$47.50
NET

* Uses the new self-cleaning Lever Action Switches for individual element testing. Because all elements are numbered according to pin number in the RMA base numbering system, the user can instantly identify which element is under test. Tubes having tapped filaments and tubes with filaments terminating in more than one pin are truly tested with the Model TV-11 as any of the pins may be placed in the neutral position when necessary. * Uses no combination type sockets. Instead individual sockets are used for each type of tube. Thus it is impossible to damage a tube by inserting it in the wrong socket. * Free-moving built-in roll chart provides complete data for all tubes. * Phono jack on front panel for plugging in either phones or external amplifier detects microphonic tubes or noise due to faulty elements and loose external connections.

Superior's New Model CA-12 SIGNAL TRACER



Completely Portable—weighs 8 pounds—measures 5 1/2" x 6 1/2" x 9".

Model CA-12 comes complete with all leads and operating instructions

\$33.95
NET

The well known model CA-12 is the only signal tracer in the low price range including both meter and speaker !!!

SPECIFICATIONS: * Comparative Intensity of the signal is read directly on the meter—quality of the signal is heard in the speaker. * Simple to Operate—only one connecting cable—no tuning controls. * Highly Sensitive—uses an improved vacuum-tube voltmeter circuit. * Tube and Resistor Capacity Network are built into the detector probe. * Built-In High Gain Amplifier—Alnico V Speaker.

Superior's New TV BAR GENERATOR



Power Supply: 105-125 Volt 60 Cycles. Power Consumption: 20 Watts. Channels: 2-5 on panel. 7-13 by harmonics. Horizontal lines: 4 to 12 (Variable). Vertical lines: 12 (Fixed). Vertical sweep output: 60 Cycles. Horizontal sweep output: 15,750 Cycles.

THROWS AN ACTUAL BAR PATTERN ON ANY TV RECEIVER SCREEN! !

Two Simple Steps

1. Connect Bar Generator to Antenna Post of any TV Receiver.
2. Plug Line Cord into A. C. Outlet and Throw Switch.

RESULT: A stable never-shifting vertical or horizontal pattern projected on the screen of the TV receiver under test.

TV Bar Generator comes complete with shielded leads and detailed operating instructions. Only . . .

\$39.95
NET

Superior's New Model 660—AN AC OPERATED SIGNAL GENERATOR

Provides Complete Coverage for A.M.-F.M. and TV Alignment

Generates Radio Frequencies from 100 Kilocycles to 60 Megacycles on fundamentals and from 60 Megacycles to 240 Megacycles on powerful harmonics. * Accuracy and stability assured by use of permeability trimmed Hi-Q coils. * R.F. available or modulated by the internal audio oscillator. * Built in 400 Cycle sine wave audio oscillator used to modulate the R.F. signal also available separately for audio testing of receivers, amplifiers, etc. * Oscillator Circuit: Uses a miniature high frequency type of acorn triode in a Hartley circuit to insure a high degree of stability. By using the same type of triode as a buffer amplifier, complete and noise isolation between the R.F. oscillator and the attenuator is attained. * Attenuator: a 3 step ladder type of attenuator is used. Each step of the attenuator is controlled by a separate attenuator control thus providing intermediate level steps. * Tubes used: 955, as R.F. Oscillator. 955 as Modulated Buffer Amplifier. 6SN7 as Audio Oscillator and Power Rectifier.



The Model 660 comes complete with coaxial cable test lead and instructions.

\$42.95
NET

NEW TIME PAYMENT PLAN ORDER BLANK

Moss Electronic Distributing Co., Inc.
Dept. B-25, 38 Murray Street, New York 7, N. Y.

Please send me the units checked below. I am enclosing the down payment with order and agree to pay the monthly balance as shown. It is understood there will be no carrying, interest or any other charges, provided I send my monthly payments when due. It is further understood that should I fail to make payment when due, the full unpaid balance shall become immediately due and payable.

- JUNIOR SUPER METER Total Price \$21.40
\$5.40 down payment. Balance \$4.00 monthly for 4 months.
- MODEL TV-11 Total Price \$47.50
\$11.50 down payment. Balance \$6.00 monthly for 6 months.
- MODEL CA-12 Total Price \$33.95
\$9.95 down payment. Balance \$4.00 monthly for 6 months.
- TELEVISION BAR GENERATOR Total Price \$39.95
\$9.95 down payment. Balance \$5.00 monthly for 6 months.
- MODEL 660 Total Price \$42.95
\$12.95 down payment. Balance \$5.00 monthly for 6 months.

I enclose \$ as down payment.
 Ship C.O.D. for the down payment.

Signature _____

Name _____

Address _____

City _____

Zone _____

State _____

The NEW 1952 Heathkit OSCILLOSCOPE KIT

MODEL O-7
SHIPPING WT. **\$435.00**
29 LBS.

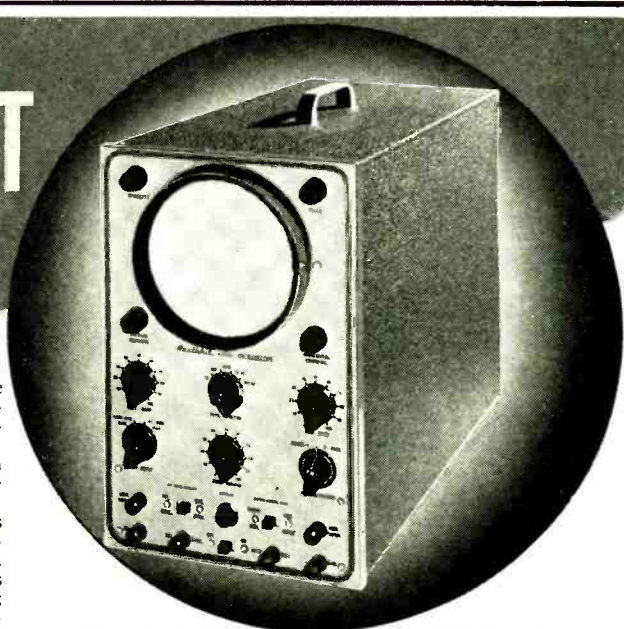

The Heathkit O-7 Oscilloscope with its 10 tube lineup (including CR tube) and carefully engineered circuit using highest quality components is truly the most outstanding scope value on the market today.

The "spot shape" (astigmatism) control working in conjunction with the focus control assures clear, sharp focusing . . . extended sweep range and faster retrace time permits the study of high frequencies . . . step-attenuated frequency-compensated cathode follower vertical input contributes to the excellent frequency response of the vertical channel03V RMS per inch vertical sensitivity makes weak input signals easy to study . . . push-pull operation of both vertical and horizontal deflection plates reduces pattern distortion . . . specially designed extra-wide CR tube mounting bracket places vertical cascade amplifier, vertical phase splitter, and deflection amplifiers near base of CR tube to reduce distributed wiring capacity and increase high frequency response.

Ideal for TV servicing—steep wavefronts encountered in TV work are easily handled. Fine for production line testing—rugged quality components can stand up under continuous hour-after-hour use. Excellent for laboratories—electrical performance comparable to scopes costing 4 and 5 times as much.

You'll like the complete instructions showing all details for easily building the kit—includes pictorials, step-by-step construction procedure, numerous sketches, schematic, circuit description. All necessary components included—transformer, cabinet, all tubes (including CR tube), completely punched and formed chassis—nothing else to buy.

- New "spot shape" control for spot adjustment—to give really sharp focusing.
- A total of ten tubes including CR tube and five miniatures.
- Cascaded vertical amplifiers followed by phase splitter and balanced push-pull deflection amplifiers.
- Greatly reduced retrace time.
- Step attenuated—frequency compensated—cathode follower vertical input.
- New mounting of phase splitter and deflection amplifier tubes near CR tube base.
- Increased frequency response—useful to 5 Mc.
- Tremendous sensitivity .03V RMS per inch Vertical—.6V RMS per inch Horizontal.

MODEL
S-2

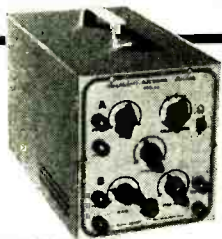

Heathkit ELECTRONIC SWITCH KIT

SHIPPING WT.
11 LBS.

\$19.50

The companion piece to a scope—Feed two different signals into the switch, connect its output to a scope, and you can observe both signals—each as an individual trace. Gain of each input is easily set (gain A and gain B controls), the switching frequency is simple to adjust (coarse and fine frequency controls), and the traces can be superimposed for comparison or separated for individual study (position control).

The kit is complete with tubes, switches, cabinet, power transformer and all other parts, plus a clear detailed construction manual.

NEW Heathkit AUDIO FREQUENCY METER KIT

MODEL AF-1
SHIPPING WT. 15 LBS.

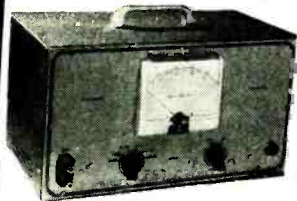

\$34.50

The ideal instrument for determining frequencies from 20 cycles to 100 KC. Set the selector switch to the proper range. Feed the signal into the input terminals—and read the frequency from the meter—completely simple to operate, and yet dependable results.

Quality Simpson 200 microampere meter has two plainly marked scales (0-100 0-300). These scales read in conjunction with the seven position selector switch, give full scale readings of 100, 300, 1000, 3000, 10,000, 30,000, and 100,000 cycles. Convenient ranges for fast and easy readings.

For greatest accuracy, the 1-3-10 ratio of ranges is maintained and each range has an individual calibrating control.

A signal voltage anywhere between 2 and 300V can be fed directly into the instrument and a change in signal voltage between these limits will not affect the meter reading. In addition, input wave shape is not critical (the unit will read the frequency of either sine wave or square wave input).

The tube complement consists of a 6SJ7 amplifier and clipper, 6V6 amplifier and clipper, 6H6 meter pulse rectifier, 6X5 power supply rectifier, and OD3/VR150 voltage regulator.

Construction is simple, and quality components are used throughout.

Heathkit INTERMODULATION ANALYZER KIT



MODEL IM-1
SHIPPING WT. 18 LBS.

\$39.50

Intermodulation testing of audio equipment is rapidly being accepted by more and more engineers and audio experts as the best way to determine the characteristics of audio amplifiers, recording systems, networks, etc.

The Heathkit Intermodulation Analyzer supplies a choice of two high frequencies (approx. 3000 cycles and 7000 cycles) and one low frequency (60 cycles). Both 1:1 or 4:1 ratios of low to high frequencies can be set up for IM testing, and the ratios are easily set by means of a set up for IM testing, and the instrument's own VTVM. An output panel control and the instrument's own VTVM. An output panel control supplies the mixed signal at the desired level with level control supplies the mixed signal at the desired level with an output impedance of two thousand ohms. The Analyzer section has input level control and proper filter circuits feeding the instrument's VTVM to read intermodulation directly on full scale ranges of 30%, 10% and 3%. Built-in power supply furnishes all necessary voltages for operating the instrument.

YOU SAVE BY ORDERING DIRECT FROM MANUFACTURER—USE ORDER BLANK ON LAST PAGE

EXPORT AGENT
ROCKE INTERNATIONAL CORP.
13 E. 40th ST.
NEW YORK CITY (16)
CABLE: ARLAB-N.Y.

The HEATH COMPANY

... BENTON HARBOR 20, MICHIGAN

THE *New* 1952 Heathkit VTVM KIT

MODEL V5-A
SHIPPING WT. 7 LBS.

\$24.50

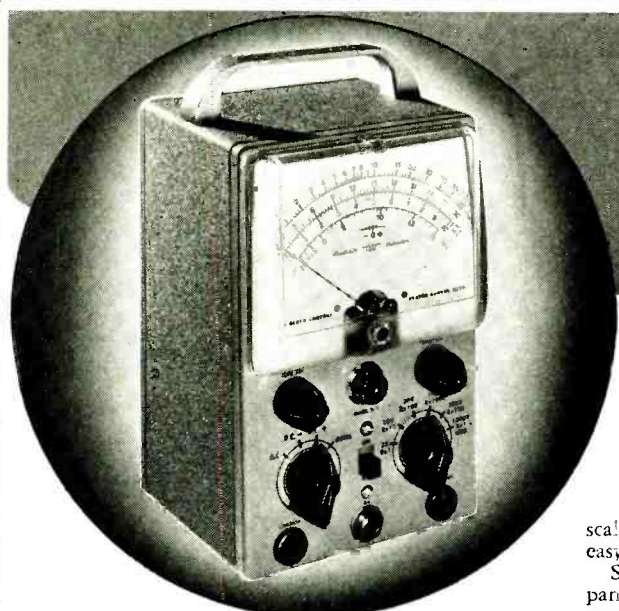

Designed to take up a minimum of space, yet designed to be the most important and useful instrument on your workbench. Really handsome looking — note the rounded edges on front panel and rear cover. New compact size has cabinet dimensions of only 4 1/8" deep x 4 1/4" wide x 7 3/8" high.

Tremendous coverage — will read from 1/2V to 1000V AC, 1/2V to 1000V DC, .1 to over 1 billion ohms resistance, and Db. Meter scale has zero-set mark for FM alignment — all scales clearly marked for easy and fast readings and Db scale is in red for easy identification.

Simple to operate. Ohms adjust and zero adjust controls located on front panel along with selector and range switches. Selector switch has four positions: AC, DC-, DC+ and Ohms to set up the instrument for type of reading desired. DC- position allows negative voltages to be taken without reversing test prods. AC and DC voltage ranges are full scale 3V — 10V — 30V — 100V — 300V — 1000V and resistance ranges are RX1, X10, X100, X1000, X10M, X1 Megohm. Convenient ranges for fast and accurate readings.

Strictly highest quality components used throughout — 1% precision resistors in multiplier circuit, Simpson 200 microampere meter movement, sturdy cabinet, excellent positive detent smooth acting switches, etc. New miniature tube used in meter balancing circuit and new battery holding clamp and spring clip assure good contact to ohms string of resistors.

Kit comes complete — and the instruction manual with its step-by-step instructions, pictorials, figures, and schematic makes assembly a pleasure.

- New styling, — formed case for beauty.
- New truly compact size. Cabinet 4 1/8" deep by 4-11/16" wide by 7-3/8" high.
- Quality 200 microamp meter.
- New ohms battery holding clamp and spring clip — assurance of good electrical contact.
- Highest quality precision resistors in multiplier circuit.
- Calibrates on both AC and DC for maximum accuracy.
- Terrific coverage — reads from 1/2V to 1000V AC, 1/2V to 1000V DC, and .1 to over 1 billion ohms resistance.
- Large, clearly marked meter scales indicate ohms, AC Volts, DC Volts, and DB — has zero set mark for FM alignment.

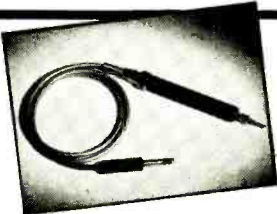

Heathkit R F PROBE KIT

Extends range of Heathkit VTVM to 250 MC ± 10%. Designed for taking RF measurements. All parts furnished including probe housing and crystal diode detector. Shipping Weight 1 lb.

\$5.50

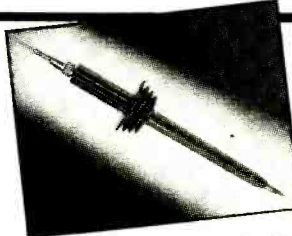

Heathkit 30,000 V DC PROBE KIT

For taking readings up to 30,000 V DC when used with the Heathkit VTVM (or any standard 11 megohm VTVM). Comes with two color molded plastic probe body and all parts. Shipping Wt. 2 lbs.

\$5.50

Heathkit A. C. VACUUM TUBE VOLTMETER KIT

Now — as a Heathkit — at a price anyone can afford, an AC VTVM. Makes possible those sensitive AC measurements required by audio enthusiasts, laboratories, and experimentors. The kit audio men have been looking for. Ten ranges consisting of full scale .01, .03, .1, .3, 1, 3, 10, 30, 100, 300 volts RMS assure easy and more accurate readings. Ten ranges on DB provide for measurements from -52 to +52 DB. Frequency response within 1 DB from 20 cycles to 50 KC.

The ingenious circuitry incorporates precision multiplied resistors for accuracy, two amplifier stages using miniature tubes, a unique bridge rectifier meter circuit, quality Simpson meter with 200 microampere movement, and a clean layout of parts for easy wiring. A high degree of inverse feedback provides for stability and linearity.

Extremely compact, cabinet size — 4-1/8" deep x 4-11/16" wide x 7-3/8" high. Newly designed cabinet makes this the companion piece to the VTVM.

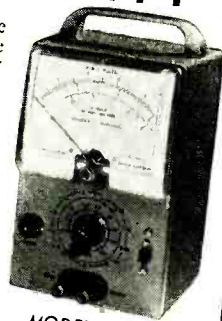

MODEL AV-1
SHIP. WT. 5 LBS.

\$29.50

Heathkit SQUARE WAVE GENERATOR KIT

The Heathkit Square Wave Generator is an excellent square wave frequency source with features you won't want to be without. Especially notable is the wide range of the instrument — 10 cycles to 100 kilocycles continuously variable. This wide range makes it useful for television and wide band amplifier work as well as audio experimentation. The output impedance is low, and the output voltage is continuously variable between 0 and 20 volts. Because a multivibrator stage cannot be accurately calibrated, terminals on the front panel can be used for synchronization to an external source should it be desired.

The circuitry consists of a multivibrator stage, a clipping and a squaring stage, and a cathode follower output stage. The power supply is transformer operated and utilizes a full wave rectifier tube with 2 sections of LC filtering.

For a good, wide range, and low priced square wave generator, the SQ-1 just can't be beat.



MODEL SQ-1
SHIP. WT. 14 LBS.

\$29.50

YOU SAVE BY ORDERING DIRECT FROM MANUFACTURER—USE ORDER BLANK ON LAST PAGE

EXPORT AGENT
ROCKE INTERNATIONAL CORP.
13 E. 40th ST.
NEW YORK CITY (16)
CABLE: ARIAB-N.Y.

The HEATH COMPANY

... BENTON HARBOR 20, MICHIGAN

Heathkit SIGNAL GENERATOR KIT

Model SG-6
Shipping Wt. 7 lbs.

The new Heathkit Signal Generator Kit has dozens of improvements. Covers the extended range of 160 Kc to 50 megacycles on fundamentals and up to 150 megacycles on useful calibrated harmonics; makes this Heathkit ideal as a marker oscillator for TV. Output level can be conveniently set by means of both step attenuator and continuously variable output controls. Instrument has new miniature HF tubes to easily handle the high frequencies covered.

Uses 6C4 master oscillator and 6C4 sine wave audio oscillator. The kit is transformer operated and a husky selenium rectifier is used in the power supply. All coils are precision wound and checked for calibration making only one adjustment necessary for all bands.

New sine wave audio oscillator provides internal modulation and is also available for external audio testing. Switch provided allows the oscillator to be modulated by an external audio oscillator for fidelity testing of receivers. Comes complete, all tubes, cabinet, test leads, every part. The instruction manual has step-by-step instructions and pictorials. It's easy and fun to build a Heathkit Model SG-6 Signal Generator.



\$19.50

Heathkit CONDENSER CHECKER KIT

Only
\$19.50

Model C-2
Shipping Wt. 6 lbs.

Checks all types of condensers — paper — mica — ceramic — electrolytic. All condenser scales are direct reading and require no charts or multipliers. Covers range of .00001 MFD to 1000 MFD. A Condenser Checker that anyone can read. A leakage test and polarizing voltage for 20 to 500 V provided. Measures power factor of electrolytics between 0% and 50% and reads resistance from 100 ohms to 5 megohms. The magic eye indicator makes testing easy.

The kit is 110V 60 cycle transformer operated and comes complete with rectifier tube, magic eye tube, cabinet, calibrated panel and all other parts. Has clear detailed instructions for assembly and use.

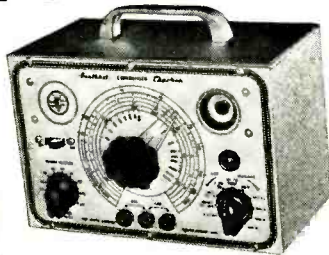

NEW Heathkit SIGNAL TRACER AND UNIVERSAL TEST SPEAKER KIT

\$19.50

Model T-2
Shipping Wt. 7 lbs.

The popular Heathkit Signal Tracer has now been combined with a universal test speaker at no increase in price. The same high quality tracer follows signal from antenna to speaker — locates intermittents — saves valuable service time — finds defective parts quicker — hour. Works equally well on broadcast, FM, or TV receivers. The test speaker has an assortment of switching ranges to match either push-pull or single output impedances. Also tests micro-60 cycle power transformer, tubes, test probe, all necessary parts, and detailed instructions for assembly and use.

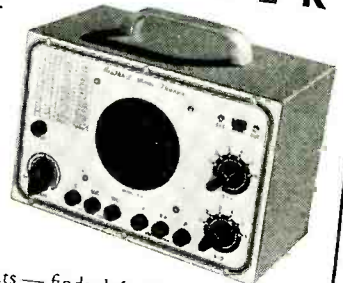

Model TC-1
Shipping Wt. 12 lbs.

\$29.50

Heathkit TUBE CHECKER KIT

The Tube Checker is a MUST for radio repair men. Often customers want to SEE tubes checked, and a checker like this builds customer confidence. In your repairing, you will have a multitude of tubes to check — quickly. The Heathkit tube checker will serve all these functions — it's good looking (with a polished birch cabinet and an attractive two color panel) — checks 4, 5, 6, 7 prong Octals, Loctals, 7 prong miniatures, 9 prong miniatures, pilot lights, and the Hytron 5 prong types. AND IT'S FAST TO OPERATE — the gear driven, free-running roll chart lists hundreds of tubes, and the smooth, acting, simplified switching arrangement gives really rapid set-ups.

The testing arrangement is designed so that you will be able to test new tubes of the future — without even waiting for factory data — protection against obsolescence.

You can give tubes a thorough testing — checks for opens, shorts, each element individually, emission, and for filament continuity. A large BAD?-GOOD meter scale is in three colors for easy reading and also has a "line-set" mark.

You'll find this tube checker kit a good investment — and it's only \$29.50.

YOU SAVE BY ORDERING DIRECT FROM MANUFACTURER—USE ORDER BLANK ON LAST PAGE

EXPORT AGENT
ROCKE INTERNATIONAL CORP.
13 E. 40th ST.
NEW YORK CITY (16)
CABLE: ARLAB-N.Y.

The HEATH COMPANY

... BENTON HARBOR 20, MICHIGAN

NEW 1952 *Heathkit* BATTERY ELIMINATOR KIT



\$24.50

Model BE-3
Shipping Wt. 17 lbs.

- Can be used as battery charger.
- Continuously variable output 0 - 8 Volts — not switch type.
- Heavy duty Mallory 17 disk type magnesium copper sulfide rectifier.
- Automatic overload relay for maximum protection. Self-resetting type.
- Ideal for battery, aircraft and marine radios.
- Dual Volt and Ammeters read both voltage and amperage continually — no switching.

The new Heathkit Model BE-2 incorporates the best. Continuously variable output control is of the variable transformer type with smooth wiper type contacts. There are no switches or steps and voltage between 0 and 8 Volts is available at 10 Amperes continuous and 15 Amperes intermittent. Maximum safety from overloads and shorts provided by automatic overload relay which resets itself when overload is removed.

The new rectifier is a 17 plate Mallory magnesium copper sulfide type. This is the most rugged type available for long trouble-free use.

Output is continuously metered by both a 0 - 10 Volt Voltmeter and a 0 - 15 Amp Ammeter. Shorted vibrators indicated instantly by ammeter.

Equip now for all types of service — aircraft — marine — auto and battery radios — this inexpensive instrument vastly increases service possibilities — better be ready when the customer walks in.

NEW *Heathkit* SINE AND SQUARE WAVE AUDIO GENERATOR KIT

Designed with versatility, usefulness, and dependability in mind, the AG-7 gives you the two most needed wave shapes right at your fingertips — the sine wave and the square wave.

The range switch and plainly calibrated frequency scale give rapid and easy frequency selection, and the output control permits setting the output to any desired level.

A high-low impedance switch sets the instrument for either high or low impedance output — on high to connect a high impedance load, and on low to work into a low impedance transformer with negligible DC resistance.

Coverage is from 20 to 20,000 cycles, and distortion is at a minimum — you can really trust the output wave shape.

Six tubes, quality 4 gang tuning condenser, power transformer, metal cased filter condenser, 1% precision resistors in the frequency determining circuit, and all other parts come with the kit — plus, a complete construction manual — A tremendous kit, and the price is truly low.

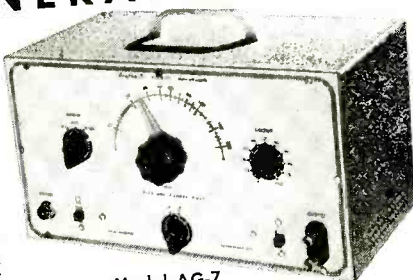

Model AG-7
Shipping Wt. 15 lbs.

\$34.50

THE NEW *Heathkit* HANDITESTER KIT

A precision portable volt-ohm milliammeter. Uses only high quality parts — All precision 1% resistors, three deck switch for trouble-free mounting of parts, specially designed battery mounting bracket, smooth acting ohm adjust control, beautiful molded bakelite case, 400 micro-amp meter movement, etc.

DC and AC voltage ranges 10 - 30 - 300 - 1000 - 5000V. Ohms range 0 - 3000 and 0 - 300,000. Range Milliamperes 0 - 10 Ma, 0 - 100 Ma. Easily assembled from complete instructions and pictorial diagrams.

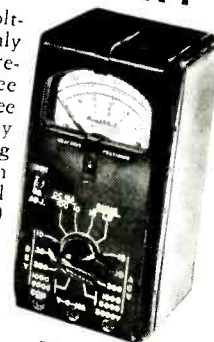

\$13.50

Model M-1
Shipping Wt. 3 lbs.

NEW *Heathkit*

T.V. ALIGNMENT GENERATOR KIT

Here is an excellent TV Alignment Generator designed to do TV service work quickly, easily, and properly. The Model TS-2 when used in conjunction with an oscilloscope provides a means of correctly aligning television receivers.

The instrument provides a frequency modulated signal covering, in two bands, the range of 10 to 90 Mc. and 150 to 230 Mc. — thus, ALL ALLOCATED TV CHANNELS AS WELL AS IF FREQUENCIES ARE COVERED.

An absorption type frequency marker covers from 20 to 75 Mc. in two ranges — therefore, you have a simple, convenient means of frequency checking of IF's, independent of oscillator calibration.

Sweep width is controlled from the front panel and covers a sweep deviation of 0-12 Mc. — all the sweep you could possibly need or want.

And still other excellent features are: Horizontal sweep voltage available at the front panel (and controlled with a phasing control — both step and continuously variable attenuation for setting the output signal to the desired level — a convenient instrument stand-by position — vernier drive of both oscillator and marker tuning condensers — and blanking for establishing a single trace with base reference level. Make your work easier, save time, and repair with confidence — order your Heathkit TV Alignment Generator now!

Model TS-2
Shipping Wt. 20 lbs.

\$39.50

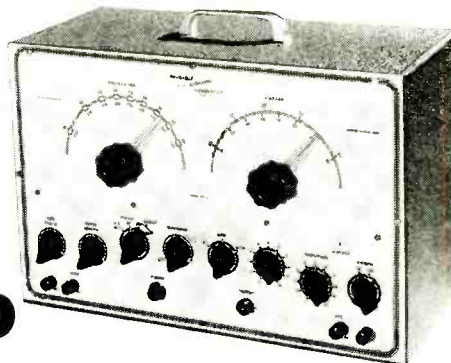

YOU SAVE BY ORDERING DIRECT FROM MANUFACTURER—USE ORDER BLANK ON LAST PAGE

EXPORT AGENT
ROCKE INTERNATIONAL CORP.
13 E. 40th ST.
NEW YORK CITY (16)
CABLE: ARAB-N.Y.

The **HEATH COMPANY**

... BENTON HARBOR 20, MICHIGAN

Heathkit IMPEDANCE BRIDGE KIT



Model 1B-1B
Shipping Wt. 15 lbs.

\$69.50

This Impedance Bridge Kit is really a favorite with schools, industrial laboratories, and serious experimenters. An invaluable instrument for those doing electrical measurements work. Reads resistance from .01 Ohms to 10 meg., capacitance from .00001 to 100 MFD, inductance from 10 microhenries to 100 henries, dissipation factor from .002 to 1, and storage factor from 1 to 1000. And you don't have to worry about selecting the proper bridge circuit for the various measurements—the instrument automatically makes the correct circuit when you set up for making the measurement you want. Bridge utilizes Wheatstone, Hay, Maxwell, and capacitance comparison circuits for the wide range and types of measurements possible. And it's self powered—has internal battery and 1000 cycle hummer. No external generator required—has provisions for external generator if measurements at other than 1000 cycles are desired. Kit utilizes only highest quality parts. General Radio main calibrated control. Mallory ceramic switches, excellent 200 microamp zero center galvanometer, laboratory type binding posts with standard 3/4 inch centers, 1% precision ceramic-body type multiplier resistors, beautiful birch cabinet and ready calibrated panel. (Headphones not included.)

Take the guesswork out of electrical measurements—order your Heathkit Impedance Bridge kit today—you'll like it.

Heathkit LABORATORY RESISTANCE DECADE KIT



\$19.50

Shipping Wt. 4 lbs.

An indispensable piece of laboratory equipment—the Heathkit Resistance Decade Kit gives you resistance settings from 1 to 99,999 ohms IN ONE OHM STEPS. For greatest accuracy, 1% precision ceramic-body type resistors and highest quality ceramic wafer switches are used.

Designed to match the Impedance Bridge above, the Resistance Decade Kit has a beautiful birch cabinet and attractive panel. It's easy to build, and comes complete with all parts and construction manual.

Heathkit LABORATORY POWER SUPPLY KITS

Limits:

No load.....	Variable	150-400V DC
25 MA.....	Variable	30-310V DC
50 MA.....	Variable	25-250V DC

Higher loads: Voltage drops off proportionally. Every experimenter needs a good power supply for electronic scrups of all kinds. This unit has been expressly designed to act as a HV supply and a 6.3 V filament voltage source. Voltage control allows selection of HV output desired (continuously variable within limits outlined), and a Volts-Ma switch provides choice of output metering. A large plainly marked and direct reading meter scale indicates either DC voltage output in Volts or DC current output in Ma. (Range of meter 0-500V D.C., 0-200 Ma. D.C.). Instrument has convenient stand-by position and pilot light.

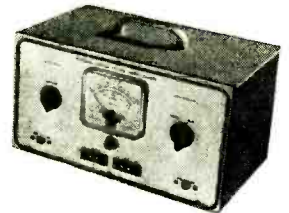

\$29.50

Model PS-1.....Ship. Wt. 20 lbs.

Comes with power transformer, filament transformer, meter, 5Y3 rectifier, two 1619 control tubes, completely punched and formed chassis, panel, cabinet, detailed construction manual, and all other parts to make the kit complete.

Heathkit ECONOMY... 6 WATT AMPLIFIER KIT



MODEL A-7
Shipping Wt. 8 lbs.

\$14.50

- Choice of 4-8-15 ohm output impedances.
- Response flat $\pm 1\frac{1}{2}$ db from 20—20,000 cycles.
- 6 watts output.
- Good fidelity at low cost.
- Output tubes working in push pull.
- Volume, bass, and treble controls.
- Two separate inputs.

The purpose of this kit is to provide to the kit builder a low cost amplifier with excellent fidelity. The circuit consists of four tubes with following functions: a 12SL7, one section working as an amplifier and one as a phase splitter, two 12A6 output tubes working in push pull,

and a 5Y3 rectifier in a full wave rectifier circuit. The unit operates from a husky power transformer, and has good output transformer with a choice of 4—8—15 ohm output impedances. (Speaker not included).

The kit provides excellent listening pleasure and the price is really low. Compare it with all others. You won't find a better buy.

MODEL A-7: For tuner and crystal phono inputs. Has two position selector switch for convenient switching to type of input desired.

Model A-7-A: Has a 12SH7 preamplifier stage with special compensation network for operation with reluctance phono input. Shipping Wt: 8 lbs. **\$16.50**

Heathkit HIGH FIDELITY 20 WATT AMPLIFIER KIT



MODEL A-8
Shipping Wt. 18 lbs.

\$33.50

The A8 (or A-8A) is a high quality amplifier for those who want high fidelity output at moderate cost. Frequency response within ± 1 db from 20—20,000 cycles. Distortion at 3db below maximum power output (at 1,000 cycles) is only .3%. Kit has a Chicago power transformer in drawn steel case and a Peerless output transformer with output impedances of 4—8—16 ohms. Bass and treble controls permit listener to select output with tonal qualities of his own liking.

The tube lineup is composed of a 6SJ7 voltage amplifier, a 6SN7 amplifier and phase splitter, two 6L6's in push-pull output and a 5U4G rectifier. All parts furnished (speaker not included) and the construction manual makes assembly easy.

MODEL A-8: For tuner and crystal phono inputs. Has two position selector switch for convenient switching to type of input desired.

MODEL A-8A: Features an added 6SJ7 stage (preamplifier) for operating from variable reluctance cartridge phono pickup, mike input, and either tuner or standard crystal phono pickup. A three position selector switch provides flexible switching. Shipping Wt. 18 lbs. **\$35.50**

YOU SAVE BY ORDERING DIRECT FROM MANUFACTURER—USE ORDER BLANK ON LAST PAGE

EXPORT AGENT
ROCKE INTERNATIONAL CORP.
19 E. 40th ST.
NEW YORK CITY (16)
CABLE ARLAB-N.Y.

The **HEATH COMPANY**

... BENTON HARBOR 20, MICHIGAN

Heathkit RECEIVER & TUNER KITS for AM and FM

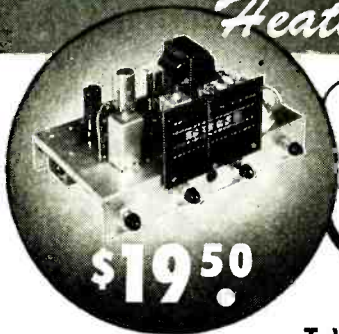

Model BR-1 Broadcast Model Kit covers 550 to 1600 Kc. Shipping Wt. 10 lbs.

\$19.50

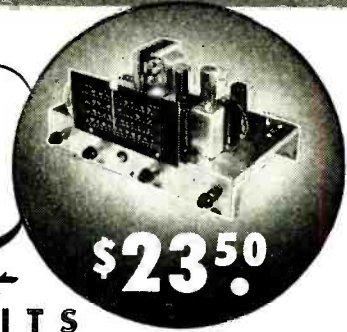

Model AR-1 3 Band Receiver Kit covers 550 Kc. to over 20 Mc. continuous. Extremely high sensitivity. Shipping Wt. 10 lbs.

\$23.50

TWO HIGH QUALITY *Heathkit* SUPERHETRODYNE RECEIVER KITS

Two excellent Heathkits. Ideal for schools, replacement of worn out receivers, amateur and custom installations.

Both are transformer operated quality units. The best of materials used throughout—six inch calibrated slide rule dial—quality power output transformers—dual iron core shielded. I.F. coils—metal cased filter condenser. The chassis has phono input jacks, 110 Volt output for phono motor and there is a phono-radio switch on panel. A large metal panel simplifying installation in used console cabinets is included. Comes complete with tubes and instruction manual incorporating pictorials and step-by-step instructions (less speaker and cabinet). The three band model has simple coil turret which is assembled separately for ease of construction.

TRUE FM FROM

Heathkit

FM TUNER KIT

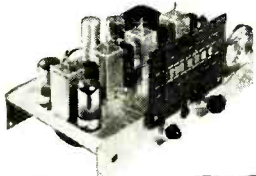

Model FM-2
Ship. Wt. 9 lbs.

\$22.50

The Heathkit FM Tuner Model FM-2 was designed for best tonal reproduction. The circuit incorporates the most desirable FM features—true FM.

Utilizes 8 tubes: 7E5 Oscillator, 6SH7 mixer, two 6SH7 IF amplifiers, 6SH7 limiter, two 7C4 diodes as discriminator, and 6X5 rectifier.

The instrument is transformer operated making it safe for connection to any type receiver or amplifier. Has ready wound and adjusted RF coils, and 2 stages of 10.7 Mc IF (including limiter). A calibrated six inch slide rule dial has vernier drive for easy tuning. All parts and complete construction manual furnished.



MAIL TO THE
HEATH COMPANY
BENTON HARBOR 20,
MICHIGAN

ORDER BLANK

From _____

SHIP VIA

- Parcel Post
- Express
- Freight
- Best Way

Quantity	Item	Price	Quantity	Item	Price
	Heathkit Oscilloscope Kit — Model O-7			Heathkit H.V. Probe Kit — No. 336	
	Heathkit VTVM Kit — Model V-5			Heathkit R.F. Signal Gen. Kit — Model SG-6	
	Heathkit FM Tuner Kit — FM-2			Heathkit Condenser Checker Kit — Model C-2	
	Heathkit Broadcast Receiver Kit — Model BR-1			Heathkit Handitester Kit — Model M-1	
	Heathkit Three Band Receiver Kit—Model AR-1			Heathkit Power Supply Kit — Model PS-1	
	Heathkit Amplifier Kit — Model A-4			Heathkit Resistance Decade Kit — Model RD-1	
	Heathkit Amplifier Kit — Model A-6 (or A-6A)			Heathkit Impedance Bridge Kit — Model IB-1B	
	Heathkit Tube Checker Kit — Model TC-1			Heathkit A.C. VTVM-KIT — Model AV-1	
	Heathkit Audio Generator Kit — Model AG-7			Heathkit Intermodul. Analyzer Kit—Model IM-1	
	Heathkit Battery Eliminator Kit — Model BE-2			Heathkit Audio Freq. Meter Kit — Model AF-1	
	Heathkit Electronic Switch Kit — Model S-2			Heathkit Square Wave Gen. Kit — Model SQ-1	
	Heathkit T.V. Alignment Gen. Kit — TS-2				
	Heathkit Signal Tracer Kit — Model T-2				
	Heathkit R.F. Probe Kit — No. 309				

On Parcel Post Orders, include postage for weight shown and insurance. (We insure all shipments.)

On Express Orders, do not include transportation charges — they will be collected by the Express Agency at time of delivery.

Enclosed find Check Money Order for _____

Please ship C.O.D. Postage enclosed for _____ lbs.

ALL PRICES SUBJECT TO CHANGE WITHOUT NOTICE

EXPORT AGENT
ROCKE INTERNATIONAL CORP.
13 E. 40th ST.
NEW YORK CITY (16)
CABLE: ARAB-N.Y.

The HEATH COMPANY

... BENTON HARBOR 20, MICHIGAN

MARKER-CALIBRATOR

The Hickok Electrical Instrument Co., 10514 Dupont Ave., Cleveland 8, Ohio, has introduced the new model 680 TV r.f. marker generator and crystal-controlled calibrator. Accurate to .05%, the unit is a crystal-calibrated standard for use in checking oscillators, generators, and front-end and over-all response curves of TV sets. A built-in heterodyne detector and electron-ray tube zero-beat indicator are provided to insure accurate calibration.



The unit has the following features:

1. An r.f. signal generator covering from 52-89 and 174-217 mc on fundamentals, and to 868 mc on harmonics.
 2. A 2.5-mc crystal to beat with the v.f.o. to provide accurate check points at 2.5-mc intervals throughout the range.
 3. Two additional crystal sockets are provided for calibrating signal generators and other equipment. If a 4.5-mc crystal is used, dual markers may be obtained.
- The unit is housed in an 11 1/2 x 6 x 9-inch portable steel case and draws 20 watts from 105-125-volt, 50-70-cycle lines.

RECORDING HEAD

Shure Brothers, Inc., 225 West Huron St., Chicago 10, Ill., announces the new TR-16 magnetic tape recording head which features excellent frequency response, compactness (0.765 inch wide, 0.845 inch long, and 0.609 inch thick), track widths from .025 to 0.1 inch, and flexible mountings which provide for vertical and angular adjustments.

The unit may be used for multiple-track applications and is recommended for dictating or low-cost playback machines. Mu-metal shielding minimizes hum pickup.

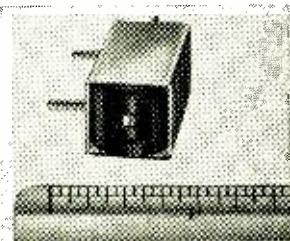

NEW TUBE TESTER

Electronic Measurements Corp., 280 Lafayette Street, New York, N. Y., has announced the addition of a new tube tester to the EMC line of electrical testing equipment. Model 205 is designed to give test readings for all tubes, including noval and subminiatures from 0.75 to 1.17 filament volts through the standard emission method of testing. This instrument, using four-position lever-type switches and individual sockets for each tube base type, is available in either stationary or portable oak cases.



GEIGER KIT

Allied Radio Corp., 833 W. Jackson Blvd., Chicago, Ill., announces that its new "Super Scout" Geiger counter is available in kit form. The unit provides effective radiation detection for schools, laboratories, civil defense applications, and prospecting use. It detects the presence of gamma rays and medium-to-high energy beta rays, as well as cosmic and X-rays. It instantly spots radiations from uranium, pitchblende radium, and other radioactive sources. Clicks heard in headphones and flashes of a neon lamp increase in frequency as the source of radiation is approached.

The unit includes a built-in vibrator-type power supply powered by two flashlight batteries, a sensitive G.M. tube, and a 1T4 tube used as a rectifier. It weighs 3 pounds and has a sturdy leather handle and a belt clip for convenient carrying. It is supplied with easy-to-read instructions, a pictorial diagram, and all parts except headphones.

TELESCOPIC TV MAST

JFD Manufacturing Co., Inc., 6101 16th Ave., Brooklyn 4, N. Y., is distributing the new Zoom-Up telescoping tower-type mast in seven models. The masts

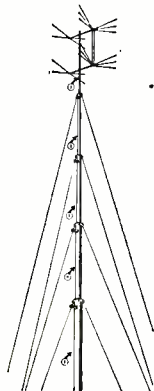

are constructed of 10-foot telescoping sections of zinc-plated seamless steel tubing with heavy-duty nuts and bolts to lock the sections firmly in position. Guy rings, clamps, and all other necessary hardware are supplied with each antenna. The units are erected simply by installing the antenna on the uppermost section and then pushing the lower sections into place.

The masts are available in three models for 20 feet, two for 30 feet, and one each for 40 and 50 feet. For a given height, the models differ in the outside diameters of the sections.

CARBON MICROPHONE

The Astatic Corporation, Conneaut, Ohio is distributing its new model 10M5 single-button, hand-held microphone which is designed for maximum



clarity of speech. Response is from 100 to 4,500 cycles. Sensitivity is rated at 1 volt for 100 microbar signal (100-ohm load).

The mike includes a built-in d.p.s.t. push-to-talk switch with microphone and relay contacts normally open. It is recommended for mobile transmitter and sound installations and similar applications. When used with a step-up transformer, it will work directly

into power-output stages without using a preamplifier. A hang-up bracket is provided for holding the mike on a wall, panel, or dashboard.

It is supplied with a 4-conductor, self-coiling, oil-resistant rubber-covered cable. The retracted length of the cable is 12 inches. The extended length is 5 feet.

CHANNEL SEPARATOR

Technical Apparatus Corp., Sherburne, N. Y., announces that the new Tacoplex channel separators are now available. These units separate TV channel signals traveling along a common transmission line and feed the



separated signals through individual outputs to separate boosters or amplifiers. Such units are employed at all booster stations in a community TV distribution system. They terminate the transmission line properly and make it possible to amplify one channel without amplifying adjacent ones. (Simultaneous amplification of adjacent-channel signals often results in distortion of both video and sound.)

The two-channel model is the 1512 and the three-channel model is the 1513. They are available for any combination of two or three low-band channels, not including adjacent channels, except 4 and 5.

TV BOOSTERS

Radio Merchandise Sales, Inc., 1165 Southern Blvd., New York, N. Y. has added two new TV boosters to the

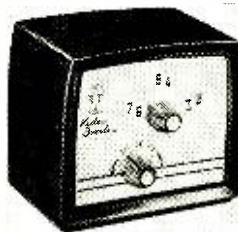

RMS line. The model SP-6 is a pentode-tube booster with an external gain control which permits operating the unit at maximum gain in extreme fringe areas and with reduced gain in areas where full gain causes overloading of the set.



The SP-6J triode-tube booster features an extremely low noise level, high gain, and a full 6-megacycle bandwidth.

Both units are approved by Underwriters Laboratories and carry a full guarantee with standard RMA warranty on tubes and parts.

LIGHTNING ARRESTER

Insuline Corp. of America, 36-05 35th Avenue, Long Island City, 1, N. Y. has announced its new 6113 and 6114 lightning arresters for TV antennas. Approved by Underwriters Laboratories, the new molded phenolic units are designed to withstand all extremes of

weather. The 6113 has a binding post for ground wire, and the 6114 has a grounding strap which fits around the



usual metal pipe of the TV mast. Either type can be installed without cutting the lead-in. Contact to the lead-in conductors is made through cup-shaped washers with serrated teeth.

PRECISION RESISTORS

International Resistance Co., 401 North Broad St., Philadelphia 8, Pa. has introduced two new types of precision resistors. The deposited-carbon (DDC) and boron-carbon (BOC) types are

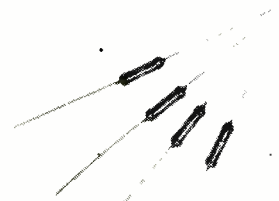

physically alike except for color. Both provide higher resistance values in less space and at lower cost than precision wire-wound units. Both are rated at 1/2 watt and are available with tolerances of 1, 2, and 5%. The body length is 9/16 inch and maximum diameter is 5/32 inch. The BOC type is recommended for applications where stability and accuracy are required under widely varying temperatures.

VIBRATORS

The Radiart Corp., Cleveland 2, Ohio, announces its Red Seal line of replacement auto radio vibrators which have a vent built into the base. This vent is wax-sealed at the factory to prevent oxidation of the points before the unit is put into use. When the vibrator is operated, the temperature rise melts out the wax and permits air to circulate inside the unit, thus providing longer life and better performance.



NEW TV ANTENNA

Davis Electronics, 3047 West Olympic Blvd., Los Angeles 6, Calif., has just announced the new Super-Vision TV antenna. It is recommended for fringe-area and dx reception and where high-gain performance is desired on all channels. Ghosts are reduced or eliminated by the sharp pattern in the forward direction. High vertical and horizontal directivity are obtained by the use of stacked dipoles, together with a "bedspring" type reflector. Aircraft flutter, diathermy, FM, and other sources of TV interference are substantially reduced. Gain is 10 db or more on high channels.

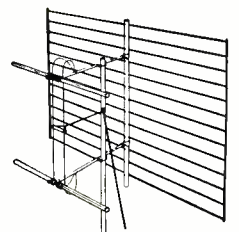

TAPE RECORDER

TapeMaster, Inc., 13 West Hubbard St., Chicago 10, Ill., is producing the new model PT-121 professional-quality tape recorder designed for operation with the user's own audio amplifier and speaker. The unit includes a tape-transport mechanism and matching self-powered preamplifier with push-pull supersonic bias-erase oscillator, fully wired and ready to plug in.

The PT-121 has a tape speed of 7.5 inches per second; maximum speed variation 2% with line variation from



95 to 125 volts. Dual-track head, for 1/4-inch tape. Fast forward and fast rewind (20:1 ratio). Inputs for both radio-phonograph and microphone. High input impedance. Output impedance 17,000 ohms. Audio output to 4 volts. Response 70-8,000 cycles plus or minus 3 db. Equalization provides high- and low-frequency compensation for recording and playback.

Fitted into a 12 x 12 1/2 x 9 1/2-inch leatherette-covered portable case, the unit is supplied with a 5-inch reel of tape and a 7-inch take-up reel. Mike, amplifier, and speaker are to be supplied by the user.

TUBE CADDY

Argos Products Co., Genoa, Ill., has introduced the "Tube Caddy Junior," a new, smaller, companion-piece to the larger "Television Tube Caddy." The new unit (model TC-2) measures 15 1/2 x 13 x 8 inches and holds up to 143 receiving tubes. The larger model (TC-1B) is 20 inches long, 13 1/2 inches high, and 9 inches wide, and carries up to 249 tubes.

Both models have two drawers at the top for miniature and medium-size tubes and space at the bottom for larger tubes. Drawers have removable partitions. Small tools and a meter also may be carried.



LIGHTNING ARRESTER

Brach Mfg. Corp., 200 Central Ave., Newark 4, N. J., announces the production of the model 4004 lightning arrester for open-wire transmission lines. The unit does not distort the line spacing nor introduce mismatch at any TV frequency. It incorporates a rare-gas tube which dissipates the charges before they can enter and destroy delicate TV receiver equipment. The 4004 is waterproof, with all parts protected against corrosion. It is listed by Underwriters' Laboratories.

—end—

All specifications given on these pages are from manufacturers' data.



IT'S A SHAME

to throw away that beautiful old Console . . . replace the obsolete radio with a modern, easily-installed



ESPEY AM / FM CHASSIS
and your console is "right-up-to-date"

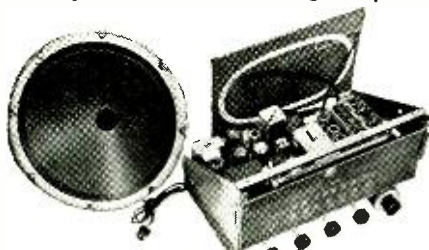

It is not necessary to spend a large sum of money to modernize your old radio or to become a "High Fidelity" enthusiast. ESPEY chassis provide the Highest Quality at moderate prices.

Fully licensed under RCA and Hazeltine patents. The photo shows the Espey Model 511-C, supplied ready to play. Equipped with tubes, antenna, speaker, and all necessary hardware for mounting.

NEW FEATURES—Improved Frequency modulation circuit, drift compensated • 12 tubes plus rectifier, and pre-amplifier pick-up tubes • 4 dual purpose tubes • High quality AM-FM reception • Push-pull beam power audio output 10 watts • Switch for easy changing to crystal or variable reluctance pick-ups • Multi-tap audio output transformer supplying 4—8—500 ohms.

Write Dept. RE-5 for literature and complete specifications on Model 511-C and others.

Visit our Booth No. 673 at Parts Show in Chicago

Makers of fine radios since 1928.

ESPEY
MANUFACTURING COMPANY, INC.
528 EAST 72nd STREET, NEW YORK 21, N. Y.

more TV set outlets per dollar!

with easy-to-install

Blonder-Tongue

ALL-CHANNEL MASTER ANTENNA SYSTEMS

Distribution Amplifier
8 TV Set Outlets
Model #DA8-1-M List Price \$87.50

Commercial Antensifier (30 Times Gain) Use As Pre-Amplifier, Line Amplifier or de-luxe Booster
Model #CA-1-M List Price \$77.50

Distribution Amplifier
2 TV Set Outlets
Model #DA2-1-M List Price \$39.50

More Gain Per Dollar!

B-T Home Antensifier Model HA-2-M
Finest All-Channel TV Booster. Fully Automatic, 16 Times Gain. In Metal Cabinet
List Price \$57.50

Literature on Request write Dept. D5
See us in Chicago, Booth 6

Blonder-Tongue Labs., Inc. Mt. Vernon, N. Y.

High score every time with "Safe Centers!"

In Basketball there's no better assurance of victory than a lengthy lad jumping center . . . and there is nothing that scores higher in radio, TV and other electronic circuits than SELETRON miniature rectifiers with "Safe Center" plates.

When you specify SELETRON Selenium Rectifiers you eliminate arc-over danger, short circuits and heating at the center contact point. Assembly pressure, or pressure applied in mounting the rectifier cannot affect its performance — a SELETRON feature accomplished by deactivating the area of the plate under the contact washer.

The millions of SELETRON Selenium Rectifiers in satisfactory service as original equipment in the products of leading manufacturers are millions of reasons why you can specify SELETRON and be safe!

Look for Howard W. Sam's Red Book Supplement listing SELETRON replacements . . . and write for Bulletin No. 104-R2

Seletron

SELETRON DIVISION
RADIO RECEPTOR COMPANY, INC.
Since 1922 in Radio and Electronics
Factory: 84 North 9th St., Brooklyn 11, N. Y. • Sales Department: 261 West 15th St., New York 11, N. Y.

NEW COAST GROUP

A new organization, the Society of Radio and Television Technicians, Inc., is reported from the San Fernando Valley, California. Dell Davis, chairman of the public relations committee, informs us that it is an outgrowth of the old Radio Technicians Association, San Fernando Valley Chapter, which has been disbanded.

Dinner meetings are held twice monthly, with the programs aimed directly at the practicing technician. Routine business is confined to a 15-minute period, the remainder of the meetings being entirely technical, and operated in "typical service club style."

An ingenious method has been adopted to insure maximum member attendance at all meetings. Members who interrupt a speaker or engage in crosstalk are fined one dollar. The fines are placed on a clothesline strung across the hall as they are levied.

At the end of the meeting a member's name is drawn from a hat. If he is present he "takes in the wash." If not, the money is held and goes toward next meeting's jackpot.

PHONE BOOK PUBLICITY

The Associated Radio-Television Service Dealers of Columbus, Ohio, have decided to have a master cut made of the organization's insignia, to be used for the telephone directory listings of members who may wish to use it.

The new president, Fred Colton, in a special message, urged all members to display the Association's emblem, not only in their places of business, but in the phone book, on trucks, on their letterheads and in all other places where it might further the public's recognition of the emblem and the competent, ethical, business operations for which it stands.

FIRST LADIES NIGHT

The Mid-State Radio Servicemen's Association of Harrisburg, Pennsylvania held its First Annual Ladies Night with sixteen members and wives in attendance on February fifth, 1952. The affair was held at Shelley's Restaurant, Steelton, with a "family style" meal.

After dinner many pictures were taken by Vance Beechley, with his Polaroid "picture-in-a-minute" camera. After this a color movie entitled "Historic Old New England" was shown. Without exception, it was acclaimed as excellent by all present.

The wives were especially enthusiastic about this event and immediately asked that plans be made to hold an annual affair. On second thought they asked, "Why wait another year to get together? Why not have a clam-bake or a wiener roast for members and wives during the summer or early fall months?"

Mid-State members cite the success of this affair in recommending that other associations follow their example.

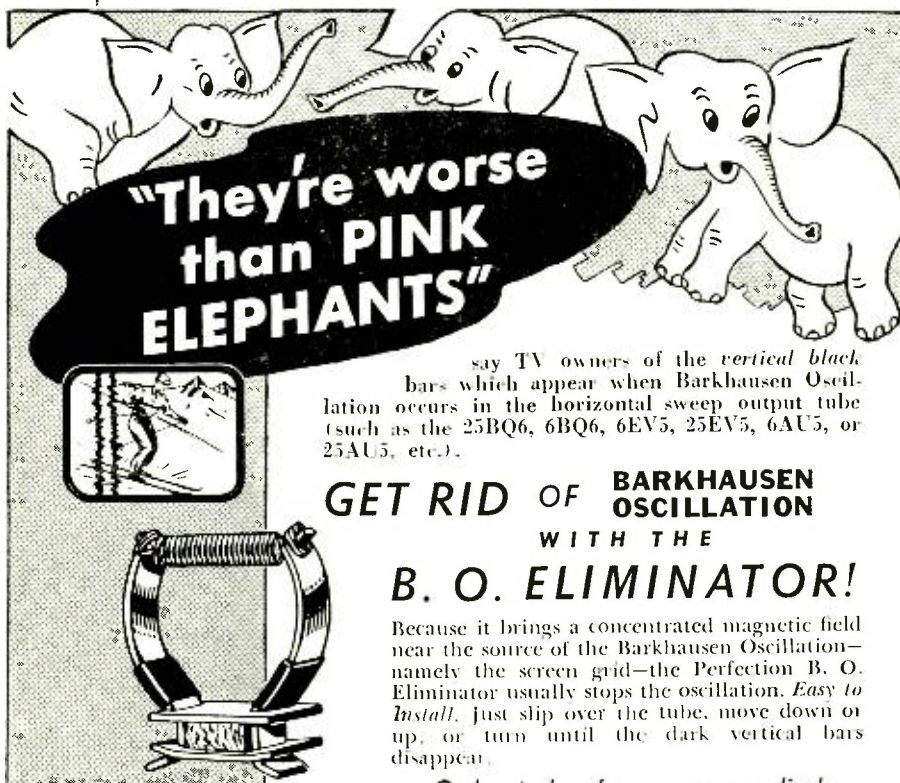

"They're worse than PINK ELEPHANTS"

say TV owners of the vertical black bars which appear when Barkhausen Oscillation occurs in the horizontal sweep output tube (such as the 25BQ6, 6BQ6, 6EV5, 25EV5, 6AU5, or 25AU5, etc.).

GET RID OF BARKHAUSEN OSCILLATION WITH THE B. O. ELIMINATOR!

Because it brings a concentrated magnetic field near the source of the Barkhausen Oscillation—namely the screen grid—the Perfection B. O. Eliminator usually stops the oscillation. *Easy to Install.* Just slip over the tube, move down or up, or turn until the dark vertical bars disappear.

Order today from your supplier!

PERFECTION ELECTRIC COMPANY
 2637 South Wabash Avenue, Chicago 16, Illinois
 MAKERS OF PERFECTION SPEAKERS AND TELEVISION COMPONENTS

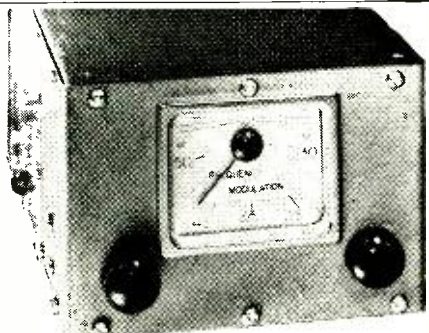
Model M-51

for emergency communications

USED BY HUNDREDS OF MUNICIPALITIES FROM BOSTON, MASS., TO ALHAMBRA, CAL.

POLICALARM MONITORADIO

Says S. L. Grant, City Manager, Winchester, Virginia . . .

"I think you have a receiver that is well built, and I see no reason why it should not be in demand by all public works departments that have a transmitter available."



Users of FM 2-Way Radio Communications equipment throughout the entire nation, find Polic-Alarm and Monitoradio a welcome innovation to low-cost mobile communications radio .

5 Models For All Systems

6 VOLT MOBILE
M-51
 Tuneable 30-50 MC
M-101
 Tuneable 152-163 MC

115 VOLT AC-DC
PR-31
 Tuneable 30-50 MC
PR-B
 Tuneable 152-163 MC
AIRCRAFT
AR-1
 AM Tuneable 108-132 MC
 115 Volt AC-DC

For Complete Information: See Your Jobber—Or Write Us Today

RADIO APPARATUS CORPORATION

55 N. NEW JERSEY ST., INDIANAPOLIS 4, IND., PHONE: ATLANTIC 1624

RIDER HONORED BY FR SAP

John F. Rider, publisher of service manuals and other books for the service technician, was honored March 16 by the Federation of Radio and Television Servicemen's Associations of Pennsylvania, as the person who, in the opinion of the Federation, had contributed most to the welfare of the service technician during 1951.

Mr. Rider was presented with a plaque at a luncheon meeting in the Harrisburger Hotel, Harrisburg, Pa. The meeting was attended by delegates from the member associations of FR SAP and by visiting delegates from New Jersey and New York, as well as by representatives of other branches of the radio and television industry.

Mr. Rider spoke briefly on receiving the plaque, and at greater length later in the meeting. He called particular attention to the strides organized service technicians have made during the past three or four years, pointing out evidence of the increased attention and respect shown them by manufacturers and manufacturers' associations. Only the "grave setback" of internal dissension could negate this progress, Mr. Rider declared. He also attacked the "professional" philosophy common among radio technicians. "Knock the 'profession' philosophy out of this business!" he said. "Service is a business—it's a technical business, but all the more a business." He then pointed out that engineering firms—every member of which might be a licensed professional engineer—conduct their affairs on a commercial, not a professional, basis, and suggested that TV and radio repair organizations could profit from their example.

Dave Krantz, chairman of the Federation, in his presentation speech, also referred to the great strides made by the industry in cooperating with the technicians. "Although," he said, "There are still many who would ignore the issue and believe that someone else will do the job for them." He gave particular praise to the RTMA, which "has made great strides in forming a program for the set manufacturers, and although we don't agree with some of its features, we still want to cooperate with the RTMA in solving any or all of the problems confronting us." He also paid tribute to some of the distributors and local chapters of the National Electronic Distributors Association, at the same time regretting that the national office of the N.E.D.A. had made "little or no effort to meet with the servicing industry to formulate a cooperative program for the technicians."

Others present who spoke briefly were Albert Coumont, service manager of the RTMA, Ed. Cahill, vice-president, and Dan Creato, legal counselor, of the RCA Service Co., Max Liebowitz, president of NETSDA, officers of FR SAP, Sandy Cowan, editor of *Radio Service Dealer*, and Fred Shunaman, managing editor of *RADIO-ELECTRONICS*.

MAY, 1952

NEW GRAYBURNE TUBE & TOOL CARRIER



HOT

EXCLUSIVE TOOL COMPARTMENT
holds tester and tools needed on most calls

HOLDS 175-200 TUBES
in 2 drawers and 1 compartment

REMOVABLE LARGE MIRROR
to observe Pix Tube from back of set

with Detachable Mirror for Observing Pix Tube

BUILT RUGGED
all solid wood and heavy masonite, lock-corner construction, extra top side clasps.

HANDSOME
Washable thick basket-weave black-and-gray leatherette. Resists all and dirt stains.

Model CP
LOW COST
\$16.95 net.

PERFECT BALANCE
Hangs straight down.

COMPACT
20 1/2" x 14" x 9"

You made it the Champ!

We interviewed hundreds of Servicemen like yourself to tell us the features you want in a professional carrier. Model CP embodies all your practical suggestions. That's why Servicemen say it's today's truly unbeatable carrier value!

Other Grayburne Tube Carriers available:
Model CL: for the "long haul". Holds 200-225 tubes. \$13.50 net.
Model CJ: for the "short haul". Holds 60-70 tubes. \$9.95 net.
SERVICEMEN: For name of your nearest Grayburne distributor, write to us NOW!



GRAYBURNE CORPORATION, 103 Lafayette St., New York 13, N. Y.

Polystyrene... 12" lengths: ROD: 14"-10c; 14"-20c; 15"-36c; 5"-55c; 3"-79c; 1"- \$1.29
Tubing (O.D.): 14"-10c; 3"-12c; 1/2"-17c; 3/8"-23c; 1/4"-27c; 1"-36c
3 Gang Variables... TRF or Superhet. 1 1/2" shaft. \$1.25
4 Gang Variable... 4-200 mmf. sects. 7 1/2" shaft. \$1.29
Portable Metal Utility Box... Hinged lid, web carrying straps. 9" x 6" x 6 1/2". \$1.69c

ALNICO MAGNET SPECIALS... Set of TWO 3/4" O.D. BAR MAGNETS, 4 1/4" & 1-5/16" boxes. \$2.29
Flat Bar Magnet... 1 1/2" x 1 1/2" x 16". \$2.79
Round Bar Magnet... 4" x 3/4" O.D. 65c 10 5.95
1/2" Magnet... 1 1/2" x 3/4" x 5/8" ea. 59c 10 5.50
Alnico Chip Magnets... small irreg. strips. APPROX. 90 pcs. oz. \$1.50 lb.
Alnico Magnet Bar... Powerful Bar, Block. 1 1/2" x 1 1/2" x 1 1/2" ea. 10 assorted. \$1.96
(WRITE FOR LATEST "ALNICO" SUPPLEMENT)

Cabinet Draw Slides... silent ball-bearing—13" (9" ext.)—\$2.10 pr.; 15" (11")—\$2.25; 16 1/2" (12 1/2")—\$2.39
Heavy duty, all-steel 16 1/2" (12 1/2" ext.)... \$3.25

MORE! MORE! MORE! FOR YOUR MONEY... with the JUMBO RADIO PARTS KIT—7 FULL LBS. OF: COILS, WIRE, SOCKETS, HARDWARE, RESISTORS, SWITCHES, CONTROLS, CONDENSERS, CHASSIS, ETC. Ship. Wt. 20 lbs. \$4.95
MAGNET WIRE... #13 SCS: 50 ft.—\$1.29; 100 ft.—\$1.98; #20 P.E.: 400 ft. coll.—23c; SCS: 400 ft. Red, Yel., Blue or Black... \$1.00
Radio Hardware... FULL 100 ft. / .89
Nuts, Screws, Lugs, Washers, etc... 69c 3 lbs. 1.98

"HEARING AID SPECIALS"
MIDGET OUTPUTS (3 x 2 1/2" 600Ω, etc. to M.C. voice coil, ea. 49c 6 2.49
Midget Audio Chokes (3 x 1 1/2" 4500 ohms DC, ea. 49c 6 2.49
Hearing Aid Amplifier (2 tubes) MAKE A REAL VEST POCKET—RA-110 adding simple tuner, 1 1/2" x 2 1/2" x 3/4" WITH SCHEMATIC FOR 2 or 3 TUBE SET. Less tubes case... 2.49
Hearing Aid Tubes... set of 2 for above... 2.98
Hearing Aid Bone Conduction Receiver... 2.49
Hearing Aid Microphone CONTACT MIKE, DETECTOPHONE, Mini-Speaker, Impedance... 2.49

H-Fidelity Crystal Hand Mike... Hi-impedance, mounted bakelite case, 5 1/2 ft. cable... 3.95
Pilot Bulbs... 8V, or 4V, min. screw... 10 30c 100 3.50
Luminous Tape... "GLOWS IN DARK", 100 ft. x 3 1/4" roll... 49c 6 2.49
Midget 3PST Relay... 1 1/2" x 1 1/4" x 3/4" 24V, 250 ohm... 98c
G.E. Tungar Bulbs... 2 2065011, 2 Amp... 1.79
289D883... 600 ohm, pi 54... 1.49
HS-33 Headset... 600 ohm, pi 54... 7.95
ANB-H-1 Phone Units... Hi-impedance... 98c
JK-26 PL-54 Connectors... set 39c 6 1.98
JK-48 PL-291 Midget Connectors... set 39c 6 1.98
12 1/2 ft. Whip Antenna... 4 steel screw sects. 1.98
Sound Power Tank Phones (B19)... NEW, PAIR... 2.49
W-108 Field Wire... M.C. Bells (60 lbs.) 17.50
FULL MILE on 60 lb. steel reel (60 lbs.)... 1.79
Power Rheostats... 32.5 Ohm-50W, 1/4" shaft... 1.79
400 ohm-50W... 1.49

"FACTORY SPEAKER REPAIRS SINCE 1927"
Min. order \$3.00, 20% deposit req. on all C.O.D.'s. Full remittance with foreign orders. Please add sufficient postage—excess refunded.

LEOTONE RADIO CORP.
67 Dek Street
New York 7, N. Y.

RADELCO

LIGHTNING ARRESTOR

MODEL R-116

IT'S THE LOWEST PRICE UNDERWRITERS' LISTED ARRESTOR ON THE MARKET

ORDER FROM YOUR NEAREST PARTS JOBBER

90c

THE **B**s... BEETHOVEN, BRAHMS AND BACH

they're different
they're improved
they're better than ever!

Yes, Bach, Beethoven and Brahms are now better than ever—we don't mean we've improved their music, but we do mean we've improved the reproduction of their recorded music.

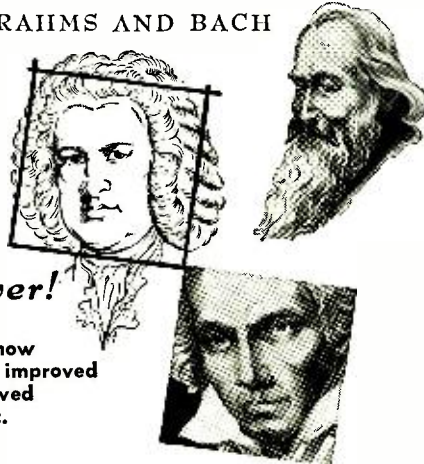

It's the new, improved Pickering Cartridges that give credence to this claim. Yes, Pickering Cartridges are different. They're improved. They're better than ever. Pickering patented Cartridges with Dynamic Coupling* are superior in every way, by providing: **HIGHER FREQUENCY RESPONSE • NEGLIGIBLE INTERMODULATION DISTORTION • BETTER TRACKING CHARACTERISTICS**

***DYNAMIC COUPLING ASSURES**

constant stylus contact with the record grooves over the entire audio spectrum (20-20,000 cps) • full frequency response • full transient response • no resonances • no mistracking • no grinding of groove walls

PICKERING and company, incorporated



Pickering High Fidelity Components are available through leading Radio Parts distributors everywhere; detailed literature sent upon request. Address Department P

Oceanside, L. I., New York



PERFORMS THE BEST IN EVERY TEST!

THE TACO ANTENNA

Supercharger

Proven in installations all over the country.

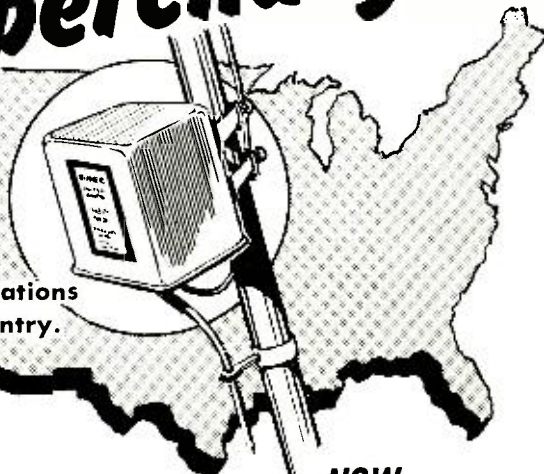

NOW...

NEW MODEL No. 1628-4½ RECEIVES CHANNELS 4 and 5!

TV, FM, AND AM ANTENNAS
TACO
TECHNICAL APPLIANCE CORP.
SHERBURNE, N. Y. • IN CANADA: STROMBERG-CARLSON CO. LTD. TORONTO 4, ONTARIO

NETSDA'S MARCH MEETING

The most recent meeting of the National Electronic Technicians' and Service Dealers' Associations was held at the Harrisburger Hotel, Harrisburg, Pa., March 2. Several important pieces of business were attended to. The National Headquarters was moved to 165 East Broadway, New York, N. Y., from its former Washington address. The attorney for the New York member of the Association was instructed to file application for a charter as a non-profit corporation in New York State. The membership application of the Radio and TV Technicians Guild of Florida was accepted.

The annual election of officers also took place. Max Liebowitz, New York City, was elected president; Roger Haines of Haddonfield, N. J., vice-president; Richard Devaney of Philadelphia, Pa., recording secretary; David Van Nest of Trenton, N. J., corresponding secretary; T. L. Clarkson of Harrisburg, Pa., treasurer; and Jack Wheaton of East Williston, Long Island, Sergeant-at-Arms.

The next meeting was set for Sunday, May 4, in New York City.

FRSAP HAS PAPER

We have received the first issue of the *FRSAP News Letter*. An eight-page paper produced by a standard duplicating process, it is an excellent job and full of news of the Pennsylvania organizations. The art work is also worthy of note. Cover design, inside heads and borders, and the cartoon are well done and interesting.

The little magazine does not confine itself to the Pennsylvania technicians' associations, but prints news of other organizations, from New York to Florida. There is also a note on community antenna systems, which are more common in Pennsylvania than in any other state.

FIX-IT-YOURSELF BOOKS

RADIO-ELECTRONICS has received letters from Frank Moch, President of NATESA, and from the Federation of Radio Servicemen's Associations of Pennsylvania commending the article "Fix It Yourself" in the March issue.

Frank Moch says "We wish to congratulate RADIO-ELECTRONICS for taking such fast and forthright action on the 'fix-it-yourself' books. Our thinking on this subject is very much akin to yours. We believe these books will lead to greater income for the service technician since it is obvious that much damage will be done by unqualified tinkering. Unfortunately, the tinkerer who does the damage won't assume the responsibility for his stupidity and will in turn pass it on to the service operator. In the meantime these books add more fuel to the fire of condemnation and derision which is burning out the souls of the legitimate operators. . . ."

The Pennsylvania Federation, while expressing no opinion as to the "material and the methods of presentation in the books," stated that "We have gone on record to investigate and have ap-

pointed a committee to obtain transcriptions and copies of all commercials used in broadcasts, and advertising in local dailies, to study for further action. These books and the methods used to sell them, plus the unfavorable publicity the TV technicians have received in the public press, are doing much to lower consumer opinion and confidence in the servicing industry."

Meanwhile, RADIO-ELECTRONICS has information that some broadcast stations have declined to handle this type of advertising, and reports of cancellation of newspaper advertising due to protests from local bodies have been received from several points. It appears that local service organizations, in cooperation with local Better Business Bureaus and other interested bodies, are in a position to make the most effective protests against any untrue or misleading advertising which may appear in connection with these books.

SYLVANIA BACKS SERVICE

Sylvania will expand its national promotion of TV-radio service technicians during 1952, according to a statement made by Terry P. Cunningham, director of advertising. The company will use such national publications as *Life*, *Colliers*, *The Saturday Evening Post*, and *Better Homes and Gardens* to promote the cause of the service technician "displaying the Sylvania seal," and tell the public that he does a good job. "They will also tell the public how to select a reliable service technician," he stated. The campaign will also be supported on the company's "Beat the Clock" program on CBS-TV every Saturday night.

N. H. COMMITTEE FORMED

Service technicians of the Manchester, N. H., area have formed an "investigative committee" to check on all customer complaints of incompetent or dishonest TV servicing. According to Frank Lavoie, chairman of the local service association: "Many TV owners have had a scalping. For example, some television dealers never sold radios. Now they sell—and service—TV sets. . . . This leads to a lot of people having to pay for labor which cannot be done competently."

Mr. Lavoie is attempting to contact other organizations and independent service technicians in the Manchester area with the view of exchanging ideas, educating the public to the problems of TV service, formulating a code of ethics, and defining guarantees more precisely.

KINGSTON CHANGES NAME

A notice received from the Kingston (New York) Radio Servicemen's Association states that henceforth that organization will be called the *Ulster Electronic Technicians' Association*. The change is apparently meant to broaden the activity of the association to cover service technicians throughout Ulster county, instead of confining it to the city of Kingston.

—end—

New
WILLIAMSON TYPE
AMPLIFIER Features

- First Williamson Type Amplifier supplied with matching preamplifier
- Uses Altec Lansing Peerless output transformer.
- Practically distortionless — Harmonic and intermodulation distortion both less than 1/2 of 1% at 5 watts output.
- Frequency response +1 db from 10 cycles to 100 kc.
- Output impedance 4, 8, or 16 ohms.

The new Heathkit Williamson Type Amplifier kit is the best obtainable in amplifiers today—the charge of the really discerning listener. You can hear the difference and measurements actually bear out the superb performance. Frequency response +1 db from 10 cycles to 100 kc allow you to hear the highs and lows with equal crispness and clarity. Harmonic and intermodulation distortion both less than 1/2 of 1% at 5 watts output eliminate the harsh and unpleasant qualities which contribute to listening fatigue.

The circuit is similar to the one published in *Audie Engineering Magazine* for November, 1949, and is considered by engineers throughout the audio field as one of the best ever developed. The Main Amplifier (which may be purchased separately) consists of a voltage amplifier and phase splitter using a 6SN7, a driver stage using a 6X4, and a push pull output stage using a pair of 6AV6 tubes. The output transformer is manufactured by the Peerless Division of Altec Lansing, and is built to the highest standards. Output impedances of 4, 8, and 16 ohms are available. The power supply uses a separate chassis with husky Chicago Transformer power transformer and choke and 250V Millory filters for long life free operation. A 5V4G rectifier is used.

The main amplifier and power supply are each on a chassis measuring 10" high by 21 1/2" wide by 11 1/2" deep.

PREAMPLIFIER AND TONE CONTROL UNIT KIT

The preamplifier kit consists of a 12AX7 for 12AY6 dual triode first amplifier stage with a turn over control for LP or 78 record tones, and a 12AU6 amplifier stage with individual bass and treble tone controls, each adjustable to 12 db of boost or attenuation. A switch on panel selects either magnetic, crystal, or tracer inputs. Preamplifier also is well suited to custom installations—it will operate in either vertical or horizontal position, and spread control shafts of the controls and switches allow a variety of shaft lengths to be selected. Dimensions: 21 1/2" high by 11 1/2" wide by 7 3/4" deep.



Heathkit AMPLIFIER KIT

WA-A1 Amplifier kit — Combination 1 — (Main Amplifier and Power Supply) complete with WA-P1 Preamplifier Kit. Total Ship. Wgt. 34 lbs. (Shipped Express only) **\$69.50**

WA-A1 Amplifier kit only — Combination 4 — (Main Amplifier and Power Supply). Less WA-P1 Preamplifier. Total Ship. Wgt. 28 lbs. (Shipped Express only) **\$49.75**

WA-P1 Preamplifier Kit only. (Less power supply) (Tubes included). Total Ship. Wgt. 7 lbs. (Shipped Express or Parcel Post) **\$19.75**

WRITE FOR Free CATALOG

The HEATH COMPANY

BENTON HARBOR 20, MICHIGAN

You SAVE BY ORDERING DIRECT

THIS AD IS YOUR ORDER BLANK

COLLINS

AM-FM "PRE-FAB" TUNERS

OUTSTANDING HIT!

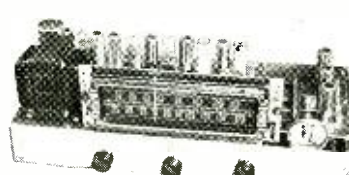

Above: Collins FM-AM Pre-Fab Tuner After You've Assembled It. Total Kit Cost, \$69.

Join thousands developing a fine radio hobby with inexpensive COLLINS FM-AM Pre-Fab Tuners — best buy in radio tuners since the crystal set! Thrilling experience in economical way to high fidelity radio reception. Radio building's a snap with COLLINS wired and tested components! Buy direct from COLLINS factory and POCKET THE SAVINGS!

Collins — the only company devoted exclusively to manufacture of radio tuners and tuner kits . . . continuously producing finer kits at LOWER COST with the SAVINGS GOING DIRECTLY TO YOU!



FM Tuning Unit
88-108 MC
\$15.25

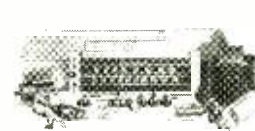

U.C-2 Universal Chassis Kit
\$14.75



AM Tuning Unit
(Includes IF & Audio Amplifier)
\$19.25



AM-4 Tuning Unit (With Tuned RF Stage & 3-gang Condenser for Higher Sensitivity)
\$24.50



FM-IF Amplifier 10.7 MC
\$19.75



Tuning Eye Kit 6U5-G
\$2.85

COLLINS AUDIO PRODUCTS CO. Inc.
Rte 29, Westfield, N. J.

Enclosed please find check money order for items checked in this ad.
Amount enclosed \$.....
Name.....
Address.....
City..... State.....

All Pre-Fab units assembled, wired, tested and aligned at factory. Prices include tubes. Chassis Kit includes all necessary parts, nothing else to buy. Instruction Manual with detailed step-by-step procedure, pictures and schematic diagrams included. Chassis measures 8" x 17" x 2 1/2". Overall, tuner assembled measured 8" x 17" x 6". Expertly engineered for utmost satisfaction.

CLIP AND MAIL WITH YOUR ORDER

MATTISON

**SILVER ROCKET
630 CHASSIS with
• TUNEABLE •
BUILT-IN BOOSTER
for Better DX Reception**

Featuring **NEW CASCODE TUNER, 70° COSINE YOKE and VARIABLE AGC CONTROL**

Tube Complement:
28 tubes
3 rectifiers
1 CRT

32

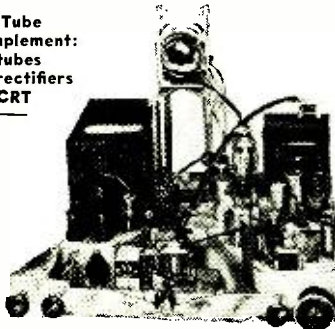

All Channel ↑ Booster

- Broad band single knob control pre-amplifier built in to eliminate long leads which may cause regeneration and attenuation of signal.
- **ONLY THE MATTISON 630 CHASSIS HAS AN ALL CHANNEL TUNEABLE BUILT-IN BOOSTER THAT INCREASES SIGNAL STRENGTH UP TO 10 TIMES. THE SILVER ROCKET WILL OUT-PERFORM ANY CHASSIS MADE AND IS PRICED RIGHT TO SELL FAST WITH AN EXTRAORDINARY MARGIN OF PROFIT FOR YOU. WRITE FOR CONFIDENTIAL PRICE SCHEDULE.**
- Mattison features a complete line of cabinets MADE IN MATTISON'S OWN CABINET FACTORY. 36 breathtaking designs that blend perfectly in any setting, traditional or modern.

DEALERS!

SERVICE-DEALERS!

Here is YOUR opportunity to become the "important" TV Dealer in your area for THE FINEST CUSTOM-BUILT LINE OF TELEVISION RECEIVERS.

FREE! Write for MATTISON'S merchandising portfolio explaining:

"THE MATTISON UNASSEMBLED PLAN"

and

"THE MATTISON \$1,000,000 FLOOR PLAN"

FREE TO ALL!!!

Write for consumer guide titled **"WHAT TO LOOK FOR WHEN PURCHASING A TV RECEIVER"**



Manufactured with integrity TV Set!

When you buy from Mattison you need only one source of supply! You can buy a Mattison Chassis, a Mattison Cabinet or a complete Mattison TV Set!

Mattison Television & Radio Corp.
893 Broadway, Dept. E2, N. Y. 3, N. Y.

R.F. ATTENUATOR

Patent No. 2,570,893

Gilbert Wilkes, Chevy Chase, Md.
(Assigned to the U. S. Government as represented by the Sec'y of the Navy)

This attenuator performs double duty. It is an effective a.g.c. device and acts as a T-R switch to protect a crystal rectifier. As described here, the invention applies especially to pulse control of a guided missile.

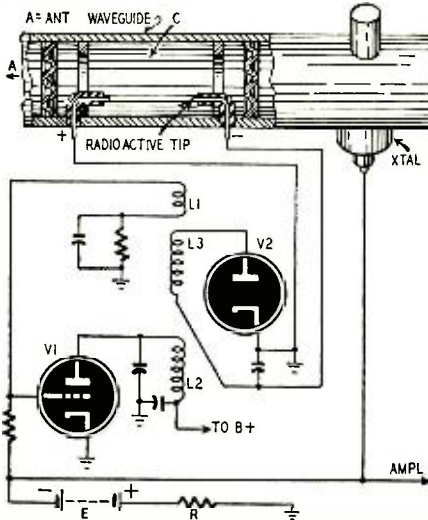

The figure shows a portion of the missile. Signals from the antenna pass through a wave guide to the crystal detector. The guide includes a sealed chamber C filled with gas at low pressure. The gas ionizes when a sufficiently strong current (d.c. or r.f.) flows through it. Ions act like a conductor in that they reflect r.f. waves. When ionization is complete, little or no r.f. signal can reach the crystal from the antenna because of the reflection.

The a.g.c. functions as follows. When the crystal rectifies a signal, d.c. flows through R. This produces a positive bias which tends to overcome voltage E of the battery. It raises the r.f. output of oscillator V1. L1 and L2 are the oscillator coils. The r.f. is stepped up in L3 and rectified by diode V2. Then the d.c. appears across C. With a larger antenna signal, there is more d.c. output from V2 so C is ionized to a greater degree. This, in turn, reflects more of the signal back to the antenna. This action tends to keep the crystal input at a steady value and protects it from heavy surges or pulses.

To minimize the output required from V2 for ionization, a radioactive cathode tip is used as shown. This keeps C partly ionized at all times so less d.c. is needed.

EXPANDED R.M.S. METER

Patent No. 2,575,996

Adolph Bunblasky, New Canaan, Conn.
(Assigned to Sorensen & Co., Inc.
Stamford, Conn.)

This r.m.s. volt meter is sensitive to small percentage changes above or below some pre-determined normal level.

R1 feeds a portion of the signal to the filament of a diode. The plate voltage is above the saturation value so that the total emission reaches the anode. Plate voltage is stabilized by a neon lamp N. R2, R3, R4 and the diode are arranged in a bridge network which is balanced when the input signal is normal. M is a center-zero instrument.

When the signal varies from its normal level, the bridge is unbalanced in one direction or the other. Therefore the meter indicates the increase or decrease. The unbalance is proportional to the

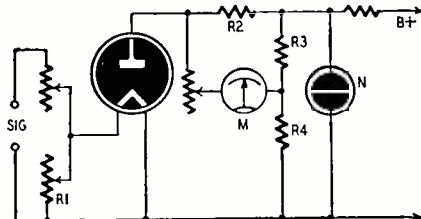

new Jensen

RP-302



HIGH FREQUENCY UNIT*

make a 3-way system from your coaxial or a 2-way from a single speaker

Improve the realism of your sound reproduction by adding this new compact advanced-design h-f unit to your present coaxial or extended range speaker. Sits atop cabinet or mounts flush on baffle or panel. Gives smooth, clean highs from 4,000 cycles to limits of audibility. List Price, \$56. Write for free illustrated folder EA, with complete installation data.

*Same h-f unit used in famous Jensen G-610 Triaxial

Jensen

JENSEN MANUFACTURING COMPANY
DIVISION OF THE MUTER COMPANY
6601 S. LARAMIE AVE., CHICAGO 38, ILLINOIS
IN CANADA: COPPER WIRE PRODUCTS, LTD., LICENSEE



A-402 Crossover Network

RECOMMENDED FOR USE WITH RP-302.
TWO CHANNEL TYPE WITH 4,000 CYCLE CROSSOVER. LIST PRICE, \$11.25.

BURTON BROUWER ADVERTISING



PUZZLED?



- TUBE TESTER?
- BATTERY TESTER?
- CONDENSER TESTER?
- AM SIGNAL GENERATOR?
- AUDIO OSCILLATOR?
- FM SIGNAL GENERATOR?
- MULTITESTER?

Here's Your Answer Now
ALL IN ONE!

SERVISHOP

NEW MODEL 8773

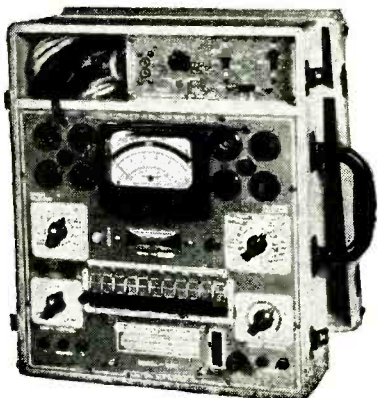

EQUIVALENT TO A COMPLETE SERVICE SHOP!

- TUBE TESTER
- SET TESTER
- A.M. GENERATOR
- F.M. GENERATOR
- A.F. GENERATOR
- CONDENSER TESTER
- FUSE PROTECTED METER

\$99⁹⁵

Every square inch solid-packed with value! Look what you get in this phenomenally low priced tester: a complete latest model obsolescent proof tube tester with approximately 1000 listings on improved roll chart together with an elaborate multimeter for measuring all AC & DC voltage DC current—resistance in ohms and megohms—output in decibels—condenser leakage—signal generators for audio—radio AM and radio FM signals.

- DC Voltmeter: 0-10-50-500-1000-2500
- AC Voltmeter: 0-10-50-500-1000-2500
- DC Milliammeter: 0-10-100-1000
- DC Ammeter: 0-10
- Decibel Meter: -8 to +15, 15 to 29, 29 to 49, 32 to 55
- Ohmmeter: 0-500-5000 ohms, 0-0.1-1-10 megohms

Complete with tubes, batteries, test leads, output leads, etc., in beautiful natural finish oak case.

Available at your distributor
Insist on R.C.P. Instruments

VISIT BOOTH 409
CHICAGO PARTS SHOW

Write for Catalog RE-5

RADIO CITY PRODUCTS CO., INC.

152 West 25th St. New York 1, N. Y.

change in filament voltage. For convenience the meter may be calibrated with sine wave input, but it remains accurate regardless of wave shape.

RELAY TIMER

Patent No. 2,577,137

Frank K. Low, Orange, N. J.

(assigned to Bell Telephone Labs., Inc.)

This is a delayed action relay circuit. It eliminates the need for special copper slug relays or other expensive timing equipment. An R-C timing network is used, but timing accuracy is much better than usually obtained by this method.

The components form a bridge. The timing interval begins when the switch is closed. The flow of current through R1 and R2 establishes point Q at a predetermined positive potential. Since capacitor C had no initial charge, point P is at zero

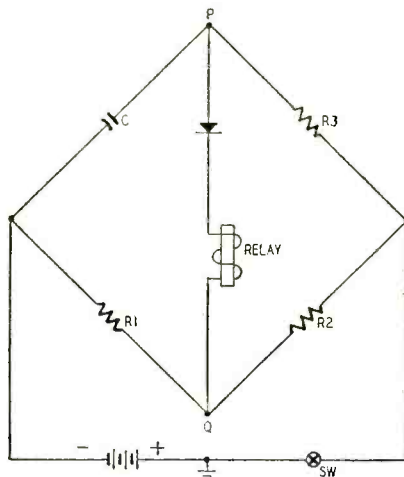

voltage. The rectifier will not conduct as long as its anode terminal P is less positive than its cathode terminal Q.

As capacitor C charges through R3, the potential at P increases and eventually becomes more positive than Q. At this instant the rectifier begins to conduct through the relatively low series resistance of the relay winding. The transition from rectifier cutoff to conduction is quite rapid and the relay is quickly energized.

ELECTRONIC SWITCH

Patent No. 2,576,026

Larned A. Meacham, New Providence, N. J. (assigned to Bell Telephone Labs., Inc.)

This gating switch is effective up to v.h.f. It consists of a T network of germanium crystals. A d.c. control voltage biases the rectifiers to cutoff or to full conduction as required. This new circuit is more effective than previous ones. It requires relatively low control voltage to control fairly large signals. Practical component values are shown in the diagram.

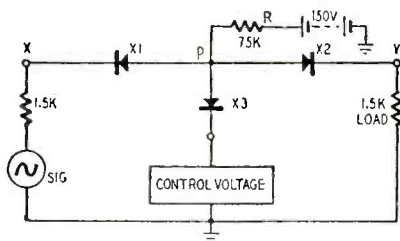

If a sufficiently large *negative* control voltage is applied in the middle branch, X3 is biased to conduction. X1, X2 are cut off. The high resistance of the latter units impedes signal current flowing to the load. X3 has low resistance so it tends to short out the signal. Accordingly, very little signal can reach the load. Attenuation may be as high as 110 db, for example. When the control voltage is *positive*, X3 is blocked. The other rectifiers conduct. Therefore maximum signal reaches the load.

The signal must not be permitted to control the gating action. With components shown, its peak must be less than 3 volts. The control voltage peak must be at least 3 volts: positive to attenuate the signal, negative to transmit it.

SMALLEST IN SIZE...

BIGGEST IN PERFORMANCE

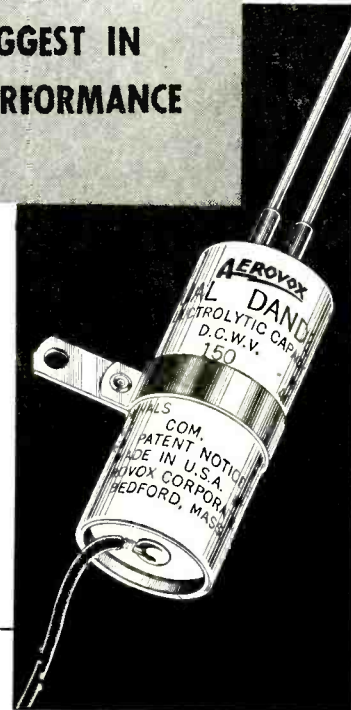

Still the smallest! And most copied! Singles, duals, triples, quads.

PRS Dandees include a host of new features. New sizes. New construction. New insulated stranded-wire leads. New stud terminals for diameter reduction. New safety sleeves. Aluminum case. Vented.

Higher voltage listings meet new radio/electronic circuit potentials.

Also PRSB units featuring entirely separate negative and positive leads.

Ask your distributor for Aerovox Dandees. Consult latest listings for greater selection of voltages, capacitances, combinations.



FOR RADIO-ELECTRONIC & INDUSTRIAL APPLICATIONS

AEROVOX CORPORATION

NEW BEDFORD, MASS., U.S.A.

In Canada: AEROVOX CANADA LTD., Hamilton, Ont. Export: 41 E. 42nd St., New York 17, N. Y.

USE PHOTOFAC

the world's best Radio and TV Service Data...

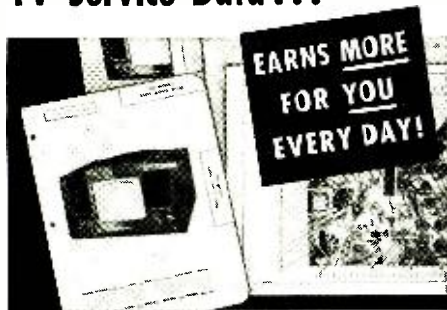

WE'LL PROVE YOU'LL SAVE TIME and EARN MORE WITH PHOTOFAC

FREE Service Technicians: We'll send you any Photofact Folder listed in the "PF INDEX and Technical Digest." If you haven't an Index, get a free copy from your local Photofact distributor or write for it today. To obtain Free Folder, be sure to state Photofact Set and Folder Number as shown in the Index.

NOW—learn for yourself how PHOTOFAC makes your Radio and TV work quicker, easier, more profitable! Just get and use an actual PHOTOFAC Folder. Discover why over 35,000 successful service technicians count on this invaluable data daily. No other service gives you PHOTOFAC'S completeness, accuracy, uniformity and lowest cost. PHOTOFAC is the only Radio-TV service data prepared from laboratory analysis on the actual equipment. Get your FREE Folder now. Examine, use, compare. See why you can't afford to be without PHOTOFAC!

NOTE: Our FREE Folder offer is limited to Service Technicians only. Attach coupon below to your letterhead and mention your jobber's name. Experimenters and others may obtain the Photofact Folder by remitting amount shown below.

HOWARD W. SAMS & CO., INC.

HOWARD W. SAMS & CO., INC.
2201 E. 46th St., Indianapolis 5, Ind.

I am a Service Technician. Send me Free Folder No. which appears in Photofact Set No. (as listed in the PF Index).

I am an Experimenter. Enclosed \$..... Send me Folder No. which appears in Photofact Set No. (TV—\$1.00. AM/FM—50c. Record Changer or Communication Receiver—75c)

Name.....

Address.....

City.....Zone.....State.....

EASY PAY PLAN!

PAY AS YOU EARN! Ask your distributor about this amazing plan. Only \$18.39 puts the entire profit-boosting Photofact library in your shop now!

New Patents

FM DISCRIMINATOR

Patent No. 2,581,968

Clyde J. Norton, Braintree, Mass.
(Assigned to Sylvania Electric Products, Inc.)

This discriminator has the advantage of being tunable. Also, it supplies a voltage output even when the signal is swept far from its average value. This voltage may be used for a.f.c., for example.

Two series-resonant networks are connected as a bridge. L1, C1, are tuned to the center i.f., as are L2, C2. The bridge output is rectified by diodes. Diode D1 has a positive voltage output, since electrons flow from ground, through R, and back to the tube. D2 is oppositely connected and has negative output.

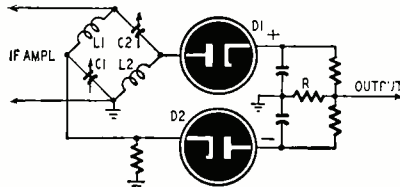

As long as the signal is unmodulated, the bridge is balanced. Each inductor has the same reactance as the capacitor which tunes it. Thus the diodes rectify equal and opposite voltages and the output is zero. When the i.f. sweeps to a higher value, L1 has more reactance than C1. Also, the reactance of L2 is greater than that of C2. From the schematic it is evident that the output from D1 will be greater than the output from D2. Thus the output is positive. During the next half-cycle of modulation, the i.f. is swept to a lower frequency and the discriminator output will be negative.

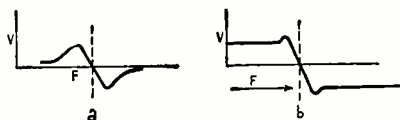

Figs. (a) and (b) show the frequency vs. voltage characteristics of conventional and the new type discriminators. Dotted lines indicate the center i.f. The new circuit (b) provides output even at frequencies far removed from the center value. This voltage can be used to control an oscillator.

GAS SUPPLY FOR THYRATRON

Patent No. 2,582,282

Jerome Rothstein, Belmar, N. J.
(Assigned to the United States of America as represented by the Secretary of the Army)

A thyatron gradually loses its gas due to absorption or "cleanup" with the tube. Eventually the tube must be discarded because the pressure is too low. This invention provides an auxiliary gas supply. Gas is admitted to the gas tube as needed to replenish it.

An elongated glass reservoir is shown at the left of thyatron V1. The reservoir holds gas at a pressure higher than that inside the envelope of V1, and it is separated from the main tube by thin glass. V1 also includes a Pirani filament P1, which may be of tungsten. Its resistance varies with the gas pressure. A second Pirani gauge, P2, is connected to P1 and R to complete a bridge. The variable arm is adjusted for balance when a new thyatron is installed.

As gas is lost from V1, the resistance of P1 becomes lower. P2 is not affected, however. Therefore the bridge is unbalanced and relay RY operates. Contact A closes, and completes an a.c. circuit through heater H (inside the reservoir). Some of the heated gas diffuses through the thin wall into V1 until bridge balance is restored.

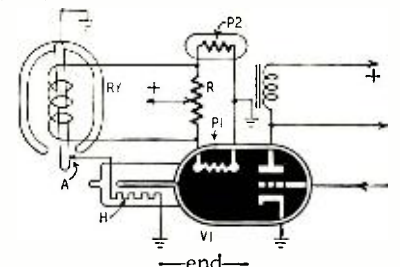

BUYING ANTENNAS?

Buy by This Mark—
The Seal of Quality Products
and Sound Business Practices



C. & M. MANUFACTURING CO.

Eastondale, Mass.

CAMBURN, INC.

Woodside, L. I. N. Y.

CHANNEL MASTER CORP.

Ellenville, N. Y.

THE FINNEY CO.

Cleveland 3, Ohio

HY-LITE ANTENNAE, INC.

New York 51, N. Y.

JFD MANUFACTURING CO., INC.

Brooklyn 4, N. Y.

RADELCO MANUFACTURING CO.

Cleveland 25, Ohio

THE RADIART CORPORATION

Cleveland 2, Ohio

RADIO MERCHANDISE SALES, INC.

New York 59, N. Y.

WALTER L. SCHOTT COMPANY

Los Angeles 18, California

SNYDER MANUFACTURING CO.

Philadelphia 40, Penna.

T-V PRODUCTS CO.

Brooklyn 5, N. Y.

WARD PRODUCTS CORP.

Division of The Gabriel Co.

Cleveland, Ohio

THE WORKSHOP ASSOCIATES

Division of The Gabriel Co.

Needham Heights 94, Mass.

SPECIALS

- SA-4A/APA-1-MOTOR DRIVEN ANT. SWITCH—NEW \$14.95
- BC 306 ANTENNA TUNING UNIT, NEW \$6.95
- R9/APN-4, New With Tubes \$75.00
- ID6/APN-4, New With Tubes and Crystal \$75.00
- A-62 Phatron Antenna \$8.50
- 2 Meter Choke, 1000 MA., 20-111 \$31.00
- Supersonic Crystal Head, MI-2, 22-25 KC HI-2 \$27.45
- Underwater Microphone, Model JR, Z=50w \$24.50
- Dynamic Mike & Headset Combo, B-19, New \$3.75
- HS-30 Inserts, 31-310 \$3.50 per M
- Synch Motors, 3 RPM—115V, 60 Cy. \$1.85
- AM/ARC-4 VHF Trans-Rev. \$37.50
- IE 36 Test Set, New \$35.00
- SCR 274 Test Set, I-101 \$42.25
- Time Delay Relay—15 Sec. 115V AC-DC 10A \$2.29
- Carbon Pile Reg., 18V-5V #35X025 \$2.29
- ART-13 Driver Trans. 6V6 to P-1P 811's \$1.29
- DM 34 Dynamotor, 115 In. 220 V, 80 MA out \$1.29
- Sens. Relay 3.5MA, 13X ohms 21ST, 2A \$1.29
- Klixon Breaker: Thermal, 35A .69
- T-30 Carbon Mikes, New .89
- Supersonic Rochell xtls. .50 ea.
- Synch. Motors, 1 rpm, 115V, 60 cy. \$2.35
- T.V. Lead-In, 300 ohms HI-Q \$17.50/1000' roll
- 1-9 Loss \$1.95
- Gibson Gift, 700 KC Emerc. xmt. \$12.95
- Screen Mod. Trans. for 807's \$1.19
- 3-4 MC Coils for ARC 5 #69291, #72471 Set \$2.79

SELENIUM RECTIFIERS

UP TO 18 VAC IN—	UP TO 120 VAC IN—
UP TO 14 VDC OUT	UP TO 100 VDC OUT
2A \$2.50	2A \$11.00
4A 4.00	10A 48.00
6A 6.00	12A 60.00
10A 7.50	
12A 9.00	
21A 18.00	
UP TO 36 VAC IN—	Hi-Current Chokes
UP TO 28 VDC OUT	1 HW—12 Amp—16 Ohms \$14.95
1A \$3.00	.61 HY—2.5 Amp—Cased \$2.25
2A 4.00	
4A 8.00	
10A 14.50	
12A 18.00	
21A 36.00	
UP TO 54 VAC IN—	LO-VOLT. XFMR'S
UP TO 42 VDC OUT	Primaries 115v, 60 Cycle
2A \$6.50	36V—40V at 3.5 amps \$3.75
1A 8.50	24v-1.5A 1.95
	8v-1.5A .98
	16v-5A 3.75
	12v-5A 3.75

Send M.O. or CHK. Mdse. Guard. Shpg. Charges Sent C.O.D. Price F.O.B. N.Y.C. Parcels in Excess of 20 Lbs. Will Be Shipped Rwy. Express or Motor Freight

COMMUNICATIONS EQUIPMENT CO.

131 Liberty St. Dept. C-5 New York City 7, N. Y. Phone DI. 9-4124



Frank J. Moch

president of the National Alliance of Television and Electronics Service Associations.

says: "there is no other Oscilloscope like the

Simpson MODEL 476 MIRROSCOPE™

Simpson Model 476 MIRROSCOPE reflects the 5-inch cathode ray tube image on a high grade mirror mounted in the cover allowing the tube to be vertically mounted which reduces bench space requirements to 9" x 8" and brings the viewing surface to eye level. The upright construction permits location of controls and connections for maximum convenience and allows for internal cathode ray tube connections at the front of the panel. The unique construction and superior specifications of the Model 476 make it worthy of leading experts' recommendation for all phases of TV receiver service including observation and diagnosis of Sync signals. For complete information see your Parts Jobber or write: SIMPSON ELECTRIC CO., 5200 W. KINZIE ST., CHICAGO 44, COLUMBUS 1-1221.

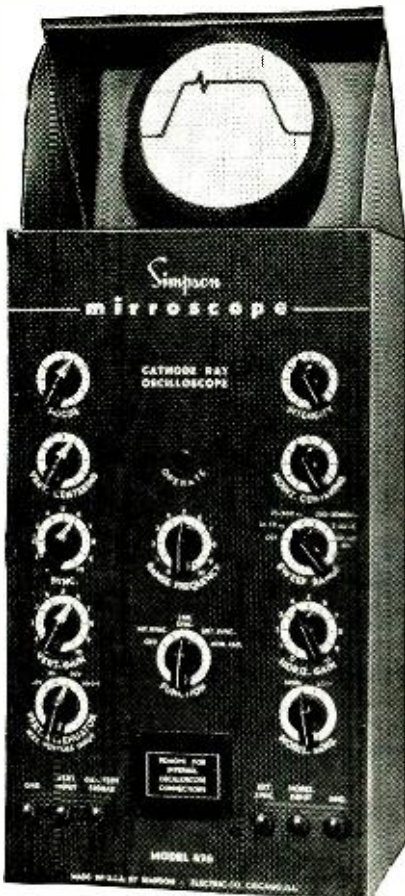

BURTON BROWNE ADVERTISING

MARKING TABS

Where tabs are required for the identification of wires and circuit components, they may be made easily with common adhesive plaster. The photograph shows the application of this material to a potentiometer and to a wire lead.

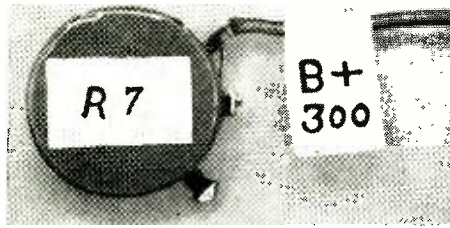

The cloth surface of the plaster takes marking well in either pencil or ink and if it is exposed to the weather, a protective coating will keep the lettering clear indefinitely. Polystyrene cement painted over the tab will provide excellent weatherproofing.—Milton White

SUBSTITUTE FOR OLD I.F.'S

Occasionally, a set lands on the service bench with an open i.f. transformer and the age and general run-down condition of the set do not justify the cost of a new replacement.

The circuit can be converted to use impedance-capacitance coupling as shown in the diagrams. An r.f. choke of about 2.5 mh is substituted for the open or shorted winding and the signal is carried over to the next stage through

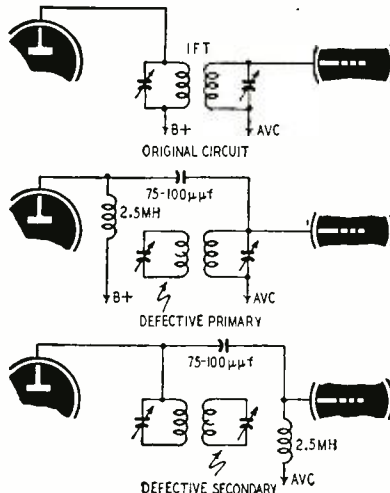

a mica capacitor of about 75 or 100 μ f. The choke can be used to replace a defective primary or secondary.

The modified circuit will not be quite as efficient as the original, so take care to align the i.f. and r.f. circuits on the nose.—Robert M. Mayo

TESTING CAPACITORS

I find this circuit handy and accurate for checking low-voltage electrolytic capacitors for leakage. In it, the capacitor to be checked is connected in series with a 6-volt battery and a 10-volt d.c.

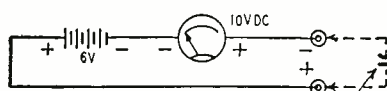

LV ELECTROLYTIC CAPACITOR TO BE CHECKED

Become an Electrical Engineer



MAJOR IN ELECTRONICS



- B. S. Degree in 36 Months
- Radio-Television Technician Certificate in 18 Months

Experts predict that by 1954 there will be at least two positions for every engineering and technician graduate. This College offers a tested plan that permits you to enter these vast employment opportunities at an early date. First—you save a valuable year through optional year-round study. Second—you can receive advanced credit for prior training gained in the armed forces, other schools or field experience.

Enter Both Radio and Television Through This Plan

12 months or one-third of the B. S. degree course (Electronics major)—also brings you the Radio Technician's certificate. An added 6-month course qualifies you for the Radio-TV Technician's Certificate.

The Famous "UNIT CHASSIS SYSTEM"



of teaching was developed here. It "breaks down" the TV set by stages. You learn every component of all types and makes—and are prepared for future design changes, including the advent of color.

SPECIAL! Television Clinics

Ambitious Radio and TV Servicemen can enroll now in special one-month spring or summer clinics—to handle latest field service problems. Write for full details.

Over 48,000 former students from all states and 23 overseas countries. Faculty of trained specialists. Modern laboratories and equipment. Nonprofit technical institute and college 49th year.

MILWAUKEE

SCHOOL OF ENGINEERING

• Founded 1903 •

Terms open April, July, October, January

FREE — Write for "Occupational Guidance Bulletin," "Your Career" booklet, and Catalog.

Milwaukee School of Engineering
Dept. RE 552, 1025 N. Milwaukee
Milwaukee, Wisconsin

Without obligation send Catalog for Electrical Engineering, B. S. Degree, major in Electronics; Power; "Your Career"; Occupational Guidance Bulletin on: Radio-TV; Electrical Power; Welding; Heating, Refrigeration Air Conditioning; TV Service Clinic.

Name.....Age.....

Address.....

City.....Zone.....State.....

If veteran, indicate date of discharge.....

WORLD'S FASTEST SELLING VOLT-OHM MILLIAMMETER



Sensitivity
1000 ohms per volt

- ★ Uses latest design 2% accurate 1 Mil. D'Arsonval type meter.
- ★ Same zero adjustment holds for both resistance ranges. It is not necessary to readjust when switching from one resistance range to another. This is an important time-saving feature never before included in a V.O.M. in this price range.
- ★ Housed in round-cornered, molded case.
- ★ Beautiful black etched panel. Depressed letters filled with permanent white, insures long-life even with constant use.

The Model 770 comes complete with self-contained batteries, test leads and all operating instructions.

\$14.90
NET

- Specifications:**
- 6 A.C. VOLTAGE RANGES: 0-15/30/150/300/1500/3000 Volts.
 - 6 D.C. VOLTAGE RANGES: 0-7.5/15/75/150/750/1500 Volts.
 - 4 D.C. CURRENT RANGES: 0-1.5/15/150 MA. 0-1.5 Amps.
 - 2 RESISTANCE RANGES: 0-500 Ohms 0-1 Megohm.

Model 770
is an accurate pocket-size V.O.M.
Measures only 3 1/8" x 5 7/8" x 2 1/4"

Write Dept. RC-5 for catalog of complete line.

SICO Manufactured and Guaranteed by
SUPERIOR INSTRUMENTS CO.
227 Fulton Street • New York 7, N. Y.

AT YOUR RADIO PARTS JOBBER

ON-THE SPOT BATTERY RECORDER

WALKIE-RECORDALL 8 lb. miniature BATTERY RECORDER-PLAYBACK
Continuous, permanent, accurate, indexed recording at only 5¢ per hr. Instantaneous, permanent playback. Picks up sound up to 60 ft. Records conferences, lectures, dictation, 2-way phone & sales talks; white walking, riding or flying. Records in closed briefcase with "hidden mike"! Write for details.

MILES REPRODUCER CO., INC.
812 BROADWAY Dep't RE-5 NEW YORK 3, N. Y.

CODE SENDING SPEED

Be a "key" man. Learn how to send and receive messages in code by telegraph and radio. Commerce needs thousands of men for jobs. Good pay, adventure, interesting work. Learn at home quickly through famous Candler System. Qualify for Amateur or Commercial License. Write for FREE BOOK.

CANDLER SYSTEM CO.
Dept. 3-E, Box 928, Denver 1, Colo., U.S.A.

Try This One

meter. On a good capacitor, the meter will read zero or close to it. Discard the capacitor if the meter shows more than 2 volts. The units can be checked for capacitance on a standard capacitance checker.—A. von Zook

CHECKING RUBBING SPEAKERS

It is often difficult to locate the source of distortion or scratching sounds which occur when an amplifier or radio is played at high volume. The trouble may be in the amplifier or it may be a rubbing voice coil in the speaker. I have a sure-fire method of detecting a rubbing voice coil. Try it the next time you have

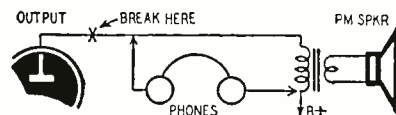







reason to suspect the speaker. With the set disconnected from the line, disconnect the plate lead to the output tube and connect a pair of high-impedance headphones across the primary of the output transformer. Press slightly on the cone while wearing the phones. A rasping sound indicates a rubbing voice coil. The voltage step-up in the transformer and the use of phones provides a sensitive test.—John Newall

LEADS FOR R-14 PHONES

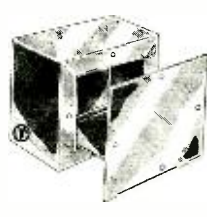
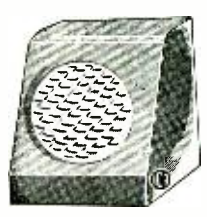
Many surplus headphones such as the popular type R-14 have special tip sockets which do not fit the tips on the replacement-type phone cords. When the cord must be replaced, this difficulty can be bypassed by purchasing phone cords with *spade lugs*. Break off the ears of the spade lugs close to the sleeves. The sleeves alone will make a neat fit in the pin sockets on the headphones.—J. Sareda

visit our booth no. 206 at the electronic parts show may 19-22 stevens hotel chicago. see the world's finest line of tv antennas and accessories.

insuline Metal Goods for every use!

 "FLEXI-MOUNT" ALUMINUM CASES	 UTILITY CABINETS with built-in chassis	 MIDGET SPEAKER CASES	 CHANNEL-LOCK ALUMINUM BOXES
 SLIP COVER ALUMINUM BOXES	 MINIATURE OPEN END ALUMINUM CHASSIS		 ALUMINUM UTILITY CABINETS

Just a few of the hundreds of different styles, sizes and types available. Write Dept. RE-5 for complete catalog.

insuline CORPORATION OF AMERICA

INSULINE BUILDING • 36-02 35th AVENUE • LONG ISLAND CITY, N. Y.
West Coast Branch and Warehouse: 1335 South Flower Street, Los Angeles, Calif.
Exclusive Canadian Sales Agents: CANADIAN MARCONI COMPANY, Toronto

INCREASING SENSITIVITY IN A.C.-D.C. RECEIVERS

Small table model a.c.-d.c. radios usually use loop antennas. While adequate for nearby stations, they seldom have sufficient sensitivity for satisfactory reception in rural areas.

The obvious solution is to use an outside antenna to increase the signal pickup. Usually an attempt to attach an outside aerial to the loop antenna results in the receiver starting to oscillate and squeal. Coupling the outside antenna to the receiver through a capacitor produces the same result.

One method which I have employed to couple an outside antenna to the receiver loop antenna is: With the outside antenna located as desired, take the free end of the antenna wire and wind several turns completely around the loop antenna. This effectively transformer-couples the outside antenna to the set with the loop acting as the secondary. Four or five turns usually proves adequate. A little experimenting will easily indicate the optimum number of turns. Grounding the free end of the antenna winding may give added gain.

An a.c.-d.c. receiver so modified has much greater sensitivity and a better signal-to-noise ratio than a similar receiver using only the loop antenna.—James J. Skiles

PLASTIC PARTS BOXES

Plastic boxes sold by hardware and five-and-ten-cent stores make neat chassis and cabinets for small code oscillators, amplifiers, and similar devices. The partitioned containers are handy to have around for storing resistors, capacitors, and other small components. But be sure to select fire-resistant or noninflammable plastic! A short circuit, a hot soldering iron, or a carelessly dropped cigarette can easily start a fire if the box is made of a highly inflammable plastic.—O. C. Vidden

CLIPS FOR ACORN TUBES

Clips or connectors for plate and grid leads of acorn tubes such as the 956 are often difficult to obtain. In an item in *Break-In*—a New Zealand amateur magazine—ZL2QH shows how you can make your own. He takes a double-ended soldering lug and bends it double so the two end holes will slip over the grid or plate lead of the tube. A short length of thin spring steel or brass wire—about No. 24 will do—is bent into a V of about 45°, and one end is soldered into the bend of the lug.

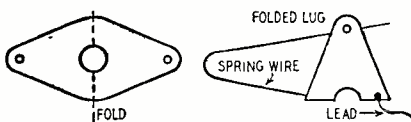

To use the clip, press open ends of the V together and slip the clip over the tube lead. When the spring is released, it presses against the lead, holding the clip in place and insuring a good electrical contact.

—end—

"CONICAL-V-BEAMS"

*REGISTERED TRADE MARK



Now! Customized for your locality

CUSTOM-DESIGNED ANTENNAS

at mass production prices!

Another Telrex first in superior antenna service. Famous Conical-V-Beams custom designed for best results in your particular area. Regular list prices prevail, meaning you get better performance, more satisfied customers and your selling territory for TV receivers is increased tremendously. Installing *customized* Telrex antennas is insurance against callbacks due to antenna adjustments and you enjoy the added protection of Telrex super-durable, all weather construction. Just specify the installation area when ordering, Telrex will supply your antennas cut-to-area for the finest pictures ever!

— for superior reception on TV, FM and UHF, —



DUBL CONICAL-V-BEAM
For outstanding all station performance. Has new HI-V-REFLECTOR.

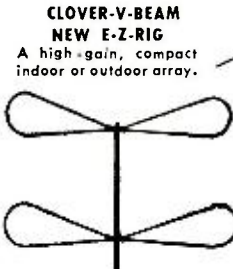

CLOVER-V-BEAM NEW E-Z-RIG
A high-gain, compact indoor or outdoor array.



TELREX "FISHBONE"
Ten WORKING elements. Guaranteed to outperform any Yagi.



TELREX V-BEAM
For superior in-line all station reception at low cost.



TELREX "BAT-WING"
Outperforms any top-of-set antenna with no tuning or pruning.



TELREX CONICAL-V-BEAMS WITH HI-V-REFLECTOR
Standard on Monarch and Universal Series.

"CONICAL-V-BEAMS" are covered by Patent No. 23,346
CANADIAN and FOREIGN PATENTS PENDING



telrex INC.
CONICAL-V-BEAMS

AMERICA'S OUTSTANDING TELEVISION BEAM

Be sure it's a "CONICAL-V-BEAM" — look for the *telrex* TRADEMARK

ASBURY PARK 9, N. J.

EASY TO LEARN CODE

It is easy to learn or increase speed with an Instructograph Code Teacher. Affords the quickest and most practical method yet developed. For beginners or advanced students. Available tapes for beginner's alphabet to typical messages on all subjects. Speed range 5 to 40 WPM. Always ready—no QRM.

ENDORSED BY THOUSANDS!

The Instructograph Code Teacher literally takes the place of an operator-instructor and enables anyone to learn and master code without further assistance. Thousands of successful operators have "acquired the code" with the Instructograph System. Write today for convenient rental and purchase plans.



INSTRUCTOGRAPH COMPANY

4701 Sheridan Rd., Dept. RC, Chicago 40, Ill.

WANTED TO BUY

Large and small quantities of new or used electronic government or manufacturers' surplus tubes and equipment. Highest prices paid. State quantity, condition and best price in first letter.

Box No. F-2 c/o Radio-Electronics
25 West Broadway
New York 7, N. Y.



STOP!
TV INTERFERENCE

Eliminates interference caused by Short Wave...F.M. Hams...Diathermy...Atmospheric disturbances, etc.

With a **TELEMATIC** Full Range **FILTER KIT**

SIMPLE — SPEEDY — EFFICIENT

- Eliminates antenna-fed interference!
- Covers full-range both I.F. and R.F. Sharper, steadier picture!
- Fewer service recalls!
- Any filter in kit replaceable separately!

FILTER KIT
contains 2 Hi-Pass Filters, 4 WAVE TRAPS covering full range of interference signals.

Send for **FREE** Booklet on TV-INTERFERENCE



TUBES at Mfr.'s. COST

Standard Brands — Unbranded — Guaranteed

*1A7GT	\$0.79	6BF6	\$1.70	7W7	\$1.25
1B3	1.35	6BG6	1.48	12A1	.70
1L4	.60	6BQ6	.94	12AT6	.40
1L6	.60	6BQ7	1.95	12AT7	.95
1LC6	1.05	6C4	.60	12AU6	.46
1LN5	1.05	6CB6	.56	12AU7	.75
1N34	.69	6CD6G	1.93	12AV7	.95
1R5	.60	6F6	.95	12AX7	.75
1S5	.80	6H6M	.75	12BA6	.48
1T4	.85	6J5M	.65	12BA7	.80
1U4	.60	6J6	.73	12BE6	.49
1U5	.50	6J6	1.09	12BH7	1.10
1X2A	1.25	6K6	.65	12J5GT	.50
3Q4	.66	6K7	.70	12SA7GT	.75
3V4	.62	6K8	1.35	12SF5M	.70
5U4G	.55	6L6GA	1.05	12SG7	.90
5V4	1.20	6S4	.51	12SK7	.60
5Y3GT	.33	6S7M	1.05	*12SK7	.65
*5Z3	.85	6SA7GT	.75	*12SQ7	.75
6AB4	.65	6SC7	1.10	12SR7GT	.75
*6AB5 6N5	1.25	6SJ7	.70	12SR7	.65
6AC7	1.25	6SK7GT	.53	14B6	.95
6AG5	.65	6SL7GT	.65	*14E6	.95
*6AG7	1.65	6SN7GT	.75	15T8	.80
*6AH6	1.75	6SQ7GT	.65	25A5	.95
6AK5	1.10	6TR	.86	*25BQ6	1.60
*6AK6	1.20	6V6GT	.60	25L6GT	.50
6AL5	.54	6W4GT	.49	25W4	.90
6AQ5	.65	6X4	.45	35L6GT	.53
6AT6	.40	6X5	.45	35W4	.37
6AU6	.65	6Y6	.95	35Y4	.89
*6AV6	.85	7AD7	1.25	35Z5GT	.39
6AX5GT	.85	7C5	.85	45Z5	.80
6B4	1.50	7C7	.85	50B5	.53
6BA6	.48	7E7	1.30	50C5	.53
6BC5	.56	7F7	.95	50L6GT	.53
6BE6	.49	7G7	1.30	59	1.50
6BF5	.65	7Q7	.89	89Y	.75

UNBRANDED — *STANDARD BRANDS
Minimum Order \$15.00

IMMEDIATE DELIVERY!
Write for quotations, many other types available. 20% Deposit with order, balance C.O.D. All tubes subject to prior sale. Prices subject to change without notice.

WRITE, WIRE, CALL—TODAY!
We Buy Anything in Electronics—
large or small quantities!

Nat Adelman
168 Washington St. New York 6, N. Y.
CO. 7-6091

EFFICIENT NOISE FILTER

Man-made interference transmitted along power lines presents a number of problems to amateurs, SWL's, and police and commercial operators. If the interference is known to be reaching the receiver via the power lines with little or no pickup by the antenna, a line filter will often prove effective in attenuating or eliminating it. The best

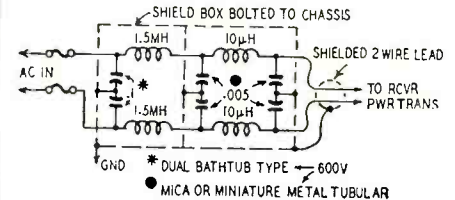

place for the filter is in the power line feeding the device producing the noise. When this is not possible, the alternative is to place the filter in the line at the input of the receiver.

The filter shown in the diagram is designed to handle receivers drawing up to about 100 watts from the line. The input half of the filter—the 1.5-mh inductors and the 0.1-µf capacitors—attenuate the lower frequencies of the noise while the pi-section filters in the output half handle the high-frequency components. The unit is constructed in a 6- x 3- x 2-inch metal shield box with cover and dividing compartment.

The inductors are wound with No. 26 single-cotton-covered enameled wire. The 1.5-mh units consist of 300 turns

LEARN Practical RADIO AT HOME

COMPLETE ONLY... **\$19⁹⁵**



BUILD 15 RADIOS

ABSOLUTELY NO PREVIOUS TRAINING NEEDED
EXCELLENT BACKGROUND FOR TELEVISION

10-DAY MONEY-BACK GUARANTEE

WHAT THE 1952 PROGRESSIVE RADIO "EDU-KIT" OFFERS YOU:

This is a practical home radio course. You learn theory, construction, operation, trouble shooting, code. You build RECEIVERS, TRANSMITTERS, AMPLIFIERS, CODE OSCILLATOR, SIGNAL TRACER.

You start with a simple radio circuit, and gradually advance to more complex circuits. No previous background is required. No instructor is needed. All parts and instructions are included and every single step is clearly explained.

All parts are guaranteed, individually packaged, identified, and explained. There is nothing extra to buy. You receive all parts, tools and instructions at once. You keep everything; there is absolutely nothing you return to us.

You can easily pay for the kit in a short time by repairing radios. Use the tester and signal tracer for servicing. The signal tracer alone is worth more than the price of the entire kit.

USED BY RADIO SCHOOLS AND GOVERNMENT AGENCIES!

The Progressive Radio "Edu-Kit" includes tubes, paper condensers, mica condensers, electrolytic condensers, variable condensers, selenium rectifiers, chassis, hardware, tie strips, tube sockets, solder, wire, soldering iron, tubing, coils, instruction book, radio trouble-shooting guide, radio tester, television trouble-shooting manual, etc.; in brief, everything you need in a practical radio course.

Order your "Edu-Kit" today, or send for further information.
Postage prepaid on Cash orders—C.O.D. orders accepted in U.S.A.

PROGRESSIVE ELECTRONICS CO.
497 UNION AVE. DEPT. RE-59 BROOKLYN, NEW YORK

FREE RADIO TESTER & SOLDERING IRON

GET A WELL-PAYING JOB



GO INTO A PROFITABLE BUSINESS AND PLAN FOR A FUTURE



pie-wound on a 1/2-inch form. These will be difficult to wind by hand, so single-pie r.f. chokes rated at 150 ma or more will suffice. The high-frequency chokes consist of 30 turns of enameled wire close-wound on a 1/4-inch form. Heavier wire should be used for the coils if the set draws much over 100 watts.

The author stressed the following precautions when describing this filter in *Short Wave News* (London, England):

1. Keep leads on the 0.1- μ f capacitors short because the capacitance and the inductance of the leads may resonate in the interference band and accentuate the noise rather than suppress it. If the physical arrangement of the components requires long leads, shunt a .005- μ f mica capacitor across each 0.1- μ f unit.
2. Bolt the filter case firmly to the chassis of the set. Scrape away any paint or oxide on the chassis and filter box to get a good metal-to-metal contact. Use short shielded leads to connect the output of the filter to the input to the power supply of the set.
3. Use a good ground on the set. Failure to ground the receiver may result in a nasty shock from the current passed by the large input filter capacitors.

RECTIFIER TESTER

This is the circuit of a handy tester for selenium rectifiers. To operate: Connect the rectifier to the Rectifier

NEW!
OAK RIDGE
"DYN-A-TUBE*"
TESTER

ONLY \$49.95
NET

*Smallest Tube Checker
in the World!*

Sensational new pocket size dynamic-type (not emission) tube checker. Already an overwhelming favorite. Meets requirements of Electronics Production Bench, Test Lab, and Radio and TV Servicing Trade. Size: 5 1/2 x 3 7/8 x 2 1/4" (Fits one compartment of Oak Ridge 4-unit carrying case). Tests octal, Ioktal, 7 and 9 pin tubes directly. Adaptors available for older types. *Trade Mark Reg.

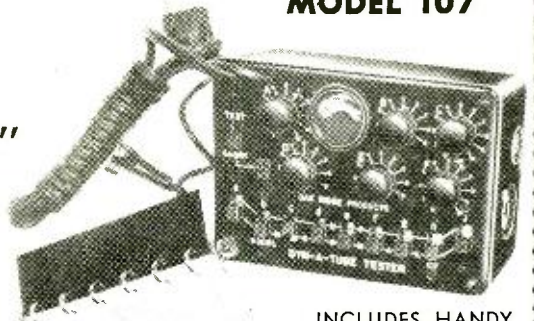

MODEL 107

INCLUDES HANDY
FOLDING CHART OF OVER
500 RECEIVING TUBE TYPES



20,000 Ohm-Per-Volt Precision-built
OAK RIDGE MULTI-TESTER

MODEL 105 Uses sensitive 50 microamp. movement. All 1% carbon deposit resistors. Ranges: DC and AC Volts: 0-2.5-10-50-250-1000-5000 Output: 0-2.5-10-50-250-1000 DC Milliamps: 10-100-500 DC Microamps: 100 Decibels: -12 to +55 in 5 ranges Ohms: 0-2000, 0-200,000, 0-20 Meg. Size 5 1/2 x 3 7/8 x 3" (Fits one compartment of Oak Ridge 4-unit carrying case.) Net **\$38.95**

Export Division: Joseph Plascencia, Inc., 401 Broadway, New York 13, N.Y. Cable Address: "UNIONTEX" N.Y.

OAK RIDGE PRODUCTS

37-01 Vernon Blvd. Long Island City 1, N. Y.
Mfg Division of VIDEO TELEVISION INC.

Oak Ridge Products, Dept. C5
37-01 Vernon Blvd., Long Island City 1, N. Y.
Please send your complete new OAK RIDGE Catalog at once, to:

Name.....
Address.....
City..... State.....

GIANT TV SALE Save on Chassis, Tubes, Cabinets, Accessories, etc.

NEW—THE SENSATIONAL 630-DX CHASSIS

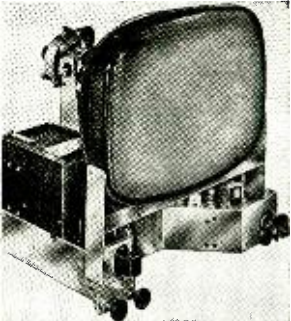

Amazing Low Price!
NEW CASCODE TUNER
1952 Model—30-Tubes—
For 16" to 24" Picture Tubes.
FINEST CHASSIS AVAILABLE AT ANY PRICE! For long range and best reception up to 200 miles without a complicated booster or antenna, this new, advanced 630 DX Chassis gives 2-times normal reception. Special extra-high gain standard coil tuner offers greater sensitivity, top performance on any channel; aligned & tested for 5 hours; milled condensers; 4 microamps sensitivity; FM sound system; horizontal & linear lock and is directly adaptable for color and UHF. This is the very best Chassis buy—order NOW at this low-low price! You can't Beat it!

RMA Guaranteed—Factory Wired Complete, ready to play including 12" speaker, hardware and knobs: **\$149.50**

Special Price—Limited time only
ORDER NOW & SAVE! (Incl. Fed. Tax—less CRT)

FREE! With any chassis, a copy of the famous "TV Trouble Shooting Method," locate all troubles in a jiffy. Complete with illustrations and hundreds of rapid checks. Get yours NOW—FREE!!

TV TUBE ACCESSORIES—ANTENNAS

- Each Specially Priced!*
- Universal Mounting Bracket \$5.95
 - Sleeve & Ring for 16" Metal 3.85
 - Sleeve & Ring for 19" " 4.04
 - Sleeve & Ring for 24" " 7.95

FAMOUS CONICAL "Fan-Tenna"
Finest antenna made at any price. Completely pre-assembled. All seamless aluminum doweled elements & crossarm. Regular list: \$12.43. Save more than half! **\$6.19 ea.** lots of 6 **\$5.59 ea.**

LUXURIOUS, NEW TV CABINETS

For 630 Chassis, 17", 19", & 20" Picture Tubes

Model 100
Reduced to **\$39.95**



Save **45%!**
Custom
Styled

Model 200
Now only **\$49.50**



Blonde finish add \$10
Every beautiful cabinet, in richly finished, hand rubbed mahogany will stand out in any room. Made special to house the 630 chassis, they will carry a 17", 19", 20" or 21" picture tube. Every cabinet is custom styled, made by craftsmen and guaranteed perfect. Includes safety glass, mask & mounting brackets. Order Now and Save 45%!

All Prices Reduced!
CRYSTAL CLEAR LUCITE MASKS

Framed in Rich Gold Leaf Finish RO—Round Tubes RE—Rect. Tubes

14" RE 10 1/2" x 13 1/2"	\$4.49
16" RE 12 1/2" x 15 1/2"	5.79
16" RO 13 1/2" x 17"	5.89
17" RE 13 1/2" x 17"	5.89
19" RO 15 1/2" x 20"	7.69
20" RE 18 1/2" x 20 1/2"	7.69
21" RO 21" x 25"	13.95

TV PICTURE TUBES

6-Months Guarantee—non pro-rata
Black Face—Brand New—Standard Brands—Sealed Cartons

10BP4 Round-Glass	\$24.95	16HP4 Round-Glass	\$33.95
12LP4 Round-Glass	24.95	17BP4 Rect. Glass	29.95
14BP4 Rect.-Glass	24.95	19AP4A Round-Metal	37.95
16GP4 Round-Metal	31.95	20CP4 Rect.-Glass	37.95
21" Rect. Cylindrical face	39.95	24AP4 Round-Metal	69.95

NOW! Write for FREE Catalog including new complete line of tubes, parts, accessories for radio & TV, plus test instruments.

MINIMUM ORDER: \$5.00. 25% deposit with order, balance C.O.D. Include postage with order. All merchandise subject to prior sale. F.O.B. New York City. Prices subject to change without notice.



THE ROSE COMPANY

100 Park Place

Dept. E-5, New York 7, N. Y.

COrtlandt 7-6195

SO IMPORTANT — it was
Featured in Special Article
in
The New York Times
Jan. 28, 1952
FREE copy
of article on request

**UNIT REACTIVATES
TV PICTURE TUBES**

Small Electronic Device Tests
Sets at Home and May Add
Year or More of Use

By T. R. KENNEDY Jr.
A small electronic device that
can be applied to home television
receivers to test and reactivate
picture tube without removing the
tube from the set, resulting in re-
freshed brightness in many and con-
siderably longer useful life, has
been placed on the market for the
first time by a New York manu-
facturer.
In some cases, it was said, the
picture tube may be made almost
as good as new and given as much
as a year's useful life before re-
placement is necessary.
The instrument is small and
compact. It weighs three pounds
is as large as the average lunch
box, costs little and is simple to
operate. Picture tubes, some of
them new and never in a receiver,
have shown remarkable improve-
ment in brilliance and definition
after a few minutes of reactivation
here in the last few days.
Although the principle of re-
activation is not new—cathode-ray
tube manufacturers have used it
for years in the initial making of
picture tubes—its incorporation
in a small

The almost immediate, urgent
need for such an instrument, which
also soon may be produced in kit
form for home assembly, is ap-
parent. Eight to ten million TV
picture tubes, Transvision engi-
neers estimate, have now been in
use for three to four years or
longer and "probably are in need of
test and reactivation to "renew"
their brightness. Unfortunately,
loss of brightness, it was pointed
out, seldom can be detected short
of comparing the old tubes with
new ones in lately produced sets.
Furthermore, picture tubes in
their original cartons in stores may
have lost some of their brightness,
which has been described as a
"kind of aging process" to which
all large cathode-ray tubes and
similar devices are subject. Such
tubes, in the current sizes most in
use today, cost from \$25 to \$65.
New picture tubes can be tested
and reactivated without removing
them from their cartons and tubes
in TV sets without removing the
tube from the receiver. It is
done by attaching a standard pic-
ture-tube socket to the tube
tube socket, turning a switch on the
instrument, turning a switch on the
tester-reactivator and noting the
glow of a small neon bulb as
directly on a dial of the tester.
The dial on the tester is indicated
condition of the tube is indicated
which is plugged into an AC home
electric socket. The receiver, mean-
while, is not turned on.
In some cases the test and re-
activation is accomplished in less
than five minutes.



**TRANSVISION CR TUBE
TESTER - REACTIVATOR**
performs 2 vital functions:

- Tests Picture Tubes
- Renews Brightness of Dim Picture Tubes

It's a **TESTER**:

Without removing picture tube from set, you apply this precise instrument to:—

- Measure Cathode emission
- Locate shorts between elements
- Locate high resistance shorts or leakage as high as 3 megohms

It's a **REACTIVATOR**

for dim CR Picture Tubes

Revives dim TV Picture Tubes, without removal of tubes from sets. Reactivation works on many tubes with low light output, if there's no mechanical break in tube. 110 V.—60 cycles. Weighs only 3 lbs. One or two applications pays for instrument.

SATISFACTION GUARANTEED or money refunded if you return the instrument in 10 days in good condition. **\$19.95 NET**

—RUSH THIS COUPON—
TRANSVISION, INC.
NEW ROCHELLE, N. Y.
() Send me _____ CR Tube Tester-Reactivator(s).
() Enclosed find \$_____ deposit. Balance C.O.D.
() Enclosed find \$_____ in full. Send prepaid.
Name _____
Address _____
City _____ State _____

pin jacks. Be sure to observe the proper polarity. Turn on the power momentarily and watch the NE-51 neon lamp. If both electrodes glow, turn off the power at once because this indicates that the rectifier is shorted. A shorted rectifier may damage the filter capaci-

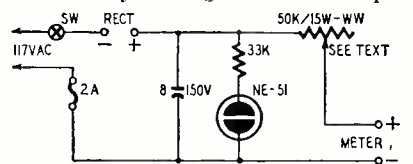

tor if power is left on. If the lamp does not glow, the rectifier is open. If only one electrode glows, connect a milliammeter to the METER terminals and adjust the 50,000-ohm control for the rated current drain through the rectifier to test for excessive heating. Be sure that the meter polarity is correct and that its full-scale rating is higher than the current rating of the rectifier under test.—O. C. Vidden

SINE WAVES FROM PULSES

In radar, television, and similar electronic applications, it is sometimes desirable to generate a sine wave which is synchronized by pulses or other non-sinusoidal recurring signals. A simple

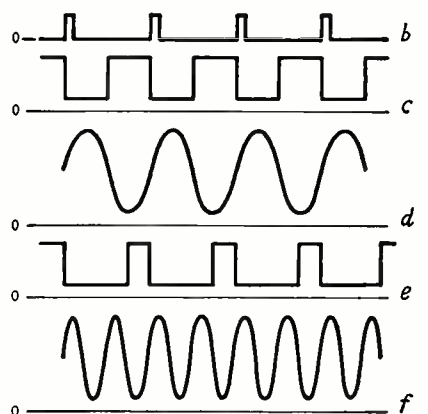
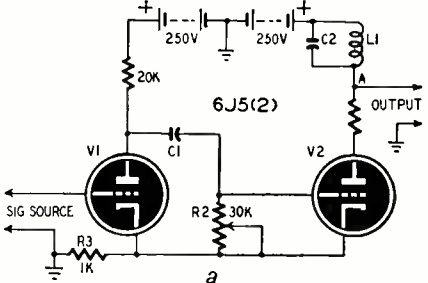

circuit which eliminates the a.f.c. and components needed to develop the sine wave and lock it in with the pulses is described in patent No. 2,559,144, issued to A. J. Baracket.

The circuit shown at a generates a sine wave at the fundamental or an integral multiple of the pulse repetition rate.

The equipment is set up with V2 drawing sufficient plate current to create enough cathode bias across R3 to cut off V1. Under this condition, the voltage on the plate of V1 equals the supply voltage (250 volts) so C1 is charged to a voltage equal to the difference between the supply voltage and the cathode bias.

SPECIAL!!
6 TUBE AC-DC KIT

At Last! A low-priced kit designed for high sensitivity, excellent selectivity and good tone quality. Uses 25L6, 25Z6, 6SQ7, 6SA7, 6SK7, 6SK7 in an easily constructed circuit. The 6 Tube Kit is shipped with all parts, including punched chassis, resistors, condensers, coil, sockets, PM Speaker, hardware, etc.
And at a closeout price of only **\$6.95**
X182 less tubes and cabinet
X183 Extra for matched set of six tubes for kit **\$3.25**

5 TUBE AC-DC SUPERHET KIT
Five tube superheterodyne kit, A.C.-D.C. contains all components required to construct this latest design, highly sensitive superheterodyne broadcast receiver complete with black bakelite cabinet (excludes wire and solder) Price \$7.95
Extra for a kit of 5 tubes (12AT6, 12BA6, 12BE6, 35WA, 50C5). Price \$3.25.

YOUR MONEY RETURNED IN FULL—
If the **New Regency Television Booster** fails to improve your television enjoyment! Bring your picture out of the snow and reduce interference!
• Push-Pull Neutralized triode design assures high gain without adding snow.
• No external impedance matching devices required.
• Inductive tuning assures same high-gain wide-band operation on all channels.
• Single knob tuning control.
• Underwriters approved with 90 day RMA guarantee.

LOWEST Price—ONLY **\$19.11**

MODEL NFRD—RADIO NOISE FILTER
If it doesn't work, send it back!

We absolutely guarantee that our Model NFRD will eliminate all line noises when properly connected to radios, television sets, short wave sets, motors, electric shavers, refrigerators, vibrators, oil burners, transmitters, and all other sources of interference. This unit will carry up to 12 amperes or 1 1/4 KW of power and may be used right at the source of interference or at the radio.
Small size only 2 1/2" x 1 3/4" x 4 1/2". Very low price only
Each **\$1.95**

A SCIENTIFICALLY DESIGNED PHONO SCRATCH FILTER

Resonated at approximately 4500 cycles effectively reducing objectionable needle scratch without altering the brilliancy of reproduction.
Contains a HI-Q SERIES resonated circuit. Tested by means of an audio oscillator and an oscilloscope to give 22 db attenuation with very low signal loss.
EASY TO ATTACH
Just two wires to clip on. Compact
Price **\$1.98**

THREE TUBE PHONO AMPLIFIER

An assembled unit ready for installation using tone and volume control and six feet of rubber cord **\$2.95**
(Not including Tubes)
With Complete Set of Tubes.....\$3.95

PHONO OSCILLATOR

Wireless phono oscillator transmits recording for crystal pick-ups or voice from carbon mike through radio without wires. Can also be used as an intercomm by using P.M. speaker as mike.
Price (excluding tubes)..... **\$2.95**
With Complete Set of Tubes.....\$3.95

Grab Bag Special, 10 pounds of Misc. Electronic Material — Transformers, Condensers, resistor, wire, etc. Price **\$1.95 ea.**

Satisfaction guaranteed on all merchandise
All prices subject to change without notice.

RADIO DEALERS SUPPLY CO.
154 Greenwich St. New York 6, N.Y.

CAPACITOR TESTERS

The capacitor checker shown at *a* and the capacitance bridge at *b* are two of a number of capacitor checkers described in an article in *Short Wave Listener* (London, England).

The checker tests mica, paper, and ceramic capacitors for excessive leakage and breakdown. It requires a 6E5 or similar electron-ray tube, two resistors, a pair of prods, and a source of operating voltage. The value of R may have to be determined experimentally. Its value should be adjusted so the shadow on the indicator tube just closes when the test prods are shorted.

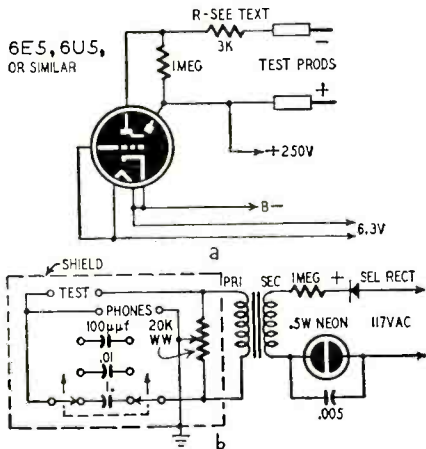

Connect the prods across the capacitor to be tested. The shadow closes if the capacitor is shorted and flickers if it is leaky or intermittent.

The capacitance bridge measures capacitance and checks capacitors for opens. The capacitors at the left are standards and should have the highest accuracy obtainable. Other values may be used if desired.

A neon-tube relaxation oscillator supplies a note of approximately 1,000 cycles to the bridge. Operating voltage is taken from the a.c. line through a selenium rectifier. The transformer is a standard audio interstage unit.

Calibrate the bridge by connecting known values of capacitance across the TEST terminals and marking the values on a scale under the pointer on the 20,000-ohm potentiometer when it is adjusted for a null in the phones. Use a separate scale for each capacitance range.



Suggested by R. H. Rogers, Brighton 35, Mass.

"Then I Put in this Resistor Here— Added a lead to this Terminal—and we plug it in."

MAY, 1952

TV DIRECT FROM THIS GREAT FACTORY TO YOU
BRINGS YOU
Finest Quality at Lowest Prices



TRANSVISION

TV KITS, WIRED CHASSIS, and SETS
CABINETS, COMPONENTS, INSTRUMENTS, and ACCESSORIES

SENSATIONAL OFFER

on top quality TV Picture Tubes.

• FREE—VALUABLE PREMIUMS:

With every Transvision tube you buy, you get a Merchandise Premium Coupon of real value. Write for list today.

• TRADE-IN ALLOWANCE on old tubes: Make from \$2.50 to \$5.00 glass allowance on each "dud."

• FULL 2 YR GUARANTEE:

Only Transvision gives you a Guarantee for 24 months.

COMPARE: Get the full details on the Transvision tube deal today.

FREE BOOKLET: "INSIDE CRT, or What You Should Know about Picture Tubes". Written by CRT experts, illustrated. It will MAKE MONEY FOR YOU. WRITE FOR IT.

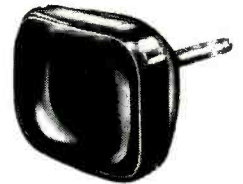

TRANSVISION Picture Tube PRICES

Type	Your Cost if no old tube is traded in— DEALER PRICE—	Allowance for old tube	Your FINAL COST, if old tube is turned in— DEALER NET—
10BP4	\$17.95	\$2.50	\$15.45
12JP4	17.95	2.50	15.45
12LP4	19.95	3.00	16.95
14RP4	19.95	3.00	16.95
16DP4	27.95	4.00	23.95
17BP4	25.95	4.00	21.95
19AP4	37.00	5.00	32.00
20CP4	35.95	5.00	30.95



SPECIAL!



REMOTE CONTROL TV CHASSIS

Here's the finest buy in Remote Control TV. Unit is all-electronic; no troublesome mechanical parts. Gives complete operating control of set. Plus—the latest Transvision A-4 Wired TV Chassis; completely aligned; ready to plug in. Has AFC and AGC. Top quality reception, even in fringe areas. 17" A-4 TV Chassis, remote control, and CRT, net \$199. 20" A-4 TV Chassis, remote control, and CRT, net 219. With Du Mont Tuner and FM radio, add..... 10

BEAUTIFUL TV CONSOLES

Ideal for Custom-Building or Conversion. Factory prices start from \$49. Send for Cabinet Catalog now.

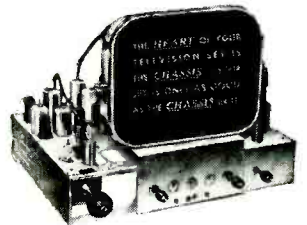

FIELD STRENGTH METER AT NEW LOW PRICE

Improve TV installations; save half the work with the Transvision Field Strength Meter. \$59 net Model FSM-1, complete with tubes.



Want to Make More Money in TV? Write for the Transvision Factory Agent Plan.

MULTI-SET CONNECTORS

Feed up to 5 TV Sets from 1 Antenna. Prices: Multi-Set Conn. for 2 sets... \$4.95 list* For 3 or 4 sets... 7.95 list*

*Dealers, write for discounts

FREE: EXTRA INCOME EVERY MONTH from hints in "TV and Electronics Notes." Request or send 50c to cover post of plate and mailing for FREE Monthly issues are gold mines of info on New Products, Sales Service, Conversion, etc. WRITE DEPT. RES TODAY!

TRANSVISION, INC. NEW ROCHELLE, N. Y.

Brooks **LIFE-SIZE Edition**

#630 TV KIT BUILDER - SET OF INSTRUCTIONS

COVERS ALL #630's 10" to 24"

including

Layout Charts, Alignment Procedure, Etc.

INDISPENSABLE — for TV building, converting, modernizing or even trouble shooting any #630 TV.

\$2.49

Popular priced at only POSTPAID

#630 STANDARD 29-TUBE TV KIT

COMPLETE SET OF PARTS for the FAMOUS ORIGINAL RCA #630 29-TUBE 10" to 12½" CHASSIS

\$99.99

Complete with all tubes and the new LIFE-SIZE TV builder's instructions (less CRT and wire)

#630 SUPER DELUXE 31-TUBE TV KIT

OPERATES ALL 16" TO 24" PICTURE TUBES

COMPLETE SET OF PARTS WITH VOLTAGE DOUBLER & AGC

\$119.44

Complete with all tubes and the new LIFE-SIZE TV builder's instructions (less CRT and wire)

#630 TELEVISION PARTS

RCA FRONT END TUNER, compl. w/tubes.	\$22.49
STANDARD CASCADE', com. w/tubes.	22.49
ESCUTCHEON PLATE, for either tuner.	.69
DUMONT INPUT TUNER, complete w/tubes.	22.49
COMPLETE SET OF KNOBS, incl. decals.	1.34
COMPLETE SET OF KNOBS, gold incl. decals	2.49
POWER TRANSFORMER, 295ma. 201T6.	9.97
VERTICAL OUTPUT TRANS. 204T2.	2.69
VERTICAL BLOCKING TRANS. 208T2.	1.32
HORIZONTAL OUTPUT TRANS. 211T3.	2.98
HORIZONTAL OUTPUT TRANS. 211T5.	3.98
FOCUS COIL, 247 ohms. 202D1.	2.29
FOCUS COIL, 470 ohms. 202D2.	3.42
DEFLECTION YOKE, 60° 201D1.	2.97
DEFLECTION YOKE, 70° 206D1.	3.98
HORIZONTAL DISCRIM. TRANS. 208T8.	1.49
FILTER CHOKE, 62 ohms.	1.47
WIDTH CONTROL COIL, keyed AGC.	.79
ION TRAP BEAM BENDER, (single) 203D1.	.79
ION TRAP BEAM BENDER, (double) 203D3.	.98
AUDIO OUTPUT TRANSFORMER (6K6).	.69
HV RECTIFIER, SOCKET ASSEMBLY, double	1.37
PUNCHED CHASSIS PAN, cadmium plated	4.87
VIDEO AND I.F. KIT, 19 items.	7.84
AGC KIT, complete with instructions.	4.59
VARIABLE CONTROL KIT, 9 controls.	5.83

FINEST PICTURE TUBES

Choice of DUMONT 6-mos. guaranty or SHELDON blue label 1-yr. guaranty.

10" — #10BP4A	\$22.36
12½" — 12LP4A	26.72
14" — 14CP4A	29.38
16" — 16AP4A	32.97
16" — 16DP4A	32.97
16" — 16GP4	32.97
16" — 16TP4	32.97
17" — 17BP4A	34.63
19" — 19AP4A	39.74
20" — 20CP4	44.68
21" — 21EP4A	49.74
24" — 24AP4	79.49

The Manhattan



CUSTOM-BUILT CABINET For #630 AND ALL OTHER TV SETS

From Factory — To You

The MANHATTAN has everything **STYLE . . . QUALITY . . . PRICE**

STYLED — to blend with any furniture setting, *it's a best seller.*

QUALITY — constructed of genuine mahogany or walnut, handrubbed to a fine piano finish.

LOW PRICE — made possible by our controlling interest at the factory.

THE MANHATTAN — Takes any TV set. The knob-panel and shelf are either drilled for a #630 chassis, or left blank for any other TV set. The picture tube cutout is any size you order (12½" to 24") and the mask and safety glass are included.

EVERYTHING NECESSARY — for an easy, perfect installation is included—assembly instructions, picture tube mounting brackets, hardware, backboard, and as a finishing touch we even include a backup for recessing the picture tube neck.

EACH CABINET — is carefully packed in an air cushioned carton & shipped F.O.B. factory, N. Y.
\$59.37 cab., size H-41", W-25", D-23", wt. 56 lbs.
\$86.22 cab., size H-46½", W-27¾", D-24", wt. 78 lbs.

MANHATTAN to fit any size CRT 12½", 14", 16", 17", 19", 20" or 21"

\$59.37

MANHATTAN also available **\$86.22** for the 24" picture tube

Blonde 10% extra

See our sensational offers on pages 96 and 97

BROOKS RADIO & TV CORP. 84 Vesey St., Dept. A, New York 7, N. Y.

RECEIVER-TRANSMITTER QUERY

? I have a model 11-UF-ED-6 Link receiver and a model 32-UFM-ED-2 transmitter. Both are crystal controlled on 39.46 mc. I want to shift the frequency to 33.86 mc. The transmitter crystal is at 1,233.125 kc. The receiver uses two crystals: one at 5.456 and the other at 6.892 megacycles. What crystals must I use for the new frequency? —G. F. B., College Park, Md.

A. The transmitter output is on the 32nd harmonic of the crystal frequency. Therefore, the new crystal frequency is 33.86/32, or 1.05925 mc. (1,059.25 kc).

The receiver is a double superheterodyne with the first i.f. at 5 mc and the second at 456 kc. The 5.456-mc crystal is in the oscillator circuit of the second converter and is not changed. The heterodyning frequency for the first converter is 5 mc below the signal frequency and is the fifth harmonic of the 6.892-mc crystal. Therefore, at the new frequency, the heterodyning signal is 33.86 minus 5, or 28.86 mc. Since the 5th harmonic of the crystal is used, the new crystal for the receiver must be 28.86/5 or 5.772 mc.

Some of the tuned circuits may not have sufficient range to tune down to the new frequencies, so you may have to shunt the coils with small padders or add a few turns to the coils. A grid-dip meter will be helpful in checking the tuning range of the coils and in making sure that you don't pick up the wrong harmonic of the crystal.

BATTERY ELIMINATOR

? I have a 4-tube battery-operated portable receiver which draws 11 ma at 90 volts and 250 ma at 1.5 volts. Please print a diagram of an a.c. operated battery eliminator for this set.—E. K. W., Greensboro, N. C.

A. The power supply shown in the diagram will supply B-voltages up to 120 and A-voltages up to 3 volts, depending

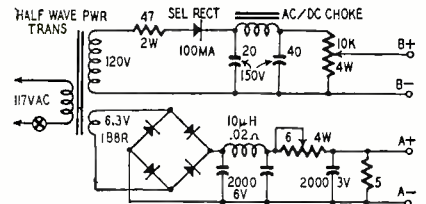

on the current drain. The low-voltage rectifier may be a Mallory 1BR8 or equivalent, and the low-voltage filter choke may be a 10-µh, .02-ohm filament choke, of the type used in auto radios. The 10,000- and 6-ohm controls may be adjusted to give the desired output voltage.

AMPLIFIER MODIFICATION

? I have an amplifier which consists chiefly of a pair of push-pull 41's operated with fixed bias and driven by a pair of 76's as voltage amplifier and phase inverter. The power transformer delivers 650 volts center-tapped to the plates of the 80 rectifier. Bias for the 41's is developed across a 985-ohm resistance in the negative lead of the supply. I want to replace the 41's

STAN-BURN E-P-A-R-K-E

★ ANTENNAE SPECIALS ★

★ DOUBLE V 3/8"	1-11	12 or more	
★ DOUBLE V 3/8" Dowel	\$2.98	\$2.20	★
★ DOUBLE V 1/2" Dowel	3.45	2.45	★
★ 10 Element Conical 3/4"	3.95	2.95	★
★ Folded Hi Straight Low Quick Rig 1/2" elements	3.55	2.55	★
★ WINDOW CONICALS	4.25	3.25	★
★ MASTS	4.95	3.75	★
★ 5 FOOT SWEGGED79		★
★ 10 FOOT PLAIN	1.39	1.29	★
★ TV WIRE			★
★ 55 Mil. 300 OHM	\$15.95	M Ft.	★
★ 72 OHM COAXIAL	52.50	M Ft.	★

★ CATHODE RAY TUBE SPECIALS ★

★ 10BP4 Zetka... \$14.95	17BP4A Federal	\$23.00	★
★ 10BP4 N.U. 19.95	17BP4A DuMont	28.00	★
★ 10BP4 N.U. 19.95	19AP4 Sheldon	29.95	★
★ 12LP4 Zetka... 19.95	19AP4 GE	39.95	★
★ 12LP4A Thomas 19.95	19BP4A Thomas	39.95	★
★ 16AP4 Zetka... 26.00	20CP4A DuMont	41.00	★
★ 16AP4 G.E. 26.00	20CP4A Sheldon	47.00	★
★ 16DP4A Thomas 28.80	21EP4A DuMont	42.95	★
★ 16GP4 Rauland 33.00	24AP4A Sheldon	76.00	★
★ 16GP4 Zetka... 26.00	24AP4A GE	76.00	★
★ 16JP4A Thomas 28.80	Single ion traps...	.39	★
★ 16RP4A GE & NU 26.00	Double ion traps...	.59	★
★ 16TP4A DuMont 28.00			★

★ CHASSIS 830 REGAL with Cascade Tuner	\$139.50
★ 21" TO PLAY BACK (Similar to RCA)	2.98
★ OPEN FACE CABINET	39.00

★ TRANSFORMERS ★

★ RCA type for 16" to 24" X032	\$3.85
★ G.E. Type for 16" to 24" X045	3.85

★ DEFLECTION YOKES ★

★ Cosine Ferrite Todd Yoke 70"	\$4.20
--------------------------------------	--------

★ SPECIALS ★

★ GI 3 speed Changer—Model 700F33-45	\$19.50
★ YM 3 speed changer—Model 407-31	22.50
★ 4 Prong Vibrators each	\$1.29
★ Lots of 12 or more	1.19
★ Standard TV Tuners	18.95

★ AUDIO DEVICES, DISCS and TAPE IN STOCK ★

★ 12" Heavy Slat Speaker	Special \$4.98
★ 500 MMFD Barrel Type—20,000 KV—Screw end	75c
★ Special while they last	55c

★ WIRE RECORDERS IN STOCK ★

★ PENPHONE—Model 973C—2 speed Tape Recorder	Net \$116.68
★ WILCOX GAY—Model 2A10	69.97

★ CASCODE Guaranteed Tuners (with tubes) ★

★ Special, while they last	\$21.95
----------------------------------	---------

★ AUTHORIZED DISTRIBUTORS for: General Electric, Konrad, Tung-Sol, National Union, Jewel, De Wald, Regal, Automatic and Setchel Carlson. ★

***** We carry a complete line of popular makes of radio and TV tubes, at 50% discount. Also many other special purpose and transmitting types, and all electronic parts and equipment at lowest prices. ★

★ Send us a list of your requirements for prompt quotations. ★

★ Terms: 20% with order. Balance C.O.D. All prices FOR New York Warehouse. Minimum order \$5.00 ★

★ Write for our latest price list to Dept. RE-4 ★

STAN-BURN RADIO and ELECTRONICS CO.
(C.B.S. THEATRE BLDG.)
1697 BROADWAY • NEW YORK 19, N.Y.

TWIN-TRAX[®] TAPE RECORDERS



...give you more

MORE MODELS
the most complete variety of recorders for professional, semi-professional and experimenter use.

MORE FEATURES
for better quality, smoother performance and easier operation.

MORE VALUE
because our direct sales policy saves you dealer markups.

Send today for our catalog 5109 which lists complete technical specifications and performance ratings for all recorder models and accessories. *Trademark Reg.

AMPLIFIER CORP. OF AMERICA
398 Broadway New York 13, N. Y.

with 6L6's to provide higher output. Please tell me what changes are needed. —J. P., Pinales, Calif.

A. You will have to double the power output of the amplifier to get a noticeable increase in volume level. From your description of the amplifier, we gather that its maximum power output is about 10 watts, so you will have to raise the output to at least 20 watts to produce a noticeable increase in the volume level.

Since the output tubes draw about 75% of the current from a power supply in the average amplifier, we feel that the power transformer is probably rated at 100-110 ma. A pair of 6L6's delivering about 20 watts draw about 160 ma. Allowing another 30 ma for the voltage-amplifier tubes, the power transformer would have to be rated at about 190 ma. This drain would most certainly overload your power transformer.

If you feel that you need more power output, it may be that you are not supplying enough voltage to the 41 grids. The peak signal voltage applied to the grids of the 41's should be equal to the d.c. bias on the grids. Thus, if the 41's are biased at 25 volts, the r.m.s. signal should be approximately 17.6 volts. If the voltage amplifiers do not deliver this voltage with normal input signals, we suggest adding another voltage amplifier or making a modification which will cause a normal input signal to drive the amplifier to full output.

We don't think that it will be practical to try to double the output of your amplifier.

G-E 17C101

? I have a G-E 17C101 TV receiver which does not have as much brightness as the 17C103 and similar later models. On my set, I have to turn the brightness control up full. On later models, there is plenty of reserve brightness. Which resistors should I change to increase the brightness?—A. L., South Swansea, Mass.

A. The circuits of these two sets are identical at most of the points most likely to affect the brightness. We would be willing to bet that when your set was new, its picture was as bright as in the new sets just off the assembly line. It is normal for the picture brightness to fall off gradually as the set ages in use.

Low-voltage rectifiers decrease in efficiency, filter capacitors lose capacitance, and resistors may change value so as to lower the B-voltage and reduce the output from all circuits. Aside from the reduction in B-voltage, the loss in light output may be caused by weak tubes or changes in the values of components in the horizontal output and high-voltage circuits.

Even if the electronic circuits of the receiver are in top-notch condition you will still lose some light because the light-output of the picture tube drops off with age. Don't forget that the face of the picture tube and the surfaces of the safety glass or mask pick up an even accumulation of dirt and



Special Offer On This Complete RADIO ENGINEERING LIBRARY

New, Up-To-Date Editions of Famous Library Covers Whole Field of Radio Engineering, Places Latest Facts, Standards, Data, Practice, and Theory At Your Fingertips

The five big volumes of the new edition of the Radio Engineering Library now include the very latest facts, standards, data, and practice. This Library will help solve hundreds of problems for designers, researchers, engineers, and students in any field based on radio.

Written by leading radio engineers, these books cover circuit phenomena, networks, tube theory, vacuum tubes, amplification, measurements, etc.—give specialized treatment of all fields of practical design and application. They provide you with a complete and dependable encyclopedia of facts.

- 5 Volumes, 3872 Pages, 2770 Illustrations
- Eastman's FUNDAMENTALS OF VACUUM TUBES, 3rd Edition.
- Terman's RADIO ENGINEERING, 3rd Edition.
- Everitt's COMMUNICATION ENGINEERING, 2nd Edition.
- Hund's HIGH FREQUENCY MEASUREMENTS, 2nd Edition.
- Henney's RADIO ENGINEERING HANDBOOK, 4th Edition.

SEND NO MONEY

Special Low Price—Easy Terms

On this special offer you get this Library for \$34.50, instead of \$39.00. You save \$4.50 and may pay on easy terms. Mail coupon below to examine the Library FREE for 10 days. No obligation. These books are recognized as standard works; you are bound to need them. So take advantage of this special money-saving offer. *Mail coupon at once!*

McGraw-Hill Book Co., Dept. RE-5-52
327 West 41st St., New York 18, N. Y.

Send for 10 days' FREE trial, the RADIO ENGINEERING LIBRARY. If not satisfied I will return books. Otherwise I will send \$4.50, plus delivery charges, then; and \$5 a month for 6 months. (Reg. price \$39.00; you save \$4.50).

Name

Home Address

City & State

We'll Pay Delivery Charges if you enclose \$4.50 first payment WITH coupon. Same return privilege for full refund.

Compare!
**PROVE
 EMC
 SUPERIORITY!**



**MODEL 106
 Vacuum Tube Voltmeter
 ✓CHECK THESE FEATURES**

Specially designed for field alignment of television and radio sets. Uses dual triode balanced bridge circuit. All functions and ranges completely electronic—meter cannot burn out. Zero center position for FM discriminator alignment. Uses 1% precision resistors for voltage multipliers. 5 DB ranges. Full scale deflection of 1½ volts for both AC-DC volts. Measures resistance in 5 ranges from .2 ohm to 1000 megohms. 1 Meg isolating resistor in probe.

SPECIFICATIONS

DC VOLTAGE: Input resistance 16.5 megohms or 1½ megohms per volt. Ranges: 0 to 1.5, 10, 100, 300, 1000 up to 30,000 volts (with accessory probe.)

AC VOLTAGE: Input resistance 2 megohms. Ranges 0 to 1.5, 10, 100, 300, 1000. Frequency response flat from: 25-100,000 cycles.

OHMS: 1000—10,000—100,000—10 megohms, 1000 megohms.

Compact, portable bakelite case measures 4¼" x 5¼" x 2⅞".

MODEL 106..... \$35.90
In Kit form..... \$23.90
MODEL HVP 30,000 Volt Probe for Model 106..... \$8.75

Write Dept. 1RE5 for latest FREE Catalog and Jobber Discount
 SEE COMPLETE LINE AT YOUR JOBBERS.

EMC Electronic Measurements Corp.
 280 Lafayette St., New York 12, N. Y.
 Export Dept., 303 W. 42nd St., N. Y. C.

PEN-OSCIL-LITE

Extremely convenient test oscillator for all radio servicing, alignment • Small as a pen • Self powered • Range from 700 cycles audio to over 600 megacycles u.h.f. • Output from zero to 125 v. • Low in cost. • Used by Signal Corps • Write for information.

**GENERAL TEST EQUIPMENT
 38 Argyle Ave. Buffalo 9, N. Y.**

RADIOS 1, 2 & 3 band Electric and/or battery
TELEVISION AC/DC Operation
TEST INSTRUMENTS
 Write for FREE Catalog
ARKAY—Radio Kits, Inc.
 120 Cedar St., New York 6, N. Y.

grime which is not noticeable until you start to clean it off. You can lose a lot of brightness here.

The loss in brightness is probably due partially to all of the items which we have mentioned. Start by cleaning the safety glass and tube face and replacing the low-voltage rectifiers. The next step would be to replace the high-voltage rectifier and horizontal output tubes and touch up the setting of the drive control. Of course, you could continue this process of replacing components until you end up with a new set, but why do it? You will only have to start all over again when the 1953 models come off the assembly line!

SUPERHET COIL DATA

? I am constructing a superhet receiver for 10 to 160 meters, and need winding data for the antenna and oscillator coils. The i.f. is 456 kc, the converter tube is a 6SA7, and the tuning capacitors are 140-µf units. I want to use 1-inch coil forms.—G. F. S., Chicago, Ill.

A. The information you requested is given in the table. The 1-3-mc antenna coil is close-wound with No. 30 s.s.c. wire. Its primary is wound over a layer of thin paper wrapped around the grounded end of the grid coil. The oscillator coil for this band is close-wound with No. 26 enameled wire.

COIL WINDING TABLE

Ant. coil (No. of turns)	1.0-3.0 mc	2.5-6.5 mc	6.3-13.8 mc	13.5-27 mc	23-47 mc
Pri.	18	12	10	9	3
Sec.	150	31	18	11	3
Osc. coil					
Full winding	70	28	16	9	3
Cathode tap	25	10	10	5	2

The antenna transformer primaries for the 2.5-, 6.3-, and 13.5-mc bands are close-wound and spaced about ¼ inch below the secondaries. In these ranges, the secondaries are all wound with No. 26 wire spaced to occupy approximately 1 inch.

For the 23-47-mc band, the secondary of the antenna transformer is space-wound with the primary interwound with the bottom turns of the secondary. The oscillator coil is initially close-wound, then the turns are spaced as required to cover the desired tuning range.

Tracking is always a major problem when using homemade coils, so we recommend that you use separate tuning capacitors for the antenna and oscillator circuits. A vernier dial should be used on the oscillator capacitor for tuning and logging. The antenna tuning capacitor is set to peak each signal after it is tuned in with the oscillator capacitor.

Tuning may be made easier on the higher frequencies by using a band-spread control. This should be a 30 µf variable capacitor connected in parallel with the oscillator tuning capacitor.

—end—

EBCO Mfrs. of PICTURE TUBES and Electronic Equipment

Sold only thru Radio Parts Jobbers
17" Rectangular C.R.T. net **\$21.95**
 With Glass Allowance
20" Rectangular C.R.T. net **\$29.95**
 With Glass Allowance
 Prices include tax
EIGHTEEN MONTHS GUARANTEE!

**"EBCO" Dual-Purpose
 CHECKER-REACTIVATOR**

for TV Picture Tubes

A Money Maker For Servicemen:

Check picture tubes for shorts, cathode emission, leakage, etc., without removing tube from TV set. Also PUT NEW LIFE into weak tubes with the REACTIVATING power of this instrument. Lightweight, portable; 110V. 60 cycles. Factory-guaranteed



ASK YOUR JOBBER. net **\$1995**

FIELD STRENGTH METER

Want better antenna orientation? Better TV performance? Want to save time and money? Then use the NEW "EBCO" FIELD STRENGTH METER. Measures field strength from 50 to 50,000 microvolts at the 300 ohm input terminals. \$6495 Many other great features. net

2-SET CONNECTORS

Two-set Connector for TV Net **\$2.95**
 Four-set Conn., operates 3 or 4 sets from 1 antenna Net **\$4.95**

ASK YOUR JOBBER!

ELECTRONIC BEAM CORP.

EBCO 923 Old Nepperhan Ave. YONKERS, N. Y. Phone: YOnkers 3-3514

AUTOMATIC M-90 AUTO RADIO



- Six Tube Superheterodyne • Three Gang Condenser • Powerful, Long-Distance Reception • Fits All Cars, Easy Installation
- Mounting Brackets Included
- 6 Tube model M90 *\$34.97
- 5 Tube Model A-15 *\$28.76
- *Above price includes Federal Excise Tax

Approx. shipping weight either radio (11) eleven pounds
MAIL US YOUR ORDERS
 All orders filled within 24 hours.
 Standard Brand tubes 50% off list

Bill Sutton's Wholesale Electronics
 Fifth at Commerce Fort Worth, Texas

Please mention **RADIO-ELECTRONICS** when writing advertisers

MOTOROLA TV-RADIO CHASSIS

In some 1951 Motorola TV combinations such as the 17F1, 17F2, etc., a.c. speaker hum may be noticed even when the a.c. power switches on both radio and TV chassis are turned off. The remedy is to reverse the leads at the speaker pin jacks.

If the AM-FM chassis has been removed for servicing, when reinstalling it plug the speaker leads in so the ground wire from the radio chassis plugs into the pin jack which is tied to terminal 2 on the socket for the speaker plug from the TV chassis. This terminal corresponds to the ground connection on the TV chassis.—*Motorola Installation and Service Bulletin*

REDUCING BCI FROM TV SETS

Whistles throughout the broadcast band can be caused by radiation from the horizontal sweep circuit of a nearby TV receiver. This trouble originates most frequently in sets having metal picture tubes. Conductive coatings of most glass tubes minimize radiation.

The trouble can be reduced or eliminated in sets having metal picture tubes by connecting a 500- μ f, 20-kv filter capacitor between ground and the high-voltage lead running directly to the second anode. The connection to the high-voltage lead should have smooth soldered joints to avoid corona discharges. A further reduction in 15.75-kc radiation can be obtained in some instances by connecting a 0.1- μ f, 600-volt capacitor from each side of the a.c. line to ground.—*Admiral Radio & TV Service Bulletin*



Low Cost Powerful P.A!
COMPLETE • READY TO USE

Tops for powerful indoor-outdoor use; ideal for electioneering. Easy portability. Covers 4,000 persons indoors, up to 25,000 sq. ft. outdoors. Full 30 watts usable output; 2 high-imp. mike inputs, 1 phono input, each with separate volume control; tone control; fidelity ± 2 db from 40-20,000 cps. Complete system includes: 30 watt amplifier and tubes, Electro-Voice "Cardax" unidirectional mike with adjustable floor stand and 20' cable; 2 General Electric 12" PM speakers, each with 30' cable; portable carrying case holds all, 16 $\frac{3}{4}$ x 12 $\frac{3}{4}$ x 25". For 110-130 v., 60 cy. A.C. Shpg. wt., 75 lbs. Complete, less only phono top.

93-372. Complete 30 Watt System. Only \$119.75
93-340. 3-Speed Phono Top for above. Only \$16.95
Available on Easy Terms—write for details

FREE See the 212-Page ALLIED Catalog for other Sound Systems, ranging from 8 to 80 watts. Write for Free copy of Radio's leading Buying Guide today.

ALLIED RADIO

833 W. Jackson Blvd., Dept. 2-EE-2, Chicago 7, Ill.



NEW!

Transformer Catalog and TV Replacement Guide

Haldorson's new one-source catalog has the components you need, well classified for easy use.

This highly active line has been super-charged with 114 new items. Special attention is given to TV replacements. A self-contained guide section tells you where they are used.

Here's extra value, too. Haldorson prices actually have been reduced, but Haldorson quality is even better than ever.

Ask for a copy at your distributor, or write direct.

The HALLDORSON COMPANY

4500 N. Ravenswood Ave, Dept
Chicago, 40, ILL.



New SUPREME 1952 TV Manual

DATA ON ALL POPULAR TV SETS

In this new giant volume of 1952 television factory data, you have everything you need to repair every present-day television set. You receive easy-to-understand explanations of circuits, 192 pages of alignment procedure, test patterns, response curves, waveforms, voltage charts, adjustment hints, and diagrams on the mammoth 11 x 17-inch blueprints. This newly published 1952 TV manual is a virtual treatise on practical television repairs. By normal standards, such a large manual packed as it is with practical facts, hundreds of illustrations, diagrams, charts, photographs, and expensive extra-large blueprints, should sell for \$10—but as another SUPREME special value, it is priced to servicemen at only \$3, postpaid. Only a publisher who sold over one million TV and radio manuals can offer such bargain prices based on tremendous volume-sales.



Compiled by M. N. Beitman, radio engineer, teacher, author, and serviceman.



AMAZING BARGAIN IN TV MANUALS

For 18 years, radio servicemen received remarkable values in SUPREME PUBLICATIONS' service manuals. The television series is the most amazing bargain and defies competition. There is nothing else like it. The new 1952 TV manual is described at left. Illustrated and listed in the coupon are earlier volumes covering 1951, 1950, 1949, 1948 TV, and 1947 TV and F.M. Use these on-the-job manuals to repair any television set. Yes, these manuals will tell you where to look and what to do. Stop guessing. Cut hour-wasting jobs to pleasant moments. Use any of these manuals without risk for 10 days. Just send coupon below.

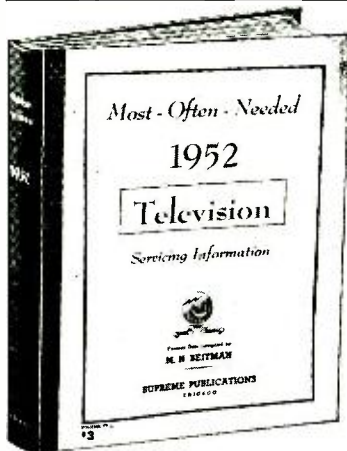

New 1952 TELEVISION manual contains complete service data on all popular present-day television sets of all makes. Gives description of modern circuits, test patterns, response curves, oscilloscope waveforms, alignment tables, service hints, diagrams in the form of double-speed blueprints, test points, voltage charts, etc. Large size: 8 $\frac{1}{2}$ x11 in., manual style binding, flexible covers. . . . \$3 at your jobber or by mail, only. . . . \$3

SUPREME RADIO DIAGRAM MANUALS



1951 1950 1949 1948 1947 1946 1942 1941 1940 1939 1926-1938
SUPREME Most-Often-Needed RADIO DIAGRAMS
Each Manual only \$2. (*51-'49, \$2.50); 192 pages of diagrams, alignment data, voltage values, parts lists, and service hints; large size, 8 $\frac{1}{2}$ x11". To order, see coupon—> Price, \$2.50

Supreme Publications

Sold by all Leading Radio Jobbers

MAY, 1952

NO-RISK TRIAL ORDER COUPON

SUPREME PUBLICATIONS, 3727 W. 13 St., Chicago 23, ILL.

Send on trial TV manuals checked below and RADIO manuals at right. You guarantee satisfaction or money back.

- New 1952 Television Service Manual \$3.
- 1951 TV . . . \$3. 1950 TV . . . \$3. 1949 TV . . . \$3.
- 1948 TV . . . \$3 1947 TV & FM, only . . . \$2.
- Complete INDEX to all Radio & TV manuals. . . \$2
- I am enclosing \$ Send postpaid.
- Send C.O.D. I am enclosing \$ deposit.

Name: _____
Address: _____

Radio Diagram Manuals

- New 1951 Manual } Each Only
- 1950 Radio Manual } \$2.50
- 1949 Radio Manual }
- 1948
- 1947
- 1946
- 1942
- 1941
- 1940
- 1939
- 1926-1938 Manual, \$2.50

PRICED AT ONLY \$2 EACH

PHILCO 51-T1443 SERIES

The filament protective fuse consists of a length of No. 26 copper wire in series with one of the filament-supply leads (black) from the power transformer. This fuse wire is connected between pin 3 of the 5AX4-GT (low-voltage rectifier) and pin 6 of the chassis power socket, J101. Always use No. 26 copper wire when replacing this fuse.—*Philco TV Service Manual*

EMERSON 661-B

If the complaint is horizontal instability or loss of horizontal sync, check for a shorted capacitor in the a.g.c. line. The short or intermittent occurs most frequently in the 200- μ f mica capacitor in the grid circuit of the second video i.f. amplifier.—*James Moudry*

PILOT CANDID TV (TV-37)

To clear up a complaint of sound bars in the picture, realign the sound trap at 21.25 mc. The sound trap is in the can with the detector coil.—*Wilbur J. Hantz*

CROSLEY 321 AND 331 CHASSIS

If it is necessary to increase the width of the picture beyond the range of the width control on models using chassis 321, 321-1, 321-2, 331, 331-1, and 331-2, remove the 15,000-ohm resistor (R24) and connect a wire between lugs 2 and 3 of the flyback transformer. Also connect a 220- μ f, 2,000-volt capacitor (part No. 137498-62) between lugs 6 and 8 of the transformer.—*Crosley Service Dept.*

DU MONT 12-INCH TV SET

A band approximately 2 inches wide traveled upward from the bottom of the screen after the set warmed up. Tubes and voltages checked O.K. The trouble was finally traced to a hot short in one of the 6AG5 video i.f. amplifier tubes. The trouble was localized by tube substitution. The short did not show up on a tube checker.—*Jacob Dubinsky, W2LVR*

ADMIRAL 21B1 CHASSIS

Picture smear or poor definition have been reported on some of these chassis. The trouble has been traced to 4.5-mc interference in the picture when the set is tuned for best picture. When the set is tuned to eliminate the interference, it is not properly tuned for best picture.

To eliminate or reduce the interference, make the following changes while referring to the partial schematic:

1. Remove peaking coil L304 (part 73A5-9) and replace it with peaking coil, 73A11-1 which has a three-pie winding.

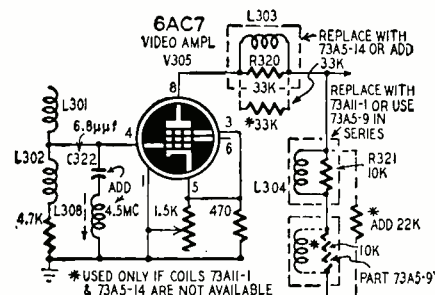

If part 73A11-1 is not available, use two 73A5-9 peaking coils connected in series, with short leads, so that the coils are not more than 3/4 inch apart. Connect a 22,000-ohm, 1/2-watt resistor across this assembly.

2. Remove peaking coil L303 (part 73A5-13) and replace it with peaking coil, part 73A5-14, coded with a blue dot.

If part 73A5-14 is not available, leave part 73A5-13 in the receiver and wire across it a 33,000-ohm, 1/2-watt resistor. 3. Connect a series resonant trap L308, part 72B99-3 (used in 20T1 receivers), between pin 4 of V305 (6AC7) and chassis ground.

Mount the trap in the chassis hole located between tubes V305 (6AC7) and V403 (12AU7), with the 6.8- μ f capacitor C322 connected to pin 4 of V305.

4. Tune the trap by watching the picture and adjusting the slug for minimum 4.5-mc interference. If greater accuracy is required, the trap should be adjusted in the following manner:

- (a) Using clip leads, short-circuit pin 1 of V201 (6AU6) to chassis ground and connect a 50- μ f capacitor between pin 8 of V305 and pin 7 of V201.
- (b) Set the channel selector to a TV station having the strongest signal. Tune the fine tuning control for loudest sound. Using a non-metallic screwdriver, carefully

the **BIG 10** is terrific!

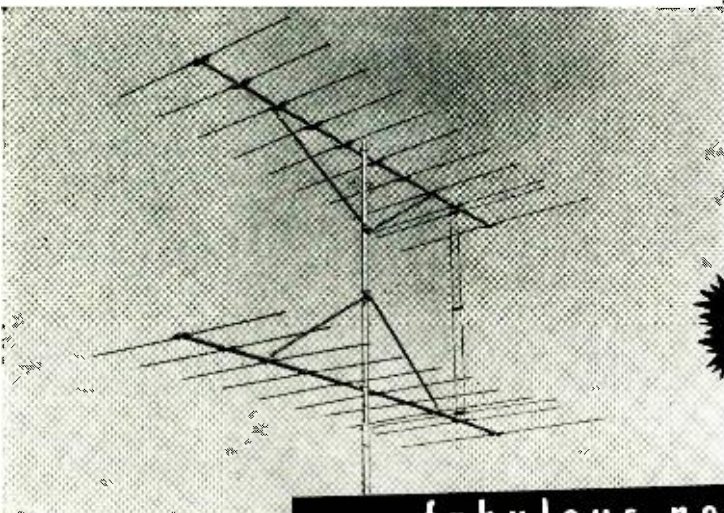

12
DB single

14 1/2
DB stacked

CHANNEL MASTER'S

fabulous new
10 Element Yagi

COMPARE these 10 Terrific Features!

- 1 10 Elements — more signal, less noise, less rear pickup.
- 2 Highest gain of any Yagi ever developed.
- 3 Over 30% more gain than any 8 element Yagi.
- 4 This antenna can be stacked, with 78% additional gain over single bay.
- 5 Includes the famous Z-Match system.
- 6 You don't pay for stacking bars.
- 7 Excellent 300 ohm match in all installations.
- 8 "Boom Braced" to prevent crossboom "bounce" which causes picture flicker.*
- 9 Two piece "Swej-Lok" cross-boom for simplified stocking, handling, and installation.*
- 10 Completely pre-assembled.

*Low Band only

LIST PRICES	
ch. 7—13	ch. 2 or 3 31. ⁹⁴
\$13⁸⁸	ch. 4 or 5 28. ⁴⁷
	ch. 6 25. ⁶⁹

CHANNEL MASTER CORP. MEMBER **AMA**
ELLENVILLE, N. Y.

adjust the trap slug for minimum sound. Warning: Do not attempt to adjust the 4.5 mc trap by using a grid-dip meter, since the reading will not be correct. *Admiral Service Bulletin*

DELCO 957582 AUTO RADIO

If this set is dead, the trouble may be traced to an open 200,000-ohm, 1/2-watt resistor between the plate of the 6SQ7 and the filter capacitor. This resistor is mounted with its leads clipped short. They often snap off or pull out. Replace this resistor with a 1-watt unit, leaving the leads longer than on the original.

This trouble may occur in other sets and in different parts of the circuit whenever the leads are so tight that vibration or expansion of components with heat will cause the leads to pull out.—*O. C. Vidden*

RCA 65AU

If this set is dead or intermittent, resolder all connections to the oscillator coil before looking elsewhere for the trouble. We've had several of these sets with cold solder joints on the oscillator coil.—*Clarence C. Lewis*

NOISE IN AUTO SETS

Stubborn cases of ignition noise may be caused by leakage between the antenna and the body of the car. A deposit of metal salts, caused by corrosion of the brass in the antenna, forms under the insulating washer. This leakage is too high to be measured with an ordinary ohmmeter. The noise can be cleared up by removing the antenna and cleaning its base and insulator.

In cases where noise is being picked up through the 6-volt supply—noise comes in with the antenna disconnected—one simple remedy is to run the hot lead from the set direct to the battery. Keep this lead dressed close to the body of the car.—*Frank Greene*

STANDARD COIL TUNERS

A weak, snowy picture may be caused by an inoperative r.f. stage in sets using these tuners. A common cause of this trouble (other than tube failure) is a shorted screen bypass capacitor. The best way to check for this is to remove the r.f. amplifier tube (6AG5, 6BC5 or 6CB6) and check the screen voltage from the top of the chassis. If this voltage is low or zero it will be necessary to remove the turret and replace the defective component.

If the set has been in operation for an extended period of time with the capacitor shorted, it is advisable to replace the two resistors between the r.f. amplifier screen and B-plus point, since they probably will have been overheated by the short. Since the short lowers the B-voltage to the 6J6 oscillator-mixer tube it may also not function (unless the resistor connected to the screen has opened because of overheating). In these cases the trouble is apparent because the resistor often breaks in two.—*DeLoss Tanner*

—end—



REGAL T-V CHASSIS "SUPER" 630 TYPE

This new Regal, powerful 32-tube chassis, capable of driving 16", 17", 19", and 20" cathode-ray tubes, has a horizontal automatic frequency control which has been tradenamed "Regalok". It has a 70 degree yoke with ample sweep to cover a 20" television picture tube without shadows.

The set also includes a turret type tuner, a high gain video amplifier, four stages of i.f. amplification, a power line filter, and sync clamping to insure absolute sync hold.

The new chassis just released is now available at Niagara.

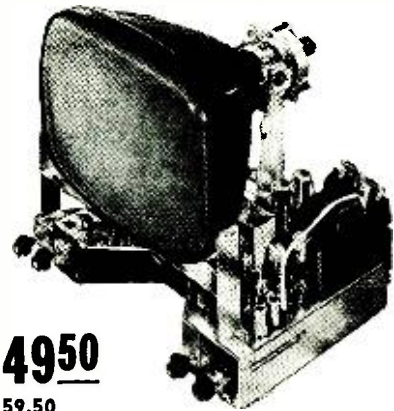

A SUPER PRICE \$14950

630 DX CHASSIS
Extra Power for FRINGE AREAS \$159.50

WHEELER SOUND POWERED HAND SETS \$9.62

NO OUTSIDE POWER REQUIRED • UP TO 25 MILES • SEND FOR WHEELER CATALOG 5E

BRAND NEW • MILITARY & MANUFACTURERS SURPLUS GUARANTEED PERFECT

TRANSFORMERS • CHOKES • COILS • VOLUME CONTROLS • SWITCHES

- Filament Transformer 115 VAC Primary 12V. — 1A., .89 ea. 10 for \$7.90
- Single 6V6 output to standard VC. .79 ea. 10 for \$6.90
- 8 hy choke 200ma. \$2.95 ea. 10 for \$24.50
- 10 hy choke 180 ma. \$2.49 ea. 10 for \$22.50
- 6 hy choke 40 ma. .44 ea. 10 for \$4.50
- Universal output — 6L6, 6V6, 25L6, etc. to any V.C. \$1.29 ea., 10 for \$10.00
- 8 hy at 40 ma., .49 ea., 10 for \$4.50
- Standard i.f., Black aluminum can, 262 KC. output, .89 ea., 10 for \$7.95
- Standard i.f., Black aluminum can, 262 KC. input, .89 ea., 10 for \$7.95
- Osc. coil, for 262 KC. 1F/365 mmfd. cond., .69 ea., 10 for \$5.95
- Standard IF 455 KC i.f. output, unshielded, .79 ea., 10 for \$6.95
- Standard IF 455/6 KC i.f. output, grey Hammett Alum. can., .99 ea., 10 for \$8.95
- Standard IF 455/6 KC i.f. input, grey Hammett Alum. can., .99 ea., 10 for \$8.95
- Standard Osc. coil 456 KC, unshielded, .39 ea., 10 for \$3.25
- Tapped OSC. coil 455/6 KC i.f., .44 ea., 10 for \$3.95
- Universal adjustable OSC coil, unshielded, .79 ea., 10 for \$6.95
- Antenna coils, midget, Standard, unshielded, .49 ea., 10 for \$3.95
- Used Low Imped. Head phones, HS 33, \$1.19 ea. pr., 10 for \$9.95
- ClaroStat Vol. control switches, SPDT., .19 ea., 10 for \$1.50
- Standard composition Vol. controls, any value, .69 ea., 10 for \$6.50
- Variable reluctance cartridge 78 rpm, \$2.75 each, 10 for \$25
- Variable reluctance cartridge 45, 33 1/3 rpm, \$3.50 each, 10 for \$32.50

REMOTE CONTROL FOR THE THING!!
(Plus \$1.00 Book Free)

The answer to the "Remote Control" experimenter's dream! A completely wired, 3 tube remote control unit, originally used as Electronic Brain for remote thermo-static control of electric blankets.

And that's not all! With each unit we will give you absolutely free, one copy of Gernsback Library's popular new book "Model Control by Radio."

Remote Control Unit, including 411, Xtfr., 300 ohm plate circuit, "Trigger" relay, completely wired, circuit diagram and above described book—less tubes.

ALL FOR ONLY..... **\$5.50**
Shipping Wgt. 3 Lbs.

WEBSTER-CHICAGO 100-75

AUTOMATIC 3 SPEED RECORD CHANGER WITH "FLIP-OVER" CARTRIDGE

One of their latest models. Plays 12, 10 or 7 inch records at 33 1/3, 45, or 78 R. P. M. New spindle carefully lowers unplayed record stack. Pickup arm comes to rest position after last record has played. Complete factory packed and sealed record changers, normally listing at \$47.50—While they last.

Shipping Wgt. **\$24.85**

ONE OF AMERICA'S GREAT RADIO STORES

Niagara

RADIO SUPPLY CORP. Dept. 5-E2

160 Greenwich Street, New York 6, N. Y.

Digby 9-1132-3-4

Save \$\$\$ On These TV BUYS OF THE YEAR

Rocket MOTORLESS TV ANTENNA

360° Electronically Switched Beam

- No Motors
- No Roof Orientation
- No Electric Power
- No Ghosts

AX-599 Direc-^{tronic} \$16.98

The Directronic 18 element, 360° antenna is the finest for ultrafringe and metropolitan reception. The HI-PAC molded insulator is a material of extreme tensile strength not affected by weather or temperature, either mechanically or electrically. Included in the AX-599 "Servicemen's Array" are:

- 18 Hi-tensile aluminum alloy elements
- 1 set of connecting stubs (3)
- Universal U Clamps for masts to 1 1/2"
- Directronic Beam Selector
- 75 feet of Tri-X Cable
- 1 stacked array per carton

AX-599 Directronic, 9 element Single... \$10.35
All above antenna prices include Tri-X Cable and Switch.
Extra Tri-X 3 Conductor Lead-In... 3c ft.
SOLD ONLY BY MAIL BY NATIONAL ELECTRONICS

Rocket YAGI

5 ELEMENT TV ANTENNA

Excellent Pictures in Fringe Areas

HIGH GAIN. Clearer, sharper, steadier pictures in Fringe Areas. Minimum interference from ghosts and noise due to a directive pattern. Five elements include one folded dipole, three directors, and one reflector. Supplied less mast. MATCHES 300 OHMS IMPEDANCE. Molded insulator provides additional strength. Exclusive design mast clamp prevents antenna turning or canting under any conditions. STURDY. TROUBLE-FREE CONSTRUCTION. No return calls. No broken elements. Stands the test of severest weather. Elements of extra heavy aluminum-clamped top and bottom. QUICK RIG. Completely pre-assembled. Just swing elements into line and tighten wing nuts. Simple & quick & easy. Available for any channel, high or low band.

Channels 2 and 3... \$7.95 each
Channels 4, 5 and 6... \$6.95 each
Channels 7 to 13... \$3.95 each

EACH CHANNEL requires a DIFFERENT Yagi. When Ordering specify exact channel number desired. **SOLD ONLY BY MAIL BY NATIONAL ELECTRONICS**

OTHER ANTENNA BARGAINS

ALL CHANNEL CONICALS
Single Bay... \$2.75 each
Stacked Array with Tie Rods... \$8.20 each

ALL CHANNEL FOLDED DIPOLE
ALL CHANNEL DOUBLE VEE... \$3.75

WORLD'S LOWEST ACCESSORY PRICES

TWIN LEAD 300 ohm #70 Mil. Solid... 13c ft. 300 ohm #60 Mil. 7-28 Stranded... 2c ft. 300 ohm #70 Mil. Solid-1000' reel... \$12.50 M	PANTHER TV LAMP 21 Inch Ebony or chartreuse... \$4.95
TELEMATIC ANTENNA SWITCH 3 position. Low loss... \$2.11	TELEMATIC COUPLERS Operates two 300 ohm receivers from one 300 ohm antenna... \$4.77

MAST STEEL (DUAL COATED) (5' crimped 1 1/4" O.D.)... \$1.05
Mast Steel (Dual Coated) 10' 1 1/4" O.D. ... \$1.95
Mast Steel (Zinc Plated) 10' 1 1/4" O.D. ... \$1.59
Mast Connectors for 1 1/4" O.D. Mast-10' Long... 49c
Chimney Mount Complete with Straps... \$1.15
PAM-9A Deluxe Chimney Mount... \$1.79
Peak Roof Saddle (Will take up to 1 1/2" O.D.)... \$1.49
Aluminum Guy Line 7-18 Stranded-100 ft. Coil... \$4.95
Galvanized Guy Wire 6 strand #20... 3c ft.
Galvanized Guy Wire 4 strand #20... 1.5c ft.
Mast Stand-Off Insulators-4" ... \$2.50 C
Stand-Off Screw Insulators-3" ... \$2.75 C
Stand-Off Screw Insulators-4" ... \$5.50 C
TC-8 3 Section Top Cowl 58" Auto Antenna... \$2.59
C-31 3 Section Side Cowl 63" Auto Antenna... \$1.95
Lightning Arrestor-TV... 69c

SOLD ONLY BY MAIL BY NATIONAL ELECTRONICS
PRICES SUBJECT TO CHANGE WITHOUT NOTICE
ALL PRICES F.O.B. CLEVELAND, OHIO
 Do not remit more than complete purchase price. Pay shipping charges on receipt of goods. 25% Deposit on C.O.D. orders, please. Money Back guarantee.

National Electronics OF CLEVELAND

THE HOUSE OF TV VALUES

205 Delco Building Cleveland 3, Ohio

THE FUND REACHES \$9,377.46

HELP-FREDDIE-WALK FUND

Herschel Thomason, radio technician of Magnolia, Arkansas, and father of little Freddie Thomason, who was born without arms or legs, has written RADIO-ELECTRONICS as follows:

"Freddie is sure getting to be a big boy now. He talks real good and is forming habits of helping himself. We feel he is going to be very independent when he grows up."

Those of us who have followed Freddie's progress and growth throughout the eighteen months that the Help-Freddie-Walk fund has been in operation will be heartened by this news.

The task of helping Freddie become a useful and well-adjusted citizen is an enormous one, one that demands the utmost in cooperation and encouragement, both financial and moral. To date, enthusiastic RADIO-ELECTRONICS readers have contributed almost \$9,400 to the fund, and all directly concerned with Freddie's welfare sincerely appreciate the kindness and generosity of his many unknown friends. However, we should like to take this opportunity to remind you that it will take many more thousands of dollars before the job will be well underway, for as Freddie continues to grow, so must the mechanical appliances upon which he depends. We know we can count upon each reader to help as he is able. Remember, no donation is too small to receive our sincere thanks and acknowledgment.

Please send your contributions from time to time. (Make all checks, money orders, etc., payable to Herschel Thomason.) Address all letters to:

Help-Freddie-Walk Fund
c/o RADIO-ELECTRONICS
25 West Broadway
New York 7, N. Y.

FAMILY CIRCLE CONTRIBUTIONS

Balance as of February 19, 1952... \$ 519.50
 Dennis Kevin Tamoson, age 17 mo., Hyattsville, Md. 2.00

FAMILY CIRCLE Contributions received to March 18, 1952... \$ 521.50

RADIO-ELECTRONICS CONTRIBUTIONS

Balance as of February 19, 1952... \$8,818.96

Anonymous, Red Bank, N. J. 5.00
 Anonymous, Williamstown, N. J. 3.00
 Leonardo Barrios, New York City ... 2.00
 William H. DePeau, Harrisburg, Pa. 10.00
 Meyer Dumanis, New York City 8.50
 Harris Radio Service, Decatur, Ala. 2.00
 Donald Norman, Newark, N. J. 1.00
 J. M. Roberts, Reno, Nevada 2.00
 Alexander Rys, Minneapolis, Minn... 1.00
 H. Weintraub, Bronx, N. Y. 2.00

RADIO-ELECTRONICS Contributions... \$8,855.96
FAMILY CIRCLE Contributions... 521.50

TOTAL CONTRIBUTIONS to March 18, 1952... \$9,377.46

ECONOMY KITS

- 50 Mica Condensers, assorted... \$2.50
- 100 Resistors-1/2, 1, & 2 watts... 2.85
- 30 By-Pass Condensers... 2.75
- 50 R.F. Chokes... 1.85
- 2 lbs. Hook-up Wire... 1.00
- Potentiometers-15 types... 2.25
- BC-408 24V DC Antenna Relay... 4.50
- BC-412 Antenna Relay without Condenser... 1.75
- BC-471 Control Box... 1.45
- BC-456 Modulator with tubes & dynamotor... 4.25
- BC-37-BRAND SW with tubes... 4.85
- Turbo Amplifier, less tubes... .98
- T-30 Throat Mike with PL 290... .35
- T-17 Microphone... .35
- FL-7 Filter... 2.00
- FL-8 Filter... 3.00
- Capacitor 250 MFD 200 WV... 1.25
- Paral capacitor-430V 60 cy 1.75 MFD... 1.50
- Mica Compression Trimmers-15 for... 1.00
- Microw Switches... .25
- Multi Outlet Box-10 ft. cord, switch, fuses, pilot light & 8 outlets... 5.95

TERMS-Send 25% deposit with order, balance C.O.D. Shipped F.O.B. N.Y.C. N.Y.C. residents add 3% sales tax.

B & W SALES CO.
 169 Chrystie St., N. Y. 2, N. Y.

500 FORMULAS TO SUCCESS

MANY million dollar firms started with a single formula, for which they paid a big price. Here you have 300-nc less-tried and tested formulas, recipes and processes for making things... all at the ridiculously low price of 25c. Here is your opportunity to start a business with but a few dollars capital and with undreamed of profits in prospect. You can also use these formulas in your own home to cut household expenses to the bone. Or you can put them to use in your workshop to cut costs as much as 100%.

Quit paying out many dollars in profits to manufacturers, wholesalers, and dealers, and work for yourself with the same thing yourself for a few cents. It's so easy when you follow our simple instructions.

66 PAGES, 47,000 WORDS IN TEXT
 Send for "500 FORMULAS AND RECIPES" today. Enclose 25c, that's all you won't be asked for another cent now or later. Sold on a money-back guarantee.

NATIONAL PLANS COMPANY
 1966R Broadway, New York 23, N. Y.

OPPORTUNITY AD-LETS

Rates-35¢ per word (including name, address and initials). Minimum ad 40 words. Cash must accompany all ads except those placed by accredited agents. Discount for 6 issues, 10%; for 12 issues, 20%. Misleading or objectionable ads not accepted. Copy for June issue must reach us before April 21, 1952.

Radio-Electronics, 25 W. Broadway, New York 7, N. Y.

SPEAKERS REPAIRED at wholesale prices. Guaranteed workmanship. Fast service. Amprite Speakers Service, 70 Vespy St., New York 7, N. Y.

MINIATURE RADIO, weight 8 oz. with batteries. Write for prices. Also plans all wave radio using hearing aid parts. 25c. Glen Ecker, 10 East Orange Grove, Pasadena, California.

WE REPAIR, CONVERT, SELL, ALL TYPES OF electrical instruments, tube checkers and analyzers. Hazleton Instrument Co. (Electric Meter Laboratory), 128 Liberty Street, New York, N. Y. Telephone-LA 9474

WANTED-TOP PRICES PAID-Navy Selsyn IE, IG, ICT, 5F, 5G, 5AT and BC-348, BC-221, AN-ART-13, AN/ARC-1, AN/ARC-3, RTA-1B, Electronic Research, 719 Arch St., Philadelphia.

WANTED: AN/APR-1, other "APR", "TS", "TE", "ARC-1, ARC-3, ART-13, BC-348, etc. Microwave Equipment, everything Surplus, Special tubes, Tec Manuals, Lab Quality Equipment, Meters, Fast Action, Fair Treatment. Top Dollar! Littell, Farhills Road 26, Dayton 9, Ohio.

"REPAIR YOUR OWN RADIOS" TELLS HOW. \$1.00 post paid. Information free. Slate's Radio Service, Corsicana, Texas.

INFORMATION \$1.00, 17 yrs. experience. Tubes 50%. Free List Television Radio, 25 N. Sarah St., St. Louis.

TV AND FM ANTENNAS, YAGI, CONICAL, BOW-TIE Mounts, accessories. Lowest prices. Wholesale Supply Co., Lunenburg 2, Mass.

\$3.00 FOR CARTOON IDEAS

RADIO-ELECTRONICS prints several radio cartoons every month. Readers are invited to contribute humorous radio ideas which can be used in cartoon form. It is not necessary that you draw a sketch, unless you wish.

Address
RADIO-CARTOONS,
RADIO-ELECTRONICS
25 West Broadway,
New York 7, N. Y.

\$3.00 FOR CARTOON IDEAS

RADIO-ELECTRONICS prints several radio cartoons every month. Readers are invited to contribute humorous radio ideas which can be used in cartoon form. It is not necessary that you draw a sketch, unless you wish.

Address
RADIO-CARTOONS,
RADIO-ELECTRONICS
25 West Broadway,
New York 7, N. Y.

Over a Million RELAYS!

This list represents only a small part of more than a million relays in our stock — one of the world's largest. All relays are standard make, brand new in original packing, and fully guaranteed by Relay Sales. Send us your relay requirements. We can make immediate delivery at substantial savings in cost to you.

IMMEDIATE DELIVERY!

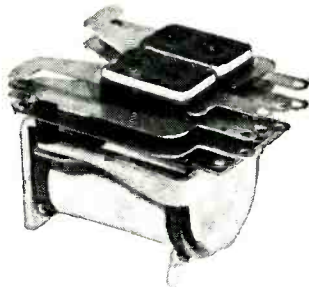
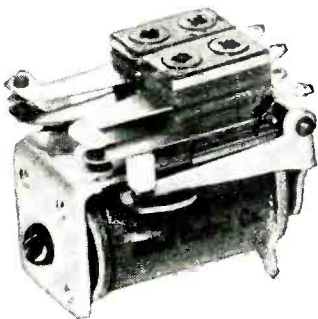
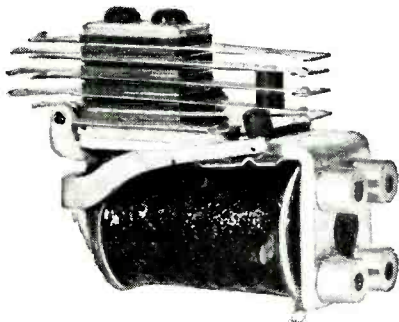

Midget Relays

STK. NO.	VOLTAGE	OHMAGE	CONTACTS	MFG. & NO.	UNIT PRICE
R-416	4 VDC.	9	1C @ 1.5 AMP.	ADVANCE 16035	\$1.65
R-378	6 VDC.	100	1A @ 1.5 AMP.	ADVANCE 1601S	1.50
R-850	12 VDC.	450	1A @ 1.5 AMP.	ADVANCE 1601	1.50
R-379	19/27 VDC.	250	2A @ 1.5 AMP.	ADVANCE 1605	1.65
R-694	24 VDC.	300	1A @ 5 AMP.	ADVANCE 1601A	1.50
R-935	28 VDC.	1000	1C @ 1.5 AMP.	ADVANCE 1603S	1.65
R-572	24 VDC.	256	1C	AIRCRAFT RADIO CORP.	1.25
R-857	24 VDC.	260	1 MAKE BEFORE MAKE	AIRCRAFT RADIO CORP. 9453	1.75
R-912	4/5 VDC.	20	3A-1C CERAMIC	ALLIED TX50	1.45
R-291	6 VDC.	5	1A	ALLIED .73A71	1.25
R-921	6.7 VDC.	18	1A Dbl. Brk. @ 10 amp.	ALLIED CRX-11	1.45
R-738	12 VDC.	60	3A	ALLIED TX3A	1.20
R-922	12 VDC.	75	1A Dbl. Brk. @ 10 amp.	ALLIED CRX-13	1.45
R-144	12 VDC.	228	1A	ALLIED D-283486	1.45
R-696	24 VDC.	230	1A @ 8 AMP.	ALLIED 55837	2.00
R-145	18/24 VDC.	250	2A CERAMIC	ALLIED 7252	1.45
R-723	24 VDC.	280	1C	ALLIED 7251	1.50
R-298	21 VDC.	300	1A	ALLIED CB-5	1.25
R-296	21 VDC.	300	1A	ALLIED CA-5	1.25
R-586	21 VDC.	300	1A & 1C	ALLIED 73A-69	1.25
R-142	24 VDC.	400	2C	ALLIED 73A50	1.50
R-785	24 VDC.	200	2C @ 10 AMPS.	AUTO. ELECT. ZH-37169-1	2.00
R-375	24 VDC.	200	2A heavy duty	AUTO. ELECT. H-87063-1	1.75
R-373	12/20 VDC.	225	1A split	AUTO. ELECT. SQA	2.50
R-370	12 VDC.	75	1C	AUTO. ELECT. MANKATO R-25	2.30
R-607	24 VAC.	INT.	1A	AUTO. ELECT. MANKATO R-45-D	1.20
R-606	24 VAC.	INT.	1A & 1B	AUTO. ELECT. MANKATO R-45-F	1.20
R-605	24 VAC.	INT.	3A	AUTO. ELECT. MANKATO R-45-G	1.20
R-374	24 VDC.	300	2A heavy duty	BETTS & BETTS RAC-15AS	1.75
R-728	6 VDC.	30	1A	CLARE A-26690	1.25
R-149	6/8 VDC.	45	1B	CLARE A-20545	1.50
R-732	12 VDC.	120	1A	CLARE A-25454	1.45
R-281	12 VDC.	126	2A	CLARE A-13415	1.25
R-347	18/24 VDC.	300	1A	CLARE A-19469	1.10
R-376	24 VDC.	300	1A	CLARE K	1.25
R-818	18/24 VDC.	300	1B	CLARE A-8058	1.30
R-133	24 VDC.	300	NONE	CLARE A-20388	.75
R-348	18/24 VDC.	300	2A	CLARE A-16734	1.15
R-138	24 VDC.	300	4A	CLARE A-16280	1.45
R-349	18/24 VDC.	300	1C	CLARE B-16947	1.25
R-377	24 VDC.	300	1C	CLARE B-22441	1.45
R-132	24 VDC.	300	2C	CLARE A-16265	1.55
R-731	24 VDC.	300	2C	CLARE A-16265	1.55
R-492	24 VDC.	300	4C 1A	CLARE A-22717	1.55
R-626	24 VDC.	400	1A @ 5 AMPS.	CLARE A-12408	2.00
R-786	60 VDC.	1300	2C	CLARE K	1.95
R-415	60/85 VDC.	1800	2A	COOK 418	1.75
R-371	2 VDC.	30	1C Ceramic	COOK 55340	1.45
R-755	24 VDC.	300	1A	E. Z. ELECTRIC	1.50
R-150	6 VDC.	30	1A	G. E. 55526	2.50
R-893	14 VDC.	150	1A, 1C	G. E. 55531	2.50
R-895	14 VDC.	150	2A, 1B, 1C	G. E. 55589	2.50
R-896	24 VDC.	260	2A	GUARDIAN 36761	1.50
R-959	24 VDC.	747	2C	LEACH P-501424	1.20
R-693	2/6 VDC.	125	1C @ 3 AMP.	LEACH P-3	1.25
R-947	12/24 VDC.	320	1C @ 3 AMP.	LEACH P-3	1.35
R-692	6/24 VDC.	1280	1C @ 3 AMP.	PAUL HENRY 1010	1.45
R-856	18/24 VDC.	300	1B	PRICE BROS.	1.45
R-913	6 VDC.	20	3A, 1C CERAMIC	PRICE BROS.	2.00
R-915	12 VDC.	70	1A Dbl. Brk. @ 10 amp.	PRICE BROS.	1.85
R-148	12 VDC.	100	2C & 1B	POTT. & BRUM.	1.00
R-222	12 VDC.	100	2A	RBM	1.45
R-834	6 VDC.	20	3A, 1C		

OTHER RELAY TYPES IN STOCK

- Keying Relays
- Rotary Relays
- Contactors
- telephone Relays
- Voltage Regulators
- Differential Relays
- Sealed Relays
- Special Relays

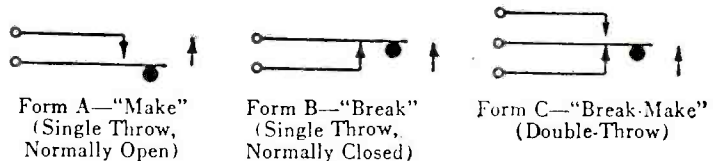

Manufacturers and Distributors:
Write for the new Relay Sales Catalog.

Telephone
SEELEY 8-4146

833 W. CHICAGO AVE., DEPT. 10, CHICAGO 22, ILL.

STOP

those costly TV service calls with ...

ELECTRO CHEMICALS

• ANTENNA KOTE • CORONA-X
• CONTACT CLEANER

ANTENNA KOTE—Our newly developed chemical compound for safely coating all exposed exterior television connections. Non-electric conductor. Eliminates use of tape. Non-corrosive, weatherproof and oil-proof. Brush attached to cap of bottle.

CONTACT CLEANER—A fast drying combination of special solvents that offers a great cleaning solution. Recommended for treating volume controls, band switches, tuning condensers, etc. Leaves a non-corrosive film on contacts after drying. Brush attached to cap of bottle.

CORONA-X—The new and superior product used to control and prevent corona arc discharge on high voltage circuits in television. Has excellent high voltage insulating qualities. Easy to apply. Air dries. Brush attached to cap of bottle.



A Complete Line of Electronic Chemicals
Exclusive territories for sales representatives
Write for circular "R-5"

DAKOLINE CHEMICAL CO., INC.
ELECTRONIC CHEMICALS DIVISION
357 ATLANTIC AVE., BROOKLYN 2, N. Y.

FIRST AID FOR TV SETS!

H. G. CISIN'S "TV DOCTOR"
Shows you how to fix TV sets RAPIDLY!



Save money—do a better job faster, with a really practical TV book. An amazing, quick, copyrighted method of fixing TV troubles. Written by a noted inventor and educator, H. G. Cisin, in plain language.

MAKES TV SERVICING EASY!
TUBES CAUSE 80% OF TV TROUBLES
TV DOCTOR QUICKLY LOCATES ALL BAD TUBES WITHOUT EXPERIENCE—PICTURES & TEXT SHOW YOU THE QUICK, EASY WAY TO FIX FAULTY TV SETS

Reveals many closely guarded **TRADE SECRETS**. Lists over 123 trouble conditions. Method applies to all TV sets from oldest to newest.

11 money-making, fact-crammed, detailed, illustrated chapters include: practical ways to combat interference and ghosts; how to appraise TV sets; valuable information on antennas, lead-ins, color, practical—not theoretical—pointers on TV sets; ion traps, tubes used in TV; mics' addresses—a veritable encyclopedia.

Only \$1—you'll say it's worth hundreds.
5-DAY MONEY-BACK GUARANTEE

FREE SPECIAL OFFER

Get a now, full-size, profusely illustrated, \$1 book—"TV TROUBLE PICTURE GUIDE IN CLUING TV TERMS SIMPLY EXPLAINED"—as a **FREE GIFT**, by ordering the "TV DOCTOR" and H. G. Cisin's famous "TV TROUBLE SHOOTING METHOD," which trains you to be a TV diagnostician, selling for \$1. Think of it—all 3 TV books postpaid for only \$2—you save \$1.

\$1 Post-paid

H. G. CISIN, Consulting Engineer (Dept. E-14)
200 Clinton Street, Brooklyn 2, N. Y.

- Enclosed find \$2, full payment for "TV DOCTOR" & "TV TROUBLE SHOOTING METHOD" PLUS my FREE copy of "TV TROUBLE PICTURE GUIDE." Rush all three books postpaid.
- Enclosed find \$1, full payment for "TV DOCTOR." Rush copy postpaid.

Name.....
Address.....
City..... State.....

ELECTRONIC LITERATURE

Any or all of these catalogs, bulletins, or periodicals are available to you on request direct to the manufacturers, whose addresses are listed at the end of each item. Use your letterhead—do not use postcards. To facilitate identification, mention the issue and page of RADIO-ELECTRONICS in which the item appears. All literature offers void after six months.

SYLVANIA LITERATURE

Sylvania offers a number of useful booklets to the engineer and service technician. Following are a few which may be obtained without cost:

No. 211: "Radio Tube Characteristics." Standard receiving tubes, sub-miniature types, and germanium rectifiers are listed with characteristics and base diagrams.

No. 213: "Transmitting Tube Characteristics." Characteristics and base diagrams of tubes used in commercial and amateur transmitters are given.

No. 216: "Television Picture Tubes and General-Purpose Cathode-Ray Tubes." Technical and physical data on all types of cathode-ray tubes.

No. 217: "Electronic Tubes." Electrical specifications on Strobotrons, flash tubes, glow modulators, thyratrons, Pirani tubes, selenium rectifiers, and silicon and germanium diodes.

No. 229: "Tube Substitution Manual." Lists possible substitute tubes for TV, radio, and electronic equipment with electrical and physical alterations which may be necessary.

Available from *Sylvania Electric Products, Inc., Electronics Division, 1740 Broadway, New York 19, N. Y.*

RADIO & TV REPAIRS

The Feiler Engineering Co. is distributing its new revised edition of "How to Simplify Radio and TV Repairs." Helpful general facts on radio and TV servicing and the advantages of the signal-tracing technique.

Available upon request to *Feiler Engineering Co., 8026 N. Monticello Ave., Skokie, Ill.*

HALLDORSON CATALOG

Catalog No. 20 is a transformer replacement guide for TV and home and auto radios produced by leading manufacturers as well as a listing of the Halldorson line of transformers, chokes, vibrators, deflection and focus coils, and Varivolt adjustable-voltage isolation transformers.

Available gratis from *The Halldorson Co., 4500 Ravenswood Ave., Chicago, Ill.*

TUBE TESTER CHART

A new tube roll chart for Hickok tube testers is now available. Dated January 1, 1952, this chart includes all the new tubes on which data was available at the time of printing.

Price \$1.00 from *The Hickok Electrical Instrument Co., 10531 Dupont Ave., Cleveland 8, Ohio.*

—end—

for dependable sound,
INDUSTRY relies on
ATLAS



DR Double-Reentrant Projectors

DEPENDABLE QUALITY:

The latest electro-acoustic research and engineering—and over 20 years of manufacturing know-how—are behind every ATLAS product.

DEPENDABLE SERVICE:

Coast-to-coast and around the world today—in every Industrial, Marine, Railroad, Military, Educational, Civic, U.S. and Foreign Government application—under every kind of climate and noise condition—ATLAS sound equipment is famous for highest efficiency and durability. That's the proof of ATLAS performance dependability.

DEPENDABLE DELIVERY:

Yes, ATLAS gives our Government highest priority. And yes, we too feel the pinch of material shortages. But our customers will continue to get our usual dependable delivery—because we believe in equitable and dependable distribution to all ATLAS users.

DEPENDABLE PROFITS:

Completeness of line, excellence of product, dependable delivery, right prices—that's the ATLAS combination that means high, steady Industrial Sound profits for You!

JUDGE for yourself, COMPARE ATLAS at your local Jobber today. See why ATLAS is the preferred line for utmost dependability. Write NOW for FREE latest Catalog 551.



Paging & Talk-Back Speakers



ALNICO-V-PLUS Driver Units



Dual Speakers

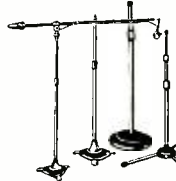

FULL-GRIP, VELVET-ACTION Mike Stands

ATLAS SOUND CORP.

1443-39th Street, Brooklyn 18, N. Y.
In Canada: Atlas Radio Corp., Ltd., Toronto, Ont.

THIS AD MAY BE SMALL—BUT IT CAN MEAN B-I-G MONEY TO YOU!

I want to buy BC-348, BC-342, BC-312, ARC-1, BC-788, I-152, T-17 MICS, ART-13, BC-221 or any parts thereof, no matter how small. In fact, I'll buy anything. I'm not kidding! Let me prove it!

Wire or write: **BOB SANETT**
4668 Dockweiler, Los Angeles, Calif.
Telephone: YORk 4637

PARTS—TUBES—KITS

50L6—.88; 35Z5—.50; 6SN7—.88; 5V4G—.99; 6J6—\$1.00. Standard Brand—Fully Guaranteed. Stanyewicz TV Coil Kit—List \$12.95—Special \$3.95
20" TV Kit \$65.00 Less Tubes. Write for free catalogue. Minimum order \$5.00 F.O.B. N. Y. Money-back guarantee. Send 20¢ with order.

CERTIFIED TELEVISION LABORATORIES
Dept. C, 5507-13th Ave., Brooklyn 19, N. Y.

People

Dr. W. R. G. Baker, General Electric vice-president and general manager of the G-E ELECTRONICS DIVISION at Syracuse, N. Y., was awarded the Medal of Honor of the I.R.E. at its annual convention in New York City. The medal, the highest honor of the Institute, was presented to Dr. Baker for distinguished service rendered in the science and art of radio communication.

William J. Doyle, for many years general sales manager of the ASTATIC CORP., Conneaut, Ohio, was appointed vice-president in charge of sales, according to an announcement by L. D. Cahoon, president of Astatic.

Bruce E. Vinkemulder was appointed distributor sales manager of the Capacitor Division of SANGAMO ELECTRIC CO. Mr. Vinkemulder was formerly in charge of engineering publications for electronic equipment manufactured by Sangamo. He will make his headquarters at the Sangamo capacitor plant in Marion, Ill.

Matthew D. Burns was appointed general manager of the Radio Tube Division of SYLVANIA ELECTRIC PRODUCTS, INC. His headquarters will be at Emporium, Pa., home of the Division. Mr. Burns was formerly general manufacturing manager of the division. Walter A. Weiss, formerly manager of the division's receiving tube plant in Burlington, Iowa, succeeds Mr. Burns as general manufacturing manager.

Sylvania also announced the appointment of its vice-president, C. A. Haines, as head of a new exchange department to supervise the planning of plant expansion. Mr. Haines was formerly in charge of operation of the Radio and Picture Tube Division.

Ray Whitmore, district sales manager at Syracuse for the AMERICAN PHENOLIC CORP., Chicago, was placed in charge of the company's new offices in the Empire State Building, New York City. The office will handle industrial sales only. Walter B. Wasson, formerly of the Chicago office, was placed in charge of the Syracuse office.

William B. Tanner was appointed director of advertising, in charge of an enlarged Advertising Department formed by AEROVOX, New Bedford, Mass. The new department will handle all advertising and publicity for Aerovox, including the Hi-Q division and Wilker Products, Inc., a subsidiary. Mr. Tanner was formerly advertising and personnel manager for the Hi-Q Division of Aerovox. He will transfer his headquarters from Olean, N.Y., to New Bedford, Mass. Fred P. Donati, advertising manager of Aerovox will assist Mr. Tanner in handling the advertising of all the company's divisions and subsidiaries.

Louis H. Niemann was appointed eastern sales manager of HYTRON RADIO & ELECTRONICS Co., Salem, Mass. He succeeds Fred Garcelon who was promoted to assistant to John Q. Adams, Hytron vice-president in charge of sales. Mr. Niemann comes to the company from Sylvania Electric Products, Inc.



DR. W. R. G. BAKER



W. J. DOYLE



B. E. VINKEMULDER



M. D. BURNS



R. WHITMORE

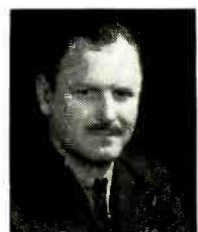

W. B. TANNER



L. H. NIEMANN

... and TV ANTENNAS too!

Amphenol has long been recognized as one of the world's leading manufacturers of radar and communications antennas for civilian and military use. When Amphenol's famed team of engineers originated the Inline Antenna, they incorporated into their design the best in mechanical and electrical characteristics that years of antenna research had developed.

In the almost four years since the Amphenol Inline Antenna was originated, many other types of antennas have come into the TV market. Comparison with the manufacturers' own test data and reports reveal that the Amphenol Inline is still the superior all-channel TV antenna.

AMERICAN PHENOLIC CORPORATION
1830 SOUTH 54th AVENUE • CHICAGO 50, ILLINOIS

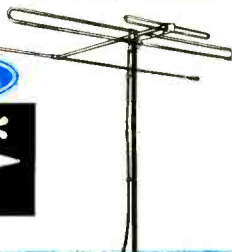

Personnel Notes

... Paul A. Walker was named chairman of the FCC. Robert T. Bartley was appointed to fill the vacancy on the commission created by the resignation of Wayne Coy.

... William L. Rollins was named vice-president in charge of industrial sales for CRESCENT INDUSTRIES, INC., Chicago. Mr. Rollins has been with Crescent for over 13 years. The company also announced the appointment of Edward M. Gietl as manufacturing manager. He will be in complete charge of the production of speakers, record changers, and allied products.

... R. W. "Bill" Woodbury, a veteran West Coast parts distributor, joined the field staff of SPRAGUE PRODUCTS Co., North Adams, Mass. He will call on Southern California distributors.

... Don E. Larson, advertising manager of HOFFMAN RADIO CORP., Los Angeles, and chairman of the Publicity and Publication Committee for the 1952 Western Electronic Show and Convention, appointed the following committeemen: James L. Fouch, Cinema Engineering Co.; Byron Cole, Packard-Bell Co.; and Lloyd Sigmon, KMPC.

... James A. Sullivan, a veteran in sales and engineering positions in the electronics field, joined the sales staff of OXFORD ELECTRIC CORP., Chicago speaker manufacturer. He will work directly under Hugo Sundberg, vice-president and manager.

... Joseph Maresca was appointed assistant to Bernard L. Cahn, general sales manager of the INSULINE CORP. OF AMERICA, Long Island City, N. Y. He will continue to act as manager of the Sales Order Department.

... Leslie E. Woods, director of industrial relations at RAYTHEON MANUFACTURING Co., Waltham, Mass., was ap-

Finest **TV CHASSIS** complete with **TUBE!**

12 $\frac{1}{2}$ " picture tube with complete chassis including:

- beautiful bronze metal mask
- permanent magnet 12" speaker
- all tubes aligned perfectly
- ideal for fringe areas ... works better than other receivers and where others can't
- ultra-sensitive fringe area tuner
- standard 90 day guarantee on all tubes and parts
- full band reception and output
- gated AGC—finest automatic gain control
- **COMPLETE ... READY TO OPERATE**

complete, including the picture tube, licensed by R C A **\$89.50**

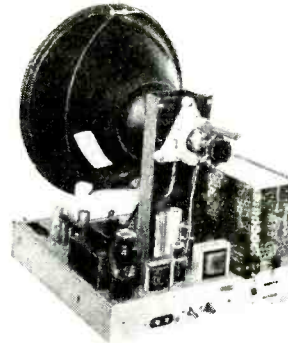

Fringe Area Double "V" TV ANTENNA ... complete with all hardware, 300 ohm line and 9 ft. mast **\$7.95**

16" picture tube with complete chassis including:

- gated AGC—finest automatic gain control
- full band reception and output
- standard 90 day guarantee on all tubes and parts
- ultra-sensitive fringe area tuner
- ideal for fringe areas ... works better than other receivers and where others can't
- all tubes aligned perfectly
- permanent magnet 12" speaker
- beautiful bronze metal mask
- **COMPLETE ... READY TO OPERATE**

complete, including picture tube, licensed by R C A **\$129.50**

CUSTOM-BUILT CABINETS

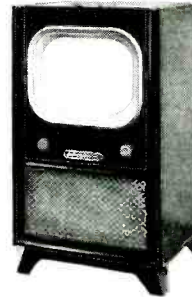

Beautifully designed console cabinets with luxurious mahogany finish ... dimensions: 38" High x 22 $\frac{1}{4}$ " w. x 18 $\frac{1}{4}$ " d. Fits 12 $\frac{1}{2}$ " and 16" tube (specify size when ordering)

ONLY \$44.95

20% deposit with order; balance C.O.D.; Ship F.O.B. Chicago; **SATISFACTION GUARANTEED**; Illinois residents add 2% sales tax.

THERE IS A LIMITED QUANTITY . . . ORDER TODAY!

Concert Master Radio & Television Company 549 W. Randolph Street Chicago 6, Illinois ANdover 3-1591

Every RADIOMAN can use these SERVICE HINTS!

Valuable Manual Yours—FREE Write today—no obligation

FEILER ENGINEERING CO. Dept. 5RC2-1 8026 N. Monticello Ave., Skokie, Ill. (Suburb of Chicago)

Every page of "How to Simplify Radio Repairs" is packed with on-the-bench, practical ideas.



221K VTVM KIT \$25.95

Another Outstanding Jobber **TROJAN RADIO CO., Inc.** 420 River Street Troy, N. Y.

has all 17 **KITS & INSTRUMENTS** in stock!



See EICO ad on Page 27

Largest Selling Booster

AT ANY PRICE !

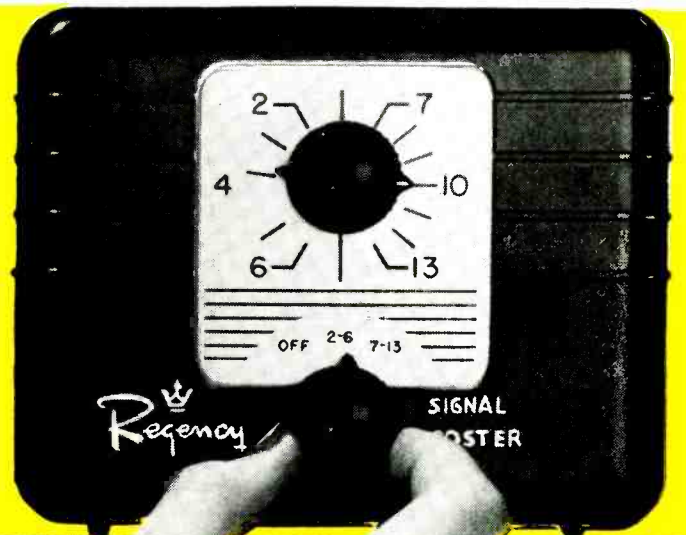

Regency

COMPARE THIS NEW ULTRA PORTABLE TAPE RECORDER



The MAGNEMITE* MIGHTY MIDGET BATTERY-OPERATED TAPE RECORDER

Compare the Magnemite* with other so-called portable recorders. Self-powered by inexpensive batteries that last and last. Always ready for instantaneous use—in or away from home, office or studio. Yes, the Magnemite* is America's first truly portable tape recorder.

Net Factory Price \$189.50

Supplied with tubes; batteries; microphone; crystal earphones; reel of tape; takeup reel; instructions.

*Trade Mark Reg. Order today, or write for additional literature to:

AMPLIFIER CORP. of AMERICA • 398 Broadway • New York 13, N. Y.

Compare the Weight
Pounds lighter than any other tape recorder.

Compare the Size
Measuring only 11½ x 8½ x 5½ inches it's actually the world's smallest tape recorder.

Compare the Motor Drive
Driven by constant-speed spring-wound motor that runs 15 minutes per winding. A tremendous advantage over variable speed DC motors.

Compare the Battery-Operation
100 operating hours per set of inexpensive dry cell batteries. No wet cells to recharge daily.

Compare the Playback
Yes, a playback preamplifier actually built-in. Listen through earphones or external amplifier.

Compare the Price
More features than other portable recorders, yet a far lower price. Reason? Our direct selling policy and expanded production facilities.

Compare the Long Play
Two full hours of economical dual-track recording on standard 5-in. reels at 1⅞ in. per sec.

pointed a member of the New England Regional Labor-Management Committee for Defense Manpower.

... M. R. Fieldman, connected with transformer sales operations for several years, was appointed sales manager of THE HALLDORSON CO., Chicago.

... Dr. P. S. Christaldi, former engineering manager of the Instrument Division of ALLEN B. DU MONT LABORATORIES, Clifton, N. J., was promoted to the post of assistant division manager. Other promotions included G. Robert Mezger to engineering manager, Emil G. Nichols to technical sales manager, and Melvin B. Kline and William G. Fockler to assistant engineering managers.

... Roy Steele was appointed advertising manager of WELLS SALES, INC., Chicago.

... Roy W. Augustine, research engineer for the MUTER COMPANY, Chicago, was presented a certificate of appreciation by the Department of the Army for his European electronic research conducted during the last year of World War. II.

... Caywood C. Cooley and Carl W. Schmelzle were appointed sales manager and assistant sales manager, respectively, of the JERROLD ELECTRONICS CORP., Philadelphia. Mr. Cooley was formerly chief field engineer, and Mr. Schmelzle was associated with Philco.

... I. L. Brandt joined TAYLOR TUBES, INC., Chicago, as chief engineer. He was previously with Continental Electric Co.

... Arthur J. Costigan, vice-president in charge of communications of the RADIOMARINE CORP. OF AMERICA, New York City, was presented the Marconi Memorial Medal of Achievement at the 27th Anniversary Dinner of the Veteran Wireless Operators Association held in New York City.

... Willis C. Toner was appointed manager of SYLVANIA ELECTRIC PRODUCTS' Television Picture Tube Division plant at Seneca Falls, N. Y. He was formerly plant manager at the Ottawa, Ohio, plant where he was succeeded by Gordon L. Fullerton, formerly manufacturing superintendent there. Homer D. Broker, former plant manager at Seneca Falls, was transferred to Boston as staff assistant to the divisional manufacturing manager.

—end—





MCA-743 UNIVERSAL MAST COUPLER

A universal mast coupler, made of PENNALOY (an aluminum alloy that is strong, durable and will withstand the most severe weather conditions). Will couple tubing up to 1¼" O.D. Has cone-pointed set screws that drive into the tubing to secure it to the coupler. Has the PENN patented Floating Guy Wire Ring, that will permit orientation of mast, while permanently guyed. Guy Wire Ring has special lubricant that will not freeze or melt only at 70 degrees below zero and 400 degrees above zero. Individually boxed and shipped 12 to master carton.



Meet us at BOOTH #124 at the 1952 Electronic Parts Show



3336-38-40 Frankford Ave.,
Phila. 34, Pa.

TRAIN AT HOME FOR UHF-TV AND

TELEVISION SERVICING

Learn practical, professional type TV Servicing without leaving your present job. Included are money-making extras such as set conversion, master antenna installation, UHF-TV, field servicing short cuts. You can start earning Television money after first few lessons. You learn to test, trouble shoot and repair all types of TV sets.

HERE'S HOW YOU GET EXPERIENCE!

You train on a large screen, modern TV receiver, furnished with the course and yours to keep! As an optional feature you can get two weeks actual experience with Chicago's largest independent servicing organization. *You learn by doing! Age is no barrier. Many students are over 50!* **ACT NOW!** Send for FREE Catalog and SAMPLE LESSON today!

TELEVISION COMMUNICATIONS INSTITUTE
205 W. Wacker Dr., Dept. RE-9, Chicago 6, Ill.



MAIL NOW FOR FREE BOOKLET

MILTON S. KIVER, President
TELEVISION COMMUNICATIONS INST.
205 W. Wacker Dr., Dept. RE-9, Chicago 6, Ill.
Rush FREE Catalog and Sample Lesson. I am not obligated. Salesman will not call.

Name..... Age

Address

City..... Zone..... State

BEGINNERS check here for Pre-TV Radio Course.

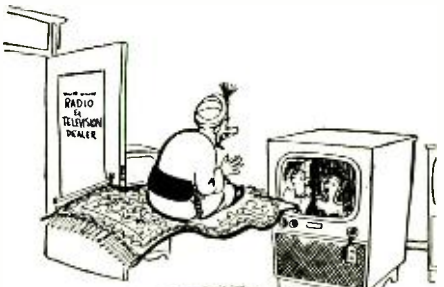

Glenko

"Amazing!"
Suggested by Robert W. Gluckstein
Menominee Falls, Wis.

RADIO-ELECTRONICS

TV DX IN LARAMIE

Dear Editor:

I feel that I owe you a note of thanks for your articles on TV dx. They were interesting enough to cause me to go out and see if I could find a receiver. The local music store had two Admiral 20X1 chassis stored upstairs. They had received them in a shipment of combinations and had taken the TV chassis out, converting the space to record compartments. No one wanted them, so I took home both for only \$50 each. All they needed were speakers (which the junk box promptly furnished).

The same night I hooked up one receiver to a two-bay folded-dipole-and-reflector array cut for the FM band. I didn't even know what all the controls were for, but 20 minutes later I heard San Francisco on channel 4, though I got no picture. That was around 7 p.m. and it lasted for about 30 minutes.

This took place in January, and for the next two months I kept the set on from 9 a.m. till midnight. I got frequent bursts of voice and music but never got a picture. Finally the little woman made me take the apparatus out of the house.

I dug up back issues of RADIO-ELECTRONICS and started studying TV circuits and antennas in earnest. After reading your dx reports and articles, I told my friends to sit tight; that along about June or July I would show them some pictures via sporadic-E.

June 8 I lugged the set back into the house and hooked it up to a channel-4-and-5 twin Yagi.

The next morning after breakfast I turned on the set and sat down to read the Sunday paper. As soon as the set warmed up all hell broke loose—all channels were full of music and pictures! They were the first TV pictures I had ever seen and in the next hour the house was full of people all wanting a look.

In the next two months there was hardly a day when one or more TV programs were not received. Altogether 30 stations were picked up, from as far east as New York City and Richmond, Virginia and from the west coast as well as the central states.

All stations had to show a picture for 5 to 10 minutes or they were not considered as logged. The West Coast, Texas, Chicago, Tennessee and Michigan stations usually gave programs from 30 minutes to several hours with very powerful signals. In fact the contrast had to be turned way down to bring out any detail. All stations were in the low band, with the greatest number on channel 4.

Laramie is down in a valley, with Sherman Hill 12 miles to the east at about 7,850 feet elevation, and the Snowy Range 30 miles to the west. The nearest TV station is in Salt Lake City, about 400 miles west. The antennas used for most of the reception were: a stacked channel 4 folded dipole with reflectors, and a single-channel 2-dipole and reflector, both on the same mast. One Admiral was hooked to each array using separate transmission lines.

NOW, for the REPLACEMENT FIELD

QUAM
Tru-Match

OUTPUT TRANSFORMERS

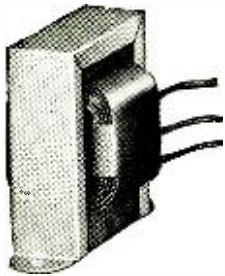

Engineered by Sound Equipment Experts

A Complete Series of Single Purpose Units designed to service any replacement requirement.

- Highest Quality Electrical Steel Stock
- Maximum Copper per windings
- Highest Quality Insulation
- Underwriter Approved Leads
- Complete Vacuum Impregnation

WRITE FOR CATALOG

QUAM-NICHOLS CO.

521 E. 33rd Place Chicago 16, Ill.

Also Manufacturers of Quam Adjust-a-Cone Speakers, Quam Focalizer Units and Quam Ion Traps

WANTED WE NEED YOUR SURPLUS ELECTRONIC EQUIPMENT
 WE PAY TOP \$\$\$ FOR:
 RADIO RECEIVERS CLAMPS PLUGS CORDS RELAYS TELEPHONE MATERIALS
 TRANSMITTERS
 ARC-1
 ARC-3
 ART-13
 CONTROL BOXES INDICATORS AN CONNECTORS
 WE BUY ANYTHING!!
 Write, Wire Today!
 Tell us what you have
TALLEN COMPANY, INC.
 Dept. RE, 159 Carlton Ave.
 Brooklyn 5, New York

WE'RE CRAZY



LIKE A FOX . . . FOR WE PROVED THAT OUR POLICY OF "PROFIT IN PENNIES" HAS PAID OFF. WE HAVE THOUSANDS OF THRIFTY-MINDED CUSTOMERS WHO BUY ONLY FROM US.

WE BUY BY THE CARLOAD AT RIDICULOUSLY LOW PRICES AND PASS ON THE SAVINGS TO YOU.

BELOW ARE TYPICAL BARGAINS IN OUR LATEST CATALOG!



FAMOUS ROLA 12" SPEAKERS

Model G12 • 1000 ohms field coil • Complete with Push-Pull 6L6 output. Ideal for P.A. Systems.

\$8⁹⁵

STANDARD BRAND

16HP4 KINESCOPE \$19⁹⁵

19AP4 KINESCOPE \$25⁹⁵

Both Fully Guaranteed.

Mail Coupon At Once

Your copy is waiting for you!

Steve-El Electronics Corp. E-5
 61 Reade St., New York 7, N. Y.
 Send me the advertised bargains at once.
 Rola Speakers 16HP4 19AP4
 Ck. or MO enclosed Send C.O.D. (20% deposit)
 Name _____
 Address _____
 City _____ Zone _____ State _____
 Send latest BARGAIN CATALOG.

NOW'S THE TIME TO BUY GREYLOCK TUBES AT THESE TERRIFIC LOW PRICES!

All tubes listed below carry 6 month guarantee—excepting only burnouts and breakages. At these sensationally low prices, these tubes must be ordered in quantities of AT LEAST 10 ASSORTED TYPES. Add 10% for orders under 10 tubes. All individually boxed in attractive Greylock Cartons. SPECIAL OFFER: Additional 5% discount on all shipments of 100 tubes or more assorted!

OY4M .69	3A4 .59	6BH6 .79	6V3 1.59	12BA7 .99	32L7GT 1.09
OZ4M .59	3A5 .79	6BJ6 .79	6V6GT .49	12BE6 .49	32 .59
1A3 .99	3A8GT .99	6BL7GT 1.09	6W4GT .49	12BF6 .59	33 .59
1A5GT .79	3B7 .49	6BN6 1.09	6W6GT .79	12BH7 .99	34 .49
1A9 .49	3D6 .49	6BO6GT .79	6X4 .49	12C8 .79	35/51 .49
1A7GT .89	3F4 .49	6B07 1.49	6X5GT .49	12FSGT .69	35A5 .69
1B3GT .89	3Q4 .49	6B07 1.19	6Y6G .79	12J5GT .89	35B5 .59
1B4 .49	3Q5GT 1.09	6C4 .49	6Z7G .49	12K7 .99	35C5 .59
1B5/255 .49	3S4 .59	6C5GT .49	6ZY5G .59	2K8 .99	35L6GT .69
1C1G .49	3V4 .49	6C6 .49	7A4 .69	207GT .69	35W4 .49
1C5GT .99	5AX4GT .69	6C8G .89	7A5 .99	12S4GT 1.09	35Y4 .69
1C6 .49	5AZ4 .69	6CB6 .49	7A6 .89	12S4GT .79	35Z3 .89
1C7G .49	5T4M .99	6CD6G 1.49	7A7 .79	12S7 .99	35Z4GT .79
1D5 .49	5U4G .69	6D6 1.09	7A8 .89	12SF5GT .69	35Z5GT .49
1D7G .49	5V4G .89	6D7 .69	7AF7 .99	12SF7 .59	36 .59
1D8G .69	5W4 .69	6D8G .49	7AG7 1.19	12SG7 1.09	37 .59
1E4G .49	5X4G .59	6E5 .79	7B4 .89	12SH7 .89	38 .59
1E5GP .49	5Y3GT .49	6F5GT .79	7B5 .89	12S17GT .69	39/44 .59
1E7G .49	5Z3 .89	6F8G .59	7B6 .59	12SK7GT .59	41 .69
1F4 .49	5Z4 .99	6G6G .69	7B7 .89	12SL7GT .79	42 .69
1F5G .49	6AB4 .69	6H6 .59	7C4 .69	12SN7GT .79	43 .69
1F7G .49	6AC5GT .99	6J5 .49	7C5 .89	12S07GT .69	45 .69
1G4 .49	6AC7M 1.09	6J6 .89	7C6 .89	12S8GT .79	45Z3 .69
1G5G .49	6AE5GT .69	6J7 .49	7C7 .89	12SR7 .89	46 .89
1G6 .59	6AF6G .69	6J7G .69	7E3 .79	12T3 .49	47 .69
1H4G .59	6AG5 .69	6K3GT .69	7E6 .79	14A4 .89	49 .69
1H5GT .49	6AG7M 1.19	6K5GT .69	7E7 .79	14A7 .89	50A5 1.09
1H5G .49	6AJ3 1.29	6K6GT .59	7F7 .99	14B6 .79	50B5 .59
1J5G .49	6AK5 .89	6K7 .79	7F8 .59	14B8 .89	50C5 .59
1J6GT .49	6AK6 .89	6L5G .49	7G7 1.59	14C5 .89	50L6GT .49
1L4 .49	6AK7 .89	6L6G 1.19	7H7 .99	14C7 .89	50Y6G .89
1L4A .89	6AL5 .49	6L6GA 1.19	7J7 .99	14E6 .89	50Y7GT .99
1L6A 1.19	6AO5 .49	6L7G .59	7K7 .89	14E7 .89	53 .89
1L8A .99	6AO6 .69	6N6 1.49	7L7 .99	14F7 .89	56 .59
1LCS .79	6AR5 .59	6N7 .99	7N7 .79	14F8 .19	57 .59
1LC6 .99	6AR6 2.49	6P5GT .79	7O7 .89	14H7 1.09	58 .69
1LD5 .99	6AS5 .69	6O7 .69	7R7 .99	14J7 .89	70A7GT 1.19
1LE3 1.19	6AT6 .49	6R7GT .79	7S7 .89	14Q7 .99	70L7GT .39
1LG5 .99	6AU5GT 1.29	6S4 .49	7V7 1.29	14R7 .89	75 .99
1LH4 .99	6AU6 .49	6S7G .59	7X7 .79	14S7 .89	76 .79
1LN5 .89	6AV5GT 1.29	6S8GT 1.29	7Y4 .89	14W7 1.19	77 .49
1NSGT .69	6AV6 .49	6SA7GT .69	7Z4 .69	14Y4 1.19	78 1.09
1PSGT .89	6AW6 1.09	6S7 .79	807 1.79	18 .89	79 .69
1OSGT .89	6AX4GT .69	6S7GT .79	10 .89	19 .89	80 .49
1R5 .59	6AX5GT .79	6S8GT .79	12A5 .99	19B6G 1.29	81 .89
1S5 .49	6A3 .49	6S9GT .79	12A6 .79	19T8 .99	82 .99
1T4 .59	6A4 1.19	6S7 .89	12A7 .89	22 .89	85 .79
1T5GT .49	6A8 1.19	6S7 .79	12A7 .89	24A .69	89 .79
1U4 .49	6B4G .99	6J7GT .69	12A8GT .49	25A6 .69	117L7 1.99
1U5 .49	6B5 .89	6K7GT .49	12A5 .79	25A7GT .89	117N7 1.99
1V .49	6B8 .69	6L7GT .69	12A6 .49	25B06GT .79	117P7 1.99
1V2 .69	6B8G .89	6M7GT .59	12A7 .79	25CGT .79	117Z3 .49
1X2 .89	6BA6 .49	6S07GT .59	12A6 .49	25L6GT .59	117Z6GT 1.09
2A3 1.09	6BA7 1.19	6S7 .69	12A7 .59	25W4GT .49	954 .59
2A4G .69	6BC5 .69	6S7 .79	12A6 .59	25Y5 .49	955 .59
2A5 .79	6BD5GT 1.09	6SU7GT .89	12A7 .69	25Z5 .49	956 .59
2A6 .49	6BD6 .59	6T7G .99	12AW6 .99	25Z6GT .69	2051 1.09
2A7 .49	6BE6 .49	6T8 .79	12AX6 .69	26 .69	9001 1.19
2B7 .49	6BF5 .69	6U4GT .59	12AX7 .59	30 .69	FM1000 .89
2X2/879 .89	6BF6 .79	6U5 .69	12AZ7 1.29	31 .69	VR105 1.09
2X2A 1.49	6BG6G 1.29	6U7G .59	12BA6 .49	31 .69	V752 .49
					CK116 .49

GREYLOCK "BONDED" ELECTROLYTIC CONDENSERS

Guaranteed Fresh Stock



LOTS OF 10 YOUR ASSORTMENT

Mfd.	W.V. DC	Net each	Mfd.	W.V. DC	Net each
16	150	.29	40 x 40	150	.45
24	150	.35	50 x 30	150	.45
30	150	.35	8	450	.29
40	150	.39	8 x 8	450	.49
20 x 20	150	.39	16	450	.39
70 x 40	150	.39	30	450	.44
30 x 30	150	.44	40	450	.49

Above prices are for minimum quantities of 10 ass'd. condensers. Deduct additional 10% discount in lots of 100 assorted condensers. Add 10% for orders under 10.

SPEAKER SPECIALS

Permanent Magnet—Alnico No. 5 Slugs

3" PM	.68	oz.	\$1.09
4" or 5" PM	.68	oz.	1.29
6" PM	1.0	oz.	1.59
4"x6" PM	1.0	oz.	1.39
5"x7" PM	1.47	oz.	1.89
6"x9" PM	3.16	oz.	3.49
8" PM	2.15	oz.	3.69
10" PM	6.8	oz.	5.95
12" PM	3.2	oz.	4.95

AUTO SPEAKERS

714 4-ohm dynamic loss output \$2.19
714-1 PM loss output 4.95

SENSATIONAL PRICE SLASH! FAMOUS MAKE TV BOOSTER

List \$32.50
Reg. Dealer Cost \$19.11

NOW ON SALE \$14.95

While Quantities last, only! Case lots of 6, each \$14.50



CATHODE RAY TUBE SPECIAL

90-DAY GUARANTEE

Closeouts, while stock lasts, only!

7JP4	\$16.50	17BP4 Rect.	\$21.95
14BP4 Rect.	18.95	20RP4 Rect.	37.95
16RP4 Rect.	21.95		

ERIE STYLE DOORKNOB CERAMIC

500 Mmfd @ 20 KV ONLY 59¢

3" WALL MOUNT for TV Antenna, with per Hardware \$39.00 pair

CHIMNEY MOUNT #E-1585 Only 99¢

RCA 205DI 63° Deflection Yoke 99¢

MCMURDO-SILVER FM-TV BOOSTER

\$12.95

Very simple to hook up, instructions included. Special, while they last!

MANY ADDITIONAL VALUES in Radio, TV and Electronic components and accessories! Send for our Great New Bargain Catalog C-5



That way we could check antenna results and also receive two channels at the same time.

The twin-driven Yagi was taken down, as I felt it was not broad-band enough to cover channels 2 to 6. However, at times it gave excellent reception on all channels. A rhombic was also tried, and at times it would pick up signals when the others wouldn't even show a bar. For dx work I think that you can't beat the plain folded dipole and reflector.

One of the sets was completely out of alignment. We followed the Photo-facts procedure and re-aligned it with an inexpensive AM generator and a v.t.v.m. The generator only went to 30 mc so we had to use harmonics for aligning the tuner, but it worked out swell. Then we tuned in a weak signal and peaked the tuner slugs, then the picture i.f.'s were peaked for best picture. This might sound screwy but it's what we did, and it resulted in a set that would bring in a faint signal and lock it perfectly. We then checked this set against the other and also against another set that someone else had brought to Laramie when he moved here from a TV area. The realigned set would consistently show pictures when the other two wouldn't make a bar.

Also built several boosters and gave them a good try, but found out that if the d.x. is there it's there, and if it isn't a booster don't help a bit. They would help out on the very weak signals but even then they always boosted the noise and snow so you didn't gain enough to bother with them.

Our latest addition is a Mattison Silver Rocket with a built-in Bogen booster. It is a modernized 630TS and is particularly adaptable to dx work, since the bottom of the chassis can be reached without taking the set out of the cabinet. By drilling a couple of holes under the sound take-off i.f. and one under the sound-discriminator transformer, you can reach in and re-align the set any way you wish. All the other transformers can be reached through the cutout portion of the panel on which the chassis rests.

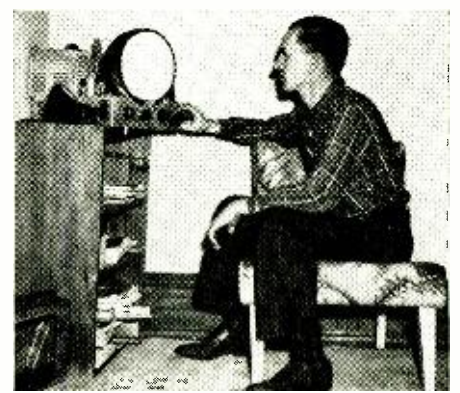

The picture is one of my brother—who helped me stand watch on sporadic-E dx and to compile lists—sitting beside the older Admiral chassis.

CARL E. WESTPHAL

Laramie, Wyo.

RADIO-ELECTRONICS

"A Trusted Name in Radio!"

GREYLOCK ELECTRONICS SUPPLY CO.

115 Liberty Street - New York 6, N. Y.

THE MIRACLE OF ELECTRONIC CONTROL

Yours to Command!

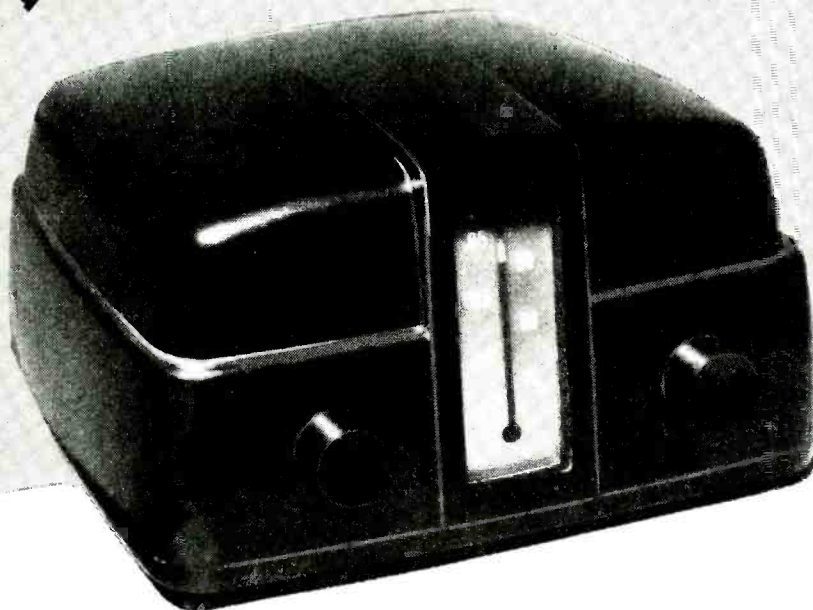

ADVANCED **THYRATRON** CIRCUIT
REMOTE CONTROL

FOR 110 VOLTS 60 CYCLES AC

Engineers — Hams — Students
Servicemen — Hobbyists

Here's the chance of a lifetime to own a genuine Thyatron Electronic Remote Control of your own at a fraction of its regular price! This mighty handful (only 5 3/4 x 3 1/4") of miracle control can be made to perform hundreds of practical, fascinating feats of remote control.

PRECISION THYRATRON CIRCUITRY

These amazing Thyatron precision thermostatic controls can easily and quickly be modified by you for electronic remote control of: Transmitters; Turn Radio and TV on and off; Open and Close Garage Doors from your car; Remote Control of Appliances, Machinery, Power Tools; Remote Controls for Model Railroads, Planes, Boats, Trucks; Burglar, Fire, Temperature and Rain Alarm Systems; Poultry Brooder Controls, etc., etc.

Your own ingenuity and inventiveness can devise many more interesting and practical uses which this remarkable unit can control for you. A complete schematic is furnished with each control.

PARTS ALONE WORTH TWICE THE COST
Each control unit contains a highly sensitive plate circuit trigger relay, a 110 volt 60 cycle AC filament transformer, many condensers and resistors (including 1% precisions) and a host of other valuable parts worth twice or more our low, low bargain price. No matter how you use it it's a great buy!

Kit of 3 Tubes for Remote Control Unit, consisting of 6SN7GT, 6SL7GT and a GE Thyatron GL-5662 (net \$3.30 by itself). All 3 plus Bakelite Cabinet, only \$4.95
No. C.O.D. Postpaid in U.S.A. Only
(10 Days Net to Rated Firms)

Send Check or Money Order to Dept. R.

ATTENTION: Electronic Alarm Manufacturers! These Thyatron controls are ideal for adaptation by you for FIRE, BURGLAR and other alarm systems you make. Increase your profits, make a better product by using this control or its components in your products. Let your engineers check a few and see for yourself. Terms: Net 10 days to rated firms.

\$2.88

only (Less Cabinet & Tube Kit)
No. C.O.D. Postpaid in U.S.A. Only

Complete With Cabinet and Thyatron Tube Kit **\$7.50**
No. C.O.D. Postpaid in U.S.A. Only

POPULAR REMOTE CONTROL USES

- ON-OFF for Transmitters, Radio or Television Sets
- Open and Close Garage Doors From Inside Your Car
- Model Railroads, Boats, Planes, Cars, Trucks
- ON-OFF for Appliances, Machinery, Power Tools
- Burglar, Fire, Temperature or Rain Alarm Systems
- Poultry Brooder Temperature Controls
- Remote Thermostatic Control

MANUEL KLEIN COMPANY

94 Chambers Street, New York 7, N. Y.
REctor 2-6460

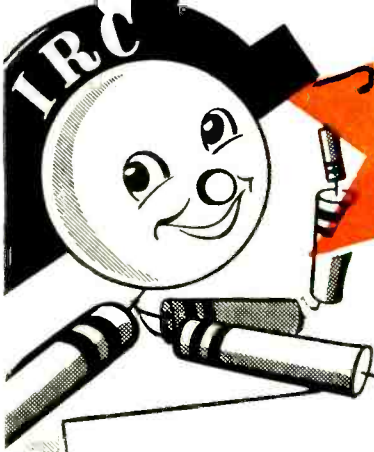

IRC ANNOUNCES A BRAND NEW LINE

UNIVERSAL REPLACEMENTS FOR CONCENTRIC DUALS

- Two new, low-priced, 4-piece CONCENTRIKITS—simplified and improved.
- Less-than-a-minute assembly of Exact Duplicate Controls—in home or shop—without special tools.
- Complete line of Exact Duplicate Shafts—no filing, slotting, cutting, hammering or soldering needed.
- Expanded line of IRC Base Elements—for assembly of both carbon and wire wound concentric dual controls.
- Cover 416 Manufacturers' Concentric Dual Parts Numbers—used in over 5,000 TV models.

Features

COVER MORE REPLACEMENTS AT LOWER STOCK COST

It's a fact! With a small stock of these new IRC CONCENTRIKITS, Exact Duplicate Shafts and Base Elements, you can cover most all concentric dual replacements. That means less money tied-up in inventories—and less stock lost through obsolescence. And it means faster servicing—and time saved because you can schedule your trips to your IRC Distributor.

GREATER STOCKING AND SERVICING CONVENIENCE THAN EVER

Cover Major TV Sets at Fractional Cost with New IRC DEALER ASSORTMENTS

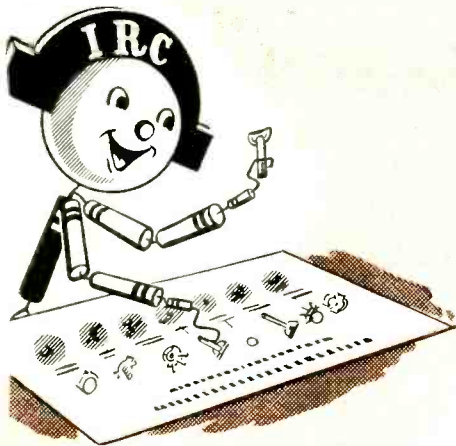

IRC CONCENTRIPAKS

You can get IRC's new CONCENTRIKITS now in low-cost, easy-to-stock CONCENTRIPAKS... handy assortments which include Base Elements, Exact Duplicate Replacement Shafts and Switches to suit specific brands of TV sets. Price is only a fraction of cost of factory-assembled controls.

CONCENTRIPAK for Philco—KC-1. Replaces any of 13 Philco concentric dual controls—plus 11 others. Costs only \$10.20.

CONCENTRIPAK for RCA—KC-2. Replaces any of 14 RCA concentric dual controls—plus 36 listings among 15 other makes. Costs only \$7.44.

CONCENTRIPAK for Admiral—KC-3. Replaces any of 14 Admiral concentric duals plus controls for Packard Bell, Sparton, Stromberg-Carlson. Costs only \$7.80.

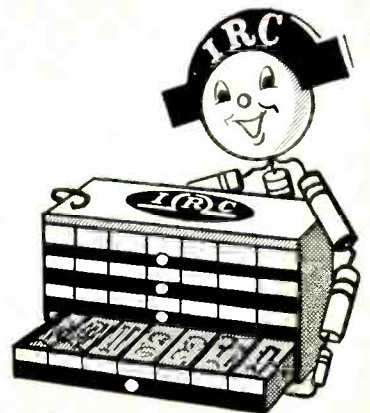

IRC DEALER ASSORTMENT #14

Wide-coverage, low-cost dealer stock of CONCENTRIKIT parts. Provides coverage of 240 concentric dual listings (equivalent of 149 different concentric duals). Supplies replacement coverage among 59 trade names, including RCA, Emerson, Admiral, Philco, Crosley, G.E. and many other widely sold makes.

MAKE YOUR IRC DISTRIBUTOR YOUR ONE STOP SOURCE OF ALL CONCENTRIC

OF CONCENTRIC DUAL REPLACEMENTS



PLUS FACTORY-ASSEMBLED EXACT DUPLICATES FOR TV CONCENTRIC DUALS

- Double-Your-Money-Back Guarantee of satisfactory mechanical fit and electrical operation.
- Full line includes 295 factory-assembled Exact Duplicate Controls covering 416 Manufacturers' Concentric Dual Parts Numbers—used in over 5,000 TV models.
- Includes both carbon and wire wound types.
- Designed and manufactured to *accurate* specifications—under rigid quality control. No need to reverse connections or alter in any way.
- Each carton stamped with Manufacturer's Part Number *and* IRC Stock Number. Frequently avoids re-checking listings for control identification.

Features

Here's the complete Exact-Duplicate TV coverage you've been wanting—all from one dependable source. A full line of 295 Exact Duplicate Concentric Dual Controls to suit almost every TV model—from the largest set producer to the smallest—and many more. AND built to accurate specifications—to fit without reverse connections or alterations. Double your money back, if any of these Factory-Assembled Exact Duplicate Concentric Dual Controls fails to give satisfactory mechanical fit or electrical operation.

Get the full story of IRC's new, improved CONCENTRIKITS and FACTORY-ASSEMBLED EXACT DUPLICATE REPLACEMENT CONTROLS. Mail the coupon for Catalog Bulletin DC1C. It contains stock numbers, prices, TV models covered, and parts numbers.

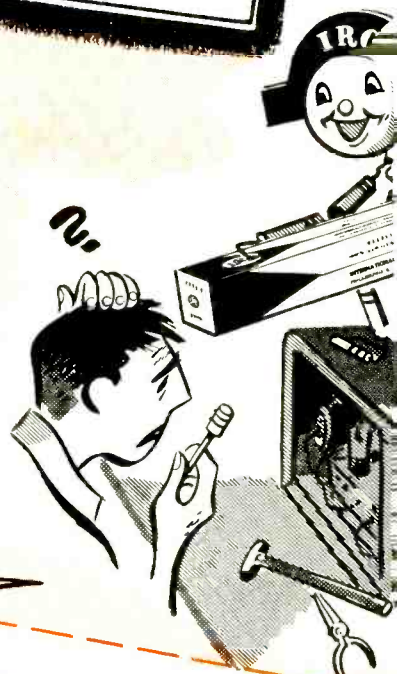

INTERNATIONAL RESISTANCE CO.

401 N. Broad Street, Philadelphia 8, Pa.

In Canada: International Resistance Company, Ltd., Toronto, Licensee.

Wherever the Circuit Says



INTERNATIONAL RESISTANCE COMPANY
417 N. Broad Street, Philadelphia 8, Pa.

Please send me full details of:—

- IRC's new, improved CONCENTRIKITS, with Exact Duplicate Replacement Shafts, Base Elements and Switches.
- IRC's 295 new Factory-Assembled Exact Duplicate Replacement Controls.

NAME

COMPANY

ADDRESS

CITY

STATE

DUAL REPLACEMENT CONTROLS

FRINGE AREA & DX PROBLEM SOLVED with NEW DAVIS SUPER-VISION ANTENNA

"THE ONLY TV ANTENNA SOLD WITH A MONEY-BACK GUARANTEE"

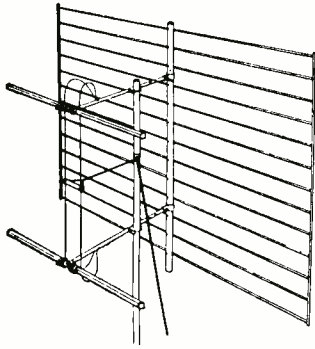

10 OUTSTANDING FEATURES:

1. EXCELLENT FOR FRINGE AREA and DX RECEIVING—and broad band receiving with high gain on all channels—2 through 13.
2. CLEARER PICTURES UP TO 125 MILES OR MORE—from the station.
3. GHOST PROBLEMS REDUCED or eliminated due to excellent pattern.
4. PROVIDES 10 DB OR MORE GAIN ON HIGH CHANNELS where gain is needed most.
5. EXCELLENT FRONT TO BACK RATIO on all channels. Eliminates co-channel interference.
6. MINIMIZES INTERFERENCE: Airplane Flutter—Diathermy and Ignition—F.M.—Neon Signs—X-Ray—Industrial—Etc.
7. ELIMINATES DOUBLE STACKED ARRAYS, and out-performs 2 bay yagis on low band and 4 bay yagis on high channels.
8. ONLY ONE TRANSMISSION LINE NECESSARY.
9. NO WORRY OVER POSSIBLE CHANNEL CHANGES on either high or low channels.
10. CAN BE TIPPED WITHOUT TILTING MAST to take advantage of horizontal wave lengths.

AT YOUR JOBBERS, OR WRITE TO:

DAVIS ELECTRONICS 1-8
3047 W. Olympic Blvd., Los Angeles 6, California
SIRS: RUSH INFORMATION TO ME AS CHECKED BELOW:

- Send Free Technical Data on new SUPER-VISION ANTENNA.
- Send Name and Address of NEAREST JOBBER.

Name _____
Street _____
City _____ State _____

WE JUST GOTTA BUY THIS STUFF!

We're tearing our hair out to buy desperately needed equipment, such as ART-13, BC-348, BC-224, BC-342, BC-788, I-152, T-17 MICs., BC-312, ARC-1, BC-221, RS/ARN-7 or components. In fact, we'll buy any parts or accessories no matter how small. For speedy, efficient service and a real honest deal, phone, wire or write:
V & H RADIO & ELECTRONICS SUPPLY CO.
2033 W. Venice Blvd., Los Angeles 6, Calif.
Telephone: REpublic 3-1127

YOU SHOULD OWN A MICRO CIRCLE CUTTER

A well built tool for those odd size holes. Cuts through 1/2 inch of steel. Has MICROMATIC SIZE ADJUSTOR. Comes complete with tool steel cutting bit for extra long service. Specify round (7/16") or square shank. See your local distributor or write us.
PRECISE MEASUREMENTS COMPANY
942 Kings Highway, Brooklyn 23, N. Y.
\$5.00

ELECTRICAL MEASUREMENTS, by Forest K. Harris. Published by John Wiley & Sons, Inc., New York, N. Y. 6 x 9 inches, 784 pages. Price \$8.00.

All branches of science and engineering depend upon measurement. This book gives complete coverage to d.c. and low-frequency a.c. measurements.

Preliminary theory of measurements includes various systems of units, error calculation, and availability of standards. This is followed by chapters on meters. The author describes their construction and use, and gives the mathematical theory to analyze motion, damping, sensitivity. In addition to the magnetic type, we learn about electrostatic, thermoelectric, electronic, rectifier, and others. Besides electrical measurements, information is provided on measuring waveform, frequency, power and magnetism. The use of instrument transformers is shown.

The last chapter deals with bridges for a.c. Detectors, oscillators, stray admittance and bridge transformers are described in addition to the bridges themselves.—IQ

MOST-OFTEN-NEEDED 1952 TELEVISION SERVICING INFORMATION (Volume TV-6), compiled by M. N. Beitman. Published by Supreme Publications, 3727 West 13th St., Chicago 23, Ill. 8 1/4 x 10 1/2 inches. 192 pages. Price \$3.00.

The latest edition of the Most-Needed series contains chassis drawings, diagrams, voltage and resistance measurements, alignment data, waveforms, and other valuable servicing information on well over 500 different models and chassis produced by about 30 TV manufacturers.—RFS

DESIGN OF SWITCHING CIRCUITS, by William Keister, Alistair E. Ritchie and Seth H. Washburn. Published by D. Van Nostrand Co., New York, N. Y. 6 x 9 inches, 556 pages. Price \$8.00.

Switching has now become a specialized science. Telephone systems, counters, computers, and other instruments of the "brain" variety are controlled by switches, electronic or mechanical. This volume describes switching right from fundamentals. It is based on an MIT graduate course, and is recommended for self-study. No math is required. Logic alone is sufficient.

The book deals with relays in particular, but there is much data on

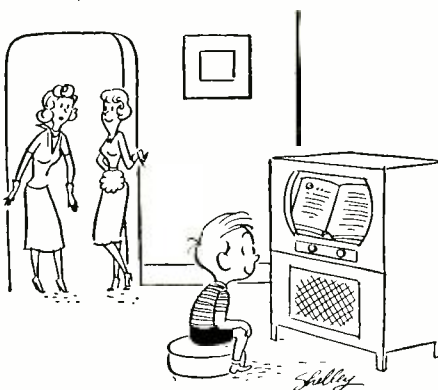

"We knocked out the insides and mounted his school books there"

SENSATIONAL VALUE!

#630 SUPER 30 TUBE CHASSIS
Mfr. Licensed under R. C. A. Patents

Complete with 21" first quality tube

AND Beautiful hand-rubbed Mahogany Console Cabinet.

COMPLETE PRICE **\$259.95** slightly higher with full doors



the latest 1952 model with all the newest electronic improvements . . .

- peak sensitivity for fringe areas
- synchrolock tuning
- keyed A G C
- 15,000 volts under load
- 12-inch RCA speaker
- can be adapted to color & UHF
- high quality parts

A set—NOT A KIT

Completely wired, Factory Engineered, aligned and tested. RMA Guaranteed

1 YEAR GUARANTEE ON TUBE

A half-hour to mount; ready for operation. Saves up to \$150.

Compare this anywhere for high quality—low price!

Write Dept. H for further information. Phone and mail orders filled on receipt of money order for 25% as deposit . . . the balance C.O.D., f.o.b. N. Y.

NEW ENGLAND TELEVISION CORP.
75 CHURCH STREET NEW YORK, N. Y.

Another Outstanding Jobber
Almo Radio Co.
509 ARCH ST., PHILADELPHIA 6, PA.
has all 17 KITS & INSTRUMENTS in stock!
EICO
21K 4TVM KIT \$25.95 See EICO ad on Page 27

EVERY RADIOMAN Can Use These SERVICE HINTS!
Valuable Manual Yours—FREE!

Every page of "How to Simplify Radio Repairs" is packed with on-the-bench, practical ideas. Contains photos, charts, diagrams—no fluff—no vague theory. In plain every-day language it gives you priceless suggestions—new servicing ideas. You'll use and benefit from the experience of experts. Partial list of contents: How to Localize Trouble; How to Service Amplifiers; How to Test for Distortion; How to Test Audio Circuits; How to Test Speakers; How to Find Faults in Oscillators; How to Test Radio Parts—and it's all yours—FREE. No obligation.



FEILER SEND COUPON OR PENNY POSTCARD FOR YOUR FREE COPY TODAY!

FEILER ENGINEERING CO., Dept. SRC2
8025 N. Montecito Ave., Skokie, Ill. (Suburb of Chicago)
Please RUSH my FREE copy of "How to Simplify Radio Repairs."
Name.....
Address.....
City..... Zone..... State.....

transistors, multivibrators, and other switching elements. Of special interest is a chapter on Boolean (switching) algebra. Other chapters deal with relays in combination and sequence, electronic switching, counting, selecting, timing, pulse generating, checking, registration, and calculating. Problems accompany each chapter. Tables, diagrams, and practical examples are added.—IQ

AMERICAN STANDARD GRAPHICAL SYMBOLS FOR SINGLE (ONE) LINE ELECTRICAL ENGINEERING DIAGRAMS. Published by American Institute of Electrical Engineers, 33 West 49th Street, New York 18, N. Y. 8½ x 11 inches, 42 pages. Price \$1.40.

Single-line diagrams are useful for indicating the path of a circuit and the functions of its components. Unlike conventional schematics, actual conductors and connections are not shown. For example, an amplifier is shown merely as a triangle pointing in the direction of transmission. Tube elements, power supplies, etc., may be omitted. A single line is drawn for the amplifier input, another for the output. This type of diagram is easy to prepare. At a glance it shows how a system operates and the general arrangement of the parts.

This volume combines for the first time the various symbols relating to power as well as communications engineering. It lists 81 sections (components, units, connections) together with the corresponding symbols. Sample diagrams appear in the appendix.

AT WHOLESALE RADIO ONLY VTVM KIT WITH 7½" METER
PRECISE 907 DELUXE VACUUM TUBE VOLTMETER



\$38.98

Factory wired 57.98

Meter can be mounted for vertical or horizontal use. Etched panel; 1% ceramic resistors; amphenol connectors; separate 5 V. AC scale; Tubes: 6AL5, 6X5, 6SN7; true zero adjust; huge 7½" meter for more accurate readings. Complete with construction book, battery and test lead. Ranges: DC: 0-5-25-250-500-1000 V. AC: 0-5-25-250-500-1000 V. Ohms: Rx1, Rx10, Rx100, Rx10,000. Rx1,000,000 ohms. DB: from -20 to -55 DB.

So Much For So Little MARKER GENERATOR RF—AF—TV KIT



FUNDAMENTALS THRU 110 mc 330mc on HARMONICS
Audio: 20-20,000 cycles. Cathode follower output. Variable per cent modulation. Stepping attenuator. External modulation. Speech amplifier. Crystal marker.

With Pre-assembled RF head, 630 KA \$38.95
Completely factory wired, 630 W \$53.95
630K Kit \$33.95
Address Orders To Dept. RE-5
Write For Free FYI Bulletin

WHOLESALE RADIO PARTS CO., Inc.
311 W. Baltimore St.
BALTIMORE 1, MD.

AUDEL'S TV SERVICE

TELLS HOW TO SOLVE TV TROUBLES AND ANSWERS TV QUESTIONS

AUDEL'S TELEVISION SERVICE MANUAL covers TV information at your finger ends. Shows good receiver adjustment and how to Get Sharp, Clear Pictures, How to Install Aerials—Avoid Blurs, Smears, Interference and How to Test. Explains Color Systems and Methods of Conversion. IT PAYS TO KNOW! Over 380 PAGES & 225 ILLUSTRATIONS explaining operating principles of Modern Television Receivers.



1001 FACTS 19 CHAPTERS
Placement of Television Receivers—Receiver Controls; Test Patterns & Adjustments—Television Interference—Interference Traps—Television Antennas & Transmission Lines—Master Antenna Systems—Antenna Installation Procedure—Television Broadcasting—Television Receiver Fundamentals—Circuit Description of Typical Receiver—Television Picture Tubes—Projection Type Receivers—Television Testing Instruments—Television Servicing—Trouble Shooting—Color Television—Television Terms.

\$2 POST PAID

7 DAYS FREE TRIAL
GET THIS PRACTICAL ASSISTANCE FOR YOURSELF — MAIL COUPON TODAY —
AUDEL, Publishers, 49 W. 23rd St., N.Y.
Mail me postpaid for 7 Days examination
AUDEL'S TELEVISION SERVICE MANUAL (Price \$2).
If O. K. I will mail you \$2, otherwise I will return book.

Name _____
Address _____
Employed by _____

T-27

Get This Valuable Book

Just for Examining COYNE'S New 6-Volume Set

FREE



"Applied Practical Radio-Television"

ON 7 DAY FREE TRIAL!



Yes, you get this big, brand new book, "150 Radio-Television Picture Patterns and Diagrams Explained", absolutely FREE! Just off the press! Gives complete wiring circuits and diagrams on the latest Radio and Television Sets. Easy-to-read, large 8½ x 11" pages, with full instructions on how to read and use the diagrams. A "must" in every Radio and Television service-man's repair kit. You get this valuable book as a FREE Gift for asking to see Coyne's great new 6-book set, "Applied Practical Radio-Television"!

Here's "Know-How" That Makes You Worth More!

You'll get into the big money faster in TELEVISION-RADIO if you know where to find the answer to servicing problems. Coyne's great new 6-volume set gives you all the answers—quickly! For basic "know-how" that is easy to understand, you'll find everything you want in volumes 1 to 5 which contain over 5000 practical facts and data. They cover every step from principles to installing, servicing, trouble-shooting and aligning all types of radio and TV sets. So up-to-date it includes COLOR TV and UHF, adapters and converters.

762-Page Television Cyclopedic Included

And then, for speedy on-the-job use, you get volume 6—the famous Coyne TELEVISION CYCLOPEDIA. It answers today's television problems on servicing, alignment, installation and others. In easy-to-find ABC order, cross indexed. Use this 6 volume TV-RADIO LIBRARY free for 7 days; get the valuable Servicing Book ABSOLUTELY FREE!

SEND NO MONEY! Just mail coupon for 6-volume set on 7 days free trial. We'll include book of 150 TV-Radio Patterns & Diagrams. If you keep the set, pay \$3 in 7 days and \$3 per month until \$23.00 plus postage is paid. (Cash price \$22.00). Or you can return the library at our expense in 7 days and owe nothing. **YOU BE THE JUDGE. Either way, the book of TV-Radio Patterns is yours FREE to keep!** Offer is limited. Act NOW!

FREE BOOK — FREE TRIAL COUPON!

COYNE ELECTRICAL & TELEVISION-RADIO SCHOOL, Dept. 52-T1
500 S. Paulina St., Chicago 12, Ill.

YES! Send 6-volume "Applied Practical Radio-Television" for 7 days FREE TRIAL per your offer. Include TV-Radio Patterns and Diagram Book FREE.

Name _____ Age _____

Address _____

City _____ Zone _____ State _____

Where Employed _____
() Check here if you want library sent COD. You pay postmtn \$22 plus COD postage on delivery. 7-day money-back guarantee.

COYNE ELECTRICAL & TELEVISION-RADIO SCHOOL
500 S. Paulina St., Dept. 52-T1 Chicago 12, Ill.

Now you can believe everything you hear!

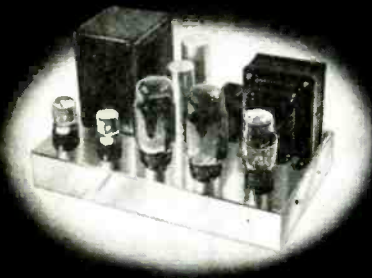

the
CRAFTSMEN 500
ULTRA FIDELITY
audio amplifier

Even we were amazed when we tested this remarkable amplifier. Never before, in our experience (or yours) has such remarkable performance been recorded. The C-500 is 99.99+% distortion-free. We had to think of a new word to describe it. The word is ULTRA-FIDELITY. Hear the "500" and you'll know why.

C500 Amplifier Features

- **FAMOUS WILLIAMSON** all-triode circuit.
- **FREQ. RESPONSE:** ±0.1 db., 20 cps to 20,000 cps; ±2 db., 5 cps to 100,000 cps.
- **POWER RESPONSE:** 12 watts ±2 db., 10 cps to 50,000 cps.
- **TOTAL H DISTORTION:** Less than 0.1% at 10 watts, at mid-freqs.
*0.01% at av. listening level below 1 watt.
- **TUBE COMPLEMENT:** (2) 6SN-7GTA; (2) KT66 power output; 5V4G rectifier.

Sold by leading radio parts distributors everywhere or write to

THE RADIO
craftsmen INC.
Dept. G-1, 4401 N. Ravenswood Ave.
Chicago 40, Ill.

RADIO SCHOOL DIRECTORY

Unlimited Opportunities in RADIO ENGINEERING

DEGREE IN 27 MONTHS

Complete Radio Engineering course including Telev., U. H. F. and F. M. Bachelor of Science Degree also in Mech., Civil, Elect., Chem., and Aero. Eng.; Bus. Adm., Acct. Extensive campus, modern buildings, well equipped labs. Low cost. Prep courses. Personalized, practical instruction. Founded 1884. Placement service. Growing shortage of engineers. Prepare now for unlimited opportunities ahead. Enter September, January, March, June. Write for catalog.



TRI-STATE COLLEGE

2452 College Ave. ANGOLA, IND.



RADIO ENGINEERING

FM—Television—Broadcast

Police Radio, Marine Radio, Radio Servicing, Aviation Radio and Ultra High mobile applications. Thorough training in all branches of Radio and Electronics. Modern laboratories and equipment. Old established school. Ample housing facilities. One acre campus. Small classes, enrollments limited. Our graduates are in demand. Write for catalog.

Approved for Veterans

VALPARAISO TECHNICAL INSTITUTE
Dept. C VALPARAISO, INDIANA

RADIO & TELEVISION ... TRANSMITTERS LAB. WORK EVERY DAY LEARN BY EXPERIENCE REHRIG SCHOOL

11-13 S. GAY ST.
BALTIMORE 2, MD.
Lex. 3195

RADIO and TELEVISION ELECTRONICS



in all Technical Phases
New Classes (Day & Evening)
Start 1st of Dec., Mar., June, Sept.
FREE PLACEMENT SERVICE
for GRADUATES

For Free Catalog write Dept. RC-52
RCA INSTITUTES, INC.
A Service of Radio Corporation of America
350 West 4th St., New York 14, N. Y.

RADIO COURSES

- RADIO OPERATING ● CODE
- RADIO SERVICING ● ELECTRONICS
- F. M. TELEVISION

Preparation for Civilian, Maritime, Army and Navy license requirements.

Write for Catalog TE



TRADE & TECH. SCHOOL 15 W. 63 St., N. Y. 23
ENdicott 2-8117

TELEVISION-RADIO ELECTRONICS

Training in all branches television, radio and electronics. FCC exam. preparation. Write for free catalog.

COMMERCIAL RADIO INSTITUTE

(Founded 1920)
38 W. Biddle St., Baltimore 1, Md.
Approved by Maryland State Board of Education

LEARN TELEVISION

ELECTRONICS and RADIO
Engineering Laboratory and Classroom
Training. Day and Evening Classes.

Write for illustrated Catalog

ELECTRONICS INSTITUTE, Inc.
21 HENRY, DETROIT 1, MICH.

RADIO ENGINEERING 27 MONTHS DEGREE IN 27 MONTHS

Intensive, specialized course including strong basis in mathematics and electrical engineering, advanced radio theory and design television. Modern labs. Low tuition. Self-help opportunities. Also B.S. degree in 27 months in Aeronautical, Chemical, Civil, Electrical, and Mechanical Engineering. G.I. Gov't approved. Enter June, Sept., Dec., March. Catalog.

INDIANA TECHNICAL COLLEGE
155 E. Washington Blvd., Fort Wayne 2, Indiana

ATTENTION...

A NEW department of the DON MARTIN SCHOOL OF RADIO AND TELEVISION ARTS AND SCIENCES... for instruction and training in—**TELEVISION**—incorporating:

Production: Writing, Directing, Producing, Acting, Staging, Lighting.

Engineering: Transmission, Receiving, Camera and Studio, Operation, Theory of Video, Pickup and Reproduction.

Approved for veterans.

THE DON MARTIN SCHOOL OF RADIO AND TELEVISION ARTS AND SCIENCES

1655 No. Cherokee, Hollywood 28, Calif. HU. 23281.

LEARN

Television-Radio Electricity REFRIGERATION-ELECTRONICS

IN THE GREAT SHOPS OF **COYNE**

TRAIN QUICKLY! OLDEST, BEST EQUIPPED SCHOOL of ITS KIND in U.S. Draft Age and Older Men...

Come to the Great Shops of Coyne in Chicago. Get practical training in TELEVISION-RADIO or ELECTRICITY—vital in Defense Program. Prepare now for a better job or better service rating.

START NOW—PAY LATER

You can finance most of your tuition, pay for it later in easy monthly payments. Special plan for men of Draft Age. Part time employment service available.

FREE BOOK Clip coupon for Big Free Illustrated Book. Indicate below, course that interests you. No salesman will call. Act NOW.

COYNE SCHOOL
B. W. Cooke, President
A TECHNICAL TRADE
INSTITUTE CHARTERED
NOT FOR PROFIT
Established 1899
500 S. Paulina, Chicago

ELECTRICITY ★ TELEVISION
RADIO ★ REFRIGERATION ★ ELECTRONICS

B. W. COOKE, Pres.
COYNE School
500 S. Paulina St., Chicago 12, Ill. Dept. 52-81H

Send FREE BOOK and full details on:

TELEVISION-RADIO ELECTRICITY

NAME.....

ADDRESS.....

CITY..... STATE.....

RADIO-ELECTRONICS

Largest Automobile Service Market!

Nearly half of all radio-equipped cars are equipped with Delco Radios . . . a total of more than 7 million. Think of this in terms of the service market.

There's big-volume opportunity right at your own front door when you are prepared to service this market with original equipment and universal parts.

Delco Radio parts are of uniform high quality—made and guaranteed by the world's largest maker of automobile radios.

Your nearby United Motors wholesaler can supply your requirements for Delco Radio service parts—promptly.



DELCO RADIO PARTS

A GENERAL MOTORS PRODUCT  A UNITED MOTORS LINE

DISTRIBUTED BY WHOLESALERS EVERYWHERE

DELCO RADIO

DIVISION OF GENERAL MOTORS CORPORATION
KOKOMO, INDIANA

The last page provides an index to all symbols.—*IQ*

RECORDING AND REPRODUCTION OF SOUND (second edition), by Oliver Read. Published by Howard W. Sams & Co., Indianapolis 5, Ind. 6 x 9 inches, 790 pages. Price \$7.95.

An excellent reference work on audio for the practical man. It should find a prominent place in libraries of audio technicians, home recordists and hi-fi hobbyists.

The volume is packed with data on recording and reproducing, especially on disc and magnetic tape and wire. Many commercial instruments are described in detail. Adequate space is devoted to accessories and circuits, microphones, speakers, filters, attenuators, tuners. Charts provide filter data, db information, circuit responses, etc. Math is held to a minimum. In spite of the wide coverage and unusual size of the book, few technical errors and misleading statements were noted.

An extensive appendix will be found useful. It includes a glossary of terms, a bibliography, color codes, filter design tables, logs, R-C amplifier data, and other information.—*IQ*

FUNDAMENTALS OF ELECTRONICS AND CONTROL by Milton G. Young and Harry S. Bueche. Published by Harper & Brothers, New York, N. Y. 6 x 9 inches, 525 pages. Price \$6.00.

This is a first course in electronics which stresses both the theoretical and practical viewpoints. It is unusual in its completeness, readability and logical arrangement. It is recommended for those who intend to specialize in the field, as well as for students of other branches of engineering.

The first chapter explains electron theory. The next covers circuits for a.c., d.c., and transients. In addition to R, C, and L, other circuit components are treated. These include thyrite, varistors, thermistors, saturable reactors, and other components found in modern circuits. The third chapter describes the principles of emission.

Succeeding chapters elaborate on the basic fundamentals of the first three. There is a chapter on vacuum tubes, another on gas tubes, and one dealing with mercury-pool tubes. These are followed by circuit chapters: amplifiers (tube, transistor, magnetic, rotating); oscillators for l.f. and h.f.; modulators; rectifiers. Equations are given where needed to aid the reader, but this is not a mathematical book.

Each chapter is followed by problems (with answers) and a reference list. MKS units are employed.—*IQ*

—end—

CORRECTION

The price of the book, *Audio Amplifiers and Associated Equipment*, Vol. 3 (Howard W. Sams & Co.), was incorrectly given in the book review on page 137 of the March, 1952 issue. The correct price of this book is \$3.95.

MAY, 1952



Balanced
tone

... from the flashing sunlight of Mozart to the storm of Shostakovich

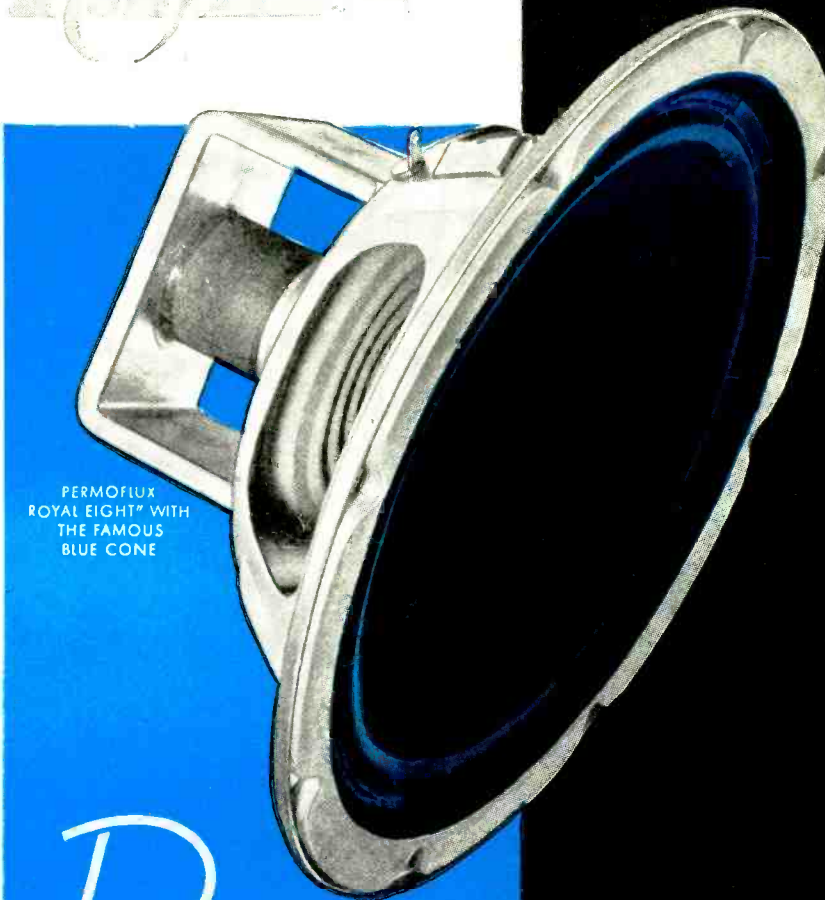

PERMOFLUX ROYAL EIGHT™ WITH THE FAMOUS BLUE CONE

Permoflux ROYAL EIGHT™

AUDIOPHILES the country over acclaim the clean, brilliant, life-like musical reproduction of the Permoflux Royal Eight™...the 8" Speaker comparable to any 12"! Combined with the new Permoflux Corner Baffle, Model CB-8-M, the Royal Eight™ re-creates original programs with even superior sensitivity and fidelity—every instrument in full-range tonal balance. Here's Big Speaker Performance in a small, easy-to-install frame at a sensible price. (\$22.50 List, less Baffle).

See your Radio Parts Distributor or write to Permoflux today for full information about the complete Royal Blue Line of 6" to 15" Speakers and Baffle Combinations. Ask for Permoflux Catalog J-202.

"Sound in Design!... Sound in Price!"

PERMOFLUX CORPORATION 4912-A W. GRAND AVE., CHICAGO 39, ILL.
236 S. VERDUGO RD., GLENDALE 5, CALIF.

Canadian Licensee—Campbell Mfg. Company, Toronto, Canada

LITTELFUSE



Be sure of your fuse!
You know you are getting *original component quality*
when your fuses come in the handy green dispenser box

Be sure of your fuse
by the handy fuse size guide
on every LITTELFUSE
dispenser box

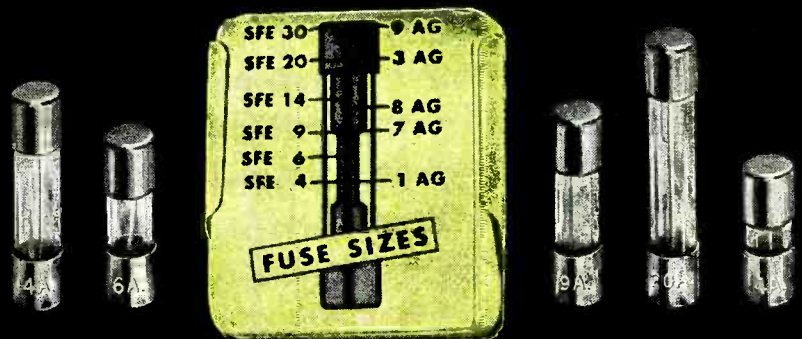

Another LITTELFUSE first. One at a time dispensing.
No lost covers. LITTELFUSE INC., 1865 Miner Street,
Des Plaines, Illinois, VANDERBILT 4-1188

BURTON BROWNE ADVERTISING

It's no trick to make 'em fit . . . fast!



MALLORY MIDGETROL®

ROUND-SHAFT VOLUME CONTROLS

FAST, EASY INSTALLATION

- Because of the wide and easy adaptability of Mallory Midgetrols, it's easy to stock—or get fast from your distributor—just what you need to do your job.
- Round tubular shaft designed and built for fast, easy and accurate cutting.
- Factory-tested AC switch may be attached instantly without disassembling control.
- Speedy adaptability to both split-knurl and flatted type knobs.

PERFORMANCE YOU CAN COUNT ON

- Longer lasting resistance elements even in extremes of temperature and humidity.
- Better and more accurate taper curves resulting from precision processing methods.
- No pigtail connections to break, thanks to Mallory's exclusive sliding contact which gives EXTRA quiet operation.
- Minimum wobble with Mallory's exclusive 2-point shaft suspension.

So versatile are Mallory Midgetrols—both standard and dual—that they reduce by 40% the cost of inventory needed to service the 10 most popular makes of radio and TV sets.

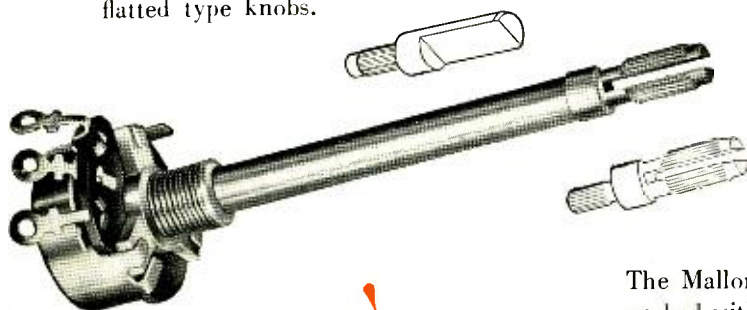

**Make Sure!
Make it Mallory!**

The Mallory Midgetrol is shown with the two shaft ends packed with every control to permit easy use of split-knurl or flatted type knobs. The Mallory Midgetrol line, in addition to round shaft standard controls, includes dual concentric controls that offer fast, easy assembly in five steps *without* special tools. Front and rear sections are factory assembled and inspected. AC switch attachment is easy.

P. R. MALLORY & CO. Inc.
MALLORY

CAPACITORS • CONTROLS • VIBRATORS • SWITCHES • RESISTORS
• RECTIFIERS • VIBRAPACK* POWER SUPPLIES • FILTERS

*Reg. U.S. Pat. Off.

APPROVED PRECISION PRODUCTS

P. R. MALLORY & CO., Inc., INDIANAPOLIS 6, INDIANA



How we *spot* "shady characters"
before they can damage your business

THE instrument you see is working for *you*. A sensitive light-measuring device, it is used like a doctor's stethoscope, to explore the surface of a picture tube for screen imperfections the unaided eye would fail to detect.

Employing a photosensitive surface and color filters, this device does two jobs. It checks not only the uniformity of brightness, but also the *color* values from center to edges of the faceplate.

Why is this important? It is important because RCA has learned, through long

experience in the manufacture of picture tubes, that the best picture—the picture having superior quality—calls for unusually rigid processing controls of the phosphor and its application. The light-measuring device spots any departure from RCA's established brightness and color standards. Result? "Shady characters"—those tubes that would produce pictures lacking in fine quality—*never reach your shop*.

This constant vigilance and *quality control* at *all* stages of manufacture assure

that RCA standards will be met. In this way, RCA guards its own reputation for quality . . . and *yours as well*.

With RCA Receiving Tubes, as well as RCA Kinescopes, **TOP-QUALITY CONTROL** makes the difference.



RADIO CORPORATION of AMERICA
ELECTRON TUBES **HARRISON, N. J.**