

# RADIO — ELECTRONICS

APRIL 1952

LATEST IN TELEVISION • SERVICING • AUDIO

MAR 29 Rec'd

HUGO GERNSBACH Editor

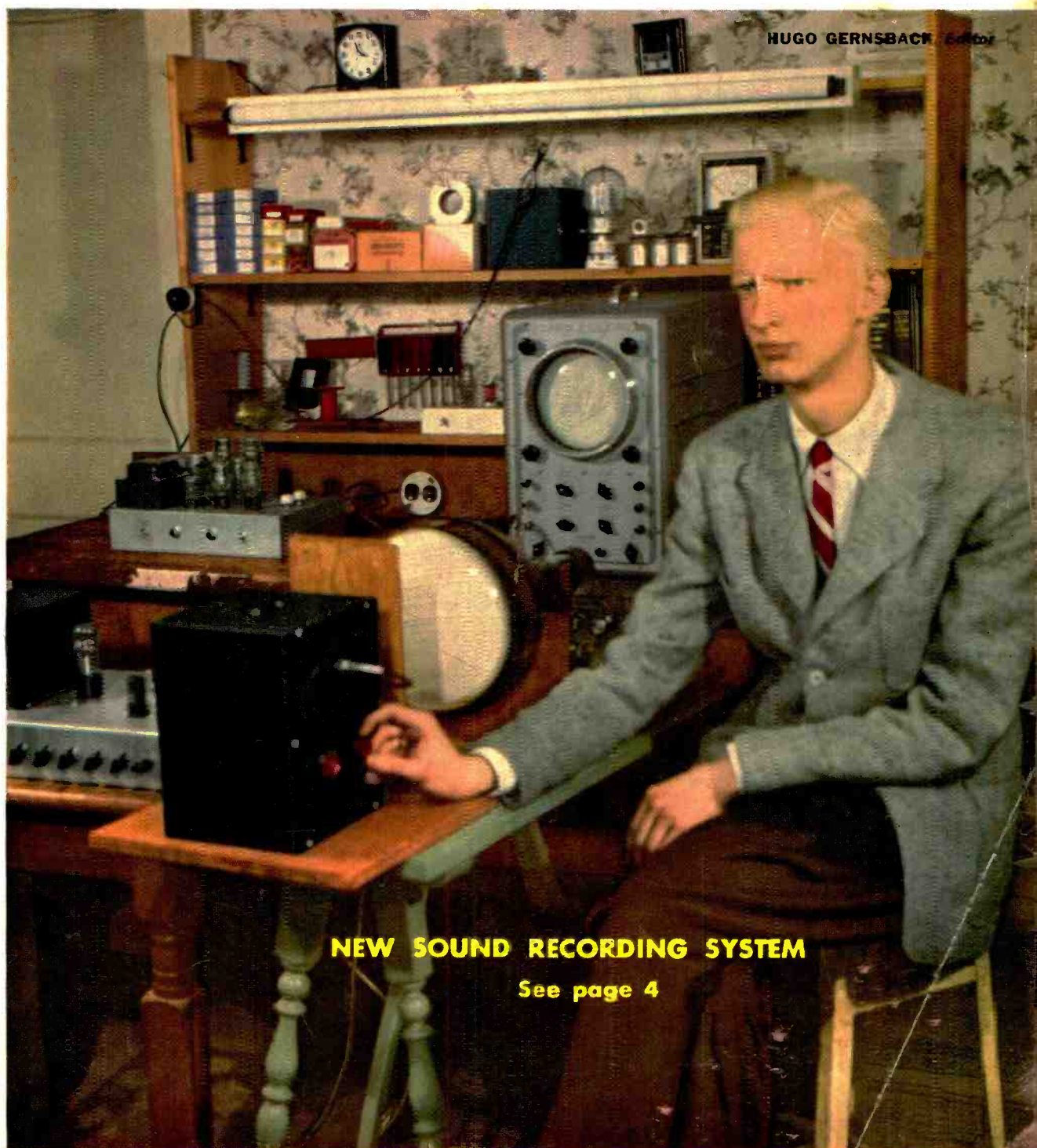

**NEW SOUND RECORDING SYSTEM**

See page 4

**30¢**

U. S. and  
CANADA

**In this issue: Circuits for the TV Fringe •  
Novel Rain Detector • Regulated Power Supply**

For YOU, the Local Radio Dealer and Serviceman . . .

# We're beating a path to your door



**HOW?** By telling millions of radio listeners and television viewers that *you, the local Radio dealer-serviceman . . .* are best qualified to sell and install RCA Radio Batteries. The RCA Battery message, beamed out on our big national

network radio and TV programs, is building BIG RCA Battery demand for you. Portable radio owners everywhere will be *beating a path to your door*. Be ready for them . . . stock, promote, and sell RCA Radio Batteries.



## Here are 3 more ways we are helping you

1. We help you advertise on the RCA Battery carton itself. A printed message on the carton of each volume-type RCA Battery tells the owner of a portable radio to come to you, his radio dealer, when it's time to buy replacements. And right on the batteries there's a space where you can stamp your own name and address to pull repeat business back to you.

2. We channel our principal battery distribution to YOU as a radio dealer and serviceman. And because radio outlets are the primary source for RCA Batteries, you get profitable repeat business from portable-radio owners in your community.

3. We will continue to provide fast, reliable battery service backed by a nation-wide warehousing and

distribution organization geared to the needs of the radio trade.

## Now! Get ready to fill the sizzling demand for RCA Batteries . . .

They're *competitively priced* for fast, easy sales. They're *geared to your Radio trade*. And your personal stamp on the batteries you sell directs new customers and old friends *to your door*. So call your RCA Battery Distributor . . . get lined up for this profitable big volume business . . . **RIGHT NOW!**



**RADIO CORPORATION of AMERICA**  
RADIO BATTERIES  
HARRISON, N. J.



**TRAIN**

**for Security! Good-Paying Jobs!**

**MAKE THE MONEY YOU'VE ALWAYS DREAMED OF!**



# LEARN RADIO -TELEVISION

**AND ELECTRONICS  
BY EASY SHOP METHOD  
TRAINING AT HOME!**

**You get  
all the parts—even tubes!—**  
for this modern Superheterodyne Receiver. You learn to build it step by step. And you keep it! Get all the facts. Mail coupon now.

Let **NATIONAL SCHOOLS**—a resident-training school for nearly 50 years—train you at home for today's unlimited opportunities in Radio-Television-Electronics. National Schools is one of the largest schools of its kind. It is located in Los Angeles—the center of Radio and TV world! It has four large buildings of modern shops and labs. Its faculty is considered tops in the business.



You learn from lessons prepared by experienced instructors and engineers. Men who are successful Radio and Television technicians. Men who have trained 1000's of men like YOU!

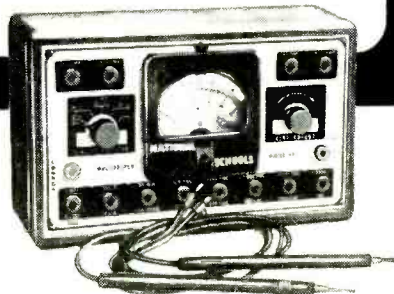

**Only National Schools Gives You This  
Professional Multi-Tester!**

You get this amazing, new testing instrument—factory-made and tested—complete—ready to use! Simple to operate. Accurate and dependable. An instrument every Radio-TV man needs. Light enough to carry around—so you can use it at home or on service calls. You'll be proud to own this valuable equipment.

**Here are only a Few of the  
Good-Paying Jobs You Can Choose**

Radio Station Engineer, District Service Manager, Aircraft Radio Inspector, Own Your Own Repair Shop, Inspector Technician, Service Specialist, Special Government Jobs, Complete TV Service, Sound Truck Operator. Many more! National Schools graduates have secure, good-paying jobs like these! So don't wait—mail the coupon today. Now—while you're thinking about it!

**Attention! Men Going into Service Soon!**

National Schools' course quickly prepares you for many important jobs in the Armed Services. With National Schools Training you have an opportunity to get into *special* service classifications—with higher pay and grade—immediately!

**FREE SERVICE FOR GRADUATES**

National Schools uses its great influence and prestige to help you find your place in the field of your choice. Don't put it off! Start yourself toward a skilled trade! Get the big pay you've always wanted!

**NATIONAL SCHOOLS**  
LOS ANGELES 37, CALIFORNIA • ESTABLISHED 1905  
In Canada: 193 E. Hastings St., Vancouver, B. C.

**You Train At Home—In Your Spare Time**

National Schools Shop Method Home Training gives you basic and advanced instruction in *all* phases of Radio-TV-Electronics. And remember—your training is based on resident school training principles. You learn *fast* from hundreds of diagrams and pictures. All instructions are written by experienced technicians who work in Radio and TV every day. All instructions have been developed and tested in National Schools' own labs and studios, which are equipped with the latest RCA equipment. No wonder this National Schools course is so up-to-date, practical, interesting. And so easy to learn! And no wonder it is held in such high regard by leaders of American industry! Approved for eligible Veterans.

**We Teach You How To Make Welcome  
Extra Money—While You Learn!**

Many National Schools students—men like you—make plenty of extra dollars each week in spare time! Fixing neighbors' radios, appliances and other ways we teach you. You start learning and earning from the day you enroll. From the very first lesson!

**WE SEND YOU LOTS OF PARTS  
LIKE THIS!**

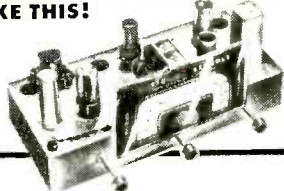

With National Schools Shop Method Home Training, you get basic principles and plenty of *practical* training. *You learn by doing.* No wonder you learn so fast!

We send you many parts—all of professional, modern quality. You do lots of practical experiments. You advance day by day, step by step. Until you can even build the modern Superheterodyne Receiver you see above—plus other important testing units. The free book tells you all about it. The free sample lesson shows how easy the training is. Use the coupon. Send today—without fail!

**DON'T PUT  
IT OFF!  
GET THE  
BIG SALARY  
YOU HAVE  
ALWAYS  
WANTED!**

**Today's Shortage of Trained Technicians  
Creates Chance of a Lifetime For You!**

Think of it! With guided missiles, radar, and other electronic devices so important to national defense! With big, new developments in TV. With over 90,000,000 home and auto radios, over 12,000,000 TV sets. With more than 3100 radio stations...over 100 TV stations—and more building every day...yes, imagine the great opportunity you have today!

**YOU** are wanted in Radio-Television-Electronics! America's fastest-growing field. High-pay jobs—the kind you've always wanted—are waiting for YOU!

**Job Security! Big Money! For YOU!  
in Today's Expanding Industries!**

Trained Radio and Television technicians really make important money these days. Thousands of National Schools graduates—men just like you—are earning good money all over the country. Why not you?

And—National Schools graduates get the personal satisfaction of being highly-skilled technicians. Men people respect. Men who *enjoy* their work—rather than having to drag along in just any old job.

**National Schools Has Trained 1000's  
of Successful Men! Why Not YOU?**

In almost every state—and many foreign countries—National Schools graduates are filling big jobs with famous companies. Or running their own successful businesses. What are YOU waiting for? National Schools training is *complete* training. So when you graduate you can take advantage of today's big opportunities in Radio-Television-Electronics—fast.



**FREE BOOK  
TELLS YOU HOW!**

Page after page—in color—tells you everything you want to know. Mail the coupon. Get this valuable book today. And if you hurry—YOU GET A FREE SAMPLE LESSON, TOO! Shows how easy National Schools Home Training is. Mail the coupon today.

**MAIL THIS COUPON TODAY—WITHOUT FAIL!**

**NATIONAL SCHOOLS, Dept. GR-42**  
4000 South Figueroa Street  
Los Angeles 37, California

Mail in envelope  
or paste on  
penny post card.

Mail me FREE the book mentioned in this ad. Also a free sample lesson. I understand no salesman will call on me.

NAME \_\_\_\_\_ AGE \_\_\_\_\_

ADDRESS \_\_\_\_\_

CITY \_\_\_\_\_ ZONE \_\_\_\_\_ STATE \_\_\_\_\_

Check here if you were released from the Service less than 4 years ago.





## HOW TO PLEASE **1,000,000** MUSIC LOVERS

**WQXR Depends on G-E Pickups and Styli to  
Capture Full Brilliance of Recorded Music**

**Rated tops by professional users** like WQXR, the radio station of The New York Times, G-E audio equipment is at a peak of popularity with lovers of good music. The same superb cartridges and styli employed in WQXR studios are available for installation in home phonographs or sound systems—at prices your customers will appreciate.

**Highest sales in G.E.'s history** are being chalked up today by this outstanding line of high fidelity speakers, tone arms and pre-amplifiers. Don't miss your share of a fast-growing market that's currently rated in the millions! Call your General Electric distributor for full information.

**Ask Us for This New Free  
Phono Accessories Folder**

Complete line-up of G-E audio equipment is listed here. Write  
*General Electric Company,  
Section 4542, Electronics Park,  
Syracuse, New York.*



**GENERAL  ELECTRIC**



What you can do now  
to speed your  
**SUCCESS IN RADIO-  
TELEVISION-  
ELECTRONICS**

Send for this **FREE CREI Booklet** and see

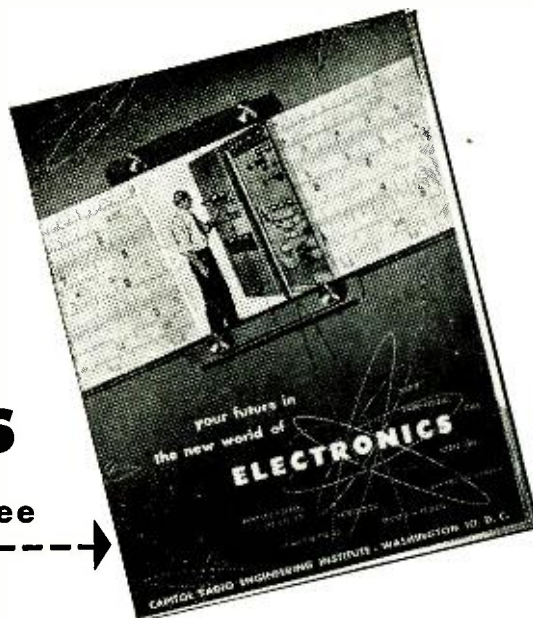

**T**HERE IS A vacancy coming up. It means a boost in pay, prestige and security. Can you fill it? The answer is "No," if you postpone your preparation for success.

The answer is "Yes," if opportunity finds you ready. "Ready" means "TRAINED." And your training must start now, if you expect to be big enough for a bigger job. You ask "What can I do *now*?" You will find many valuable suggestions in a free booklet, "Your Future in the New World of Electronics." Not only does it picture fabulous opportunities . . . it tells you what to do to grow with an industry desperately seeking trained men. Expansion is phenomenal: In the defense build-up alone, more than \$7 billion in electronics contracts have been awarded. In 1951, the top manufacturers alone sold about \$3 billion in equipment. It is estimated that by 1961 the radio-electronics industry will do no less than \$10 billion per year, excluding defense orders.

Growing civilian markets include radio-equipped police cars, fire-equipment, taxis, planes, ships—in increasing numbers. There are industrial radio network installations, medical applications, and countless others. There are 109 TV stations now on the air. The FCC's chairman predicts 1500 stations within 5 years, and 2500 stations by 1961. Already it is estimated there are 15,690,394 TV sets and over 100,000,000 radios in operation. How these figures will increase in the next few years, the most daring experts are reluctant to predict. This much is certain: Limitless numbers of positions must be filled—in development, research, design, production, testing, inspection, manufacture, broadcasting, telecasting, and servicing. To fill these posts, trained men are needed—men who somewhere along the line are alert enough to improve their knowledge and skills. "Your Future in the New World of Electronics" shows how CREI Home Study leads to greater earnings, by helping get you ready for the openings described above.

CREI promises no short cuts. In an accredited technical school such as this, *you must study* to transform your ambition and energy into knowledge that pays off. Since its founding in 1927, CREI has provided thousands of pro-

fessional radio men with technical educations. During World War II CREI trained thousands more for the Armed Services. Leading firms choose CREI courses for group training in electronics at company expense; among them are United Air Lines, Canadian Broadcasting Corporation, Trans Canada Airlines, Bendix Products Division, All American Cables and Radio, Inc., RCA Victor Division, Mochlett Laboratories, Canadian Marconi and Heppner Mfg. CREI's practical courses are prepared by recognized experts. You get up-to-date material; your work is under the personal supervision of a CREI staff instructor, who knows and teaches you what industry needs. Training is accomplished on your own time, during hours chosen by

you. As a graduate, you'll find your CREI diploma the key to success in Radio, TV and Electronics. At your service is the CREI Placement Bureau, which finds positions for advanced students and graduates. Although CREI does not guarantee jobs, requests for personnel far exceed current supply. CREI alumni hold top positions in America's leading firms.

Now is the time to decide—to act. When opportunity knocks, knowledge

must be "at home." You supply the willingness to learn. We supply the technical training. This combination of ambition and knowledge is unbeatable in the new Age of Electronics. Fill out the coupon and mail it now. We'll promptly send you your free copy of "Your Future in the New World of Electronics."

CREI Resident Instruction (day or night) is offered in Washington, D. C. Here work is done with the latest equipment, in ideal surroundings, under close personal supervision. New classes start once a month. For a CREI Residence School catalog, check the last line of the coupon below.

**MAIL COUPON FOR FREE BOOKLET**

**CAPITOL RADIO ENGINEERING INSTITUTE**

Dept. 144D, 16th & Park Rd., N.W., Washington 10, D. C.

Send booklet "Your Future in the New World of Electronics" and course outline.

CHECK FIELD OF INTEREST  TV, FM & Advanced AM Servicing  Aeronautical Radio Engineering  Practical Television Engineering  Broadcast Radio Engineering (AM, FM, TV)  Practical Radio Engineering

Name .....

Street .....

City ..... Zone ..... State .....

If residence school in Wash., D. C. preferred, check here



# MERIT

TV full-line\* Components For  
Improvement, Replacement, Conversion



## SELL IMPROVED RECEPTION

MERIT "TV" Kit #1000 for edge to edge focus—contains MDF-70 Cosine Yoke, HVO-7 Universal Flyback and MWC-1 Width Linearity Control. Keep a Kit handy — you'll get plus business and a reputation for "know-how."



MDF-70 . . . original of the "cosine" series — low horz, high vert inductance. Used by such famous sets as Radio Craftsman. Cosine Yokes will improve 10,000,000 sets now in use!

## MERIT...HQ for TV Service Aids

MERIT's 1952 Catalog #5211 now available . . . introducing MERIT IF-RF Coils, includes Coil & Transformer data, listings. Other MERIT service aids: TV Repl Guide #404, Sept. '51 issue — covers 3000 models, chassis of 82 mftrs; Cross Ref Data on IF-RF Coils, Form #14. Write: Merit Coil and Transformer Corporation, 4425 North Clark Street, Chicago 40.

## These three MERIT extras help you:

- Exclusive: Tape-marked with specs and hook-up data 
- Full technical data packed with every item
- Listed in Howard Sams Photo-facts



\*Merit is meeting the TV improvement, replacement and conversion demand with a line as complete as our advance information warrants!

BURTON BROWNE ADVERTISING

**WAYNE COY**, chairman of the Federal Communications Commission, resigned his post with the FCC late in February to accept a position as full-time consultant with Time, Inc., publishers of the weekly newsmagazine of that name, as well as the magazines *Life* and *Fortune* (and the TV presentation, *The March of Time*). Mr. Coy will divide his time between New York and Washington, according to a representative of the publishing house.

**CANADIAN TV** broadcasts are expected to start in August, according to J. A. Ouimet of the Canadian Broadcasting Corporation. Local availability of structural steel will determine whether Montreal or Toronto will be on the air first. Programs for Ottawa will be provided later by an inter-city link with one or both of these cities.

**SERIOUS LOSS** to the nation's electronics and communications industries may result from the FCC's acute shortage of personnel and its limited funds. In requesting adequate appropriations from Congress, Commissioner Coy cited as only two items in the FCC's workload — the vast increase in portable-mobile authorizations and the lifting of the TV freeze.

Increased funds for FCC operations were asked by President Truman in his recent budget message. Additional monitoring facilities required by the defense program, as well as the increased work load expected with the lifting of the TV "freeze" were cited by the President in his request for an appropriation of \$8,075,000.

**OREGON AMATEURS** will hold their annual convention at the Osburn Hotel, Eugene, Oregon, Saturday and Sunday, April 26 and 27. Highlight of the convention will be a demonstration by the pioneer ham, John Reinartz, of his portable 1-kw Eimac transmitter. Hidden transmitter hunts, demonstrations of electronic control of ship models, a "swapfest" and prize drawings will also be included among the features of the meeting.

**AN AUDIO FAIR** will be held in Chicago on May 23 and 24. It will follow immediately the Electronic Parts Show at the Conrad Hilton Hotel, and will occupy three entire floors. It will be open to the public.

**MASS PRODUCTION** of a small automatic radar device for jet fighters, produced faster than any types of radar in World War II, makes the unit the most widely used type in the world, according to Dr. W. R. G. Baker, vice president and general manager of the electronics division of the General Electric Company. The radar unit, credited with giving American jet pilots an advantage over enemy planes in Korea, is being installed in Air Force, Navy and Marine Corps planes throughout the world.

**ARMY'S WALKIE-TALKIES** may soon be equipped with an alerting vibrator that frees the user from continuous listening. The device, invented by Neil C. Fowlson of Council Bluffs, Iowa, is worn on the arm, and is actuated by the incoming signal.

**NATIONAL AIRBORNE ELECTRONICS** conference of the Institute of Radio Engineers will be held May 12, 13, and 14 at the Dayton Biltmore Hotel, Dayton, Ohio. Greatly expanded in scope, the conference will cover military and commercial aviation electronics.

**"PIRACY ON THE HIGH C'S"** has been charged by Columbia Records, Inc., and Louis Armstrong against Paradox Industries, Inc. Suing to halt distribution and sale of six "Jolly Roger" label discs, Columbia and Armstrong claim unauthorized "dubbing" of the six records from Columbia originals. An injunction against the alleged pirate was obtained.

**LIFEBOAT TRANSMITTERS** will become compulsory equipment after November 19, 1952, for all U. S. cargo vessels of 500 gross tons or over, according to a recent statement of the Coast Guard.

This step will carry out the requirements of the 1948 Convention for the Safety of Life at Sea, to which this country is a signatory.

**CLEAR CHANNELS** for closed-circuit theatre-TV networks have been requested from the FCC by the motion picture industry. Spokesmen for the industry predict that such allocations will make possible interference-free programs in black and white or full color, superior even to film.

**TV'S EDUCATIONAL EFFECTS** can be as pronounced for harm as for good. A 16-year-old baby sitter, Delora Mae Campbell, high school sophomore of Los Angeles, was arrested for strangling a 6-year-old child with a stocking after she had watched a TV presentation of a strangling.

**RADIO LISTENING** continues to grow despite the inroads of television, according to Robert M. Hoffman, research director of WOR. In the New York City area, 84.5% of families owning TV receivers listen to radio as well, and the continual increase in the non-TV-owning population provides a comfortable margin for the elder industry.

**COCKROACHES** are the latest form of TV interference, reports John Crosby, radio and television commentator of the *New York Herald Tribune* syndicate. Citing sources of unquestionable authority, he attributes the menace to the irresistible attractions of warm, spacious quarters, free entertainment, and unlimited opportunities for appearing in the limelight behind the well-advertised protection of the tube's safety glass.

RADIO-ELECTRONICS



**NOW... GET EVERYTHING YOU NEED TO LEARN AND MASTER**

# TELEVISION

**RADIO-ELECTRONICS ...AT HOME!**

Use REAL commercial-type equipment to get practical experience

Your future deserves and needs every advantage you can give it! That's why you owe it to yourself to find out about one of the most COMPLETE, practical and effective ways now available to prepare AT HOME for America's billion dollar opportunity field of TELEVISION-RADIO-ELECTRONICS. See how you may get and keep the same type of basic training equipment used in one of the nation's finest training laboratories... how you may get real STARTING HELP toward a good job or your own business in Television-Radio-Electronics. Mail the coupon today for complete facts — including 89 ways to earn money in this thrilling, newer field.

**D.T.I., ALONE, INCLUDES BOTH MOVIES and HOME LABORATORY** In addition to easy-to-read lessons, you get the use of HOME MOVIES — an outstanding training advantage — plus 16 big shipments of Electronic parts. Perform over 300 fascinating experiments for

practical experience. Build and keep real commercial-type test equipment shown at right

**MODERN LABORATORIES** If you prefer, get all your preparation in our new Chicago Training Laboratories—one of the finest of its kind. Ample instructors, modern equipment. Write for details!

### MILITARY SERVICE!

If you're subject to military service, the information we have for you should prove very helpful. Mail coupon today.

**89 WAYS TO EARN MONEY IN TELEVISION RADIO ELECTRONICS**

**YOU GET \$116**

**ACT NOW! MAIL COUPON TODAY!**

DE FOREST'S TRAINING, INC, Dept. RE-4-1  
2533 N. Ashland Ave., Chicago 14, Ill.

Without obligation, I would like your Opportunity News Bulletin showing "89 Ways to Earn Money in Television-Radio-Electronics"; also, the folder showing how I may prepare to get started in this thrilling field.

Name.....Age.....  
Address.....Apt.....  
City.....Zone.....State.....



**Here's the REAL THING!**

**SET UP YOUR OWN HOME LABORATORY**



R-F Signal Generator



Oscilloscope



6-Tube Radio

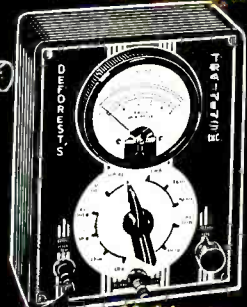

Multimeter

**"ONE OF AMERICA'S FOREMOST TELEVISION TRAINING CENTERS"**

**De FOREST'S TRAINING, INC.**  
CHICAGO 14, ILLINOIS  
A DeVRY INSTITUTION



# Famous Guns



## Colt Army Revolver, Model 1872, Caliber .45

Known as the "Peacemaker" and, in .44 caliber, the "Frontier" revolver. This famous Colt was *the law west of the Mississippi!* Weight and ruggedness made it a convenient means of administering a "pistol whipping".



**Model 1808 Navy Pistol, Caliber .64,** made by Simeon North of Berlin, Conn. Boarding pistols like this rendered valuable service in the War of 1812. In building them, North actually used a modern mass production technique—*standardized parts!*



## Instant-heating

Weller Soldering Gun for light or heavy work. Dual heat greatly increases tip life. Switch instantly to high or low heat as job requires. Pre-focused spotlights end "blind soldering". Exclusive tip-fastening arrangement assures full, constant heat. High-impact plastic housing. Perfect balance. Low-cost replaceable tips. Pays for itself in a few months. See at your Distributor or write for Bulletin direct.

Get **SOLDERING TIPS**, new Weller Handy Guide to faster, easier soldering. 20 pages fully illustrated. Price 10c at your Distributor or order direct.

**Weller** BETTER FROM GRIP TO TIP

**SOLDERING GUNS** 828 Packer Street, Easton, Pa.

*The Finest Soldering Tool for the Finest Craftsmen*



Signal Corps Photo

The robot weather station as it looked during tests at Mt. Washington, N.H.

**A ROBOT WEATHER STATION**, developed by the Signal Corps Engineering Laboratories at Fort Monmouth, N. J., has been automatically sending weather data for six months from a deserted island in the Aleutians. Capable of operating unattended for a year or more in Arctic cold, wind, and fog, its code transmissions report vital meteorological data to an Air Force station 250 miles away.

The unattended weather station is located on an island, where thick fogs prevail in the summer and gusty 100-mile-per-hour winds during the winter. The station can operate in temperatures lower than 60 degrees below zero.

Transportable by air, the station consists of an insulated metal shelter and a small instrument section atop the shelter. There are built-in automatic heating and fire-extinguisher controls.

The heart of the station is a self-winding clock which acts as the "master brain." The clock does the same job as a car's starter button, putting the motor into operation.

**TOTAL RADIO STATIONS** in the United States exceeded 190,000 in 1951, according to the Federal Communications Commission. The report listed (as of September) 2,401 AM broadcast stations, 653 FM broadcast stations, and 108 TV stations. Common-carrier services amounted to 822 and industrial services 10,591. Marine radio included 29,826 ship stations. Other stations in the maritime services bring up the total to 32,870, slightly above the aeronautical services' 32,221. There were 95,131 licensed amateur stations and 651 licensed stations in the Citizens Band. The bulk of the others are in the Safety and Special Radio Services.

The figures above give a conservative picture of the number of radio stations in the country, as they are based on station licenses which may cover more than one transmitter.

—end—

RADIO-ELECTRONICS



# Six Months from Today Which will YOU hold?



ADD TECHNICAL TRAINING TO YOUR PRACTICAL EXPERIENCE

## GET YOUR FCC LICENSE IN A HURRY!

Then use our Amazingly Effective  
JOB-FINDING SERVICE

Get this Valuable Booklet **FREE**



TELLS HOW YOU CAN GET A  
**FREE** TELEVISION  
ENGINEERING  
COURSE

**TELLS HOW —**

### WE GUARANTEE

TO TRAIN AND COACH YOU AT HOME  
IN SPARE TIME UNTIL YOU GET  
**YOUR FCC LICENSE**

If you have had any practical experience — Amateur, Army,  
Navy, radio repair, or experimenting.

**TELLS HOW —**

Employers make

**JOB OFFERS Like These**

to Our Graduates Every Month

Letter, October 11, 1951, from Chief Engineer, Broadcast Station, North Carolina. "Need men with radiotelephone 1st class licenses, no experience necessary. Will learn more than at average station for we are equipped with Diesel Electric power, transmitting and studio equipment."

Telegram, October 2, 1951, from Chief Engineer, Broadcast Station, Wyoming. "Please send latest list available first class operators. Have November 10th opening for two combo men."

These are just a few samples of the job offers that come to our office periodically. Some licensed radioman filled each of these jobs . . . it might have been you!

**HERE'S PROOF FCC LICENSES ARE OFTEN SECURED IN A FEW HOURS OF STUDY WITH OUR Coaching AT HOME in Spare Time.**

Name and Address	License	Lessons
Lee Worthy 2210 1/2 Wilshire St., Bakersfield, California	2nd Phone	16
Clifford E. Vogt Box 1018, Oania, Florida	1st Phone	20
Francis K. Foersch 38 Heuler Pl., Bergenfield, New Jersey	1st Phone	38
S/Sgt. Ben M. Davis 317 North Roosevelt, Lebanon, Illinois	1st Phone	38
Albert Schoell 110 West 11th St., Escondido, California	2nd Phone	23

**CLEVELAND INSTITUTE OF RADIO ELECTRONICS**  
Desk RE-40, 4900 Euclid Bldg., Cleveland 3, Ohio

APRIL, 1952

**TELLS HOW —**

Our Amazingly Effective  
**JOB-FINDING SERVICE**

Helps CIRE Students Get Better Jobs

Here are a few recent examples of Job-Finding results:

**GETS CIVIL SERVICE JOB**  
"Thanks to your course I obtained my 2nd phone license, and am now employed by Civil Service at Great Lakes Naval Training Station as an Equipment Specialist."  
Kenneth R. Leiser, Fair Oaks, Mtd. Del., McHenry, Ill.

**GETS STATE POLICE JOB**  
"I have obtained my 1st class ticket (thanks to your school) and since receiving same I have held good jobs at all times. I am now Chief Radio Operator with the Kentucky State Police."  
Edwin P. Healy, 261 E. 3rd St., London, Ky.

**GETS BROADCAST JOB**  
"I wish to thank your Job-Finding Service for the help in securing for me the position of transmitter operator here at WCAE, in Pittsburgh."  
Walter Kosehik, 1442 Ridge Ave., N. Braddock, Pa.

**GETS AIRLINES JOB**  
"Due to your Job-Finding Service, I have been getting many offers from all over the country, and I have taken a job with Capital Airlines in Chicago, as a Radio Mechanic."  
Harry Clare, 4537 S. Drexel Blvd., Chicago, Ill.

OURS IS THE ONLY  
HOME STUDY  
COURSE WHICH  
SUPPLIES FCC-  
TYPE EXAMINA-  
TIONS WITH ALL  
LESSONS AND  
FINAL TESTS.

Your FCC Ticket is recognized in all radio  
fields as proof of your technical ability



**Get All 3 FREE**

**MAIL COUPON NOW**

CLEVELAND INSTITUTE OF RADIO ELECTRONICS  
Desk RE-40—4900 Euclid Bldg., Cleveland 3, Ohio  
(Address to Desk No. to avoid delay)

I want to know how I can get my FCC ticket in a minimum of time. Send me your FREE booklet, "How to Pass FCC License Examinations" (does not cover exams for Amateur License), as well as a sample FCC-type exam and the valuable booklet, "Money-Making FCC License Information."

Tell me how I can get your Free Television Course.

NAME.....  
ADDRESS.....  
CITY..... ZONE..... STATE.....  
Paste on penny postcard or send air mail



# The 7" TV scope for professionals

## RCA WO-56A

### DUAL CONTROLS FOR "COARSE" AND "FINE" ADJUSTMENTS

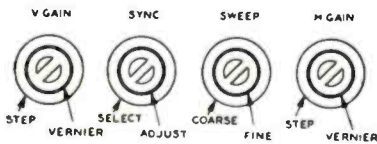

No hunting or fumbling for controls when adjusting Vertical Amplifier Gain, Sweep Frequency, Sync Injection, and Horizontal Amplifier Gain.

### FEATURING—

- Giant RCA 7JP1 cathode ray tube.
- Direct-coupled, 3-stage, push-pull, vertical and horizontal amplifiers.
- Frequency-compensated and voltage-calibrated attenuators on both amplifiers.
- A set of matched probes and cables.
- Panel source of 3 volts peak-to-peak calibrating voltage.
- Identical vertical and horizontal amplifiers with equal phase-shift characteristics.
- Retractable light shield for maximum visibility.
- New filter-type graph screen with finely ruled calibrations.
- Magnetic shield enclosing CR tube to minimize hum-pickup from internal and external fields.

### SPECIFICATIONS—

- Vertical Deflection Sensitivity: 10.6 rms millivolts per inch.
- Frequency Response: Flat within -2 db from dc to 500 kc; within -6 db at 1 Mc; useful response beyond 2 Mc.
- Input Capacitance: Less than 10 uuf with WG 216A Low-Capacitance Probe.
- Square-Wave Response: Zero tilt and overshoot using dc input position. Less than 2% tilt and overshoot using ac input position.
- Linear Sweep: 3 to 30,000 cps with fast retrace.
- Trace Expansion: 3 times screen diameter with corresponding centering control range.
- Power Supply: 105-125 volts 50/60 cycles; power consumption 65 watts.
- Size 13 3/4" h, 9" w, 16 1/2" d. Weight only 31 pounds (approx.).

### ADVANCED SWEEP FACILITIES—

- Preset fixed sweep positions for vertical and horizontal television waveforms.
- Positive and negative syncing for easy lock-in of upright or inverted pulse waveforms.
- 60-cycle phase-controlled sweep and synchronizing.



Supplied with direct probe, low-capacitance probe, and ground cable.

Built for laboratory, factory, or shop use, the WO-56A combines the advantages of high-sensitivity and wide-frequency range in a *very small* instrument with a *large* cathode-ray tube.

Designed with the user in mind, this new scope can be depended upon to provide sharp, bright, large, and accurate pictures of minute voltage waveforms over the entire useful surface of the 7JP1 screen.

The amplifier selector switches are provided with both "AC" and "DC" positions so that measurements can be made with or without the effects of any dc component.

Square-wave reproduction is excellent, whether the application is low-frequency TV sweep-alignment or observation of high-frequency steep-fronted sync and deflection voltage waveforms.

A special sync-limiter circuit automatically maintains proper synchronization of the sweep oscillator over a

wide range of input-signal levels without the need for manual adjustment of the sync-vernier control.

The excellent linearity and fast retrace of the sweep or time base are functions of the Potter-type oscillator. Undistorted reproduction of the sawtooth waveform is assured by use of a horizontal amplifier with a wide-band characteristic. The preset sweep positions provide rapid switching between vertical and horizontal TV waveforms.

Truly, the WO-56A is a most useful and practical instrument for everyday work in the fields of television, radio, ultra-sonics, audio, and a wide array of industrial applications.

For details, see your RCA Distributor, or write RCA, Commercial Engineering, Section DX 49, Harrison, N. J.



**RADIO CORPORATION of AMERICA**

TEST EQUIPMENT

HARRISON, N. J.

RADIO-ELECTRONICS



GET THIS  
**ALLIED**  
 Best Buy  
 in Hi-Fi

**New Pilot AF-605 Hi-Fi AM-FM Tuner**  
 at a sensationally low price

only \$42<sup>95</sup>

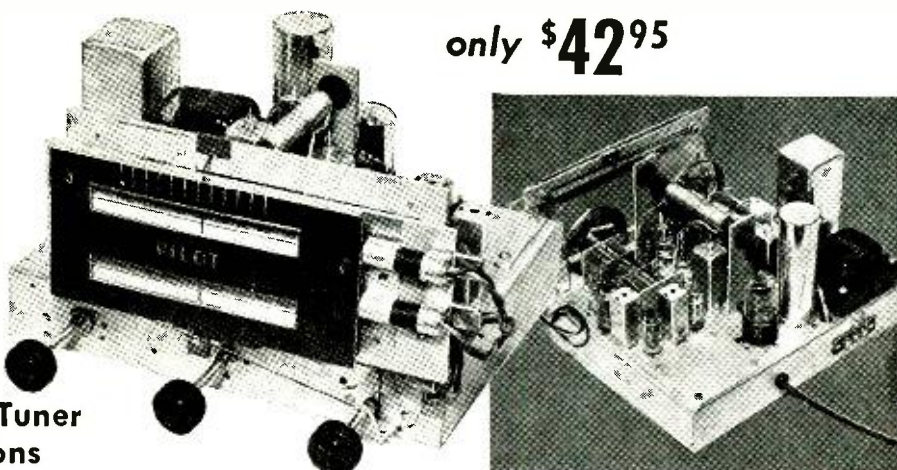

**Lowest Cost High-Quality Tuner**  
 Ideal for Custom Installations

The new Pilot AF-605 Tuner provides splendid reception of standard AM broadcasts and the 88-108 mc FM band. Features flat response within 2 db from 20-15,000 cps, with low distortion and high signal-handling ability. Has relatively low output impedance to minimize high frequency attenuation in output cable. Includes inputs for phono and TV, controlled by band switch. With slide-rule dial (each band separately illuminated); separate 3-gang tuning condensers for AM and FM; provision for outside AM and FM antennas; self-contained power supply.

**FM Features:** Tuned RF stage for maximum sensitivity and selectivity; built-in line; antenna temper-

ature-compensated oscillator; ratio detector with 225 kc wide linear response; IF response 200 kc wide at 6 db points; 300 ohm balanced input to antenna coil with electro-static shield.

**AM Features:** Tuned RF stage; built-in high efficiency new "ceramic loop stick" iron-core antenna; IF wave trap; IF response 7.5 kc wide at 6 db points; separate diode for AVC voltage.

**Pilot AF-605 Tuner Complete.** Chassis size, 11 1/2 x 6 x 9". For 110-120 volt, 50-60 cycle A.C. Complete with 9 miniature type tubes and rectifier. Shpg. wt., 8 1/2 lbs. **97-944. ALLIED'S low price only . . . . . \$42.95**

**Best Buy**  
 IN A CUSTOM  
**Hi-Fi AM-FM-  
 Phono System**

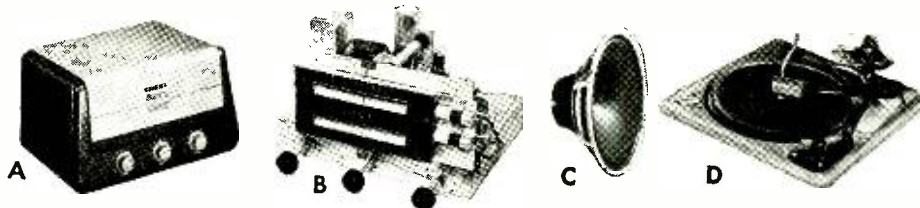

**a complete top quality AM-FM-Phono System at low cost**

Here's the special value ALLIED complete home entertainment system that provides superb reproduction from records as well as AM-FM broadcasts. The system includes (A) the famous KNIGHT 20-Watt High-Fidelity Amplifier with response ±1 db, 20-20,000 cps—unconditionally guaranteed for one full year; (B) the Pilot AF-605 FM-AM Tuner described above; (C) the General Electric S1201D 12" High-Fidelity Speaker with 14.5 oz. Alnico V magnet; (D) the Webster-Chicago 106-27 Three-Speed Automatic Record Changer with plug-in heads and 2 General Electric variable reluctance cartridges (one for standard

records, one for LP records). The system is supplied complete, with all necessary cables and leads for interconnecting the components, plus all tubes, hardware and complete installation and operating instructions. Cables are equipped with plugs, ready to connect—no soldering required. Shpg. wt., 66 lbs. Here is a complete High-Fidelity system, unsurpassed for value, providing wide-range reproduction from records and AM-FM radio.

**93-422. Complete AM-FM-Phono System. ALLIED'S low price... \$169.50**  
 \$25.43 down, \$12.73 monthly for 12 months

**FREE**  
 212-PAGE  
**ALLIED**  
 CATALOG

Send today for ALLIED'S authoritative, complete 1952 catalog, listing full selections of tubes, parts, test instruments, audio equipment, industrial components—everything in Electronics at lowest prices. Look to ALLIED for speedy delivery, expert personal help and complete satisfaction. Get your FREE 212-page ALLIED catalog now.

**ALLIED RADIO CORP., Dept. 2-D-2**  
 833 W. Jackson Blvd., Chicago 7, Illinois

Ship the Pilot AF-605 AM-FM Tuner (\$42.95)  
 Ship the complete AM-FM Phono System (\$169.50)  
 \$ . . . . . enclosed.  Full Payment  Down Payment  
 Send FREE 1952 ALLIED 212-Page Catalog

Name . . . . .  
 Address . . . . .  
 City . . . . . Zone . . . . . State . . . . .



# SAVE TUBES— WITH G.E.'S NEW

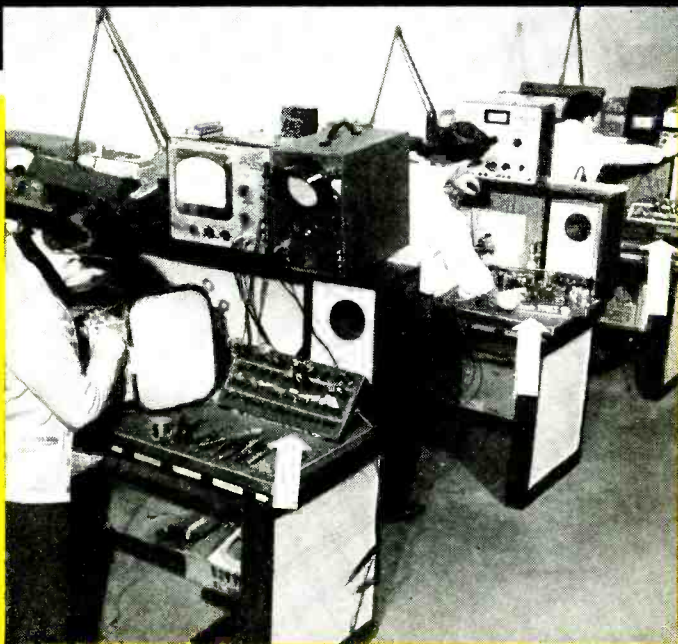

## TUBESAVER

*Says Al Mirus of Mirus TV Service Shop (left), 6579 Glenway Ave., Cincinnati, O.: "Our G-E Tubesavers do just what the name says. That's why we have one at every bench. A Tubesaver holds up to 52 tubes in their proper sequence, gripping the tubes so tightly they can't fall out. Built-in pin-straighteners help, too. The best and most practical device we've seen!"*

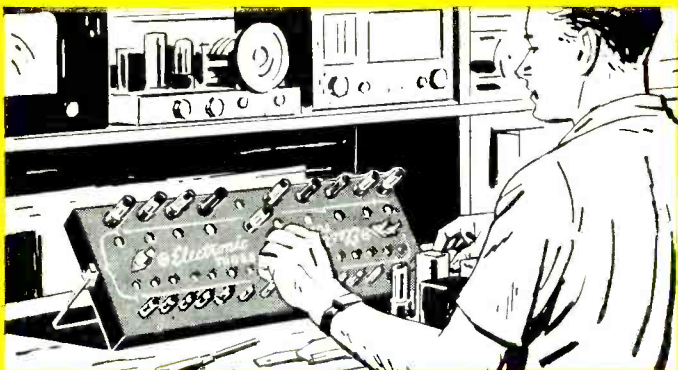

← **NO MORE WORRY ABOUT PUTTING TUBES BACK IN THE WRONG SOCKETS! . . .** The systematic layout of the G-E Tubesaver keeps tubes in their exact order. Moreover, they stay that way because rubber inserts keep them from dropping out—even if you tip the Tubesaver sharply! With its convenient handle design, the Tubesaver can be laid flat on the bench, angled, or hung on the wall nearby.



**NOW YOU CAN TEST TUBES FAST AND ACCURATELY! . . .** Place tubes in the inner holes of the G-E Tubesaver. Test them one-by-one. Put the good tubes in the outer set of holes, and return rejects to the inner set. Interruptions are no handicap—the Tubesaver keeps tubes correctly arranged till you resume work. *In their proper order* you now show the full tube complement of the receiver —

← which tubes are usable, which not!

**SEE YOUR G-E  
TUBE DISTRIBUTOR  
FOR FULL DETAILS!**



# SAVE TIME- SERVICE AIDS!

## PICTURE-TUBE CARRIER

Here's a practical aid that enables you to carry a cartoned picture tube safely and easily with one hand, leaving the other free for service equipment. Heavy canvas straps—quickly adjusted—hold the tube carton firmly. Rounded leather grip fits snugly in the hand. Blue and yellow colors are attractive. Save extra steps with this new convenience!

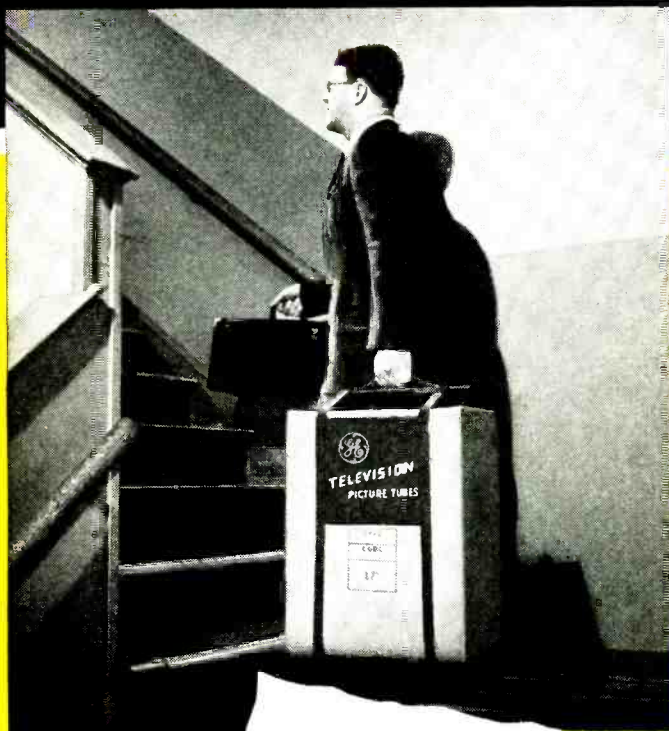

## DROP-CLOTH

Use this handy G-E drop-cloth to cover fine rugs or cabinets. It's durably woven, with a soft texture that won't harm the most delicate surface. A plastic top coating takes hard wear, resists hot solder, can be wiped clean in a jiffy. Customers will appreciate your protecting their furnishings from dust, grime, and stray particles of metal!

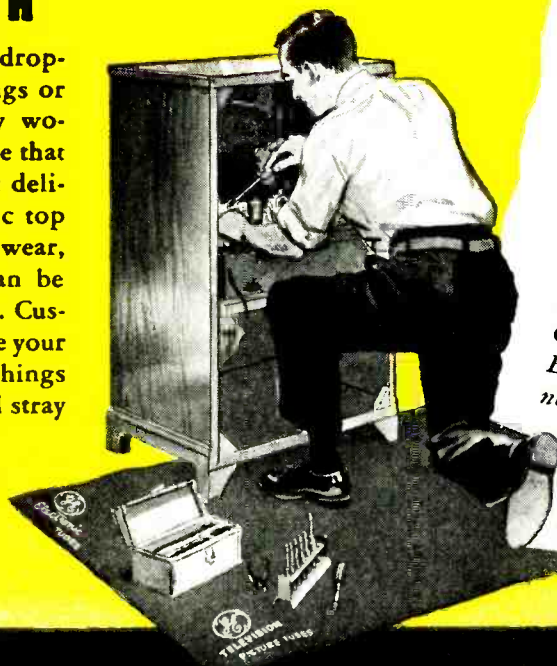

## MAKE MORE CALLS PER DAY

... with these G-E-tube service aids! They cut time and costs, build customer goodwill. Your General Electric tube distributor will be glad to help you obtain them. Phone or write him today! General Electric Company, Electronics Division, Schenectady 5, New York.

181-1A1

*You can put your confidence in—*

**GENERAL  ELECTRIC**



**NEW! 2ND EDITION**  
of the only complete  
reference on AUDIO!

**"The Recording &  
Reproduction  
of SOUND"**

by OLIVER READ



Completely revised and vastly enlarged new edition

**OVER 800 PAGES**

A "Must" for Sound Engineers, Hi-Fi Enthusiasts, P. A. Men, Broadcasting Stations, Recording Studios, Students

largest selling book in its field

**CONTENTS:**

**A Partial List of Authoritative Chapters:**

Behavior of Sound Waves; Basic Recording Methods; Lateral Disc Recording; Microgroove Recording; The Decibel; Phono Reproducers; Styli; Microphones; Loudspeakers and Enclosures; Dividing Networks and Filters; Attenuators and Mixers; Home Music Systems; P.A. Systems; Amplifiers; AM and FM Tuners—PLUS HUNDREDS OF OTHER SUBJECTS

Now you can have all the *right* answers to any subject in the field of Audio. Learn how to select and get the most out of recording equipment. Tells you how to select the proper amplifier for given applications, how to test amplifier performance, how to eliminate hum. Explains microphone, speaker and pickup principles and selection factors. Shows how to utilize inverse feed-back, expanders and compressors. Covers hundreds of subjects—a vast wealth of reliable information found in no other single volume. If you work in the field of Audio, this book belongs in your library. Order your copy today!

6" x 9" **ONLY \$7.95**  
Hard Covers  
800 pages 700 illustrations

**ORDER TODAY**

Order from your Parts Jobber, or write direct to  
**HOWARD W. SAMS & CO., INC.**  
2201 E. 46th St., Indianapolis 5, Ind.

My (check) (money order) for \$..... is enclosed.

Send ..... copy(ies) of *The Recording & Reproduction of Sound (RR-2)*. \$7.95 per copy.

Name.....

Address.....

City..... State.....

**Merchandising and Promotion**

Perfection Electric Co., Chicago, is now marketing its television components in individual cartons. The com-



pany's *Beamajuster*, *Kine-Center*, *Ion Trap* Magnets and *B.O. Eliminators* will be packaged in the new cartons.

JFD Manufacturing Co., Brooklyn, N. Y., has released a colorful decalcomania for display by distributors of JFD television antennas and accessories.

Allen B. Du Mont Laboratories' Teletest Service Control Department has issued a 115-page manual, "Service Operations of the Du Mont Distributor." The guide was published to acquaint new Du Mont distributors with their service responsibilities. Among the subjects covered are shop-work control, equipment, service department layout and training of service personnel.

Ohmite Manufacturing Co., Chicago, manufacturer of electrical rheostats, resistors, and tap switches, has brought out a new plastic version of its Ohm's Law Calculator. On the back are a standard slide rule and direct-reading scales for computing parallel resistance. It is available from Ohmite and its distributors for \$1.50. The company's original cardboard calculator is still available for 25c.

Hickok Electrical Instrument Co., Cleveland, Ohio, has issued a new folder illustrating and describing 10 new models in its line of dynamic mutual-conductance tube testers.

United Technical Laboratories, Morristown, N. J., has released a new two-color folder describing its "Klipzon" test prod products.

Telematic Industries, Brooklyn, N. Y., has developed a new display, the "Silent TV Salesman," which shows 12 of the company's TV accessories. Designed either to stand on the counter or hang on the wall, the display is part of a promotional campaign now under way.

National Union Radio Corp., Orange, N. J., has introduced an improved version of its carrying case for receiving tubes and small tools. The height has been increased and the top compartments redesigned for greater capacity. The case is available only through Na-



**BAROMETER**  
of the Parts Industry

During February, 53 of the leading 375 manufacturers of radio-television-electronic components and equipment made changes in their lines. Actually there was a slight decrease in "change activity" as compared with January.

In price revisions and the number of products affected, the following summary illustrates the

	No. of Manufacturers		No. of Products	
	Jan.	Feb.	Jan.	Feb.
Increased Prices	6	17	21	451
Decreased Prices	19	16	509	166

broken down into the following categories:

For product comparison, these figures can be broken down into the following categories:

	Increased Prices		Decreased Prices		New Products		Discontinued Products	
	No. of Mfrs.	No. of Products	No. of Mfrs.	No. of Products	No. of Mfrs.	No. of Products	No. of Mfrs.	No. of Products
Antennas & Accessories	2	14	2	14	5	14	3	5
Capacitors	1	1	None	None	2	8	None	None
Controls & Resistors	1	12	1	2	2	41	1	14
Sound & Audio	3	30	4	36	12	99	11	15
Test Equipment	None	None	1	14	3	5	None	None
Transformers	1	176	None	None	3	14	1	2
Tubes	8	255	7	63	7	19	2	4
Wire, Cable, Connectors	1	3	1	25	2	3	None	None

↑ Increase over January  
↓ Decrease

**Comment:**

Tube and audio items showed a trend toward increased prices. This could be due to adjustments allowed under the Copeland Amendment.

↑ Increase over January  
↓ Decrease

**Comment:**

In the number of February items introduced and discontinued by leading manufacturers, sound and audio equipment showed the most activity.

This data is prepared by the staff of United Catalog Publishers, Inc., 110 Lafayette Street, N. Y. C., publishers of RADIO'S MASTER.

*Greatest in demand  
Greatest in service*

Insist on **N V C** National Video Corp.

**TELEVISION REPLACEMENT TUBES**

Demand the  
N.V.C. trade mark  
on every picture tube.



*over*  
**1,000,000**

**Television Tubes Already Produced**

In more than a million sets you will find a National Video Corporation tube in active service — every one delivering a clearer, brighter, better picture. Designed to meet the service man's exacting requirements and interchangeable in every standard set.

Be sure to install a N.V.C. Television Tube to eliminate call-backs and waste of time and dollars. See your local distributor — say, "N.V.C.", the next time you buy replacement tubes.

Write for name of Distributor nearest you

3019 West 47th Street, Chicago, Ill.

Three plants with over 17 acres of coordinated machinery and personnel, producing the world's finest television picture and receiving tubes.



*National Video Corporation*

3019 W. 47th St.  
Chicago

Grays Lake  
Illinois

NAVIDICO  
901 W. Huron St. Chicago



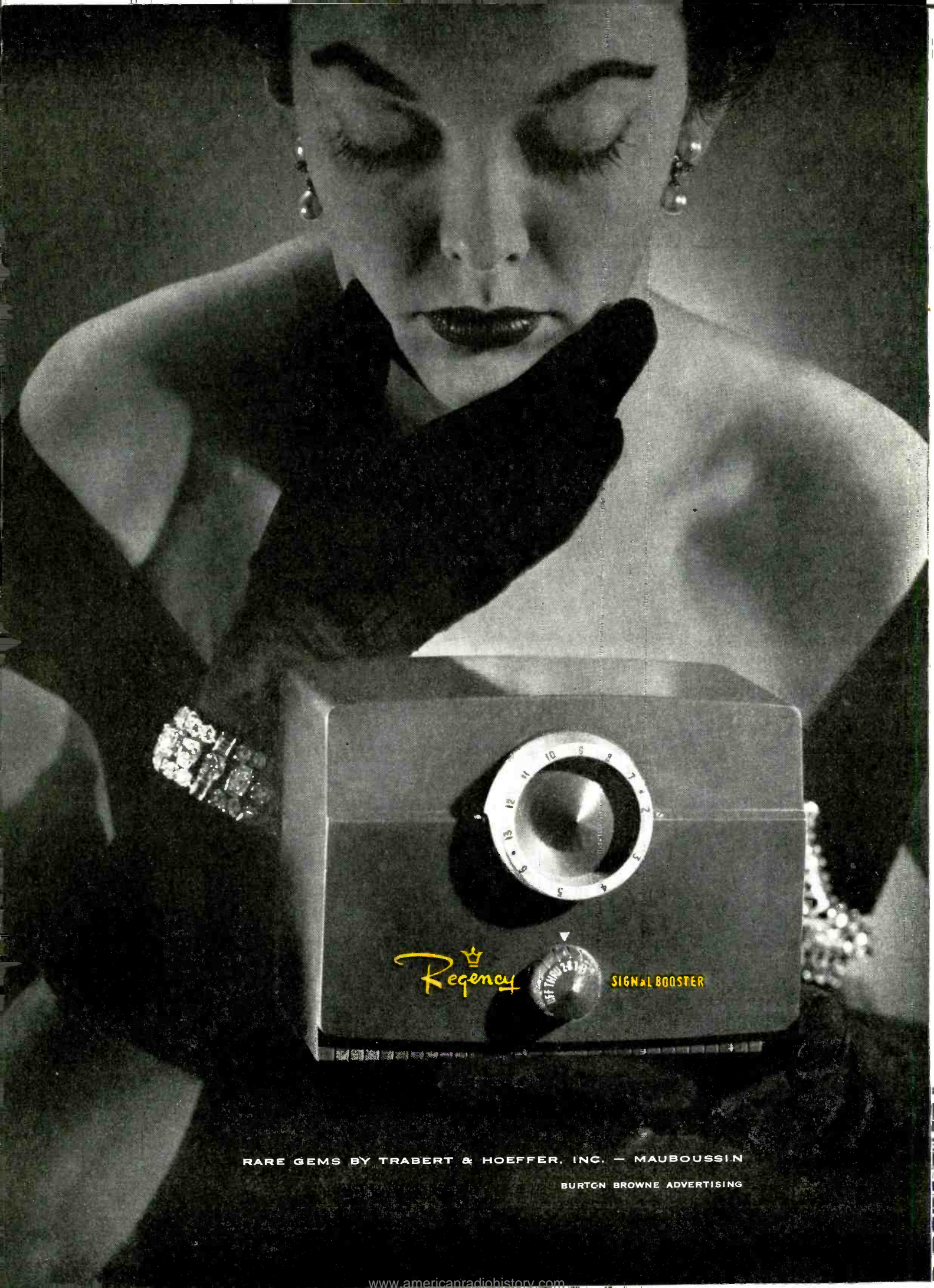

RARE GEMS BY TRABERT & HOFFER, INC. — MAUBOUSSIN

BURTEN BROWNE ADVERTISING



tional Union distributors with the purchase of N.U. tubes.

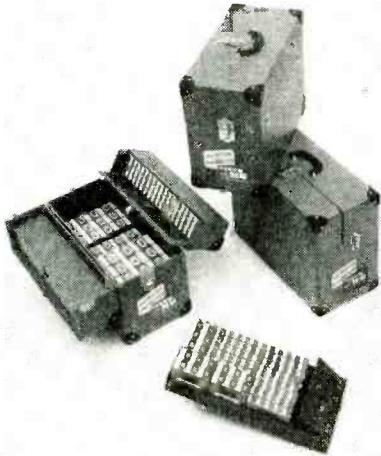

**Production and Sales**

The NBC TV Sales Planning and Research Department announced that there were 16,129,300 TV sets installed in the United States as of February 1st. There were 2,840,000 in New York City, 1,100,000 in Los Angeles, 1,093,000 in Chicago, 1,006,000 in Philadelphia and 862,000 in Boston.

The RTMA announced that 5,384,798 TV receivers were produced during 1951 compared with 7,463,800 in the record-breaking year 1950. Radio set production was estimated at 12,299,146 against the 1950 total of 14,589,900.

The RTMA reported that 4,434,614 TV picture tubes had been sold to receiver manufacturers during 1951. 88% of these were rectangular and 16-inch or larger. Of the 7,473,614 TV picture tubes sold in 1950, only 34% were in this category. The association also reported that 375,643,697 receiving tubes were sold in 1951 as compared to the 382,960,599 for 1950. Of the 1951 total, 247,855,249 were sold for new sets, 94,596,563 for replacements, and the balance for export and government agencies.

**New plants and Expansions**

Standard Coil Products Co., Inc., Chicago, and General Instrument Corp., Elizabeth, N. J., have announced an agreement to exchange stock at the rate of five shares of General Instrument for four shares of Standard Coil. Standard Coil will operate General Instrument as a wholly-owned subsidiary.

Aerovox Corp., New Bedford, Mass., has announced a formal merger with Electrical Reactance Corp. The latter company will be known as Hi-Q Division, Aerovox Corp., Olean, N. Y.

I.D.E.A. (Regency), Indianapolis, has purchased the Ohm-Art Division of the Chicago Dial Co., manufacturer of deposited carbon resistors. The new company will be known as the Radell Corp. Its equipment has been flown to its new factory in Puerto Rico. Sales offices will be in Indianapolis.

Philco Corp. has arranged for a \$40,000,000 three-year V-loan to finance its rapidly-increasing production of advanced electronic equipment for the Army, Navy, and Air Force.

—end—



**AMERICA'S NO. 1 CAPACITOR FAVORITE**



Over 200 million Sprague Black Beauty Telecap molded paper tubular capacitors in use today tell their own story of unsurpassed quality! And they cost no more!

These sturdy molded tubulars are the only capacitors in radio-television parts history that have been imitated but *not* duplicated. Only Sprague Telecaps are made by the exclusive *dry* assembly process... and that's why they're unmatched for dependable performance!

**TELECAP®  
MOLDED  
TUBULARS**

*Sprague's Famous  
"Black Beauties"*



**SPRAGUE PRODUCTS COMPANY**  
(Distributors' Division of Sprague Electric Co.)  
81 Marshall Street  
North Adams, Massachusetts



# Here's why it saves you Centralab switches —

*You'll get the switch you want...when you want it...at one source!  
Your nearby Centralab distributor offers the most complete line of  
switches, kits and parts available to the industry!*

"If it's available at all — my Centralab distributor will have it."

That's what more and more servicemen are saying. And that's why the trend to Centralab is growing every day. Today's servicemen know that Centralab carries the most complete line of switches and switch parts available to the industry.

If you need standard or special-purpose switches for AM, FM or TV repair, intercom installations, P. A. systems or medium-duty power applications — your

Centralab distributor has them in stock. Single- and multi-pole. Rotary or lever action (phenolic or steatite). Shorting or non-shorting contacts.

If you are building your own switches for test gear, etc. — you'll find switch parts, indexes, kits in Centralab's standard or "DD" line that meet your requirements. And that goes for highly rated switches for custom installations or high fidelity power supply, too.

When you need switches or switch parts, make your choice Centralab — the most complete line available.

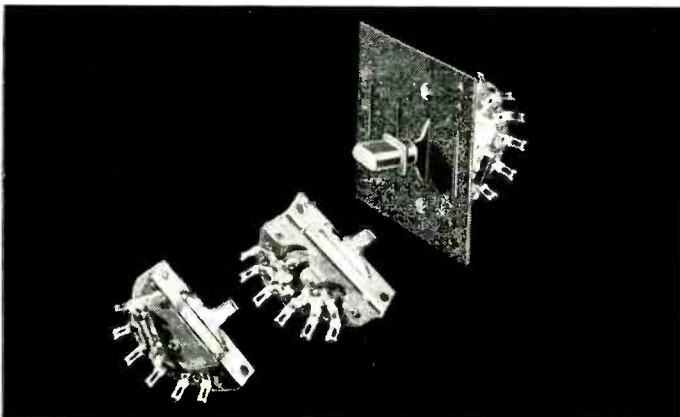

**LEVER ACTION SWITCHES**—for speech input equipment for line and program switching-monitoring, transceivers, band change, P. A. and intercoms, model railroad systems and industrial test equipment. Available in positive, spring return or combination. Coil spring index has minimum life of 150,000 switching cycles.

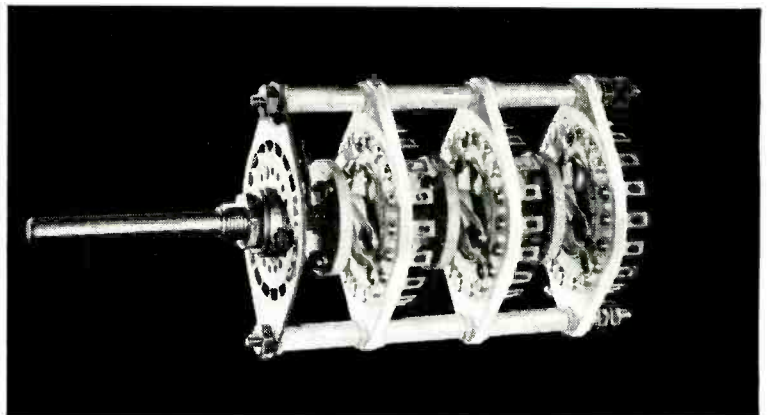

**MEDIUM DUTY ROTARY SWITCH** — for medium high power and excellent accuracy in transmitter, industrial control and balancing, laboratory testing, power supply converter and many other special applications. Rated at 750 watts (7½ amps, 60-cycle, 115 volts AC). 1, 2 or 3 poles...18 contact sections...up to 20 sections per shaft.

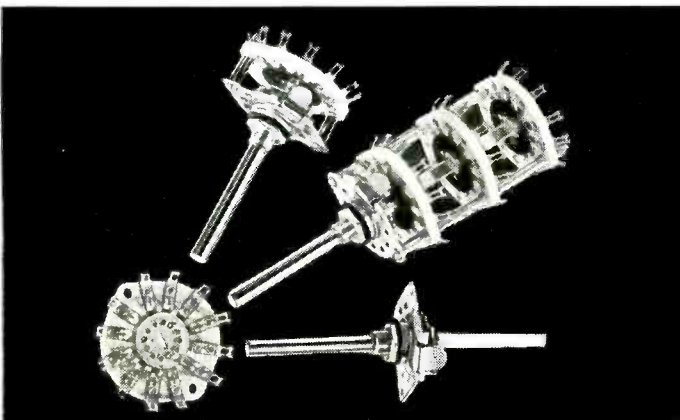

**ROTARY SELECTOR SWITCHES** — for use in fast, positive band switching in critical radio frequency circuit applications — in the oscillator, buffer or final amplifier stages of transmitters with input up to 75 watts and plate voltages up to 850 v.d.c. Also amateur rigs, test equipment and low current switching. Steatite or phenolic insulation.



**ROTARY ACTION FLAT SWITCHES**—for program switching — monitoring, transceivers, band change, P. A. and intercoms. Phenolic insulation. Cadmium plated metal parts. A 4-pole, 2-position, non-shorting type with positive leaf spring index. Can be used a SPST, SPDT, DPST, DPDT, 3PST, 3PDT, 4PST or 4PDT.

RADIO-ELECTRONICS

# time and money to buy

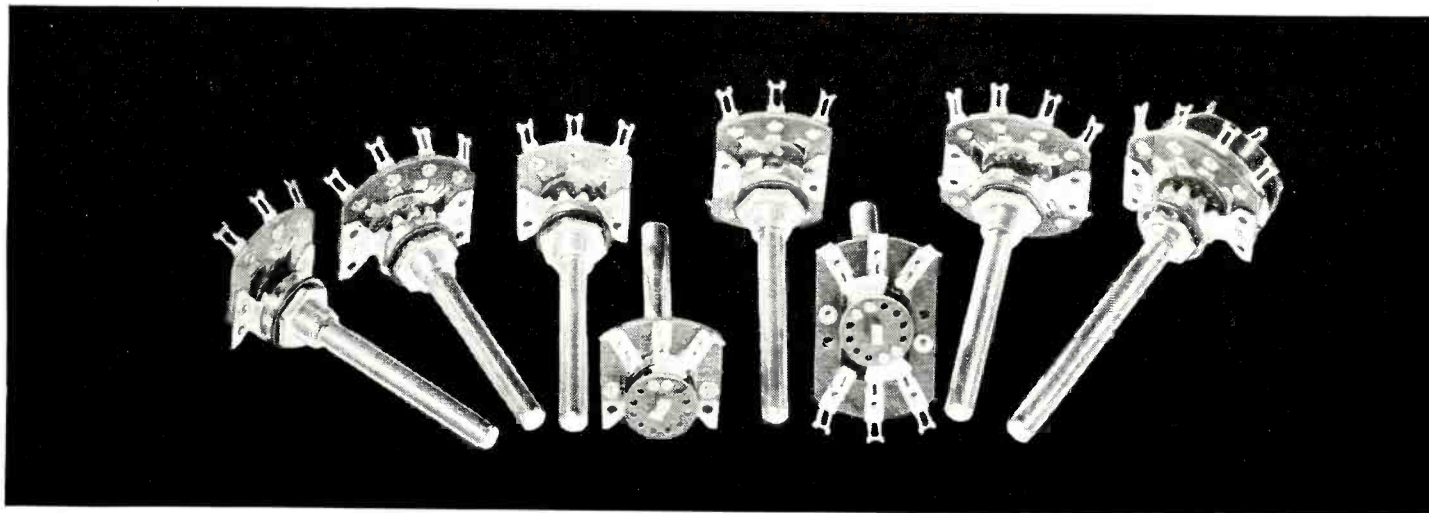

**SMALL GENERAL PURPOSE SWITCHES**—on-off and step control switches for radio, P. A. channel selectors, wave band, meter reversing, meter selector, intercom talk-listen,

momentary line or remote speaker return and dual auto radio speaker control. Clips and contacts heavily silver plated. Phenolic insulation. SPST, SPDT, DPST, DPDT, etc.

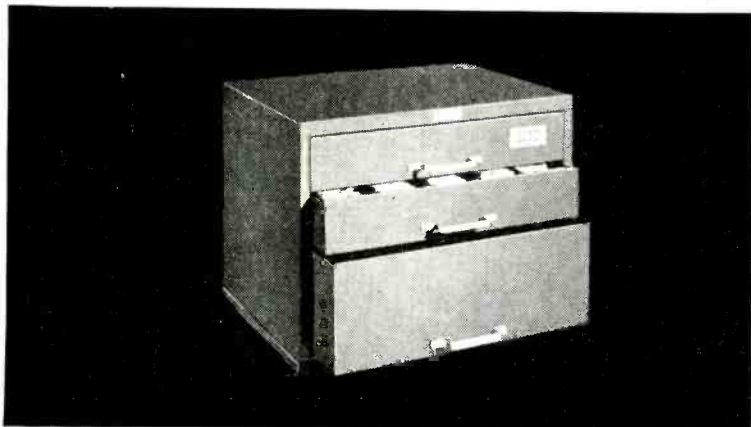

**414-419 ROTARY SWITCH KITS**—give you a convenient, easily available source of stock sections, indexes and hardware for assembling practically any standard or special switching arrangement desired. Contain Centralab "DD" Index and Section construction. Attractive steel cabinet, fits standard steel shelving. 17" x 11 $\frac{1}{16}$ " x 12 $\frac{3}{4}$ ".

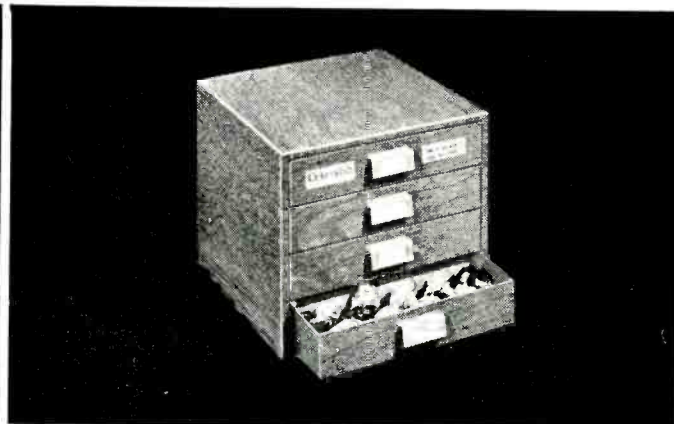

**1500 SELECTOR SWITCH KIT**—ideal convenience for labs, design and service engineers, industrial electronic maintenance departments, hams and experimenters. 33 standard rotary switch phenolic sections, 16 index assemblies and adequate supply of flat shafts, spacers, nuts, bolts, lockwashers and knobs. 8" x 8" x 7".

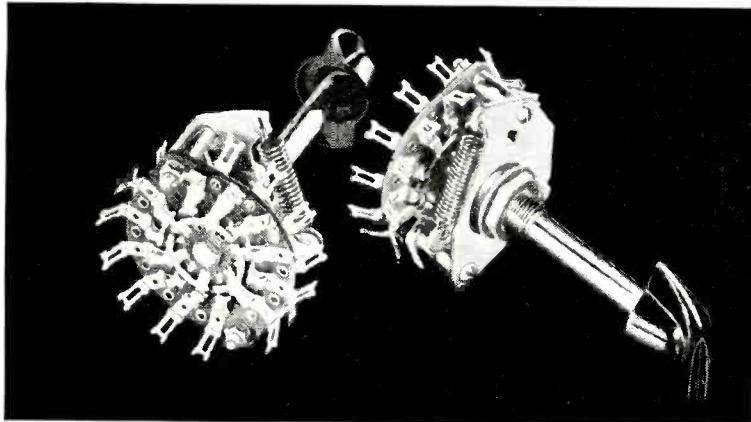

**INTERCOM SWITCHES**—for public address and intercom talk-listen systems. Six pole, 3 position. Available in two types—spring return from both sides to center and spring return one side, positive opposite side. For long, hard use in industrial test equipment. They are Centralab De luxe, "DD", style.

## Centralab

A Division of Globe-Union Inc.  
922 E. KEEFE AVE., MILWAUKEE

Get the whole story of Centralab switches for electronic and industrial uses. Write for Centralab Catalog.





# Electrons probe the future



**1** Electron micrograph of an alloy of aluminum, nickel, cobalt and iron. Magnification 20,000 diameters.



**2** Cooled from high temperature in a magnetic field, the alloy becomes a powerful, permanent magnet. Note changed structure. Black bars reveal formation of precipitate parallel to the applied field. Each bar is a permanent magnet.

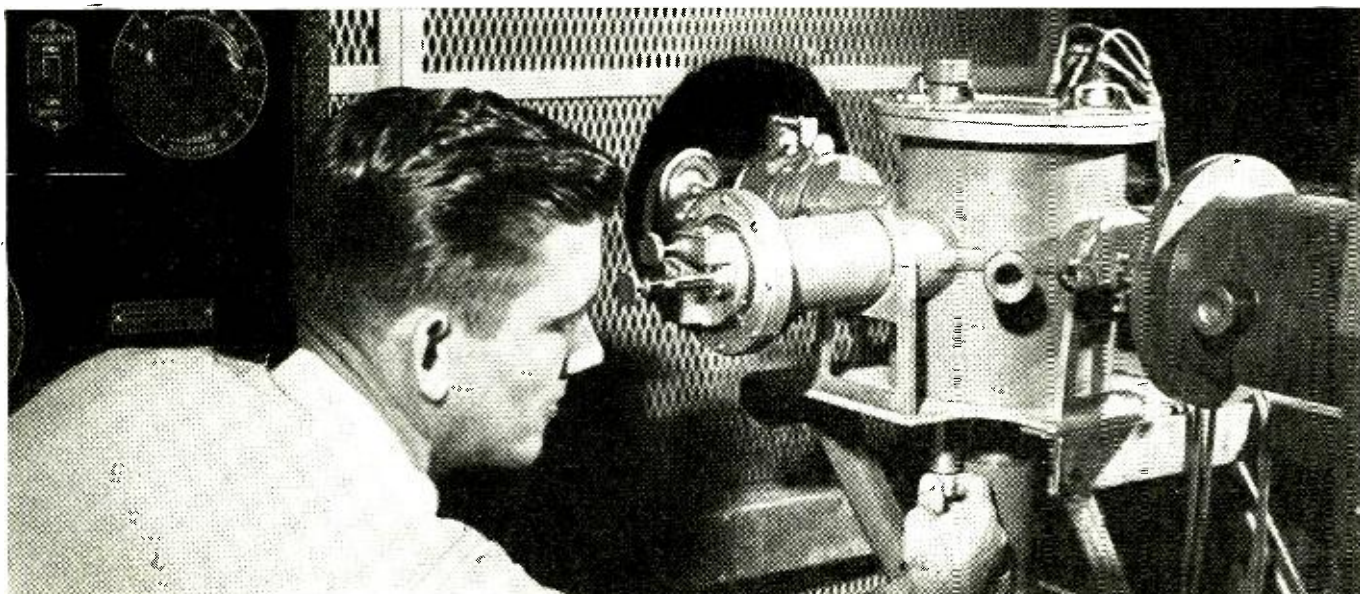

**3** A Bell scientist adjusts electron diffraction camera. Electrons are projected on the specimen at glancing angles. They rebound in patterns which tell the arrangement of the atoms . . . help show how telephone materials can be improved.

**I**N 1927, Bell Laboratories physicists demonstrated that moving electrons behave like light waves, and thus launched the new science of electron optics.

Now, through the electron beams of the electron microscope and electron diffraction camera, scientists learn crucial details about the properties of metals far beyond the reach of optical microscopes or chemical analysis.

At the Laboratories, electron beams have revealed the minute formations which produce the vigor of the permanent magnets used in telephone ringers and magnetron tubes for radar. The same techniques help show what makes an alloy hard, a cathode emit more electrons and how germanium must be processed to make good Transistors.

This is the kind of research which digs deep *inside* materials to discover how they can be made better for your telephone system . . . and for the many devices which the Laboratories are now developing for national defense.

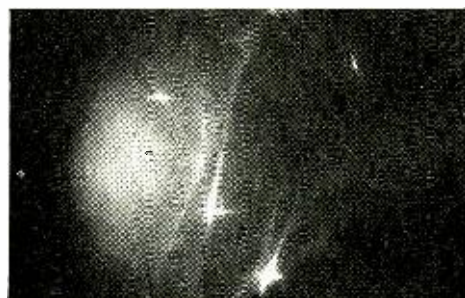

**4** Diffraction pattern of polished germanium reveals minute impurities which would degrade the performance of a Transistor.

## BELL TELEPHONE LABORATORIES



Improving telephone service for America provides careers for creative men in scientific and technical fields.

RADIO-ELECTRONICS

# OOG BONGO WALSCO FRINGO

(Translation)

"WALSCO MODEL M ANTENNA OUT-PERFORMS ALL OTHERS IN FRINGE AREAS"

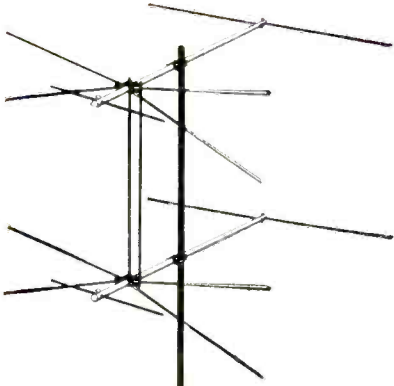

Almost *anywhere*, the WALSCO Model M Signal King will out-perform, out-last any competitive antenna. It's a fact... the Model M brings fringe areas closer to the TV transmitter... produces sharper, crystal-clear pictures.

And once you install... *that's all*. No costly call-backs that quickly eat up profit. Guaranteed sturdier, more dependable in *any climate*. Chromate-coated, magnesium cross-arms have a structural strength almost equal to steel, yet  $\frac{1}{3}$  lighter than aluminum. Positive corrosion resistance in severest weather. Elements are made of high-conductivity, super-strength aluminum alloy, reinforced with Swiss "Permalum." Here is quality you can trust *anywhere!*

## WALSCO

Walsco quality earned its reputation

**WALTER L. SCHOTT CO.**

3225 Exposition Place, Los Angeles 18, Calif.  
Branch: Chicago 6, Illinois

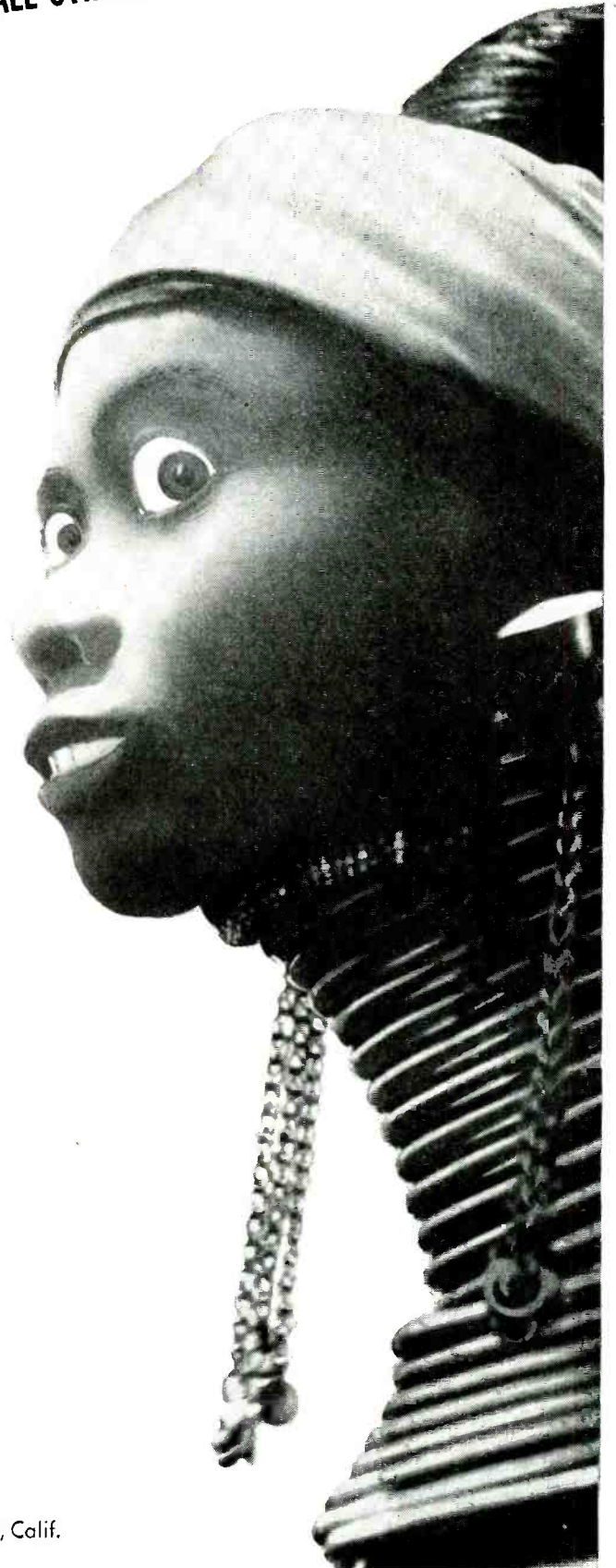



# EICO

TEST INSTRUMENTS

guards

*Majestic*  
HIGH STANDARDS OF  
TELEVISION PRODUCTION QUALITY



In the Majestic design laboratories, Frank J. Djeli and assistant, Paul Smith, discuss with Harry R. Ashley, some important prototype-circuit measurements just taken, with the 425 Oscilloscope, #22VTVM and #HVP-1 HV Probe.

Frank J. Djeli, Majestic's Chief Engineer, and Harry R. Ashley, President of EICO, inspecting the use of the EICO Model 425 5" Push-Pull Oscilloscope, Model 221 Vacuum Tube Voltmeter and Model HVP-1 High Voltage Probe at the important Final Test Position on the Majestic Television production lines.

## KITS - Wired Instruments

For Laboratory Precision at Lowest Cost -  
the Leaders Look to **EICO!**

**WHY** does The Majestic TV Division of The Wilcox-Gay Corp., another one of America's leading TV manufacturers, specify EICO Test Instruments on both its production lines and in its design laboratories?

**BECAUSE** -like Emerson, Tele-King, Tele-Tone, CBS-Columbia, and many another famous TV manufacturer coast to coast, Majestic knows that

**ONLY EICO TEST EQUIPMENT DELIVERS ALL 10 EICONOMICAL FEATURES**

1. Laboratory Precision
2. Lowest Cost
3. Lifetime Dependability
4. Speedy Operation
5. Rugged Construction
6. Quality Components
7. Latest Engineering
8. Super-Simplified Assembly and Use Instructions
9. Laboratory-Styled Appearance
10. Exclusive EICO Make-Good Guarantee

Before You buy any higher-priced equipment, be sure You look at the **EICO** line - in **Wired** as well as **Kit form!** Each EICO product is jam-packed with unbelievable value. **YOU** be the judge - compare, see **EICO** instruments **today** - in stock at your local jobber - and **SAVE!** Write **NOW** for **FREE** newest Catalog 4-C.

**FOLLOW THE LEADERS . . . INSIST ON EICO!**



**NEW 425K 5" PUSH-PULL SCOPE KIT \$44.95. WIRED \$79.95**



**NEW 221K VTVM KIT \$25.95 WIRED \$49.95**



**HIGH VOLTAGE PROBE \$6.95**



**NEW 555K MULTIMETER KIT \$29.95. WIRED \$34.95**  
20,000 ohms/volt

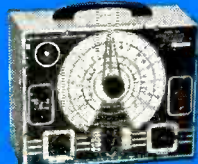

**NEW 950K R-C BRIDGE & R-C-1 COMP. KIT \$19.95**  
WIRED \$29.95



**320K SIG. GEN. KIT \$19.95. WIRED \$29.95**  
**NEW 322K SIG. GEN. KIT \$23.95. WIRED \$34.95**



**NEW 1040K BATTERY ELIM. KIT \$25.95. WIRED \$34.95**



**511K VOM KIT \$14.95**  
WIRED \$17.95



**NEW 425K TUBE TESTER KIT \$34.95**  
WIRED \$49.95



**NEW 315K DELUXE SIG. GEN. KIT \$39.95**  
WIRED \$59.95



**360K SWEEP GEN. KIT \$31.95**  
WIRED \$49.95



**NEW 526K MULTIMETER KIT \$13.90** WIRED \$16.90  
1000 ohms/volt

**NEW 1171K RES. DECADE BOX KIT \$19.95** WIRED \$24.95



**145K SIG. TRACER KIT \$19.95**  
WIRED \$28.95



**ELECTRONIC INSTRUMENT CO., INC.**  
84-86 Withers Street, at Meeker Ave., Brooklyn 13, New York

©1954

Prices 5% Higher on West Coast. Due to unstable conditions, prices and specifications are subject to change without notice



# ANTI-COLLISION CARS

. . . Electronically-controlled, collision-proof cars are feasible today . . .

By HUGO GERNSBACK

IN THE U.S. in 1950, over 35,000 people were killed and some 1,200,000 were injured in automobile accidents. This appalling situation—the killing and injuring of more of our people than in a major shooting war of a similar period—has become the grave concern of every auto maker, just as it has been the concern of society at large.

Benson Ford, vice-president of Ford Motor Co., on October 1, 1951, in a talk before the Detroit section of the *Society of Automotive Engineers*, called for "better automobile safety devices, including an electronic control that would apply brakes when collision is imminent."

Sixteen years ago, in the June, 1935, issue of *RADIO-CRAFT*, in an editorial entitled "Auto-Radio Developments," I stated on the identical subject:

"By means of photoelectric cells and capacitance-effect devices it should not be a difficult problem for radio engineers, in conjunction with automobile technicians, to evolve ways and means to make automobiles safer—far safer than they are today. To mention just a few ideas on the subject, all of which are possible even today:

"Many accidents are caused today by cars colliding, by one car running into another, by one car being bumped in the rear by another, etc. Authorities have long agreed that cars, even when stopping, should not come closer than two or three feet of each other. If a capacitive device were installed on the front fenders of all cars, then as soon as a body having a large capacitance (such as an automobile, truck, pedestrian) came within say two feet of it, a relay would automatically cause the brakes to be applied. This would obviate a great many collisions, and while it would not stop all of them, it would certainly minimize their effects. It is better to stop a car suddenly, without hitting another car, even if slight injuries result, than to have a serious collision, killing the driver or passengers outright when the cars crash or having them die in fire which often breaks out. While it is true that such an automatic capacitance-operated device would not be very effective when a car going at 40 miles an hour suddenly came within two feet of a pedestrian, the chances are that the damage done might not be as great as if the progress of the car had not been halted. It is one thing to strike a human being with a car going 40 miles an hour and quite a different thing if the car strikes at a speed of 8 or 10 miles an hour. The difference may be one of life or death to the person struck."

Sixteen years ago, electronic science perhaps was not sufficiently advanced to cope with the problem as effectively as we can today, but now there is no valid reason for not equipping cars with *anti-collision* electronic devices, if auto makers sincerely demand them.

I can visualize an electronic system which embodies a combination of a simplified, special radar plus a capacitance-

effect device—both acting together. Such a system should give us a greater margin of safety to prevent or minimize collisions.

True, such improved cars will be more expensive than present-day ones, but it is a certainty that the public will want such safety-equipped cars—at almost any price.

Moreover, the first automobile manufacturer to pioneer in the electronic anti-collision device will create a worldwide sensation. Other manufacturers will then have to follow suit if they wish to compete.

It must be realized that such an anti-collision device will never prevent every type of collision.

Side-swipes, oblique collisions, and other unusual types of auto accidents, it is true, are much more difficult to prevent, although even these are not impossible to avert in the future, with more advanced and refined electronic devices.

With constantly increasing car speeds, no human can be trusted always to stop a car quickly enough to avoid acci-

dent. Human reactions are too slow. With a car moving at 65 m.p.h.—let us picture a very common situation: From a shrubbery-obscured side street another car moves across the main road. The driver of the first car going 65 miles sees the other car 75 feet away. *But it takes about ¼ of a second before he can apply the brakes.\** In that time his car has traveled 77½ feet. Then the car's momentum will cause it to cover, say at least 100 feet before it can be brought to a dead stop. Thus the first car will have traveled 177½ feet from the moment it sighted the second car. Result—unless both cars swerve—a bad crash!

Why will an electronic control be better in such a situation than the driver? The answer is that human reactions are not instantaneous; in emergency the driver rarely has sufficient time to put on his brakes—but electronics can do it *instantly* when the car gets in the danger zone. True, not all collisions will be prevented, but the force of the impact will be greatly reduced. *It will be the difference between death and injury.*

An important point too, is the fact that when electronic anti-collision once is in universal use, BOTH colliding cars are braked simultaneously—an invaluable safety measure in cars moving into a head-on crash.

The electronic anti-collision device need not be very large nor cumbersome, perhaps not much larger than a medium table radio. It will have a rudimentary radio brain that will also make *certain decisions as to when and where NOT to put on the brakes.* For instance: when another car travels in the same direction in close city traffic and comes within 6 inches of the anti-collision-equipped car; or when you wish to park your car in the street. The electronic device can be designed to differentiate between such situations and those involving danger.

\* According to research at N. Y. University Center of Safety Education.

**Over one million people have been killed by automobiles in the United States to date. 35,000 were killed in the U. S. in 1950—more than this number in 1951. Much of this slaughter will cease when the car makers will adopt electronically operated anti-collision devices as explained here. They are feasible now and we are certain to have them soon.**

Without moving parts, this all-electronic system combines the techniques of sound-on-film and disc recording. Spiral scanning of an intensity-modulated cathode-ray beam records 30-minute programs on discs of ordinary photographic film. Standard commercial components are used.

## NEW SOUND RECORDING SYSTEM

By JOHN POTTER SHIELDS

**T**HE writer has developed a new system of sound recording and reproduction which is believed to be a definite advance in this field.

Fig. 1 is a block diagram of the recording system. It operates as follows: The cathode-ray tube generates a beam of electrons which produces a movable spot of light on its screen. This movable spot of light is focused by the lens onto the unexposed film plate. The output of the amplifier is connected to the control grid of the cathode-ray tube so that its bias will vary in accordance with the audio frequency variations applied to the amplifier's input. As the bias on the cathode-ray tube is varied, the brightness of the spot of light will vary; therefore the intensity of the spot of light will vary in accordance with the audio signal applied to the input of the amplifier. This so far stationary spot of light is deflected by the following means: The deflection generator produces a 40 c.p.m. sine-wave output which is applied to the 90-degree phase-shift network. This splits the output

from the deflection generator into two parts which are equal in frequency and amplitude, but differ in phase by 90 degrees. The two outputs from the phase-shift network are applied to the vertical and horizontal deflection plates of the cathode-ray tube. The above-mentioned spot of light will now form a circular trace, or more exactly the spot of light will rotate at a speed of 40 r.p.m. By varying the gain of the deflection generator linearly from maximum to minimum, the rotating spot of light will travel in a spiral toward the center of the cathode-ray tube screen. By properly varying the gain decay time of the deflection generator, very close spacing may be obtained between adjacent turns of the spiral trace.

Thus it can be seen that the developed film plate will consist of a spiral trace with very close spacing between adjacent turns on the spiral. Each line of the spiral will consist of varying light and dark areas which correspond to the audio-frequency variations applied to the input of the amplifier. A little more

than 30 minutes of recorded material can be placed on a single 12-inch disc.

In the development of this new sound recording system, several rather large problems had to be solved. For example, a suitable oscillator had to be chosen for the deflection generator. The conventional L-C oscillator naturally would be of no use here, as the values of inductance and capacitance required for operation at 40 c.p.m. would be much too large to be practical. Several types of R-C oscillators were tried and the circuit that was finally chosen was the phase-shift oscillator. This type of circuit requires only one tube; it is extremely stable; relatively small values of resistance and capacitance are required for its operation at 40 c.p.m.; and when properly adjusted it is capable of almost pure sine-wave output. The type of 90-degree phase-shift network used requires a balanced input, so a modified cathodyne phase inverter is used for this purpose.

The outputs from the 90-degree phase-shift network are fed to two

Fig. 1 — Block diagram of the all-electronic recording system. Special oscillators in the deflection generator produce the low scanning frequencies required.

Fig. 2—(On opposite page.) Light from an unmodulated cathode-ray beam scans the developed film in the reproducing setup. The scanning circuits are identical to those used for recording.

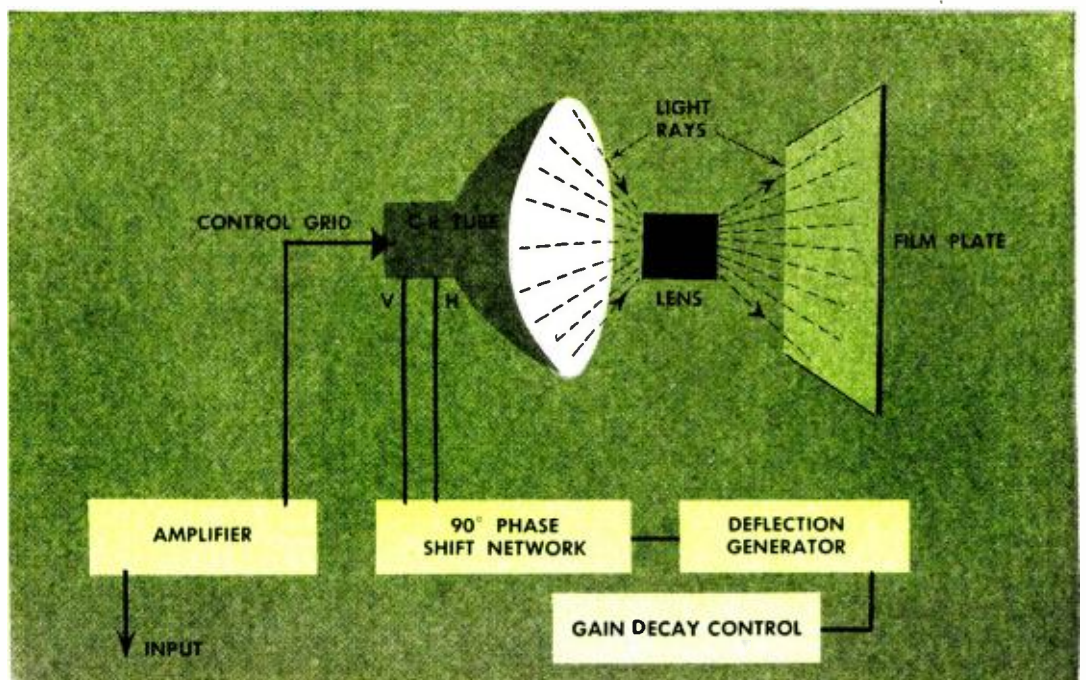



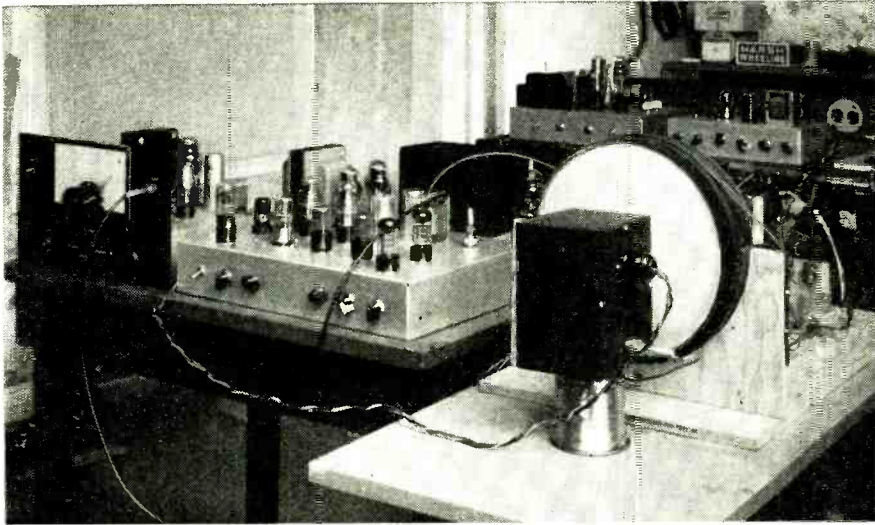

The development model of the all-electronic recording and playback system.

push-pull deflection amplifiers whose outputs are connected to their respective sets of deflection plates. Modified R-C amplifiers are used throughout this system, as they were found to be as satisfactory in this case as direct-coupled amplifiers. An r.f. voltage-doubling power supply is used with the cathode-ray tube to provide maximum brightness and sharpness of focus. The type of cathode-ray tube used in both the recording and reproducing systems is a type 10HP4.

When work was first started on this system it was planned to use a type 10BP4, as it has an almost flat face, and a higher second-anode voltage can be applied to it than to an electrostatic tube. The deflection amplifiers obviously could not be connected to the deflection yoke by a transformer, due to the extremely low frequencies involved. Cathode-follower coupling circuits were tried with little success, due to the low resistance of commercially available yokes. It was also found that

the direct current flowing in the yoke caused excessive deflection of the electron beam. Thus the type 10HP4 was chosen. It was found that more second-anode voltage could be applied than had been expected. Naturally as the second-anode voltage is increased, greater deflection voltage is required due to the increased stiffness of the beam.

The type P4 phosphor is satisfactory, as its decay characteristics are sufficiently rapid to allow its use at the commonly employed audio frequencies. A small amount of high-frequency equalization was used to produce output flat from 20 to 20,000 cycles from the photocell. If a tube with a short-persistence phosphor, such as type P11, were used, no equalization would be required.

The photograph shows the equipment used by the writer in developing this system. On the extreme left is an audio-frequency oscillator. Next to it is the chassis containing the phase-shift oscillator, control circuit, 90-degree phase-shift network, and the push pull deflec-

tion amplifiers. The tuning eye on this chassis is for adjusting the phase-shift oscillator for optimum sine wave output. Behind this chassis is the r.f. power supply, and to their right is the 10HP4 cathode-ray tube. In front of it is the shield box containing the photocell used for reproduction.

### Reproduction

The recording process has to be reversed for reproduction. In Fig. 2 is shown a cathode-ray tube identical to the one in the recording system. A beam of electrons is generated within the cathode-ray tube, producing a spot of light which is focused by the lens onto the photocell. The deflection generator and 90-degree phase-shift network are identical to those used in the recording system.

The control grid of the reproducing cathode-ray tube is grounded and thus maintained at a fixed potential to keep the spot of light on the cathode-ray tube at a fixed intensity. As in the case of the recording system, a spiral trace will be produced on the reproducing cathode-ray tube. It will be identical to the trace on the recording tube, as the same type of deflection generator and 90-degree phase-shift network is used in each case. The film plate, on which audio-frequency sounds were recorded, is now developed and placed between the face of the cathode-ray tube and the lens so that the spiral trace recorded on the developed film will correspond to the spiral trace on the reproducing cathode-ray tube. As the spot of light—maintained at a constant intensity—travels spirally toward the center of the screen of the cathode-ray tube at the same speed as the recording spot of light, it will pass through the varying light and dark areas of the film and strike the photocell. The light of varying intensity striking the photocell causes corresponding voltage variations from the photocell. These voltage varia-

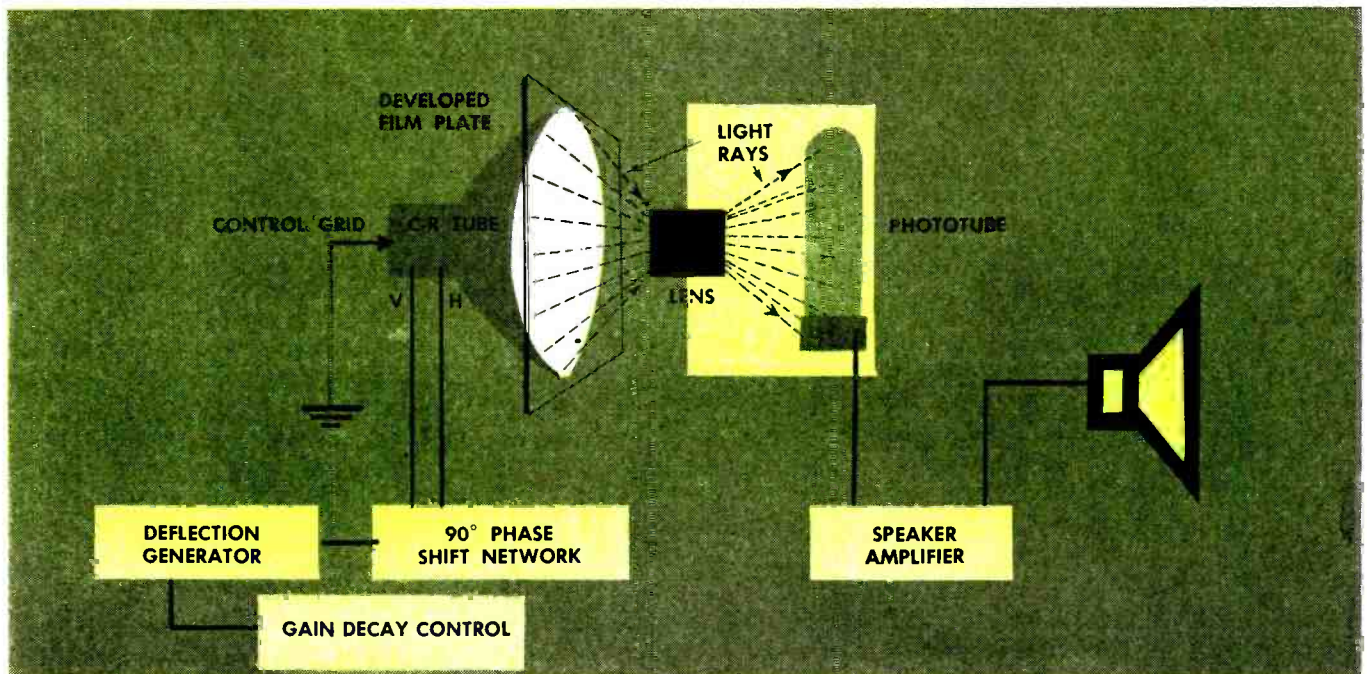



tions will be an exact facsimile of the audio-frequency variations applied to the recording system amplifier's input. The output from the photocell is then amplified and applied to a suitable loudspeaker.

It is apparent that many advantages are to be gained by use of the Shields recording and reproducing system. In the first place, this system does not require motors or mechanical drive systems, and so far as is known (a thorough patent search was made before applying for patents), it is the first recording and reproducing system which is entirely electronic in operation. Many advantages are to be gained by this. It is extremely difficult to design and produce mechanical drive systems which operate properly at the low speeds which are required for recording work. Wow and flutter are two factors which must be contended with, and as the speed is reduced these factors become more prominent. With this all-electronic system it is an easy matter to have the spot of light rotate at extremely low speeds with the phase-shift oscillator in the deflection generator. Trouble with wow or flutter disappears as the phase-shift oscillator is very stable. If extreme spot rotation stability is required (as might be the case in laboratory work) there are various R-C oscillator circuits which will operate at these low frequencies, and which can be readily synchronized. Precise control can be maintained over the deflection generator and its associated circuits.

This system does not require any mechanical movement of the recording medium. Thus there will be no deterioration of the recording medium, as it is stationary and is contacted by nothing heavier than a beam of light. Hence it will last indefinitely. There is also little chance of it collecting dust particles, as there is no friction caused by mechanical movement to attract dust. Inexpensive copies can be easily made of the original developed film plate. This recording medium is small in size and light in weight; thus it can be conveniently stored. By employing cathode-ray tubes in the recording and reproducing systems which produce traces of extremely small diameter, considerable sound (or other types of data that can be expressed in electrical form) can be recorded on a single film plate.

Although not mentioned in this article, the writer has developed methods to automatically select any portion of the recording for reproduction. This would be useful in coin-operated machines where it is desired to play only one musical selection out of several which were recorded. By simply pressing a button, the proper selection can be chosen without need of rather complicated mechanical means. This system is simple in design and construction considering the advantages to be gained by its use. Only a few of its advantages have been cited in this article; others will become apparent to the reader.

—end—



This magnetic tape-recording adapter is designed to be driven from a phonograph.

## TAPE RECORDING ADAPTER

By D. E. RAVALICO

From Italy comes news of a simple, magnetic tape-recording adapter capable of being used with mechanically or electrically driven phonograph turntables. The device allows 7.5 minutes of recording time using double track tape at a speed of 7.5 inches per second.

In operation, the adapter is positioned over the phono motor turntable which drives a capstan drum from a friction plate resting on the turntable. A fly-wheel stabilizes the capstan drum, and adjustable posts accommodate for variations in vertical and lateral positioning. A two-tube electronic unit supplies ultrasonic bias.

A stud on the side of the unit controls the position of the magnetic head which is located under the cover-plate. The rewind speed is seven times the recording or playback speed.

Simplicity and lightweight construction would appear to make it a "natural" for the home experimenter.

Several versions of this unit have been described in European magazines and a similar professional unit is marketed in the United States by Presto Recording Corp., Paramus, N. J.

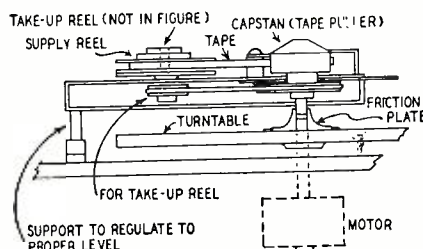

Side elevation showing drive mechanism.

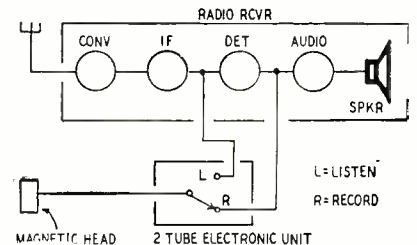

Simplified circuit of recorder and radio.

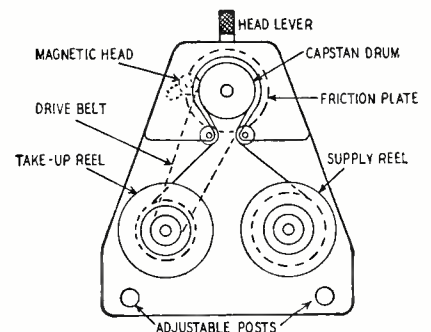

Top plan of magnetic recording adapter.



Adapter mounted on phono turntable.



# AUDIO IMPEDANCE MEASUREMENT



A complete setup for measuring amplifier impedance.

Simple measurements with minimum equipment provide answers to audio problems.

By JAMES A. MITCHELL

THE measurement of impedances in audio equipment has become a potent tool in our sound troubleshooting kit since an audio enthusiast came to us with a puzzler. Let's call it "The Case of the Screwy Bass." He claimed that after he had installed a high-fidelity Williamson-type amplifier, his sound system actually had *less* bass than with an inexpensive PA amplifier. He had run response curves on each amplifier, and while both were flat in the middle range, the PA amplifier *fell off* in output below 100 cycles but the Williamson was perfectly flat down to 20 cycles. Our friend demonstrated the problem by switching his speaker from one to the other. There was no doubt that we heard more bass from the PA amplifier in spite of the measured response curves.

In checking the problem, we found the response curves had been measured with a *resistor* load. However, when we checked the response of the amplifiers with the *speaker* as the load, two high peaks in the bass range were found with the PA amplifier. These peaks were entirely absent when the Williamson-type amplifier was tested. The two amplifiers were affected quite differently by the change in the type of load. By a few measurements we were able to show that this was a matter of differences in impedances. The Williamson-type amplifier had a very different internal impedance characteristic from the PA amplifier.

The impedance of any device is its tendency to oppose the flow of current when an a.c. voltage is applied to it. In many devices this is simply resistance, but in equipment such as speakers, transformers, and amplifiers there are elements of inductive and capacitive reactance as well as resistance. These

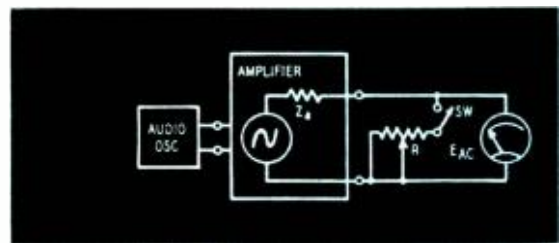
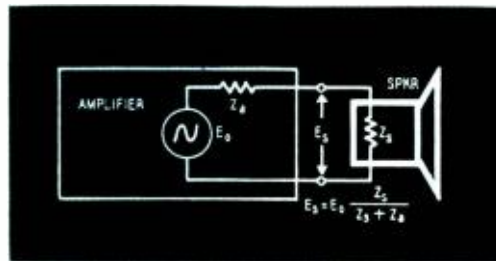

Figs. 1 and 2—Basic impedances and measurement circuit.

all affect the flow of alternating current. Impedance is the effective sum of these three elements. The inductive and capacitive elements in audio equipment cause impedance to change with frequency. This curve of impedance versus frequency tells us a good deal about the performance of an audio unit.

When an audio amplifier drives a speaker system there are two impedances which affect the performance. The first ( $Z_a$  in Fig. 1) is the internal impedance of the amplifier. The second ( $Z_s$ ) is the impedance of the speaker. It can be seen that the voltage across the speaker is not the full voltage of the amplifier ( $E_a$ ) because the internal impedance of the amplifier is in series with the speaker. If the amplifier's internal impedance is big enough to be

significant and if the speaker impedance varies with the frequency, the voltage across the speaker will not be uniform at all frequencies but will have peaks at the impedance peaks in the speaker. The voltage across the speaker will differ from the fundamental voltage of the amplifier by the ratio indicated in the formula of Fig. 1. This is one reason why an audio amplifier should have a low internal impedance.

## The damping factor

The internal impedance of an amplifier may be measured at any one of the amplifier's output taps. A more useful unit is the *damping factor*, which is equal to the rated output impedance divided by actual internal impedance. This makes it unnecessary to state at

which output taps the measurements were made. The internal impedance is not a constant value but depends on the frequency at which it is measured. The complete description of an amplifier's internal impedance is a curve showing the damping factor versus frequency.

Normally an audio amplifier will have an internal impedance of 1/2 to 1/20 its rated output impedance. The damping factor will therefore be in the range of about 2 to 20. This damping factor is determined by the plate resistance of the output tubes, the circuit in which they are used, and the design of the output transformer. The use of feedback around the output stage reduces the effective internal impedance. Amplifiers with triode output tubes such as 2A3's or 6B4-G's without feedback and using traditional transformer design, have damping factors of 2 to 3. Feedback will increase the damping factor. Beam power tubes such as the 6L6 give an amplifier a very high internal impedance. Feedback is essential with these types, and their high gain

the same scale if your meter isn't uniformly calibrated on all scales.

One of the simplest methods of measuring the internal impedance of an amplifier is to use the scheme shown in Fig. 2. The plan is to measure the output voltage with no load across the amplifier; then with an adjustable resistor as a load to find at what load resistance the output voltage will be one-half the no-load voltage. The audio oscillator is connected to the amplifier input, and an on-off switch and rheostat are connected in series to the amplifier output terminals. These should be the impedance taps used in your particular installation. The rheostat should be capable of covering a range down to about 1/20 of the nominal output impedance. The voltmeter is placed across the output taps. With the switch open, the amplifier gain or oscillator input is adjusted until a conveniently measurable voltage is obtained, say 2.0 volts. The switch is then closed and the rheostat adjusted until the voltage drops to 1.0. The switch can now be opened and the

when the load resistance is lowered to 1.3 ohms (as far as you can go with your rheostat), the output voltage is 1.4 volts, and the internal impedance is

$$Z_a = \frac{1.3 \times 2.0}{1.4} - 1.3 = 1.85 - 1.3 = 0.55 \text{ ohms.}$$

These measurements should be made at several different audio frequencies until the entire audio range is covered. A good plan is to check at 1,000, 100, 50, 30, 20, 5,000, 10,000, 15,000 cycles. If the results are about equal or change smoothly you have a good picture of the amplifier's internal impedance characteristics. If irregular results are obtained, further checking is in order.

The internal impedance curves of two very different amplifiers are shown in Fig. 3. The lower curve (amplifier A) is that of the Brook 12A amplifier. This is a triode output amplifier (push-pull 2A3's), with a high-quality output transformer and with inverse feedback. The upper curve (amplifier B) is that of a home-built beam-power-tube ampli-

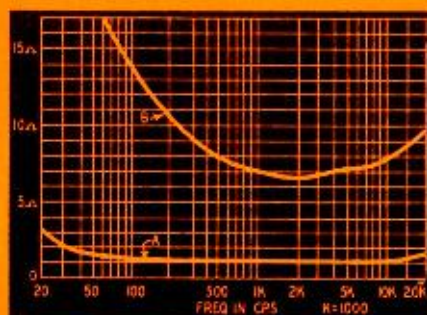

Fig. 3—Amplifier impedance curves. Details given in the text.

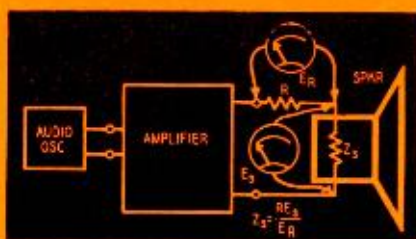

Fig. 4—Circuit for measuring the impedance of a loudspeaker.

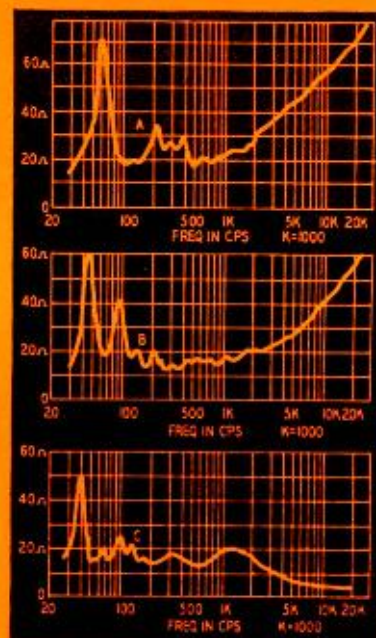

Fig. 5—Typical speaker impedance curves. See text for details.

makes considerable feedback feasible.

There are several ways of measuring electrical impedance. Many of them require bridge circuits or that hard-to-find item, an a.c. milliammeter. The methods to be described have been limited to the simplest equipment possible. An audio oscillator is needed as well as an a.c. voltmeter, a couple of rheostats of about 10 and 25 ohms and a few 10-watt resistors between 10 and 50 ohms. The oscillator should be capable of covering the audio range in which you are interested with reasonably low distortion. The voltmeter is preferably of the electronic type, though good results can be obtained with a sensitive volt-ohm-milliammeter with a.c. scales in the 0.5- to 3.0-volt range. Just remember to make all measurements on

resistance of the rheostat measured. This resistance equals the internal impedance of the amplifier.

It may sometimes happen with an amplifier of very high damping factor that you cannot get down to one-half the no-load voltage with the rheostats available. In that case the internal impedance can be calculated from the following formula, using voltage readings taken at the lowest resistance setting of the rheostat.

$$Z_a = \frac{RE_o}{E_r} - R.$$

$Z_a$  is the internal impedance of the amplifier,  $E_o$  is the no-load output voltage,  $E_r$  is the voltage across the load resistance  $R$ . For example: if the open-circuit voltage at the 8-ohm tap is 2.0 volts and

the load resistance is lowered to 1.3 ohms (as far as you can go with your rheostat), the output voltage is 1.4 volts, and the internal impedance is

when the load resistance is lowered to 1.3 ohms (as far as you can go with your rheostat), the output voltage is 1.4 volts, and the internal impedance is

These measurements should be made at several different audio frequencies until the entire audio range is covered. A good plan is to check at 1,000, 100, 50, 30, 20, 5,000, 10,000, 15,000 cycles. If the results are about equal or change smoothly you have a good picture of the amplifier's internal impedance characteristics. If irregular results are obtained, further checking is in order.

The internal impedance curves of two very different amplifiers are shown in Fig. 3. The lower curve (amplifier A) is that of the Brook 12A amplifier. This is a triode output amplifier (push-pull 2A3's), with a high-quality output transformer and with inverse feedback. The upper curve (amplifier B) is that of a home-built beam-power-tube ampli-

Amplifier B may sound satisfactory with a narrow range speaker



system but the superiority of amplifier A with a wide range system is obvious.

To measure the impedance of a loudspeaker (or other nonresistive load) the oscillator, amplifier, speaker and a 10-watt resistor are connected as shown in Fig. 4. The resistor should have about twice the rated impedance of the speaker under test. The resistor value should be known accurately. The plan is to measure the voltage across the speaker and to compare it with the voltage across the resistor over the audio-frequency range. Since the resistor and speaker are in series the current through both is the same and the impedance of the speaker can be calculated from the following formula:

$$Z_s = R \frac{E_s}{E_R}$$

where  $Z_s$  is the speaker impedance,  $R$  is the resistor in ohms,  $E_s$  is the voltage across the speaker, and  $E_R$  is the voltage across the resistor. The oscillator is first set at 1,000 cycles and the amplifier output is adjusted so that conveniently measureable voltages are obtained across both the resistor and the speaker. It is a good point to have the sum of the two voltages less than the maximum of the meter scale in use so that you will not have to change the scale at any possible impedance.

If you have an insensitive voltmeter you may have to have the volume rather loud in order to get readings, but if the neighbors and the amplifier can stand it the results will be just as good. Voltage readings are taken across the standard resistor and across the speaker. It is a good plan to start at 1,000 cycles and to sweep continuously down the

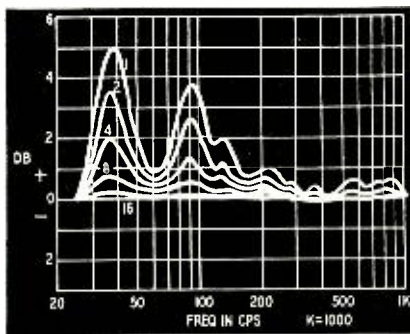

Fig. 6—The effect of amplifier damping factor on speaker response. See text.

audio spectrum to 20 or 30 cycles. Since some speakers may have several closely adjacent peaks, a number of measurements should be made in these ranges to get an accurate picture of the impedance curve. One method is to leave the voltmeter across the speaker after each measurement and to note the significant peaks and valleys as the oscillator is tuned up and down. Readings are made at these peak points along with enough in-between measurements to draw a good curve.

After covering the bass range, the spectrum from 1,000 cycles up should be checked. A smoother curve is usually

found in this range, but the technique of continuously sweeping the oscillator up and down the scale will reveal any peaks which exist. The voltage readings are then converted to impedance values.

Fig. 5 presents some typical speaker-impedance curves. Curve A is that of a single-cone 15-inch speaker in an open-back cabinet. Curve B is the same 15-inch speaker in a 7-cubic-foot bass-reflex corner cabinet. Curve C is a two-speaker system with dividing network at 800 cycles. Both speakers are horn-loaded. It is immediately apparent that though all these speakers are rated at 16 ohms, such a rating is only nominal, and much higher impedances are actually present at many frequencies. The high-impedance peaks in the bass range are produced whenever there is a tendency for the voice coil to resonate, either because of resonances in the speaker itself or in combination with the air loading in the cabinet. These peaks in the bass range tell us a good deal about the speaker system. The fairly smooth rise of impedance at the higher frequencies is due to the inductance of the voice coil. This inductance is really too high in the treble range but is needed in the bass. In dual-voice-coil speakers or two-speaker systems this impedance rise can be eliminated by designing each driver for its particular response range.

The high peak in curve A occurs at the resonant frequency of the speaker cone. Mounting the speaker in an open-back cabinet has done little to damp this resonance and seems to have added a couple of new ones at higher frequencies. In the reflex cabinet the air loading raises the frequency at which the cone resonates but reduces the amount of resonance and adds a lower frequency resonance of the reflex cabinet. These effects can be seen in the impedance curves which are very helpful in adjusting reflex baffles. The horn-loaded speakers show a more uniform impedance curve down to the bottom peak. This peak is at the cutoff frequency of the horn and the resonant frequency of the low-frequency driver. The driver has been selected to resonate at this point to hold up the low-frequency response where the horn falls off.

It might well be asked why the speaker impedance rises at these resonant points. It is helpful to look at it this way. The a.c. voltage from the amplifier sends current through the voice coil so that it vibrates in the magnetic field of the speaker. This vibration of the coil in the magnetic field causes it to generate an a.c. voltage of opposite sign to the driving voltage. When a resonant frequency is reached the mass of the voice coil and cone just balances the compliance of the cone and the air chamber, and the coil vibrates back and forth much more vigorously. The voltage generated by the voice coil increases, opposing the driving voltage and reducing the current. Thus the impedance of the unit rises. This is a desirable counterbalance because it is important to reduce the power input at

these resonant points to avoid a loudness peak. However, if the amplifier has a high internal impedance, as the speaker impedance rises, the voltage across the speaker will also rise, thus increasing the tendency to resonate, and creating a peak.

As an example of this condition, Fig. 6 shows the frequency response as measured across the voice coil of a 15-inch speaker in a 7-cubic-foot bass reflex corner baffle when driven by amplifiers of different damping factors. These curves were determined by varying the internal impedance of a high-quality amplifier. The responses obtained can be calculated from the equation in Fig. 1, knowing the impedance curve of the speaker and the internal impedance of the amplifier. (Editor's Note—The equation is in voltage terms, not db.)

In all these cases the amplifier produced a flat frequency curve into a resistor load. The frequency deviations shown are simply the effects of the variations in speaker impedance with the variations in both frequency and the damping factor of the amplifier. Note that with damping factors of 8 or higher the effect on the response of even large changes in speaker impedance is negligible. With a damping factor of 4 the rise in frequency response is just noticeable. With factors of 2 or 1 the bass peaks are pronounced and may be noticeably boomy.

Another important angle is the damping effect of the amplifier on the natural speaker system resonances when the system is subjected to sudden bursts of tone or transient impulses. These shock impulses tend to throw the speaker into vibration at its resonant points unless the speaker is critically damped. Part of this damping is provided in the construction of the speaker itself; part is supplied by the air loading of the cabinet or horn and by the internal impedance of the amplifier. Damping is not greatly affected when the amplifier internal impedance drops to less than 1/8 or 1/10 of the voice coil resistance.

You will be on safe ground if your amplifier has a damping factor of at least 3 over the entire range of audibility.

Internal impedance measurements are therefore important tests for amplifier constructors. When coupled with speaker impedance measurements the information gained can be used to improve the over-all audio performance considerably.

—end—

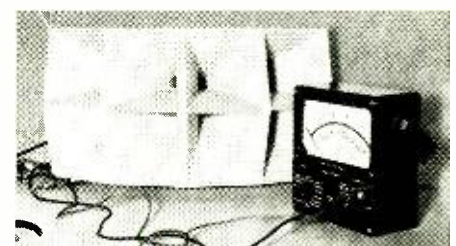

Measuring the impedance of a tweeter.

# ELECTRONICS and MUSIC



Fig. 1—The Organo used with a spinet-type piano in a typical installation.

Part XXII—New electronic instrument makes organ of any piano

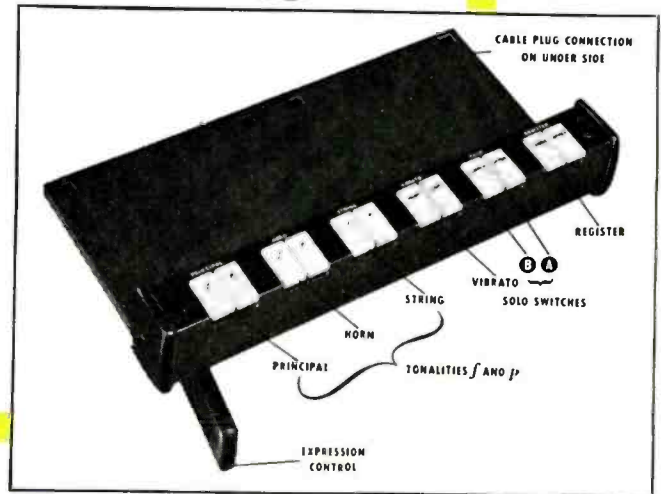

Fig. 3—The compact Organo control panel.

By RICHARD H. DORF

THE Lowrey Organo, made by the Lowrey Organ Division of Central Commercial Industries, Inc., Chicago, gives the player the facilities of a complete, small, one-manual organ, but has no console of its own. Its unique feature is that it utilizes the keyboard of any piano without impairing the regular operation of the piano. The photograph, Fig. 1, shows a complete Organo installation on a standard pi-

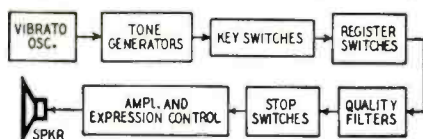

Fig. 2—Block diagram of the Organo circuit. Units are analyzed in the text.

ano. The cabinet at the right houses the speaker, amplifier, and generators; the attachment on the piano's front is a small control panel; the long, narrow frame across the back of the keyboard contains the mechanism by which pressure on the piano keys brings forth organ tones from the instrument.

The Organo is an electronic instrument which generates its tones in vacuum-tube oscillators. Fig. 2 is a block

diagram showing in a general way what the instrument contains.

The range is five octaves—the standard organ-manual compass—from two octaves below middle C to three octaves above. The tones are generated by frequency-dividing multivibrator chains, 12 in all, each synchronized by a master oscillator and vibrato-controlled by a reactance tube fed by a single vibrato-frequency oscillator for all the chains.

The generators are connected to 60 key switches actuated by the piano keys. The output points of the lower 25 switches are connected in parallel. This line is the lower-register bus which carries all the tones up to middle C. The remaining 35 key-switch outputs are paralleled to form the upper-register bus, which carries all the tones above middle C. Two register switches determine whether one or both of the two registers is to be heard, since the player may wish to hear the piano only in the lower register and the organ tone in the upper register, or *vice versa*. These switches appear on the control panel pictured in Fig. 3 at the far right.

The tones from upper or lower reg-

isters, or both, are passed through six R-C and L-C filters with paralleled inputs and separate outputs. Each imparts a different quality to the tone. These qualities are selected by the stop switches which also appear on the control panel. Three different qualities or stops are available—*principal*, *horn*, and *string*—each loud (*forte* or *f*) or soft (*piano* or *p*). The solo switches on the panel enable the player to make either register somewhat louder than the other so that a melody may be made to predominate over an accompaniment. The vibrato switches select either a light, (small-amplitude) or heavy (large-amplitude) frequency variation at about 6 cycles per second.

The tones selected with the stop switches pass to the amplifier located in the tone cabinet. There is a preset volume control between two of the amplifier stages; and between two other stages is a second potentiometer-type volume control, the leads of which are brought to the control panel. This is the expression control, operated by a knee lever.

## Tone generators

The heart of the Organo is the tone-



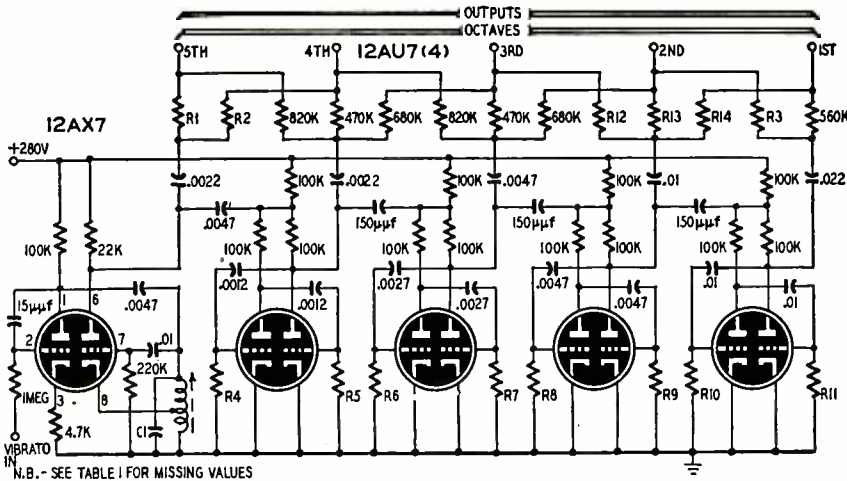

Fig. 4—Basic master-oscillator and frequency-divider chain, producing five octaves. Twelve of these units are used in the Organo to cover its full tonal range.

TABLE I  
Values For Fig. 4.

NOTE	R1	R2	R3	R4-R11	R12	R13	R14	C1
C	220,000	330,000	8.2 meg	820,000	2.7 meg	560,000	1 meg	.039
C *	220,000	330,000	8.2 meg	820,000	2.7 meg	560,000	1 meg	.039
D	220,000	330,000	8.2 meg	820,000	2.7 meg	560,000	1 meg	.033
D *	220,000	330,000	8.2 meg	680,000	2.7 meg	560,000	1 meg	.033
E	150,000	220,000	5.6 meg	680,000	1.8 meg	560,000	820,000	.027
F	150,000	220,000	5.6 meg	680,000	1.8 meg	560,000	820,000	.027
F *	150,000	220,000	5.6 meg	470,000	1.8 meg	560,000	820,000	.027
G	150,000	220,000	5.6 meg	470,000	1.8 meg	560,000	820,000	.027
G *	100,000	150,000	3.9 meg	470,000	1 meg	470,000	680,000	.022
A	100,000	150,000	3.9 meg	470,000	1 meg	470,000	680,000	.022
A *	100,000	150,000	3.9 meg	470,000	1 meg	470,000	680,000	.018
B	100,000	150,000	3.9 meg	470,000	1 meg	470,000	680,000	.018

generator system with its 60 tubes and 12 chassis. Each note, A through G sharp, is generated in the third octave above middle C by an inductively tuned master oscillator. A typical generator string is shown in Fig. 4, with the master oscillator the second triode of the 12AX7. The oscillator may be tuned by adjusting the slug within the coil form.

Each of the following twin-triode 12AU7's is a multivibrator with the customary cross-connected plates and grids. The first multivibrator is synchronized to the master-oscillator frequency by the capacitive connection between the oscillator plate and the resistive network in the multivibrator plate. The remaining multivibrators are synchronized, each by the preceding one, in a similar way. The unmarked values on the schematic diagram of Fig. 4 differ according to the notes generated by the various strings. Table I shows the missing values.

The master oscillator and each multivibrator furnish an output lead, the five outputs being separated by an octave each. Each output is taken from a plate through a capacitor and resistor. These outputs are not single-frequency tones, however. Each of the

lower (1 through 4) stages borrows some tone from the stage above it through resistors R2, R14, and the others similarly placed. In addition, each of the higher four stages (2 through 5) borrows some tone from the one below it through R3, R12, and so on. Thus each output contains principally the tone which it is supposed nominally to supply, with the addition of some tone an octave higher and an octave lower.

The first triode of the 12AX7 is a reactance tube placed across the master-oscillator tuned circuit. The grid is controlled by a signal from the instrument's 6-cycle vibrato oscillator. Varying the pitch of the master oscillator varies that of all the tones in the string because of the synchronism.

Fig. 5 is a photograph of a portion of the key switch frame with the cover removed. The frame is placed over the rear of the keyboard and is fastened down with adjustable end brackets. Sixty small plungers project downward and rest on sixty of the piano keys. The shorter plungers in Fig. 5 are those which touch the black keys.

Each switch is a single-pole, double-throw unit, the arm of which is a small coil spring which moves up and down

with the plunger when the key is pressed. The spring, connected to a generator output, is grounded to the topmost bus bar (see photo) when the key is up, short-circuiting the tone to ground. When the key is pressed, the spring contacts the lower bus bar. The lower bar is divided into two parts, the lower part encompassing the first 25 notes—the lower register—and the upper part the remaining notes—the upper register. These are collector bars on which all generator outputs switched by the player appear.

The vibrato oscillator is shown in Fig. 6. It is a simple phase-shift unit located on the power-supply chassis. The left triode of the 6SL7-GT is the oscillator itself, with its grid connected to the second triode which acts as an amplifier. Output is taken from the plate of the amplifier to modulate the 12 reactance tubes in the generator strings.

The degree of vibrato (amplitude, not frequency) is controlled by a pair of frequency) is controlled by a pair of switches and three resistors located in the control panel (drawn as part of Fig. 6 for easier understanding). With both HEAVY VIBRATO and LIGHT VIBRATO switches in the OFF position the amplifier output goes through a voltage divider consisting of the 560,000-ohm resistor as one element and a total of 10,000 ohms in the switching network as the second element, across which the reactance-tube grids are connected. The reduction in output voltage reduces the vibrato effect to negligibility.

If the LIGHT VIBRATO switch is placed in the ON position, the net resistance of the switching network rises to 10,000 plus about 9,600 (27,000 and 15,000 in parallel) ohms or about 20,000 ohms, which raises the network output sufficiently to obtain a moderate vibrato effect. When the HEAVY VIBRATO switch is on, the total in the switching network is 27,000 plus 10,000 or 37,000 ohms, which raises the vibrato effect to a large value.

**Tone coloring**

The key-switch upper- and lower-register collector bars are connected to the circuit shown in Fig. 7, the components of which are located in the control panel. Each register goes to a switch which either grounds the bus or passes it on to a voltage-divider network and solo switch. If both registers are to be played at the same volume the solo switch is in the normal position, as the lower-register solo switch is in Fig. 7. The upper element of the voltage divider is the resistor from the plate of a multivibrator tube to the octave output terminal in Fig. 4; the lower element, across which the output is taken, is whatever appears between the register switch and ground in Fig. 7. With the solo switch at normal, the lower element is 4,700 ohms. With the switch in solo position, it is 22,000 ohms. Thus the register selected is louder than the other and a solo melody may be played on it, with a softer accompaniment on the other. This is one

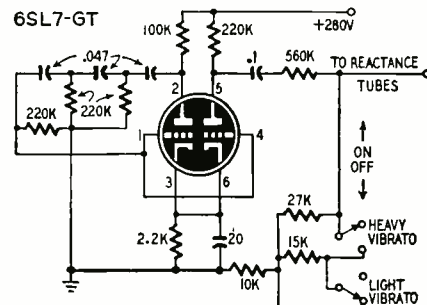
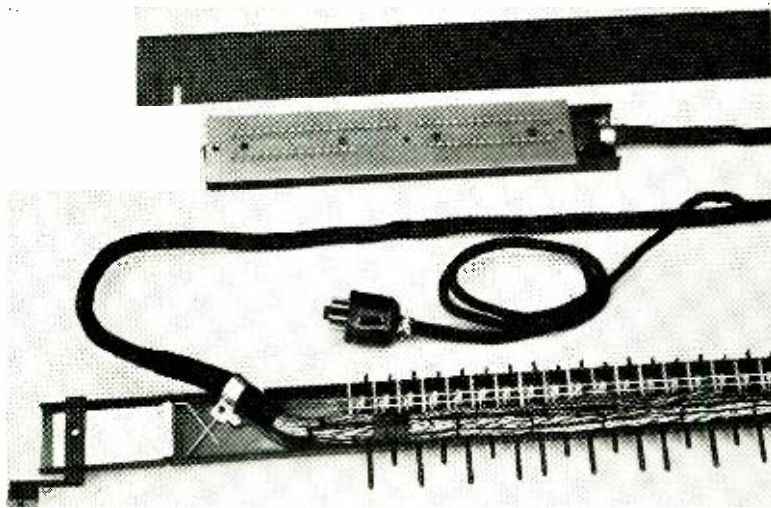

Left, Fig. 5—Part of the keyboard actuating mechanism. Above, Fig. 6—Schematic diagram of the vibrato oscillator.

form of "split keyboard" very often employed on single-manual organs. The split keyboard is common in nonelectronic instruments such as the old-fashioned harmonium, where it usually has a separate group of stops—tone colors—as well as different volume level.

The tones emerging from the solo-switch network are fed to two buses, one for each register. The buses are brought together through 500- $\mu$ f capacitors to the first stop switch, labeled STRING *p*. The small value of capacitance tends to filter out low frequencies from the complex waveform of each note, producing pulse-type waveforms with fairly sharp "spikes." This simulates a string tone, which has this character because the hairs of the bow have comparatively rough surfaces and pull the string in little jerks.

The buses are connected through a second pair of capacitors with a value of .0018  $\mu$ f to the STRING *f* switch. This gives the tone a bit more body, changing the quality somewhat and in the process allowing more of the fundamental to come through with an effect of greater volume.

All horns are resonant in at least one frequency range, as explained in the December article on the Baldwin organ. The horn effect is simulated in the

Organo by an L-C resonant filter composed of two .0027- $\mu$ f capacitors and a 24-henry inductor in series. This is the *piano* or soft horn. For the *forte* or loud horn one of the capacitors is increased to .01  $\mu$ f, with a lowering of resonant frequency.

The principal tone is simply the normal output waveform of the generators, with some of the higher harmonics reduced. The principal networks consist of a pair of resistors and a capacitor in a T configuration. The second resistor value is lowered from the value used for *piano* to obtain the *forte* volume.

Each stop switch is single-pole, double-throw and the arm is connected to ground for the OFF position and to an output bus for the ON position. The bus is connected to the amplifier.

**Amplifier and other equipment**

The amplifier is pictured in Fig. 8 and diagrammed in Fig. 9. Tubes V5 and V6 in the photograph are the power supply rectifier and the vibrato oscillator.

Referring to Fig. 9, the first triode of a 6SN7-GT is grid-excited by the output of the stop-switch bus in Fig. 7. Between this and the second triode is a volume control which is preset at installation for the maximum volume de-

sired in the room. The second triode is a cathode-follower, included to obtain a low-impedance line feeding to the expression control. The expression control, a 2,000-ohm potentiometer, is located in the control panel, the inside of which appears in Fig. 10. The lever and spring mechanism operated by the knee-lever turns the potentiometer. The low-impedance cathode line and the low resistance of the potentiometer prevent appreciable loss of treble or hum pickup in the line between the amplifier (which is in the tone cabinet) and the control panel on the piano.

The next stage is a phase inverter of the classical tapped-grid-resistor type, except that the cathodes of the two triodes are commoned to an unbypassed cathode resistor for better balance. The two plate outputs are fed to the grids of the 6V6 output tubes through 0.1- $\mu$ f blocking capacitors. The .0047- $\mu$ f capacitor across the output of the first phase-inverter tube reduces the high-frequency response slightly to eliminate some noise. The loudspeaker is an electrodynamic whose field coil is used as a filter choke. The power supply is conventional.

The layout of the Organo components is simple and straightforward. The control panel shown in Fig. 10 contains all the tone-coloring components as well

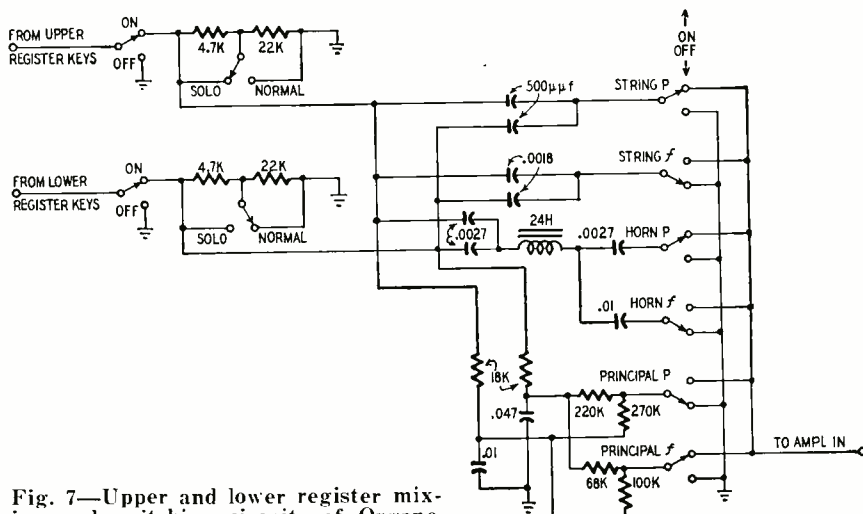

Fig. 7—Upper and lower register mixing and switching circuits of Organo.

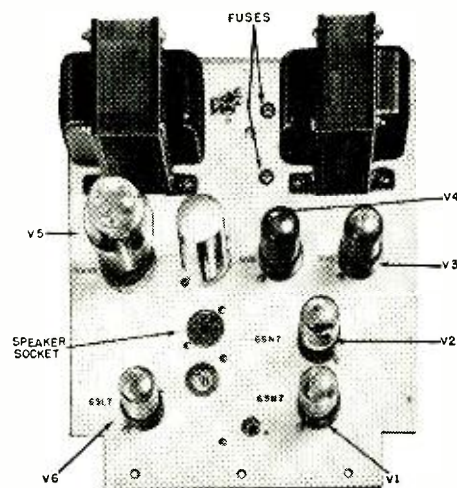

Fig. 8—Output amplifier chassis assembly. See text for the full details.



as the expression control and the switches. The photo shows an older model than that of Fig. 3, with the solo switches at the ends.

Fig. 11 is a rear view of the tone cabinet with the covers removed. The numbered components are as follows:

1. Auxiliary power switch (there is a switch and pilot light on the front of the cabinet).
- 2 and 18. Power and filament transformers.
- 3 and 14. Cabinet portions.
- 4 and 12. Rear covers.
5. Component frame.
6. Cable for speaker, power-switch, and pilot-light.
7. Terminal board.
8. Pilot light.
9. Output transformer.
10. Speaker.
11. Generator tubes.
13. Speaker plug.
15. Power cord.
16. Rectifier tube (a pair of 6W4's has been included in the newer models using 12AU7 generator tubes instead of 12AX7 as formerly).
17. Filter capacitor.

All connections to and between the various units are brought to the terminal boards at the center, so that complete accessibility to all units is provided and removal for repairs is facilitated.

An interesting variation of the usual component scheme has been made available in the Janssen piano, of which the Organo may be made an integral part. Fig. 12 shows a piano so equipped. There is no separate tone cabinet; all units of the Organo are built into the piano case. The oscillators, amplifiers, and other heat-producing units are installed along with the speaker on the inside of the piano kneeboard. A ventilating fan is provided to keep the interior cool enough to prevent damage to the piano mechanism. The key switch frame is placed inside the piano out of sight toward the rear ends of the keys.

In playing an ordinary piano equipped with an Organo attachment, striking the piano keys with normal pressure will actuate both mechanisms and produce both piano and organ tones simultaneously. However, in experimenting with the instrument, the writer has found that it is possible to play the Organo without appreciable "interference" apparent from the piano strings. It is a matter of regulating touch, since the key switches are adjusted so that tone will be heard when the key is depressed about halfway. Full depression sounds both string and organ tone, the effect of which can be quite pleasing. However, a damper bar may be obtained and installed in the piano. It has a lever at the end, with which the bar can be rotated on its axis, placing damping material on the strings so that they do not sound. The action then produces only organ tones. Damper bars are not common, however, and users do not seem to have felt a great need for them.

(to be continued)

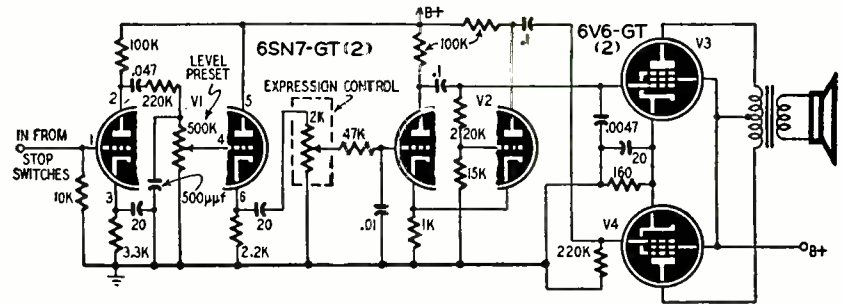

Fig. 9—Schematic diagram of the output amplifier shown in the photo of Fig. 8.

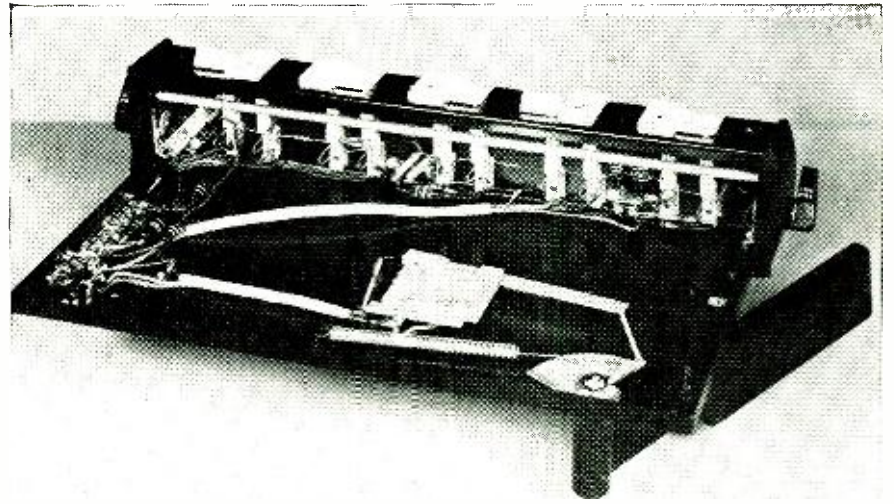

Fig. 10—This interior view shows simplicity of keyboard-mounted control unit.

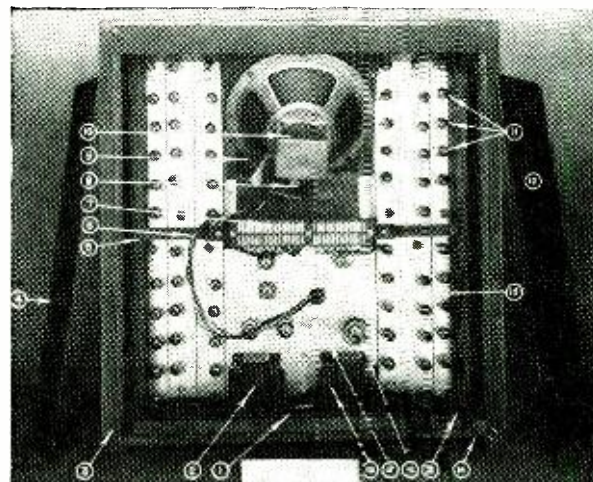
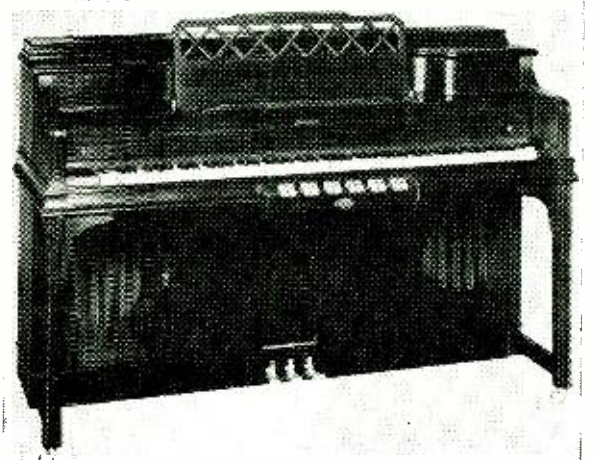
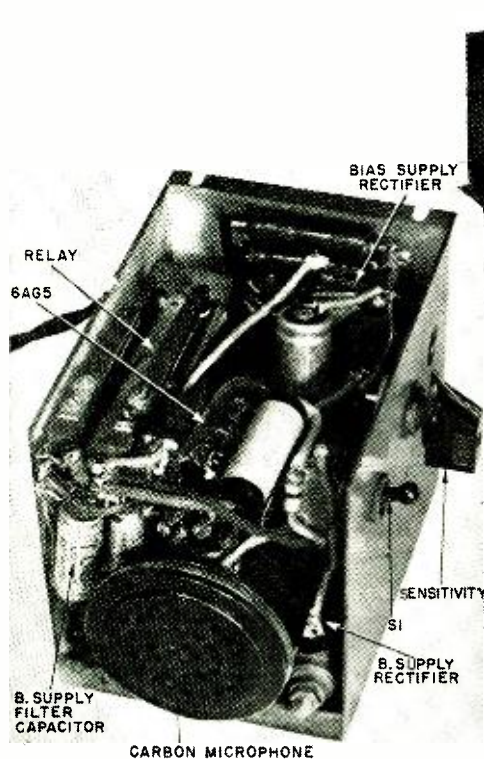

Fig. 11—Inside the speaker-amplifier housing. Note accessibility of units.

Fig. 12—A commercial model of an Organo-piano combination. The keyboard actuating mechanism is built in. A ventilating fan is behind one grille.





## SOUND OPERATED SWITCH

By JOHN RUNDO

**T**HIS simple switch may be used to control a variety of circuits by sound. For instance, it can be made to open garage doors by the toot of the car's horn, and is considerably cheaper than either a radio-controlled or photoelectric device for the same job.

The experimenter will think of several uses for this switch; the amateur can use it for switching on the plate current of his modulator and transmitter when he speaks into the microphone. It might be used as a burglar alarm, or to signal if a baby or invalid requires attention. The author built his to switch on his bedside receiver when his alarm clock sounded.

The principle of operation is that of the well-known plate detector. A high-mutual-conductance pentode with sharp-cutoff characteristics is biased to somewhere near zero plate current by a fixed bias obtained by rectifying the heater voltage. A carbon microphone, energized from the same source, drives (through a step-up transformer) the grid of the 6AG5 or similar tube. When the microphone picks up a sound, an a.f. voltage is applied to the grid of the tube, increasing the mean plate current to a value which will operate the sensitive relay RY. This has two sets of contacts, one of which supplies power to the controlled circuit. The other set opens the ground side of the primary of the heater transformer and also connects the plate of the tube to ground through the 22,000-ohm resistor. This keeps the relay operated when the actuating sound has stopped.

Operation of switch S1 opens the B-supply (which is obtained by half-

wave rectification of the line voltage by a selenium rectifier), and allows the relay to reset; if S1 is a s.p.d.t. switch and the connection shown as a broken line is made, the new position shunts the switch contacts of the relay and keeps the controlled circuit in the "on" condition, if this is desired. Setting S1 back to its original position switches off the controlled circuit and puts the relay-operated switch on again.

The sensitivity of the switch is remarkable. It is controlled by the value of the bias applied to the tube's grid by the potentiometer across the bias supply. At full sensitivity this unit operates at the sound of a cough or a door shutting!

The relay used should be fairly sensitive; one that pulls in at about 2-3 ma is suitable. The writer used a surplus item with a coil resistance of 12,000 ohms. Naturally, such relays do not have contacts capable of handling very high currents; so for a controlled circuit which is to take more than average power, another slave relay should be used, controlled by the contacts A. The .01- $\mu$ f capacitor across these contacts is for surge suppression, the 100-ohm series resistor serving to protect the capacitor when an inductive circuit is broken by the contacts. The capacitor across the relay is essential. Its value may be found by trial and error for optimum performance under any particular conditions. However, a suitable starting value would be about 5  $\mu$ f at 150 volts working. The value of the limiting resistor in the microphone energizing circuit will depend on the particular microphone available. Gen-

erally it will be a few hundred ohms. The microphone energizing voltage is negative with respect to ground; the 100- $\mu$ f electrolytic capacitors must be connected correctly, with their shells isolated from ground.

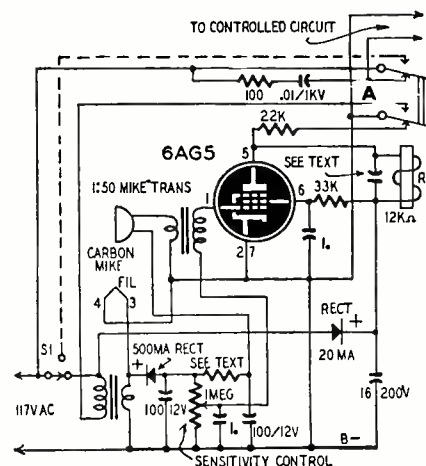

Fig. 1—Schematic of the sound-operated switch. Note capacitor polarities.

### Materials for the sound operated switch

**Resistors:** 1—22,000 ohms, 1 watt; 1—33,000 ohms, 1/2 watt; 1—100 ohms, 1/4 watt; 1—microphone current-limiting resistor from 100 to 1,000 ohms, 1/2 watt; Potentiometer: 1—1 megohm.  
**Capacitors:** (Paper) 2—1- $\mu$ f, 200 volts, metallized tubular, 1—.01- $\mu$ f, 1,000 volts; (Electrolytic) 2—100- $\mu$ f, 12 volts, 1—16- $\mu$ f, 250 volts, 1—5-to-25- $\mu$ f, 50 volts, across relay coil.  
**Miscellaneous:** 1—6AG5 tube, or similar, and socket. 1—20-ma selenium rectifier, 1—500-ma copper oxide rectifier. 1—5,000-to 12,000-ohm plate relay, d.p.d.t. contacts. 1—single-button carbon microphone. 1—mike transformer, 1—6.3-volt, 0.5-ampere filament transformer. 1—s.p.d.t. power switch. 1—knob, chassis, and sponge rubber pad. Hardware, solder, and wire.

—end—



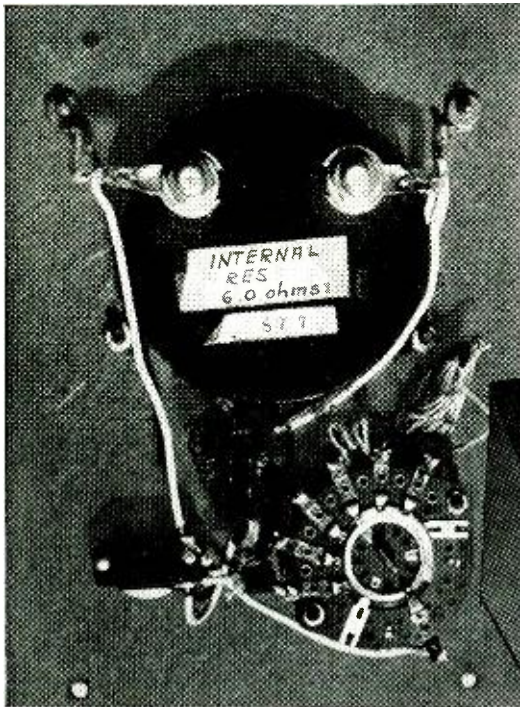

# MULTIRANGE MILLIAMMETER

By R. L. PARMENTER, W1JXF



**A** USEFUL piece of test equipment around the average hamshack is a multirange milliammeter for checking operating conditions in experimental transmitters. The surplus market still offers good buys in meters, and the necessary shunts are easy to wind. Low-range movements (0-5, 0-10 ma) naturally provide greater flexibility and usually cost less than the higher ranges.

This unit was built around a 0-5-ma movement. Using a selector switch, a s.p.s.t. switch, a pair of insulated jacks and a few lengths of magnet wire we have an instrument with which we can measure currents up to 500 milliamperes, with several useful intermediate ranges. The 5-ma and 10-ma ranges can be used for measuring the excitation to beam tetrodes or pentodes, while the 0-50-ma range can handle triode grid currents. The 100- and 200-ma ranges are useful for the plate circuits.

Perhaps the simplest way to find the amount of wire to wind for a shunt is to use the setup shown in Fig. 1. The meter is connected in series with a battery (E) and an adjustable resistor (R). Observe meter polarity. The value of the series resistor can be found from the simple Ohm's law relationship  $R = 1,000E/I$ , where E is the battery voltage and I is the full-scale reading of the meter in milliamperes. If the battery is a 1.5-volt dry cell and the full-scale reading of the meter is 5 ma, then  $R = 1,000 \times 1.5/5$ , or 300 ohms. A 500-ohm potentiometer would be suitable.

Adjust the potentiometer until the meter reads exactly full scale (in this case 5 ma). Connect just enough wire across the meter terminals to reduce the reading to  $\frac{1}{2}$  the full-scale value. (Start with a piece of wire several feet long; then trim it down little by little to the exact length required.) This is the 10-ma shunt.

Connect the completed shunt across the meter terminals. For the 20-ma shunt first reduce the series resistance to bring the pointer back to full scale. Now try another length of wire *in parallel with the first*, and trim the second piece until the meter again reads exactly  $\frac{1}{2}$  full scale.

The shunts for the higher ranges are made in the same manner, with all shunts for the ranges below connected in parallel across the one being made. (NOTE: The shunts for the 50-ma and 500-ma ranges must be trimmed for a meter reading of 40% of full scale.)

If a Wheatstone bridge is available, the internal resistance of the meter may be found by measuring the resistance of the 10-ma shunt. (*Do not try to measure the resistance of the meter itself, as it may be damaged by the bridge current.*) The value of the shunting resistance needed for any range may then be determined from the formula  $R = \frac{R_m}{n - 1}$  where R is the resistance to be found,  $R_m$  is the internal resistance of the meter and n is the scale multiplying factor. When the shunts are finished, wire the instrument

as shown in Fig. 2.

Because of the high voltages in the circuits where this meter may be used, the terminals, leads and switch knobs must be completely insulated, and contact with the meter itself should be avoided while in the circuit.

The s.p.s.t. switch is a convenience for shorting out the meter without removing connections to the equipment under test.

The shunt coils may be soldered directly to the switch terminals as shown in the photo. No. 28 magnet wire will be suitable for intermittent duty.

A small wood or plastic box with a sloping panel as shown above makes a convenient cabinet.

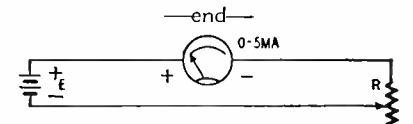

Fig. 1—Basic circuit for winding shunts.

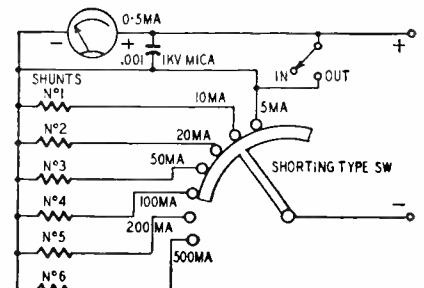

Fig. 2—Multirange milliammeter schematic.

# TV SERVICING with SIMPLE

By CHARLES G. BUSCOMBE

Planned procedures for on-the-spot trouble shooting save time and money for technician and customer.

THE technician called to service a television receiver in the customer's home cannot very well carry his shop with him. A set of replacement tubes, a v.t.v.m. and a few small servicing aids are all that one man can conveniently handle. However, the *right* servicing aids, and an organized logical procedure for using them, can help the technician solve most service problems on the spot.

The various checks and tests in the following article were made with the help of the TV *service aid* described in the March issue of RADIO-ELECTRONICS.

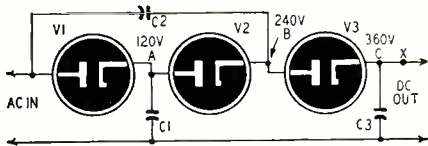

Fig. 1—Half-wave tripler schematic.

However, a standard v.t.v.m. (especially if equipped with a high-voltage probe) could probably handle most of these problems.

## B-plus circuit troubles

Possible symptoms: No raster or sound; raster dim and of small size; poor focus; sync instability; weak sound (any one or combination of these symptoms may be noted).

If tubes fail to light, the first things to look for are an open a.c. line, a defective interlock, or a blown fuse. If tubes are lit check for presence of normal B+. A loss of more than 10% in the B+ can cause most of the above-mentioned troubles. For this condition try substitute replacement of rectifier tubes or selenium units. Where sparking occurs in a rectifier, check for a shorted input filter. If filter chokes or resistors show signs of overheating, check other filters and bypass capacitors and investigate the possibility of one or more tubes drawing excessive current. This latter trouble can be verified by removing tubes one at a time, and noting the B+ voltage changes. Normally, pulling most of small tubes will result in an increase in the B+ of 10 to 20 volts. Removal of power amplifiers (vertical, horizontal, and audio output) will raise B+ 50 to 100 volts, depending on the set. Where removal of a tube causes a greater increase than this, its circuit should be checked for a leaky coupling capacitor,

and loss of bias or screen voltage. The tube itself may be shorted or gassy.

## The low-voltage doubler or tripler

Where output from this type of supply is low or zero, it is not advisable to start with rectifier substitution, as a shorted filter capacitor might damage one or more of the substitutes. Start by disconnecting the set load at point X in Fig. 1. Under this no-load condition, voltages at points A, B, and C should be approximately as indicated. If there is no voltage at any point, check for a.c. up to the first tube via the ballast resistor and input filter. Output at B but not at C, indicates defective V3 or C3. If there is voltage at A but none at B, check V2 and C2. No d.c. at A indicates V1 or C1 is at fault.

Where selenium rectifiers are used, follow the same procedure, making certain that substitute rectifiers have adequate current capacity.

## The high-voltage power supply

Symptoms: Sound O.K., no raster, or dim raster; blooming. In receivers using the flyback type of power supply shown in Fig. 2, first check for presence of h.v. on the anode lead, and measure it if possible. This should be done at both ends of the filter resistor under varying load conditions by adjusting the brightness control over its full range. Next, touch the anode lead to the picture tube, noting intensity of the spark. If weak with brightness control at maximum, trouble may be a weak picture tube, loss of anode No. 1 voltage, or a defect in the brightness control circuit. If h.v. is low or nonexistent, try to draw a corona arc from the plate cap of the h.v. rectifier tube. If this is O.K., trouble will be a bad rectifier, filter capacitor, or resistor, or a grounded anode lead. Verify by tube substitution, disconnecting one end of the capacitor, or shorting out the filter resistor. If there is no corona arc or a very weak one, cause may be overload conditions as above or trouble at some prior point. Next try to draw a corona arc from the plate of the horizontal output tube or tubes. If this is O.K., fault lies in the h.v. winding of the transformer. Look for indications of coil heating or a broken lead to the rectifier plate. If the arc is absent or very weak at the output plate, check the d.c. voltage at the low end of the

transformer primary, and back through the fuse, linearity coil, and the cathode and plate of the damper tube. The boosted voltage at the transformer primary should be 75 to 150 volts higher than the voltage at the damper plate. If the boosted voltage is low, the damper tube may be weak, or there may be insufficient drive to the amplifier grid. Absence of boost voltage may be caused by an open fuse or linearity coil, by shorted linearity capacitors, or by a grounded transformer primary.

Where the boosted voltage to the output tube is normal, yet corona arc at the plate is weak or absent, check for sawtooth drive to the grid. If this is normal (at least 20 volts peak to peak), try tube substitution and tests on the cathode and screen circuits. Continued trouble is probably due to shorted turns in any winding of flyback transformer. Substitution is the most reliable verification. Insufficient sawtooth voltage at the output grid indicates incorrect drive adjustment, a shorted drive control, or trouble in the oscillator circuit.

## R.f. high-voltage supplies

Fig. 3 shows a type of h.v. supply used in most electrostatic receivers and in some electromagnetic models. In electrostatic sets, measure h.v. on the second anode and at all four deflection plates. Variations can result in an off-center raster and are usually caused by leaky or shorted coupling capacitors from the sweep output circuits. Other causes of this condition are: Plate load resistors of the sweep amplifier open or changed in value; open or increased value of the isolating resistors feeding the deflection plates of the picture tube; open or changed value of a fixed or variable

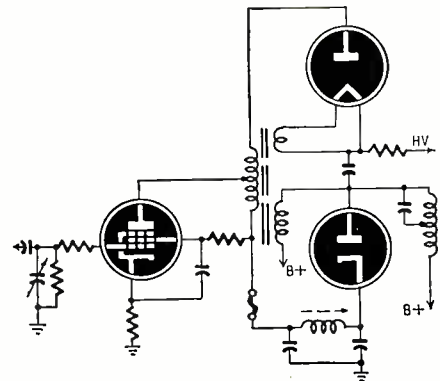
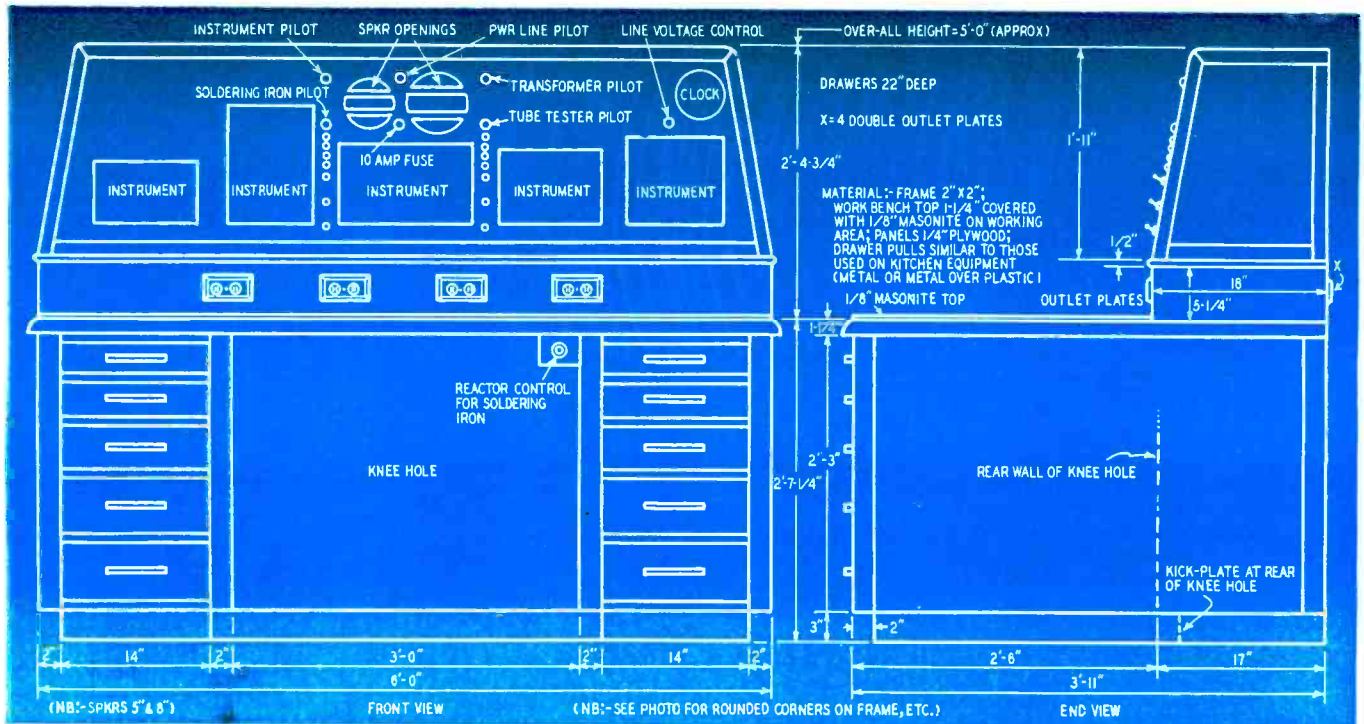

Fig. 2—Typical flyback h.v. circuit.

RADIO-ELECTRONICS







Structural details of the prize-winning bench. One speaker is connected to the Chanalyst; the other is used with a universal output transformer for substitution tests. In the original bench the superstructure base extends forward about 6 inches to provide a shelf for test leads and small tools. Outlets marked "X" are for auxiliary instruments.

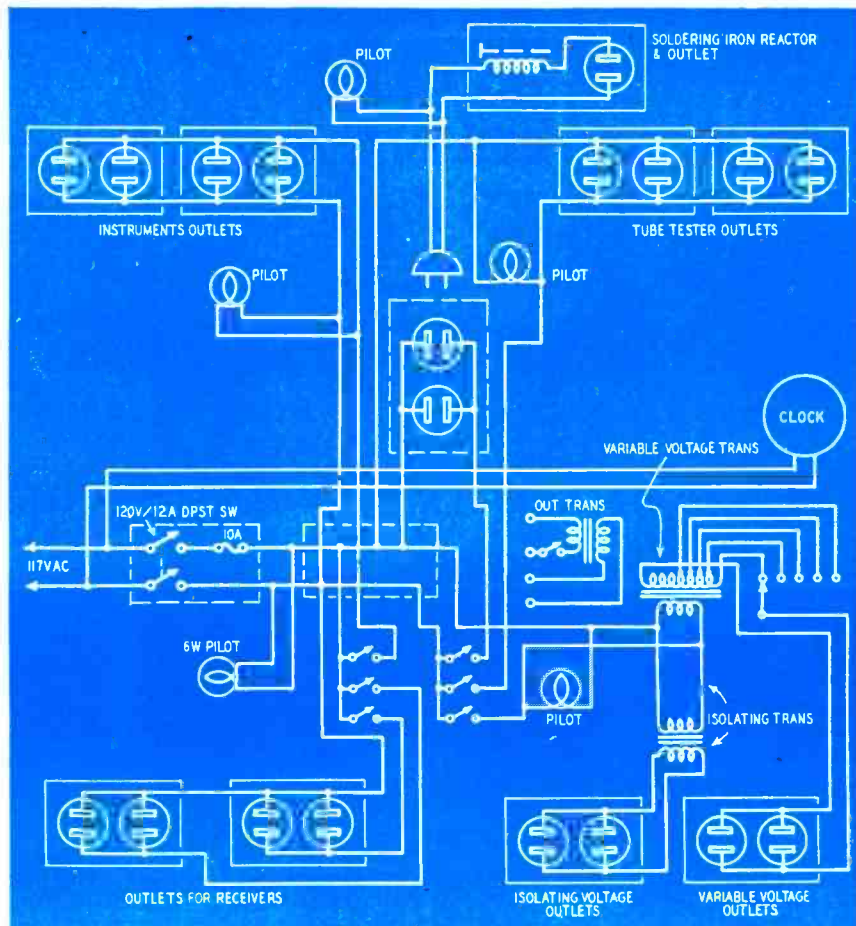

Internal wiring of the bench. All basic servicing requirements are provided for in this flexible arrangement. Individual line fuses would give added protection, especially to the variable-voltage and line-isolating transformers. A permanently connected line voltage meter would be a worth-while addition.



## THIRD PRIZE | RADIO-ELECTRONICS SERVICE BENCH CONTEST

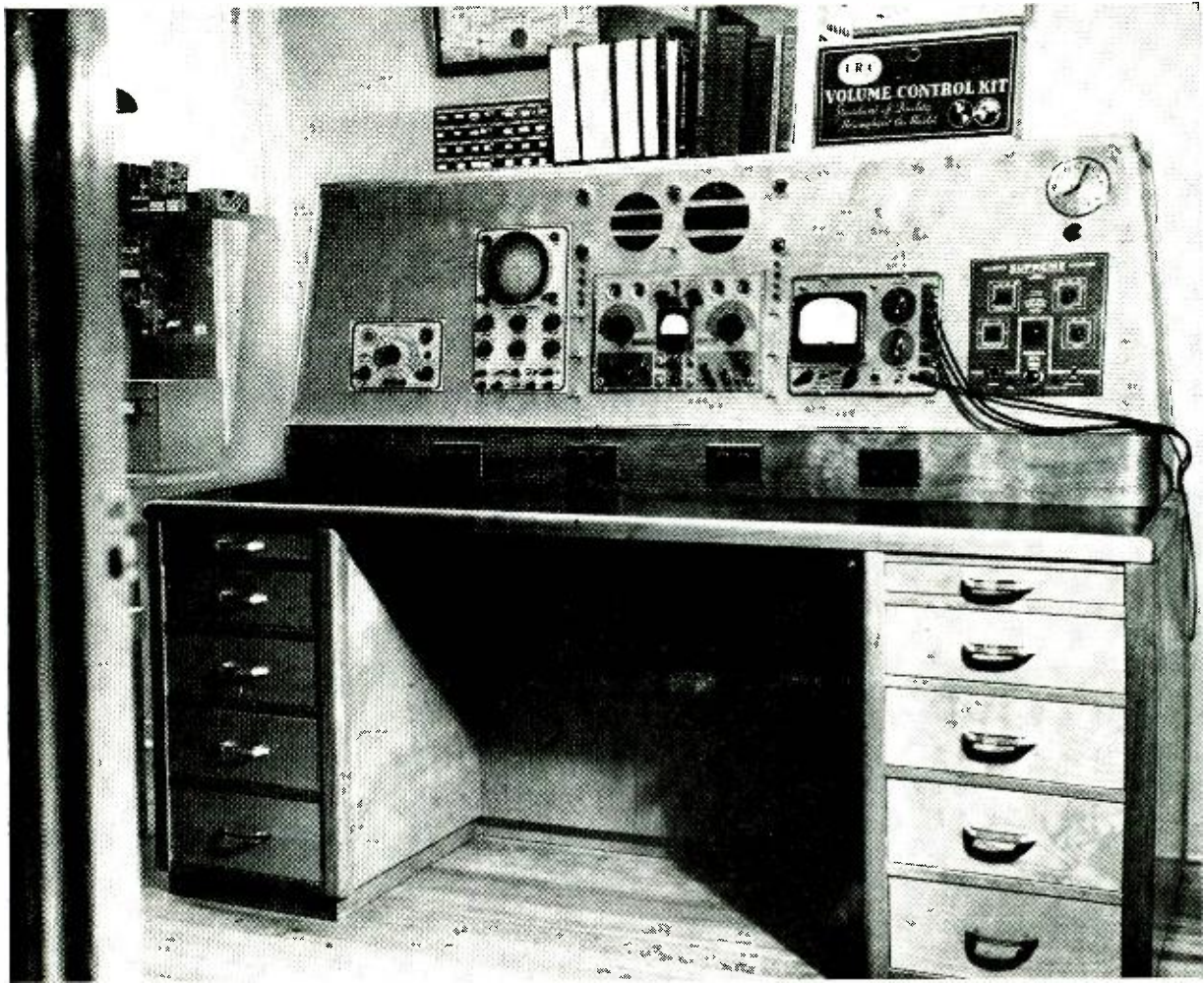

Skilled cabinetry and handsome finish distinguish this fully-equipped, roomy prize winner.

## A TV-ADAPTABLE RADIO BENCH

**C**LEAN-CUT functional utility and smart professional appearance are combined in this Canadian radio service bench. Designed and built by Albert Mercier, of La Tuque, Quebec, our third-prize bench shows intelligent planning and a high degree of craftsmanship. Although the Canadian service technician does not yet have to contend with the physical and electrical problems of handling TV receivers, the large working area and uncrowded instrument panel of this bench are readily adaptable to TV. A novel wiring arrangement adds to its flexibility.

All outlets, wiring, and controls are built into the removable superstructure.

Panel instruments plug in at the rear. An extension socket and temperature control for the soldering iron are mounted under the bench top. Along the bottom of the superstructure the left-hand pair of dual outlets connect directly to the power line; the third is connected through an isolating transformer; and the fourth outlet provides adjustable line voltage controlled by the knob just below the electric clock. All outlets have individual switches and pilot lamps, and a fused master switch controls power to the entire bench.

Except for the working surface and the drawer bottoms the bench is built entirely of yellow birch. Pieces of 2 x 2 scantling are used for the framework

of the base and superstructure, and solid 5/8-inch stock is used for the drawers. The latter are supported on both sides by 1/4 x 1/2-inch guide strips. The sides of the base and the panels of the superstructure are of 1/8-inch yellow birch plywood.

The work top is built up of ordinary 1 1/4-inch pine boards, and covered with 1/8-inch tempered Masonite. Masonite is also used for the drawer bottoms. All joints in the framing are mortised, glued, and held with No. 8 x 2-inch flat-head wood screws.

The shallow top drawers on either side are used for schematics; the others are compartmented for parts.

—end—



# SHORT

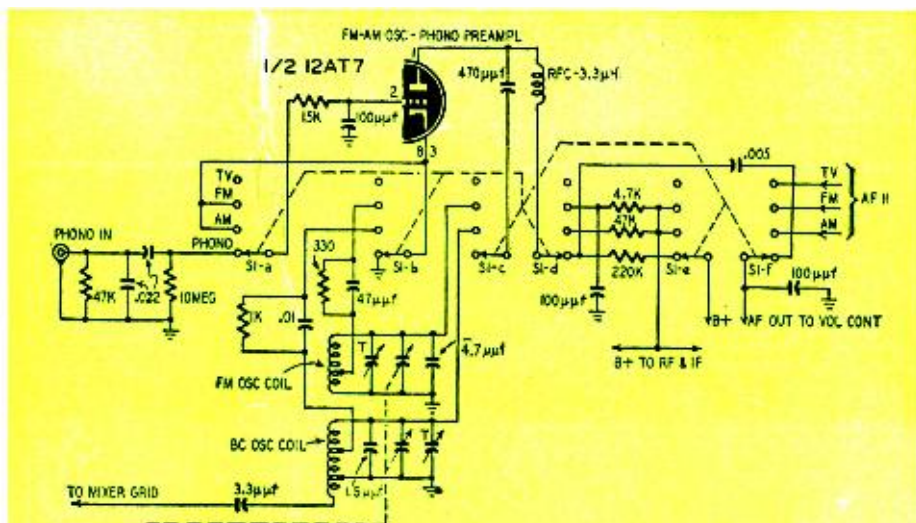

Fig. 1—AM-FM-Phono switching circuit of Philco RT-2 tuner.

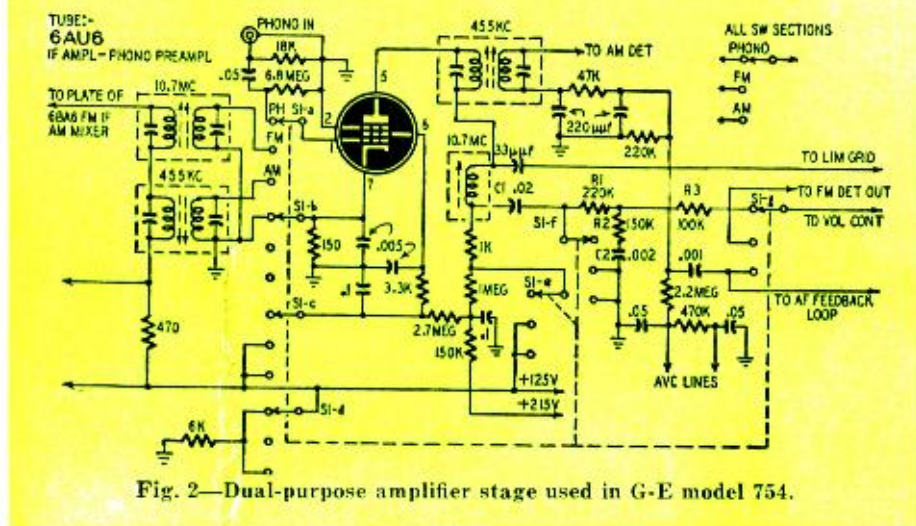

Fig. 2—Dual-purpose amplifier stage used in G-E model 754.

ONE of our hobbies is analyzing the different types of circuits used in receivers, amplifiers, and other types of electronic equipment. We always get a kick out of finding a circuit which is either entirely new or differs in some significant way from the conventional. A little study of some of the new circuits found in receivers and amplifiers may also save you a few headaches when you have to service them in the future. The circuits discussed in this article are taken from present-day AM-FM tuners and receivers.

### Phono input circuits

Whenever we think of a phono input circuit in a receiver, we usually visualize the pickup connected directly across the volume control in the set. This type of connection is still commonly used with crystal pickups which deliver from 1 to 4 volts into the a.f. amplifier. However, preamplifiers are required when low-output pickups such as the variable-reluctance type are employed.

Several receiver manufacturers have developed novel circuits to raise the output of the pickup to a useful level

without using a separate preamplifier stage. One such circuit is used in several Philco sets. The circuit shown in Fig. 1 is taken from the RT-2 AM-FM tuner in the 51-T1875 and similar sets.

In this circuit, the AM-FM oscillator—one-half of a 12AT7—is converted to a phono preamplifier. The drawing shows the selector switch S1 in the PHONO position. Section S1-a disconnects the 15,000-ohm oscillator grid resistor from the cathode and connects it to ground through a 10-megohm resistor when the cathode is grounded through S1-b. The signal from the pickup is applied across this resistor and appears on the grid of the tube.

Switch sections S1-d and S1-e disconnect the 4,700- and 47,000-ohm plate-dropping resistors used in the FM and AM functions and insert the 220,000-ohm plate-load resistor used in the pre-amplifier circuit. The .005-µF coupling capacitor connects the plate side of the load resistor to the hot end of the volume control through S1-f. From the arm of the volume control the signal goes to the 6T8 first audio and the 7C5 power amplifier on the sound chassis

of the TV set.

When the tube is used for AM or FM reception, the triode is converted to a grounded-grid Hartley oscillator. Switch section S1-a connects the 15,000-ohm resistor between the grid and cathode. The 100-µF capacitor grounds the grid for r.f. S1-b connects the cathode to the feedback tap on the oscillator coil being used. Section S1-c connects the 470-µF feedback capacitor between the plate and hot end of the oscillator coil. The 3.3-µH r.f. choke prevents r.f. voltages from appearing on the B-plus line. S1-e connects the FM r.f. amplifier-mixer section of the 12AT7, and the 2-stage FM-AM i.f. amplifier to the B-plus line.

### Another phono circuit

G-E eliminates the preamplifier for the variable-reluctance pickup in the model 754 and similar sets by using an i.f. amplifier stage as the phono-graph preamplifier. The circuit is shown in Fig. 2.

Section S1-a of the selector switch disconnects the grid of the 6AU6 i.f. amplifier from the input i.f. transformer and connects it to the 6.8-meg-





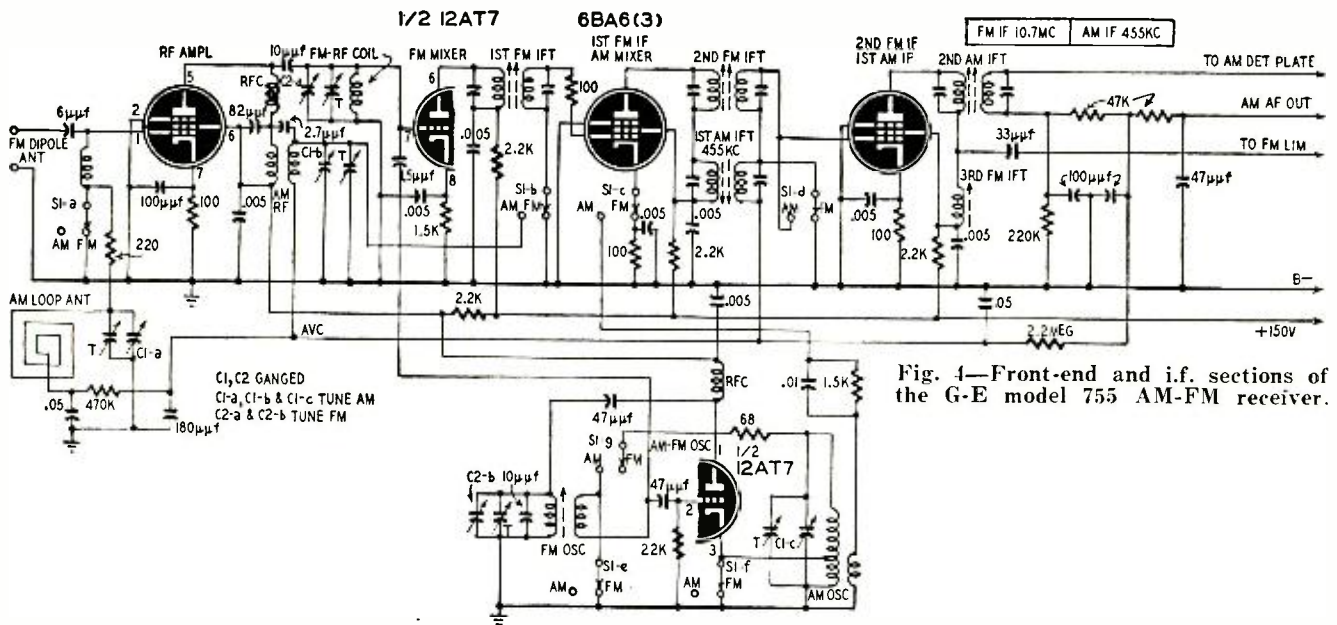

Fig. 4—Front-end and i.f. sections of the G-E model 755 AM-FM receiver.

ground through a pickup winding on the AM oscillator coil. When used as a mixer, this stage is biased by a 1,500-ohm resistor bypassed by a .01- $\mu$ f capacitor. Since the small inductance of the 2nd FM i.f. transformer primary is effectively a dead short at 455 kc, the AM output signal of the mixer is developed across the primary winding of the first AM i.f. transformer. The secondary of the second FM i.f. transformer is shorted out by section S1-d of the selector switch. After passing through the AM i.f. amplifier, the signal goes to a conventional diode detector.

The AM oscillator is a shunt-fed Hartley circuit with its cathode connected to a tap on the tuned winding and its grid connected to the hot end of the AM oscillator coil through the feedback winding on the FM oscillator transformer. Coupling between the AM

oscillator and mixer circuits is by cathode injection to the mixer through the small pickup winding around the AM oscillator coil.

When used on FM, the bottom of the FM antenna coil is grounded and the signal voltage developed across the coil is fed to the r.f. amplifier. The FM signal voltage appears across the r.f. choke in the plate circuit of the r.f. amplifier and is capacitance coupled to the tuned FM r.f. coil in the grid circuit of the triode section of the 12AT7 used as the FM mixer. The oscillator is converted to a Hartley circuit of the shunt-fed, tuned-plate type. S1-b grounds one end of the untuned grid winding on the FM oscillator coil. The 10.7-mc output of the FM mixer passes through the two 6BA6 FM i.f. amplifier stages into a 6AU6 limiter followed by a conventional Foster-Seeley dis-

criminator using part of a 6T8.

We have tried to analyze these circuits so as to leave nothing to guesswork on your part. However, by so doing, we have been forced to limit this discussion to four circuits. It is our hope that these discussions may simplify a servicing or trouble-shooting job which might otherwise turn out to be an unprofitable pain in the neck.

In the future, we would like to discuss new and unusual circuits in auto radios, TV sets, three-way portables, audio amplifiers, communications receivers, test equipment, and perhaps—for the industrial electronics technician—new developments in special-purpose circuits such as frequency dividers, pulse shapers, counters, etc. Drop us a line and let us know how you like the idea.

—end—

# Simple Capacitor Checker

Most of the capacitance meters described in technical literature are designed around a bridge circuit. A novel approach to the problem of measuring small capacitors is described in *Radio Constructor* (London, England).

The instrument shown in the diagram consists of two oscillators, V1 and V2. One of the oscillators (V2) is also used as a zero beat detector. The unknown capacitance is connected to the terminals across the coil of V1, and then the 500- $\mu$ f tuning capacitor across the coil of V2 is adjusted until the two oscillators are zero-beat as indicated by a null in the phones. The value of the unknown is then read from the calibrated dial of the variable capacitor.

With the range switch in position 1, the maximum range is approximately equal to the maximum capacitance of the variable or nearly 500  $\mu$ f. In posi-

tion 2, a 400- $\mu$ f silver-mica capacitor is inserted in series with the unknown, and values as high as .01  $\mu$ f can be read with accuracy.

The oscillators use identical coils. These may be standard broadcast oscillator coils. They should be mounted some distance apart with their axes at right angles. If there is not enough coupling between the coils to produce a good beat note, swing one of them so the coupling is tightened. If the oscillators pull, reduce the coupling by placing a small shield between the two.

The instrument can be calibrated by measuring known capacitors and marking the values on the dial of the variable control.

Although Armstrong-type oscillator coils are shown in the circuit diagram, the capacitor checker can be readily adapted to use tapped-winding Hartley oscillator coils if these are available.

It should also be possible to construct the unit around battery-type tubes, for complete portability.

—end—

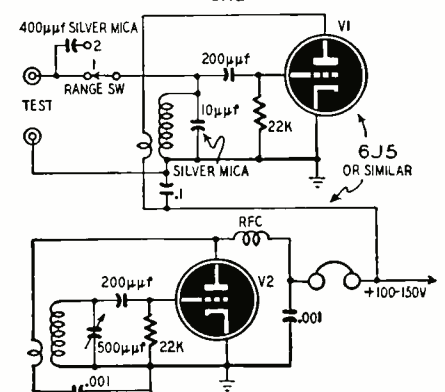

Schematic of the capacitor meter. Modifications are discussed in the text.



# Kill That Ghost!

A TV ghost can easily spoil an image that is otherwise clear and sharp. There are two major sources of this interference. A ghost may be produced by a long transmission line that is not correctly matched at both ends. It may also be produced by reflection from a building

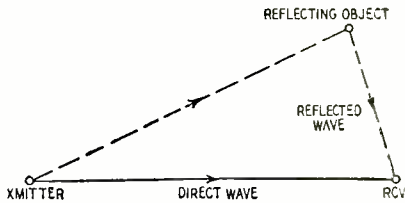

Fig. 1—Paths of direct signal and ghost.

or other object (Fig. 1). Ghosts may be positive or negative, depending upon the phase with which the echo returns. To kill the ghost, we must know what is causing it. Then several methods are available for eliminating it.

Fig. 2 shows a transmission line between an antenna system and the input coil of a tuner. The intercepted signal is sent along the line from A to B. If a mismatch exists here, a portion of the signal is reflected back to the antenna. If this is also mismatched, some of the voltage is reflected again. The signal returns to B and reproduces the image a second time.

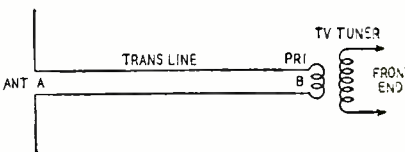

Fig. 2—Transmission line signal path.

The displacement between the direct signal and its echo depends upon the type of line and its length. If the transmission line is short, the direct signal and ghosts combine to form a single, blurred image.

We can determine whether ghosts are being produced by a mismatched line. It is easy to find the time required for a signal to complete the trip from B to A and back again to B (Fig. 2). Then we can measure the time lag between direct signal and ghost as seen on your TV screen. If these are nearly equal,

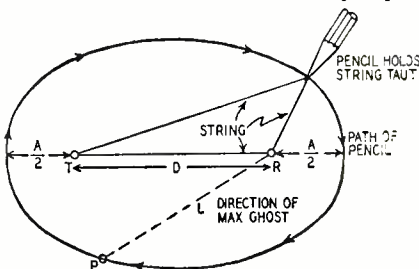

Fig. 3—Locating the source of a ghost.

APRIL, 1952

the transmission line matching may be at fault.

Delay due to different lines is listed in the table. Each length listed causes

Type of Line	Impedance	Velocity Constant	Length (Feet)
Ribbon	300 ohm	.85	425
	150 ohm	.76	380
Coaxial	72 ohm	.67	335
	52 ohm	.66	330

a delay of one microsecond. For example, 850 feet of 300-ohm ribbon line delays the echo by 2 microseconds. The raster itself is used as a time base to measure the interval between direct image and ghost. The raster is scanned horizontally in 53.3 microseconds. If the width is adjusted to any convenient value W (inches), the fraction W/53.3 gives inches per microsecond. When the raster is 13 3/16 inches, each one-fourth inch corresponds to one microsecond. For a width of 6 3/8 inches, each 1/8 inch is equivalent to one microsecond. If you have a rule handy, adjust the raster to 10 1/2 inches. Then each centimeter along the time base is equivalent to 2 microseconds.

The RCA Microstick may be used for direct time measurements. This is a scale calibrated in microseconds.

If it appears probable that line reflections are producing ghosts, you may adjust the input coil at the receiver, and note the effect on the echoes. If the primary turns are squeezed together or more turns added, the coil impedance will increase. Impedance is also changed by varying the primary-secondary coupling. Sometimes the echoes can be reduced (especially at higher frequencies) by wrapping a piece of tin foil around ribbon-type transmission line and sliding the metal back and forth. The change in line impedance may effect a better match. (See also P. 107.)

If a mismatched line is not at fault, the echoes are being reflected from a building or other external object. The echo travels further than the direct signal so it arrives later. The time interval may be measured with a Microstick or ruler as previously explained. Since electromagnetic waves travel .186 (or 3/16) miles per microsecond, we can determine the extra distance traversed by the echo. For example, a ghost which arrives 2 microseconds after the original signal must have traveled .372 (or 3/8) more miles.

You can locate the source of the echo as follows. Drive two nails into a wooden board as shown in Fig. 3. Nail T represents the transmitter, and R is the receiver. The distance D is proportional to the distance between receiver and transmitter. For example, if you are 4 1/2 miles from the station, drive

the nails 4 1/2 inches apart. Now prepare a loop of string with total length 2D + A. Here A is the extra distance of the echo path. Using figures given in this paragraph and the previous one, we would have a loop length of 9 plus 3/8 inches.

Place the loop around both nails and hold a pencil against the string so that it remains taut. As the pencil is moved, it traces out a curve like the one in Fig. 3. The offending object lies somewhere on the curve. The exact spot is found with the aid of a directional antenna. Draw a line L along the direction which is giving maximum ghost signal. The reflecting point P lies at the intersection between line L and the curve.

Knowing the location of P helps to plan an antenna system so that least signal will be picked up from it.

—end—

## TV DX FOR APRIL

By the middle of April we will be well over the low period of the TV dx year, and approaching the best months. There will not be a lot of dx of any sort during April, but there will be a definite upturn in conditions. This turning point will be associated in a general way with the changing season, and will show first in the warmer climates.

Both sporadic-E dx and tropospheric extensions of normal coverage will be most pronounced in the southern portions of the country. An interesting report from Cuba confirms our frequently expressed view that TV dx reception is more frequent for southern viewers. Observer Albor Otero Garcia, of Varadero Beach, says that he has been using our predictions as a guide, but that he finds conditions running about a month in advance of them. This is undoubtedly true, for Bureau of Standards information shows a marked peak in sporadic-E incidence in the lower latitudes.

The first pronounced sporadic-E openings will probably occur sometime after April 20th. The avid dx enthusiast will do well to make a careful record of such openings as they occur, for they provide the best indication of when to look for the best dx the following month. Because such dx breaks are associated with solar conditions, they usually recur 27 to 28 days later.

As the weather moderates, fringe-area reception will improve markedly in April. Observers whose antennas are heavily screened by tree foliage later in the spring may actually have better reception in April than in the warmer months, and in all locations the average signal levels will be well above those of the winter season. There will be little extreme tropospheric dx on the high channels.

April is the last of the spring aurora months. There are usually at least two aurora periods in April that are of sufficient strength to influence low band TV reception in the areas north of Latitude 40.

—end—

# CIRCUITS FOR THE TV FRINGE

By WALLACE WANER

A number of this year's television receivers are definitely designed with fringe-area reception in mind. Manufacturers feel that metropolitan areas have now been saturated and the greatest future sales will be in the fringe areas. This means that many new receivers have high-gain, low-noise circuits. More stable sweep systems and other features appear in these fringe-area receivers.

Familiarity with these new developments will help the progressive technician when such receivers come in for servicing. Only with such know-how will he be able to maintain such sets at the peak efficiency for which they were originally designed.

## Front ends

Some ingenious advances have been made in television-receiver tuners. One such circuit which uses the new 6BQ7 low-noise dual-triode tube is shown in

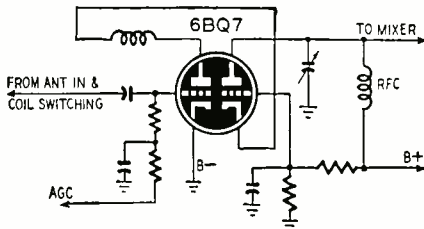

Fig. 1—Cascode amplifier circuit used in several recent TV receiver models.

Fig. 1. A special circuit, designed around this tube, features:

- Less local-oscillator radiation.
- Low-noise triode advantages.
- Good selectivity and bandpass characteristics.
- Minimum cross-modulation between r.f. and mixer.
- High output impedance features of a pentode.

As shown in Fig. 1, the plate of the first tube is directly coupled to the cathode of the second-triode section. Thus, the second triode acts as a low-impedance plate load for the first triode. This arrangement is known as *cascode* and is used in the latest RCA, Admiral, and Philco tuners. It is the circuit of the Philco "Colorado" tuner.

Slight variations exist among the various manufacturers but essentially the circuits are identical. Philco uses its tapered-line input and RCA employs the elevator transformer input

system. These circuits, by themselves, are not new and have been used for the past few years. The input systems maintain a fairly constant impedance for the various channels and provide a balanced input or a 75-ohm input for coaxial cable use.

The cascode circuit is self-compensating with respect to a.g.c. in the second-triode section. A bias increase on the first tube for a stronger signal results in less current flow and an increase in plus voltage at the cathode of the second tube. This, in effect, increases bias on the second tube and prevents overload on strong stations. For fringe-area reception the opposite occurs and the over-all gain is high. The d.c. potential on the grid of the second tube is kept constant by the bleeder network from the plus-B tap to ground.

The triode-section input is a low impedance while the output-circuit impedance is relatively high. Thus, gain advantages comparable to those of pentode amplifiers are realized. As fewer grid wires are involved, thermagitation effects are reduced. This minimizes snow effect and gives a cleaner picture. The several advantages of this circuit combine to make an excellent r.f. stage for fringe areas.

## Servicing factors

Several factors must be observed when servicing the cascode circuit. One of the most important is the maintenance of proper voltage relationships between the two triode sections. As can be seen from Fig. 1, the plus-B voltage is applied across both tubes in series. The total plate voltage is the sum of the voltages across the cathode and plate of the first tube plus the cathode and plate of the second tube. A voltage reading from the second

tube's plate to ground would not be a true indication of the second-triode potential, as it would represent the voltage drop across *both* tubes. In testing, relative plate voltages must be measured from each tube's plate to its cathode.

Lead dress and mechanical placement of parts are highly critical in such tuners. When these front ends are serviced for any reason, extreme care not to disturb either the lead dress or the physical arrangement of parts. Actually, in the RCA receivers (17T153) undesired resonant effects are kept above channel 13 by using insulating washers of proper thickness in the front-plate-to-tuner-chassis mounting. Tuner performance will be materially decreased if the proper washers are not replaced when tuner removal is necessary during servicing.

## I.f. sections

Besides improved tuners, many receivers have increased intermediate-frequency gain. A number of the newer receivers use four stages in the picture i.f. section for good gain and a 4-mega-cycle bandpass. If three stages of picture i.f. are employed, the bandpass is reduced to maintain high gain.

Many of the late models also use improved sound-i.f. sections. In intercarrier receivers, for instance, older receivers used only one sound-i.f. stage. Sufficient gain was obtained for the sound portion by common amplification in the preliminary i.f. stages. The modern trend, however, is to use two sound-i.f. stages following the sound pick-off point. This allows sound to be taken off before the contrast control circuit to minimize intercarrier buzz; and assures sufficient gain in fringe areas to minimize noise effects which

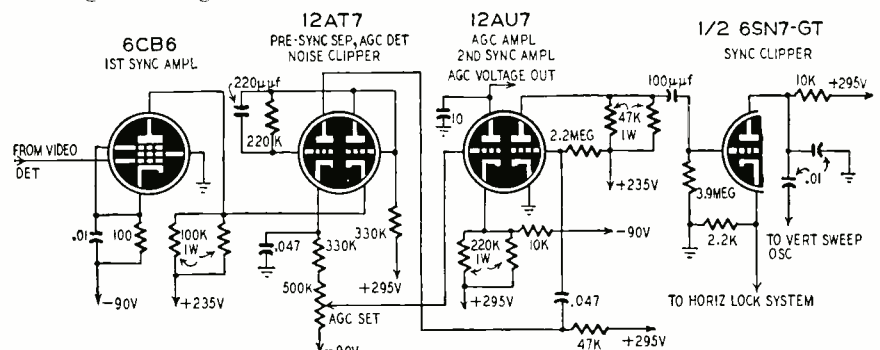

Fig. 2—High gain sync-a.g.c. circuit used in Capehart model CX-33DX chassis.



can arise in FM reception if the signal-to-noise ratio is substantially less than two to one.

**Sweep stability**

With the various lock systems heretofore used, fairly good stability has always been obtainable with the horizontal sweep system. In general, little had been done with the vertical sweep systems. The low field rate (60 pulses per second) and the low-pass filter network preceding the vertical oscillator assured reasonable stability. Short duration pulses had little effect unless they were of high amplitude and then only caused momentary sync loss. In good signal areas this meant that only on occasion would the picture roll, and in most instances it would roll vertically once and then lock in.

For fringe areas, however, additional stability would be desirable both in the horizontal and vertical system. For this reason modern receivers have more elaborate sync separator-amplifier systems preceding the vertical and horizontal sweep stages. By thus increasing sync pulse amplitude and clipping noise peaks, greater stability is secured in fringe areas where the signal-to-noise ratio is low.

A typical system of this type is shown in Fig. 2 which represents that used in the Capehart CX-33DX chassis receivers. Here, the combined a.g.c. and sync separator system actually represents six tubes, inasmuch as several dual-triodes are employed. A high-transconductance 6CB6 tube, the initial sync amplifier, receives the composite video signal from the detector stage. The output from this stage is coupled to the next circuit in a cathode-follower arrangement. The 12AT7 is a combined pre-sync separator, a.g.c. detector, and noise clipper. Noise pulses greater in amplitude than the average sync levels are removed, as well as the video signal information. The a.g.c. bias potential is also developed in this stage, and its output fed to one section of the 12AU7 a.g.c. amplifier. The amount of a.g.c. is regulated by the 500,000-ohm potentiometer in the cathode-to-grid sections of these stages. This permits adjustment for higher gain in fringe areas, while in metropolitan areas the a.g.c. can be set below the point where strong signals would begin to bend the picture or cause phase reversal.

The second section of the 12AU7

gives additional amplification to the sync, which is then fed to one triode section of a 6SN7-GT sync clipper. This stage assures constant sync level so important for good stability and provides a sync pulse of the proper polarity to the vertical sweep oscillator.

with the integrator circuit for suppression of 15,750 horizontal pulse interference.

Cascade coupling makes the grid voltage curve of V11-b cross the cutoff voltage line at a much steeper angle than it would with a single coupling

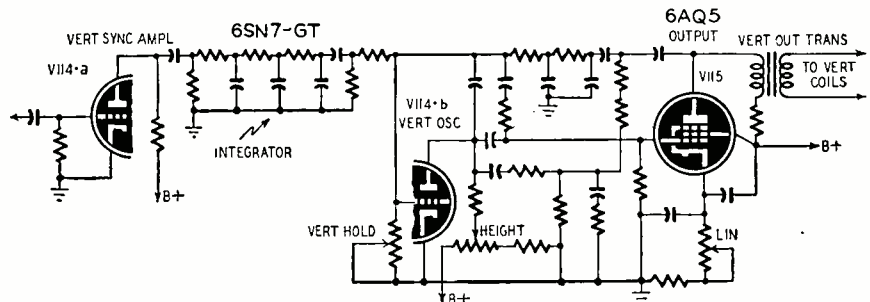

Fig. 4—Another version of the combination vertical oscillator-output amplifier. This circuit is found in RCA's 17T153 series, using the KCS66 chassis.

New circuit designs are also found in the vertical sweep systems. Heretofore, many vertical stages have consisted of the conventional blocking oscillator followed by the vertical output amplifier. A low-pass filter, consisting of a network of resistors and shunting capacitor, called an "integrator," filtered out the 15,750-cycle horizontal sweep from the vertical system as well as noise pulses above the 60-cycle vertical repetition rate.

One of the new vertical systems is shown in Fig. 3. This is the circuit used in the Bendix C172 series of receivers. A conventional sync clipper feeds the vertical sweep oscillator. The sync clipper utilizes one-half of a 6SN7-GT tube. The other half of this tube is V11-b of Fig. 3. Both V11-b and V12 form a multivibrator type of oscillator. You will note that the plate of V11-b is coupled to the grid of V12 by conventional capacitance coupling. The plate of V12, however, is coupled back to the grid of V11-b via an R-C network consisting of C29, C31, C63, C30, R96, R46, and R47. The V12 tube, besides acting as part of the multivibrator, is also the output amplifier feeding the vertical output transformer.

The R-C coupling network is a cascade affair instead of the usual single one. This enables the vertical sweep circuit to be much less susceptible to noise pulse interference and to be able to lock in more smoothly with the vertical sync pulses. It also establishes an excellent filter network in conjunction

circuit. This gives better noise immunity and also assures better maintenance of interlace. Bendix refers to this circuit as "Magic Interlace."

You will note that the circuit of Fig. 3 also uses a retrace eliminator. The vertical pulses are coupled to the grid of the picture tube in a negative-going polarity and thus assure complete blanking of the picture-tube beam during retrace. This is particularly useful in fringe areas where the weaker signal level may cause the retrace lines to be visible on the screen. Many other manufacturers now utilize a similar retrace eliminator operating from the vertical sweep circuit.

A similar cascade-coupled multivibrator circuit is used by RCA for their vertical system. Fig. 4 shows the system used in model 17T153 series receivers. Note the elaborate integrator network (low-pass filter). This gives a much sharper attenuation of frequencies above the 60-pulse-per-second vertical field rate and thus gives improved noise immunity. Cascade coupling is used between the oscillator tubes, as in the Bendix circuit previously described. Slight differences are to be noted, such as the use of a 6AQ5 tube instead of the 6W6 employed by Bendix. This receiver also uses the retrace eliminator feature previously described.

Other circuits designed for improved fringe area reception undoubtedly will be forthcoming in future receivers. These and the ones previously described not only aid in fringe-area reception but also give improved performance in the metropolitan areas. This is particularly true where ignition interference is a problem. The high gain of such receivers improves signal-to-noise ratios and gives a cleaner picture as well as a more stable one.

When used in fringe areas, particularly with high-gain Yagi antennas and good boosters, reception from stations many miles distant is possible. Thus many ultra-fringe area locations which had been unable to receive a remote station because of receiver limitations have been opened to television reception

—end—

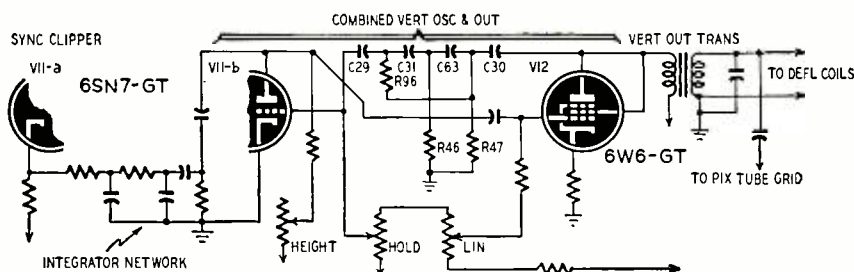

Fig. 3—Combined vertical sweep oscillator and output amplifier used in Bendix C172 series TV receivers. V11-b and V12 form a multivibrator circuit, with sufficient output to sweep the picture tube without additional amplification.

Loss of brightness control is a common fault in TV receivers of all types. Some causes and remedies are given in detail.

# Loss of Control over

By CYRUS GLICKSTEIN\*

**L**OSS of control over brightness means simply that it is impossible to dim out the screen at any position of the brightness control. A review of the function and operation of the brightness circuit will be helpful in trouble-shooting this section of the receiver.

Brightness of the raster or picture depends on the speed of the electrons in the beam striking the screen of the picture tube, and the number of electrons in that beam. The speed of the electrons is determined by the amount of high voltage. The number of electrons depends on the grid bias level and the voltage fluctuations on the C-R tube grid due to the video signals.

Loss of control over brightness is not caused by trouble in the high voltage section, or signal circuits. It stems entirely from faulty operation of the tube bias circuit. The bias (negative grid with respect to cathode) can be varied by a control usually labelled BRIGHTNESS, BRILLIANCE, INTENSITY, or BACKGROUND. This control is used to set the over-all level of brightness in the picture. For most types of C-R tubes, a bias of approximately -50 volts cuts off electron flow, extinguishing the raster. In most receivers the normal range of the brightness control is from zero volts, or a few volts negative, to more than -50 volts.

common defects which can affect the bias of the C-R tube.

1. Defective tube;
2. Defect in the immediate bias circuit of the tube;
3. Defect in some other circuit.

A defective C-R tube can cause loss of control if either of two conditions is present: a short or partial short from cathode to grid or heater; or a gassy C-R tube. When the cathode is shorted to the grid, possibly by a piece of cathode material lodged between the cathode and grid, bias no longer is present. The brilliance control has no effect in cutting down the brightness. Even under such conditions there may be a picture on the screen. The picture quality may even appear normal. Of course, the brightness level of the picture will usually be too high. Loss of sync, especially horizontal, may also occur. A short from cathode to a grounded heater has the same effect.

A gassy picture tube may cause loss of control over brightness because ionization takes place inside the tube. This causes the grid to become more positive than normal. When a picture tube is gassy, a picture may still be visible on the screen. The picture usually turns negative (white areas black and black areas white) at high levels of contrast and brilliance.

Defects in the bias circuit of the C-R tube may include:

A shorted bypass capacitor, C1, at the brilliance control. (Fig. 1-a). With a shorted capacitor the cathode potential is the same as that of the control grid. With no bias, brilliance is maximum and the brightness control has no effect.

An open 220,000-ohm resistor in the brilliance-control voltage divider network, (Fig. 1-a); a large increase in the value of this resistor; or an open circuit at the top lug of the brilliance-control potentiometer. Under these conditions, the cathode cannot be made positive enough to cut off current flow in the tube. In circuits where the control-grid voltage is varied, similar troubles will remove the bias.

Leaky coupling capacitors at the grid of the picture tube: Both C1 and C2 (Fig. 2) can become leaky enough to place a positive voltage on the picture-tube control grid. This positive voltage may be equal to or greater than the most positive voltage placed on the cathode by the brightness control. It

then becomes impossible to extinguish the picture. The picture detail may be almost normal. Depending on the amount of leakage, the control may either be unable to reduce brilliance at all or just cut down brightness a little.

Defective video output tube: In a number of models, the plate of the last video-amplifier tube is direct-coupled to the control grid of the C-R tube (Fig. 3). Normally the plate of the video amplifier and the grid of the C-R tube are approximately +150 v. With the control potentiometer the cathode of the C-R tube can be varied from about +150 volts to +250 volts. However, if the filament of the video-amplifier tube opens, with no current through this tube the plate voltage, and the voltage on the C-R tube grid increases to the full +250 volts. With this increased voltage on the control grid of the C-R tube, it becomes impossible to cut off electron flow in the tube by means of the brightness control. This trouble can be considered a bias-circuit fault, since it upsets the bias relationship. Of course, with the video-amplifier stage defective, there is no picture on the screen, just a raster. An open peaking coil, L1, may produce the same effect, even with a damping resistor across the coil.

The third and fourth class of troubles originate in circuits external to the C-R tube or the bias circuit. An excellent example of this occurred recently in an RCA model 6T74. There was no control over brightness; the picture was fair, but sync was very poor. Sound was very low and distorted. The cause was found to be a bad 6K6 audio-output tube. The cathode was shorted to the filament. In this model, part of whose circuit is shown in Fig. 4, the cathode of the audio-output stage goes to the +120-volt bus of the low-voltage supply (Fig. 4-a). The plate goes to the +375-volt bus from the B-supply

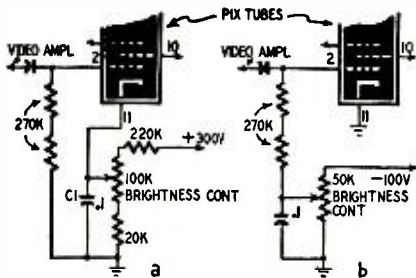

Fig. 1—How a C-R tube may be biased.

Simplified biasing circuits are shown in Fig. 1. The bias control may be in the cathode circuit of the tube, Fig. 1-a, or in the grid circuit, Fig. 1-b. In some receivers, the video signal is fed to the cathode. These models usually use a grid-circuit brightness control.

### Causes of Trouble

Loss of bias control will result in loss of brightness control. There are three

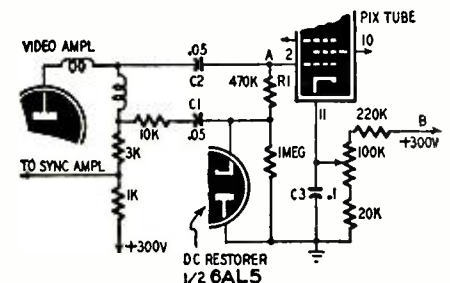

Fig. 2—Leakage causes control loss.

\* American Radio Institute



# BRIGHTNESS

through the output transformer primary. When the cathode shorted to the filament, the cathode was grounded, bringing the +120-volt point to about ground potential. This caused a redistribution of voltage across the low-voltage supply. The point which was +120 volts became just slightly positive. As a result, the operation of the C-R tube bias circuit whose cathode worked off the +120-volt point (Fig. 4b), was drastically affected. This trouble also affected the operation of the sound i.f. stages and the sync amplifier (also connected to the +120-volt point).

With this background on likely sources of brightness trouble, localization of the defect is materially simplified. Check the picture and sound to see if there are any other apparent defects besides loss of control over brilliance. The action of the other controls should also be checked. There is no point in removing a chassis from the cabinet if the trouble is only a bad tube.

If there is a complete loss of pix, with raster and sound O.K., the fault could be an open filament in a video-amplifier stage, in models using a circuit similar to Fig. 3. On the other hand, if there are two or more defects, such as loss of sound, etc., as well as no control over brilliance, then it is advisable to substitute tubes in the other affected stages before proceeding further. If tube substitutions do not clear up the trouble, then make stage-by-stage voltage and resistance checks.

Assuming the indications are loss of control over brightness, and possibly some impairment of picture quality (with or without loss of sync), the trouble can then be assumed to be either in the C-R tube or the tube bias circuit. Once the chassis is out of the cabinet, the following procedures will help to localize the trouble:

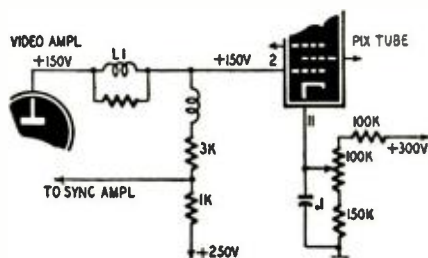

Fig. 3—Effects of video tube burnout.  
APRIL, 1952

Measure the voltage from the variable arm of the brightness control to ground. Rotate the control and note the minimum and maximum readings.

Measure the control grid voltage of the C-R tube, with the meter probe at the junction of C2 and R1 (point A, Fig. 2). With the meter still connected, vary the brilliance control, *even though the control is in the cathode circuit*. If the voltage reading varies as the control is rotated, a cathode-to-grid short in the C-R tube is indicated in models using the circuit of Fig. 2.

Repeat these measurements with the tube base socket of the C-R tube removed. (This removes the tube from the circuit.) Any abnormal readings observed now will indicate that the fault is not in the C-R tube but in the bias circuit. If the readings are normal, the fault must be in the tube.

In some receivers the filaments are in series-parallel, and removing the tube socket opens the entire filament circuit of the receiver. A jumper—a piece of solder will do—inserted in the filament pins of the tube socket will restore filament continuity and permit the checks outlined.

If the reading at the control-grid lug is more positive than normal with the C-R tube disconnected, the trouble probably is a leaky coupling condenser, C1 or C2 (Fig. 2). The defect can be pinned down by unsoldering one end of each capacitor in turn and measuring the grid voltage.

If the intensity control does not vary through a proper voltage range with the C-R tube socket off, trouble in the brightness voltage divider circuit can be suspected. Possible troubles are: a shorted capacitor, C3, an open 220,000-ohm resistor or a large increase in its value, an open 100,000-ohm pot, or wrong voltage at point B (Fig. 2).

It is worth noting that there may be an abnormally high positive voltage on the control grid, causing a large grid-current flow in the C-R tube with the socket on. Varying the brightness control may not have much effect in varying the cathode voltage, Fig. 2, due to the grid current flow. The fault, however, is in the grid circuit, not the cathode circuit. This becomes apparent when the readings are repeated with the socket off the C-R tube. Cathode voltage will vary normally while the control grid reading remains abnormally high.

A partial short between the cathode and grid of the C-R tube can be verified by an ohmmeter reading between pins 2 and 11 at the tube base. The short may be from less than one hundred ohms to over a megohm. It may be possible to clear up such a partial short by flashing the *cold* tube. Leads are connected to the plates of the low-voltage rectifier tube, where 700 volts a.c. is available. One lead is connected to the cathode pin. The second lead is tapped *quickly* several times to the control grid pin.

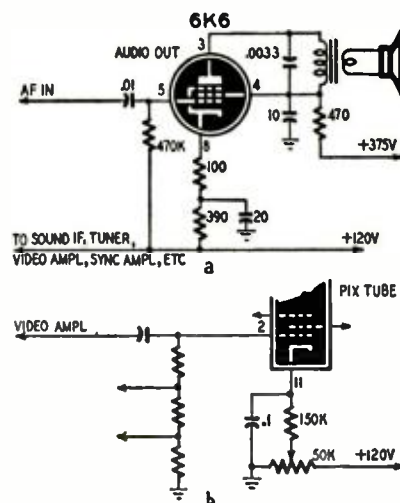

Fig. 4—A cathode short in the audio stage grounds the C-R tube cathode.

Summing up, loss of control over brightness is caused by bias trouble. This can be caused by troubles in (a) the C-R tube, (b) the C-R tube bias circuit, and (c) other circuits. Sound and picture quality may furnish clues to the trouble spot in the receiver. If the C-R tube or its bias circuit is indicated as the source of trouble, and a bad video-amplifier tube is not responsible, then voltage checks are made. Voltage readings are taken at the picture tube grid and cathode socket lugs while the brightness control is rotated. These checks are repeated with the tube socket off. This makes it possible to eliminate either the tube or its bias circuit as the source of trouble. Further voltage and resistance checks will reveal the actual defective component.

—end—

# TV SERVICE CLINIC



Conducted By **MATTHEW MANDL**

**A** NUMBER of queries received by the Service Clinic still relate to converting small screen receivers to large tube types. Most of these involve changes in flyback type horizontal sweep and high-voltage circuits. There are occasions, however, when the r.f. type of high-voltage supply is encountered and some of our readers have made inquiries regarding conversion procedures for these.

Such receivers can be converted to large-screen types by several methods. If the change is from a 10-inch tube to a 12-inch tube, direct substitution can usually be made without any electrical modifications. Most of the 10- and 12-inch tubes have deflection angles between 50 and 56 degrees and can be interchanged. Sometimes the round-type 16-inch tubes can be utilized if they do not have deflection angles in excess of 65 degrees. With round types having an angle in excess of 65 degrees, and with all rectangular tubes, major changes are required which involve a new yoke, a matching transformer, and higher second-anode voltages.

Quite often a comparison of manufacturers' schematics for several successive models will give clues to certain possible circuit modifications necessary for using larger tubes. As an illustration, a reader inquired about the changes necessary to a Westinghouse model H-223 which used a 10BP4 picture tube. This receiver, like many Westinghouse models, uses an r.f. power supply as shown in Fig. 1. Here the high voltage can be increased slightly by replacing the oscillator coil section with one which gives increased r.f. output. Thus, the circuit shown in Fig. 2 can be used which is that employed in the Westinghouse H-603C12 receiver. You will note that this is similar to the H-223 circuit except that the oscillator coil produces 10,500 volts instead of 8,500. A 6Y6 tube also replaces the 6V6 in Fig. 1. The modified circuit permits using a 12KP4 picture tube or equivalent. The higher-voltage oscillator coil assembly is part No. V-92803. This is

a replacement part available at local distributors.

A 16JP4 can also be used with some slight modifications. The circuit is identical to the one shown in Fig. 2 except that high-voltage assembly part No. V-92802 should be used to give about 11,000 volts. This conforms to the Westinghouse H-600T16 using the 16JP4 tube. The 10-inch receiver uses two 7A5 tubes in parallel for the horizontal output. An additional 7A5 tube can be added in parallel for increased drive if necessary. This addition will require changing the screen-dropping resistor from 7,500 ohms to 5,800 ohms, and the cathode resistor from 50 ohms to 39 ohms.

Receivers of other manufacture can be modified in similar fashion. However, if a rectangular tube or other 70-degree deflection tube is desired it would be preferable to eliminate the r.f. high-voltage system and install a flyback type of horizontal output and high voltage system. Many of the several conversion kits on the market can be used. Inasmuch as conversion to large-screen tubes with deflection angles above 65 degrees means a new horizontal output transformer, matching deflection yoke, focus coil, and width coil, all the components involved would require complete rewiring of the older system in either case. The kits may also be less expensive than the r.f. replacement part assemblies, depending on requirements.

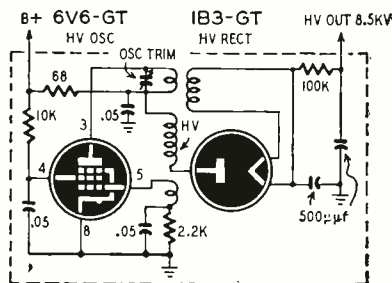

Fig. 1—R.f. type high voltage power supply from Westinghouse model H-223.

## Repeated 6BG6-G failure

*In a Montgomery Ward Airline 16-inch receiver I am encountering repeated 6BG6-G failure. This receiver has had six such tubes replaced within eight months. They do not burn out, but the emission decreases considerably, which results in complete loss of high voltage. What could cause this trouble? V. B. D., Ann Arbor, Mich.*

Constant failure of the horizontal output tube is caused by an excessive amount of current flow. You should check for proper screen voltage as well as correct bias between the cathode and grid of the output tube. Do not, however, attempt to measure the B-voltage at the 6BG6-G plate cap because high pulse potentials are present here. Incorrect bias can be caused by improper or defective components in the cathode circuit or improper B-potentials.

If the 6BG6-G has insufficient (or occasionally, excessive) grid drive it would also cause abnormal currents to flow which would result in repeated tube failure. Check the peak-to-peak voltages of the grid signal with a calibrated oscilloscope or peak-to-peak voltmeter to ascertain that they conform to those given in the service notes for this receiver. Excessive drive will, of course, manifest itself by the presence of "overdrive lines" on the screen.

## Double image

*I have converted a Tech-Master kit to a 16KP4 tube. I have used the Merit*

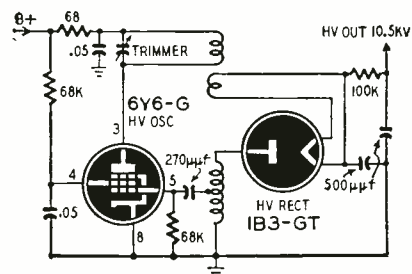

Fig. 2—High voltage supply in Westinghouse model H-603C12 gives 10,500 volts.



*MDF-70 cosine yoke, the MWC-1 width coil with a.g.c. winding, and the HVO-7 output transformer. I now receive a double image for all stations (see photo). What could cause this trouble? Could I also use a larger picture tube with these components? P.M., Orrick, Mo.*

It is possible that you have upset the voltage boost potentials during conversion and you should refer to the Clinic, page 44, in December, 1951, RADIO-ELECTRONICS, for a more complete discussion of the effects this will have on the picture as well as suggested remedies.

Check the high voltage with a v.t.v.m., using a special probe in order to ascertain whether the potential is that required. Also make sure that all the tubes in the sweep circuits are giving full emission. After tubes have been in use for several years their emission drops, and decreased sweep amplitude as well as nonlinearity often results. Also check for improper drive as well as incorrect components in the horizontal output system. An incorrectly set drive control or a wrong-value grid leak sometimes give the double image picture which you mention.

You could utilize a 20-inch tube instead of a 16KP4 because the yoke and horizontal output transformer you mentioned will handle tubes up to this size.

### Space loops

*I have a problem on an installation using two five-element Yagi antennas located approximately 93 air miles from channel 4 in Boston. We had been getting fair-to-good reception until this station increased its tower height about 300 feet and added three bays, making it a six-bay transmitting antenna. Since then we barely get an outline of a picture. Shouldn't the increase in transmitting antenna height have bettered our reception? J. H. S., White River Junction, Vt.*

The decrease in reception which you have experienced since WBZ has increased its tower height may be caused by a repositioning of the space loops in the immediate vicinity of your antenna. Usually space loops are fixed areas of higher-than-normal signal strength located a wavelength apart in both the vertical and horizontal planes. They are caused by the addition of direct waves and reflected-angle ground waves. (See page 54, March, 1949, issue of RADIO-ELECTRONICS.) You can regain signal strength by either raising the receiving antenna approximately one-half wavelength or by shifting it horizontally by the same amount. Also try reorientation, for increased height has been known to affect Yagi antenna orientation slightly because of terrain effects.

### Conversion components

*Could I use a 211T5 horizontal output transformer with a 16GP4 tube and a 70-degree deflection yoke? I would like to convert a 12-inch Transvision to the 16-inch tube. Also, can I have the picture tube about 15 feet from the re-*

*ceiver? S. A., Warren Point, N. J.*

The 211T5 horizontal output transformer may not be suitable for the tube and yoke which you now have. You should get a transformer which matches the inductance of the 70-degree deflection yoke you now possess.

A 15-foot run is rather long for the picture tube. For any lengthy separation of the picture tube from the chassis, a separate slave unit is recommended. These have been described in previous issues of RADIO-ELECTRONICS.

In particular, the high-frequency components of the video signal suffer severe attenuation because of capacitance effects when the signal carrier wires are extended for more than a few feet.

### Contrast delay

*In an Air King television receiver the picture tube is very slow in developing sufficient contrast. It requires about three to five minutes to get a good picture. The vertical lines are tilted for part of the picture and the horizontal lines are also bent in the upper half of the test pattern. What could cause these troubles? T. J. R., Seattle, Wash.*

When there is a delay of three to five minutes before securing proper contrast, it would indicate a slow-heating tube in the picture amplifier system. This could include the tuner, the picture i.f. stages, the detector, and the video amplifiers or the picture tube. One or more tubes may be causing this trouble and they should all be checked to ascertain which are abnormally slow in coming to proper temperature.

The tilt of the vertical lines as well as the elongated center circle of the pattern indicate poor vertical as well as horizontal linearity. Proper linearity adjustment when both vertical and horizontal systems are deficient requires painstaking procedures while a test pattern is on the air. This means that the vertical and horizontal linearity controls as well as the height and width controls must be adjusted sequentially with readjustments. These are complementary and one influences the other.

### Tuner troubles

*In a G-E television receiver, model 811, the tuner contacts went bad and I installed a Standard Coil tuner. Eventually a trouble developed which caused both the picture and the sound to be intermittent. When the tuner shaft was moved up and down, however, it restored picture and sound. I changed the 6J6 which seemed to help for a while but now the trouble has developed again. The voltage on the first 6J6 was 210, but when I replaced it the potential dropped to 150 with a decrease in contrast. What could cause this? R. T. H., Pleasant Gap, Pa.*

The fact that pressure on the tuning shaft restored normal operation would seem to indicate that you have a bad socket or that there is some other mechanical trouble in the tuner itself. Socket trouble seems to be indicated, inasmuch as this condition was tem-

porarily corrected with the insertion of a new tube. Probably the pins of the new tube made better contact when first installed.

Another probable cause would be that the Standard Coil tuner contact springs are not making good connection. The entire drum section of the tuner can be removed by disconnecting the wire springs at each end. Upon doing this you can inspect the contact points as well as the undersides of the tube sockets.

If the second 6J6 tube dropped the voltage at the plate and also decreased contrast it would indicate that this tube is defective and causing a partial short. Try another tube and if this works the same way it would indicate that the fault lies in the tube socket.

### Failure of 6AQ5

*In a Muntz model 17A3A receiver, the 6AQ5 sound-output tube does not last more than two or three days. This tube also affects the picture with a loss of contrast. The audio gets distorted and the volume level drops considerably. The picture also has been pulling at the top. What could cause these troubles? H. F. B., Fredericksburg, Va.*

The fact that your 6AQ5 sound-output tube lasts only two or three days would indicate that an excessive amount of current is flowing through it. Besides acting as an audio amplifier this tube also serves as a dropping resistor to supply reduced B-plus voltage to the tuner, i.f. amplifier, sound, and sync circuits. A defective tube, or a shorted or leaky bypass capacitor in any of these circuits might cause excessive current through the 6AQ5.

The same trouble could be caused by a leaky coupling capacitor which is reducing grid bias or by improper cathode voltage. Check the .01- $\mu$ f grid coupling capacitor of the 6AQ5 with the R x 1 MEG scale of a v.t.v.m. If less than 500 megohms, replace with a new one. (A leakage resistance check should be made with the capacitor disconnected.) Also check the voltage between grid and cathode to make sure the grid potential is minus with respect to cathode. A positive or zero potential at the grid would indicate improper bias or a leaky coupling capacitor. Finally, check all resistors and capacitors associated with the input circuit, including the 100- $\mu$ f, 200-volt cathode bypass capacitor.

Inasmuch as this circuit is obviously overloading the power supply, it may be contributing to sync instability and causing the pull at the top of the screen. In this respect also check the 6AU6 video amplifier, for this precedes sync take-off. Also check the 12AT7 sync separator and associated parts. If these steps do not solve the problem, the trouble may lie in the horizontal sweep circuit. The Synchroguide a.f.c. system may require complete readjustment, or there may be defective components in the oscillator circuit itself.

—end—

Sound can now be neutralized by dead-beat heterodyne

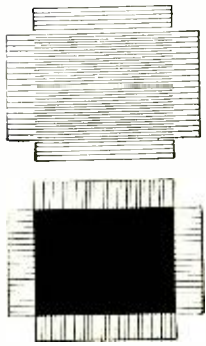

How waves of light can be neutralized.

# NOISE NEUTRALIZER

By MOHAMMED ULYSSES FIPS, I.R.E.\*

THE editor was more grumpy than usual that morning when he called me into his sanctum.

"Fips, my boy," he began expansively, puffing on a huge cigar, "the noise around here is beginning to drive me crazy. I simply cannot do my work; soon I'll have to write my editorials in a padded cell. Now, I know you are pretty good in physics and general science. What I want is a *noise killer* that works, a gadget that silences *all* the infernal noise in a busy office. If you want to keep your job, you are to produce a machine to kill every type of sound and noise within two months, or out you go."

He puffed a huge cloud of smoke towards the ceiling, glared malevolently at me and returned to his work.

The order did not surprise me, because the big boss had come up with such notions before. I tackled the job immediately, as is my custom, confident that my mental resources would come through with flying colors.

We all know that noise is a special kind of sound. Sound is a wave-form set up in the air or other mediums such as gases, solids, or liquids. Visible light is also a wave-form. Now, physics teaches us that light can be entirely eliminated or neutralized by various means. Thus when the crest of one light wave corresponds to the depression of another, *there is no light*. This is called *interference*.

If we use two tourmaline crystal plates (see figure) and place them so that the axes of the crystals are parallel, light passes through both plates. But if placed at right angles, *no light passes*. I reasoned that it should be possible to apply these physical principles to sound, and this is the way I figured the problem could be solved:

We already have today excellent oscillators such as are used in laboratories to create sounds of all frequencies from 8 vibrations per second (below the lowest audible sound) to the inaudible ones, 24,000 cycles or more.

We can now build a special electronic oscillator that will produce automati-

\*International Research Electronicker

cally all sounds in the entire audible spectrum, SIMULTANEOUSLY, at any intensity desired.

Then we place a number of special microphones about the room or office where noise is to be eliminated. These special microphones receive *all* the mixed noises in the room at *all* frequencies. These sounds are relayed electrically to our electronic noise eliminator and are amplified by means of special electronic circuits. Then they are fed into a special *differential oscillator*. The machine now emits the identical sounds or noises it hears, at the exact frequencies and intensities. The result is a *dead-beat heterodyne*. This causes total sound interference. The result is *absence of all sound*—a dead quiet.

The idea of neutralization is old, simple, and universally understood. The problems of applying it to the annihilation of sound are tremendously complex, and taxed even my inventive brain. The first step was to pick up the sound with a rotating microphone, and to try to amplify it and swing the output 180 degrees out of phase with the input. But as anyone who has studied amplifier theory knows, different frequencies undergo different phase changes while going through an amplifier. Thus negative feedback gradually rotates as the frequency rises until at some point it may become *positive* feedback and cause an amplifier to oscillate. It was found that the simple approach would not work, and a more refined solution was in order.

### How it was done

This was achieved with a filter system, in which the incoming components of the noise signal were resolved into different bands. By means of a sort of reversed a.g.c. system the bands controlled the volume of a number of multivibrators, which thereby produced more or less signal according to the fluctuations of the signal in the input. Further difficulty was experienced, however. Multivibrators produce a broad signal and can be triggered and synchronized by a rather wide band of

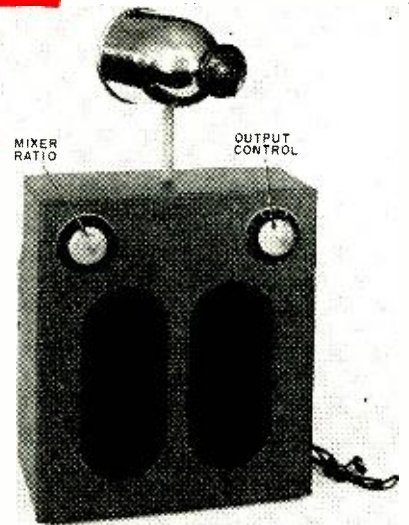

A front view of the sound annihilator.

frequencies. But a multivibrator can be swung into action much more easily by a signal on its free running frequency than by one nearly half way to the frequency of the next unit. A weak signal near its natural frequency would produce as much output as a strong signal further away. This caused frequency-controlled non-linearity between input and output, as well as a peculiar condition which appeared when a threshold signal existed midway frequencywise between two multivibrators. Both would then be triggered, resulting in *too much* neutralizing sound.

The solution was to have a group of *differential resonance tubes*, each with its own microphone. Each tube controls one unit of the *differential oscillator*. To smooth out the hollows between the spectra of the differential oscillator units and reinforce the neutralizing signal on sharply directional noises, the rotating microphone—with a sharply restricted frequency range—feeds its 180-degree-phase-reversed signal into a mixer which also receives the output of the differential oscillator. A control varies the proportional input from the oscillator and rotating microphone, and is adjusted for best results. Another control sets the volume of signal fed to the amplifier. The output volume control is first adjusted for minimum noise and the mixer control then varied till the sound is completely silenced.

In practice, the system is much more regular and continuous than might be expected. Noise is seldom spread evenly over the entire audio spectrum—it tends to occur in discrete bands, often with harmonics. The electronic multi-



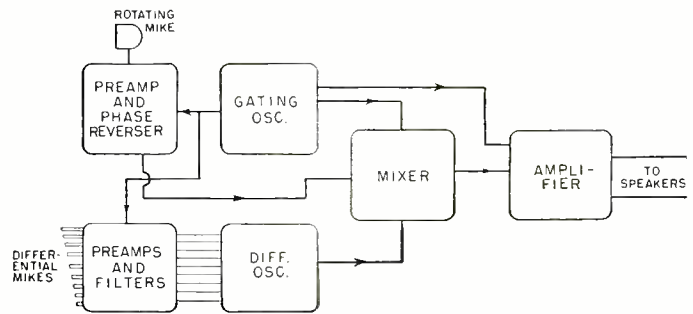
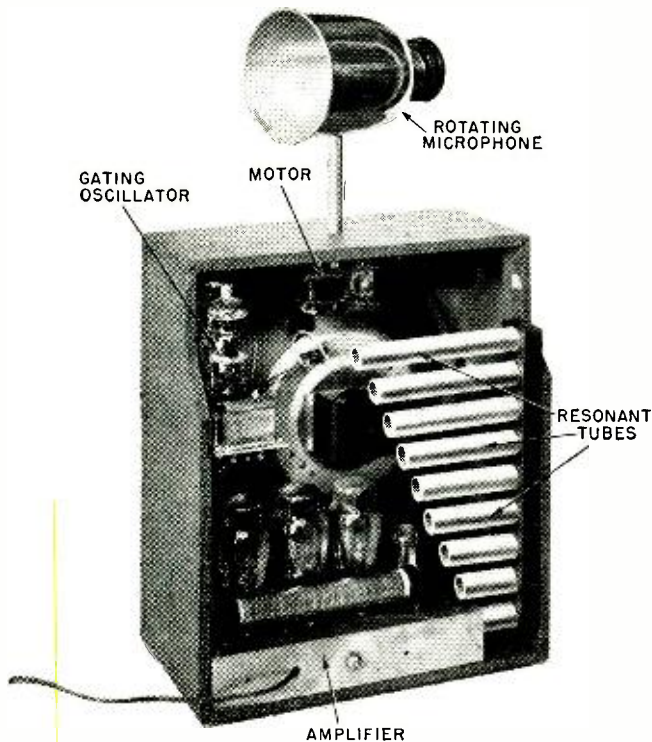

Above is a block diagram of the noise neutralizing device described in these pages. Note especially the progressive gating system which was the secret of success of the device. At left is a rear view photo, showing the resonant tubes.

vibrator is a broadband oscillator, rich in harmonics, and the multivibrator units in the differential oscillator are controlled both as to frequency and amplitude by the incoming signal.

But, you may ask: "Why don't the microphones pick up the transmitter sound, resulting in feedback and consequent 130-db bedlam?" The answer is that the microphones are *gated*, so that they are turned on only a few microseconds at a time, several times a second. During these periods, the output of the amplifier is suppressed. The gating circuit presented the toughest problem in the whole job, since time constants had to be such that the signal from the microphones would not disappear before the amplifier was activated, and that hangover would not cause feedback during the first part of the period the microphones were "on."

A *progressive gating* system solved the problem. Its details are impossible to describe within the limits of this article, but full information on this and all other features of the system will not be forwarded free of charge to all registered professional electronic engineers who request them.

### Operational details

In practice the sound annihilator works excellently in a closed room. As with air conditioning it is essential that the doors be closed, otherwise the device does not work as well, because the heterodyning effect would have to go beyond the room and therefore take too much power. Normally, when the machine works and you enter the room, you are aware of an uncanny, com-

pletely-dead silence. It is as if you stepped into an anechoic chamber, where all noises of all types are completely absorbed.

The machine is constructed in such a way that it can cope with noises up to 50 decibels in a fairly large room. This is more than sufficient to neutralize the sound of even a typewriter going at full blast in the same room.

I see a great future for the noise annihilator, and there is no reason why it cannot be commercially introduced not only in all noisy offices, but even industrially in boiler factories, machine shops, and other plants where noise has become a large factor in impairing the health of the workers.

\* \* \*

The great day finally arrived, and with my model in good working condition I installed it in the big boss' office before he came in. I set the dials for full operation, closed the door softly, and went to my office. I was so proud of my work that I had no compunctions about swiping one of his best Havana cigars. I was puffing away contentedly when I was suddenly and rudely awakened by a terrific noise—*not annihilated*—as if an angry bull was trying to burst into my office. It was none other than the big boss, who had ripped my noise annihilator from his office wall and was now heaving it at me—fortunately not too accurately. It smashed to pieces on the floor, and it was some time before I recovered my composure and listened to the angry tirade from the chief.

"You infernal idiot! What was the idea of putting that silly contraption in

my office? My first early appointment was with Mr. Duffus, of the Hectic Electronics Corporation, who called to discuss a \$15,000 advertising contract for our magazine. He came in my office and sat down, then started to talk to me. I talked back to him, *but no sound was audible*. For a while we gesticulated, to no purpose; then we started to make grimaces at each other; and in desperation we had to use paper and pencil to make ourselves understood. Finally, Duffus pulled me from my seat and out into the hall where he could be heard. He told me that if this was one of my jokes, it was an exceedingly bad one; that he had had enough of my silly tricks, and that he was canceling all of his advertising.

### Some unexpected results

"Only a goofy moron like you would dream up a gadget that would kill ALL noise. How in blazes does one conduct a conversation, or answer the phone, or dictate a letter?"

With that he stomped out, and slammed the door, but not before he had thrown over his shoulder—"And as of now, you're fired."

It took me some time to regain my wits. The boss, of course, was wrong. I *had* thought of all the vital points he mentioned. For that purpose I had provided a foot switch under his desk, so that every time he wanted to talk or listen to someone, all he had to do was press a pedal that opened the circuit and stopped all heterodyning. Then he could conduct his conversations.

I ruefully admit that I should have told the chief about that foot switch when he came in, but sometimes I forget little items of this kind. All inventors forget periodically. Just as I forgot to pull down the leaf of my big desk calendar, as I had done that morning. I reached over and automatically tore off the previous day's leaf, and for a while stared stupidly at the date. It read:



# TRANSFORMERS

By T. W. DRESSER\*

**T**HIS article will discuss power transformer design, show the methods by which the design data is arrived at, and illustrate these methods by working out the details of a typical radio power transformer.

Power transformers, generally speaking, are fairly easy to design; essentially they are based upon the fundamental theory of induction which states that the E.M.F. induced in a coil inserted in a changing magnetic field is directly proportional to:

The number of turns in the coil.

The rate of change of flux (frequency).

The maximum number of flux lines.

A numerical constant (to make the figures read in inches, centimeters, or whatever units may be used).

Expressed as a formula, the relationship becomes:

$$E = \frac{4.44 \times T \times F \times B \times A}{10^8}$$

where E = the voltage across the coil

T = the number of turns in the coil

F = the rate of change of flux

B = the maximum number of flux lines per square inch of core area

A = the cross-sectional area of the core in square inches

$\frac{4.44}{10^8}$  = a numerical constant

It will be apparent from the requirements listed that the greater the number of turns on the coil or the faster the flux changes the greater will be the voltage across the coil. Equally, the greater the flux density or lines of force linked by the coil the greater will be the induced voltage.

For our purpose it is more convenient to use the formula in its transposed form:

$$T = \frac{E \times 10^8}{4.44 \times F \times B \times A}$$

in which T is the number of turns required for the transformer primary; E is the line voltage, the factor F is

the line frequency in c.p.s.; and the value of B can be taken as 60,000 for standard silicon steel core material. For standard 117-volt, 60-cycle-line operation the formula becomes:

$$T = \frac{117 \times 10^8}{4.44 \times 60 \times 60,000 \times A} = \frac{732}{A}$$

The value of A depends on the power the transformer must handle, so the next step is to establish the transformer requirements. A typical radio power transformer would have the following characteristics:

Primary: 117 volts 60 cycles.

Secondary No. 1: 700 volts at .05 amp center-tapped. (Note: For full-wave rectification this would represent a d.c. output of 0.1 amp at approximately 350 volts.)

Secondary No. 2: 5.0 volts at 2 amp.

Secondary No. 3: 6.3 volts at 3 amp. The total power required by the secondary windings is found by adding their volt/ampere products:

No. 1—700 v × 0.05 amp = 35.0 v/amp

No. 2—5.0 v × 2 amp = 10.0 v/amp

No. 3—6.3 v × 3 amp = 18.9 v/amp

Total secondary power = 53.9 v/amp

Due to copper and iron losses small transformers of this type require about 10% more input to the primary than is taken from the secondary, so that in this case the primary power would be: 1.1 × 53.9 = 59.3 v/amp.

For conservative design, A should be at least 0.04 square inches per volt/ampere. The cross-sectional area of the core is found to be

$0.04 \times 59.3 = 2.5$  square inches approx. (Note: Britain is said to be a conservative country, and her transformer engineers are held to be conservative by most Britons. This will explain why the core areas given here are much larger than any the average American technician is likely to find on the transformers he tears down as a means of studying transformer design. For practical work, these figures can be cut almost in half, especially for transformers of 100 watts or over.—*Editor*)

It is unlikely the technician will have

Knowing the principles of transformer design, the technician can often modify an existing transformer, or construct his own to meet special voltage or space requirements.

access to any variety of laminations. It is much more likely he will have to make his windings suit a core he already possesses, and he may not know what wattage the core is capable of carrying. The following formula will give him this information.

$$\text{Watts} = \frac{\text{Weight} \times \text{Frequency}}{2.5}$$

where weight is in pounds  
frequency is supply frequency  
2.5 is a constant.

If a core of adequate weight is available, its effective core area can be found by multiplying the width of the center leg by the thickness of the lamination stack. (See Fig. 1).

The number of primary turns is found by substituting the core area in the formula  $T = \frac{732}{A}$

$$T = \frac{732}{2.5} = 293 \text{ turns}$$

The turns-per-volt ratio is then

$$\frac{293}{117} = 2.5 \text{ turns per volt}$$

The number of turns for each secondary winding is found by multiplying the required secondary voltage by the

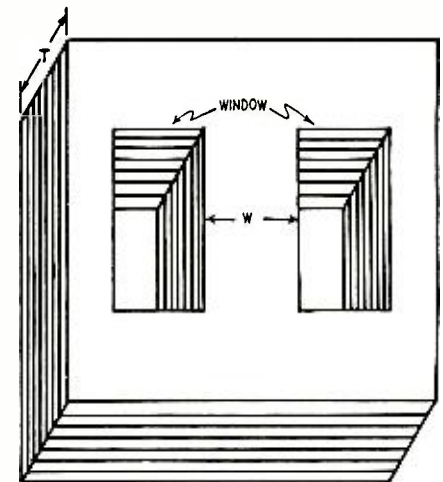

Fig. 1—Basic dimensions of the core.

\*Chief Designer, R.T.S. Transformer Co., Bradford, England



turns-per-volt ratio. In practice, about 5% is added to each secondary winding to compensate for voltage drop in the resistance of the wire. Time and computation may be saved by adding 5% to the turns-per-volt ratio:

$$1.05 \times 2.5 = 2.63$$

Sec. 1:  $700 \times 2.63 = 1841$  turns (This should be wound in two equal sections of 920.5 turns each.)

Sec. 2:  $5.0 \times 2.63 = 13.2$  turns

Sec. 3:  $6.3 \times 2.63 = 16.6$  turns

The next step is to select—with the aid of a wire table—the proper size wire for each winding. Wire tables are obtainable from wire manufacturers and appear in many manuals. For average intermittent operation, wire with a cross-sectional area of 1,000 circular mils per ampere is permissible. For continuous operation, at least 1,500 circular mils per ampere is required to prevent overheating.

The primary current is

$$I_p = \frac{W_p}{E_p} = \frac{59.3}{117} = 0.5 \text{ amp.}$$

From the wire table No. 23 is seen to be suitable for the primary. No. 33 can be used for secondary No. 1; No. 17 for secondary No. 2; and No. 15 for secondary No. 3. If the specified wire sizes are not readily obtainable, the next larger size should be used.

Filling the "window" and thereby insuring a well balanced transformer is not difficult. The majority of wire tables give the number of turns per square inch for each wire size. Calculate the window area in square inches, ascertain the number of turns per square inch for primary and secondaries and add about 50% for interleaving paper and board to insure that they fit in. If the windings will not fit, it is permissible to reduce the size of wire one or two gauges and thereby gain sufficient space to accommodate them.

The points to remember are:

The core wattage is determinable by weight and supply frequency.

Use a gauge of wire which will carry the current adequately.

Interleave each layer of primary and secondaries with insulating paper. Secondaries are insulated with thin "glassine," primaries and filament windings with electrical insulating paper of varying thickness, depending both on wire size and voltage. Check an old transformer for types of paper required, and your local armature winder for a source of supply.

If a transformer with a core of adequate size and weight is being rewound for different secondary voltages, it may be possible to utilize the original primary winding. In most radio transformers, the primary is wound next to the core, with the high-voltage secondary over it. The filament windings are generally on the outside.

Proper methods of insulating and anchoring the windings and making connections can best be learned by dismantling any good commercial transformer.

—end—

## Suppressor A. G. C. Circuit

This new a.g.c. circuit uses a suppressor grid to control gain. The method was described recently in *Wireless World* and a patent has been applied for. To show its effectiveness, it was tried out on a 4-tube t.r.f. receiver. The input signal was increased from 100 microvolts to 0.3 volts while the output was measured. Using only a *single* suppressor-grid-controlled tube, the output increased less than 2 db. With *two* conventional control-grid-controlled tubes, the output would have increased by about 15 db.

An important difference between ordinary a.g.c. and the new circuit is explained as follows: When a negative a.g.c. voltage is applied to the control grid of a vacuum tube, the space current is reduced. If some cathode bias is used, this cathode voltage becomes more negative because of the reduced space current, and the original bias is partially canceled out. This represents a form of degenerative feedback which is normally eliminated by the use of a cathode bypass capacitor. However, in the case of an r.f. or i.f. amplifier the capacitor is an effective bypass only for the signal frequencies, while the control voltage varies so slowly that it is almost pure d.c.

With suppressor injection, conditions are different. A negative suppressor *cannot change space current*. It only determines the ratio between plate and screen currents. The bias on the suppressor merely diverts electrons from the plate to the screen. Therefore no negative feedback occurs and the suppressor voltage is fully effective. A suppressor is better than the grid for controlling mutual conductance and gain.

The new circuit needs an extra-large a.g.c. voltage. At least 50 volts must be applied to a suppressor to cut off tube gain. In this circuit the first a.f. tube is also utilized to amplify the a.v.c. to provide this high voltage.

The new circuit appears in the illustration. V1 is the controlled i.f. (or r.f.) tube. V2 is the a.f.-a.g.c. amplifier. V3 is the detector. The reader may notice several unusual and perhaps puzzling features in this diagram.

These are explained as follows:

1. A large resistor R1 raises the cathode of V1 to 100 volts above ground. With no input signal, the V1 suppressor and the V2 plate are also 100 volts positive. With a signal, the suppressor of V1 is driven more negative. Therefore this suppressor never goes positive with respect to the cathode.

2. No dropping resistor is used for V1, therefore screen voltage and current are maintained constant. This is important since the screen voltage greatly affects the cathode current. As previously pointed out, a cathode-bias change with signal is equivalent to negative feedback on the a.v.c. line.

3. The detector output must have *positive* polarity. In other words, a stronger signal must drive the V2 grid more positive. More plate current flows, and the plate voltage drops. The V1 suppressor has approximately the same potential as the V2 plate. Therefore the stronger signal cuts down the gain of V1. Obviously the usual diode-triode cannot be used as detector-amplifier, since the audio load must be in the cathode circuit of the detector.

4. To prevent negative feedback on a.v.c., the cathode voltage of V2 must remain fairly constant. That is why the combined V1 and V2 cathode currents flow through R2.

5. The screen of V2 is stabilized by connecting it to a voltage divider composed of V1 and R1.

V1 should be a high-gain sharp-cut-off pentode. The EF50 was used in the original circuit. The 6AS6 may be usable because it needs much less suppressor voltage for cutoff. Of course a separate suppressor lead is essential. The tube should have a relatively low suppressor cut-off. V2 and V3 are not critical.

As pointed out previously, R1 should be large enough to raise the cathode of V1 to 100 volts. R2 is chosen to provide correct bias on V2. Due to diode contact potential, a positive bias exists regardless of signal. R3 is chosen to drop the V2 plate to 100 volts without a signal.

—end—

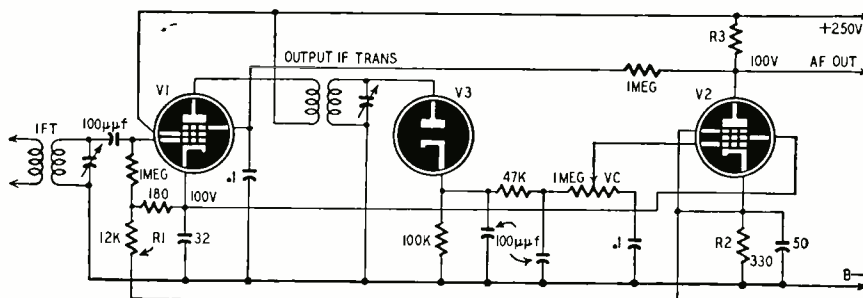

Schematic of the suppressor a.g.c. circuit described in the article above.

# TRANSISTOR OSCILLATORS with CRYSTAL CONTROL

By NATHANIEL RHITA

**M**ANY laboratories are engaged in the present race to develop new circuits for transistors and to discover new applications for them. Transistors are similar to tubes in certain respects but their circuits are usually much different. Within the past few months, transistor amplifiers and multivibrators have been described here. Recently several new and basic crystal-controlled oscillators have been disclosed. These circuits have relatively large output, good sinusoidal waveform, and excellent frequency stability.

The new transistor circuits are quite flexible. The crystal may be connected to the emitter, base, or collector, whichever is most convenient or desirable. (The terms emitter, base and collector correspond to cathode, grid and plate.) Also, a tuned circuit is needed in one of the circuits of the transistor. In any case, two requirements must be met: First, a high impedance is required in the base circuit. This provides the necessary feedback to maintain the oscillations. In addition, the high impedance of the quartz crystal must be matched to the transistor. A potentiometer accomplishes the matching.

Fig. 1 shows how the impedance of a transistor element varies with collector current,  $I_c$ . For each element there is some critical current which corresponds to high impedance. For example, if the crystal is used in the emitter circuit, the impedance of this transistor element must be raised so that it matches the crystal. Collector current is adjusted for operation close to the dotted line (Fig. 1). In the new oscillators, this current is controlled by the emitter bias.

Figs. 2-a and 2-b show the crystal in the base circuit. A choke bypasses the crystal to give the base a d.c. return to ground. A series circuit LC (in either

the collector or emitter circuit) is tuned to the crystal frequency. R is used to prevent shorting out the transistor to ground through a bypass capacitor.

In both circuits P controls the collector current. It is adjusted for optimum output with stability. The usual precautions, chokes and bypass capacitors, keep r.f. out of the batteries. Sinusoidal output is available from the terminals shown in the diagrams.

The crystal is connected in the collector circuit in Figs. 3-a and 3-b. A parallel-resonant network tunes the base to the crystal frequency and provides the high impedance for feedback. As in the previous figures, the emitter bias is adjustable. This time the collector must match the crystal impedance.

Figs. 4-a and 4-b are suitable when the crystal is connected in the emitter circuit. The first figure shows a parallel resonant network in the base circuit. This is tuned to the crystal frequency. Note that it supplies the high impedance needed in this circuit. In Fig. 4-b a series-tuned network LC is used in the collector circuit. Note that the emitter battery is reversed. This is necessary because of the high bias developed across the base resistor. This bias makes the emitter positive with respect to the base. The negative battery voltage overcomes part of this bias and leaves a small positive potential on the emitter.

In each of these diagrams the collector battery may be 22.5 volts or less. The emitter bias may be supplied by a single 1.5-volt cell. However, Fig. 4-b may require a larger emitter battery to overcome the drop in the base resistor.

These circuits were invented by two scientists, Everett Eberhard and Richard O. Endres. Their patent (No. 2,570,436) is assigned to RCA.

—end—

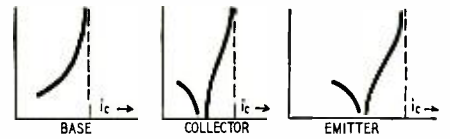

Fig. 1—Impedance variations of transistor elements as functions of the collector current.

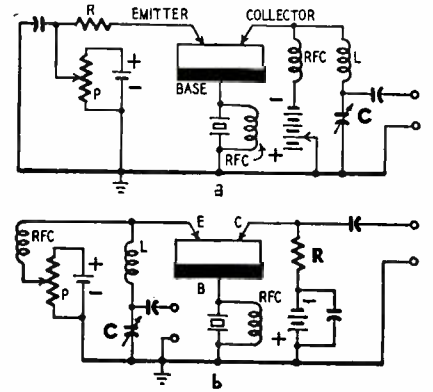

Fig. 2—Two forms of the transistor oscillator, with the crystal connected in the base circuit.

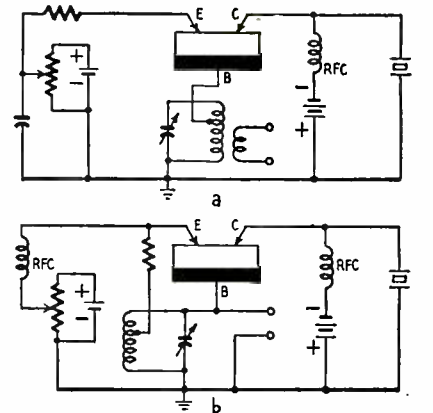

Fig. 3—Two methods of operating the transistor oscillator with the crystal in the collector arm.

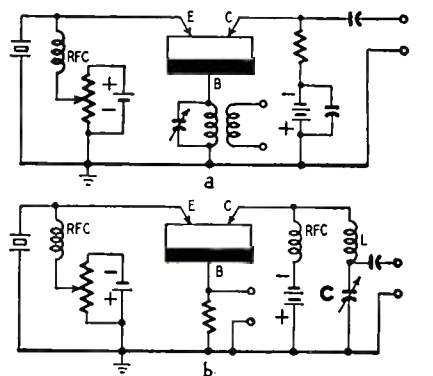
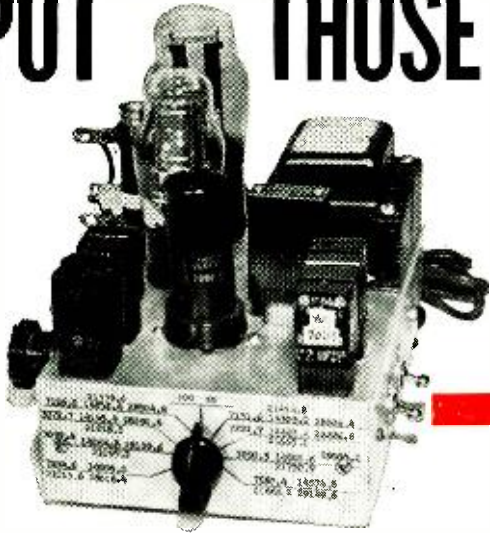

Fig. 4—The crystal is connected in the emitter branch in these modifications of the oscillator.



# PUT THOSE CRYSTALS TO WORK



By ROBERT H. DELLAR, W8ALV

This calibration unit  
uses your old crystals.

THE quartz crystal, once a popular device for controlling the frequency of amateur transmitters, has apparently been relegated to the limbo of ancient museum pieces no longer of any value (except to the novice) in today's crowded amateur bands. A few minutes listening on any band is sufficient to confirm the impression that out of some eighty thousand hams in the United States at least 78,462 must be using v.f.o.'s! Today, if an immediate answer to a CQ is not forthcoming, practically zero beat on the calling frequency, it can be reliably assumed that the CQ was not heard. More often than not, however, the result is a screaming bedlam of squeals, grunts and howls from at least five stations all calling the CQer at the same time. While the pro and con of crystal versus v.f.o. is not the subject of this article, the situation does pose a very interesting question: What's become of all those crystals that used to grace the spectrum in the rock-bound days when a ham was known by the frequency he kept? It could be, perhaps, that they are now tucked away in some remote corner of a bureau drawer, unused in the mistaken belief that they are of no value in a v.f.o.-equipped ham station.

Why not put those valuable little frequency control devices to work?

The myriad of radio services that jampack the spectrum make it more important than ever that the amateur be absolutely certain that his transmitter will not cause interference to any of these services, and that the radiated signal is within the particular amateur band. The very fact that v.f.o. controlled transmitters are widely used makes it almost mandatory that an accurate, external r.f. generator be used to determine that the transmitter is actually within the band.

The rules governing the Amateur Service plainly state that some means, independent of that used to control the transmitter frequency, must be provided to insure proper operation. The

exact method to be employed is not specified in the rules; the intent being that it is up to the amateur to be certain that his transmitter is within the band even though he may have only his receiver to determine the fact.

While it is true that the receiver itself may be satisfactory for this purpose when operation is well inside the band, in most cases its reliability decreases directly as the transmitter is operated closer to a band edge. Misinterpretation of the receiver dial, tuning the receiver to an image or other spurious response, and other factors such as frequency drift, make the receiver by itself a rather poor instrument for frequency measurement.

Why not, then, use those crystals to increase the receiver's accuracy and usefulness? A half dozen or more amateur-band crystals combined with a 100-ke crystal oscillator can convert any good communications receiver into the equivalent of a reasonably accurate heterodyne frequency meter. The instrument and method of accomplishment are described in this article.

### Construction features

The oscillator, shown in Fig. 1, uses eight 7-mc crystals and one 100-ke secondary-standard crystal in a highly stable arrangement which is essentially a combined form of the Pierce and Colpitts circuits, designed to maintain a minimum of frequency drift due to heating effects or slight changes in circuit constants.

To achieve this high order of frequency stability all capacitors associated with the oscillator circuit are of the highest quality silver mica, zero temperature-coefficient type. Power supply stability is maintained through the use of an OD3 voltage regulator and its associated limiting resistor, R3. It will be seen in the photo that the 25-watt resistor is mounted on top of the 7 x 5 x 2-inch aluminum chassis. This minimizes temperature differences between "stand-by" and "power on" conditions.

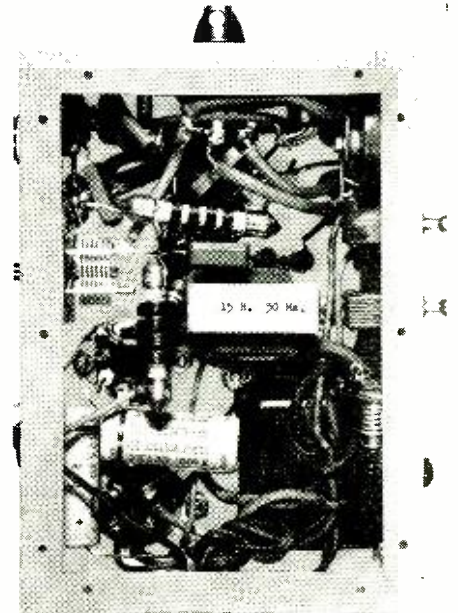

The placement and wiring of the principal components. A metal plate covers the bottom when the unit is in use.

A small copper flange mounted on top of the resistor aids in dissipating the heat.

The crystal selector switch can be seen at the end of the chassis in the under-side view above. Since only nine of the eleven positions are required the switch stop may be adjusted to prevent turning the switch to the extra two positions. They are available, however, if the constructor wishes to incorporate more than nine crystals. The switch stop can, of course, be adjusted to any position if fewer crystals are available.

It is recommended that even if only four or five crystals are at hand, the unit should be wired to include at least nine crystal sockets. As additional crystals become available they may be plugged into the appropriate sockets without any circuit changes. Use an

aluminum bottom plate for the chassis to add additional strength and to aid in the uniform distribution of heat. A 2 x 5-inch plastic sheet covers the paper upon which the crystal frequencies or switch positions are typed.

A 2- or 3-foot length of RG-59/U cable, fitted with an Amphenol Type 80-M connector, provides a convenient method for coupling the frequency standard to the receiver input terminals. Although construction of the unit is simple, be very careful that all connections are tightly soldered and that the individual parts are mounted in a manner to prevent vibration.

**Preliminary adjustment**

After the unit has been wired, adjust the voltage limiting resistor, R3, to

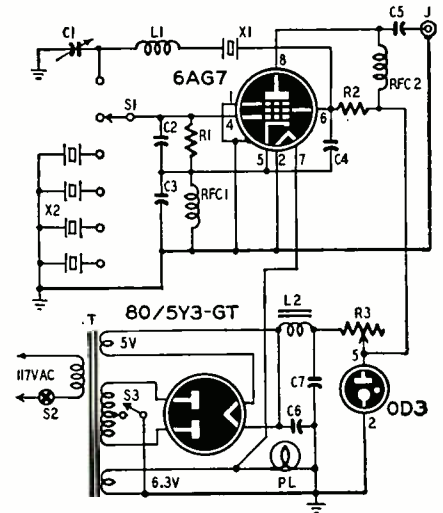

Fig. 1—Schematic of the combined receiver calibrator and crystal checker.

permit a current of 30 milliamperes to flow through the voltage-regulator tube. This may be done by inserting a milliammeter into the circuit between connection 2 of the V-R tube socket and ground and adjusting the tap on R3 so that the proper current is indicated on the meter. The unit can now be given a preliminary check to see that the 100-kc and 7-mc crystals are oscillating properly.

Before serious use is made of the frequency standard, such as receiver calibration, allow the unit to warm up thoroughly. About two hours are necessary to reach a relatively stable temperature of approximately 10° C. above average room temperature. Plate voltage may now be applied and switch S1 set to the 100-kc position. Tune the receiver to one of WWV's frequencies or to a suitable station in the broadcast band. Connect the frequency standard to the receiver input and slowly adjust C1 to bring the 100-kc crystal to zero beat. This condition will be indicated by a slow waxing and waning of the signal as zero beat is approached. If the receiver is equipped with an "S" meter, zero beat conditions will produce a slow and regular periodic swing of the meter needle.

Be careful that zero beat is not ob-

tained against one of WWV's modulating frequencies, 440 or 4,000 cycles. It is best to wait for the one-minute period when the modulation is cut off before making the initial zero beat adjustment. After a little experience gained in this operation it will not be necessary to wait each time for the modulation to cut off since it will be easy to find the correct beat. It is good practice to wait a few minutes with the oscillator in "stand-by" and then check against WWV again to make sure that the 100-kc crystal is still zero beat or nearly so. Repeat this procedure several times, especially if critical measurements are to be made.

It will probably be found that the beat is from two to five cycles at 10 mc, after a stand-by period of five or ten minutes. If so, C1 may again be adjusted for zero beat, at which time the frequency standard is ready for use. The 100-kc crystal can be expected to remain within a deviation of ten cycles or less in 10 mc for several hours at a time after the unit has been thoroughly warmed up.

Of course, wide variations in room temperature, or operating the standard in front of an open window will affect the degree of frequency stability. This factor is not too important, since in practice, use is made of the standard generally within a few minutes after it has been checked for zero beat—a period of time too brief to affect the frequency by more than a very few cycles.

Long warm-up periods are not necessary in the case of the 7-mc crystals since the modern AT type crystal has practically a zero-temperature/frequency characteristic and is not affected much by small changes in temperature. Measurements of the writer's crystals show a maximum deviation of not more than about 30 cycles in 7 mc under a variety of temperature conditions. This stability is more than adequate for amateur applications where band edge factors are not involved.

A number of commercially manufactured crystals has been frequency measured in this oscillator and in each case the crystal was found to be within two or three hundred cycles of the frequency stamped on the holder. This is certainly close enough for receiver calibration. In cases where the greatest accuracy may be desirable or necessary, it is possible that arrangements could be made for the amateur to ship his crystals and oscillator (or take them in person) to a frequency measuring laboratory or to the crystal manufacturer for precise measurement of the crystals operating in the standard itself. Charges for this service would probably be nominal enough to make such a procedure well worth while.

**Frequencies and adjustments**

The amateur band crystals should be selected so that their frequencies are more or less evenly distributed throughout the band, but at the same time be values that will not coincide

with the 100-kc check points in any amateur band. One crystal should be close to the low-frequency edge of the band to aid in quickly identifying the proper 100-kc check point. Added usefulness, for traffic or emergency net operation, can be obtained by using a crystal cut to the frequency of net operations as one of the check points. It is then a simple matter to put the transmitter on exactly the right frequency by beating the v.f.o. against the crystal. This method can also be applied to check the stability and keying characteristics of the v.f.o., since variations in the beat or tone will not be due to receiver instability but practically entirely to factors in the v.f.o. itself.

Before the receiver is calibrated, put it in first-class operating condition. Any future adjustments may affect the calibration and the whole procedure will have to be repeated. Check the bandspread dial for backlash, since this can adversely affect the accuracy of dial calibration. This may be done by tuning in a signal from the standard and with the receiver b.f.o. on, approach zero beat by turning the dial in a clockwise direction. Note the dial reading and continue turning the dial past this point. Now, retune the dial in a counterclockwise direction until zero beat is again obtained. If both dial readings are exactly the same there is no backlash; if the amount of backlash is not more than a tenth of a dial division it can be considered excellent. If the difference is more than this, try to reduce the backlash to a minimum by tightening gears or installing a new dial cable. Errors can also be minimized by tuning to zero beat from the same direction every time.

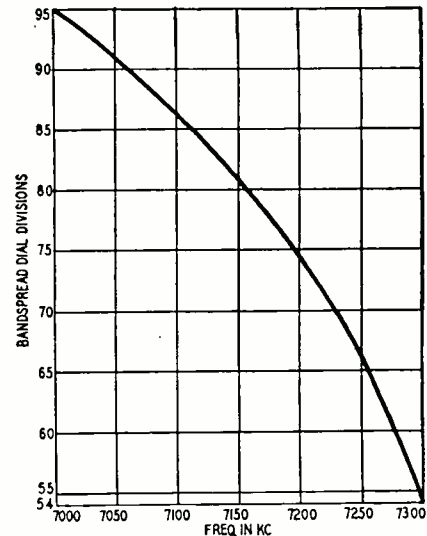

Fig. 2—Typical receiver calibration curve obtained by using the checker.

**How to calibrate**

Assuming that the receiver is in first-class condition, and that both it and the secondary standard have had sufficient time to warm up thoroughly, all that remains is the calibrating process which will convert the receiver into a reason-





# Learn RADIO TELEVISION

## -New Package Unit Plan- PAY AS YOU LEARN NO MONTHLY PAYMENT CONTRACT TO SIGN!

**I Send You  
18 BIG  
KITS  
OF RADIO-  
TELEVISION  
EQUIPMENT**

### TRAIN IN 10 MONTHS <sup>OR</sup> LESS At Home in Your Spare Hours

Now . . . be ready for Radio-Television's big pay opportunities in a few short MONTHS! Frank L. Sprayberry's completely new "Package" training unit plan prepares you in just 10 MONTHS . . . or even less! Equally important, there is NO monthly payment contract to sign . . . thus NO RISK to you! This is America's finest, most complete, practical training—gets you ready to handle any practical job in the booming Radio-Television industry. In just 10 months you may start your own profitable Radio-Television shop . . . or accept a good paying job in this fascinating expanding field at work you've always wanted to do. Mr. Sprayberry has trained hundreds of successful Radio-Television technicians—and stands ready to train you in less than one year, even if you have no previous experience. You learn by DOING . . . actually working with your hands with equipment of special design to illustrate basic theory instead of relying on books alone.

#### VALUABLE EQUIPMENT INCLUDED WITH TRAINING

The new Sprayberry "package" plan includes many big kits of genuine, professional Radio-Television equipment. While training you actually perform over 300 demonstrations, experiments and construction projects. In addition, you build a powerful 6-tube standard and short wave radio set, a multi-range test meter, a signal generator, signal tracer, many other projects. All equipment is yours to keep . . . you have practically everything you need to set up your own service shop. The interesting Sprayberry book-bound lessons and other training materials . . . all are yours to keep.

#### EARN EXTRA MONEY WHILE YOU LEARN!

All your 10 months of training is AT YOUR HOME in spare hours. Keep on with your present job and income while learning . . . and earn EXTRA CASH in addition. With each training "package" unit, you receive extra plans and ideas for spare time Radio-Television jobs. Many students pay for their entire training this way. You get priceless practical experience and earn generous service fees from grateful customers. Just one more reason why the Sprayberry new 10 MONTH-OR-LESS training plan is the best Radio-Television training in America today. If you expect to be in the armed forces later, there is no better preparation than good Radio-Television training.

### FREE 3 BIG RADIO-TELEVISION BOOKS

I want you to have ALL the facts about my new 10-MONTH Radio-Television Training—without cost! Act now! Rush the coupon for my three big Radio-Television books: "How to Make Money in Radio-Television," PLUS my new illustrated Television Bulletin PLUS an actual sample Sprayberry Lesson—all FREE with my compliments. No obligation and no salesman will call on you. Send the coupon in an envelope or paste on back of post card. I will rush all three books at once!

**SPRAYBERRY ACADEMY OF RADIO**  
Dept. 20-H, 111 N. Canal St., Chicago 6, Ill.

SPRAYBERRY ACADEMY OF RADIO, Dept. 20-H  
111 North Canal St., Chicago 6, Ill.

Please rush to me all information on your 10-MONTH Radio-Television Training Plan. I understand this does not obligate me and that no salesman will call upon me.

Name.....Age.....

Address.....

City.....Zone.....State.....

Please check Below About Your Experience

Are You Experienced?  No Experience

**Mail  
Coupon  
Today!**  
NO OBLIGATION  
No Salesman  
Will Call

**APPROVED  
FOR VETERANS  
UNDER THE  
G.I. BILL**

**IF YOU ARE  
EXPERIENCED IN RADIO**

Men already in Radio who seek a short intensive 100% TELEVISION Training with FULL EQUIPMENT INCLUDED are invited to check and mail the coupon at the right.



# New TUBE TESTER

Exclusive

# HICKOK

Dynamic  
Mutual Conductance



Model 533AP

Larger, easy-to-read meter scale and a calibrated GM circuit provide increased accuracy in testing today's newer tubes.

This handy new HICKOK portable is a sound investment in highest quality electronic test equipment—whether for the radio-TV service bench, the inspection line or the laboratory.

## FEATURES . . .

- Exclusive HICKOK Tube Gas Test, Tube Noise Test and Future Tube Life Test provide for accurate electronic circuit balancing.
- New calibrated GM circuit.
- Separate Grid Signal: 2.5 volts AC.
- HICKOK Dynamic Mutual Conductance circuits with most accurate tube evaluation directly in micromhos.
- Bias Fuse prevents accidental damage to bias potentiometer.

See the 533AP at your Jobber's today, and write for full information on the HICKOK complete 10-model line of Dynamic Mutual Conductance Tube Testers.

**THE HICKOK ELECTRICAL INSTRUMENT CO.**  
10531 Dupont Avenue Cleveland 8, Ohio

able facsimile of a heterodyne frequency meter. First, adjust the main dial so that the low-frequency edge of the amateur band occurs with the bandspread dial at nearly maximum capacity. This, of course, applies to receivers with "electrical" bandspread. If the bandspread dial is mechanically geared to the main dial, merely note the bandspread dial reading. Now tune in the 100-kc check point corresponding to the band edge, exactly center it with the "S" meter or by ear, and with the b.f.o. off. Next turn on the b.f.o. and bring it to zero beat by adjusting the b.f.o. pitch control. Thereafter, leave b.f.o. on and don't touch the pitch control. Remember, the b.f.o. should always be adjusted initially at the same point on the dial and thereafter left alone.

Note the dial reading corresponding to the band edge on a sheet of paper and turn the dial to the rest of the 100-kc points within the band and record their dial readings. This procedure should be repeated to verify the dial readings. Next, turn the crystal selector switch to the first position, which will be the lowest frequency amateur band crystal, and tune the receiver to zero beat. Note its dial reading on the paper and do the same with the rest of the crystals. Again, repeat the entire process to make sure that nothing has changed in the meantime. Tune in WWV again to confirm that the 100-kc crystal is still on frequency.

Next, prepare a sheet of squared paper, similar to that shown in the example in Fig. 2, with the frequency represented by the horizontal axis and the bandspread dial divisions by the vertical axis. The check points, previously recorded on the sheet of paper, are now carefully plotted on the graph at the points corresponding to the dial/frequency intersection. If the receiver bandspread has a linear frequency characteristic the plotted points will be in a straight line, which will greatly simplify the calibration. However, some receivers do not have a straight-line characteristic and the plotted check points will describe a curve such as the one in Fig. 2. Be extremely careful that the check points have been properly

located on the graph and that the line connecting them is smoothly constructed.

The final step in the calibration job is to extract from the graph the dial reading for every ten kilocycles throughout the amateur band. This data may be typed on a sheet of paper in a manner similar to the following example:

### 7 MC BAND

Receiver Dial Calibration			
Dial	Frequency	Dial	Frequency
95.0	7000*	92.8	7030
94.8	7004.6*	92.6	7032.4*
94.3	7010	92.0	7040
93.6	7020	91.1	7050

Each 10-kilocycle point may be indicated in black type except the check points which should be indicated in red or by an asterisk to readily identify the crystals. The calibration sheets for each band can be bound in book form or covered with a cellophane sheet and mounted on stiff cardboard if desired.

All the foregoing remarks concerning the use of 7-mc crystals will also apply if 3.5-mc crystals are used instead. Either will produce strong harmonics in the 28-mc band or higher. The 100-kc crystal, on the other hand, will produce usable harmonics only to about 20 mc, depending on the sensitivity of the receiver. Beyond this point the signals are too weak to be usable. Nevertheless, 100-kc check points can still be obtained in the 28-mc band by zero beating the transmitter v.f.o. to a 100-kc check point on a lower frequency and then tuning the receiver to the 28-mc harmonic from the v.f.o.

### PARTS LIST

- C1—50 muf midget variable, Millen 20050
- C2—10 muf silver mica, C-D 5R5Q1
- C3—150 muf silver mica, C-D 2R5T15
- C4—.005 muf silver mica, C-D 1DR5D5
- C5—50-100 muf mica
- C6, C7—8 mf, 450-volt-electrolytic
- R1—50,000 ohms, 1/2 watt
- R2—100,000 ohms, 1 watt
- R3—5,000 ohms, 25-watt adjustable
- L1—60-mh air-core r.f. choke, Meissner 19-3247
- L2—15-H, 50-ma filter choke
- RFC1, RFC2—2.5mh r.f. choke, National R-100
- T—Power transformer, 240-240-volt, 50-ma; 5-volt, 2-amp 6.3-volt, 2-amp., Merit P2958
- P1—6-volt pilot light
- J—Output jack, Amphenol 80-C chassis connector
- X1—100-kc crystal, JK H-165
- X2—3.5- or 7-mc crystals
- S1—11-position rotary switch, Mallory 1311L
- S2, S3—S.p.s.t. toggle switches

—end—

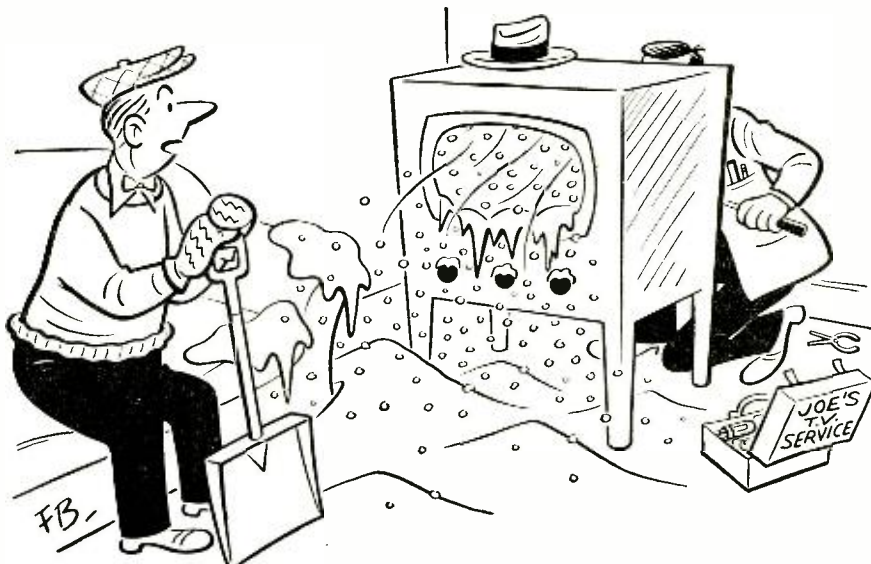

"Still too much snow, Joe"

Suggested by F. McCarroll, Medford, Mass.

RADIO-ELECTRONICS



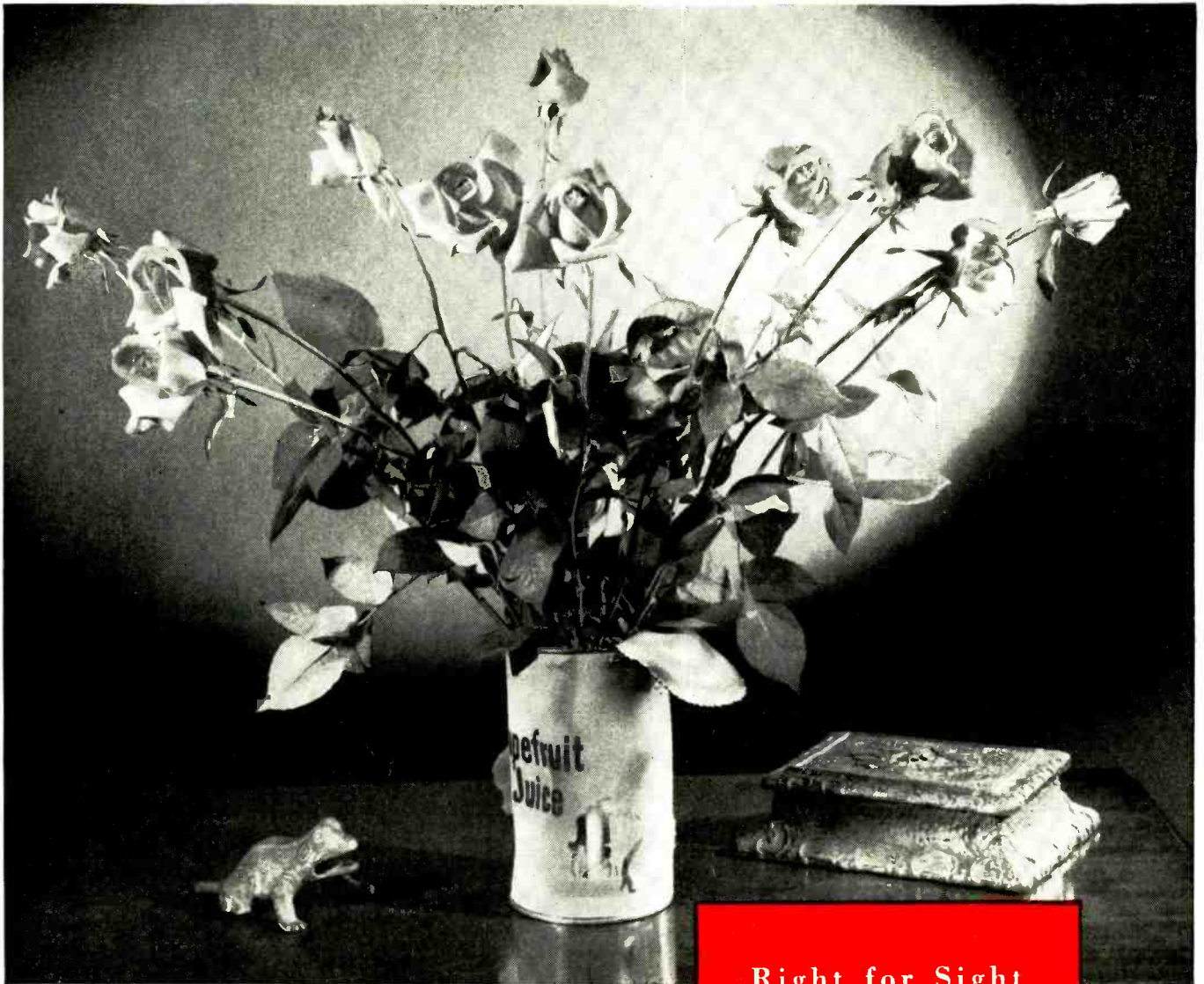

Right for Sight



**RAYTHEON PICTURE  
TUBES**

Makeshift Replacements  
Reduce Picture Quality

Replacements with  
Raytheon Television Tubes  
assure picture quality

*Don't forget!* Raytheon Picture Tubes with Corona Inhibitor  
give constant picture clarity whatever the weather.



*Excellence in Electronics*

RECEIVING AND PICTURE TUBES • RELIABLE SUBMINIATURE AND MINIATURE TUBES • GERMANIUM DIODES AND TRANSISTORS • RADIAC TUBES • MICROWAVE TUBES

**RAYTHEON MANUFACTURING COMPANY**

Receiving Tube Division

Newton, Mass., Chicago, Ill., Atlanta, Ga., Los Angeles, Calif.

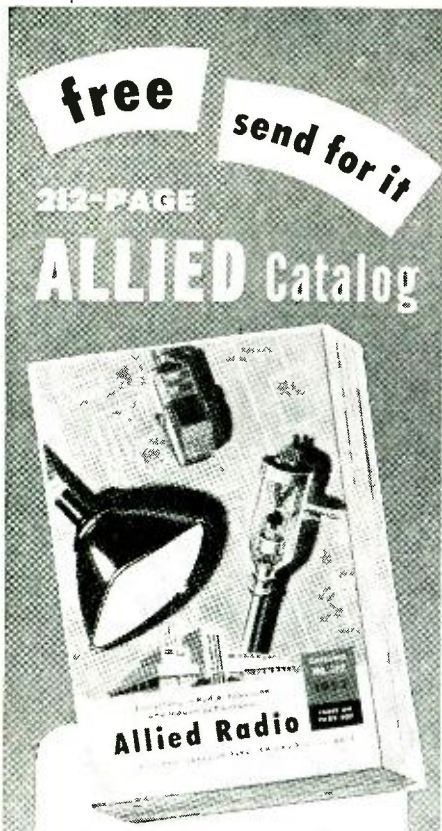

**free**  
send for it  
212-PAGE  
**ALLIED Catalog**  
Allied Radio

**the only complete up-to-date catalog for Everything in Radio, Television & Industrial Electronics**

Send for the Buying Guide that's used daily by thousands of service technicians, engineers, Amateurs, sound men, builders and experimenters. Make your selections from the world's largest stocks of quality equipment—at lowest money-saving prices. Get every buying advantage at ALLIED—speedy delivery, expert personal help, and complete satisfaction on every order. Make ALLIED your single, dependable source for electronic supplies.

**SEND FOR FREE CATALOG**

**ALLIED RADIO**

ALLIED RADIO CORP., Dept. 2-DA-2  
833 W. Jackson Blvd., Chicago 7, Ill.

Send FREE 212-Page ALLIED Catalog

Name \_\_\_\_\_  
Address \_\_\_\_\_  
City \_\_\_\_\_  
Zone \_\_\_\_\_ State \_\_\_\_\_

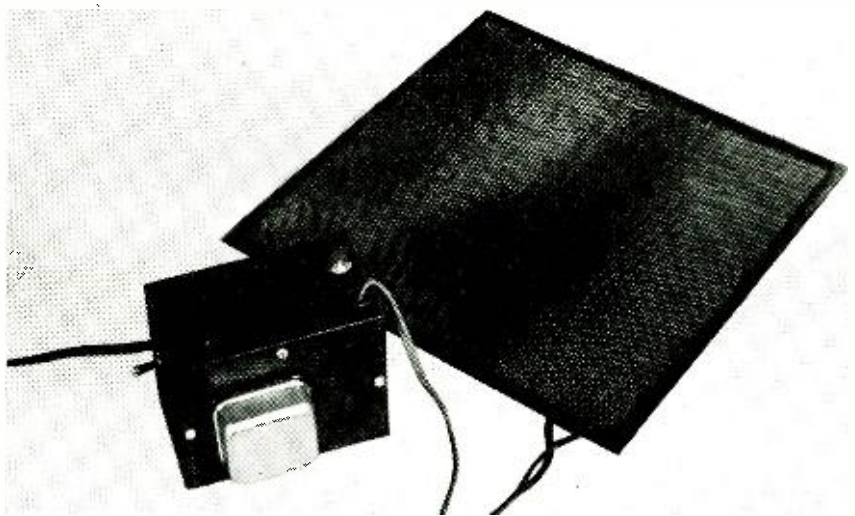

The two units of the electronic rain detector. The wire mesh is 1 foot square.

# Novel Rain Detector

By S. W. HASKELL

**T**HIS unit is designed to sound an alarm when a drop of water falls on a detector unit.

The circuit (Fig. 1) is a d.c.-operated thyratron triggered by moisture. Initially the thyratron, a 2D21, is nonconducting, a small negative voltage on the grid preventing the tube from firing. The detector element is in effect a switch which applies a positive voltage to the grid. The drop of water creates a low resistance between two slightly separated wires connected to a positive voltage from a tap on the bleeder resistor in the grid circuit of the 2D21. When the tube conducts, it causes the relay to close and sound the buzzer.

Since the tube will continue to conduct until its plate voltage is interrupted, a push-button switch with normally closed contacts is inserted in the plate circuit. When the button is pressed the relay will open and the circuit will be recocked.

A less sensitive relay than the one shown may be used provided the series resistor used limits the current through the relay to rated values. The one used has a coil resistance of 5,000 ohms and closes at 5 ma. A limiting resistor of

about 3.9 megohms is required in the grid lead of the 2D21, and an isolating resistor of the same value is necessary between the detector-screen unit and the bias tap. The second grid is tied to the cathode, resulting in a very sensitive circuit. The moisture of the fingers causes enough conduction to trigger the circuit.

The selenium rectifier and resistor-capacitor filter provide a compact power supply. A 6.3-volt, 1.2-amp transformer heats the tube filament and operates a buzzer. The unit is built in a 3 x 4 x 5-inch metal box. No ground connection is required. It would, however, be wiser to use a nonmetallic cabinet to reduce the shock hazard.

The detector element (Fig. 2) is made with two pieces of copper window

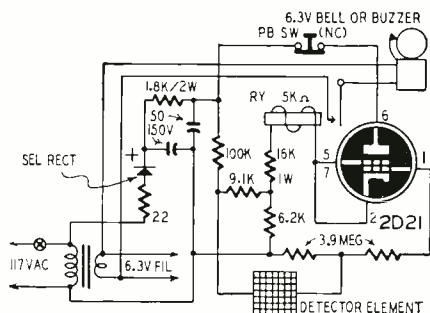
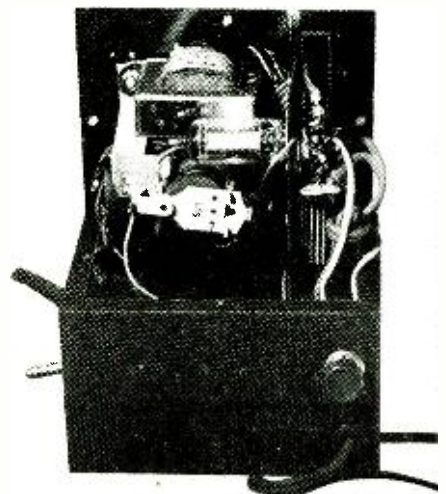

Fig. 1—Schematic of the rain detector.



Inside the detector control housing.



# the most convenient TV tower ever made

THE TEL-A-RAY

## SWING-OVER\* TOWER

*swings over  
to the ground  
for servicing . . .*

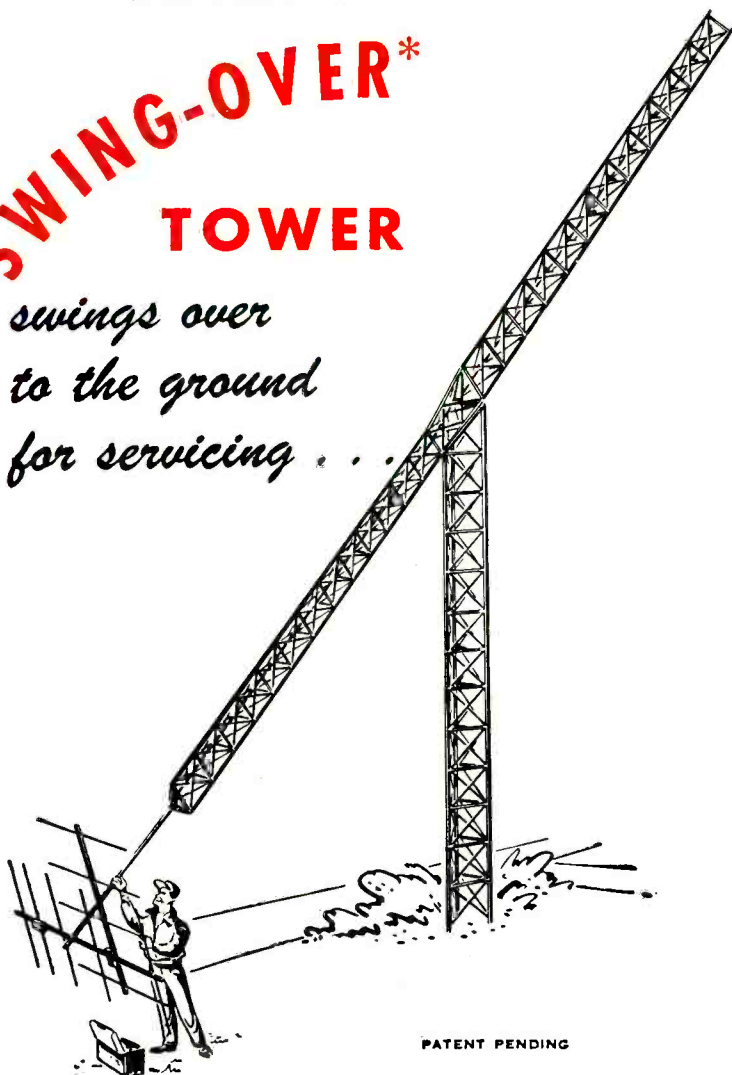

The biggest new idea in television — the Tel-a-Ray Swing-Over Tower\* — swings over to the ground for easy servicing! One man can raise or lower this counterbalanced tower in three minutes!

Model TT1, for ground installations, is 50 feet high when a recommended 10 feet of water pipe is added — can be quickly erected with no guy wires.

Model TT2 is designed for roof tops, reaches up 24 feet with the addition of an eight-foot pipe.

Although light in weight, the Swing-Over Tower is ruggedly built with steel angles and welded construction. Simple to assemble . . . no machinery necessary . . . low in price.

Write today for information.

APRIL, 1952

FOR WONDERFUL  
TV RECEPTION  
WHEREVER YOU ARE



The weatherproof Model T antenna . . . brings in wonderful reception up to 200 miles.



Only low-priced Pre-Amplifier on the market, the TB. Multiplies signal gain . . . holds noise to a minimum.

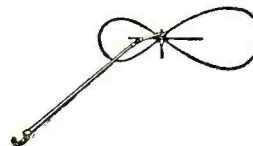

Butterfly Swivel-Positioned TV and FM antenna . . . designed to give the finest reception in primary areas.

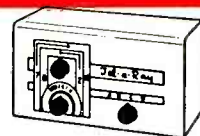

Tel-a-Ray's new Switching Booster (Model PTB1) — one switch changes channels and antennas. Eliminates the need for a separate booster for each antenna . . . for as many as four antennas. Automatic features make this outstanding.

FOR COMPLETE INFORMATION WRITE

*Tel-a-Ray*

ENTERPRISES, INC.



TRADEMARK

BOX 332E  
HENDERSON, KY.

## INDISPENSABLE! PHOTOFACT BOOKS



**Photofact Television Course.** Covers TV principles, operation and practice. 216 pages; profusely illustrated; 8½ x 11". Order **TV-1**.....Only **\$3.00**

**Television Antennas. New 2nd edition.** Describes all TV antenna types; tells how to select, install, solve troubles. Saves time; helps you earn more. 200 pages; illustrated. Order **TAG-1**.....Only **\$2.00**

**Television Tube Location Guide. Volume 2.** Accurate diagrams show position and function of all tubes in hundreds of TV sets; helps you diagnose trouble without removing chassis. 224 pages; pocket-size. Order **TGL-2**.....Only **\$2.00**

**Television Tube Location Guide. Vol. 1.** Over 200 pages of TV receiver tube position diagrams on hundreds of models. Order **TGL-1**.....Only **\$1.50**

**Making Money in TV Servicing.** Tested proved methods of operating a profitable TV service business. Covers all important phases. Authoritative, valuable guide to success. Over 130 pages. Order **MM-1**.....Only **\$1.25**

**Servicing TV in the Customer's Home.** Shows how to diagnose trouble using capacitor probe and VTVM. Short-cut methods help save time, earn more on outside service calls. Order **TC-1**.....Only **\$1.50**

**1949-1950 Record Changer Manual. Vol. 3.** Covers 44 models made in 1949, including multi-speed changers and wire and tape recorders. Original data based on actual analysis of equipment. 286 pages; 8½ x 11"; paper-bound. Order **CM-3**.....Only **\$3.00**

**1948-1949 Changer Manual. Vol. 2.** Covers 45 models made in 1948-49. Paper bound. Order **CM-2**.....Only **\$4.95**

**1947-1948 Changer Manual. Vol. 1.** Covers 40 post-war models up to 1948. Order **CM-1**.....Only **\$3.95**

**Recording & Reproduction of Sound. 2nd Edition.** New, completely revised and vastly enlarged edition of the outstanding original volume. The most authoritative treatment of all phases of recording and amplification ever written. Over 800 pages. 6 x 9". Order **RR-2**.....Only **\$7.95**



**Audio Amplifiers. Vol. 3.** Clear, uniform, accurate data on 50 important audio amplifiers, plus full coverage of 22 FM and AM tuners, produced during 1950. 362 pages, 8½ x 11". Order **AA-3**.....Only **\$3.95**

**Audio Amplifiers. Vol. 2.** A complete analysis of 104 well-known audio amplifiers and 12 tuners made 1949-50. 368 pages, 8½ x 11". Order **AA-2**.....Only **\$3.95**

**Audio Amplifiers. Vol. 1.** 102 amplifiers and FM tuners made through 1948. 352 p. Order **AA-1**.....Only **\$3.95**

**Auto Radio Manual.** Complete service data on more than 100 post-war auto radio models. Covers over 24 mfrs. 350 pages, 8½ x 11". Order **AR-1**.....Only **\$4.95**

**Communications Receiver Manual.** Complete analysis of 50 popular communications models. 246 pages, 8½ x 11". Order **CR-1**.....Only **\$3.00**

**Radio Receiver Tube Placement Guide.** Accurate diagrams show where to replace each tube in 5500 radio models, covering 1938-1947 receivers. 192 pages, pocket-size. Order **TP-1**.....Only **\$1.25**

**Dial Cord Stringing Guide. Vol. 2.** Covers receivers made from 1947 through 1949. Shows you the one right way to string a dial cord in thousands of models. Pocket-size. Order **DC-2**.....Only **\$1.00**

**Dial Cord Guide. Vol. 1.** Covers sets produced 1938 through 1946. Order **DC-1**.....Only **\$1.00**

Order from your Parts Jobber or write direct to  
HOWARD W. SAMS & CO., INC., 2201 E. 46th St., Indianapolis 5, Indiana

**HOWARD W. SAMS & CO., INC.**

screening slightly less than one foot square, separated and insulated from each other by a piece of plastic window screening. The two outside copper screens are soldered to a 15-foot length of lamp cord connected to the control unit. (For outdoor use connecting leads

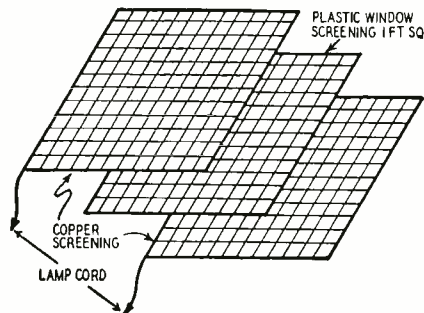

Fig. 2—The detector element assembly.

should be weatherproof. Standard 300-ohm line would be highly suitable.) As a convenience in handling, it might be a good idea to use a small connector plug and jack at the box for this cord.

In operation the buzzer is placed in a convenient spot and the detector element is extended out a window or put on a roof. The first drop of rain to strike this 1-square-foot area will sound the alarm. Larger or smaller detector elements may be made if desired. Normally, a drop of rain will pass through the mesh (provided that the underside of the detector element is not directly

in contact at all points with the supporting surface. A plastic supporting frame with four mounting feet one or two inches high should solve the problem). This makes it possible to silence the alarm by pushing the button of the plate-circuit switch. If water remains lodged in the screen it will be necessary to remove all moisture before the unit can be reset.

One of the most obvious uses for this device is as a rain detector—guarding the family washing. Housewives form on the left! The unit may serve as a leak detector, and other uses will doubtless occur to the constructor.

Numerous requests have been made for a device of this type to warn of bed-wetting by children and invalids. It should be noted that because of the possible shock hazard resulting from operation of this device from the power line, it is *not* recommended for such use in its present form. However, it should be possible to modify the unit for operation from batteries so as to make it safe for applications involving body contact.

### Materials for the rain detector

**Resistors:** 2—3.9 megohms, 1—100,000, 1—9,100, 1—6,200, 1—22 ohms, ½ watt; 1—16,000 ohms, 1 watt; 1—1,800 ohms, 2 watts.

**Capacitors:** (Electrolytic) 1—dual 50 uf, 150 volts.  
**Miscellaneous:** 1—2D21 tube and socket, 1—65-ma selenium rectifier, 1—s.p.s.t. toggle switch, 1—Merit P-3045 or equivalent half-wave power transformer, 1—6-volt buzzer, 1—sensitive plate relay (normally open contact), 1—push-button switch (s.p.s.t. normally closed), some copper and plastic window screening, rubber-insulated line cord, chassis, hardware, hookup wire, and solder.

—end—



"Look, it says WOW every time she walks through!"



# “When we think of V-R tubes, we think of **CBS-HYTRON**”

## TUBES ARE KNOWN BY THE COMPANY THEY KEEP

It's automatic with scores of top-flight manufacturers. They turn to CBS-Hytron for the miniature OA2, OB2 and standard OC3, OD3.

That's only natural. They know CBS-Hytron has the know-how... know-how gained from making over 15,000,000 voltage regulators. They know CBS-Hytron supplies these apparently simple tubes to either JAN or commercial specifications. (In fact, CBS-Hytron's factory tests of VR tubes are much tougher than JAN.) And they know CBS-Hytron... top producer of VR tubes... can be depended upon for prompt delivery.

Follow the leaders yourself. Buy the best. Order your gaseous voltage regulators from CBS-Hytron.

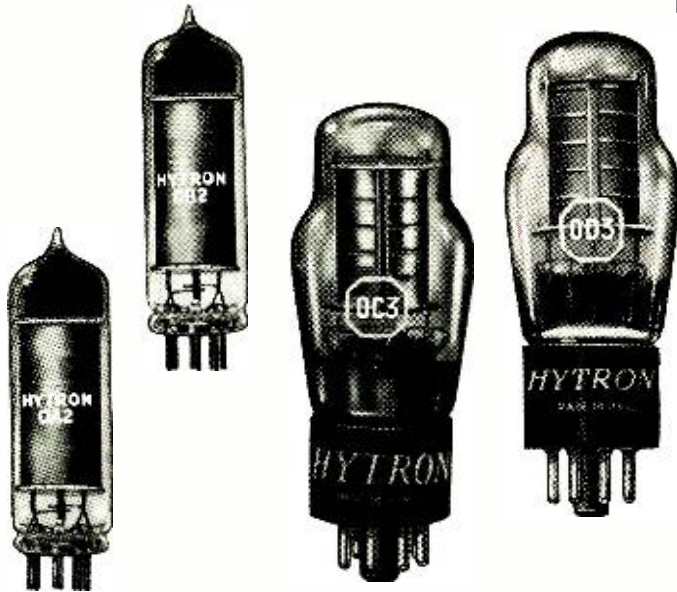

Write for Complete Free Data on  
CBS-HYTRON voltage-regulator tubes



MAIN OFFICE: Salem, Massachusetts

**Reads like the blue book of electronics...**  
this list of famous companies who from long experience buy the best in voltage-regulator tubes... CBS-Hytron.

Admiral Corporation • Airborne Instruments Lab., Inc. • Aircraft Armaments, Inc. • Aircraft Radio Corp. • Aircsearch Mfg. Co. • Applied Physics Corp. • Applied Research Laboratories • Arma Corporation A.R.F. Products, Inc. • Atomic Instrument Co. Audio Products Corp. • Ballantine Laboratories, Inc. • Arnold O. Beckman, Inc. • Bell Aircraft Corp. • Bell Telephone Laboratories, Inc. • Bellaire Electronics, Inc. • Bendix Aviation Corp. • Berkeley Scientific Corp. • Bill Jack Scientific Instrument Co. • Bright Radio Laboratories • The Brinnell Co. Browning Laboratories, Inc. • J. H. Bunnell & Co. Cambridge Instrument Co., Inc. • The Allen D. Cardwell Mfg. Corp. • CBS-Columbia, Inc. • CBS Television • Collins Radio Co. • Connecticut Telephone & Electric Corp. • Consolidated Vultee Aircraft Corp. • Cornell-Dubilier Electric Corp. • Crosley Division, Avco Mfg. Corp. • DDD Manufacturing Co. • Douglas Aircraft Co., Inc. • Allen B. DuMont Laboratories, Inc. • Edo Corporation • Eicor, Inc. • Electro-Physical Laboratories, Inc. • Electrotechnic Corp. • El-Tronics, Inc. • Fada Radio and Electric Co., Inc. • Fairchild Guided Missiles Div., Fairchild Engine and Airplane Corp. • Federal Manufacturing and Engineering Corp. • Federal Telecommunication Laboratories, Inc. • Federal Telephone and Radio Corp. • Ford Instrument Co., Div. of Sperry Corp. • Gaveco Laboratories, Inc. • General Communication Co. General Precision Laboratory, Inc. • General Radio Co. • Gilfillan Bros., Inc. • Gonsset Company • The Gray Mfg. Co. • The Hallcrafters Co. • The Hammarlund Mfg. Co., Inc. • Harvey-Wells Electronics, Inc. • Hazeltine Electronics Corp. • Hewlett-Packard Co. • Hickok Electrical Instrument Co. • Hoffman Radio Corp. • Hubbell & Miller Co. • Industrial Control Co. • Industrial Development Engineering Associates, Inc. • Jack & Heintz, Inc. Jackson Electrical Instrument Co. • Kepco Laboratories, Inc. • Lavoie Laboratories, Inc. • Lear, Incorporated • Lewyt Corporation • Link Radio Corp. • Loral Electronics Corp. • Lyman Electronic Corp. • Lysco Mfg. Co., Inc. • P. R. Mallory & Co., Inc. • The Glenn L. Martin Co. • The W. L. Maxson Corp. • McDonnell Aircraft Corp. • McElroy Manufacturing Corp. • Melpar, Inc. • Midwest Engineering Development Co., Inc. • Minshall-Estey Organ, Inc. • Motorola, Inc. • National Company, Inc. National Electrical Machine Shops, Inc. • National Research Corp. • National Research Council, Canada • New London Instrument Co. • Nuclear Measurements Corp. • Nutone, Inc. • Photobell Co. Pilot Radio Corp. • Portable Electric Tools, Inc. Precision Apparatus Co., Inc. • Press Wireless Mfg. Co., Inc. • Radiation, Inc. • Radio Development & Research Corp. • Radio Engineering Laboratories, Inc. • Rauland-Borg Corp. • Raymond Rosen Engineering Products, Inc. • Raytheon Mfg. Co. Reed Research, Inc. • Sanborn Company • Sangamo Electric Co. • Schuttig & Company, Inc. • Sentinel Radio Corp. • Servomechanisms, Inc. • Setchell Carlson, Inc. • Shallcross Mfg. Co. • F. W. Sickles Div., General Instrument Corp. • Sierra Electronic Corp. • A. F. Smuckler & Co., Inc. • Sonar Radio Corp. • Spence-Kennedy Laboratories, Inc. • The Stamford Electronics Co. • Fred Stein Laboratories • The Superior Electric Co. • The Technical Materiel Corp. • Telchrome, Inc. • Tel-Instrument Co., Inc. • Times Facsimile Corp. • Tracerlab, Inc. • Trad Television Corp. • Transducer Corp. • United Scientific Laboratories, Inc. • Varo Mfg. Co., Inc. Wells-Gardner & Co. • Western Electric Co. • Western Sound & Electric Labs., Inc. • Westinghouse Electric Corp. • Weston Electrical Instrument Corp. • Weston Laboratories • Wilcox Electric Co., Inc. • Witco Mfg. Co.

In addition to many other prominent manufacturers, the U. S. Army, Navy, Air Force, Coast Guard, AEC, CAA, FCC, National Bureau of Standards, government development laboratories and other government agencies, well-known research laboratories and universities, foreign countries, and the nation's leading electronic parts distributors,

# 10,000,000\* Waiting to be SOLD!

**Perma-Power<sup>®</sup>  
TV TUBE  
BRITENER**

\* Over 10,000,000 television sets were purchased prior to 1951. Each of these has a picture tube which is getting dimmer . . . 10,000,000 set owners need the "TV TUBE BRITENER."

- Prolongs tube brilliance; fully automatic
- Isolates filament; relieves cathode filament shorts
- Eliminates nuisance calls
- Protects tube guarantee
- Made to sell; packaged to sell
- Producing sales everywhere

Get a  
**BRILLIANT  
PICTURE**

"TV TUBE BRITENER" was designed by engineers to produce sales for television servicemen. Adds brilliance to any picture tube; extends useful life of tube for year or more; adaptable for all tubes with duodecal base. Write for complete, illustrated literature. SOLD through recognized wholesalers ONLY. ORDER TODAY!

**Perma-Power<sup>®</sup> COMPANY**

4721 N. Damen Ave., Chicago 25, Ill.

Manufacturers of  
electronic equipment  
since 1928



## Voltage Regulated Power Supply

By J. W. HEINRICH

The modern voltage-regulated power supply is gaining increasing attention and popularity. Its basic advantage of low internal resistance minimizes one of the common sources of troubles associated with high-gain amplifiers. Experimenters find it especially useful as a reliable source of constant d.c. voltage to test the behavior and characteristics of new and experimental equipment.

The illustrated power supply was designed to deliver a constant d.c. output voltage adjustable from 250 to 400 volts at a maximum output current of 150 ma. Two unregulated a.c. filament voltages of 2.5 and 6.3 volts are also available at individual terminals on the panel. Separate fusing and switches are provided for both filament and d.c. voltages. The panel meters indicate the output terminal voltage and the total current drawn by the external load.

The entire unit is built on a 10 x 17 x 3-inch chassis and a 8 1/4-inch relay rack panel with side supports for the chassis. All wiring is cabled to give the unit a neat and professional appearance. The power supply, diagrammed in Fig. 1, uses a full-wave mercury-vapor rectifier with a capacitor input filter circuit. The distinction between this power supply and an unregulated type delivering similar output voltage and current is that the power transformer is considerably larger than would be required in the latter. This is due to the d.c. voltage requirements of the regulator tubes for proper circuit operation over the entire voltage and current range.

### Theory of operation

The regulator tubes serve to maintain constant output voltage by absorbing the excess voltage and applying all or part of it to the output terminals when the load voltage falls below the pre-set value. The regulator tubes serve essentially as a variable d.c. resistance between the power supply and the external load. This resistance is affected by changes in the grid bias of the regulator tubes. Increasing the bias causes an increase in the plate-to-cathode resistance; lowered bias causes a decrease in the series resistance.

The choice of regulator tubes is dictated by several considerations. The governing factor is the power that can be dissipated safely by the individual tube. The manufacturer's maximum rating for the particular tube should never

RADIO-ELECTRONICS



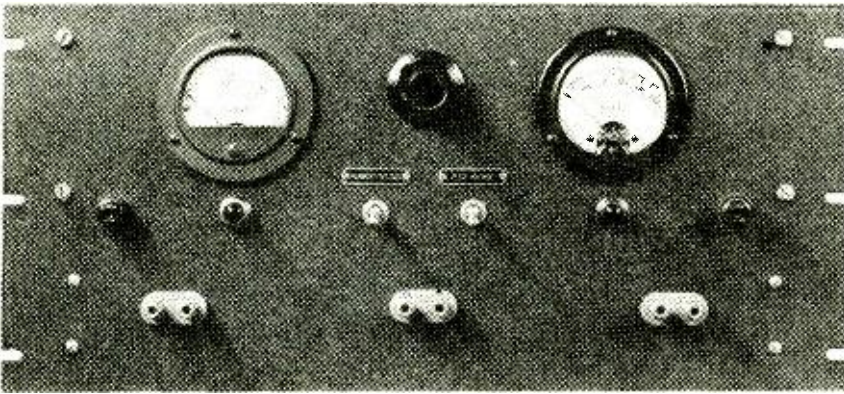

The supply is adapted to rack mounting. The meters indicate voltage and current.

be exceeded; this may be evaluated by:

$$P = I_p E_p$$

where  $I_p$  is the maximum individual plate current at a plate to cathode voltage of  $E_p$ . If a single tube will not handle the required power dissipation in the regulator circuit, two or more similar tubes can be paralleled. A larger tube, such as the 6AS7-G, may also be used. Its low internal impedance and large current capacity should make it a natural for this application, but it requires a sturdy filament transformer.

The control tube, a 6AC7, serves as a direct-coupled, high-gain voltage amplifier. Its grid is connected to a resistance network directly across the output terminals; the plate is connected to the grids of the regulator tubes. Slight changes in the output terminal voltage are amplified and applied to the grid circuit of the regulator tubes. The greater the over-all voltage gain, the more constant the output-terminal voltage will remain over the entire current range of the unit. There is a very slight change in output voltage at minimum and maximum output current. With the voltage control set at maximum, the d.c. voltage into the regulator is 620 volts with no load and 530 volts with a 150-ma drain. When the voltage control is adjusted for 250 volts, the input

to the regulator is 380 volts and 280 volts, respectively, for no load and a 150-ma drain. The maximum regulator bias is minus 118 volts. However, the output voltage drops only 2 volts at 400 volts output and 1.8 volts at 250 volts when the load is varied from 0 to 150 ma. The internal resistance of the supply is very close to 10 ohms and 13.5 ohms for 250 and 400 volts output, respectively.

Fig. 2 illustrates performance characteristics. The output voltage variations are referred to a constant voltage at the cathode of the control tube. If the output voltage decreases, there is a proportionate decrease in voltage at the grid of the control tube. This change in relation to the reference voltage at the cathode of the control tube results in increased grid bias, causing the plate current to decrease. This in turn results in a smaller voltage drop across the plate-load resistance. This causes the grids of the regulator tubes to become more positive with respect to their own cathode circuit. The reduced grid bias of the regulator tubes causes the plate-to-cathode resistance to decrease and the plate-to-cathode voltage drop across the tube is reduced. The output-terminal voltage then increases to its original value. If the output-terminal voltage

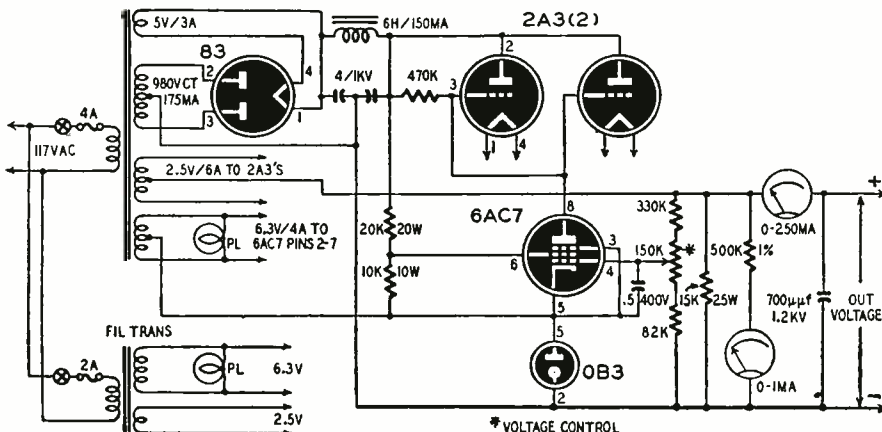
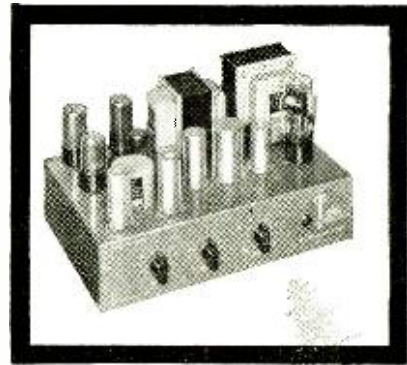

Fig. 1—Schematic of the supply. Output comes from the 2A3 filament circuit.  
APRIL, 1952



*your  
ear  
will  
tell  
you*

**the performance  
of the TRIAD  
Hi-Fidelity  
Amplifier is equal  
to that of amplifiers  
costing much more**

Listening tests conducted before groups of critical music lovers have proved that the difference in reproduction qualities between the low cost Triad Amplifier and the other higher priced units is undistinguishable. Available in kit form only, with complete assembly instructions, the Triad HF-10 Amplifier provides valuable experience while affording substantial savings. In quality and performance it is a fitting companion to the finest sound system components available today.

**prices**

HF-10 Kit — Includes S-31A, R-14A, A-74J and C-10X Triad transformers, chassis, prints and assembly instructions.....\$43.00

HF-10A Kit — Same as above except for substitution of HS-81 output transformer for S-31A..\$63.50

Both of above available with 500/250/125 ohm output

Write for Catalog  
TR-52

2254 So. Sepulveda Blvd.  
Los Angeles 64, California



**SO IMPORTANT** — it was  
Featured in Special Article  
in  
**The New York Times**

Jan. 28, 1952  
FREE copy  
of article on request

**UNIT REACTIVATES  
TV PICTURE TUBES**

Small Electronic Device Tests  
Sets at Home and May Add  
Year or More of Use

By T. R. KENNEDY Jr.

A small electronic device that can be applied to home television receivers to test and reactivate the picture tube without removing the tube from the set, resulting in renewed brightness in many and considerably longer useful life, has been placed on the market for the first time by a New York manufacturer.

In some cases it was said the picture tube may be made almost as good as new and given as much as a year's useful life before replacement is necessary.

The instrument is small and compact. It weighs three pounds, is as large as the average lunch box, coils into a carrying case, and is simple to operate. Picture tubes some of them new and never in a receiver have shown remarkable improvement in brilliance and definition after a few minutes of reactivation here in the last few days.

Although the principle of its operation is not new—cathode-ray tube manufacturers have used it for years in the initial making of picture tubes—the incorporation

The almost immediate urgent need for such an instrument, which also soon may be produced in sufficient quantity for home assembly is apparent. Eight to ten million TV picture tubes, Transvision engineers estimate, have now been in use for three to four years, and more, and probably are in need of test and reactivation to renew their brightness. Unfortunately, loss of brightness is not detected until, seldom, the old tubes with new ones in lately produced sets. Furthermore, picture tubes in their original cartons in stores may have lost some of their brightness which has been described as "aging process" to which all large cathode-ray tubes and similar devices are subject. Such tubes, in the current sizes most in use today cost from \$25 to \$65. New picture tubes can be tested and reactivated without removing them from their cartons, and tubes in TV sets without removing the tubes from the receivers. This is done by attaching a standard picture-tube socket to the tube, turning a switch on the instrument, turning a switch on the glow of a small neon bulb as a check on the tester's watch. The dial on the dial of the tube is indicated which is plugged into an AC home electric socket. The receiver, meanwhile, is not turned on. In some cases the test and reactivation is accomplished in less than ten minutes.



**TRANSVISION CR TUBE  
TESTER - REACTIVATOR**  
performs 2 vital functions:

- Tests Picture Tubes
- Renews Brightness of Many Dim Picture Tubes

It's a **TESTER**:

Without removing picture tube from set, you apply this precise instrument to:—

- Measure Cathode emission
- Locate shorts between elements
- Locate high resistance shorts or leakage as high as 3 megohms

It's a **REACTIVATOR**

for dim CR Picture Tubes

Revives dim TV Picture Tubes, without removal of tubes from sets. Works on a great many tubes with low light output, if there's no mechanical defect in tube. 110 V—60 cycles. Portable, weighs only 3 lbs. One or two applications pays for instrument.

SATISFACTION GUARANTEED \$19.95 NET or money refunded if you return the instrument in 10 days in good condition.

RUSH THIS COUPON  
TRANSVISION, INC.

DEPT. RE4 NEW ROCHELLE, N. Y.

- ( ) Send me CR Tube Tester-Reactivator(s).
- ( ) Enclosed find \$\_\_\_ deposit. Balance C.O.D.
- ( ) Enclosed find \$\_\_\_ in full. Send prepaid.

Name \_\_\_\_\_  
Address \_\_\_\_\_  
City \_\_\_\_\_ State \_\_\_\_\_

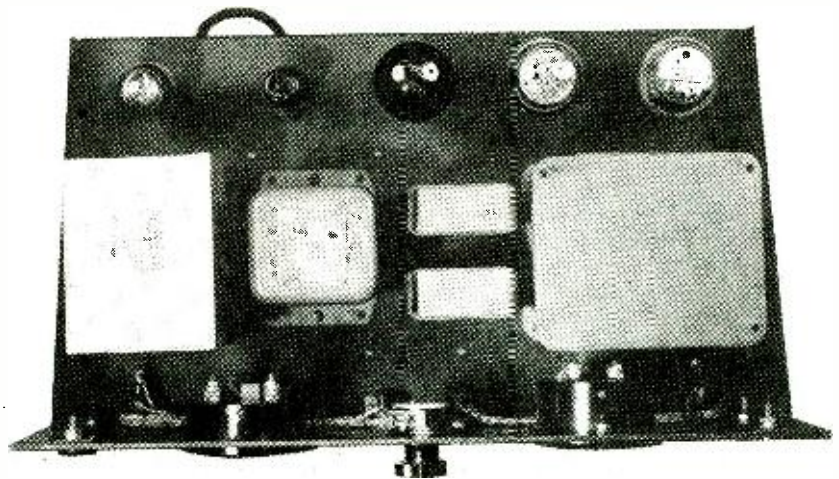

Top view. Control tubes are at left, rectifier center, and regulators at right.

should increase beyond its preset value it will cause a proportionate increase in the voltage at the grid of the control tube. This change in relation to the reference voltage in the cathode circuit results in a decrease in the grid bias of the control tube and an increase in its plate current. This in turn results in a greater voltage drop across its plate-load resistance and a decreased voltage between its plate and cathode. The grids of the regulator tubes become more negative with respect to their own cathode circuit. An increase in the bias of the regulator tubes causes an increased plate-to-cathode resistance which results in an output-terminal voltage reduced to its original value.

The bypass capacitor between the grid and cathode of the control tube prevents hum (which normally appears across the output terminals) from being amplified by the regulator circuit and modulating the output voltage. The hum level in this unit is so low that it cannot be measured with a copper-oxide rectifier type meter. Hum was checked with a PM speaker by connecting a high-impedance output transformer in series with a 4 µf capacitor across the output terminals. With the capacitor in the control-tube circuit and an output-terminal voltage of 250 volts the hum is reduced to a rushing noise similar to that found in high-gain amplifiers. At 400 volts output-terminal voltage the

pedance output transformer in series with a 4 µf capacitor across the output terminals. With the capacitor in the control-tube circuit and an output-terminal voltage of 250 volts the hum is reduced to a rushing noise similar to that found in high-gain amplifiers. At 400 volts output-terminal voltage the

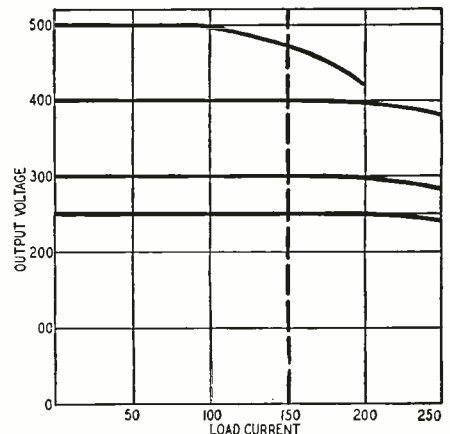
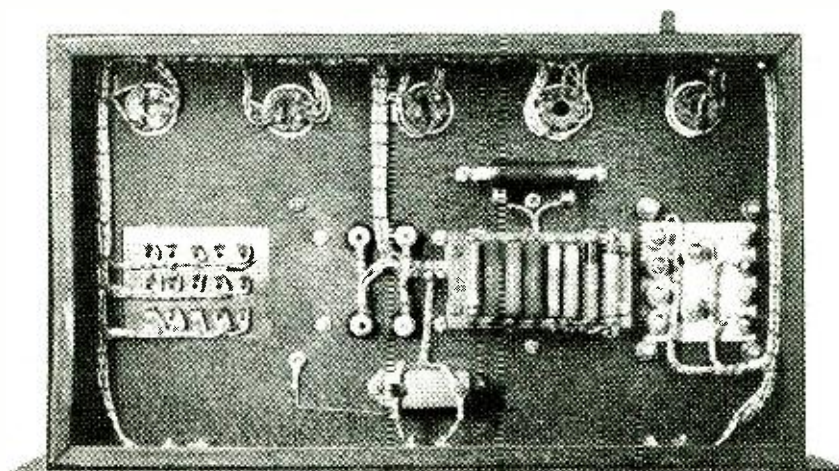

Fig. 2—Voltage with increasing loads.



Mr. Heinrich has a fine underchassis job. Wiring is clean and cabling is neat.

RADIO-ELECTRONICS



hum becomes only slightly audible. The time delay of this circuit is negligible.

The versatility and convenience of this voltage-regulated power supply will more than offset the initial cost of parts. It compares favorably in performance to commercial counterparts.

**Materials for regulated power supply**

**Resistors:** 1—10,000 ohms, 10 watts; 1—15,000 ohms, 25 watts; 1—20,000 ohms, 20 watts; 1—500,000 ohms, 1% precision; 1—82,000 ohms, 1/2 watt; 1—330,000 ohms, 1 watt; 1—150,000-ohm potentiometer.

**Capacitors:** (Paper) 2—4  $\mu$ f, 1,000 volts; 1—5  $\mu$ f, 400 volts; (Mica) 1—700  $\mu$ mf, 1,200 volts.

**Miscellaneous:** Tubes: 1—83, 2—2A3, 1—6AC7, 1—0B3, and sockets for same; 1—0-1-ma meter, 1-0 250 ma meter, 1—6-henry, 150-ma, 100-ohm filter choke, 1—filament transformer delivering 6.3 and 2.5 volts at about 3 to 10 amp, 1—UTC-5-39 power transformer, 2—s.p.s.t. toggle switches, 1—2-amp and 4-amp fuse and holders, 2—6.3-volt pilot lamps and assemblies, 1—knob, 3—dual terminal binding posts, name-plates, panel, chassis, hardware, wiring, and solder.

—end—

**PLUG-IN UNITS FOR EXPERIMENTERS**

The problem of constructing compact plug-in assemblies for experimental circuits is usually a tough one for the average experimenter or electronic design engineer. In many cases, the job requires metal-working tools and a lot of mechanical ingenuity, if feedback, stray coupling, and other electronic (and even mechanical) headaches are to be avoided.

Many such problems can be eliminated through use of the new plug-in package assemblies made by Alden

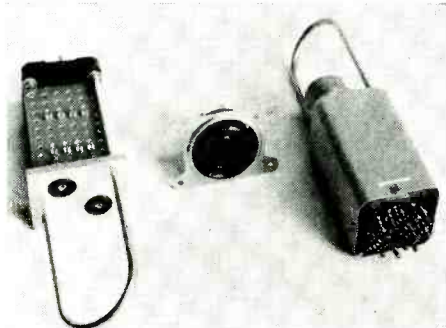

Products Co. The basic assembly unit consists of a 20-pin plug upon which is mounted either a single terminal board 2 x 2 7/16 inches or two boards 1 1/2 x 2 7/16 inches each. The boards are available with either single-ended or feed-through terminal lugs. A shield 3 1/4 inches high and approximately 2 inches square fits over the assembly. A bail-type handle is available for easy insertion and removal of the unit. The same basic assemblies are available with one and two 7- or 9-pin miniature sockets mounted on a plate atop the terminal board.

Such plug-in assemblies are suitable for use in constructing oscillators, special phono preamplifiers and equalizers, or matching pads; and for housing frequency-determining components of null indicators or oscillators, as well as for other applications too numerous to mention.

—end—

# TV DIRECT FROM THIS GREAT FACTORY TO YOU

BRINGS YOU

## Finest Quality at Lowest Prices

# TRANSVISION

### TV KITS, WIRED CHASSIS, and SETS

CABINETS, COMPONENTS, INSTRUMENTS, and ACCESSORIES

## SENSATIONAL OFFER

on top quality TV Picture Tubes.

- **FREE—VALUABLE PREMIUMS:**  
With every Transvision tube you buy, you get a Merchandise Premium Coupon of real value. Write for list today.
- **TRADE-IN ALLOWANCE** on old tubes: Make from \$2.50 to \$5.00 glass allowance on each "dud."
- **FULL 2 YR GUARANTEE:**  
Only Transvision gives you a Guarantee for 24 months.

**COMPARE:** Get the full details on the Transvision tube deal today.

**FREE BOOKLET:** "INSIDE CRT, or What You Should Know about Picture Tubes". Written by CRT experts, illustrated. It will **MAKE MONEY FOR YOU. WRITE FOR IT.**

Type	Your Cost if no old tube is traded in— DEALER PRICE—	Allowance for old tube	Your FINAL COST, if old tube is turned in. DEALER NET—
10BP4	\$17.95	\$2.50	\$15.45
12JP4	17.95	2.50	15.45
12LP4	19.95	3.00	16.95
14RP4	19.95	3.00	16.95
16DP4	27.95	4.00	23.95
17BP4	25.95	4.00	21.95
19AP4	37.00	5.00	32.00
20CP4	35.95	5.00	30.95
24AP4	69.95	—	—

**SPECIAL!**

REMOTE CONTROL TV CHASSIS

Here's the finest buy in Remote Control TV. Unit is all-electronic; no troublesome mechanical parts. Gives complete operating control of set. Plus—the latest Transvision A-4 Wired TV Chassis: completely aligned; ready to plug in. Has AFC and AGC. Top quality reception, even in fringe areas. 17" A-4 TV Chassis, remote control, and CRT, net \$199. 20" A-4 TV Chassis, remote control, and CRT, net 219. With Du Mont Tuner and FM radio, add..... 10

**BEAUTIFUL TV CONSOLES**  
Ideal for Custom-Building or Conversion. Factory prices start from \$10. Send for Cabinet Catalog now.

THE HEART OF YOUR TELEVISION SET IS THE CHASSIS. YOUR SET IS ONLY AS GOOD AS THE CHASSIS IN IT.

## FIELD STRENGTH METER AT NEW LOW PRICE

Improve TV installations; save half the work with the Transvision Field Strength Meter. **\$59 net**

## MULTI-SET CONNECTORS

Feed up to 5 TV Sets from 1 Antenna

Prices: Multi-Set Conn. for 2 sets ..... \$4.95 list\*  
For 3 or 4 sets ..... 7.95 list\*

\*Dealers, write for discounts

Want to Make More Money in TV?  
Write for the Transvision Factory Agent Plan.

**FREE: EXTRA INCOME EVERY MONTH** from hints in "TV and Electronics Notes." Request or send 50c to cover cost of sample copy, plate and mailing for FREE Subscription. Monthly issues are gold mines of info on New Products, Sales, Service, Conversion, etc. **WRITE DEPT. RE4 TODAY!**

TRANSVISION, INC. NEW ROCHELLE, N. Y.

# MAINTAINING TWO-WAY RADIO

By HARDIN G. STRATMAN

Part II—Two useful instruments for use in mobile radio maintenance.

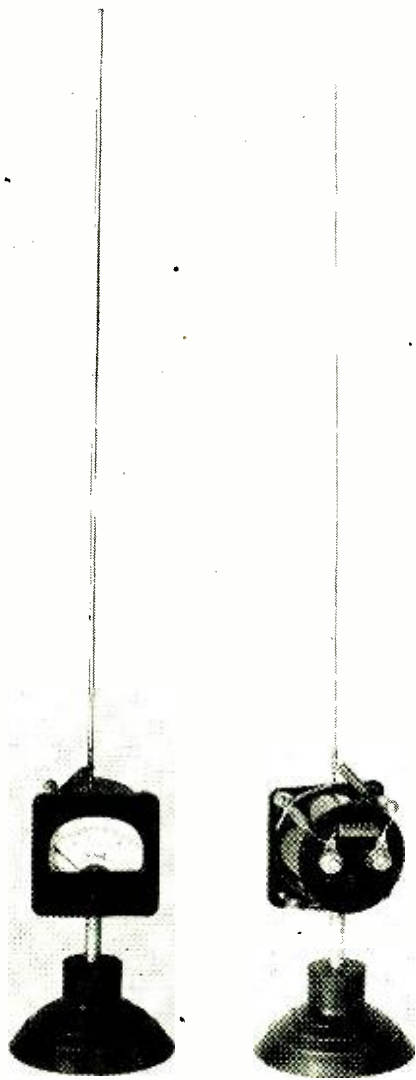

Two views of the field strength meter.

**I**N servicing mobile two-way radio units a bench setup duplicating actual operating conditions will prove a great help. This will necessitate having an extra set of cables, control head, speaker, battery and associated charger, and a microphone. An extra microphone on hand is especially desirable, so that a bad one can be quickly replaced on the road and fixed at leisure. Mike troubles often entail replacing the cord, which takes considerable time and care.

## Helpful home-made instruments

Two easily made devices that will greatly simplify and speed up the tuning of transmitters are a dummy antenna and a field strength meter indicating relative values. If a transmitter is tuned up while connected to its antenna, it will naturally radiate energy and cause interference in the communications band. If the output stage is not connected to the antenna and is left floating, excessive r.f. voltage may cause damage to the output tube or components, and the readings of most of the other stages will not be the same as

when the output stage is delivering power to a load. A dummy load connected to the transmitter output receptacle is a servicing necessity. One that absorbs a maximum of energy and matches the impedance of the antenna is preferable. The transmitter can then be tuned up in the normal manner and no great change in the final power amplifier tuning will be needed when connected to the antenna for final adjustment. Such a dummy antenna is easily made (Fig. 1).

Remove the base of a 25-watt, 32-volt light bulb, being careful to protect the two flexible leads; cut a 2½-inch length of RG-8/U cable and remove the inner conductor. Ream out the core of one end of this piece of cable to a depth of about an inch with a 3/16-inch drill. Cut off about an inch-long piece of the outside braid from this end and place it over the insulating material opposite the reamed end, and solder this shielding braid in an 83-1SPN Amphenol plug in the manner that a coaxial line is usually terminated. Solder a three- or four-inch piece of about No. 22 wire to one of the flexible leads of the light bulb and draw it through the center hole of the short length of coaxial line, starting with the reamed-out end (this extended lead becomes the center conductor). Push the reamed-out end of the coax slowly over the glass seal while at the same time drawing the center lead from the light bulb through the coax, and at the same time, see that the other light bulb lead is on the outside of the coax. Pour a little coil dope, glyptal, or acroloid around the outside of the junction of coax with light bulb to strengthen the joint. For frequencies from 150 to 200 mc remove all but one stator plate and one rotor plate from an APC 25 capacitor, and solder the rotor connecting lug to the outside shell of the coaxial plug. Solder the

free lead of the light bulb to the stator connection of the variable capacitor. The photo and drawing show the construction details.

Tests were made with a Jones model MM-200 Micromatch and coupler unit to determine the loading and standing-wave ratio of both the quarter-wave antenna used with the mobile equipment and the dummy antenna described above. The antenna was found to have a standing-wave ratio of from 1:1.15 to 1:1.3, depending somewhat upon the length of coaxial line used to connect it to the transmitter. The dummy antenna described above was checked and its loading could be varied over quite

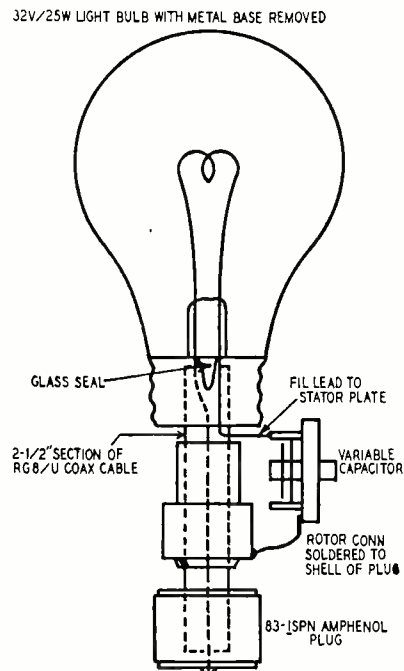
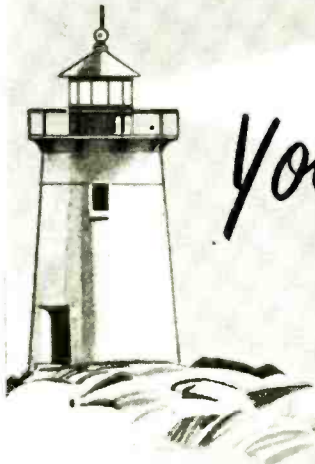

Fig. 1—Details of the dummy antenna.  
RADIO-ELECTRONICS



A Guiding Beacon For  
Quality Electronic Parts

Your Local  
**RADIART**  
Distributor



**RADIART Sales Offices Across The Nation**



**These Are The Cities With  
RADIART Distributors  
In Arizona and California**

**ARIZONA**

PHOENIX

TUSCON

**CALIFORNIA**

ALHAMBRA  
BAKERSFIELD  
BURBANK  
EL CENTRO  
GLENDALE  
HOLLYWOOD  
INGLEWOOD  
LONG BEACH

LOS ANGELES  
PASADENA  
SAN BERNADINO  
SAN DIEGO  
SANTA ANA  
SANTA BARBARA  
SOUTH GATE

**BUY OF THE MONTH**



The RADIART line of auto aerials offers a wide variety. Featured is the "H1-BALL 8 BD", the most versatile highest quality of its type at the lowest price . . . only \$5.05 list. It has 30 degree mast adjustment and fits all body and fender contours. Some of the other features include stainless steel rod, "Super-chrome" finish on heavy duty brass mast, full polyethylene lead-in and others. So why pay more — get the best for less! See your RADIART distributor or write us —

**FOR NAME OF YOUR NEAREST RADIART DISTRIBUTOR  
USE COUPON BELOW**

**RADIART SALES CO. 10373 W. Pico Blvd., Los Angeles 64, California**

..... Please send names of the Radiart Distributors in my area stocking the following Radiart products in which I am interested:  Tele-Rotors,  Vibrators,  TV and FM Antennas,  "Spee-Dee" Chimney Mounts,  Lightning Arresters,  Auto Aerials,  Power Supplies  
..... Please have a Radiart Distributor call on me.

Name .....

Address .....

City ..... State .....



**THE RADIART CORPORATION CLEVELAND 2, OHIO**

VIBRATORS • AUTO AERIALS • TV ANTENNAS • ROTATORS • POWER SUPPLIES

# All Channel Reception



With Extra Performance  
WHERE YOU NEED IT

WITH **DUBL-VEE**

BY **WORKSHOP**

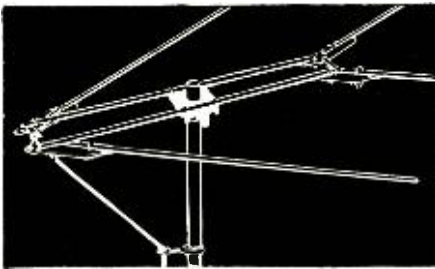

In the high bands . . . it's the original patented **Dubl-Vee** specially designed by **WORKSHOP** engineers to "bring-in" extra signal on channels 7 thru 13, while retaining excellent reception on channels 2 thru 6.

Gains up to 8 db for single bays and 10 db for double bays assure maximum signal. Rugged, streamlined construction cuts wind resistance. Only the **Dubl-Vee** gives these performance extras . . . tops for signal and tops for strength.

On your next installation, install the **WORKSHOP** **Dubl-Vee** . . . the original **Dubl-Vee** designed and patented by **WORKSHOP** . . . at radio parts distributors everywhere.



**THE WORKSHOP ASSOCIATES**  
Division of the Gabriel Co.  
135 Crescent Road  
Needham Heights 94, Mass.

a wide range by merely adjusting the capacitor setting. At one adjustment of the variable capacitor, practically unity standing wave ratio was obtained. This was noted at 155.85 mc with the capacitor about one-quarter meshed. The bulb will not necessarily light brightest at this point. The brightest point was found to be slightly to one side of the lowest standing-wave ratio point. The dummy antenna was then adjusted to have a standing wave ratio of 1:1.2 which coincided approximately with the standing wave ratio of the antenna. This was accomplished with the capacitor still about one-quarter meshed.

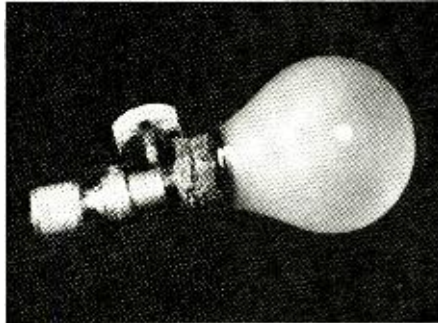

A photograph of the dummy antenna.

Upon completion of the above tests, the power-amplifier stage and output tuning of one of the transmitters was adjusted in the conventional manner with the dummy connected. When the transmitter output was shifted to the antenna, no difference in plate or output tuning was noted. A dummy load made as recommended could easily be adjusted for a load equal to that of the antenna by tuning the output stage of the transmitter in the usual manner with the antenna connected and then shifting to the dummy antenna and adjusting the variable capacitor on the dummy until the plate current is the same as it is with the antenna connected.

This particular dummy load was found very effective for many low-power applications. It can present a standing-wave ratio of unity to a transmitter at any frequency from 50 to 200 mc by adjusting the variable capacitor. At 50 mc the capacitor (without any plates removed) will be fully meshed. At 200 mc the capacitor will be barely meshing (with all but one stator and one rotor plate removed). This is true only when the r.f. output line impedance ranges over the usual 20 to 100 ohms.

The meter to be described is more convenient to use and an improvement over an earlier one described by me<sup>1</sup>. To construct a relative reading field-strength meter: Fasten a good 0-1-milliamperemeter to a large suction cup as shown in the drawing (Fig. 2-a) and photograph. Fasten a solder lug to each of the two top mounting holes and solder a length of No. 12 bus wire one-quarter wavelength long at the frequency used (about 16 inches for the 152- to 162-mc band) to one of these lugs. Connect an Ohmite Z-144 or some other effective choke from this lug to the positive meter terminal. From this same lug, connect another Ohmite Z-144

choke to the other lug. To this second lug connect the cathode side of a 1N34 crystal (see Fig. 2-b). The other crystal lead goes to the negative meter terminal. Connect a 30- $\mu$ f ceramic capacitor across the meter terminals. The rod inserted in the rubber suction cup is fastened to the bar soldered across the lower meter-mounting studs. By using the suction cup, the field strength meter can be easily positioned near the transmitting antenna on the body of the car. The transmitter output stage is tuned for maximum reading. The field-strength meter will read full scale when placed three or four feet away from the transmitting antenna of a properly tuned 30-watt transmitter. A maximum reading on the field strength meter will coincide with the plate-current dip at resonance when properly tuned. The transmitter can be completely tuned up while connected to the dummy antenna, then the output stage can be quickly peaked for final adjustment when connected to the antenna by using the field-strength meter.

(The photos of the units were taken by Bill Fisher of Gates Radio Co.)

### Oddities in the field

Some interesting situations occasionally arise in the course of operating and maintaining a mobile two-way radio system. A technician can seem almost clairvoyant to the average client when trouble has arisen in a mobile rig, by opening the trunk door in the

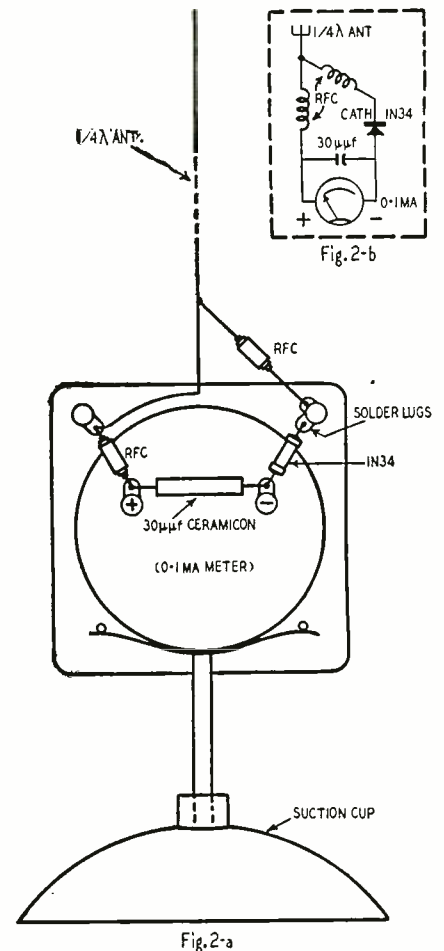
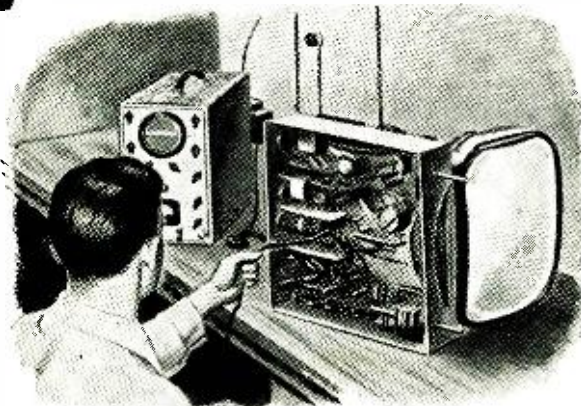

Fig. 2—Meter schematic and details.  
RADIO-ELECTRONICS



# Here's your Opportunity



## to prepare for a good job or a business of your own in TV SERVICING

**There are today more good jobs** open in TV Servicing than there are trained and experienced men to fill them. Yes, thousands of opportunities exist now for good-pay jobs offering employment security for years and years to come. Thousands of TV Servicing jobs are going begging. Do you want one of them?

Experts agree, that because of the critical shortage of trained and experienced TV Servicemen, and the tremendous future growth of the industry, no vocational field today offers more opportunities than TV Servicing.

### The Big New Industry with a Great Future

Television is just in the beginning stages of its big industrial boom. Look at these amazing facts:

- Lifting the freeze on new TV stations will open many new TV areas and will improve the coverage of existing areas. The result will be an enormous demand for TV receivers.
- Within a few years over 1000 TV stations will be telecasting compared with 108 TV stations now on the air.
- Nearly one-half of all families living within the present TV areas do not yet own TV receivers.
- The new trans-continental video network plus better and more interesting programs plus larger viewing screens and color TV will increase the installation of new receivers, will induce present owners of 12-inch and smaller size viewing screens to buy newer model receivers.
- The power increases of many existing stations and improved reception range of current receivers will result in receivers being installed and serviced in the fringe areas of present stations.
- Under the FCC proposal, over 70 per cent of all communities will be served by UHF channels exclusively. This means TV servicemen must know UHF receivers before the new UHF stations in their area are opened.
- No one yet knows how great the industrial TV market will be.

### RCA Institutes Home Study Course prepares you for a Career in TV Servicing

The addition of the RCA Institutes TV Service Training to your present radio-electronics experience will qualify you to step out and grasp the golden opportunities that now exist in television—America's fastest growing industry.

Learn at home—in your spare time—while you study the practical *how-to-do-it* techniques with *how-it-works* information. Easy-to-read and easy-to-understand lessons under the supervision of RCA engineers and experienced instructors quickly train you to qualify for the many good jobs now waiting for trained TV servicemen. Don't pass up this lifetime opportunity for financial security and a bright future in TV. Learn TV Servicing from RCA—pioneers and leaders in radio, television and electronic developments.

RCA Institutes conducts a resident school in New York City offering day and evening courses in Radio and TV Servicing, Radio Code and Radio Operating, Radio Broadcasting, Advanced Technology. Write for free catalog on resident courses.

## Send for FREE BOOKLET

Mail the coupon—today. Get complete information on the RCA INSTITUTES Home Study Course in Television Servicing. Booklet gives you a general outline of the course by units. See how this practical home study course trains you quickly, easily. Mail coupon in envelope or paste on postal card.



## MAIL COUPON NOW!

RCA INSTITUTES, INC., Home Study Department RE-452  
350 West Fourth Street, New York 14, N. Y.

Without obligation on my part, please send me copy of booklet "RCA INSTITUTES Home Study Course in TELEVISION SERVICING." (No salesman will call.)

Name \_\_\_\_\_ (please print)  
Address \_\_\_\_\_  
City \_\_\_\_\_ Zone \_\_\_\_\_ State \_\_\_\_\_

**RCA INSTITUTES, INC.**  
A SERVICE OF RADIO CORPORATION of AMERICA  
350 WEST FOURTH STREET, NEW YORK 14, N. Y.



**FOR PERFECTION**



in TV INSTALLATIONS  
in any locality use the new

**Simpson MODEL 488  
TV FIELD STRENGTH METER**

Ideal for antenna orientation, comparison of antenna systems, adjustment of TV signal boosters, checking antenna and lead-in installations and many other functions . . . the 50 microvolt full scale range is an outstanding feature for those concerned with fringe area installations where maximum efficiency must be attained . . . the 500, 5,000 and 50,000 microvolt ranges extend the usefulness of the Simpson Model 488 into areas of higher signal strength.

**SIMPSON ELECTRIC COMPANY**  
5200 WEST KINZIE STREET, CHICAGO 44, ILL.  
Phone: CO lumbus 1-1221  
In Canada: Bach-Simpson, Ltd., London, Ontario

**TRY  
CLAROSTAT'S  
RTV  
PROGRAM!**

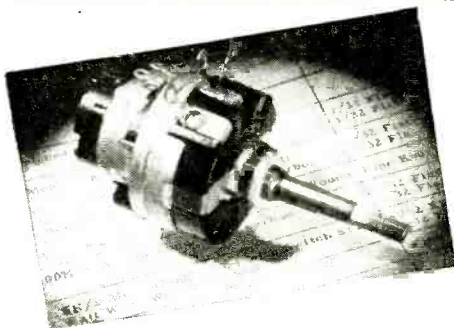

By all means, TRY IT! Because, when it comes to those tricky TV control replacements, you can save time, trouble, money and even reputation with Clarostat's RTV program. It means exact-duplicate replacements that positively match initial equipment. In many cases the RTV replacements cost less than any makeshift or "kit" assembly. Prove it for yourself.

And of course where standard controls, plus Ad-A-Switches and Pick-A-Shafts, can do the trick, Clarostat has them too.

Ask your Clarostat distributor for the *Clarostat TV Control Replacement Manual* (with supplements). Also for the latest *Clarostat Catalog No. 51*.



**Controls and Resistors**

CLAROSTAT MFG. CO., INC., DOVER, NEW HAMPSHIRE  
In Canada: Canadian Marconi Co., Ltd., Toronto, Ontario

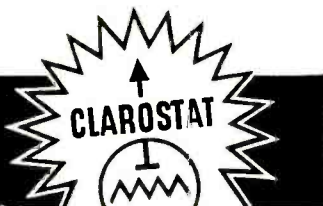

dark, and observing which, if any, of the tubes is not lit. Since a large percentage of failures will be due to burned-out tube filaments, this is one of the prior processes in diagnosis of trouble.

Outside interference has seldom been noticed on this radio equipment, but it can be a minor source of trouble. It has never been known to have been tracked down except in one instance when a clear-channel station about a thousand miles away was heard quite distinctly for several hours. It came over one of the control-station receivers. Upon checking with amateur operators, that particular night was found to abound with reports of freak radio reception over the whole country.

The main control station should be protected by lightning arresters. Ours was once hit by lightning and all the wires and parts on the underside of the chassis of one of the transmitters were welded into one inseparable mass of metal.

To demonstrate how proper design and installation of the equipment pays off in reliable communication, consider the lesson to be learned from an actual incident:

A patrol car was so totally wrecked as to necessitate its being junked; the radio was unharmed and was used to summon aid at that time, although the car was lying on its side. Even in that unconventional position, operation was perfect.

During an ice storm, a car antenna was encased in a thick coating of ice about one-half inch in diameter from the tip of the antenna to the body of the car, but no ill effects whatever were noted!

In the long run, troubles encountered on standard type equipment will follow a definite pattern. After experience, a certain trouble will suggest a particular cause. A good memory is a highly valuable asset to the service technician.

RADIO-ELECTRONICS, June 1951  
—end—



Suggested by:  
Leslie Boisen, Indianapolis, Ind.



Industrials



Communications



**SANGAMO**  
*Capacitors*

papers 

micas 

buttons 

electrolytics 

All approved for Armed Services applications

*Those who know...choose Sangamo*  
for every radio and  
electronic application

SANGAMO Capacitors have been the choice of discriminating users for a quarter of a century. Radio servicemen, amateurs, electronic engineers, the Armed Services—all testify to the design, construction, honesty of characteristics, and conservativeness of ratings of Sangamo capacitors.

Television

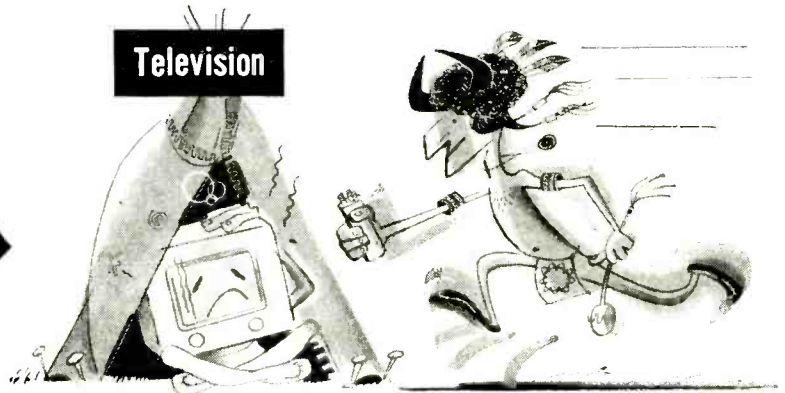

Armed Services



  
**SANGAMO**  
**ELECTRIC COMPANY**  
MARION, ILLINOIS  
IN CANADA  
SANGAMO COMPANY LIMITED, LEASIDE, ONTARIO



**41% MORE GAIN**  
than the best 5 element Yagi

**GIVES EQUAL GAIN TO A DOUBLE-STACKED 5 ELEMENT YAGI ARRAY**

*at lower cost!*

MODEL LJ \$12.50 LIST  
for Channels 7-13

**COMPARE THESE TIME AND MONEY SAVING FEATURES**

- Faster, easier to install than stacked arrays
- Better roof-top appearance
- Higher front-to-back ratio eliminates co-channel interference
- Full 6 megacycle band width
- Rugged pre-assembled construction
- Low channels (2-6) have 1 1/4" reinforced boom of highest quality aluminum tubing and extra rugged VEE-type clamp (CL-10) which allows use of mast up to 2" diameter

*Another Great Product by* **VEE-D-X**

**Originators of the World's Most Powerful TV Antenna Systems**

THE LaPOINTE-PLASCOMOLD CORPORATION  
Windsor Locks, Connecticut

Gentlemen:  
Send me complete information on Long John

Name .....

Street .....

City..... Zone.....

State .....

Check here if technician

Placing the dome atop the equipotential rings of the Statitron in the laboratory. The high-pressure tank covers this complete assembly.

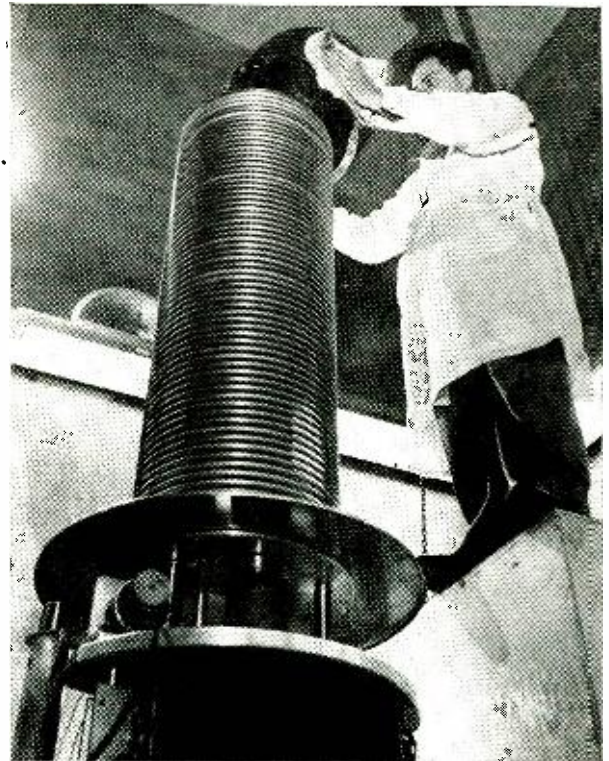

# An Electronic Hammer For Material Testing

By S. M. MILANOWSKI

THE Statitron, an unusual electronic generator now being used in the Atomic Energy Development Laboratory at North American Aviation's plant near Downey, Calif., has been picturesquely termed a "hammer" because it is used to bombard materials with electrons, to displace or rearrange their atoms.

It is related to the Van de Graaf electrostatic generators used in the production of atomic bombs, and is believed to be the first device of this type that has been designed for commercial applications. However, it should not be confused with the atom-smashing cyclotrons or synchrotrons for it is incapable of causing nuclear fission.

The Synchrotron develops 300 MEV (million electron volts) while splitting atoms, whereas the Statitron is rated at only 2 MEV which is insufficient to produce nuclear fission. However, the energy output of the Statitron can be controlled with more precision than that of so-called atom smashers.

At this writing, the Statitron is being used almost exclusively in testing metals and other materials used in the construction of modern airplanes, determining with unprecedented accuracy the forces that may cause structural materials to fail in actual use. Many

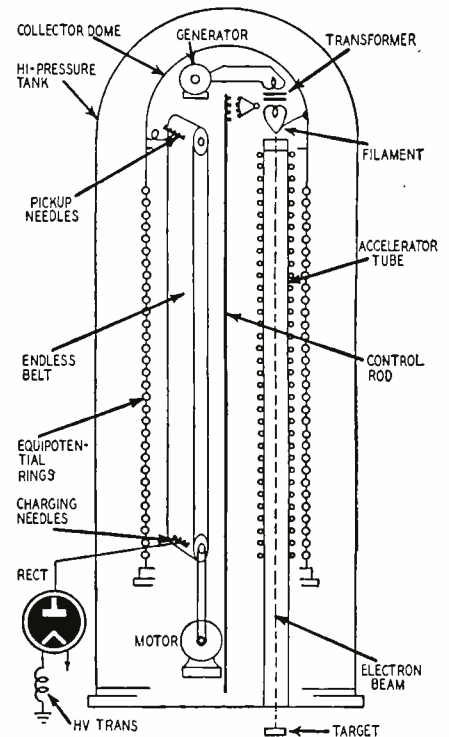

Idealized schematic of the equipment.  
RADIO-ELECTRONICS





# WHAT IS TEK- FILE?

1. Tek-File is Rider TV service data in individual package form . . . grouped according to manufacturers.

2. Each Tek-File Pack contains a minimum of 128 pages (8½ x 11") separated into file folders for fast, easy reference; perfect for house calls.

3. New Tek-File packs are available every month . . . so far, a total of 48 packs have been issued.

4. All Tek-File data is the official, complete factory-issued data direct from the manufacturer . . . *not* edited, abridged or prepared by an independent laboratory.

5. Tek-File makes servicing easy. Each pack contains all the manufacturer's data you need . . . and it's guaranteed to match the set! Schematics, chassis views, troubleshooting test patterns, parts lists, circuit changes . . . it's all there!

6. Check these Tek-File extras: Free index covering all Tek-File packs at your jobber. Free coupon in each pack; 15 gives you permanent binder for Tek-File shelf use. Free Tek-File Handies containing the manufacturer's cures for troubles.

Remember, all this for only \$2.00! Buy it from your jobber . . . today!

**JOHN F. RIDER**

PUBLISHER, INC.

480 Canal St., N. Y. 13, N. Y.



# NOW YOU'LL Really Know How to Use 'Scopes!

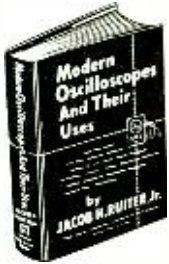

Don't let the oscilloscope "stump" you! Learn to use it fully on all sorts of jobs—and watch your efficiency soar!

## MODERN OSCILLOSCOPES AND THEIR USES

BY JACOB H. RUITER, Jr.  
of Allen B. DuMont Laboratories, Inc.  
326 pages, 370 illustrations, \$6.00

Here at last is a book that makes it easy for you to become expert in the many uses of the greatest, most versatile service instrument of all—the oscilloscope! It contains no involved mathematics. First, the author explains oscilloscopes fully—then gets right down to earth in telling exactly how to use them on AM, FM and TV service work . . . from locating receiver troubles to aligning and adjusting the most complicated circuits.

### HOW THEY WORK

Expert knowledge of oscilloscopes helps you work faster, far more accurately and more profitably on all sorts of service and laboratory jobs. Basic subjects covered include:

1—Introduction to Oscilloscopes; 2—History of the Oscillograph; 3—Development of the Cathode Ray Tube; 4—Principles of Cathode Ray Tube Operation; 5—Details of the Modern Cathode Ray Tube; 6—The General-Purpose Oscilloscope; 7—Power-Supply Circuits; 8—Amplifiers, Attenuators and Positioning Circuits; 9—Time-Base Circuits.

### HOW TO USE OSCILLOSCOPES ON ALL TYPES OF JOBS

Each operation is carefully explained including the making of connections, adjustment of circuit components, setting the oscilloscope controls and analyzing patterns. About 400 illustrations including dozens of pattern photos make things doubly clear. Here are the specific how-to-do-it subjects covered; 10—Operation; 11—Interpretation of Basic Patterns; 12—Auxiliary Equipment; 13—Typical Applications in Electronics; 14—Servicing A-M Receivers; 15—Servicing F-M Receivers; 16—Television Receiver Servicing; 17—Use of the Radio Transmitter; 18—Using the Oscilloscope in Teaching; 19—Additional Industrial Uses; 20—Photographing Cathode Ray Tube Patterns; (a) Glossary. **Send coupon today!**

### READ IT 10 DAYS . . . at our risk!

Dept. RE-42, RINEHART BOOKS, Inc.,  
Technical Division,  
252 Madison Avenue, New York 16, N. Y.

Send MODERN OSCILLOSCOPES AND THEIR USES for 10-DAY FREE EXAMINATION. If book is satisfactory, I will then send you \$6.00 promptly in full payment. If not, I will return book postpaid in good condition and owe you nothing.

Name.....

Address.....

City, Zone, State.....

Employer's Name and Address.....

Price outside U.S.A. \$6.50, cash only.  
Money back if you return book within 10 days.

other applications in various industrial fields should be equally practical.

Blows from the electronic hammer may be used like blows from a conventional drophammer to fabricate extremely small articles or to produce fine details on relatively large articles. In many circumstances, the output of a Statitron can be utilized more effectively than the output of an X-ray machine since its electronic beam can penetrate many substances (such as a two-foot layer of solid steel) which would dissipate gamma radiations of the types that have heretofore been generated for industrial inspection work, medical diagnoses or treatments, etc.

As shown in accompanying illustrations, the Statitron might be described as a giant vacuum tube—comprising in general a cylindrical pressure tank about 9½ feet tall and 40 inches in diameter, mounted on a 30-inch-high base. The pressure tank is an 1,800-pound steel casting, and serves as an airtight housing for an internal tower comprising 63 equipotential rings or ribs which are stacked vertically and spaced by a ribbed ceramic insulator

pose of which is to mechanically convey high-voltage electrostatic charges from a sequence of charging needles at the lower end of the equipotential column to a series of discharge needles in the collector dome on top of the column. The belt is operated at a constant speed of 3,000 feet per minute, and its charges are obtained from an a.c. power line through a conventional transformer-rectifier circuit.

A hot filament in the collector dome releases accumulated electrostatic charges as they are required, so that the charges are literally "thrown downhill" (at the rate of 60 thousand billion electrons per second) through the evacuated accelerator tube, the purpose of which is to accelerate the released particles to approximately the speed of light as the electrons bombard a "target" (at ground potential) at the base of the Statitron.

Dry nitrogen (obtained from liquid air) provides a pressure of 200 pounds per square inch for operational elements in the electronic hammer's pressure tank, so that a constant potential of two million volts can be maintained in the collector dome while a potential

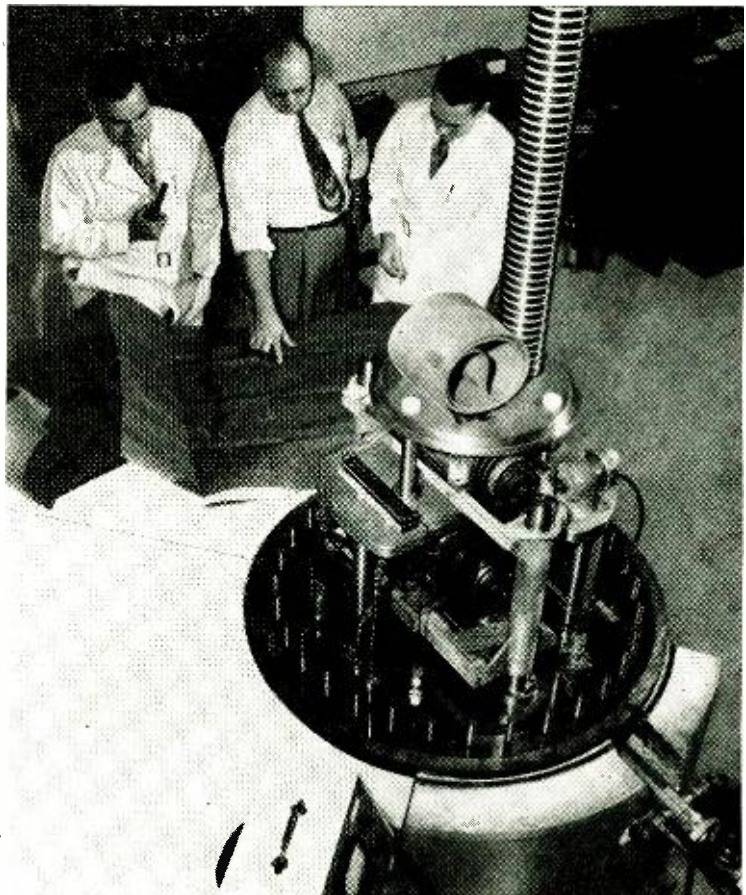

This view, shows the "cannon" down which the electrons are projected.

on each ring. The tower in turn serves as an electrostatic housing for an endless friction belt and a ribbed accelerator tube, and is capped by a highly polished metal collector dome.

Two pulleys, one in the collector dome and the other mounted so that it can be motor-driven from the base of the Statitron, serve as vertical mounts for the endless friction belt, the pur-

of 25 to 35 kilovolts is maintained between the equipotential rings.

The Statitron is housed in a lead-and-concrete room, and is controlled by workers from outside the room because its radiation leakage is believed to greatly exceed the radiation tolerance of the human body for any continued exposure.

The effectiveness of the unit in pres-





Famous RCA-515S2 15" Duo-cone high-fidelity speaker

## A complete line of quality speakers from one dependable source

RCA *quality-line* speakers employ *full-size Alnico V magnets* for top efficiency and performance... yet they are popularly priced for replacement needs. You'll find a PM or field-coil type to meet virtually every requirement for home and auto radios, for television receivers, as well as for public address and high-fidelity systems.

From the miniature 2" x 3" to the superb 15" Duo-cone—each RCA *quality-line* speaker is skillfully designed, fabricated from the finest materials, and produced under the most rigid quality-control methods.

RCA *quality-line* speakers offer you a better selling potential, because they're backed by the greatest

name in radio—a name that insures unqualified customer acceptance.

Look to RCA—and your *RCA Parts Distributor*—as the dependable source for *all* your speaker requirements.

### Get the Handy RCA Flip-Up Speaker Index

Here are all the electrical and mechanical specifications on the complete line of RCA speakers—right at your fingertips. Get your free copy today from your *RCA Parts Distributor*.

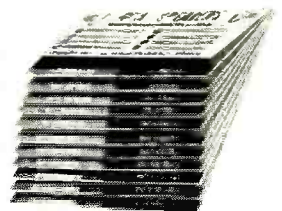

**RADIO CORPORATION of AMERICA**  
**ELECTRONIC COMPONENTS** **HARRISON, N. J.**



**Just Published**



**EXACTLY what you want in servicing instruction**

- detailed, illustrated trouble-shooting procedures
- for every flaw or failure you're likely to encounter in any TV receiver
- completely and clearly indexed for quick reference

**You'll find**

Handy lists of troubles that may occur in each section of the TV receiver and the exact procedures for correcting each.

Large clear block diagrams of typical commercial circuits for tuners, focus control systems, R-F voltage supply, sync separator systems and all other basic TV receiver circuits.

New original photographs showing actual symptoms of trouble on TV screens to aid identification.

Full explanation of unusual, hard-to-find troubles and how to fix them, as well as all ordinary defects.

Complete instruction on the use of testing equipment, and oscilloscope patterns to facilitate the checking of test results.

Ways of improving overall performance; how to improve gain, reduce ghost reception, minimize interference.

Special servicing instruction for color TV and for VHF and UHF receivers.

Whatever the trouble, in picture or sound, you'll be able to put your finger on it quickly and accurately with the aid of this book. More important, you'll KNOW HOW TO FIX IT, without guesswork or trial and error, and with full assurance that the trouble is REALLY CORRECTED.

A complete master index, in clear, convenient tabular form, lists over 100 trouble symptoms—all the various hums, sound distortions, streaks and bars on picture, focus defects and all others that you're likely to find—with the probable causes of each and the page on which full servicing instruction for that particular fault is given.

You won't have to thumb through batches of manufacturers' notes, never sure that you have the right directions for the latest improvements or changes. Here are the instructions you need for correcting trouble in each circuit in any set, and the CLEAR UNDERSTANDING of each circuit you need in order to BE SURE that the adjustments you make will achieve the desired results.

*300 illus.  
A handy 421-page,  
fact-packed guide*



**Are these top-ranking aids on your working reference shelf?**

and much more

**Fischer's RADIO & TV MATHEMATICS**

"An extremely useful reference," wrote *Radio News* about this unique book. Here are step-by-step solutions, showing what formulas to use and what numerical values to substitute, for HUNDREDS of typical radio and TV servicing, construction, and operational problems, arranged under radio topics for quick reference.

**Noll & Mandl's TELEVISION & FM ANTENNA GUIDE**

A basic course on antenna theory combined with a complete handbook on antennas and their installation. Shows how to pick the right antenna for the site, determine the best position for it, install transmission line for maximum efficiency and all other practical details for getting the most out of the antenna system.

**Noll's TV FOR RADIOMEN**

Explains very clearly and fully all basic principles of television reception, the essentials of TV transmission, and the construction and operation of each part of modern TV receiving systems; and gives step-by-step instruction in installation, adjustment, alignment, and basic trouble-shooting procedures. A basic book for anyone in television servicing, noted for clarity and completeness. Here are all the fundamental why's and how's by a man known throughout the country as a leading authority on the technical aspects of television.

ent test operations is attributed to the fact that its energy output can be measured with infinitesimal accuracy, making it possible for scientists to determine the precise number of electronic blows that may be sustained before rupture of a test specimen—since a prolonged or extensive displacement of atoms will cause any material to break down.

Earlier methods of materials testing were much cruder in that—in general—they did not permit accurate determination of what part of the applied force was actually engaged in tearing down the material. Part of the force of a hammer blow, for example, is transmitted through the material, part of it is translated to not-necessarily-destructive heat, and only a part to actually rupturing molecules and actively breaking down the material.

Many other methods of "destructively testing" materials have been developed and used by engineers over a period of years. The strength of a sheet of metal may be determined roughly by bending a test strip back and forth until it is work-hardened enough to



Putting the top assembly in place. Pressure tank can be seen in background.

break. Previously, though, nobody has been able to determine precisely what electronic and atomic displacements were involved in material failures. It may now be possible for engineers to design airplanes—or anything else—calculating more accurately the strength/weight ratio. This will mean higher operational efficiency plus the durability that will contribute to safety and over-all economy.

—end—

**See them ON APPROVAL**

Look them over. If you're not entirely satisfied you may return the books without further obligation.

The Macmillan Co., 60 Fifth Ave., New York 11 E

<input type="checkbox"/> Mandl's TV Servicing	\$5.50	Please send me the books checked at left. I will either remit in full or return the books in 10 days.
<input type="checkbox"/> TV for Radiomen	\$7.75	
<input type="checkbox"/> Radio & TV Math.	\$6.75	
<input type="checkbox"/> TV & FM Antenna Guide	\$6.25	

Signed .....

Address .....



# BUY TEST EQUIPMENT ON THIS RADICALLY NEW TIME PAYMENT PLAN **NO INTEREST!! - NO CARRYING CHARGES!!**

USE CONVENIENT TIME PAYMENT ORDER BLANK BELOW

## Superior's New JUNIOR SUPER-METER

**MOST COMPLETE AND COMPACT MULTI-SERVICE INSTRUMENT EVER DESIGNED**



**Measures:**  
 • Voltage • Current • Resistance  
 • Capacity • Reactance • Inductance  
 • Decibels

**Specifications:** D.C. Volts: 0-7.5/75/150/750/-1500 Volts. A.C. Volts: 0-15/150/300/1500/3000 Volts. Resistance: 0-10,000/100,000 ohms. 0-10 Megohms. D.C. Current: 0-7.5/75 Ma. 0-7.5 amps. Capacity: .001 Mfd.—2 Mfd.. 1 Mfd.—20 Mfd. Electrolytic Leakage: Reads quality of electrolytics at 150 Volt test potential. Decibels: -10 Db to +18 Db. +10 Db to +38 Db. +38 Db. to +58 Db. Reactance: 15 ohms—25 K ohms 15 K ohms—2.5 Meg-ohms. Inductance: .5 Henry—50 Henries 30 Henries—10 K Henries. Plus Good-Bad scale for checking the quality of electrolytic condensers.

Handsome round cornered molded bakelite case 3 1/4" x 5 1/4" x 2 1/4" complete with all test leads and instructions. **\$21.40 NET**

## Superior's New Model TV-11 TUBE TESTER



Operates on 105-130 Volt 60 Cycles A.C. Hand-rubbed oak cabinet complete with portable cover **\$47.50 NET**

\* Uses the new self-cleaning Lever Action Switches for individual element testing. Because all elements are numbered according to pin number in the RMA base numbering system, the user can instantly identify which element is under test. Tubes having tapped filaments and tubes with filaments terminating in more than one pin are truly tested with the Model TV-11 as any of the pins may be placed in the neutral position when necessary. \* Uses no combination type sockets. Instead individual sockets are used for each type of tube. Thus it is impossible to damage a tube by inserting it in the wrong socket. \* Free-moving built-in roll chart provides complete data for all tubes. \* Phone jack on front panel for plugging in either phones or external amplifier detects microphonic tubes or noise due to faulty elements and loose external connections.

## Superior's New Model CA-12 SIGNAL TRACER



The well known model CA-12 is the only signal tracer in the low price range including both meter and speaker !!!

**SPECIFICATIONS:** \* Comparative Intensity of the signal is read directly on the meter—quality of the signal is heard in the speaker. \* Simple to Operate—only one connecting cable—no tuning controls. \* Highly Sensitive—uses an improved vacuum-tube voltmeter circuit. \* Tube and Resistor Capacity Network are built into the detector probe. \* Built-In High Gain Amplifier—Alnico V Speaker.

Completely Portable—weighs 8 pounds—measures 5 1/2" x 6 1/2" x 9". Model CA-12 comes complete with all leads and operating instructions **\$33.95 NET**

## Superior's New TV BAR GENERATOR



**THROWS AN ACTUAL BAR PATTERN ON ANY TV RECEIVER SCREEN!!**

Two Simple Steps

1. Connect Bar Generator to Antenna Post of any TV Receiver.
2. Plug Line Cord into A. C. Outlet and Throw Switch.

**RESULT:** A stable never-shifting vertical or horizontal pattern projected on the screen of the TV receiver under test.

Power Supply: 105-125 Volt 60 Cycles. Power Consumption: 20 Watts. Channels: 2-5 on panel. 7-13 by harmonics. Horizontal lines: 4 to 12 (Variable). Vertical lines: 12 (Fixed). Vertical sweep output: 60 Cycles. Horizontal sweep output: 15,750 Cycles.

TV Bar Generator comes complete with shielded leads and detailed operating instructions. Only **\$39.95 NET**

## Superior's New Model 660—AN AC OPERATED SIGNAL GENERATOR

Provides Complete Coverage for A.M.—F.M. and TV Alignment

\* Generates Radio Frequencies from 100 Kilocycles to 60 Megacycles on fundamentals and from 60 Megacycles to 240 Megacycles on powerful harmonics. \* Accuracy and stability assured by use of permeability trimmed Hi-Q coils. \* R.F. available or modulated by the internal audio oscillator. \* Built in 400 Cycle sine wave audio oscillator used to modulate the R.F. signal also available separately for audio testing of receivers, amplifiers, etc. \* Oscillator Circuit: Uses a miniature high frequency type of acorn triode in a Hartley circuit to insure a high degree of stability. By using the same type of triode as a buffer amplifier, complete and positive isolation between the R.F. oscillator and the attenuator is attained. \* Attenuator: a 3 step ladder type of attenuator is used. Each step of the attenuator is controlled by a separate attenuator control thus providing intermediate level steps. \* Tubes used: 955, as R.F. Oscillator, 955 as Modulated Buffer Amplifier, 6SN7 as Audio Oscillator and Power Rectifier.

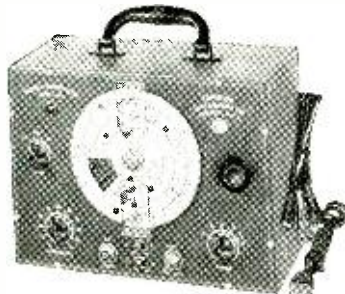

The Model 660 comes complete with coaxial cable test lead and instructions.

**\$42.95 NET**

## NEW TIME PAYMENT PLAN ORDER BLANK

Moss Electronic Distributing Co., Inc.  
Dept. B-23, 38 Murray Street, New York 7, N. Y.

Please send me the units checked below. I am enclosing the down payment with order and agree to pay the monthly balance as shown. It is understood there will be no carrying, interest or any other charges, provided I send my monthly payments when due. It is further understood that should I fail to make payment when due, the full unpaid balance shall become immediately due and payable.

- JUNIOR SUPER METER.....Total Price \$21.40  
\$5.40 down payment. Balance \$4.00 monthly for 4 months.
- MODEL TV-11.....Total Price \$47.50  
\$11.50 down payment. Balance \$6.00 monthly for 6 months.
- MODEL CA-12.....Total Price \$33.95  
\$9.95 down payment. Balance \$4.00 monthly for 6 months.
- TELEVISION BAR GENERATOR.....Total Price \$39.95  
\$9.95 down payment. Balance \$5.00 monthly for 6 months.
- MODEL 660.....Total Price \$42.95  
\$12.95 down payment. Balance \$5.00 monthly for 6 months.
- I enclose \$\_\_\_\_\_ as down payment.
- Ship C.O.D. for the down payment.

Signature \_\_\_\_\_

Name \_\_\_\_\_

Address \_\_\_\_\_

City \_\_\_\_\_ Zone \_\_\_\_\_ State \_\_\_\_\_



# BY ACTUAL COUNT...

THE LARGEST AND MOST  
COMPLETE TV GUIDE  
IN THE INDUSTRY!

NEW 10th EDITION OF THE  
**STANCOR**  
TV TRANSFORMER  
REPLACEMENT GUIDE  
and CATALOG

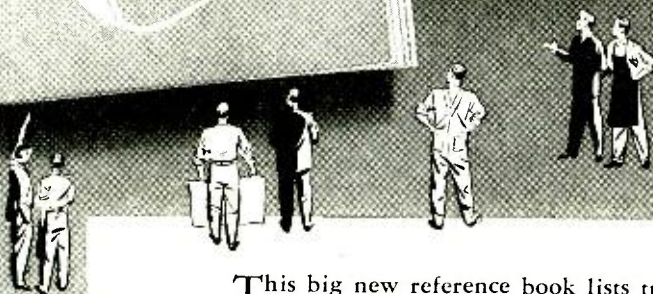
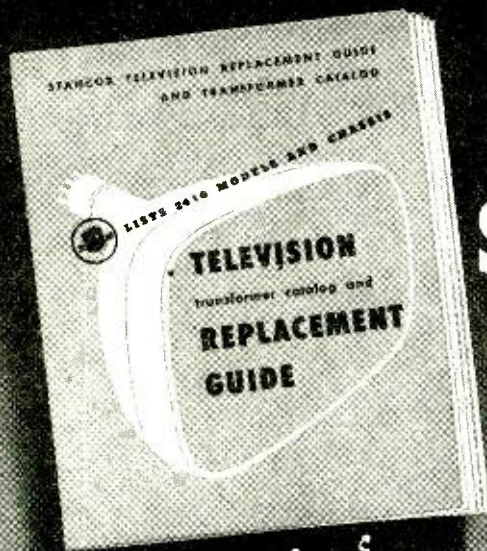

This big new reference book lists transformer replacement information on 2416 TV models and chassis made by 82 manufacturers. The catalog section carries detailed electrical and physical specifications on 106 Stancor TV Replacement Transformers. A frequency chart shows the number of chassis that use each component.

To save your valuable time, this Guide lists all models and chassis components in numerical order under each manufacturer's name. Every replacement recommendation is listed with the manufacturer's part number for instant identification.

Get this up-to-the-minute TV Guide from your Stancor distributor now—or write directly to Stancor.



**STANDARD TRANSFORMER CORPORATION**  
3592 ELSTON AVENUE • CHICAGO 18, ILLINOIS

NEW... Stancor Part  
Nos. A-8133 and A-8134



"Flyback" transformers—exact replacements for Admiral #79C30-1, 79C30-3, 79C30-4 in 80 Admiral TV models. See Stancor Bulletin #391.

## WESTCHESTER HOLDS CLINICS

The technicians of southeastern Westchester County, New York, are now meeting every Wednesday at the Edison High School, Mount Vernon, N. Y., for a television service clinic. At each meeting a member is selected to demonstrate for the others a subject such as front-end or i.f. alignment, horizontal sweep and lock adjustment, or any other of the many circuit adjustments of a TV receiver.

## PRMA AND FRSA MULCTED

The Philadelphia Radio Servicemen's Association and the Federation of Radio Servicemen's Associations of Pennsylvania were ordered to pay damages of \$1,500 to Milton Shapp of Jerrold Electronics, manufacturer of electronic equipment and manufacturers' representative. Mr. Shapp alleged that statements made about him by officials of the two associations in an effort to require him to stop selling direct to consumers, had the effect of a boycott on his business, and caused him to suffer loss. Damages in the amount of \$285,000 were originally asked.

The amount has been divided between the two associations by agreement, PRMA paying \$1,000 and FRSA \$500, according to unofficial reports.

## ESFETA AT POUGHKEEPSIE

The January meeting of the Empire State Federation of Electronic Technicians Associations was held at Smith Brothers' Restaurant, Poughkeepsie, N. Y., Sunday, January 27. Present were delegates and guests from seven associations in New York State. Several excellent suggestions regarding methods of increasing interest of service technicians in existing associations and in forming new associations within the state were made. An exchange of ideas was urged and invitations extended to the secretaries of all associations within the state and of federations of other states to write to Ed Fisk, 234 Knickerbocker Avenue, Rochester, New York, Secretary of ESFETA, for further exchange of ideas relating to a more closely-knit and active fraternity of electronic technicians.

The next meeting—which will be the annual meeting—will be held in the Hotel Arlington, Binghamton, New York, April 27.

## ARTSNY ELECTS OFFICERS

The Associated Radio-Television Servicemen of New York (City) elected their 1952 slate at a meeting held at its headquarters, 165 East Broadway February 12. Max Liebowitz was re-elected president; Ted Caumont, vice-president; O. Capitelli, recording secretary; John Wagonny, corresponding secretary; Ed Eisen treasurer; and Jack Katz sergeant-at-arms.

The association reports that Howard Sams has sent a complete set of his publications for the new headquarters, and that additional test equipment has been received.

RADIO-ELECTRONICS

## For GREATER TV ENJOYMENT...

### Install a MOSLEY 3-WAY ANTENNA SWITCH

Here's convenience! MOSLEY TV Antenna Switches give instant, easy selection of any one of three antennas. Special rotary type switch, making silver-to-silver contact, assures low loss, constant impedance.

Cat. No. F-10 is Flush Mounted Switch and Lead-in Socket combination for neat, concealed-in-wall installation in standard electrical box. Cat. No. F-20 is enclosed in attractive plastic case for mounting on wall or back of set. If mounting on back of set, attach special extension lever provided and install in position for easy accessibility.

At leading Radio Parts Jobbers everywhere

**MOSLEY ELECTRONICS** 2125 Lackland Road  
Overland, Missouri



Cat. No. F-20  
List \$3.75



Cat. No. F-10  
List \$3.75



# Features OF THE NEW 1952

# Heathkits



## PROOF OF THE NEW O-7 OSCILLOSCOPE'S OUTSTANDING PERFORMANCE

Below are actual, unretouched photographs showing the outstanding frequency response characteristics of the NEW 1952 HEATHKIT OSCILLOSCOPE, MODEL O-7. To the left is a 10 KC square wave — to the right a 4 MC sine wave as they actually appear on the screen. Two highly severe tests to make on any scope (only the best of scopes will show traces like these) — and the O-7 really comes through.

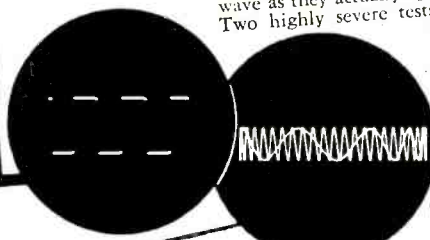

## COMPANION VACUUM TUBE VOLTMETERS

Here are the two NEW 1952 VACUUM TUBE VOLTMETER COMPANION PIECES. Matched instruments of new design to open up the whole field of DC, AC, and resistance measurements for you. The new greatly reduced size combines style, beauty, and compactness — The V-5 and AV-1 have the panel and cabinet construction as shown on the right. A tremendous pair of voltmeters. Small in size but virtual giants in the range of measurements they make.



## NEW STYLE AND BEAUTY

Style that's modern, yet functional — that's the trend of today — and Heathkits are right up to the minute. Note the cut showing the new V-5 and AV-1 cabinet and panel construction. The front panel and rear cover slide right over the recessed flange of the case thereby eliminating sharp edges and pointed corners. The voltmeter kits aren't "shelf" or "mounted" instruments — they're moved about on the bench a lot and thus the new compact size and specially designed cabinets — Another 1952 Heathkit feature.

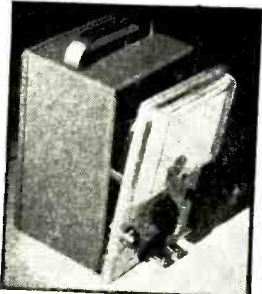

## A STATEMENT FROM SIMPSON ELECTRIC CO.

In choosing Simpson Meters for their Heathkit VTVM, the Heath Co. has set a new high standard of kit meter quality. The same high quality of material, workmanship and design that has given Simpson the reputation for building "Instruments That Stay Accurate" is found in the Heathkit Meter Movement.

SIGNED  
SIMPSON ELECTRIC CO.

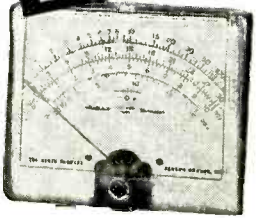

## A STATEMENT FROM CHICAGO TRANSFORMER

It is indeed gratifying to note the outstanding sales records you are building with your Heathkits. This sales success is readily understandable, since we are cognizant of the high quality standards you have established for your component suppliers. We at Chicago Transformer are proud that our product has contributed to the recognized quality and increasing popularity of Heathkits.

CHICAGO TRANSFORMER DIVISION  
Essex Wire Corporation

L. S. RACINE  
Vice-President and Sales Manager



## HEATHKIT PRECISION RESISTORS

Where exact resistance values are required for instrument accuracy, the Heath Co. has spared no effort in supplying the finest resistors available. Precision resistors as manufactured by Continental Carbon Inc., and Wilcor Corp., meet the rigorous JAN (Joint Army-Navy) specifications and are small in size, extremely non-inductive, highly stable, have a low temperature coefficient, and can be held to great accuracy. You'll find quality components in Heathkits.

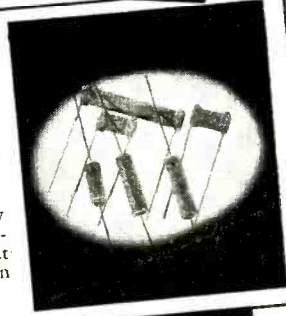

## COLLEGES USE HEATHKITS

Colleges and Universities throughout the country are using Heathkits in their electrical engineering, radio, and physics laboratories — Heathkits are the answer to good test equipment at low cost, plus being rugged, dependable, and accurate. Trade schools are having their students build Heathkits to obtain a first hand working knowledge of test equipment and to get the practical experience gained by construction. Heathkits fill school needs.

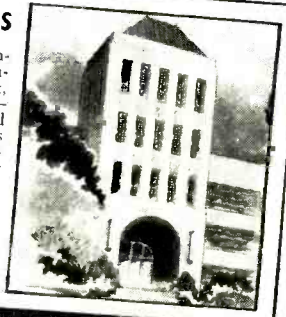

YOU SAVE BY ORDERING DIRECT FROM MANUFACTURER—USE ORDER BLANK ON LAST PAGE

EXPORT AGENT  
ROCKE INTERNATIONAL CORP.  
12 E. 40th ST.  
NEW YORK CITY (16)  
CABLE: ARLAB-N.Y.

# The HEATH COMPANY

... BENTON HARBOR 20, MICHIGAN



THE *New* 1952  
*Heathkit*  
**OSCILLOSCOPE  
 KIT**

MODEL O-7  
 SHIPPING WEIGHT 24 LBS.

**\$43<sup>50</sup>**

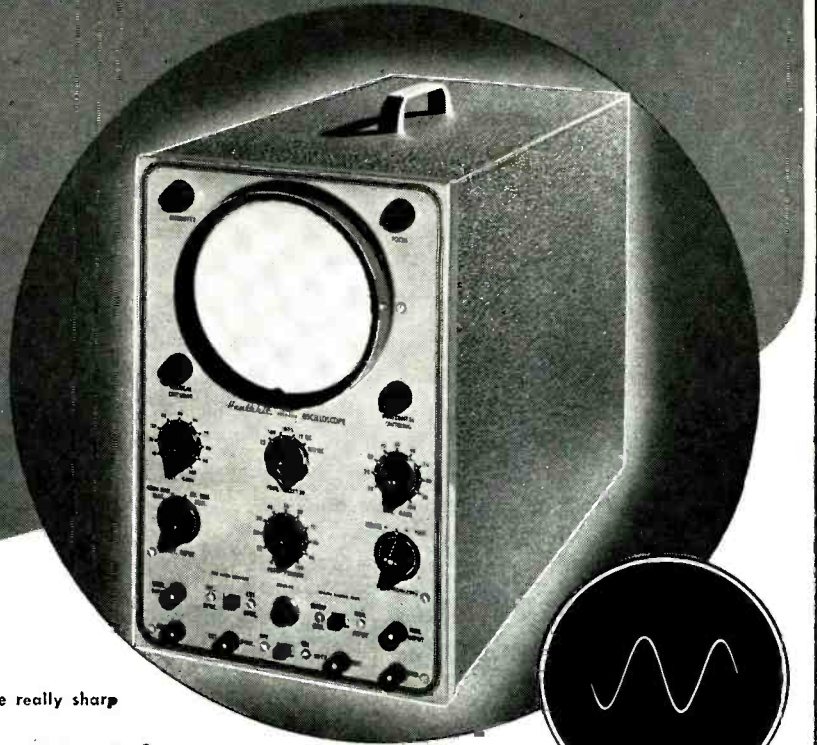

*Features*

- New "spot shape" control for spot adjustment — to give really sharp focusing.
- A total of ten tubes including CR tube and five miniatures.
- Cascaded vertical amplifiers followed by phase splitter and balanced push-pull deflection amplifiers.
- Greatly reduced retrace time.
- Step attenuated — frequency compensated — cathode follower vertical input.
- Low impedance vertical gain control for minimum distortion.
- New mounting of phase splitter and deflection amplifier tubes near CR tube base.
- Greatly simplified wiring layout.
- Increased frequency response — useful to 5 Mc.
- Tremendous sensitivity .03V RMS per inch Vertical — .6V RMS per inch Horizontal.
- Dual control in vernier sweep frequency circuit — smoother acting.
- Positive or negative peak internal synchronization.

The performance of the NEW, IMPROVED, HEATHKIT 5" OSCILLOSCOPE KIT is truly amazing. The O-7 not only compares favorably with equipment costing 4 and 5 times as much, but in many cases literally surpasses the really expensive equipment. The new, and carefully engineered circuit incorporates the best in electronic design — and a multitude of excellent features all contribute to the outstanding performance of the new scope.

The VERTICAL CHANNEL has a step attenuated, frequency compensated vertical input which feeds a cathode follower stage — this accomplishes improved frequency response, presents a high impedance input, and places the vertical gain control in a low impedance circuit for minimum distortion. Following the cathode follower stage is a twin triode — cascaded amplifiers to contribute to the scope's extremely high sensitivity. Next comes a phase splitter stage which properly drives the push-pull, hi-gain, deflection amplifiers (whose plates are directly coupled to the vertical deflection plates). This fine tube lineup and circuitry give a sensitivity of .03V per inch RMS vertical and useful frequency response to 5 Mc.

The HORIZONTAL CHANNEL consists of a triode phase splitter with a dual potentiometer (horizontal gain control) in its plate and cathode circuits for smooth, proper driving of the push-pull horizontal deflection amplifiers. As in the vertical channel, horizontal deflection amplifier plates are direct coupled to the CR tube horizontal deflection plates (for improved frequency response).

The WIDE-RANGE SWEEP GENERATOR circuit incorporates a twin triode multivibrator stage for producing a good saw-tooth sweep frequency (with faster retrace time). Has both coarse and vernier sweep frequency controls.

And the scope has internal synchronization which operates on either positive or negative peaks of the input signal — both high and low voltage rectifiers — Z axis modulation (intensity modulation) — new spot shape (astigmatism) control for spot adjustment — provisions for external synchronization — vertical centering and horizontal centering controls, wide range focus control — and an intensity control for giving plenty of trace brilliance.

The Model O-7 EVEN HAS GREAT NEW MECHANICAL FEATURES — A special extra-wide CR tube mounting bracket is provided so that the vertical cascade amplifier, vertical phase splitter, vertical deflection amplifier, and horizontal deflection amplifier can mount near the base of the CR tube. This permits close connection between the above stages and to the deflection plates; distributed wiring capacity is greatly reduced, thereby affording increased high frequency response.

The power transformer is specially designed so as to keep its electrostatic and electromagnetic fields to a minimum — also has an internal shield with external ground lead. You'll like the complete instructions showing all details for easily building the kit — includes pictorials, step-by-step construction procedure, numerous sketches, schematic, circuit description. All necessary components included — transformer, cabinet, all tubes (including CR tube), completely punched and formed chassis — nothing else to buy.

NEW INEXPENSIVE *Heathkit*  
**ELECTRONIC SWITCH KIT**

The companion piece to a scope — Feed two different signals into the switch, connect its output to a scope, and you can observe both signals — each as an individual trace. Gain of each input is easily set (gain A and gain B controls), the switching frequency is simple to adjust (coarse and fine frequency controls) and the traces can be superimposed for comparison or separated for individual study (position control).

Use the switch to see distortion, phase shift, clipping due to improper bias, both the input and output traces of an amplifier — as a square wave generator over limited range.

The kit is complete; all tubes, switches, cabinet, power transformer and all other parts, plus a clear detailed construction manual.



Model S-2  
 Shipping Wt. 11 lbs.

*Only*  
**\$19<sup>50</sup>**

**YOU SAVE BY ORDERING DIRECT FROM MANUFACTURER—USE ORDER BLANK ON LAST PAGE**

EXPORT AGENT  
**ROCKE INTERNATIONAL CORP.**  
 13 E. 40th ST.  
 NEW YORK CITY (16)  
 CABLE: ARLAB-N.Y.

*The* **HEATH COMPANY**

**... BENTON HARBOR 20, MICHIGAN**



THE *New* 1952*Heathkit*  
**VTVM  
KIT**MODEL V-5  
SHIPPING WT. 5 LBS.**\$24.50***Features*

- New styling, — formed case for beauty.
- New truly compact size. Cabinet 4 $\frac{1}{8}$ " deep by 4-11 $\frac{1}{16}$ " wide by 7 $\frac{3}{8}$ " high.
- Quality 200 microamp meter.
- New ohms battery holding clamp and spring clip — assurance of good electrical contact.
- Highest quality precision resistors in multiplier circuit.
- Calibrates on both AC and DC for maximum accuracy.
- Terrific coverage — reads from  $\frac{1}{2}$ V to 1000V AC,  $\frac{1}{2}$ V to 1000V DC, and .1 to over 1 billion ohms resistance.
- Large, clearly marked meter scales indicate ohms, AC Volts, DC Volts, and DB — has zero set mark for FM alignment.
- New styling presents attractive and professional appearance.

A real beauty — you'll have only highest praise for this NEW MODEL VACUUM TUBE VOLTMETER. Truly a beautiful little instrument — and it's more compact than any of our previous models. Note the new rounded edges on the front panel and rear cover. The size is greatly reduced to occupy a minimum of space on your workbench — yet the meter remains the same large size with plainly marked scales.

A set of specially designed control mounting brackets permit calibration to be performed with greatest ease — also makes for ease in wiring. New battery mounting clamp holds ohms battery tightly into place, and base spring clip insures a good connection to the ohms string of resistors.

The circuitry employs two vacuum tubes — A duo diode operating when AC voltage measurements are taken, and a twin triode in the circuit at all times. The cathode balancing circuit of the twin triode assures sensitive measurements, and yet offers complete protection to the meter movement. Makes the meter burn-out proof in a properly constructed instrument.

Quality components are used throughout — 1% precision resistors in the multiplier circuit — conservatively rated power transformer — Simpson meter movement — excellent positive detent, smooth acting switches — sturdy cabinet, etc.

And you can make a tremendous range of measurements —  $\frac{1}{2}$ V to 1000V AC,  $\frac{1}{2}$ V to 1000V DC, .1 to over 1 billion ohms, and DB. Has mid-scale zero level marking for quick FM alignment. DB scale in red for easy identification — all other scales a sharp, crisp black for easy reading.

A four position selector switch allows operator to rapidly set the instrument for type or reading desired — positions include ACV, DC+V, DC-V, and Ohms. DC — position allow negative voltage to be rapidly taken. Zero adjust and ohms adjust controls are conveniently located on front panel.

Enjoy the numerous advantages of using a VTVM. Its high input impedance doesn't "load" circuits under test — therefore, assures more accurate and dependable readings in high impedance circuits such as resistance coupled amplifiers, AVC circuits, etc. Note the 30,000 VDC probe kit and the RF probe kit — available at low extra cost and specially designed for use with this instrument. With these two probes, you can make DC voltage measurements up to 30,000V, or make RF measurements — added usefulness to an already highly useful instrument.

The instruction manual is absolutely complete — contains a host of figures, pictorials, schematic, detailed step-by-step instructions, and circuit description. These clear, detailed instructions make assembly a cinch.

And every part is included — meter, all controls, pilot light, switches, test leads, cabinet, instruction manual, etc.

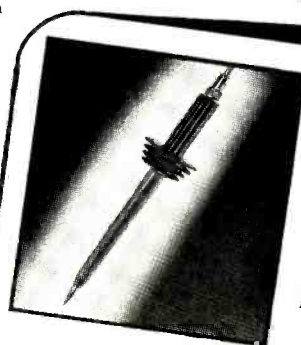
*Heathkit* 30,000V DC  
**PROBE KIT**

A new 30,000 V DC Probe Kit to handle high voltages with safety. For TV service work and all other high voltage applications. Sleek looking — Two color molded plastic — Red looking — and guard — jet black handle. Red body with connector, cable, and PL55 type plug. Plugs into Heathkit VTVM so that 300V scale is conveniently multiplied by 100. Can be used with any standard 11 megohm VTVM.

**\$550**No. 336 High Voltage Probe Kit  
Shipping Wt. 2 lbs.*Heathkit*  
**RF PROBE KIT**

This RF Probe Kit comes complete with probe housing, crystal diode detector, connector, lead and plug and all other parts plus clear assembly instructions. Extends range of Heathkit VTVM to 250 Mc.  $\pm$  10%. Works on any 11 megohm input VTVM. Specify No. 309 RF Probe Kit.

**\$550**

Ship. Wt. 1 lb.

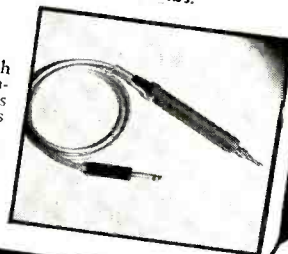
**YOU SAVE BY ORDERING DIRECT FROM MANUFACTURER—USE ORDER BLANK ON LAST PAGE**

EXPORT AGENT  
**ROCKE INTERNATIONAL CORP.**  
13 E. 40th ST.  
NEW YORK CITY (16)  
CABLE: ARLAB-N.Y.

*The* **HEATH COMPANY****... BENTON HARBOR 20, MICHIGAN**



# Heathkit SIGNAL GENERATOR KIT

Model SG-6  
Shipping Wt. 7 lbs.

The new Heathkit Signal Generator Kit has dozens of improvements. Covers the extended range of 160 Kc to 50 megacycles on fundamentals and up to 150 megacycles on useful calibrated harmonics; makes this Heathkit ideal as a marker oscillator for TV. Output level can be conveniently set by means of both step attenuator and continuously variable output controls. Instrument has new miniature HF tubes to easily handle the high frequencies covered.

Uses 6C4 master oscillator and 6C4 sine wave audio oscillator. The kit is transformer operated and a husky selenium rectifier is used in the power supply. All coils are precision wound and checked for calibration making only one adjustment necessary for all bands.

New sine wave audio oscillator provides internal modulation and is also available for external audio testing. Switch provided allows the oscillator to be modulated by an external audio oscillator for fidelity testing of receivers. Comes complete, all tubes, cabinet, test leads, every part. The instruction manual has step-by-step instructions and pictorials. It's easy and fun to build a Heathkit Model SG-6 Signal Generator.



**\$19.50**

## Heathkit CONDENSER CHECKER KIT

Only  
**\$19.50**

Model C-2  
Shipping Wt. 6 lbs.

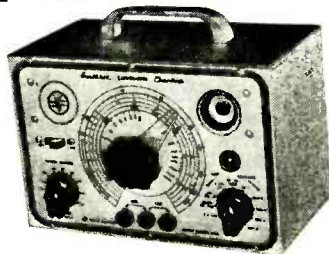

Checks all types of condensers — paper — mica — ceramic — electrolytic. All condenser scales are direct reading and require no charts or multipliers. Covers range of .00001 MFD to 1000 MFD. A Condenser Checker that anyone can read. A leakage test and polarizing voltage for 20 to 500 V provided. Measures power factor of electrolytics between 0% and 50% and reads resistance from 100 ohms to 5 megohms. The magic eye indicator makes testing easy.

The kit is 110V 60 cycle transformer operated and comes complete with rectifier tube, magic eye tube, cabinet, calibrated panel and all other parts. Has clear detailed instructions for assembly and use.

## NEW Heathkit SIGNAL TRACER AND UNIVERSAL TEST SPEAKER KIT

**\$19.50**

Model T-2  
Shipping Wt. 7 lbs.

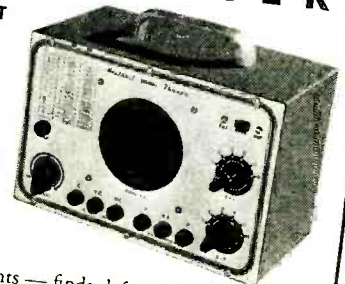

The popular Heathkit Signal Tracer has now been combined with a universal test speaker at no increase in price. The same high quality tracer follows signal from antenna to speaker — locates intermittents — finds defective parts quicker — saves valuable service time — gives greater income per service hour. Works equally well on broadcast, FM, or TV receivers. The test speaker has an assortment of switching ranges to match either push-pull or single output impedances. Also tests microphones, pickups and PA systems. Comes complete: cabinet, 110V 60 cycle power transformer, tubes, test probe, all necessary parts, and detailed instructions for assembly and use.



Model TC-1  
Shipping Wt. 12 lbs.

**\$29.50**

## Heathkit TUBE CHECKER KIT

The Tube Checker is a MUST for radio repair men. Often customers want to SEE tubes checked, and a checker like this builds customer confidence. In your repairing, you will have a multitude of tubes to check — quickly. The Heathkit tube checker will serve all these functions — it's good looking (with a polished birch cabinet and an attractive two color panel) — checks 4, 5, 6, 7 prong Octals. Loctals, 7 prong miniatures, 9 prong miniatures, pilot lights, and the Hytron 5 prong types. AND IT'S FAST TO OPERATE — the gear driven, free-running roll chart lists hundreds of tubes, and the smooth acting, simplified switching arrangement gives really rapid set-ups.

The testing arrangement is designed so that you will be able to test new tubes of the future — without even waiting for factory data — protection against obsolescence.

You can give tubes a thorough testing — checks for opens, shorts, each element individually, emission, and for filament continuity. A large BAD-?-GOOD meter scale is in three colors for easy reading and also has a "line-set" mark.

You'll find this tube checker kit a good investment — and it's only \$29.50.

**YOU SAVE BY ORDERING DIRECT FROM MANUFACTURER—USE ORDER BLANK ON LAST PAGE**

EXPORT AGENT  
**ROCKE INTERNATIONAL CORP.**  
13 E. 40th ST.  
NEW YORK CITY (16)  
CABLE: ARLAB-N.Y.

**The HEATH COMPANY**

**... BENTON HARBOR 20, MICHIGAN**



New LABORATORY LINE HEATHKITS

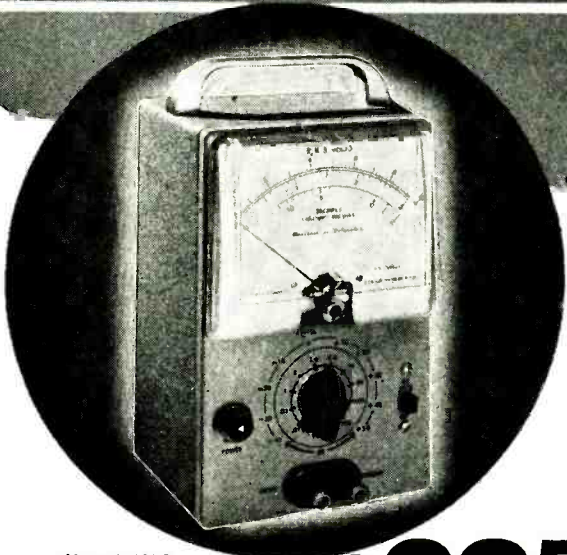

NEW *Heathkit*  
A.C. VACUUM TUBE  
**VOLTMETER KIT**

Now — as a Heathkit — at a price anyone can afford, an AC VTVM. A new kit to make possible those sensitive AC measurements required by audio enthusiasts, laboratories, and experimentors. Here is the kit that the audio men have been looking for. Its tremendous range of coverage makes possible measurements of audio amplifier frequency response — gain or loss of audio stages — characteristics of audio filters and attenuators — hum investigation — and literally a multitude of others. Ten ranges consisting of full scale .01, .03, .1, .3, 1, 3, 10, 30, 100, 300 volts RMS assure easy and more accurate readings. Ten ranges on DB provide for measurements from -52 to +52 DB. Frequency response within 1 DB from 20 cycles to 50 KC. The ingenious circuitry incorporates precision multiplier resistors for accuracy, two amplifier stages using miniature tubes, a unique bridge rectifier meter circuit, quality Simpson meter with 200 microampere movement, and a clean layout of parts for easy wiring. A high degree of inverse feedback provides for stability and linearity.

MODEL AV-1  
Shipping weight 5 lbs.

**\$29<sup>50</sup>**

Simple operation is accomplished by the use of only one control, a range switch which changes the voltage ranges in multiples of 1 and 3, and DB ranges in steps of 10.

The instrument is extremely compact, cabinet size — 4 1/8" deep x 4-11/16" wide x 7 3/8" high, and the newly designed cabinet makes this the companion piece to the VTVM. For audio work, this kit is a natural.

NEW *Heathkit*  
**AUDIO FREQUENCY METER KIT**

MODEL AF-1  
Shipping weight 12 lbs.



**\$34<sup>50</sup>**

A NEW Heathkit Audio Frequency Meter — the ideal instrument for determining frequencies from 20 cycles to 100 KC. Set the selector switch to the proper range — feed the signal into the input terminals — and read the frequency from the meter — completely simple to operate, and yet dependable results.

Quality Simpson 200 microampere meter has two plainly marked scales (0-100 0-300). These scales, read in conjunction with the seven position selector switch, give full scale readings of 100, 300, 1000, 3000, 10,000, 30,000, and 100,000 cycles. Convenient ranges for fast and easy readings.

For greatest accuracy, the 1-3-10 ratio of ranges is maintained and each range has individual calibrating control.

Input impedance is high (1 megohm) for negligible circuit loading. A signal and a change in signal voltage between these limits will not affect the meter reading. In addition, input wave shape is not critical (the unit will read the frequency of either sine wave or square wave input).

The tube complement consists of a 6SJ7 amplifier and clipper, 6V6 amplifier and clipper, 6H6 meter pulse rectifier, 6X5 power supply rectifier, and OD3/VR150 voltage regulator.

Construction is simple, and quality components are used throughout.

NEW *Heathkit*  
**INTERMODULATION ANALYZER KIT**

Intermodulation testing of audio equipment is rapidly being accepted by more and more engineers and audio experts as the best way to determine the characteristics of audio amplifiers, recording systems, networks, etc. — shows up those undesirable characteristics which contribute to listening fatigue when all other methods fail.

The Heathkit Intermodulation Analyzer supplies a choice of two high frequencies (3000 cycles and a higher frequency) and one low frequency (60 cycles). Both 1:1 or 4:1 ratios of low to high frequencies can be set up for IM testing, and the ratios are easily set by means of a panel control and the instrument's own VTVM. An output level control supplies the mixed signal at the desired level with an output impedance of two thousand ohms. The Analyzer section has input level control and proper filter circuits feeding the instrument's VTVM to read intermodulation directly on full scale ranges of 30%, 10% and 3%. Built-in power supply furnishes all necessary voltages for operating the instrument.

You won't want to be without this new and efficient means of testing

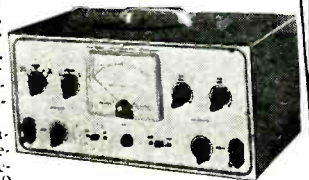

MODEL IM-1  
Shipping wt. 18 lbs.

**\$39<sup>50</sup>**

NEW *Heathkit* SQUARE WAVE GENERATOR KIT

The new Heathkit Square Wave Generator Kit with its 100 KC square wave opens an entirely new field of audio testing. Square wave testing over this wide range will quickly show high and low frequency response characteristics of circuits — permit easy adjustment of high frequency compensating networks used in video amplifiers — identify ringing in circuits — demonstrate transformer characteristics, etc.

The circuitry consists of a multivibrator stage, a clipping and squaring stage, and a cathode follower output stage. The power supply is transformer operated and utilizes a full wave rectifier tube with 2 sections of LC filtering.

As a multivibrator cannot be accurately calibrated, a provision is provided to allow the instrument to be accurately synchronized with an accurate external source when extreme accuracy is required.

The low impedance output is continuously variable between 0 and 25 volts and operation is simple. You'll really appreciate the wide range of this instrument, 10 cycles to 100 kilocycles — continuously variable. Kit is complete with all parts and instruction manual, and is easy to build.

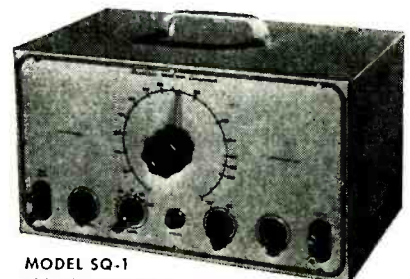

MODEL SQ-1  
Shipping wt. 14 lbs.

**\$29<sup>50</sup>**

YOU SAVE BY ORDERING DIRECT FROM MANUFACTURER—USE ORDER BLANK ON LAST PAGE

EXPORT AGENT  
ROCKE INTERNATIONAL CORP.  
13 E. 40th ST.  
NEW YORK CITY (16)  
CABLE: ARLAB-N.Y.

*The* **HEATH COMPANY**

... BENTON HARBOR 20, MICHIGAN



# Heathkit IMPEDANCE BRIDGE KIT



Model 1B-1B  
Shipping Wt. 15 lbs.

**\$69.50**

This Impedance Bridge Kit is really a favorite with schools, industrial laboratories, and serious experimenters. An invaluable instrument for those doing electrical measurements work. Reads resistance from .01 Ohms to 10 meg., capacitance from .00001 to 100 MFD, inductance from 10 microhenries to 100 henries, dissipation factor from .002 to 1, and storage factor from 1 to 1000. And you don't have to worry about selecting the proper bridge circuit for the various measurements—the instrument automatically makes the correct circuit when you set up for taking the measurement you want. Bridge utilizes Wheatstone, Hay, Maxwell, and capacitance comparison circuits for the wide range and types of measurements possible. And it's self powered—has internal battery and 1000 cycle hummer. No external generator required—has provisions for external generator if measurements at other than 1000 cycles are desired. Kit utilizes only highest quality parts, General Radio main calibrated control.

Mallory ceramic switches, excellent 200 microamp zero center galvanometer, laboratory type binding posts with standard 3/4 inch centers, 1% precision ceramic-body type multiplier resistors, beautiful birch cabinet and ready calibrated panel. (Headphones not included.)

Take the guesswork out of electrical measurements—order your Heathkit Impedance Bridge kit today—you'll like it.

## Heathkit LABORATORY RESISTANCE DECADE KIT



**\$19.50**

Shipping Wt. 4 lbs.

An indispensable piece of laboratory equipment—the Heathkit Resistance Decade Kit gives you resistance settings from 1 to 99,999 ohms IN ONE OHM STEPS. For greatest accuracy, 1% precision ceramic-body type resistors and highest quality ceramic wafer switches are used.

Designed to match the Impedance Bridge above, the Resistance Decade Kit has a beautiful birch cabinet and attractive panel. It's easy to build, and comes complete with all parts and construction manual.

## Heathkit LABORATORY POWER SUPPLY KITS

*Limits:*

No load.....	Variable 150-400V DC
25 MA.....	Variable 30-310V DC
50 MA.....	Variable 25-250V DC

Higher loads: Voltage drops off proportionally

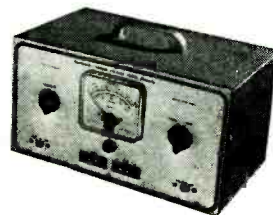

**\$29.50**

Model PS-1.....Ship. Wt. 20 lbs.

Every experimenter needs a good power supply for electronic setups of all kinds. This unit has been expressly designed to act as a HV supply and a 6.3 V filament voltage source. Voltage control allows selection of HV output desired (continuously variable within limits outlined), and a Volts-Ma switch provides choice of output metering. A large plainly marked and direct reading meter scale indicates either DC voltage output (Range of meter 0-500V D.C., 0-200 Ma. D.C.). Instrument has convenient stand-by position and pilot light.

Comes with power transformer, filament transformer, meter, 5Y3 rectifier, two 1619 control tubes, completely punched and formed chassis, panel, cabinet, detailed construction manual, and all other parts to make the kit complete.

## Heathkit ECONOMY . . . 6 WATT AMPLIFIER KIT



MODEL A-7  
Shipping Wt. 8 lbs.

**\$14.50**

- Choice of 4-8-15 ohm output impedances.
- Response flat  $\pm 1\frac{1}{2}$  db from 20—20,000 cycles.
- 6 watts output.
- Good fidelity at low cost.
- Output tubes working in push pull.
- Volume, bass, and treble controls.
- Two separate inputs.

The purpose of this kit is to provide to the kit builder a low cost amplifier with excellent fidelity. The circuit consists of four tubes with following functions: a 12SL7, one section working as an amplifier and one as a phase splitter, two 12A6 output tubes working in push pull,

and a 5Y3 rectifier in a full wave rectifier circuit. The unit operates from a husky power transformer, and has good output transformer with a choice of 4—8—15 ohm output impedances. (Speaker not included).

The kit provides excellent listening pleasure and the price is really low. Compare it with all others. You won't find a better buy.

**MODEL A-7:** For tuner and crystal phono inputs. Has two position selector switch for convenient switching to type of input desired.

**MODEL A-7-A:** Has a 12SH7 preamplifier stage with special compensation network for operation with reluctance phono input. **\$16.50**

## Heathkit HIGH FIDELITY 20 WATT AMPLIFIER KIT



MODEL A-8  
Shipping Wt. 18 lbs.

**\$33.50**

The A8 (or A-8A) is a high quality amplifier for those who want high fidelity output at moderate cost. Frequency response within  $\pm 1$ db from 20—20,000 cycles. Distortion at 3db below maximum power output (at 1,000 cycles) is only .3%. Kit has a Chicago power transformer in drawn steel case and a Peerless output transformer with output impedances of 4—8—16 ohms. Bass and treble controls permit listener to select output with tonal qualities of his own liking.

The tube lineup is composed of a 6SJ7 voltage amplifier, two 6L6's in push-pull output and a 5U4G rectifier. All parts furnished (speaker not included) and the construction manual makes assembly easy.

**MODEL A-8:** For tuner and crystal phono inputs. Has two position selector switch for convenient switching to type of input desired.

**MODEL A-8A:** Features an added 6SJ7 stage (preamplifier) for operating from variable reluctance cartridge phono pickup, mike input, and either tuner or standard crystal phono pickup. A three position selector switch provides flexible switching. Shipping Wt. 18 lbs. **\$35.50**

**YOU SAVE BY ORDERING DIRECT FROM MANUFACTURER—USE ORDER BLANK ON LAST PAGE**

REPORT AGENT  
ROCKE INTERNATIONAL CORP.  
13 E. 40th ST.  
NEW YORK CITY (16)  
CABLE: ARAB-N.Y.

**The HEATH COMPANY**

**... BENTON HARBOR 20, MICHIGAN**



## NEW 1952 *Heathkit* BATTERY ELIMINATOR KIT



**\$24<sup>50</sup>**

- Can be used as battery charger.
- Continuously variable output 0 - 8 Volts — not switch type.
- Heavy duty Mallory 17 disk type magnesium copper sulfide rectifier.
- Automatic overload relay for maximum protection. Self-resetting type.
- Ideal for battery, aircraft and marine radios.
- Dual Volt and Ammeters read both voltage and amperage continually — no switching.

The new Heathkit Model BE-2 incorporates the best. Continuously variable output control is of the variable transformer type with smooth wiper type contacts.

There are no switches or steps and voltage between 0 and 8 Volts is available at 10 Amperes continuous and 15 Amperes intermittent. Maximum safety from overloads and shorts provided by automatic over-load relay which resets itself when overload is removed.

The new rectifier is a 17 plate Mallory magnesium copper sulfide type. This is the most rugged type available for long trouble-free use.

Output is continuously metered by both a 0 - 10 Volt Voltmeter and a 0 - 15 Amp Ammeter. Shorted vibrators indicated instantly by ammeter.

Equip now for all types of service — aircraft — marine — auto and battery radios — this inexpensive instrument vastly increases service possibilities — better be ready when the customer walks in.

Model BE-2  
Shipping Wt. 17 lbs.

## NEW *Heathkit* SINE AND SQUARE WAVE AUDIO GENERATOR KIT

Designed with versatility, usefulness, and dependability in mind, the AG-7 gives you the two most needed wave shapes right at your fingertips — the sine wave and the square wave.

The range switch and plainly calibrated frequency scale give rapid and easy frequency selection, and the output control permits setting the output to any desired level.

A high-low impedance switch sets the instrument for either high or low impedance output — on high to connect a high impedance load, and on low to work into a low impedance transformer with negligible DC resistance.

Coverage is from 20 to 20,000 cycles, and distortion is at a minimum — you can really trust the output wave shape.

Six tubes, quality 4 gang tuning condenser, power transformer, metal cased filter condenser, 1% precision resistors in the frequency determining circuit, and all other parts come with the kit — plus, a complete construction manual — A tremendous kit, and the price is truly low.

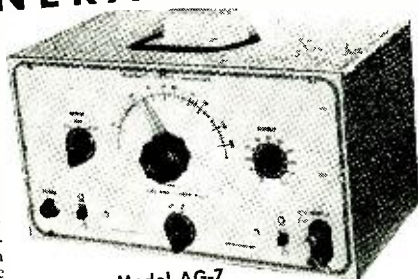

Model AG-7  
Shipping Wt. 15 lbs.

**\$34<sup>50</sup>**

NEW *Heathkit*

## T.V. ALIGNMENT GENERATOR KIT

Here is an excellent TV Alignment Generator designed to do TV service work quickly, easily, and properly. The Model TS-2 when used in conjunction with an oscilloscope provides a means of correctly aligning television receivers.

The instrument provides a frequency modulated signal covering, in two bands, the range of 10 to 90 Mc. and 150 to 230 Mc. — thus, ALL ALLOCATED TV CHANNELS AS WELL AS IF FREQUENCIES ARE COVERED.

An absorption type frequency marker covers from 20 to 75 Mc. in two ranges — therefore, you have a simple, convenient means of frequency checking of IF's, independent of oscillator calibration.

Sweep width is controlled from the front panel and covers a sweep deviation of 0-12 Mc. — all the sweep you could possibly need or want.

And still other excellent features are: Horizontal sweep voltage available at the front panel (and controlled with a phasing control — both step and continuously variable attenuation for setting the output signal to the desired level — a convenient instrument stand-by position — vernier drive of both oscillator and marker tuning condensers — and blanking for establishing a single trace with base reference level. Make your work easier, save time, and repair with confidence — order your Heathkit TV Alignment Generator now!

Model TS-2  
Shipping Wt. 20 lbs.

**\$39<sup>50</sup>**

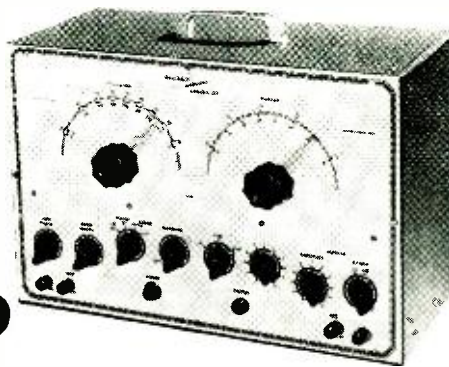

## THE NEW *Heathkit* HANDITESTER KIT

A precision portable volt-ohm milliammeter. Uses only high quality parts — All precision 1% resistors, three deck switch for trouble-free mounting of parts, specially designed battery mounting bracket, smooth acting ohm adjust control, beautiful molded bakelite case, 400 micro-amp meter movement, etc.

DC and AC voltage ranges 10 - 30 - 300 - 1000 - 5000V. Ohms range 0 - 3000 and 0 - 300,000. Range Milliamperes 0 - 10 Ma, 0 - 100 Ma. Easily assembled from complete instructions and pictorial diagrams.

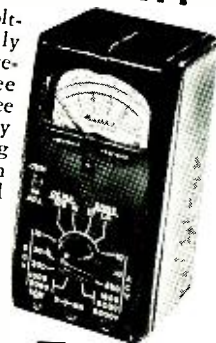

**\$13<sup>50</sup>**

Model M-1  
Shipping Wt. 3 lbs.

YOU SAVE BY ORDERING DIRECT FROM MANUFACTURER—USE ORDER BLANK ON LAST PAGE

EXPORT AGENTS  
ROCKE INTERNATIONAL CORP.  
13 E. 46th ST.  
NEW YORK CITY (10)  
CABLE: ARIRAH N.Y.

The **HEATH COMPANY**

... BENTON HARBOR 20, MICHIGAN



# Heathkit RECEIVER & TUNER KITS for AM and FM



Model BR-1 Broadcast Model Kit covers 550 to 1600 Kc. Shipping Wt. 10 lbs.

**\$19.50**

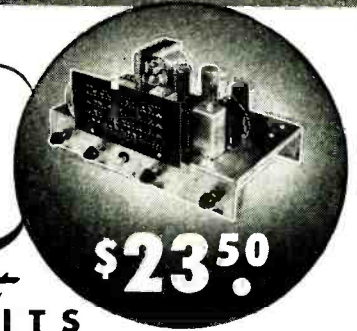

Model AR-1 3 Band Receiver Kit covers 550 Kc. to over 20 Mc. continuous. Extremely high sensitivity. Shipping Wt. 10 lbs.

**\$23.50**

## TWO HIGH QUALITY *Heathkit* SUPERHETRODYNE RECEIVER KITS

Two excellent Heathkits. Ideal for schools, replacement of worn out receivers, amateur and custom installations. Both are transformer operated quality units. The best of materials used throughout—six inch calibrated slide rule dial—quality power output transformers—dual iron core shielded. I.F. coils—metal cased filter condenser. The chassis has phono input jacks, 110 Volt output for phono motor and there is a phono-radio switch on panel. A large metal panel simplifying installation in used console cabinets is included. Comes complete with tubes and instruction manual incorporating pictorials and step-by-step instructions (less speaker and cabinet). The three band model has simple coil turret which is assembled separately for ease of construction.



Model FM-2  
Ship. Wt. 9 lbs.

**\$22.50**

## TRUE FM FROM *Heathkit* FM TUNER KIT

The Heathkit FM Tuner Model FM-2 was designed for best tonal reproduction. The circuit incorporates the most desirable FM features—true FM. Utilizes 8 tubes: 7E5 Oscillator, 6SH7 mixer, two 6SH7 IF amplifiers, 6SH7 limiter, two 7C4 diodes as discriminator, and 6X5 rectifier. The instrument is transformer operated making it safe for connection to any type receiver or amplifier. Has ready wound and adjusted RF coils, and 2 stages of 10.7 Mc IF (including limiter). A calibrated six inch slide rule dial has vernier drive for easy tuning. All parts and complete construction manual furnished.



MAIL TO THE  
**HEATH COMPANY**  
BENTON HARBOR 20,  
MICHIGAN

## ORDER BLANK

From \_\_\_\_\_  
\_\_\_\_\_

- SHIP VIA
- Parcel Post
  - Express
  - Freight
  - Best Way

Quantity	Item	Price	Quantity	Item	Price
	Heathkit Oscilloscope Kit — Model O-7			Heathkit H.V. Probe Kit — No. 336	
	Heathkit VTVM Kit — Model V-5			Heathkit R.F. Signal Gen. Kit — Model SG-6	
	Heathkit FM Tuner Kit — FM-2			Heathkit Condenser Checker Kit — Model C-2	
	Heathkit Broadcast Receiver Kit — Model BR-1			Heathkit Handitester Kit — Model M-1	
	Heathkit Three Band Receiver Kit—Model AR-1			Heathkit Power Supply Kit — Model PS-1	
	Heathkit Amplifier Kit — Model A-4			Heathkit Resistance Decade Kit — Model RD-1	
	Heathkit Amplifier Kit — Model A-6 (or A-6A)			Heathkit Impedance Bridge Kit — Model IB-1B	
	Heathkit Tube Checker Kit — Model TC-1			Heathkit A.C. VTVM-KIT — Model AV-1	
	Heathkit Audio Generator Kit — Model AG-7			Heathkit Intermodul. Analyzer Kit—Model IM-1	
	Heathkit Battery Eliminator Kit — Model BE-2			Heathkit Audio Freq. Meter Kit — Model AF-1	
	Heathkit Electronic Switch Kit — Model S-2			Heathkit Square Wave Gen. Kit — Model SQ-1	
	Heathkit T.V. Alignment Gen. Kit — TS-2				
	Heathkit Signal Tracer Kit — Model T-2				
	Heathkit R.F. Probe Kit — No. 309				

On Parcel Post Orders, include postage for weight shown and insurance. (We insure all shipments.)  
On Express Orders, do not include transportation charges — they will be collected by the Express Agency at time of delivery.

Enclosed find  Check  Money Order for \_\_\_\_\_  
Please ship C.O.D.  Postage enclosed for \_\_\_\_\_ lbs.

ALL PRICES SUBJECT TO CHANGE WITHOUT NOTICE

EXPORT AGENT  
**ROCKE INTERNATIONAL CORP.**  
13 E. 40th ST.  
NEW YORK CITY (16)  
CABLE: ARLAB-N.Y.

# The HEATH COMPANY

... BENTON HARBOR 20, MICHIGAN



**PENNSYLVANIA ACTIVITIES**

The many items discussed and decided at the January meeting of the Federation of Radio Servicemen's Associations of Pennsylvania (FRSAP) made it, by consensus of attending members, the most important meeting in the Federation's existence.

The final vote on the recipient of the Federation's annual plaque was announced after three months of voting by all chapters. John F. Rider was designated the recipient. The time and place of the award was set for February 16, at Harrisburg, Pa.

The Federation's vice - chairman, Milan Krupa, was appointed chairman of a committee to arrange a series of meetings with the broadcasters in Pennsylvania, with the purpose of promoting better reception and increasing public confidence in the membership of the Federation's local chapters.

A committee of delegates from Harrisburg and York was appointed to investigate State insurance, workmen's compensation costs, and coverage for the radio and television installation and service industry. Previous reports showed costs to be too high, and the committee is to meet with the chairman of the Insurance Commission and request a new classification for this industry.

Delegates forwarded letters of congratulation and offers of cooperation to Albert Coumont, the newly appointed service manager of the Radio-Television Manufacturers Association, and to Ray J. Yeranko, the new chairman of the RTMA Service Committee.

A 10-man committee was appointed to obtain from all chapters a list of suggestions for ways and means of eliminating friction and indifference that may now exist among service technicians, dealers, and distributors. After studying the situation, the committee was authorized to arrange a series of meetings with all distributors in Pennsylvania, to find ways to promote harmony and cooperation.

Other business included final arrangements for obtaining a charter for the Federation, and a report on the lectures and technical meetings up to date. Special mention and whole-hearted endorsement was given the series of Capehart-Farnsworth meetings.

The Central Pennsylvania Association (Williamsport) announces its new slate of officers for 1952. The president is Carl W. Smith; vice-president, Frederick Delzert; secretary, William T. Mosteller; corresponding secretary, William S. Guild; and treasurer, Philip Marciani. Delegates to the Federation are to be appointed by the president. The chapter is arranging for a complete TV class for all members, in anticipation of the completion of the Community TV system now being installed.

The Mid-State Association (Harrisburg) reports that its president, George Hardy, is working with a committee to formulate a complete program for 1952. A new series of technical and business lectures is being arranged through the Federation's Lecture Bu-



**RADIO and TELEVISION RECEIVER TROUBLESHOOTING and REPAIR**

by A. A. Ghirardi and J. R. Johnson  
820 pages, 417 illustrations, 6x9, price \$6.75

The complete know-how of service procedure by the most modern time-saving professional methods

**NOW!**

**Ghirardi's Complete Training Course**

Helps you lick the toughest service problems!  
Paves your way to the big-money jobs!

**22 COURSES IN ONE!**

Here is what this big book covers:

- 1—Receiver Components and Their Troubles; 2—How to Develop a Systematic Troubleshooting Procedure; 3—Basic Methods: Preliminary Questions and Checks; 4—Static Tests; 5—Dynamic Testing; 6—Practical Direct-Approach Troubleshooting; 7—Special Problems in AC/DC and 3-Way Portables; 8—Special Battery Set Problems; 9—Servicing Communications Receivers; 10—Troubleshooting Television Receivers; 11—Taking Performance Data; 12—Re-aligning AM Receivers; 13—Re-aligning FM; 14—Re-aligning TV; 15—Replacing Defective Resistors; 16—Replacement and Repair of R-F and I-F Inductors and Transformers; 17—Power, A-F and Deflection - Frequency Inductors and Transformers; 18—Defective Capacitors; 19—Servicing Tuning-Drive Mechanisms, Station Selector and Band Switches; 20—Testing, Replacing and Repairing Loudspeakers; 21—Servicing Record-Playing Equipment; 22—Servicing Home Recorders.



**MONEY-SAVING COMBINATION**

Make your service library complete—save money in the bargain. Get the above great new Ghirardi book PLUS the new Ghirardi RADIO AND TELEVISION RECEIVER CIRCUITRY AND OPERATION (issued only a few months ago) at the special price of only \$12.00 for the two. (Regular price for the two books is \$12.75.)

Ghirardi's RECEIVER CIRCUITRY & OPERATION brings you complete, easy training on the basic circuits and operating principles of all radios, TV sets, record players, etc. Makes you far less dependent on service manuals, mfrs.' data—helps you go right to the seat of troubles in 1/2 the usual time! SEE COMBINATION OFFER IN COUPON!

**BRAND NEW... Just off the Press!**

Here's the big book you've been waiting for . . . the new Ghirardi guide to modern Radio-TV servicing by professional methods . . . a book that can help give your earning power a big boost by teaching you to work faster, more efficiently on every receiver service job!

RADIO AND TV RECEIVER TROUBLESHOOTING AND REPAIR starts with a full analysis of radio-TV components and why they fail. Next you learn how to work by the most modern service methods—from quick analyses to static tests of electrical characteristics to dynamic signal tracing and signal injection. Special problems in ac/dc, battery sets and others are clearly explained. A big TV service section is arranged so that you can find answers to specific problems in a jiffy. Complete chapters greatly simplify alignment procedure for each type of receiver. Six chapters cover every phase of component replacement, testing, tuning problems, speaker troubles, etc. Over 400 illustrations make things doubly easy to understand—including dozens of unique step-by-step charts that explain complicated details of the work almost at a glance.

Nowhere else will you find servicing explained so clearly or in such handy form for either study or on-the-job reference. Read this great book for 10 full days at our risk. MAIL COUPON TODAY!

**FLASH! SHOULD SERVICEMEN BE LICENSED?**

No matter how any of us may feel about it, the fact remains that many cities and states are now preparing laws requiring servicemen to undergo rigid licensing tests. Let these two Ghirardi books help prepare you today for any such test you might have to pass!

**10-DAY EXAMINATION**

Dept. RE-42 Rinehart Books, Inc., Technical Division, 232 Madison Ave., New York 16, N. Y.

Send Ghirardi's RADIO & TELEVISION RECEIVER TROUBLESHOOTING & REPAIR for 10-day examination. If I like book, I will promptly send \$6.75 in full payment. If not, I will return book postpaid in good condition and owe you nothing.

RADIO-TV SERVICE COMBINATION OFFER—Send above book PLUS RADIO & TV RECEIVER CIRCUITRY AND OPERATION for examination. Special price for both books only \$12.00 (To be paid in 10 days, or book returned.)

Name \_\_\_\_\_  
Address \_\_\_\_\_  
Employer's name & address \_\_\_\_\_  
City, Zone, State \_\_\_\_\_

Prices outside U.S.A., cash only—\$7.25 for RADIO & TV RECEIVER TROUBLESHOOTING & REPAIR or \$13.00 for COMBINATION OFFER. Money back if you return books within 10 days.



# ENGINEERS • HAMS • STUDENTS SERVICEMEN • HOBBYISTS

Get this Advanced Thyatron Circuit  
110 V, 60 cycle AC  
**REMOTE CONTROL**  
at this SENSATIONALLY low price

Here's your chance to own a genuine Thyatron Electronic Remote Control at Sensationally low cost!

### PRECISION THYATRION CIRCUITRY

These completely wired, Thyatron precision thermostatic remote controls can be modified by you, easily and quickly, for remote control of hundreds of such devices as: Model Trains, Planes, Boats, Cars; turn radio and TV sets on-off; open and close garage doors from within car; control appliances; machinery, power tools; Burglar, Fire, Temperature and Rain Alarm Systems; Poultry Brooder Controls, and many, many more amazing controls your own ingenuity and inventiveness can dream up. Complete schematic diagram supplied. Each control unit contains a highly sensitive relay, a 110V, 60 cycle filament transformer, many condensers and resistors, (some

10% precisions) and a host of other valuable parts easily worth several times our low cost for the wired, tested unit.

### SUPPLY LIMITED ORDER NOW!

Remote Control Unit, Less Cabinet and Tubes — **2.88**

Kit of 3 Tubes for above, consisting of 1—6SN7GT, 1—6SL7GT and a genuine GE Thyatron GL-5662 (net 3.30). All 3 tubes when ordered with Remote Control Unit, all for **3.95**

Bakelite Cabinet for Remote Control Unit, size 5 3/4" x 5" x 3 1/4". Sturdy, handsome. Special **1.00**

Order all three. The Remote Control Unit, Kit of Tubes, and Cabinet and save! All Three items Above. Special **7.50**

No C.O.D. Postpaid in U.S.A. only.  
Send Check or Money Order to Dept. R.



only **\$288**

(Less Cabinet and Tube Kit)  
Shipped Postpaid in U.S.A. Only

### POPULAR REMOTE CONTROL USES

- ON-OFF For Radio or TV, Transmitters
- Model Trains, Planes, Boats, Cars, Trucks
- Open and Close Garage Doors From Inside Car
- Control Appliances, Machinery, Power Tools
- Alarm Systems — Burglar, Fire, Temperature, Rain
- Poultry Brooder Controls
- And Many, Many More

**MANUEL KLEIN CO.**  
(The House of Integrity)

94 Chambers Street, New York 7, N. Y.  
REctor 2-6460

## WORLD'S FASTEST SELLING VOLT-OHM MILLIAMMETER



### Model 770

is an accurate pocket-size V.O.M.  
Measures only 3 1/8" x 5 7/8" x 2 1/4"

Write Dept. RC-4 for catalog of complete line.

Sensitivity  
1000 ohms per volt

- ★ Uses latest design 2% accurate 1 Mil. D'Arsonval type meter.
- ★ Same zero adjustment holds for both resistance ranges. It is not necessary to readjust when switching from one resistance range to another. This is an important time-saving feature never before included in a V.O.M. in this price range.
- ★ Housed in round-cornered, molded case.
- ★ Beautiful black etched panel. Depressed letters filled with permanent white, insures long-life even with constant use.

The Model 770 comes complete with self-contained batteries, test leads and all operating instructions.

### Specifications:

- 6 A.C. VOLTAGE RANGES:  
0-15/30/150/300/1500/3000 Volts.
- 6 D.C. VOLTAGE RANGES:  
0-7.5/15/75/150/750/1500 Volts.
- 4 D.C. CURRENT RANGES:  
0-1.5/15/150 MA. 0-1.5 Amps.
- 2 RESISTANCE RANGES:  
0-500 Ohms 0-1 Megohm.

**\$14.90**  
NET

AT  
YOUR  
RADIO  
PARTS  
JOBBER



Manufactured and Guaranteed by  
**SUPERIOR INSTRUMENTS CO.**  
227 Fulton Street • New York 7, N. Y.

reau. The first lecture is expected in the near future.

Blair County Radio Service Engineers (Altoona) have elected K. R. Brubaker, president; W. J. Lansberry, vice-president; Wm. Moffitt, secretary; and G. W. Eboch, treasurer, for 1952. Membership in the Blair County association has increased greatly since beginning Federation-sponsored meetings and programs, Mr. Lansberry reports, and great interest is expected in the new TV and radio course now ready to be activated by the Educational Committee.

The Philadelphia Radio Servicemen's Association elected James Daly president for 1952. Vice-president is John Dickstein; recording secretary, William Humes; corresponding secretary, Samuel Brenner; and treasurer, Stanley W. Meyers. Delegates to the State Federation are James Daly, Dick Devaney and William Poole, with S. M. Brenner as alternate.

### B. C. RECOMMENDATIONS

The Fraser Valley Chapter of the Radio-Electronic Technicians Association of Canada (RETA) British Columbia Council, adopted a number of recommendations to take up with the RTMA Service Committee in regard to improving service data. These included:

Service data sheets to be of standard size and form, and preferably punched for 3-ring binders.

D.c. resistances to be marked clearly on all components, such as transformer windings, etc.

Dial scales to be mounted on chassis, or duplicates on chassis where dial is mounted in cabinet.

Trimmers to be identified on chassis. Service data to be issued before receivers appear on the market.

It was also recommended that theory on new and unusual circuits, stage gain measurements, and parts values and voltage readings be included in service data.

Sectional diagrams were disapproved.

Other reports included in the Council's publication, the *Bulletin*, indicate that all chapters are issuing membership badges, decals, rubber stamps, and other equipment to make the change-over from the old ART (Associated Radio Technicians of B.C.) to the new RETA emblem, indicating membership in the national organization.

### NEW YORK BILL INTRODUCED

A bill recently introduced in the New York State Senate would amend the state's emergency housing rent control law in such a way as to forbid landlords from making any charges whatsoever for ownership of a TV receiver by a tenant or for installation of an antenna "on or about the roof or windows of the premises."

### CHICAGO LICENSES ASKED

Regulatory legislation for television and radio servicing was recommended to the Chicago City Council by Alder-



We're going to tell  
everybody you sell  
about

# PHILCO

## Accessory Products

You know what Philco national advertising has done to build nation-wide public demand for Philco products. Now we are putting it to work for *you*—featuring Philco Accessory Products! Yes, month after month, a continuous campaign of Philco Accessory Products ads in big-circulation magazines like The Saturday Evening Post and Better Homes and Gardens. And *every month* special bargain offers for you on Philco Parts and Accessories. Beginning NOW! Don't miss it.

Ask for the Special

**HIT OF THE MONTH OFFERS**

on Philco Parts and  
Accessories

**NOW AT YOUR  
PHILCO DISTRIBUTOR**



# COYNE BOOKS

SHOP-TESTED TECHNICAL BOOKS  
ON RADIO, TV AND ELECTRONICS

Distributed by  
**HOWARD W. SAMS & CO., INC., Indianapolis 5, Ind.**



### APPLIED PRACTICAL RADIO-TELEVISION

Brand new! Over 1500 pages on the latest in Radio and TV—EVEN COLOR TV and UHF. Over 5,000 subjects, 1,000 illustrations. Shows how to install, align, balance all Radio and TV

sets... how to use test instruments for TV service... latest data on adaptors, converters, much more. Get this 5-Volume Library now.

No. CTB-11—Vol. 1... \$3.25  
No. CTB-12—Vol. 2... 3.25  
No. CTB-13—Vol. 3... 3.25  
No. CTB-14—Vol. 4... 3.25  
No. CTB-15—Vol. 5... 4.25

**5 VOLUME SET COMPLETE**  
No. CTB-50 \$15.00

### CYCLOPEDIA OF TELEVISION

Complete, Up-to-Date Reference Manual  
Fact-packed reference book that covers every phase of Television, including COLOR TV and UHF. Gives you complete understanding of how TV receivers work, how to repair and keep them operating properly. Special complete section on picture pattern servicing (dozens of actual photos). 750 pages, over 450 photos, diagrams, charts, drawings, test patterns. In quick reference alphabetical order. **\$5.95**  
Order your copy now. No. CTB-1.....



### PRACTICAL TELEVISION SERVICING, TROUBLE-SHOOTING MANUAL

SHOWS YOU HOW TO align, service, install, adjust and tune every part of the audio and video sections. Helps you handle all problems. Covers sweep oscillators, frequency control, FM, amplifiers, tuners, etc. Latest data on COLOR TV and UHF! 18 big chapters, 300 illustrations (many in 4 colors)—1500 TV facts. Complete, practical, up-to-date. **\$4.25**  
No. CTB-4.....



### ELECTRONICS

You will find this book a "gold mine" of easy-to-follow "on-the-job" electronic data. Starts right at the beginning—explains in simple language all the basic principles of electronics. Fully illustrated with helpful photographs, diagrams, and tables. Endorsed by leading manufacturers, union officials and educators. 400 pages. **\$3.75**  
No. CTB-2.....



### MODERN RADIO INSTRUMENTS AND TESTING METHODS

This up-to-the-minute book tells all about modern radio and electrical testing equipment and how to use it. Packed with money-making shortcuts on trouble-shooting, servicing, construction and other jobs. Over 350 pages, 220 photos and diagrams. Covers Multipliers, Resistors, Ohmmeters, Oscilloscopes and many other subjects. All data has been pre-tested and checked in the Coyne radio shops. **\$3.25**  
No. CTB-3.....



### RADIOMAN'S HANDBOOK

Here is a remarkable radio "answer" book. 3,000 facts packed into 350 pages give you complete instructions to speed trouble-shooting. Illustrated with hundreds of charts, diagrams, tables, circuits and shortcuts. Fully indexed. **\$2.75**  
No. CTB-5.....



Order from your Parts Jobber today, or write direct to Howard W. Sams & Co., Inc., 2201 E. 46th St., Indianapolis 5, Ind.

\$..... enclosed (no C.O.D.'s please). Send the following Coyne Books:

- CTB-11    CTB-14    CTB-1    CTB-4
- CTB-12    CTB-15    CTB-2    CTB-5
- CTB-13    CTB-50    CTB-3

Name.....

Address.....

City..... Zone..... State.....

man Otto Janousek. He stated that the recommendation was the result of a number of complaints about fly-by-night operators. After discussions with Chicago's Better Business Bureau and the State Attorney's office, he believes that a city ordinance creating an examining board to pass on technicians' qualifications would be desirable. The proposed ordinance might be based on the New York City licensing bill.

Before Chicago can pass a licensing law, it will presumably be necessary for the State Senate to pass legislation permitting the city to take such a step.

### FLORIDA CHAPTER GROWING

Dade County Chapter (Miami) of the Radio and Television Technicians Guild of Florida voted to join the National Electronic Technicians and Service Dealers Association (NETSDA) at its February meeting.

New officers were elected for 1952. They are Steven Petrucci, president; Shan Desjardines, vice-president; Thomas Middleton, secretary; and A. Ed. Stevens, treasurer. Membership is increasing with every meeting, states Tom Middleton, as editor of the association's monthly newsletter. Some of the credit may be due to the "lovely three-piece all-girl band" at the restaurant where meetings are held, but genuine increase in interest is stated to be the chief factor. The mimeographed newsletter carries technical items as well as news of the chapters. The latest issue is beautifully mimeographed on three sheets, one of which is devoted to technical notes.

### ENCOURAGING SIGNS

Releases from two television manufacturers indicate that the recommendations made by service technicians' organizations at the Chicago meeting of the RTMA Service Committee are beginning to bear fruit. Emerson and Du Mont both stress the feature of removability of the safety glass in 1952 TV models. This was one of the things asked for at the Chicago meeting, but at that time it was believed by manufacturers' representatives that underwriters' regulations might prevent such a design feature.

Emerson now says of its 1952 sets that it is possible to "readily remove the bezel and safety glass, clean any accumulation of dust or soot from the tube and glass, then replace the glass and snap the bezel back in position..." Du Mont states: "Easy cleaning or removal of the cathode-ray tube is accomplished because the front safety glass can be removed easily." In addition, Du Mont points out further features of interest to the service technician, including the bringing out of selected test points to enable trouble-shooting without pulling the chassis, simplification of servicing and operation due to self-focusing tubes, and provision for aligning the horizontal oscillator without removing the chassis.

—end—

The Book that takes  
Drudgery out of  
Mathematics

Only  
\$1.  
postpaid

SOLVES EVERYDAY PROBLEMS  
HELPS YOU GET AHEAD IN LIFE

How many times have you lost money because of a mistake in figuring? Do you know how to figure quickly and correctly? Can you figure discounts, interest rates, taxes and all the other calculations you meet up with in your daily life?

Are you having trouble qualifying for Civil Service Exams or Armed Services Promotions, because you're not up on mathematics?

## ILLUSTRATED

Here is the book that gives you a good background in mathematics; that takes all the irritation and drudgery out of it. You don't need to be scared of mathematics, because here's the subject explained without frills, without useless computations. Here's the book for men in radio jobs; for business men; technicians and craftsmen, explaining and answering everyday mathematical problems in easy-to-understand words and illustrations.

## A BOON TO EVERY RADIOMAN

The Radio Technician will find information on the following: Ohm's Law—Resistance—Reactance—Capacities—Inductances.

The valuable tables are multiplication and division table. Squares; Square Roots; Cubes and Cubic Roots Tables. Areas of Circles Table. Common Fractions reduced to Decimal Table. Factors and Prime Numbers Table. Table of Multiples.

Yes, it's the key to a simple understanding of mathematics. It's a real home-study course in mathematics for the man who's alert to its importance in the world today.

### ELEMENTARY MATHEMATICS

• EASY — SIMPLIFIED — PRACTICAL •

#### CONTENTS OF BOOK

- CHAPTER I. Arithmetic—Addition—Subtraction—Multiplication—Division.
- CHAPTER II. Factoring and Cancellation—Fractions—Decimals—Percentage—Ratio—and Proportion.
- CHAPTER III. The Metric System.
- CHAPTER IV. How to Measure Surfaces and Capacity (Geometry).
- CHAPTER V. Powers and Involution—Roots and Evolution.
- CHAPTER VI. Mathematics for the Manual and Technical Craftsman—Thermometer conversions—Graphs or Curve Plotting—Logarithms—Use of the Slide Rule.
- CHAPTER VII. Special Mathematics for the Radio Technician.
- CHAPTER VIII. Commercial Calculations—Interests—Discounts—Short Cut Arithmetic.
- CHAPTER IX. Weights and Measures—Useful Tables.

ONLY  
**\$1.**  
POSTPAID

STAMPS, CASH OR MONEY ORDER ACCEPTED

Send Today for Your Copy of This Indispensable Book. It Can Be Carried Readily in Your Pocket. (Size 6 x 9 in.)

## TECHNIFAX,

100 East Ohio St.  
Chicago 11, Ill.

Enclosed find \$1.00 for which send me ELEMENTARY MATHEMATICS prepaid.

Name.....

Address.....

City & State.....

RE-4-52



**TUBES OF THE MONTH**

The Rauland type described in this column last month as the 27QP4 is now known as type 27AP4. Recommended operating conditions for the 27AP4 are: Ultor voltage, 15,000; focusing electrode voltage, 0-350; grid 2 voltage, 300; grid 1 voltage, -33 to -77; ion-trap magnet, single-field RTMA No. 111.

**Industrial and radar tubes**

The RCA 5893 is a u.h.f. medium-mu pencil-type triode for use as a plate-pulsed oscillator up to 3,300 mc. It is capable of giving a peak power output of 1,200 watts in such service. As an unmodulated class-C r.f. grounded-grid amplifier under ICAS conditions, up to 6 watts at 1,000 mc may be obtained with only 300 volts on the plate. Coaxial-electrode construction is used with disk-seal type of electrode termination. This facilitates the use of closed-cavity resonators. The overall length is only 2 3/16 inches and the diameter is 1/4 of an inch, exclusive of the grid flange.

The RCA 5822 is a water-cooled, steel-jacketed, mercury-pool-cathode ignitron tube. It is intended for use in frequency-changer resistance-welding service in which three-phase 60-cycle power is converted to single-phase at a frequency of 5 to 12 cycles per second. This permits economy and improved results in welding aluminum, magnesium, and their alloys. Anode voltage drop, 25; peak anode voltage, 1,500 (forward or inverse), anode current, 1,200 amp peak, 16 amp average.

General Electric's new industrial types are the GL-5727 thyatron and the 6038 ATR tube.

The GL-5727 is a rugged, high reliability, 7-pin miniature type thyatron. The tube is an inert-gas-filled unit with four electrodes with negative control characteristics and suitable for relay and grid-controlled rectifier applications. It is rated at an average plate current of 100 ma, with very low grid current, and features a high control ratio from minus 75°C to 90°C. Pin connections are the same as for the 2D21.

The 6038 is a broadband gas switching tube designed for commercial and military radar. Resembling a miniature cigarette lighter the tube weighs 2 ounces and is less than 1 1/2 inches long, 1 inch wide, and 1/2 inch thick. The tube will aid in viewing objects at close range on radar by cutting the recovery time to only 8 usec at 50 kw with a



The 6038 "Cigarette-lighter" gas tube.

APRIL, 1952



**let's talk SENSE about BOOSTERS**



**TV-IF Signal Booster**  
produces  
**20% AVERAGE Boost** in "Weak Station" Areas.



\$9.95 list, plus extra tube required.

**You don't use a 5-ton truck** to haul 10 light bulbs! The same basic logic applies to TV boosters, too. In many "weak station" areas, in sets forced to use only indoor antennas, in RF-boosted sets still needing more gain—experience proves a **20% average** boost in overall signal is all that's needed to give satisfactory reception.

**Model TSB-1** does exactly that—and **everything expected of an added stage of TV-IF**—at low cost, to complete customer satisfaction, at a handsome profit for you. It's well-designed and wired up in Adaptor form for easy installation. Only **one** wire to connect.

- AMPLIFIES SIGNAL OVER 20% ON ALL CHANNELS
- INCREASES PICTURE BRIGHTNESS
- ELIMINATES OR MINIMIZES "SNOW"
- HAS ALL ADVANTAGES OF BROAD BAND BOOSTERS
- ELIMINATES SEPARATE TUNING FOR EACH CHANNEL
- NO SWITCHES OR EXTERNAL CONNECTIONS
- SIMPLE, PERMANENT, EASY INSTALLATION *INSIDE* CABINET
- EQUALS PERFORMANCE OF MANY HIGHER-PRICED BOOSTERS

**Specifications:** 4" high, excluding tube. Min. Diam., bottom, 3/8". Max. Diam., top, 1 1/8". Silver-plated contact pins. Draws only 0.3 amp. additional filament current from set's filament transformer. Individually boxed with complete instructions.

See the Grayburne TV-IF Booster at your favorite distributor today. Write now for complete catalog.

**GRAYBURNE CORPORATION, 103 Lafayette St., New York 13, N. Y.**

**SPRING SALE**

**BRAND NEW STANDARD BRAND TUBES**

*Individually Boxed and Guaranteed*

0Z4	.59	6BG6	1.76	7Z4	.84
1A7	.98	6BH6	.86	12AT6	.65
1B3	1.02	6BN6	1.32	12AT7	1.09
1H5	.89	6BQ6	1.44	12AU6	.89
1N5	.87	6C4	.76	12AU7	.96
1R5	.82	6CB6	.86	12AV6	.79
1S5	.79	6CD6	2.49	12AV7	1.24
1T4	.83	6F6	.88	12AX7	.99
1U5	.78	6H6	.76	12BA6	.79
1X2A	.96	6J5	.59	12BE6	.79
3Q4	.89	6J6	1.09	12SA7	.77
3Q5	1.02	6J7	.81	12SK7	.77
5U4	.65	6K6	.66	12SN7	1.09
5V4	1.10	6K7	.74	12SQ7	.68
5Y3	.47	6L6GA	1.69	14A7	1.03
6AB7	1.39	6SA	.76	14B6	1.03
6AC7	1.21	6SA7	.76	19T8	1.34
6AG5	.86	6SK7	.79	25BQ6	1.49
6AH6	1.49	6SL7	1.19	25L6	.85
6AK5	1.49	6SN7	.89	25W4	.88
6AL5	.68	6SQ7	.72	35L6	.86
6AQ5	.72	6T8	1.19	35W4	.58
6AT6	.68	6V6GT	.86	35Y4	.86
6AU5	1.59	6W4	.66	35Z5	.57
6AU6	.76	6W6	.89	50A5	.96
6AV6	.67	6X4	.74	50B5	.86
6BA6	.69	6X5	.74	50C5	.86
6BA7	1.16	7C5	.89	50L6	.72
6BC5	.86	7F7	.93	117Z3	.78
6BE6	.82	7N7	.99		

*Above only partial list of tubes on sale. Send for complete list.*

**FREE — New Big Catalog Just Off the Press!!**

**STEVE-EL ELECTRONICS CORP.**

VISIT OUR NEW STORE

Dept. E-4 61 Reade St., New York 7, N. Y. COrtlandt 7-0086

**630 CHASSIS**

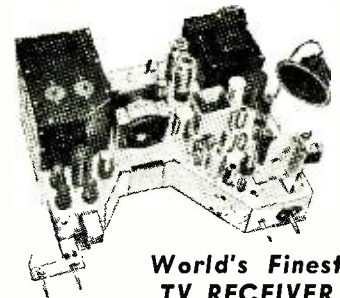

**World's Finest TV RECEIVER**

New and improved Super Famous "630" T.V. Chassis. 30 tubes (including 3 rectifiers) manufactured under license by the Radio Corporation of America. Standard R.M.A. Guarantee! **FREE** replacement on all defective tubes and parts. **FEATURES:** • Full channel coverage. • Discriminator-type FM sound system. • Improved picture brilliance. • AFC horizontal hold. • 3 stage sync. separator and clipper. • Automatic brightness control. • 4 Mc band width. • Highest quality parts used. All standard tubes. • For all Cathode Ray tube sizes and types. 16", 17", 19", 20", 24" Tubes. With HiGain standard coil tuner and R.C.A. Hi-Fi 12" Speaker, knobs and **\$141.50** hardware. Less Cathode Ray Tube

630DX Chassis—Extra power for fringe areas. Can be operated without booster or complicated antenna. **\$151.50** Less Cathode Ray Tube

Available with DuMont Input Tuner FM Radio, less Cathode Ray Tube **\$148.50**

Chassis Mounting Brackets when ordered with chassis **\$4.95**

# SPECIAL!! 6 TUBE AC-DC KIT

At Last! A low-priced kit designed for high sensitivity, excellent selectivity and good tone quality. Uses 25L6, 25Z6, 6SQ7, 6SA7, 6SK7, 6SK7 in an easily constructed circuit. The 6 Tube Kit is shipped with all parts, including punched chassis, resistors, condensers, coil, sockets, PM Speaker, hardware, etc.

And at a closeout price of only **\$6.95**  
X162 less tubes and cabinet

X183 Extra for matched set of six tubes for kit **\$3.25**

## 5 TUBE AC-DC SUPERHET KIT

Five tube superheterodyne kit, A.C.-D.C. contains all components required to construct this latest design, highly sensitive superheterodyne broadcast receiver complete with black bakelite cabinet (excludes wire and solder) Price \$7.95

Extra for a kit of 5 tubes (12AT6, 12BA6, 12BE6, 35WA, 50C5). Price \$3.25.

### YOUR MONEY RETURNED IN FULL—

If the New Regency Television Booster fails to improve your television enjoyment! Bring your picture out of the snow and reduce interference!

- Push-Pull Neutralized triode design assures high gain without adding snow.
- No external impedance matching devices required.
- Inductive tuning assures same high-gain wide-band operation on all channels.
- Single knob tuning control.
- Underwriters approved with 90 day RMA guarantee.

LOWEST Price—ONLY **\$19.11**

## MODEL NFRD—RADIO NOISE FILTER

If it doesn't work, send it back!

We absolutely guarantee that our Model NFRD will eliminate all line noises when properly connected to radios, television sets, short wave sets, motors, electric shavers, refrigerators, vibrators, oil burners, transmitters, and all other sources of interference. This unit will carry up to 12 amperes or 1/4 KW of power and may be used right at the source of interference or at the radio.

Small size only 2 1/2" x 1 3/4" x 4 1/2". Very low price only

Each **\$1.95**

## A SCIENTIFICALLY DESIGNED PHONO SCRATCH FILTER

Resonated at approximately 4500 cycles effectively reducing objectionable needle scratch without altering the brilliancy of reproduction.

Contains a HI-Q SERIES resonated circuit. Tested by means of an audio oscillator and an oscilloscope to give 22 db attenuation with very low signal loss.

EASY TO ATTACH

Just two wires to clip on. Compact **\$1.98**

Price

## THREE TUBE PHONO AMPLIFIER

An assembled unit ready for installation using tone and volume control and six feet of rubber **\$2.95**

(Not including Tubes)

With Complete Set of Tubes.....\$3.95

## PHONO OSCILLATOR

Wireless phono oscillator transmits recording for crystal pick-ups or voice from carbon mike through radio without wires. Can also be used as an inter-comm by using P.M. speaker as mike. **\$2.95**

With Complete Set of Tubes.....\$3.95

Grab Bag Special, 10 pounds of Misc. Electronic Material—Transformers, Condensers, resistor, wire, etc. Price **\$1.95 ea.**

Satisfaction guaranteed on all merchandise  
All prices subject to change without notice.

# RADIO DEALERS SUPPLY CO.

154 Greenwich St. New York 6, N. Y.

pulse repetition rate of 1000 per second and a pulse width of 0.5 usec at 9,300 mc. It can handle up to 100 kw transmitting power.

The Amperex Electronic Corporation announces the 6155 and 6156, improved versions of the 4D21 and 5D22, respectively. The skirt and metal base have been eliminated and the pins pass directly through the powdered glass seal base, allowing free circulation of air around the pin connections. Both tubes are smaller in size but directly interchangeable with their prototypes.

## Special receiving types

The Bell Telephone System has developed three new tubes for its coaxial system which can accommodate 1,800 simultaneous one-way telephone channels over a 4,000-mile circuit. Compared to the 6AK5, also developed by Bell, the tubes feature a remarkably high transconductance and figure of merit. The latter is the product of bandwidth and gain. A special grid construction allows closer spacing to the cathode than formerly possible. Low noise level and a life expectancy of over 15,000 hours, in suitable equipment, is claimed.

Tube type	6AK5 pentode	435A tetrode	436A tetrode	437A triode
Heater voltage	6.3	6.3	6.3	6.3 (volts)
Heater current	.175	.3	.45	.45 (amps)
Plate current	7.5	13	25	40 (ma)
Screen current	2.5	3.5	8.0	— (ma)
Gm	5,000	15,000	28,000	45,000 (uhhos)
Input cap	3.9	7.8	15.2	11.5 (uuf)
Output cap	2.85	2.5	3.3	9 (uuf)
Plate-grid cap	.01	.025	.05	3.5 (uuf)
Figure of merit	72	146	165	—

General Electric has announced two new subminiature receiving tubes. These are high-reliability types designed to resist the extreme shock, vibration, and high temperature conditions encountered in military aircraft operations.

The GL-5797, is a semi-remote-cutoff pentode designed for use as a radio-frequency amplifier. Its characteristics are:

Heater voltage, 26.5 volts; heater current, 0.045 ampere; maximum plate dissipation, 0.8 watt; maximum heater-cathode voltage, 90 volts; plate voltage, 26.5 volts; plate current, 2.75 milliamperes.

The GL-5798 is a medium-mu twin triode designed for use as an oscillator-mixer. Its ratings are: Heater voltage, 26.5 volts; heater current, 0.090 ampere, maximum plate dissipation, each section, 0.4 watt; maximum heater-cathode voltage, 90 volts; plate voltage, each section, 21; plate current, each section, 2.3 milliamperes.

Both are rated for use up to 400 megacycles, and are particularly suited for applications in which the supply voltage for the heaters and plates is about 26.5.

Their special heater-cathode construction will withstand frequent on-off switching, and both types have the following maximum mechanical ratings: Peak impact acceleration in any direction, 300 G; vibrational acceleration in any direction, 2.5 G; ambient temperature, 175 degrees above zero, C.

—end—

## GREAT TUBE VALUES

01A	.66	12HP7	14.65	723A	9.75
2C21	.66	12SK7	.79	723A/B	17.95
2C22	.54	12SR7	.79	724B	3.15
2J21A	14.95	15E	.98	725A	7.95
2J22	14.95	15R	.75	726A	6.75
2J26	21.50	23D4	.42	730A	37.50
2J27	21.50	35.51	.74	800	1.45
2J31	29.75	38	.54	801-A	.44
2J32	38.75	39.44	.52	809	2.35
2J38	.455		.32	837	1.65
2J39	47.50	227A	4.39	838	3.25
2J49	59.50	5027	4.39	860	
2J52	54.50	335A	14.00	861	23.50
2J82	48.50	417A	8.75	876	1.45
3B24W	5.25	532	3.40	932	.75
3BP1	4.95	559	.98	1619	.28
3CP1	2.25	615	.44	1625	.39
3C23	9.95	700-A	23.50	1626	.39
3C30		700-B	23.50	1629	.35
3D1	3.95	700-C	23.50	1961	4.75
3EP1	3.95	703-A	6.75	8013A	4.85
3FP7	2.19	704-A	2.45	9006	.49
3J31	85.00	705-A	2.45	9006	.27
4C27	9.75	706-AY	42.50	GL697	
4J38	87.50	706BY	37.50	NR74	.27
5FP7	2.95	706CY	37.50	QK60	85.00
5GP1	4.75	706EY	44.50	QK61	85.00
5J30	12.75	715B	15.95	QK62	85.00
6U5/6U5G	24.50	717A	4.25	VR91	1.45
6U5/6U5G	.89	718DY	4.25	WL530	9.95
10Y		4219A	24.50		

## SPECIALS

BC 306 ANTENNA TUNING UNIT, NEW	\$ 6.95
19/APN14, New, With Tubes and Crystal	75.00
ID6/APN-1, New, With Tubes and Crystal	75.00
A-62 Phantom Antennae	8.50
2 Meter Choke, 1000 MA, 20-111	8 for 1.00
Supersonic Crystal Head, M-1, 22-27KC HI-2	27.45
Underwater Microphone, Model JR, Z=500w	24.50
Dynamic Mike & Headset Combo, B-19, New	3.75
118-30 Inserts, M-300-A	per M 3.50
Motors, 3 RPM—115V, 60 Cy	1.85
AN/ARC-1 VHF Trans-Rev	75.00
IE 36 Test Set, New	37.50
SCR 274 Test Set, I-104	42.25
Carbon Pile Reg., 18V-5V #35X025	
ART-13 Driver Trans. 6V6 to P-P 811's	1.29
DM 34 Dynamotor, 115V In, 220V, 80 MA out	
Sens. Relay; 3.5MA, 13K ohms, 2PST, 5A	1.29
Klixon Breaker; Thermal, 35A	.69
T-30 Carbon Mikes, New	.89
Screen Mod. Trans. for 807's	1.19
3-4 MC Coils for AR-5 #6020, #7247	Set 2.75
400 Cy Volt Reg. RH Transtat. In: 115V, 400 Cy, Out: 75-120V, 6A	12.79
BC 1203 Pulse Test Set for SCR 555	175.00

Send M.O. or CHK. Mds. Guardt. Shpg. Charges  
Sent C.O.D. Price F.O.B. N.Y.C. Phone Di. 9-4124

## COMMUNICATIONS EQUIPMENT CO.

131 Liberty St. Dept. C-4 New York City 7, N. Y.

## \$3.00 FOR CARTOON IDEAS

RADIO-ELECTRONICS prints several radio cartoons every month. Readers are invited to contribute humorous radio ideas which can be used in cartoon form. It is not necessary that you draw a sketch, unless you wish.

Address  
RADIO CARTOONS, RADIO-ELECTRONICS  
25 West Broadway, New York 7, N. Y.



# EVERY RADIOMAN

Can Use These  
SERVICE HINTS!

Valuable Manual Yours—FREE!

Every page of "How to Simplify Radio Repairs" is packed with on-the-bench, practical ideas. Contains photos, charts, diagrams—no fluff—no vague theory. In plain every-day language it gives you priceless suggestions—new servicing ideas. You'll use and benefit from the experience of experts. Partial list of contents: How to Localize Trouble; How to Service Amplifiers; How to Test for Distortion; How to Test Audio Circuits; How to Test Speakers; How to Find Faults in Oscillators; How to Test Radio Parts—and it's all yours—FREE! No obligation.



SEND COUPON OR PENNY  
POSTCARD FOR YOUR  
FREE COPY TODAY!

FEILER ENGINEERING CO., Dept. 4RC2  
8026 N. Monticello Ave.  
Skokie, Ill. (Suburb of Chicago)

Please RUSH my FREE copy of "How to Simplify Radio Repairs."

Name.....

Address.....

City.....Zone.....State.....



**OVERTONE OSCILLATOR**

Patent No. 2,575,363

Burton H. Simons, Morristown, N. J.

(Assigned to Bell Telephone Laboratories, Inc.)

The recently developed overtone oscillator is the biggest news in crystal circuits in several years. With a single tube, higher frequencies can now be generated with excellent stability. The oscillator uses an AT- or BT-cut crystal and gives output directly on an odd overtone (harmonic). Several oscillators were described in this magazine, December, 1951. The circuit arrangement shown below has been found very efficient by scientists of the Bell Laboratories.

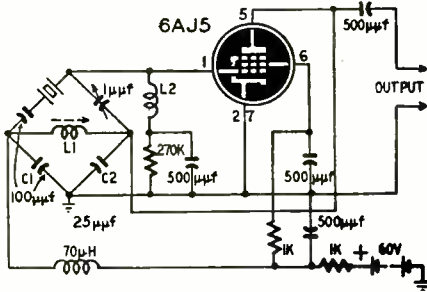

This circuit is specifically designed for an 8- or 9-mc crystal operating at its fifth overtone. With few changes it is suitable for other bands. The pentode works into a bridge composed of three capacitors and the crystal. The small capacitor (about 1 µf) neutralizes crystal capacitance so the bridge is balanced when the crystal reactance is high.

At an odd overtone, the crystal reactance becomes low. Then the bridge is unbalanced and voltage is fed from plate to grid of the tube. The circuit oscillates at an odd overtone to which L1 (with C1 and C2) is tuned. L2 also resonates (with stray capacitance) near the same frequency. This coil has low reactance at the crystal fundamental so this undesired frequency is effectively shorted out.

**INDUCTANCE MEASUREMENT**

Patent No. 2,577,592

Edward M. Shiepe, Brooklyn, N. Y.

This instrument measures the apparent inductance of a coil. With only 2 controls, it is effective from .7-200 mh. No calculations are required. A dial is adjusted for a peak v.t.v.m. reading. Then inductance is indicated on a direct-reading calibrated scale.

Schematic Fig. 1 shows an oscillator which covers a fundamental range 50-100 kc. Harmonics up to the sixth are available. C1 is calibrated at 6

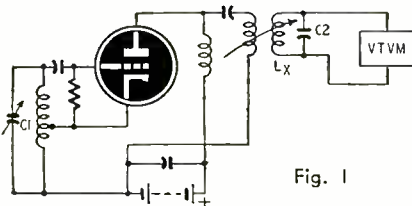

Fig. 1

points as shown in Fig. 2. Oscillator output is coupled to network Lx. C2, with Lx the inductor to be measured. When this is tuned to the oscillator fundamental or any harmonic (up to the 6th) peak output is indicated on the vacuum tube voltmeter.

To make a measurement, C1 is set to 50 kc and C2 is adjusted for peak output. Now C1 is rotated counter-clockwise to find a possible second peak. If none occurs, the correct inductance is read off on scale 1 of the C2 dial. Where no second peak is present, coil Lx and capacitor C2 must be tuned to 50 kc.

Now suppose that one peak is obtained when C1 is set to 50 kc and that a second occurs, say at point 5 (62.5 kc). This indicates that Lx. C2 is tuned to the 5th harmonic of 50 kc. Check this by noting that 250 kc is the only harmonic of both 50 and 62.5 kc (neglecting harmonics above the 6th). In this case we would read scale 5 of C2. Similarly, if the second peak occurred at point 3 (75

*New*  
**WILLIAMSON TYPE**  
**AMPLIFIER Features**

- First Williamson Type Amplifier supplied with matching preamplifier
- Uses Altec Lansing Peerless output transformer.
- Practically distortionless — Harmonic and intermodulation distortion both less than 1/2 of 1% at 5 watts output.
- Frequency response
- ±1 db from 10 cycles to 100 kc.
- Output impedance 4, 8, or 16 ohms.

The new Heathkit Williamson Type Amplifier kit is the best obtainable in amplifiers today—the choice of the really discerning listener. You can hear the difference and measurements actually bear out the superb performance. Frequency response ± 1 db from 10 cycles to 100 kc allow you to hear the highs and lows with equal crispness and clarity. Harmonic and intermodulation distortion both less than 1/2 of 1% at 5 watts output eliminate the harsh and unpleasant qualities which contribute to listening fatigue.

The circuit is similar to the one published in Audio Engineering Magazine for November, 1949, and is considered by engineers throughout the radio field as one of the best ever developed. The Main Amplifier (which may be purchased separately) consists of a voltage amplifier and phase splitter using a 6SN7, a driver stage using a 6SN8, and a push-pull output stage using a pair of 607 tubes. The output transformer is manufactured by the Peerless Division of Altec Lansing and is built to their highest standards. Output impedances of 4, 8, and 16 ohms are available. The power supply uses a separate chassis with husky Chicago Transformer power transformer and choke, and 700V Mallory filters for long life, trouble-free operation. A 5V4G rectifier is used.

The main amplifier and power supply are each on a chassis measuring 7" high by 5 1/2" wide by 11" long.

**PREAMPLIFIER AND TONE CONTROL UNIT KIT**

The preamplifier kit consists of a 12AX7 (or 12AT7) dual triode first amplifier stage with a turn-over control for LP or 78 record types, and a 12AU7 amplifier stage with individual bass and treble tone controls which each provide up to 15db of boost or attenuation. A switch on panel selects either magnetic, crystal, or tuner inputs. Preamplifier also is well suited to custom installations—it will operate in either vertical or horizontal position, and special detuned shafts of the controls and switches allow a variety of shaft lengths to be selected. Dimensions: 2 1/4" high by 10 1/4" wide by 5 1/4" deep.

**WRITE FOR Free CATALOG**

*The*  
**HEATH COMPANY**  
BENTON HARBOR 20,  
MICHIGAN

**Heathkit AMPLIFIER KIT**

WA-A1 Amplifier kit — Combination 1 — (Main Amplifier and Power Supply) complete with WA-P1 Preamplifier Kit. Total Ship. Wgt. 34 lbs. (Shipped Express only) **\$69.50**

WA-A1 Amplifier kit only — Combination 4 — (Main Amplifier and Power Supply). Less WA-P1 Preamplifier. Total Ship. Wgt. 29 lbs. (Shipped Express only) **\$49.75**

WA-P1 Preamplifier Kit only. (Less power supply) (Tubes included). Total Ship. Wgt. 7 lbs. (Shipped Express or Parcel Post) **\$19.75**

*You SAVE BY ORDERING DIRECT*

Let **MILTON S. KIVER** Help You Prepare For **U.H.F.-TV** And...

**TELEVISION SERVICING**

**Easy to TRAIN AT HOME This Practical Way!**

Men with the right training in Television Servicing are in big demand... pull down big pay. T.C.I. TRAINS YOU RIGHT with easy-to-follow technical training designed by servicemen, for servicemen! You learn practical, professional type Television Servicing without leaving your present job. Included are money-making extras such as set conversion, master antenna installation, U.H.F.-TV and field servicing short cuts. You can start earning Television money after the first few lessons. You learn to test, trouble shoot and repair all types of TV sets the proven, practical way!

**HERE'S HOW YOU GET EXPERIENCE!**

You train on your own large screen modern television receiver, furnished as part of your course. This set is yours to keep! As an optional feature you can get two weeks of actual field experience out on service jobs and on the repair bench for Chicago's largest independent servicing organization. You learn Television Servicing by actually doing Television Servicing... you get the practical know-how you need to qualify for BIG MONEY in this fast-growing field! Age is no barrier. Many TCI students are over 40!

**ACT NOW!** Fill out and mail coupon for FREE Catalog and SAMPLE LESSON. Write TODAY!

**TELEVISION COMMUNICATIONS INSTITUTE**  
205 W. Wacker Dr., Dept. RE-8, Chicago 6, Ill.

**YOU GET and keep modern large screen Television receiver.**

**YOU DO actual testing, servicing, trouble shooting and repairing**

**TV BROADCASTING COURSE READY NOW!**

Train at home for these big pay studio jobs! Video engineers, cameramen, microwave engineers, etc. Easy non-mathematical training covers all phases. Write!

**MAIL NOW FOR FREE BOOKLET**

**MILTON S. KIVER, President**  
**TELEVISION COMMUNICATIONS INSTITUTE**  
205 W. Wacker Dr., Dept. RE-8, Chicago 6, Ill.

Rush full facts on the course checked below. I am not obligated. Salesman will not call.

( ) TV Servicing ( ) TV Broadcasting

Name..... Age.....

Address.....

City..... Zone..... State.....

( ) BEGINNERS check here for information on Pre-Tel Radio Course



# NOW!

## THE NEW R.C.P. TUBE TESTER KIT MODEL 322AK

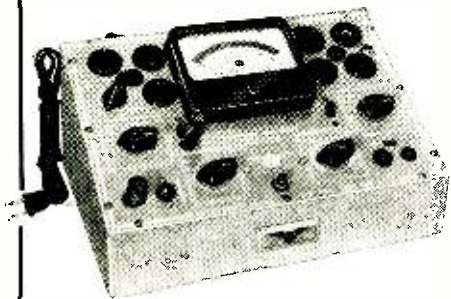

Fully engineered to test all recently developed tubes and television types. Has provisions for checking individual sections of multi-purpose tubes as well as miniature and subminiature receiving tubes. Jack for head-phone noise test to check noisy swinging or high resistance internal tube connections. Neon lamp for rapid short and leakage tests between elements.

MODEL 322A  
KIT COMPLETE ..... **\$28<sup>95</sup>**

## THE MODEL 345K SUPER VACUUM TUBE VOLTMETER



Features long scale 4 1/2" meter in burn out proof meter circuit—electronic balanced bridge type push pull circuit—negligible current drawn due to high input impedance of 25 megohms—Isolation Probe—center of ohm scale 10 ohms—5 ohm-meter ranges reading from 2 ohms to 1 billion ohms (1000 megohms). 20 voltage ranges 0-1000 volts including AC and DC—Complete D.B. meter.

Discriminator alignment scale with zero center permitting operation in both directions. Operates on 105-130 volts. 50-60 cycles—Extra heavy panel, case and chassis. Size 10" x 6" x 5". Weight 8 1/4 lbs. Shipping weight 11 lbs.

MODEL 345K  
KIT COMPLETE ..... **\$25<sup>95</sup>**

**ORDER THESE KITS  
TODAY**

AVAILABLE AT YOUR DISTRIBUTOR  
INSIST ON R.C.P. INSTRUMENTS  
WRITE FOR CATALOGUE RE-4

**RADIO CITY PRODUCTS CO., INC.**

152 West 25th St.  New York 1, N. Y.

kc), Lx is tuned to the 3rd harmonic of 50 kc, 150 kc, and scale 3 is applicable.

Scale 1 (C2) is calibrated from equation  $Lx = \frac{1}{(2\pi f)^2 C_2}$  where  $f = 50$  kc. Scale 2 corresponds to the second harmonic, therefore its values are 4 times smaller than the first (since C2 is unchanged). Likewise, scale 3 is marked with

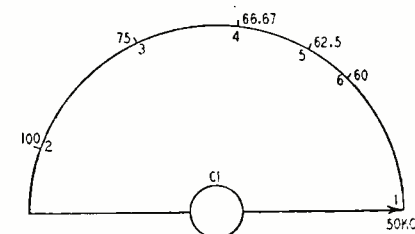
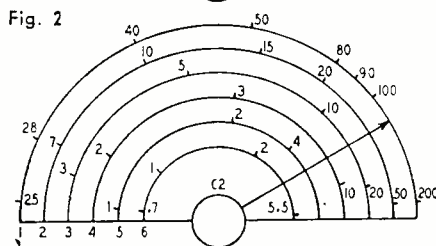

Fig. 2



values 9 times smaller than scale 1, and other scales in a similar manner.

For maximum accuracy, the self capacity of the inductor may be balanced out by a small compensating control.

Small capacities may be also be measured by a similar method.

## LINE SYNCHRONIZATION CONTROL

Patent No. 2,574,229

Kurt Schlesinger, Maywood, Ill.

(Assigned to Motorola, Inc.)

Proper picture synchronization in TV is difficult when signals are weak or noise level high. The circuit of Fig. 1, using a duo-triode, solves the problem. It generates sharp pulses, correctly timed, for horizontal deflection.

V1-a operates in class C for high efficiency. Its plate circuit contains two iron-core resonant circuits. L1 is tuned to the line frequency, 15,750 cycles. L2 is tuned to a low odd harmonic, preferably the third. Both frequencies are induced in a third coil which drives V1-b.

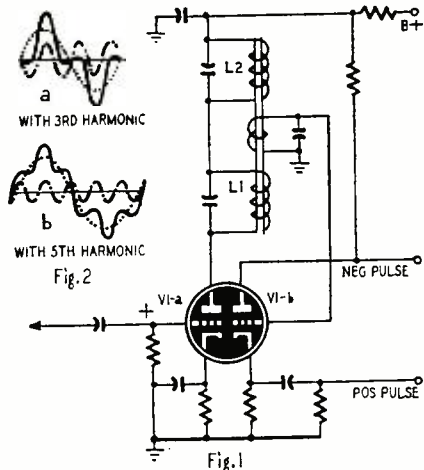

V1-a is pulsed by positive line syne signals which shock L1 and L2 so that they oscillate at their respective frequencies. These circuits have high Q so the oscillations decay slowly. When a fundamental is combined with a low odd harmonic, the result is a highly peaked wave. See Fig. 2. V1-b is biased to clip the negative peak. As shown, the output line pulse may be either negative or positive depending upon whether taken from the V1-b plate or cathode. It is fed to the horizontal deflection circuits for positive control.

—end—

## BUYING ANTENNAS?

Buy by This Mark—  
The Seal of Quality Products  
and Sound Business Practices



C. & M. MANUFACTURING CO.  
Eastondale, Mass.

CAMBURN, INC.  
Woodside, L. I., N. Y.

CHANNEL MASTER CORP.  
Ellenville, N. Y.

THE FINNEY CO.  
Cleveland 3, Ohio

HY-LITE ANTENNAE, INC.  
New York 51, N. Y.

JFD MANUFACTURING CO., INC.  
Brooklyn 4, N. Y.

RADELCO MANUFACTURING CO.  
Cleveland 25, Ohio

THE RADIART CORPORATION  
Cleveland 2, Ohio

RADIO MERCHANDISE SALES, INC.  
New York 59, N. Y.

WALTER L. SCHOTT COMPANY  
Los Angeles 18, California

SNYDER MANUFACTURING CO.  
Philadelphia 40, Penna.

T-V PRODUCTS CO.  
Brooklyn 5, N. Y.

WARD PRODUCTS CORP.  
Division of The Gabriel Co.  
Cleveland, Ohio

THE WORKSHOP ASSOCIATES  
Division of The Gabriel Co.  
Needham Heights 94, Mass.

## ON-THE SPOT BATTERY RECORDER

WALKIE-RECORDALL 8 lb. miniature BATTERY CONTINUOUS permanent, accurate, indexed recording at only 3c per hr. Instantaneous, permanent playback. Picks up sound up to 60 ft. Records conferences, lectures, dictation, 2-way phone & sales talks; while walking, riding or flying. Records in closed briefcase with "hidden mike"! Write for details.

MILES REPRODUCER CO., INC.  
812 BROADWAY Dep't RE-4 NEW YORK 3 N. Y.

## WE JUST GOTTA BUY THIS STUFF!

We're tearing our hair out to buy desperately needed equipment, such as ART-13, BC-348, BC-224, BC-342, BC-788, I-152, T-17 MICS., BC-312, ARC-1, BC-221, RS/ARN-7 or components. In fact, we'll buy any parts or accessories no matter how small. For speedy, efficient service and a real honest deal, phone, wire or write:  
V & H RADIO & ELECTRONICS SUPPLY CO.  
2033 W. Venice Blvd., Los Angeles 6, Calif.  
Telephone: REpublic 3-1127

## Every RADIOMAN can use these SERVICE HINTS!

Valuable Manual Yours—FREE

Write today—no obligation

FEILER ENGINEERING CO. Dept. 4RC-2  
8026 N. Monticello Ave., Skokie, Ill. (Suburb of Chicago)

Every page of "How to Simplify Radio Repairs" is packed with on-the-bench, practical ideas.

## PARTS—TUBES—KITS

50L6—68; 35Z5—50; 6SN7—88; 5Y4G—99; 6J6—\$1.06. Standard Brand—Fully Guaranteed. Stanwyck TV Coil Kit—List \$12.95—Special **\$3.95**, 20" TV Kit **\$65.00** Less Tubes. Write for free catalogue. Minimum order \$5.00 F.O.B. N. Y. Money-back guarantee. Send 20¢ with order.

CERTIFIED TELEVISION LABORATORIES  
Dept. C, 5507-13th Ave., Brooklyn 19, N. Y.



# NIAGARA TOPS 'EM ALL!

## REGAL T-V CHASSIS "SUPER" 630 TYPE

This new Regal, powerful 32-tube chassis, capable of driving 16", 17", 19", and 20" cathode-ray tubes, has a horizontal automatic frequency control which has been tradenamed "Regalok". It has a 70 degree yoke with ample sweep to cover a 20" television picture tube without shadows.

The set also includes a turret type tuner, a high gain video amplifier, four stages of i.f. amplification, a power line filter, and sync clamping to insure absolute sync hold.

The new chassis just released is now available at Niagara.

**A SUPER PRICE ..... \$14950**  
630 DX CHASSIS

Extra Power for FRINGE AREAS ..... \$159.50

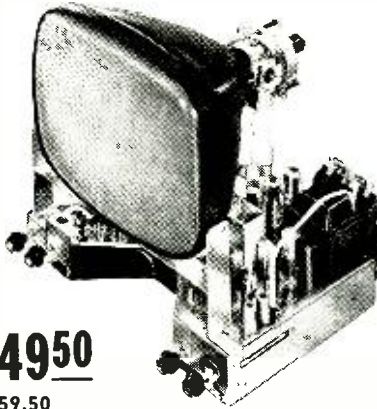

## WELLER SOLDERING GUNS NEW LOW PRICES!!!



Model	Watts	Old Price	New Price
WS-100	100	\$11.95	\$ 8.95
WS-135*	100-135	13.95	10.95
WS-200	200	12.95	9.95
WD-250*	200-250	14.95	11.95

\*DUAL HEAT

**FREE!** With each gun ordered one copy of the valuable Booklet "Soldering Tips—Your Guide To Easier Soldering."

**REMOTE CONTROL FOR THE THING!!**  
(Plus \$1.00 Book Free)

The answer to the "Remote Control" experimenter's dream! A completely wired, 3 tube remote control unit, originally used as Electronic Brain for remote thermo-static control of electric blankets.

And that's not all! With each unit we will give you absolutely free, one copy of Tomstack Library's popular new book "Model Control by Radio".

Remote Control Unit, including PH. Xmer, 300 ohm plate circuit "trigger" relay, completely wired, circuit diagram and above described hook-less tubes. .... \$5.50  
Shipping Wgt. 3 Lbs.

WEBSTER-CHICAGO 100-75

**AUTOMATIC 3 SPEED RECORD CHANGER WITH "FLIP-OVER" CARTRIDGE**



One of their latest models. Plays 12, 10 or 7 inch records at 33 1/3, 45, or 78 R. P. M. New spindle carefully lowers unplayed record stack. Pickup arm comes to rest position after last record has played. Complete factory packed and sealed record changers, normally listing at \$47.50. While they last. .... \$24.85  
Shipping Wgt. ....

## ASTATIC BOOSTER

MODEL BT-1

A simplified high gain booster using the famous Mallory inducto-tuner for continuous tuning over entire TV and FM spectrum. Gives exceptional improvement on all channels. Single tuning knob. Mahogany finished metal case. Low noise. For either 72 or 300 ohm line. Wgt. 5 lbs.



**SPECIAL! \$18.45**

MODEL AT-1



Astatic four-tube deluxe models—no other booster can do so much in improving TV picture contrast and clarity, in improving sound, in eliminating interference. Feature exclusive variable gain control and dual-tuning.

Model AT-1 in fine furniture finish mahogany.

**Special \$29.10**

**New Low Price**  
Niagara Famous High Pass Filter



**BLEEP BLOOP BLAP**

Banish Interference with Niagara's Hi-pass filter! Positive protection against interference from a m a t e u r

transmitters, diathermy, and all other devices generating radio frequency interference below 40 MCS. Designed for 300 ohm leadin. No loss in brightness or clarity. .... \$2.95  
Wired and tested .....  
Postpaid if entire amount is included with order.

National



SW-54

\$49.95

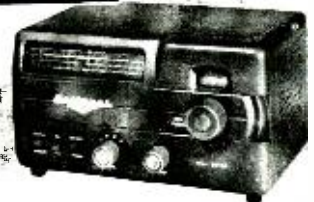

Sleek, Low-Priced, Beauty in a Compact General Coverage Receiver. 11" x 7" x 7"  
**NATIONAL SW-54 IN STOCK**  
WRITE FOR FREE LITERATURE

COMPLETE LINE OF

**WHEELER**

SOUND POWERED PHONES

TALK

Up to 25 Miles without Batteries or Power Supply  
The Finest!

WRITE FOR FREE WHEELER CATALOG



MODEL SPT-102 (Illustrated) WITH TEST CLIPS

\$9.62

EACH

A HIGH PRECISION VTVM KIT By

**TEICO**



**TOPS ON ANY WORK BENCH**

Versatility plus! 15 different ranges, 100-5000 Ohms, from 2 ohms to 1000 megohms in 5 steps! Exceptionally accurate. Big 4 1/2" fused meter. Dozens of features too numerous to mention. Buy it up in one word. **TERRIFIC!**  
EICO VTVM Kit No. 221K ..... \$25.95  
EICO VTVM, wired and tested ..... \$49.95  
Write for Free EICO Catalogue

## SYNCHRO-SELSYNS

All Brand New



Machine aluminum housing and case. Bakelite end cap with coded screw terminals. 1/4" shaft.

C-78249 Cal. 11280 Synchro Differential 100 V. 60 Cycle. Price ..... \$3.75  
C-78173 Cal. 10920 Repeater type XX 50 V. 50 Cycle. Price ..... 3.75  
C-78411 Cal. 11925 Transmitter 50 V. 50 Cycle. Price ..... 3.75  
The below listed type is similar to above, but contained in a solid machined bronze housing. 5 leads 5 ft. long, of color coded fiber glass insulation are provided.  
C-59276 1 cu-1160-4-1 Repeater type 11-5 100 V. 50 Cycle. Price ..... \$7.50

**14 KV. H. V. FLYBACK XFMR**



Corona Sealed Universal Replacement

Type horizontal output and high voltage transformer for TV sets up to 20 inches. Completely encased in chip-proof plastic to prevent "corona" effect or arcing. An exceptionally high rated transformer at a new low price. Individually boxed with instructions, specifications and mounting hardware. Meas. 3x2x2 1/2" h. Shipping wgt. 3 lbs.

Each **\$4.97**

ONE OF AMERICA'S GREAT RADIO STORES  
**Niagara**  
RADIO SUPPLY CORP. Dept. 4-E2  
160 Greenwich Street, New York 6, N. Y.

Digby 9-1132-3-4



## New Devices

### WILLIAMSON AMPLIFIER KIT

The Heath Co., Benton Harbor, Mich., is now producing a Williamson-type amplifier in kit form. Known as the WA-1, the unit consists of the pre-amplifier-equalizer (WA-PI) and the amplifier and power supply (WA-31). The main amplifier has two 6SN7-GT's, a pair of 807's in the familiar Williamson triode-connected arrange-

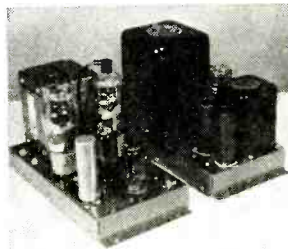

ment, and a 5V4-G rectifier. The frequency response is flat within 1 db from 10 cycles to 100 kc, harmonic distortion is less than 0.5% between 20 and 20,000 cycles at 5 watts output. At this output level, the input is 1.2 volts across 470,000 ohms and the inter-modulation distortion is 0.5% (using 60 and 3,000 cycles). The unit draws 120 watts from a 105-125-volt, 60-cycle line and is on a chassis 7 inches high, 5 1/2 inches wide, and 11 inches long.

The WA-PI preamplifier uses one 12AU7 and a 12AY7 or 12AX7. A switch selects any one of two low-gain inputs for crystal pickup and tuner or the high-gain input channel for magnetic cartridge. A two-position turnover switch operating in the high-gain channel has positions for 78-r.p.m. and LP recordings. Separate bass and treble controls provide 15 db boost or cut at

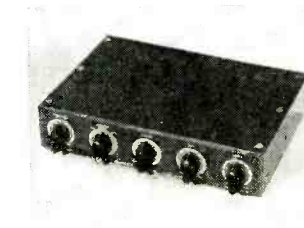

20 and 20,000 cycles, respectively. Signal voltage required for 1.2 volts output is 0.2 volts across 1 megohm in the low-gain channels and .004 volts across 3,300 ohms in the high-gain channel. The unit measures 2 1/4 x 10 1/4 x 10 1/4 inches overall. The power supply on the main chassis delivers 220 volts d.c. at 6 ma and 6.3 volts at 600 ma to the preamplifier.

### TV PREAMP-COUPLER

JFD Mfg. Co., Inc., 6101 16th Ave., Brooklyn 4, N. Y., is now producing the new EC-4 TV preamplifier and coupler called the Hide-Away. Video signals are boosted by a two-stage amplifier using a 6BQ7 tube and may be fed to as many as four separate TV sets without signal loss. By connecting several EC-4's in cascade, up to 13 sets may be fed from a single antenna with no loss in signal strength.

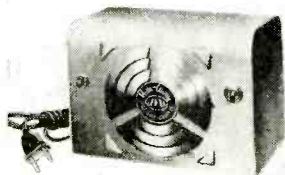

### BINAURAL HEADSETS

Permoflux Corp., 4900 W. Grand Ave., Chicago 39, Ill., announces the development of a new line of binaural dynamic headsets designed especially for reproducing stereophonic (binaural) sound. They are used for choir and orchestra rehearsals, by engineers

when monitoring two audio channels, and by classroom instructors of the deaf.

In binaural recording two microphones are used. They are generally spaced and directed so as to receive sounds in the same relationship as a pair of human ears. The outputs of the two microphones are amplified and recorded separately. When replayed, each sound channel is fed into the earphone corresponding to the microphone which picked up the original sound. This system gives a three-dimensional quality and a more realistic character to many forms of recorded sound.

The headsets are available in two standard models having an impedance of 12 ohms per phone and as two high-fidelity models having an impedance of 300 ohms per phone.



### OPEN-WIRE LINE

The Fretco Corp., 1041 Forbes St., Pittsburgh 19, Penna., is now manufacturing its Fretline open-wire transmission line with a newly designed insulator made of clear virgin polystyrene. The elimination of coloring matter from the insulator decreases the line loss and maintains characteristic impedance. Hard-drawn wire is used in the new Fretline.



### TUBE AND TOOL CARRIER

Grayburne Corp., 103 Lafayette St., New York 13, N. Y., announces a new type tube and tool carrier that incorporates features not available in previous types. The new carrier offers two units in one, a top section for tools and pocket type instruments and the lower section for tubes and small components.

The unit is all wood and Masonite construction with such parts as slide supports glued and nailed into grooved side pieces. A large mirror is set into a removable cover which may be placed in any convenient position so that the picture tube may be focused from the rear of chassis.

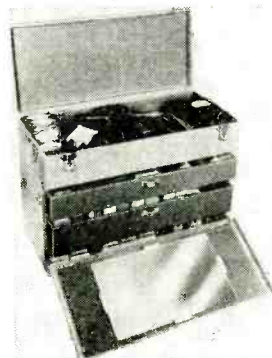

RADIO-ELECTRONICS

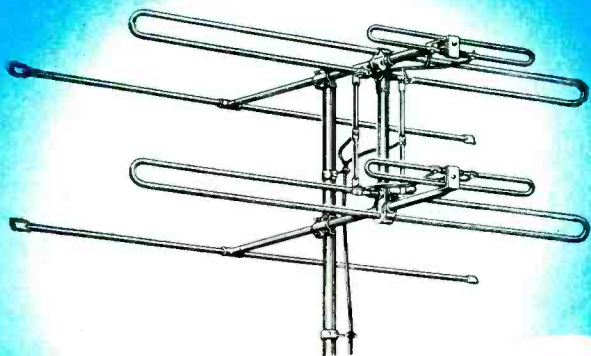

AMPHENOL

this  Book



... contains information never before available in a concise, readable form. It presents a complete discussion of the factors and conditions which affect television reception and the reasons for good TV pictures. The one single factor which contributes the most to Better TV Picture Quality is the television antenna. The best and most expensive TV set can present a picture no better than that received by the antenna.

This book gives a detailed discussion, complete with illustrations and graphs, of the various types of antennas, their characteristics and performance under given conditions. In addition, the book contains information on the problem of coordinating the antenna with the location.

Your Authorized Amphenol Distributor has a free copy of this book waiting for you—ask for yours today!

AMERICAN PHENOLIC CORPORATION  
1830 SOUTH 54th AVENUE • CHICAGO 50, ILLINOIS

AMPHENOL



**SOLDERING GUN**

The Wen Products Co., 5806 Northwest Highway, Chicago 31, Ill., announces its new transformer-type soldering gun which heats in 3 to 5 seconds when the trigger is pressed. A built-in spot light illuminates the work. A long slim tip reaches into otherwise inaccessible spots. The 250-watt iron can be used for heating liquids, wood or leather burning, and other craft work, as well as for most soldering requirements. Soldering tips are replaceable.



**VARIABLE LOOPSTICK**

The Grayburne Corp., 103 Lafayette St., New York, N. Y., announces its new Vari-Loopstick as a companion unit to the Ferri-Loopstick. The new unit has the advantages of the older unit with the added feature of micrometer adjustment. This feature makes it possible to peak the circuit on any station at will. Both units can be used to replace loop antennas in broadcast sets.



**WIDE-RANGE SPEAKER**

University Loudspeakers, Inc., 80 S. Kenosia Ave., White Plains, N. Y., has introduced the Diffusicone-12, a new wide-range, wide-dispersion loud-

speaker. It features a dual concentric apex horn which extends the range to over 13,000 cycles and disperses the normally beam-like high frequencies throughout the listening area. The 30-watt speaker has a 1 1/2-pound Alnico-V magnet and a 2-inch voice coil.



**POWER RESISTORS**

Dale Products, Inc., Columbus, Neb., has announced the addition of 2-, 5-, and 10-watt resistors to its line of power resistors. Like the 25- and 50-watt units, the new ones offer com-



pletely welded construction from terminal to terminal and a silicone material to seal the resistance element against moisture.

The temperature coefficient is practically flat and the resistance shift is less than 0.00002% per degree Centigrade. Standard tolerance is 1%, but tolerances as high as 0.05% are available on order.

**TV DISTRIBUTION UNIT**

Blonder-Tongue Laboratories, Inc., 38 N. Second St., Mt. Vernon, N. Y., is now producing the model DA2-1-M ampli-



fied TV distribution unit. Featuring two isolated TV set outlets and a through line output, it can be used in master TV antenna systems of any size or as a complete system for the two-set home. Two 6BC5's provide electronic isolation and amplify all channels simultaneously to each TV set. Each terminal provides correct matching to 75- or 300-ohm lines. The units may be used in series by interconnecting them with 75-ohm cable. Maximum input and output signal voltages are 0.5 on 75 ohms and 1.0 on 300 ohms.

**KLIPSCH SPEAKER CABINET**

Electro-Voice Inc., Buchanan, Mich., has recently introduced the Royal—a new Klipsch-licensed folded-horn corner enclosure designed for 15-inch coaxial speakers and for 800-cycle crossover-two- and three-way speaker systems. By using the walls of the room as an extension of the exponential air load on the driver, bass reproduction goes down to 30 cycles with high efficiency. The baffle board arrangement permits mounting 15-inch coaxials or separate two- and three-way systems without modifications.

The Royal is 37 inches high, 20 1/4 inches deep, and 23 3/4 inches wide. It is available with mahogany or blond Korina finishes on the woodwork and a brushed-brass antique finish on the front grille.



**80-WATT A.F. AMPLIFIER**

Allied Radio Corp., 833 W. Jackson Blvd., Chicago 7, Ill., has released the new Knight 80-watt amplifier designed for such industrial applications as high-power paging and music distribution throughout entire plants; for outdoor stadium use, large auditoriums, schools, and churches. Actual coverage is approximately 260,000 sq. ft. and up to 40,000 people when used with proper accessories such as trumpet-type speakers.

Technical specifications include: Power output, full 80 watts; hum 76 db down; four inputs for microphone and phono; five outputs from 4- to 500 ohms, plus new ETMA 70-volt and special 600-ohm low level lines, ungrounded output for connection to phone lines or additional amplifiers for extra power; response, ± 2 db, 30-20,000 c.p.s.; bass and treble tone controls; 6 tubes plus 4 rectifiers; power drain, 127 watts at no signal and 300 watts at rated output. Operation is from 110-130 volts, 50-60 cycle a.c., with

# FIX ANY RADIO

## Amazing New Invention



Find radio faults with a new simplified method. Repair all radios in minutes instead of hours. Revolutionary, different Comparison technique permits you to do expert work almost immediately. Most repairs can be made without test equipment. Simplified point-to-point, cross-reference, circuit suggestions locate faults quickly and easily.



**NO TESTERS NEEDED**

This newly developed method tells you how to locate the source of trouble in any radio set without equipment. Make needed tests, measure voltage, trace the signal, by using only a 5¢ resistor, small condenser, and a crystal detector. Inject signals without any signal generator. Test parts by the new Comparison method. Test tubes without equipment. Repair any radio expertly following simplified picture plans. Improve your radio servicing ability. Data on all sets, portables, FM, AC-DC, P.A., and television. Send coupon below.

**CHARTS, BLUE-PRINTS, TESTS**

Learn time-saving trouble-shooting short-cuts; find any radio fault with ease. Follow the tests shown on 24 large circuit blue-prints. Gives over 1,000 practical repair hints. For all types of radios. Hundreds of simplified tests using a 5¢ resistor and any filter condenser. Introductory material to help beginners. Several chapters on test equipment. Complete plan in manual form, 61 job-sheets, data on all tubes. 92 large pages, 8 1/2 x 11 in. Schematics, pictures, charts. Sold on no-risk trial. Price, only \$1.50.



**Supreme Radio & TV Manuals**

Your complete source of all needed RADIO and TV diagrams and service data. Most amazing values. Still sold at pre-Korean prices. Only \$2 for most volumes. Every Radio manual contains large schematics, all needed alignment facts, parts lists, voltage values, trimmers, dial stringing, and service hints. Each TV manual is a practical treatise on servicing the year's sets, with giant blueprints, patterns, waveforms, charts, suggested changes. See coupon at right for a complete list of these low-priced manuals.

**NO-RISK TRIAL ORDER COUPON**

**SUPREME PUBLICATIONS, 3727 W. 13 St., Chicago 23, ILL.**

Send the manuals checked below and at right. You guarantee satisfaction or money back.

- Simplified Radio Servicing by Comparison...\$1.50
- New 1952 Television Service Manual..... \$3.
- 1951 TV...\$3.    1950 TV...\$3.    1949 TV... \$3.
- 1948 TV...\$3.    1947 TV & FM, only... \$2.

- Radio Diagram Manuals**
- New 1951 Manual } Each Only
  - 1950 Radio Manual } **\$2.50**
  - 1949 Radio Manual }

**PRICED AT ONLY \$2 EACH**

**RADIO MANUALS**

- 1948
- 1947
- 1946
- 1942
- 1941
- 1940
- 1939
- 1926-1938 Manual, \$2.50

I am enclosing \$..... Send postpaid.

Send C.O.D. I am enclosing \$..... deposit.

Name: .....

Address: .....

**Supreme Publications**  
Sold by All Leading Radio Jobbers

**IF YOU WANT THE BEST...**

The #630 TV RECEIVER remains unmatched for quality and performance • RCA designed and developed this set quality-wise not price-wise • The original 10" set retailed at \$375.00 • Subsequent TV sets serve to prove the sacrifice of quality for price • What better proof can there be of its superiority than the fact that it is the private choice of TV engineers and TV technicians! • There is....

**NOTHING BETTER AT ANY PRICE**

**\* 630 SUPER DELUXE 31-TUBE TV CHASSIS... LICENSED BY RCA**

Nationally Known Manufacturer — Brochure Sent With Order Or On Request

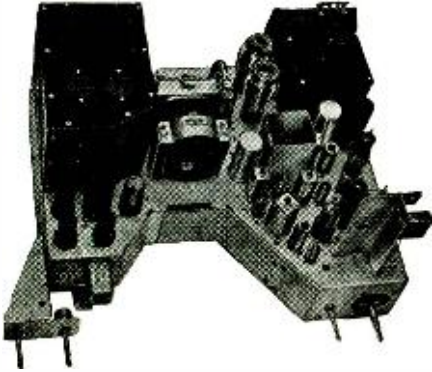

OPERATES ALL **16" TO 24"** PICTURE TUBES

Engineered in strict adherence to the genuine RCA #630, plus added features ★ ★ ★ ★ ★

- Standard Turret Tuner (Cascode) for DX
- Original 630 Synch. Chain for Stability
- 16.5 KV for Clarity and Brilliance
- Peak Sensitivity for Fringe Areas
- 4 Megacycle Bandwidth for Definition
- Fast Action Pulse Keyed AGC
- Large Concert-tone 12" PM Speaker

Complete ready to play with all tubes, hardware, knobs, etc. (less C.R. tube)

**\$167.97**

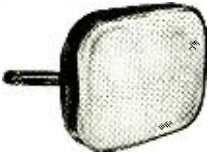

**FINEST STANDARD GUARANTEED PICTURE TUBES**

Most desirable 3 sizes. Choice of DUMONT 6-mos. guaranty or SHELDON blue label 1-yr. guaranty.

**17" Rect. \$34.63**

**21" Rect. \$49.74**

**24" Round \$79.49**

NOW... The NEW 21" PICTURE TUBE for the same price as the 20"

**CUSTOM-BUILT CABINETS FOR #630 AND ALL OTHER TV SETS — FROM FACTORY TO YOU**

5 LEADING STYLES in genuine mahogany or walnut (blonde 10% extra). NEW YORKER or WINDSOR when open look like STREAMLINER. Ready drilled for any #630 TV chassis and cutout for any 12 1/2" to 21" picture tube at no extras in price. Also supplied with undrilled knob panel for any other TV set. EVERYTHING NECESSARY for an easy perfect assembly is included. Each cabinet is delivered complete as pictured with mask, safety glass, mounting brackets, backboard, backcup, hardware and assembling instructions. Each cabinet is shipped in an air cushioned carton from FACTORY to YOU.

The **VOGUE**  
Most Popular  
Table Model.

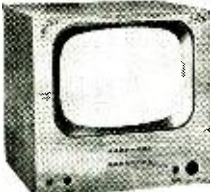

H-24", W-26", D-23"  
**\$39.89**

VOGUE also available for 24" picture tube

**\$62.54**

The **MANHATTAN**  
It Has Everything  
Style, Quality, Price

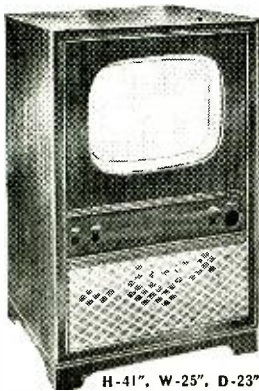

H-41", W-25", D-23"  
**\$59.37**

MANHATTAN also available for 24" picture tube. \$86.22

The **STREAMLINER**  
Center Drop Panel  
Conceals Tuning Knobs.

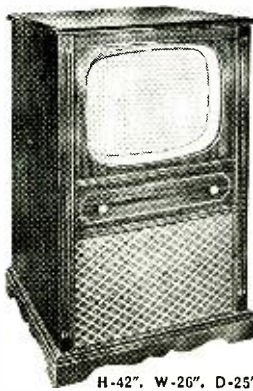

H-42", W-26", D-25"  
**\$74.98**

The **NEW YORKER**  
A Deluxe Cabinet  
With a Piano Finish.



H-42", W-26", D-24"  
**\$96.87**

The **WINDSOR**  
Aristocrat of Cabinets  
Doors in Genuine Leather  
Hand Tooled In Gold



H-42", W-26", D-25"  
**\$117.46**

**SPECIAL COMBINATION OFFERS**

**VOGUE CABINET SUPER D-CHASSIS and PICTURE TUBE**  
17" ... \$218.21  
21" ... 231.64  
24" ... 278.86

**MANHATTAN CABINET SUPER DELUXE CHASSIS and PICTURE TUBE**  
17" ..... \$235.78  
21" ..... 249.37  
24" ..... 298.24

**STREAMLINER CABINET SUPER DELUXE CHASSIS and PICTURE TUBE**  
17" ..... \$249.82  
21" ..... 263.43

**NEW YORKER CABINET SUPER DELUXE CHASSIS and PICTURE TUBE**  
17" ..... \$269.58  
21" ..... 283.16

**WINDSOR CABINET SUPER DELUXE CHASSIS and PICTURE TUBE**  
17" ..... \$298.16  
21" ..... 301.62

(Above offers apply to mahogany or walnut, for blonde add 10% on cost of cabinet.)

**BROOKS RADIO & TV CORP., 84 Vesey St., Dept. A, New York 7, N. Y.** TELEPHONE COrtlandt 7-2359



**BUILDING ANY #630 TV SET**  
Is Now Easy  
with the

**Brooks LIFE-SIZE Edition**  
#630 TV KIT BUILDER - SET OF INSTRUCTIONS

**LIFE SIZE** — Everything from chassis pan, to part, to tube, to wire is life-size, you just can't make mistakes. **NO MORE FUMBLING** — The diagrams, layouts, and easy to follow step by step instructions are all neatly arranged on 25" x 38" charts eliminating the old method of looking and craning from booklet to diagram.

**INDISPENSABLE** — for TV building, converting, modernizing or even trouble shooting any #630 TV RECEIVER.

Popular priced at only **\$2.49** POSTPAID

## #630 STANDARD 29-TUBE TV KIT

COMPLETE SET OF PARTS  
for the FAMOUS ORIGINAL RCA #630  
29-TUBE 10" to 12 1/2" CHASSIS

Complete with all tubes and the new LIFE-SIZE TV builder's instructions (less CRT and wire)

**\$99.99**

## #630 SUPER DELUXE 31-TUBE TV KIT

OPERATES ALL 16" TO 24" PICTURE TUBES

COMPLETE SET OF PARTS  
WITH VOLTAGE DOUBLER & AGC

Complete with all tubes and the new LIFE-SIZE TV builder's instructions (less CRT and wire)

**\$119.44**

## #630 TV BASIC PARTS KIT

Totals over \$100 if purchased separately at list prices:

- PUNCHED & DRILLED CHASSIS PAN
- BRACKET & SHIELD KIT (18 items)
- VIDEO & I.F. KIT (19 items)
- POWER TRANSFORMER #201T6
- VERTICAL OUTPUT TRANSFORMER
- VERTICAL BLOCKING TRANSFORMER
- FLYBACK TRANS. #211T3 or #211T5
- FOCUS COIL, #202D1 or #202D2
- DEFLECTION YOKE, 60° or 70°

ALL FOR ONLY

**\$39.49**

Including the new LIFE-SIZE TV builder's instructions

## UNIVERSAL Picture Tube Mounting BRACKETS

Fits All 12 1/2" to 21" Picture Tubes

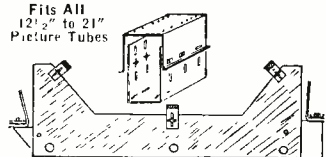

Complete—including band that holds picture tube.

**\$6.97**

(Also available for the 24" CRT.....\$7.97)  
CRT is the abbreviation for picture tube

# HOTTEST TV PACKAGE for "ONE BUCK"!

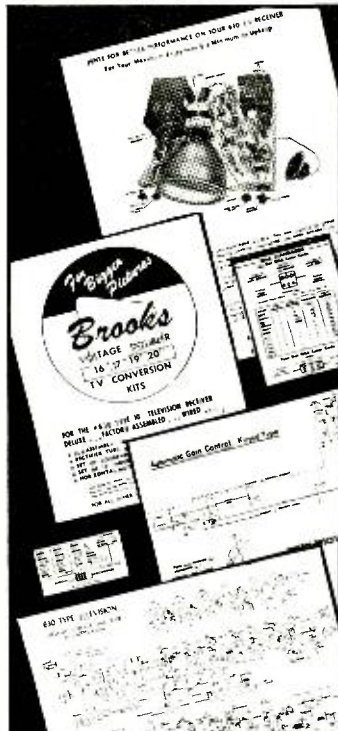

EVERYONE INTERESTED IN TELEVISION should own this TV literature package . . . The information will be found useful on any make TV set. Easy enough for anyone to understand and follow.

Just think of being able to convert any 10" TV set into a life-size 16" to 24" receiver . . . The ILLUSTRATED TV CONVERSION MANUAL makes that possible.

**SAVE MONEY ON REPAIRS** — Common occurrences are carefully analyzed and corrective procedures are suggested. You are told what to do—WHEN THE RECEIVER FAILS TO OPERATE, WHEN THERE ARE GHOSTS, INTERFERENCE, NO PICTURE, PICTURE FOLD-OVER, NO RASTER, PICTURE BLOOMS, DISTORTED PICTURE, PICTURE ROLLS, NO SOUND, DISTORTED SOUND, CORONA EFFECTS, ETC. PICTURE TUBE ASSEMBLY and PATTERN ADJUSTMENTS are outlined in detail (the ion trap adjustment caution may save you the price of a new picture tube). The HORIZONTAL SYNC, and STANDARD TUNER step by step adjustments alone are worth many times the cost of this package.

**TUNING GUIDANCE** and **ANTENNA ADVICE** will enable you to enjoy peak performance at its best.

The 630 DIAGRAM, KEYED AGC DIAGRAM, RESISTOR & MICA CODE CHARTS need no emphasis as to their usefulness.

You will also receive our latest catalog and flyers with hundreds of special offers in Television, Chassis, Cabinets, Picture Tubes, Parts, Radios, Portables, Auto Radios, Radio Tubes, Test Equipment, Etc., at WHOLESALE PRICES.

- 1—Hints for Better Pictures on #630 TV
- 2—#630 TV Diagram With Modifications
- 3—Illustrated TV Conversion Manual
- 4—Pulse Keyed AGC Circuit Diagram
- 5—RMA Resistor & Mica Code Charts

ALL FOR ONLY **\$1.00** POSTPAID

## CONVERT ANY 10" TV SET TO A 16" to 24" RECEIVER

With a new **DELUXE VOLTAGE DOUBLER KIT**—scientific . . . accurate . . . eliminates guess work. Anyone with even a limited knowledge of TV can follow the simple step by step instructions and produce a perfect conversion in as little as one hour.

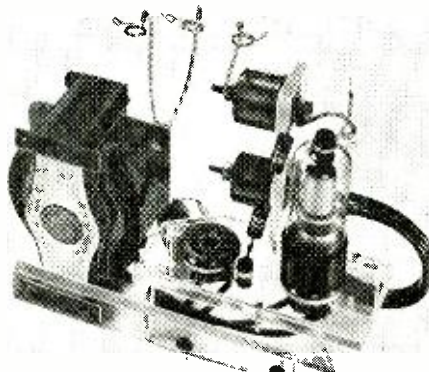

### ASSEMBLED KIT FOR THE 630 CHASSIS

- Sub-Assembly (illustrated)
- Flyback Transformer #211T5
- Rectifier Tube #1B3
- Resistors & Condensers
- Set of 16" Mounting Brackets

**\$15.98**

### UNASSEMBLED KIT FOR ANY TV CHASSIS

(SAME SET OF COMPONENTS AS LISTED ABOVE)

Electrically the circuit remains the same. Unassembled form allows for modifications in mounting and wiring.

**\$13.98**

ILLUSTRATED CONVERSION MANUAL  
SUPPLIED WITH EACH KIT  
(add \$3.99 for Universal Mounting Brackets)

## #630 TV PARTS . . . TOP QUALITY . . . LOW PRICES

RCA FRONT END TUNER, compl. w/tubes.	\$22.49
STANDARD CASCODE " ", com. w/tubes	22.49
ESCUTCHEON PLATE, for either tuner.	.69
DUMONT INPUTUNER, complete w/tubes.	22.49
COMPLETE SET OF KNOBS, incl. decals.	1.34
COMPLETE SET OF KNOBS, gold incl. decals	2.49
POWER TRANSFORMER, 295ma., 201T6	9.97
VERTICAL OUTPUT TRANS. 204T2	2.69
VERTICAL BLOCKING TRANS. 208T2	1.32
HORIZONTAL OUTPUT TRANS. 211T3	2.98
HORIZONTAL OUTPUT TRANS. 211T5	3.98
FOCUS COIL, 247 ohms, 202D1	2.29
FOCUS COIL, 470 ohms, 202D2	3.42
DEFLECTION YOKE, 60° 201D1	2.97
DEFLECTION YOKE, 70° 206D1	3.98
HORIZONTAL DISCRIM. TRANS. 208T8	1.49
FILTER CHOKE, 62 ohms 208T8	1.47
WIDTH CONTROL COIL, keyed AGC	.79
ION TRAP BEAM BENDER, (single) 203D1	.79
IONTRAPBEAM BENDER, (double) 203D3	.98
AUDIO OUTPUT TRANSFORMER (6K6)	.69
HV RECTIFIER, SOCKET ASSEMBLY, single	.79
HV RECTIFIER, SOCKET ASSEMBLY, double	1.37
HV KINESCOPE LEAD, with clip	.39
PUNCHED CHASSIS PAN, cadmium plated	\$4.87

630KIT, screws, nuts, washers	1.69
12" PM SPEAKER, heavy alnico #5 magnet	6.94

## TV WIRE AND SOLDER KIT

Good for any TV Kit

**\$1.49**

## #630 PARTS-COMPLETE SETS

VIDEO AND I.F. KIT, 19 items	\$7.84
AGC KIT, complete with instructions	4.59
VARIABLE CONTROL KIT, 9 controls	5.83
CARBON RESISTOR KIT, 107 resistors	6.98
WIREWOUND RESISTOR KIT, 4 resistors	2.31
BRACKET AND SHIELD KIT, 18 items	8.63
ELECTROLYTIC CONDENSER KIT, 6 cond.	7.37
TUBULAR CONDENSER KIT, 37 condensers	4.28
CERAMIC CONDENSER KIT, 28 condensers	3.37
MICA CONDENSER KIT, 11 condensers	1.38
OCTAL WAFER SOCKET KIT, 13 sockets	.72
MIN. WAFER SOCKET KIT, 10 sockets	.63
MIN. MOLDED SOCKET KIT, 2 sockets	.22

**BROOKS RADIO & TV CORP., 84 Vesey St., Dept. A, New York 7, N. Y.** TELEPHONE  
CORtlandt 7-2359

transformer taps at 117 and 130 volts. Fused.

The case is made of welded steel, and is finished in 2-tone gray enamel. Size is 8 3/8 inches high, 17 inches wide, and 1 1/4 inches deep.

**NEW MULTIMETER**

Electronic Instrument Co., Inc., 84 Withers St., Brooklyn 11, N. Y., announces the EICO model 536 multimeter as an addition to its 1952 line of test instruments. The 536 is a 1,000-ohm-per-volt instrument. Voltage ranges (a.c. and d.c.): 0-1, 5, 10, 50, 500, and 5,000. Current ranges (a.c. and d.c.): 0-1, 10, 100 ma, 1 amp. Ohms: 0-500, 100,000 ohms, 1 megohm. Decibels: minus 20 to plus 69 in six ranges.

The instrument uses a 3/2-inch, 400-ua meter and a 6/4 x 3 3/4 x 2 inch case. It is also available as a kit called the 536-K which comes complete with simple wiring and operating instructions.



**TAPE RECORDER UNIT**

Tape Master, Inc., 13 W. Hubbard St., Chicago 10, Ill., has announced the new model TH21 tape-transport mechanism and the model PA1 matching preamplifier and bias-erase oscillator.

The mechanism operates at 7 1/2 inches per second and incorporates both fast forward and fast rewind with a single switch control. The PA1 is fully wired and includes a push-pull bias-erase oscillator, inputs for radio-phonograph and microphone, outlets for amplifier and headphones, complete switching controls, and a recording-level indicator. These two units can be combined with any high-grade audio system to make a complete high-fidelity tape recording and playback system.

**TV ANTENNA COUPLER**

Telematic Industries, Inc., 1 Jaramon St., Brooklyn, N. Y., is now delivering the Add-A-Set coupler (model AM-20) which is designed to couple two TV receivers to a single antenna. The unit provides a perfect impedance match to two 300-ohm receivers and a 300-

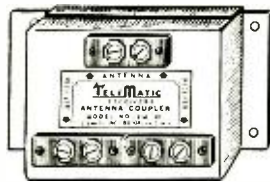

ohm antenna. The model AM-40 coupler operates four 72-ohm receivers from a 300-ohm antenna without noticeable signal loss. The units include bifilar impedance dividing network transformers have good high-pass filter action while completely decoupling the sets and minimizing interaction. The units are compact and light weight and may be mounted inside the TV cabinet or on the wall or baseboard.

**TV ANTENNA TOWERS**

Tel-Ray Enterprises, Inc., Box 332, Henderson, Ky., has introduced two new TV antenna towers which pivot in the middle and swing over to the ground or roof for servicing antennas mounted on them. The Swing-Over Towers are of steel angle

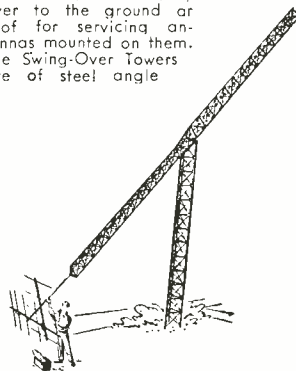

and welded construction and are guaranteed against weather damage. The tower is available in two models—a 50-foot model for mounting in concrete in the ground without any wires, and a 24-foot house-top model.

**PREFAB AM-FM SETS**

Collins Audio Products Co., P.O. Box 368, Westfield, N. J., has added an AM-FM tuner to its line of Pre-Fab assemblies. Wired and aligned units which are available include an FM tuning unit, FM i.f. strip, two AM tun-

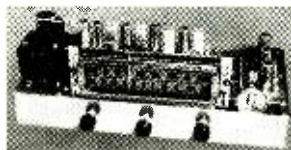

ing units with i.f. amplifiers, and an electron-ray tuning indicator kit. A chassis kit which includes a pre-punched chassis, power transformer, filter capacitors, hardware, and other components necessary for the finished tuner is also available. The photograph shows the assembled AM-FM tuner.

**NEW TV TESTER**

Radio Merchandise Sales, Inc., 1165 Southern Blvd., New York, N. Y., announces a new TV test instrument. Known as the Pix-Eye, the unit permits instantaneous spot-check on the picture tube and on the condition of the brightness, contrast, and video circuits, and the low-voltage and heater supplies, without pulling the chassis.

The unit uses a 6AF6 electron-ray indicator tube in a small assembly which is plugged into the picture-tube socket. One of the shadows of the 6AF6 is controlled by the brightness control and the other by the contrast. Varying these controls on the set causes the corresponding shadow to vary in length when the circuits are normal. If a video signal is present at the picture-tube socket, the normally sharp shadow edge will become blurred as it is modulated by the video when the contrast is turned up.



If all indications are normal on the tester and the high-voltage supply is normal, this indicates that the trouble is in the picture tube. Failure of the tester to show normal variations as the controls are varied shows that the trouble is in the set.

The Pix-Eye is housed in a protective shield—not shown in the drawing—which extends about an inch beyond the face of the indicator and shields it against stray light, making the indications easier to read.

**LEARN Practical RADIO AT HOME**



COMPLETE ONLY . . .

**\$19<sup>95</sup>**

**BUILD 15 RADIOS**

ABSOLUTELY NO PREVIOUS TRAINING NEEDED  
EXCELLENT BACKGROUND FOR TELEVISION

**10-DAY MONEY-BACK GUARANTEE**

**WHAT THE 1952 PROGRESSIVE RADIO "EDU-KIT" OFFERS YOU:**

This is a practical home radio course. You learn theory, construction, operation, trouble shooting, code. You build RECEIVERS, TRANSMITTERS, AMPLIFIERS, CODE OSCILLATOR, SIGNAL TRACER.

You start with a simple radio circuit, and gradually advance to more complex circuits. No previous background is required. No instructor is needed. All parts and instructions are included and every single step is clearly explained.

All parts are guaranteed, individually packaged, identified, and explained. There is nothing extra to buy. You receive all parts, tools and instructions at once. You keep everything; there is absolutely nothing you return to us.

You can easily pay for the kit in a short time by repairing radios. Use the tester and signal tracer for servicing. The signal tracer alone is worth more than the price of the entire kit.

**USED BY RADIO SCHOOLS AND GOVERNMENT AGENCIES!**

The Progressive Radio "Edu-Kit" includes tubes, paper condensers, mica condensers, electrolytic condensers, variable condensers, selenium rectifiers, chassis, hardware, tie strips, tube sockets, solder, wire, soldering iron, tubing, coils, instruction book, radio trouble-shooting guide, radio tester, television trouble-shooting manual, etc.; in brief, everything you need in a practical radio course.

Order your "Edu-Kit" today, or send for further information.  
Postage prepaid on Cash orders—C.O.D. orders accepted in U.S.A.

**PROGRESSIVE ELECTRONICS CO.**

497 UNION AVE. DEPT. RE-58 BROOKLYN, NEW YORK

**FREE RADIO TESTER & SOLDERING IRON**

GET A WELL-PAYING JOB



GO INTO A PROFITABLE BUSINESS AND PLAN FOR A FUTURE



RADIO-ELECTRONICS



**Z-MATCH YAGI**

Channel Master Corp., Naponoch Road, Ellenville, N. Y., announces that all the features of the Z-Match Yagi system are now available in its new model 645 Z-Match dual Yagi. Covering both channels 4 and 5, the antenna provides a good match to a 300 ohm line in both single and stacked arrays. Performance has been improved by

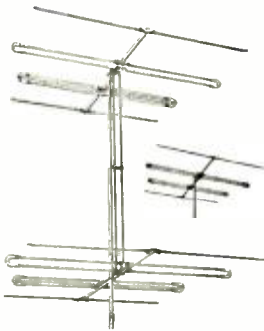

new element and reflector lengths. A single bay gives over 8 db gain on each channel. Four stacked 645's furnish a gain of 14 db on each channel. The gain is flat over channels 4 and 5 and the front-to-back ratio is over 20 db.

Stacking bars are not needed as extra equipment. The center bars—removed from the larger foiled dipole of each antenna—are used as stacking bars.

**SWEEP AND MARKER**

General Electric Co., Electronics Park, Syracuse, N. Y., announces two new precision test instruments and a voltage regulated power supply. The model ST 11A is a combination TV-channel sweep and marker generator designed primarily for factory use in aligning TV tuners and over-all systems. It features single-knob selection of the sweep signal and from one to five marker

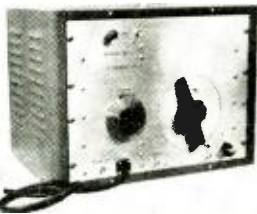

frequencies simultaneously. A continuously variable capacitor type attenuator has a range of more than 100 db. Output is 0.25 volt into 300 ohms balanced or 72 chms unbalanced.

The new 5-inch all purpose oscilloscope, model ST-2B features identical high gain direct coupled vertical and horizontal amplifiers essentially flat to 500 kc. It uses a driven sweep and high accelerating voltage to permit use of tubes with long-persistence phosphors. It has a low-input capacitance probe (10 μmf) and an internal voltage calibrator covering the range of 0.1 to 300 volts peak-to-peak in eight steps.

In the new ST-11A dual regulated power supply each subunit is independently regulated, controlled and metered from 0 to 500 volts at up to 100 milliamperes. Hum and noise are always below 3 millivolts r.m.s. It has electronic overload protection for both tubes and meters, bias voltages and a.c. filament supply. Regulated outputs may be modulated through an internal amplifier. Regulated outputs may be paralleled for increased current ratings.

**TV TRAPS**

Jerrold Electronics Corp., 26th and Dickinson Streets, Philadelphia 46 Pa., has developed four new high-Q traps designed for use between the TV antenna and receiver to eliminate adjacent-channel and FM interference. Model TLB covers the low-band TV channels 2 through 6; model THB traps out adjacent channel interference on TV channels 7 through 13. Interference from FM stations is trapped by using model TFM, covering the range from 88 to 108 mc. The fourth trap—the T Special—is custom built, an order to eliminate interfering frequencies in any bands other than v.h.f. television, and FM.

These traps, which are particularly useful in master television antenna systems for both apartment house and community installations, consist of bridged-T networks with variable series and shunt inductance circuits. With both the series and shunt circuits tuned to the signal to be trapped, this undesired signal is attenuated a minimum of 50 db. The TV channel to be received is attenuated only 2 db.

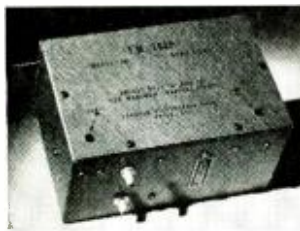

**TAPE RECORDER**

Ampex Electric Corp., Redwood City, Calif., has announced the model 400 A tape recorder which features push-button operation and recording up to 15,000 c.p.s. with a tape speed of 7.5 i.p.s. (inches per second). The new recorder is available with heads for either half- or full-track recording. It can be operated at either 7.5 or 15 i.p.s. simply by throwing the speed selector switch. Proper equalization for either speed is available for the operator's selection.

Differing from the model 400 which it supersedes, the 400-A has all mechanical motions controlled electrically by push-buttons to permit full use of the instant-start (0.1-second) feature.

The response of the 400-A is down not more than 4 db at 30 and 15,000 c.p.s. at 7.5-inches per second tape speed. At 15 i.p.s., the response is ±2 db from 50 to 15,000 cycles. Noise level is 55 db below 2% total harmonic distortion level. Wow and flutter are less than 0.2% at 15 i.p.s. and less than 0.25% at 7.5 i.p.s.



**PHONO CARTRIDGE**

The Astatic Corp., Conneaut Ohio, announces the Twin CAC which is described as two complete single-needle phonograph cartridges mounted back-to-back on a common plate. The slow-speed cartridge matches closely the recording characteristic of Columbia LP's. The output of the Twin CAC is 0.8 volt at 1 kc on the Audiotone 78 1 test record and 0.7 volt on the RCA 12-531 V. The frequency range is 30 to 11,000 cycles.

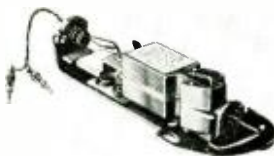

The cartridge is furnished with turn-over bracket, knob, and standard 1/2-inch mounting holes. The turnover knob automatically connects the side to be used to the output terminals. Wiring terminals are pin connectors tapered to fit either of the two standard lead connectors. Needles used are the Astatic Q (3 mils) and the Q-33 (1 mil) sapphire tipped.

Two standard pickups and one transcription pickup (Studio Master 400) are now equipped with the new cartridge.

All specifications given on these pages are from manufacturers' data.

—end—

*more TV set outlets per dollar!*

with easy-to-install

**Blonder-Tongue**

**ALL-CHANNEL MASTER ANTENNA SYSTEMS**



Distribution Amplifier  
8 TV Set Outlets  
Model #DAB-1-M List Price \$87.50



Distribution Amplifier  
2 TV Set Outlets  
Model #DA2-1-M List Price \$39.50



Commercial Antensifier (30 Times Gain) Use As Pre-Amplifier, Line Amplifier or de-luxe Booster  
Model #CA-1-M List Price \$77.50

**More Gain Per Dollar!**

B-T Home Antensifier Model HA-2-M  
Finest All-Channel TV Booster. Fully Automatic, 16 Times Gain. In Metal Cabinet  
List Price \$57.50



Literature on Request write Dept. D4

**Blonder-Tongue Labs., Inc. Mt. Vernon, N. Y.**

**SAVE**

THAT GOOD LOOKING OLD CONSOLE—  
REPLACE THE OBSOLETE RADIO

with a modern, easily installed

**ESPEY AM/FM CHASSIS**

and your favorite console is "right-up-to-date"



Rated an excellent instrument by America's foremost electronic engineers. Fully licensed under RCA and Hazeltine patents. The photo shows the Espey Model 511-C, supplied ready to play. Equipped with tubes, antenna, speaker, and all necessary hardware for mounting.

**NEW FEATURES**—Improved Frequency modulation circuit, drift compensated • 12 tubes plus rectifier, and pre-amplifier pick-up tubes • 4 dual purpose tubes • High quality AM-FM reception • Push-pull beam power audio output 10 watts • Switch for easy changing to crystal or variable reluctance pick-ups • Multi-tap audio output transformer supplying 4—8—500 ohms.

Write Dept. RC4 for literature and complete specifications on Model 511-C and others.

Makers of fine radios since 1928.

**ESPEY**  
MANUFACTURING COMPANY, INC.  
528 EAST 72nd STREET, NEW YORK 21, N. Y.

# USE PHOTOFAC

the world's best Radio and TV Service Data...



WE'LL PROVE YOU'LL SAVE TIME and EARN MORE WITH PHOTOFAC

**FREE** Service Technicians: We'll send you any Photofact Folder listed in the "PF INDEX and Technical Digest."

If you haven't an Index, get a free copy from your local Photofact distributor or write for it today. To obtain Free Folder, be sure to state Photofact Set and Folder Number as shown in the Index.

NOW—learn for yourself how PHOTOFAC makes your Radio and TV work quicker, easier, more profitable! Just get and use an actual PHOTOFAC Folder. Discover why over 35,000 successful service technicians count on this invaluable data daily. No other service gives you PHOTOFAC's completeness, accuracy, uniformity and lowest cost. PHOTOFAC is the only Radio-TV service data prepared from laboratory analysis on the actual equipment. Get your FREE Folder now. Examine, use, compare. See why you can't afford to be without PHOTOFAC!

**NOTE:** Our FREE Folder offer is limited to Service Technicians only. Attach coupon below to your letterhead and mention your jobber's name. Experimenters and others may obtain the Photofact Folder by remitting amount shown below.

## HOWARD W. SAMS & CO., INC.

HOWARD W. SAMS & CO., INC.  
2201 E. 46th St., Indianapolis 5, Ind.

I am a Service Technician. Send me Free Folder No. .... which appears in Photofact Set No. .... (as listed in the PF Index).

I am an Experimenter. Enclosed \$..... Send me Folder No. .... which appears in Photofact Set No. .... (TV—\$1.00. AM/FM—50c. Record Changer or Communication Receiver—75c)

Name.....  
Address.....  
City..... Zone..... State.....

**EASY PAY PLAN!**

**PAY AS YOU EARN!** Ask your distributor about this amazing plan. Only \$18.39 puts the entire profit-boosting Photofact library in your shop now!

## Try This One

### 3-WAY SPEAKER BAFFLE

After constructing an amplifier designed to use separate speakers for low, medium, and high notes, I tried a number of different baffles before I decided to use the one shown in the drawing. I use 3-, 6-, and 8-inch speakers to handle the high, medium, and low notes respectively.

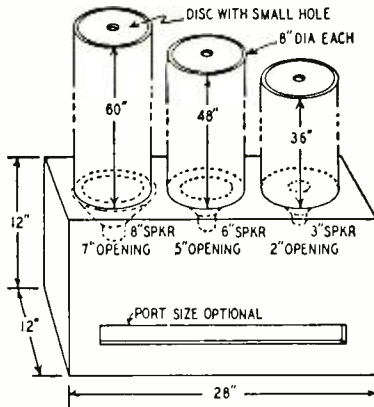

The base of the baffle is a heavy box, 12 inches high, 28 inches wide, and 12 inches deep. Holes 7, 5, and 2 inches in diameter are drilled in the top for mounting the speakers. The resonant columns are cut from heavy 8-inch cardboard tubing like that used for shipping rugs. The top of each column is plugged with a wooden disc having a 1-inch hole in the center. The port size is optional. I made mine 2 x 18 inches.  
—Robert P. Kraig

### POLARITY REVERSING SWITCH

This polarity-reversing switch is simple and easily made. It consists of a slide or toggle type d.p.d.t. switch and a pair of jacks on an insulated panel or on the top of a small box. The flexible leads which connect to the switch arms (see diagram) are fitted with tips which fit the jacks on the multitester. The jacks on the polarity-reverser fit the tips of the test leads.

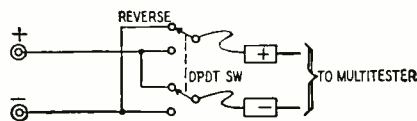

To use the unit, plug the flexible leads into the jacks on the multitester and plug the test leads into the jacks on the switch panel. When measuring negative voltages, all that is necessary is to flip the switch instead of transferring the leads at the multitester.  
—Hyman Herman.

### ADJUSTING TURRET TUNERS

The individual oscillator adjustment screws for each channel of turret tuners often fit so loosely that movement of the channel selector causes some of them to shift and throw the circuit out of alignment, making it difficult to tune in some stations properly with the fine-tuning control. We recommend that you adjust the oscillator trimmer for each channel with the fine-tuning control centered, then apply a drop of cement to each trimmer screw to lock it firmly in place.  
—M. G. Harvey

# STAN-BURN ELECTRONICS

## ★ ANTENNAE SPECIALS ★

★ DOUBLE V 3/8"	1-11	12 or more
★ DOUBLE V 3/4"	\$2.98	\$2.20
★ DOUBLE V 1/2" Dowel	3.45	2.45
★ 10 Element Conical 3/8"	3.95	2.95
★ Folded Hi Straight Low Quick	3.55	2.55
★ Rig 1/2" elements	4.25	3.25
★ WINDOW CONICALS	4.95	3.75
★ MASTS		
★ 5 FOOT SWEDGED	.79	.69
★ 10 FOOT PLAIN	1.39	1.29
★ TV WIRE		
★ 55 Mil. 300 OHM	\$15.95 M Ft.	
★ 72 OHM COAXIAL	52.50 M Ft.	

## ★ CATHODE RAY TUBE SPECIALS ★

★ 10BP4 Zetka	\$14.95	17BP4A Federal	\$23.00
★ 10BP4 N.U.	19.95	17BP4A DuMont	28.00
★ 10BP4A N.U.	19.95	19AP4 Sheldon	29.95
★ 12LP4 Thomas	19.95	19AP4 GE	39.95
★ 16AP4 Zetka	26.00	19BP4A Thomas	39.95
★ 16AP4A G.E.	38.00	20CP4A DuMont	41.00
★ 16BP4A Thomas	28.50	20CP4A Sheldon	37.00
★ 16GP4A Rauland	33.00	21EP4 DuMont	42.95
★ 16GP4 Zetka	26.00	24AP4 Sheldon	63.00
★ 16P4A Thomas	28.80	24AP4 GE	76.00
★ 16RP4A GE & NU	28.00	Single ion traps	.39
★ 16TP4A DuMont	28.00	Double ion traps	.59

★ CHASSIS 630 REGAL with Cascode Tuner...\$139.50  
★ 211 TR3 FLY BACK (similar to RCA)... 2.98  
★ OPEN FACE CABINET... 39.00

## ★ TRANSFORMERS ★

RCA type for 16" to 24" X032... \$3.85  
G.E. Type for 16" to 24" X045... 3.85  
These are very special prices while they last!

## ★ DEFLECTION YOKES ★

★ Cosine Ferrite Todd Yoke 70".....\$4.20

## ★ SPECIALS ★

★ GI 3 speed Changer—Model 700FB3-15.....\$19.50  
★ VM 3 speed Changer—Model 407-31..... 22.50

★ 4 Prong Vibrators each.....\$1.29  
★ Lots of 12 or more..... 1.19  
★ Standard TV Tuners..... 18.95

## ★ AUDIO DEVICES, DISCS and TAPE IN STOCK ★

★ 12" Heavy Slug Speaker.....Special \$4.98  
★ 500 MMFH Barrel Type—20,000—Screw end. 42.95  
★ Special while they last..... 75c  
★ Plain end. Special while they last..... 55c

## ★ WIRE RECORDERS IN STOCK ★

★ PENTRON—Model 9T3C—2 speed Tape Recorder.....\$116.68  
★ WILCOX GAY—Model 2A10..... 89.97

★ CASCODE Guaranteed Tuners (with tubes)  
★ Special, while they last.....\$21.95

★ AUTHORIZED DISTRIBUTORS for: General Electric, Konrad, Tung-Sol, National Union, Jewel, De Wald, Renal, Automatic and Setchel Carlson.

★ We carry a complete line of popular makes of radio and TV tubes, at 50% discount. Also many other special purpose and transmitting tubes, and all electronic parts and equipment at lowest prices.

★ Send us list of your requirements for prompt quotations.  
★ Terms: 20% with order. Balance COD. All prices FOB. New York Warehouse. Minimum order \$5.00

★ Write for our latest price list to Dept. RE-4

**STAN-BURN RADIO and ELECTRONICS CO.**  
(C.B.S. THEATRE BLDG.)  
1697 BROADWAY • NEW YORK 19, N.Y.

## AUTOMATIC M-90 AUTO RADIO



• Six Tube Superheterodyne • Three Gang Condenser • Powerful, Long-Distance Reception • Fits All Cars, Easy Installation

• Mounting Brackets Included  
• 6 Tube model M90.....\*\$34.97  
• 5 Tube Model A-15.....\$28.76  
\*Above price includes Federal Excise Tax  
Approx. shipping weight either radio (11) eleven pounds

**MAIL US YOUR ORDERS**  
All orders filled within 24 hours.  
Standard Brand tubes 50% off list

*Bill Sutton's* Wholesale Electronics  
Fifth at Commerce Fort Worth, Texas

## NATIONAL EMERGENCY

If you have any scrap iron, steel, copper, bronze, aluminum, lead, zinc or other metal, turn it over to cooperating scrap-collecting agencies. The defense effort needs it more than you do.



**TV ANTENNA PHASING UNIT**

In many TV installations, the location and type of antenna and the length and type of transmission line may produce a mismatch which will cause ghosts. To solve this problem and to prevent complaints, we use the tubeless phasing unit shown in the diagram. By shunt-

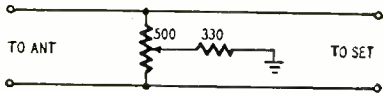

ing the noninductive potentiometer across the line and grounding its arm through a 330-ohm resistor, we can vary the over-all impedance to a point where it matches the receiver and eliminates the troubles caused by a mismatch of this type.

The action of the control is to load one side of the line, permitting the other to balance out and present an even load to the input of the set.—Walter S. Miller.

**NONSKID CABINET FEET**

The flat parallel-conductor line cord of the type widely used on receivers and lamps can be used to make nonskid feet for wooden radio cabinets. Cut the line to the desired length and attach it to the bottom of the cabinet with thin, flat-head wire nails. Drive the nail head through the insulation so it flattens against the wire inside the cord. With the nail head below the surface of the insulation, there is no danger of it scratching the surface supporting the set.—B. W. Welz.

**METAL FILINGS IN SPEAKERS**

Those stubborn metal filings that become lodged in the magnet gap of a loudspeaker can be removed efficiently and quickly with a piece of gummed masking tape, such as is used by painters and draftsmen. Insert the tape and rub it around against the sides of the gap. The gummed surface will remove even the smallest particles with ease. Larger filings can be chased up to the top of the gap with the edge of the tape and then picked off with a little pressure against the gummed surface.

A blast of compressed air into the gap or through a hole at the rear of the magnet pot will bring to light filings that would later work their way into the gap.—J. Gordon Holt.

**HANDY SOLDER HOLDER**

Discarded cellulose-tape dispensers make handy holders for wire-type solders. They are lighter and require less space than the usual 1/2- or 1-pound spools. Simply wind a length of solder around the empty tape reel and pull the free end through the hole in the end as shown.—Milton M. Schuman

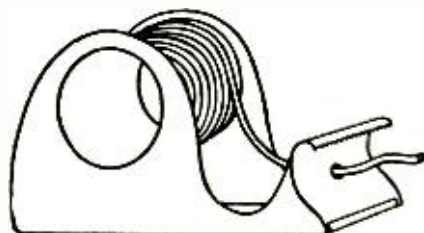

**AT LAST LUMOMETER**

**RADIO TELEVISION ELECTRONICS Multi-Tester**

TESTS FOR: OPENS - SHORTS CONTINUITY

- RADIOS - AMPLIFIERS - TELEVISION - A. C. & D. C. sets, etc.
- RADIO & T. V. Tubes (picture tubes also.)
- TRANSFORMERS (all types) - POWER - A. F. and R. F.
- IGNITION COILS - HEATERS - BULBS - BZZERS - RELAYS
- SPARK PLUGS - FANS - FUSES - ELECTRIC TOASTERS - IRONS
- SPEAKERS - DYNAMIC - P. M. - MAGNETIC
- WIRING - All types of circuits - MOTOR and generator windings.
- CONDENSERS - All types mica, paper, oil, ceramic, air, and electrolytic

Will indicate capacity as low as 25 Micro-Microfarads (.000025 MFD)

ALSO A. C. OR D. C. VOLTAGE TESTER

FROM 70-750 VOLTS AC OR DC (one shot—without range switching)  
 MOST RADIOS-TV SETS-AMPLIFIERS, etc. AC OR DC HAVE BOTH PLATE & SCREEN VOLTAGES  
 OVER 70 VOLTS - THEY CAN BE TESTED EASILY WITH THE NEW HOWARD LUMOMETER

**THE NEW HOWARD LUMOMETER TUBE CHART WITH FILAMENT HEATER PINS OVER 425 RADIO TV AND PICTURE TUBES 25¢ FREE WITH LUMOMETER**

INDUCTANCE TEST

Money back in 5 days

**100% Faster for PRODUCTION SERVICE MAINTENANCE CONSTRUCTION**  
**THE MOST COMPLETE AND COMPACT MULTI-SERVICE INSTRUMENT EVER DESIGNED!**  
 HOWARD SALES COMPANY • 539 ATLANTIC AVENUE • BROOKLYN 17, N. Y. Dept. RE

Sensitivity Compares with Vacuum Tube Voltmeter.



1 1/2" X 2 1/2" X 3 1/2" Weight 11 ozs

**ONLY \$4.95**

Allow 25c. postage

**RADIO ENGINEERING IN 27 MONTHS**

Intensive, specialized course including strong basis in mathematics and electrical engineering, advanced radio theory and design (inc. TV and Electronics), Modern lab. Low tuition. Self-help opportunities. Also 27-month courses in Aeronautical, Chemical, Civil, Electrical, and Mechanical Engineering. Approved for G.I.'s. Enter June, Sept., Dec., March. Catalogue.

**INDIANA TECHNICAL COLLEGE**  
 154 E. Washington Blvd., Fort Wayne 2, Indiana

**REDI-VOLT MODEL 60 PLUG-IN D.C. POWER SUPPLY**  
 Furnishes 60 ma. filtered D.C. at 140 V. with 115 V. A.C. input.  
 A thousand uses, makes building neat equipment easier. Use like a tube, plug into socket on radio, amplifier, or other chassis.  
 Price \$2.95 Satisfaction guaranteed.  
 Post paid U.S.A.  
**Z-LAB CO. Box 48, Grand Rapids, Mich.**

**Leotone**

**POWERFUL !!!ALNICO MAGNETS!!!**

2-Polished, 1 1/2" x 1 1/4" x 3/8" . . . . . \$1.65  
 3-Polished, 2 1/2" x 1 3/8" x 3/8" 10" . . . . . 1.65  
 4-Polished, 1 1/2" x 1 1/8" x 3/8" . . . . . 59c  
 5-Polished, 7/8" x 9/32" x 3/8" . . . . . 59c 10 5.50

Alnico "Chip" Magnets, small irreg. shapes.  
 1000's, 500's, 100's, 50's, 25's, 10's, 5's, \$1.50 lb.  
 Alnico Magnet Kit - Powerful Bar, Block, "H" Rod, etc. Kit of 10 asstd. . . . . \$1.98

**(Write for Latest "Alnico" Supplement)**

6V. AC-DC Solenoid . . . 112x1 x 2 1/2" . . . \$5.89  
 Radio-TV Builders Library . . . for Ham, Services, Students, 15 asstd. TV, Hi-Fi, S.W. diagrs. . . . . 98  
 10 Push-Button Assembly . . . ckt. transformer, fuel, 2 SPST AC switches, 812" x 2 1/2" x 1 1/2" . . . . . 1.49  
 Set of 10 Knobs for P.B. Assembly . . . . . 69  
 Ornamental Metal Grille . . . Gold Finish; diamond, 2 1/2" x 3 1/2" . . . . . 59c  
 121 Crystal Diodes . . . 16x116-\$1.59; 18x24 . . . \$2.69  
 Gold or Silver Grille Cloth . . . 10" sq. ft. 35c sq. ft. \$2.98  
 1N21 Crystal Diode . . . 100's, 50's, 25's, 10's, 5's, 1.50  
 115V. Power Transformers . . . 600 w. 100 V. CT. 900ma. 0.3V 3A., 0V 7A. Double, half-shell . . . 2.95  
 115V. AC Induction Motor . . . 1750 RPM, fraction. H.P., Dblc. 1/2" shaft, 27" O.D. x 4 1/2" H. . . . . 1.75  
 Hi-Freq. 6V. Buzzer . . . adjustable . . . . . 69c 3 1.98

1 Bargain in kits! . . . New Jumbo Radio parts Kit! . . . 17 full lbs. of: coils sockets, controls, resistors, switches, hardware, chassis, condensers, etc., etc. Shipping weight 20 lbs. . . . . 3.95  
 Speaker Cone Kit . . . 1 1/2" to 1 1/2" incl. freezies, Less voice coils, Kit of 12 asstd. . . . . 1.98  
 Speaker Repair Kit . . . A Professional kit containing a Liberal assortment of Speakers, Rings, V.C. Forms, Felt, Cement, Shim Kit Chamois Lthr. & instructions . . . . . 2.49  
 1 Special . . . Both Cone & Repair Kit for Only 3.95  
 Radio Hardware Treasure . . . Full lb. can of Nuts, Screws, Lug, Washers, Etc. 69c 3 lbs. 1.98

FACTORY SPEAKER REPAIRS SINCE 1927  
 Min. Order \$3.00 20% deposit on all C.O.D.'s  
 Please add sufficient postage—excess refunded  
 Full remittance with foreign orders

**LEOTONE RADIO CORP.**  
 67 Dey Street  
 New York 7, N. Y.

**LEARN Television-Radio Electricity REFRIGERATION-ELECTRONICS IN THE GREAT SHOPS OF COYNE**

**TRAIN QUICKLY! OLDEST, BEST EQUIPPED SCHOOL OF ITS KIND in U.S. Young and Older Men . . . .**

Come to the Great Shops of Coyne in Chicago. Get practical training in TELEVISION-RADIO or ELECTRICITY—vital in Defense Program. Prepare now for a better job or better service rating.

**START NOW—PAY LATER**  
 You can finance most of your tuition, pay for it later in easy monthly payments. Special plan for men of Draft Age. Part time employment service available.

**FREE BOOK** Clip coupon for Big Free Illustrated Book. Indicate below, course that interests you. No salesman will call. Act NOW.

**COYNE SCHOOL**  
 B. W. Cooke, President  
 A TECHNICAL TRADE INSTITUTE CHARTERED NOT FOR PROFIT  
 Established 1899  
 500 S. Paulina, Chicago

**ELECTRICITY ★ TELEVISION RADIO ★ REFRIGERATION ★ ELECTRONICS**

B. W. COOKE, Pres.  
 COYNE School  
 500 S. Paulina St., Chicago 12, Ill. Dept. 42-81H

Send FREE BOOK and full details on:  
 TELEVISION-RADIO  ELECTRICITY

NAME . . . . .  
 ADDRESS . . . . .  
 CITY . . . . . STATE . . . . .



# Perfection TV Components

*Now-  
Individually  
Packaged!*



## More Popular Than Ever!

The new Perfection Kine-Center for finger-tip picture centering in electrostatic tubes—the BeamaJuster for 3-second centering of pictures in focus-coil tubes—the B. O. Eliminator for removing black lines caused by Barkhausen Oscillation—and easily installed Perfection Ion Traps—all are now available in handy individual cartons at no extra cost.

**Order Today from Your Supplier!**

**PERFECTION ELECTRIC COMPANY**  
2635 South Wabash Avenue, Chicago 16, Illinois  
MAKERS OF PERFECTION SPEAKERS AND TELEVISION COMPONENTS



## RECORD PLAYER REQUIREMENTS

For good reproduction of disc recordings, it is essential that you use a heavy turntable which is driven by a powerful motor free from wow and rumble. The pickup should have a long arm to minimize tracking error.

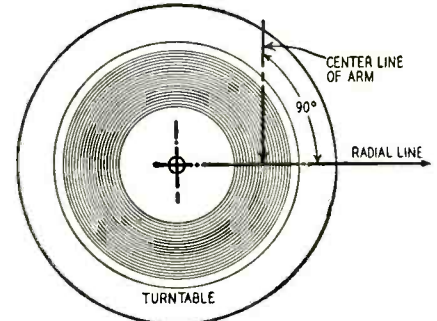

If LP's are used frequently or exclusively, readjust the tracking angle of the arm to reduce tracking error. This is necessary because the grooved section of an LP does not extend as far into the record as it does on the standards. (The minimum diameter of standard 78-r.p.m. records is 3 5/8 inches as compared to 4 5/8 inches for 33 1/3-r.p.m. LP's.—Editor)

To find the correct position for mounting the arm, find the average width of the grooved area of several LP's. Mark off this distance on a radial line drawn from the center of the turntable as shown on the diagram. The shaded area represents the grooved portion of the record. Locate the pivot point of the arm so the needle touches the radius at the center of the playing area and the center line of the arm is at right angles to the radius at the point of contact. Correct tracking insures best reproduction and minimizes wear on the records and needle because needle pressure is more evenly distributed in the groove.—Jacinto Suñares

## HANDY SERVICING TOOL

A handy tool for your radio service bench consists of a bicycle spoke—or any wire of similar diameter and length—with one end bent as shown and the other end heavily wrapped with



rubber tape to form a handle. It can be used for tapping tubes and other components, stringing dial cords, and for testing connections for intermittents.—Richard Sandretto

## SIMPLE ALIGNING TOOL

While visiting a friend at his summer cottage I was asked to look at a TV set which would not sync with the horizontal hold control. I assured him that an adjustment of the sync lock would probably restore normal operation. Having no suitable tools, we purchased a plastic darning needle and filed its point to fit the slot in the tuning slug.—Alfred Huntington

RADIO-ELECTRONICS

*If your Recording Jobs  
are like these... you need*

## THE MAGNEMITE\*

### The 10-Pound Portable BATTERY-OPERATED TAPE RECORDER

The MAGNEMITE\* offers convenience in field recording never before attained. This unusual unit measures only 11 1/2 x 8 1/2 x 5 1/2 inches, and weighs only 9 3/4 lbs., including its self-contained batteries which last 100 operating hours. At 1 7/8 in. per sec. tape speed, 2 full hours of recordings are accommodated on standard 5 in. reels of tape. Constant tape speed is assured by means of a governor-controlled spring-wound motor that runs 15 minutes per winding. Recordings can be made up to a distance of 100 feet from the microphone. The same instrument may be used for playback through earphones or external amplifier. For any recording, in or away from home, office, or studio, it's the MAGNEMITE\*!

Order today, or write for additional literature to:

- ✓ On-the-Spot News
- ✓ Sidewalk Interviews
- ✓ Conference Recording
- ✓ Courtroom Reporting
- ✓ Traveling Secretary
- ✓ Salesmen's Reports
- ✓ Confidential Recording
- ✓ Lecture Note-taking
- ✓ Missionary Work
- ✓ Testimony Recording

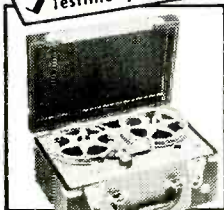

Net  
Factory Price **\$189.50**

Complete with batteries, microphone, and earphones.

\* Trade Mark Reg.

## AMPLIFIER CORP. of AMERICA

398 Broadway

New York 13, N. Y.

From the earliest days of Radio . . .  
to the present era of Television . . .



"Made by Engineers for Engineers"

CORNISH WIRE CO., Inc. — 50 Church St., N. Y. C. 7

## CODE SENDING RECEIVING SPEED

Be a "key" man. Learn how to send and receive messages in code by telegraph and radio. Commerce needs thousands of men for jobs. Good pay, adventure, interesting work. Learn at home quickly through famous Candler System. Quality for Amateur or Commercial License. Write for FREE BOOK. CANDLER SYSTEM CO. Dept. 3 D, Box 928, Denver 1, Colo., U.S.A.





Mrs. of  
**PICTURE TUBES**  
and  
Electronic  
Equipment

Sold only thru Radio Parts Jobbers  
**17"** Rectangular C.R.T. ....net **\$21.95**  
**20"** Rectangular C.R.T. ....net **\$32.95**

Prices include tax  
**EIGHTEEN MONTHS GUARANTEE!**

**"EBCO" Dual-Purpose  
CHECKER-REACTIVATOR**  
for TV Picture Tubes

A Money Maker  
For Servicemen:

Check picture tubes for shorts, cathode emission, leakage, etc., without removing tube from TV set. Also PUY NEW LIFE into weak tubes with the REACTIVATING power of this instrument. Lightweight, portable; 110V-60 cycles. Factory-guaranteed.



ASK YOUR JOBBER. net **\$19.95**

**FIELD STRENGTH METER**

Want better antenna orientation? Better TV performance? Want to save time and money? Then use the NEW "EBCO" FIELD STRENGTH METER. Measures field strength from 50 to 50,000 microvolts at the 300 ohm input terminals. net **\$64.95**

**2-SET CONNECTORS**

Two-set Connector for TV ..... Net **\$2.95**  
Four-set Conn., operates 3 or 4 sets from 1 antenna ..... Net **\$4.95**

ASK YOUR JOBBER!

**ELECTRONIC BEAM CORP.**



923 Old Nepperhan Ave.  
YONKERS, N. Y.  
Phone: YOnkers 3-3514

**TEAR OUT THIS AD!**



Simply attach TELECOLOR FILTER to front of set and enjoy programs in glorious color tones instead of dull black and white. GUARANTEED to give genuine color tone. Can also be used with any other filter. Once tried, you will never go back to old black and white. Write for FREE information. ORDER BY MAIL. NEW REDUCED PRICES!  
Send check, M.O., cash, COD to Dept. RE-5  
**10 in. ....\$1 16, 17 in. ....\$3**  
**12, 14 in. \$2 19, 21 in. ....\$5**

**HARVARD LAB.** 859 FULTON ST. BROOKLYN, N.Y.

**TUBES BRAND NEW! 100% GUARANTEED! STANDARD BRANDS ONLY!**

0B3	\$.19	6AL5	\$.69	7C7	\$.99
0D3	1.10	6AU6	.69	7E5	.99
0Z4	.59	6BA6	.79	7F8	1.49
1B3	1.15	6BC5	.79	12AU7	.99
1J6/G	.89	6BG6/G	1.89	12AT7	1.29
1L4	.79	6BQ6/GT	1.29	12BA6	.69
1N5/GT	.89	6J6	.98	12SA7	.69
1R5	.79	6K6/GT	.79	12SK7	.69
5U4 G	.69	6SK7	.79	12SQ7	.59
5Y3 GT	.99	6SL7	.99	32S5	.59
6AB4	.89	6SL7 GT	.89	50A5	1.05
6AB7	1.29	6W4/GT	.79	50B5	.79
6AC7	1.15	7A7	.99	50L6	.72
6AG5	.99	7C4	.79	76	1.49
					.49

WANTED! YOUR RECEIVING & TRANSMITTING TUBES. CASH WAITING—TOP PRICES PAID!

**Standard Brand High Capacity CONDENSERS**  
500-500 mf/5-150 vdc ..... 69¢  
6000mf/15 vac-SPECIAL ..... \$1.29

J.F.D. 3-WIRE RESISTOR CORDS (ORIGINALLY BOXED) 220 ohms or 200 ohms—49¢ each (10 for \$3.90) Prices subject to change without notice. C.O.D. F.O.B. N.Y.C.

**ADAMSON ELECTRONICS CO.** 1978 Arthur Ave., New York 57, N.Y. Tel. CY 9-0970

**CAPACITY RELAY**

The electronic relay control circuit shown in the diagram is simple to construct and economical to operate. It does not draw current from the line until it is triggered by an object touching the contact terminal. It can be used as an intruder alarm, annunciator, or safety control for industrial machinery.

The relay should operate when a grounded object touches the contact terminal. If it does not, reverse the line plug in its socket.

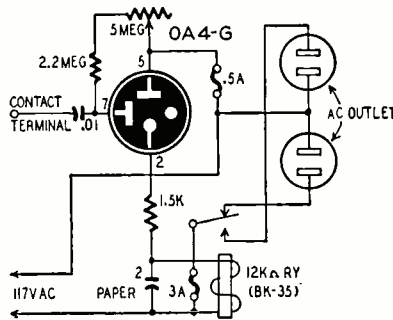

The relay used is a surplus BK-35 which has a resistance of approximately 12,000 ohms. Other sensitive relays closing at about 1 ma can be used, but it will probably be necessary to change the values of the sensitivity-control potentiometer and the resistor in the cathode circuit. You can increase sensitivity of some relays by loosening the armature spring.—O. C. Vidden

**SIMPLE D.C. AMPLIFIER**

Electron-ray indicator tubes are useful as signal indicators in some applications but they are sometimes unsatisfactory when a distinct, easy-to-see indication is required. To this end, we have developed the d.c. amplifier and neon lamp arrangement shown in the diagram. The amplifier may be a 6C5 or similar tube. The plate load resistor must be determined experimentally after the neon lamp is installed.

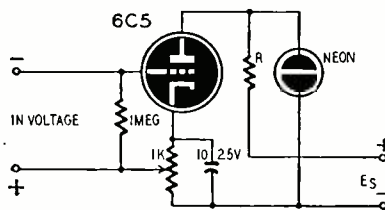

When no signal is being received, the voltage on the plate of the tube equals the supply voltage  $E_s$  minus the drop across load resistor R. This resistor must be adjusted so the voltage on the plate is slightly lower than the ignition voltage of the lamp. When a negative voltage is applied to the grid, the plate current decreases and plate voltage rises, causing the neon lamp to flash. Sensitivity is controlled by varying the setting of the 1,000-ohm control in the cathode circuit. This indicator makes a sensitive tuning indicator when its input terminals are connected directly across the diode load resistor in the receiver provided a common B-supply is not used.—A. Ivanirsky.

*Cash in on*  
**TV Service Profits!**

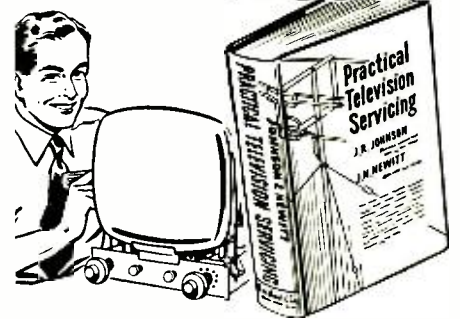

**PRACTICAL TELEVISION SERVICING**

By **J. R. JOHNSON and J. H. NEWITT**  
375 pages, 230 illustrations, \$4.00

Good training for television service doesn't need to cost you a lot of money! This great book at only \$4.00 is a complete guide that tells you step by step just what to do, what mistakes to avoid, what tools, parts and equipment to use—in short, how to handle every phase of television receiver servicing promptly, efficiently and profitably.

**LEARN FAST! . . . LEARN RIGHT!**

The authors of PRACTICAL TELEVISION SERVICING actually operated a TV service shop to get the specific, how-to-do-it information they now pass along to you in easily understood form. In addition to a clear explanation of how television work differs from radio, they show exactly how to perform all operations in trouble-shooting, diagnosing and remedying television troubles. No needless theory! They show you exactly how to do the work!

**CHOCK FULL OF HELPFUL CASE HISTORIES AND SERVICE HINTS**

Dozens of actual TV servicing case histories and service hints make the book literally worth its weight in gold.

Subjects include: TV System Fundamentals; R-F, I-F and Detector Sections; Video Amplifiers; Cathode Ray Tubes; Synchronizing and Sweep Circuits; Power Supplies; Antenna & Wave Propagation; TV Receiver Installation; Test Equipment and Alignment; Wiring and Repair Techniques; Color Television; Receiver Layout Diagram—and dozens more. In addition there are countless tips on such things as getting better fringe area reception; improving picture linearity; checking video response with a square wave; getting signals over a mountain and numerous others. Send coupon today for 10-day examination.

**READ IT 10 DAYS . . . at our risk!**

Dept. RE-42, RINEHART BOOKS, Inc., Technical Division, 232 Madison Avenue, New York 16, N. Y.

Send PRACTICAL TELEVISION SERVICING for 10-DAY FREE EXAMINATION. If book is O.K. I will then promptly remit \$4.00 in full payment. If not, I will return book postpaid in good condition and owe you nothing.

Name.....  
Address.....  
City, Zone, State.....  
Employers' Name & Address.....  
Price outside U.S.A., \$4.50—cash only. Money back in 10 days if you return book.



HEAT DISSIPATING CONNECTORS

**Vacuum Tube Accessories by Eimac — Now Available!**

Type HR heat dissipating connectors are designed to provide an efficient method of heat transfer from tube elements and seals to the air. Also facilitate electrical connection to plate or grid leads of most popular transmitting tube types. Machined from solid dural rod, come complete with necessary machine screws for use.

- Write for new Eimac Catalogue Summary showing Eimac tubes and other accessories.



EITEL - McCULLOUGH, INC. San Bruno, California

**KINK FOR ALL-BAND AMPLIFIER**

Most modern multiband transmitters use plug-in coils in the plate circuit of the final amplifier. The usual design procedure is to select a tuning capacitor having the correct capacitance for the lowest frequency band, and then wind coils which will resonate with the

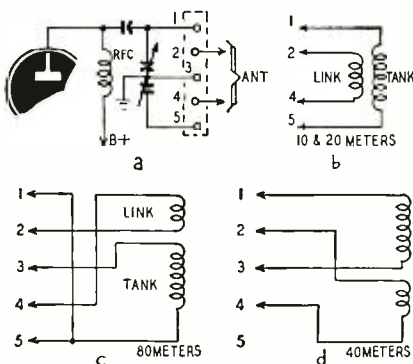

capacitor in the other bands. On the higher frequencies, the C/L ratio is usually too large and the plate-circuit efficiency falls off. In most circuits, the correct plate-circuit capacitance ranges from 0.75 to 2.5  $\mu\text{f}$  per meter, depending on the plate voltage and current.

Writing in *Le Haut-Parleur*, a French amateur, F3RH, describes a system of automatically switching in the correct amount of tuning capacitance for each band. The drawing at *a* shows the connections between a standard

jack-bar and a split-stator tuning capacitor. The tube may be a pentode, tetrode, or grid-neutralized triode.

Drawings at *b*, *c*, and *d* show how the coils for different bands are connected to the plug-bar. The numbers on the terminals correspond to those on the jack-bar.

The coils for 10 and 20 meters are connected across the two sections of the tuning capacitor in series. Thus, if the capacitor has 50  $\mu\text{f}$  per section, the full capacitance across the coil is 25  $\mu\text{f}$ . On 40 meters, only one section of the capacitor is used, so there is a maximum of 50  $\mu\text{f}$  across the tank. On 80 meters, the two sections of the tuning capacitor are paralleled across the coil, so the circuit has a maximum tuning capacitance of 100  $\mu\text{f}$ .

When the full capacitance of the tuning capacitor is used for resonance on each band, the tuning capacitance is 1.25  $\mu\text{f}$  per meter on 80, 40, and 20 and 2.5  $\mu\text{f}$  per meter on 10 meters. These values apply with a 50- $\mu\text{f}$ -per-section capacitor. The C/L ratio and Q of the circuit should be designed to provide optimum loading and harmonic rejection under specific operating conditions. For details, refer to the amateur handbooks.

**ANTENNA FOR SWL**

The serious SWL often has difficulty in finding a single receiving antenna which performs well on the band of frequencies between 2 and about 30 mc. This is particularly so when he does not have space enough for a harmonic-

**GIANT TV SALE Save on Chassis, Tubes, Cabinets, Accessories, etc.**

**NEW—THE SENSATIONAL 630-DX CHASSIS**

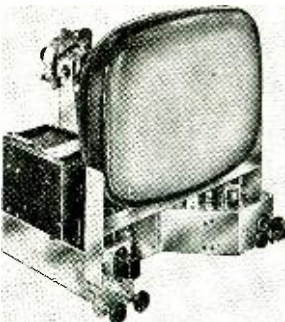

*Amazing Low Price!*  
1952 Model—30-Tubes—For 16" to 24" Picture Tubes. FINEST CHASSIS AVAILABLE At Any Price! For long range and best reception up to 200 miles without a complicated booster or antenna, this new, advanced 630 DX Chassis gives 3-times normal reception. Special extra-high gain standard coil tuner offers greater sensitivity, top performance on any channel; aligned & tested for 5 hours; molded condensers; 1 microvolts sensitivity; FM sound system; horizontal & linear lock and is directly adaptable for color and UHF. This is the very best Chassis buy—order NOW at this low-low price! You can't beat it!

**RMA Guaranteed—Factory Wired**

Complete, ready to play including 12" speaker, hardware and knobs:

**Special Price—Limited time only \$149.50** (Incl. Fed. Tax—less CRT)

**FREE!** With any chassis, a copy of the famous "TV Trouble Shooting Method," locate all troubles in a jiffy. Complete with illustrations and hundreds of rapid checks. Get Yours NOW—FREE!

**TV TUBE ACCESSORIES—ANTENNAS**

Universal Mounting Bracket	\$5.95
Sleeve & Ring for 16" Metal	3.85
Sleeve & Ring for 19" "	4.04
Sleeve & Ring for 24" "	7.95

Each Specially Priced!

**FAMOUS CONICAL "Fan-Tenna"**  
Finest antenna made at any price. Completely pre-assembled. All seamless aluminum doweled elements & cross-arm. Regular list: \$12.43. Save more than half! \$6.19 ea. lots of 6 \$5.59 ea.

**LUXURIOUS, NEW TV CABINETS**

For 630 Chassis, 17", 19", & 20" Picture Tubes

Model 100 Reduced to \$39.95		Save 45%! Custom Styled	Model 200 Now only \$49.50
------------------------------	--	-------------------------	----------------------------

Blonde finish add \$10  
Every beautiful cabinet, in richly finished, hand rubbed mahogany will stand out in any room. Made special to house the 630 chassis, they will carry a 17", 19" or 20" picture tube. Every cabinet is custom styled, made by craftsmen and guaranteed perfect. Includes safety glass, mask & mounting brackets. Order Now and Save 45%!

**CRYSTAL CLEAR LUCITE MASKS**

All Prices Reduced!

Framed in Rich Gold Leaf Finish

RO—Round Tubes	
RE—Rect. Tubes	
14" RE 10 1/2" x 13 3/4"	\$4.49
16" RE 12 1/2" x 15 3/4"	5.79
16" RO 13 1/2" x 17"	5.89
17" RE 13 1/2" x 17"	5.89
19" RO 15 3/4" x 20"	7.69
20" RE 16 1/4" x 20 1/2"	7.69
24" RO 21" x 25"	13.95

**TV PICTURE TUBES**

6-Months Guarantee—non pro-rata  
Black Face—Brand New—Standard Brands—Sealed Cartons

10BP4 Round-Glass	\$24.95	16HP4 Round-Glass	\$33.95
12LP4 Round-Glass	24.95	17BP4 Rect. Glass	29.95
14BP4 Rect.-Glass	24.95	19AP4A Round-Metal	37.95
16GP4 Round-Metal	31.95	20CP4 Rect.-Glass	37.95
21" Rect. Cylindrical face	39.95	24AP4 Round-Metal	69.95



**THE ROSE COMPANY**

100 Park Place

Dept. E-4, New York 7, N. Y.

COrtlandt 7-6195

NOW! Write for FREE Catalog including new complete line of tubes, parts, accessories for radio & TV, plus test instruments.

MINIMUM ORDER: \$5.00. 25% deposit with order, balance C.O.D. Include postage with order. All merchandise subject to prior sale. F.O.B. New York City. Prices subject to change without notice.



type long-wire antenna. An all-wave antenna only 68 feet long is described in *Short Wave News* (London, England).

Called the SWL Special, the antenna is derived from the off-center-fed Hertz. The 68-foot radiator has feeders tapped on one-third the length from each end.

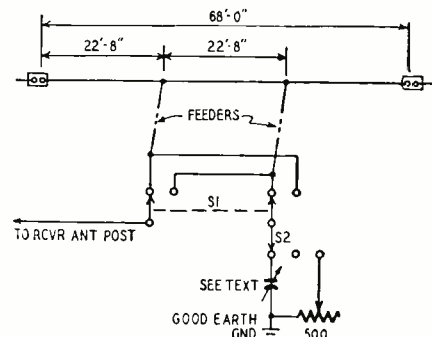

These feeders are brought to a double-pole, double-throw switch S1, which is used to connect either one to the antenna post or the receiver. The unused feeder is brought to the arm of a 3-position, single-pole switch S2. By selecting the proper position for S2, the unused feeder may be left open or it may be returned to ground through a variable capacitor or through a variable resistor.

The directivity can be shifted by throwing S1, and the antenna can be adjusted for maximum sensitivity on any frequency by experimenting with the setting of S2 and by varying the setting of the variable resistor and

capacitor. (The value of the tuning capacitor was not specified, but a standard 365- $\mu$ f variable capacitor will probably work nicely. If a signal peaks with the capacitor fully meshed, try connecting a second capacitor in parallel with the first.)

### NOVEL TONE CONTROL

Recently we ordered a 2.5-megohm tone control for an amplifier which we were building. The unit which was shipped to us was as tapped at 500,000 ohms so we decided to try a more elaborate tone control. After some experimenting, we arrived at the circuit shown.

When the arm of the potentiometer is at the top, the high frequencies pre-

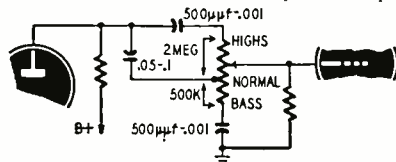

dominate, going directly to the following grid through the 500  $\mu$ f capacitor. The 2-megohm section of the control effectively blocks the low frequencies. The response is normal when the arm is at the tap position, and the lows are boosted when the arm is near the bottom.

You may use two 500- $\mu$ f and one .05- $\mu$ f capacitor or two .001- and one 0.1- $\mu$ f capacitor. Use the values which give the most pleasing performance.—*S. Fuhrman.*

—end—

## AUDELS TV SERVICE TELLS HOW TO SOLVE TV TROUBLES AND ANSWERS TV QUESTIONS

AUDELS TELEVISION SERVICE MANUAL covers T.V. information at your finger ends. Shows good receiver adjustment and How to Get Sharp, Clear Pictures, How to Install Aerials—Avoid Blurs, Smears, Interference and How to Test. Explains Color Systems and Methods of Conversion. IT PAYS TO KNOW! Over 380 PAGES & 225 ILLUSTRATIONS explaining operating principles of Modern Television Receivers.



**\$2 POST PAID**

Shooting—Color Television—Television Terms. **7 DAYS FREE TRIAL** GET THIS PRACTICAL ASSISTANCE FOR YOURSELF — MAIL COUPON TODAY — **AUDELS Publishers, 49 W. 23rd St., N.Y.** Mail me postpaid for 7 days examination. **AUDELS TELEVISION SERVICE MANUAL (Price \$2).** If O.K. I will mail you \$2, otherwise I will return book.

Name \_\_\_\_\_  
Address \_\_\_\_\_  
Employed by \_\_\_\_\_

### XTALS FOR ALL PURPOSES

LOW FREQ. XTALS—FT 241A	SCR 522 Xtals	BC-61 Xtals
For SSB, lattice filter, etc. 1/2" spc. 54th or 72nd harmonic channels listed by fundamentals. Fractions omitted.	1/4" ins 1/2" spc.	2 banana plugs 3/4" spc.
372 404 436 506	400 462	5910 2030 2435
374 405 437 507	440 463	6370 2045 2442
375 406 438 508	441 464	6450 2105 2532
377 407 481 509	442 466	6470 2125 2545
379 408 483 511	444 468	6497 2145 2557
380 409 484 514	446 470	6522 2155 3202
381 411 485 515	447 472	6547 2220 3215
383 412 487 516	448 474	6610 2258 3237
384 413 488 518	450 475	7350 2280 3250
385 414 490 519	451 476	7480 2282 3322
386 415 491 520	452 477	7580 2290 3510
387 416 492 522	457 479	7810 2300 3520
388 418 493 525	461 480	7930 2305 3550
390 419 494 526		2320 3580
391 420 495 530		2360 3945
392 422 496 531		2390 3955
393 423 497 533		2415 3995
394 424 498 537		
395 425 503 538		
396 426 504		
397 427		
398 429		
401 431		
402 433		
403 435		
99c ea.	\$1.29	
10 for \$9.00	each	
<b>SPECIAL</b>		
200 Kc xtals without holders		
69c each		
3 for \$2.00		
\$1.29 each		
49c ea.		
10 for \$4.50		

HAM XTALS—FT 243 HOLDERS—1/2" pin spc.					
4190 6773 7840	1015 5800 6306 6573 7506 7673				
5030 6873 7873	1129 5806 6325 6575 7540 7706				
5485 6906 7906	2045 5825 6340 6600 7573 8240				
6040 6973 7940	3735 5840 6373 6606 7606 8340				
6073 7740 7873	5305 5850 6406 6625 7640 8400				
6106 7773 8273	5677 5873 6440 6640 7650				
6125 7806 8306	5706 5875 6450 6673				
6140	5725 5906 6473 6706				
6173	5740 5940 6475 6740				
6175	5760 5973 6506 7440				
6206	5773 6273 6540 7473				
		99c ea.			
		10 for \$9.00			
		\$4.50			

Add 20c for each 10 xtals or less for postage and handling.

**TERMS:** All items F.O.B., Washington, D.C. All orders \$30.00 or less, cash with order. Above \$30.00, 25 per cent with order, balance C. O. D. Foreign orders cash with orders, plus exchange rate.



### Special Purchase FM Radio Chasis

88-108MC

Complete with 6 tubes. Built-in Antenna and Speaker. Products of Famous Radio & TV Manufacturer whose name we promised not to mention.

**TUBE LINEUP**  
1-12BA7 1-12SR  
2-12BA6 1-35W4  
1-35B5

May also be used as an FM Tuner by picking signal off detector.

Regularly \$29.95  
**Brand New \$16.95**

**NOW AVAILABLE: Cabinets for above—Maroon Plastic—may be bought separately .....\$5.95**

**SPECIAL PURCHASE Record Changer Gen. Instruments 3-speed Automatic Reg. \$34.95 Brand New \$19.97**



With all purpose cartridge & needle. Plays 33 1/3-45 and 78 RPM records automatically.

**NOTE:** Do not send money for postage on above items—we ship best way—charges collect.

**JUST ARRIVED!! NEW PHILMORE NOVICE XMTR KIT**

Approx. 35-40 watts input. Uses plug in coils for all band C. W. operation. 6V6 OSC; 6L6 AMP., 80 RECT. on 2 chasses. Complete with punched chasses, tubes, coils for 80 meters, all parts, antenna, key, step-by-step instructions, less crystal. Write for further description and price.

### BUILD YOUR OWN TEST EQUIPMENT WITH EICO KITS

Model 145-K, Multi-Signal tracer...	Net \$19.95
Model 221-K Vacuum Tube Voltmeter	Net 25.95
Model 315-K Signal Generator Kit...	Net 39.95
Model 320-K Signal Generator Kit...	Net 19.95
Model 425-K 5" Oscilloscope Kit...	Net 44.95
Model 625-K Tube Tester Kit...	Net 34.95
Model 360-K Sweep Generator Kit...	Net 34.95
Model 950-K Cond. Res. Comp. Bridge Kit	Net 19.95
Model 1040-K Battery Eliminator Kit	Net 25.95

### HI-FIDELITY ENTHUSIASTS!!

Sun Radio stocks most of the famous lines of tuners, amplifiers, speakers, changers, cartridges as follows:

Radio Craftsmen, Newcomb, Bogen, Bell, Rauland, Jensen, Altec Lansing, Jim Lansing, Stephens, Electrovoice, University, Meissner, Brooks, Brook, Pickering, G.E., Garrard, Audax, Webster, and many others. Write our Audio department for recommendations and prices.

**HAMS!** Sun Radio is headquarters for most of the famous lines of ham gear—like National, Hallicrafters, Hammarlund, B&W, Bud, etc. Write our ham department for availability and prices. W3PPQ—"Pick" is at your service.

**NEW** a "must" book  
for every  
**TV Service Technician**

**"Servicing TV  
in the  
Customer's Home"**



**SAVES TIME  
SAVES WORK  
Earns More  
for You  
on Outside  
Service Calls**

shows how  
to diagnose trouble using  
capacitor probe and VTVM

Here's the book you've been asking for—practical, proved help to make your outside TV servicing really effective and profitable. Saves time, work and chassis hauling . . . shows you how to make successful repairs on the spot. You learn the following: 1. A simple, effective method for tracing down trouble, using your VTVM and a simple capacitor probe. 2. Methods for finding your way around a strange circuit—shows you how to "pull tubes" and diagnose trouble by observing audio and picture effects. 3. How to judge TV set performance by analysis of the test pattern. 4. Methods for making adjustments in the field. You'll want this essential, profit-building book. Handy pocket size; sturdy cover. **\$1.50**

**ORDER TC-1. Only . . . . . \$1.50**

**Pays for itself on the very first job.**

**HOWARD W. SAMS & CO., INC.**

Order from your Parts  
Jobber, or write direct to  
**HOWARD W. SAMS & CO.,**  
2201 E. 46th St., Indianapolis 5, Ind.

Send . . . copy(ies) of "SERVICING TV IN THE  
CUSTOMER'S HOME," \$1.50 per copy.

(Check) (money order) for \$ . . . . . enclosed

Name . . . . .

Address . . . . .

City . . . . . State . . . . .

**ORDER  
TODAY**

**TUNER MODIFICATION**

? I have a Lafayette tuner type PA 530 to which I would like to add a single push-button tuning unit for WQXR on 1560 kc. Since I need more selectivity on this end of the band, the switching arrangement should cut out the variables and cut in correctly tuned trimmers and coils if necessary.—J. H. M., Crozet, Va.

**A.** If your chassis is crowded with little space for extra components, modify the circuit as shown at a. A d.p.d.t. wafer switch cuts out the variable capacitors and inserts 100- $\mu$ f variable trimmers across the antenna and oscillator tuned circuits.

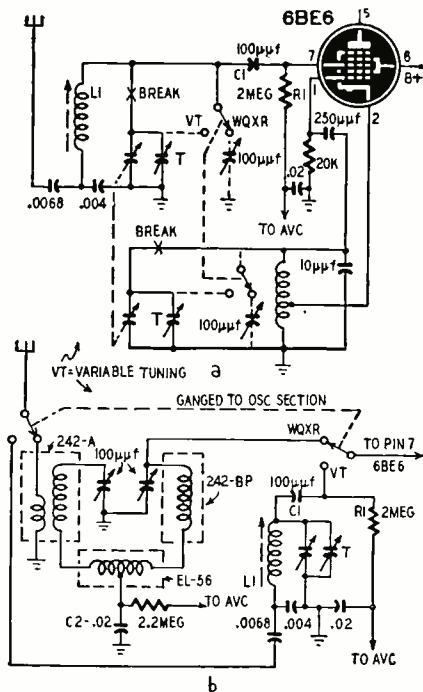

If you can find space near the converter tube for two shielded coils 1 1/2 inches in diameter and 3 inches high, you can get more selectivity by using the circuit at b. Here a 3-pole, double-throw switch is used. One section switches the oscillator modified as at a. The other two sections switch in a negative mutual coupling antenna circuit. The switch wafers should have low-loss insulation and should be shielded from each other to prevent interaction and feedthrough from the antenna to the mixer grid.

The antenna, bandpass, and negative mutual coupling coils are types 242-A, 242-BP, and EL-56, respectively, made by the J. W. Miller Co.

To align the set on WQXR, set a modulated signal generator to 1560 kc and adjust the 100- $\mu$ f trimmers for maximum output. Selectivity can be increased by making C2 larger.

**FL-8 FILTER CONNECTIONS**

? I have an FL-8 filter which I want to use with my communications receiver. Please prepare a diagram showing how it can be connected.—F. R., Vicksburg, Miss.

**A.** Remove the four screws which hold the front cover on the filter and you will

find three terminals marked as shown on the drawing. Use shielded cable to run a lead from the REC terminal to a high-impedance point in the output of the receiver. Connect the outer shield to the GND terminal of the FL-8 and to

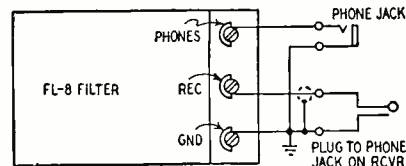

ground. If the receiver has its phone jack in a high-impedance circuit, equip the shielded lead with a phone plug and insert it into the phone jack on the set. Connect a phone jack between the PHONES and GND terminals. Plug a pair of high-impedance phones or a speaker and output transformer into the jack connected to the FL-8.

**CALIBRATING ALL-WAVE SETS**

? I have a multiband foreign receiver having a dial marked with station call signs and with cities having some sectors underscored and marked 49 meters, 41 meters, 19 meters, etc. Can you tell me how to recalibrate the set in terms of frequencies so I can tune with greater accuracy? How can I convert wavelength to frequency.—D. M. J., Seattle, Wash.

**A.** To convert wavelength in meters to frequency in kilocycles, divide 300,000 by wavelength. To convert to megacycles, divide 300 by the wavelength. To accurately recalibrate the receiver in terms of frequency, first take a signal generator and check the approximate frequency coverage of each of the receiver bands.

Then, after having allowed both the receiver and the signal generator to warm up for approximately one-half hour, tune in a broadcast station on 1,000 kc (1 mc). (Station KOMO in Seattle operates on this frequency.) Set the signal generator to 1,000 kc (unmodulated) and vary the tuning as much as may be necessary to make it zero beat with the broadcast signal. Regardless of its dial reading, the signal generator is now tuned to exactly 1 mc, and is also producing harmonic frequencies of 2 mc, 3 mc, and so on up the scale.

Without changing the setting of the signal generator, switch the receiver to one of the bands to be calibrated. Tune in a station whose frequency is accurately known. If possible, one of the standard frequency transmissions from WWV on 2.5 mc, 5 mc, 10 mc, etc. should be used.

Disconnect the antenna and feed in the 1-mc signal from the signal generator. (If the set does not have a beat-frequency oscillator, the signal generator should be modulated with an audio tone. Keep modulation turned down to the point where the audio signal is just sufficient to permit identification of the signal. Keep the signal generator output turned down and turn up the audio on the set. This prevents overloading the receiver.) Tune the receiver slightly



to both sides of the broadcast signal and log the positions where the signal generator is heard. For example, if you have the set tuned to WWV on 2.5 mc the signal generator can be tuned in at 2 and 3 mc. Working from these points, you can then mark off 1-mc points throughout the band. Next, set the signal generator to 500 kc by beating its fifth harmonic against WWV on 2.5 mc or its tenth harmonic against WWV on 5 mc. The even 500-kc harmonics will fall directly on the previously marked 1-mc points and the odd harmonics will fall midway between them.

If the dial can be read and reset with sufficient accuracy, additional points can be marked on the dial by setting the signal generator to 50, 100, 200, or 250 kc, depending on the accuracy desired on the band.

**TRANSMITTER MODIFICATION**

**?** *I have a surplus transmitter which uses a pair of 807's in the final. I want to replace these tubes with 814's and run them with 1,500 volts on the plates. Please prepare a diagram showing the necessary changes.—C. B., Welland, Ont.*

**A.** Since you did not send a circuit of your rig, we don't know anything about its size or circuit arrangement. However, the following notes may be useful in making the change.

1. The 807 is a cathode-type tube with a 6.3-volt, 0.9-amp heater while the 814 is a filament-type tube requiring 10 volts at 3.25 amps. The two tubes will require a center-tapped 10-volt filament transformer rated at 6.5 amps or more. The center tap should be grounded and each filament pin bypassed to ground with a .005- $\mu$ f mica capacitor. You can use either cathode, fixed, or grid-leak bias. For c.w., about 90 volts of bias will be O.K. You can develop this from a 245-ohm resistor (50 watts or larger) connected between the center tap of the filament transformer and ground. In this case, the filament bypass capacitors and the beam-forming plates should be connected directly to the center tap on the transformer. Bypass this cathode biasing resistor with a .005- $\mu$ f mica capacitor. For grid-leak bias, use a 4,500-ohm, 10-watt resistor.

2. The spacing between the plates of the plate tank tuning capacitor may not be wide enough to handle the 1,500 volts fed to the 814's. If the present circuit is series fed, we suggest changing over to parallel feeding to get the d.c. voltage off the capacitor plates and the tank coil. Study the circuits of transmitters using two 813's, 8001's, 4E27's. These circuits can be used for 814's. The only differences are in the operating voltages and in the current and voltage ratings of the circuit components. Suitable circuits will be found in the various amateur handbooks and magazines.

If the driver stage doesn't supply enough drive for the 814's (10 ma) you can probably raise it by increasing the plate voltage on the driver or by using a heavier tube in the driver stage.

—end—

**HI-FI FANS Order the Famous PERMOFLUX Royal Eight" SPEAKER**

**For Test TODAY!  
10 DAY TRIAL  
MONEY BACK GUARANTEE!**

High Fidelity Fans the country over acclaim the clean, brilliant life-like musical reproduction of the Permoflux Royal Eight" . . . the 8" Speaker proved comparable to any 12"! Combined with the new Permoflux Corner Baffle . . . either singly or arranged in Multiple Speaker Units . . . the Royal Eight" re-creates original programs with even superior sensitivity and fidelity . . . every instrument in full range tonal balance. Here's Big Speaker Performance in a small easy-to-install frame at a sensible price.

**IMPORTANT:** This sensational offer available from Distributors displaying a Blow-up of this ad or upon writing to the PERMOFLUX CORPORATION, Chicago 39, Illinois.

Royal Blue Line Catalog J-207 available upon request.

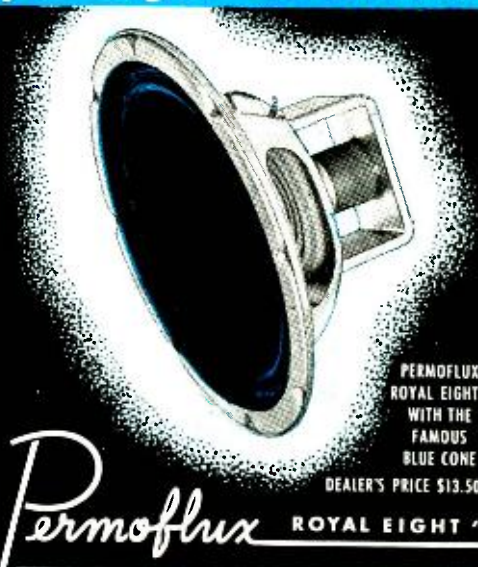

PERMOFLUX ROYAL EIGHT" WITH THE FAMOUS BLUE CONE

DEALER'S PRICE \$13.50

*Permoflux* ROYAL EIGHT"

**PERMOFLUX CORPORATION**

CHICAGO 39, ILLINOIS  
GLENDALE 5, CALIFORNIA

Canadian Licensee—Campbell Mfg. Company,  
Toronto, Canada

**PERMOFLUX CORPORATION**

4912 W. Grand Ave., Chicago 39, Ill.

- Please send \_\_\_\_\_ Permoflux Royal Eight" (8T-8-1) FOR 10 DAY TRIAL
- Check  Money order enclosed

Your Name \_\_\_\_\_

Address \_\_\_\_\_

City \_\_\_\_\_ Zone \_\_\_\_\_ State \_\_\_\_\_

**TRIPLEX WAVE MASTER**

**YOUR BEST ANTENNA BUY!  
PROVEN UNDER  
ACTUAL TESTS!**

- ✓ GHOST FREE RECEPTION—ALL CHANNELS
- ✓ MATCHES ANY OHM WIRE 75—150—300
- ✓ USERS REPORT UP TO 300 MILE RECEPTION
- ✓ TRIPLE DIRECTORS
- ✓ EASY TO INSTALL



NO BOOSTER REQUIRED!

**\$8.90**  
Lots of 3 \$8.45 each

YOUR COST NOW ONLY

Approximate Weight . . . 9 lbs.

20% deposit on all C.O.D. orders

**RAY CO.** • SOLD DIRECT! WRITE . . . WIRE OR CALL FAIRFAX 9171 441 SUMMIT ST., TOLEDO, OHIO

**PARTS LISTS**

Bills of material for most of the pieces of equipment described in RADIO-ELECTRONICS construction articles are on hand at all radio parts jobbers and distributors who sell the magazine. See your dealer for a complete parts list of any of this apparatus you wish to construct.



General Industries' 3-Speed Turret-type Phonomotor for record-changer applications.

# Quietness...

## an important reason why leading manufacturers prefer General Industries' 3-Speed Phonomotors

Because they are extremely low in hum, wow, rumble and speed variation, General Industries' Phonomotors meet every performance requirement of radio and television set manufacturers and record-changer producers alike.

Write *today* for detailed information, including specifications, design features and dimensions of General Industries' complete line of phonomotors.

**THE GENERAL INDUSTRIES CO.**  
Department ME • Elyria, Ohio



Over 43,000 Technicians Have Learned  
**HOW TO GET THE MOST OUT OF BASIC TEST EQUIPMENT**  
Why Not You, Too?

**SERVICING by SIGNAL SUBSTITUTION**  
A BEST SELLER FOR OVER 9 YEARS! (NEW, UP-TO-DATE, 72TH EDITION)

The Simple, Modern, Dynamic Speed Approach To Receiver Adjustment and Alignment Problems, AM-FM-TV.

- Nothing complex to learn
- Universal — non-obsolete
- No extra equipment to purchase
- Employs Only Basic Test Equipment

only 40¢

100 pages. Invaluable information that will help you re-double the value of your basic test equipment.

Ask for "S.S.S." at your local Radio Parts Jobber or order direct from factory.

PRECISION APPARATUS COMPANY, INC. • 92-27 Horace Harding Blvd., Elmhurst 4, N. Y.

### WESTINGHOUSE H-188

Short-wave interference in this model can often be eliminated by replacing the .05- $\mu$ f resonant capacitor (between the chassis and B-minus bus) with a 0.1- $\mu$ f standard paper capacitor rated at 200 volts or more.—*Westinghouse Service Hints*

### HALLICRAFTERS T-54

Intermittent reception of sound and picture is likely to be caused by dirty contacts on the push-button tuning assembly. Clean the entire assembly with carbon tetrachloride.—*Wilbur J. Hantz*

### DU MONT RA-113

Intermittent overloading of the picture circuits is sometimes due to trouble in the narrow-band sync circuit. If the trouble cannot be cleared by replacing the narrow-band sync amplifier and sync and a.g.c. tubes, check the peaking coil in the grid circuit of the sync amplifier. This coil sometimes opens up intermittently after the set has been in operation a few hours. Replacing this coil (L213) will eliminate the intermittent condition.

This circuit is critical as to components, so be sure to use the manufacturer's exact replacement.—*James T. Smith*

### PHILCO 48-1001

No raster. High voltage O.K. This can be caused by excessive bias on the cathode of the picture tube. Check the 0.5- $\mu$ f capacitor between the cathode of the 10BP4 and the B-plus line to the 7B5 video output tube. If the capacitor breaks down, it places approximately 300 volts positive on the cathode of the picture tube thus cutting it off. If the capacitor is shorted or leaky, replace it with a 600-volt unit.—*James Moudry*

### PHILCO 46-350

Severe distortion on battery and a.c. operation was traced to one of the batteries which had corroded. Distortion was cleared up by replacing the battery. The same type of trouble can occur on any number of battery sets. It is a good idea to check the batteries by substitution before you start replacing tubes and coupling capacitors.—*Charles F. Otto*

### OPEN 35Z5'S IN A.C.—D.C. SETS

Don't be too hasty in replacing a 35Z5-GT or similar tube when you find the heater tap is open. Some receivers have a line filter capacitor connected to the center tap as shown in the diagram. If this capacitor is shorted, it will burn out one section of the heater as fast as you can plug in new tubes.

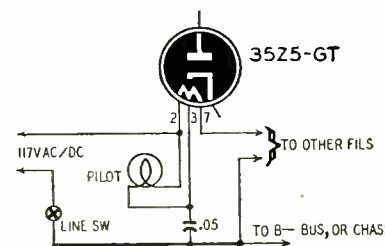



You can check this capacitor without pulling the chassis. Remove one of the other tubes from the string then plug in a new 35Z5. With the line switch ON, use an ohmmeter across the line plug to check for a short. This precaution requires only a few seconds and will save many new tubes.—*Wm. R. Brown*

**A.C.-D.C. RECEIVERS**

Many sets and amplifiers have a pilot lamp connected between one side of the line and the plate of a 35Z5-GT, 35W4, or similar rectifier as shown at *a*. If the set is turned off and turned back on

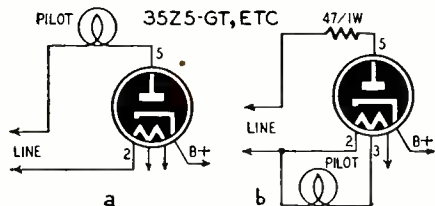

while the rectifier is still warm, the pilot lamp will flash very brightly and may burn out. This condition can be eliminated by connecting the pilot lamp across the tapped heater and connecting a 47-ohm, 1-watt resistor in series with the plate as shown at *b*.—*Richard Sandretto*

**CURING TV BREAKDOWNS**

Most TV receiver breakdowns are due to excessive heat generated in the small boxed-in compartment. It doesn't take much brains to figure that out. In fact, you could cook a meal on top of some sets.

A simple but effective solution to this problem is a small fan inside the cabinet, that goes on and off with the TV



set, to circulate the air. This prevents many breakdowns because of the much lower ambient temperature in which the parts have to operate.

An excellent compact unit that will

APRIL, 1952

fit in any set is a phonograph synchronous motor with a 4-blade fan, commonly used by amateurs for cooling transmitting tubes. Make sure to face the fan to blow the air to the back of the set and out the cabinet. These can be purchased from almost any radio supply house at small cost.—*Milton Kalashian, WINXT*

**FREED 16- AND 19-INCH SETS**

A loud 60-cycle sync buzz which is audible in the speaker can be reduced by connecting a .03- $\mu$ f, 400-volt capacitor from the plate of the vertical oscillator tube to ground.—*Freed Field Service Bulletin*

**G-E MODELS 610 AND 611**

Always leave the A-battery in place in the cabinet, even if it is not connected to the circuit. The reason for this is that the capacitance between the loop and the battery is utilized as part of the tuning capacitance of the antenna circuit. Removing the battery will change the alignment and reduce the sensitivity of the receiver.—*G-E Radio Service Bulletin*

**EMERSON 12½-INCH CHASSIS**

When the picture is centered properly, a shadow sometimes appears on the right side of the tube on 12½-inch chassis such as the 120123B, 120131B, 120133B, and 120138B which use mechanical centering. If proper adjustment of the focus coil and deflection yoke does not eliminate the shadow when the beam-bender is adjusted for maximum brightness, use the following procedure:

1. Check capacitor C61 (0.5  $\mu$ f) and replace if shorted.
2. Magnetize the metal band around the deflection yoke in the following manner:

Connect the negative terminal of an 8- $\mu$ f electrolytic capacitor to B-neutral (switch on the rear of volume control). With the set operating, momentarily touch the positive side of the capacitor to the junction of C61 and the red lead to the horizontal deflection winding (located on the lug farthest from the front of the chassis on the terminal board near the volume control). The picture will jump from left to right then settle to a position slightly to the right of its original position. If necessary, discharge the capacitor to B-neutral and repeat the operation. Be careful not to overdo this because you will then cause a shadow to appear on the lower left side of the picture.—*Emerson Service Dept.*

**SPARTON 5006X and 5007X**

Complaint: Sound weak, sensitivity poor.

Some of these models came off the assembly line with 6AX5's as low-voltage rectifiers. After a few days of operation, the voltage on the 150-volt bus drops to less than 100. Replace the 6AX5-GT with a 6X5-GT to restore normal operation. The two tubes are interchangeable.—*William Phillips*

—end—

**Become an Electrical Engineer**



**MAJOR IN ELECTRONICS**



- B. S. Degree in 36 Months
- Radio-Television Technician Certificate in 18 Months

Experts predict that by 1954 there will be at least two positions for every engineering and technician graduate. This College offers a tested plan that permits you to enter these vast employment opportunities at an early date. First—you save a valuable year through optional year-round study. Second—you can receive advanced credit for prior training gained in the armed forces, other schools or field experience.

**Enter Both Radio and Television Through This Plan**

12 months or one-third of the B. S. degree course (Electronics major)—also brings you the Radio Technician's certificate. An added 6-month course qualifies you for the Radio-TV Technician's Certificate.

**The Famous "UNIT CHASSIS SYSTEM"**



of teaching was developed here. It "breaks down" the TV set by stages. You learn every component of all types and makes—and are prepared for future design changes, including the advent of color.

**SPECIAL! Television Clinics**

Ambitious Radio and TV Servicemen can enrol now in special one-month spring or summer clinics—to handle latest field service problems. Write for full details.

Over 48,000 former students from all states and 23 overseas countries. Faculty of trained specialists. Modern laboratories and equipment. Nonprofit technical institute and college 49th year.

**MILWAUKEE SCHOOL OF ENGINEERING**

• Founded 1903 •

Terms open April, July, October, January

FREE — Write for "Occupational Guidance Bulletin," "Your Career" booklet, and Catalog.

Milwaukee School of Engineering  
Dept. RE 452 1025 N. Milwaukee  
Milwaukee, Wisconsin

Without obligation send Catalog for  
Electrical Engineering, B. S. Degree,  
major in  Electronics;  Power;  "Your  
Career"; Occupational Guidance Bulletin  
on:  Radio-TV;  Electrical Power;  
 Welding;  Heating, Refrigeration Air Conditioning;  
 TV Service Clinic.

Name.....Age.....  
Address.....  
City.....Zone.....State.....  
If veteran, indicate date of discharge.....



# 3

New  
Custom-Built  
Deluxe  
TV Chassis

*by* **TECH-MASTER**



for  
16"  
to  
24"  
Picture  
Tubes

**MODEL 2430**—Designed specifically for all picture tubes requiring from 65 to 70 degrees horizontal deflection, (such as 24AP4, 20CP4, 19AP4, etc.) Supplied with quality PM speaker, and Universal Picture Tube Mounting Brackets & Photo Jack. ....\$189.50

**MODEL 2431P**—Similar to model 2430, but with Push-Pull Audio, True Fidelity Output and Universal Picture Tube Mounting Brackets. ....\$199.95

**MODEL 2431C**—Basically same as Model 2430 but with Continuous Tuner, Push-Pull Audio, True Fidelity Output and Universal Picture Tube Mounting Brackets. Allows complete coverage of both TV and F.M. bands. ....\$199.95

The new **Gold Medal Series** incorporates all the latest Tech-Master features which have made this improved 630 type chassis the standard by which custom-built TV is measured... performance and service are assured because Tech-Master design and construction are as fine as human hands and brains can produce. All chassis are supplied completely wired, aligned and tested with all tubes (less picture tube).

**LOOK** for your Tech-Master registration and guarantee card attached to each chassis... it is your assurance that you are buying a genuine Tech-Master receiver.

See the Gold Medal Series and other quality Tech-Master products at your favorite Radio Parts Jobber or write direct to Tech-Master Products Co. Dept. RE-14 for complete descriptive literature.



**TECH-MASTER PRODUCTS CO.**  
443-445 Broadway • New York 13, N. Y.



THE FUND REACHES  
\$9,338.46

HELP -  
FREDDIE-WALK  
FUND

RADIO-ELECTRONICS recently received the following letter from Herschel Thomason, radio technician of Magnolia, Arkansas, and father of little Freddie Thomason, who was born armless and legless:

"... Your effort in building up the fund has been a tremendous help to us and we do appreciate it very much.

"Freddie is scheduled to return to the Institute (Kessler Institute for Rehabilitation, West Orange, New Jersey—Editor) in the next few weeks for new legs. He has just about outgrown the ones he has now. He is trying to walk and we are hoping the new legs will help him to do so."

Faith, probably the strongest factor in human existence, has long been of utmost importance to the Thomasons, and faith combined with the good wishes and encouragement of unseen and unknown friends is a force that can't be beaten.

To date, RADIO-ELECTRONICS readers have contributed over \$9,325.00 to the Help-Freddie-Walk Fund, but we can all readily understand that thousands more will be needed to assure Freddie a happy and useful life. As his father indicated in his letter above, Freddie's continued growth means that the mechanical appliances on which he will always depend must grow with him. This, we all realize, is an expensive undertaking, and we urge all of our readers to contribute whatever and whenever they can. Any donation, however small, will receive our sincere thanks and acknowledgment.

Please send your contributions from time to time. (Make all checks, money orders, etc., payable to Herschel Thomason.) Address all letters to:

Help-Freddie-Walk Fund  
c/o RADIO-ELECTRONICS  
25 West Broadway  
New York 7, N. Y.

**FAMILY CIRCLE CONTRIBUTIONS**

Balance as of January 18, 1952 .... \$ 517.50  
Anna Judge, Providence, R. I. .... 2.00

FAMILY CIRCLE Contributions received to February 19, 1952 .... \$ 519.50

**RADIO-ELECTRONICS CONTRIBUTIONS**

Balance as of January 18, 1952 .... \$8,756.50

A Friend, U. S. S. Mount McKinley	1.00
Anonymous, Albuquerque, New Mexico	1.00
Anonymous, Brooklyn, New York	1.00
Anonymous, East Liverpool, Ohio	1.00
Anonymous, Flushing, New York	2.00
Anonymous, Hartford, Connecticut	1.00
Anonymous, Minersville, Pennsylvania	5.00
Anonymous, Omaha, Nebraska	1.00
Anonymous, Steubenville, Ohio	20.00
L. A. Doll, Omaha, Nebraska	2.00
Van H. Ferguson, Tallahassee, Florida	5.00
Pfc. Robert F. Hoiber, Korea	10.00

RADIO-ELECTRONICS

**The TURNTABLE is the HEART  
OF YOUR  
HIGH FIDELITY SYSTEM**

You may own the finest pickup, amplifier and speaker that money can buy... yet you'll get poor reproduction if your TURNTABLE has excessive wow, hum or rumble!

REK-O-KUT offers a complete range of 12" Turntable models to match your present high-fidelity equipment and your own pocketbook. Not every sound system requires the most expensive turntable... your turntable must be chosen to complement your other components. Each REK-O-KUT Turntable carries an engineering specification which enables you to select the appropriate unit to match your other components. Quality and workmanship of every REK-O-KUT Turntable is identical... price differential depends solely on type of materials used.



**MODEL LP-743**  
3-Speed 12" Turntable  
Induction type motor, designed for smooth, vibration-free operation. Instantaneous speed changes without stopping turntable or removing disc. ....\$54.95 Net

**MODELS T-12H & T-43H - 2-Speed 12" Turntables**

Recommended for use with **ULTRA HIGH FIDELITY Amplifiers and Speaker Systems.** The only 12" Turntable that meets N.A.B. specifications for speed regulations and Wow content.

MODELS	MOTOR	DB Noise Level	SPEED	PRICE
T-12 H*	Hysteresis Synchronous	-50DB	78-33 1/3	\$119.95
T-43 H*	Hysteresis Synchronous	-50DB	45-33 1/3	\$119.95
T-12	4 Pole induction	-40DB	78-33 1/3	\$84.95
T-43	4 Pole induction	-40DB	45-33 1/3	\$84.95

\*Delivery limited due to short supply of hysteresis motors.

**REK-O-KUT CO.**

38-05 Queens Blvd., Long Island City, N. Y.

EXPORT DIVISION: 458 Broadway, New York City, U. S. A.  
CANADA: ATLAS RADIO CORP., LTD., 560 King St. W., Toronto 28, Ontario

BACK AGAIN!

And "Wholesale" Has Them

OHMITE "LITTLE DEVIL"

1/2 WATT RESISTOR ASSORTMENT  
**IN PLASTIC CABINET**

\$12.50

Cost of Resistors Alone!  
**CABINET FREE**



**125 Resistors in 40 Compartments**

A real timesaver in your shop. Easy to find the right resistor in seconds. Sturdy, five-drawer, plastic cabinet is 9"x5 1/4"x4 3/4". Selected servicemen's assortment of 125 resistors in 40 values from 10 ohms to 10 megohms. You pay for resistors only. Cabinet Free!

Order from Dept. RE-4

**WRITE FOR FREE FYI FLYER**

WHOLESALE

RADIO PARTS CO., Inc.

311 W. Baltimore St.

BALTIMORE 1, MD.



Hartmann Radio & Television, Woodside, N. Y. ....	3.00
Stevie Kitchen, age 4 1/2 mos., Ottawa, Canada .....	1.00
Henry Stockhouse, Portland, Maine .....	1.00
Alfred Voyer, Greenland .....	7.46

RADIO-ELECTRONICS  
Contributions ..... \$8,818.96  
FAMILY CIRCLE Contributions ..... 519.50

TOTAL CONTRIBUTIONS to February 19, 1952 ..... \$9,338.46

**USING BLANKING TIME**

Pulses are needed to control the synchronization of TV pictures. These pulses are transmitted at definite instants. The picture must be blanked out during the transmission of the sync pulses. Some inventors have devised circuits for sending other signals in addition to the sync pulses during blanking. For example, the audio modulation may be sent during these times, thus eliminating the need for a separate carrier. More recently it has been suggested that pulses may be sent to control color at the receiver. Of course these auxiliary signals must not interfere with the sync pulses.

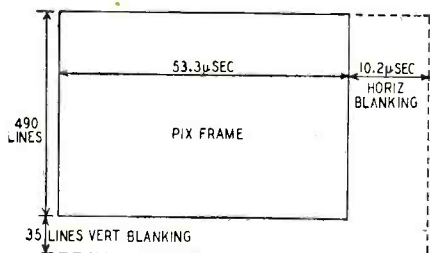

The blanking periods represent considerable time during which no picture appears. Each picture line lasts 53.3 microseconds (see drawing). At the completion of each line, a horizontal blanking period of 10.2 microseconds follows. The total (63.5) is the total horizontal deflection period.

There are 525 lines per frame, not all of which are visible. Approximately 35 lines are lost during blanking when the beam retraces vertically. This leaves only 490 lines per frame.

Actual picture time is easily calculated. It is the product of: 53.3 (microseconds per visible line); 490 (visible lines per frame); and 30 (frames per second). The answer is .7835 microseconds of picture per second. This shows that no picture appears for nearly one-fourth of the total time.

**BETTER ALNICO MAGNETS**

An improved casting process has been patented by Dolph G. P. Ebeling, Troy, N. Y., and assigned to the General Electric Co. The process results in greater directivity of the field of the magnet. This has been accomplished in the past by a heat treatment in a magnetic field. In the new method the alloy, containing iron, aluminum, nickel and cobalt, is cast in molds in which the heat loss through the sides is held to a minimum during solidification. Heat is removed by chilling one end of the melt. This produces crystals which extend lengthwise to form in the solidifying mass.

**Sensational TV BARGAINS!**

**Rocket DIRECTRONIC Motorless TV Antenna**

"Amazing Fringe Area Reception"

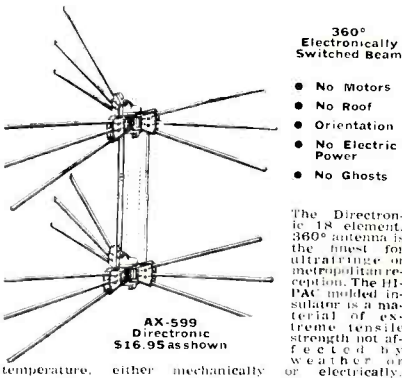

**Included in AX-599 Serviceman's Array:**  
18 hi-tensile aluminum alloy elements  
1 set of connecting stubs (3)  
Universal U Clamps for masts to 1 1/2"  
Directronic Beam Selector  
75 feet of Tri-X Cable  
1 stacked array per carton  
**\$16.95**

**Included in AX-599 Serviceman's Array:**  
9 hi-tensile aluminum alloy elements  
Universal U Clamps for masts to 1 1/2"  
Directronic Beam Selector  
75 feet of Tri-X Cable  
**\$10.35**

**SOLD ONLY BY MAIL BY NATIONAL ELECTRONICS**

**Why Your Dollar Buys Better From National Electronics!**

1. With our Big Buying Power, we buy for less —so we sell for less.
2. We are set up to give you fast, efficient, dependable service.
3. FREE help with installation problems.

**Rocket YAGI 5 Element TV Antenna**

Excellent Pictures in Fringe Areas

**HIGH GAIN.** Clearer, sharper, steadier pictures. PERFECT PROTECTION IN FRINGE AREAS. Minimum interference from ghosts and noise due to a directive pattern. Five elements include one folded dipole, three directors, and one reflector. Supplied less mast. MATCHES 300 OHM IMPEDANCE. Molded insulator provides additional strength. Exclusive design mast clamp prevents antenna turning or cabling under any conditions. STURDY, TROUBLE-FREE CONSTRUCTION. No return clips. No broken elements. Stands the test of severest weather. Elements of extra heavy aluminum-clamped top and bottom. QUICK RIG. Completely pre-assembled. Just swing elements into line and tighten wing nuts. Simple, quick, easy. Available for any channel, high or low band.

Channels 2 and 3 **\$7.95** each  
Channels 4, 5 and 6 **\$6.95** each  
Channels 7 to 13 **\$3.95** each

EACH CHANNEL requires a DIFFERENT Yagi. When Ordering specify exact channel number desired.  
**SOLD ONLY BY MAIL BY NATIONAL ELECTRONICS**

**Rocket All Channel CONICALS**

This sturdy, all-aluminum constructed TV antenna design for broad-band reception on all TV channels, plus FM, High Gain, 4 to 1 Special to look ratio. All Channels 2-13. For use with 75-170-300 ohm lines. Low inception angle. Complete with all hardware—less mast.

Single Bay, **\$3.75** each  
Stacked Array with **\$8.20** each  
**SOLD ONLY BY MAIL BY NATIONAL ELECTRONICS**

**Deluxe Antenna Kits for Fringe Areas At Tremendous Savings**

**Complete-Ready to Install**

**Each Fringe Area Kit Contains:**

- 2 5-foot Mast Sections (Swaged)
- 75 Feet 300 ohm Twin Lead
- 60 Feet Galvanized Guy Wire
- 3 No. 4 Guy Wire Screw Eyes
- 2 Mast Standoffs
- 1 Guy Ring for Guy Wire
- 3 Screw Eye Insulator Standoffs
- 1 Mounting Base
- 1 Lightning Arrestor
- 1 Instruction Sheet

**\$12.95 Value**  
**Your Cost \$6.95**

**With Antennas, YOU SAVE EVEN MORE**

Deluxe Fringe Area Kit With AX-599 Directronic Antenna **Special \$22.95**  
Deluxe Fringe Area Kit With Channel 2 or 3 Yagi Antenna—Stacked Array With Tie Rods **Special \$22.95**  
Deluxe Fringe Area Kit With Channel 4 or 6 Yagi Antenna—Stacked Array With Tie Rods **Special \$20.95**  
Deluxe Fringe Area Kit With Channel 7 to 13 Yagi Antenna—Stacked Array With Tie Rods **Special \$14.95**  
Deluxe Fringe Area Kit With Stacked Conical Array and Tie Rods **Special \$13.95**

Remember when ordering Yagi Kits—EACH CHANNEL requires a DIFFERENT YAGI. Be sure to specify exact channel number desired.  
**SOLD ONLY BY MAIL BY NATIONAL ELECTRONICS**

**SPECIAL BUY**

1 Conductor — 20 Solid Motor Wire ..... 134c ft.  
While It Lasts ..... \$15  
1000 ft. reel ..... \$15  
4 Conductor Stranded Motor Wire ..... 234c ft.  
**SOLD ONLY BY MAIL BY NATIONAL ELECTRONICS**

**Rocket TWIN LEAD**

300 Ohm ..... 70 3/4 Solid ..... 2c ft.  
300 Ohm ..... 65 3/4-10 28 Stranded ..... 212c ft.  
Rocket Bare Wire Twin Lead, 500 ft. reel **\$24.80**  
**SOLD ONLY BY MAIL BY NATIONAL ELECTRONICS**

**PICTURE TUBES BARGAIN PRICES**

121P4 ..... \$23.50	SUPER SPECIAL
14HP4 ..... \$23.50	WHITE-FACE TUBES
16RP4 ..... \$25.50	10HP4 ..... \$17.50
163P4 ..... \$34.95	121P4 ..... \$18.50
17B14 ..... \$25.00	

**National Electronics OF CLEVELAND**

**THE HOUSE OF TV VALUES**

204 Delco Building • Cleveland 3, Ohio

**GUY WIRE**

Galvanized—4 strand = 20-	12c ft.
Galvanized—6 strand = 20-	14c ft.
Galvanized—11 strand = 20-	18c ft.
Aluminum Guy Line	14 1/2c ft.
7 1/8—Stranded 300 ft. Coil	\$4.95

**SOLD ONLY BY MAIL BY NATIONAL ELECTRONICS**

**Rocket Bargain Priced TV Accessories**

11 1/2" O.D. Mast Steel (Ducto-Test 5' crimped) .....	\$1.05
Mast Steel (Ducto-Test 10' crimped) .....	\$1.95
Mast Steel (Zinc plated) 10' .....	\$1.99
Mast Connectors for 1 1/2" O.D. Mast—10' long .....	48c
Chimney Mount Complete with Straps .....	\$1.19
PAM-9A Deluxe Chimney Mount .....	\$1.79
Peak Roof Saddle (Will Take up to 1 1/2" O.D.) .....	\$1.49
Sidewall Mounts .....	75c
12" Extension .....	5c, 25c
12" Extension .....	\$2.25
12" Extension .....	\$3.75
TV Lightning Arrestor (2 Conductor) .....	69c
TV Lightning Arrestor (3 Conductor) .....	Special \$1.25
Ground Rods 3/4" by 6 ft. with clamp .....	95c
Mast Stand-off Insulators—3" .....	58.50c
Stand-off Screw Insulators—3" .....	\$2.75c
Stand-off Screw Insulators—7" .....	\$2.50c
Stacking Bars for Conical Arrays .....	Pair 75c
Stacking Bars for Yagi Arrays—11-Band .....	Pair 90c
Lo-Band .....	Pair 75c
Double Stacking Assembly for Stacking .....	Pair \$1.25
1 Bay Arrays .....	Set \$1.70
Coaxial—72 Ohm .....	612c ft.
Tri-X—1 Conductor Lead-In .....	26c
Snyder 3 Section "Rabbit Ears" Indoor .....	90c
Antenna .....	\$1.60 each
Florida Signal 44" or 46" .....	Pair 90c
Boosters—Anchor 101-75 .....	\$2.50
TC-805 .....	\$26.97
TC-8 Section—58" Auto Antenna .....	\$2.98 each

**SOLD ONLY BY MAIL BY NATIONAL ELECTRONICS**

PRICES SUBJECT TO CHANGE WITHOUT NOTICE  
ALL PRICES F.O.B. CLEVELAND, OHIO  
Do not permit more than complete purchase price. Pay shipping charges on receipt of goods. \$5.00 Deposit on C.O.D. orders, please. Money Back guarantee.

# TUBES

Every Critical Type

WE BUY FIRST QUALITY TUBES FOR CASH!

Fully Guaranteed • Brand New • Immediate Delivery

.59	.69	.79	.99	1.29
5U4G 5Y3GT 6AL5 6AU6 6AV6 6BE6 6J5GT 6K5GT 6K6GT 6W4GT 35W4 35Z5GT	1R5 1U4 3S4 3V4 6BA6 6SA7GT 6SK7GT 6SN7GT 6V6GT 6X5GT 6BJ6 12AT6	183GT 3Q4 12AU7 12SA7GT 12SK7GT 12SN7GT 12SQ7GT 35L6GT 50L6GT 6CB6 6BH6 25L6GT	1X2A 5V4G 6BC5 6AG5 6AC7 6J6 6T8 6AB4 12AV7 12BH7 12SC7 12SG7	6AH6 6BG6 6CD6 6BQ6 6BN6 6AK5 12AT7 19C8 19T8 25BQ6 19BQ6 70L7GT

300-ohm twin lead, pure copper and polyethylene, \$19.50 per thousand feet. 1500 feet to a roll.  
TERMS: Orders for less than \$25.00, add 10% to above prices. 25% deposit with order, balance C.O.D. F.O.B. New York City.

All Merchandise Subject to Prior Sale.

## Supreme Radio & Television Co.

136 Liberty Street, New York 6, N. Y.

### PEN-OSCIL-LITE

Extremely convenient test oscillator for all radio servicing: alignment • Small as a pen • Self powered • Range from 700 cycles audio to over 600 megacycles u.h.f. • Output from zero to 125 v. • Low in cost • Used by Signal Corps • Write for information.

**GENERAL TEST EQUIPMENT**  
38 Argyle Ave. Buffalo 9, N. Y.

**THIS AD MAY BE SMALL—BUT IT CAN MEAN B-I-G MONEY TO YOU!**

I want to buy BC-348, BC-342, BC-312, ARC-1, BC-788, I-152, T-17 MICS, ART-13, BC-221 or any parts thereof, no matter how small. In fact, I'll buy anything. I'm not kidding! Let me prove it!

Wire or write: **ROBERT SANETT**  
4668 Dockweiler, Los Angeles, Calif.  
Telephone: York 4637

### SENSATIONAL VALUE!

#630 SUPER 30 TUBE CHASSIS  
Mfr. Licensed under R. C. A. Patents

Complete with 21" first quality tube  
AND Beautiful hand-rubbed Mahogany Console Cabinet.

COMPLETE PRICE  
**\$259.95**  
slightly higher with full doors



the latest 1952 model with all the newest electronic improvements . . .

- peak sensitivity for fringe areas
- synchrolock tuning
- keyed A G C
- 15,000 volts under load
- 12-inch RCA speaker
- can be adapted to color & UHF
- high quality parts

A set—NOT A KIT  
Completely wired, Factory Engineered, aligned and tested. RMA Guaranteed  
**1 YEAR GUARANTEE ON TUBE**  
A half-hour to mount; ready for operation. Saves up to \$150.  
Compare this anywhere for high quality—low price!  
Write Dept. H for further information. Phone and mail orders filled on receipt of money order for 25% as deposit . . . the balance C.O.D., f.o.b. N. Y.

**NEW ENGLAND TELEVISION CORP.**  
75 CHURCH STREET NEW YORK, N. Y.

### THE NEW Sky Hi TELEVISION MAST

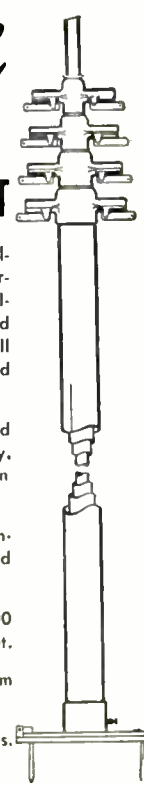

With the SKY-HI mast, installations are easy. No dangerous climbing is necessary. Telescoping sections and hinged base make it possible to install and service from the ground without the use of ladders.

. . . The Sky-Hi mast is raised and lowered hydraulically. Double latches on each section holds most securely.

. . . This tower is used extensively on mobile units for field work.

Standard 40, 60, 80 and 100 feet. Special towers to 200 feet.

Available in steel and aluminum deluxe and standard models.

Used by 5 Government agencies.

Write for literature.

**THOMAS MOLD & DIE CO.**  
WOOSTER, OHIO

### Radio Thirty-Five Years Ago

In Gernsback Publications

**HUGO GERNSBACK**  
Founder

Modern Electrics	1908
Wireless Association of America	1908
Electrical Experimenter	1913
Radio News	1919
Science & Invention	1920
Television	1927
Radio-Craft	1929
Short-Wave Craft	1930
Television News	1931

Some of the larger libraries still have copies of ELECTRICAL EXPERIMENTER on file for interested readers.

- APRIL, 1918**  
**ELECTRICAL EXPERIMENTER**
- Seaplane Radios Trawlers and Destroyers U-Boat
  - The Phenomena of Electrical Conduction in Gases, by Rogers D. Rusk, M.A.
  - Intensive Training for the Signal Corps, by A. C. Lietz
  - New Phantom Antenna and Aperiodic Circuit
  - A Radio Blinker Set for Teaching Code
  - An Oil Antenna Switch for High Power, by M. M. Valentine
  - A Motor-Boat Radio Receptor, by F. MacMurphy
  - The Design and Use of the Wave-Meter, by Morton W. Sterns
  - Simpson Mercury Valve Radio Transmitter, by Walter R. Rathbun

### ELECTRONIC LITERATURE

Any or all of these catalogs, bulletins, or periodicals are available to you on request direct to the manufacturers, whose addresses are listed at the end of each item. Use your letterhead—do not use postcards. To facilitate identification, mention the issue and page of RADIO-ELECTRONICS on which the item appears. All literature offers void after six months.

### SELENIUM RECTIFIER HANDBOOK

A book devoted to selenium rectifier characteristics and applications to a variety of electronic circuits has been compiled by Sarkes Tarzian, Inc. There are 25 pages on power and high voltage selenium rectifiers with iso-thermal, frequency and reverse characteristics, to assist design engineers. Radio-TV type rectifiers, with various schematic diagrams, are discussed in 48 pages; replacement information for service technicians is listed in 7 pages.

*Fifty cents to experimenters, amateurs, and service technicians, and free to engineers from Sarkes Tarzian, Inc., 415 North College Ave., Bloomington, Ind.*

### CERAMIC PRODUCTS

In a new 52 page catalog, the Stupakoff Ceramic and Manufacturing Co. has listed more than 500 steatite parts like tubing, coil forms, stand-offs, bushings, etc. The brochure contains line drawings, dimensions, and many photographs of the items. A special feature is a chart which shows 18 technical characteristics of 14 typical products.

*Catalog No. 951 is available from Stupakoff Ceramic and Manufacturing Co., Latrobe, Pa.*





**RADIO TUBE FUNDAMENTALS**

by **George J. Christ**

Instructor, Div. of General Education,  
New York University

**Only \$1.00** 96 pages  
74 illustrations

What! You never went to college? You don't understand calculus backwards (and forwards)? You can't outperform an electronic computer? Really deep down you don't understand radio tubes?

Don't worry about it, for here's a brand new book whose sole object is to make you understand just what radio tubes are, how they work, and just how you can expect them to behave in a radio circuit. The author, with years of radio tube teaching experience for a background, takes the complicated subject of radio tubes and makes it so simple and easy to understand that you'll just naturally wonder why you didn't understand it all by yourself.

If you're a beginner, then this book is a definite must, and if you've been in the business more years than you can (or care to) remember, then this book will give you a fresh new approach to the subject.

RADIO TUBE FUNDAMENTALS goes all the way from diodes on through multi-purpose tubes, and then into circuits. Don't worry about getting lost—the author is with you all the way. Get it today. It's the biggest dollar's worth of radio info you can possibly buy.

**USED AS A REFERENCE TEXT**

Radio Course, Div. of General Education, New York University

**Partial list of Contents**

- Electrons in motion. Thermionic emission • The cathode • Plate current • Space charge • Diode load voltage • Ionization • Voltage regulators • The triode • Plate resistance • Amplification factor • Oscillation • Gas triodes • Tetrodes • Pentode characteristics • Multipurpose tubes • Vacuum and gas photo-tubes • Vacuum-tube grid bias • Radio Tube applications • Voltage doublers • Detectors • Automatic volume control • FM detection • Oscillators • Converters • Conversion gain.

**Order your copy from your distributor or MAIL THIS COUPON TODAY**

Radcraft Publications, Inc., Dept. 42  
25 West Broadway, New York 7, N. Y.  
My remittance of \$1.00 is enclosed. Please send me postpaid a copy of RADIO TUBE FUNDAMENTALS, Gernsback Library Book No. 45

Name \_\_\_\_\_  
Street \_\_\_\_\_  
City \_\_\_\_\_ Zone \_\_\_\_\_ State \_\_\_\_\_

**INDUSTRIAL ELECTRONIC TUBES**

A 28-page booklet devoted to industrial and special-purpose tubes has just been published by Milo Radio & Electronics Corp. The booklet furnishes technical data on a great number of specialized tubes and units such as germanium and silicon crystal diodes, panel lamps, strobotrons, trigger tubes, cathode-ray tubes, photocells, phanotrons, etc. Available gratis to interested readers by writing to the company at 200 Greenwich St., New York 7, N. Y.

**CORRECTIONS**

The text referring to this diagram was omitted from the item "New Circuits in FM Sets" on page 119 of our March, 1952 issue. The power supply shown was used in an FM receiver designed by J. G. Spencer of the BBC.

The .001- $\mu$ f capacitor, push-button switch, and 47,000-ohm resistor were connected into the circuit to insure correct tuning. When the switch is pressed, an a.c. voltage is injected into the lim-

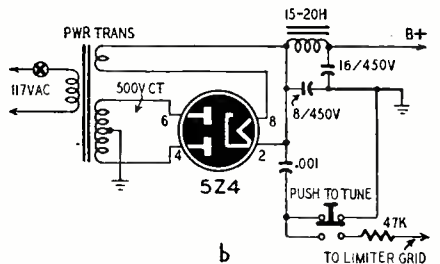

iter grid circuit. This voltage amplitude modulates the FM i.f. signal and causes hum in the output when the receiver is detuned. When the set is tuned on the nose, hum is minimized or eliminated because the discriminator does not respond readily to AM signals.

Mr. H. E. Warriner has called our attention to the fact that the photograph in Fig. 7 of his article, "TV Ghost Story," is not right-side up. This photograph, page 39 of the February, 1952, issue should be turned 90 degrees counter clockwise. The antenna is mounted horizontally but the photograph makes it appear to extend at an angle from the wall.

The diagram of the elaborate antenna array on page 27 of the March issue shows the three rhombic antennas connected in series across the quarter-wavelength matching section connected to the 450-ohm open-wire line. These antennas should be paralleled across the matching section.

Mr. George E. Row has called our attention to an error which appeared in the description of his capacitor substitution box which appeared on page 94 of the December, 1950 issue. The text erroneously states that the unit covers a range of 54 different capacitances. This is quite an understatement. The text should have stated that the substitution box described is the equivalent of 54 different capacitors arranged in the form of a decade box. Actually, the unit substitutes for approximately 262,656 individual capacitors.

**Compare!**  
**PROVE EMC SUPERIORITY!**

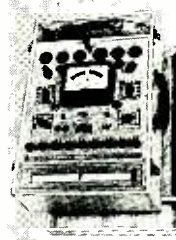

**Model 201**  
mutual conductance tube tester  
• Checks mutual conductance on calibrated micro scale • Checks tubes for gas content • Detects both shorted and open elements • Tests all tubes from 75V to 117 Filament volts • Tests all loctal, octal, and miniature tubes • Checks individual sections of multi-purpose tubes • Built-in roll chart  
Model R201BC — 4½" meter-sloping counter case..... **\$69.50**  
Model R201BP — 4½" meter-hand rubbed oak carrying case..... **\$73.50**



**Model 204**  
tube-battery-ohm capacity tester  
• Tests all tubes including Noval & sub-miniature • Tests all batteries under rated load • Emission testing method gives easy, direct readings • Tests resistance to 4 megohms • Tests condensers from .01 to 1 mfd. • Uses four-position lever type switches • Checks condenser leakage  
Model 204 — portable oak case, removable cover..... **\$55.90**

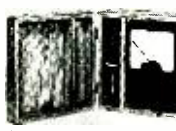

**Model 120**  
(20,000 ohms per) (volt meter)  
• Resistance ranges from 2 ohm to 300 Megs. • 5 Current ranges to 6 Amps. • Uses 1% precision resistors • 6 AC & DC voltage ranges to 6,000 volts • AC volts at 10,000 ohms/volt.  
Model 120 — open face..... **\$31.95**  
Model 120P — portable oak case..... **\$36.95**

Write Dept. RE-4 for Free Complete Catalog of these and other Instruments.

—See them at your Jobbers—



**DIAMOND NEEDLES \$10.50 plus postage**

Our main business is the manufacture of diamond styli for broadcasting stations and high fidelity sound equipment. As a service to the general public we offer to retrofit your present replaceable needle with a genuine, unconditionally guaranteed broadcast quality diamond tip for either LP or Standard records. Send us your replaceable needle (or complete cartridge except Pickering) together with check or money order for \$10.50 plus 25¢ for shipping.

**THE TRANSCRIBER CO.**  
176 Green Street Dept. R Boston 30, Mass.

# TUBE DEAL?

## Get a dozen FREE with every order at 70% OFF LIST

### MINIMUM ORDER: 100 ASSORTED TYPES

Every Type in Stock • Guaranteed • Brand New

Terms: 25% with order, balance C.O.D. All merchandise subject to prior sale, F.O.B. New York City

# TeleVision Materials Corp.

120 LIBERTY ST., NEW YORK 6, N.Y. • COrtlandt 7-4307



*"Positively Amazing Performance!"*  
is what they are all saying about the new ALL-CHANNEL

## GONSET "RADARRAY"

"Model C"

High gain and front-to-back ratio on all 12 channels. No side lobes. Ideally suited where maximum gain is required on several channels, or where ghosts, co-channel or adjacent channel interference problems exist in combination. Eliminates or greatly reduces oscillator interference troubles.

Ruggedly constructed yet light enough to be used on a rotator. Another engineering achievement by the originators of prefabricated open-wire line for T-V. Write for our "Fringe Area" brochure.

available at most dealers



GONSET CO. 801 S. MAIN ST. BURBANK, CALIF.

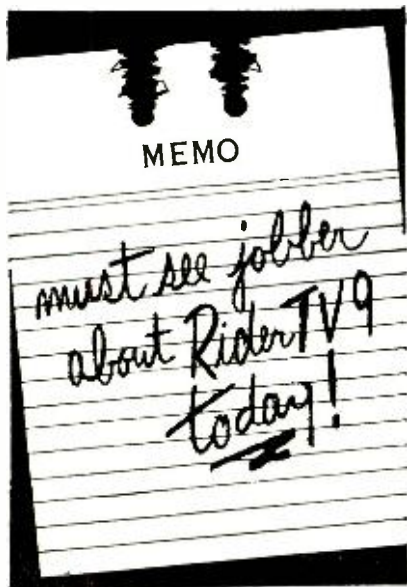

**LOVE THAT QUICK-WEDGE!**  
*I use it instead of a conventional screwdriver!*

Quick-Wedge  
**SCREW-HOLDING**  
SCREWDRIVER

*unconditionally guaranteed*

**ASK FOR IT AT YOUR DEALER**  
KEDMAN CO. • 233 S. 5th WEST • SALT LAKE CITY, UTAH

Irving G. Rosenberg was appointed director of operations for the ALLEN B. DU MONT LABORATORIES' Television Receiver and Cathode-Ray Tube Divisions. He was formerly manager of the Cathode-Ray Tube Division. Fritz P. Rice, formerly assistant manager of the Cathode-Ray Tube Division, was named to succeed Mr. Rosenberg as manager of the division.



I. G. Rosenberg



W. S. Parsons

William S. Parsons, vice-president in charge of sales of the CENTRALAB DIVISION of GLOBE-UNION, INC., Milwaukee, since 1945, was elected president of Centralab. Mr. Parsons was also elected a director of Globe-Union, Inc., to fill the unexpired term of the late Walter F. Dunlap. Mr. Parsons, who joined Centralab in 1931, has spent his entire business career in the electronics field.

Henry C. Roemer, executive vice-president of FEDERAL TELEPHONE & RADIO CORP., Clifton, N. J., since September, 1950, was elected president of the company. Mr. Roemer directed Federal's activities during World War II.



Above—H. C. Roemer



Right—W. J. Slawson

William J. Slawson has joined BRACH MANUFACTURING CORP., Division of GENERAL BRONZE CORP., Newark, N. J., as distributor sales manager. He comes to Brach from John F. Rider, Publisher. He has been associated with the electronics industry for the past nine years.

Charles P. Cushway has joined CRES-CENT INDUSTRIES, INC., Chicago, as vice-president and chairman of the Advisory Board. He was formerly executive vice-president of Webster-Chicago.



Above—C. Cushway



Right—Dr. R. Bown

Dr. Ralph Bown, director of research for BELL TELEPHONE LABORATORIES since 1946, was appointed vice-president in charge of research. Other Bell Laboratories organization changes include the appointment of Dr. J. B. Fisk as direc-



tor of research in physical sciences; Dr. H. T. Friis, director of research in high frequency and electronics; and Dr. W. H. Doherty, director of research in electrical communications. Dr. R. M. Burns was appointed chemical co-ordinator in addition to his present position as director of chemical and metallurgical research.

J. A. Milling has succeeded Edmund T. Morris, Jr., as director of the Electronics Division of the NATIONAL PRODUCTION AUTHORITY. He also succeeds Mr. Morris as chairman of the Electronics Production Board, Defense Production Administration. He is on leave from the RCA Victor Division where he was vice-president of the RCA Service Co. Mr. Morris has returned to the Westinghouse Electric Corp., Baltimore.



Above—  
M. L. Bruckner  
Left—J. A. Milling

Marvin L. Bruckner joined QUAMNICHOLS Co., Chicago, speaker and electronics manufacturers, as assistant sales manager of the Jobber Division. He was formerly sales engineer with the Thordarson-Meissner Division of Maguire Industries.

**Personnel Notes**

... Walter H. Furneaux was appointed vice-president in charge of manufacturing of AEROVOX CORP., New Bedford, Mass. He was formerly vice-president and general manager of Aerovox Canada in Hamilton, Ont.

... Albert Coumont was appointed service manager of the RTMA. He was formerly sales manager of the Electronics Section, International General Electric Co., Inc.

... Walter E. Kingston was named director of the new Atomic Energy Division of SYLVANIA ELECTRIC PRODUCTS, INC. He formerly headed Sylvania's Metallurgical Laboratories. Sylvania also announced the appointment of Albert Lederman as a technical representative of its Government Relations Department in Washington. Mr. Lederman had been with the Office of the Secretary of Defense.

... Hugo Sundberg, vice-president and general manager of OXFORD ELECTRIC CORP., Chicago, speaker manufacturers, will personally direct future sales policies in addition to his other executive duties.

... Charles Shaw was appointed to head the recently expanded Purchasing Department of the TRIAD TRANSFORMER MANUFACTURING Co., Los Angeles.

... Vice Admiral Edwin Dorsey Foster, U.S.N., retired, was elected vice-president and director of planning for the RCA VICTOR DIVISION. He was previously director of the company's Mo-



**Low Cost Powerful P.A.!**  
COMPLETE • READY TO USE

Tops for powerful indoor-outdoor use; ideal for electioneering. Easy portability. Covers 4,000 persons indoors, up to 25,000 sq. ft. outdoors. Full 30 watts usable output; 2 high-imp. mike inputs, 1 phono input, each with separate volume control; tone control; fidelity ± 2 db from 40-20,000 cps. Complete system includes: 30 watt amplifier and tubes, Electro-Voice "Cardax" unidirectional mike with adjustable floor stand and 20' cable; 2 General Electric 12" PM speakers, each with 30' cable; portable carrying case holds all, 16 3/4" x 12 3/4" x 25". For 110-130 v., 60 cy. A.C. Shpg. wt., 75 lbs. Complete, less only phono top.

93-372. Complete 30 Watt System. Only \$119.75  
93-340. 3-Speed Phono Top for above. Only \$16.95  
Available on Easy Terms—write for details

**FREE** See the 212-Page ALLIED Catalog for other Sound Systems, ranging from 8 to 80 watts. Write for free copy of Radio's leading Buying Guide today.

**ALLIED RADIO**

833 W. Jackson Blvd., Dept. 2-DD-2, Chicago 7, Ill.

**Get This Valuable Book**

**FREE**



Just for Examining COYNE'S New 6-Volume Set

**"Applied Practical Radio-Television"**

Yes, you get this big, brand new book, "150 Radio-Television Picture Patterns and Diagrams Explained", absolutely FREE! Just off the press! Gives complete wiring circuits and diagrams on the latest Radio and Television Sets. Easy-to-read, large 8 1/2 x 11" pages, with full instructions on how to read and use the diagrams. A "must" in every Radio and Television service-man's repair kit. You get this valuable book as a FREE Gift for asking to see Coyne's great new 6-book set, "Applied Practical Radio-Television"!

**Here's "Know-How" That Makes You Worth More!** You'll get into the big money faster in TELEVISION-RADIO if you know where to find the answer to servicing problems. Coyne's great new 6-volume set gives you all the answers—quickly! For basic "know-how" that is easy to understand, you'll find everything you want in volumes 1 to 5 which contain over 5000 practical facts and data. They cover every step from principles to installing, servicing, trouble-shooting and aligning all types of radio and TV sets. So up-to-date it includes COLOR TV and UHF. adapters and converters.

And then, for **762-Page Television Cyclopedic Included**—the famous Coyne TELEVISION CYCLOPEDIA. It answers today's television problems on servicing, alignment, installation and others. In easy-to-find ABC order, cross indexed. Use this 6 volume TV-RADIO LIBRARY free for 7 days; get the valuable Servicing Book ABSOLUTELY FREE!

**ON 7 DAY FREE TRIAL!**



**SEND NO MONEY!** Just mail coupon for 6-volume set on 7 days free trial. We'll include book of 150 TV-Radio Patterns & Diagrams. If you keep the set, pay \$3 in 7 days and \$3 per month until \$23.00 plus postage is paid. (Cash price \$22.00). Or you can return the library at our expense in 7 days and owe nothing. **YOU BE THE JUDGE.** Either way, the book of TV-Radio Patterns is yours FREE to keep! Offer is limited. Act NOW!

**FREE BOOK—FREE TRIAL COUPON!**

COYNE ELECTRICAL & TELEVISION-RADIO SCHOOL, Dept. 42-T1  
500 S. Paulina St., Chicago 12, Ill.

YES! Send 6-volume "Applied Practical Radio-Television" for 7 days FREE TRIAL per your offer. Include TV-Radio Patterns & Diagram Book FREE.

Name..... Age.....

Address.....

City..... Zone... State.....

Where Employed.....

( ) Check here if you want library sent COD. You pay postman \$22 plus COD postage on delivery. 7-day money-back guarantee.

**COYNE** ELECTRICAL & TELEVISION-RADIO SCHOOL  
500 S. Paulina St., Dept. 42-T1 Chicago 12, Ill.



## FRINGE AREA & DX PROBLEM SOLVED with NEW DAVIS SUPER-VISION ANTENNA

"THE ONLY TV ANTENNA SOLD WITH A  
MONEY-BACK GUARANTEE"

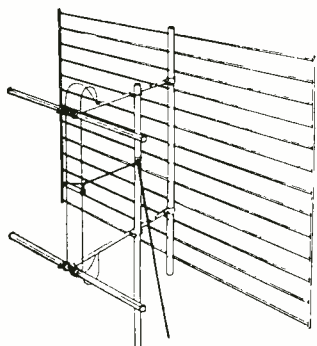

### 10 OUTSTANDING FEATURES:

1. EXCELLENT FOR FRINGE AREA and DX RECEIVING—and broad band receiving with high gain on all channels—2 through 13.
2. CLEARER PICTURES UP TO 125 MILES OR MORE—from the station.
3. GHOST PROBLEMS REDUCED or eliminated due to excellent pattern.
4. PROVIDES 10 DB OR MORE GAIN ON HIGH CHANNELS where gain is needed most.
5. EXCELLENT FRONT TO BACK RATIO on all channels. Eliminates co-channel interference.
6. MINIMIZES INTERFERENCE: Airplane Flutter—Diathermy and Ignition—F.M.—Neon Signs—X-Ray—Industrial—Etc.
7. ELIMINATES DOUBLE STACKED ARRAYS, and out-performs 2 bay yagis on low band and 4 bay yagis on high channels.
8. ONLY ONE TRANSMISSION LINE NECESSARY.
9. NO WORRY OVER POSSIBLE CHANNEL CHANGES on either high or low channels.
10. CAN BE TIPPED WITHOUT TILTING MAST to take advantage of horizontal wave lengths.

AT YOUR JOBBERS, OR WRITE TO:

DAVIS ELECTRONICS 1-6  
3047 W. Olympic Blvd., Los Angeles 6, California  
SIRS: RUSH INFORMATION TO ME AS CHECKED BELOW:

Send Free Technical Data on new SUPER-VISION ANTENNA.  
 Send Name and Address of NEAREST JOBBER.

Name \_\_\_\_\_  
Street \_\_\_\_\_  
City \_\_\_\_\_ State \_\_\_\_\_

## NEW CONDENSER TESTER



Finds Intermittent  
Condensers Instantly

Pres-probe's sliding tip with variable resistance prevents condenser heating. Tests with power on. Requires no adjustment. Stops guesswork. Saves time. Convenient probe size (long) Satisfaction guaranteed

NET  
**795**  
Postpaid  
U. S. A.

See Your Dist. or Order Direct

**PRES-PROBE CO.**

4034 N. Sixth St., Milwaukee 12, Wisc.

bilization Planning Department.

... Howard W. Sams, president of HOWARD W. SAMS & Co., INC., Indianapolis, was elected president of the Indianapolis Board of Works.

... Frank Dell'Olivo was promoted to purchasing agent in charge of all purchasing in the Mount Bethel and Plainfield, N. J., plants of HAYDU BROTHERS.

... Arthur M. Wengel, pioneer inventor in electronics research engineering for the RAY-O-VAC BATTERY Co., Madison, Wis., died recently of a heart attack.

... Hugh P. McTeigue, manager of training for the RCA SERVICE Co., was named to direct the company's accelerated military electronics training program.

... Dr. Courtney Pitt, vice-president, Finance, PHILCO CORP., was appointed to the top-level Management Policy Committee of the company.

... Steven E. Lasewicz has joined LAPOINTE-PLASCOMOLD CORP., Windsor Locks, Conn., as production manager. He was formerly with the Horton-Bristol Co. The company also announced that Thomas Lamont had rejoined them as assistant publicity director.

... Everett E. Gramer, vice-president of the GRAMER TRANSFORMER CORP., Chicago, has assumed the duties of western sales manager.

... J. J. Samuels, formerly of SHELTON ELECTRIC Co., has joined the FIDELITY TUBE CORP., East Newark, N. J., as general sales manager.

... Kenneth A. Hoagland, who has been directing ALLEN B. DU MONT LABORATORIES' tube design and development engineers, was promoted to the position of assistant engineering manager of the Cathode-Ray Tube Division.

... Leslie F. Muter, president of THE MUTER Co., was re-elected president of the RADAR-RADIO INDUSTRIES OF CHICAGO; Paul V. Galvin, Motorola, Inc.; Raymond F. Durst, Hallcrafters Co.; and Richard Graver, Admiral Corp., were elected vice-presidents.

... Homer R. Oldfield, Jr., was appointed resident manager of the recently established GENERAL ELECTRIC ADVANCED ELECTRONICS CENTER at Cornell University, Ithaca, N. Y. He was formerly manager of sales for all Government Department sales.



Suggested by Dan Koenig, New York, N. Y.

## TUBES at Mfr's. COST

Standard Brands — Unbranded  
—Guaranteed

1B3	\$1.35	6BF5	\$ .65	12A6	\$ .70
1L4	.60	6BF6	.70	12AT6	.40
1L6	.60	6BG6G	1.48	12AT7	.85
1LN5	1.05	6BQ6	.94	12AU6	.46
1R5	.60	6C4	.60	12AU7	.75
1U4	.60	6CB6	.56	12AV7	.85
1U5	.50	6CD6G	1.93	12AX7	.75
2A3	1.48	6HM	.75	12BA6	.48
2X2	.60	6J5M	.65	12BA7	.80
3Q4	.66	6J6	.73	12BE6	.49
3V4	.62	6J6	1.05	12J5GT	.50
5U4G	.75	6K6	.65	12SA7GT	.75
5V4	1.20	6K7	.70	12SF5M	.70
5Y3GT	.33	6L6GG	1.05	12SG7	.90
5Z3	.95	(M & G)	1.10	12SJ7	.60
6AB4	.65	6S4	.51	12SK7	.65
6AC7	1.25	6S7M	1.05	12SQ7	.75
6AG5	.65	6SA7GT	.75	12SN7GT	.75
*6AG7	1.65	6SC7	1.10	12SR7	.65
*6AH6	1.75	6SJ7	.70	14B6	.85
6AK5	1.10	6SK7GT	.53	19T8	.86
*6AK6	1.20	6SL7GT	.65	25L6GT	.50
6AL5	.54	6SN7GT	.75	25W4	.90
6AQ5	.65	6SQ7GT	.65	35L6GT	.53
6AT6	.40	6T8	.86	35W4	.37
6AU6	.65	6V6GT	.80	35Z5GT	.30
*6AV6	.65	6W4GT	.49	50B5	.53
6BA6 6N5	1.25	6X5	.45	50C5	.53
6BC5	.56	6Y6	.85	50L6GT	.53
6BE6	.49	7AD7	1.25	89Y	1.50

UNBRANDED—\*STANDARD BRANDS  
Minimum Order \$15.00

### SPECIAL PURPOSE TUBES

VR105	\$ .95	2051	\$ 1.00	9003	\$ 1.75
VR150	1.05	9001	1.75	9005	1.75
2050	1.45	9002	1.50		

### IMMEDIATE DELIVERY!

Write for quotations, many other types available. 20% Deposit with order, balance C.O.D. All tubes subject to prior sale. Prices subject to change without notice.

### WRITE, WIRE, CALL—TODAY!

We Buy Anything in Electronics—  
large or small Quantities!

## Nat Adelman

168 Washington St. New York 6, N. Y.  
CO. 7-6091

## IF YOU BUY ON SPECIFICATIONS



and tops in value, you'll buy the

## TWIN-TRAX\* TAPE RECORDER

"Choice of Engineers Everywhere"

Compare the guaranteed specifications of a Twin-Trax Tape Recorder with any other recorder in any price class. You'll find that Twin-Trax gives you more features, better all-around performance and more value for your money.

Complete specifications, performance ratings and direct factory prices in our catalog 5109. Send for it today.

\*Trademark Reg.

## AMPLIFIER CORP. of AMERICA

398 Broadway, New York 13, N. Y.



Another Outstanding Jobber

**Almo Radio Co.**  
6205 MARKET ST., PHILA. 39, PA.

**EICO** has all 17 KITS & INSTRUMENTS in stock!

4234 5" SCOPE KIT 24.95

See EICO ad on Page 24



**ATTENTION EXPERIMENTERS AND SERVICE MEN**

Complete conversion kit consisting of 70° yoke, hi-efficiency horizontal output transformer, width coil, complete instructions \$7.95 complete. Used 52° yoke ..... 99¢ ea.  
 Used 10"–12" RCA 63OTS type Horizontal Output Transformer ..... 99¢ ea.  
 Gold-bordered lucite masks  
 14" \$3.50 17" \$4.50  
 16" Rect. 4.25 20" 4.25  
 7" Test record and speed indicator with large hole to test mechanical operation of 45 R.P.M. changers—made of unbreakable vinyl—takes less than 15 seconds for complete playing cycle—a boon to technicians who do any changer work—75¢ each.  
 Minimum order \$2.00. Limited quantities 25% deposit with order—balance C.O.D.  
**CLEAR-VIEW TELEVISION, INC.**  
 5542-44 Ridge Ave. Philadelphia 28, Pa.

**WANTED TO BUY**

Large and small quantities of new or used electronic government or manufacturers' surplus tubes and equipment. Highest prices paid. State quantity, condition and best price in first letter.

Box No. F-2 c/o Radio-Electronics  
 25 West Broadway  
 New York 7, N. Y.

\*\*\*\*\*  
 \* **WANTED** WE NEED YOUR \*  
 \* **WE PAY TOP \$\$\$ FOR:** SURPLUS \*  
 \* **RADIO RECEIVERS** | **CLAMPS** \*  
 \* **TRANSMITTERS** | **PLUGS** \*  
 \* **ARC-1** | **CORDS** \*  
 \* **ARC-3** | **RELAYS** \*  
 \* **ART-13** | **TELEPHONE** \*  
 \* **CONTROL BOXES** | **MATERIALS** \*  
 \* **INDICATORS** | **WE BUY ANYTHING!!** \*  
 \* **AN CONNECTORS** | \*  
 \* **Write, Wire Today!** \*  
 \* **TALLEN COMPANY, INC.** \*  
 \* **Dept. RE, 159 Carlton Ave.** \*  
 \* **Brooklyn 5, New York** \*  
 \*\*\*\*\*

**EASY TO LEARN CODE**

It is easy to learn or increase speed with an Instructograph Code Teacher. Affords the quickest and most practical method yet developed. For beginners or advanced students. Available tapes for beginner's alphabet to typical messages on all subjects. Speed range 5 to 40 WPM. Always ready—no QRM.

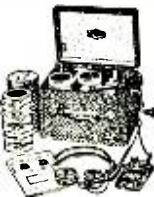

**ENDORSED BY THOUSANDS!**

The Instructograph Code Teacher literally takes the place of an operator-instructor and enables anyone to learn and master code without further assistance. Thousands of successful operators have "acquired the code" with the Instructograph System. Write today for convenient rental and purchase plans.

**INSTRUCTOGRAPH COMPANY**

4701 Sheridan Rd., Dept. RC, Chicago 40, Ill.

**RADIOS**  
 1, 2 & 3 band. Electric and/or battery  
**TELEVISION**  
 A.C./D.C. Operation  
**TEST INSTRUMENTS**  
 Write for FREE Catalog  
**ARKAY—Radio Kits, Inc.**  
 120 Cedar St., New York 6, N. Y.

**MORE ON TV GHOSTS**

Dear Editor:

In the February issue of RADIO-ELECTRONICS, pages 37 and 38, your feature, "TV Ghost Story," by H. E. Warriner, describes an indoor antenna with a tunable matching stub, shorting bar, and tunable capacitor.

We compliment you on this story, and compliment Mr. Warriner. . . . He knows indoor antennas, and his vivid description is excellent. However, we feel that if he had known that we have marketed this antenna for over a year (many thousands have been sold and are now in use) he would have written us. (Warriner's experiments go back to 1950.—Editor.). Our Spico TV-503 Super Phantom antenna, engineer-designed and precision-built, we feel, fulfills his specifications.

I might add that as a result of our extensive experimentation in this field, we came up with all the technical features explained in your detailed article, offering the maximum television reception from an indoor antenna. We use brass tubing instead of steel throughout for the telescopic rods, to insure perfect rust-proof contacts between sections.

We are regular readers of RADIO-ELECTRONICS. The magazine is one of the most informative and enlightening in the industry. Keep up the good work!  
 MILTON SPIRT

Spirling Products Co.  
 New York, N. Y.

**IS INDUSTRY TO BLAME?**

Dear Editor:

I have just read the article entitled "Shortage of Technicians Imminent?" in RADIO-ELECTRONICS for December, 1951, in which Paul V. Forte blames the radio and television industry for "failing miserably to train service technicians."

I agree with Mr. Forte. The technician graduating from radio and television school, upon applying to industry for a job, is usually greeted with the typical question: "What experience do you have?"

Why doesn't the industry make available to the graduate the experience, or the additional special training? Your editorials are always well-inspired. I hope you will write one on this important subject.

J. G. SAVAGE

New York, N. Y.

**SMALL TOWNS CROWDED OUT?**

Dear Editor:

I am a small-town radio technician. I have an idea that I think should be brought to the attention of the FCC, and the only way I know of getting it there is through RADIO-ELECTRONICS.

This concerns the small towns that have been denied their own commercial broadcasting outlets. Large-town radio advertising is pumped in 18 hours a day, and local business must suffer in silence. Small-town talent goes unnoticed for lack of an outlet. Most important of all: the small-town radio station would be a link between the town and the rest of the country in case

**Operate 2 sets from 1 Antenna**  
 with the  
**TELEMATIC ADD-A-SET**  
 TV Receiver Coupler

**SAVE money! labor! materials!**

- Highest efficiency transformers used.
- Operates in fringe areas.
- High pass filter action.
- No inter-set coupling.
- Eliminates soldering, screw terminal.
- Compact, mounts inside cabinet.

Sold by leading Jobbers Everywhere  
 Send for FREE booklet on TV INTERFERENCE

**TELEMATIC**  
 ONE JORALEMON ST. BROOKLYN 2, N. Y.

**FIRST AID FOR TV SETS!**

**H. G. CISIN'S "TV DOCTOR"**  
 Shows you how to fix TV sets RAPIDLY!

Save money—do a better job faster. Here's a really practical TV book. An amazing, quick, copyrighted method of fixing TV troubles. Written by a noted inventor and educator, H. G. Cisin, in plain language.

**MAKES TV SERVICING EASY!**  
**TUBES CAUSE 80% OF TV TROUBLES**  
**TV DOCTOR QUICKLY LOCATES ALL BAD TUBES WITHOUT EXPERIENCE—PICTURES & TEXT SHOW YOU THE QUICK, EASY WAY TO FIX FAULTY TV SETS**  
 Reveals many closely guarded TRADE SECRETS. Lists over 123 trouble conditions. Method applies to all TV sets from oldest to newest.

**11** money-making, fact-erammed, detailed, illustrated chapters include: practical ways to combat interference and ghosts; how to appraise TV sets, valuable information on antennas, lead-ins, color, practical—not theoretical—pointers on TV sets, ion traps, tubes used in TV, miss' addresses—a veritable encyclopedia.  
**Only \$1—you'll say it's worth hundreds.**  
**5-DAY MONEY-BACK GUARANTEE**

**FREE SPECIAL OFFER**  
 Get a new, full-size, profusely illustrated, \$1 book—**TV TROUBLE PICTURE GUIDE IN CLOUDBY TV TERMS SIMPLY EXPLAINED!** as a **FREE GIFT**, by ordering the "TV DOCTOR" and H. G. Cisin's famous "TV TROUBLE SHOOTING METHOD," which trains you to be a TV Diagnostician, setting for \$1. Think of it—all 3 TV books postpaid for only \$2—you save \$1.

**\$1 Post-paid**

H. G. CISIN, Consulting Engineer (Dept. E-12)  
 200 Clinton Street, Brooklyn 2, N. Y.

Enclosed find \$2, full payment for "TV DOCTOR" & "TV TROUBLE SHOOTING METHOD" PLUS my FREE copy of "TV TROUBLE PICTURE GUIDE." Rush all three books postpaid.  
 Enclosed find \$1, full payment for "TV DOCTOR." Rush copy postpaid.

Name.....  
 Address.....  
 City..... Zone..... State.....

## TUBES and Parts

### TV PICTURE TUBES

Six month guarantee

10BP4	\$13.95	16GP4	\$29.95
12LP4	16.95	16JP4	29.95
12LP4A	16.95	16RP4	23.95
14PB4	22.95	16TP4	23.95
7JP4	15.95	17BP4A	24.95
16AP4	29.95	19AP4A	39.95

### TUBE KITS

#### BEST BRANDS at BEST PRICES

3Q4, 1T4, 1R5, 1S5. List Value \$8.00. Tube Kit only	\$2.39
3S4, 1T4, 1S5, 1R5. List Value \$7.80. 4 Tube Kit	\$2.39
1U4, 3S4, 1S5, 1R5. List Value \$7.80. All Four Tubes for	\$2.39
3V4, 1R5, 1S5, 1T4. List Value \$7.80. All for	\$2.39
117Z3, 1U5 3V4, 1R5, 1T4. AC-DC Portable Kit. All for	\$2.89
12AT6, 12BA6, 12BE6, 35W4, 50B5. 5 Tubes for	\$2.95
50L6GT, 35Z5GT, 12SQ7GT, 12SK7G, 12SA7G, 5 Tubes for	\$3.22

All type of radio receiving tubes at 60 and 10% discount... write today!

### RESISTOR KITS

Insulated 1/2, 1 and 2 watt assortment of most used values, best brands 100 for **\$4.95**  
50 asst.—\$2.95

### 12" PM SPEAKER



12" coaxial High fidelity with high pass filter attached 20 watt; 40-17500 cps. response; 8 ohm VC.

Very best quality—NATIONAL BRANDS—Individually packed  
3" \$1.26 ea. 8" \$3.23 ea.  
4" 1.36 " 10" 5.10 "  
5" 1.59 " 12" 6.54 "

6" (SPECIAL PRICE) \$1.59 ea.

### TV INLINE Folded Dipole ANTENNA

At this price, we cannot mention manufacturer's name, complete with mast, individually boxed 6 for \$7.99 ea. **\$7.99**

### TV "Perfect Balance" ANTENNA

High-low, 6 element Yagi TV antenna, cut for all channels, stack it or mount it in line complete with 8 foot mast, individually boxed 6 for \$6.49 ea. **\$6.98**

### SPECIAL!

### Double "V" High Gain TV Antenna Hit

Complete, ready to install, 300 ohm line, insulators, guy wire hardware. Full size antenna with 9 ft. mast. Complete for **\$7.95** ea. Buy 10 for \$7.49 each

TERMS: 20% DEPOSIT with order, balance C.O.D. \$1.00 handling charge for orders less than \$5.00. All shipments F.O.B. Chicago. Our parts and tubes are warranted to be 100% replacements for the Definitives in the list above. Prices are subject to revision without notice. SATISFACTION GUARANTEED. Illinois residents add 2% sales tax.

ORDER TODAY!

**PREMIER Radio Tube Co.**  
549 W. Randolph St., Chicago 6, Illinois  
ANdover 3-1590

of disaster, or a national emergency.

I operated radio transmitters and taught radio repair in the Signal Corps. I believe that if I could legally construct and operate a low-power broadcast station I could meet any reasonable requirements of the FCC; and that the cost would be less than \$100.

I propose that the FCC set aside one frequency in the standard broadcast band for the exclusive use of small-town radio stations; authorize operation on this frequency with a power of 5 to 10 watts; and license qualified radio service technicians to build, install, operate, and maintain these stations.

R. L. HAWBAKER

Belton, Texas.

(The foregoing represents the gist of Mr. Hawbaker's letter, which was too long to publish in full. It advocates just what the FCC tried to do for many years—put low-power community stations together on frequencies where they would (theoretically) cause little interference to each other, and would be able to cover their own communities with local services. However, the system is not extendable to all towns and cities because of the interference that would exist, even if station power were reduced to 10 watts. (The power generally used for community stations was 250 watts. A large number of these stations are still in existence—see the broadcast station list for frequencies from 1450 up). In effect, not one frequency, but several, are devoted to the small-town station.

The solution appears to be FM—if any solution exists. Using the best engineering brains of the country, the FCC has been able to find no way of crowding more stations into the broadcast band. But the FM band is still partly unoccupied. It has its own difficulties, such as the present small number of FM receivers. But progress is possible in that direction, and appears not to be possible in others.—Editor)

### ASKS ANNUAL INDEX

Dear Editor:

As a subscriber to RADIO-ELECTRONICS for six years, I would like to make some comments on the magazine.

I think that the distribution of articles among various fields is very well proportioned. I found the following items in the December, 1951, issue especially interesting: "Electronics and Music," "Ionophone Circuitry," "TV Predictions," "Light-Sensitive Electronic Beast," "Transistor Amplifier Circuits," "New Devices," "New Patents," and "Radio-Electronic Circuits."

The main thing that I would like to see added to the magazine is a yearly master index. I consider your articles of lasting reference value, but they are useless to me without a master index. I know that outside organizations print up master indexes combining several magazines, but they cost too much and are too watered down with references to magazines that I do not have.

C. W. KNOOP

Saginaw, Michigan

—end—

## OPPORTUNITY AD-LETS

Advertisements in this section cost 35¢ a word for each insertion. Name, address and initials must be included at the above rate. Cash should accompany all classified advertisements unless placed by an accredited advertising agency. No advertisements for less than ten words accepted. Ten percent discount six issues, twenty percent for twelve issues. Objectionable or misleading advertisements not accepted. Advertisements for June issue must reach us not later than April 21, 1952. Radio-Electronics, 25 W. Broadway, New York 7, N. Y.

SPEAKERS REPAIRED at wholesale prices. Guaranteed workmanship. Past service, Amprito Speaker Service, 70 Vesey St., New York 7, N. Y.

PLANS ALL WAVE RADIO USING HEARING AID parts. Send 25¢. Glen Ecker, 10 East Orange Grov., Pasadena 3, Calif.

10 WATT ALL TRIODE HIGH FIDELITY AUDIO amplifiers. Built-in preamplifier, separate tone controls. Tubes: 6sc7, 6j5, 2-6sn7, 2-6B4 outputs, 5U4 Rectifier, \$67.50. Send for particulars. Electronic Wiring, Selden, L. I., N. Y.

WE REPAIR, CONVERT, SELL, ALL TYPES OF electrical instruments, tube checkers and analyzers. Hazleton Instrument Co. (Electric Meter Laboratory), 128 Liberty Street, New York, N. Y. Telephone—BARELAY 7-4239.

WANTED: AN APR-1, other "APR-1", "TS-3", "1E-1", ARC-1, ARC-3, ART-13, BC-318, etc. Particularly needed: TS-3, 12, 13, 14, 33, 35, 36, 45, 76, 111, 125, 129, 116, 153, 173, 174, 175, 323; Microwave Spectrum Analyzers; R-77 ARC-3; quantities of 723A/B, 3C22 Tubes; LAE, LAF, LAG; General Radio, Ferris items, etc.; Microwave Equipment, everything Surplus, Special tubes, Test Manuals, Lab Quality Equipment, Meters, Fast Action, Fair Treatment, Top Dollar; Littell, Fairhills Box 26, Dayton 9, Ohio.

TV ANTENNA DESIGN, AUDIO ENGINEERING, Electronic Mathematics, Electronic Calculators, Data Sheets 50¢ each or 3 for \$1. FCC Radio-telephone operator license course, \$25 complete. Willard R. Moody, Consulting Engineer, 5705 Carters Lane, Riverdale, Maryland.

"REPAIR YOUR OWN RADIOS", TELLS HOW, \$1.00 post paid. Information free. Slate's Radio Service, Corsicana, Texas.

TELEVISION TUNER REPAIR SERVICE. REPAIRS on all types of Tuners. Workmanship guaranteed. Television Tuner Company, 40-09 82nd Street, Jackson Heights 73, N. Y. Newtown 9-1690.

TV AND FM ANTENNAS, YAGI, CONICAL, BOW-TIE, Mounts, accessories. Lowest prices. Wholesale Supply Co., Lunenburg, 2, Mass.

## NEW OAK BOOSTER

Precision Engineered!

for TV-FM  
by OAK ELECTRONICS  
**\$39.95**

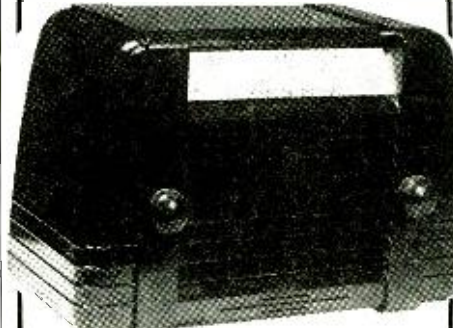

The booster that finally satisfies your demands by succeeding where others have failed. The OAK BOOSTER uses Mallory INDUCTUNER same as used in Dumont, Crosley and Stromberg Carlson TV sets) in a newly engineered circuit on which patent is pending. Provides variable bandwidth to control adjacent channel interference and reduce noise to a minimum. Uses new "Q" multiplier circuit to increase gain enormously.

- ✓ Highest gain of any booster
- ✓ Gain adjustable from front knob
- ✓ Dual Input
- ✓ Automatic On-Off
- ✓ Dual Output
- ✓ Variable bandwidth controllable from front panel

Order Oak Booster from your jobber today Write for specifications and discounts

**OAK ELECTRONICS**  
150 Oak Street, Buffalo, N. Y.



**BLAK-RAY SELF-FILTERING  
ULTRA VIOLET LAMP**

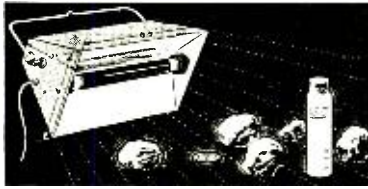

Experimenters have been looking for a reasonably priced Ultra-Violet lamp that would supply a rich quality radiation with minimum power consumption. The BLAK-RAY 4-watt lamp, model X-4, complete with U-V tube, fills these requirements admirably. Over 3000 substances are affected by the so-called "black light" and glow visibly or fluoresce in a weird manner when illuminated by the U-V lamp here illustrated. This lamp gives long-wave ultra-violet radiation having a wavelength of 3654 to 4000 angstrom units. Some of the substances made to fluoresce visibly when illuminated by U-V light are certain woods, oils, minerals, milkstone, cloth, paints, plastics, yarn, drugs, crayons, etc. This lamp is self-filtering and the invisible U-V rays are harmless to the eyes and skin. The lamp is equipped with spectral-finish aluminum reflector. The lamp consumes only 4 watts and can be plugged into any 110 volt 50-60 cycle alternating current outlet. Will give 2000 to 3000 hours of service. It weighs but 1 3/4 lbs. and has a convenient adjustable handle. The lamp is approved by the Underwriters Laboratories and has a built-in transformer so that it may be safely used for long periods when necessary. Extra U-V tubes are available at nominal cost. The outer casing of the lamp is richly finished and very sturdy.

Ship wt. 4 lbs.  
ITEM NO. 125  
UNUSUAL BUY **\$14.75**

**POWERFUL ALL PURPOSE MOTOR**



Sturdy shaded pole A.C. induction motor. 15 watts, 3000 rpm. 3"x2"x1 1/2"; 4 mounting studs; 7/8" shaft, 3/16" diameter; 110-120 volts. 50-60 cycles. A.C. only. When geared down, this unit can operate an 18" turntable with a 200 lb. dead weight. Use it for fans, displays, timers and other purposes. Ship. wt. 2 lbs.  
ITEM NO. 147  
UNUSUAL BUY **\$2.45**

**WATTHOUR METER**

Leading makes — completely overhauled, ready for service. 100-110 volts, 60 cycles, 2-wire A.C. 5 amp. Heavy metal case 8 1/2" x 6 1/4" x 5". Easy to install. Ship. wt. 14 lbs.



ITEM NO. 33  
NOW ONLY **\$4.50**

**WESTERN ELECTRIC BREAST MIKE**



Lightweight 1 lb. carbon microphone. Aircraft type. Breastplate mounting, adjustable 2-way swivel. Easily fastened straps. For home broadcasts, communications etc. Complete with 6 foot cord, hard rubber plug. Sheradized plate, non-rusting finish. Ship. wt. 2 lbs.

ITEM NO. 152  
NEW LOW PRICE **\$1.75**

**AMAZING BLACK LIGHT**



250-watt ultra-violet light source. Makes fluorescent articles glow in the dark. Fits any lamp socket. For experimenting, entertaining, unusual lighting effects. Ship. wt. 2 lbs.  
ITEM NO. 87  
A SAVING AT **\$2.45**

HUDSON SPECIALTIES CO.  
40 West Broadway, Dept. RE-4-52  
New York 7, N. Y.

1 cent enclosing full remittance for items circled below.  
(Be sure to include shipping charges.)

OR, my deposit of \$..... Ship balance C.O.D.  
MINIMUM C.O.D. ORDER \$5.00.  
C.O.D. ORDERS ACCEPTED ONLY WITH 20% DEPOSIT  
INCLUDE SHIPPING CHARGES.

Circle Items Wanted  
87 147 33 152 125

Name.....  
Please Print Clearly

Address.....

City..... Zone..... State.....

**APPLICATION OF THE ELECTRONIC VALVE** in Radio Receivers and Amplifiers (volume 2 of a series), by Dr. B. G. Dammers, J. Haantjes, J. Otte, and H. Van Suchtelen. Published by Philips' Technical Library. Distributed by Elsevier Press Inc., 402 Lovett Blvd., Houston 6, Texas. 6 x 9 inches, 431 pages. Price \$7.75.

Three general topics are covered here: a.f., output, power supply. The a.f. chapter includes phase inversion, frequency response, distortion. Class A, AB, and B stages are discussed, and measurements are described. Many design examples are given. While European tubes are mentioned, the same principles apply to American types, of course.

Because of the limited field of subjects, the authors can (and do) provide thorough discussions. The book is well written and illustrated. The treatment is on a high scientific plane but is not too rigorous. If the reader knows algebra and trigonometry, he will absorb and retain much useful information on a.f. and power supplies. —IQ

**PRINCIPLES OF RADIO** (Sixth Edition), by Keith Henney and Glen A. Richardson. Published by John Wiley & Sons, Inc., New York, N. Y. 5 1/4 by 8 1/2 inches, 655 pages. Price \$5.50.

Every would-be scientist, engineer or technician must first learn the principles of his chosen profession. If the background is presented to him clearly and logically, the student can go on to advanced concepts sooner and less painfully. This book on radio and TV is an excellent one. Its first few chapters discuss electrons, Ohm's law, simple circuits, batteries, etc. The final ones deal with multivibrators, oscilloscopes, color TV, and radar. In between, there is a concise treatment of modern radio.

It is gratifying to see that so much highly useful material can be packed into a single volume without losing readability. Adequate treatment is given to magnetism, electronic instruments, tubes and circuits, TV, FM, and others. Problems and practical examples appear throughout. The chapter on a.c. introduces sine functions and vectors without confusion.

Transmitters, antennas, waveshapers, are among other subjects taught in this book. —IQ

**THEORY AND CONSTRUCTION OF A SELF-CHARGING VAN DE GRAEFF**, by Richard H. Waters. Published by American Electrostatic Co., Tulsa, Oklahoma. 8 1/2 x 11 inches, 20 pages. Price \$2.50.

This paper describes the theory of a self-charging Van deGraaff "lightning" generator and provides design details. The device is capable of generating up to 300 kilovolts with a short-circuit current of about 12  $\mu$ a or more. The generator is safe to operate yet is capable of producing sparks more than a foot long.

The booklet should interest physics classes, experimenters, and perhaps amateur magicians. —IQ

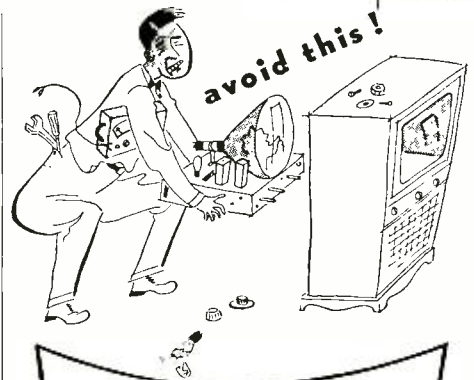

**GET RMS  
PIX-EYE  
CHECK PICTURE TUBE  
and VITAL RECEIVER  
CIRCUITS  
ON-THE-SPOT**

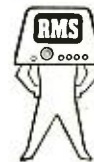

Model TE-5  
**\$9.95**  
LIST

**PIX-EYE** speeds TV trouble shooting . . . eliminates the time, labor and danger involved in unnecessary removal of picture tube. Plug Pix-Eye into the CRT socket . . . to help you quickly analyze the picture tube for shorts, intermittents, opens . . . make instant check of—

- brightness control circuits
- contrast control circuits
- video circuits
- low voltage circuits
- filament voltage circuits

Extension units EX-5 can be supplied for working at front of set. Take Pix-Eye on the call . . . keep one at the bench.

See your local RMS jobber today!  
**RADIO MERCHANDISE SALES, Inc.**  
NEW YORK 59, N. Y.

# Solderless Cable Fittings



## By Workshop

Whenever you need a cable fitting for RG-8 U, RG-11 U and RG-59 U, specify **WORKSHOP . . . Solderless silver plated connectors, receptacles, junctions and adaptors.** Look for the complete line at your distributor's on the *red and white* display card.



### THE WORKSHOP ASSOCIATES

Division of the Gabriel Co.  
135 Crescent Road  
Needham Heights 94, Mass.

## SPECIAL CLOSEOUT! ALL CHANNEL BOOSTERS



Retail List \$39.50

Your Cost **13.95** EACH

This famous all channel booster pulls in distant stations at from 6 to 10 times normal signal strength. Cuts down off channel interference. Given clear, easy-to-look-at pictures. Just plug in. Has self-contained power supply. A real buy at this closeout price.

10% CASH WITH ORDERS

### ALMO RADIO CO.

509 ARCH ST. & 6205 MARKET ST.  
Philadelphia, Pa.  
6th & ORANGE STS. • Wilmington, Del.  
4401 VENTNOR AVE. • Atlantic City, N. J.  
1133 HADDON AVE. • Camden, N. J.

## BE A RADIO AMATEUR!

A profitable hobby that can lead to better paying jobs, preferred positions and ratings in the armed forces, worldwide friendships with "hams" in the U.S. and foreign countries. Simplified new short cut HOME STUDY course teaches you quickly, easily all you need to know to pass F.C.C. Amateur Radio Operators' License exams. The entire up-to-date, one volume course, nothing else to buy, containing complete material, diagrams, etc., yours for only \$9.95. Send check or money order; or pay postman \$9.95 upon receipt, plus small C.O.D. charges. Complete satisfaction or money refunded within ten days.

STREAMLINED SELF STUDY COURSES  
509 Fifth Ave. Dept. B New York, N. Y.

# RADIO SCHOOL DIRECTORY

## F.C.C. COMMERCIAL RADIO OPERATORS LICENSE

CRITICAL SHORTAGE OF LICENSED OPERATORS EXISTS!!!

A wonderful future is yours with an F.C.C. commercial radio telephone or telegraph operators license, leading to top-salaried jobs in aviation, broadcasting, transportation and Civil Service. Sensational new simplified HOME STUDY course teaches you in the shortest possible time at lowest possible cost. NO OTHER COURSE LIKE IT! Proven valuable during World War II in speedily training thousands of men, eliminates tedious schooling, exam papers, waiting through books. Each page of text directly related to official F.C.C. exam questions, thus assuring you of all theory requirements.

The entire up-to-date course, nothing else to buy, containing 230 pages of complete material, diagrams, etc., yours for only \$9.95. Send check or money order; or pay postman \$9.95 upon receipt, plus C.O.D. charges.

Complete satisfaction or money refunded within ten days.

STREAMLINED SELF STUDY COURSES  
509 5th Ave. Dept. A New York, N. Y.

## Unlimited Opportunities in RADIO ENGINEERING

### DEGREE IN 27 MONTHS

Complete Radio Engineering course including Telev., U. H. F. and F. M. Bachelor of Science Degree also in Mech., Civil, Elect., Chem., and Aero. Eng.; Bus. Adm., Acct. Extensive campus, modern buildings, well equipped labs. Low cost. Prep courses. Personalized, practical instruction. Founded 1884. Placement service. Growing shortage of engineers. Prepare now for unlimited opportunities ahead. Enter September, January, March, June. Write for catalog.



### TRI-STATE COLLEGE

2442 College Ave. ANGOLA, IND.

## RCA RADIO and TELEVISION ELECTRONICS

Thorough Training For Men and Women in All Technical Phases  
New Classes (Day & Eve.) Start MARCH 3, 1952  
FREE PLACEMENT SERVICE FOR GRADUATES  
For Free Catalog Write Dept. RC-52

### RCA INSTITUTES, Inc.

A Service of Radio Corporation of America  
350 WEST 4TH STREET NEW YORK 14, N. Y.

## LEARN TELEVISION

ELECTRONICS and RADIO  
Engineering Laboratory and Classroom  
Training, Day and Evening Classes.

Write for illustrated Catalog

### ELECTRONICS INSTITUTE, Inc.

21 HENRY, DETROIT 1, MICH.

## BE YOUR OWN BOSS!

### MAKE MORE MONEY



\$1.00 VALUE  
**25c**  
40,000 WORDS IN TEXT  
NO ADS ALL "MEAT!"  
Money Back Guarantee

In "CASH IN" you now get THE real money-makers — dozens of profitable tested mail order plans, confidential business secrets, dozens of practical tested formulas. Successful tested schemes — actual experiences of men who have started on a shoe-string — with less than \$10 capital. 25c a copy postpaid. Send U. S. stamps, money order, or coin.

NATIONAL PLANS COMPANY  
1966R BROADWAY, NEW YORK 23, N. Y.

## RADIO & TELEVISION . . . TRANSMITTERS LAB. WORK EVERY DAY LEARN BY EXPERIENCE

### REHRIG SCHOOL

11-13 S. GAY ST.  
BALTIMORE 2, MD.  
Lex. 3195

## TELEVISION

Big demand for graduates

B.S. DEGREE IN 27 MONTHS in radio including TV engineering—VHF, UHF, AM and FM. New TV lab. Over \$100,000 worth of equipment. Also new modern physics lab. Intense specialized course includes strong basis in mathematics, advanced design in radio and in TV.

Hundreds of young men each year are earning engineering degrees in this recognized institution. Start any quarter. Many earn a major part of expenses in this industrial center. Low tuition. Competent instruction. Thorough, intense, practical program.

Also B.S. degree in 27 mo. in Aeronautical, Chemical, Civil, Electrical and Mechanical Engineering. Approved for veterans. Enter March, June, Sept. and Dec. Send for free catalog. **ENROLL NOW**

INDIANA TECHNICAL COLLEGE  
1742 E. Washington Blvd., Fort Wayne 2, Indiana

## ATTENTION . . .

A NEW department of the DON MARTIN SCHOOL OF RADIO AND TELEVISION ARTS AND SCIENCES . . . for instruction and training in—TELEVISION—incorporating:

Production: Writing, Directing, Producing, Acting, Staging, Lighting.

Engineering: Transmission, Receiving, Camera and Studio, Operation, Theory of Video, Pickup and Reproduction.

Approved for veterans.

### THE DON MARTIN SCHOOL OF RADIO AND TELEVISION ARTS AND SCIENCES

1655 No. Cherokee, Hollywood 28, Calif. HU. 23281.

## RADIO ENGINEERING

FM—Television—Broadcast

Police Radio, Marine Radio, Radio Servicing, Aviation Radio and Ultra High mobile applications. Thorough training in all branches of Radio and Electronics. Modern laboratories and equipment. Old established school. Ample housing facilities. 7 acre campus. Small classes, enrollments limited. Our graduates are in demand. Write for catalog.

Approved for Veterans

VALPARAISO TECHNICAL INSTITUTE  
Dept. C VALPARAISO, INDIANA

## TELEVISION-RADIO ELECTRONICS

Training in all branches of radio and electronics. FCC exams, preparation. Write for catalog.

### COMMERCIAL RADIO INSTITUTE

Founded 1920  
Dept. A, 38 West Biddle St.,  
Baltimore, Md.



# RADELCO

## LIGHTNING ARRESTOR

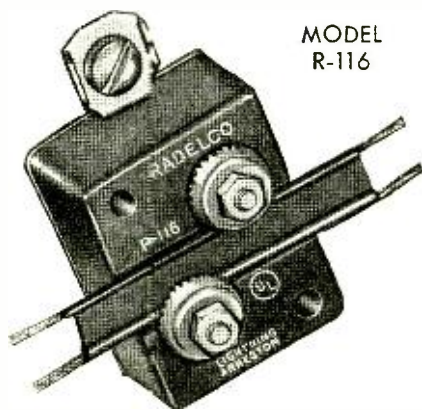

MODEL R-116

IT'S THE LOWEST PRICE UNDERWRITERS' LISTED ARRESTOR ON THE MARKET

ORDER FROM YOUR NEAREST PARTS JOBBER

LIST PRICE **90¢**

# AMPERITE

Studio Microphones at P.A. Prices

Ideal for BROADCASTING RECORDING PUBLIC ADDRESS

"The ultimate in microphone quality," says Evan Rushing, sound engineer of the Hotel New Yorker.

- Shout right into the new Amperite Microphone—or stand 2 feet away—reproduction is always perfect.
- Not affected by any climatic conditions.
- Guaranteed to withstand severe "knocking around."



Models  
RBLG—200 ohms  
RBHG—Hi-imp.  
List \$42.00



"Kontak" Mikes  
Model SKH, list \$12.00  
Model KKH, list \$18.00

**Special Offer:** Write for Special Introductory Offer, and 4-page illustrated folder.

**AMPERITE Company, Inc.**  
561 BROADWAY • NEW YORK 12, N. Y.  
Canada: Atlas Radio Corp., Ltd., 560 King St. W., Toronto

TELEVISION ENGINEERING (Second Edition), by Donald G. Fink, Published by McGraw-Hill Book Co., Inc., New York, N. Y. 6 x 9 inches, 721 pages. Price \$8.50.

This authoritative text will be of help to receiving and transmitting engineers and technicians. Except for advanced scientific journals, few other sources now present data on the subjects covered here. Comparatively little math is involved. A knowledge of radio principles is assumed.

First chapters discuss topics in optics: flicker, illumination, resolution, lenses, etc., for an understanding of cameras and kinescope operation. Scanning and synchronization are explained. A number of patterns show the effects of improperly adjusted circuits. There is detailed information on video amplification and transmission. Among the subjects are: stagger tuning design, frequency compensation, antennas (including u.h.f. types), a.g.c., amplifiers, etc. Frequency modulation and demodulation are given adequate space.

Two chapters are devoted to modern color TV, both principles and practice. The final chapters illustrate and describe TV broadcast equipment and receivers. This includes field and studio cameras, electronic view finders, relay apparatus, complete receivers, gated a.g.c., and others.

Exercises and bibliographies are given with each chapter.—IQ

TRANSMITTING VALVES, by J. P. Heyboer. Revised by P. Zijstra. Published by Philips' Technical Library. Distributed by Elsevier Press, Inc., 402 Lovett Blvd., Houston 6, Texas. 6 x 9 inches, 284 pages. Price \$6.25.

There are not many good books devoted specifically to transmitting tubes. This one, prepared by authorities on the subject, is recommended. It shows how to use tubes as amplifiers, modulators, oscillators, and frequency multipliers. Several u.h.f. types are discussed. Many characteristic curves, graphs, and charts are included to illustrate design principles.—IQ

SERVICING TV IN THE CUSTOMER'S HOME, by Milton S. Kiver. Published by Howard W. Sams & Co., Inc., 2201 E. 46th St., Indianapolis 5, Indiana. 5 x 8 inches, 96 pages. Price \$1.50.

For the experienced technician as well as the novice, this handy pocket-sized book is a valuable servicing aid. The author tells *what* to do and *how* to do it when time is money and equipment (and the customer's patience) limited.

The material is arranged in four clearly written, fully illustrated sections. The first three sections give explicit instructions for isolating troubles with the aid of a simple capacitor probe; for identifying and tracing circuits in unfamiliar receivers; and for checking set performance from the picture characteristics. The final section simplifies the usually confusing procedures for adjusting horizontal a.f.c. systems.—MB

# NOW! BECOME EXPERT AT RADIO-TELEVISION IN 4 EASY STEPS!



Complete Self-Training Course in RADIO and TV by Famous Experts—Takes You BY SIMPLE STEPS From Basic Theory to Problems of Repair, Installation, Color TV, etc.

NOW you can do ANY Radio-TV installation, service, or repair job like an expert; operate field-testing equipment; understand problems of TV, FM-AM transmission, etc. Step into a good-paying job—or start your own service business. Train yourself AT HOME... IN SPARE TIME... with the McGraw-Hill Basic Course in Radio and TV.

2296 Pages—1611 Illustrations

The men who wrote this complete 4-volume course are among the outstanding radio and TV instructors in America today. Every detail is clearly explained in over TWO THOUSAND PAGES of step-by-step instruction and over SIXTEEN HUNDRED "how-to-do-it" illustrations, cross-section diagrams, etc. The review questions and answers "nail down" everything you learn. At-a-glance "trouble-shooting" charts show how to diagnose instantly any radio or TV breakdown... and how to repair it expertly and quickly.

The course will pay for itself many times over. It can qualify a beginner for FCC's 1st-Class License test; gives an experienced technician more confidence and skill.

### SEND NO MONEY

Mail coupon below to examine complete four-volume course FREE for 10 days. No obligation. Or you may examine individual books FREE for 10 days by checking the proper boxes in coupon.

**PARTIAL CONTENTS ESSENTIALS OF RADIO.**  
800 pages, 433 illus.  
Circuit Analysis • Vacuum Tubes • Circuits: Detector • Amplifier • Tube Oscillator • Power Supply • Transmitting, Receiving, Etc.  
**ELEMENTS OF RADIO SERVICING.**  
475 pages, 375 illus.  
Multimeters • AC Power Supply • Speakers • Antennas • Auto Radios • Push-Pull Output Stage  
**BASIC TELEVISION.**  
592 pages, 415 illus.  
Scanning • Synchronization • Video Signal • Brightness Control • DC Reinsertion • Picture • FM Alignment • Picture Tubes • VHF and UHF transmission  
**TELEVISION SERVICING.**  
429 pages, 388 illus.  
Antennas • Transmission Lines • Test-pattern and Picture Analysis • Localizing Reception Troubles • Interference Remedies • Deflection Circuits • AND MUCH MORE!

### FREE 10-DAY TRIAL COUPON

McGraw-Hill Book Co., Inc., Dept. RE-4-52  
327 West 41st St., New York 18, N. Y.

Send me for 10 day free examination the Basic Course in Radio and TV, 4 Vols. (Regular retail price is \$26.00; Special Course Price only \$21.95 in easy installments.) If not satisfied with Course, I will return it, pay nothing. Otherwise, I'll send \$1.95 plus delivery then and only \$4.00 in monthly installments.

If you wish to examine any of these books individually, check below the ones you wish us to send you for 10 Days' FREE EXAMINATION:

<input type="checkbox"/> Essentials of Radio, \$6.75	<input type="checkbox"/> Elements of Radio Servicing, \$5.25
<input type="checkbox"/> Basic Television, \$7.50	<input type="checkbox"/> Television Servicing, \$6.50

For any book I keep, I'll send \$2.00 plus delivery in 10 days, balance in easy monthly installments.

Name.....

Address.....

City..... Zone..... State.....

Position.....

Company..... RE-4-52

WE PAY FOR DELIVERY if you send first payment of \$1.95 when ordering Course or full price when ordering individual books (prices above). Same return privilege.







**FUNDAMENTALS OF MAGNETIC RECORDING**, by C. J. LeBel. Published by Audio Devices, Inc., 444 Madison Avenue, New York 22, N. Y. 5 1/4 x 7 1/2 inches, 50 pages. Gratis on application to Audio Devices on business letterhead.

In view of the small amount of material written on the subject, this little book fills a need. It is a very elementary treatise on tape recording dealing with both theoretical and practical angles. A thorough explanation of the "how" of magnetic recording on tape is given, as well as a number of hints of value on maintaining and troubleshooting magnetic recorders. The prospective purchaser is given a few suggestions on selecting a tape recorder and told what he may expect from one. —FS

**HOW TO PASS RADIO LICENSE EXAMINATIONS (Third Edition)**, by Charles E. Drew. Published by John Wiley & Sons, Inc., New York, N. Y. 6 1/4 x 9 1/4 inches, 367 pages. Price \$1.50.

Once every five years or so, this reviewer takes the Government exams and renews his commercial radiotelephone and radiotelegraph licenses. Like so many others, he finds a Q & A manual very helpful. While a manual cannot teach basic radio, it brings us up to date on latest radio rules and regulations and indicates the types of questions being asked. This third edition does a fine job.

The volume contains questions and answers for elements 1-6—radiotelephone and radiotelegraph licenses. Element 7 (aircraft radiotelegraph) and element 8 (radar) are not included.

All answers are clear and detailed. Diagrams are fully explained. Solutions to numerical problems are given step-by-step. The appendix contains a complete Q code list, extracts from radio laws, and a frequency-wavelength conversion table.—IQ

**TV SERVICING**, by John R. Meagher and Art Liebscher. Published by Tube Dept., Radio Corp. of America, Harrison, N. J. 8 1/4 x 11 inches, 45 pages. Price 35 cents.

This compilation of articles by two TV specialists supplies valuable data for trouble-shooting and adjusting receivers.

The first article, "TV service," has 13 parts. Published originally in installments in "RCA Service News," they describe defects and remedies in the a.g.c., deflection, r.f., sync and other circuits. Distorted patterns show how specific troubles affect the pictures. There is also specific information on how to use station patterns to test a receiver.

The other articles are shorter but no less informative. They deal with horizontal pulling, hum and buzz, antennas and tuner alignment. The last article contains complete step-by-step procedure for aligning the Standard Coil, Sarks-Tarzian, and KRK-2 tuners.

This booklet by two TV specialists should increase the know-how of any TV technician.—IQ

—end—

*Practical, Popular-priced Books on*  
**RADIO•AUDIO•SERVICING**

At last—a practical book on basic radio principles!

**BASIC RADIO COURSE—No. 44.** By John T. Frye. 176 Pages, 120 illustrations. Durable hard cloth cover. \$2.25.

RADIO-ELECTRONICS' popular technician-writer, John T. Frye, takes the mystery away from learning theory! A 25-year veteran technician himself, he talks your language when he tells you just why resistors, capacitors, tubes and other components act as they do in a radio. His style makes each of the 26 chapters as easy to read as a novel. But when you've finished, you realize he's made every basic rule stand out clearer than you ever thought possible. Covers theory from Ohm's Law to advanced servicing techniques. Order your copy today!

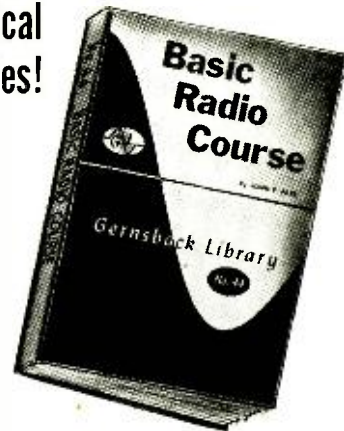

**TWO TOP-FLIGHT \$1.00 BOOKS**

**MODEL CONTROL BY RADIO—No. 43.** By Edward L. Safford, Jr., 112 pages. An authority in the field of radio control gives you the first complete book on the subject. For beginner and expert. Tells you what radio control is, how it works and how to construct not only component parts but a complete system as well. Illustrations explain each step.

**HIGH-FIDELITY TECHNIQUES—No. 42.** By James R. Langham, 112 pages. You've never seen a technical book like it! Just as he'd talk to you across the work bench, RADIO-ELECTRONICS' popular audio writer tells you how to design your own equipment and how to get top performance from it. Takes the double talk out of high-fidelity work.

**THREE IMPORTANT 75¢ BOOKS**

**PUBLIC-ADDRESS GUIDE—No. 41.** 80 pages. This handy book shows the service technician the way to extra income in big-paying PA work. Covers installation, maintenance and construction.

**THE CATHODE-RAY OSCILLOSCOPE—No. 40.** 112 pages. A "must" for servicing TV, FM and AM receivers and in amateur operation! Tells in simple, but technically sound language, how the scope works and how to use it.

**PRACTICAL DISC RECORDING—No. 39.** 96 pages. Tells you how to make good disc recordings. Covers every phase, theory as well as technique. A full chapter is devoted to each component.

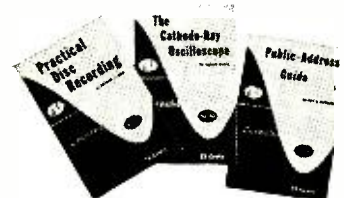

**5 POPULAR 64-PAGE BOOKS — 50¢ EACH**

**HANDY KINKS AND SHORT CUTS—No. 29.** A treasury of time savers! Antennas, power supplies, test equipment, phonographs, amplifiers. Easy reference. Illustrated.

**UNUSUAL PATENTED CIRCUITS—No. 30.** A gold mine of important hook-ups. Control circuits, detectors, amplifiers, power supplies, foreign circuits.

**RADIO QUESTIONS & ANSWERS—No. 31.** Answers the tough ones on circuit diagrams,

amplifiers, receivers, transmitters, meters and test equipment.

**ADVANCED SERVICE TECHNIQUE—No. 32.** A "must" for the advanced service technician! Covers specialized problems of servicing not usually found in ordinary textbooks.

**AMPLIFIER BUILDER'S GUIDE—No. 33.** For the designer and builder of audio equipment. Covers a variety of amplifiers with power outputs from 8 to 30 watts.

**THE GERNSBACK LIBRARY**

SEE YOUR DISTRIBUTOR OR MAIL THIS COUPON TODAY

**RADCRAFT PUBLICATIONS, INC.** Enclosed is \$..... for which please send me postpaid, the books checked below.  
25 West Broadway, New York 7, N. Y.

- 29     30     31     32     33  
 39     40     41     42     43     44

Name.....

Street.....

City..... Zone..... State.....

IMMEDIATE DELIVERY OF

# Top Quality MINIATURE SWITCHES

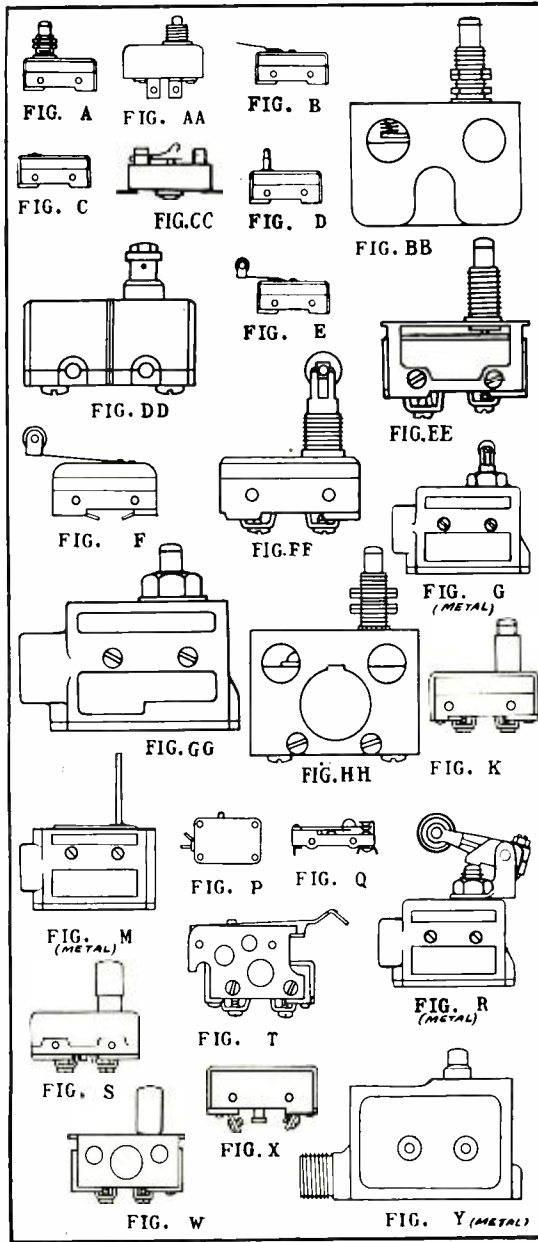

This list of brand new standard brand miniature switches represents only a few of many types in stock at Wells. Large quantities of most types are on hand for your immediate requirements. Write or wire for quotations on switches not listed.

Stock #	Mfr.	Type #	Contact	Fig.	Price	Stock #	Mfr.	Type #	Contact	Fig.	Price
4MC2	ACRO	2M03.1A	NO	P	.50	4MC27	MICRO	WZ2RST	NC	D	.55
4MM2	MU	AC2101BB	SPDT	W	.85	4MD16	MICRO	WZ7R	NC	C	.55
4MC17	MICRO	B-1	NC	Y	1.45	4MC15	MICRO	WZ7RQT2	NC	A	.70
4MC16	MICRO	B-1T	NC	DD	.90	4MD36	MICRO	WZ7RST	NC	D	.55
4MC7	MICRO	B-14	NO	HH	1.70	4MC23	MICRO	WZ7RQTN	NC	R	3.75
4MO62	MICRO	B-R	SPDT	C	.70	4MD54	MICRO	WZRBX	NC	X	.80
4MD63	MICRO	B-RS36	SPDT	D	.80	4MC9	MICRO	WZ31	NC	C	.65
4MD23	MICRO	BD-RL32	SPDT	B	.95	4MD57	MICRO	WZ31	NC	T	.70
4C51	MICRO	BZ2FC1	SPDT	C	.75	4MD31	MICRO	WZRD	NC	C	.55
4ML4	MICRO	BZRQ41	SPDT	W	.85	4MD19	MICRO	WZRL8	NC	B	.70
4MD51	MICRO	BZ-R37	SPDT	C	.70	4ML3	MICRO	WZRQ41	NC	W	.65
4MD2	MICRO	BZE7RQT2	SPDT	GG	1.70	4ML2	MICRO	XZV7RQ9T1	NC	G	2.25
4MD21	MICRO	BZ-7RST	SPDT	D	.80	4MC21	MICRO	X757	NC	C	.55
4MD38	MICRO	BZE2RQ9TN1	SPDT	G	2.65	4MD37	ACRO	XC1A	NC	C	.55
4MD6	MU	CUM 24155	NO	E	.80	4MC5	ACRO	XD45L	SPDT	B	.95
4ML1	MU	D	NO	BB	1.50	4MD4	MICRO	YZ	NO	C	.75
4MC12	MICRO	D in case	NC	Y	1.45	4MD40	MICRO	YA2RLE4D13	NO	B	.70
4MD60	MICRO	G-RL	NO	B	.80	4MD24	MICRO	Y22YLTCL	SPDT	B	.95
4MC11	MICRO	G-RL 5	NO	B	.80	4MC1	MICRO	Y22YST	SPDT	D	.60
4MD61	MICRO	G-RL35	NO	B	.80	4MD13	MICRO	Y23R3	NO	C	.60
4MC32	ACRO	HRO 7.1P2TSP1	NO	K	.65	4MD56	MICRO	Y23RLTC2	NO	B	.80
4MC19	ACRO	HRO7.4P2T	NO	S	.60	4D79	MICRO	Y23RT	NC	C	.60
4MD8	ACRO	HRRC 7.1A	NC	C	.55	4D127	MICRO	Y23RW2	NC	F	.80
4MD27	ACRO	HRR0 7.1A	NO	C	.60	4MC14	MICRO	Y23RW2T	NO	F	.90
4MC31	MICRO	LN-11 H03	SPDT	M	1.70	4MD49	MICRO	Y27RQ9T6	NO	FF	.85
4MC18	MU	MLB 321	SPDT	B	.95	4MD32	MICRO	Y27RST	NO	D	.60
4MD1	MU	MLR 643	NC	B	.70	4MC13	MICRO	Y27RA6	NO	EE	1.00
4MD55	PHAO	PS 2000	SPDT	C	.85	4C116	MICRO	Y2RE4	NO	C	.65
4MC28	ACRO	RC71P2T	NC	A	.70	4MC20	MICRO	Y2RQ4	NO	S	.60
4D129	ACRO	RD71A2T	SPDT	C	.75	4MC22	MU	Z	NC	Y	1.45
4MD22	ACRO	RO2M	NO	E	.80	4MD52	MU	Blue Dot	SPDT	E	.90
4MC28	ACRO	RO2M12T	NO	E	.80	4C73	MU	Blue Dot	SPDT	D	.80
4D87	ACRO	RO7 8586	NO	K	.70	4MC8	MU	Red Dot	NC	C	.65
4MC25	MICRO	R-RS	NC	D	.50	4MD18	MICRO	Open Type	SPDT	Q	.50
4MD9	MICRO	SW-186	NC	D	.50	4MD39	MU	Green Dot	NO	B	.80
4MC10	MICRO	WP3M5	NC	AA	.50	4MC29	MU	Green Dot	NO	D	.55
4MC4	MICRO	WP5M3	NC	AA	.50	4D84	MU	Green Dot	NO	B	.80
4MD53	MICRO	WP5M5	NC	AA	.50	4MD26	MAXSON	Precision	SPDT	B	.95

### SWITCHETTE



Stock #	Mfr. Type #	Contacts	Terminals	Price
41SF3	CR1070C103-A3	N.C.	SIDE	\$0.53
41SF2	CR1070C103-B3	N.O.	ENO	.53
41SF9	CR1070C103-F3	1-N.O. 1-N.C.	SIDE	.53
41SF12	CR1070C123-B3	N.O.	END	.53
41SF10	CR1070C123-C3	1-N.O. 1-N.C.	END	.53
41SF5	CR1070C123-D3	N.C.	SIDE	.53
41SF4	CR1070C123-J2	SPDT	ENO	.53
41SF11	CR107 C124-M4	SPDT	SIDE	.53
41SF1	CR1070C128-C3	1-N.O. 1-N.C.	ENO	.53

MANUFACTURERS AND DISTRIBUTORS:  
Write for Catalog

## SEELEY 8-4143



833 W. CHICAGO AVE., DEPT. Y, CHICAGO 22, ILL.

RADIO-ELECTRONICS

Order Direct or Through Your Local Parts Jobber.





First Choice with Servicemen Everywhere . . .

## MALLORY VIBRATORS

Servicemen know Mallory Vibrators give long, dependable performance—performance that keeps their customers happy. In fact, servicemen prefer Mallory Vibrators by a 2 to 1 margin, according to a recent survey. Mallory Vibrators give you . . .

- 1**—Slow contact impact for minimum wear
- 2**—High contact pressure for low resistance
- 3**—Fast contact break for reduced arcing, pitting

Only from Mallory—with its patented, tuned vibrator mechanism—do you get this important three-way performance combination. It helps you beat the comeback problem. It's the reason manufacturers use more Mallory Vibrators as original equipment than all other brands combined. Follow their lead . . .



**Mallory Vibrator Deals Help  
Keep Inventory Down . . .  
Include Parts Chest At  
No Additional Cost**

You can service 47 different radio makes with the 6 vibrator types in these Mallory special deals. And you get a handy parts chest at no additional cost when you buy at your regular discount price. Ask your distributor for details today.

## Make Sure! Make it Mallory!

P. R. MALLORY & CO. Inc.

# MALLORY

CAPACITORS • CONTROLS • VIBRATORS • SWITCHES • RESISTORS  
• RECTIFIERS • VIBRAPACK\* POWER SUPPLIES • FILTERS

\*Reg. U.S. Pat. Off.

APPROVED PRECISION PRODUCTS

**P. R. MALLORY & CO., Inc., INDIANAPOLIS 6, INDIANA**

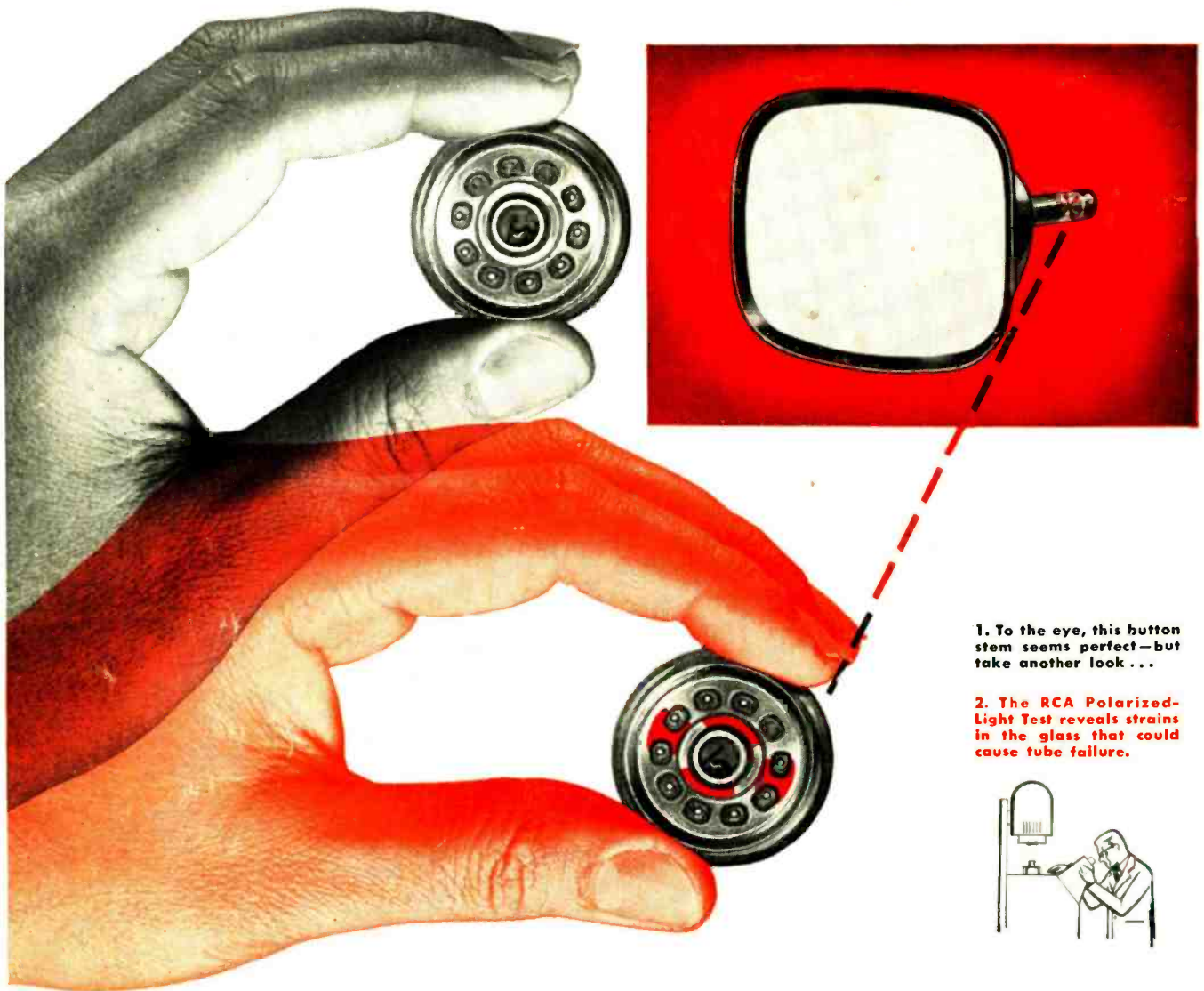

1. To the eye, this button stem seems perfect—but take another look . . .

2. The RCA Polarized-Light Test reveals strains in the glass that could cause tube failure.

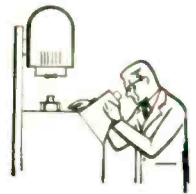

## A **DOUBLE-TAKE** to safeguard your reputation

AT FREQUENT INTERVALS throughout the day, RCA production inspectors pick finished button stems hot off the griddles of the sealing machines, and subject them to an ingenious "polarized-light test." Reason? Even slight variations in sealing temperature can, and do, set up strains in the areas of glass-to-glass and glass-to-metal seals that could result in fractures. The Polarimeter . . . especially designed for RCA . . . reveals these otherwise invisible strains, and prevents im-

perfect assemblies from reaching the final production line.

By taking a second look, RCA virtually licks a possible fracture before it occurs . . . not only on button stems, but also neck-to-flare seals and the face-plate section adjacent to the rim seal of metal-shell picture tubes.

This constant vigilance and *quality control* at *all* stages of manufacture assure that RCA standards will be met on the final assembly line. In this way, RCA closely guards its own reputation

for quality . . . and yours as well.

In RCA picture tubes, the difference is *top-quality control*. That's why, dollar for dollar, RCA picture tubes have no equal.

With RCA Receiving Tubes, as well as RCA Kinescopes, **TOP-QUALITY CONTROL** makes the difference.



**RADIO CORPORATION of AMERICA**  
ELECTRON TUBES

HARRISON, N. J.