

SEPTEMBER 1951

RADIO — ELECTRONICS

LATEST IN TELEVISION  SERVICING • AUDIO



HUGO GERNSBACK, Editor

30¢
U.S. and
CANADA

**THE SHIP RADIO OPERATOR
SEE BROADCASTING AND COMMUNICATIONS**

***In this issue: Using TV Test Equipment •
Magnetic Amplifiers • Compact Portable Receiver***

another **important** first from du mont:

the tube that is always in focus

automatically

...the tube that needs no

focusing circuits or components

...the tube that replaces either

electromagnetic- or electrostatic-focusing tubes

...the tube the whole industry has

wished for...the ...

DUMONT

Complete Technical Information

on Request:

CATHODE-RAY TUBE DIVISION,

ALLEN B. DU MONT LABORATORIES, INC.,

CLIFTON, N. J.



*Trade-mark

J. E. SMITH,
President,
National Radio
Institute,
Wash., D. C.

I Will Show You How to Learn RADIO-TELEVISION

by Practicing at Home in Spare Time



You Practice **SERVICING** with Equipment I Furnish

You build the modern Radio (at left) as part of my Servicing Course. I send you speaker, tubes, chassis, transformer, loop antenna, everything you need. You use it to make many tests, get practical experience you need to make **EXTRA** money fixing Radios. I send you many other kits of parts with which you build other circuits common to Radio and Television, some of which are pictured on the next page. All equipment is yours to keep. See and read about them in my **FREE 64-PAGE BOOK**. Mail card below.



You Practice **COMMUNICATIONS** with Equipment I Furnish

As part of my Communications Course I send you kits of parts to build the low power broadcasting transmitter shown at the right and many other circuits common to Radio and Television. You use this equipment to get practical experience putting a station "on the air," performing procedures demanded of Broadcast Station operators. I train you for your FCC Commercial Operator's License that puts you in line for good pay in Radio or Television Broadcasting. Mail card below.



**NEW! Advanced
Television Practice!**

New, special TV kits furnished to build high-definition SCOPE... RF OSCILLATOR with flyback power supply... complete TV SET... many other units. You see pulse, trapezoidal, saw-tooth wave forms. Get valuable **PRACTICAL EXPERIENCE** locating and correcting TV troubles. Mail coupon for facts, pictures and prices!

**CUT OUT AND
MAIL CARD
NOW!**

SEE OTHER SIDE THE TESTED WAY
TO BETTER PAY



Television Is Today's Good Job Maker

In 1946 only 6,000 TV sets sold. In 1950 over 5,000,000. By 1954, 25,000,000 TV sets estimated. Over 100 TV Stations now operating. Authorities predict 1,000 TV Stations. This means more jobs, good pay for properly trained men. Mail this Postage-Free card **NOW** for **FREE** book and sample lesson.

NO POSTAGE NEEDED

Both FREE

Sample Lesson & 64-Page Book

ACT NOW! Send for my **DOUBLE OFFER FREE**. This card entitles you to Sample Lesson on Servicing; shows how you learn Radio-Television at home. You'll receive my 64-page Book, "How To Be a Success in Radio-Television." Mail card now! No postage needed. J. E. SMITH, President, National Radio Institute, Washington 9, D. C. Our 38th year.

**Mr. J. E. SMITH, President, Dept. 1RRRR
National Radio Institute, Washington 9, D. C.**

Mail me Sample Lesson and 64-Page Book, "How to Be a Success in Radio-Television." (No Salesman will call. Please write plainly.)

NAME AGE.....
ADDRESS.....
CITY..... ZONE..... STATE.....

The ABC's of
SERVICING

How to Be a
Success
in **RADIO-
TELEVISION**

BE A RADIO-TELEVISION TECHNICIAN *Train at Home in Spare Time*



J. E. SMITH, President,
National Radio Institute,
Washington, D. C.

There's a Bright Future For You In America's Fast Growing Industry

Do you want good pay, a job with a bright future and security? Would you like to have a profitable shop or store of your own? If so, find out how you can realize your ambition in the fast growing RADIO-TELEVISION industry. Even without Television, the industry is bigger than ever before. 90 million home and auto Radios, 3,100 Broadcasting Stations, expanding use of Aviation and Police Radio, Micro-Wave Relay, Two-Way Radio for buses, taxis, etc. are making opportunities for Servicing and Communications Technicians and FCC Licensed Operators.

You Learn by Practicing with Kits I Furnish

With both my Servicing Course and my NEW Communications Course I send you many Valuable Kits of Parts. They "bring to life" theory you learn in my

illustrated texts. Some equipment from both courses is shown below and on previous page. All equipment I send is yours to keep. Among equipment you build is a Tester. Use it to make extra money fixing neighbors' sets while training. Special booklets show you how.

Training Features Television

Both my Servicing and Communications training include up-to-date lessons on TV principles. Throughout the country my graduates are filling jobs, making good money in both Radio and Television. Remember the way to a successful career in Television is through experience in Radio.

Send NOW for 2 Books FREE— Mail Card

Send the Postage-Free card now for my FREE DOUBLE OFFER. You get Sample Servicing Lesson to show you how you learn at home. Also my 64-page book, "How to Be a Success in Radio-Television." Read what my graduates are doing, earning; see equipment you practice with at home. Mail card now. We pay postage. J. E. SMITH, President, National Radio Institute, Washington 9, D. C. Our 38th Year.

Read What Successful NRI Graduates Say:



Radio Operator with ABC

"I was a bookkeeper with a hand-to-mouth salary. Now, a Radio Operator." — N. H. Ward, Ridgefield Park, N. J.



Can Step Into FM, Television

"When I enrolled with N.R.I., I was a laborer. Now I have a position paying over \$10 a day." — R. Ford, Phila., Pa.



Is Broadcasting Operator

"Now employed at station WHAW as operator. I have also opened my own Radio business." — R. J. Bailey, Weston, W. Va.



\$10 Week In Spare Time

"Before finishing your course, I earned \$10 a week in Radio servicing in my spare time." — S. J. Pettruff, Miami, Fla.



\$10 to \$15 Week Spare Time

"4 months after enrolling averaged \$10-\$15 a week spare time servicing Radios. Now have business." — W. B. Weyde, Brooklyn, N. Y.



Lost Job, Now Has Own Shop

"Got laid off. Best thing that ever happened as I opened a Radio shop." — E. T. Slate, Corsicana, Texas.

Make Extra Money While Learning

Keep your job while training. Learn Radio-Television principles from illustrated lessons. Get Practical Experience experimenting with circuits common to Radio and Television. Many students make \$5, \$10 a week extra fixing neighbors' Radios in spare time while learning. I send you special booklets that start teaching you the day you enroll.



IMPORTANT!
See Other Side

Extra Pay in Army, Navy, Air Force

Knowing Radio, TV, Electronics can help you get extra rank, extra prestige, more interesting duty at pay up to several times a private's base pay. You are also prepared for good Radio-TV jobs upon leaving service. Mail Coupon NOW.

You Build These and many more for Practical Experience



MAIL POSTAGE FREE CARD TODAY

Want Your Own Business?

Let me show you how you can be your own boss. Many N.R.I.-trained men start their own business with capital earned in spare time. Robert Dohmen, New Prague, Minn., whose store is shown at right, says, "Am now tied in with two television outfits and do warranty work for dealers. Often fall back to N.R.I. textbooks for information on installing Television sets."



FIRST CLASS
Permit No. 20-R
(Sec. 34.9 P L & R)
Washington, D. C.

BUSINESS REPLY CARD

No Postage Stamp Necessary If Mailed In The United States

4c POSTAGE WILL BE PAID BY
NATIONAL RADIO INSTITUTE
16th and U Sts. N. W.
Washington 9, D. C.

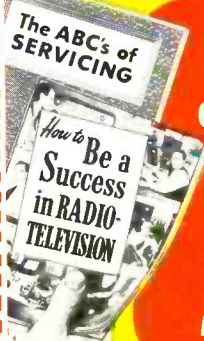
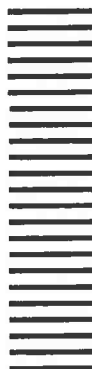

SAMPLE LESSON
and 64-PAGE BOOK
Both FREE

Cut out and mail
postage-free card now!

Be Sure of Your Installations Get the *Aptitude-Tested* RG/U TRANSMISSION LINE CABLES

● You know what you are doing when you use Belden RG/U Transmission Line Cables—they're aptitude rated. They are designed to provide desirable electrical characteristics, and rigid control assures constant quality.

Specify Belden Radio Wires.
Belden Manufacturing Co.
4623 W. Van Buren Street
Chicago 44, Illinois

APTITUDE RATING No. 8236		APTITUDE RATING No. 8237		APTITUDE RATING No. 8238		APTITUDE RATING No. 8239		APTITUDE RATING No. 8241		APTITUDE RATING No. 8240	
Frequency (Mc)	Attenuation per 100 ft	Frequency (Mc)	Attenuation per 100 ft	Frequency (Mc)	Attenuation per 100 ft	Frequency (Mc)	Attenuation per 100 ft	Frequency (Mc)	Attenuation per 100 ft	Frequency (Mc)	Attenuation per 100 ft
100.	2.65	100.	2.10	100.	1.90	100.	2.90	100.	3.75	100.	4.10
200.	3.85	200.	3.30	200.	2.85	200.	4.20	200.	5.60	200.	6.20
300.	4.80	300.	4.10	300.	3.60	300.	5.50	300.	7.10	300.	8.00
400.	5.60	400.	4.50	400.	4.35	400.	6.70	400.	8.30	400.	9.50



Belden
Radio WIRE

The
Aptitude-Tested **LINE**

RADIO - ELECTRONICS

formerly RADIO-CRAFT

MEMBER
AUDIT BUREAU OF CIRCULATIONS

Hugo Gernsback, Editor-in-Chief
M. Harvey Gernsback, Editorial Director

Fred Shunaman, Managing Editor
Robert F. Scott, W2PWG, Technical Editor
Mel Kramer, Associate Editor

Incorporating
SHORT WAVE CRAFT* TELEVISION NEWS*
RADIO & TELEVISION
*Trademark registered U. S. Patent Office

Lee Robinson, General Manager
John J. Lamson, Sales Manager

G. Aliquo, Circulation Manager
Robert Fallath, Promotion Manager

CONTENTS SEPTEMBER, 1951

Editorial (Page 19)			
Teleducation	by Hugo Gernsback	19	
Television (Pages 20-29)			
Using TV Test Equipment	by H. G. Cisin	20	
Profitable Conversions with Rectangular Tubes, Part II	by Ted Cantor	22	
Conversion—A Practical Approach	by Thomas E. Fairbairn	24	
September TV DX		25	
Vari-Directional Antenna is Rotated by Switching	by Matt Mandl and Ed Noll	26	
Television Service Clinic	by Matt Mandl	28	
Servicing-Test Instruments (Pages 30-36)			
Meters Properly Used Aid Trouble Shooting	by Rudolf E. Graf	30	
Ethical Service Pays Off	by Walter R. Rogers	32	
The Useful Impedance Bridge	by Richard H. Dorf	33	
Servicing the AM Receiver	by J. Travis Rodgers	36	
Broadcasting and Communications (Pages 37-39)			
The Ship Radio Operator (Cover Feature) ...	by Aaron Nadell	37	
Electronics (Pages 40-47)			
The Magnetic Amplifier	by A. A. Bosschart	40	
The Practical Field Electron Microscope ...	by Dr. Erwin W. Müller	43	
How an Electronic Brain Works, Part XII	by Edmund C. Berkeley and Robert A. Jensen	45	
Construction (Pages 48-54)			
Midget Shortwaver for DX Reception	by Glenn H. Querna	48	
Telephone Dial Pulses Remote Control Circuit ...	by Rane L. Curl	52	
Audio (Pages 56-74)			
Electronics and Music, Part XV	by Richard H. Dorf	56	
Audio Feedback Design, Part XI	by George Fletcher Cooper	64	
High Power A.C.-D.C. Amplifier	by John Rundo	70	
Phono Oscillator Uses Crystal	by John S. Hill	73	
Audio Phase-Shift Measurements		73	
Remote Phono Control		74	
New Design (Pages 83-94)			
Tiny Personal Set Uses Efficient Circuit		83	
Tubes of the Month		87	
Transistors as Multivibrators	by I. Queen	92	
Departments			
Radio Month	12	Question Box	111
Radio Business	16	Technotes	114
People	96	With the Technicians	117
Radio-Electronic		Communications	121
Circuits	100	Miscellany	122
New Patents	105	New Devices	124
Try This One	108	Book Reviews	126

ON THE COVER

Radiomarine installation in the radio room of the Esso tanker *Bermuda*, one of the most modern of our merchant marine radio stations. Ektachrome original by Avery Slack

September, 1951

RADIO-ELECTRONICS

Vol. XXII, No. 12

Published monthly by Radcraft Publications, Inc., at Erie Ave., F to G Streets, Philadelphia 32, Pa.

EXECUTIVE, EDITORIAL and ADVERTISING OFFICES: 25 West Broadway, New York 7, N. Y. Telephone REctor 2-8630. Hugo Gernsback, President; M. Harvey Gernsback, Vice-President; G. Aliquo, Secretary.

SUBSCRIPTIONS: Address correspondence to Radio-Electronics, Subscription Dept., Erie Avenue, F to G Sts., Philadelphia 32, Pa., or 25 West Broadway, New York 7, N. Y. When ordering a change please furnish an address stencil impression from a recent wrapper. Allow one month for change of address.

SUBSCRIPTION RATES: In U. S. and Canada, in U. S. possessions, Mexico, South and Central American countries, \$3.50 for one year, \$6.00 for two years; \$8.00 for three years; single copies 30c. All other foreign countries \$4.50 a year, \$8.00 for two years; \$11.00 for three years. Entered as second class matter September 27, 1948 at the post office at Philadelphia, Pa., under the Act of March 3, 1879. Printed in U. S. A. Copyright 1951 by Radcraft Publications, Inc. Text and illustrations must not be reproduced without permission of copyright owners.

BRANCH ADVERTISING OFFICES: Chicago: 520 N. Michigan Ave. Telephone Superior 7-1796. Los Angeles: Ralph W. Harker, 1127 Wilshire Blvd., Tel. MA 6-1271. San Francisco: Ralph W. Harker, 582 Market St., Tel. (Arfield 1-2481). FOREIGN AGENTS: Great Britain: Atlas Publishing and Distributing Co., Ltd., London E.C.4. Australia: McGill's Agency, Melbourne. France: Brentano's, Paris 2e. Holland: Trillecton, Heemstede. Greece: International Book & News Agency, Athens. So. Africa: Central News Agency, Ltd., Johannesburg. Capetown: Durban, Natal. Universal Book Agency, Johannesburg. Middle East: Steimatzky Middle East Agency, Jerusalem. India: Broadway News Centre, Dadar, Bombay #14. K. L. Kannappa Mudalliar, Madras 2. Pakistan: Paradise Book Stall, Karachi 3. POSTMASTER: If undeliverable send form 3578 to: RADIO-ELECTRONICS, 25 West Broadway, New York 7, N. Y.

SOMETHING TO
REMEMBER
ABOUT
SPRAGUE
TWIST-LOK* TV
CAPACITORS



• More twist-prong electrolytic capacitors are made by Sprague than by any other manufacturer ... And Sprague naturally lists the largest, most complete line for exact TV replacement applications.

• And when you use a Sprague Twist-Lok TV Capacitor, you can be sure it's dependable. No costly call-backs will jeopardize your profit or your reputation. Your business judgment will tell you to *accept no substitutes*.

*Trademark



GET YOUR
NEW
SPRAGUE TV CAPACITOR
REPLACEMENT MANUAL TODAY!

Just off press, this NEW 3rd edition of the famous Sprague Manual is jam-packed with up-to-the-minute replacement recommendations for critical capacitors in practically every TV set on the market today! FREE from your Sprague parts distributor or send 10¢ directly to Sprague to cover handling and mailing costs.

SPRAGUE
PRODUCTS COMPANY

81 Marshall St.
NORTH ADAMS, MASSACHUSETTS
(Distributors' Division of the Sprague Electric Company)

RADIO-ELECTRONICS for



Learn RADIO TELEVISION, ELECTRONICS *by* SHOP METHOD HOME TRAINING

Let NATIONAL SCHOOLS, of Los Angeles, a practical Technical Resident Trade School for almost 50 years, train you for today's unlimited opportunities.

You receive all parts, including tubes, for building this fine, modern Superheterodyne Receiver. This and other valuable standard equipment becomes your property.

these two FREE books will tell you how



WE BRING NATIONAL SCHOOLS TO YOU!

GOOD JOBS AWAIT THE TRAINED RADIO TECHNICIAN

You are needed in the great modern Radio, Television and Electronics industry! Trained technicians are in constant and growing demand at excellent pay—in Broadcasting, Communications, Television, Radar, Research Laboratories, Home Radio Service, etc. National Schools Master Shop Method Home Study Course, with newly added lessons and equipment, can train you in your spare time, *right in your own home*, for these exciting opportunities. Our method has been proved by the remarkable success of National Schools-trained men all over the world.

You Learn by Building Equipment with Standard Radio Parts We Send You

Your National Schools Course includes not only basic theory, but *practical* training as well—you *learn by doing*. We send you complete standard equipment of professional quality for building various experimental and test units. You advance *step by step* until you are able to build the modern superheterodyne receiver shown above, which is yours to keep and enjoy. You perform more than 100 experiments—build many types of circuits, signal generator, low power radio transmitter, audio oscillator, and other units. The Free Books shown above tell you more about it—send for them today!

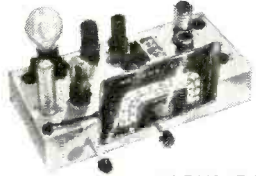

NOW! NEW PROFESSIONAL MULTITESTER INCLUDED



This versatile testing instrument is portable and complete with test leads. Simple to operate, accurate and dependable. You will be able to quickly locate trouble and adjust the most delicate circuits. You can use the Multitester at home or on service calls. It is designed to measure AC and DC volts, current resistance and decibels. You will be proud to own and use this valuable professional instrument.

GET THE DETAILS — SEND THE COUPON →

Lessons and Instruction Material Are Up-to-date, Practical, Interesting

National Schools Master Shop Method Home Training gives you basic and advanced instruction in all phases of Radio, Television and Electronics. Each lesson is made easy to understand by numerous illustrations and diagrams. All instruction material has been developed and tested in our own shops and laboratories, under the supervision of our own engineers and instructors. A free sample lesson is yours upon request—use the coupon below.

TELEVISION TRAINING

A complete series of up-to-the-minute Television lessons is an integral part of your course, covering all phases of Television repairing, servicing and construction.

- Here are just a few of the interesting facts you learn with the **FREE SAMPLE LESSON**
1. How radio receivers operate.
 2. How the antenna circuit is constructed.
 3. Converting signal currents into sound.
 4. How the R-F transformer handles the signal.
 5. How the tuning circuit functions.
 6. The Radio "bands."

Both Resident and Home Study Courses Offered

NATIONAL SCHOOLS

LOS ANGELES 37, CALIFORNIA EST. 1905



MAIL OPPORTUNITY COUPON FOR QUICK ACTION

National Schools, Dept. 9-RE (Mail in envelope or 4000 South Figueroa Street paste on penny postcard.) Los Angeles 37, California

Mail me FREE the book "Your Future in Radio-Television" and the sample lesson of your course. I understand no salesman will call on me.

NAME _____ AGE _____

ADDRESS _____

CITY _____ ZONE _____ STATE _____

bringing
a
giant
down
to
size

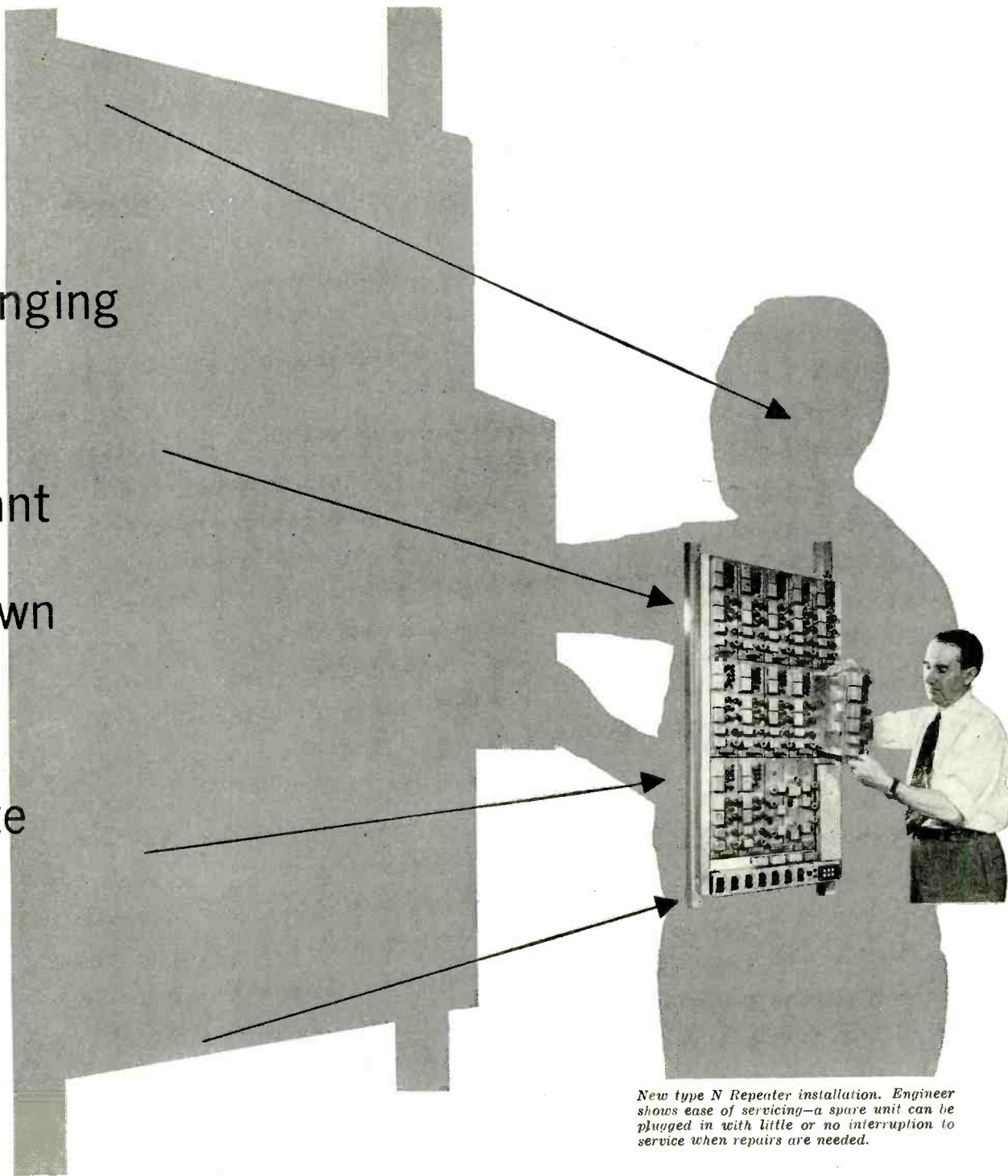

New type N Repeater installation. Engineer shows ease of servicing—a spare unit can be plugged in with little or no interruption to service when repairs are needed.

“CARRIER SYSTEM” telephony is economical, because many voices use the same pair of wires. But the extra equipment needed formerly limited it to the longer distances.

Now Bell Laboratories have developed new short-haul carrier, economical down to 25 miles, sending 12 conversations on two pairs of wires in a cable.

Keys to the new system are new circuits, miniature tubes, pocket-size wave filters and Permalloy “wedding ring” transformer cores that will barely slip over a man’s finger. New

manufacturing processes were developed in co-operation with the Western Electric Company. Components are pressed into a plastic mounting strip with heat, a score at a time, instead of being mounted separately.

With this new carrier system more service can be provided without laying more cables. Tons of copper and lead can be conserved for other uses. It’s another example of how science takes a practical turn at Bell Telephone Laboratories, to improve service and to keep its cost down.

BELL TELEPHONE LABORATORIES

WORKING CONTINUALLY TO KEEP YOUR TELEPHONE SERVICE ONE OF TODAY'S GREATEST VALUES



RADIO-ELECTRONICS for

TV Means Jobs—Good Paying Jobs—for Technically Trained Men



★ ENGINEERS



★ OPERATORS



★ CAMERAMEN



★ TECHNICIANS



★ INSTALLERS

Here's How CREI Home Study Training
Prepares You for a Better Job in
TELEVISION



★ SERVICEMEN

WHAT YOU DO to keep yourself abreast of new developments is what counts toward advancement in television. Obviously, everyone cannot qualify. *Those who do are well rewarded.* The television industry offers almost unlimited opportunity to trained engineers and technicians. CREI training helps all levels, from novice to experienced engineer, because its specialized individual instruction brings out the best in a man and takes him as far as his own aptitude and effort will let him go.

CREI is an accredited technical institute founded in 1927. Its home study graduates fill important jobs throughout the radio, television and electronics industries. Leading industrial firms—RCA Victor, Pan American Airways, United Air Lines, to name only a few—have used or are now using CREI group training

programs. Industry welcomes CREI grads—CREI training is recognized as a respected reference.

Make your own opportunity in television! Add CREI technical training to your present experience—start either at the beginning or at an advanced stage. Get yourself a better TV job—make more money—enjoy increased security. The next two years can be the most important of your lifetime. Write today for complete information. The cost is popular, the terms easy.

NOTE TO MEN WHO EXPECT TO BE IN UNIFORM SOON:

TV-Electronics training is excellent background for vitally important radar, communications and navigation work in the Armed Services. If you expect to enter service, prepare now to qualify via CREI Home Study for a higher rating in interesting technical work.

THE THREE BASIC CREI COURSES:

- ★ **PRACTICAL RADIO ENGINEERING**
Fundamental course in all phases of radio-electronics
- ★ **PRACTICAL TELEVISION ENGINEERING**
Specialized training for professional radiomen
- ★ **TELEVISION AND FM SERVICING**
Sit-down course for men in "top-third" of field

ALSO AVAILABLE AS RESIDENCE SCHOOL COURSES

CAPITOL RADIO ENGINEERING INSTITUTE

An Accredited Technical Institute Founded in 1927
Dept. 149C, 16th & Park Rd., N. W., Washington 10, D. C.
Branch Office: San Francisco (2) 780 Market St.

MAIL COUPON FOR FREE BOOKLET

CAPITOL RADIO ENGINEERING INSTITUTE
Dept. 149C, 16th & Park Road, N. W., Washington 10, D. C.

Gentlemen: Send booklet, "Your Future in the New World of Electronics," together with details of your home study training, CREI self-improvement program and outline of course. I am attaching a brief resume of my experience, education and present position.

Check the Field of Greatest Interest:

- | | |
|--|--|
| <input type="checkbox"/> Practical Television Engineering. | <input type="checkbox"/> Aeronautical Radio Engineering. |
| <input type="checkbox"/> Practical Radio Engineering. | <input type="checkbox"/> Broadcast Radio Engineering (AM, FM, TV). |
| <input type="checkbox"/> TV, FM & Advanced AM Servicing. | |

NAME _____ AGE _____

ADDRESS _____

CITY _____ ZONE _____ STATE _____

If Residence School in Wash., D. C. Preferred. Check Here

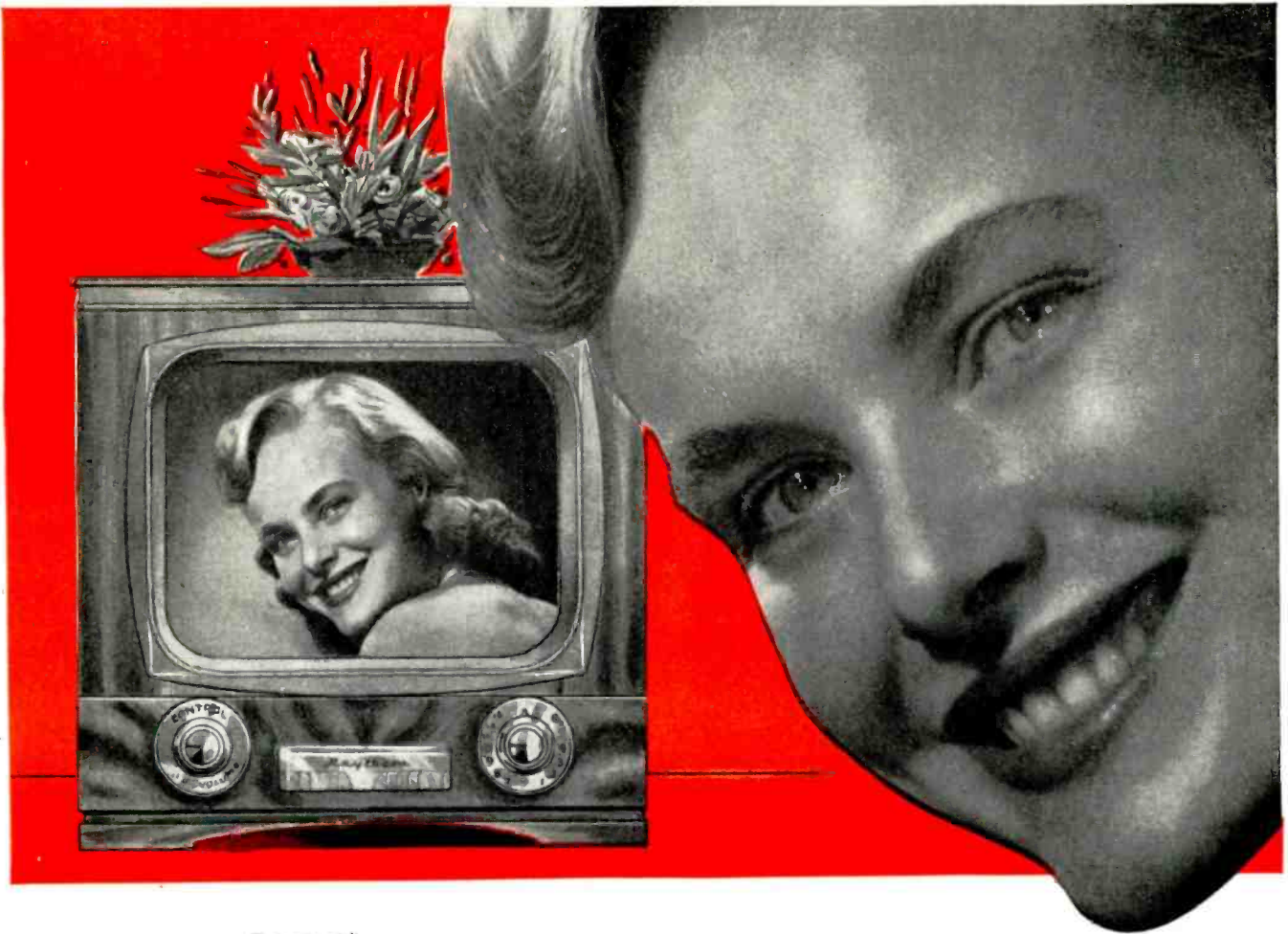

THERE ARE "101" REASONS WHY I LOOK MY BEST ON

RAYTHEON TELEVISION PICTURE TUBES

The reasons are the 101 *rigid quality tests and inspections* that Raytheon Television Picture Tubes must pass before shipment. At every stage of their assembly — the components, the chemicals, the processing, — Raytheon Tubes are checked and rechecked to insure electrical and mechanical perfection of finished tube.

This strict control of quality is an old story at Raytheon. For more than twenty-five years they have pioneered and manufactured almost every type of electronic tube — always to the highest standards of quality and performance known to the industry.

Logically, this vast experience and knowledge applied to Raytheon Picture Tubes guarantees superior quality and performance, makes them Right for Sight! That's why you can replace with Raytheons with

complete confidence that you are giving your customers the finest tubes on the face of the earth — the finest pictures on the face of a tube. See your Raytheon Tube Distributor today.

A "MUST" for SERVICE DEALERS!

8 pages of the latest information on all Television Picture Tubes

The new RAYTHEON Television Picture Tube Characteristics Chart lists over 110 television picture tubes, including the new 14", 17" and 20" electrostatic focus tubes. It contains complete basing information, technical data, safety handling precautions plus a section covering factors concerning interchangeability. Write for your free copy of this valuable booklet, today. Address Dept. F Raytheon Mfg. Co., Receiving Tube Division, 55 Chapel Street, Newton 58, Massachusetts.



Excellence in Electronics

RADIO AND TELEVISION RECEIVING TUBES, CATHODE RAY TUBES, SPECIAL PURPOSE TUBES, SUBMINIATURE TUBES, MICROWAVE TUBES

RAYTHEON MANUFACTURING COMPANY

Receiving Tube Division

Newton, Mass., Chicago, Ill., Atlanta, Ga., Los Angeles, Calif.

NOW... GET EVERYTHING YOU NEED TO LEARN AND MASTER

TELEVISION

RADIO-ELECTRONICS ...AT HOME!

Use REAL commercial-type equipment to get practical experience



Here's the REAL THING!

SET UP YOUR OWN HOME LABORATORY

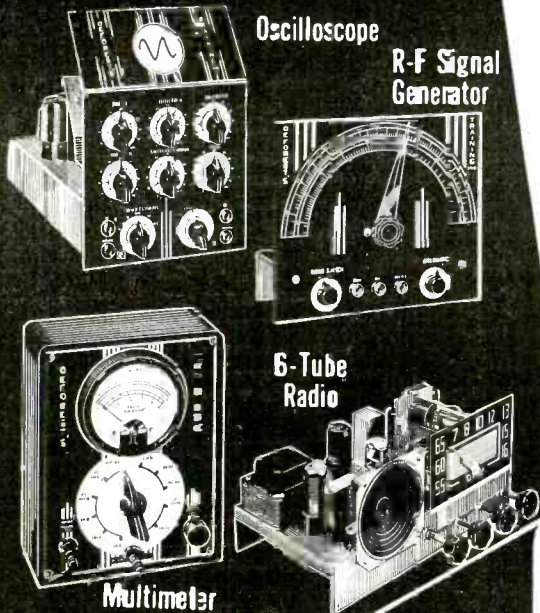

Oscilloscope

R-F Signal Generator

6-Tube Radio

Multimeter

ABOVE: Build and keep a real 16 INCH commercial TV receiver. Optional after completing regular training at slight additional cost.

D.T.I., ALONE, INCLUDES BOTH MOVIES and HOME LABORATORY In addition to easy-to-read lessons, you get the use of HOME MOVIES — an outstanding training advantage — plus 16 big shipments of Electronic parts. Perform over 300 fascinating experiments for practical experience. Build and keep real commercial-type test equipment shown at left.

MODERN LABORATORIES

If you prefer, get all your preparation in our new Chicago Training Laboratories—one of the finest of its kind. Ample instructors, modern equipment. Write for details!

MILITARY SERVICE!

If you're subject to military service, the information we have for you should prove doubly interesting. Mail coupon today.

Get BOTH of these information packed publications FREE!



HOME MOVIES

De FOREST'S TRAINING, INC.
CHICAGO 14, ILLINOIS
A De VRY INSTITUTION

ACT NOW! MAIL COUPON TODAY!

DeFOREST'S TRAINING, INC., Dept. RE-9-H
2533 N. Ashland Ave., Chicago 14, Ill.

Without obligation, I would like your late News-Bulletin showing 89 ways to earn money in Television-Radio-Electronics ... and how I may prepare to get started in this thrilling field.

Name..... Age.....
Street..... Apt.....
City..... Zone..... State.....

For a
BETTER PICTURE
on the TV Screen
.. And Atop the TV
Receiver Cabinet
ASTATIC TV and FM BOOSTERS



Model BT-1
List Price
\$32.50

IT'S better viewing all around, with one of the four Astatic TV and FM Booster models. Advanced engineering principles and famous Astatic manufacturing quality assure better performance . . . brighter, clearer pictures . . . crisp, clear sound. Handsome, luxurious cabinets—in a variety of styles and finishes—permit selection to suit the style of the TV receiver. No matter how you look at it, the better booster is an Astatic. Write for full details.

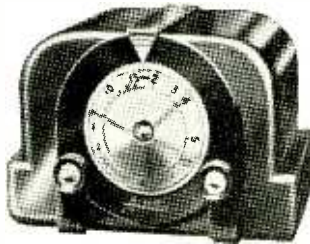

Model BT-2
List Price
\$34.95

THE
Astatic
CORPORATION
CONNEAUT, OHIO
IN CANADA, CANADIAN ASTATIC LTD., TORONTO, ONTARIO

Model AT-1
List Price \$54.50
(Also available in
blond wood cabinet
—Model AT-1B
List Price \$56.50.)

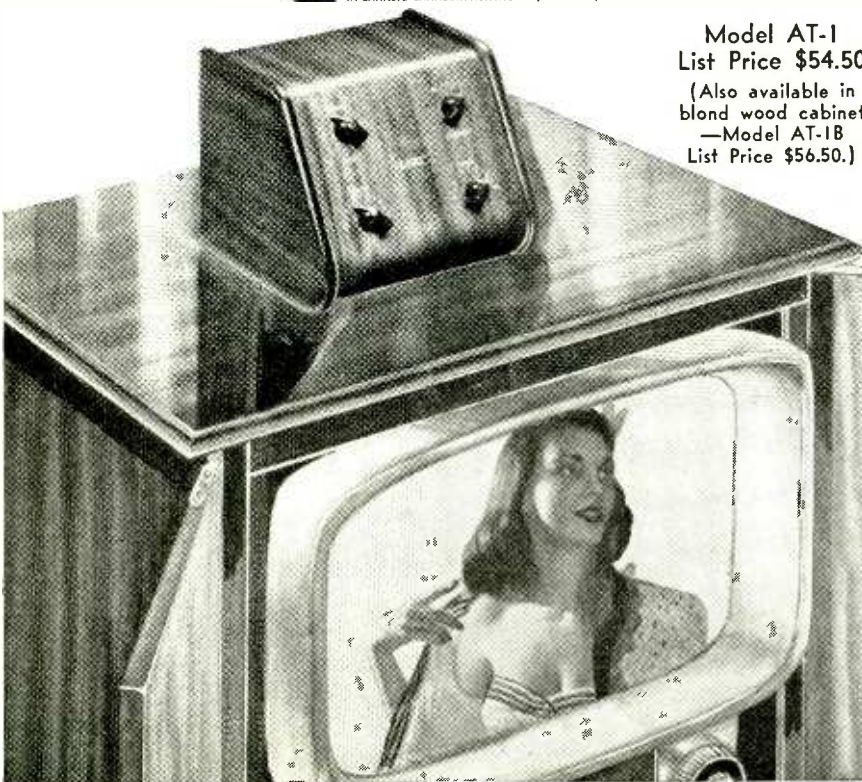

TRANSCONTINENTAL TV is just around the corner. September 30 will see two-channel service initiated on coast-to-coast microwave radio-relay facilities of the Long Lines Department of the American Telephone and Telegraph Co.

Words and pictures will be relayed between 107 towers stretching from New York through Chicago, Omaha, and Denver to San Francisco. The system will handle two channels, one east, one west.

Microwave radio-relay transmissions, coast-to-coast, of telephone calls was scheduled to start August 17. Construction of the project began in 1948. The total cost is 40 million dollars.

LEROY A. WILSON, president of the American Telephone and Telegraph Co., died June 28, in New York City. He was 50 years old, and had headed A. T. & T. since 1948. His formula for success, he once said, hinged on "two simple things—first, the ability of the individual to analyze a situation and decide what should be done, and second, his capacity and courage to get it done."



Mr. Wilson studied engineering at Rose Polytechnic and was graduated in 1922. Starting at \$27.50 a week with Indiana Bell Telephone, he advanced to head the corporation which in 1948 had assets totalling more than 10 billion dollars and is the largest corporate enterprise in the world.

A STORAGE SYSTEM using a cathode-ray tube is being introduced by International Business Machines Corp. for use in their new electronic calculators. The system was developed by F. C. Williams, English radar expert and will be used under a licensing agreement with National Research Development Corp. of London.

Information is stored as dots and dashes on the face of the tube in a manner similar to the projection of a picture on the ordinary home TV set.

The information is read back from the tube to the computer in a few millionths of a second by passing the cathode-ray beam over the same area. As many as 2,048 items of information have been stored on a cathode ray tube with a 24-square-inch screen.

Which Do You Want?



Better Pay



A Nice Home



A New Car



Greater Security



Happy Vacations and Travel

Get Your FCC Ticket
Then Use Our
Amazingly Effective
Job-Finding Service
To Get a Better Job

Add Technical Training to Your Practical Experience and

Get Your FCC COMMERCIAL RADIO OPERATOR LICENSE



I can train you to pass your FCC License Exams in a few short weeks if you've had any practical radio experience—amateur, Army, Navy, radio servicing or other. My time-proven plan can help put you, too, on the road to success.

Edw. H. Guifford
Vice President

in a Minimum of Time

Get this Amazing Booklet **FREE**

TELLS HOW — WE GUARANTEE
TO TRAIN AND COACH YOU AT HOME
IN SPARE TIME UNTIL YOU GET
YOUR FCC LICENSE

TELLS HOW —
Our Amazingly Effective
JOB-FINDING SERVICE
Helps CIRE Students Get Better Jobs



TELLS HOW — Employers Make
JOB OFFERS Like These
to Our Graduates Every Month

OURS IS THE ONLY HOME STUDY COURSE WHICH SUPPLIES FCC-TYPE EXAMINATIONS WITH ALL LESSONS AND FINAL TESTS.

Gets Five Job-Offers From Broadcast Stations
"Your 'Chief Engineer's Bulletin' is a grand way of obtaining employment for your graduates who have obtained their 1st class license. Since my name has been on the list, I have received calls or letters from five stations in the southern states, and am now employed as Transmitter Engineer at WMMT."
Elmer Powell, Box 274, Sparta, Tenn.

Telegram, August 9, 1950, from Chief Engineer, Broadcast Station, Pennsylvania. "Have job opening for one transmitter operator to start immediately, contact me at once."
Letter, August 12, 1950, from Dir. Radio Div. State Highway Patrol. "We have two vacancies in our Radio Communication Division. Starting pay \$200; \$250 after six months' satisfactory service. Will you recommend graduates of your school?"
Letter, August 21, 1950, from radio-television sales and service company, Ohio. "We are in need of a good television man. The pay will be good, also good surroundings to work in. Please let us hear from you."
These are just a few examples of the job offers that come to our office periodically. Some licensed radioman filled each of these jobs . . . it might have been you!

Your FCC Ticket is always recognized in all radio fields as proof of your technical ability.

Get All 3 FREE

MAIL COUPON NOW

HERE'S PROOF FCC LICENSES ARE OFTEN SECURED
IN A FEW HOURS OF STUDY WITH OUR
Coaching AT HOME in Spare Time

Name and Address	License	Lessons
Lee Worthy 2210 1/2 Wilshire St., Bakersfield, Cal.	2nd Phone	16
Clifford E. Vogt Box 1016, Dania, Fla.	1st Phone	20
Francis X. Foersch 38 Braucher Pl., Bergenfield, N. J.	1st Phone	38

CLEVELAND INSTITUTE OF RADIO ELECTRONICS
Desk RE-33, 4900 Euclid Bldg., Cleveland 3, Ohio

CLEVELAND INSTITUTE OF RADIO ELECTRONICS
Desk RE-33—4900 Euclid Bldg., Cleveland 3, Ohio
(Address to Desk No. to avoid delay.)
I want to know how I can get my FCC ticket in a minimum of time. Send me your FREE booklet, "How to Pass FCC License Examinations" (does not cover exams for Amateur License), as well as a sample FCC-type exam and the amazing new booklet, "Money-Making FCC License Information."

Name.....
Address.....
City..... Zone..... State.....
Paste on penny postcard or send air mail.



Optical comparator is used to check mica disc specifications to thousandth-inch accuracy.

ONE STANDARD

*The best that can
be made-for*
**Initial Equipment
and Replacement**



TUNG-SOL
RADIO, TV TUBES, DIAL LAMPS



TUNG-SOL LAMP WORKS INC. Newark 4, N. J.
Sales Offices: Atlanta • Chicago • Dallas • Denver •
Detroit • Los Angeles • Newark

RCA COLOR television tests were started July 9 in New York City. Half-hour programs every morning continued for a week, and another later series was planned. At the beginning of tests, extra programs were transmitted over a closed circuit for press and industry representatives.



RCA's Engstrom holds tricolor tube. He explained processes to other companies.

The morning tests, which included live pickup of outdoor scenes, were received in black-and-white by more than a million receivers in the New York metropolitan area. Stressing the compatibility angle, RCA ran large ads in the metropolitan papers urging the public to monitor the broadcasts and report the results. A huge and enthusiastic response was reported. Many viewers stated that the colorcasts received in black-and-white were better than standard black-and-white television broadcasting.

Reception in color, on special 54-tube receivers, was necessarily confined to a much smaller number. Response was mixed. Some reported that the color pictures seemed hazy as compared to CBS color. Others believed that the texture and detail were better than in Columbia's system.

In line with its policy of putting an electronic color system before the public, RCA is making available samples of the 16-inch basic developmental model tricolor tube and kits of associated circuit components and parts. The photo shows E. W. Engstrom, RCA vice-president in charge of research, holding a cutaway model of the 16-inch tube, with a 21-inch model before him. The occasion was a meeting of 231 radio-TV manufacturers at which RCA explained details of the new tube.

A representative of CBS expressed disappointment because of the complexity of the tube and the problems to be surmounted in manufacturing it. He said he had hoped that the company would be able "to plug it in" to the CBS system, thus eliminating rotating discs and drums. "I thought we would have a nice color tube to shove in, possibly this fall, but its use is pretty

far off . . ." He said it would be a long time before production in volume.

DR. LEE DE FOREST, called the father of radio because of his invention of the three-element vacuum tube, charged in a recent Chicago interview that his "grandchild," television, was running wild.

"Television, which could be so uplifting and enlightening is being used degradingly. In Los Angeles where I live, there are eighty or ninety murders a week broadcast on TV programs, mostly movies . . . It can only have a vicious effect on children . . ."

He said that television had been a disappointment in its handling of good music, and was having an adverse effect on reading of books and magazines. "Sponsors must reform and raise their intellectual levels," he said, adding that they could do so without losing a single viewer.

ADHESIVE TAPE RESISTOR is the latest in printed circuits and miniaturization techniques. A major disadvantage of printed circuits has been the difficulty of putting satisfactory resistors in the circuit.

In this new technique, circuits are printed in narrow metallic bands, leaving a gap at points where resistors are

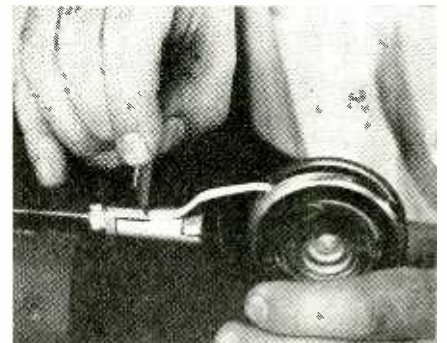

Resistors are attached and later fired.

used. Resistor lengths are then clipped off plastic tape which has an adhesive backing and which is coated with carbon black or graphite. These resistors are attached at the right point and fired at high temperatures.

The new method was developed as part of a research program sponsored by the Navy Bureau of Aeronautics and devised by B. L. Davis and associates of the National Bureau of Standards. The resistor is manufactured by spraying the resistance mixture onto a moving belt of tape.

RESEARCH by the Advertising Research Bureau, Inc., conducted for WRC-NBC showed that radio produced more traffic and a greater percentage of dollar volume than did equal amounts of newspaper advertising. An important result of the study showed that radio brought in large numbers of customers who had not seen newspaper advertising of certain commodities or services and proves that radio offers a separate market which retail stores thus would have lost.

—end—

RADIO-ELECTRONICS for

Take off the *blinders* and *EAT* again!

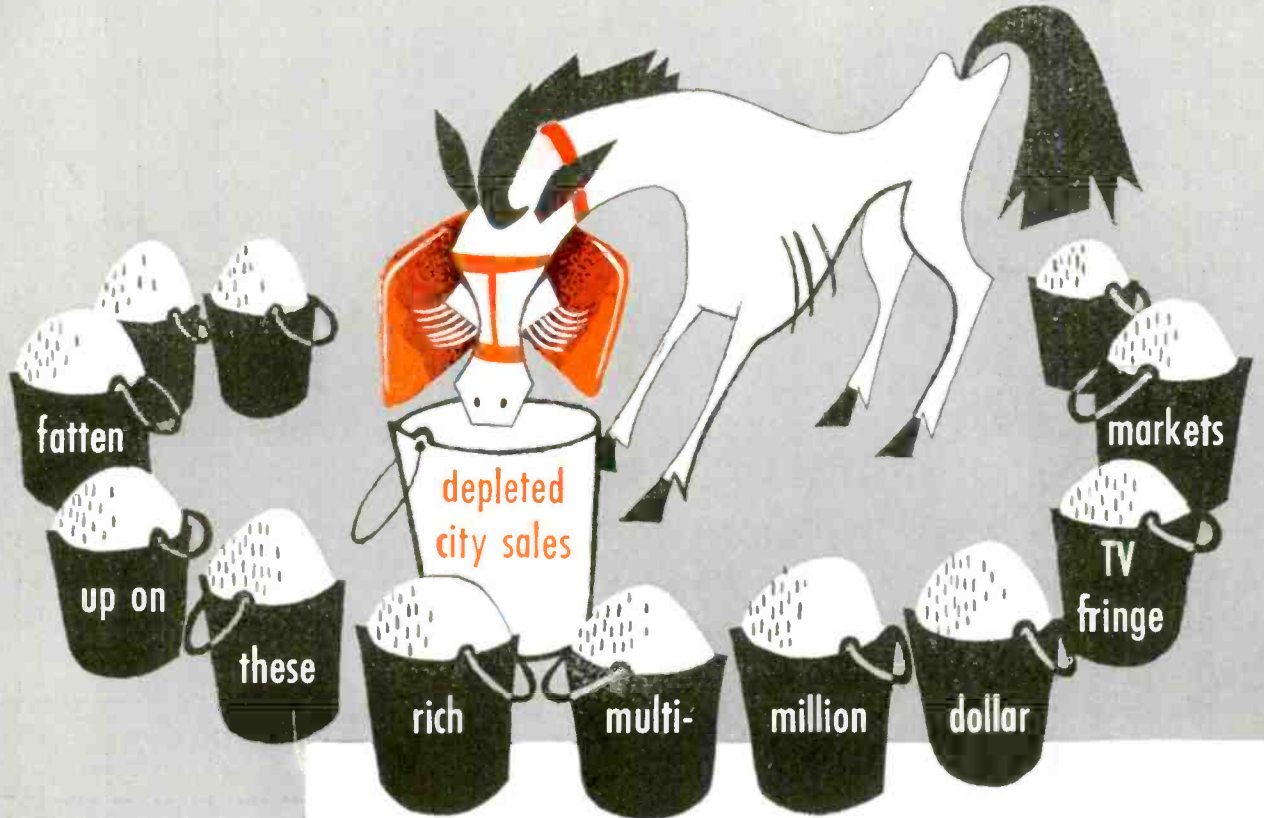

**ANCHOR
BOOSTERS**
make it possible!



THE ANCHOR *Suburbanite*
For Intermediate Reception



THE ANCHOR *Granger*
For Fringe Area Reception

ANCHOR RADIO CORP.
2215 SOUTH ST. LOUIS AVENUE • CHICAGO 23, ILLINOIS

MERIT

Best for Better TV Service

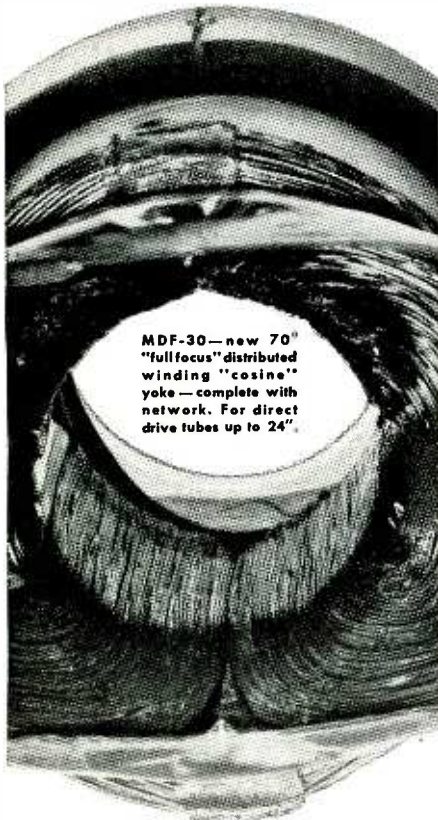

MDF-30—new 70" "fullfocus" distributed winding "cosine" yoke—complete with network. For direct drive tubes up to 24".

Merit TV full-line* Components For Conversion or Replacement

Merit... HQ for TV Service Aids

Keep ahead of TV conversion and component replacement service problems—write *MERIT, HQ for TV Service Aids*.

Ask for your free copy of: Merit TV Repl. Guide; Merit 1951 Complete Catalog N.5111; Merit Auto Vibrator Transformer Dealer Sheet and Repl. Guide, form N.3; Merit Output Transformer Chart, No. 4. Write to Merit Transformer Corporation, 4425 North Clark Street, Chicago 40, Illinois

These 3 Merit extras help you:

1. Exclusive: Tapemarked © with all specifications and complete hook-up data.
2. Full technical data packed with every item.
3. Listed in Howard Sam's Photofacts.

HVO-8—air core "flyback" for direct drive systems.



*Merit is meeting the TV replacement component and conversion demand with a line as complete as our advance information warrants!

Merchandising & Promotion

RCA Tube Dept., Harrison, N. J., has designed an illuminated "Professional Television Service" sign for TV service technicians. Available through distributors, the sign is part of an RCA campaign to promote the sale of its test



equipment and to build prestige for the TV servicing industry. Distribution of the sign will be limited as far as possible to service technicians who own RCA test equipment.

Sprague Products Co., North Adams, Mass., has issued the third edition of its Television Replacement Capacitor Manual which lists capacitor replacements for 964 TV sets under more than 60 brand names.

The manual can be obtained free from Sprague distributors or for 10 cents, to cover the cost of mailing, when ordered directly from the company. Sprague also released a 16-page catalog covering its capacitors, resistors, filters, and other products.

Jensen Industries, Inc., Chicago, has designed a new transparent plastic dealer pack which holds 32 needles. As each needle is removed, information on what to reorder can be seen in the vacant space.

Allen B. Du Mont Laboratories, Inc., Electronic Parts Division, East Paterson, N. J., has issued an instruction brochure for converting small TV sets to larger sizes. The instructions are available to service technicians through Du Mont distributors.

Sarkes Tarzian Inc., Bloomington, Ind., has released a brochure, "UHF Television Reception." The book shows how UHF can be received on any existing TV set with the addition of a Sarkes Tarzian Translator.

Cornell-Dubilier Electric Corp., South Plainfield, N. J., has compiled a manual listing over 400 TV twist-prong electrolytic capacitors. The manual, "C-D's Television Replacement Guide TVR 7," was designed to aid the service technician in selecting the proper replacement capacitor since there are some 500-odd types of twist-prong electrolytics.

The guide may be obtained from distributors or direct from the Jobber Division of Cornell-Dubilier. It is priced at 50 cents.

Hytron Radio & Electronics Co., Salem, Mass., has worked out a new budget plan to help distributors and service technicians sell Hytron TV picture tubes. Under the plan, set owners are able to purchase TV picture tube replacements on a time-payment basis with no down payments necessary. A national finance company is handling the arrangements and the distributor or service technician receives cash in full at the time of the sale.

National Union Radio Corp., Orange, N. J., is offering a tube carrying case free to service technicians through distributors. The company suggests that the distributor offer the case free with the purchase of 500 N.U. receiving tubes made within 60 to 90 days.

Standard Transformer Corp., Chicago, has issued two new catalogs: its mid-year catalog which lists 441 Stancor transformers and related components, and its television catalog and replacement guide listing more than 1,500 models and chassis built under 79 brand names.

The Easy-Up Tower Co., Racine, Wis., has made available a counter piece which displays Easy-Up pole accessories. It consists of a miniature roof on which is mounted a pole section with universal foot mount, fixed pole ring, and two types of rotating pole rings. It is available to distributors without charge.

Astron Corp., East Newark, N. J. manufacturer of capacitors and noise suppressors, is now packaging its products in new, handy, and attractive red-and-black cartons.



The Rauland Corp., Chicago, is offering prize certificates to push TV picture tube replacement sales among service technicians. Jack Powers, jobber sales manager of Rauland, indicated that the prize certificates are worth \$1.50 to \$4.50 in merchandise for each tube sold. He stated that the program was planned to stress the growing importance of the replacement market as the average age of TV sets increases.

General Electric Co.'s expansion plans include the construction of a 20,000-square-foot building in Springfield, N. J., for Precision Laboratories, Inc., a unit of the company's Components Division, now located in Irvington, N. J. G-E also announced that construction had begun on a new \$6,000,000 plant in Anniston, Ala.

—end—

RADIO-ELECTRONICS for

the only complete catalog
for everything in Radio,
TV & Industrial Electronics

your 1952 **free!**
ALLIED 212-page
value-packed catalog



Send for it today!

Here's the *one* authoritative, complete, up-to-date Buying Guide to TV, Radio and Industrial Electronics. Make your selections from the world's largest stocks of quality equipment at lowest, money-saving prices. See the latest and most complete presentation of electronic apparatus: new TV, AM and FM receivers; High-Fidelity Custom Sound components; latest P.A. Systems and accessories; recorders; fullest selections of Amateur receivers and station gear; specialized industrial electronic equipment; test instruments; builders' kits; huge listings of parts, tubes, tools, books—the world's *most complete stocks* of quality equipment.

ALLIED gives you *every* buying advantage: speedy delivery, expert personal help, lowest prices, liberal time payment terms, assured satisfaction. Get the latest 1952 ALLIED Catalog. Keep it handy—and save time and money. Send for your FREE copy today!

the world's
largest stocks

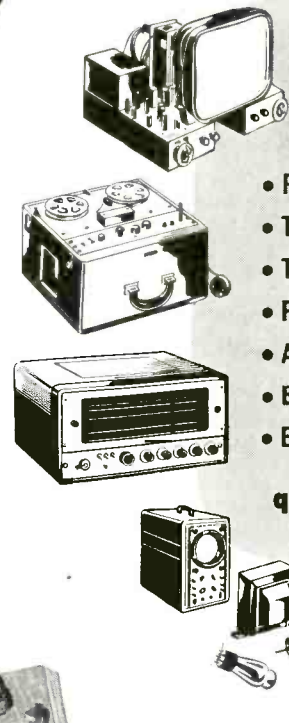

- Radio Parts Unlimited
- Test Instruments
- Television & Home Radios
- P.A. and Hi-Fi Equipment
- Amateur Station Gear
- Builders' Supplies
- Equipment for Industry

quick, expert service

ALLIED IS YOUR TV and HI-FI HEADQUARTERS

Count on ALLIED for the latest in TV! If it's made—we have it for quick delivery. We specialize, too, in High-Fidelity sound components—everything in amplifiers, speakers, tuners, phono gear and accessories. For TV or Hi-Fi—think of ALLIED!

TV **HI-FI**



free

**SEND TODAY FOR RADIO'S
LEADING BUYING GUIDE**

ALLIED RADIO
the World's Largest Radio Supply House
EVERYTHING IN ELECTRONICS

ALLIED RADIO CORP., Dept. 2-J-1
833 W. Jackson Blvd., Chicago 7, Illinois

Send FREE 212-page 1952 ALLIED Catalog No. 127.

Name _____

Address _____

City _____ Zone _____ State _____

EICO
TEST INSTRUMENTS

Guard

CBS-Columbia Inc.
COLOR TELEVISION PRODUCTION QUALITY



In the CBS-Columbia design laboratories, Al Goldberg makes some important readings with the EICO Model 221 Vacuum Tube Voltmeter and Model 555 Multimeter, as Harry R. Ashley looks on.



Mr. Al Goldberg, Assistant Chief Engineer of CBS-Columbia, and Harry R. Ashley, President of EICO, inspecting the use of the EICO Model 221 Vacuum Tube Voltmeter and Model HVP-1 High Voltage Probe at the Sweep Frequency Troubleshooting Position on the CBS-Columbia Color Television production lines.

KITS
WIRED INSTRUMENTS

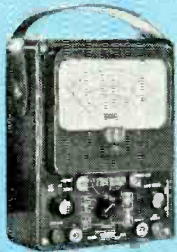

NEW 555K MULTIMETER KIT \$29.95. WIRED \$34.95
20,000 ohms/volt



320K SIG. GEN. KIT \$49.95. WIRED \$29.95

NEW 322K SIG. GEN. KIT \$23.95. WIRED \$34.95



NEW 950K R-C BRIDGE & R-C-L COMP. KIT \$19.95
WIRED \$29.95

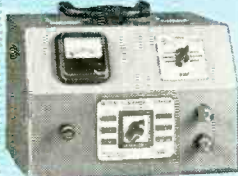

NEW 1040H BATTERY ELIM. KIT \$25.95. WIRED \$34.95



511K VOM KIT \$14.95
WIRED \$17.95



NEW 526K MULTIMETER KIT \$13.90
WIRED \$16.90
1000 ohms/volt

NEW 1171K RES. DECADE BOX KIT \$19.95
WIRED \$24.95

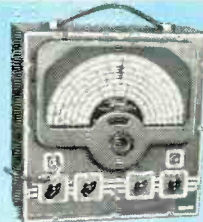

NEW 315K DELUXE SIG. GEN. KIT \$39.95
WIRED \$59.95



145K SIG. TRACER KIT \$19.95
WIRED \$28.95



NEW 625K TUBE TESTER KIT \$34.95
WIRED \$49.95

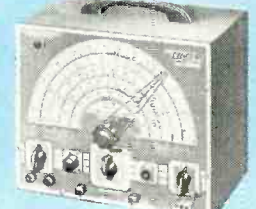

360K SWEEP GEN. KIT \$34.95
WIRED \$49.95

For Laboratory Precision at Lowest Cost—the Leaders Look to EICO!

WHY does CBS-Columbia, Inc., today's headline-maker in Color Television set production, use EICO Test Instruments on its new Color Television production lines and in its design laboratories?

BECAUSE — like Emerson, Tele-King, Teletone, and many another famous TV manufacturer coast to coast, CBS-Columbia knows that . . .

Only EICO Test Equipment delivers All 10 EICO nomical Features!

1. Laboratory Precision
2. Lowest Cost
3. Lifetime Dependability
4. Speedy Operation
5. Rugged Construction
6. Quality Components
7. Latest Engineering
8. Super-Simplified Assembly and Use Instructions
9. Laboratory-Styled Appearance
10. Exclusive EICO Make-Good Guarantee

Before You buy any higher-priced equipment, be sure You look at the *EICO* line—in *Wired* as well as *Kit form!* Each EICO product is jam-packed with unbelievable value. YOU be the judge—compare, see *EICO instruments today* — in stock at your local jobber — and **SAVE!** Write NOW for FREE newest Catalog 9-C.

FOLLOW THE LEADERS . . . INSIST ON EICO!



NEW 221K VTMV KIT \$25.95
WIRED \$49.95



HIGH VOLTAGE PROBE \$6.95



NEW 425K 5" PUSH-PULL SCOPE KIT \$44.95. WIRED \$79.95

EICO

ELECTRONIC INSTRUMENT CO., Inc.
276 NEWPORT STREET, BROOKLYN 12, NEW YORK

©1951, Electronic Instrument Co., Inc.
Prices 5% higher on West Coast. Due to unstable conditions, prices and specifications are subject to change without notice.

TELEDUCATION

... A radically new type of teaching now becomes possible ...

By HUGO GERNSBACH

"A COUNTRY is only as good as its schools," may be a trite remark. More to the point is the version: "A country is only as good as its school teachers."

By this yardstick the U. S. has been a mediocrity a long time. This appalling situation has steadily worsened during recent years chiefly because teachers as a class are notoriously underpaid and frequently go into other professions or industry where their talents will be paid on a more commensurate plane.

It is within the realm of possibility that television will finally solve this problem that for many years has been a nightmare to forward looking educators.

As early as December, 1945, the writer asked the question: "Why use 100 mediocre teachers when one brilliant one can be simultaneously in 100 schools via television?"

In recent months television in the classroom has received a great deal of publicity. The usual idea in these projects is merely to have teachers address classes via TV broadcast stations. It is not intended to continuously cover all types of classes, but only occasionally. There would still have to be a present day type of teacher in the classroom under such a system. This is a most unsatisfactory means of exploiting television. Indeed, such a system hardly scratches the surface of television's possibilities.

In the future we can foresee an entirely new and revolutionary television development that to the best of our knowledge has not been visualized before. It would work somewhat as follows:

There will be a TV Education Center whence issues all teaching for all the public schools of the city. This would include high schools. The system is, of course, applicable to universities, colleges, or other seats of learning. For want of a better term, let us call the new endeavor *Teleducation*.

Indeed, it is quite possible that in the future there might be a national Teleducation Center which would originate and radiate to the rest of the country the services of the nation's greatest teachers.

Take the City of New York, which at present has over 700 schools and over 35,000 teachers.* It would only require 30, and certainly not more than 50 teachers to teach New York City's 800,000 pupils via television. These teachers would be giants in their field—the best that money could secure. Thus, one teacher would teach arithmetic only for the lower grades, another would teach grammar for the higher grades, etc.

With television important physical props in all classes would become eminently feasible. Thus, in the lower grades the teacher speaking from the teleducation center would place a boy behind a row of apples, displayed on a table. Apples would be added or subtracted, using actual apples, while simultaneously the problem and the solution appear on the school's "electronic blackboard". Here figures from 1 to 9 and 0 pop mysteriously into place after meandering all over the board. Colored figures can be used if so desired.

In the geography classes, colored maps can be displayed of any country being studied. These effects and many others are flashed on huge TV classroom screens simultaneously in all the 700 schools.

While standard television equipment can be used, the transmission had best be over wire lines, in order to obtain

disturbance-free pictures of the highest quality. All TV broadcasts would be in full color.

In time to come, for greatly enhanced effects, three-dimensional, direct-view stereoscopic pictures will be flashed on the screen.

In the classroom we will no longer have regulation teachers. Instead, there will be a trained "teacher attendant"—a class supervisor—to keep order, to collect all pupils' papers and supervise other activities such as penmanship, individual recitations, etc.

Now comes a rather radical innovation made necessary by class television. During the periods when no teaching programs are being telecast from the teleducation center *the entire class is televised* by special TV cameras in the classroom. Thus the class and its pupils are supervised continuously "by the principal"—actually by a distant electronic gadget which makes a motion picture record on minifilm. This film can be played back by the central teachers at any time in both sight and sound.

Do not imagine that televising the pupils is for eavesdropping purposes. Instead the pupils are encouraged to ask questions, to recite texts, poems, etc. The pupils in turn are asked questions by the teacher attendant, *who however does not grade the pupils*. At the teleducation center special professional educators and grading teachers view and listen to all classes. These educators then grade all pupils. The pupils' most recurring questions are noted by the distant teachers who answer them via television the next day. If required, certain outstanding pupils can be called by name. This the TV teachers can do readily, as all school desks are numbered, these numbers showing in the filming of the classroom.

It would seem certain that television classes will be highly popular with children and students of all ages. "Playing hookey" with the younger element will probably become a lost art! Incidentally, the classroom teacher attendant—most likely a mature woman—will have little to do to keep her occupied when the television classroom screen is "alive". Fighting among the younger children will probably be rare and there will be little censure for unruliness among the smaller fry during the TV teaching period.

It will even be possible for backward children to receive "personal" instruction after school hours, because all programs at the central teleducation center are recorded. It will be a simple matter for the attending class supervisor to request the playing back of certain lessons for the benefit of those children who need extra and repeated instruction.

Education via television can become a tremendous force in our future classroom teaching. It is sufficiently flexible to encompass all eventualities and in time to come *any* teaching problem can readily be solved by its means.

What will be the advantages of the new teleducation system?

1. Pupils and students will obtain an immensely better education for less money expended.
2. Education will no longer be "spotty" due to incompetent or poor teachers—all grades now having only top flight teachers.
3. "Faulty teaching, due to teacher's quirks, subversion, etc., will no longer be possible.
4. Central supervision of all classrooms by the higher teaching echelon will make for eventual better educational practices.

*New York City at present has five grades of teachers: 1. Kindergarten. 2. 1st to 6th grade. 3. 1st to 8th grade. 4. Junior high school. 5. High school.

(A condensed form of this article was first published on December 10, 1950, in the author's annual Christmas booklet NEWSPEEK.)

Using TV TEST EQUIPMENT

Proper procedure and instrument use simplifies TV alignment problems

By H. G. CISIN

THE finest test equipment is worthless if improperly used. It's "what you do with what you've got," that counts. Even mediocre instruments, properly used, can produce worthwhile results. Consider an ordinary television receiver alignment job. This appears to be a routine procedure. You have: the manufacturer's detailed instructions; specified response characteristic curves including marker frequencies; a new sweep-signal generator; a medium-priced scope; and a fairly good multimeter with a vacuum-tube voltmeter.

The set seems to need complete re-

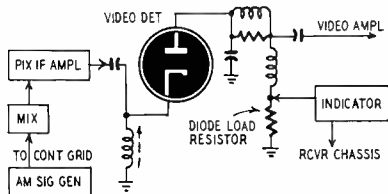

Fig. 1—The traps are aligned first, using apparatus and connections shown.

alignment, so you will proceed as follows: traps including sound take-off; pix i.f. amplifier, including mixer, sound section, oscillator; and r.f. amplifier. The traps are first, since if they were aligned after the pix i.f., the over-all response curve would be spoiled. Align the sound section before proceeding with the front-end alignment, since a correctly adjusted sound system helps in rapid alignment of the oscillator.

Set up the apparatus (Fig. 1) and, following accepted alignment procedure, adjust the traps. If the v.t.v.m. is the indicator, inject an unmodulated signal at the mixer control grid; if the scope is used, inject a modulated signal. Everything seems O.K., so you proceed with the i.f. alignment. The manufacturer's instructions state that this set incorporates an overcoupled pix i.f. amplifier and you decide to use your sweep generator with inbuilt marker for this alignment, using the scope as indicator.

These are connected and here you hit what appears to be the *first snag*. Actually, this is the second, for you neglected to warm up the AM signal generator before using it and failed to *calibrate* it, so the chances are that the traps are more poorly aligned now than when you began. It's a good idea to allow 15 or 20 minutes for the signal generator to become stabilized before starting alignment work. As to calibration, more about that later.

Getting back to the pix i.f. alignment snag, the first response curve obtained from the stage preceding the video detector bears no resemblance to the curve specified by the manufacturer. You manipulate the designated slugs unsuccessfully. You bring down an unwanted peak with one adjustment and it appears incorrectly at another point. You rest your hand on the scope and get a different curve. Worse yet, weird oscillations appear along with the response curve, making it difficult to recognize the real curve.

Causes of alignment troubles

The hand on the scope affects the response curve and is definitely a result of improper grounding. You did ground each instrument to the TV set chassis, using wire, but this is not sufficient. Some of the test equipment was at different ground potentials than others so that stray current flowed between them. Use a copper bench top, with the receiver chassis and all test instruments placed on this. If copper cannot be obtained, galvanized iron will do. Or else bond the units with heavy copper braid, such as electricians use to carry heavy currents.

Use shielded leads for all connections between the instruments and the TV set. Unshielded leads pick up stray currents.

A common cause of misleading response curves is too strong a signal. Use the weakest signal possible. You can use a strong output from the generator when you are first forcing the signal through, especially where the

alignment of a single stage is involved and the amplification offered by the stage is small. Just as soon as the desired response is seen on the scope, *reduce* the signal strength at the generator, raising it if necessary at the scope with the scope amplifier. Unless this is done, the response curve will probably be useless. It may show a beautiful flat top as indicated in Fig. 2 but this is due to overloading of the pix i.f. amplifier with resultant "clipping." An overloaded scope amplifier can do the same, so use caution. Always try to work with minimum amplification.

Spurious oscillations

The next step is to get rid of the oscillations which spoil the response curve. Assume you have used shielded leads, but this trouble persists. Oscillations may be picked up from other oscillators in the set. Remove the local oscillator which beats against the incoming signals when the set is in use, unless the manufacturer recommends otherwise. In that case, tune to a high-band channel.

In the pix i.f. alignment of any set where the signal generator connection is moved back stage-by-stage, from the input of the stage nearest the video detector to the input of the mixer, oscillations may come through from the preceding stages. This is true in alignment of an overcoupled i.f. amplifier. To avoid this when the stage nearest the video detector is being aligned, shunt .001- μ f capacitors between the control grids and chassis of all the preceding stages. As the signal generator input is moved back to a preceding stage, the .001- μ f capacitor at that grid is removed.

It is often possible to shut out unwanted frequency disturbances by con-

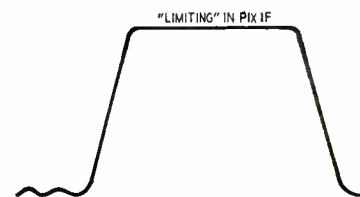

Fig. 2—Clipping due to i.f. overload.

RADIO-ELECTRONICS for

necting a .001- μ f capacitor between the vertical and ground post of the scope. This applies only when the scope is connected to the video detector as an indicator, but does not apply to other signals. The video detector is an AM detector, and it detects changes in the amplitude of the signal from the sweep generator. If a signal of constant amplitude (c.w.) is injected, the amplitude varies at the output of the i.f. amplifier as the signal is swept back and forth across the desired band of i.f. frequencies. This is due to the response of the i.f. amplifier. The sweep takes place at a 60-cycle rate in most sweep-signal generators and the output of the video detectors varies at this rate. Consequently, the .001- μ f capacitor across the scope does not affect the response characteristic, but effectually shorts out any high frequencies.

Some technicians also place an isolating resistor of 5,000-15,000 ohms in

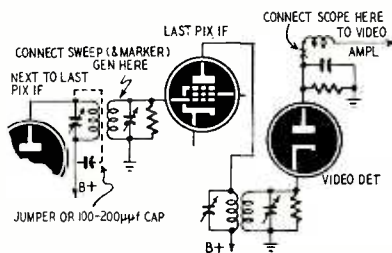

Fig. 3—Keeping overcoupled transformer primary from acting as absorption trap.

series with the V post of the scope, forming an R-C filter. Use this when the scope is connected across a high-impedance point where high-frequency loading effect results from the shunt capacitance of the scope. Although this may be only .00001 μ f, the reactance at 25 megacycles is 636 ohms, so the leakage would be considerable. Some of the better oscilloscopes have high-frequency probes which include a high series resistance which forms part of an R-C filter.

Other poor curve causes

Incorrect bias on the i.f. tubes causes trouble in alignment. Verify this by changing the setting of the contrast control (use a TV set whose control changes the i.f. bias) and at the same time watching the response curve obtained in the usual way from a pix i.f. alignment setup. The response curve will change until, when the bias becomes too high, the curve will disappear entirely. Most manufacturers specify the exact bias to be used throughout the pix i.f. alignment process. For example, Magnavox calls for a bias of -3 volts on the i.f. bus line for its CT-219, 220, and 222 models. A better practice is to set the bias at a value which would give normal operating conditions in the customer's home, since a set in a fringe area would normally operate with much less bias than one in a strong-signal area. If the service shop is in the same area as the customer, there should be little difficulty, as the correct bias can

be deduced by checking the bias for several stations on a set which is operating perfectly. In other cases, experience can be a guide.

Best procedure always

When aligning an overcoupled i.f. amplifier, the primary of the transformer ahead of the control grid to which the signal is applied will absorb energy in a manner similar to an absorption trap, putting a dip in the response curve. The remedy is to shunt the primary with a jumper or with a small capacitor, approximately .0001 μ f, as shown in Fig. 3. When alignment is completed the shunt is removed. This applies to an alignment procedure employing a sweep generator and an oscilloscope.

If an overcoupled system is aligned with an AM signal generator and a v.t.v.m., the primary is shunted with a jumper or a low-value resistor (500 to 1,000 ohms) while the secondary is tuned to a maximum voltage reading. The shunt is then taken off the primary and put across the secondary, while the primary is tuned to a maximum.

Need for calibration

Both the sweep-signal generator and the marker generator must be accurate, otherwise results are valueless. Some commercial generators contain built-in crystal standards. Any well-designed crystal-controlled heterodyne frequency meter, such as the surplus Signal Corps (BC-221) meter, will serve as a calibrator if it covers the necessary frequency range. The zero-beat principle is used. The signal from the generator to be calibrated is beat against a signal from an accurate crystal-controlled oscillator which serves as a standard. Harmonics may be used, thus extending the range of the calibrator.

A commercial unit, the RCA Calibrator, incorporates a 2.5 mc primary and a 0.25 mc, modulating crystal, a heterodyne detector, an audio amplifier and a speaker. The combination of the two crystals will calibrate any signal source over a range of 250 kc to 250 mc. Audible beats are provided to identify the 2.5 mc and 0.25 mc check points. This instrument includes a marker signal generator and is designed to work along with the RCA WR-59B TV sweep generator. It can be used on any other unit, though.

Weakening the marker signal

It is often difficult to attenuate the marker to a point where it will not affect the response. Then a sufficient marker signal may be obtained by connecting the high side of the marker generator to the receiver chassis. Sometimes, even this gives too strong a signal. In this case, try operating the marker generator near the TV set, but without any connection to it. If a marker generator is part of a sweep-signal generator, turn the marker generator "off" except when locating the required frequency position on the response

curve. Some technicians put pencil marks directly on the face of the scope to show the location of the desired frequencies, then turn off the marker generator and observe the response curve. Take care not to change the horizontal position of the response curve.

If the signal from the marker generator is too weak and a separate marker generator is used, the signal may be injected into the video i.f. amplifier several stages ahead of a stage being aligned, thus obtaining additional amplification. This applies where the stages nearest the video detector are being aligned. If scope indications are too weak and maximum scope amplification has been reached, the scope may be connected beyond the first video amplifier, or, in fact, at any point in the video amplifier, even to the grid of the cathode ray tube. Use a .1- μ f blocking capacitor in series with the lead from the scope to protect against high voltage at the scope terminals. Place the capacitor at the point where the lead connects to the receiver to avoid extra shock hazard near scope posts. To avoid the possibility of contact with high d.c. voltage at the binding posts of the scope, place a 0.1 μ f blocking capacitor in series with lead "V" post of the scope at the point of scope connection in the receiver.

Portions of this article are excerpts from the author's forthcoming book "Rapid TV Alignment Method."

—end—

Puzzling Picture Jump

The complaint was that the picture would tear and jump whenever anyone walked across the floor in the same room with the TV console. (Brand new set; using its built-in antenna.) Sure enough! It did it for me when I went to this house on the service call.

I shook the tuner shaft, looking for a noisy tuner—but it wasn't. I removed the back of the set and tapped the tubes gently. Ah, the first video i.f. tube was noisy—the picture tore when it was struck. I replaced the defective tube with a new one and tapped it again. No more tearing.

As I straightened up from behind the set and announced to the owner that I had found the trouble, he stamped his foot on the floor. Result: disastrous! The picture went back to its former tearing. Slightly angry, I struck the cabinet a solid blow with the palm of my hand. Result: very little tearing!

The realization finally sunk in that the trouble must be outside of the set. I circled the room shaking a.c. cords and lamps. When I reached the fireplace, I gave the fire-screen a slight shake. The picture tore with it. I folded the screen, laid it on the floor, and jumped with joy—absolutely no trace of tearing in the picture. The screen had been reflecting the signal from the station into the set's built-in antenna. The owner decided that he would rather watch TV without a fire in the fireplace than move the set to another location in the room.

Profitable Conversions with Rectangular Tubes

Part II—Covering horizontal and vertical sweep problems

By TED CANTOR

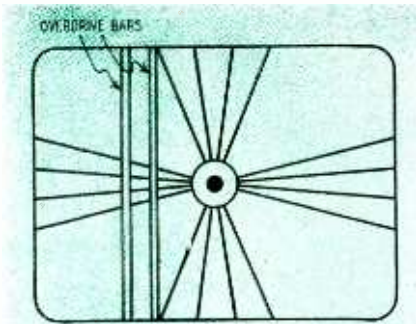

Fig. 1—White bars caused by overdrive.

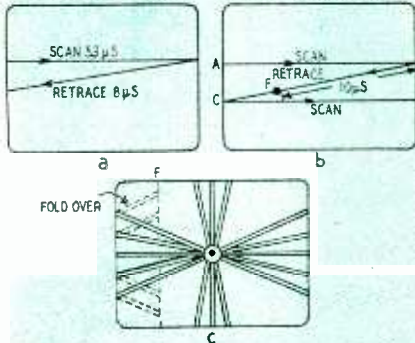

Fig. 2—Retrace times: (a) Good, 8-10 microseconds; (b) Excessive, over 10 μ s; (c) Large retrace causes foldover.

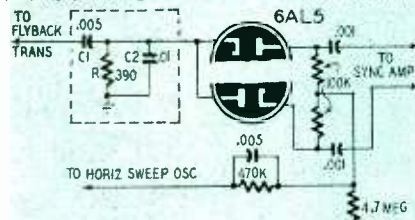

Fig. 3—Horizontal phase-detector.

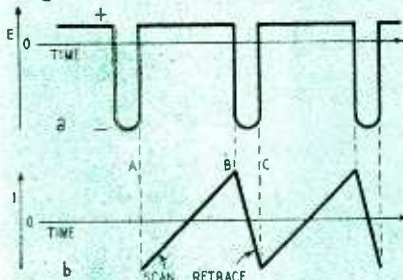

Fig. 4—Yoke voltage, current pulses.

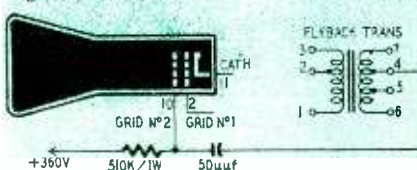

Fig. 5—Screen blanking during retrace.

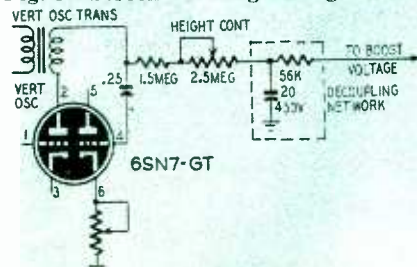

Fig. 6—This circuit gives more height. The decoupling network is essential.

In last month's article such topics as focusing, width control, linearity, and power supplies were covered. We now continue with additional considerations of rectangular conversion problems, including horizontal and vertical sweep, and some conversion data for several Philco TV sets.

Horizontal drive circuit

The output of the horizontal sweep and high-voltage circuits depend upon the waveshape and amplitude of the sawtooth wave at the grid of the horizontal output tube. The maximum amplitude of this sawtooth is limited by core saturation of the flyback transformer, resulting in the characteristic overdrive white bars as in Fig. 1.

Optimum drive is obtained when the drive control is backed off until the white bars just fade out. If an overdrive condition cannot be produced, then it may be possible to increase the drive as follows: (a) Replace the horizontal discharge tube, 12AU7, with a 12BH7, a 6SN7 with a 6SL7 or 6BL7. No wiring changes are required, but these substitutions cannot be used in series-connected heaters because the heater currents are not identical. (b) Increase the size of the coupling capacitor feeding the grid of the horizontal output tube. (c) Bypass the cathode resistor of the horizontal output tube with a 20- μ f, 25-volt electrolytic. (d) Vary the size of the discharge capacitor and resistor in the plate circuit of the horizontal-discharge tube. Decreasing the resistor will usually increase the sawtooth amplitude, so a compromise must be obtained between amplitude and linearity.

Horizontal foldover

Foldover is due to the large distributed capacitance in some yokes and flyback transformers, resulting in increased retrace time. The visible portion of the horizontal trace is approximately 53 microseconds (μ s) and the horizontal blanking is approximately 10 μ s. If the beam is to be returned to the left side of the picture in time to start the trace and contain all the video information supplied to the kinescope

grid, then the retrace time should be no more than 8 μ s as in Fig. 2-a. This leaves 2 μ s for variations in transmitters, components, and horizontal hold adjustment.

Where the retrace time is from 9 to 10 μ s, then foldover may result when the horizontal hold control is varied or different channels are viewed. When the retrace time is over 10 μ s, then foldover is *always* present. This occurs because the beam returning to the left side of the screen from B to C in Fig. 2-b, will have only reached F at the end of the 10 μ s blanking period. Since video information will be provided immediately to the kinescope grid, part of the picture will be formed from F to C, and the remainder from C to D, resulting in a folded-over picture as in Fig. 2-c.

The simplest way to handle this is to shift the phase of the horizontal oscillator to move the foldover off the screen or distribute it equally on both sides of the screen where it may be hidden by the mask. This may be done readily on the RCA syncro-lock type circuit where there is a separate phasing slug.

Many current production sets use a horizontal phase-detector circuit similar to Fig. 3. Variation of R will in most cases act as a phasing control, making it possible to position the foldover where it is least objectionable. Variation of C1 and C2 will have secondary effects. Be sure to reset the horizontal oscillator frequency slug after any phasing adjustment.

Another method—to be tried last—is blanking. The voltage pulses across the horizontal yoke are shown in Fig. 4-a, while simultaneous current through the yoke is shown in Fig. 4-b. The flat positive portion of the voltage pulse occurs from A to B while the sawtooth current wave through the yoke is sweeping the beam across the screen. When the voltage wave goes negative from B to C, the current through the yoke reverses, producing the retrace.

Since the negative pulse and the retrace are in phase, the negative pulse can be applied to the number 2 grid of the kinescope, blanking out the screen during the retrace as in Fig. 5. The capacitor sharpens the pulse. The resistor should be 310,000 to 560,000 ohms, 1

watt, the capacitor 40-60 μ f, 600 volts. The number 2 grid is pin 10 on the kinescope tube socket and is connected to 265 to 365 volts, B-plus. Insert the resistor between pin 10 and B-plus. Feed the blanking pulse from pin 4 of the flyback transformer through the capacitor to the number 2 grid. If the blanking pulse darkens too much of the picture, it may be reduced by using a smaller capacitor.

Eliminating arcing or corona

Since most sets being converted were originally designed for voltages of 7-10 kv, take special precautions to avoid corona or arcing. Be sure connections on the high-voltage rectifier socket are rounded and free from sharp points. If the hissing characteristic of corona is heard, it can be easily located in a dark room and the sharp points rounded off.

If arcing occurs from the rectifier socket to ground, insert a sheet of bakelite $\frac{1}{8}$ inch to $\frac{1}{4}$ inch thick, or layers of rubber tape on the chassis directly under the socket to insulate it from ground. If arcing occurs from the cap of the rectifier tube to the top of the high-voltage cage, replace the spring clip on the cap with an Alden or Warren type plastic cap or cut out a section of the cage directly above the cap.

Centering systems

In most conversions, the original centering systems may be used. Additional centering may be obtained by tilting the focus coil or using inexpensive magnetic centering rings which slip over the neck of the tube and are shifted and rotated as required.

Vertical sweep

If adjustment of the vertical linearity and height controls fails to provide sufficient vertical sweep, the following steps will correct this condition:

1. Replace the vertical output tube, a 6K6 with a 6V6, a 6SN7 with a 6SL7 or 6BL7, a 12AU7 with a 12BH7. No wiring changes are necessary, but these substitutions cannot be used in series-connected heaters as the heater currents are not identical.

2. Disconnect the height control from B-plus and connect it to the boost voltage at pin 1 of the flyback transformer. A decoupling network, to keep the vertical and horizontal circuits from mutual interaction is required unless already present as in Fig. 6. Be sure the voltage rating of the original decoupling capacitor is sufficient for the higher voltage (20 μ f at 450 volts is a good choice).

3. For additional height, reduce the value of any resistor in series with the B-plus side of the vertical output transformer primary. If necessary connect the primary to the boost voltage through a decoupling network of approximately 10,000 ohms, 2 watts, and 20 μ f, 450 volts as in Fig. 7. As this will load down the boost voltage and reduce the high voltage somewhat, use the

highest decoupling resistor that provides sufficient vertical sweep.

H.v. and sweep troubles

If there is lack of high voltage—indicated by little or no brightness—bring the end of the h.v. lead close to ground and draw it away quickly. If a large arc is produced, the trouble is probably in the ion trap or picture tube. If not:

1. Try to draw an arc off the h.v. rectifier cap with the tip of a well insulated screwdriver. If a good spark results, the h.v. pulses are reaching the cap of the rectifier tube; the circuit is all right to there.

a. A dental mirror will make it possible to see if the 1B3 filament is glowing. If not, change the 1B3.

b. Check the h.v. filter capacitor for open or leakage. A good one will read infinite resistance. An open one will cause picture bloom when the brightness control is advanced.

c. Check the h.v. filter resistor and the h.v. cable. A defective filter resistor will cause the picture to bloom when the brightness control is advanced.

2. If there is no arc drawn off the h.v. rectifier cap:

a. Check the $\frac{1}{4}$ -ampere fuse in the h.v. B-plus circuit.

b. Change horizontal output tube, damper tube, horizontal sweep generator tube.

3. Check the flyback transformer for resistance and voltage at its terminals. A flyback with only a few turns shorted will usually appear to have normal resistance, but typical indications are: little or no high voltage; excessive cathode current in the horizontal output tube; overheating.

4. An arcing transformer or yoke is indicated by ripples in the picture, hash, flashes, or loss of horizontal synchronization.

5. A shorted yoke is usually indicated by collapse of the sweep or a trapezoidal picture as in Fig. 8.

6. Check for a sawtooth wave at the grid of the horizontal output tube with a scope. There should be at least 60 volts peak-to-peak present. If a sawtooth wave of proper shape and amplitude is not indicated, check through the sweep-generating circuit for open or changed value resistors and for leaky or open capacitors.

Converting Philco sets

The following data is for Philco 1000, 1001, 1278, and similar models. Refer to Fig. 9.

1. Remove original yoke, flyback transformer, and width coil.

2. Remove any resistors shunted from plate to cathode of the damper tube.

3. Replace the h.v. capacitor with one rated for 20 kv.

4. When converting doubler circuits, disconnect one rectifier tube socket and wire up the other for single rectifier operation.

5. Remove the negative side of the 500- μ f h.v. capacitor from ground and run it to the plates of the damper tube.

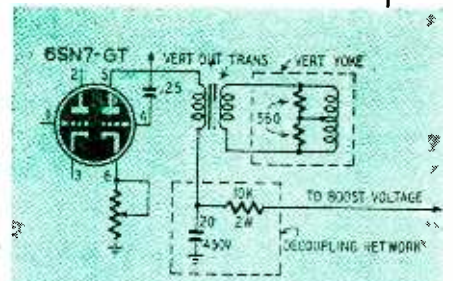

Fig. 7—Another height control circuit. More B-plus is applied in this way.

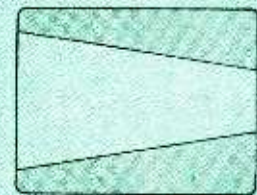

Fig. 8—A partially shorted yoke will cause this trapezoidal type pattern.

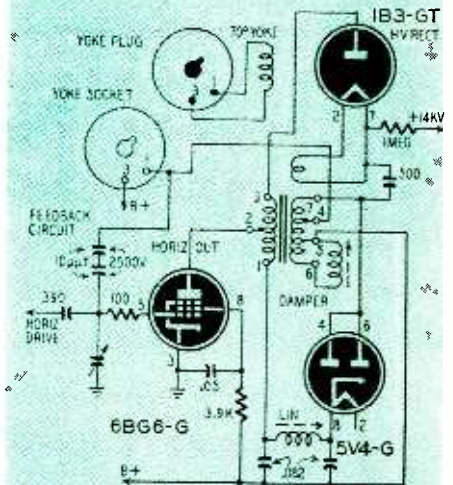

Fig. 9—Philco model 49-1278 modified to use hi-efficiency flyback and 70" yoke.

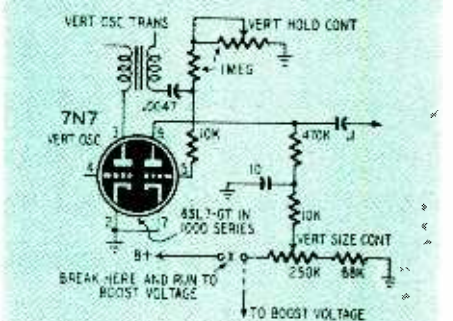

Fig. 10—Philco 49-1278 circuit as modified to obtain increased vertical sweep.

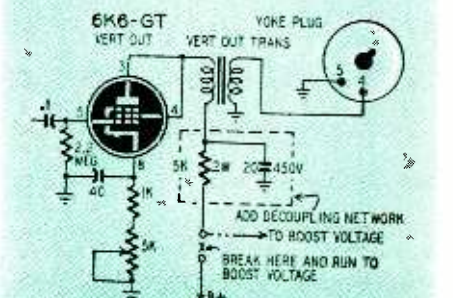

Fig. 11—Getting more vertical sweep another way; decoupling is still necessary.

CONVERSION-

a practical approach

Simple changes solve problems in sweep, brightness, deflection

By THOMAS E. FAIRBAIRN

IN converting to 16- or 17-inch picture tubes a 14CP4 should be used first for preliminary adjustments. This tube presents the most problems in sweep, brightness, and degree of deflection. If the 14-inch tube can be swept properly, then any other size can. Experience shows that the 14CP4, 16KP4, and the 17RP4 need the least amount of voltage to produce the greatest brightness, and these are the best tubes to use in conversion work.

First change the old deflection yoke to a 70° unit. After this, the 14-inch

tube is placed temporarily in the yoke and focus-coil assembly. A new ion trap is used, and is adjusted so that the picture is brightest. You will note that the picture is not fully swept horizontally. Change the horizontal circuits as follows:

Fig. 1 shows a typical horizontal high-voltage circuit with the necessary changes. The most important part of the conversion is the small 2,000-volt, 160- μ f capacitor, *a*, placed across the plates of the 5V4-G damper tube to ground. In 95% of the conversions, the addition of

one or more 160- μ f capacitors will give nearly—or all—the needed sweep.

If there is a width coil, *b*, in the circuit, Fig. 1, remove and replace with a .05- μ f, 600-volt moulded capacitor, *c*, Fig. 1. Do not remove the width coil from sets that have a double coil width control, as part of the coil is used to feed back voltage for the a.g.c. system and with it open you will lose control of the horizontal hold.

Reduce the cathode resistance in the vertical amplifier by one-half if there is not enough height. If this is not enough, replace the vertical amplifier 6K6-G or -GT with a 6V6 or 6V6-GT, or the 6SN7-GT with a 12BH7 with an adapter plug.

Replace the 14-inch tube with the 16KP4 or 17RP4. A marked picture improvement should be noticed. If after having adjusted the horizontal drive control the width is still not enough, use additional 160- μ f capacitors across the damper tube. If there is still low brightness, replace the low-voltage rectifier with a 5U4-G. If still low, for the needed picture width, replace the flyback transformer with the latest high-efficiency type.

Focus is checked next. If the tube does not go through focus properly, cut

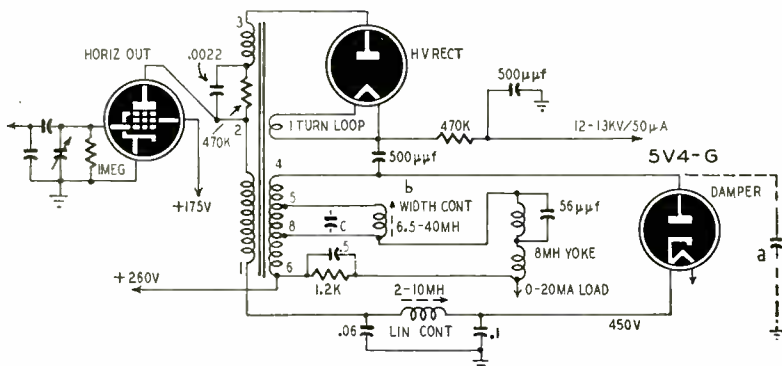

Fig. 1—Typical horizontal output circuit with conversion changes discussed.

PROFITABLE CONVERSIONS WITH RECTANGULAR TUBES

(Continued from preceding page)

Refer to section on h.v. capacitors in Part I, in the August issue.

6. Fasten the XO35, or equivalent, transformer to the side of the high-voltage cage.

7. Solder filament leads to pins 2 and 7 of the 1B3 socket.

8. Connect the leads of the wide angle ferrite yoke to the yoke plug.

9. Disconnect the high side of the horizontal yoke from the plates of the damper tube and run it to pin 4 of the flyback transformer. If there is a blocking capacitor in series with the lead, it may be left in place. The capacitor keeps d.c. out of the yoke to facilitate centering.

10. Connect the plates of the damper tube to pin 7 of the flyback transformer.

11. Connect pin 5 of the flyback transformer to B-plus.

12. Connect a 201R4 width coil between pins 5 and 6 of the flyback transformer.

13. Connect pin 1 of the flyback transformer to the linearity coil.

14. Connect two 10- μ f, 2500-volt capacitors in series from pin 4 of the flyback transformer to the grid of the 6BG6-G providing feedback for additional sweep and high voltage. Refer to Fig 7 in Part I, August issue.

Vertical sweep circuit

To increase vertical sweep:

1. Substitute a 6V6 for the 6K6 vertical output tube (Fig. II).

2. Disconnect the vertical size con-

trol from the B-plus and connect it to the boost voltage at pin 1 of the flyback transformer as in Fig. 10.

3. If this additional voltage fails to provide sufficient vertical sweep, then connect the B-plus side of the primary of the vertical output transformer to the boost voltage as shown, Fig. 11.

Focusing circuit

If the focus control does not have the required range, then insert a 100- to 500-ohm, 5-watt resistor in series with the focus control to reduce its shunting effect and pass more current through the focus coil. Refer to the previous section on focusing in Part I, August issue.

—end—

RADIO-ELECTRONICS for

out the shunt resistor across the focus coil. This allows more current to flow through the coil. The same result can be achieved by increasing the size of the resistor—because with a larger resistor, less current will flow through it and so a larger fraction of the total current will go through the focus coil.

The service technician should now go through the chassis and feel if there are

any resistors which are getting too hot from overload. Replace these with higher-wattage units.

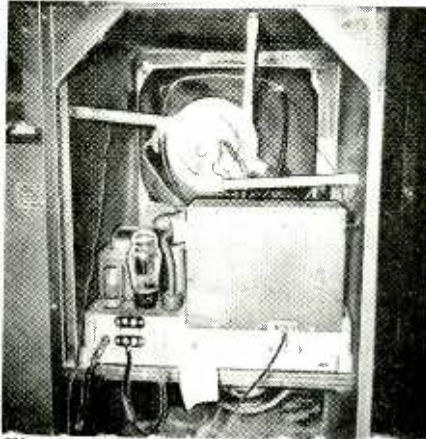

Fig. 5—The final assembly in cabinet.

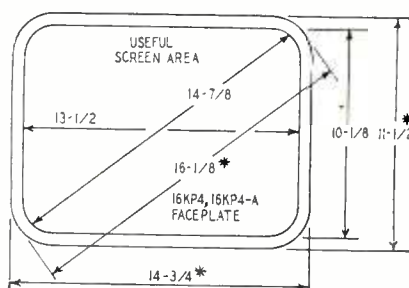
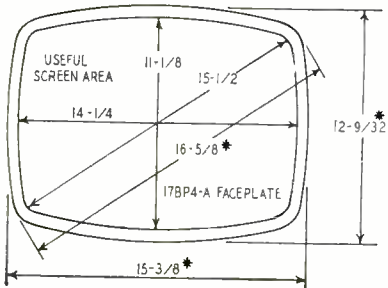
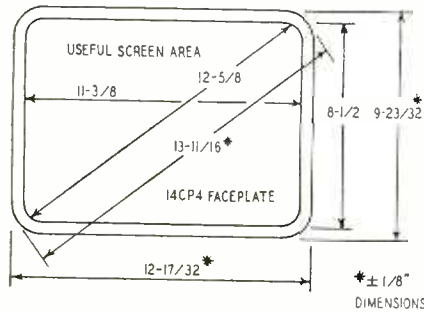

Fig. 2—Dimensions of three popular TV picture tubes.



Fig. 3—Cut-out before installing mask.

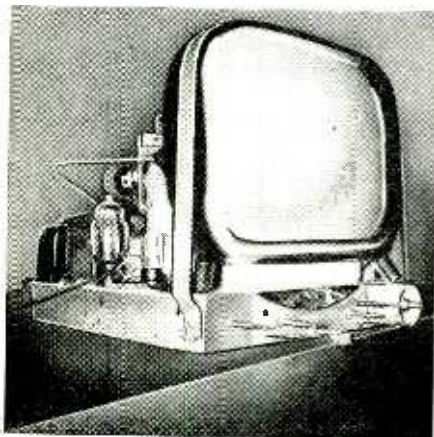

Fig. 4—Tube (14 inch) mounted on chassis. Larger ones go in cabinet.

Carefully examine *all* the set components as a matter of routine procedure. Suspicious parts should be replaced. This is especially true of parts subjected to heat, high current, etc. Check the tubes before starting conversion. Sometimes just replacing a tube or two will simplify your conversion problems.

Chassis conversion is now complete and the picture tube is fitted in the cabinet. Fig. 2 gives useful measurements of the 14CP4, 16KP4, 16KP4-A, and 17BP4-A. Fig. 3 shows the cutout before the mask is installed (always cut the hole smaller than the mask).

Fig. 4 shows the tube mounted on the chassis. Most of the 14-inch conversions will mount on the chassis, and the majority of the 16- and 17-inch conversions will mount in the cabinet as a rule (Fig. 5).

In some conversions it is necessary to lower the wood bottom to make room for the larger tube. The chassis may have to be relocated. The leads of the focus and deflection coils, the high-voltage and picture-tube socket will probably have to be lengthened.

Final adjustments are made after the chassis is installed. The deflection yoke is adjusted and tightened. The ion trap is set for maximum brightness. Sometimes there is still a slight shadow in the picture. Proper adjustment of the ion trap may remove this.

In a future issue additional problems in large-screen conversion will be discussed.

—end—

September TV DX

If we think of TV only in terms of sporadic-E skip, bringing in signals from distances of 600 to 1,500 miles or more, September will be a barren month. On the other hand, the bright hot days and cool nights that characterize September in many parts of the country are ideally suited to dx reception of a less spectacular but no less interesting sort: the extension of normal receiving range by wave bending in the lower atmosphere.

Because this phenomenon is directly related to observable weather conditions it may be predicted on a short-range basis with considerable success. Tropospheric bending is generally best in periods of fair calm weather, or gradually increasing cloudiness. Watch the daily weather maps printed in many newspapers. When a large slow-moving high-pressure area moves across your locality, fringe-area reception is sure to be better than normal. If the path between you and a TV station is across a pronounced "low," or if there is heavy rain or high winds, reception is likely to be poor and erratic.

Tropospheric dx reception is much more a test of the quality of the TV receiver and antenna installation than is the sporadic-E skip dx of the early summer months. Like dx signals on the short-wave bands, sporadic-E dx comes in via reflection from the ionosphere, often at a fairly high angle. If the ionization is dense and steady the signals are reflected with almost no loss. The result is that the energy received from stations 1,000 miles or more away may be about equal to that of a local.

Tropospheric reception, on the other hand, is often a matter of a relatively small increase in the field strength of a station that is not well received under average conditions. If you are 100 miles from your TV station, for instance, you can expect many nights of good picture quality during September. If you are a dx enthusiast and willing to go to some trouble in erecting a big antenna system or building a good low-noise pre-amplifier, September will be one of your most rewarding months.

Particularly on the high channels does this sort of thing pay off. The average TV installation is poor on channels 7 through 13. Pentode front ends work well enough on the low channels, but tend to be ineffective on channel 7 and up. Neutralized-triode or grounded-grid preamplifier stages and properly designed *large* antenna systems could work wonders in improving high-band reception. September will provide opportunities for high-band tropospheric dx up to several hundred miles, but only in certain areas.

Literally hundreds of observers have sent in dx reports during the summer, in such volume that it is no longer possible to acknowledge them individually in these pages. The reports are being studied, however, and the co-operation they represent is deeply appreciated.

—end—

Vari-Directional Antenna is "Rotated" By Switching

Many advantages of directivity obtained without a drive motor

By MATT MANDL and ED NOLL

A NEWLY marketed antenna called the *Directronic** permits changing beam directivity without physical rotation of the elements. Thus it can be oriented for virtually every direction by a simple switching unit at the receiver.

Most installation men who work in areas where stations from several di-

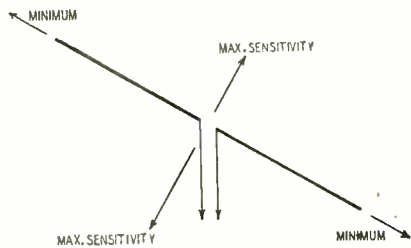

Fig. 1—Signal pickup of simple dipole.

rections are encountered know what a trying and time-consuming problem it is to get best antenna orientation. It is equally difficult to establish optimum signal-to-interference figures on all channels (particularly with an assortment of low- and high-band stations to contend with) when the location is a noisy one. The additional v.h.f. and u.h.f. assignments proposed by the FCC can only make these problems more acute. Obviously, a simple controlled-pattern antenna is a direct and inexpensive solution.

The principles underlying this beam-selector antenna can be best understood by reviewing some basic antenna func-

* Snyder Mfg. Co., Philadelphia, Pa.

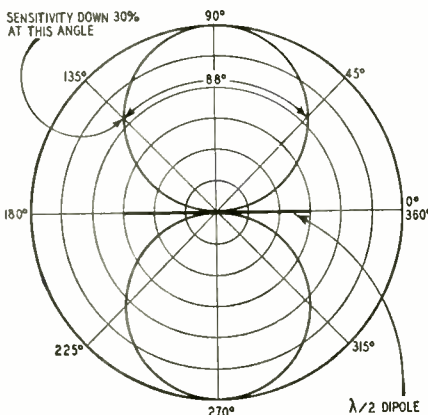

Fig. 2—A dipole's sensitivity pattern.

tions. Peak sensitivity of the standard half-wave dipole, for instance, is broadside to its elements as shown in Fig. 1. As seen from above, such an antenna has a pickup pattern in the form of a figure eight. The acceptance angle (Fig. 2) of such a half-wave antenna (the angle between voltage levels at which antenna sensitivity is down 30%) is some 88 degrees (44 degrees to either side of best-signal position). Thus, there can be an appreciable error in orientation without serious loss in signal level. In fact, an orientation error of plus or minus 30 degrees would result in only a 15% decline in sensitivity (-1.3 db). Such a slight loss goes unnoticed on the modern receiver (particularly with a.g.c. circuits in operation).

Therefore, one possible method for receiving signals from any bearing through 360 degrees would be to mount three separate dipoles on a mast, run three separate lines, and make a switch mount at the receiver so any one line could be selected. The three separate dipoles would be mounted 120 degrees apart, producing a lobe maximum each 60 degrees (six lobes). At only one point between maxima would sensitivity be down as much as 15% (Fig. 3). Desirable orientation advantages are secured, but the system has three separate lead-ins to contend with, besides being costly and inconvenient.

How can we secure the benefits from such a system with a relatively simple installation? Mounting just three quarter-wave elements 120 degrees apart in the same horizontal plane as shown in Fig. 4 will do the trick. A single 3-wire line connects these three elements to a switch at the receiver. The switch selects any two of these antenna elements to form a half-wave antenna with a specific orientation.

As indicated in Fig 5-a, the switch shifts the element connections and thereby brings about a 20-degree shift in the figure-eight lobes, permitting a maximum choice for each 60 degrees identical to patterns of Fig. 3. Because of the switch arrangement, lobe switching is, of course, instantaneous.

With a 120-degree mounting relation between quarter-wave elements, there is a definite forward tilt to the quarter-wave elements chosen to form a given half-wave antenna. This tilt does no

harm to low-band performance and has the added advantage of improving reception for higher channels. This is so because the forward tilt of elements cut for a low band will align and combine the high-band lobes so they have maximum pickup characteristics in the same direction as the low-band figure-eight pattern. Inasmuch as the lobes in the direction of the forward tilt combine, they serve to give the antenna unidirectional characteristics on the high channels with added gain.

A typical commercial antenna of this type would be cut for channel 3, producing an 88-degree figure-eight pattern. This antenna would perform up through channel 6 with only slight change in acceptance angle. On the high-band channels the lobes tend to narrow, but the forward tilt of the elements increases gain. This means that in most metropolitan and near-fringe areas no orientation of the antenna is necessary during installation, inasmuch as orientation of pattern is controlled by the switch at the receiver. However, in a critical location for a particular high-band station, some slight initial orientation would be of some help in obtaining maximum results.

Such an antenna lends itself easily to stacking, as shown in Fig. 5-b. This makes for a higher-gain construction in fringe areas and reduces pickup from above and below. Added advantages of decreased ignition or airplane interference are realized. In field tests, excellent results have been procured in excess of 60 miles.

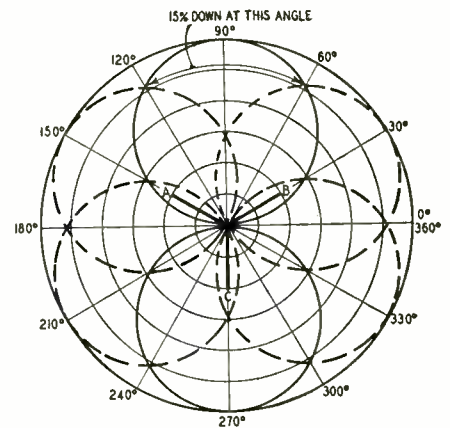
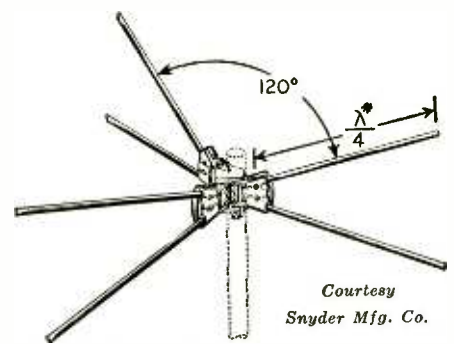

Fig. 3—Pickup pattern, three dipoles.



* LESS 5% FOR END EFFECT

Fig. 4—How a Directronic antenna looks.

Problems that can be solved

There are numerous applications for such a lobe-switching antenna system. In metropolitan and near-fringe areas it solves orientation and interference problems. As shown in Fig. 6, it per-

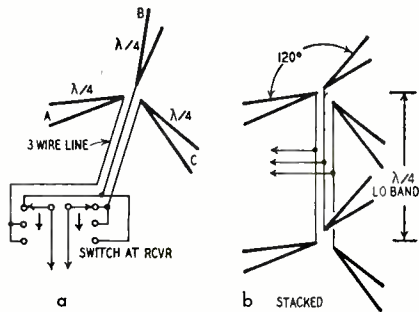

Fig. 5—Switching and stacking methods.

mits optimum orientation for each channel. For example, elements A and C would be used to pick up channel 6, elements A and B for channel 3, while B and C are used for channel 10. This is one way of minimizing the influence of noise, for it makes signals as strong as possible for each station without a compromise in antenna orientation.

It should also be mentioned that in a strong signal area, good results can be obtained on at least two positions of the switch due to overlap of lobes. Thus, a switch position can be chosen that has the least interference pickup. For example, in Fig. 7 the elements A and B normally would be switched to receive station S. However, a strong noise level is being picked up from point N. If elements A and C are switched in, signal from S is reduced but would still be reasonably strong (down 35%), while the noise component would be down as much as 80%. Thus, in the presence of noise, choose a switch position which permits best signal-to-noise ratio. In fact, for a critical noise condition, the antenna can be oriented slightly on the roof to a position that has the least noise pickup for a given switch position. The antenna can thus be helpful in minimizing local oscillator interference as well as ghosts and other types of interference. The reasons for this are twofold: it can be beamed directly on each station or switched to the position of least noise pickup.

Fringe-area tests have indicated good performance for this antenna type (stacked). In a weak-signal area, some improvement is secured for a weak high-band station if the antenna is oriented slightly as the station is being received on the best switch position.

Note that if stations are all in the same direction this antenna has no particular advantages (any more than a motor-driven job). It is basically a problem antenna and gives peak performance when stations are in different directions or in areas where directional noise and interference prevail.

Switch and transmission line

The switch must be of low-loss, low-capacity construction to minimize

losses, particularly on the higher channels. It can be mounted at the rear of (or alongside) the receiver. Such a simple switching arrangement can become a part of a manufactured receiver or tuner. It would also be convenient if such a switch were incorporated in manufactured boosters.

The transmission line *must* have good-quality dielectric. It cannot be a high-loss 3-wire motor cable! A poor line can destroy most of the advantages of this lobe-switching system, for it destroys signal levels. The line should be 300 ohms between outer conductors. With such a value the impedance drops to approximately 200 ohms between center and either outer conductor of the 3-wire line. There is only a minor loss of a fraction of a db per hundred feet with this small mismatch to a 300-ohm antenna. Losses due to line capaci-

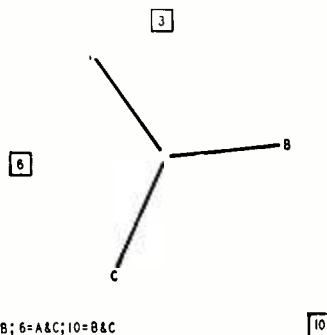

Fig. 6—Typical reception in large city.

tance, poor dielectric, and weather attenuation are far higher. Therefore the slight mismatch is relatively minor compared to losses which are experienced with poor installations or poor lead-in.

Installation factors

With the flat, 3-wire line, lead-in installation is identical to that employed for the conventional 2-wire line. Stand-off insulators should be used to keep the transmission line well away from metal objects or guy wires to prevent losses. This is of particular importance

ION BURNS ARE AVOIDABLE

Ion burns on picture tubes can be prevented. Here are some fundamental facts. We know that the ion is an atom with electrons added or removed. If there are fewer negative charges (electrons) than there are positive charges in an atom, the atom is positive-charged and is a "cation." If there are more negative than positive charges, the atom is an "anion."

Ions are always present in cathode-ray tubes. Some "anions" come into the electron beam from the cathode. If they are not diverted—or trapped—they are accelerated to the face of the tube and a phosphor burn may result. Compared to the electrons which normally make up the beam, these "anions" are like A-bombs hitting the anode and screen. They range in size up to

on the high channels, for the capacitance effect increases due to the lower ohmic shunting path encountered. This, of course, holds true for any antenna installation where the twin-lead type of line is used, and such precautions should not be ignored with the lobe-switching type. Again, as with conventional antenna installations, the lead-in should be given a 180-degree turn every foot or so. This twisting of the transmission line will decrease noise interference picked up by the transmission line some 30%.

The switch is of a wafer type, and must be capable of selecting *any two* wires of the 3-wire line. The 3-wire line from the antenna terminates at the switch, and another conventional 2-wire twin-lead section connects the switch to the receiver input terminals. For receivers with 75-ohm input, a coaxial cable section can be used from the switch to the receiver terminals.

In areas where signals are relatively strong, little difference in contrast may be noticed in either of two switch positions. This is due to the automatic gain-

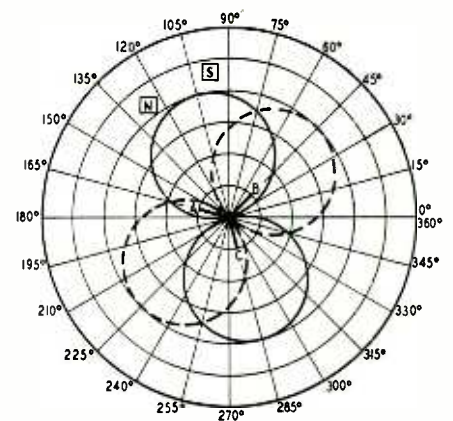

Fig. 7—Switching to reject interference.

control action of modern receivers. It will be noted, however, that in one position picture quality is better because of better orientation. Slight snow effect also will be overcome under such circumstances.

—end—

100,000 times the size of the electron.

In electrostatically deflected tubes, ions are deflected equally all over the tube and there is no burn. But in magnetically deflected tubes, because of the field of the yoke, most ions strike approximately the same spot on the screen—and burn.

Remember these five points:

1. Adjust the trap for maximum brightness with the brightness control set halfway.
2. Use the trap recommended by the manufacturer.
3. When using a double-magnet ion trap set the stronger magnet at the rear (next to the base of the tube).
5. Be sure that there is enough spring in the ion trap so that vibration or jarring does not shift it.

—end—

Television Service Clinic

Conducted by **MATTHEW MANDL**

WHEN we answer queries submitted, our diagnosis of the trouble must be based on symptoms the reader lists. It is essential, therefore, that we get a complete description and explanation of the trouble, whether it exists on all stations and corrections attempted prior to writing. The name of the receiver, model number, and tube complement are also important. All this information is necessary to evaluate the trouble and suggest remedies.

A particular symptom, by itself, is often meaningless; it could be caused by any one of a number of circuit faults. Fig. 1-a, for instance, shows a negative picture, but does this type of picture occur only for the strongest station? If so, it would indicate overload or an improperly set a.g.c. system. Does the picture turn negative only occasionally? If so it might indicate strong local interference from short-wave station. Is the picture always negative, though the antenna lead is disconnected and receiver circuits check all right? The picture tube is probably defective. Obviously, a correct diagnosis of the trouble can be made only if all symptoms are considered.

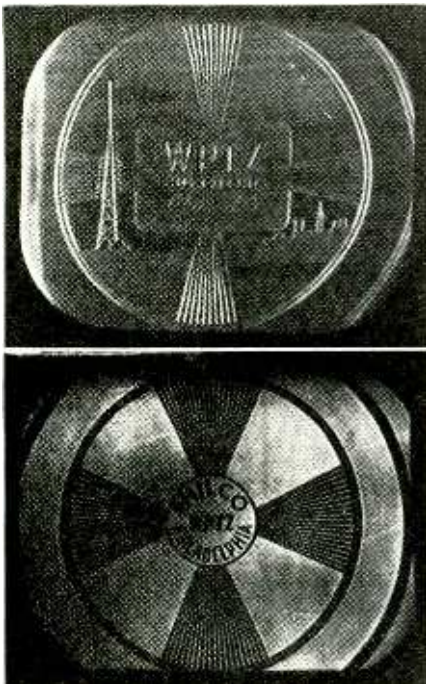

Fig. 1—Puzzling pictures can have many causes. (a) negative; (b) much too dark. Correct diagnosis requires care.

Another example is Fig. 1-b, where the picture is excessively dark, but not fuzzy or negative. Does the brilliancy control still function to increase and decrease brightness? If so, the trouble may be a defective contrast control. Can

the contrast be varied though the picture still remains dull? Perhaps the fault is in the brilliancy control or its associated resistor network. Is an r.f. type of high-voltage power supply used in this receiver? The oscillator trimmer capacitor across the tank circuit of the high-voltage system probably requires adjustment.

The same need for facts holds true for defects in sound, in sync stability, linearity troubles and picture interference. Give us the complete story. Help us to help you. The questions which appear in this column are brief because they have been condensed to meet space requirements.

Intermittent brightness

I have an RCA 2T51 receiver in which the brightness is intermittent. When the brightness increases I lose vertical and horizontal sync. Advancing the contrast control will restore synchronization, but with the increased brightness there is also an increase in vertical height. H. S., Bayonne, N. J.

Your trouble is due to either a bad tube in the sweep system, or a defective part between the horizontal sweep oscillator and the input to the 6AU5-GT horizontal output tube. The defective part increases horizontal drive, which in turn increases high voltage and thus the brilliancy. The increased drive and high voltage also increases the output from the voltage boost system. Inasmuch as the voltage-boost system feeds both the horizontal sweep oscillator plate potential as well as the B-plus for the vertical sweep oscillator, the change is sufficient to upset both vertical and horizontal synchronization.

By advancing the contrast control, sync is re-established because this increases the amplitude of the sync pulses sufficiently to lock in the sweep oscillators again. (Sync pulses are taken at the d.c. restorer circuit following the contrast control.) The increased voltage boost also feeds the vertical-sweep output tube plate via the primary of the vertical output transformer, and the increased voltage here increases height.

Try a new 6SN7-GT horizontal oscillator, as well as a new 6AU5-GT horizontal output tube. If this does not help, check all components for correct value (between the plate of the horizontal oscillator and the grid of the horizontal output tube). Keep a v.t.v.m. across one voltage source at a time to see if this changes when brightness advances.

Spots on screen

What causes brownish spots on the screen of a 16RP4 picture tube? This condition developed over a period of

time and adjustment of the single-magnet ion trap does not help. I intend replacing this tube with a new 16RP4 and want to avoid this condition. H. B., New York, N. Y.

A 16RP4 requires a double-magnet ion trap. This is probably the cause of your trouble. Brownish spots are also caused by an incorrectly adjusted ion trap. New tubes can be permanently damaged if the ion trap is not adjusted properly as soon as the set is put into operation. With wrong trap adjustment the electron beam strikes the disc aperture of the gun structure and may decompose the metal. This vaporized material will cause brownish spots on the tube face which cannot be eliminated. On new tubes keep brilliancy down and advance it slowly as the ion trap is adjusted in a rotary, forward and back motion. Only when correctly adjusted should the brilliancy be advanced substantially.

Vertical transformer replacement

I replaced a defective vertical output transformer on a Raytheon model M1105 receiver and since then have had considerable trouble with a buzz from the speaker. The buzz increases with an advance of either the volume control or when the fine tuning control is adjusted for best picture. F. S., San Diego, Cal.

If nothing else was disturbed when you replaced the vertical output transformer, the buzz you describe may be due to the fields of the transformer affecting the audio circuit with the 60-cycle vertical repetition rate. This interaction between the two circuits would account for the fact that the buzz increases with an advance of volume control or adjustment of fine tuning.

Tighten all bolts to make sure the transformer has a good electrical connection to the chassis. Extra shielding also may help if the new transformer is developing stronger fields. Repositioning it with respect to other circuits also will help.

Your trouble may be due also to a disturbance of some other circuit which has increased in carrier buzz, for the same symptoms would result. Check both video i.f. and sound i.f. alignment.

Unstable vertical sync

In a Regal Model 16T31 (similar to RCA 630) there is bad vertical sync stability which requires fairly frequent adjustment of the hold control. New tubes in the separator and oscillator circuits did not help. S. S., Mattapan, Mass.

The vertical hold trouble you are having is most likely caused by a change in value in one of the parts in the grid circuit of the vertical blocking oscillator.

Take a resistance reading of grid leak and hold-control potentiometer and if they are off value by more than 10% replace them. If this doesn't help, try a new grid capacitor. Check for incorrect parts values in the integrator circuit. You should also check voltages at the plate of the second sync amplifier and the negative potential at the bot-

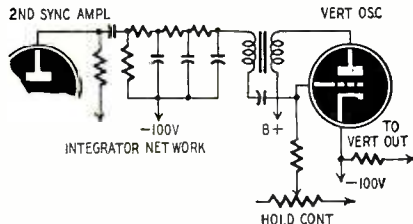

Fig. 2—Wrong plate and integrator voltages may cause unstable vertical sync.

tom of the integrator network, Fig. 2. Misalignment resulting in poor low-frequency response is another cause of poor vertical stability.

Yagi antenna

One of my customers is moving to an outlying location near Tampa, Florida. The nearest television station is in Jacksonville, about 190 miles distant by road. He tells me the land around Tampa is very level and slightly rolling south of Jacksonville.

I am recommending a double-stacked Yagi because the single station (channel 4) is the only one he will be able to receive. Would you also suggest a good two-stage booster and changing the i.f. tubes in his Admiral receiver? Would an antenna height of 60 feet be adequate? E. W., Buffalo, N. Y.

Your idea to use a stacked Yagi for the channel 4 station is a good choice. This is the logical antenna to use for only a single station because it will give much higher gain than virtually all others for use in the present allocations. A good two-stage booster will be of decided help, though we would not suggest changing i.f. tubes or "doctoring" alignment unless absolutely necessary. Try to get a good grade of twin lead, or use open-wire line, for the latter has less loss than the other types. A height of 60 feet is good, but usually the higher the antenna the better.

Loss of width

A 16-inch RCA TC166 developed loss in width after eight months of operation. There is now a one-inch space on each side and adjust of controls doesn't help. Replacement of the 6BG6-G, the 6W4 damper, the 1B3 and the 6SN7 oscillator increased the width slightly, but it still does not fill out the mask. Brightness and contrast are excellent as well as focus and vertical masking. J. M., Lynbrook, N. J.

First try replacing the 5U4-G rectifier, which you have not mentioned. If this does no good the decrease in width is probably due to degeneration in the horizontal output circuit which is decreasing deflection below normal. Since you have tried tube replacement, check for proper voltages at the screen of the 6BG6-G (not plate) and from grid to

cathode. Also check the values of grid leak, screen-dropping resistor, etc., and replace if they are off by more than 10%. Also check by direct replacement the several capacitors associated with this circuit, for any defective one may cause degeneration. Use an oscilloscope and check for proper peak-to-peak voltage of driving signal at the grid of the 6BG6-G tube.

Poor brightness

A Sylvania T1-125 developed poor brightness. Contrast and definition remained good, but the brightness control must be at maximum to get fair brilliancy. I took a reading from pin 2 of the picture tube to chassis and got 15 to 60 volts, depending on the setting of the brilliancy control. Voltage feed to the control is 125 volts. While taking this reading I got more brightness than needed with voltmeter (not a v.t.v.m.) attached. What causes this condition? F. S., Freemansburg, Pa.

With a negative voltage of 125 present at the brilliancy control, you should be able to get a variation at pin 2 of the picture tube from 40 to approximately 115 volts instead of only to 60. The amount you got, however, may be partially due to the loading effect of your voltmeter combined with a defective resistor in this circuit. The fact that brightness increased with the application of the voltmeter indicates that the resistance of the voltmeter has compensated for a defective (excessive resistance) condition between pin 2 and chassis.

Check all three resistors associated with the brilliancy control and grid circuit for change in value or open circuit. Replace any which are off rated value by more than 10%. Inasmuch as the 6AQ5 video amplifier in this receiver is directly coupled to the cathode of the picture tube, resistor values are critical if a proper range of bias is to be maintained.

Intermittent sound

Picture is all right, but the sound fades down to a whisper. When I turn up the volume control, the sound is good for a while, then suddenly blasts in and I have to cut down on the volume. What is the best method for locating this trouble? J. W., Pittsburgh, Pa.

Intermittent troubles have always plagued the servicing technicians, and they are sometimes the most difficult things to localize. While the set is playing normally, there is no point checking voltages or parts, since nothing appears amiss. However, when the intermittent occurs, it may be of such critical nature that the mere approach of a test instrument probe is enough to cause the part to act normal again.

I suggest you try replacing one tube at a time and waiting to see if the trouble still occurs. Repeat, until all tubes in the audio section (i.f. amplifier to audio output) have been replaced. Also, install a new coupling capacitor in the grid of the audio output tube, for these are frequent offenders. As a last

resort gently push each paper capacitor with an insulated screwdriver while the set is in operation in order to find which might have loose internal lead contacts.

There are other methods for checking intermittents. Try raising the line voltage or applying shock. In using higher voltages, a variac or similar auto-transformer will be useful. Raise the voltage to about 130, maximum, but don't keep it there too long, and look out for sudden failures.

Open grid resistors, faulty filters, trouble in the output transformer, voice coil, and proper seating in tube sockets (if miniature tubes are used) are other sources to check.

The automatic signal tracers, such as the Chanalyst, which can be hooked into several parts of a circuit, and show by the indication on an electron-ray tube the part of the circuit in which the intermittent occurs, are very useful in locating this type of fault.

Picture drift

In a receiver using a Sarkes Tarzian tuner, the oscillator drifts quite a bit on channel 13, and as the picture fades out, noise levels increase and snow effect becomes very bad. I have tried a new local oscillator tube without effect. There is a slight drift on the lower channels, but it doesn't affect performance nearly as much as it does on channel 13. I have also changed the tuner, but the results are the same. H. S., Union City, N. J.

The drift on channel 13 which you mention could be due to improper tuner tracking or misalignment of the video i.f. stages. Improper tracking and alignment usually result in more critical performance on the upper channels because normal oscillator drift has a more pronounced effect on the higher frequencies. If the bandwidth is too narrow, normal oscillator drift will not be so noticeable on the lower channels, but would be on the higher. This is particularly true if lower channel stations are being received better than the higher. Stations from some distance also fade out on occasion. In either case (oscillator drift or fade-out) the signal-to-noise ratio decreases and the result is increase in noise and picture interference. With volume control and contrast up high, the low signal-to-noise ratio becomes serious. Automatic gain-control circuits work in this fashion also—with no signal input, the resultant low bias on the amplifier tubes increases gain and also noise, with no signal riding through.

Try adjusting the sound and picture output trimmers on the tuner—these may not be giving you good match between tuner and i.f. stages. On the Sarkes Tarzian tuner channel 13 screw adjustments are on the top for r.f. grid, r.f. plate and mixer grid circuits. Channel 13 oscillator screw adjustment is on front. Try several different r.f. tubes also. Some give a better signal-to-noise ratio than others, which means decreased snow effect.

—end—

Meters Properly Used Aid Trouble Shooting

Basic v.t.v.m. and multimeter circuits described with a few hints for their accurate use.

By **RUDOLF F. GRAF**

AS RADIO and television circuits increase in complexity, the troubles of the repair man increase with them. Even the meters he has always used seem to fail him at times. Service manuals or schematic diagrams generally indicate the proper voltages at various points of the circuit. But different and sometimes greatly confusing results may be obtained in some parts of the circuit if the meter used is not the same type as the one used to make the original measurement. The two basic types of meter today are the vacuum-tube voltmeter and the multimeter. We shall briefly explain the operation of both types, and then compare the readings obtained by each type in the identical circuit.

Multimeters

This type of meter has until recently been the more popular of the two. It has the advantage of being rugged; it is less expensive than the v.t.v.m. and generally is completely self contained. (No need for connection to a.c. line.) Its usefulness is limited, however, as we shall point out later.

All the so-called multimeters employ a basic D'Arsonval meter movement which is connected to various resistors. These resistors are selected either with a switch, or by connecting the test leads to any two of a number of pin jacks on the panel of the multimeter. The

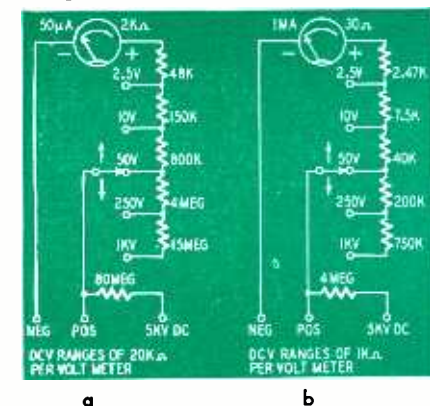

Fig. 1—D.c. voltage ranges: (a) 20,000-ohms-per-volt meter; (b) 1,000 ohms/volt.

D'Arsonval movements used in multimeters require anywhere from 25 microamperes to 5 milliamperes of direct current for full-scale deflection. The less current required for full-scale deflection, the more expensive is the meter movement and hence the complete instrument. The voltmeter ranges are always specified as having a certain "ohms-per-volt" rating. This is determined by the basic sensitivity of the meter movement used.

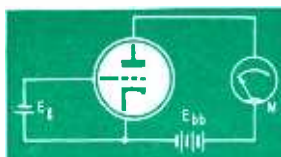

Fig. 2—Fundamental circuit of a VTVM

Fig. 1-a shows the d.c. voltmeter ranges of a popular multimeter (the Simpson model 260) which has a sensitivity of 20,000 ohms per volt. We shall now see how the voltmeter sensitivity is determined.

The basic meter movement used requires 50 microamperes for full-scale deflection and has a resistance of 2,000 ohms. If we wish to use this meter movement to indicate full scale when measuring 2.5 volts, we must arrange the circuit in such a fashion that the current through the meter will be 50 microamperes. By dividing 2.5 volts by 50 microamperes we find that the total circuit resistance must be 50,000 ohms. Since the meter movement itself has a resistance of 2,000 ohms, we need only to add a 48,000-ohm resistor and we are ready to measure all d.c. voltages up to 2.5 volts. Anything less than 2.5 volts will cause a correspondingly lower current and hence will be indicated on the meter scale as a smaller voltage. We can measure any higher voltage as long as we keep sufficient resistance in the circuit to limit the maximum current through the meter at all times to 50 microamperes. This particular multimeter has full-scale ranges of 2.5, 10, 50, 250, 1,000, and 5,000 volts d.c. As can be seen from Fig. 1-a, the higher voltage ranges are obtained by simply

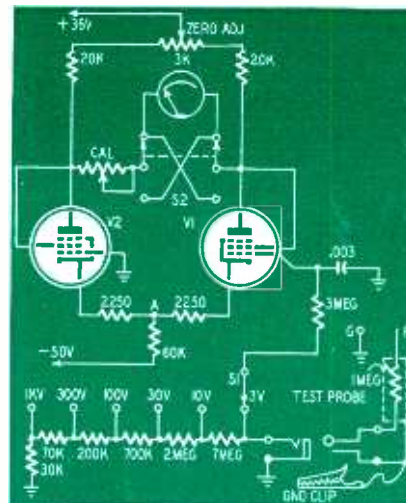

Fig. 3—D.c. voltmeter part of VTVM.

adding resistors in series to those already in the circuit. These resistors are called multipliers.

To determine the ohms per volt all we have to do is divide the full scale voltage of any one range into the total resistance in the circuit at that particular range. For example on the 50-volt range, the ohms per volt equals 1,000,000 divided by 50. (We get 1,000,000 by adding all the resistances; namely 800,000, plus 150,000, plus 48,000, plus 2,000-ohms.) This comes out to be 20,000. Actually a more correct designation would be "ohms per range volt," since for every volt on any one range the meter has a resistance of 20,000 ohms.

The voltage under test is applied between the POS and the NEG terminals and we can see that the resistance which will be presented to the circuit under test will be different for every voltage range. It is lowest on the lowest range (50,000 ohms) and highest on the highest range (100,000,000 ohms). This variation of input resistance is shown in Table I.

Fig. 1-b shows a schematic of the d.c. voltage circuit of a meter having the identical ranges of the above instrument, but employing a meter movement whose full-scale sensitivity is only 1 milliampere. In this case the multipliers are much lower in resistance than those we had before. The sensitivity of this meter is easily found to be 1,000 ohms per volt. The input resistance on all ranges is much lower than for the 20,000-ohms-per-volt meter, and is also shown in Table I.

From these two examples it can be seen that the ohms per volt of a meter depends strictly on the basic movement used. The more sensitive the basic movement, the higher the ohms per volt. Now let us look at the other type of meter, the v.t.v.m.

Vacuum-tube voltmeter

A vacuum-tube voltmeter is, as its name implies, a voltmeter using one or more vacuum tubes. A circuit of a basic v.t.v.m. is shown in Fig. 2. The meter is so connected that it measures plate

current. If we change the grid voltage E_g , this voltage change will cause a change in plate current and hence a change in meter reading. Since the grid circuit of a vacuum tube does not require any power if it is not permitted to go positive, we have an instrument which will give us a meter reading without requiring any power from the circuit under test. This is the fundamental advantage of a v.t.v.m.

We recall that in the multimeter we had to have a current through a resistance. It was the current which caused the meter needle to deflect. This requires power (I^2R) which, though it is small, must come from the circuit under test.

In recent years almost all v.t.v.m.'s have used a very stable 2-tube bridge circuit. The essential components of the d.c. voltage circuit of Electronic Designs, model 100 v.t.v.m., are shown in Fig. 3. The instrument uses two triode-connected 6K6 tubes which are linked together by a 60,000-ohm resistor which is common to both cathode circuits. The meter is connected between the two plates to indicate any potential difference that may exist. If there is no voltage applied to the grid of V1 the circuit will be exactly balanced due to its symmetry. The plate currents of both tubes will be exactly the same, the potentials at both plates will be equal, and the meter will read zero. The 3,000-ohm zero-adjust potentiometer is used to balance out any slight difference in tube characteristics or component values which may exist in the unit. If the grid of V1 is made positive, the plate current of this tube will increase.

Increase in the plate current of V1 will make point A more positive. This will also cause the cathode of V2 to become positive and hence decrease the plate current of that tube. So we see that an increase in plate current of V1 causes a decrease in the plate current of V2. Due to the different plate currents there will now exist a potential difference between the plates of the tubes, and the meter will deflect. The amount of deflection depends on the difference in potential, which, in turn, depends directly on the magnitude of the voltage applied to the grid of V1.

If the voltage applied to the grid of V1 is negative, the plate current of this tube will decrease, point A will become

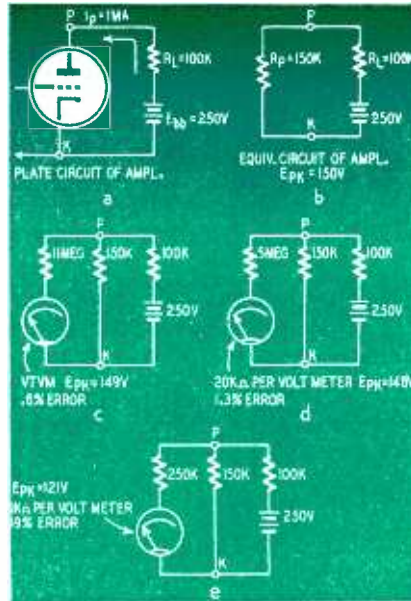

Fig. 4—Errors in measurement, where $E_{pk}=150$. (c) .6%, (d) 1.3%, (e) 19%.

less negative, and the plate current of V2 will increase. There will again be a potential difference between the two plates, but this time in the opposite direction. In order to be able to employ a left-zero meter, it is necessary to incorporate in the instrument a reversing switch by means of which the polarity of the meter movement can be reversed so as to have the meter read "up" at all times. This reversing switch is shown as S2 in Fig. 3. The voltage for the grid of V1 is obtained from a voltage divider consisting of R1 to R6. This voltage divider applies approximately 3 volts to the grid of V1 to obtain full-scale meter deflection. The voltage being measured is applied between the terminals P and G, and S1 picks off a portion thereof and applies it to V1.

A 1-megohm isolating resistor is incorporated in the d.c. test probe to reduce the input capacitance of the meter. This isolating resistor offers the advantage of permitting the measurement of d.c. voltages at points where r.f. voltages are also present, without detuning the circuit to any appreciable extent. The resistance presented to the circuit under test is constant and remains at 11 megohms regardless of the range.

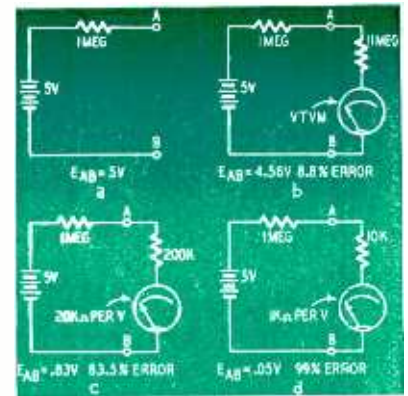

Fig. 5—Circuit measurement errors: (b) 8.8%, (c) 83.5%, (d) 99%.

Suppose we now want to find the ohms per volt as before, by dividing the full-scale voltage by the resistance in the circuit. Referring to Table II, we see that the ohms per volt of the v.t.v.m. is different for every range. We find the highest ohms per volt on the lowest range, and the lowest on the highest range. We say, then, in Table II, ohms per range volt. It may be interesting to note at this point that on the 1,000-volt

Voltage range	Input resistance	
	20,000 ohms/v	1,000 ohms/v
2.5 v	50K	2.5K
10 v	200K	10K
50 v	1 meg	50K
250 v	5 meg	250K
1,000 v	20 meg	1 meg
5,000 v	100 meg	5 meg

Voltage range	Ohms per range volt
3 v	3.65 meg
10 v	1.1 meg
30 v	365,000
100 v	110,000
300 v	36,500
1,000 v	11,000

range a 20,000-ohms-per-volt meter has a greater sensitivity (less circuit loading) than the vacuum-tube voltmeter. But since most servicing does not require the use of the 1,000-volt scale, it is still preferable to use the VTVM.

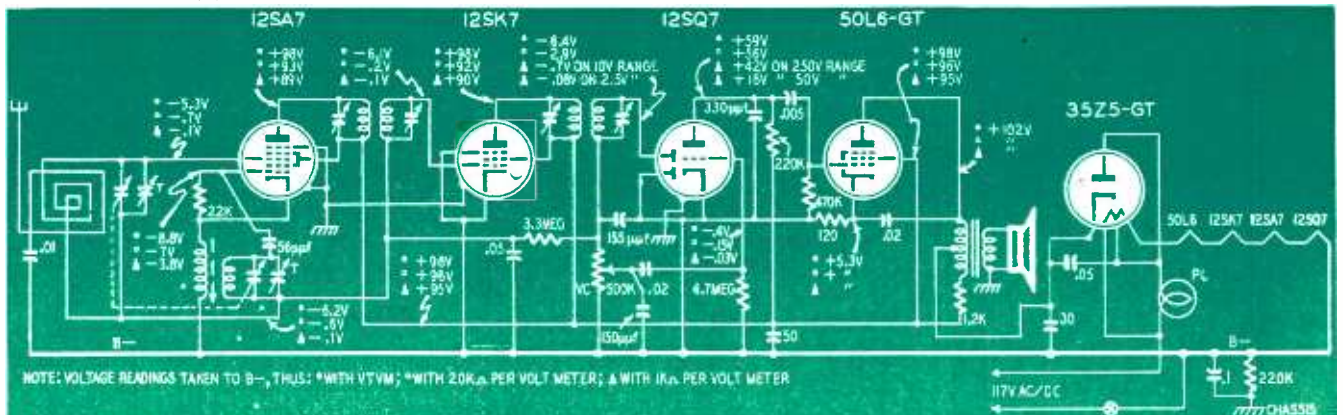

Fig. 6—Schematic of 5 tube a.c.-d.c. receiver with comparative voltage readings for different types of meters.

Using meters

Now let us observe the voltage readings at a point in a circuit, using different types of meters as voltage indicating devices. Fig. 4-a shows the plate circuit of a voltage amplifier having a load resistor of 100,000 ohms, a plate current of 1 ma and a B-voltage supply of 250 volts. Fig. 4-b shows the equivalent circuit with the tube replaced by R_p . Under the above conditions the voltage which will exist between the plate and cathode of the tube is 150 volts. To measure this voltage the meter must be connected between points P and K as shown in the illustration. Three different types of meters are shown connected, 4-c, 4-d, 4-e, and the readings obtained as well as the percentage of error are shown. The 1,000-ohms-per-volt meter will give a reading of 121 volts instead of the 150 volts which is actually on the plate when the meter is disconnected. Thus, the error in reading is almost 20%. The other two meters

will give readings which are closer to being correct.

The errors introduced become much more severe when we attempt to measure voltages on circuits whose resistance becomes appreciable when compared with the resistance of the meter on the range employed. An illustrative example is shown in Fig. 5 which involves a circuit whose resistance is 1 megohm and whose open circuit voltage is 5 volts. As before, the readings obtained, as well as the percentage of error are shown. We can very easily see that under these conditions the low ohms-per-volt meters are quite useless.

Fig. 6 shows a typical superhetrodyne receiver, RCA 65X1, with voltage readings. There are three voltage readings at all critical points and where there are two for the same type of meter, different ranges were used as indicated. It is evident from these readings on the grids of tubes and on the a.v.c. line that the 1,000-ohms-per-volt

meters can not be used as an indicating device, and that in most cases a v.t.v.m. should be used if at all possible. Of course, a stable v.t.v.m. is required. In manufacturers' servicing instructions you will generally note that the type instrument employed for taking voltage measurements is mentioned. The above article has been written with the hope that it will clarify and help account for some of the inexplicably "wrong" voltage readings which may have been obtained in perfectly normal and well-operating equipment.

It will only take a little forethought on the part of the meter user to often save a great deal of time and effort otherwise expended in making the "wrong" meter reading fit a "good" circuit. So let's not blame the meter if it will not measure anything beyond the point for which it has been designed. Let's follow the manufacturer's recommended procedure.

—end—

Ethical Service Pays Off

By WALTER R. ROGERS



High repair estimate tag; everyone loses.

NOT too long ago, when returning from lunch with three fellow workers, we spotted a friend rummaging around some trash barrels. It was rather strange, to say the least, to see Charlie at such an occupation. But when he saw us and invited us to see what he was up to, there were five of us in the junk business. Here were some 15 radio sets, more or less complete, tagged and waiting for the city trash trucks to haul off.

A casual look showed most of them complete and a few bashed in as if dropped. For the fun of it, each of us dragged back to the shop with a set or two. Each was tagged with customer's name, address, date, and a repair tabu-

lation which was higher than the value of the set. Charlie had time—before going to work—to replace a defective a.c. plug. The set worked right off with no real servicing at all. That night I left my set with another service technician just to see what he would do with it. It took 12 minutes to find an open coupling capacitor and align the set at the cost of \$1.50 at his regular prices. This set is playing in our kitchen in spite of the tag, similar to that shown in Fig. 1. No wonder the former owner gave up this little a.c.-d.c. set after the estimate of \$11.00 when new sets cost only a couple of dollars more.

Other genial weaknesses

There is no excuse for a radio service technician, because of his superior knowledge of radio, to take a "public be damned" attitude, appearing in dirty clothes and leaving a mess behind. The customer is paying for his time and the customer expects to receive protection of property and a decent cleaning up when the service technician is through.

In one locality, an electrician and a plumber are on the customers' preferred list because they always clean up after a job and are considerate of all wishes of the customer. I have never heard an objection to the slight charge which covers this time and makes each job pay a little more.

There is no question as to the need of genuinely professional radio service. How can it best be accomplished with the least red tape? Authorized service for certain makes of sets can be a factor in larger cities. But in the smaller cities and towns, a radio service shop

must take on anything that comes over the counter. There are many of these fellows who may only have a small sign out front and do their repairing at night and on week-ends.

As a starter, how about bonding radio service establishments in such a way that both they and the customer are protected from abuses? (At least one manufacturer has set up a bonding program in an attempt to meet this need.—*Editor*) A small fee must be added one way or another to each job, and the final arbiter of disputes would be the local Chamber of Commerce, Board of Trade, or Better Business Bureau. A reasonable code of ethics would be agreed on, publicized, and displayed by all radio service technicians who were able and willing to comply. Even the set manufacturers, through the RMA, might help further such a bonded service, in a manner that would not discriminate against the smaller service technician but that would make radio servicing a *real service to the public*.

Reasonable allowances must be made. For instance a reasonable minimum must be charged and rates so adjusted that the occasional tough job can be covered. There is a public service that any profession must undertake, and those who have gained solid public acceptance know what I mean. Price, quality of service, and speed of repair must be tempered with reasonable business practice and fair dealing.

What do you think would be the best way to make servicing a more responsible profession?

—end—

The Useful Impedance Bridge

By RICHARD H. DORF

VERY few radio service technicians, experimenters, or amateurs today feel that they can get along without test equipment. Even the "screwdriver" service operator has at least a volt-ohmmeter and a signal generator; to these the technician, experimenter and amateur may add audio oscillators, frequency meters, and similar equipment.

The majority of radiomen, however, are still forced to guess at the true value of a capacitor or measure it by the inaccurate impedance method on a v.t.v.m. And very few radiomen have any way at all of approximating even vaguely the inductance of a reactor. With the advent of television, the guess method is on its way out, for in many circuits only correct values will work at all.

The hobbyist and amateur have always had trouble constructing devices using capacitors and inductors, particularly the latter. Ordinary values as marked do very well for filter and bypass capacitors and filter chokes; but when a filter or tone control or a loud-speaker crossover network or any of many devices requiring accurate values of C and L is to be built, where are the inductors to come from? Filter chokes have other than rated inductance with no d.c. flowing through them. Audio inductors of the correct values are expensive. The usual practice is to start removing turns from an old choke whose initial inductance may not even be known.

It is easy to calculate the correct inductance for receiver and transmitter coils, but winding them is something else again. If clear directions are given in a magazine article, the results *may* be close, but often, it is necessary to rewind them altogether—after installation. And what of those old variable capacitors in the junk box—how can their capacitance be found? And what happens when a low-resistance shunt is needed for a meter? The volt-ohmmeter will measure none of these with useful accuracy.

The answer is the impedance bridge. For many years the bridge has been strictly a laboratory instrument, but it is gradually finding its way into the service shop and onto the basement bench.

A bridge that will measure resistance, capacitance, and inductance, with *Q* of inductors and dissipation factor of capacitors, is not impossible to build; it requires no vacuum tubes or high-voltage supply. It does, however, require careful attention to rigid wiring, and a minimum of stray capacitance and resistance.

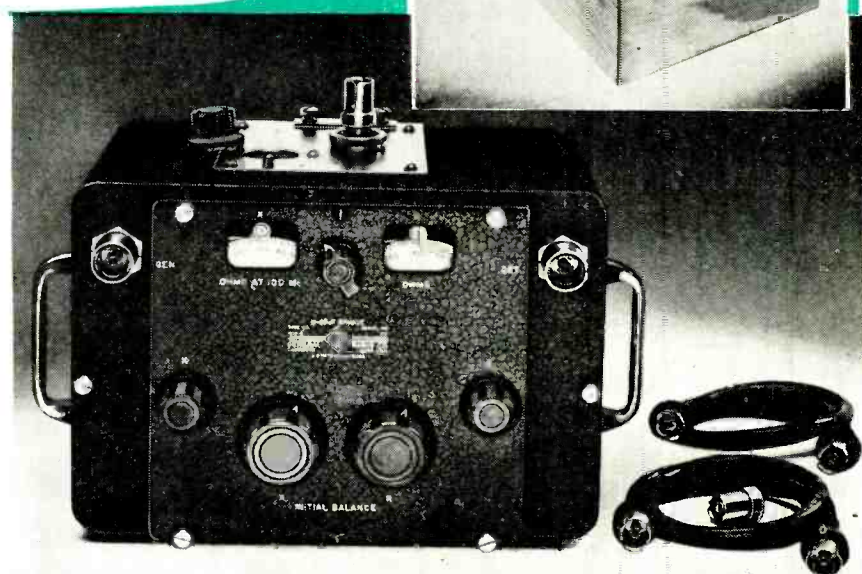
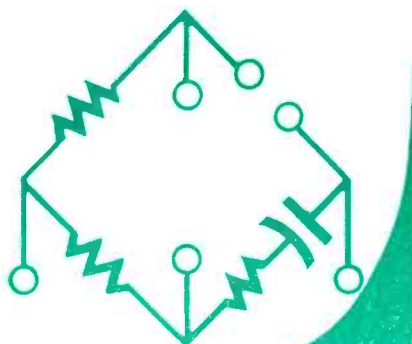

Two typical commercial impedance bridges are illustrated. The Heathkit comes in kit form; the GR unit factory wired. Both are accurate, flexible instruments.

The constructor may either purchase a kit or obtain his own parts. In the latter case only the highest quality parts should be purchased. For instance, switches should be ruggedly constructed, with heavy silver-alloy contacts. Low-tolerance parts are essential. Bus wire should be used throughout.

A commercial, proved circuit was used by the author (see Fig. 4). Figs. 1, 2, and 3 are simplified diagrams extracted from Fig. 4 for explanatory purposes. Resistance, capacitance, and inductance measurement procedures will follow below in that order.

Resistance measurement

A bridge operates by comparing the component to be measured with a standard rather than by observing its effect on current flow as in a volt-ohmmeter or v.t.v.m. As a result, the inaccuracy introduced by variations in a power supply or by a meter movement are avoided.

Fig. 1 is the circuit of a Wheatstone bridge suitable for measuring resist-

ances from about .005 ohm to 10 meg-ohms. (See Fig. 4 for significance of range switch position.) The important components are the resistors attached to S1-a and S1-b, which must be very precise (they are $\pm 0.5\%$ in one commercial bridge) and the 10,000-ohm variable resistor, which is calibrated to read the unknown values. The 10,000-ohm resistor has an approximately logarithmic taper. It must be wire-wound for good accuracy and long wear. Special units are usually used in bridges, the ones made by General Radio being most common.

The zero-center galvanometer has a movement of 100 μ a each side of center. S3-b places a 100-ohm shunt across it to reduce its sensitivity during the initial balancing.

The bridge in the top photograph has the dial of the 10,000-ohm variable resistor calibrated in large units. The markings are simply in thousands of ohms, arranged so that when the pointer is at 1, for instance, the arm is set for a resistance of 1,000 ohms. The ranges

marked in Fig. 1 for S1-a and S1-b are in multiples of 10 so that all can use the same main dial markings.

For measuring resistors S2 is usually set on DC so that the 6-volt built-in battery voltage is applied through a 68-ohm current-limiting resistor to the bridge input. The unknown resistor is connected to the R terminals as one arm of the bridge. Let us assume that the unknown is 1,000 ohms.

Setting S1 to the 1,000-ohm range (E) we find that the total resistance between points X and Z is 10,000 ohms.

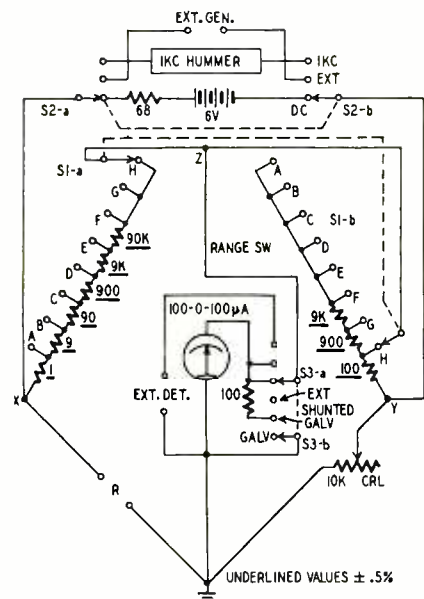

Fig. 1—Wheatstone bridge measures resistance. Battery or hummer is used.

Between Z and Y is also 10,000 ohms. Therefore exactly one-half the battery voltage appears between Z and either X or Y. If we then set the potentiometer to 1,000 ohms, one-half the battery voltage appears between ground and either X or Y. Thus, points Z and ground are at exactly the same potential and the galvanometer will draw no current. In operating the bridge, the potentiometer is first set for a near-zero meter reading, then the meter shunt is removed with S3-b to make the meter more sensitive so that it can be zeroed more exactly.

Suppose now that a 500-ohm resistor is to be measured on range D. On that range the resistance from X to Z is 1,000 ohms; from Z to Y is 10,000 ohms; the ratio is 1 to 10. If the same ratio is held for the other two arms, the voltages at Z and ground will again be equal for zero meter reading. To make it so, the potentiometer must be set at 10×500 or 5,000 ohms. The pointer is then on the 5 mark. Multiplying the range switch setting (10) by the potentiometer dial reading (5) gives the correct resistance of the unknown (500).

On the very high and very low ranges the current through the meter when the bridge is slightly off balance is very small, making it difficult to set the potentiometer exactly. The solution is to substitute a higher voltage for the

built-in battery by connecting an external source to the EXTERNAL GENERATOR terminals and switching S2 to its center position. On the A through D settings of S1, a maximum external voltage of 67.5 may be used with a series current-limiting resistor of at least 1,500 ohms. On the E position, 135 volts may be used with at least 4,000 ohms in series. On the F, G, and H ranges, 202.5 volts is the maximum, with at least 6,500 ohms series resistance.

The 1,000-cycle hummer used for L and C measurements can also be used for R measurement, with a set of headphones connected to the external detector terminals, setting the bridge for a null in the phones.

Capacitance measurement

The circuit given in Fig. 2 measures capacitance from about 10 μf to 95 μf and does it accurately, provided the wiring does not add stray capacitance. The writer has measured calibrated capacitors as small as 15 μf , a value with which almost no v.t.v.m. instrument will cope. S1-a, its resistors, and S2-a and -b are the same units shown in Fig. 1. The same 10,000-ohm potentiometer and dial scale are used as well.

A capacitor has two important ratings, capacitance and power or dissipation factor. Capacitive reactance alone does not consume power, but since no dielectric is a perfect insulator, all dissipate some power.

The dielectric resistance across the capacitance is usually very high. In a bridge we must duplicate the effect of this high shunt resistance on the standard capacitor. Using a high-resistance potentiometer (sometimes of several hundred megohms) is impractical. The same effect is obtained with a low resistance in series. This produces the same change in net impedance and the same power loss as a high resistance in parallel.

In Fig. 2 a 1,000-cycle hummer powered by the 6-volt battery or an external audio oscillator furnishes a.c. for the bridge. A hummer is an electromagnetic buzzer-like device especially made for this purpose. It eliminates the need for a vacuum-tube oscillator. The .01- μf capacitor (accurate to within $\pm 0.5\%$) is a standard with very low dissipation factor.

In operation, the unknown capacitor is connected to the C terminals. The range switch and the 10,000-ohm main potentiometer are adjusted so that the impedance ratios are equal, just as in the resistance bridge. The net impedance of both the standard and unknown capacitors depend not only on capacitive reactance but also on the resistance. Two variable resistors with dials marked D are provided in series with the standard capacitor to provide for dissipation or power factors from 0.1 to 1. Power factor is the ratio of actual watts of power consumed to volt-amperes (voltage drop across the capacitor times current through it).

The two D dials may be calibrated

from 0 to 10 linearly (if the resistors have a linear taper). They are read as .01-0.1 and 0.1-1, as indicated in Fig. 2. Set the knobs so that each resistor is exactly in the middle of its resistance range with the pointer on 5.

When measuring a capacitor, the final settings must be made with the D and main dials at the same time, setting both for a null in the headphones.

Inductance measurement

The diagram of Fig. 3 actually shows two different bridge circuits for measuring inductances from 5 μh —100 h. With S4-a closed the circuit is a Maxwell bridge for inductances with Q of 0 to about 10. With S4-a open and S4-b closed, the circuit becomes a Hay bridge, taking care of Q from .10 to about 1,000.

The dissipation factor of a capacitor is usually very low and has little effect on its circuit. On the other hand, resistance in coils of all kinds is usually very important. It is due to the wire with which the coil is wound. The Q of an inductor is its factor of merit and is the ratio of inductive reactance (at a given frequency) to ohmic resistance. Q determines the shape of resonance curves and the steepness of cutoff in filters, among other things.

With S4-a closed, the 16,000-ohm variable resistor is across the standard 0.1- μf capacitor (made up of 10 .01- μf units).

The unknown inductor is placed in the diagonally opposite bridge arm instead of in the adjacent one, as with the unknown capacitor of Fig. 2, because inductive reactance is opposite in sign to capacitive reactance. The bridge is adjusted to a rough balance with the range switch and the 10,000-ohm main control. Then the 16,000-ohm resistor is adjusted for minimum sound output. Final balance is obtained with both controls. Inductance is read from the main control dial and the range switch; Q is

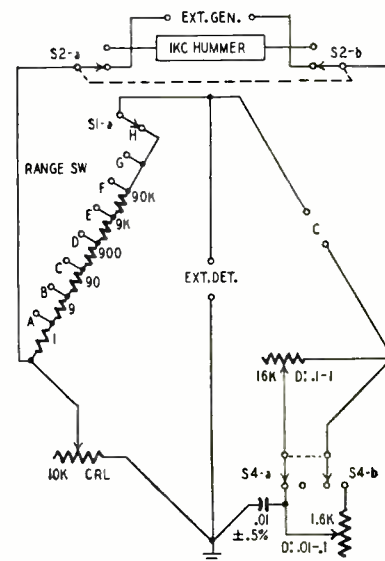
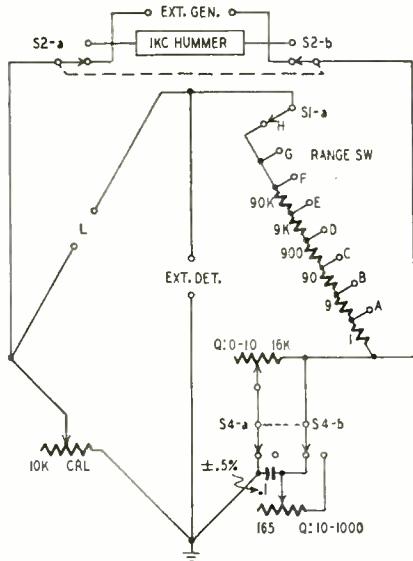

Fig. 2—This circuit measures capacitor values for all but electrolytic units.



read from the 16,000-ohm resistor dial. When balance is impossible in this way, the 165-ohm potentiometer is switched in series with the standard capacitor. It accounts for Q of 10 or more, corresponding to low coil resistance. The same procedure as above described is applied. The series resistance (of a higher value) could be used even for low Q, but a high resistance in series with the capacitor would alter its impedance enough to make the bridge frequency-sensitive.

Fig. 4 is a complete schematic diagram of the Heathkit impedance bridge used by the author. It contains the circuits of Figs. 1, 2, and 3. Heavy bus wire is used for all connections except for the battery and hummer, to keep stray capacitance, wiring resistance, and instability low. New bus wire should be stretched first to make it straight. Put one end in a vise and pull hard on the other end with a pair of pliers until the stretch is felt. Make each connection mechanically sound.

RANGE CHART

Range	R	C	L
A	.005-1.0 ohm	0.5-100 μ f	5-1,000 μ h
B	.05-10 ohms	.05-10 μ f	.05-10 mh
C	0.5-100 ohms	.005-1 μ f	0.5-100 mh
D	5-1,000 ohms	.0005-0.1 μ f	5-1,000 mh
E	50-10,000 ohms	.00005-.01 μ f	50 mh-10 h
F	500-100,000 ohms	5-1,000 μ f	0.5-100 h
G	5,000 ohms—1 meg.	—	—
H	.05-10 megohms	—	—

Main dial calibration of the kit job is simple. In the kit the panel is already marked; it is necessary only to set up the bridge for resistance measurement, using as the "unknown" a 1,000-ohm standard resistor supplied.

Without the kit, another bridge can be used to measure the resistance of the 10,000-ohm unit at several points, after which the dial is marked in thousands of ohms. The knobs for the Q and dissipation factor controls then may be oriented by measuring their resistances with the bridge itself.

In using the inductance ranges, remember that the Q reading is accurate only for the frequency at which it is

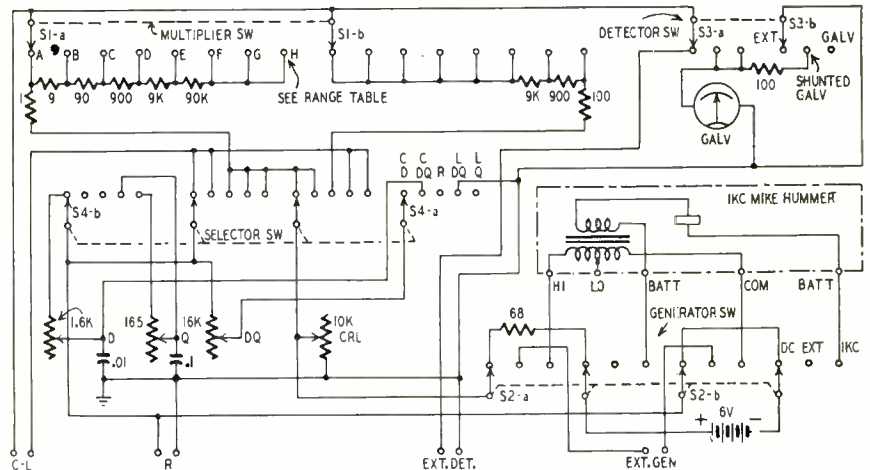

Fig. 3—left. Hay and Maxwell bridges selected by S4 measure inductance and Q. Fig. 4—above. Switch numbers of Heathkit schematic are same as in Figs. 1, 2, 3.

measured. For use at frequencies other than 1,000 cycles S2-a and -b (Fig. 4) may be switched to the external generator position and an external signal of the correct frequency applied. Inductance readings are reasonably accurate at all frequencies even though taken at 1,000 cycles, but r.f. resistance at higher frequencies will lower the Q of most coils, and results are unreliable. Special

bridges are required for high radio frequencies.

Capacitance readings may be relied upon at all but the very highest radio frequencies because of the leads and so on. Resistance is accurate for all frequencies, but wire-wound units may become inductors at high frequencies.

—end—

Battery Checker Gives 6 Different Tests

The Army Signal Corps Engineering Laboratories, Fort Monmouth, N. J., have developed a storage battery checker which combines numerous functions and tests which previously required several separate checkers.

Certain Signal Corps batteries don't have more than a teaspoonful of acid in their cells in case a hydrometer is used, literally, there isn't enough acid to be tested by the float method. The new tester gives an electrical rather than a chemical test. The basic principle and design, worked out by Grenville Ellis, chief of the Laboratories Power Services branch, was incorporated in the developmental model built by Hickok Electrical Instrument Co., Cleveland.

Problems in testing the batteries which might be used throughout the world are complicated because to get maximum performance, batteries in the Arctic zone are given a higher specific gravity acid, while in tropical zones, the specific gravity of the acid is reduced to prolong the battery life span. Ordinary testers can test batteries designed only for temperate climates.

The following is an explanation of the scales on the dial face:

VOLTS: All scales on the dial are based on voltage scale. Voltages are measured under no-load or load, depending on test required.

FREEZING POINT: This tells at what temperature the battery acid will freeze. It ranges down to -85 degrees F.

PERCENTAGE OF CHARGE: This is based on open circuit tests and there are scales for Tropic, Normal, Arctic; since percentage of charge remaining is a measure of the specific gravity, and different specific gravity is necessary in

separate climates, three scales are necessary.

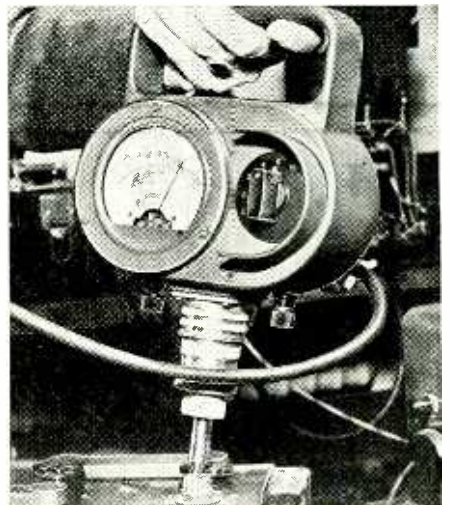

CHARGING VOLTAGE: (to right of percentage of charge). This tests the battery under charge, and tells whether the battery is charging at the proper rate.

LOAD TEST: This is based on a closed-circuit test, and shows whether it is working properly under load. The dial at the right of the meter selects the load. If used in an auto (mounted on dash or steering wheel) the vehicle supplies the load. There are three sections to the load test, +80° F.; 0° F.; and -40° F.

CRANKING TEST: This is a high rate load test at high current. It tells whether there is enough juice to start the engine and has two sections, 0° and -40° F. —end—

Servicing the AM Receiver

Eliminating minor troubles in i.f. or r.f. stages; realignment pays off in better set performance.

By J. TRAVIS RODGERS

THE ability of a receiver to pull in weak signals and to separate stations which are on adjacent channels depends, in most cases, on proper alignment of all tuned circuits. Realignment of the average set is no problem for the technician. The real headaches arise when one must track down and eliminate minor troubles in the i.f. or r.f. circuits before the set can be correctly aligned.

If a set oscillates badly over part or all of the band, and peaking the i.f.'s at the correct frequency does not eliminate the trouble, the next logical step is to check for an open a.v.c. or screen bypass capacitor. In large a.c. sets, an open or partially open filter capacitor may be the cause of oscillations, even though it is not bad enough to cause noticeable hum. Close coupling between grid and plate leads in r.f. or i.f. stages also may be the source of trouble. Moving these leads around with an insulated tool may lengthen the feedback path and eliminate oscillations.

Recently I spent some time going over a practically new radio—one of RCA's miniature-tube models. Oscillation was so bad that it was impossible to send a clear signal through the set. After considerable manipulation, I noticed that oscillation stopped when the tuning capacitor was wide open. A close examination showed a few drops of water between the plates. The set had been left by an open window during a rainstorm. The water was removed by sliding a strip of blotting paper between the plates. Oscillation vanished and the set was realigned without further trouble.

Another annoyance is excessive static. A comparison with a set known to be in good condition will quickly reveal whether the noise originates in the set or is caused by atmospheric conditions or power-line disturbances. If the noise is produced or intensified by jarring the set, the chances are good that it is due to a loose connection, faulty tube, or coupling capacitor. Tapping these parts or moving them slightly will usually disclose the source of the noise. If the disturbance is a popping or crackling sound, it may be the result of a partially shorted or open winding on a transformer. Of course, the output transformer can cause this trouble, but it is more likely to be the primary of the oscillator coil or an i.f. transformer. Momentarily shorting to ground the plate side of each coil will send exces-

sive current through it. This will usually result in the leak being healed or will cause the winding to completely open up so it can be located and replaced.

Often static is noticeable only when the tuning dial is moved. This is probably the result of the tuning capacitor plates rubbing or the presence of dust or metal particles between the plates. If the plates are rubbing, they usually can be straightened with a little patience and effort. Foreign particles usually can be removed with a blast of air or a small paint brush. If this does not work, try the gadget shown in the diagram.

Be sure to disconnect the r.f. and oscillator coils before using this device. If you don't, the coils will be damaged. Plug in the test leads and connect the clips to the stator and rotor of the

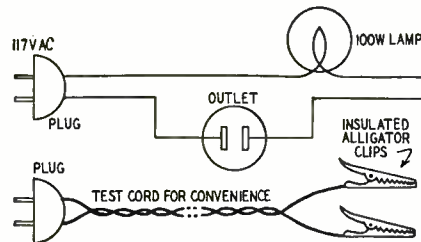

How to spot shorted variable capacitors.

As the tuning dial is turned, the lamp will glow or burn brightly as the foreign material is burned out. If the lamp remains lighted there is a direct short between the plates. Sparking between the plates when contact is made or broken will show the exact location of the short. Some prewar sets have chrome- or nickel-plated capacitor plates. The plating often peels and causes no end of trouble. This gadget is the most effective means of removing plating which has peeled or scaled.

Alignment procedure

Poor selectivity, low volume, tuning stations at the wrong point of the dial, sensitivity fair at one end of the dial and poor at the other, and a tendency to oscillate are all indications of misalignment. Assuming that tubes and other components check O.K., we are ready to align the set. If you do not have a signal generator, get one! All this ballyhoo about aligning radios without a signal generator is the bunk. Even if it can be done fairly accurately without a generator, it is neither practical nor profitable.

It is well worth the time to look up

the correct intermediate frequency before attempting the job. If the data is not available, the correct i.f. usually can be found by trying the most common i.f.'s (175, 262, and 456 kc). Most sets are better aligned with the tuning dial set to the low-frequency end of the band. When a signal comes through clearly, try tuning set and generator across the dial. If the signal continues to be heard at a constant level, the i.f. is O.K. If it peaks at several points on the dial, try another i.f.

An output meter is a worth-while piece of equipment to have but is not essential. If you have a sensitive ear, you can do a good job without one.

If a strong broadcast station comes in at the correct spot on the dial, it can be used instead of a signal generator for aligning the r.f. and oscillator. The most common procedure is to align the oscillator trimmer at around 1600 and the r.f. trimmer or trimmers at 1400 kc. If an oscillator padder is used, it should be adjusted for maximum output at around 600 kc. This adjustment should be made while rocking the tuning control. Repeat this procedure until tracking is correct at both ends of the dial.

In the Communications section some time ago, a reader voiced his disapproval of technicians who bend tuning capacitor plates instead of adjusting trimmers. I agree with him as a general rule; however, some sets—particularly small a.c.-d.c. models—cannot be aligned without bending the plates.

Because of some peculiar change in circuit constants, some sets have entirely too much capacitance in the tuned circuits to permit the stations to be tuned in at the correct spot on the dial when the i.f.'s are correctly peaked. I balance this condition by unwinding a few turns from the oscillator or antenna coil, or a single turn from the loop. This usually results in increased volume and better selectivity and stability. Take care that you don't remove too many turns and reach the opposite extreme. Removing the necessary turns sometimes turns out to be quite a job, so an additional charge is in order when this is necessary.

Some customers may argue against paying a nominal fee for alignment until they see how their sets have improved. Afterward, they go away contented with the job. Customer confidence and good-will build up repeat business.

—end—

The Ship Radio Operator

Opportunity beckons in the merchant marine radio service

By **AARON NADELL**

PRESENT international tensions reopen the opportunity, normally scarce in peacetime, for radiomen to serve their country in civilian status—and see the world, gain interesting and valuable experience, and enjoy a good income—as radio officers aboard ships of the merchant marine. Men who do this work are also draft-exempt; at least they were doing the two previous world wars.

The work itself is not strenuous. It is pleasant, interesting, and decidedly well paid according to present rates of pay for radiomen in shore jobs. It provides endless opportunity for travel, to get out of the rut, to break with routine, to see far and wonderful places, where life and people are different.

There is ample opportunity for advancement in the sense that the radio officer has an abundance of spare time that he can use for studying correspondence courses in his own profession or any other field, if he so desires. And there is excellent opportunity for a well-paid lifetime career of sailing the seas, if the radioman cares to convert this temporary opportunity into a permanent place among the country's professional merchant seamen.

Minimum pay at present is about \$350 a month. There are additions, which ordinarily operate to raise the real pay to between \$400 and \$500 a month (plus room, board, and travel).

Note that this is civilian, not service pay. There are no service benefits: for example, no allowances for dependents. The radio officer supports his own, if he has any. Income tax concessions and other privileges granted to members of the armed forces also do not apply. There are some seamen's privileges; the R.O. can buy standard brand cigarettes aboard at 70 cents a carton or thereabouts; and razor blades, work clothes, and other small items at cost.

The radio officer is licensed. He may at any moment find the ship's safety, and the life of everyone aboard, in his own two hands. Not everybody is allowed to take on that responsibility. The United States Government licenses those who pass appropriate examinations for competence. The average radioman, however, has nine-tenths of the background needed for the technical examination and can easily acquire the rest. If he does not know the International code, or first aid, he will have to train himself in those matters.



Radio room of the S.S. Independence, with Radio officer Charles C. Berger on duty. Radiomarine Corp. of America

Three kinds of ships

There are three types of American merchant ships: dry-cargo, tanker, and passenger. The passenger ships are publicized and glamorized to attract customers, but in the American merchant marine they are a very small minority. A number of dry cargo ships and tankers, however, do earn extra money for their owners by carrying a few passengers also—in some cases no more than half a dozen.

Backbone of the merchant marine is the dry cargo freighter. This is simply a seagoing truck. Just as some trucks on the road move general merchandise for anybody who wants to ship it and go wherever they are needed, so there are dry-cargo freighters (and tankers also) called "tramps" because they have no steady runs but go wherever they can find cargos. On the road there are also fleets of trucks that are owned by one corporation and carry that corporation's goods only. Similarly there are ships and fleets of ships that carry only aluminum ore, or sulphur, or bananas, for corporations dealing in those commodities.

The U. S. merchant marine also includes a large number of tankers. These are like gasoline trucks or milk trucks—built to carry fluids, usually crude oil. Some oil companies own large fleets of tankers.

Life on the deep sea

The radio officer's life on shipboard,

outside his working hours, depends a good deal on the kind of ship he rides. On freighters and tankers, especially those carrying no passengers, matters are usually informal. More like a stag camping party than like business ashore. Even the captain does not always trouble to shave. Any kind of working clothes are acceptable; nobody thinks of wearing a necktie until the ship approaches port. Discipline is easy-going—the captain is "Sir" or "Captain," the chief engineer is "Chief"; the mates and engineer officers are called either "Mr. So-and-so" or by their first names. However, the first assistant engineer is sometimes "First" and the first mate "Mate." The radio officer is addressed, by one and all, officers and crewmen, as "Sparks." The boatswain—top sergeant of the deck gang—is "Bos'n," the pumpman is "Pumps."

Although the captain is absolute dictator, and his orders, under the law, must be obeyed, unreasonable orders can be protested very effectively after the ship reaches port. It is in fact the duty of the radio officer to note the fact in his log if he considers an order incorrect or dangerous. No captain is unreasonable. He would not sail as captain very long if he were. There is too much competition for that enviable job.

The radio officer's status as officer is a matter of law. On dry cargo freighters and tankers he has his own private cabin, usually located next to the radio shack. On the latest ships he even has

his own private bath; more normally, he shares the officers' facilities. His bunk is made up, and his cabin swept and dusted, by a utility member of the crew; and utility messmen also wait on him at table. Sleeping quarters are comfortable except that the bunk is only cot size; there are no bathtubs as a rule but showers are plentiful, with hot and cold running fresh water. Living and working quarters are always warm in winter (every ship's engine room produces heat in abundance). Quarters are not always cool in summer, although a very few of the newest ships are air-conditioned. Mostly, fans are used.

Food on freight ships and tankers commonly is good while in and just after leaving port. Fresh milk and leafy vegetables are not to be expected far out at sea. Because a ship's work runs through the 24 hours, coffee is available at any time and the messroom refrigerator usually contains the makings of a midnight snack—unless your fellow officers beat you to it.

There are no laundries on freight ships or tankers—officers and crew alike, even the captain, wash their own clothes. Clean towels and bed linen are furnished by the ship, but if the voyage proves unexpectedly long supplies may run out. In that case each officer can take his choice between washing his own or contenting himself with soiled linen.

Life on passenger ships is somewhat different. It is more formal: Shaving and uniforms may be required. The R.O.'s quarters and general comfort are much as described above. Meals, being on the passenger scale, are more elaborate. The late-evening snack may be served to the radio shack by a steward who brings a well-filled tray. Laundry facilities may be available. To what extent ship's officers, including the radio officer, are encouraged, permitted, or forbidden to mingle with passengers socially depends on company policy.

Beginners at sea often become seasick, but soon get their "sea legs" and aren't troubled any more. To the contrary, one comes to like the motion of a ship in fresh weather, and being rocked to sleep by it like a baby in a cradle. A violent storm is another matter. The seasoned seaman does not become sick, but the fierce rocking and pitching require a constant exertion of muscular force to maintain equilibrium, which soon becomes tiring. Not because there is any danger, but because of the discomfort, even the oldest and most experienced seaman is relieved when a storm subsides. As for danger—driving almost any highway on a Sunday afternoon is much more venturesome.

War risks are another matter. In World War II casualties in the merchant marine were higher than in some branches of the armed services.

Despite the fact that all ship personnel work a full 56-hour week at sea, all have plenty of spare time on their hands; the radio officer perhaps most of all. The time normally spent ashore in going places—commuting to work, or

even traveling to amusement—is all saved. There's no place to go. "Commuting" to work is a matter of stepping across a threshold or down a corridor. Entertainment is found in listening to the short-wave radio, in playing cards, checkers, or other games, in reading, and in bull sessions. Sparks in particular has an abundance of spare time. Most of his work consists merely in listening to a loudspeaker and making a note of what he hears once every few minutes. He can keep his equipment clean and lubricated, make minor repairs, charge and care for the storage batteries, and do other chores, while simultaneously standing watch.

Sparks and the other officers soon become friendly enough for normal social intercourse aboard. One point of ship's etiquette that should be remembered especially: each man's work is his own business, and not open to comment by anyone except his superior.

The most important part of seafaring life is shore leave. Sparks is exceptionally fortunate in that respect because he has little to do when the ship is in port. He must wait aboard for quarantine and to draw his pay or part of it; he must wait or arrange to be back aboard if his equipment is to be inspected or supplies for it delivered; he must keep in touch by telephone often enough to make sure he won't be left behind if sailing orders are changed. Otherwise—unlike other officers, who have work to do in port—the radio operator is free to go ashore and stay as long as he likes.

The operator's wages

The operator's pay varies somewhat according to the ship. The chief radio officer of a large passenger ship may draw a base pay of \$460 a month; but there is little overtime when the ship carries an around-the-clock supply of radio operators, as large passenger ships are required to do by law. Overtime may be paid, however, when the ship is at sea on Sundays or holidays—or if in port, if the radio officers are deprived of shore leave on such days.

The same Sunday and holiday overtime applies aboard freighters and tankers. Additionally, three hours overtime per week is often paid for charging the storage batteries, although it is entirely permissible to do this work while on regular watch. If Sparks is called on to work beyond his regular watches—to get storm warnings or radio-compass bearings, or for any other reason—overtime is paid for the extra hours.

On some freighters and tankers the ship's operator can earn up to roughly \$100 a month additional by doing the ship's bookkeeping—making up the payroll, and the like—and by taking care of the "slop chest," which is the variety store that sells cigarettes, razor blades and other necessary items. (This "store" exists because the law requires it, and it must not earn a profit.)

The communications equipment

Communications and auxiliary equip-

ment carried aboard is divided between the radio shack and the navigation room. The radio officer is completely and directly responsible for everything in the shack. His responsibility for the other electronic installations is much lighter.

The shack commonly is fitted with two transmitters and two receivers, plus the auto alarm. The latter is the automatic receiver and keyer for distress signals. Also often kept in the shack is the portable lifeboat radio, which Sparks tests from time to time to keep it always ready for emergency, and which he carries to his assigned lifeboat in case of "abandon ship."

The standard international marine communications frequency is 500 kc. This is the distress call frequency. It is also used for general calling, but not for traffic. When contact has been established or is expected as a result of a call broadcast on 500, the caller designates some adjacent frequency between 500 and 100 kc for working. Thus 500 is kept open for distress calls.

The ship's main transmitter is tuned to 500 and to a number of other frequencies. The main receiver has a range from 500 kc downward to perhaps 16 kc or thereabouts.

Additionally, most ships carry a high-frequency transmitter capable of operating on the assigned marine bands up to perhaps 25 mc, and a short-wave receiver with a continuous tuning range from roughly 2000 kc to 25 mc.

The auto-alarm is a receiver tuned to 500 kc and equipped with step-by-step audio selection to respond to the automatic distress call only. That call is not the conventional SOS (. . . — — — . . .) but instead a series of 12 dashes, each exactly 4 seconds long and spaced by intervals of exactly one second.

The operator's duties

All this equipment is the responsibility of the radio officer. He not only operates it; he keeps it in condition and repairs it when it goes wrong. Extensive repairs are not expected of him; he is primarily an operator and not a repair man. Nevertheless, it is his job and responsibility to maintain communications, and with two receivers and two transmitters he should be able to do it.

Routine operation of the shack equipment divides into listening and transmitting. Primarily Sparks listen to ("guards") 500 kc. He listens for three things: distress calls, calls for his own ship, and general traffic notices that may or may not concern his ship. When the latter require him to shift to another band for further details, he may abandon 500 kc temporarily.

Since ship's business of various kinds—including navigation warnings, storm warnings, and calls for the ship itself—may also come over h.f., it is common practice to keep two loudspeakers on and guard an appropriate h.f. band in addition to 500. Keeping that kind of watch does not preclude other activities. Sparks on watch is in the position of a

person eating lunch in a crowded restaurant with much conversation all around. He can attend to his lunch and ignore the conversation with complete assurance that if his own name is called or something of special interest to him is mentioned he will certainly hear it. Similarly, Sparks can do the ship's bookkeeping while on watch, or write letters, or dress the storage batteries, with two loudspeakers running and absolute confidence that if anything comes through either that concerns him, he won't miss it.

Ship's business to be received includes direct instructions—for example, orders for change in destination, or docking instructions on approaching port. Indirect business includes storm and navigation warnings, weather forecasts and time signals. The latter are needed by the navigation officers for check on the ship's chronometers.

Business to be transmitted includes the daily position report—the owners want to know where the ship is and what progress it is making. A brief coded weather report also may be sent. On approaching port the captain will want to send a message containing expected time of arrival, and need for fuel or supplies, if any. Bearings and position reports may be requested from shore stations rendering such service. On passenger ships, passenger radio-grams may keep the radio operators busy and the transmitters hot.

Miscellaneous equipment

The auxiliary equipment found in the navigation room now almost universally includes a direction finder. This is a receiver with a well-designed rotatable loop antenna, through which the ship takes its own bearings on shore stations and, by triangulation on two stations, may find its own latitude and longitude. Sonar is an audio-signal transmitter and receiver through which a pulse of sound is transmitted to the bottom of the sea and the echo caught and timed. A dial calibrated to the velocity of sound in salt water reads the depth directly in feet or fathoms. "Iron mike" is a gyroscopic servomechanism that operates the steering wheel, replacing the helmsman and keeping the ship on any course desired.

All these auxiliaries are commonly operated by the navigation officers. When one breaks down, however, Sparks may (or may not) be asked to make repairs, at overtime rates. It is permissible but not wise to plead ignorance of the equipment. Sparks will do better, if the captain is willing, to borrow the instruction books for those items of electronic equipment and read up on them in advance. Both his income, and the respect accorded him aboard, will be enhanced. The same applies to radar equipment.

Whatever the radio officer does in the line of duty, he notes in his log. If he merely listens and hears nothing of interest, he enters one call heard each 15 minutes, to show he was on watch.



This installation is in the radio room of the Moore-McCormack liner *Uruguay*.

The technical requirements

Examinations for technical competence are given by the FCC. They relate to standard electronic principles and practices with which the trained radio-man is familiar. He may need to brief himself a little on the detailed applications of those principles to ship's equipment.

Those imperfectly familiar with the International Morse code will find that more of a stumbling block. No one has ever invented a way to learn Morse except by practice. To receive well, it is necessary to persevere until the beginner's habit of translating Morse into English to understand it has been overcome.

To send well, it is necessary to persevere until wrist and fingers form perfect characters mechanically without any attention—a muscular habit perfected and automatic. Sending and receiving speeds of 25 words per minute are required for a first-class license. It is not necessary to receive on a typewriter. A pencil will do, for service on freighters or tankers. Typing is necessary on passenger ships where traffic is heavy, and messages must be taken down right the first time because there is no leisure to retype.

The Coast Guard examines license candidates for loyalty and for knowledge of first aid. The latter is required because freighters and tankers do not carry doctors. All officers must know how to give first aid in illness as well as accident. A radio service exists by which Sparks can get medical advice through a shore station.

The FCC license certifies that the holder is a competent operator; the Coast Guard license makes the holder a merchant marine officer under the laws of the United States.

The radio officer's status, duties, and privileges aboard ship are thus affirmed and defined by law, as well as by the

customs of the trade, and by labor unions. There are several unions. Membership is wide open now that the demand for radio officers has again become strong. It is not necessary to be a member of any union, although most ship companies are now organized under contract. Unions have done an enormous amount of good work for the radio officer during the past 20 years. Twenty years ago the pay was not one-tenth what it is now; privileges and living accommodations were poorer; and the "wireless operator" did not have legal status as a ship's officer.

The law is singularly favorable toward the radio officer who wants to make a lifetime career of his work. Other technicians may be displaced by technological improvements. But the law says that ships **MUST** use Morse communicating equipment, and **MUST** carry Morse-trained men to operate it. International treaties so require. Those treaties, since they have been duly ratified by the U. S. Senate, carry in this country not merely the force of law but that of amendments to the Constitution. They are not likely to be altered to permit elimination of the radio officer in favor of mechanical devices until the poorest and most backward seafaring nations agree.

The R.O. who wishes to convert the present temporary opportunity for service at sea into a lifelong career can do so quite readily. Now that radio officers are scarce, it is quite practicable to get into the service of one of the steamship companies that have rules of seniority, pension and vacation plans, and similar up-to-date employee benefits and relations. But the R.O. who is willing to settle down to the area covered by a single company of the type just referred to, and who joins such an organization and accumulates seniority, can have a well-paid and protected career at sea. —end—

The Magnetic AMPLIFIER

By A. A. BOSSCHART

**Rugged unit uses d.c.
to control power; gain
to 10 million possible**

MAGNETIC amplifiers have been used for many years. As early as 1916, Alexander-son of G-E used them to modulate a 72-kw transatlantic radio transmitter. Many countries have contributed to our present-day knowledge. The German navy, after experiments, used them to stabilize range finders during the last war. Dr. Uno Lamm of Sweden is the author of one of the best works (*Fundamentals of Transducers or Magnetic Amplifiers*) available on the subject. Japanese scientists conducted research on core materials for many years and developed several excellent high-permeability types.

Magnetic amplifiers are sometimes called d.c. transformers, an appropriate name. They consist essentially of a magnetic core and coils of wire. One or more *input* coils are fed with d.c. to control the power available from the *output* coils. Power is taken from the line or other source of a.c. The a.c. power supply is 60-1,000 cycles.

Unlike a tube amplifier, the magnetic type has relatively high distortion and an inherent time delay as great as 0.1 second. It is not applicable to many types of amplification, and would not be found in a phonograph amplifier.

However, it is far more rugged than a tube amplifier, requires no filament supply, and needs no maintenance, so it is ideal for many industrial applications. It is especially suitable for amplifying d.c. signals, which fluctuate very slowly; therefore it is well adapted for use with thermocouples and photocells when they are used for such purposes as turning on lamps at dusk or recording slow changes of temperature. The magnetic amplifier is also widely used in servomechanism applications.

Magnetism

Magnetic theory and electric circuit theory are very similar. Ohm's law may be written: $E = IR = I/G$, where the conductance G equals I/R . In a magnetic circuit $MMF = \phi/P$. In this equation, MMF is the total *magnetomotive* force in the circuit. It corresponds to EMF and can be stated in ampere-turns (NI). Total *flux* ϕ corresponds to current and total permeance P is similar to conductance in an electric circuit. Permeability μ is related to permeance P as resistance is to specific resistivity, and might be called the specific permeance of a material. For example, the permeance of a piece of material varies with the size of the material, just as the resistance of a wire varies with the size and length of the wire. The resistivity remains the same (10.36 ohms per mil-foot for ordinary copper wire). However, the permeability of a magnetic material may change with the magnetomotive force applied to it (as the conductivity of a metal rectifier may change with the density of current). This makes magnetic circuits much harder to calculate than electric circuits.

Magnetic circuits are analyzed by considering the length and area of the path. Instead of total MMF we use the *field intensity*, or H , which equals the MMF divided by the path length.

In the same way, *flux density*, or B , is considered instead of total flux. If B is constant over an area A , $\phi = BA$. Permeability is equal to B/H , or $H\mu = B$. This means that in materials with a high μ , only a small magnetizing force

is necessary to have a high flux density. The permeability of air is set at 1, and various types of iron and magnetic alloys may have a permeability of about 600 (cast iron) to 50,000 or more (permalloy and other special magnetic alloys).

The *self-inductance* L of our magnet coils is also important in magnetic amplifier theory. If an alternating current is applied across a coil, B varies at the same rate as the alternating current. This variation in the magnetic field induces a counterelectromotive force in

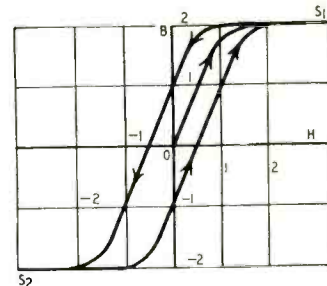

Fig. 1—The general hysteresis curve. The enclosed area and steepness of the curve are a measure of core properties.

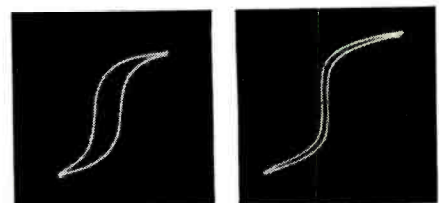

Fig. 2—B-H curve of magnetic iron, left, and mu-metal, right, shows effect of various core material on hysteresis.

the coil which is proportional to the flux density B and the frequency f . Two important facts should be remembered: the induced voltage E is proportional to B and f ; and, field intensity H is proportional to current I .

Magnetization curves

From the foregoing, it appears that we can increase the flux density B by increasing the magnetizing force H . Since $H = NI$, it would appear that increasing the current or the number of turns around a core increases B . When a.c. is applied to a winding, though, we come up against *hysteresis*, or magnetic friction.

Magnetic material is supposed to be composed of small permanent magnets, which in an unmagnetized piece of material are randomly oriented—that is, they point in all directions. Passing an electric current through a coil wound around the material magnetizes it—aligns the magnets so they all point in one direction. But if the current is turned off the material does not go back to its unmagnetized state. Many of the minute permanent magnets remain lined up and give the material more or less *residual magnetism*. It is necessary to pass current through the coil in the opposite direction to *demagnetize* the material. This is shown in Fig. 1.

The magnitude of H plotted along the horizontal axis represents current through the winding, since $H = NI$; the vertical axis represents flux density B . If alternating current is applied, during the starting half cycle (represented by the line inside the closed curve), B increases as current is increased. As the current reaches 1.5 on the chart (divided into arbitrary units) B reaches its maximum and remains the same even though H passes 2. S_1 and S_2 are saturation levels.

As the current is *reduced* toward zero, magnetic flux density in the core remains at maximum till the coil current has dropped below 1, and then drops slowly, so that B is still nearly 1 when the current is zero. To demagnetize the core (reduce B to zero) it is necessary to apply a current of about

-0.4. After this point, the core magnetizes in the opposite direction, so that when current reaches -1, the core is again magnetized to *saturation*.

From here on each alternation produces the same result, magnetism always lagging behind magnetizing force till the core is saturated, then remaining constant through any increase in H . A certain amount of power is used to turn the molecular-sized magnets around in the material. This is called *hysteresis* loss.

The enclosed area and width of the curves in Figs. 1 and 2 are a measure of the hysteresis, or magnetic friction, of the material. The best material for magnetic amplifiers is the one with the narrowest curve. Note, Fig 1, if the material were perfect, the curve which started from zero and went up to 2 as H increased would decrease in exactly the same fashion. That is, by the time the coil current (NI) which produced H had sunk to zero, the magnetism B would be at zero also. Then the B - H curve would be a slim line. But, the higher on B the curve is when H reaches zero, the stronger the negative H field (current in the coil in the opposite direction) will have to be before B goes to zero; the field will have to be stronger after the current in the coil has turned again, to bring B back to zero. This widens the curve.

It is impossible to get a single-line B - H curve (perfect magnetic material) but narrow curves can be obtained with magnetic alloys, as may be seen in Fig. 2.

Modern magnetic material has low hysteresis losses, so the two branches of the curve are close together. Fig. 2 shows B - H curves for magnetic iron and high-grade magnetic alloy. In transformer design the working point is along the linear portion of the B - H curve. The area of saturation is used for magnetim amplifiers and is different for different core materials.

Magnetic amplifiers

A circuit for the simplest type of magnetic amplifier is shown in Fig. 3. The secondary coils $L1$ and $L2$ are connected in series-aiding. The equal primaries are connected in opposition. A source of alternating current is connected in series with the secondary and the resistive load. The cores, of high-permeability alloy, increase the self-inductance of $L1$ and $L2$ to such a high value that little a.c. can flow through them and the load. But if d.c. is passed through the primary and increased till the core saturates, its permeability drops, the secondary self-inductance becomes negligible, and a.c.—limited only by the resistance of the load—flows. If the amount of d.c. is kept slightly below the saturation point, small changes in the d.c. can produce large changes in the a.c. through the load. Thus *the d.c. input controls the current through the load*.

If the current in the primary is I_1 , and that in the secondary, I_2 , then the a.c. component in the secondary is

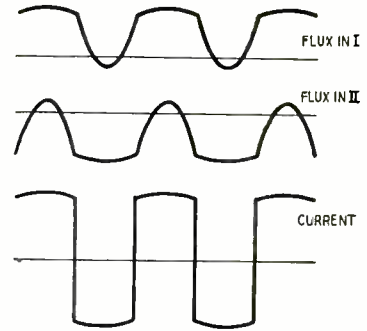

Fig. 5—Flux waveforms in core.

$(I_2 + I_1)$ and the a.c. component in the primary is $I_2 - I_1$. If curves (not shown) drawn for both these conditions are *added*, the waveshape current in the secondary is $(I_2 + I_1) + (I_2 - I_1) = 2I_2$; the primary wave shape resulting from *subtracting* one curve from the other (the primaries are series opposing), $(I_2 + I_1) - (I_2 - I_1) = 2I_1$ and the waveshape in the primary will have an a.c. component *twice* the supply frequency.

Fig. 4 is the operating curve of a magnetic amplifier. If heavy d.c. is applied to the primaries of Fig. 3, the two cores will be oppositely saturated, because the d.c. flows in opposite directions through the two cores. With no a.c., the operating points are at I and II of Fig. 4.

If a.c. is switched on, it magnetizes each core *in the same direction*. During the first or positive half cycle the current acts to increase the magnetization of the already saturated core L1 as indicated at I, so there is no effect. But it acts to neutralize the magnetization L2, as indicated at II in Fig. 4 (imagine the operating point moving to the right), and if the current is great enough, the flux will drop to zero. During the second half cycle the flux in L1 drops to zero and L2 is unaffected (operating point moves to the left). The flux waveforms in each core and resulting output current are shown in Fig. 5.

It is then apparent that for *large power output* the hysteresis curve should be long. For *high amplification* a steep curve (indicating high μ) is more desirable, since a slight change in d.c. causes a large change in the magnetization of the core, and thereby has a greater effect on the a.c. output current.

It is not necessary that a magnetic amplifier have two coils in the primary and the secondary, or that they be in series. It is possible and often desirable to connect the coils in parallel. We may also use more than one coil in the input circuit, to amplify more than one input voltage, or even to amplify the resultant of the input voltages, a thing which usually presents difficulties when attempted with vacuum-tube amplifiers. It is also possible to construct a magnetic amplifier with only one winding for the d.c. coil, so placing the coil that its field affects both a.c. coils in the right way.

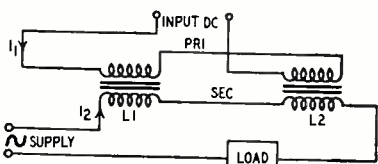

Fig. 3—Simple circuit of the amplifier.

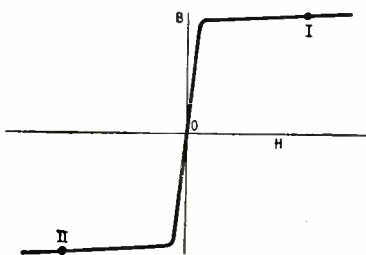

Fig. 4—The amplifier operating curve.

A shell-type transformer (Fig. 6) can be used to cancel a.c. from the primary. The center leg is used for the d.c. coil, while the outer legs hold the output

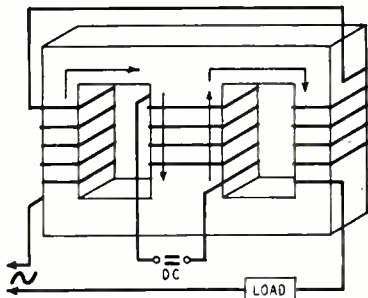

Fig. 6—Magnetic amplifier on shell-type frame uses one primary winding.

a.c. windings, which are oppositely wound. The arrows show how induced voltages balance out in the d.c. winding.

When a.c. flows through the output circuit of an amplifier, one half of each cycle tends to desaturate the core. This can be prevented by adding a rectifier (with proper polarity) in the secondary. Such an amplifier is called a *self-saturating* device. The *rectified* d.c. now adds to the *control* d.c. to give increased amplification. If too much feedback is used, the amplifier may go into sustained oscillation.

Fig. 7 shows how a self-saturating amplifier is connected. The a.c. source is connected in series with L3 and a full-wave rectifier. Rectified current flows through the load and L2. The d.c. through L2 combines with the d.c. in L1 to control the amplifier.

One big disadvantage of magnetic amplifiers is *time lag*. Typical circuits have a delay of 6 cycles with a 60-cycle supply frequency, and 16 cycles with a supply frequency of 333. Note that the proportional lag is reduced as the sup-

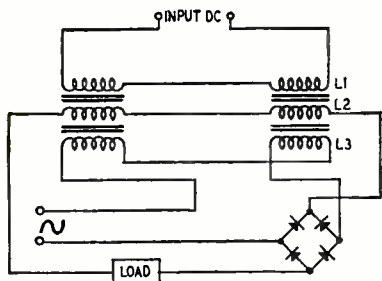

Fig. 7—A self-saturating amplifier.

ply frequency is raised. Special "phase advance" circuits have been developed to minimize the effects of time lag.

Applications

Modern magnetic amplifiers can be designed with a power gain as high as 10 million, while a gain of 10,000 is a very practical figure. Signal inputs may be as low as .001 microwatt. Unlike a tube amplifier, the magnetic type is current-operated. Therefore the input resistance is low. However, less distortion is produced if the input resistance is kept as high as possible.

Fig. 8 is a typical frequency stabilizer. Here a 2-phase motor drives a

3-phase generator. There are three d.c. control windings in the amplifier, L3, L4, and L6. The first and third of these are control windings wound in the same direction. L5 is the a.c. or secondary coil. The required generator frequency is assumed to be 500 cycles. Two series-resonant circuits (L1 and L2) are across two phases of the generator. One is tuned to 475 cycles—the other to 525 cycles. If the frequency is too high (above 500) more current flows through L2 and less through L1. After rectification, there is more d.c. through L3 and less through L4. These are so poled that in this case more a.c. flows through the output winding L5. Therefore more

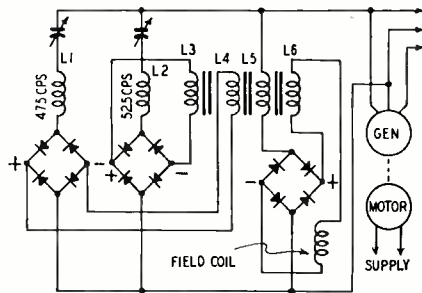

Fig. 8—A typical frequency stabilizer.

d.c. flows through the feedback coil L6 and through the motor field coil. This slows the motor and reduces the generator frequency. Accurate stabilization to within 1 part in 1,000 is possible.

Another useful application is for measurement of current in high-voltage d.c. lines. Two toroidal cores with windings are placed around the line (Fig. 9) and a.c. is fed to the coils. The d.c. saturates these cores to a greater or less degree (depending on the amount of d.c.). A small a.c. voltmeter may be calibrated to read the direct current.

The reader may realize by now that the design of a magnetic amplifier is involved. For example, there is no simple relationship that expresses the power output available. Various factors such as linearity, input and output resistance, etc., complicate the problem. The factor of interaction between the output and input circuit (the a.c. in the output induces currents in the input) has been merely skirted in this article. Still other problems have not been mentioned.

For these and other reasons magnetic

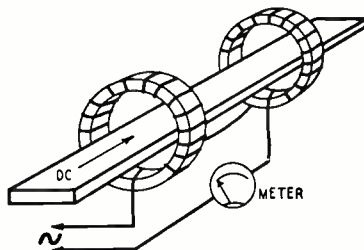

Fig. 9—Measuring current in d.c. lines.

amplifiers have not become as widely known as they otherwise might have. A possibly more important reason is that

they are not too adaptable to experimentation by the individual enthusiast. Suitable core materials, such as the expensive permalloy and mu-metal, are hard to obtain. Generally speaking, most ordinary core material is not easily enough saturated to use as magnetic amplifier cores, though it is possible that some results might be obtained.

The would-be experimenter can obtain B-H curves directly with an oscilloscope with the circuit of Fig. 10. The core material being investigated is placed within a coil L through which a.c. flows. A relatively small resistor (470 ohms) is connected in series with L. The drop across this resistor is proportional to the current through L and therefore to the field intensity H. This drop produces horizontal deflection. The induced voltage across L is integrated by an R-C network as shown and applied to the vertical plates. It can be shown mathematically that the integral of the voltage is proportional to the flux. Therefore the vertical plates are supplied with voltage which varies as B.

Only materials with a small hysteresis area (highly permeable) should be used. A steep curve indicates high permeability, and likewise great amplifica-

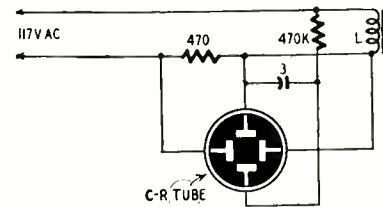

Fig. 10—Circuit to read BH on scope.

tion. Materials with a high value of saturation are good for power applications. The following bibliography will aid the student who wishes to pursue the subject further. He will find the calculations of A. G. Milnes and Dr. Uno Lamm particularly interesting if he wishes to enter the design field.

References

The Transductor; D.c. Pre-saturated Reactor. Uno Lamm, Stockholm, 1948.
 A New Theory of the Magnetic Amplifier. A. G. Milnes, *Proc. IEE*, Aug., 1950, Part II.
 The Transductor Amplifier. Ulrich Krabbe. Rectifier Voltage Control. *Wireless World*, June, 1949.
 Amplification by Magnetization. *Westinghouse Engineer*, May, 1949.
 Magnetic Amplifiers. *Wireless World*, Feb., 1949.
 Applications of Magnetic Amplifiers. *Electronics*, Sept., 1947.
 Components of U. H. F. Meters. Eduard Karpus. *Electronics*, 1946.
 Frequency Modulation by Nonlinear Coils, L. R. Wrathall, *Electronics*, May, 1946.
 Ibid. *Bell Laboratories Record*, March, 1946.
 Reactance Amplifiers. *Electronics*, Oct., 1947.
 Voltage Rectifiers Using Magnetic Saturation. *Electronics*, July, 1937.
 Selbsttätige Strom und Spannungsregler. *Achiv für technische Messen*, Nov.-Dec., 1934.

(In editing Mr. Bosschart's excellent and in some parts very technical manuscript, it was necessary to abridge some points and omit others. Our apologies to Mr. Bosschart if he feels that we have oversimplified his exposition in parts. We believe that the changes were necessary to make this difficult subject intelligible to persons with no previous knowledge of magnetic amplifiers.)

—end—

The Practical Field Electron Microscope

Simple instrument magnifies million times with 20 Å resolution; only 5 kv is needed

By DR. ERWIN W. MÜLLER*

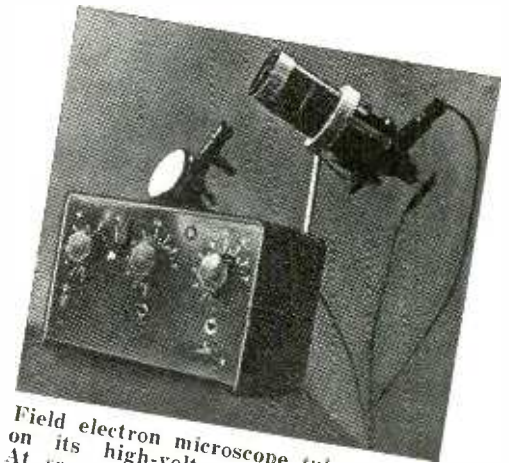

Field electron microscope tube resting on its high-voltage supply cabinet. At rear is a projection viewing unit.

FOR over-all effectiveness, the magnification of a microscope is less important than its resolving power. The resolving power determines the smallest separation between two points at which they can still be distinguished. This resolving power, under the most favorable conditions (that is, using widely divergent beams) amounts to a half wavelength of the light used. Points just 2,000 Ångströms apart may be resolved with an ordinary light microscope. The great effectiveness of the well-known electron microscope depends upon the very short electron wavelength which, at a 100 kv beam voltage amounts to about .04 Ångstrom. Because of the large optical defects of electron lenses, it is necessary to use them with very small apertures, and a resolving power of only 15-20 Ångströms is attainable. Nevertheless details 100 times finer than those recognizable with the light microscope may be resolved.

To recognize fine objects it is further necessary to have sufficient contrast. This is difficult with the electron microscope because of the necessity of working with very thin layers. These thin layers are transparent for the fast electron beams. Theoretically (for example) 500 carbon atoms must be agglomerated to form an image point with 1% contrast. Indeed, the finest objects that have been made visible by the electron microscope are macromolecules with a molecular weight of more than 100,000.

The contrast in the emission microscope, from which the whole development of the electron microscope stemmed, is more favorable. Even a monoatomic layer is sufficient to influence the electron productivity of the cathode surface which forms the image. Unfortunately, the resolving power is very small because the electrons start from the surface with a velocity corresponding to a few tenths of a volt, and consequently a large wavelength. The electrons should be accelerated very

rapidly near the cathode; but in order to achieve the resolving power of the modern transmission electron microscope, a field strength of 10 million volts/cm is needed at the cathode. Electron lenses cannot be constructed for such extremely high field strengths.

Field electron microscope

The necessary magnification for the observation of the smallest objects as well as the electrical field strengths for achieving the high resolving power may be obtained in a surprisingly simple manner without any electron-optic lenses. This is accomplished with the field electron microscope invented by the author 15 years ago, although the full effectiveness of the instrument has only recently been demonstrated.

The field electron microscope consists of an evacuated tube in which a fine metal point stands opposite a screen

(Fig. 1). The metal tip is cap-shaped, almost hemispherical, perfectly smooth, and has a radius of 10^{-7} cm. If 5,000 volts are applied to the anode ring, a field strength of about 40 million volts/cm results. Under these conditions field electrons are emitted from the tip. They flow radially from the tip in straight lines to the screen and form a projection image of the tip. The enlargement is simply the ratio of screen distance to tip radius. A millionfold magnification results with a screen distance of 10 cm.

The electrons emitted from a point object have a small tangential velocity component of about 0.5 electron-volts so that the image on the screen is a disc of about 2 mm diameter. This corresponds—at a magnification of 1,000,000—to an object diameter of 20 Ångströms. The resolving power attainable with this simple microscope, of about

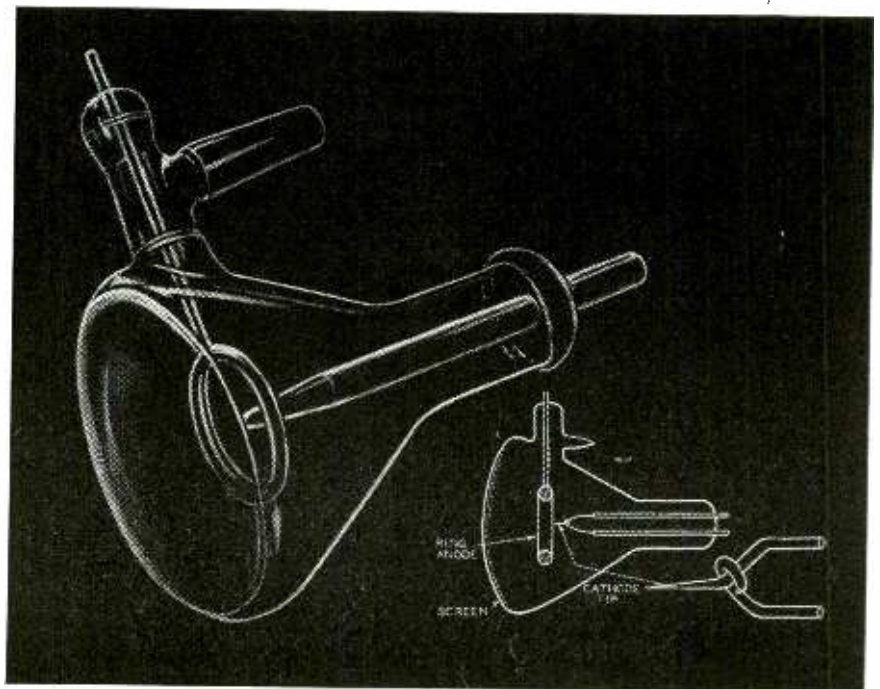

Fig. 1—The principle of the field electron microscope is very simple.

*Kaiser-Wilhelm-Institut für Physikalische Chemie und Elektrochemie, Berlin Dahlem, Germany.

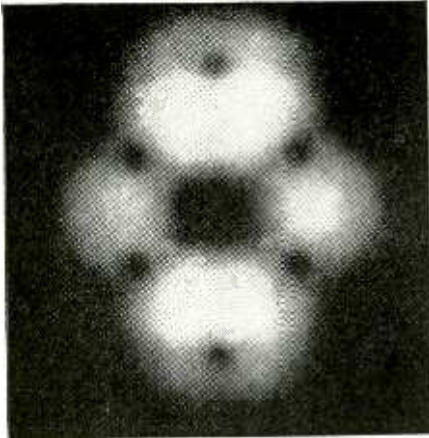

Fig. 2—Image of a clear tungsten tip.

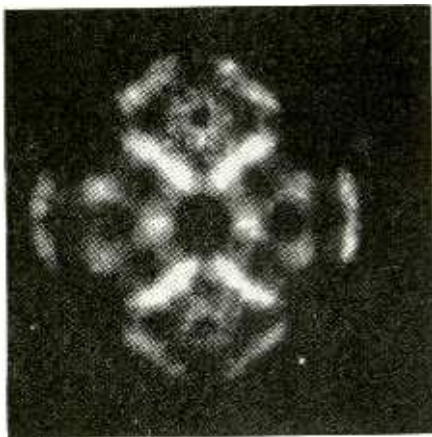

Fig. 3—Thin film of single barium atoms adsorbed on a tungsten tip.

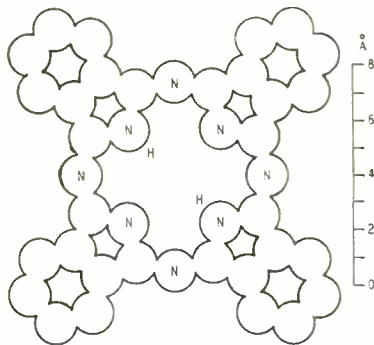

Fig. 4—Ideal theoretical diagram of a single molecule of phthalocyanine.

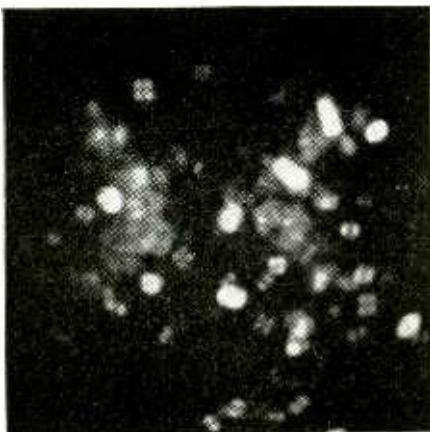

Fig. 5—The four-sectioned molecules of phthalocyanine are visible above.

15 Angströms, is not inferior to that of the usual electron microscope.

The objects suitable for examination with the field electron microscope are entirely different than for the standard microscope. The pure cathode surface gives a picture of the crystal structure of the metal of the tip. In Fig. 2 the particular crystal directions of tungsten are recognized because the 110 and 112 surfaces are characterized by low electron emission. The fine lattice steps, only about 3 Angströms, from which the whole crystalline cathode tip is built, cannot be seen with the given resolving power.

The object to be observed must be placed on the tip by sublimation or adsorption. Many gases are adsorbed on specific crystal surfaces so that their presence may be established in quantities corresponding to less than monatomic thickness. Indeed, it is possible to observe reactions between different adsorbed substances in which the metal of the tip acts as a catalyst. The temperature range over which observations may be made is wide. The whole tube may be immersed in liquid air so that adsorption processes at -180°C may be observed, since the tip does not become heated by the emission. At the other extreme, contact catalytic processes that occur at red heat may just as easily be observed.

Single large atoms are individually recognizable if they are adsorbed on the very smooth and perfectly round tip in favorable orientations. Fig. 3 shows a very thin adsorption film of barium in which the granulation arises from single barium atoms.

The average distance of separation of the atoms in the less densely filled region about the cube faces (top and bottom center Fig. 3) amounts to about 30 Angströms to 40 Angströms, in the more densely filled regions to about 20 Angströms. The field emission is completely independent of the temperature, and if the cathode is heated somewhat the surface migration of the adsorbed atoms can be seen. This occurs at different rates, depending on the adsorption energy on the various crystal surfaces.

These migrations can even be followed quantitatively. With tungsten atoms sublimed on the tip, the measurement of the energy of activation of the surface migration gave precisely the theoretical value calculated for single atoms. This constitutes important evidence that the smallest visible image points correspond not to an agglomeration of a large number of particles, but rather to individual atoms.

The visibility of certain types of small articles can be demonstrated easily with some organic molecules. If the dyestuff phthalocyanine, whose molecular structure (Fig. 4) is known exactly as a result of chemical analysis and long calculations, is sublimed onto the tip, the contour of the flat molecule is made clearly visible (Fig. 5). Because of the thermal motion and the impact of positive ions, a rotatory motion of

the four-sectioned molecule can often be seen.

Resolution of the molecular image in a four-sectioned form similar to the object results from the molecules being adsorbed flat on underlying impurity atoms. These impurity atoms are easily adsorbed on the crystalline surface of the tip. The potential distribution directly in front of the molecule causes a divergence of the electron beams leaving the four corners. In this special case, a resolving power of 7.7 Angströms, the average distance between the corners, consisting of benzol rings, is attained. Each of the four corners of the molecule has a weight of 128 and is just about as heavy and as large as a single barium atom with an atomic weight of 137 and a diameter of 4.5 Angströms.

Even the essentially smaller porphyrin rings of haemine or chlorophyll with their four-sectioned structure are made visible with the field electron microscope. The distance of the pyrrol ring corners amounts to only five Angströms. This is the smallest separation of two particles resolvable with an electron microscope to the present time. It is not to be expected, however, that the location of single atoms can be determined with the simple field electron microscope. [From rubrene, for example, four-sectioned images with only one symmetrical axis are obtained. The two ends of the molecule containing a middle tetracene nucleus differ in the direction of the region corresponding to the four-sided phenyl residues.] Only as many singularities are seen as a result of diffraction effects in these kinds of molecules as is recognizable in the profile of the equipotential surfaces about 12 to 15 Angströms above the adsorbed molecules on the cathode. It is only at this distance from the cathode that the electrons concerned have a short enough wavelength to achieve a resolving power of 5 Å.

Even here (as generally in microscopy) the wavelength of the applied radiation imposes on the effectiveness a limit that can hardly be overcome. The true form of the molecules can be established in only a few favorable cases. The field electron microscope affords for the first time, however, a general method of viewing such small objects directly. The instrument's most important region of applicability may be the investigation of the behavior of adsorption films on metal crystals rather than making visible individual atoms. All processes of surface reactions and contact catalysis proceed in similar adsorption layers. These can now be extensively observed. Obviously the technique of observation as well as the interpretation of the pictures obtained requires laborious investigation and much experience.

References

- E. W. Müller, *Z. f. Physik*, 106 (1937) p. 541, 108 (1938) p. 668, 120 (1943) p. 270, 126 (1949) p. 642.
Z. f. Naturforschung, 5a (1950) p. 473.

—end—

How an Electronic Brain Works

Part XII—Pulse patterns rearranged and programmed

BY EDMUND C. BERKELEY and ROBERT A. JENSEN

IN THE last few articles, we have shown how an electronic brain can store information, add, subtract, multiply, divide, and arrange different timing pulses and select them. We have also shown how, when the right control pulses are provided, an electric brain can pick numbers out of storage, run them into the computer, produce com-

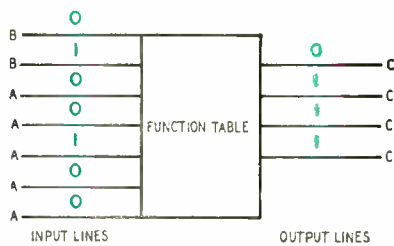

Fig. 1—The function table converts incoming pulses into other pulse patterns.

such a way that any outgoing pattern is precisely determined by the incoming pattern. See the block diagram in Fig. 1, where the pattern 0100100 on seven input lines is being converted into the pattern 0111 on four output lines. Other names for function-table are *matrix*, *coding device*, *coder*, or *decoder*.

In an electronic computer, function tables may be used in many different ways, in fact wherever a mathematical function of pulses is desired. Examples are: 1—a built-in multiplication table; 2—conversion of binary digits to decimal digits, or of decimal to binary; 3—built-in tables of first approximations to reciprocals, so that hardware for dividing can be left out and the accurate reciprocals can be calculated by successive multiplications (see article X of this series); 4—built-in tables for first

approximations to square roots, logarithms, etc., with the same kind of scheme for successive approximation;

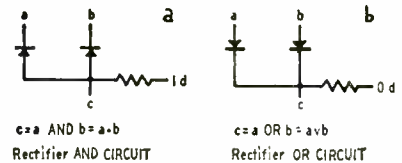

Fig. 2—Function tables use rectifiers.

5—conversions of orders (i.e., one kind of a set of pulses) given to the computer into control signals (i.e., another kind of a set of pulses) for gates (AND circuits), so that the machine can be automatically controlled.

One of the most convenient elements to use in a function table is a crystal

puted results, and put the results back in storage.

In this article we shall finish with such of the theory of electronic computer construction as we intend to cover.

We must emphasize again that not all the work in the design of a miniature electronic brain has been done yet, not by a long way. For example, one of the elements that will turn up in such a computer over and over again is the AND circuit; there are many different ways of making one; energy spent on perfecting an AND circuit useful for all parts of the machine would be well repaid; but we shall not investigate that subject here. Furthermore, the authors have as yet constructed only a miniature relay Simon, not a miniature electronic Simon; no one has yet made a miniature automatic electronic sequence-controlled digital computer (to give it its full name).

It is interesting to note one reader of RADIO-ELECTRONICS, Thomas P. Weir, W7GDM, of Powell, Wyoming, has written us that he has started construction of "a small machine using tape and a pulse frequency of 60 cycles"; and it may well be that one of the readers of RADIO-ELECTRONICS will be the first man to make a miniature automatic electronic computer.

Function tables

The term *function table* means an arrangement of equipment which will take in any one of a number of patterns of pulses and will put out any one of a number of other patterns of pulses, in

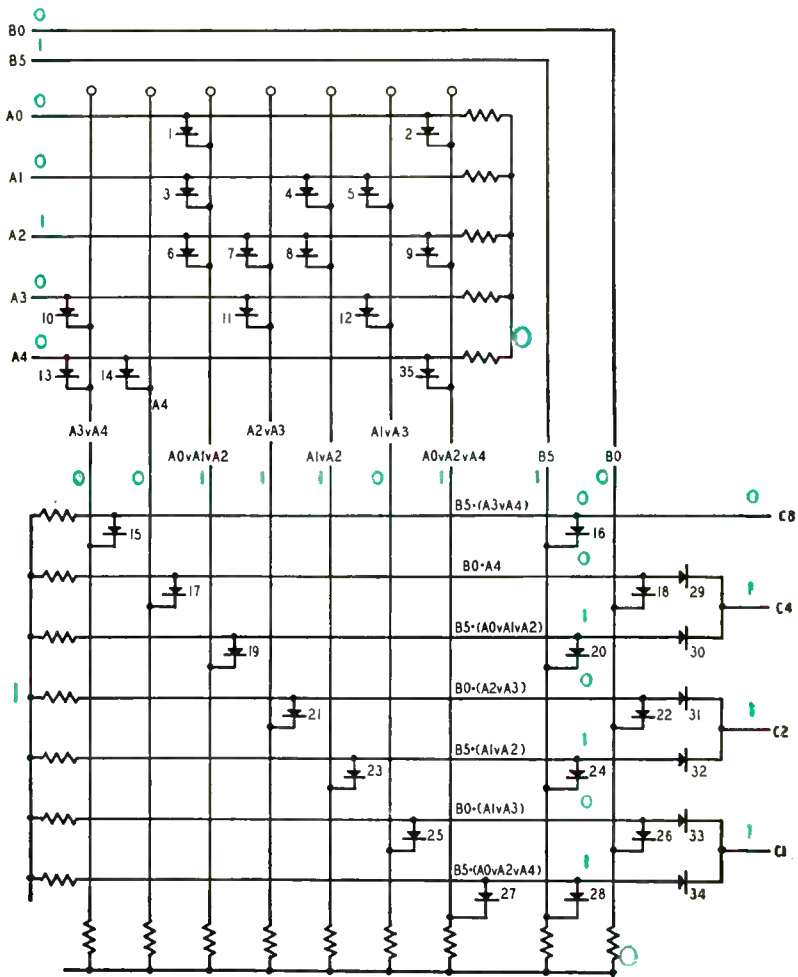

Fig. 3—A complete function table for converting biquinary notation to binary.

diode, or rectifier, although other elements may be used. The computing unit of SEAC consists entirely of rectifiers; the few tubes in use in that unit are for amplification only, do not compute, do not change pulses into other patterns.

How do we make use of rectifiers for a function table, for transforming one set of pulses into another set of pulses, such as the case shown in Fig. 1 of the three logical circuit elements, an AND circuit, an OR circuit, and an EX-



Fig. 4—Computer input and output.

CEPT circuit, the first two can be constructed readily with rectifiers, and the third can be constructed if the negative of a pulse is available. Suppose that we have two voltages, which will be designated 1 for the higher voltage and 0 for the lower voltage. Then an AND circuit is shown Fig. 2-a, an OR circuit Fig. 2-b.

In each of these circuits, there are four terminals. A common point in the circuit is connected across a resistance to terminal d, which in the AND circuit is kept uniformly at voltage 1, and in the OR circuit at voltage 0. Terminals a and b are input and c is output.

Now what happens? Examination of the AND circuit shows that the voltage at c will be 1 if and only if the voltage at a is 1 AND the voltage at b is 1. Also, in the OR circuit the voltage at c will be 1 if and only if either a or b or both a and b have the voltage 1. Hence, these circuits are properly AND circuits and OR circuits.

Using a rectifier there is no way of converting a pulse into its negative. But if the negative of a pulse is available—from a tube or otherwise—the AND circuit can be an EXCEPT circuit, simply by putting the negative pulse on one of the input lines.

Coding conversion

One of the ways function tables can be used is for converting a decimal digit expressed in one kind of notation into a decimal digit expressed in another kind of notation. This is useful to do from time to time in an electronic computer because some kinds of operations are much easier in some notations than in others.

For example, one of the ways in which decimal digits can be represented is the following regular notation:

Decimal	Binary	Decimal	Binary
	8 4 2 1		8 4 2 1
0	0 0 0 0	5	0 1 0 1
1	0 0 0 1	6	0 1 1 0
2	0 0 1 0	7	0 1 1 1
3	0 0 1 1	8	1 0 0 0
4	0 1 0 0	9	1 0 0 1

These binary columns have the value respectively of 8, 4, 2, and 1 (powers of 2); for example, 9 is one 8 plus one 1.

Another way decimal digits can be represented is in *biquinary notation* (like hands and fingers, or Roman numerals). In this notation the coding is:

Decimal	Biquinary	Decimal	Biquinary
00	0 1 2 3 4	00	0 1 2 3 4
6	1 0 1 0 0 0 0	5	0 1 1 0 0 0 0
1	0 0 1 0 0 0 0	6	0 1 0 1 0 0 0
2	1 0 0 0 1 0 0	7	0 1 0 0 1 0 0
3	1 0 0 0 0 1 0	8	0 1 0 0 0 1 0
4	1 0 0 0 0 0 1	9	0 1 0 0 0 0 1

These columns have the values 0, 5, 0, 1, 2, 3, 4. Seven, for example, is one 5 and one 2, 0100100. This notation was actually used in one of the big relay computers produced by Bell Telephone Laboratories, because the feature that two and only two pulses occurred in each row was useful for checking purposes.

Now, how do we convert biquinary notation into regular binary notation? This we can do with rectifiers in a function table. But how can we design the function table? That is easily done with one of the neat techniques of Boolean algebra (one of the algebras of symbolic logic), which has been alluded to from time to time in this series of articles. Here is the way. See Fig. 1 and Fig. 3.

Let's say that the A terminals are the 0, 1, 2, 3, 4 lines of the biquinary notation and the B terminals are the 00, 5 lines. These will be input. Let us say that the C terminals are the 1, 2, 4, 8 lines of the regular binary notation. These will be output. What conditions do we have to arrange?

Well, the C8 line is to have a pulse if and only if the B5 line has a pulse AND either the A3 line OR the A4 line has a pulse. Let us use "•" for AND and "v" for OR. Then we can write:

$$C8 = B5 \cdot (A3 \vee A4)$$

where C8 stands for 1 if the C8 line has a pulse and 0 if the C8 line does not have a pulse (remember those truth-values?). We can also write down at once the other conditions:

$$C4 = (B0 \cdot A4) \vee B5 \cdot (A0 \vee A1 \vee A2)$$

$$C2 = B0 \cdot (A2 \vee A3) \vee B5 \cdot (A1 \vee A2)$$

$$C1 = B0 \cdot (A1 \vee A3) \vee B5 \cdot (A0 \vee A2 \vee A4)$$

Every operation that appears in these equations is either an AND or an OR. So we can just make up a function table, connecting the lines with rectifiers, in just the fashion that the equations tell us to. The result appears in Fig. 3.

Sample code

Now let's take a look at Fig. 3 and see how it works on a particular case. Suppose we want the number 7 in biquinary, 0100100, changed into the number 7 in binary, 0111. We use red numbers to stand for the values of the voltage, and put on each line in the circuit the value of the voltage which it will have. Line B5 and A2 will have the voltage 1. Consequently, vertical lines A0 v A1 v A2, A2 v A3, A1 v A2, A0 v A2 v A4, will have the voltage 1. Also the horizontal lines B5 • (A0 v A1 v A2), B5 • (A1 v A2), B5 • (A0 v A2 v A4) will have the voltage 1. As a result, lines C4, C2, C1 will have the voltage 1 and the C8 line will have the voltage 0. So the circuit works.

In the same way, other function-table circuits can be designed by simply writ-

ing down the conditions in convenient notation with AND and OR. If NOT or EXCEPT occurs, we use the negative of the pulse.

Input and output

The relation of input and output to the rest of an electronic computer is shown schematically in Fig. 4. The choice of input for a small computer would be either magnetic tape or punched paper tape (for discussion of magnetic tape see article VIII). The choice for a large computer would be magnetic tape only; paper tape would be too slow. A mechanism feeds the tape past a reading device; the reading device converts the patterns of punched holes or magnetized spots, possibly through a function table, into appropriate patterns of pulses to be used or stored in the computer.

The choice of output for a small computer would be an electric typewriter, a paper tape perforator, or a magnetic tape recorder (one that could record discontinuous pulses, irrespective of continuous sound recording). The choice for a large computer would be only magnetic tape recording, for the others would be too slow. Some special large computers record also in a pattern of bright and dark spots on motion picture film, which is then developed. This of course is nonerasable storage.

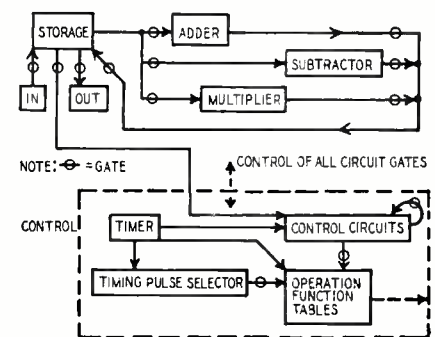

Fig. 5—Block diagram of the computer.

Both input and output give rise to problems of translation. For example, the number 7 expressed as 0111 in magnetized spots is to be translated into the number 7 expressed as 0111 in pulses circulating in a delay line. To carry out this translation, simply, cheaply, and reliably is an important engineering problem, although it does not appear as a problem at all in the logical design of the machine.

A block diagram

We shall now redraw the block diagram of Fig. 4 in an expanded form, showing what may be called the "block diagram of an electronic computer." See Fig. 5. The "o" drawn on each of the flow lines indicates a gate (an AND circuit or an EXCEPT circuit), which may or may not be open allowing information or timing pulses to flow or not flow. The group of units together marked

CONTROL and surrounded by a dashed line is the group of circuits which control the gates all through the machine, both outside itself and inside. The unit marked OPERATION FUNCTION TABLES converts various pieces of information, particularly instructions that program the operation of the computer, into gate controls. An example of this kind of situation in a relay computer is shown in article V and in an electronic computer is shown in article XI. Control over the connection of circuits to the bus results in the control of the flow of information through the machine.

Programming

The term *programming* is now generally used to mean giving or arranging a sequence of instructions under which an automatic sequence-controlled calculator operates. In Simon, and other "old-

noted by 0 to 9.

r, the number of a register referred to, which may be from 000 to 999, if the machine has a thousand registers.

Many programs can be covered in 400 orders, and they may be stored in 400 of the 1,000 registers. The other 600 registers are used to store numbers involved in the calculation. The machine is designed so that regularly order number n is stored in register number n.

Necessary orders

Now what are the kinds of orders sufficient to carry on the functioning of a modern versatile electronic computer? They are surprisingly few. See the order chart.

The list shown in Chart 1 may be made longer or shorter. We have here used the device of calling for operation

CHART 1

If k equals:	Machine Performs Operation:	and For the Next Order Goes to:
0	Transfer operation in register r to computer's operation register	
1	Transfers number in register r to computer's register A	Next numbered order
2	Transfers number in register r to computer's register B	"
3	Transfers number in computer's result register C to register r	"
4	Transfers number on input tape to register r	"
5	Transfers number in register r to output tape	"
6	None	"
7	None	"
8	None	The order numbered r The order numbered r, provided some special register (No. 069 for example) contains 1; otherwise the next number numerically. The order number stored in register r, provided special register 069 contains 1; otherwise, the next order numerically.
9	Stops	

fashioned" automatic computers, the sequence of instructions is external to the machine, comes along on a loop of tape, and is read order by order. But in many of the new computers, and in modified examples of the old computers (including the Harvard IBM Mark I machine at Harvard University), the instructions are almost all internal, within the machine, and can be called for by the machine itself as it requires them.

Typically, the control of one of these newer types of machines is in a register called the "program register" or the "control register." On each machine cycle this register contains an "order," information which is interpreted by the machine to control the opening and closing of the gates (such as shown in Fig. 5). In general an order consists of three parts:

n, the number of the order, which will generally be from 000 to 999.

k, the kind of order, such as "transfer into . . ." and which may be de-

specified out of certain storage registers. In this way the machine may be made very versatile. On the other hand, by lengthening the list of kinds of orders, to include directly addition, subtraction, multiplication, and other operations among the kinds of orders, some machine time can be saved, and some programming directness gained.

The most important of all the orders is the conditional transfer of program, kind of order 8 (also to some extent, kind of order 7). This order is the heart of flexible automatic control, and is one of the main reasons for asserting that these machines are intelligent—are brains—because they can adjust their activity to indications revealed as they compute.

In the next and last article of this series, we shall discuss the application of a good deal of what we have been talking about, to the Bureau of Standards Eastern Automatic Computer, SEAC.

—end—

HIGH-EMISSION CATHODE

Electron-tube cathodes with exceptionally high emissivity are made possible with the use of boron compounds, it is announced by Dr. J. M. Lafferty of General Electric.

Among the best cathodes are those in which a thin layer of good emitting material is deposited on a metal cathode which can be raised to a higher temperature than would be practical with a cathode made of more volatile surface material. Thus some transmitting tubes (and some early receiving tubes) used a tungsten cathode which contained thorium.

The weakness of this type of cathode construction is that with heavy currents the surface layer may entirely evaporate before it can be replaced from the interior. By embedding the surface material in a matrix of boron, Dr. Lafferty has found that this "stripping" of the cathode can be avoided. The boron forms a compound with the thorium or similar emissive element, and has such a strong affinity for it that as soon as an atom of the emitting material evaporates, the boron immediately draws up a new one from the metal beneath.

CAPACITOR TESTER

An intermittent capacitor can be very troublesome in radio or electronic circuits. Breakdowns may occur momentarily and at random, so tracing is difficult. The Bell Laboratories* have designed an instrument which indicates momentary breakdowns in capacitors. In the figure Cx is the unit under test.

First S2 is closed to put anode voltage on the thyatron. Bias on the starter element is set just under the firing point. Test voltage is applied across Cx when S1 is closed. Electrons flow into this capacitor as shown (dotted arrow). There is also a flow into the shunt circuit R1-C1, as the second dotted arrow shows. The drop across R1 adds negative bias to the starter element, so the tube cannot ionize.

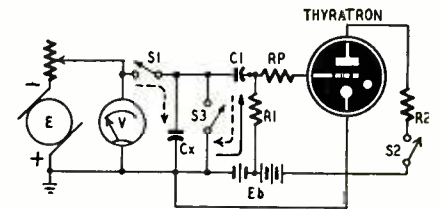

If the test unit breaks down even for a duration of a few milliseconds, C1 discharges through the test capacitor and R1. The full arrow indicates that the drop across the resistor now adds positive voltage to the starter. Ionization follows. The tube lights and continues to conduct until S2 is opened.

The thyatron may be one of the WE 313 series or one similar to the OA4-G type. RP and R2 are protective resistors.

*Bell Lab Record, January 1951.

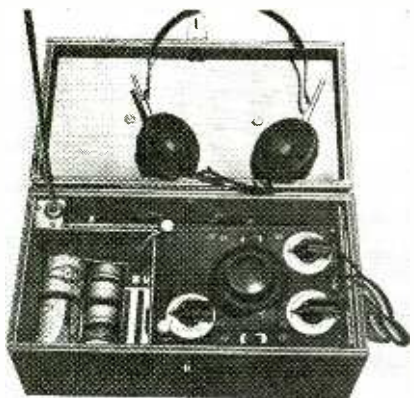

Top view of set. The case has room for batteries, extra coils, and headphones

Midget Shortwaver for DX Reception

This easy-to-build portable
tunes from 1400 kc to 32 mc

By GLENN H. QUERNA

THE regenerative receiver is easy to build and light on the pocketbook. It is ideal for portable or emergency service where maximum performance, minimum size and weight, and long battery life are essential.

This portable receiver covers a frequency range of 1.4 to 32 mc with bandspread tuning. Regeneration control is smooth, the audio output is ample, and it is sensitive and easy to construct.

Midget components and miniature low current drain tubes and parts placement make the receiver compact. Unlike many so-called "portable" rigs, it is completely self-contained. Batteries, headphones or speaker, antenna, all plug-in coils, and even a spare set of tubes have places inside the case, which measures 4½ x 5 x 9 inches.

The parts cost is about \$15, and the builder may cut it materially by buying surplus parts or raiding the junkbox of a ham friend.

Fig. 1 shows the 3-tube circuit. The semituned aperiodic r.f. stage increases

sensitivity, isolates the detector from the antenna and reduces detector blocking and body capacity effects. Detector tuning is conventional, using a 140- μ f capacitor and bandspreading with the 50- μ f capacitor.

There is a capacitor in series with a parallel-feed tickler. The 5,000-ohm potentiometer regeneration control varies the bypassing effect of the .001- μ f capacitor. This method requires no B-battery switch, uses less B-current, and is quieter than the usual series-feed tickler. Impedance coupling between detector plate and following amplifier grid permits smooth regeneration control and maximum audio output.

The triode-connected 1S5 puts a husky signal into the headphones and its current needs are small. The 150-ohm bias resistor maintains proper grid voltage to the 1S5 as the B-battery ages. If speaker operation is desired, a 1S4 may be used instead of the 1S5 (see Fig. 2), with a 3-inch PM unit fitted in the cabinet space provided for head-

phone storage. Ample volume is assured.

The receiver fits into a 4½ x 5 x 9-inch carrying case of ¼-inch plywood with space for batteries and accessories. A standard 5 x 6 x 9-inch metal case can also be used. The wooden box shown is easy to duplicate. Most woodworking shops will cut the plywood to size.

To assemble, glue and brad the sides to the ends, then similarly attach top and bottom. When the glue has set, sandpaper rough edges, mark and saw off the 1-inch-deep top, smooth the edges, and finish with shellac and spar varnish. Hinges, hasp, and handle complete the case except for partitions. Their location is dictated by the panel size, and parts layout and can best be done after completing the panel and subpanel assembly.

The panel is a 4 x 5-inch piece of ⅛-inch masonite, backed by thin sheet-metal shielding trimmed to clear the antenna post and phone jacks.

A 2½ x 3½-inch subpanel of 22-gauge aluminum carries the tube sockets and r.f. chokes and has a ½-inch lip for mounting to the front panel. The coil socket bracket is cut from ¼-inch Dural and is long enough to provide ½-inch clearance for the tube-base coil from the panel shield.

In the top view photo of the receiver, the large dial controls bandspread, the lower left knob the bandsetting, the upper right knob the r.f. coil tap switch, and the lower right knob the regeneration potentiometer. The slide switch at the lower edge of the panel breaks the A-plus lead; the upper slide switch is part of the r.f. tuning arrangement.

Lay out the panel by placing the parts in their approximate positions, then mark the shaft and screw holes. Locate tube sockets on the subpanel to clear the panel-mounted parts with tubes in place. Mount the subpanel with space below it for the necessary small parts. See parts arrangement in the back-of-panel photo.

The audio choke bolts to the lower rear partition wall. This choke is the primary winding of an interstage audio transformer, or the primary and secondary winding of an interstage trans-

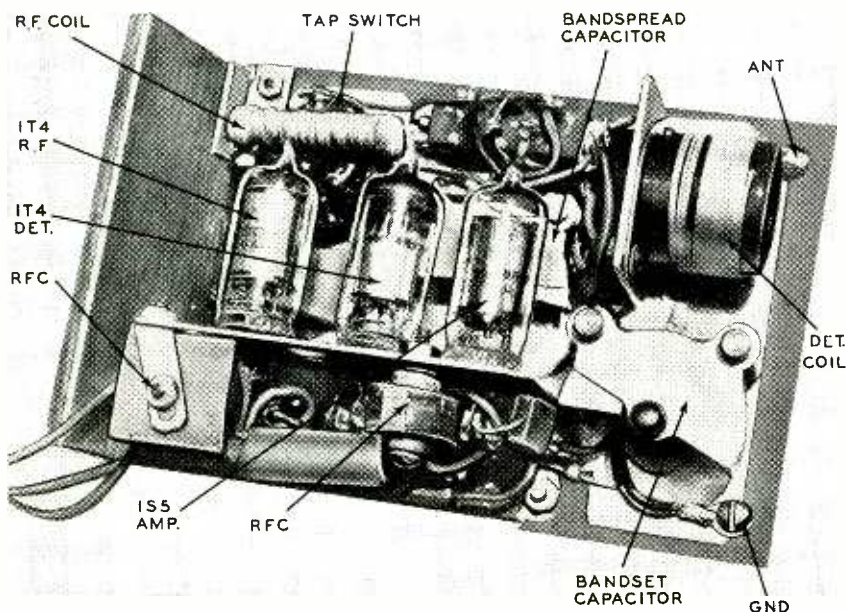

Under-chassis view of the receiver. Note position of parts on the metal chassis.



NOW-Be a Fully Trained, Qualified RADIO TELEVISION TECHNICIAN IN JUST 10 MONTHS OR LESS!

**I Send You
18 BIG
KITS
OF RADIO-
TELEVISION
EQUIPMENT**

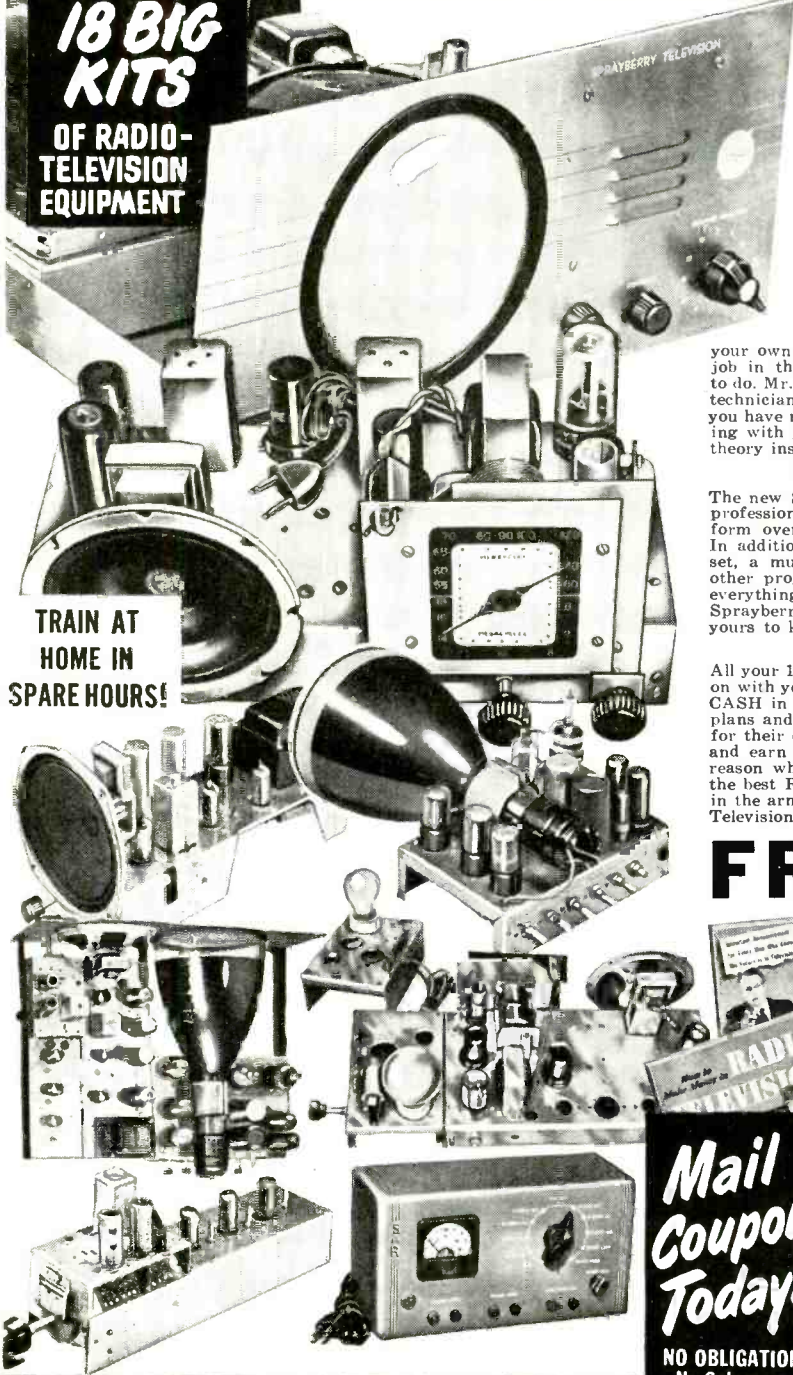

**TRAIN AT
HOME IN
SPARE HOURS!**

**New "Package" Unit Training Plan
PAY AS YOU LEARN-YOU SET THE PACE!**

**No Monthly Payment Contract
to Sign!**

Now . . . be ready for Radio-Television's big pay opportunities in a few short MONTHS! Frank L. Sprayberry's completely new "Package" training unit plan prepares you in just 10 MONTHS . . . or even less! Equally important, there is NO monthly payment contract to sign . . . thus NO RISK to you! This is America's finest, most complete, practical training—gets you ready to handle any practical job in the booming Radio-Television industry. In just 10 months you may start your own profitable Radio-Television shop . . . or accept a good paying job in this fascinating expanding field at work you've always wanted to do. Mr. Sprayberry has trained hundreds of successful Radio-Television technicians—and stands ready to train you in less than one year, even if you have no previous experience. You learn by DOING . . . actually working with your hands with equipment of special design to illustrate basic theory instead of relying on books alone.

VALUABLE EQUIPMENT INCLUDED WITH TRAINING

The new Sprayberry "package" plan includes many big kits of genuine, professional Radio-Television equipment. While training you actually perform over 300 demonstrations, experiments and construction projects. In addition, you build a powerful 6-tube standard and short wave radio set, a multi-range test meter, a signal generator, signal tracer, many other projects. All equipment is yours to keep . . . you have practically everything you need to set up your own service shop. The interesting Sprayberry book-bound lessons and other training materials . . . all are yours to keep.

EARN EXTRA MONEY WHILE YOU LEARN!

All your 10 months of training is AT YOUR HOME in spare hours. Keep on with your present job and income while learning . . . and earn EXTRA CASH in addition. With each training "package" unit, you receive extra plans and ideas for spare time Radio-Television jobs. Many students pay for their entire training this way. You get priceless practical experience and earn generous service fees from grateful customers. Just one more reason why the Sprayberry new 10 MONTH-OR-LESS training plan is the best Radio-Television training in America today. If you expect to be in the armed forces later, there is no better preparation than good Radio-Television training.

FREE 3 BIG RADIO-TELEVISION BOOKS

I want you to have ALL the facts about my new 10-MONTH Radio-Television Training—without cost! Act now! Rush the coupon for my three big Radio-Television books: "How to Make Money in Radio-Television," PLUS my new illustrated Television Bulletin PLUS an actual sample Sprayberry Lesson—all FREE with my compliments. No obligation and no salesman will call on you. Send the coupon in an envelope or paste on back of post card. I will rush all three books at once!

**Mail
Coupon
Today!**

**NO OBLIGATION
No Salesman
Will Call**

SPRAYBERRY ACADEMY OF RADIO, Dept. 20-A
111 North Canal St., Chicago 6, Ill.

Please rush to me all information on your 10-MONTH Radio-Television Training Plan. I understand this does not obligate me and that no salesman will call upon me.

Name.....Age.....

Address.....

City.....Zone.....State.....

Please check Below About Your Experience

Are You Experienced? No Experience

IF YOU ARE EXPERIENCED IN RADIO Men already in Radio who seek a short intensive 100% TELEVISION Training with FULL EQUIPMENT INCLUDED are invited to check and mail the coupon at the right.

former connected in series-aiding.

Plywood partitions form panel supports and compartments for accessories. Audio choke, A- and B-batteries and nested plug-in coils occupy the cabinet bottom, and speaker or headphones fit

long rear cabinet compartment.

Five plug-in coils cover the 1400 kc to 32 mc range which includes a small part of the standard broadcast band and the 10- through 160-meter amateur bands. All coils are wound on octal tube

phones indicates the wiring probably is correct.

Next, slowly turn the regeneration control until a rushing noise indicates that the detector is oscillating. If fully advancing the control does not cause oscillation, push the plate winding of the coil nearer the grid winding; if fully retarding the control does not stop oscillation, move the plate winding farther away from the grid winding. Should further adjustment be necessary, the removal or addition of another turn or two may suffice, but before resorting to this step, make sure the polarity of the windings is as shown in Fig. 3.

A 50,000- or 75,000-ohm resistor con-

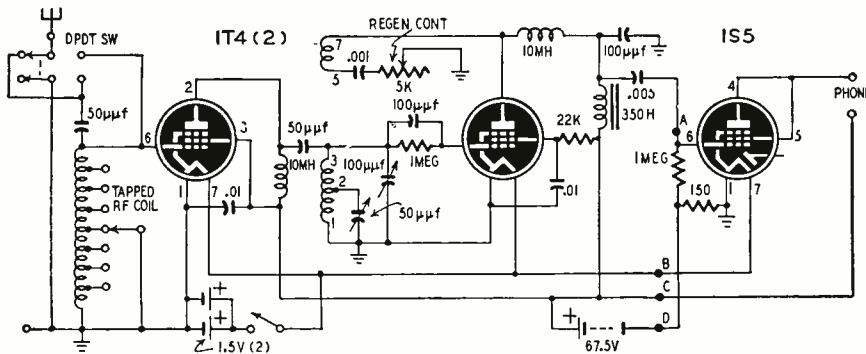

Fig. 1—Receiver schematic; regeneration is smooth, and r.f. stage gets dx.

in the space above the A cells and coils.

To facilitate changing coils, the panel is hinged to the removable right-hand support, using small brass box-hinges. After wiring and testing, the assembly is placed in the cabinet and this support is bolted in place.

The receiver is wired with small diameter, stranded, plastic-insulated wire. Several colors aid circuit tracing. Battery and choke leads are dressed to the hinged side of the panel. The B-battery leads terminate in snap fasteners. The B-battery, a Burgess XX45 or similar type, clips to the cabinet bottom below the central partition. It just clears the subpanel.

The A leads are soldered to a spring brass clip, simplifying battery changing. Paralleled cells bring the A-battery service life close to that of the B-battery. The cells are clamped together, positive pole to positive pole in a U-shaped brass strip holder. The connection to A-plus is made by inserting a brass leaf between the positive poles. The negative lead is run directly to the brass frame holding the cells.

The take-down antenna rod is made of four 8-inch lengths of No. 9 aluminum

bases of about 1 1/8 inches diameter. Unused pins may be removed if desired.

Coil taps are formed by bringing a short loop of the winding wire through a hole properly located in the coil form and soldering the bared loop to a length of heavier wire extending down to the appropriate pin.

Grid and plate coils are wound in the same direction. The start of the grid coil (Fig. 3) should go to pin 1 of the coil form, the end to pin 3, the adjacent start of the plate coil to pin 5, and the end to pin 7.

The tapped r.f. coil is wound on a 2-inch section of 3/8-inch dowel, and 8 shallow grooves are cut around the dowel. Each groove is jumble-wound with 20 turns of No. 34 d.s.c. wire, and tap-loops between each 20-turn section connect to the switch points. Ends of the dowel are drilled to take short lengths of No. 20 bare wire to which the start and end of the winding are soldered. These leads connect the coil to the arm and final clockwise point of the tap switch and also serve as coil supports.

After the coils have been checked for proper operation, coat them with coil

COIL WINDING DATA FOR RECEIVER

Frequency Range	Grid Winding	Plate Winding*	Tap
1.4-2.8 mc	65 turns 32 d.s.c.	20 turns 32 d.s.c.**	no tap-jumper between pins 2 and 3
2.5-5.0 mc	32 turns 32 d.s.c.	10 turns 32 d.s.c.	no tap-jumper between pins 2 and 3
5.0-10.0 mc	16 turns 28 d.s.c.	6 turns 32 d.s.c.	tap 5 turns from start of winding
10.0-20.0 mc	8 turns 26 d.s.c.	3 turns 26 d.s.c.	tap 5 turns from start of winding
20.0-32.0 mc	3 1/2 turns 26 d.s.c. spaced dia. of wire	4 turns 26 d.s.c.	tap 2 1/4 turns from start of winding

*Except as noted, plate windings spaced 1/8 in. from grid winding. Both coils wound in same direction.

**Wound as second layer over lower (ground) end of grid winding.

needed across the audio choke may be required to cure fringe howl (a squeal at the point where the detector goes into oscillation).

Adjust the r.f. tuning tap and series-parallel switches for best reception after the detector has been tuned.

The amateur bands are found on the dial by turning the bandspread capacitor to maximum capacitance and tuning the bandset capacitor until the low end of the desired band is located. The bandspread capacitor then will spread the band over half or more of the dial divisions. Band-set dial settings for the proper spread may be marked on the Bristol board dial for reference.

The rod antenna provides excellent reception in good locations; the added pickup of the extended wire boosts signals in others. In changing from the rod to the wire, some adjustment in r.f. tuning is required.

Although the receiver operates satisfactorily ungrounded, a ground connection made to one of the antenna rod sections pushed into damp earth has improved reception at several camp sites.

Materials for receiver

Resistors: 1—150, 1—22,000 ohms, 2—1 megohms; 1—5,000 ohms potentiometer.
Capacitors: 2—.01, 1—.001, 1—.005 µf, paper, 200 volts; 2—100 µmf, mica; 1—50 µmf, mica; 1—50 µmf, 1—100 µmf, variable.
Speaker Stage: 1—resistor 470 ohms; 1—output transformer; 1—3-inch speaker.
Miscellaneous: 2—IT4, 1—IS5; 1—d.p.d.t., 1—s.p.s.t. switch; 1—9 contact, rotary, wafer switch; 2—10 mh r.f. chokes, 1—350-henry choke (see text); 3 tube sockets; 2—binding posts; knobs; dial; 1—phone jack; 2—1 1/2 volt, 1—6 1/2 volt B.battery; panel; chassis; 5—coil forms: wire, solder, assorted hardware.

—end—

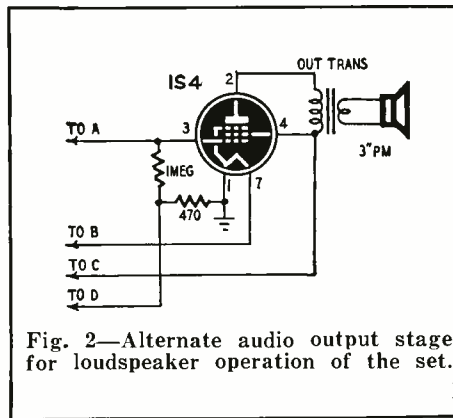

Fig. 2—Alternate audio output stage for loudspeaker operation of the set.

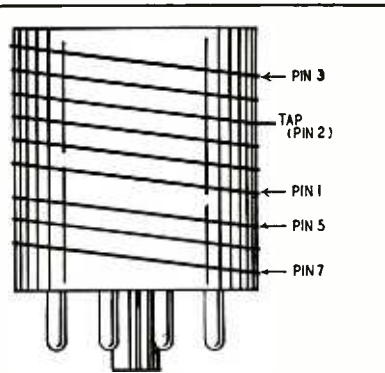

Fig. 3—Trapped detector coil connections.

wire with crimped-on brass sleeves as couplings. It plugs into a jumbo pin jack mounted in the left rear corner of the case. A lead from this jack connects to the receiver's antenna post. Rod sections, antenna and ground wire, coils, and spare tubes stow away in the

dope or Duco cement to prevent turns from shifting and to keep out moisture.

After completing and checking the wiring, insert tubes, coil, antenna rod, and phone tips, and with battery switch on, touch a finger to the detector grid (socket terminal 6). A squeal in the

To Servicemen... Who want to protect their future in Television Servicing

MEN who are interested in continuing their careers as TV service technicians and desire to increase their earnings, will find the information in this page calls for serious thought—and for action.

Your future, the future of your business in television servicing depends on what you do about it.

LICENSING OF SERVICEMEN IS A GOOD REASON WHY YOU SHOULD ACQUIRE TECHNICAL KNOWLEDGE NOW

In New York City, it is proposed that licenses and permits be required of TV contractors, subcontractors, service shops, technicians and apprentices. Once licensing becomes law in New York City this requirement is sure to spread to other municipalities. Licensing and permits mean passing a technical examination. Stiff penalties are cited in the licensing bill upon conviction of a violation. The required technical knowledge can easily and quickly be learned through study of the RCA Institutes Course in Television Servicing. One of the advantages of the RCA Institutes Course, to you as a working serviceman, is that you can study this course at home, in your spare time, and still keep working on your regular job. Now is the time to prepare for license examinations and protect your future in TV servicing.

TELEVISION SERVICING IS SPREADING TO NON-TV AREAS

The Federal Communications Commission recently announced plans for setting up 1,807 new TV broadcasting stations, most of them in the new UHF channels. This will open up areas that have never been touched by television. Radio servicemen in those locales should take a

lesson from servicemen in areas now served by television. In these areas, TV servicing has substantially replaced radio servicing as a means of income. Practical experience in radio servicing is not the important qualification for a successful and profitable career in TV servicing. Practical radio experience *plus* the technical training of the RCA Institutes Home Study Course in Television Servicing, will put you on the right track to be successful in TV servicing.

PRACTICAL, PRE-TESTED DATA MAKES TV SERVICING EASY

The RCA Institutes Home Study Course in Television Servicing is a "down-to-earth" course in the underlying principles of television. It is printed and illustrated in easy-to-understand, non-mathematical language. You learn pre-tested "How-to-do-it" techniques interwoven with "How-it-works" information. The course is based on the actual experience of the RCA Service Company in servicing thousands of home television receivers. You learn the "short-cuts" in TV trouble-shooting that enable you to do a good job in less time, saving you many hours of on-the-job labor. *This up-to-the-minute course contains material on the latest developments in color TV and UHF.*

APPROVED BY LEADING SERVICEMEN'S ASSOCIATIONS

Such well-known associations as—National Appliance & Radio Dealers Association; Television Contractors Association; National Alliance of Television & Electronic Service Associations—are already using the RCA Institutes course for upgrading the standing of their members. *Tell the Secretary of your local or State association to write us for low rates for group enrollment.*

RCA Institutes conducts a resident school in New York City offering day and evening courses in Radio and TV Servicing, Radio Code and Radio Operating, Radio Broadcasting, Advanced Technology. *Write for free catalog on resident courses.*

Send for FREE BOOKLET

Mail the coupon—today. Get complete information on the RCA INSTITUTES Home Study Course in Television Servicing. Booklet gives you a general outline of the course by units. See how this practical home study course trains you quickly, easily. Mail coupon in envelope or paste on postal card.



MAIL COUPON NOW!

RCA INSTITUTES, INC.
Home Study Department, RE-951
350 West Fourth Street, New York 14, N.Y.

Without obligation on my part, please send me copy of booklet "RCA INSTITUTES Home Study Course in TELEVISION SERVICING." (No salesman will call.)

Name _____ (Please Print)

Address _____

City _____ Zone _____ State _____



RCA INSTITUTES, INC.
A SERVICE OF RADIO CORPORATION OF AMERICA
350 WEST FOURTH STREET, NEW YORK 14, N.Y.

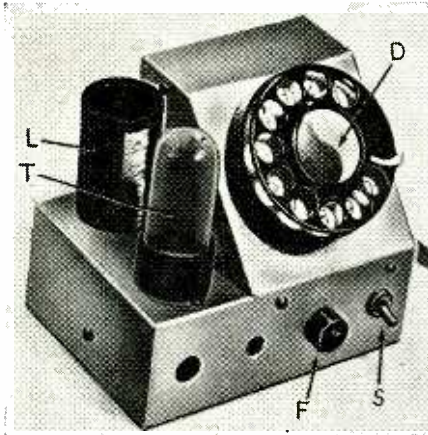

Telephone dial remote control unit operates stepping relay at receiver site.

TELEPHONE DIAL PULSES REMOTE CONTROL CIRCUIT

Pulsed oscillator sends messages to remote unit

By RANE L. CURL

IN ORDER to control a number of circuits by carrier from a remote unit, the following device (see photo) was designed. The oscillator is a Hartley, pulse modulated by a telephone dial. The carrier pulses actuate a receiver (cold-cathode tube) at a distance, which drives a stepping relay through a few

doubler (full wave) was used instead. This supplies a sufficiently high plate potential to work over considerable distance. The voltage doubler is standard. Note that the power supply and filament supply are isolated from the line by an r.f. choke, CH1, so as not to short the signal from the transmitter to ground.

suit individual requirements, but a frequency in the range used by the author (approximately 300kc) is a good choice because of power-line attenuation of higher frequencies and component's size for lower frequencies.

The telephone dial was used to pulse the transmitter in the circuit depicted. However, the unit may be used for simple on-off single-pulse control. The pulsing operation is as follows: When the dial is started "up" contacts A close and initiate plate current in the tube. In idle or rest position the tube thus draws no current. After reaching the desired dial number the dial is released and the oscillator is pulsed by contacts B opening. Normally these contacts are closed, thereby producing a radio-frequency short between the plate and ground, and preventing oscillations. The transients present in opening these contacts are sufficient to initiate oscillations and the unit transmits until contact B again closes between pulses. This arrangement was necessary because of the dial's construction.

The value of C5 which couples the oscillator to the line is not critical. The first value chosen was 100 μ f. This put insufficient voltage upon the line so the value was increased to the present .003 μ f. At this point the oscillator was still going strong so it is likely that even a higher value could be used with subsequent greater power output. In the writer's application too much power produced difficulties with the receiving equipment. The output is developed across CH2 so this should present a much higher impedance to the outgoing signal than does the coupling capacitor C5.

Capacitor C3 in parallel with C2 may not look right until one considers that an electrolytic capacitor at high frequencies acts only as a high resistance. In a typical electrolytic, all filtering or "capacitive" ability is lacking above 10,000 cycles. Capacitor C1 keeps the chassis at r.f. ground potential. This eliminates "body capacity" influences on the frequency of the oscillator. The chassis was *not* connected directly to one side of the power line (in accord with UL recommendations), but in use

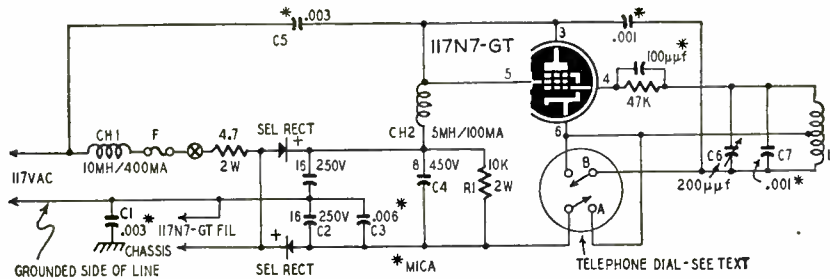

Fig. 1—Telephone dial pulse modulates the oscillator in this remote control.

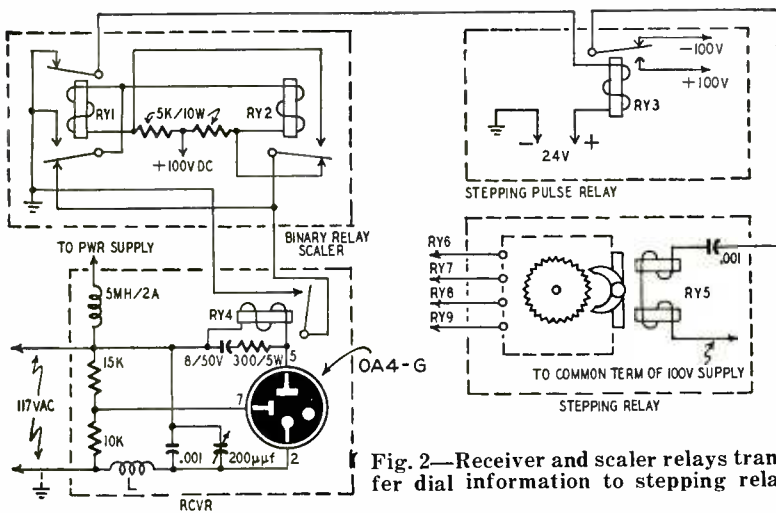

Fig. 2—Receiver and scaler relays transfer dial information to stepping relay.

necessary relays. The transmitter is built on a separate small chassis.

D,F,L,S and T refer respectively on the photo to the telephone dial, fuse, coil, switch and 117N7 tube.

The tube selected was a 117N7-GT (see circuit, Fig. 1) so as to eliminate the filament transformer. The diode unit in the tube was not used; a voltage

R1 was necessary to obtain clean makes and breaks on the pulses. It maintains the potential across C4 at the transmitting value while the unit is idle.

Using the values given for L (120 turns, center-tapped, No. 26 enameled, 1 1/4-inch form) and C6 and C7, it is possible to obtain comparatively sharp resonance peak. Values may be varied to

BE ALERT—CONVERT...

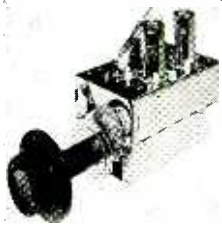

quality
conversion with

DUMONT

quality
electronic parts



ORIGINAL
RECEIVER



Inputuner
Deflection Yoke
Horizontal Output and
High-Voltage Transformer
Horizontal Width and
Linearity Coils

CONVERTED
RECEIVER

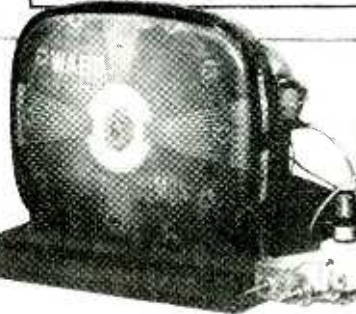
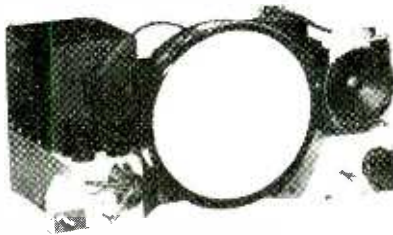

EASY-TO-FOLLOW STEP-BY-STEP INSTRUCTIONS

Available from Your Jobber

INPUTUNER* SERIES T3C

Available in four types. Improves the performance and entertainment value of any receiver by covering FM broadcast band in addition to TV channels. Replaces, electrically and mechanically, most switch-type tuners. Detent action simplifies tuning. Continuous tuning (Mallory-Ware Inductuner**) for utmost dependability.

DISTRIBUTED-WINDING DEFLECTION YOKE

A unique and better winding technique produces that edge-to-edge sharpness essential for good pictures on

big-screen TV tubes.

Compact size lends itself to modern short-neck tubes. Will retain performance quality under most adverse conditions. Designed for use with the Du Mont horizontal deflection and HV transformer, or equivalent.

HORIZONTAL DEFLECTION AND H.V. TRANSFORMER

Supplies the necessary deflection and high-voltage for large size picture tubes. Only one driver and one high-voltage rectifier tube needed. Ideal for use with Du Mont Deflection Yoke, or equivalent. Compact design. Fits in any chassis—mounts either on side or bottom. The right flyback for quality conversions.

HORIZONTAL WIDTH CONTROL AND HORIZONTAL LINEARITY CONTROL

Designed for use with the Du Mont Type Y2A1 Deflection Yoke and the Type H1A1 Horizontal Deflection Transformer.

DUMONT

Electronic Parts

ASK YOUR JOBBER!

*RTM ABD LABS., Inc.

**RTM PRM Co., Inc.

SEPTEMBER, 1951

ALLEN B. DU MONT LABORATORIES, INC., East Paterson, N. J.

the device should be plugged in so that the output is into the hot side of the power line.

Relatively large changes in the value of C5 had only slight detuning affect upon the oscillator. The tendency was to lower the frequency of oscillation as the value of C5 increased, but this amounted to only a few kilocycles for a tenfold change in C5.

The receiver (Fig. 2) is a conventional circuit, with power supply (Fig. 3) employing the cold-cathode OA4-G tube. L is same as in Fig. 1, but not

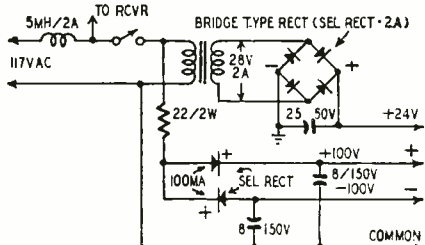

Fig. 3—Receiver and relay power supply.

tapped. A 10- and 15,000-ohm resistor keep the starting anode at a high potential so that the voltage developed across the tuning capacitors when a carrier of the right frequency is impressed on the line is sufficient to start a discharge. A.c. on the anode assures that the discharge is extinguished between pulses. The anode current of the OA4-G drives

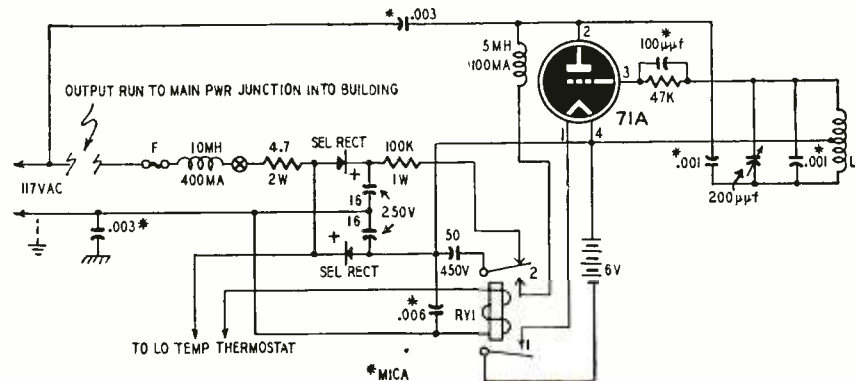

Fig. 4—Transmitter control circuit in greenhouse temperature warning alarm.

relay RY4 into a binary scaler arrangement. This is necessary since the stepping relay works from a source changing in polarity, so that in effect the stepping relay receives two pulses for each one into relay RY3.

The action of the binary scaler can be seen from the sequence of operations. (1) Relay RY4 is closed by the start of a pulse, closing relay RY1. (2) Relay RY4 is opened by the completion of a pulse, thereby allowing relay RY2 to close. (3) Relay RY4 is again closed by another pulse, shorting out relay RY1 this time and allowing it to open. (4) The completion of the second pulse from RY4 opens relay RY2. Each time that relay RY1 operated, it put one pulse through RY3 and therefore through the stepping relay. This occurred only once per two pulses so the necessary scaling has been accomplished. A single pulse will reset the stepping re-

lay at any time because of its construction. RY1 must make before break: RY2 break before make.

Greenhouse alarm

Fig. 4 shows an alarm circuit for a greenhouse, to give a warning if the power to the greenhouse failed or if the temperature fell below a certain danger level. (It could work equally well to warn if the temperature rose too high.) The greenhouse was some distance from the residence with power brought to it by buried cables. It was decided to use carrier warning.

If power should fail, a well-charged, high-value capacitor is inserted into the plate circuit by relay RY1 coincident with the lighting of the tube filament. The 71A was selected because it has a rapid heating filament. The oscillator transmits until the capacitor potential falls too low. This is for at least a second, which is plenty to actuate the receiver. The output of the unit must be connected ahead of the intermediate equipment which might fail, or else the pulse will not carry over the conduit to the residence. L is same as in Fig. 1.

If the power failure is general, a warning is still given by the receiver itself. Fig. 5 shows a receiver like Fig. 2, with some modifications. The same L is used. If pulse is received, relay RY1 closes, actuating relay RY3 which is self-locking on its own battery supply.

This same battery also rings the alarm. The alarm is therefore not dependent upon the house power supply. If the power should fail generally, relay RY2 will open (it draws negligible current

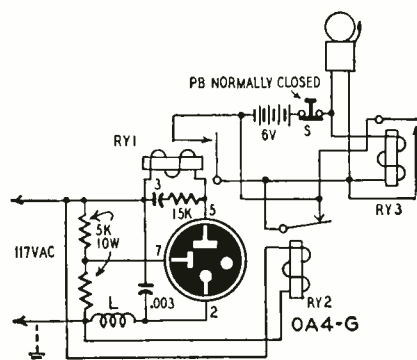

Fig. 5—Greenhouse alarm receiver circuit. Bell rings even if power fails.

on constant duty) and accomplish the same as the closing of relay RY1 by a pulse; relay RY3 will close and lock and the bell will ring. Pushbutton S, normally closed, resets the receiver conveniently. If power does not return immediately, the unit cannot be reset until it does.

A modification may be made to the circuit by inserting a capacitance (300 μ f, 10 volt) into one lead to the armature on the relay RY2. An electrolytic would be best but if a paper capacitor is used it should be bypassed by a resistance of a few megohms. The result will be that if RY2 opens by an interruption of power, relay RY3 will be momentarily pulsed—it is hoped sufficiently long so that RY3 can take over and lock itself. Then while power remains off and S is depressed, relay RY3 will drop and will not return when the button is released. Relay RY2 will have to be actuated for only a few seconds to reset the capacitor by allowing its charge to leak off through the resistor, or through its internal resistance in the case of the electrolytic.

Other uses

Leads from the stepping relay go to other relays numbered 6, 7, 8, and 9 (Fig. 2). In practice up to ten relays can be used, corresponding to the numbers on the telephone dial, 1 through 0.

These multiple relays can be arranged to control numerous circuits around the house. For instance, a central control dial might turn on the coffee percolator in the morning. Its code might be dial C. Radio turn-on or turn-off might be dial R, and so on.

Although it might not be economically practical several dial units might be scattered around the house so that various activities can be carried on conveniently from several points. Experiment will show whether such installations would be feasible.

Materials for remote control

Resistors: 1—47,000 ohms, 1/2 watt; 1—4.7, 1—22, 2—10,000 ohm, 2 watts; 2—5,000 ohms, 1—15,000 ohm, 10 watts; 1—300 ohms, 5 watts.

Capacitors: (Mica) 1—.0001, 2—.001, 3—.003, 1—.006 μ f. (Paper) 1—3 μ f, 250 volts. (Electrolytic) 1—8 μ f, 1—25 μ f, 50 volts; 2—8 μ f, 150 volts; 1—8 μ f, 450 volts; 2—16 μ f, 250 volts. (Trimmer) 1—200 μ f.

Chokes: 1—10 mh, 400 ma, 1—5 mh, r.f. 100 ma, 1—5 mh, r.f., 2 amp.

Relays: RY1, 5,000 ohms, d.p.d.t., make before break, RY2, 5,000 ohms, s.p.d.t., break before make, RY3, 300 ohms, 24 volts d.c., s.p.s.t., RY4, 1,200 ohms, s.p.s.t., RT5, stepping relay.

Miscellaneous: Tubes: 1—117N7-GT, 1—OA4-G. Tube sockets. 2—Single pole, single-throw switches. 1—Telephone dial. 1—Transformer, 28 volts, 2-ampere rating. L—see text for data. 1—Fuse holder and fuse. 4—Selenium rectifiers, 100 ma, 1—selenium rectifier, bridge type, 2-ampere rating. Insulating washers. Wire. Hardware. Solder.

Materials for Greenhouse alarm

Resistors: 1—47,000 ohms, 1/2 watt; 1—100,000 ohms, 1 watt; 1—4.7 ohms, 2 watts; 2—5,000 ohms, 1—15,000 ohm, 10 watts.

Capacitors: (Mica) 1—.0001, 2—.001, 2—.003, 1—.006 μ f. (Paper) 1—3 μ f, 250 volts. (Electrolytic) 2—16 μ f, 250 volts, 1—50 μ f, 450 volts. (Trimmer) 1—200 μ f.

Chokes: 1—10 mh, r.f., 500 ma, 1—5 mh, r.f., 100 ma. Relays: (transmitter) RY1, 117 volt, a.c., d.p.d.t.; (receiver) RY1, 1,200 ohms, s.p.s.t., RY2, 117 volts, a.c., s.p.s.t., RY3, 6 volts d.c., locking type.

Miscellaneous: Tubes: 1—71A (6A3 may be substituted). 1—OA4-G. Batteries: 2—6 volts, 1—Pushbutton, normally closed. 1—6-volt bell. 1—Single-pole, single-throw switch. 2—Selenium rectifiers, 100 ma. Chassis. Wire. Solder. Hardware.

—end—



2-YEAR ALL-WEATHER TESTS

Show G-E Speakers Unsurpassed for Long-Life!



Twenty-seven sizes to choose from... and they're all G-E!

★ After two years exposure to hot sun, rain, sleet and snow — with no shelter whatever in any season — 7 out of 8 General Electric speakers played well enough to perform in your radio set!

These recent tests at Electronics Park subjected the speakers to many times the abuse they would receive under years of actual playing conditions, indoors or out. It boils down to one more dramatic proof of this fact: *You can depend on General Electric quality — in design, in engineering, in construction.*

Your customers are entitled to this quality. How are your stocks of General Electric speakers?

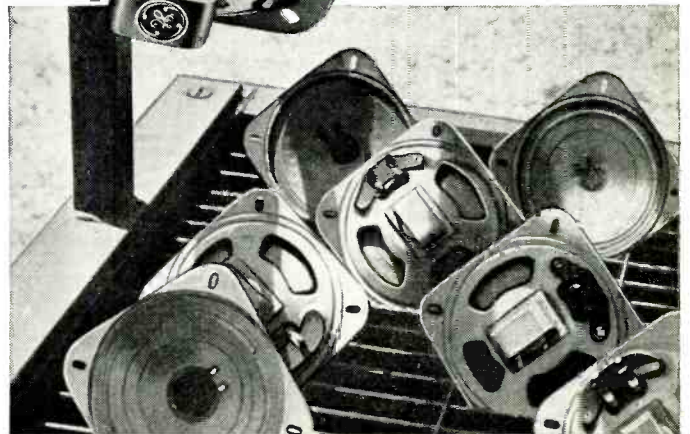

▲ Unretouched photo shows only slight tarnish on speakers. Special G-E plating gives excellent protection to steel frames, none of which were corroded after grueling tests.

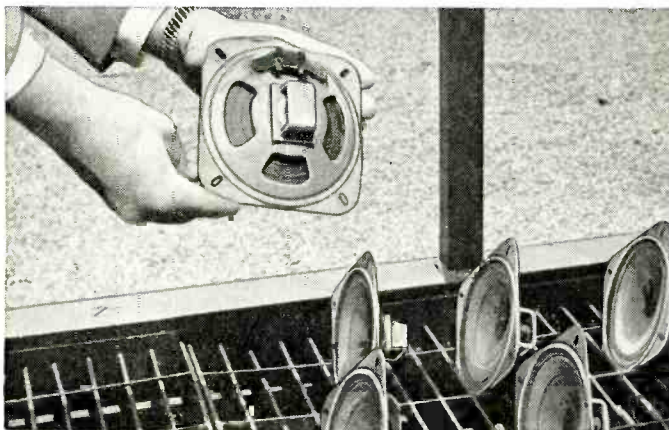

◀ Racked on exposure tray, speakers were checked at intervals for 2 years, then taken apart and examined for wear. Outdoor-type cones were warped only slightly, G-E aluminum voice coils were like new.

General Electric Co., Section 4591
 Electronics Park, Syracuse, N. Y.

Yes — send me latest speaker information plus new booklet on G-E Stylis and Cartridges.

NAME _____

ADDRESS _____

CITY _____ STATE _____

You can put your confidence in—

GENERAL  ELECTRIC

Electronics and Music

Part XV — The Hammond organ; music from spinning wheels and electric circuits

By RICHARD H. DORF

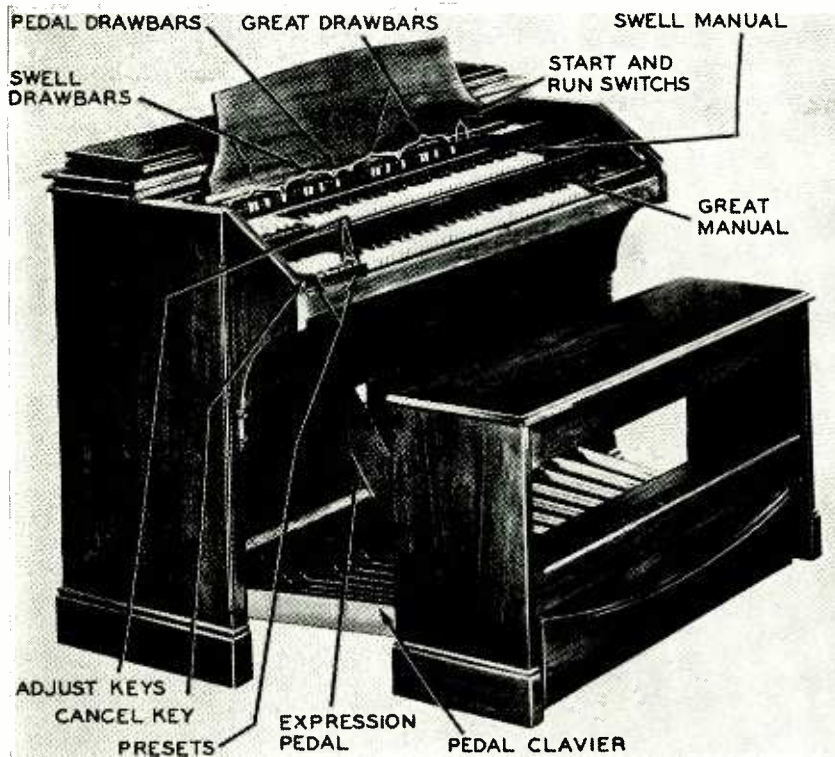

The Concert Model is similar to other Hammonds but has vibrato and more pedals.

THE Hammond organ is a notably popular instrument. This is not to say that other organs, for example, Baldwin, Wurlitzer, Consonata, and others, are not equally good. In all cases, price, contemplated use, and other factors are involved.

In this article and the succeeding one we shall discuss the Hammond organ. In future articles other commercial in-

struments of the organ type will be taken up.

The block diagram of Fig. 1 gives a preliminary over-all view of the Hammond organ. The tone generator assembly generates a sine-wave tone of every pitch required, 61 for the 5-octave range, plus an extra 30 tones for use as harmonics and subharmonics in mixing tone colors, or 91 in all. Nine of these tones are fed to a 9-pole, single-throw switch assembly under each playing key, each pole carrying the tone corresponding to one of the harmonics or subharmonics of the tone represented

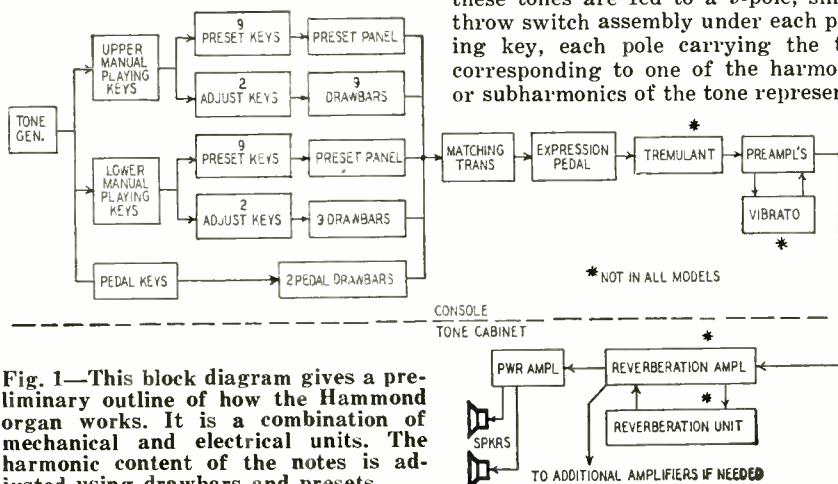

Fig. 1—This block diagram gives a preliminary outline of how the Hammond organ works. It is a combination of mechanical and electrical units. The harmonic content of the notes is adjusted using drawbars and presets.

by the key. The pedals operate 8-pole switch assemblies.

From the playing keys and pedals the tones go (through preset and adjust switches) to sets of drawbars. Each drawbar is an attenuator for one harmonic—the third, for instance. As the draw bar is pulled out step by step it increases the amplitude of the third harmonic of each note played on the manual controlled by that set of drawbars. There are five sets of drawbars, two for each of the two manuals and one for the pedal clavier. Which set shall govern at a particular time on a given manual is decided by whichever adjust key is selected. To set up a particular tonal "formula" on one manual, the player pulls out the drawbar corresponding to each harmonic to an extent corresponding to the amplitude of that harmonic he desires in the tone.

Preset panel

A preset panel is provided for each manual. This is an octave of 12 keys at the left of the manual, with colors reversed—black keys white, and white keys black. The second through twelfth of the preset keys are push switches; push one, it remains down and causes any other key down to spring up. Push the first (the lower C key) and it cancels whatever was down, then springs up itself.

The second through tenth keys (C-sharp through A) control certain preset combinations of harmonics. The eleventh and twelfth (B-flat and B) are adjust keys. They switch over to manual drawbar control and select the combination which the player has set up on one of the two sets of drawbars for each manual. Quick changes in registration are easy, requiring only a quick push of one preset or adjust key for each manual. There are no presets for the pedal clavier. Two drawbars are provided, one giving a combination of the lower-frequency harmonics and the other higher-frequency tones.

Tone emerging from the harmonic mixing system is fed to a matching transformer and then to an attenuator or expression pedal. Next it passes

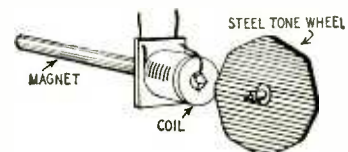

Fig. 2—A small voltage is induced in the pickup coil as the rotating steel phonic wheel varies distance to magnet.

RADIO-ELECTRONICS for

through a tremulant, which is a motor-driven variable-resistance device to vary volume at the tremolo rate. Finally the tone reaches a preamplifier, combined with which may be a device which gives a vibrato effect—varying the pitch of the tones slightly at a rate of a few cycles per second.

The output of the preamplifier is fed to one or more loudspeaker units. Each contains at least one power amplifier and one may have a reverberation unit which gives the echo effect found in large halls. As many speaker units may be used as are necessary for the volume required.

The Hammond organ is made in several models. They all operate as above, but some lack features such as the vibrato or reverberation. Some have fewer notes in the generator assembly or pedal clavier, or fewer preset combinations. The spinet is entirely self-contained, including the speaker.

Tone generator

Fig. 2 shows how tones are generated. For each of the 91 tones, a steel phonic wheel rotates close to a magnetized bar on which a coil of wire is wrapped. Each wheel is accurately machined with a certain number of high and low points around its periphery. As the wheel rotates, the steel body is effectively brought closer to and farther from the magnetized rod with a frequency depending on the rotational speed and the number of teeth. As this occurs, there is a small change in the magnetic field. The field

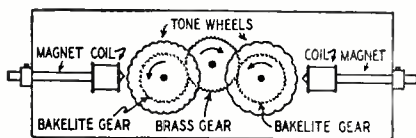

Fig. 3—Side view of tone generator compartment. Each contains four phonic wheels and pickup coils with magnets.

changes induce a small voltage in the coil at the frequency of the changes. The voltage is a.c. of roughly sine-wave form, and is, in effect, the generated tone.

The long generator assembly contains 48 rotating assemblies, each including two phonic wheels. Since there are only 91 tones, five of the wheels are blanks, included for mechanical balance.

Drive assembly

The drive assembly has a long drive shaft. At one end of the shaft is the starting motor, a shaded-pole induction unit; at the other end is the synchronous running motor, which holds the speed of the shaft in step with the power-line frequency. Couplings to the motors are resilient so small instantaneous changes in speed due to line frequency variations are absorbed.

Along the drive shaft are 24 brass gears, two each of 12 different sizes. Within the assembly, the space is divided into 24 compartments, each containing one brass gear attached to the drive shaft and four tone wheels. Fig. 3 shows in cross-section one of the 24

tone-wheel assemblies. At center is one of the 24 brass gears on the drive shaft. This drives two bakelite gears, one on each side and each on its own shaft. At the two ends of each of the two subsidiary shafts is a tone wheel. There is a total of four in each compartment. Four magnetized rods with coils are provided, one for each wheel.

All the tone wheels within one compartment run at the same speed. Since there are 24 compartments (and brass drive-shaft gears), and since there are only 12 sizes of brass gears, two pairs of compartments contain wheels rotating at each of 12 speeds. Thus one speed is provided for each of the 12 tones of the chromatic scale. Tone wheels with 2, 4, 8, 16, 32, 64, and 192 teeth provide the 12 tones repeated at various octave intervals to fill out the complete range of the instrument.

The tone generator assembly is a unit of the highest precision. The steel of the phonic wheels must be homogeneous and exactly the same from one wheel to another. Machining of the wheel teeth must be precise to avoid introducing spurious harmonics and to get a good sine wave. The wheels must be dynamically balanced, and there must be no play in the gears. A synchronous motor actually runs in a series of pulsations and the pulsations must be ironed out. Resilient coupling from motor to drive shaft and similar couplings dividing the shaft itself are necessary.

Lubrication is important. The individual tone-wheel shafts are mounted in bearings of porous bronze. Each bearing is connected to an oiling system by a cotton thread. Capillary action carries oil from a reservoir trough. Proper maintenance includes using the grade of oil recommended, for mixing grades will gum up the cotton threads and prevent oil flow.

Sine wave output

The output of each tone generator must be as nearly sine-wave as possible. The tone coloring system requires this. The lower-frequency coils have copper rings on them. The eddy-current loss in the ring is low for the fundamental frequency but high for the harmonics. All the coils have simple filters at their outputs. As shown in Fig. 4, the first 43 coils are shunted with a resistor. The next five are fed through tapped transformers to reduce upper-harmonic content. The upper coils are fed through the transformers with a series capacitor; the capacitor and transformer make up a tuned circuit at the fundamental frequency. Each transformer is different, with the correct turns ratio and inductance for the frequency.

The entire generator assembly is built as one unit, and a new one can be substituted in case of damage or change to a location with a new line frequency. When the service technician orders a new assembly, however, he must give the model and serial number of the organ, as different generator types are not interchangeable.

Some models of the Hammond organ

have a chorus generator in addition to the main generator. The chorus generator is similar to the main generator, and provides frequencies 56 through 91. Frequencies 56 to 67, however, are 0.8% sharp or flat, while the rest are 0.4% from the correct frequency. This slight difference between the frequencies of the two generators gives a chorus or ensemble effect of two instruments playing at the same time. It destroys the undesirable tuning of the electrical system.

The precise, perfect tuning of the electrical generation of tones destroys, some say, the very quality of music produced by ordinary acoustic instruments. These have an imprecision, or variation in pitch and tone quality, which gives the music warmth, life, and vibrancy. One of the major drawbacks, then, of making music electrically, is that this very quality of spontaneous, live, direct control of the tone, pitch, and quality of the music is not possible in an electric system.

Manuals and pedal clavier

Each of the 61 playing keys and each of the nine preset and two adjust keys for each manual actuates nine small bronze contact springs with precious metal points (Fig. 5). When the key is pressed, each spring makes contact with a busbar which runs the width of the manual.

Each contact spring (note shape, Fig. 6), is connected to the output of one tone generator. Resistance wire is used, the resistance affording isolation necessary because each tone generator is connected to a number of contact springs. This arrangement is the key to the harmonic synthesis tone color system employed in the Hammond electric organ.

The tones provided by the generator are the fundamentals of all the 61 notes

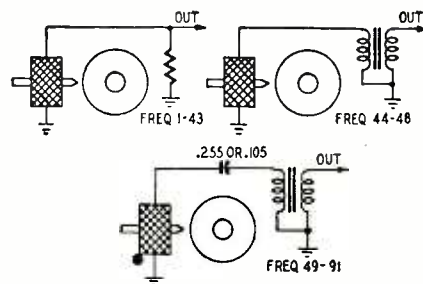

Fig. 4—There are three groups of pickup coils, divided according to frequency. Harmonic content is filtered from each.

plus another 12 below the lowest keyboard note and another 18 above the topmost one. Each of these tones is one of the 12 in the "well-tempered" scale with which we are familiar. In addition to being used as fundamental tones, however, they are also used as harmonics. For instance, suppose the lowest C on the manual is pressed and the fundamental drawbar is pulled out. The note heard will be 65.41 cycles (refer to the frequency chart on page 42, Au-

gust, 1950, RADIO-ELECTRONICS). Now, with the same key pressed and the second-harmonic drawbar pulled, the note heard will be 2×65.41 , or 130.8 cycles, derived from the same tone generator which would furnish 130.8 as the fundamental for the C one octave higher.

The third harmonic for the lowest C key is derived from the same generator which also furnishes the fundamental for the G an octave and a half higher. The frequency of this generator is 196.0 cycles. The true third harmonic of 65.41 would be 196.2 cycles, however, so the tone used as third harmonic on the Hammond is really slightly flat. The

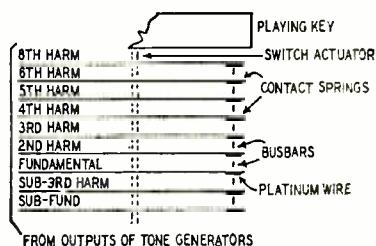

Fig. 5—Side view of one key assembly. Key pushes down actuator to make nine springs (carrying tones) hit nine busbars. Contacts are made of platinum.

fourth harmonic, 261.7 cycles, is the same as middle C, so there is no discrepancy. The fifth harmonic should be 327.1 (approximately) but the nearest tone which is also part of the scale as a fundamental is the E above middle C, which is 329.6, so again there is an error. The sixth harmonic should be 392.5, while the nearest available note (G above middle C) is 392.0, another error. The seventh harmonic should be 457.9, but the nearest are 440 and 493.9, neither of which is close enough to do. The seventh harmonic therefore is not used on the Hammond. The eighth harmonic is the following C at 523.3 and is perfectly accurate.

The so-called sub-third harmonic is an octave below the normal third harmonic and has the same error. The sub-fundamental is simply one octave below the fundamental.

The errors in harmonics are actually slight, the worst being the fifth harmonic. Not many listeners can tell that the harmonic structure is faulty. The effect, if audible, is merely characteristic of the instrument and is neither a fault nor a virtue. It would be economically unfeasible to furnish the necessary fundamental tones plus the additional generators needed to supply the exact harmonics for each note.

Mixing harmonics

The method by which drawbars and presets control harmonic mixture is ingenious and simple. Fig. 7 shows the entire tone coloring system. Note the set of busbars marked LOWER MANUAL. There are nine bars, one for each harmonic and subharmonic. These bars run the width of the console, under the playing keys, the preset keys, and the two adjust keys.

Each of the 61 playing keys actuates a set of nine vertical contact springs, as in Fig. 5. Each spring is wired to an appropriate tone generator and carries that tone continuously. A typical playing key, with its resistance-wire connections to the tone generators, is represented by the vertical set of contacts at the left of the lower-manual busbars in Fig. 7. All 61 keys are the same. Any number pressed at the same time make contact with the same set of busbars.

When a playing key is pressed, tones are sent to the busbars. The bottom busbar receives the sub-fundamental of the desired note. The next receives the sub-third, and the third from the bottom gets the fundamental. Thus at any time, every bar may be carrying many different notes; but all the notes carried by any one bar are fundamentals, or third harmonics, and so on, depending on the particular bar.

In Fig. 7 there is a set of contacts representing one of the two adjust keys on the preset panel to the left of the playing keys. Let us assume that that adjust key is pressed and stays down. Following the wire from each adjust key contact we find that it leads to a contact on the end of a drawbar, and that there are nine drawbars in the group. We also find that the drawbar contact is at present sitting on the lower busbar of a group of nine attached to taps on the primary of a matching transformer. Note well at this point that the number of nine transformer

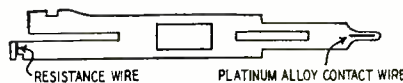

Fig. 6—Resistance wire is used in contact spring to isolate it, because each tone generator connects to several springs. Platinum contacts bus-bar.

taps and tap busbars has no relation to the nine bars below corresponding to the harmonics. There might just as well be 12 or four taps and tap busbars.

A sample tone

The lowest transformer tap and busbar is grounded. Trace the circuit now for, say, the fundamental tone. The generator terminal for this tone is connected through a resistance wire to the contact spring of the corresponding key. That spring is contacting the third busbar from the bottom (lower manual). The tone then goes through the corresponding adjust key contact to the third drawbar, which is contacting a grounded transformer busbar.

Now suppose we pull out that third drawbar one notch. The contact at its end is now connected through the second busbar from the bottom to the first transformer tap up from ground. A small voltage appears in the transformer primary and the secondary shows some output of that tone. The output increases by pulling the drawbar out more, placing the tone across a larger section of the transformer primary.

Suppose we also wish some sub-fundamental output. Sub-fundamental tone is reaching the first drawbar via the lowest lower-manual busbar and the lowest adjust-key contact. By pulling out the first drawbar, we introduce some sub-fundamental. Thus, by simply pulling out drawbars to the desired step, we can produce in the output a tone in which are mixed all the harmonics and subharmonics in any tone quality formula. Because all the lower-manual playing keys send tones to the same set of lower-manual busbars, the drawbars control the identically numbered harmonics of all the keys pressed at the same time.

A second set of drawbars (not shown) is furnished for each manual, with a second group of adjust-key contacts on the lower busbars. It is possible to set up the drawbars in advance for a certain mixture formula, then bring that mixture into play by pressing the unused adjust key. This releases the first adjust-key contacts, taking the first set of drawbars out of action, and makes the contacts for the second drawbar group. All the action we have discussed is identical for both manuals.

Preset operation

The preset keys determine certain standard formulae, and are a part of the same system. As Fig. 7 shows, one lead from each transformer tap is brought down to an auxiliary set of busbars known as the preset panel. Each of these bars has a large number of screw terminals along its length.

Each preset key has nine contact springs which, when the key is pressed, make contact with the same group of nine busbars as is used for the playing keys. This, when a preset key is pressed, its nine contacts pickup from the busbars the nine tones corresponding to the harmonics of whatever playing keys are being used. These nine tones appear in a group of nine color-coded wires which come up through a hole below the preset-panel busbars on the back of the organ case.

To set up a present combination, the coded wire carrying each harmonic is attached with a screw to the appropriate preset-panel bar corresponding to the strength with which that harmonic is desired in the combination. For instance, if no sub-fundamental is desired, the red wire (which leads to the lowest contact of that preset key on the lower-manual busbar group) is connected to a terminal on the lowest bar of the preset panel. Since that bar is wired to the grounded end of the transformer primary, the wire is effectively grounded. If loud fundamental is desired, the orange wire, connected, when that preset key is pressed, to the third busbar of the manual, may be connected to the top preset-panel bar, which puts it across the full transformer primary for full output.

Changing presets

The organ is shipped from the factory with preset combinations already

the First **VEE**
with **GOOD**
Low Band Performance

RADIART SUPER VEE

This antenna design is recognized as the top "high-band" performer compared with any other all-channel array. High forward gain, sharp directivity and excellent rejection from back and sides on channels 7 to 13, combine to deliver the best picture possible! NOW . . . THE RADIART DOUBLE STACK VV2, features full 1/2 wave spacing between bays and extra "Q" bar length giving you more total gain and **OUTSTANDING LOW BAND PERFORMANCE**. An exclusive RADIART development!



PRE-ASSEMBLED FOLD-OUT
DESIGN FOR **FAST** INSTALLATIONS

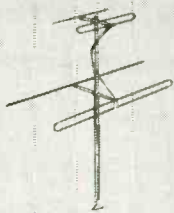

HI-LO ANTENNAS

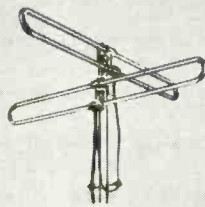

FM ANTENNAS

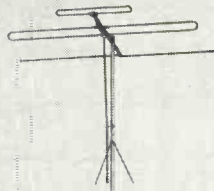

STRATE-LINE ANTENNAS

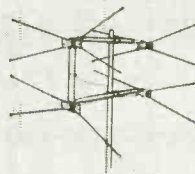

LAZY-X CONICALS



INDOOR ANTENNAS

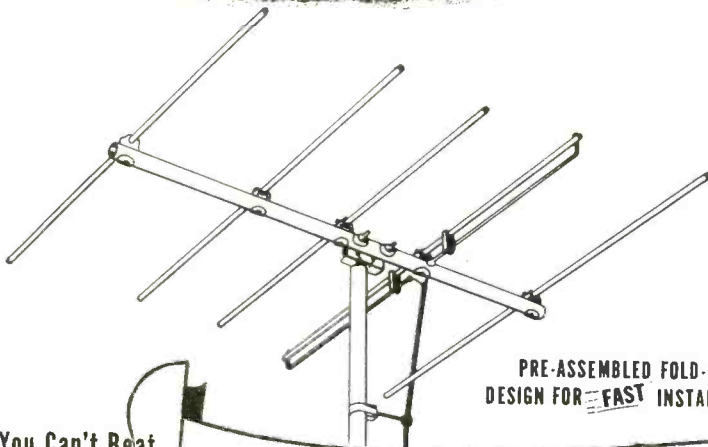

PRE-ASSEMBLED FOLD-OUT
DESIGN FOR **FAST** INSTALLATIONS.

RADIART YAGI

The perfect answer to the need for maximum signal pick-up in "fringe" areas. Each YAGI is cut for a specific TV channel and may be used singly or doubly stacked. Features include low standing wave ratio . . . over 8 db. forward gain . . . and narrow beam width that develops high signal-to-noise ratio.

You Can't Beat
a RADIART
Antenna on a
TELE-ROTOR
...IT'S TOPS!



THE RADIART CORPORATION CLEVELAND 2, OHIO

VIBRATORS • AUTO AERIALS • TV ANTENNAS • ROTATORS • POWER SUPPLIES

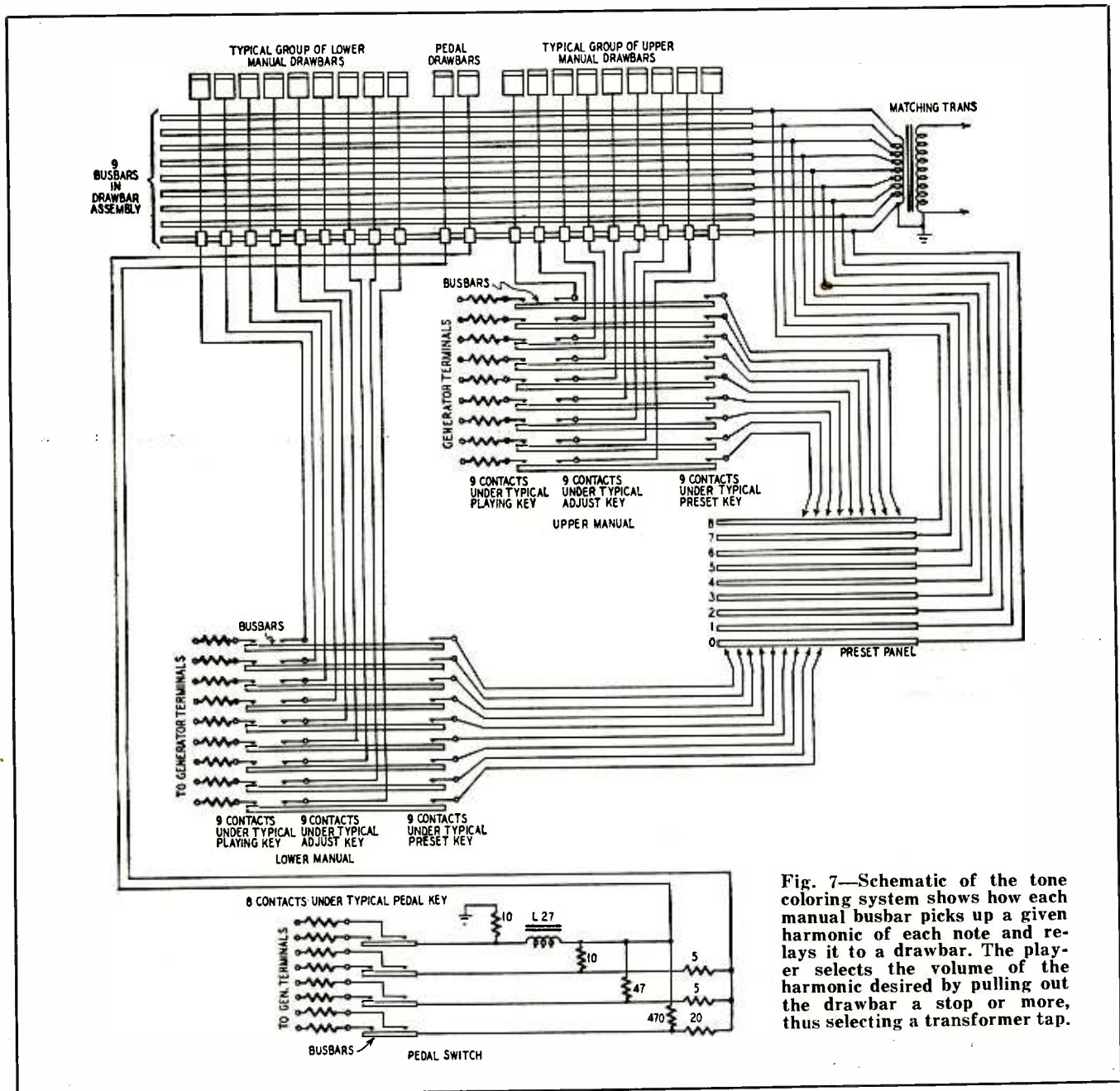

Fig. 7—Schematic of the tone coloring system shows how each manual busbar picks up a given harmonic of each note and relays it to a drawbar. The player selects the volume of the harmonic desired by pulling out the drawbar a stop or more, thus selecting a transformer tap.

made up and the wires connected. Individual owners, however, often wish to change the presets for their own favorite tonal varieties. To do so, the experimentation is done with a set of manual drawbars, with, of course, the appropriate adjust key pressed. Then the positions of the drawbars are noted in terms of how many steps each has been pulled out. With a screwdriver in his hand and a list of the drawbar numbers, the owner or service technician may reconnect the preset wires as desired, keeping in mind that a connection to the lowest preset bar simulates a drawbar pushed all the way in and connection to the highest gives the effect of a drawbar pulled all the way out. The preset panel is, in effect, 9 sets of drawbars fixed permanently in position. Enough terminals are provided on the preset busbars so that all 9 preset keys can be set up as desired.

Table 1 below gives the color coding of the present key wires.

Table 1

Harmonic	Wire color
Sub-fundamental	Brown
Sub-third harmonic	Red
Fundamental	Orange
Second	Yellow
Third	Green
Fourth	Blue
Fifth	Violet
Sixth	Grey
Eighth	White

Pedal drawbars
 The pedal drawbars work on the same principle as the manual drawbars but the wiring is different and there are no presets. In some models fundamental through eighth harmonic tones are used; in others the tenth and twelfth

are added. In each case, however, two harmonics are fed to each pedal busbar, as indicated in Fig. 7. The outputs of all the busbars are mixed with a resistor system and two outputs are derived, one predominant in low and one in high harmonics. These are fed to two drawbars which control pedal tone quality in a much less exact and selective manner than for the manuals. This is justified because the pedal is ordinarily used only as a "foundation" tone to add a solid bass to the ensemble, and it is rare to play two pedal notes simultaneously.

In next month's article we shall complete the Hammond organ description with the amplification system, tremulant, vibrato, expression control, pedal solo unit, and tone cabinets. We shall also include a "numbers table" giving such statistics, and other details.

(continued next month)

A Guiding Beacon For
Quality Electronic Parts

Your Local
RADIART
Distributor



BUY OF THE MONTH

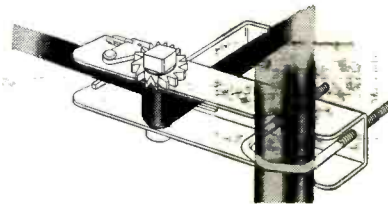

Radiart scores again, this time with a sensational NEW Chimney Mount, the SPEE-DEE model AK-35! It is the fastest, easiest to install chimney mount ever made. Made of heavy gauge zinc plated steel with large "U" bolt for up to 1 3/4" O.D. mast. See your RADIART DISTRIBUTOR, or write us.

These are the Cities with RADIART DISTRIBUTORS in OHIO, MICHIGAN, WEST VIRGINIA, Western PENNSYLVANIA and Eastern KENTUCKY, serviced by NEAL BEAR CORP., West Richfield, Ohio
for name of your nearest Radiart Distributor, use coupon below

OHIO . . . Akron . . . Ashtabula . . . Canton . . . Cincinnati
Cleveland . . . Columbus . . . Dayton . . . Elyria . . . Lima
Mansfield . . . Marion . . . Portsmouth . . . Springfield
Steubenville . . Toledo . . Warren . . Youngstown . . Zanesville

MICHIGAN . . . Ann Arbor . . . Battle Creek . . . Cheboygan
Detroit . . . Flint . . . Grand Rapids . . . Highland Park
Jackson . . . Kalamazoo . . . Lansing . . . Laurium . . . Muskegon
Port Huron . . . Saginaw

WEST VIRGINIA . . Bluefield . . Charleston . . Clarksburg
Huntington . . Parkersburg . . Wheeling

WESTERN PENNSYLVANIA . . Altoona . . Erie
Johnstown . . Pittsburgh . . Uniontown

EASTERN KENTUCKY . . . Ashland . . . Glasgow
Lexington . . . Louisville



THE RADIART CORPORATION
CLEVELAND 2, OHIO

VIBRATORS • AUTO AERIALS • TV ANTENNAS • ROTATORS • POWER SUPPLIES

THE NEAL BEAR CORP.
West Richfield, Ohio

.....Please send me a listing of the Radiart Distributors
in my area.

.....Please have a Radiart Distributor call on me.

Name

Address

City..... State.....

READY NOW FOR YOU: THE NEW



ADVANCED
COURSE

in

Television Servicing

GIVES YOU THE PRACTICAL KNOW-HOW FOR PROFITS!

- ... How to locate and correct troubles.
- ... How to get the most out of your test equipment.
- ... How to make TV-set conversions.

Post-graduate throughout—with actual TV-service problems discussed and solved for your guidance—this home-study course by G.E. is both an aid to better repairwork, and an income-booster.

Trouble-shooting. By means of photographs, drawings, and text, you're shown the common faults you will encounter in TV operation ... their causes ... how to find and eliminate them.

Test equipment. Your test apparatus can, and should, pay dividends. G.E.'s Advanced Course explains in detail how to use test equipment for efficient and profitable TV servicing.

Conversions. You're told how to convert TV sets to larger screen sizes—how to estimate costs on this remunerative work. You're also shown how conversions can be used as a means to make additional sales of tubes and parts.

G.E.'s original service course laid a solid foundation of TV principles. This new Advanced Course helps you turn your knowledge into dollars. Register *today* through your G-E tube distributor! *Electronics Department, General Electric Company, Schenectady 5, New York.*

EARN THIS STERLING-SILVER EMBLEM—
along with a distinctive wall-plaque
that bears your name—by completing
G.E.'s Advanced Course! These are the
symbols of the television expert!



SEE YOUR G-E TUBE DISTRIBUTOR FOR FULL DETAILS!

GENERAL  **ELECTRIC**

181-KA9

Audio Feedback Design

Part XI—Low distortion single-frequency signal generator uses a feedback circuit

By GEORGE FLETCHER COOPER

FOR the last few months we presented a considerable amount of (necessary) mathematics. This month's offering may therefore be a welcome change to those readers who dislike mathematical treatment, as well as to editors. Editors react to mathematics as ordinary mortals react to alcohol; a small dose makes them smile happily, but on a larger shot they go fighting mad. Before we return to audio completely, however, there is one feedback system which offers a little of everything; a designer's smörgåsbord, hors d'oeuvres, hot-pot or junkbox, as you will.

You will have read dozens of articles on new designs of high-fidelity amplifiers: how often has the designer told you where you can get a correspondingly high-fidelity input? If you have 0.2 volts of input, you get 10 watts of true and faithful copy; but copy of what? The output from a receiver of unknown performance, or pickup which seems to sound quite good? In the ground-ray region, of course, there's WWV. Elsewhere, a signal generator must be used, and the average commercial unit is not good enough.

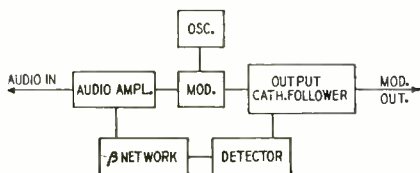

Fig. 1—Single-frequency generator showing feedback components and loop.

The solution was to build a special signal generator. For my purposes, 0.5% distortion up to 50% modulation was good enough. Mr. Sampson* of G-E has described a similar but more elaborate circuit, which has 0.1% distortion at 100% modulation. In this article I shall describe my own circuit with emphasis on feedback circuit design because it contains all the basic elements to be considered.

The performance can be improved by elaborating the modulator and detector but these do not involve the feedback loop. The signal generator is a single-frequency unit. The commercial design by Sampson requires six adjustments when changing frequency, but for receiver testing it is always possible to tune the receiver to the generator.

**Electronics*, Apr., 1949; *Proc. Nat. Elec. Conf.*, 1948.

To simplify arithmetic, I shall not follow my own design exactly, but will use a design carrier of 800 kc in this article. Any type of modulation may be used, so it is quite easy to run comparative tests on the signal generator and receiver, using a microphone or tape recording as source. A good audio oscillator is used for normal distortion measurements.

The basic circuit diagram is shown in Fig. 1. It looks exactly like a feedback amplifier, except that inside the forward path there is a modulator, and in the feedback path there is a detector.

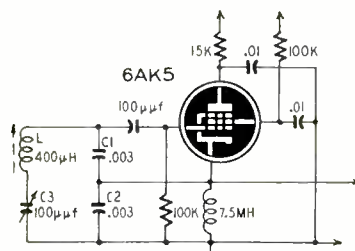

Fig. 2—Circuit of the master oscillator.

Ideally, just as in the ordinary audio feedback case, the performance depends only on the feedback path, so that instead of needing to design a good modulator, all we must do is produce a good detector.

In practice, just as we make our audio amplifiers as good as possible before we apply feedback, here we try to get a good modulator, because we cannot apply unlimited feedback. The problem is to decide what we mean by amplitude and phase characteristics when one part of the circuit works at audio frequencies and another at 800 kc. First, consider the component parts of the system which take the place of the individual stages of an ordinary amplifier.

Oscillator circuit

The master oscillator circuit, Fig. 2, is the highly stable Clapp-Gouriet circuit. It was incorporated because we wanted to see whether it was as good as reported. If a new oscillator appears while you are building a signal generator, by all means try it! In case you have forgotten about the Clapp-Gouriet circuit, I have shown the bare bones of this circuit together with the Colpitts circuit in Figs 3-a and 3-b. The tank circuit capacitors of the Colpitts are made very large, and the necessary small inductance is obtained by series

tuning a normal inductance. The oscillation frequency is just above the series-resonance frequency of the LC branch. The main disadvantage of this circuit in some applications is the rather low output, but we only need about 1 volt for the modulator grid.

The modulator

The modulator uses a 6AS6 tube. This is like the phantastron, and has a relatively high suppressor mutual conductance. Suppressor modulation is frequently used at moderate power levels, 10-50 watts, but most small pentodes require at least 50 volts on the suppressor to cut off the plate current. In the 6AS6, 5 volts on the suppressor will cut off plate current. The exact figure depends on screen and plate voltages. It makes a convenient modulator for this circuit, because the oscillator and audio inputs can be completely isolated by applying them to separate grids. The circuit, shown in Fig. 4, provides cathode degeneration at audio frequencies, because the 3,000-ohm resistor is only decoupled to radio frequencies. The result is the modulator gives fairly low distortion up to about 50% modulation.

The output is taken from a cathode follower so that the load does not react back on the circuit. The external load is tapped down on the cathode-follower resistor, because we require only small outputs and we can use the decoupling produced by this resistive attenuator. An external attenuator was used to control the level, but a tapping slider on the 75-ohm resistor could be used. We can neglect the frequency response of the cathode follower, fortunately, so that we need not put in the actual circuit at this point.

Detector

The key to the feedback loop is the detector. A germanium diode, together with a filter circuit to eliminate the radio-frequency components, provides audio voltages which can be connected back into the audio amplifier. The circuit of this is shown in Fig. 5. It would

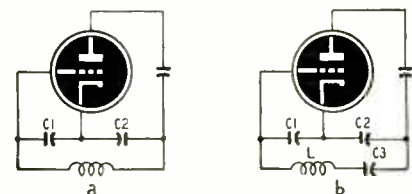

Fig. 3—(a) Colpitts; (b) Clapp-Gouriet.

be a considerable improvement to add extra carrier at this point to keep the effective depth of modulation very low. The Sampson circuit does this but unless you expect to be working in the region below 1% with your receivers it is not worth going to the extra complication involved.

These bare bones must now be assembled into a complete circuit, with its feedback loop closed. As we saw in the last article, the r.f. stages operate right down to zero modulation frequency. Therefore regarding low-frequency audio response only one RC circuit has any effect, and we cannot possibly have low-frequency instability. All our problems are concentrated on the high-frequency audio response.

Circuit problems

Three circuits affect circuit behavior for high modulation frequencies: the plate circuit of the audio amplifier; the plate circuit of the modulator; the smoothing circuits in the detector. Let

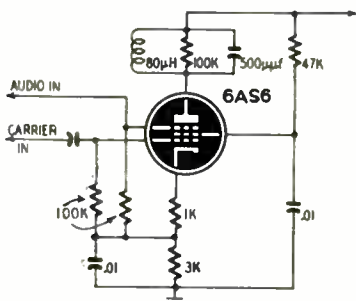

Fig. 4—Modulator circuit provides cathode degeneration at audio frequencies.

us consider them separately, and put in numbers which look reasonable: if the result is not satisfactory we must make the changes suggested by the shape of the curves. I am trying, as always in this series, to take the reader right along with me in working out the design. Most of the interest lies in the spots where you go wrong!

The audio amplifier is quite conventional and its main purpose is to provide a convenient means of connecting the feedback into the circuit without using a very large feedback voltage.

The audio amplifier has a plate resistor of 100,000 ohms and a total capacitance, including wiring, which should not exceed 20 µmf. The characteristic frequency,

$$f_0 = \frac{1}{2\pi\sqrt{LC}} = \frac{1}{20 \times 10^{12} \times 10^{-20}}$$

$$= \frac{1}{10^{-7} \times 20} = \frac{10^6}{2} = 500,000$$

$$2\pi f = 500,000$$

$$f = 80 \text{ kc.}$$

is therefore 80 kc. We can afford to put in a stabilizing circuit here, and a convenient design frequency is 8 kc. The

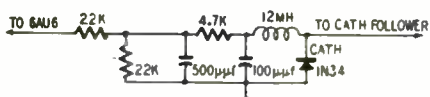

Fig. 5—Germanium diode detector circuit.

capacitance is therefore 200 µmf. If 20 µmf gives a frequency of 80 kc, then 8 kc will give (since capacitance is inversely proportional to frequency) a figure of 200 µmf. The point at which we flatten out the characteristics settles the amount of phase shift we shall have, and I shall guess the value of resistor

to be used as 27,000 ohms. This makes the response of the audio stage flatten out about 14 db down, and moves the final cutoff up to 400 kc. These values are the sort of values I have been using in a lot of audio circuits, so this guess has pretty strong inspiration.

For the plate circuit of the 6AS6 we can start from several different assumptions. To get stable tuning without the tube capacitance having too much effect, the capacitance must be at least, say, 100 µmf. The corresponding inductance, for a frequency of 800 kc, is 400 µh,

$$f_0 = \frac{1}{2\pi\sqrt{LC}}$$

$$\sqrt{LC} = \frac{1}{6.28 \times 800,000}$$

$$\sqrt{L \times 100 \times 10^{-12}} = \frac{1}{50.24 \times 10^5}$$

$$L = 400 \mu\text{h.}$$

and the plate impedance is 2,000 × Q ohms: Q is the figure of merit of the plate circuit inductance. The coil itself will give us a Q value in the order of 100, but the tube characteristics suggest that Q = 10, giving 20,000 ohms plate load, would be more suitable.

Let us look at it another way. You may remember from the last article that the bandwidth associated with a given resistance and capacitance is unaltered by moving from audio to bandpass problems. Since we are to work with audio frequencies up to about 8 kc, the bandpass bandwidth must be about 16 kc. Taking 20,000 ohms as the desired resistance value, we have

$$20,000 C \times 2\pi \times 16,000 = 1$$

$$C = 1/2000 \mu\text{f} = 500 \mu\text{mf.}$$

The use of 100 µmf, giving a bandwidth of 80 kc, would mean that the envelope response was 3 db down at 40 kc modulation frequency, and that the gain was only about 40 db down at audio frequencies. Too much audio would then come straight through to the output. Let us switch designs to the 500-µmf, 80-µh basis, and make sure that we get a Q of 50. An ordinary slug type, dust-core coil will do the job.

In designing the detector circuit we have another problem. We want to keep the radio frequency out of the feedback loop, but yet not produce too much phase shift at audio frequencies. The detector network, of course, is an audio network:

it is only in the modulator that we have the bandpass type of circuit. To find what we need we must construct the amplitude and phase response characteristics for the portions of the circuit already designed. Those are shown in Fig. 6.

If we assume that we want to put on 20 db of feedback, we can take a 7-db margin and make sure that the phase shift is less than 180° at 45 kc. Looking up low-pass filters in reference tables we see that a full section of constant-K low-pass filter has a phase shift of 180° at cutoff, and a phase characteristic roughly linear with frequency.

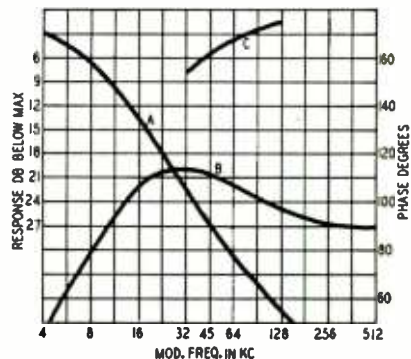

A-AMPLITUDE RESPONSE; B-PHASE RESPONSE WITHOUT DIODE FILTER; C-PHASE RESPONSE WITH DIODE FILTER

Fig. 6—Amplifier and phase responses found with templates of previous articles.

Usually it is slightly concave downward, so that we get a slight safety margin thrown in if we take the phase as proportional to frequency. By taking a cutoff frequency of 3 × 45 kc = 135 kc, we shall have only 60° phase shift at 45 kc, making the total phase shift here 170°. As I have not used a full section, but have replaced one inductance by resistance, the filter is slightly safer than the design suggests. This network will give us 30-40 decibels attenuation at the carrier frequency, so that there is no danger of carrier overloading the audio amplifier.

As a filter design impedance we take 10,000 ohms. The inductance and capacitance are then:

$$L = R/2\pi f_c = 10,000/6.28 \times 1/135,000$$

$$= 11.7 \text{ mh}$$

$$C = 1/2\pi f_c R = 1/6.28 \times 1/10,000 \times$$

$$1/135,000 = 117 \mu\text{mf}$$

These values are convenient, and the final network is shown in Fig. 7.

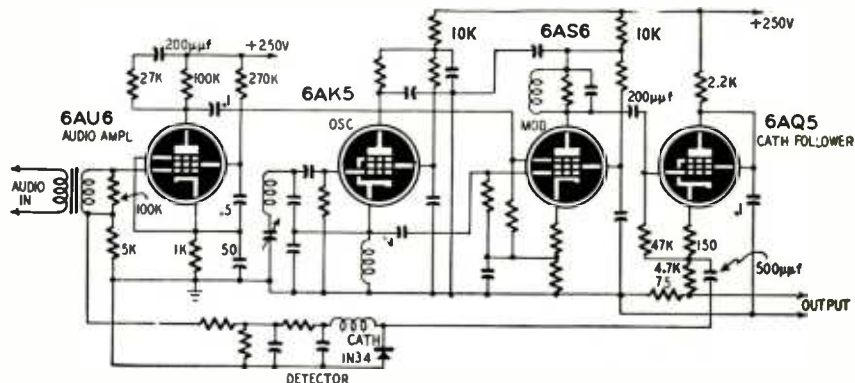

Fig. 7—Circuit of the feedback signal generator shows values not included in the previous partial circuit diagrams. A regulated power supply is suggested.



"They're worse than PINK ELEPHANTS"

say TV owners of the vertical black bars which appear when Barkhausen Oscillation occurs in the horizontal sweep output tube (such as the 25BQ6, 6BQ6, 6EV5, 25EV5, 6AU5, or 25AU5, etc.).



GET RID OF BARKHAUSEN OSCILLATION WITH THE B. O. ELIMINATOR!

Because it brings a concentrated magnetic field near the source of the Barkhausen Oscillation—namely the screen grid—the Perfection B. O. Eliminator usually stops the oscillation. *Easy to Install.* Just slip over the tube, move down or up, or turn until the dark vertical bars disappear.

Order today from your supplier!

PERFECTION ELECTRIC COMPANY
2637 South Wabash Avenue, Chicago 16, Illinois
MAKERS OF PERFECTION SPEAKERS AND TELEVISION COMPONENTS



TELEVISION RECEIVER—\$1.00

Complete instructions for building your own television receiver. 16 pages—11"x17" of pictures, pictorial diagrams, clarified schematics. 17"x22" complete schematic diagram & chassis layout. Also booklet of alignment instructions, voltage & resistance tables and troubleshooting hints.—All for \$1.00. Write for free catalogue.

CERTIFIED TELEVISION LABORATORIES
Dept. C, 5507-13th Ave., Brooklyn 19, N. Y.

COLOR TELEVISION PATENTS

Study first hand information, including Columbia system, by reading actual patents. Secure this comprehensive patent search report.

\$1 postpaid

PATENT SERVICE INSTITUTE
945-06 Pennsylvania Avenue
Washington 4, D.C.

It is necessary to know the total gain round the feedback loop to make sure that one audio stage is enough. The audio amplifier, with a plate load of 100,000 ohms and about 1 ma plate current, where the mutual conductance is low, will have a gain about 40 db. The modulator has a conversion conductance of about 500 μ mhos, but the cathode feedback brings the gain down to not much more than unity. Let us assume a gain of 100 from audio grid to detector. This is just about enough to make the system conform to the standard feedback theory, for we have $A = 100$, $B = 1/10$, and $AB = 10$. Final adjustment of gains and feedback is done when the model has been built.

Tuning modulator plate

The most important detail in the construction of this signal generator is the tuning of the modulator-plate circuit. It must be tuned exactly to the oscillator frequency. If the modulator is detuned by 8 kc, there will be an extra 45° phase shift on one side or other of the carrier, and the system will be unstable with full feedback. It is not easy to tune on amplitude alone, because the response is only 30% down at 45° phase shift. The phase is very dependent on tuning, so this can be used as a guide: the tuning is rocked to the unstable point on either side of the center frequency, and the mean position used as a final setting.

In the form in which I have been using it, this signal generator, designed for operation at 5 mc, gave a distortion of 0.9% at 90% modulation, and less than 0.5% at 50% modulation. The output was about 100 millivolts, which is more than is needed for any normal receiver test. The level required to modulate it fully was less than 0.1 volt on the grid of the audio amplifier: the input voltage depends on your choice of input transformer.

Largest Selling Booster

AT ANY PRICE !

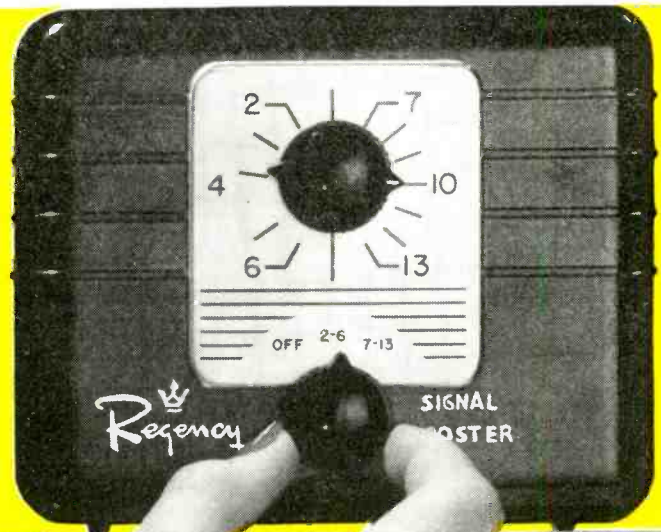

Regency



Here's how YOU
can sell more
Picture Tubes
WITH
HYTRON'S NEW
EASY BUDGET PLAN!

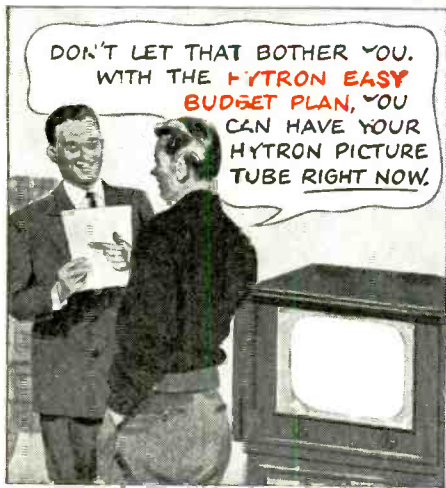
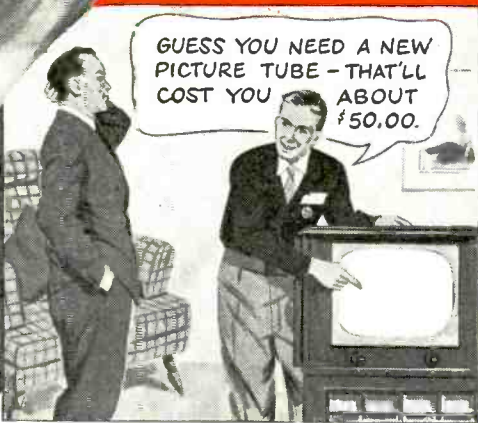

ANOTHER HYTRON FIRST FOR YOU!

No need to miss that profitable picture-tube sale — just because the customer doesn't have the cash. The original Hytron Easy Budget Plan saves the sale. Gives you a competitive edge. Hytron has arranged the details for you. A national credit organization, with facilities in all TV areas, stands ready to serve you.

Find out how you can put this wonderful, timely Hytron plan to work right now! Write for: complete information today.



ANOTHER HELPFUL SERVICE FOR YOU FROM . . .



Hytron Radio and Electronics Co.
Salem, Massachusetts

Please rush me details on the Hytron Easy Budget Plan.

Name
(please print)

Street

City..... State.....

**From
Finest Studio
Equipment and
Servicemen's Needs
To Toughest
Military
Requirements...**

It's
Permoflux
"SOUND" IN DESIGN

Permoflux Royal Blue Line

Here's good news for every sound and serviceman! The famous Permoflux Royal Blue Line (with Alnico V magnets) is available for immediate delivery. This should be good news for your Hi-Fi customers too. So let them know about it! Remember the

Permoflux Royal Blue Line gives Big Speaker Performance—clean, brilliant, musical reproduction. Laboratory tests have proved over and over again that the Royal Blue Line Speakers produce a smooth, faultless flow of tone over an unusually large band of frequencies, up to 12,000 cycles in width. Averaged response curves show that these Speakers not only have excellent highs but also produce low frequency response, 50 cycles and lower depending on baffle, characteristic of much higher priced speakers.

For a quick sales clincher sell your replacement customers the Permoflux "Champion" Line. These top quality Speakers are available in all the popular sizes and are ideal as Radio, Television and Auto replacement Speakers. Popular sizes furnished with universal mounting brackets.

Replacements for Government Applications

Due to stepped up military requirements for Communications equipment, much of this equipment is today being demoth-balled and reconditioned by service organizations for government use. Permoflux, one of the largest speaker sources for this type of equipment makes available thru jobbers many replacement types of speakers for the above.

For further information on Permoflux Speakers send for these two attractively illustrated catalogs "Permoflux Royal Line No. J202 and Permoflux 'Sound' in Design No. J203."



TRADE MARK
PERMOFLUX
"SOUND IN DESIGN"

PERMOFLUX CORPORATION

4912-I W. GRAND AVE., CHICAGO 39, U. S. A. • 263 S. VERDUGO RD., GLENDALE 5, CALIF.

Canadian Licensee . . . Campbell Mfg. Company, Toronto, Canada

From the feedback aspect the point of interest which this system has illustrated is the way in which audio and modulated radio frequency systems can be combined in a single feedback loop, using exactly the same ideas of amplitude and phase response as are used in the audio systems alone. Transmitter designers and other high-level engineers use this technique regularly, but most people commonly think of negative feedback for audio only. So long as you remember that the system is intended to pass audio through, and all speech devices are meant for just this, you need only keep an eye on the audio amplitude and phase response. The carrier, like the d.c. on the telephone local circuit, can be allowed to look after itself.

Before leaving this special mixed system and returning to more everyday matters, there is a reversed form of this signal generator which the reader can think about himself. Suppose that you take the audio output from your FM receiver, add a reactance tube in shunt with the local oscillator, and modulate the local oscillator by means of the audio output. The result will be to provide feedback round the discriminator loop. Exactly the same design procedure must be used for this case, provided you can keep the audio in mind. If you think about the problem you will see that trouble arises from the multiple side frequencies; the audio is no longer just one side frequency, and it is hard to see what the phase means. There is an amplitude-modulated version of this problem too. I do not propose to write anything about these particular devices, but I mention them here just to set you thinking, and to encourage you to plan new combinations for yourself.

—end—

NOVEL A.F. TONE SOURCE

A simple nonelectronic tone generator which produces a sine-wave output at frequencies from nearly zero to approximately 2,000 cycles can be made by driving an ordinary 110-volt synchronous clock motor as a generator. Any small variable-speed motor can be used to drive it. The frequency is varied by adjusting a rheostat in series with the supply to the driving motor. The sine-wave output is taken from the input leads to the clock motor.

The output voltage varies with the make and model of the motor. I use a 250-volt Sangamo motor which delivers 13 volts peak into a high-impedance load such as an oscilloscope or the grid of an amplifier tube.—*J. Katchliffe*

AUDIO COSTS

There is a law of diminishing returns in the amount of money invested in audio equipment and improvement in quality obtained. This is directly related to the *limen*, a unit which is a measure of bandwidth a listener can perceive at a given volume level. According to a *Jensen Monograph*, cost of equipment to reproduce up to 10 kc is about half of equipment cost to reproduce to 13 kc.

RADIO-ELECTRONICS for

NEW PARA-CON ANTENNA COMBINES PARABOLIC & CONICAL PRINCIPLES



Barbara Lee—Rising TV Star, WEWS Cleveland

Sight Sells It

After all, people buy TV sets to enjoy the picture. It just makes sense that the antenna bringing in the best picture brings in the best entertainment and the most customer satisfaction. Hook a Para-Con onto any set and you'll agree—it sells on sight.

Solves 9 out of 10 Installation Problems—Challenges Comparison

Two best features are incorporated into one BEST antenna. The praiseworthy features conical type aerials possess for supplying full audio and full video bandwidth reception are used with a parabolic design that gives the Para-Con a concentration of signals. Para-Con is engineered to concentrate the maximum wave energy on the antenna by providing all-around, unmatched performance . . . perfect picture clarity . . . long customer satisfaction.

Any TV Set Performs Better With a Para-Con Antenna

Every set performs better when conditions are better. Install Para-Con when older sets are starving for a stronger signal. Install a Para-Con when any set is being drowned in a sea of local interference. In the majority of set installations, Para-Con makes both old and new sets perform at their peak. To be on the safe side every time, install the sensationally performing new Para-Con antenna and forestall TV troubles at both the reception and the service end.

Proved in Thousands Of Installations

Spectacular success has been achieved in practically every installation. Even in locations far removed and in difficult terrain where other more elaborate arrays were tried and failed, PARA-CON aerials not only bring in brighter, clearer pictures but seize and channel in stations where dependable reception has not been possible with an ordinary antenna. Ward's new PARA-CON Antenna has been field tested in thousands of installations . . . proved far and away better.

Singles Out The Stations High Front to Back Ratio

The new Para-Con design achieves an unusual capacity to obtain sharp directivity over all the television spectrum. Para-Con principles afford greater power and less interfering noise on each channel.

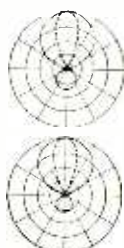

One Antenna Covers All Channels

The Para-Con antenna reaches out and grasps all channels. The Ward Para-Con has an exceptionally low standing wave ratio combined with a spectacular high gain advantage on all channels.

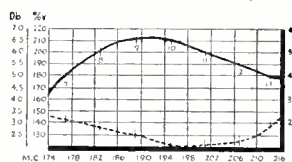
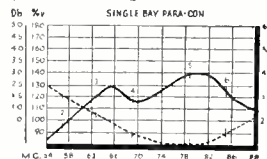

No Ghost Hunts

No more skeletons in your customer's TV closets. Scientifically determined direct impedance matching characteristics eliminate many ghosts. Para-Con's revolutionary design transfers the maximum power from the antenna to the receiver with a minimum of reflections.

Profit-Wise Dealers Prefer Para-Con*

The antenna is one of the most important and critical components of a TV receiver. Nearly 20% of all TV service calls result from faulty antennas. The general all-around, high performance of Ward's Para-Con antenna gives customer satisfaction right from the initial installation. Expensive call-backs due to antennas are slashed. Ruggedly built for long lasting trouble-free service Para-Con withstands winds and weather. Easy to handle and quick to install . . . saves time and expense.

See your distributor for Ward's answer to your antenna problems. *Trade Mark

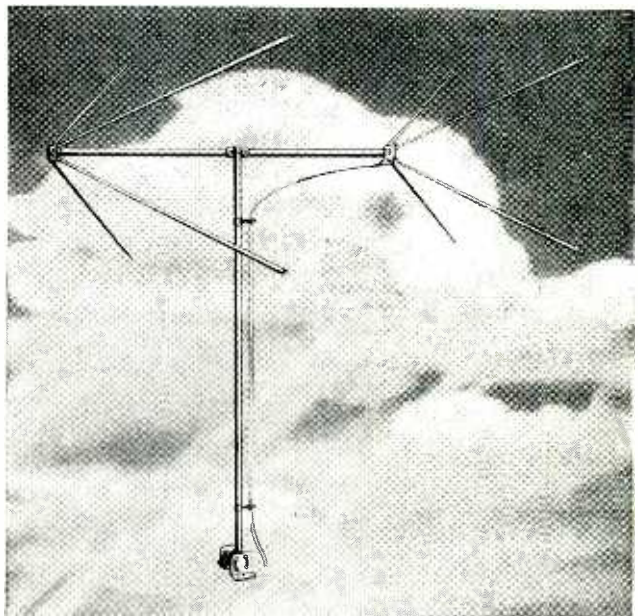

The First In TV To Use Parabolic Principle

Parabolic antennas have long been used in special applications for concentrating weak signals onto driven elements. The brilliant results of Ward Para-Con are now setting new performance standards on all channels and in most every area. Ward's Para-Con Antenna is different. It's new. Now it is possible for one antenna to meet and solve many of the local problems of installation and reception.

Ideal For All Band Fringe Areas

In fringe areas where selection of a number of channels is available, Ward's stacked Para-Con models provide the ideal compromise antenna for maximum results on all bands. Stacked in either two or four bay arrays, the Parabolic design reflectors reach out, gather and concentrate maximum energy on the antenna elements.

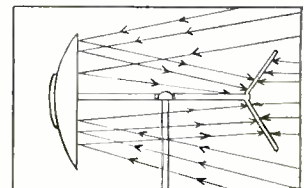

Diagrammatic sketch showing how parabolic reflectors gather in and concentrate energy on conical elements.

WARD

PARA-CON

(Combining Parabolic and Conical Principles)

ANTENNAS

THE WARD PRODUCTS CORPORATION, Division of The Gabriel Co.
 1523 E. 45th Street, Cleveland 3, Ohio
 IN CANADA: ATLAS RADIO CORP., LTD., TORONTO, ONT.

High Power A.C.-D.C. Amplifier

Using 20 db feedback, this amplifier gives high output with low total harmonic distortion; has high gain phase splitter and flexible tone control

By JOHN RUNDO

A PREVIOUS article (September, 1950) described a 30-watt amplifier with an unusual tone-control circuit and high-gain

phase splitter. This article applies these circuits to an a.c.-d.c. amplifier. Design of such an amplifier presents two problems: appropriate output tubes, and a high-current power supply.

B-supply and its delay

The standard 117-volt a.c. line voltage means that a voltage doubler circuit must be used to supply 200 volts d.c. at 245 ma without a transformer, Fig. 2. With this arrangement nearly 20 watts output is possible at fairly low distortion.

Considering the first, tube manuals show that a single tube of the 25L6 type requires 50 ma at 200 volts for 3.8 watts of audio output with 10% total harmonic distortion. Generous negative feedback (20 db) can reduce the harmonic distortion to better than 1%. To obtain *clean* audio at sufficient power it is obviously necessary to use four tubes in push-pull parallel. Allowing 50 ma plate current and 7 ma screen current per tube, the four 25L6's require 228 ma; with three tubes preceding the output stages (see block diagram, Fig. 1), this is further increased to about 245 ma.

Operation for 110 volts d.c. presents another problem. It is not possible (without using a vibrator or inefficient rotary converter) to obtain 200 volts for B-supply. The circuit of Fig. 3 can be used for 117 volts, a.c. or 110 volts d.c., but the amplifier output will be reduced to 10 watts as the B-plus voltage will be slightly lower than line voltage.

To delay application of the B-plus voltage, a switch (S1-a, Fig. 4) is included in the supply to the output tubes and is closed about one minute after the main switch. The disadvantage here is the possible failure of the human element in forgetting to make sure that this switch is off, before applying line voltage to the B-supply. A foolproof but more expensive solution would be to use a thermal time delay relay.

Selenium rectifiers are the best choice for the power supply, owing to their compactness, low internal resistance, and high current output, especially as they develop much less heat than vacuum tube rectifiers. The only serious disadvantage of the metal rectifier in the present application is the fact that the B-supply is ready immediately after switching on. Because of the high current taken by the output tubes and an appreciable time-lag before their cathodes have reached full working temperature, it is *essential* to introduce a delay before applying the full B-supply, or the cathodes will be damaged.

Surge prevention

During the initial testing a serious snag was apparent; no line dropping resistance was included for the heaters as the tubes employed required 118 volts. When switched on, the initial current surge was very high (about .5 amp) and two of the output tubes lit up very brightly!

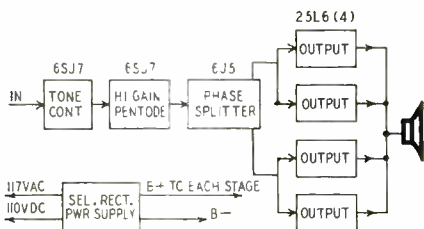

Fig. 1—Block diagram of the a.c.-d.c. amplifier that has high power output.

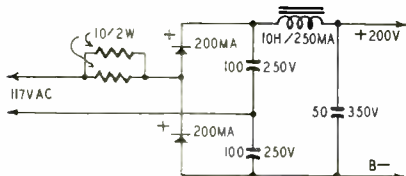

Fig. 2—Voltage doubler circuit for the amplifier. This is for use on a.c. only.

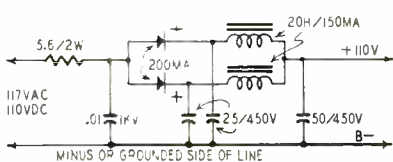

Fig. 3—This power supply for the amplifier can be used on both a.c. and d.c.

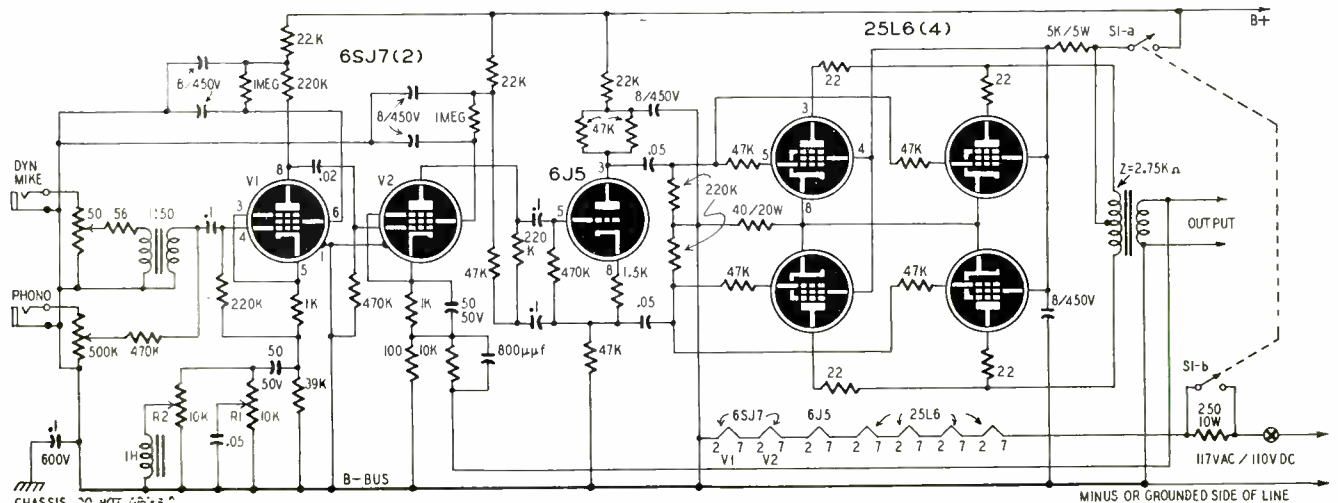
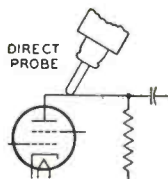

Fig. 4—Schematic of the amplifier. The second 6SJ7 uses the cathode follower's high input impedance as a.c. plate load.

Now ... a NEW Junior VoltOhmyst* ...the WV-77A

For all regular measurements and specialized measurements as illustrated.



MEASURES AC VOLTS . . .
such as signal voltage on plate of a tube.

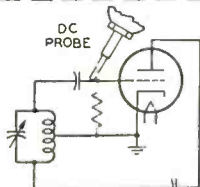

MEASURES DC VOLTS . . .
such as oscillator grid bias. One-megohm resistor in probe prevents circuit loading.

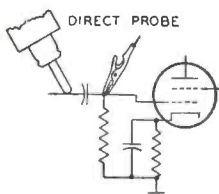

MEASURES RESISTANCE . . .
such as leakage in coupling capacitor up to 1000 megohms.



Just one probe cable and one slip-on probe handle all measurements.

Check these important features . . .

- ✓ Accurate laboratory calibration.
- ✓ Meter electronically protected against burn-out.
- ✓ Metal case shielding . . . extra stability in rf fields.
- ✓ Sturdy 200-microampere meter movement.
- ✓ Carbon-film 1% multiplier resistors . . . dependability plus.
- ✓ Zero-center scale . . . for discriminator alignment.
- ✓ Frequency response flat from 30 cps to approximately 3 Mc.
- ✓ High ac input resistance for greater accuracy.
- ✓ Constant dc input resistance . . . 11 megohms on all scales.
- ✓ Negative feedback circuits for greater over-all stability.
- ✓ Ohms cable always positive . . . for quick leakage measurements of electrolytic capacitors.
- ✓ Polarity reverse switch . . . eliminates cable switching.
- ✓ $\pm 3\%$ over-all accuracy on +dc scales, and $\pm 5\%$ on ac and -dc scales.

An all-electronic ac-operated vacuum-tube volt-ohmmeter by RCA ONLY \$47.50.

Includes DC probe, AC direct probe and cable, ground lead, and alligator clip.

The RCA WV-77A VoltOhmyst* provides the extra features you have tried to find in an inexpensive VTVM. Using the famous Volt-Ohmyst electronic bridge circuit, 200-microampere meter movement, and carbon-film multiplier resistors, the WV-77A incorporates features you would expect to find only in more expensive instruments. Sturdily built . . . calibrated against laboratory standards . . . and backed by a 12-month warranty . . . the WV-77A has the durability, versatility, and accuracy to please discriminating customers such as service technicians, engineers, amateurs, and military personnel.

As a DC Voltmeter it measures dc from 0.05 volt to 1200 volts in five ranges. Uses 1-megohm resistor in isolating probe; probe has less than 2-uuf input capacitance. Has 11-megohm input; useful for measuring high-resistance circuits such as oscillator, discriminator, and avc.

As an AC Voltmeter it measures ac from 0.1 volt to 1200 volts rms in five ranges.

Uses high-impedance diode tube as signal rectifier. Frequency range is more than adequate for measurement of power line, audio, and ultra-sonic frequencies.

As a wide-range Ohmmeter the WV-77A measures resistance from 0.2 ohm to 1 billion ohms in five ranges. Requires only 1.5-volt battery as burn-out protection in measuring such low-power elements as battery-type tube filaments.

The all-new RCA WV-77A VoltOhmyst comes completely equipped with probes and cables as illustrated. For complete details, see your RCA Test Equipment Distributor today . . . or write to RCA, Commercial Engineering, Section 49IX, Harrison, N. J.

Accessories Available on Order

The WG-289 High-Voltage Probe and WG-206 Multiplier Resistor extend the dc range of the WV-77A to 50,000 volts.

The WG-264 Crystal-Diode Probe extends frequency range of the WV-77A to 250Mc.

*Reg. U. S. Pat. Off.

Available from your
RCA Test Equipment
Distributor



RADIO CORPORATION of AMERICA
TEST EQUIPMENT
HARRISON, N. J.

There's a **NEW SILHOUETTE**
on the Microphone Horizon...

THE NEW
**ULTRA-CARDIOID
DYNAMIC**

MODEL **55s**

"THE PERFECT PERFORMER"

SMALL
Unidyne

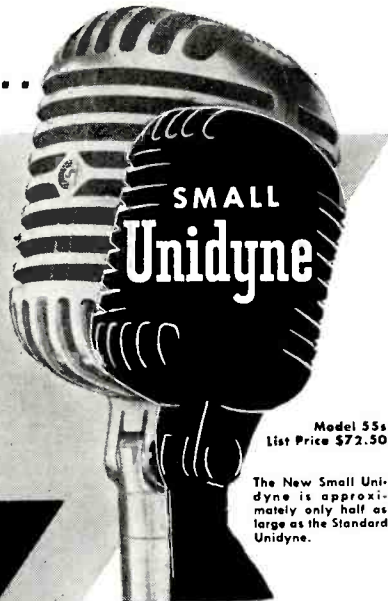

Model 55s
List Price \$72.50

The New Small Unidyne is approximately only half as large as the Standard Unidyne.



Model 556s
Small
Broadcast
Dynamic

Model 55s
Small
Unidyne

► **Eliminates Feedback Problems**

► **Permits performer to stand farther from the microphone**

THIS MIGHTY, though little, Microphone, is the *only* small-size, uni-directional moving-coil dynamic microphone—all the important directional qualities are retained. The 55s is actually a new Microphone retaining all the highly desirable features that made the Model 55 "Unidyne" world-famous.

Model 55s offers superior performance, featured in a streamlined, small, functionally-designed case. The moving-coil system has a high overall efficiency and smooth frequency response. A large air-gap clearance and a rugged coil construction provide immunity of the moving-coil system to abnormal atmospheric conditions and severe mechanical shocks.

The New Small "Unidynes," Model 55s and 556s, are not replacements for the current Models 55 and 556 "Unidynes." The Standard "Unidynes" are not being discontinued. You now have four outstanding, feedback-killing dynamic microphones from which to choose for the most severe acoustic applications.

Model 55s Small Unidyne
Model 556s Small Broadcast
Model 55 Standard Unidyne
Model 556 Standard Broadcast

Code: RUDOT List Price: \$72.50
Code: RUDDV List Price: 100.00
Code: RUMUL List Price: 72.50
Code: RUMUB List Price: 100.00

Patented by Shure Brothers, Inc.

"not 2
but 4!"

SHURE BROTHERS, Inc.

225 W. Huron St., Chicago 10, Illinois

★ **MANUFACTURERS OF MICROPHONES
AND ACOUSTIC DEVICES**

● **Cable Address: SHUREMICRO**

SHURE

Audio

It is possible to use a Global resistor or thermistor to limit the surge. This would cause a drop of only a few volts. However, since this amplifier was to be used for at least 50% of its time on d.c. lines whose voltage is slightly lower than a.c. lines, it was felt that as little voltage as possible should be lost. Consequently, the surge is limited by including in the heater chain a 250-ohm resistor which is short-circuited by one side of a double-pole on-off switch (S1-b, Fig. 4); the other side is used for the B-supply delay.

Amplifier construction

A complete schematic of the amplifier is given in Fig. 4; the tone-control and phase-splitter circuits are exactly the same as in the a.c. version previously published. Grid stoppers (50,000-ohm resistors) are included for each of the four output tubes to prevent push-pull oscillation at high frequencies, and small plate resistors (22 ohms) are included for the same reason. These resistors should be mounted as near the sockets of the tubes as possible. For stable operation with 20 db feedback, it was necessary to put a small (800 μ f) capacitor across the feedback resistor. Other setups might need slightly different values.

Construction of this amplifier presents no really difficult problems. Take the usual precautions to minimize hum, and make no attempt to pack the components into the smallest possible space.

Adequate ventilation is important as far as the output tubes are concerned because they get very hot. They should be well separated.

The amplifier is straightforward and if instructions are followed no "bugs" should be encountered. The phase-inverting circuit is stable, and consists of the 6SJ7 and the 6J5. The 6SJ7 is operated so that the stage gain approaches the amplification factor of the tube. This is achieved by making the plate load of the tube the extremely high input impedance of a cathode-follower phase splitter. For additional consideration of this point and the action of the bass-boost control, R2, and the treble boost, R1, refer to the previous article which appears on page 45 of the September, 1950, issue.

Materials for amplifier

Resistors: 4—22, 1—50, 1—56, 1—100, 1—1,000, 1—1,500, 1—10,000, 3—22,000, 1—39,000, 7—47,000, 4—220,000, 2—470,000 ohms; 2—1 megohm, 1/2 watt. (Potentiometers) 1—50, 2—10,000, 1—500,000 ohms; 1—5,000 ohms, 5 watts; 1—40 ohms, 20 watts; 1—250 ohms, 10 watts.

Capacitors: (Paper) 1—.0008, 1—.02, 3—.05, 2—.01 μ f, 450 volts. (Electrolytic) 5—8 μ f, 450 volts; 2—50 μ f, 450 volts; 2—50 μ f, 50 volts.

Inductors: 1—Output transformer, primary impedance 2,750 ohms, 10-20 watts output rating. 1—Input transformer for dynamic mike.

Miscellaneous: Tubes: 2—6SJ7, 1—6J5, 4—25L6. Tube sockets. 1—Double-pole, single-throw switch. Mike jack. Phone jack. Output binding posts. Insulating washers. Lock washers. Chassis. Hardware. Hookup wire.

Power Supplies (Choose (a) or (b))
(a) Chokes: 2—20 h, 150 ma. Selenium rectifiers: 2—200 ma. Capacitors, electrolytic: 2—25 μ f, 450 volts; 1—50 μ f, 450 volts. Capacitor, paper: 1—.01 μ f, 1,000 volts. Resistor: 1—5.6 ohms, 2 watts.
(b) Choke: 1—10 h, 250 ma. Selenium rectifiers: 2—200 ma. Capacitors, electrolytic: 2—100 μ f, 250 volts; 1—50 μ f, 350 volts. Resistors: 2—10 ohms, 2 watts.

—end—

RADIO-ELECTRONICS for

Phono Oscillator Uses Crystal

Features of this simple phono oscillator are crystal control, a high level of modulation, excellent fidelity, and a minimum of parts. Two 12AX7's were used in the original circuit, but 12SN7's, 12AY7's, 12SL7's, and other similar double triodes can be used.

One section of the first tube is a Pierce crystal oscillator and the other section is a cathode-modulated r.f. amplifier. The second tube is connected as a high-gain speech amplifier and a cathode-follower type series modulator. The cathodes of the modulator and r.f. amplifier tubes are returned to ground through a 100-ohm resistor bypassed for r.f. but not for audio. The power amplifier is modulated by the a.f. voltage drop across the cathode resistor.

The crystal may be cut to the fundamental or subharmonic of the desired broadcast frequency. Surplus crystals

ranging from approximately 310 to 500 kc are available from some sources for less than 50 cents each. These can be used for the broadcast band by adjusting the tuned circuit to the desired harmonic. The coil L may be the secondary of a broadcast antenna coil. The tuning capacitor C may be a trimmer of approximately 400 μmf maximum capacitance.—*John S. Hill*

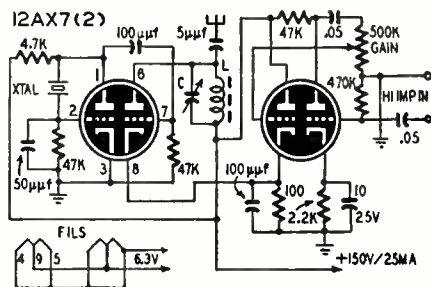

Audio Phase-Shift Measurements

Phase angle between two a.f. voltages is usually measured on a Z-angle meter or by measuring the tilt of an elliptical pattern on an oscilloscope. The first method is expensive for those who rarely have need for such instruments. The latter method does not permit precise measurements. Writing in *Electronics*, L. Fleming describes two inexpensive devices which simplify the problem of measuring phase angle on an oscilloscope.

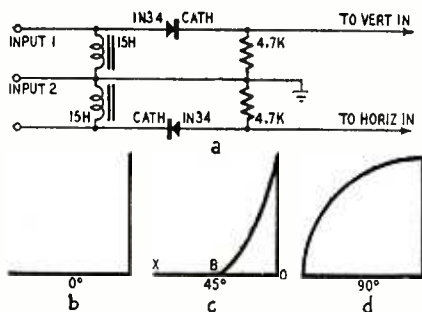

Fig. 1—Clippers provide voltages for comparing phase of two audio signals.

The circuit of the first device is shown at a in Fig. 1. Two 1N34 rectifiers are connected so as to clip the positive half-cycle of one signal and the negative half-cycle on the other. When the phase angle is 0, an L-shaped pattern is produced as at b. When the angle is between 0 and 90°, the pattern looks like a shelf bracket as shown at c. This pattern is produced because of the difference in trace and retrace paths of the beam. The sine of the phase angle is the intercept distance OB divided by the base distance OX. A pattern for a phase angle of 90° is shown at d. Above 90°, the legs of the L are foreshortened and measurements are difficult. This circuit will not distinguish between lag and lead. Its usefulness is confined to measurements less than approximately 60°. The d.c. resistance on the input

side of the rectifiers should be low compared to the load resistance to insure clipping at the zero line.

The second circuit is shown at a in Fig. 2. One of the signals is differentiated into sharp positive pips which are superimposed on the sine wave of the other. The position of the pip is determined by the phase angle. Pips are shown on the sine wave at b in the positions they would occupy with phase angles of 0, 90, 180, and 270°.

The top frequency for this circuit is approximately 3 kc because of the difficulty in obtaining sharp pips with this circuit. The differentiators—the .001- and .002- μf capacitors and 10,000-ohm resistors—have time constants usable over a frequency range of approximately 2 to 1. Values shown are suitable for 250 to 500 cycles. For other ranges, the values of the capacitors should be varied accordingly.

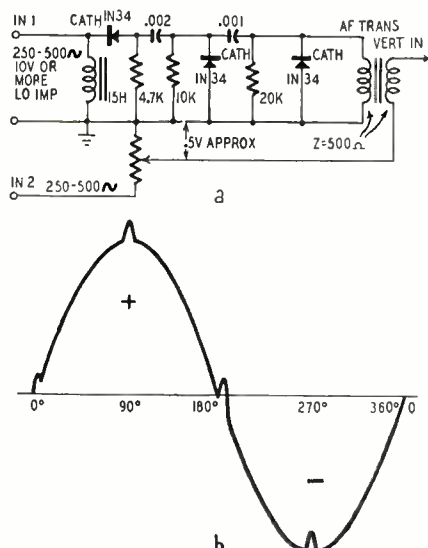

Fig. 2—Easier to read, this circuit has wider range than circuit in Fig. 1.

USE PHOTOFAC

the world's best Radio-TV service data—it pays for itself every working day



Try PHOTOFACT!

FREE

We'll send you any Photofact Folder listed in the Photofact Cumulative Index*

WE'LL PROVE YOU'LL SAVE TIME and EARN MORE WITH PHOTOFACT

NOW—learn for yourself—at our expense—how PHOTOFACT makes your Radio and TV work *quicker, easier, more profitable!* Examine an actual PHOTOFACT Folder. Use it. You'll learn first-hand why over 35,000 successful service technicians use PHOTOFACT daily. You'll learn that no other service gives you PHOTOFACT's *completeness, accuracy, uniformity, and lowest cost.* PHOTOFACT is the *only* radio and TV service data prepared from laboratory analysis of the actual equipment. Know the facts—get your **FREE** Folder now. Examine, use, compare—learn why no modern service shop can afford to be without PHOTOFACT!

* Except those followed by asterisk (*) or letter A.

WRITE FOR FREE INDEX

PAY AS YOU EARN! Ask your distributor about this amazing plan. Only \$18.39 puts the entire profit-boosting Photofact library in your shop now!

NOTE: Our **FREE** Folder offer is limited to Service Technicians only. Attach coupon below to your letterhead and mention your jobber's name. If you have no letterhead, send coupon to your jobber. Experimenters and others may obtain the Photofact Folder by remitting amount shown below.

HOWARD W. SAMS & CO., INC.
2201 E. 46th St., Indianapolis 5, Ind.

Send **FREE** Photofact Cumulative Index
 Send Full Easy-Pay Details

I am a Service Technician:
 Send **FREE** Folder for set model.....

I am an Experimenter: Enclosed \$.....
 Send Folder for set model.....
TV-\$1.00, Record Changer or Comm. Receiver-75c, AM/TM-50c

Name.....

Address.....

City.....Zone...State.....



Don't
TAKE CHANCES
WITH "JUST-AS-GOOD"
REPLACEMENT PARTS

Be Right with
OHMITE
—IT'S GOOD BUSINESS!

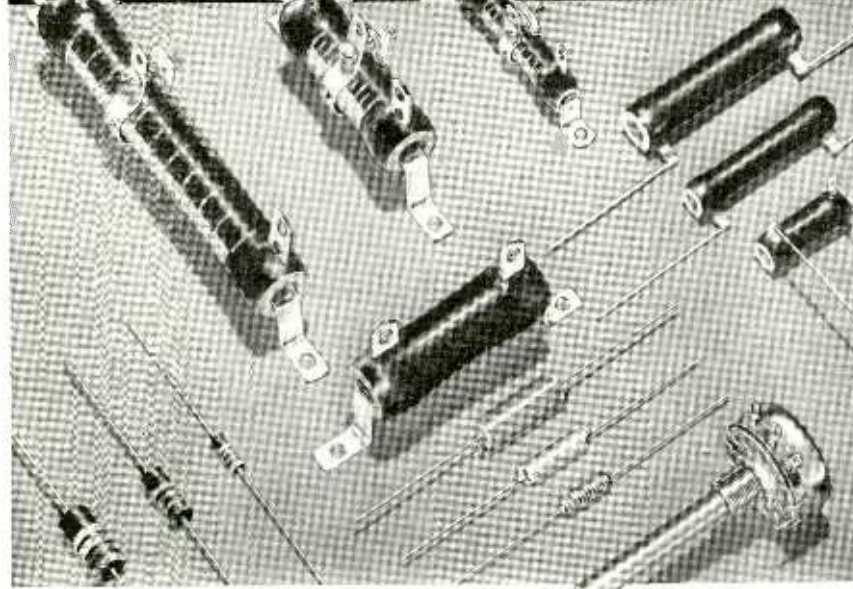

A satisfied customer is your most valuable business asset. You take a chance on losing him with "just-as-good" replacement parts. Standardize on Ohmite resistance components—known the world over for top dependability among servicemen, amateurs, and design engineers. It's smart business!

OHMITE MANUFACTURING COMPANY
 4895 Flournoy St., Chicago 44, Illinois



Be Right with

OHMITE®

RHEOSTATS • RESISTORS • TAP SWITCHES



REMOTE PHONO CONTROL

The remote-control circuit shown in *a* turns on a radio and switches it to phono without any controls on the radio set being touched. A midget d.p.d.t. relay is used, for instance the Leach, model 327, 110 volt, a.c. unit. One set of contacts shunts the radio on-off switch. The other set of contacts disconnects the receiver's audio amplifier from the detector output and connects it to the phono input jack. The

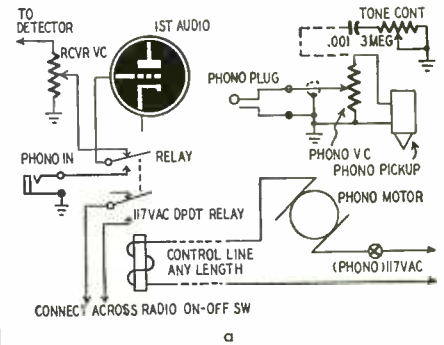

relay closes when the phono motor is turned on. A control line of lamp cord is run from the phono to the radio, and a shielded lead connects the pickup with the phono input jack on the receiver. Volume is controlled directly from the record player. Turning off the phonograph restores normal radio operation.

Any location on the radio chassis is suitable for the relay. Keep the leads going to the volume control and phono

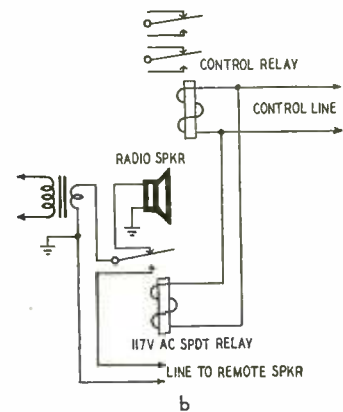

input jack well shielded. The relay coil and radio power switch leads should be isolated from the audio circuit and twisted to prevent stray hum pickup. The phono unit may be located up to 25 feet from the radio. It is important to use shielded mike cable to the radio, and the phonograph output should be reasonably high.

Tone can also be controlled at a distance from the radio set by using the high-frequency attenuation circuit shown in dotted lines in the diagram. In this case adjust the radio tone control beforehand to the maximum treble position.

Circuit *b* shows how to switch on an extension speaker while using phono by wiring another relay in parallel with the radio-phono control relay.

—end—

Features OF THE NEW 1952



PROOF OF THE NEW O-7 OSCILLOSCOPE'S OUTSTANDING PERFORMANCE

Below are actual, unretouched photographs showing the outstanding frequency response characteristics of the NEW 1952 HEATH-KIT OSCILLOSCOPE, MODEL O-7. To the left is a 10 KC square wave — to the right a 4 MC sine wave as they actually appear on the screen. Two highly severe tests to make on any scope (only the best of scopes will show traces like these) — and the O-7 really comes through.

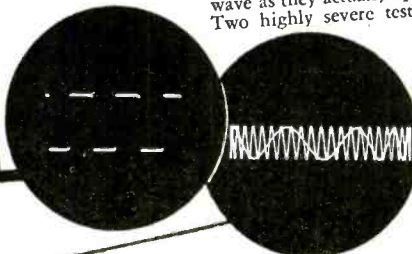

COMPANION VACUUM TUBE VOLTMETERS

Here are the two NEW 1952 VACUUM TUBE VOLTMETER COMPANION PIECES. Matched instruments of new design to open up the whole field of DC, AC, and resistance measurements for you. The new greatly reduced size combines style, beauty, and compactness — The V-5 and AV-1 have the new panel and cabinet construction as shown on the right. A tremendous pair of voltmeters. Small in size but virtual giants in the range of measurements they make.



NEW STYLE AND BEAUTY

Style that's modern, yet functional — that's the trend of today — and Heathkits are right up to the minute. Note the cut showing the new V-5 and AV-1 cabinet and panel construction. The front panel and rear cover slide right over the recessed flange of the case thereby eliminating sharp edges and pointed corners. The voltmeter kits aren't "shelf" or "mounted" instruments — they're moved about on the bench a lot and thus the new compact size and specially designed cabinets — Another 1952 Heathkit feature.



A STATEMENT FROM SIMPSON ELECTRIC CO.

In choosing Simpson Meters for their Heathkit VTVM, the Heath Co. has set a new high standard of kit meter quality. The same high quality of material, workmanship and design that has given Simpson the reputation for building "Instruments That Stay Accurate" is found in the Heathkit Meter Movement.

SIGNED
SIMPSON ELECTRIC CO.

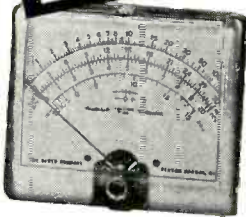

A STATEMENT FROM CHICAGO TRANSFORMER

It is indeed gratifying to note the outstanding sales records you are building with you Heathkits.

This sales success is readily understandable, since we are cognizant of the high quality standards you have established for your component suppliers.

We at Chicago Transformer are proud that our product has contributed to the recognized quality and increasing popularity of Heathkits.

CHICAGO TRANSFORMER DIVISION
Essex Wire Corporation

L. S. RACINE
Vice-President and Sales Manager



HEATHKIT PRECISION RESISTORS

Where exact resistance values are required for instrument accuracy, the Heath Co. has spared no effort in supplying the finest resistors available. Precision resistors as manufactured by Continental Carbon Inc., and Wilcor Corp., meet the rigorous JAN (Joint Army-Navy) specifications and are small in size, extremely non-inductive, highly stable, have a low temperature coefficient, and can be held to great accuracy. You'll find quality components in Heathkits.

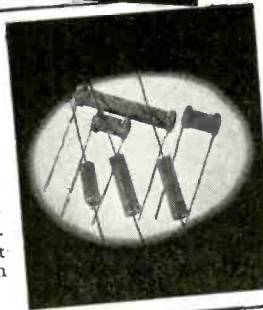

COLLEGES USE HEATHKITS

Colleges and Universities throughout the country are using Heathkits in their electrical engineering, radio, and physics laboratories — Heathkits are the answer to good test equipment at low cost, plus being rugged, dependable, and accurate. Trade schools are having their students build Heathkits to obtain a first hand working knowledge of test equipment and to get the practical experience gained by construction. Heathkits fill school needs.



YOU SAVE BY ORDERING DIRECT FROM MANUFACTURER—USE ORDER BLANK ON LAST PAGE

EXPORT AGENT
ROCKE INTERNATIONAL CORP.
33 E. 40th ST.
NEW YORK CITY (16)
CABLE: ARLAB-N.Y.

The HEATH COMPANY

... BENTON HARBOR 20, MICHIGAN

THE *New* 1952
Heathkit
**OSCILLOSCOPE
 KIT**

MODEL O-7
 SHIPPING WEIGHT 24 LBS.

\$43⁵⁰

Features

- New "spot shape" control for spot adjustment — to give really sharp focusing.
- A total of ten tubes including CR tube and five miniatures.
- Cascaded vertical amplifiers followed by phase splitter and balanced push-pull deflection amplifiers.
- Greatly reduced retrace time.
- Step attenuated — frequency compensated — cathode follower vertical input.
- Low impedance vertical gain control for minimum distortion.
- New mounting of phase splitter and deflection amplifier tubes near CR tube base.
- Greatly simplified wiring layout.
- Increased frequency response — useful to 5 Mc.
- Tremendous sensitivity .03V RMS per inch Vertical — .6V RMS per inch Horizontal.
- Dual control in vernier sweep frequency circuit — smoother acting.
- Positive or negative peak internal synchronization.

NEW INEXPENSIVE *Heathkit*
ELECTRONIC SWITCH KIT

The companion piece to a scope — Feed two different signals into the switch, connect its output to a scope, and you can observe both signals — each as an individual trace. Gain of each input is easily set (gain A and gain B controls), the switching frequency is simple to adjust (coarse and fine frequency controls) and the traces can be superimposed for comparison or separated for individual study (position control).

Use the switch to see distortion, phase shift, clipping due to improper bias, both the input and output traces of an amplifier — as a square wave generator over limited range.

The kit is complete; all tubes, switches, cabinet, power transformer and all other parts, plus a clear detailed construction manual.



Model S-2
 Shipping Wt. 11 lbs.

Only
\$19⁵⁰

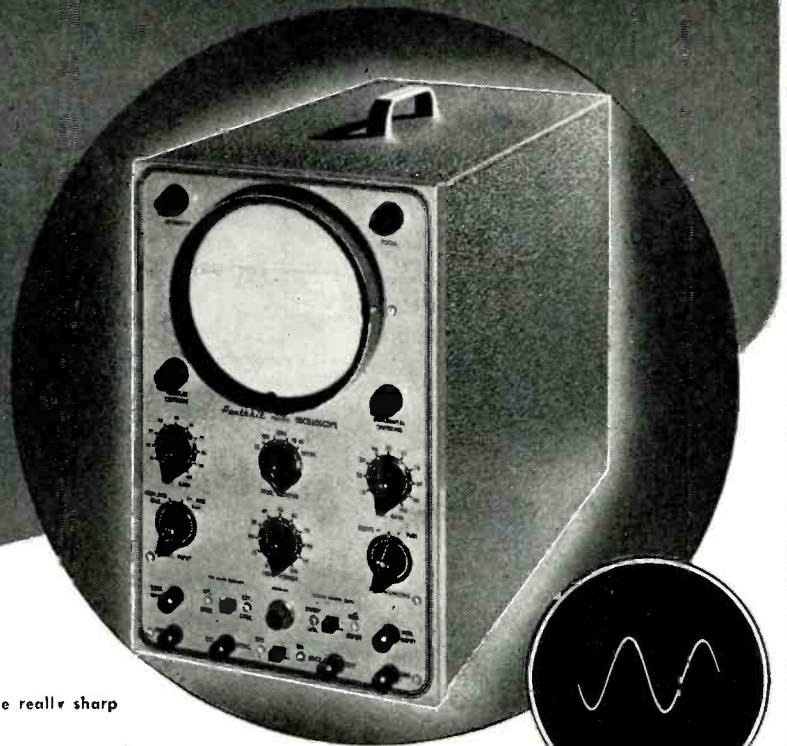

The performance of the NEW, IMPROVED, HEATHKIT 5" OSCILLOSCOPE KIT is truly amazing. The O-7 not only compares favorably with equipment costing 4 and 5 times as much, but in many cases literally surpasses the really expensive equipment. The new, and carefully engineered circuit incorporates the best in electronic design — and a multitude of excellent features all contribute to the outstanding performance of the new scope.

The VERTICAL CHANNEL has a step attenuated, frequency compensated vertical input which feeds a cathode follower stage — this accomplishes improved frequency response, presents a high impedance input, and places the vertical gain control in a low impedance circuit for minimum distortion. Following the cathode follower stage is a twin triode — cascaded amplifiers to contribute to the scope's extremely high sensitivity. Next comes a phase splitter stage which properly drives the push-pull, hi-gain, deflection amplifiers (whose plates are directly coupled to the vertical deflection plates). This fine tube lineup and circuitry give a sensitivity of .03V per inch RMS vertical and useful frequency response to 5 Mc.

The HORIZONTAL CHANNEL consists of a triode phase splitter with a dual potentiometer (horizontal gain control) in its plate and cathode circuits for smooth, proper driving of the push-pull horizontal deflection amplifiers. As in the vertical channel, horizontal deflection amplifier plates are direct coupled to the CR tube horizontal deflection plates (for improved frequency response).

The WIDE-RANGE SWEEP GENERATOR circuit incorporates a twin triode multivibrator stage for producing a good saw-tooth sweep frequency (with faster retrace time). Has both coarse and vernier sweep frequency controls.

And the scope has internal synchronization which operates on either positive or negative peaks of the input signal — both high and low voltage rectifiers — Z axis modulation (intensity modulation) — new spot shape (astigmatism) control for spot adjustment — provisions for external synchronization — vertical centering and horizontal centering controls, wide range focus control — and an intensity control for giving plenty of trace brilliance.

The Model O-7 EVEN HAS GREAT NEW MECHANICAL FEATURES — A special extra-wide CR tube mounting bracket is provided so that the vertical cascade amplifier, vertical phase splitter, vertical deflection amplifier, and horizontal deflection amplifier can mount near the base of the CR tube. This permits close connection between the above stages and to the deflection plates; distributed wiring capacity is greatly reduced, thereby affording increased high frequency response.

The power transformer is specially designed so as to keep its electrostatic and electromagnetic fields to a minimum — also has an internal shield with external ground lead.

You'll like the complete instructions showing all details for easily building the kit — includes pictorials, step-by-step construction procedure, numerous sketches, schematic, circuit description. All necessary components included — transformer, cabinet, all tubes (including CR tube), completely punched and formed chassis — nothing else to buy.

YOU SAVE BY ORDERING DIRECT FROM MANUFACTURER — USE ORDER BLANK ON LAST PAGE

EXPORT AGENT
ROCKE INTERNATIONAL CORP.
 13 E. 40th ST.
 NEW YORK CITY (16)
 CABLE: ARLAB-N.Y.

The **HEATH COMPANY**

... BENTON HARBOR 20, MICHIGAN

THE *New* 1952*Heathkit*
**VTVM
KIT**MODEL V-5
SHIPPING WT. 5 LBS.**\$24.50***Features*

- New styling, — formed case for beauty.
- New truly compact size. Cabinet 4 1/8" deep by 4-11/16" wide by 7 3/8" high.
- Quality 200 microamp meter.
- New ohms battery holding clamp and spring clip — assurance of good electrical contact.
- Highest quality precision resistors in multiplier circuit.
- Calibrates on both AC and DC for maximum accuracy.
- Terrific coverage — reads from 1/2V to 1000V AC, 1/2V to 1000V DC, and .1 to over 1 billion ohms resistance.
- Large, clearly marked meter scales indicate ohms, AC Volts, DC Volts, and DB — has zero set mark for FM alignment.
- New styling presents attractive and professional appearance.

A real beauty — you'll have only highest praise for this NEW MODEL VACUUM TUBE VOLTMETER. Truly a beautiful little instrument — and it's more compact than any of our previous models. Note the new rounded edges on the front panel and rear cover. The size is greatly reduced to occupy a minimum of space on your workbench — yet the meter remains the same large size with plainly marked scales.

A set of specially designed control mounting brackets permit calibration to be performed with greatest ease — also makes for ease in wiring. New battery mounting clamp holds ohms battery tightly into place, and base spring clip insures a good connection to the ohms string of resistors.

The circuitry employs two vacuum tubes — A duo diode operating when AC voltage measurements are taken, and a twin triode in the circuit at all times. The cathode balancing circuit of the twin triode assures sensitive measurements, and yet offers complete protection to the meter movement. Makes the meter burn-out proof in a properly constructed instrument.

Quality components are used throughout — 1% precision resistors in the multiplier circuit — conservatively rated power transformer — Simpson-meter movement — excellent positive detent, smooth acting switches — sturdy cabinet, etc.

And you can make a tremendous range of measurements — 1/2V to 1000V AC, 1/2V to 1000V DC, .1 to over 1 billion ohms, and DB. Has mid-scale zero level marking for quick FM alignment. DB scale in red for easy identification — all other scales a sharp, crisp black for easy reading.

A four position selector switch allows operator to rapidly set the instrument for type of reading desired — positions include ACV, DC+V, DC-V, and Ohms. DC- position allows negative voltage to be rapidly taken. Zero adjust and ohms adjust controls are conveniently located on front panel.

Enjoy the numerous advantages of using a VTVM. Its high input impedance doesn't "load" circuits under test — therefore, assures more accurate and dependable readings in high impedance circuits such as resistance coupled amplifiers, AVC circuits, etc. Note the 30,000 VDC probe kit and the RF probe kit — available at low extra cost and specially designed for use with this instrument. With these two probes, you can make DC voltage measurements up to 30,000V, or make RF measurements — added usefulness to an already highly useful instrument.

The instruction manual is absolutely complete — contains a host of figures, pictorials, schematic, detailed step-by-step instructions, and circuit description. These clear, detailed instructions make assembly a cinch.

And every part is included — meter, all controls, pilot light, switches, test leads, cabinet, instruction manual, etc.

*Heathkit*
**30,000V DC
PROBE KIT**

A new 30,000 V DC Probe Kit to handle high voltages with safety. For TV service work and all other high voltage applications. Sleek looking — Two color molded plastic — Red body and guard — jet black handle. Comes with connector, cable, and PL55 type 300V plug into Heathkit VTVM so that 300V scale is conveniently multiplied by 100. Can be used with any standard 11 megohm VTVM.

\$5.50No. 336 High Voltage Probe Kit
Shipping Wt. 2 lbs.*Heathkit*
RF PROBE KIT

This RF Probe Kit comes complete with probe housing, crystal diode detector, connector, lead and plug and all other parts plus clear assembly instructions. Extends range of Heathkit VTVM to 250 Mc. ± 10%. Works on any 11 megohm input VTVM. Specify No. 309 RF Probe Kit.

\$5.50

Ship. Wt. 1 lb.

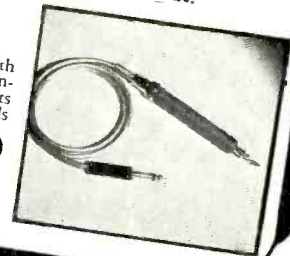
**YOU SAVE BY ORDERING DIRECT FROM MANUFACTURER—USE ORDER BLANK ON LAST PAGE**

EXPORT AGENT
ROCKE INTERNATIONAL CORP.
13 E. 40th ST.
NEW YORK CITY (16)
CABLE: ARLAB-N.Y.

The **HEATH COMPANY****... BENTON HARBOR 20, MICHIGAN**

Heathkit SIGNAL GENERATOR KIT

Model SG-6
Shipping Wt. 7 lbs.

The new Heathkit Signal Generator Kit has dozens of improvements. Covers the extended range of 160 Kc to 50 megacycles on fundamentals and up to 150 megacycles on useful calibrated harmonics; makes this Heathkit ideal as a marker oscillator for TV. Output level can be conveniently set by means of both step attenuator and continuously variable output controls. Instrument has new miniature HF tubes to easily handle the high frequencies covered.

Uses 6C4 master oscillator and 6C4 sine wave audio oscillator. The kit is transformer operated and a husky selenium rectifier is used in the power supply. All coils are precision wound and checked for calibration making only one adjustment necessary for all bands.

New sine wave audio oscillator provides internal modulation and is also available for external audio testing. Switch provided allows the oscillator to be modulated by an external audio oscillator for fidelity testing of receivers. Comes complete, all tubes, cabinet, test leads, every part. The instruction manual has step-by-step instructions and pictorials. It's easy and fun to build a Heathkit Model SG-6 Signal Generator.



\$19.50

Heathkit CONDENSER CHECKER KIT

Only
\$19.50

Model C-2
Shipping Wt. 6 lbs.



Checks all types of condensers — paper — mica — ceramic — electrolytic. All condenser scales are direct reading and require no charts or multipliers. Covers range of .00001 MFD to 1000 MFD. A Condenser Checker that anyone can read. A leakage test and polarizing voltage for 20 to 500 V provided. Measures power factor of electrolytics between 0% and 50% and reads resistance from 100 ohms to 5 megohms. The magic eye indicator makes testing easy.

The kit is 110V 60 cycle transformer operated and comes complete with rectifier tube, magic eye tube, cabinet, calibrated panel and all other parts. Has clear detailed instructions for assembly and use.

NEW Heathkit SIGNAL AND UNIVERSAL TEST SPEAKER KIT

\$19.50

Model T-2
Shipping Wt. 7 lbs.

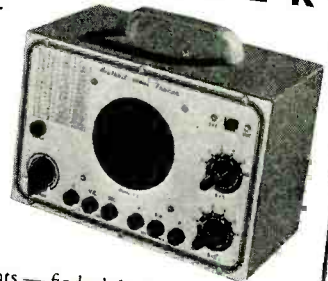

The popular Heathkit Signal Tracer has now been combined with a universal test speaker at no increase in price. The same high quality tracer follows signal from antenna to speaker — locates intermittents — finds defective parts quicker — saves valuable service time — gives greater income per service hour. Works equally well on broadcast, FM, or TV receivers. The test speaker has an assortment of switching ranges to match phones, pickups and PA systems. Also tests micro-60 cycle power transformer, tubes, test probe, all necessary parts, and detailed instructions for assembly and use.



Model TC-1
Shipping Wt. 12 lbs.

\$29.50

Heathkit TUBE CHECKER KIT

The Tube Checker is a MUST for radio repair men. Often customers want to SEE tubes checked, and a checker like this builds customer confidence. In your repairing, you will have a multitude of tubes to check — quickly. The Heathkit tube checker will serve all these functions — it's good looking (with a polished birch cabinet and an attractive two color panel) — checks 4, 5, 6, 7 prong Octals, Locals, 7 prong miniatures, 9 prong miniatures, pilot lights, and the Hytron 5 prong types. AND IT'S FAST TO OPERATE — the gear driven, free-running roll chart lists hundreds of tubes, and the smooth, acting, simplified switching arrangement gives really rapid set-ups.

The testing arrangement is designed so that you will be able to test new tubes of the future — without even waiting for factory data — protection against obsolescence.

You can give tubes a thorough testing — checks for opens, shorts, each element individually, emission, and for filament continuity. A large BAD-?-GOOD meter scale is in three colors for easy reading and also has a "line-set" mark.

You'll find this tube checker kit a good investment — and it's only \$29.50.

YOU SAVE BY ORDERING DIRECT FROM MANUFACTURER—USE ORDER BLANK ON LAST PAGE

EXPORT AGENT
ROCKE INTERNATIONAL CORP.
13 E. 40th ST.
NEW YORK CITY (16)
CABLE: ARIAB-N.Y.

The **HEATH COMPANY**

... BENTON HARBOR 20, MICHIGAN

New LABORATORY LINE HEATHKITS

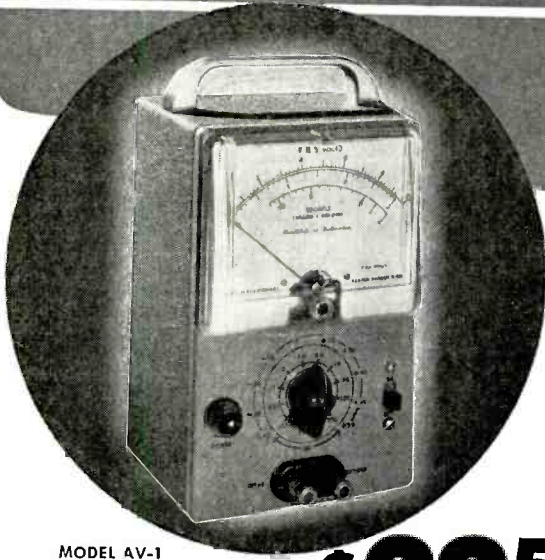

**NEW Heathkit
A.C. VACUUM TUBE
VOLTMETER KIT**

Now — as a Heathkit — at a price anyone can afford, an AC VTVM. A new kit to make possible those sensitive AC measurements required by audio enthusiasts, laboratories, and experimentors. Here is the kit that the audio men have been looking for. Its tremendous range of coverage makes possible measurements of audio amplifier frequency response — gain or loss of audio stages — characteristics of audio filters and attenuators — hum investigation — and literally a multitude of others. Ten ranges consisting of full scale .01, .03, .1, .3, 1, 3, 10, 30, 100, 300 volts RMS assure easy and more accurate readings. Ten ranges on DB provide for measurements from -52 to +52 DB. Frequency response within 1 DB from 20 cycles to 50 KC.

The ingenious circuitry incorporates precision multiplier resistors for accuracy, two amplifier stages using miniature tubes, a unique bridge rectifier meter circuit, quality Simpson meter with 200 microampere movement, and a clean layout of parts for easy wiring. A high degree of inverse feedback provides for stability and linearity.

MODEL AV-1
Shipping weight 5 lbs.

\$29⁵⁰

Simple operation is accomplished by the use of only one control, a range switch which changes the voltage ranges in multiples of 1 and 3, and DB ranges in steps of 10.

The instrument is extremely compact, cabinet size — 4 1/8" deep x 4-11/16" wide x 7 3/8" high, and the newly designed cabinet makes this the companion piece to the VTVM. For audio work, this kit is a natural.

**NEW Heathkit
AUDIO FREQUENCY METER KIT**

MODEL AF-1
Shipping weight 12 lbs.



\$34⁵⁰

A NEW Heathkit Audio Frequency Meter — the ideal instrument for determining frequencies from 20 cycles to 100 KC. Set the selector into the proper range — feed the signal into the input terminals — and read the frequency from the meter — completely simple to operate, and yet dependable results.

Quality Simpson 200 microampere meter has two plainly marked scales (0-100 0-300). These scales, read in conjunction with the seven position selector switch, give full scale readings of 100, 300, 1000, 3000, 10,000, 30,000, and easy readings.

For greatest accuracy, the 1-3-10 ratio of ranges is maintained and each range has individual calibrating control.

Input impedance is high (1 megohm) for negligible circuit loading. A signal and a change in signal voltage between 2 and 300V can be fed directly into the instrument reading. In addition, input wave shape is not critical (the unit will read the frequency of either sine wave or square wave input).

The tube complement consists of a 6SJ7 amplifier and clipper, 6V6 amplifier and clipper, 6H6 meter pulse rectifier, 6X5 power supply rectifier, and OD3/VR150 voltage regulator.

Construction is simple, and quality components are used throughout.

**NEW Heathkit
INTERMODULATION
ANALYZER KIT**

Intermodulation testing of audio equipment is rapidly being accepted by more and more engineers and audio experts as the best way to determine the characteristics of audio amplifiers, recording systems, networks, etc. — shows up those undesirable characteristics which contribute to listening fatigue when all other methods fail.

The Heathkit Intermodulation Analyzer supplies a choice of two high frequencies (3000 cycles and a higher frequency) and one low frequency (60 cycles). Both 1:1 or 4:1 ratios of low to high frequencies can be set up for IM testing, and the ratios are easily set by means of a panel control and the instrument's own VTVM. An output level control supplies the mixed signal at the desired level with an output impedance of two thousand ohms. The Analyzer section has input level control and proper filter circuits feeding the instrument's VTVM to read intermodulation directly on full scale ranges of 30%, 10% and 3%. Built-in power supply furnishes all necessary voltages for operating the instrument.



MODEL IM-1
Shipping wt. 18 lbs.

\$39⁵⁰

You won't want to be without this new and efficient means of testing

**NEW
Heathkit SQUARE WAVE
GENERATOR KIT**

The new Heathkit Square Wave Generator Kit with its 100 KC square wave opens an entirely new field of audio testing. Square wave testing over this wide range will quickly show high and low frequency response characteristics of circuits — permit easy adjustment of high frequency compensating networks used in video amplifiers — identify ringing in circuits — demonstrate transformer characteristics, etc.

The circuitry consists of a multivibrator stage, a clipping and squaring stage, and a cathode follower output stage. The power supply is transformer operated and utilizes a full wave rectifier tube with 2 sections of LC filtering.

As a multivibrator cannot be accurately calibrated, a provision is provided to allow the instrument to be accurately synchronized with an accurate external source when extreme accuracy is required.

The low impedance output is continuously variable between 0 and 25 volts and operation is simple. You'll really appreciate the wide range of this instrument, 10 cycles to 100 kilocycles — continuously variable. Kit is complete with all parts and instruction manual, and is easy to build.



MODEL SQ-1
Shipping wt. 14 lbs.

\$29⁵⁰

YOU SAVE BY ORDERING DIRECT FROM MANUFACTURER—USE ORDER BLANK ON LAST PAGE

EXPORT AGENT
ROCKE INTERNATIONAL CORP.
13 E. 40th ST.
NEW YORK CITY (16)
CABLE: ARLAB-N.Y.

The HEATH COMPANY

... BENTON HARBOR 20, MICHIGAN

Heathkit IMPEDANCE BRIDGE KIT



Model 1B-1B
Shipping Wt. 15 lbs.

\$69.50

This Impedance Bridge Kit is really a favorite with schools, industrial laboratories, and serious experimenters. An invaluable instrument for those doing electrical measurements work. Reads resistance from .01 Ohms to 10 meg., capacitance from .00001 to 100 MFD, inductance from 10 microhenries to 100 henries, dissipation factor from .002 to 1, and storage factor from 1 to 1000. And you don't have to worry about selecting the proper bridge circuit for the various measurements—the instrument automatically makes the correct circuit when you set up for taking the measurement you want. Bridge utilizes Wheatstone, Hay, Maxwell, and capacitance comparison circuits for the wide range and types of measurements possible. And it's self powered—has internal battery and 1000 cycle hummer. No external generator required—has provisions for external generator if measurements at other than 1000 cycles are desired. Kit utilizes only highest quality parts, General Radio main calibrated control.

Mallory ceramic switches, excellent 200 microamp zero center galvanometer, laboratory type binding posts with standard 3/4 inch centers, 1% precision ceramic-body type multiplier resistors, beautiful birch cabinet and ready calibrated panel. (Headphones not included.)

Take the guesswork out of electrical measurements—order your Heathkit Impedance Bridge kit today—you'll like it.

Heathkit LABORATORY RESISTANCE DECADE KIT



\$19.50

Shipping Wt. 4 lbs.

An indispensable piece of laboratory equipment—the Heathkit Resistance Decade Kit gives you resistance settings from 1 to 99,999 ohms IN ONE OHM STEPS. For greatest accuracy, 1% precision ceramic-body type resistors and highest quality ceramic wafer switches are used.

Designed to match the Impedance Bridge above, the Resistance Decade Kit has a beautiful birch cabinet and attractive panel. It's easy to build, and comes complete with all parts and construction manual.

Heathkit LABORATORY POWER SUPPLY KITS

Limits:

No load.....	Variable 150-400V DC
25 MA.....	Variable 30-310V DC
50 MA.....	Variable 25-250V DC

Higher loads: Voltage drops off proportionally



\$29.50

Model PS-1.....Ship. Wt. 20 lbs.

Every experimenter needs a good power supply for electronic setups of all kinds. This unit has been expressly designed to act as a HV supply and a 6.3 V filament voltage source. Voltage control allows selection of HV output desired (continuously variable within limits outlined), and a Volts-Ma switch provides choice of output metering. A large plainly marked and direct reading meter scale indicates either DC voltage output in Volts or DC current output in Ma. (Range of meter 0-500V D.C., 0-200 Ma. D.C.) Instrument has convenient stand-by position and pilot light.

Comes with power transformer, filament transformer, meter, 5Y3 rectifier, two 1619 control tubes, completely punched and formed chassis, panel, cabinet, detailed construction manual, and all other parts to make the kit complete.

Heathkit ECONOMY... 6 WATT AMPLIFIER KIT



Model A-4
Ship. Wt. 8 lbs.

\$12.50

No. 304 12 inch speaker... **\$6.95**

This fine Heathkit Amplifier was designed to give quality reproduction and yet remain low in price. Has two preamp stages, phase inverter stage, and push-pull beam

power output. Comes complete with six tubes, quality output transformer (to 3-4 ohm voice coil), husky cased power transformer and all other parts. Has tone and volume controls. Instruction manual has pictorial for easy assembly. Six watts output with response flat ± 1 1/2 db from 50 to 15,000 cycles. A quality amplifier kit at a low price. Better build one.

Heathkit HIGH FIDELITY... 20 WATT AMPLIFIER KIT



\$33.50

Shipping Wt. 18 lbs.

Our latest and finest amplifier—the model A-6 (or A-6A) is capable of a full 20 Watts of high fidelity output—good faithful reproduction made possible through careful circuit design and the use of only highest quality components. Frequency response within ± 1 db from 20-20,000 cycles. Distortion at 3 db below maximum power output (at 1000 cycles) is only .8%. The power transformer is rugged and conservatively rated and will deliver full plate and filament supply with ease. The output transformer was selected because of its exceptionally good frequency response and wide range of output impedances (4-8-16-150-600 ohms). Both are Chicago Transformers in drawn steel case for shielding and maximum protection to windings. The unit has dual tone controls to set the output for the tonal quality desired—treble control attenuates up to 15 db at 10,000 cycles—bass control gives bass boost up to 10 db at 50 cycles.

Tube complement consists of 5U4G rectifier, 6SJ7 voltage amplifier, 6SN7 amplifier and phase splitter, and two 6L6's in push-pull output. Comes complete with all parts and detailed construction manual. (Speaker not included.)

MODEL A-6: For tuner and crystal phono inputs. Has two position selector switch for convenient switching to type of input desired.

MODEL A-6A: Features an added 6SJ7 stage (preamplifier) for operating from variable reluctance cartridge phono pickup, mike input, and either tuner or standard crystal phono pickup. A three position selector switch provides flexible switching. **\$35.50**

Shipping Wt. 18 lbs.

YOU SAVE BY ORDERING DIRECT FROM MANUFACTURER—USE ORDER BLANK ON LAST PAGE

EXPORT AGENT
ROCKE INTERNATIONAL CORP.
13 E. 40th ST.
NEW YORK CITY (16)
CABLE: ARLAB, N. Y.

The HEATH COMPANY

... BENTON HARBOR 20, MICHIGAN



Model TS-2
Shipping Wt. 20 lbs.

NEW *Heathkit* T.V. ALIGNMENT GENERATOR KIT

Here is an excellent TV Alignment Generator designed to do TV service work quickly, easily, and properly. The Model TS-2 when used in conjunction with an oscilloscope provides a means of correctly aligning television receivers.

The instrument provides a frequency modulated signal covering, in two bands, the range of 10 to 90 Mc. and 150 to 230 Mc. — thus, ALL ALLOCATED TV CHANNELS AS WELL AS IF FREQUENCIES ARE COVERED.

An absorption type frequency marker covers from 20 to 75 Mc. in two ranges — therefore, you have a simple, convenient means of frequency checking of IF's, independent of oscillator calibration.

Sweep width is controlled from the front panel and covers a sweep deviation of 0-12 Mc. — all the sweep you could, possibly need or want.

And still other excellent features are: Horizontal sweep voltage available at the front panel (and controlled with a phasing control) — both step and continuously variable attenuation for setting the output signal to the desired level — a convenient instrument stand-by position — vernier drive of both oscillator and marker tuning condensers — and blanking for establishing a single trace with base reference level. Make your work easier, save time, and repair with confidence — order your Heathkit TV Alignment Generator now!

NEW *Heathkit* SINE AND SQUARE WAVE AUDIO GENERATOR KIT

Designed with versatility, usefulness, and dependability in mind, the AG-7 gives you the two most needed wave shapes right at your fingertips — the sine wave and the square wave.

The range switch and plainly calibrated frequency scale give rapid and easy frequency selection, and the output control permits setting the output to any desired level.

A high-low impedance switch sets the instrument for either high or low impedance output — on high to connect a high impedance load, and on low to work into a low impedance transformer with negligible DC resistance.

Coverage is from 20 to 20,000 cycles, and distortion is at a minimum — you can really trust the output wave shape.

Six tubes, quality 4 gang tuning condenser, power transformer, metal cased filter condenser, 1% precision resistors in the frequency determining circuit, and all other parts come with the kit — plus, a complete construction manual — A tremendous kit, and the price is truly low.



Model AG-7
Shipping Wt. 15 lbs.

\$34.50

THE NEW *Heathkit* HANDITESTER KIT

A precision portable volt-ohm milliammeter. Uses only high quality parts — All precision 1% resistors, three deck switch for trouble-free mounting of parts, specially designed battery mounting bracket, smooth acting ohm adjust control, beautiful molded bakelite case, 400 micro-amp meter movement, etc.

DC and AC voltage ranges 10-30-300-1000-5000V. Ohms range 0-3000 and 0-300,000. Range Milliampers 0-10 Ma, 0-100 Ma. Easily assembled from complete instructions and pictorial diagrams.



Model M-1
Shipping Wt. 3 lbs.

\$13.50

NEW *Heathkit* BATTERY ELIMINATOR KIT

A few auto radio repair jobs will pay for the Heathkit Battery Eliminator Kit. It's fast for service. The voltage can be lowered to find sticky vibrators or raised to ferret out intermittents. Provides variable DC voltage 5 to 7½ Volts at 10 Amps. continuous or 15 Amps. intermittent.

Also serves as storage battery charger. A well filtered, rugged power supply uses heavy duty selenium rectifier, a husky choke, and a 4000 MFD electrolytic condenser for clean DC. 0-15V voltmeter indicates output which is variable in eight steps. Better be equipped for all types of service — it means more income.

Model BE-2
Shipping Wt. 19 lbs.

\$22.50



YOU SAVE BY ORDERING DIRECT FROM MANUFACTURER—USE ORDER BLANK ON LAST PAGE

EXPORT AGENTS
ROCKE INTERNATIONAL CORP.
13 E. 40th ST.
NEW YORK CITY (16)
CABLE: ARLAB-N.Y.

The **HEATH COMPANY**

... BENTON HARBOR 20, MICHIGAN

Heathkit RECEIVER & TUNER KITS for AM and FM



Model BR-1 Broadcast Model Kit covers 550 to 1600 Kc. Shipping Wt. 10 lbs.

\$19.50



Model AR-1 3 Band Receiver Kit covers 550 Kc. to over 20 Mc. continuous. Extremely high sensitivity. Shipping Wt. 10 lbs.

\$23.50

TWO HIGH QUALITY *Heathkit* SUPERHETRODYNE RECEIVER KITS

Two excellent Heathkits. Ideal for schools, replacement of worn out receivers, amateur and custom installations.

Both are transformer operated quality units. The best of materials used throughout—six inch calibrated slide rule dial—quality power output transformers—dual iron core shielded. I.F. coils—metal cased filter condenser. The chassis has phono input jacks, 110 Volt output for phono motor and there is a phono-radio switch on panel. A large metal panel simplifying installation in used console cabinets is included. Comes complete with tubes and instruction manual incorporating pictorials and step-by-step instructions (less speaker and cabinet). The three band model has simple coil turret which is assembled separately for ease of construction.

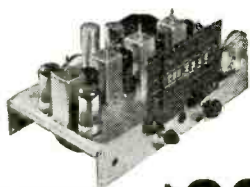

Model FM-2
Ship. Wt. 9 lbs.

\$22.50

TRUE FM FROM *Heathkit* FM TUNER KIT

The Heathkit FM Tuner Model FM-2 was designed for best tonal reproduction. The circuit incorporates the most desirable FM features—true FM.

Utilizes 8 tubes: 7E5 Oscillator, 6SH7 mixer, two 6SH7 IF amplifiers, 6SH7 limiter, two 7C4 diodes as discriminator, and 6X5 rectifier.

The instrument is transformer operated making it safe for connection to any type receiver or amplifier. Has ready wound and adjusted RF coils, and 2 stages of 10.7 Mc IF (including limiter). A calibrated six inch slide rule dial has vernier drive for easy tuning. All parts and complete construction manual furnished.



MAIL TO THE
HEATH COMPANY
BENTON HARBOR 20,
MICHIGAN

ORDER BLANK

From _____

SHIP VIA

- Parcel Post
- Express
- Freight
- Best Way

Quantity	Item	Price	Quantity	Item	Price
	Heathkit Oscilloscope Kit — Model O-7			Heathkit H.V. Probe Kit — No. 336	
	Heathkit VTVM Kit — Model V-5			Heathkit R.F. Signal Gen. Kit — Model SG-6	
	Heathkit FM Tuner Kit — FM-2			Heathkit Condenser Checker Kit — Model C-2	
	Heathkit Broadcast Receiver Kit — Model BR-1			Heathkit Handitester Kit — Model M-1	
	Heathkit Three Band Receiver Kit—Model AR-1			Heathkit Power Supply Kit — Model PS-1	
	Heathkit Amplifier Kit — Model A-4			Heathkit Resistance Decade Kit — Model RD-1	
	Heathkit Amplifier Kit — Model A-6 (or A-6A)			Heathkit Impedance Bridge Kit — Model IB-1B	
	Heathkit Tube Checker Kit — Model TC-1			Heathkit A.C. VTVM-KIT — Model AV-1	
	Heathkit Audio Generator Kit — Model AG-7			Heathkit Intermodul. Analyzer Kit—Model IM-1	
	Heathkit Battery Eliminator Kit — Model BE-2			Heathkit Audio Freq. Meter Kit — Model AF-1	
	Heathkit Electronic Switch Kit — Model S-2			Heathkit Square Wave Gen. Kit — Model SQ-1	
	Heathkit T.V. Alignment Gen. Kit — TS-2				
	Heathkit Signal Tracer Kit — Model T-2				
	Heathkit R.F. Probe Kit — No. 309				

On Parcel Post Orders, include postage for weight shown and insurance. (We insure all shipments.)

On Express Orders, do not include transportation charges — they will be collected by the Express Agency at time of delivery.

Enclosed find Check Money Order for _____

Please ship C.O.D. Postage enclosed for _____ lbs.

ALL PRICES SUBJECT TO CHANGE WITHOUT NOTICE

EXPORT AGENT
ROCKE INTERNATIONAL CORP.
13 E. 40th ST.
NEW YORK CITY (16)
CABLE: ARLAB-N.Y.

The HEATH COMPANY

... BENTON HARBOR 20, MICHIGAN

RADIO-ELECTRONICS for

Tiny Personal Set Uses Efficient Circuit

A small, truly portable radio is always handy to have and there are numerous models on the market. But a tiny receiver usable for personal ear-phone reception is far from common. The Privat-Ear* fills this bill, covering the broadcast band, pulling in stations from as much as 50 miles away, and giving real listening privacy.

The diagram, page 84, shows the circuit used. Two low-current drain 2E31 tubes and a germanium crystal detector provide sensitive reception with adequate volume. A reflex type circuit is used.

The signal is picked up on the collapsible antenna which extends to 18 inches. A switch on the antenna turns on the set when the antenna is extended. The incoming r.f. signal passes through the first 2E31 tuned by L1 and L2. Then it is rectified by the 1N60 or 1N34 crystal detector and finally passes back through the same 2E31, then on through a standard RC network to the second 2E31 which acts as audio amplifier.

Reflex circuit

The reflex type circuit is one in which the vacuum tubes perform double duties as both radio-frequency and audio-frequency amplifiers. The incoming r.f. signal is amplified at radio frequency (thus giving a stage of r.f.), rectified by a detector, in this case the 1N60 (1N34 can be used), and then amplified at audio frequency using the same tube.

In this particular case no feedback loop is used as in the original reflex,

*Manufactured by Privat-Ear Corp., 2016 Bronx-dale Ave., Bronx, N. Y.



Sensitive receiver covers broadcast band

but the amplified r.f. signal is returned to the grid of the first 2E31 by the network, C1, R1, R2.

The circuit may be critical, since both r.f. and rectified audio frequency waves are passed through the same tube. Theoretically the circuit can become unstable if the audio component overloads the tube, but this is unlikely in the present hookup.

Compact construction

The frequency range tuned by the coils is 600 to 1,500 kc. Slug tuning eliminates the need for bulky variable capacitors, and provides fairly high Q for selectivity.

The power output of the small set is about 55 milliwatts, ample for the magnetic headphone used which inserts

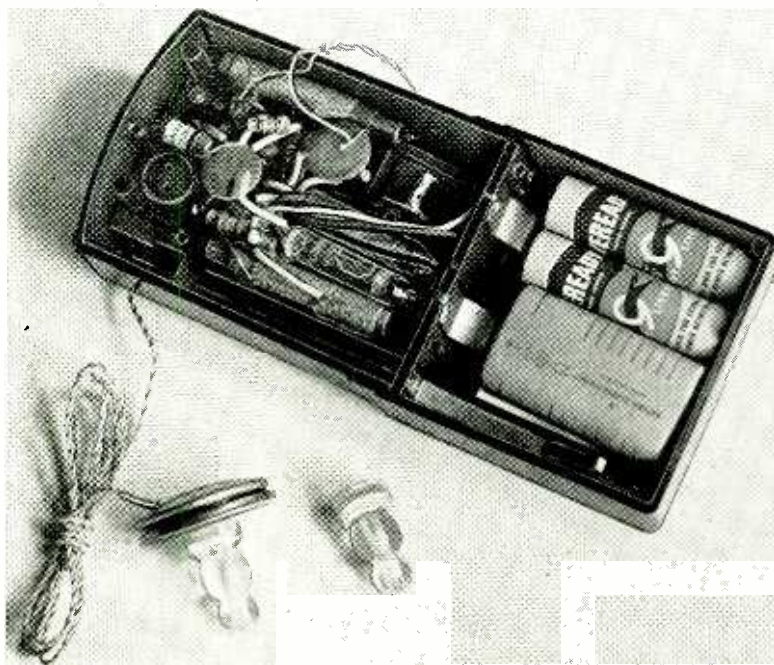

Photos courtesy Alex Taylor and Co., New York, N. Y.

Sensitive unit uses two hearing-aid tubes, 1N60 crystal and miniature parts.

COMPLETE TRAINING

FOR BETTER JOBS
in Radio-Electronics



ONLY
\$14

5 MONTHS TO PAY!

Here are three world-famous books so thoroughly covering radio theory, troubleshooting and servicing methods; so clearly explaining every phase of the work that, with a minimum of time, you'll soon be able to handle repairs on any type of Radio-Electronic Equipment and qualify for better jobs, bigger pay checks! You couldn't get a finer, more complete or easier to understand training course AT ANY PRICE. Remember! These are the same Ghirardi books that were more widely used for wartime radio-electronic training than any other books or courses of their type!

Ghirardi's BIG-3

RADIO SERVICING LIBRARY

These three big books contain a total of 3016 pages and 1214 illustrations covering the complete range of basic radio-electronic and service subjects:

1—RADIO PHYSICS COURSE

Complete basic training for beginners. Makes even the most difficult subjects easy to understand! 972 pages, 508 illus. Price \$5.00.

2—MODERN RADIO SERVICING

The 1300-page book that teaches you to work by truly professional methods. Explains all about test instruments, how to use them, circuit analysis, component replacements and dozens of other subjects. 1300 pages, 706 illus. Price \$5.00.

3—RADIO TROUBLESHOOTER'S HANDBOOK

The great Ghirardi book that cuts service time in half on most jobs. Tells what to do, exactly how to do it in making quick repairs on over 4800 specific radio models. 744 manual-size pages, \$5.00.

Let A. A. Ghirardi train you for Radio-Electronics—AT ABSOLUTE MINIMUM COST! Starting with the fundamentals of basic electricity, these 3 books take you step-by-step through the efficient radio testing, adjustment and repair procedures that mean time saving and more profitable work. Hundreds of working data on tubes, color codes, transformers, resistors capacitors, record changers and other components help you solve job snags in record time.

NEW LOW PRICE . . . Easy Terms

Bought singly, the books in this fact-packed library would cost you \$15. Under this special offer, you save \$1 and also have the privilege of paying in easy monthly installments, while you use the books. No waiting for monthly lessons. You learn fast—and you learn right!

10 DAYS' MONEY BACK EXAMINATION

Dept. RE-91, RINEHART BOOKS, Inc.,
Technical Division,
232 Madison Ave., New York 16, N.Y.
Send me GHIRARDI'S BIG-3 Radio-Electronics Library. I enclose \$2 as my first instalment and will send you \$3 a month for four months until the total special price of only \$14 is paid. It is understood I may read the books for 10 days. Then, if not satisfactory, I will return them postage paid and you agree to refund my \$2 and cancel the remaining instalments. (Offer good in U.S. only. Outside U.S. send cash. Same return privilege.)

Name

Address

City, Zone, State

Occupation

How you can get

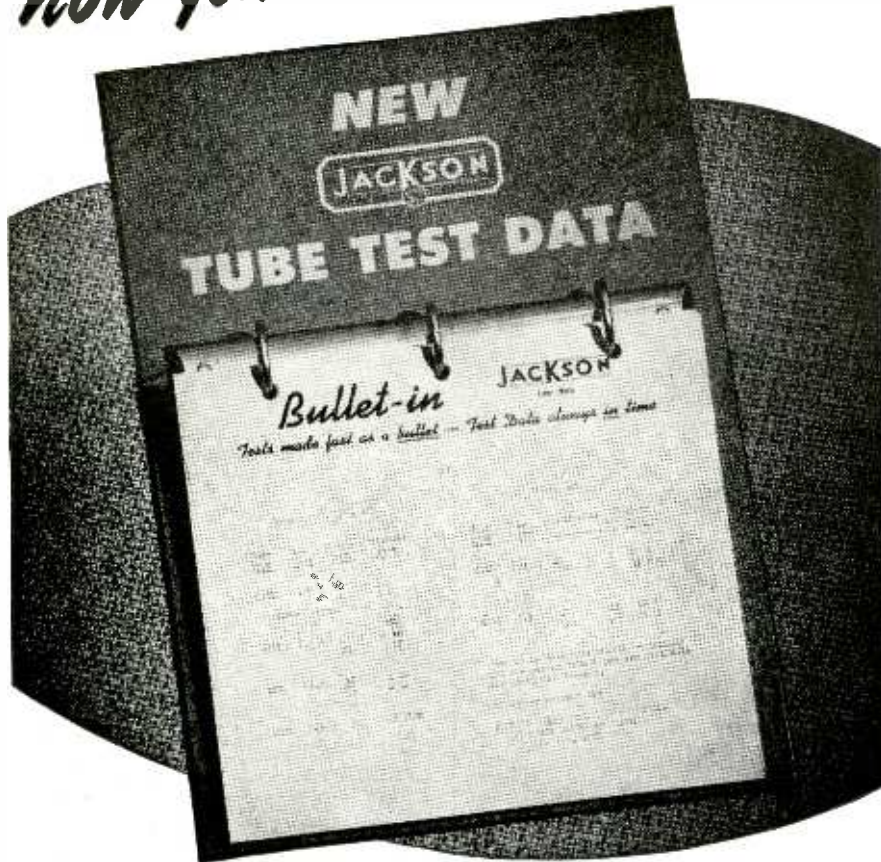

QUICK test setting data on new tubes

Two weeks after a manufacturer has made the characteristics of a new tube available, we supply a test setting bulletin to distributors. The above photograph shows the "Bullet-in" board that is furnished free and upon which each bulletin is posted as soon as a distributor receives it.

Users of Jackson Testers can obtain the information from distributors immediately instead of waiting until a new roll chart is issued.

Recognizing the value of this service, alert distributors post each new bulletin promptly so that their customers can get the benefit at the earliest possible moment.

For the convenience of Jackson Tester users who are no longer entitled to free roll charts, the bulletins advise when new charts are ready.

Look for the bulletin when you visit your distributor's store. If you see it, copy the test setting data. If you can't locate the bulletin, tell the distributor you want to see it.

into the ear canal. A choke, L3, provides efficient loading of the audio tube, with proper impedance coupling to the headphone.

Current drain is very low, since the subminiature pentodes draw a total of 100 ma filament current and 0.8 ma plate current. Two 1.5-volt cells and a 22.5-volt hearing-aid battery are used.

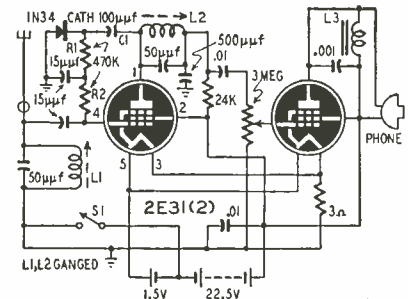

SI ASSOCIATED WITH TELESCOPE TYPE ANT AT POINT ϕ

The simple Privat-Ear reflex circuit.

The compact unit, which weighs less than 8 ounces, requires a minimum of parts. Ceramic-disc capacitors, miniature chokes, and 1/8-watt resistors cut down the size.

The plastic case measures 2 1/2 x 5 3/4 x 3/4 inches. An extra earplug is furnished, and the unit comes complete with batteries.

—end—

ELECTRONIC GATING CIRCUIT

Gating or keying circuits which permit a tube to conduct and amplify during predetermined intervals and prevent it from amplifying during others are widely used in computers, TV sync generators and timers, radar equipment, and various other devices. Patent No. 2,519,763 issued to R. H. Hoglund describes a simple gating circuit designed around a 6SA7 or similar tube having two grids which are highly effective in controlling the flow of plate current. The basic circuit is shown in the diagram.

The tube is biased to cutoff by the voltage applied to grid 1 from battery B1. Screen-grid voltage is supplied by B2 and plate voltage by B2 and B3 in series. When a signal is applied to grid 3, no output is developed across the plate-load resistor R1 because the tube is cut off by the bias on grid 1. However, if a positive gating or enabling pulse is applied simultaneously to grid 1, the tube will conduct and amplify the signal on grid 3. Because of degeneration produced by the unbypassed cathode resistor, only a small portion of the enabling pulse appears in the output circuit, while the signal applied to grid 3 is amplified as much as the circuit will permit.

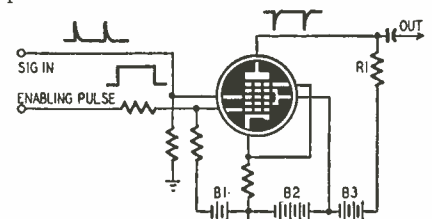

—end—

JACKSON ELECTRICAL INSTRUMENT CO.
 "Service Engineered" Test Equipment DAYTON 2, OHIO In Canada: The Canadian Marconi Co

SUPREME TEST EQUIPMENT AT SPECIAL SAVINGS

THAT FAMOUS QUALITY RECOGNIZED AND PRAISED BY ELECTRONIC TECHNICIANS FOR OVER 24 YEARS
 ● NO REDUCTION OF COMPONENTS ● NO REDUCTION IN QUALITY ● ONLY A REDUCTION IN PRICE TO YOU

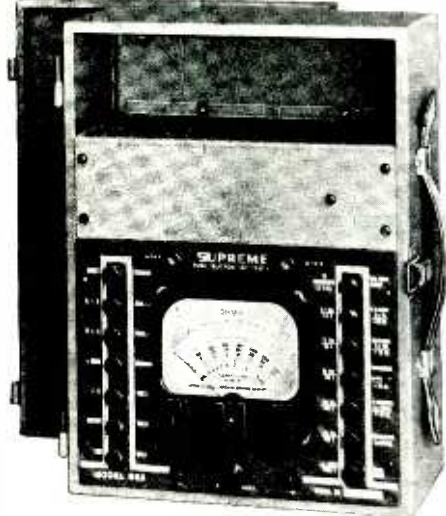

AM - FM - TV MULTI-METER

MEASURES DC VOLTAGE TO 35,000 VOLTS AT 25,000 OHMS PER VOLT! The popular Supreme Model 592 has been extended for television. It now measures up to 35,000 volts DC with input resistance of the high range being 875 megohms. Many VTVMs are below this. Once you have used the Supreme 592, you would not trade it for all the rest. It's simple to operate and gives the user speed he never dreamed of. After test leads are inserted in the two pin jacks, it is not necessary to move them again (except on the 14 ampere and 35,000 volt ranges).

Fifteen DC VOLTAGE ranges—two sensitivities—8 ranges at 25,000 ohms/volt and 7 ranges at 1000 ohms/volt—0/3.5/7/35/140/350/700/1400 volts DC. External extension unit included for 35,000 volt range at 25,000 ohms/volt. Six OHMMETER ranges—0/500/5000/50,000/500,000/5 meg./50 meg. No ranges omitted to confuse operator. All readings are made on easy-to-read single scale by simply adding zeros. Ohmmeter uses standard type batteries—simple, economical replacement. No external power required, even for the 50 megohm range! Six AC VOLTAGE ranges—0/7/35/140/350/700/1400 volts. Temperature compensated double bridge rectifier circuit provides maximum accuracy and protection. Seven DIRECT CURRENT ranges—0/70 microamperes, 0/7/35/140/350 milliampere, 0/1.4/14 amperes. Six OUTPUT VOLTAGE ranges—0/7/35/140/350/700/1400. No external blocking condenser required when used as output meter in alignment. Four DECIBEL ranges—0 to plus 16, plus 10 to plus 26, plus 26 to plus 36, plus 36 to plus 46 db. All decibel ranges calibrated for direct reading on 500 ohm line. Full-vision, Supreme built, four inch meter with 40 microampere movement and sturdy pointer. Instrument housed in attractive, sturdy, metallic carrying case with leather handle, test lead compartment, and detachable lid. Shipped complete with instruction manual, test leads, batteries, and high voltage extension unit. Approx. dimensions 8½ x 12 x 5 inches. Shipping Weight 13 pounds.

Regular Value \$69⁹⁰

YOUR COST DURING THIS SPECIAL OFFER \$36⁹⁵

ALL SUPREME INSTRUMENTS ARE COMPLETELY WIRED, TESTED AND CALIBRATED AGAINST RELIABLE STANDARDS BY SKILLED INSTRUMENT TECHNICIANS. THEY ARE NOT KITS. EACH SUPREME INSTRUMENT IS BRAND NEW FRESH EQUIPMENT—NOT SURPLUS OR REBUILT.

TUBE AND BATTERY TESTER

CHECKS AM—FM—TV RECEIVING TUBES AND PORTABLE RADIO BATTERIES. The SUPREME Model 616 cannot be beat for efficient bench or counter tube testing. Incorporating that famous tube test circuit and patented regulated neon leakage test, both pioneered and developed by Supreme. Have set tube rejection standards for years. Minimized obsolescence by use of Supreme patented element selector system. Thousands of testers using this circuit have been in use over ten years. Socket facilities for all AM, FM and TV receiving tubes. ILLUMINATED ROLL CHART with hundreds of types listed. TUBE SETTING DATA on future tubes supplied by Supreme as they come into use. Quality test readings for both tubes and batteries on "Replace-Good" scales of beautiful BIG SEVEN INCH FULL VISION METER designed and built by SUPREME. Non-breakable window. Most people can read this meter ten feet away. Also checks portable radio batteries UNDER PROPER LOAD. Tests batteries with rated voltages of 1½, 4½, 6, 45, 67½, 90 volts. Hammerloid finished metallic case with detachable cover. Approx. dimensions 11 x 15 x 6½ inches. Shipping weight 20 pounds.

Regular Value \$87⁵⁰

YOUR COST DURING THIS SPECIAL OFFER \$54⁹⁵



SUPREME MODEL 600 (not illustrated) is also being made available during this special offer. Similar in appearance to Model 616, with all the features listed above plus 31 multi-meter ranges (1000 ohms/volt).

Regular Value \$117⁵⁰

Your Cost during this Special Offer \$74⁹⁵

ORDER TODAY—THIS OFFER IS SUBJECT TO WITHDRAWAL IN 60 DAYS, OR BEFORE IF ANY MODEL IS SOLD OUT AND NOT AVAILABLE FOR IMMEDIATE DELIVERY. PRICES APPLY ONLY TO ORDERS FROM INSIDE THE CONTINENTAL U. S. A.

A DEPENDABLE SIGNAL GENERATOR

RF TO 82 MC—400 CYCLE AF—COVERS TV IF MARKERS

Supreme pioneered in the development of all wave signal generators and the Model 661 is the result of many years of development and research to find the most stable circuits and provide the most simple operation. Many circuits were explored and the one used in the 661 was declared the best of all. Many dial arrangements were investigated; many calibration methods checked; many attenuators and modulation methods carefully analyzed. There is no better service oscillator on the market than the Model 661. Only 2 dial scales but 5 bands. All ranges are read simply on two basic scales that are accurately calibrated—even at both ends. Impregnated iron core tuned inductors and air dielectric trimmers provide the maximum frequency stability. Guards against shift due to line voltage fluctuation, aging, temperature and humidity. Continuously variable output in a 4 step ladder attenuator. Double shielding to minimize leakage. Shielded line cord, illuminated hair line dial. RF ranges from 65kc to 82 megacycles (65kc to 20.5 Mc on fundamentals). Audio frequency output, continuously variable from minimum to maximum. Internal modulation of RF signal approximately 50%. Jack provided for external amplitude modulation. Housed in heavy steel case, attractive finish. Complete with instruction manual and shielded connector. Approx. dimensions 9½ x 8¾ x 7½ inches. Shipping weight 15 pounds.

Regular Value \$72⁵⁰

YOUR COST DURING THIS SPECIAL OFFER \$34⁷⁵

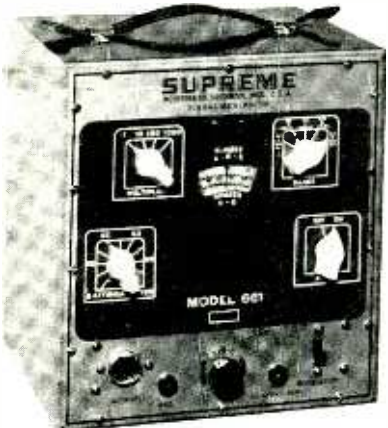

EVERY SUPREME INSTRUMENT IS BACKED BY OUR COURTEOUS AND EFFICIENT SERVICE ORGANIZATION. NO "ORPHAN" INSTRUMENTS. FULL ONE YEAR GUARANTEE, BACKED BY THE FACTORY. ANY SUPREME INSTRUMENTS SHIPPED DIRECTLY FROM THE FACTORY ARE SOLD STRICTLY ON A "MONEY-BACK-IF-NOT-SATISFIED" BASIS. TRY ANY OF THEM FOR 10 DAYS. IF NOT COMPLETELY SATISFIED, RETURN FOR FULL REFUND OF PURCHASE PRICE.

MAIL YOUR ORDER TO SUPREME, INC., BOX 9552, GREENWOOD, MISSISSIPPI—ORDER TODAY

I WANT TO TAKE ADVANTAGE OF THIS SPECIAL SUPREME SAVINGS OFFER—PLEASE RUSH THE MODELS CHECKED—

_____ Model 592 @ \$36.95 \$ _____ Ship to _____
 _____ Model 616 @ \$54.95 \$ _____ Address _____
 _____ Model 600 @ \$74.95 \$ _____ City _____ State _____
 _____ Model 661 @ \$34.75 \$ _____ Deposit ship balance C.O.D. \$ _____ Payment in full

Enclose full payment with order or send 20% deposit with C.O.D. orders. (Full payment orders are the quickest to handle and save you C.O.D. fees). NOTE: If you do not want to cut this page, copy above on separate sheet of paper and mail. It will receive same prompt handling.

**A Giant Stride Toward
Good Television Everywhere!**

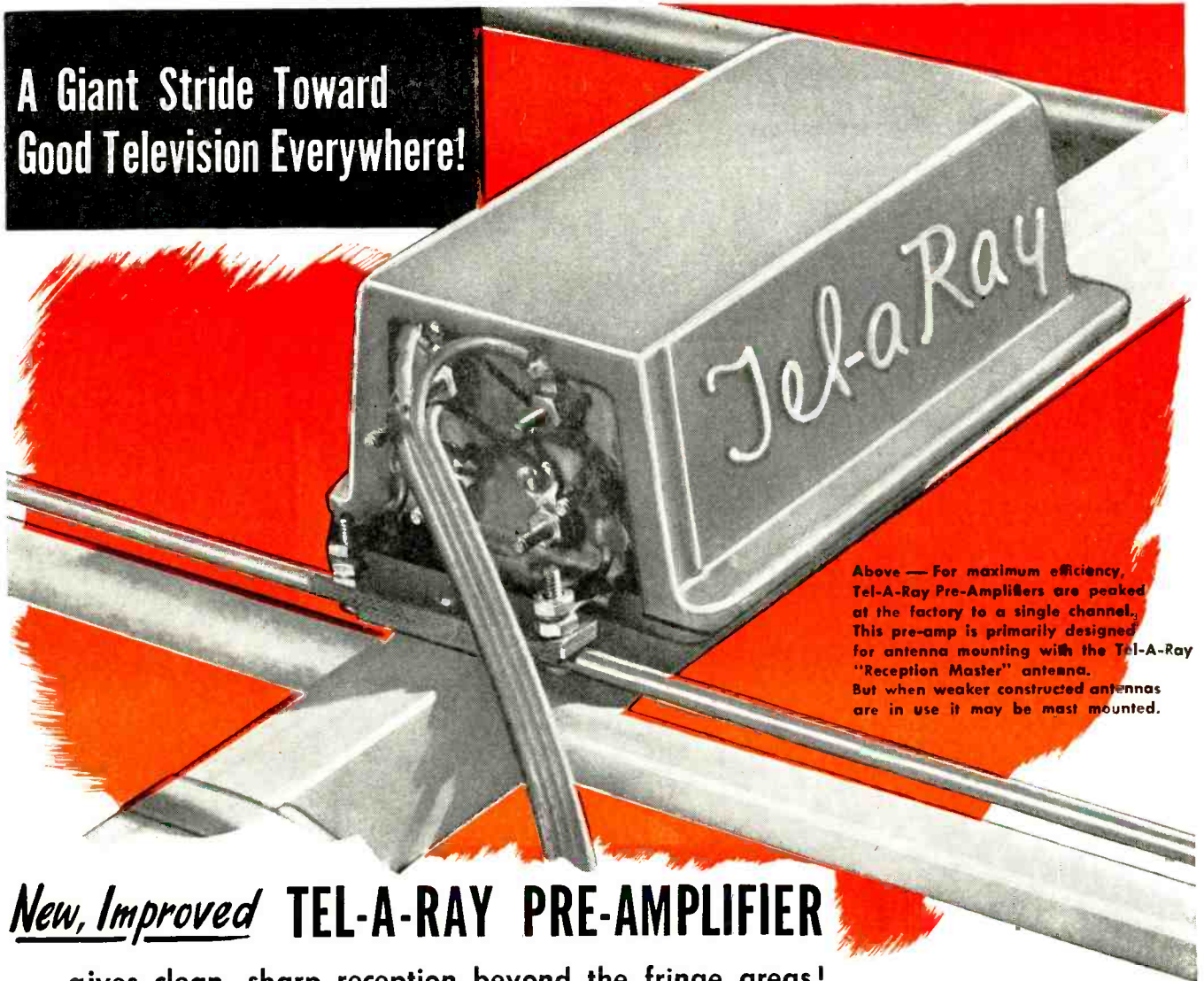

Above — For maximum efficiency, Tel-A-Ray Pre-Amplifiers are peaked at the factory to a single channel. This pre-amp is primarily designed for antenna mounting with the Tel-A-Ray "Reception Master" antenna. But when weaker constructed antennas are in use it may be mast mounted.

New, Improved TEL-A-RAY PRE-AMPLIFIER

gives clean, sharp reception beyond the fringe areas!

Here is an advance that can help sell many more television sets . . . that is a "must" installation wherever signals are weak and snow is a problem.

The only antenna-mounted device of its kind, the new, improved Tel-A-Ray Pre-Amplifier is now made in separate models for high and low channels . . . with a matched and tuned grid circuit that insures maximum gain and a stable signal. With it, television can now go beyond the fringe areas, and you have the simple, easily installed and economical means of insuring clear, sharp, snow-free television reception in many other locations. It is a tremendous advance with all the bugs worked out of it . . . ready for your use now in bringing good television to many more people.

USE WITH MODEL T OR TD ANTENNA for the best results

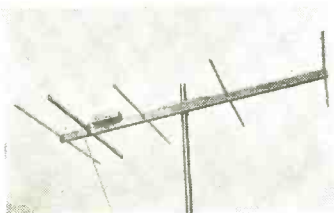

Installation of these famous long distance Tel-A-Ray antennas is the first step in getting clear, snow-free reception. With the Pre-Amplifier, they give up to 300 times gain over dipole.

- Gives maximum gain in signal.
- Insures stability of signal.
- Provides for vastly improved signal-to-noise ratio.
- Compensates for lead line loss.
- Eliminates or greatly reduces snow.
- An essential complement to the booster at the set in many locations, and can be used without a booster in numerous cases.
- Made of Dural and weather-sealed . . . completely guaranteed against weather damage.
- Inexpensive . . . speedily and easily installed to any mast or antenna.

Tel-a-Ray

ENTERPRISES, INCORPORATED

BOX 332E
HENDERSON, KENTUCKY



TRADE MARK

RADIO-ELECTRONICS for

TUBES OF THE MONTH

Among the new tubes this month is the RCA 21AP4, a metal-shell, rectangular picture tube using magnetic focus and deflection. It has a maximum rating of 18,000 volts, a horizontal deflections angle of 66° and requires a single-magnet ion trap. Tube length: 22⁷/₁₆ inches picture size: 18³/₈ x 13¹⁵/₁₆ inches.

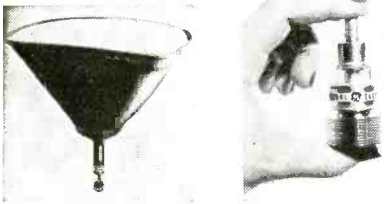

21AP4, metal; GL-2C39A, lighthouse.

General Electric is producing the GL-2C39A, a high- μ triode, lighthouse tube, designed for use up to 2,500 mc. Maximum d.c. plate voltage is 1,000 volts, and dissipation is 100 watts. It is designed for use as a grounded-grid class-C r.f. amplifier and oscillator, in both fixed and mobile services. Output at 500 mc, operating as a class C oscillator, is 40 watts. At 2,500 mc, output is 15 watts.

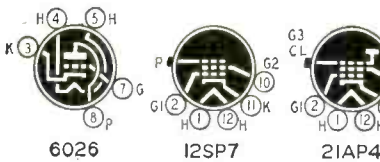

G-E is also producing the 6005, designed mainly for mobile and aircraft applications where shock and vibration are encountered. It is a miniature beam-power amplifier designed for audio-frequency service. It can withstand peak impact acceleration up to 600 g, and vibrational acceleration up to 2.5 g. Maximum ratings of the tube include: plate dissipation, 12 watts; screen dissipation, 2 watts. Power output is 4.5 watts. It is a high-reliability version of the 6AQ5.

Another RCA tube is the new flexible-lead, subminiature type 6026, a high-efficiency oscillator triode designed for transmitting service at 400 mc in radio-sonde and similar applications. The structure of the 6026 permits short transit time and low interelectrode ca-

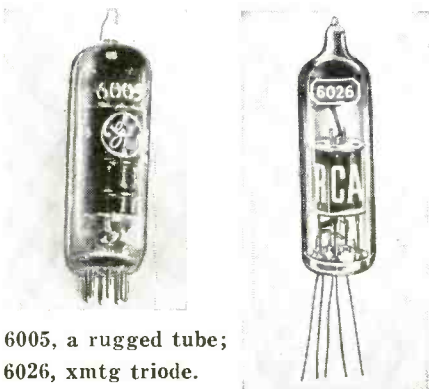

6005, a rugged tube;
6026, xmtg triode.

LOOK-NO HANDS!

- NO SEPARATE BOOSTER TUNING
- UNIFORMLY HIGH USABLE GAIN
- LESS "SNOW"—BETTER PICTURES
- EXCLUSIVE 4-STAGE BROADBAND CIRCUIT
- EASILY CONCEALED—HIGHLY STABLE

AUTOMATIC SELF-TUNING

SUPER Tune-O-Matic TV BOOSTER

Connect it...and forget it! Anyone... ever a child...can get his favorite programs with a clarity of picture and sound like never before...on any channel...automatically...without any booster tuning!

Exclusive E-V all-electronic broadband circuit gives superb low-noise performance...provides higher effective gain on all channels...works where others have failed, even in tough fringe areas. Furthermore, the booster can be easily concealed. Installation is quick and simple. Plugs into 50-60 cycle a.c. outlet. Thousands of installations have proved it completely trouble-free. There's nothing like it!

Model 3000 TUNE-O-MATIC. List...\$59.50

Tenna-Top

First all-channel, low-noise, antenna-mounted, self-tuning TV booster! Mounts on antenna mast ahead of the lead-in. Automatically boosts the signal—not any local noise picked up by the lead-in. Clearly brings in telecasts you could never get before. Finest booster for tough fringe areas or noisy locations in primary areas.

Model 3000 TENNA-TOP. List price...\$69.50

Electro-Voice

TV BOOSTERS • MICROPHONES • HI-FI SPEAKERS • PHONO-PICKUPS

Patent Pending

Electro-Voice, Inc., Dept. E9-1
421 Carroll St., Buchanan, Michigan
Send Free Bulletin No. 163

Name _____
Address _____ (PLEASE PRINT)
City _____ Zone _____ State _____

Serviceman Installer Dealer TV Fan

Send for FREE BULLETIN TODAY!

IN TUNE WITH THE TUNER!

NEW...IMPROVED

"STANDARD TV BOOSTER"



MODEL B-51

Millions of "Standard Tuners"

Now In Use

Used by over 75
TV Set Manufacturers



The new "Standard Booster" will increase the TV signal strength to a degree that will make possible "city" reception in areas remote from the TV transmitter. It reduces the "snow" or noise and interference to give a clearer, sharper picture and improved sound reception. It also makes possible receiving a picture in very remote areas or "blind" areas in close-to-transmitter locations where the TV set alone will not — makes a TV set a real enjoyment!

Standard COIL PRODUCTS CO. INC.
CHICAGO • LOS ANGELES • BANGOR, MICH.

RADIO-ELECTRONICS for

pacitance. It has a useful power output of 1.25 watts. Since in most of its applications, tube life is not the primary consideration (usually a life of only a few hours is required), ratings have



12SP7, radar tube.

been established on the basis of power output, compactness, and low weight.

A 12-inch cathode-ray tube, type 12SP7, is being produced by RCA for radar indicator service. It is the magnetic focus, magnetic deflection type. The face plate, coated with phosphor P7, has almost a flat surface. The gun design produces a sharper, rounder spot, resulting in greater resolution when the tube is operated at high beam current.

—end—

EMPIRE STATE TOWER

This picture of the Empire State Building multiple TV antenna installation represents a unique solution of a photographic problem. Because it was difficult to get a suitable, complete photo of the inaccessible installation, engineers built a model and photographed that.

The complete installation should be in operation by the time this is read. Transmitted signals cover TV channel 2, 4, 5, 7, and 11, plus three FM stations. Channel 13 will be added later.

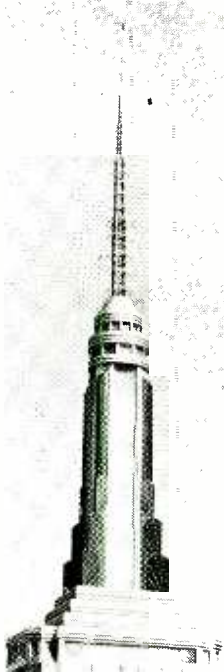

CORRECTION

Merit Transformer Corp. has informed us that the MD-70 and MDF-70 deflection yokes are matching units for the HVO-6 horizontal output and high-voltage transformer; not the type MD-12 shown in the tabulation on page 31 of the August issue. The type MDF-70 also can be used with the HVO-7 output transformer.



A NIAGARA SPECIAL
WESTERN ELECTRIC 25 WATT AUDIO REPRODUCER



AMAZING FREQUENCY RESPONSE! 25 WATT RECEIVER
Made by W. E. no D-173246, for the famous BEECHMASTER 250 watt P. A. systems used in guiding blind aircraft for landings and for P. A. from flying aircraft. These P. M. dynamic receivers have an impedance load of 8 ohms to the output of any amplifier. DUAL CO-AXIAL MAGNETS weigh 23 ounces. Perfect for use as horn type drive speaker or co-axial high power tweeters. Shipping wgt. 7 lbs. **\$12.50** Each

LIMITED QUANTITY

ASTATIC BOOSTER

MODEL BT-1

A simplified high gain booster using the famous Mallory inductor-tuner for continuous tuning over entire TV and FM spectrum. Gives exceptional improvement on all channels. Single tuning knob. Mahogany finished metal case. Low noise. For either 72 or 300 ohm line. Wgt. 5 lbs.



SPECIAL! \$19.10



MODEL AT-1
Astatic four-tube deluxe models—no other booster can do so much in improving TV picture contrast and clarity, in improving sound, in eliminating interference. Feature exclusive variable gain control and dual-tuning. Model AT-1 in fine furniture finish mahogany.

Special \$29.10

TV PICTURE TUBES



TYPE	Prices Slashed EACH
7DP4	9.95
7JP4	18.37
8BP4	22.54
10BP4	17.50
10BP4A	24.99
12LP4	25.73
12LP4A	25.73
14CP4/14BPA	25.97
14GP4	25.97
16AP4	43.12
16DP4	37.44
16UP4A	37.44
16JP4	37.44
16JPHA	37.44
16KP4/16RP4	32.34
16TP4	32.34
17BP4A	32.34
17FP4	32.34
19FP4	66.89
20CP4	51.21
20FP4	51.21

Dlgby 9. 1132.3-4

WEBSTER CHICAGO AUTOMATIC RECORD CHANGER
TYPE 100—SERIES



A fortunate purchase makes it possible for us to offer these fine, new record changers at less than regular manufacturer's cost. Made by Webster-Chicago and only introduced on the market a few months ago as one of their latest models. Plays 12, 10 or 7 inch records at 33 1/3, 45, or 78 R. P. M. New spindle carefully lowers unplayed record stack. Balanced arm assures light needle pressure and long wear. Needle-tip (included) for standard or micro-groove records. Inside-out records played without any adjustment. Pickup arm comes to rest position after last record has played. Complete factory packed and sealed record changers, normally listing at \$47.50—While they last. **\$24.85**

SOUND POWER PHONES

Model No. RCA MI-2475
Model No. RCA MI-2475
Navy type "Q." 10 miles without Batteries. Rubber cushioned earphones, mouthpiece microphone attached, 22 ft. rubber cord, push-to-talk switch, navy water-proofing plug. Excellent condition. One complete unit as illustrated...
Same as above with mike on chest plate type "O" RCA MI-2454B **\$4.95**



\$9.95 Each

MASCO Midgetalk

COMPLETE 2-STATION SYSTEM

Remote has "press-to-talk" switch—may be wired for "private" or "non-private" use; either station may call the other at will. Only one connection to 115-volt AC wall plug! Two tubes and selenium rectifier provide 2.5 watts output. Natural voice reproduction over distances to 500-feet! 3" Alnico V speaker. Complete with 50-ft. of 3-wire cable, instructions. Master has "On-Off" switch and volume control. U.S. Approved! "MASCO MIDGETALK" INTERCOMM SYSTEM. Complete, **\$27.49**
Your Cost



REMOTE CONTROL FOR THE THING!!
(PLUS \$1.00 BOOK FREE)

The answer to the "Remote Control" experimenter's dream! A completely wired, 3 tube remote control unit, originally used as Electronic Brain for remote thermo-static control of electric blankets. Can be used, with slight modification, to control model trains, planes, trucks, remote on-off for radios, open and close garage doors for remote control any device in "accordance with your own ingenuity. And that's not all! With each unit we will give you absolutely free, one copy of Germsback Library's popular new book "Model Control by Radio." 112 pages, containing more than 125 illustrations, diagrams, tables and formulas, crammed full of theory and practical uses for Electronic Remote Control.

Remote Control Unit, including Fil. Xmr., 300 ohm plate circuit "trigger" relay, completely wired, circuit diagram and above described book—less tubes. **\$5.50**

ALL FOR ONLY... Shipping Wgt. 3 Lbs.

Niagara
RADIO SUPPLY CORP.
Dept. 9-E1
160 Greenwich Street, New York 6, N. Y.

STAY TUNED IN!

Always
There's a **NEWS Program**
from the **TELETOWER!**

Teletower always has... does... and always will... place "high priority" upon development engineering. It was constant design study that pushed Teletower to top position in sales. *Continuing* design study will keep it "the tower in your future".

Penn's newest development is a "revolution"—a *new* self-supporting tower that carries two hundred and fifty pounds of head-load without using a single strand of guy wire! You'll be hearing *plenty* more about this one soon... from Penn... from dealers... from set owners.

Watch this publication for our advertising... and watch your mail for timely messages from Teletower.

STAY TUNED IN... WITH TELETOWERS!

A FEW DEVELOPMENT ENGINEERING ACHIEVEMENTS OF JUST ONE YEAR!



Pole Base Mount.
Durable aluminum base with adjustable socket to accommodate 1" O.D. tubing to 2" pipe. Competitively priced.



Universal Motor Mount.
Easy to adapt to all antenna rotors.

Built-In Base permits raising tower on slope after base is fastened to roof.

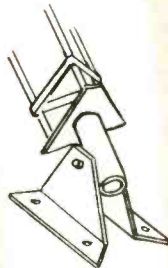

PENN

Teletowers
Lift-towers
Mast
Hardware

PENN BOILER & BURNER MFG. CORP., LANCASTER, PA.

CENTERING DEVICE

A new picture centering device has been designed for the new type electrostatic focus picture tubes which use no focus coil. It is being marketed by the Perfection Electric Co.

It has two metal rings which can be rotated independently to adjust the picture and center it. The rings are mounted on a special form which is easily clamped to the neck of the tube.

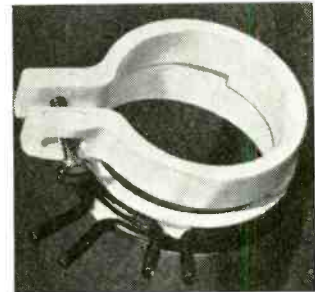

The Kine-Center can be quickly mounted and stays in place without wobble. It can be operated by fingertip control. The two rings are rotated either independently or together to center the picture. When the tabs of both rings are parallel and they are rotated together around the neck of the tube, the picture will rotate in a circle. When the tabs are directly opposite one another and the entire mounting is rotated around the tube, the picture moves very slightly, if at all. When the tabs are placed at any position other than opposite each other, the amount of adjustment of the picture will be between the maximum and minimum, depending upon the position of each tab. Straight-line movement of the picture is obtained by rotating one ring and allowing the other to remain stationary.

—end—

NEW CALLS FOR NOVICE HAMS

On July 1, 1951, novice class licenses became available to radio beginners who wish to become active amateur radio operators while obtaining the experience and know-how necessary to qualify for higher amateur licenses. The beginner must demonstrate his ability to send and receive International Morse code at the rate of five words per minute. He must pass a simple written examination which includes questions on rules and regulations essential to novice licensees and a few questions on elementary radio theory.

Distinctive prefixes are used on call signs issued to stations licensed to holders of novice licenses. In the continental United States where the call-sign prefix is a single W or K (such as W2ABC or K2ABC), the letter N is inserted between the normal prefix and the numeral designating the call area. Thus call signs for novice stations would then be WN2ABC and KN2ABC.

Two-letter prefixes beginning with K (such as KG4ABC and KR6ABC) are assigned to amateur stations in territories and possessions of the United States. Call signs issued to novices in these areas will have the letter W substituted for K.

IMMEDIATE DELIVERY OF

Top Quality MINIATURE SWITCHES

This list of brand new standard brand miniature switches represents only a few of many types in stock at Wells. Large quantities of most types are on hand for your immediate requirements. Write or wire for quotations on switches not listed.

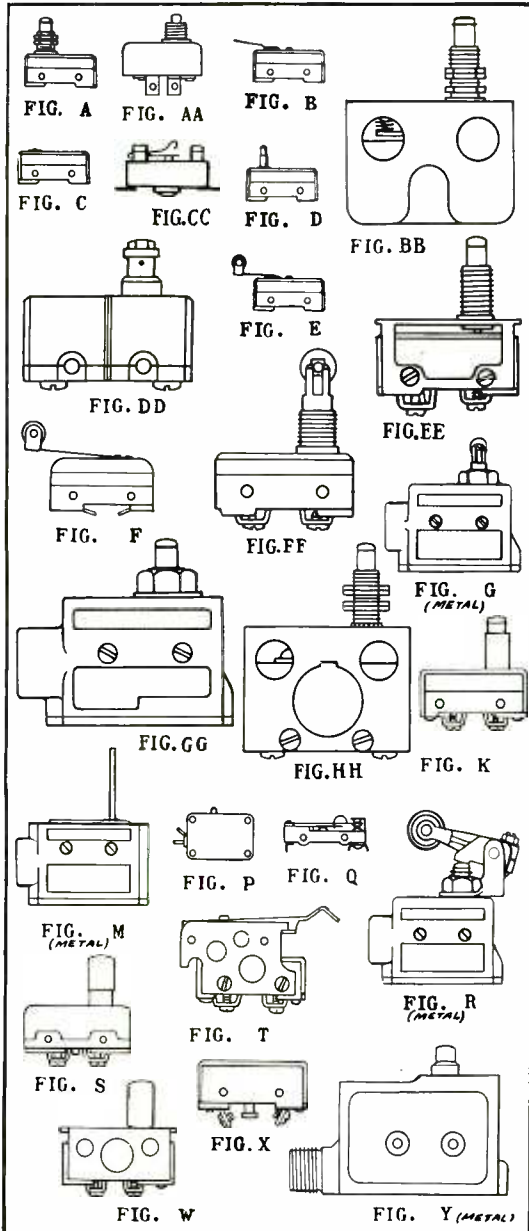

Stock #	Mfr.	Type #	Contact	Fig.	Price	Stock #	Mfr.	Type #	Contact	Fig.	Price
41MC2	ACRO	2M03.1A	NO	P	.50	41MD53	MICRO	WPSM5	NC	AA	.50
41MM2	MU	ACZ101BB	SPDT	W	.85	41MC27	MICRO	WZ2RST	NC	D	.55
41MC6	MU	APB236	SPDT	A	1.15	41MD48	MICRO	WZ2RT	NC	C	.65
41MC26	MU	APG210	NO	A	.80	41MD33	MICRO	WZ3PW2	NC	F	.80
41MC17	MICRO	B-1	NC	Y	1.45	41MD16	MICRO	WZ7R	NC	C	.55
41MC16	MICRO	B-1T	NC	DD	.90	41MD43	MICRO	WZ7RQ1T	NC	A	.70
41MC7	MICRO	B-14	NO	HH	1.70	41MC15	MICRO	WZ7RQ2	NC	A	.70
41MD62	MICRO	B-R	SPDT	C	.70	41MD36	MICRO	WZ7RST	NC	D	.55
41MD46	MICRO	B-RL18	SPDT	B	.95	41MC24	MICRO	WZE7RQTN	NC	Y	1.45
41MD63	MICRO	B-RS36	SPDT	D	.80	41MC23	MICRO	WZE7RQTN	NC	R	3.75
41MD23	MICRO	BD-RL32	SPDT	B	.95	41MD54	MICRO	WZ7R8X	NC	X	.80
41MLH	MICRO	BZ7RQ41	SPDT	W	.85	41MC9	MICRO	WZ7R31	NC	C	.65
41MD51	MICRO	BZ-R37	SPDT	C	.70	41MD57	MICRO	WZ7R31	NC	T	.70
41MD2	MICRO	BZE7RQ2	SPDT	GG	1.70	41MD31	MICRO	WZ7R	NC	C	.55
41MD21	MICRO	BZ-7RST	SPDT	D	.80	41MD19	MICRO	WZ7R8	NC	B	.70
41MD38	MICRO	BZE2RQ9TN1	SPDT	G	2.65	41ML3	MICRO	WZ7RQ41	NC	W	.65
41MD6	MU	CUM 24155	NO	E	.80	41ML2	MICRO	WZV7RQ9T1	NC	G	2.25
41ML1	MU	D	NO	BB	1.50	41MC21	MICRO	X757	NC	C	.55
41MC12	MICRO	D in case	NC	Y	1.45	41MD37	ACRO	XC1A	NC	C	.55
41MD34	KLIXON	ES692070	NC	CC	.50	41MC5	ACRO	XD45L	SPDT	B	.9
41MD65	MICRO	G-R26	NO	C	.60	41MD4	MICRO	YZ	NO	C	.75
41MD60	MICRO	G-RL	NO	B	.80	41MD40	MICRO	YA2RLE4C13	NO	B	.70
41MC11	MICRO	G-RL 5	NO	B	.80	41MD24	MICRO	Y22YLTC1	SPDT	B	.95
41MD61	MICRO	G-RL35	NO	B	.80	41MC1	MICRO	Y22YST	SPDT	D	.60
41MD41	MICRO	G-RL43	NO	B	.80	41MD13	MICRO	Y23R3	NO	C	.60
41MD64	MICRO	G-RS	NO	D	.55	41MD56	MICRO	Y23RLTC2	NO	B	.80
41MD66	MICRO	G-RS36	NO	D	.60	41MC14	MICRO	Y23RW2T	NO	F	.90
41MC32	ACRO	HRO 7.1P2TSP1	NO	K	.65	41MD49	MICRO	Y27RQ9T6	NO	FF	.85
41MC19	ACRO	HRO 7.4P2T	NO	S	.60	41MD32	MICRO	Y27RST	NO	D	.60
41MD8	ACRO	HRRC 7.1A	NC	C	.55	41MC13	MICRO	Y27RA6	NO	EE	1.00
41MD27	ACRO	HRR0 7.1A	NO	C	.60	41MD25	MICRO	Y2RQ1	NO	A	.80
41MC31	MICRO	LN-11 H03	SPDT	M	1.70	41MC20	MICRO	Y2RQ4	NO	S	.60
41MC18	MU	MLB 321	SPDT	B	.95	41MD59	MICRO	Y2RQ41	NO	W	.75
41MD1	MU	MLR 643	NC	B	.70	41MD20	MICRO	Y27RQT	NO	K	.65
41MD55	PHAO.	PS 2000	SPDT	C	.85	41MD42	MICRO	Y2RTX1	NO	X	.95
41MC28	ACRO	RC71P2T	NC	A	.70	41MC22	MU	Z	NC	Y	1.45
41MD45	ACRO	ROI2P2T	NO	A	.80	41MD44	ACRO	Blue Strip	SPDT	C	.70
41MD22	ACRO	RO2M	NO	E	.80	41MD52	MU	Blue Dot	SPDT	E	.90
41MD28	ACRO	RO2M12T	NO	E	.80	41MC8	MU	Red Dot	NC	C	.65
41MC25	MICRO	R-RS	NC	D	.50	41MD18	MICRO	Open Type	SPDT	Q	.50
41MD47	MICRO	R-RS13	NC	D	.50	41MD39	MU	Green Dot	NO	B	.80
41MD9	MICRO	SW-186	NC	D	.50	41MC29	MU	Green Dot	NO	D	.55
41MC10	MICRO	WP3M5	NC	AA	.50	41MD26	MAXSON	Precision	SPDT	B	.95
41MC4	MICRO	WPSM3	NC	AA	.50						

SWITCHETTE	STOCK NO.	MFR. TYPE NUMBER	CONTACTS	TERMINALS	PRICE
	41SF3	CR1070C103-A3	N.C.	SIDE	\$0.53
	41SF2	CR1070C103-B3	N.O.	END	.53
	41SF8	CR1070C103-C3	I-N.O. I-N.C.	END	.53
	41SF7	CR1070C103-E3	N.O.	SIDE	.53
	41SF9	CR1070C103-F3	I-N.O. I-N.C.	SIDE	.53
	41SF12	CR1070C123-B3	N.O.	END	.53
	41SF10	CR1070C123-C3	I-N.D. I-N.C.	END	.53
	41SF5	CR1070C123-D3	N.C.	SIDE	.53
	41SF4	CR1070C123-J2	SPDT	END	.53
	41SF11	CR1070C124-M4	SPDT	SIDE	.53
	41SF1	CR1070C128-C3			

Order direct or through your local parts jobber



SEeley 8-4143



833 W. CHICAGO AVE., DEPT. Y, CHICAGO 22, ILL.

WIDE SELECTION OF ELECTRONIC COMPONENTS AT WELLS

- Tubes • Resistors • Condensers • Wire and Cable
- Volume Controls • Co-ax Connectors • Relays • Rectifiers
- Transformers • Chokes • Micro Switches, Toggles • Antennas
- Accessories • Electronic Assemblies • Dial Light Assemblies

MANUFACTURERS AND DISTRIBUTORS: WRITE FOR CATALOG

ILLINOIS ELECTROLYTIC CAPACITORS

of "Time Tested Quality"

For Every Electronic Application

Seventeen years of production experience, making millions of quality capacitors, has created this complete, outstanding ILLINOIS CONDENSER line. There's a full Jobber line of capacitors for every TV and radio replacement purpose; capacitors for the entire electronics industry—capacitors that meet the highest standards of dependability.

This engineering and manufacturing experience enables ILLINOIS CONDENSER COMPANY to meet every demand for new capacitor types, whether for peace or defense applications.

Write for catalog or tell us your needs. There is an ILLINOIS ELECTROLYTIC CAPACITOR exactly suited for the job—a capacitor of "Time Tested Quality."



ILLINOIS CONDENSER CO.

1616 NORTH THROOP STREET • CHICAGO 22, ILL.

EXPORT DIVISION: 15 Moore St., New York 4, N.Y. U.S.A.

CABLE ADDRESS: "MINTHORNE"



Transistors as Multivibrators

By I. QUEEN

Recent patents assigned to RCA for counting circuits use transistors instead of tubes. Transistors require no filament power and they are more compact than tubes. Their disadvantages include a limited r.f. response and low power output. Neither of these is objectionable in a counter.

Transistors were discussed in this magazine in September, 1948, page 24 and in June, 1950, page 66. Briefly, they have three elements which roughly correspond to those in a triode tube. The emitter and collector are catwhiskers in contact with a germanium crystal, and the crystal is soldered to a metal case. Normally the emitter is positive and the collector negative with respect to the base.

Fig. 1 uses two transistors in a multivibrator designed by Raymond P. Moore, Jr. (Patent No. 2,531,076). The usual R-C circuits are not practical due to the low impedance between transistor elements. When no input is impressed, the emitter bias (with respect to base) is adjusted slightly positive. The bias voltage is the difference between that of the emitter battery and the voltage drop across the base resistor.

As with a tube multivibrator, this circuit has two stable conditions. When either transistor is blocked, the other conducts heavily. For example, let TR1 be blocked. Then a relatively large negative voltage exists on COL1. A portion of this voltage is fed through a voltage divider to B2. This is equivalent to a large positive bias on EM2. Therefore TR2 conducts heavily and its collector voltage drops sharply from its high negative voltage. A positive pulse is transmitted to B1 through the voltage divider. This maintains TR1 in a cutoff condition.

The trigger signal to the multivibrator is a series of thin positive square waves. These are differentiated, then impressed on B1. Each differentiated square wave gives rise to a sharp positive pulse followed by a negative one.

Assume that initially TR1 is the conducting transistor and TR2 is blocked. The first positive pulse blocks TR1, and, as previously explained, it permits the

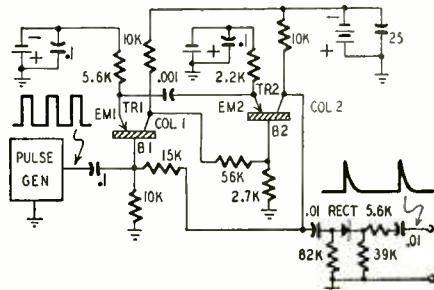
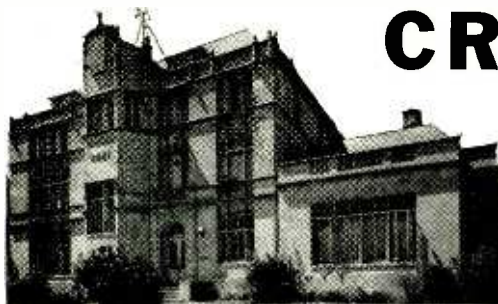

Fig. 1—Multivibrator counter circuit.

RADIO-ELECTRONICS for



CREI Prepares Young Men
for Professional Careers
with Industry-Recognized
Training in a
Minimum of Time

RADIO-ELECTRONICS TELEVISION ENGINEERING

Graduates of the Capitol Radio Engineering Institute residence school are preferred by industry because of their training and ability. This recognition is the reason that CREI men quickly find good jobs in radio-electronics-television engineering.

With 24 years of practical teaching experience in these highly technical fields, CREI offers an outstanding faculty, modern and complete laboratories, shops and equipment in Washington, D. C.

New students are accepted twice monthly and each may advance as rapidly as he is capable. The basic courses require an average of 21 months to complete, depending on the ability of the individual.

CREI is recognized as one of the country's leading technical institutes.

Its work is of college level. It prepares Young men for good jobs in the giant electronics industry in a minimum of time. To insure your profitable, interesting career, ACT NOW! Send today for free catalog.

MAIL COUPON FOR FREE CATALOG

Capitol Radio Engineering Institute, Dept. 309C
16th & Park Rd., N. W., Washington 10, D. C.

Please send me your residence school catalog and details. (If interested in Home Study check below.)

Name Age

Street

City Zone State

Send information on Home Study Courses.

3 Important Rauland Policies

...Are they
paying off for you?

1 Did you know that Rauland's Replacement Picture Tube Warranty and Adjustment Policy provides a 6 months warranty from the date of purchase by the consumer? And that all Rauland replacement tubes now carry a triple registration card providing protection for jobber, dealer and consumer?

2 Did you know that Rauland provides a full 120-day price protection on distributor inventory of replacement picture tubes? That Rauland distributors can carry a stock adequate for their territories without risk of loss through price adjustment?

3 Did you know that Rauland offers valuable premium points for the prompt return of warranty registration cards? Each card returned promptly entitles dealer and distributor to premium points redeemable in valuable merchandise prizes.

If you have not received full details on all of the above, write, phone or wire your distributing contact on Rauland tubes. If you have not received your prize merchandise catalog, use the coupon below today.

THE RAULAND CORPORATION



Perfection Through Research

4245 N. KNOX AVE. • CHICAGO 41, ILLINOIS



The Rauland Corporation
4245 N. Knox Ave., Chicago 41, Illinois

Please rush premium merchandise catalog and full information on:

Earning Premium Prizes 6 Months Warranty
 Distributor Price Protection

Name _____

Address _____

City _____ State _____



C-D's Tiny Mike

—the ceramic with the million dollar body!

Never before such uniformity, such dependability in ceramic capacitors! TINY MIKE is C-D through and through. Even the ceramic body is made by C-D, in its brand new ceramic body plant, electronically controlled at every stage!



Write for Catalog Dept. RC-91,
Cornell-Dubilier Electric Corp.
South Plainfield, N. J.

CONSISTENTLY DEPENDABLE CORNELL-DUBILIER CAPACITORS

Plants in South Plainfield, N. J., New Bedford, Worcester and Cambridge, Mass.; Providence, R. I.; Indianapolis, Indiana; Fuquay Springs, North Carolina, and subsidiary, The Radiart Corporation, Cleveland, Ohio.

**Free NEW
BIG RADIO
CATALOG**



Ready now. Complete with everything in radio, television and electronics. Newest parts, as well as old, standard lines. Paste coupon on penny postcard and mail today!

Lafayette Radio

DIVISION: RADIO WIRE TELEVISION, INC.

NEW YORK 13 100 Sixth Ave. NEWARK 2 24 Central Ave. BOSTON 10 110 Federal St. BRONX 58 542 E. Fordham Rd.

LAFAYETTE RADIO,
Dept. JI-1
100 Sixth Avenue, N. Y. 13

Please rush Free catalog to:

Name

Address

City State

PASTE ON PENNY POSTCARD

other transistor to conduct. Additionally, a positive pulse is initiated on EM1 when its current disappears. This pulse is transmitted through the coupling capacitor to EM2 and then it gradually decays. As long as it exists, however, it maintains TR2 conduction and keeps TR1 blocked. This condition lasts until after the arrival of the negative pulse from the differentiating network.

The second trigger signal now arrives. Its differentiated positive pulse can accomplish nothing, since TR1 is already blocked. The negative pulse which follows permits this transistor to conduct and TR2 returns to conduction.

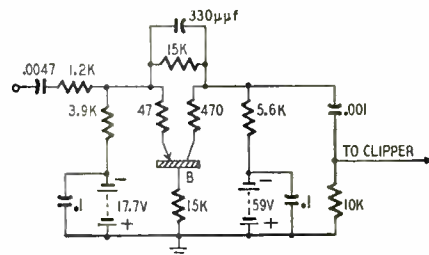

Fig. 2—Transistor in flip-flop circuit.

Output from COL2 passes through a clipper. This first differentiates the voltage, then rectifies it. The result is one positive pulse for each pair of trigger pulses.

The circuit shown in Fig. 2 also has two states of equilibrium, although it needs only one transistor. Of course it does not have the gain of the previous circuit but it can be used where the trigger pulses have relatively large amplitude. This flip-flop circuit was designed by Everett Eberhard (Patent No. 2,533,001).

As before, a differentiating network provides a positive pulse followed by a negative one for each trigger signal. The positive pulse raises the bias on the emitter and permits current flow in the collector circuit. Conduction is aided by positive feedback as follows: More current flows through the base resistor, thus increasing emitter bias. Also, the rapid rise of collector current gives rise to a positive pulse through the coupling capacitor to the emitter. A large positive emitter bias exists until after the arrival of the input negative pulse.

As for the next trigger signal, its positive pulse maintains conduction in the transistor. Then the negative pulse blocks the emitter. As in the case of the multivibrator, this flip-flop provides one output pulse for each pair of trigger signals.

The low resistances (47 and 470 ohms) in the emitter and collector are current-limiting resistors. They may be dispensed with if desired.

An important application for these two circuits is for counting pulses. Each stage has a 2:1 reduction ratio. Several stages may be connected in series as desired. It is not possible to obtain decade counting or a 10:1 reduction ratio directly, since 10 is not an integral power of 2. However, feedback may be added in the circuit for this purpose.

—end—

MOST COMPLETE BOOK OF ITS KIND —a “Must” for TV-Radio Servicemen!

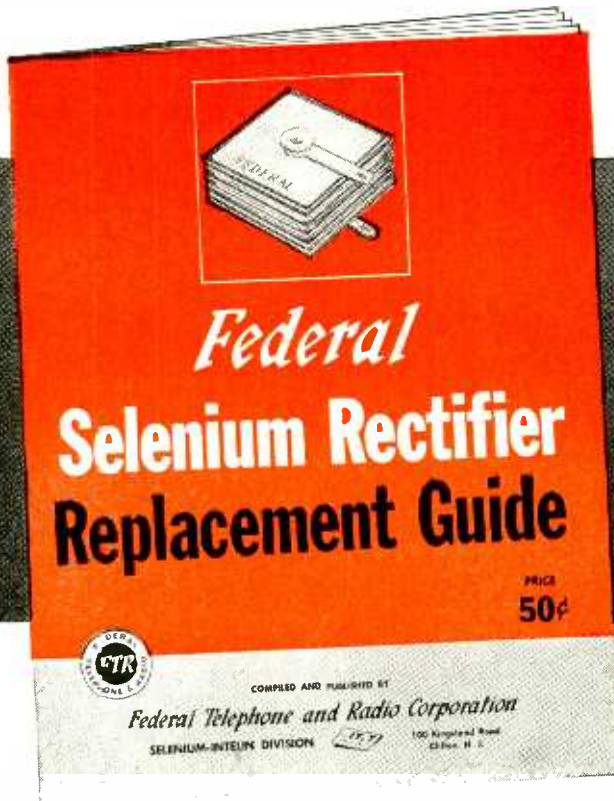

**Simplifies and Speeds
the Replacement of**

SELENIUM RECTIFIERS In TV and Radio Sets

**COVERS OVER 20,000,000
UNITS ALREADY INSTALLED**

Millions more being added yearly!

A VALUABLE GUIDE PLUS HANDBOOK

—packed with authoritative, up-to-the-minute data on how to service the growing, profitable Selenium Rectifier Replacement Market!

Important sections in this new book include:

- ★ TV replacement part numbers and corresponding Federal numbers
- ★ Radio replacement part numbers and corresponding Federal numbers
- ★ Operating characteristics of Federal selenium rectifiers
- ★ Fundamental circuits using Federal selenium rectifiers
- ★ How to replace a 35Z5 with a Federal 100 Ma selenium rectifier
- ★ “Packaged Power” for engineering your own AC to DC power conversion

Order one or more copies now—from your Federal Distributor

**America’s Oldest and Largest Manufacturer
of Selenium Rectifiers**

Federal
Telephone and Radio Corporation

SELENIUM-INTELIN DIVISION • 100 Kingsland Road, Clifton, N. J.

In Canada: Federal Electric Manufacturing Company, Ltd., Montreal, P.Q.
Export Distributors: International Standard Electric Corp., 67 Broad St., N. Y.

SEPTEMBER, 1951

FEDERAL’S Selenium Rectifier Replacement Guide is a book the servicing industry has been waiting for. A copy should be on *every* TV-radio workbench!

Since 1946, when Federal pioneered and introduced the miniature selenium rectifier, the use of this versatile component by leading set makers has grown tremendously . . . a huge replacement market potential has been created. Now this fact-filled book tells how to service it quickly, easily, effectively and profitably.

Get your copy without delay, Mr. Serviceman. You’ll be ready to tell at a glance the *right* selenium rectifier to use for *any* job. And remember: It pays to replace with the best . . . to insist on *Federal* . . . the *original* miniature selenium rectifier. Use the handy coupon below:

MAIL To Your FEDERAL Distributor

To My FEDERAL Distributor: F-663

Name _____

I am enclosing \$_____ to cover the cost of _____ copies (at 50¢ per copy) of the Federal Selenium Rectifier Replacement Guide.

Name _____

Company _____

Address _____

City _____ Zone _____ State _____

How To Prepare for COLOR TELEVISION

By
Milton S. Kiver

Internationally
Famous Author of
"Television Simplified"
and other TV Books



CAN YOU AFFORD TO WAIT ?

The recent Supreme Court decision, in favor of the C.B.S. Color TV System shows that **color television is here!** Trained television technicians capable of servicing the complex black-and-white sets and the even more complex color television circuits will be the ones who will command respectable positions and high salaries as color TV grows.

The radioman of today who recognizes this growing demand for trained television servicemen . . . who acts by preparing himself now with the proper training and information . . . is the man who is insuring his future. You just cannot afford to waste time!

PROPER TRAINING: A KEY TO SUCCESS

Every practical man knows that to learn TV servicing the right way, you have to do actual TV servicing. You have to know how to locate troubles quickly . . . repair them efficiently. Some men are fortunate enough to be able to attend school. A good many others cannot leave their jobs and so must get whatever they can at home. Fortunately, there is a training program available that teaches you television servicing in a practical, learn-by-doing way.

It's a home study program in which you learn up-to-date practical, professional television servicing in your spare time—without leaving your present job. Included in this course is information on testing, trouble-shooting, repairing and servicing of all types of TV sets plus set conversion, master antenna installation, printed circuits and many field servicing short cuts. In addition, a complete section on Color TV is also included. As developments take place in Color TV, this section will be expanded accordingly, to give you all the latest facts.

PRACTICAL EXPERIENCE IS ESSENTIAL

To give you the experience you need, you build and service a modern large screen television receiver which is furnished as part of the course and which is yours to keep. As an *optional* feature, you can get two weeks of actual field experience going out on service jobs and working on the repair bench for Chicago's largest independent television servicing organization. So practical is this course that after the first few lessons you can start earning money doing actual television servicing!

You can get complete information on this practical television servicing course as well as sample lessons. Just write **Television Communications Institute, 205 W. Wacker Dr., Dept. RE-4, Chicago 6, Ill.**

Dr. C. J. Breitwieser joined P. R. MALORY & Co., INC., Indianapolis, as executive assistant to



Dr. C. J. Breitwieser

Dr. F. R. Hensel, vice-president of engineering. Dr. Breitwieser was formerly chief of electronics and head of the engineering laboratories at Consolidated Vultee Aircraft Corp.

Carl E. Smith, former supervisor of equipment sales service for the radio tube division, SYLVANIA ELECTRIC PRODUCTS INC., was appointed supervisor of factory sales service. Luther C. Henrichs, former sales account specialist for the division, succeeds Mr. Smith. Sylvania also announced the appointment of W. Benton Harrison, Jr. as treasurer of the corporation. Mr. Harrison came to Sylvania from the General Aniline & Film Corp.



C. E. Smith

L. B. Calamaras was promoted to the post of executive vice-president of the NATIONAL ELECTRONIC DISTRIBUTORS ASSOCIATION (NEDA) under a new five-year contract. He had been secretary since 1944. In his new position Mr. Calamaras will represent NEDA in all Government activities. He will also work on the development of a weekly Washington letter for NEDA members.

Gordon Groth joined the ERIE RESISTOR CORP., Erie, Pa., as executive vice-president. Mr. Groth was previously president of the Electra Manufacturing Co. In his new position he will be responsible to G. Richard Fryling, president of Erie Resistor, for all phases of the company's activities.



G. Groth

Dr. Robert D. Huntoon was appointed associate director of the NATIONAL BUREAU OF STANDARDS in charge of the Bureau's newly-established Corona Laboratories near Corona, Cal. Dr. Huntoon was formerly chief of the NBS Atomic and Radiation Physics Division. The Corona Laboratories will be concerned with various phases of electronic research, development, and engineering.

Louis Kahn was appointed expert consultant on components on the Panel of Components and chairman of the Capacitor Sub-Panel, Research and Development Board for the Armed Forces. Mr. Kahn is director of research for AEROVOX CORP., New Bedford, Mass. and a director of AEROVOX CANADA, LTD.

**TWIN-
TRAX*
TAPE
RECORDERS**



...give you more

MORE MODELS

the most complete variety of recorders for professional, semi-professional and experimenter use.

MORE FEATURES

for better quality, smoother performance and easier operation.

MORE VALUE

because our direct sales policy saves you dealer markups.

Send today for our catalog 5109 which lists complete technical specifications and performance ratings for all recorder models and accessories. *Trademark Reg.

AMPLIFIER CORP. OF AMERICA

398 Broadway New York 13, N. Y.

SURPLUS TRANSMITTER

(Item 60) Type SCR 578, portable. Only 18 lbs. Ideal for boats, Hams, etc. Crank operated generator produces ample current to send Morse code built-in hand key, blinker light or continuous, automatic SOS. 500 KC. mek. Can be converted to power transmitter. Contains hundreds of valuable parts. Built in antennae and ground. Slightly used for training. Complete instruct. and Morse code incl. Cost, govt. over \$200. **\$18.95**
Terrific value



Prices f.o.b. Chicago area.

10 day Money back guarantee. Send check or M. O.
MASTER MECHANIC Mfg. Co., Dept. 62, Burlington, Wis.

WANTED TO BUY

Large and small quantities of new or used electronic government or manufacturers' surplus tubes and equipment. Highest prices paid. State quantity, condition and best price in first letter.

Box No. F-2 c/o Radio-Electronics
25 West Broadway
New York 7, N. Y.

AUTOMATIC M-90 AUTO RADIO



- Six Tube Superheterodyne • Three Gang Condenser • Powerful, Long-Distance Reception • Fits All Cars, Easy Installation
- Mounting Brackets Included
- 6 Tube model M90 ***\$33.87**
*Above price includes Federal Excise Tax
Approx. shipping weight (11) eleven pounds.

MAIL US YOUR ORDERS

All orders filled within 24 hours.
Standard Brand tubes 50% off list

Bill Sutton's Wholesale Electronics
Fifth at Commerce Fort Worth, Texas



Sensationally NEW for 1952!
MIDWEST TELEVISION



A Magnificent New Line of Beautiful CONSOLES and Complete CHASSIS featuring the Mammoth

20-Inch
 RECTANGULAR
 PICTURE TUBE

FACTORY-TO-YOU



THE New 1952 MIDWEST "VIDEO GRAND"

20-Inch
 TELEVISION-
 RADIO-PHONO
 CONSOLE

In addition to its mammoth 20-Inch Rectangular Picture, this luxurious instrument offers a powerful, long-distance A.M.-F.M. Radio plus the newest-type 3-Speed Automatic Intermix Record-Changing Phonograph.

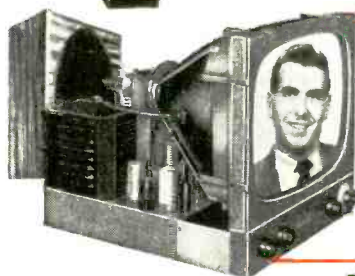

MIDWEST
 20-Inch
 TELEVISION
 CHASSIS
 and SPEAKER
 —for easy installation
 in your own cabinet.



30 DAYS TRIAL New 1952 MIDWEST "CONSTELLATION" 20-Inch TELEVISION CONSOLE

Also—Powerful New 1952 World-Ranging
MIDWEST Series of RADIOS
 For Beautiful Consoles and Complete Chassis



An entirely new line of radios featuring the powerful Series 16 five wave band A.M.-F.M. Radio Chassis and the magnificent Symphony Grand Radio-Phonograph with 3-Speed Automatic Intermix Record Player.

Easy Terms

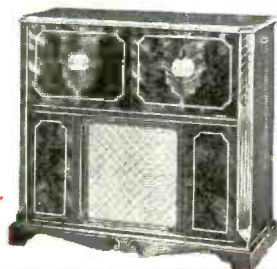

WRITE or PHONE
 For This NEW 1952
FREE MIDWEST
TELEVISION
RADIO CATALOG



If You Live In One of These Cities
 Phone and Ask for Your Catalog

- NEW YORK Murray Hill 2-6810
- CHICAGO State 2-5600
- PITTSBURGH Grant 1-0609
- CLEVELAND Prospect 1-7450
- DETROIT Woodward 3-1233
- ST. LOUIS Grand 1161
- PHILADELPHIA Locust 4-1035

or Send Coupon Below

WRITE IN NAME AND ADDRESS (PLEASE PRINT) ON COUPON OR 1c POSTCARD

MIDWEST RADIO & TELEVISION CORP.
 Dept. 382, 909 BROADWAY • CINCINNATI 2, OHIO

Please send me your new FREE 1952 Catalog.

NAME _____

ADDRESS _____

CITY _____ ZONE _____ STATE _____

MIDWEST RADIO & TELEVISION CORP.
 DEPT. 382, 909 BROADWAY, CINCINNATI 2, OHIO

WHEN Demanding THE BEST ...

DEMAND PENN TV ANTENNA MOUNTS

Universal Base Mount BMA-136
 Designed and sturdily constructed for most type roofs. Cadmium plated nuts & bolts, plus patented locking bearing and tongue, secure mast in any position. Takes masts from 3/4" to 1 1/2".



Write today for complete information on the Penn TV line.

PENN TELEVISION PRODUCTS CO.
 3336-38-40 Frankford Ave., Phila. 34, Pa.

Solomon Zimmerman joined the development engineering staff of the JFD MANUFACTURING CO., INC., Brooklyn, N. Y. Mr. Zimmerman, a veteran in the radio-television industry, was previously with the Product Engineering Division of the Teletone Radio Corp.



S. Zimmerman

William C. (Bill) Grunow, founder of the GRIGSBY-GRUNOW Co., original manufacturer of Majestic radio sets, died of a heart attack in Chicago on July 6. He was 58 years old.

Personnel Notes

... Wayne Coy was approved as chairman of the FCC for a new seven-year term.

... Lieut. Gen. Albert C. Wedemeyer joined the AVCO MANUFACTURING CORP. as a vice-president and director upon his retirement from the Army on July 31.

... Edmund C. Berkeley, actuary and engineer, was elected to the Board of Directors of the VIDEO CORP. OF AMERICA, New York City. Mr. Berkeley is the author of the series of articles on the "Electronic Brain" now running in RADIO-ELECTRONICS.

... Ovid Riso was appointed vice-president in charge of advertising for the PHILCO INTERNATIONAL CORP. He has been with the company since 1944 and is a member of the management committee.

... E. L. Hulse, former comptroller of GENERAL ELECTRIC Co.'s Electronics Department, was appointed manager of the newly formed Components Division.

... Edmund T. Morris, Jr., former assistant to the vice-president and manager of the Electronics and X-Ray Divisions of WESTINGHOUSE ELECTRIC CORP., was appointed director of the Electronics Division of the NATIONAL PRODUCTION AUTHORITY. He continues to serve as chairman of the Electronics Board at the Defense Production Administration.

... Matthew Mandl and Edward M. Noll joined the TV engineering staff of the SNYDER MANUFACTURING Co., Philadelphia, on a full-time basis. Both had been previously associated with the company as consultants. They are recognized as experts in the antenna field and have contributed frequent articles to RADIO-ELECTRONICS.

... Sidney J. Mass, former director of advertising and sales promotion, was appointed sales manager of the JERROLD ELECTRONICS CORP., Philadelphia. Edmund D. Lucas, Jr., formerly with Philco, joined Jerrold as manager of advertising and public relations.

—end—

Consecrated to Quality Output and Golden Rule Service

ASTRON

Write for catalogue

Fixed Capacitors and RF Interference Filters

ASTRON CORPORATION — 255 Grant Ave., East Newark, N. J.

Every RADIOMAN can use these SERVICE HINTS!

Valuable Manual Yours—FREE Write today—no obligation.

Every page of "How to Simplify Radio Repairs" is packed with on-the-bench, practical ideas.

FEILER ENGINEERING CO. Dept. 9RC-1
 8026 N. Monticello Ave., Skokie, Ill. (Suburb of Chicago)

New Equipment for an Old Objective... QUALITY



Planet's new winding room is a good example of quality control at its best. These spacious, well-lighted facilities, equipped with modern, high-speed machines, permit maximum output with minimum loss.

From start to finish each Planet capacitor is made under just such ideal conditions. And only after 100% testing does it leave the plant. That's why each unit is backed up by a full year guarantee!

For complete information send for free catalog C-2

PLANET MANUFACTURING CORPORATION
 225 Belleville Avenue, Bloomfield, N. J.



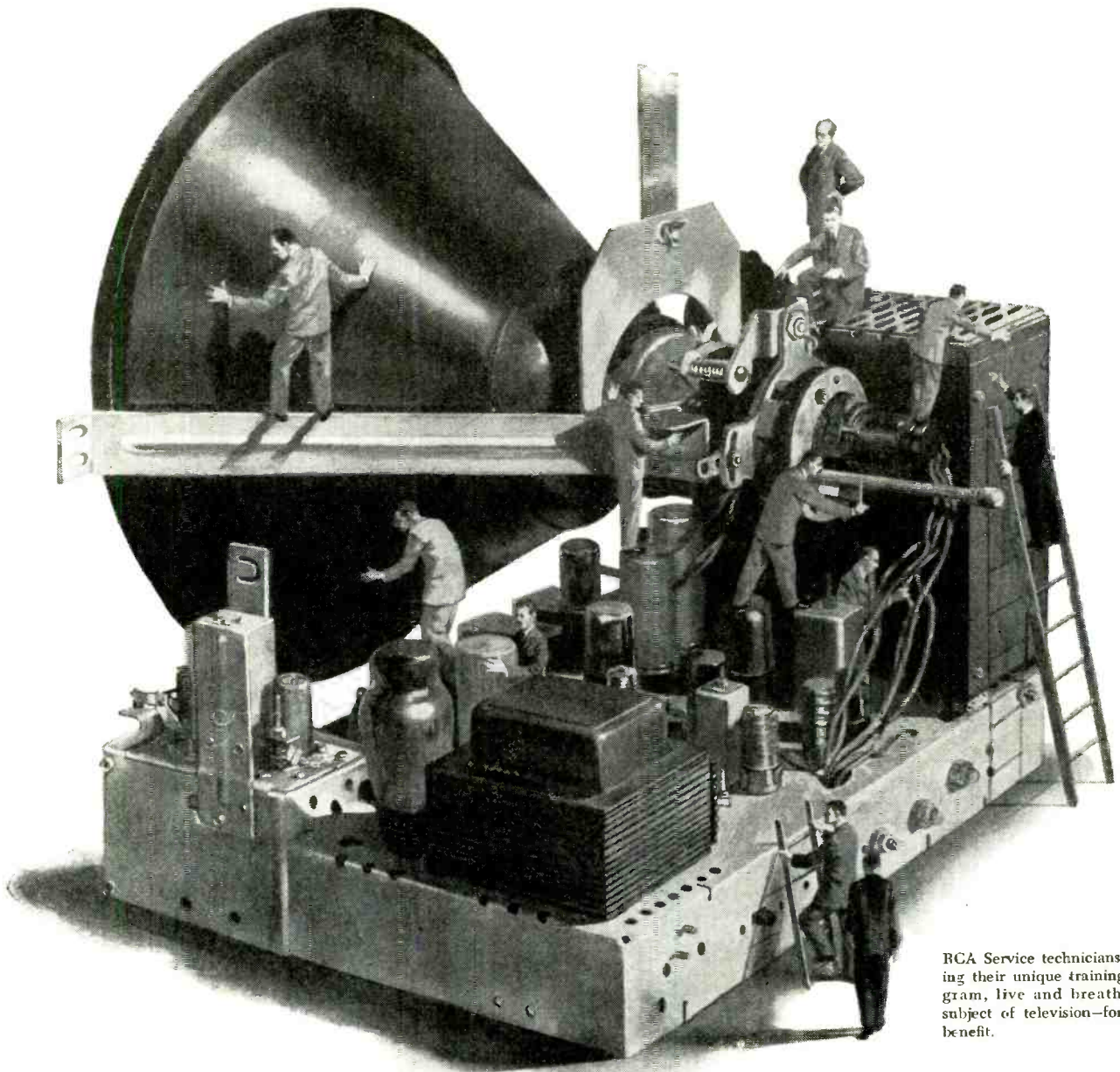

RCA Service technicians, during their unique training program, live and breathe the subject of television—for your benefit.

These men get TV's Inside Story

When you buy a fine television receiver, correct installation and maintenance are as important as the set. For service technicians, RCA has developed the only training program of its kind—a *factory* program.

During their studies, these men learn the basic facts of modern, all-electronic TV...how it reached its present perfection by research at RCA Laboratories...how to build a television receiver...how to select and install the right antenna for your home

...all the complexities of kinescopes, electron guns, tubes, television cameras and transmitters.

When their studies are complete, they have a grasp of television's *inside story* that assures you the most perfect installation and maintenance possible—under your RCA Victor Factory-Service Contract.

See the latest wonders of radio, television, and electronics at RCA Exhibition Hall, 36 West 49th Street, N. Y. Admission is free. Radio Corporation of America, RCA Building, Radio City, N. Y. 20, N. Y.



Get all the performance that's built into your new RCA Victor home television receiver through an RCA Victor Factory-Service Contract.



RADIO CORPORATION of AMERICA

World Leader in Radio — First in Television

America's Newest High Gain All Band Television Antennas

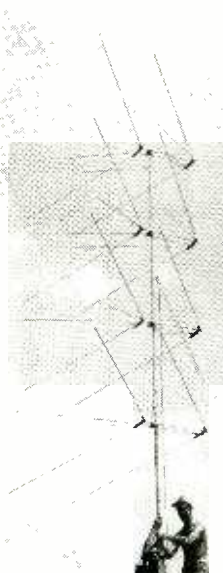

- ONE LEAD IN
-
- RUGGED
-
- DURABLE
-
- ALL ALUMINUM
-
- MORE DETAIL
-
- LESS SNOW
-
- HIGH GAIN
-
- ALL BAND
-
- EASY TO INSTALL
-
- LESS INTERFERENCE
-
- QUALITY THROUGHOUT

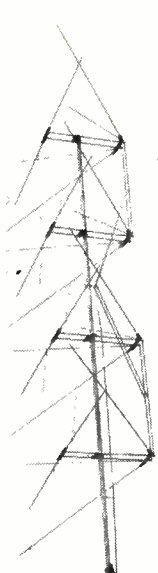

A new line of high gain, all band television antennas that have been tested in the deep fringe areas and have proven to outperform all others. They are twin driven and offer two bay performance per single bay. The elements are long and provide high gain throughout the entire television spectrum.

DISTRIBUTORS—MANUFACTURERS AGENTS—CONTACT
KAY-TOWNES ANTENNA CO. ROCKMART, GA.

DUAL POWER SUPPLY

Power supplies delivering approximately 300 volts are handy for checking and aligning radios while awaiting the arrival of a new power transformer or vibrator. The supply shown in the diagram is designed to operate from 117 volts a.c. in the shop or a 6-volt d.c. source when servicing battery-powered amplifiers and radios away from power lines.

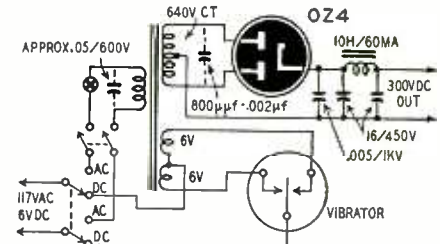

The unit uses a power transformer with two 6-volt filament windings. These are connected in series-aiding and are used as the low-voltage primary. The ends of the series-connected windings are connected to the contacts on the vibrator. A buffer capacitor should be added to minimize sparking at the vibrator contacts. The buffer may be connected across the 117-volt primary or the high-voltage secondary windings. Typical values are shown on the diagram. Connect a d.c. ammeter in series with one lead from the battery and use the capacitor which gives the lowest line current. Always remove the vibrator when using the supply on a.c.—A. Ivanivsky

NOVEL B.F.O. CIRCUIT

There are a number of multi-band broadcast receivers which cover one or more of the amateur bands. Many can be modified for c.w. reception with the simple b.f.o. circuit used in the Halli-crafter S-38B receivers.

A single 470-ohm resistor and a s.p.d.t. switch is added to the circuit of the i.f. amplifier as shown in the diagram. When the switch is in the CW position, the i.f. amplifier oscillates because of feedback from plate to grid through C1 and C2 in series. The a.v.c. line is grounded through the 470-ohm resistor to prevent the oscillations from increasing the a.v.c. voltage and reducing the gain of the receiver. In the PHONE position, C1 and C2 are grounded at their junction and the set operates normally. C1 and C2 may be ceramic capacitors of 1 µf or so or they may be two or three turns of insulated wire wrapped around the leads to plate and grid of the i.f. amplifier tube.

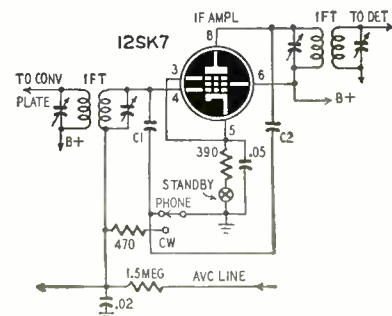

RADIO-ELECTRONICS for

TUBES Price - Slashed! Receiving & Transmitting

RMA Guaranteed—All Standard Brands			
3EP1 \$ 5.39	OZ4 \$.59	7C4/1203A .89	TV PICTURE TUBES BLACK FACE
3HP7 3.49	1R5 .89	12AT7 1.19	10BP4 \$22.50
5FP14 16.99	5U4 .79	12AU7 1.19	12LP4 23.50
7BP7 7.89	5Y4 1.39	12BH7 1.19	14BP4 24.50
7CP1 12.49	6AC7 .49	12SA7 .79	16GP4 32.50
803 2.49	6AG5 1.29	12SK7 .79	16HP4 32.50
805 2.99	6AL5 .79	12SQ7 .69	17BP4 32.50
885 1.29	6AU6 .79	35A5 .98	19AP4 36.50
905 2.29	6BC5 .89	35L6 .89	20CP4 39.50
954 .29	6BG6 1.89	35W4 .69	24AP4 74.50
1624 1.49	6BN6 1.39	35Y4 .89	
1629 .35	6BQ6 1.59	35Z5 .59	
7193 .29	6K7 .59	50A5 .98	
8020 1.25	6SA7 .69	50B5 .98	
GL471A 2.75	6SN7 1.09	50L6 .75	
	6V6 .89		

SPEAKERS

All Alnico V—Priced Extra Low

4" PM	\$1.59
5" PM	1.69
4" x 6" PM	1.79
6" PM	1.89
6" 62 ohms with output trans.	2.79
4" x 6" 1,500 ohm	\$1.69
8" Auto 4-6 ohm	2.89
8" PM	3.25
12" PM	6.69

SPECIAL OFFER!
 DEDUCT 5% from the price of any speaker in lots of 10 or more. Can be assorted.

630 SUPER CHASSIS

30-Tubes—Licensed by RCA



- High efficiency high voltage circuit
- For all picture tubes up to 24"
- Keyed AGC • Automatic brightness control
- Special extra high gain standard coil tuner
- Complete, ready to play
- Including all hardware & knobs. \$139.95 (less CRT)

FREE! Set of brackets for tube with any TV chassis!
 630 DX Chassis—3 times normal reception—designed expressly for fringe areas. Needs no complicated booster or antenna. \$159.97 (less CRT)

GENUINE MOLDED CONDENSERS

Fresh Stock—All Mineral Oil Filled—100° Centigrade—Meets Jan. CBI Tests All 600 Volts

Cap.	Per 10	Per 100
.001	\$.79	\$ 6.90
.002	.79	6.90
.005	.79	6.90
.01	.89	7.90
.02	.89	7.90
.05	1.09	9.90
.1	1.25	11.50

ELECTROLYTIC CONDENSERS

	Ea.	Lots of 10
20 x 20—150V.	\$.39	\$3.70
40 x 40—150V.45	4.30
50 x 30—150V.45	4.30
25—25V.19	1.50
20—250V.29	2.59
8—450V.39	3.69
10—450V.39	3.69
16—450V.59	5.69

All Guaranteed Fresh Stock!

Minimum order: \$5.00. 25¢ deposit with order, balance C.O.D. Include postage with order. All merchandise subject to prior sale. P.O.B. New York, N. Y.



98 Park Place Dept. E9 New York 7, N. Y. Cortland 7-6195

Just Out

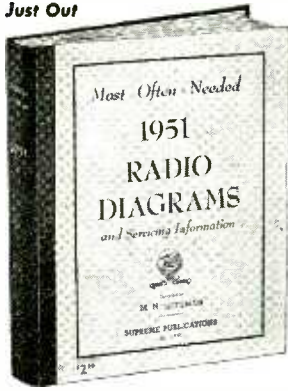

New SUPREME 1951 Radio Manual

GET IT AT YOUR RADIO JOBBER OR ORDER BY MAIL

Now you can benefit and save money with Supreme amazing scoop of 1951. This one giant volume has all the service data you need on all recent radio sets. A full year of models on all popular makes, home and auto sets, portable radios, combinations, changers, all included. The full price for this mammoth 1951 manual is only \$2.50, nothing else to pay, nothing else to buy for a whole year. Again Supreme Publications

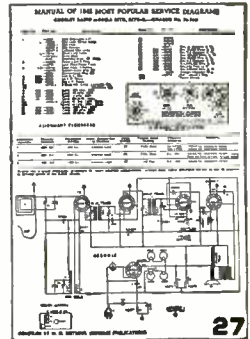

New 1951 Manual
Be prepared to repair quickly all new 1951 radio receivers. In this big single volume you have clearly-printed, large schematics, needed alignment data, replacement parts lists, voltage values and information on stage gain, location of trimmers, and dial stringing, for almost every recently released set. Makes toughest jobs amazingly easy. Find all faults in a jiffy. Speed-up all repairs. The time saved on your next job will pay the \$2.50 bargain price for the complete manual — after that you use it FREE. A worthy companion to the 10 previous volumes used by over 131,000 shrewd and experienced radio men. Giant size 8½" x 11", 192 pages; index Manual - style, **\$2.50** sturdy binding. Price, only.....

SERVICE MATERIAL ON THESE MAKES:

- R.C.A., Zenith, Philco, Sears, Nash, Emerson, Arvin, Hoffman, Crosley, G.E., Westinghouse, Stewart-Warner, Admiral, Delco, Stromberg-Carlson, Wards, Motorola, Bendix, Olympic, Western Auto, and many others.

beats all competition and gives you the greatest bargain in radio service information. Other Supreme radio service volumes for previous years (mostly at \$2) and TV manuals are described below. Available at your radio jobber or by mail on no-risk 10-day trial.

A typical page from any Supreme Publications Radio or TV Manual is extra large in size (8½ x 11 inches), and is well printed on heavy, 60-pound paper. It contains a complete schematic diagram, easy-to-follow instructions for alignment, voltage comparison charts, parts lists, and other facts needed for fast trouble-shooting and simplified repairs. Supreme Publications give more useful on-the-job information for the lowest cost.

SUPREME TELEVISION MANUALS

MOST AMAZING MONEY-SAVING BARGAIN

The television series manuals are the most remarkable values offered by Supreme Publications in their 18 years of business. These TV manuals at only \$3 and \$2 each are amazing bargains and defy competition. There is nothing else like them. Each manual is a virtual treatise on practical television repairs. By normal standards, each such large manual packed as it is with practical facts, hundreds of illustrations, diagrams, charts, photographs, and expensive extra-large blueprints, should sell for \$10—but as SUPREME special values they are priced at \$3 and \$2 each. Only a publisher who sold over one million TV and radio manuals can offer such amazing bargains based on tremendous volume-sales.

New 1951 TV Manual, Just Out

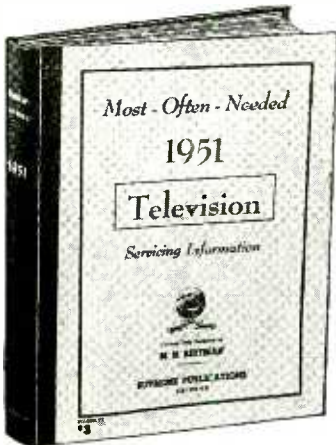

New 1951 TELEVISION manual contains complete service data on all popular present-day television sets of all makes. Gives description of modern circuits, test patterns, response curves, oscilloscope waveforms, alignment tables, service hints, diagrams in the form of double-spread blueprints, test points, voltage charts, etc. Large size: 8½ x 11 in., manual style binding, flexible covers, at your jobber or by mail, only..... \$3

1951 TV. New giant volume of 1951 television factory data, gives you everything you need to repair and adjust all present day TV sets. There are easy-to-follow circuit explanations, 192 pages of alignment procedures, many test patterns, response curves, waveforms, voltage charts, hints and dozens of mammoth double-page workbench diagrams. Only... \$3

1950 TV Manual. Includes service data on all popular makes from Admiral to Zenith. Large size + 10 blueprints, 11x15". Available at your jobber or ppd., only... \$3

1949 TV Manual. Similar to volume listed above. Has 160 large pages, plus 9 giant blueprints, only... \$3

1948 TV Manual. Earlier volume has material on all popular sets of this period. Eight fold-out blueprints. Remarkable value at only..... \$3

1947 F.M. and TV Manual. Covers popular F.M. and TV sets. Data on 192 pages, 8½ x 11". Only... \$2

SUPREME RADIO MANUALS for PREVIOUS YEARS



1950 1949 1948 1947 1946 1942 1941 1940 1939 1926-1938
SUPREME Most-Often-Needed RADIO DIAGRAMS
Each Manual only \$2 ('50, '49, \$2.50); 192 pages of diagrams, alignment data, voltage, values, parts lists, and service hints; large size, 8½" x 11". To order, see coupon below. **RADIO DIAGRAMS 240 PAGES PRICE \$2.50**

CUT SERVICE TIME and SIMPLIFY ALL REPAIRS

You can speed-up and simplify all radio repairs with Supreme Publications Manuals. Service all radios faster, better, easier, save time and money, use these most-often-needed diagram manuals to get ahead, earn more per hour. For the remarkable bargain price (only \$2 for most volumes) you are assured of having in your shop and on the job, needed diagrams and other essential repair data on 4 out of 5 sets you will ever service. Every popular radio of all makes from old-timers to new 1951 sets is covered.

Clearly printed circuits, parts lists, alignment data, and helpful service hints are the facts you need to improve your servicing ability. Save hours each day, every day, begin to earn more by making repairs in minutes instead of hours.

BIGGEST VALUES IN SERVICE DATA

Here is your lowest-priced service information. There is no need to spend large sums for bulky, space-wasting manuals, or to buy additional material every few weeks, be wise use SUPREME Manuals to get the most in diagrams and service data for the smallest cost. Rush coupon today and try these manuals for 10 days at our risk.



Compiled by M.N. Beltman, radio engineer, teacher, author, and serviceman.

NO-RISK TRIAL ORDER COUPON

SUPREME PUBLICATIONS, 3727 W. 13 St., Chicago 23, ILL.

Send manuals checked below and at right. You guarantee complete satisfaction or money back.

- New 1951 Television Service Manual... \$3
- 1950 Television Manual, \$3. 1949 TV, \$3.
- 1948 TV, \$3. 1947 TV & FM, only \$2.

- I am enclosing \$..... Send postpaid.
- Send C.O.D. I am enclosing \$... deposit.

Name:

Address:

- RADIO Diagram Manuals
 - New 1951 Manual, \$2.50
 - 1950 Radio
 - 1949 Manual } **\$2.50**
 - 1948
 - 1947
 - 1946
 - 1942
 - 1941
 - 1940
 - 1939
 - 1926-1938 Manual, \$2.50
- PRICED AT ONLY \$2 EACH**

Supreme Publications

Sold by all Leading Radio Jobbers

NO SHADOWS

with new DUAL SPOTLIGHT Soldering Gun

Pull the trigger of your new light-duty Weller Soldering Gun, and instantly twin spotlights focus on the job—banish every shadow. Five seconds later the tip is at soldering heat! No waiting. No wasted current. This streamlined 135-watter—newest of the famous Weller line—is fast! Built compactly for working in crowded chassis, too. And the time and power you save pays for your Weller Gun in a few months.

New 135-Watt Weller Soldering Gun

Specially Designed for TV and Radio Work

- **DUAL SOLDERLITE**—Two prefocused spotlights completely eliminate shadows.
- **OVER/UNDER DESIGN**—Tube construction braces tip and improves visibility.
- **5-SECOND HEATING**—Pull the trigger and you solder!
- **LONGER REACH**—Slides easily into deep chassis; reaches the tightest corners.
- **GREATER CAPACITY**—Smaller, lighter, with greater soldering capacity.
- **TRIGGER-SWITCH CONTROL**—Adjusts heat to the job. No need to unplug gun between jobs.
- **DUAL HEAT**—Single heat 100 watts; dual heat 100/135 watts; 120 volts; 60 cycles. Handles all light-duty soldering.

See new Models WS-100 and WD-135 at your distributor, or write for bulletin direct.

• **SOLDERING GUIDE**—Get your new copy of "Soldering Tips"—revised, up-to-date, fully illustrated 20-page booklet of practical soldering suggestions. Price 10¢ at your distributor, or order direct.

WELLER

ELECTRIC CORP.

Packer Street, Easton, Pa.



NOVEL TONE CONTROL FOR RECEIVERS OR AMPLIFIER

A novel audio amplifier which incorporates inverse feedback and a low-pass filter type tone control is used in the G-E model 303 table radio-phonograph. The phonograph uses a variable-reluctance pickup working into a standard preamplifier (not shown in the diagram). Approximately 1/2 watt of power is developed across the voice coil when .05 volt at 400 cycles is fed into the high side of the volume control. Maximum undistorted output is 3 watts.

The feedback voltage is developed across the 100-ohm resistor connected between the low-volume side of the volume control and ground. The 100,000-ohm resistor and .007-μf capacitor are connected in series across one-half of the volume control to provide bass boost at low volume levels. Surface noise, scratch, and some highs are attenuated by setting the tone control to positions 1 or 2. The tone control is out of the circuit when the switch is in position 3.

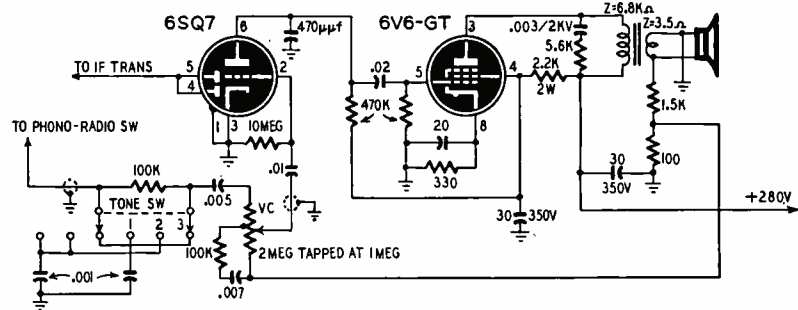

PRECISION AUDIO TONES FROM POWER LINES

Single-frequency tones having good waveform, stability, and accuracy are often needed to excite bridges and for other purposes in an electronic laboratory or service shop. A novel 400-cycle source which is basically a tuned amplifier fed at power-line frequencies is described in *Electronic Engineering* (London, England). The circuit is shown in the diagram.

The input of the two-stage tuned amplifier is coupled to one of the rectifier plates through a differentiator consisting of the 100-μf blocking capacitor and the grid resistor for the input stage. The purity of the output waveform is governed by the Q of the tuned circuits, which must be adjusted to resonate precisely at the desired frequency. In one model the tuned circuits had a Q of 20, and all hum and distortion component peak values did not exceed 1%.

The power lines in Britain operate at 50 cycles so the 400-cycle note was obtained by amplifying the 8th harmonic. Tones of 360, 420, 480 cycles or any reasonable multiple of 60 can be

obtained by using 60-cycle a.c. lines as the standard. In this case, the values of the inductors and/or capacitors must be changed accordingly. A reactance slide rule is useful in determining the proper values.

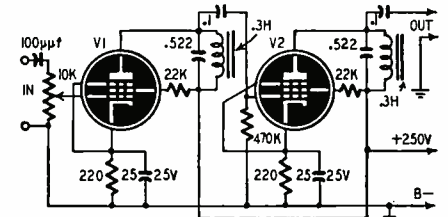

V1 and V2 may be any convenient high-gain pentodes. Values shown are suitable for EF50's. Other tubes such as 6AC7's, 6AK5's, etc., will work equally well and can be substituted, but the values of the screen-grid and cathode-biasing resistors must be changed. Bypassing the screens may provide slightly more gain, but the waveform should be checked before and after to determine the effects of the bypass capacitor.

SIMPLE D.C. SUPPLY FOR 6- OR 26-VOLT SERVICE

Every radio service technician can make use of a low-voltage d.c. supply for testing automobile and battery-powered radios d.c. relays, small motors, etc. We have constructed a supply of this type which delivers 26 volts d.c. un-

filtered and 6 volts d.c. out of a capacitor-input filter. The circuit is shown. The rectifier and meters are on one chassis and the filter on the other.

The transformer was wound to deliver 30 volts a.c. We selected an old power transformer which had a core area of approximately 3 square inches. After rewinding the primary with 250 turns of No. 20 enameled wire, we wound on 60 turns of No. 12 wire for the secondary. The choke was made by winding 800 turns of No. 26 wire on the 1-inch square core from an old filter choke.

The resistance of the choke is used to drop the output to 6 volts under load. A low-resistance, high-wattage

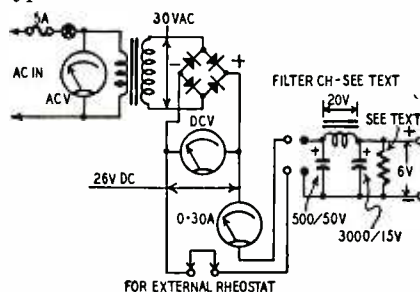

variable resistor is used across the output of the filter to adjust the output voltage to the required value under light loads and to prevent the voltage from soaring when the load is removed.

Some surplus filament transformers deliver 24 volts at several amperes. One of these will supply 18 to 20 volts from the average dry rectifier. Greater output can be obtained by connecting the secondary of a heavy 6-volt filament transformer in series-aiding with the 24-volt winding and connecting the two primaries in parallel. You can use a filter choke of 30 to 50 mh at the desired current rating. These are available from sources manufacturing components for low-voltage, high-current supplies.—A. Ivanivsky

AIRCRAFT LIGHT CONTROL

A simple electronic timer suitable for controlling aircraft running-lights and similar devices is described in patent No. 2,534,299 issued to Alfonso J. Ruiz and Eugene J. Kupjack. The unit is particularly applicable to aircraft because it is sturdy, light in weight, and consumes comparatively little power. It produces predetermined on-off cycles which are substantially independent of temperature and pressure.

The operation of this circuit is based on heating and cooling of the heater of an ordinary diode or a multi-element tube connected as a diode as in the diagram. The unit operates from a.c. or d.c. sources. When d.c. is used, its polarity must be as shown.

When the relay is unenergized, heater voltage is applied through the normally closed contacts 5 and 6. R1 drops the supply voltage to the proper value for the heater. When the tube reaches operating temperature, its plate draws current and the relay pulls in. Capacitor C1 is charged by the voltage drop across the relay coil. When the relay is energized, R2 is automatically inserted in series with one side of the heater circuit. The value of this resistor is such that the heater current is limited to a point below that needed to maintain the cathode at proper operating temperature.

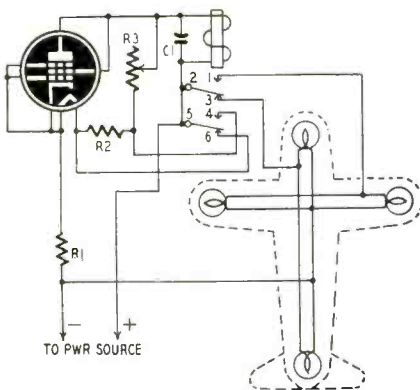

As the cathode cools, the plate current drops and C1 discharges gradually through the relay coil, keeping it energized until the plate current is much less than the hold-in current of the relay. The time that the relay remains pulled in is determined by the

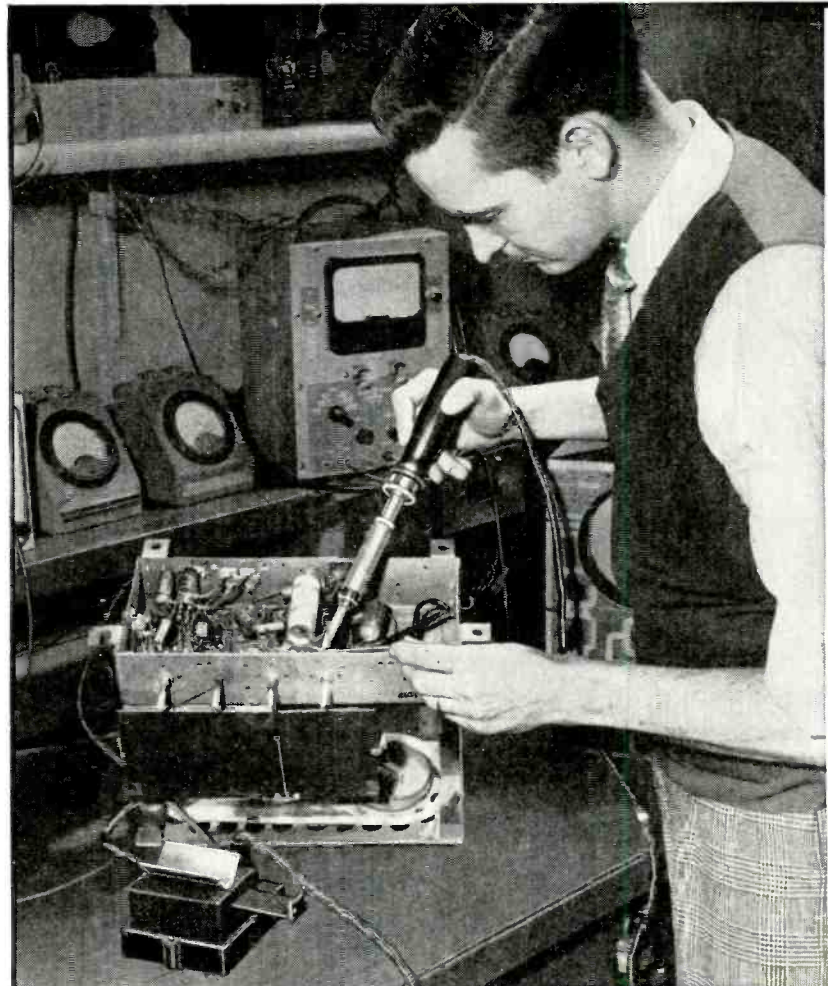

... **SERVICEMEN, AMATEURS, TECHNICIANS SELECT—**

American Beauty
SOLDERING IRONS
for
TOP SOLDERING PERFORMANCE!

Outstanding performance coupled with durability of construction make American Beauty electric soldering irons the choice of discriminating users in all fields

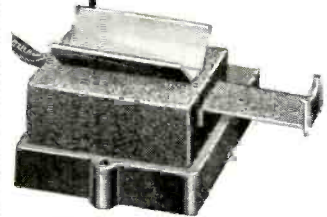

TEMPERATURE REGULATING STAND

Providing heat-regulation for all sizes of electric soldering irons, this stand is adjustable for all heats up to full working-temperature. Assures longer life of iron and tip.

122

For descriptive catalog pages write Dept. S-23

AMERICAN ELECTRICAL HEATER CO.
 DETROIT 2, MICH.

We're Practically Giving the Stuff Away at These Prices!

STANDARD BRAND TUBES
Receiving • Special Purpose • Television

ALL GUARANTEED

VR90	1.40	217C	8.99	813	7.95
VR150	1.40	220	1.95	814	3.90
C61	5.85	221A	.99	815	2.95
2A4G	.84	231B	1.18	827R	8.95
2B2	4.50	264C	.39	830B	3.74
1B29	4.69	274B	1.50	832	6.95
2C21	1.63	276A	9.75	837	1.36
2C22	4.43	282B	8.25	836	3.75
2C26	.24	304TH	11.95	841	.44
2C40	6.50	304TL	11.95	843	.37
2C44	11.25	434A	1.93	840	27.75
2E22	1.59	393A	9.50	864	.35
2J21A	9.50	417A	9.25	865	1.35
2J22	11.25	434A	4.85	863A	1.90
2J26	36.00	446A	1.15	872A	2.39
2J27	36.50	446B	6.95	876	.57
2J32	67.50	471A	2.65	878	1.90
2J33	36.50	506AX	9.50	885	1.69
2J34	47.95	517L	19.50	954	.24
2K25	27.75	531	3.50	955	.48
2K29	34.75	1B32	1.15	957	.37
2V3G	.96	615	.15	957	.39
2X2/879	.74	702A	2.49	958A	.95
3A4	7.00	702A	7.89	991	1.15
3C24	2.19	704A	1.22	CK1005	.57
3C28	10.50	705A	1.22	CK1005	.57
3D23	10.50	705A	1.22	CK1005	.57
4B25	8.75	708A	4.69	1016	1.85
4C36	15.25	713A	.95	1619	.29
4D23	11.25	713A	1.93	840	.48
5B1P	4.85	715A	6.95	1626	.47
10Y	.65	715B	9.95	1629	.39
15E	1.50	715B	3.75	1630	.95
15R	.95	718AY	48.50	1633	.72
5CP1	4.85	718BY	48.50	1639	1.55
4P2	4.95	718BY	48.50	1639	.95
RK34	5.45	718DY	48.50	1642	.95
53A	5.45	719A	28.75	1851	1.69
RK72	8.95	720E1	15.95	1852	.94
HF100	11.85	721A	5.69	802	1.25
FL23A	8.69	722A	3.39	8020	1.28
VT158	13.95	725A	9.95	8025	5.85
203A	1.95	800	1.95	8004A	1.95
2058	1.59	801A	.95	9006	.75
211	.74	803	2.95	7193	.34
217A	7.95	805	3.94		

LATEST 30 TUBE 630 TV CHASSIS Ready to Work

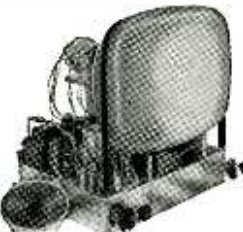

Nickel plated chassis. All molded, high quality condensers, and molded sockets. All standard brand tubes. Prestested before shipment. Complete with hardware.

Finest for fringe area reception. R.C.A. Licensed. Take all picture tubes from 16" to 24" round or rectangular.

Complete with 12" R.C.A. Speaker & with Hi-Gain Standard Coil

Tuner (Less C.R. Tube) **\$133.50**
Available with DuMont Input Tuner FM Radio **\$138.50**
Chassis Mounting Bracket for Picture Tube **\$4.95 Extra**

PARTS SPECIALS

Controls	1 Meg w/sw 3" Shaft. 54c
500 K w/sw 3" Shaft. 54c	
1 Meg w/DP Switch. 49c	
1" Knurl Shaft. 49c	
100K w/sw 3/4" Shaft. 39c	
100K Control 1.15	
3/4" Milled Shaft. 24c	
250K Control .24c	
3/4" Milled Shaft. 24c	
500K Control 2" Shaft. 26c	
Vibrators	
Stand 4 Prong	
6 Volt. Ea. 1.19	
T.V.—H.V. Cartwheel Cond. 500 Mmmf. 10KV. 48c	
500 Mmmf. 20KV. 69c	
Famous Make P.M. Speakers	
Alnico #5 Each 10 or more	
4" 1.59 1.44	
3" 1.65 1.49	
6" 1.92 1.73	
8" 3.49 3.05	
10" 5.59 4.99	
12" 6.85 6.17	
P. M. Speakers with 50L6 Output Tx.	
4" Each 10 or more	
2" 2.10 1.90	
5" 2.20 2.00	
EXTRA SPECIAL	
8" Dynamic Speaker 450 ohm field with 50L6 output tx. 2.69	
Each 10 or more 2.45	
Replacement Output Transformers	
for 50L6, 9Q5, 354, 6K6, 6V6, 6F6. 49c	
Push-Pull Output for 60L6, 251E, 6K6, 6V6, 6F6. 65c	
Phono Motors	
78 R.P.M. with Turntable. Ea. 2.49	
Mica Kits	
10 Assorted 89c	
100 6.95	
Ceramic Kits	
10 Assorted 79c	
100 5.95	
Resistor Kit	
10 Assorted 49c	
100 3.79	
20x450V—20 20x50V. 29c	
800 Mfdx15V 66c	

TV TUBES—All Black

Sheldon, Zetka & other Standards

14" rect.	\$23.25	16" rect. or rd.	\$31.95
17" rect.	37.49	19" rd. metal	51.50
20" rect.	49.95		

Factory Guaranteed—Individually Boxed

Extra Discounts—25 or more 5%; 100 or more 10%

024A	.64	68A6	.79	7N7	1.10
1A6	1.00	68A7	1.19	7Q7	.89
1A7GT	1.17	68B	.89	7Z6	.84
1B3GT	1.22	68D6	1.35	7Z6A	1.30
1B5/255	1.51	68E6	.98	12A6	1.30
1C6	1.00	68G4	1.94	6X4RG	1.10
1C7G	.74	68H6	.99	12AL5	1.19
107G	.74	68J6	1.49	12AT6	.90
108GT	1.00	68K6	1.49	12AX7	.99
1F4	.74	68Q6GT	1.44	12AU7	1.09
1F5G	.74	68C5	.83	12AX7	.99
164GT	1.00	68B	.89	12C6	.89
166	.74	68D6G	2.99	12BE6	.89
168	.84	68F5	.75	12BH7	1.69
114	1.30	68G6	1.32	12H6	.89
11C5	1.30	68H6	.93	12J5GT	.79
11C6	1.30	68J6	1.36	12K5GT	1.10
11D5	1.30	68K6	1.36	12L6GT	1.32
11N5	1.30	68L6 or GT	.81	12Q7GT	.89
11SGGT	1.00	68M6	1.19	12R7GT	1.08
1R5	.99	68K5G	.75	12S7GT	1.01
1S4	.74	68K6GT	.83	12S7GT	1.01
1S5	.74	68K6GT	.83	12S7GT	1.01
174	1.00	68K6	1.48	12SH7GT	1.12
1U4	.79	68L6	1.45	12SL7GT	.82
1U5	.89	68G6A	1.98	12SK7GT	.89
1X2-1X2A	1.32	6N7/6N7GT	1.19	12SN7GT	1.49
2A3	1.60	68G6	1.12	12SO7GT	.89
2A4G	.84	68G6	1.28	12SR7	.89
2A5G	.84	68G7	.90	12T3	1.32
2A6	.84	68H6	.90	12T6	1.32
2A7	.44	658	1.32	14AF7	1.09
7A8GT	2.39	5A7 or GT	1.09	14B6	1.09
30A	3.67	5C7 or GT	1.19	14B8	1.10
305	1.15	5C7	.99	14C7	.99
354	.96	65D7	.97	14F7	.89
3V4	1.72	65G7	.99	14J7	1.09
5T4	1.72	65G7	.99	14Q7	1.09
5V4G	.89	5H7 or GT	.84	14R7	1.27
5V4GT	1.05	65J7 or GT	.76	14L7	1.27
6A0	1.21	68K7 or GT	.66	65E6	3.00
5X4	.89	65J7GT	1.19	19T8	1.34
5V3GT	.75	65N7GT	.92	25B06GT	1.59
5V4G	1.09	65K6GT	.92	25C06GT	.89
5Z3G	1.09	65R7	1.00	25W4GT	1.00
5Z4	1.18	65S7	.79	25Z6GT	.74
6A6	1.19	65T8	1.39	29Z7	1.29
6A8A	1.19	65U7G	1.23	30	1.23
6A8R	1.39	65V7 or GT	.99	32L7GT	1.59
6A07	1.21	68W4GT	.66	35Z5	1.09
6AF6G	1.28	65W6	.99	35L6GT	.89
6AG5	1.29	68X4	.74	35W4	.62
6AG7	1.60	65SGT	1.01	37	1.01
6AH6	1.79	68Y6	.84	35Z5S	.74
6AK5	1.59	7A6	.89	39/44	.79
6AL5	1.79	68Z7	.89	43	1.09
6AQ5	.84	78A	.89	46	1.62
6A85	1.79	68Y6	.89	47	1.44
6AS5	.99	70C4	1.49	50B5	.99
6A85G	5.34	70C5	.89	50C5	.99
6AT6	1.54	70E5	1.12	50L6GT	.84
6A85GT	1.54	70E5	1.12	56	.89
6A86	.85	70E7	.99	76	.89
6AV5GT	1.31	70F7	1.01	77	.99
6AV6	.74	70F8	1.79	80	.89
6B4G	1.50	70G7	1.33	85	1.09
6B7	1.21	70H7	1.17	87	1.09
6B8	1.49	71J7	1.48	117N7	2.50

Battery Operated SIGNAL TRACER KIT

Complete with steel cabinet, speaker, 3 tubes, all other components, and easy-to-follow instructions. \$9.95 (Less Batteries)



WEBSTER CHICAGO



Automatic 3-Speed RECORD CHANGER

Type 100 Series. Plays 12, 10 or 7 inch records at 33 1/3, 45 or 78 R.P.M. Needle tip (included) for standard or micro-groove records **\$25.40**

Mica Condensers
All Standard Brands. 1/2 and Postage Stamp Sizes
5%, 10% and 20%.
Price each **\$1.0**

Size	Size
2 Mmfd	30 Mmfd
2	33
7	40
10	40
17	40
22	30
15	60
25	75
25	100
110	750
150	1,000
200	1,500
450	2,000
650	2,500
500	3,000
510	3,500
550	4,000
600	6,000
620	6,200
700	10,000

Buy 25 Assorted and save 10%. Minimum 5 of a type.

Ceramic Condensers
All Standard Brands. 5%, 10% and 20%.
Price each **\$1.10**

VALUE	VALUE	VALUE
2.5 Mmfd	30 Mmfd	
3.3	33	
5	35	
5	36	
6	40	
7	47	
7.5	50	
10	51	
15	60	
24	60	
24	75	
80	500	
90	510	
91	600	
100	750	
135	1,500	
200	6,800	

Buy 25 Assorted and Save 10%. Minimum 5 of a type.

resistance of the relay coil R3 and the capacitance of C1. When the relay drops out, full heater voltage is again applied to the tube and the cycle repeats. A second set of s.p.d.t. contacts control external circuits such as aircraft running-lights as shown in the diagram.

Battery type tubes can be used for on-off cycles as short as one-eighth of a second. Tubes having 117-volt heaters can be used for time cycles of approximately 5 seconds or more.

A blinker circuit of this type has a number of interesting possibilities in the field of industrial electronics, particularly when used in conjunction with other control circuits. Model railroad fans can use such a system to operate crossing, block, and caution signals on their favorite track layouts.

Because of the snap-action of the relay, this system will probably cause less arcing and subsequent interference than the more conventional thermal or motor-driven blinkers used in Christmas-tree lights, signs, and other devices used for display purposes.

SOUND SWITCH

Sound-operated relays or switches have many useful applications such as: turning on a light; sounding an alarm when a baby cries; or as an automatic talk-listen switch for intercoms and radiotelephone transmitters. Most circuits of this type have three or more separate tubes which operate as sound amplifier, rectifier, and relay-control. A circuit which requires only one tube for these functions is described in *Radio Constructor* (London, England).

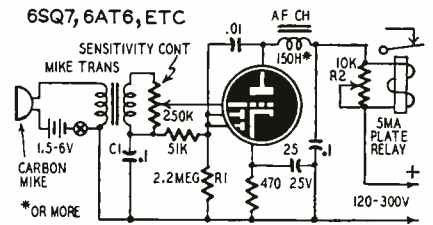

The circuit shown uses a double diode-triode such as a 6S7Q or 6AT6 along with a high-output carbon microphone and a high-gain transformer. The amplified output of the microphone appears across the a.f. choke which is the plate load for the triode. The amplified audio voltage is fed to the diode plates to develop a negative voltage across the diode load resistor R1. This voltage charges C1 and biases the triode grid to the point where the plate current drops enough to release the relay. When the sound stops, the charge leaks off C1, plate current increases, and the relay returns to normal (pulls in). The speed with which the relay returns to normal depends on the values of C1 and R1. Increasing the size of either or both increases the time-delay action.

The sensitivity control is adjusted so ordinary background noise will not operate the relay. R2 is set to the point where the relay just pulls in with no input to the microphone.

—end—

Terms: 20% cash with order, balance C.O.D. Prices F.O.B. N.Y. City warehouse. Min. order \$5.
NOTE: Availability of merchandise subject to prior sale. Prices subject to change without notice.
STEVE-EL ELECTRONICS CORP.
Dept. E-9, 65 READE ST., NEW YORK 7, N. Y. COrtlandt 7-0086 * Free Catalog.

COLOR TELEVISION TRANSMITTER CONTROL

Patent No. 2,548,829
 George C. Sziklai, Princeton, and
 Milton Rosenberg, Trenton, N. J.
 (Assigned to Radio Corp. of America)

This system applies especially to TV transmitters which use color films or slides. As the film is scanned by the cathode-ray "flying-spot" tube, the light beam is focused on a phototube. The tube gain is governed by an automatic level control (a.l.c.) to prevent overloading on film highlights. The automatic level control is shown within dotted lines.

Light from the scanned film falls on the cathode of the phototube. Secondary emission from the dynodes successively multiplies the output. The collector current flows through R1 and a negative voltage is applied to the 1st video-amplifier

stage. Since each stage reverses the polarity, a positive signal is fed to the a.l.c. This signal increases with the intensity of light to the phototube.

In the a.l.c. circuit the voltage is rectified and a positive voltage appears at the tube grid. The increased plate current flows through R2 which drops the dynode voltages. Therefore the gain of the phototube drops while film highlights are being scanned.

A manual gain control is also included at P. As P is decreased it shunts out dynodes 5, 6, and 7 and lowers the total gain of the phototube.

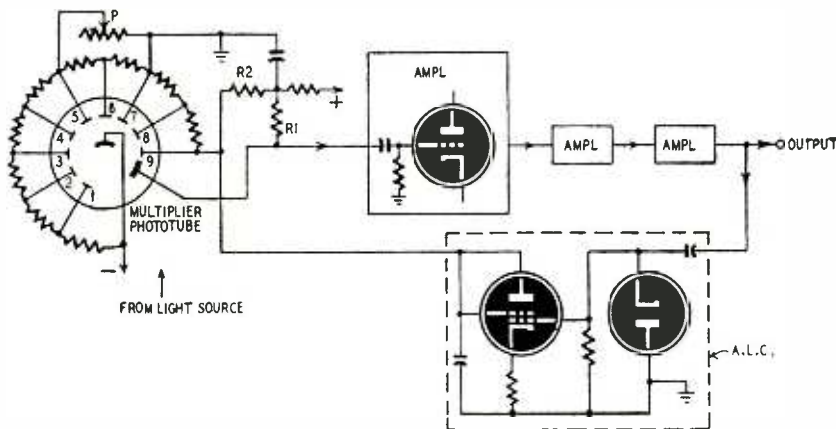

PULSE AMPLIFIER WITH DELAY LINE

Patent No. 2,543,431
 Leon Bess, Kansas City, Mo.
 (Assigned to United States of America as represented by the Secretary of War)

This pulse amplifier has a low recovery time or interval during which it is blocked. It also eliminates low-frequency interference such as microphonics. The circuit is especially suitable for timing or sync purposes where the leading pulse edges are utilized.

An R-C network couples the pulse source to the tube. To attenuate the undesired low frequency, the R-C time-constant should be small, but this causes the pulse signal wave shape to be distorted. There is a large recovery time during which the tube is blocked. On the other hand, a relatively large time-constant would transmit the low-frequency interference.

A delay line solves the problem. This is a circuit made up of series inductance and shunt capacitance. This line shorts out the low frequency and offers impedance to the high-frequency components of the signal. Due to charging and discharging of the shunt capacitances, the pulse is delayed. Arriving at the line termination (which is shorted), the pulses are reflected be-

cause of impedance mismatch. They arrive back at the grid with reversed polarity and delayed in time. The pulses are much narrower than the original, but this is no disadvantage if only the

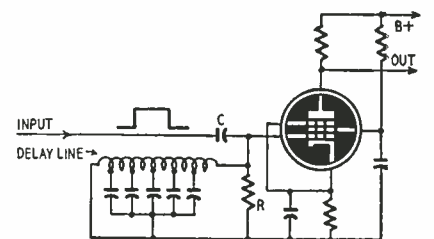

leading edges are utilized for timing or sync purposes. The grid recovers after a short interval and is ready to receive other signals or pulses which follow.

HIGH GAIN MAGNETIC AMPLIFIER

Patent No. 2,548,049
 Robert W. Olson, Dallas, Tex.
 (Assigned to Geophysical Service, Inc.)

This amplifier has sufficient gain to operate from a thermocouple. It combines the effects of magnetic saturation and thermionic emission.

The a.c. for the diode filament is limited only

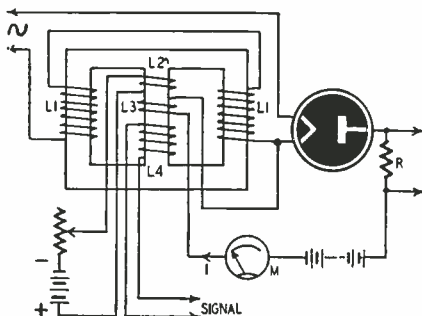

by the reactance of coils L1. Plate current flows through the load R, meter M, and returns through L3. The coils L2, L3 are wound to magnetize the core in opposite directions.

Initially, L2 partly saturates the core. After the a.c. is turned on, current I tends to reach some definite value and remains constant. If it were to increase, for example, it would desaturate the core and increase the reactance of L2. On the other hand, a decrease would further saturate the core and reduce the reactance of L2. In either case there is opposition to a change in I once it has reached stability.

The stable value of I depends upon core saturation. This is set initially by the battery current through L2. When a signal flows through L4, it controls the saturation and therefore determines the value of I (as measured by M). If L4 is wound with many more turns than L3, the output (I) is greatly amplified. For maximum gain, the diode should be operated on the steepest portion of its Ef-Ip characteristic.

**ARMY - NAVY -
 AIR FORCE - MARINES
 Here's Help!**

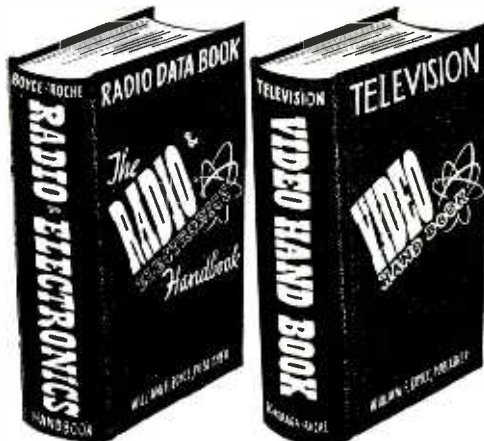

**GET AHEAD FASTER IN
 RADIO
 TELEVISION
 ELECTRONICS**

Two great books assist you in every operation in radio, television and electronics. Give you the fundamentals, complete ground work, understanding of all types of radio, television, electronic gear and their circuits, including theory of operation.

Show you expert methods of planning, building, installing, operating, testing, adjusting, and servicing. The know-how of radio, television and electronics presented in plain language and simple terms with easy to understand pictures and working diagrams.

You get 1800 pages of basic knowledge, methods and data of radio, television, electronics completely illustrated with over 2000 pictures, drawings, codes, charts and graphs.

Written by the Boyce-Roche experts who make electronic manuals for the U. S. Signal Corps.

SPECIAL OFFER - Save Two Dollars
 Send for both books together and get them at the special combination price of only \$12.00!

RADIO & ELECTRONICS HANDBOOK provides instruction and reference on fundamentals, parts, tubes, circuit elements, receivers, transmitters, amplifier systems, power supplies, antennas, meters, test equipment, and accessories, with complete Data Section.....\$7.00

VIDEO HANDBOOK teaches television and provides complete handbook reference on all phases with full sections on principles of television, receivers, antennas, test equipment, servicing, pattern interpretation, transmitters, show production and more.....\$7.00

SEND NO MONEY - 10-DAY FREE EXAMINATION COUPON (Good only while special combination offer lasts.)

**BOYCE-ROCHE BOOK CO.
 CALDWELL 49, NEW JERSEY**

Send () Both books together @ \$12.00
 () Radio & Electronics Handbook @ \$7.00
 () Video Handbook @ \$7.00

In ten days I will send you price plus postage or I will return book(s) postpaid. (Offer good only in U. S.)

Name

Address

City, Zone, State

Employed by

SAVE POSTAGE. We pay postage if you enclose full price now. Money back on same return privilege.



SW-54
\$49⁹⁵

THE
**MIGHTY
MIDGET**
THE BIGGEST
RECEIVER VALUE
IN AMERICA!

National's entire initial production run of the sensational new SW-54 receiver was exhausted in just a few short months after production! Now, at last, the "Mighty Midget" is once more available.

This amazing receiver tunes the entire frequency range from 540 kcs. to 30 mcs., voice and code, with big set sensitivity, yet measures only 11" x 7" x 7"! Has edge-lighted slide rule dial calibrated in 4 bands with foreign, ship, amateur and police frequencies clearly marked and unique plastic bandspread knob. Has new miniature tubes. Housed in smart modern metal cabinet with tough velvet-gray finish.

See and hear it today!

Write for name of nearest dealer.



L.F. MAGNETRON AMPLIFIER

Patent No. 2,546,033

Chester R. Knight, Scotia, N. Y.
(Assigned to General Electric Co.)

This high-gain amplifier uses 2 magnetrons per stage. It eliminates contact potential errors and has high stability. It is effective at low frequencies down to d.c.

A magnetron is a diode with a straight wire cathode surrounded by a cylindrical anode. It requires an external magnetic field parallel to the cathode. Electrons from the cathode are attracted to the positive anode. The electrons tend to move simultaneously in circular orbits around

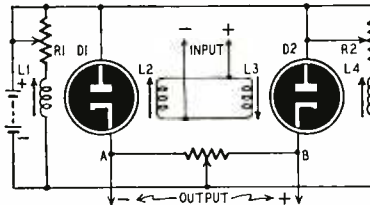

the cathode. But due to the magnetic field, under the combined effects of the anode and the field, electrons travel along spiral paths which begin at the cathode and terminate at the anode.

If the field is intensified, some electrons assume circular paths about the cathode and do not reach the anode at all. Further increase in flux density reduces the space current because still more electrons do not reach the anode. A typical magnetron characteristic is almost flat up to a critical flux density, then current drops sharply toward cut off.

Each magnetron is surrounded by a pair of coils to generate the required field. Coils L1, L2 energize magnetron D1. The arrows indicate that their fields are additive. Coils for D2 have opposing fields.

With zero signal input, R1, R2 are adjusted to bias the magnetrons to a critical operating point. Therefore the space currents are sensitive to either decrease or increase of flux density. The output voltage is initially balanced to zero by R3.

When d.c. (or slowly varying a.c.) is fed to the amplifier, the field of one magnetron is strengthened and the other weakened. For example, if the signal has polarity as indicated, the field acting on D1 is strengthened so this tube passes less current. D2 conducts more freely at this time. The currents through R3 are no longer equal (and opposite) so output appears between terminals AB.

AUTOMATIC GAIN CONTROL

Patent No. 2,552,586

Thomas A. Read and Herbert I. Fufeld,
Philadelphia, Pa.

(May be manufactured or used by the U. S. Government without royalty payments)

This control is more sensitive than previous ones. Unlike conventional circuits, this arrangement reduces control bias to decrease gain. Gain may be controlled either by increasing the bias or decreasing it. Higher sensitivity is obtained by the latter method. Signals from the amplifier

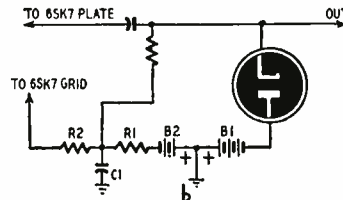

(6SK7, for example) are fed to a rectifier which is normally blocked by B1. When the signals are large enough, they overcome the bias and permit tube conduction. A positive drop is produced across R1. This opposes the effect of the bias battery B2, and the 6SK7 grid voltage is reduced toward zero. Therefore the amplifier shows less gain.

The 6SK7 screen voltage should be maintained constant by a VR tube rather than through a dropping resistor. This prevents overloading the screen at low control bias. The plate voltage should be low.

7 HARD TO GET ITEMS AT BIG SAVINGS TO YOU

AMAZING BLACK LIGHT



250-watt ultra-violet light source. Makes fluorescent articles glow in the dark. Fits any lamp socket. For experimenting, entertaining, unusual lighting effects. Ship. wt. 2 lbs.
ITEM NO. 87
A SAVING AT **\$2.45**

LITTLE GIANT MAGNET



Lightweight 4 oz. ALNICO permanent magnet. 1 3/4" x 1 1/2". Lifts more than 20 TIMES ITS OWN WEIGHT! Ideal for hobbyists, experimenters. Ship. wt. 3/4 lbs.

ITEM NO. 159
BIG VALUE AT **\$2.45**

POWERFUL ALL PURPOSE MOTOR



Sturdy shaded pole A.C. induction motor. 15 watts, 3000 rpm. 3"x2"x1 3/4"; 4 mounting studs; 7/8" shaft, 3/16" diameter; 110-120 volts. 50-60 cycles, A.C. only. When geared down, this unit can operate an 18" turntable with a 200 lb. dead weight. Use it for fans, displays, timers and other purposes. Ship. wt. 2 lbs.

ITEM NO. 147
UNUSUAL BUY **\$2.45**

WATTHOUR METER



Leading makes — completely overhauled, ready for service. 100-110 volts, 60 cycles, 2-wire A.C. 5 amp. Heavy metal case 8 1/2" x 6 1/4" x 5". Easy to install. Ship. wt. 14 lbs.

ITEM NO. 33
NOW ONLY **\$4.50**

WESTERN ELECTRIC BREAST MIKE



Lightweight 1 lb. carbon microphone. Aircraft type. Breastplate mounting, adjustable 2-way swivel. Easily fastened straps. For home broadcasts, communications etc. Complete with 6 foot cord, hard rubber plug. Sherardized plate, non-rusting finish. Ship. wt. 2 lbs.

ITEM NO. 152
NEW LOW PRICE **\$1.50**

TELEPHONE TRANSMITTERS

Genuine transmitters made by Kellogg Western Electric Stromberg Carlson. Work on two dry cells. For P.A. systems, intercoms, other practical uses. Shipping weight 1 lb.



ITEM 160
REAL VALUE **\$2.45**

250 POWER TELESCOPE LENS KIT

Make your own high powered 6 ft. telescope! Kit contains 3" diam., 75" focal length, ground and polished objective lens and necessary eye pieces. Magnifies 50x to 250x. Full instructions. Ship. wt. 1 lb.
ITEM NO. 123
YOU SAVE AT **\$2.95**

HUDSON SPECIALTIES CO.
40 West Broadway, Dept. RE-9-51
New York 7, N. Y.

I am enclosing full remittance for items circled below. (Be sure to include shipping charges.)

OR, my deposit of \$..... Ship balance C.O.D.
MINIMUM C.O.D. ORDER \$5.00.
C.O.D. ORDERS ACCEPTED ONLY WITH 20% DEPOS. . .
INCLUDE SHIPPING CHARGES.

Circle items wanted

87	159	147	33	152	160	123
----	-----	-----	----	-----	-----	-----

Name..... Please Print Clearly
Address.....
City..... Zone..... State.....

GE THYRATRON FG-105



Brand New MERCURY RECTIFIER

Individually boxed in factory sealed cartons. List Price \$60.00. Your cost... **\$18.95** While They Last! For continuous rectifier and welder control service. Tetraode type, indirectly heated cathode; 10000 V peak, 10000 V peak inverse. Av. Max. current 6.4 amps continuous. 2.4 to 4 amps welder control service.

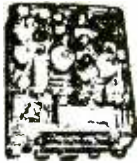

BC-645 XMITTER RECEIVER 15 Tubes 435 To 500 MC

The electronic equipment that saved many lives in the war. Set can be modified to use for 2-way communications, voice or code, on following bands: ham band 420-450 mc, citizens radio 460-470 mc, fixed and mobile 450-460 mc, television experimental 470-500 mc. 15 tubes (tubes alone worth more than sale price): 4-7E7, 4-7H7, 2-7E6, 2-6F6, 2-955 and 1-WE316A. Now covers 460 to 400 mc. Brand new BC-645 with tubes, less power supply in factory carton. Shipping weight 25 lbs.

BRAND NEW **\$18.95** each

PE-101C DYNAMOTOR for above BC-645 **\$3.95** UHF ANTENNA ASSY, for above BC-645 **\$2.45**

Smash Values in Radio Receivers & Xmitters

BC 453 Rcvr.	Used \$17.95	New \$35.00
BC 454 Rcvr.	Used 9.95	New 16.50
BC 455 Rcvr.	Used 8.95	New 11.95
BC 456 Mod.	Used 3.95	New 6.95
BC 457 Xmtr.	Used 7.95	New 12.95
BC 458 Xmtr.	Used 8.95	New 13.95
BC 459 Xmtr.	Used 16.95	New 29.50
BC 696 Xmtr.	Used 16.95	New 24.95

Dynamotor DM-32A **\$3.95**



11-TUBE SUPERHET RECEIVER Model BC-652-A 2000 to 6000 KC (75-80 Meters) BRAND NEW IN ORIGINAL CRATE SMASHING LOW PRICE **\$49.50**

Complete with Crystal Tubes and Dynamotor. For those of you "salts" in need of a great radio receiver aboard ship, the Model BC-652-A made by General Electric Co. will fill your needs! It is a rugged, good performer which will give fine service for a long long time. This set is designed for 12/24 volt DC operation, which is ideal for shipboard use. It needs absolutely no conversion. Just connect it into your batteries. Technically this set is an 11-tube superhet receiver with a freq. range of 2000 to 6000 kc (75-80 meter ham bands), a crystal freq. standard, and a 12/24 volt dynamotor, on two chassis combined into one case. The sensitivity is one microvolt or greater.

SELSYN 2J1G1

Operates from 57 1/2 V 100 cycles. Suggested wiring for 110 V 60 cycle included. New, tested. Price per pair **\$4.50**



WILLARD 2-VOLT STORAGE BATTERY 20 Ampere-Hours

Exact replacement for GE portable for LB-500— BRAND NEW. Each **\$2.69**



WILLARD MIDGET 6-V STORAGE BATTERY

3 amp hour rating. Transparent plastic case. Brand new. 3 5/8" x 1 13/16" x 2 3/8" high. Uses standard electrolyte. Each **\$2.65**



ONE-QUART BOTTLE BATTERY ELECTROLYTE

Made by Willard, for above storage batteries. 1 quart sufficient for two 2-volt cells. Hermetically sealed. SPECIAL. **\$1.45** per qt. bottle

7-PRONG 2-VOLT RADIO VIBRATOR for Portable and Farm Sets Replacement for GE LB 530. **\$1.95**

Please include 25% Deposit with order—Balance C.O.D. MINIMUM ORDER \$3.00. All Shipments F.O.B. Our Warehouse N.Y.C.

G & G GENUINE MAZDAIC RADIO PARTS SERVICE 53 VESEY STREET - NEW YORK 7, N.Y.

A.C. POWER MEASUREMENT

Patent No. 2,550,492

Norval P. Millar, Danvers, Mass.

(Assigned to General Electric Company)

This is a new application of the Hall effect. When connected across an a.c. line, the device indicates load power as well as power factor. P is a Hall plate, for example a piece of germanium 1/4-inch square and .015-inch thick. L generates a magnetic field proportional to current I through the load. Current through R is proportional to voltage V across the load. Under the combined effects of field and current through P, a Hall voltage is generated across leads A.

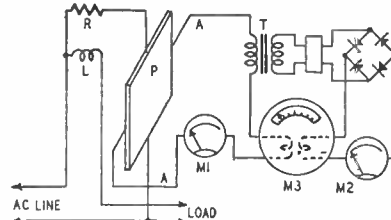

The voltage has an a.c. and a d.c. component. The first has an average value proportional to VI. The d.c. is proportional to VI cos O where O is the phase angle.

M1 measures the d.c. component. It is calibrated to read VI cos O or power. The a.c. component appears across the secondary of T. After rectification it is measured by M2 which is calibrated to read VI or volt-amperes. M3 is a ratio-type meter which indicates the ratio between d.c. and a.c. components. The ratio is the power factor.

MAGNETIC ERASING HEAD

Patent No. 2,550,753

Dallas R. Andrews, Collingswood, N. J. (Assigned to Radio Corp. of America)

This is a highly efficient erasing head for magnetic tape or wire. It uses 2 separate magnetic gaps, each providing a concentrated high-frequency field, usually 100 kc. Due to the high magnetic intensity, each gap may be wider than in conventional types. This eliminates the possibility of the tape contacting the pole pieces with consequent wow. Ordinarily tape passes over the copper filled gap of a conventional single-ended erasing head, and the magnetic flux arches due to the eddy current effect. Here, a solid cloud of flux is formed, hitting the whole tape.

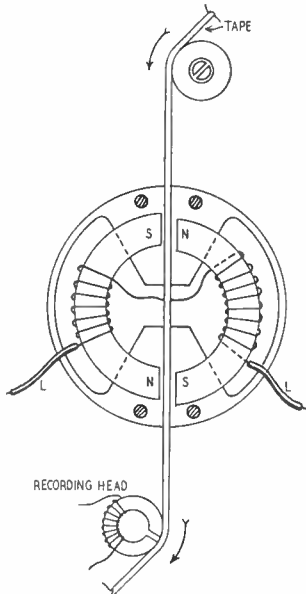

The high frequency is fed to erasing coil leads L as the tape is moved downward between poles SN. The poles are not directly opposite each other but are diagonally offset. Therefore flux flows at an angle through the tape. More tape is demagnetized at the same time than if the poles were directly opposite each other. The tape is acted upon successively by the 2 pairs of poles. After erasure, the tape is ready for recording.

—end—

there's only ONE APPROVED POWER SUPPLY

Patent Pending

New Low Cost "BJ" JUNIOR Save Time, Money Servicing DC Equipment

Demonstrate and test car and marine radios... relays, phone circuits, instruments, other low voltage devices. End costly storage battery failures with Electro's dependable filtered Power Supply. Exclusive conduction cooling doubles rectifier power rating, assures lowest cost per ampere output over other types and dissipates over 3 times the heat. Quality components withstand high overloads. 6 Volts, 1 to 12.5 amps. continuous output.

Model "B" 6 Volt DC Power Supply 1 to 20 Amps. for Heavy Duty Applications

OVER 2 MILLION Battery Radios Offer Huge PROFIT Market!



New Model "B" BATTERY ELIMINATOR with Selenium Rectifier

Battery radios in city and rural areas offer you big profit opportunities. Converts any 1.4 volt, 4 to 6 tube battery radio to an efficient AC radio, plugs into a 115 volt 50/60 cycle outlet. Gives years of dependable hum-free reception at lowest cost. Guaranteed for three years.

SEND COUPON **Electro** ELECTRONIC EQUIPMENT

Electro Products Labs. 4507-JS Ravenswood Ave., Chicago 40, Ill.

Send literature, name of nearest source.

Name.....
Address.....
City.....State.....

IN CANADA: ATLAS RADIO CORP. LTD., TORONTO



Tight spot? Especially for a multiple-section electrolytic? And the job's got to stand up, regardless?



Your best bet is the new SMALLER Type PRS Dandee. Metal-can electrolytic. Single, dual, triple and quad combinations. Stranded-wire leads and safety sleeves. High-purity aluminum. Vented. Ask your Aerovox jobber for PRS Dandees!



FOR RADIO-ELECTRONIC INDUSTRIAL APPLICATIONS
AEROVOX CORPORATION
 NEW BEDFORD, MASS., U. S. A.
 Export: 41 E. 42nd St., New York, N. Y.
 Cable Address: AEROCAP, N. Y.
 In Canada: AEROVOX CANADA LTD.
 Hamilton, Ont.

PHONO-RADIO SWITCHING

In a custom radio-phono installation, the problem was to connect a Meissner FM tuner and a record player to a high-gain amplifier which had a low-gain input for a tuner and a built-in pre-amplifier for the variable-reluctance pickup cartridge. A method of switching the inputs had to be devised because no provisions were made for this on the amplifier. The tuner has a change-over switch but manufacturer's instructions state that the switching circuit should not be used with low-level magnetic pickup. Hum would be too great with a 10-microvolt input signal.

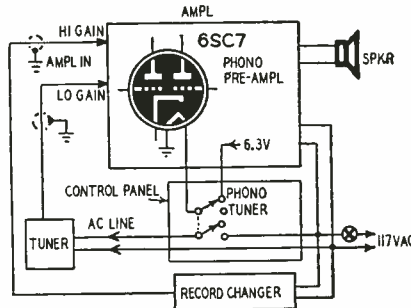

Standard input-switching circuits were tried but none could be made to work satisfactorily without major changes in the amplifier circuit. Hum pickup and feed-through were the major objections. Furthermore, any noise, hum, or microphonics developed in the phono preamplifier could be heard when the tuner was in use. Cushioning the preamp against shock did not help.

The problem was solved by connecting the units as shown in the diagram. The record changer and tuner are connected to the input of the amplifier at all times. One side of the preamplifier heater lead was broken and connected to one side of a d.p.d.t. switch on a control panel. The other side of the switch was connected in series with one of the a.c. leads to the tuner. This switch is wired so the preamplifier heater circuit is open when a.c. is applied to the tuner. Thus there is no possibility of preamplifier hum or microphonics when the volume is turned up on FM. An added advantage of this switching system is that the preamplifier tube will probably last longer because with this circuit it is turned off when not in use.—*Nicholas B. Cook*

RADIATION DETECTOR USES

I've had lots of fun experimenting with the radiation detector described in the article "Everything Radiates" in the March, 1950, issue of RADIO ELECTRONICS. It is quite useful in checking transformers and chokes for shorted turns. I find that a ragged hum or chatter will be heard in the phones when the probe is held close to a partially shorted choke or transformer. The circuit under test must be operating to get an indication.

Incidentally, an NE-57 neon lamp is more sensitive than the NE-51 specified in the article.—*O. C. Vidden*

New 5 Inch Oscilloscope

FOR TELEVISION, AM & FM SERVICING



only \$127⁵⁰ Available on monthly terms

PERFORMANCE EQUALS SCOPES MUCH HIGHER PRICED

- WIDE-BAND VERTICAL AMPLIFIER ± 3 db from 10 cps to 4.5 mc on any attenuator setting; useful to 7 mc.
- VERTICAL SENSITIVITY—.014 volt (RMS) per inch.
- CALIBRATED THREE STEP VERTICAL ATTENUATOR (Frequency Compensated)—gives peak-to-peak voltages direct.
- BALANCED PUSH-PULL DEFLECTION AMPLIFIERS—used for both horizontal and vertical deflection.
- WIDE-RANGE HORIZONTAL SWEEP—10 cps to 100 kc in four overlapping ranges; will sync with 3 mc sine wave.
- THIRTEEN TUBES including 6SU1 CR Tube.
- VOLTAGE REGULATED FUSED POWER SUPPLY.

DESCRIPTIVE CIRCULAR FREE

Servicemen, investigate this scope before you buy another. Save yourself money, keep down your investment in equipment. Mail coupon or postcard for free descriptive circular giving details regarding its operation, specifications, and terms. You'll agree that this scope is just what you want for TV, AM, and FM servicing jobs—that it is an exceptional value. Send coupon in envelope or paste on penny postal.

MAIL NOW

NATIONAL RADIO INSTITUTE, DEPT. SD1
 16th & U STS., N.W., WASHINGTON 9, D. C.
 Send me, without obligation, descriptive circular regarding the NRI 5" Professional TV Scope.

NAME.....
 ADDRESS.....
 CITY..... ZONE..... STATE.....

RENOVATING SHORTED 12JP4'S

High-resistance shorts between grid and cathode are common troubles in 12JP4 TV picture tubes. They cause loss of sync pulses which thus produces tearing in the picture. In most cases the short can be burned out by applying a high voltage between the shorted elements.

Like most experimenters and service technicians, we did not have a source of voltage which would do the job. We hit on the idea of using an automobile ignition system to supply the voltage. We grounded one of the elements to the frame of the car and held the lead from the other near a spark plug while the motor was running. This method worked three out of four times and enabled us to continue to use tubes which ordinarily would have been discarded.—*Leonard Pfeiffer*

KEY-CLICK ELIMINATION.

I use a surplus 24-volt d.c. relay and a 22.5-volt battery for keying my c.w. transmitter. When the keying relay was first connected, a spark jumped across the contacts each time the key was opened. This spark caused some TVI, pitted the key contacts, and caused an annoying click in the monitor.

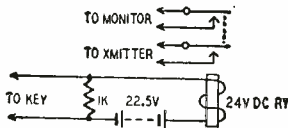

These troubles were eliminated by connecting a resistor across the contacts of the key. The exact value of the resistor must be determined by experimenting because the optimum resistance is determined by the battery voltage and the characteristics of the relay. Use the lowest value which can be connected across the open key without closing the relay. The diagram shows the circuit of the keying relay and the resistor.—*Dominic Angelo*

HUM REDUCTION METHOD

Many small receivers have high hum levels which are annoying under some conditions yet cannot be traced directly to any particular circuit defect. Most of these sets have .01- μ f or larger coupling capacitors between the plate of the first a.f. amplifier and the grid of a beam-power output tube. When working into the usual 470,000-ohm grid resistor, the capacitor provides bass response considerably lower than the speakers can handle.

Change the coupling capacitor to 500 μ f. This provides sufficient attenuation for 60- and 120 cycle hum originating in or before the first a.f. amplifier but it does not eliminate the harmonics. Fortunately, these frequencies are at lower levels than the fundamental and are masked by the signal frequencies.

Hum originating in the power amplifier can be eliminated by additional filtering and adequate shielding in the grid circuit.—*Charles Erwin Cohn.*

"CONICAL-V-BEAMS"

*REGISTERED TRADE MARK

for FULL TONE and VIDEO BANDWIDTH

NO OTHER ANTENNA
Provides the gain, bandwidth and rugged construction of the genuine *Telrex*

"CONICAL-V-BEAM"

ELIMINATE "CRUD" (busy background), "TINNY SOUND," "GHOSTS" and a droopy looking installation.

INSTALL genuine Telrex "Conical-V-Beams" and "See the Difference"—on the tube and in the air. No other antenna compares.

BE BRAND CONSCIOUS! "Just as Good" is a fable. Don't be sold an imitation of the genuine, patented "Conical-V-Beam". Look for the Telrex trademark and be sure.

DELUXE "CONICAL-V-BEAM"

World's most famous, most powerful, most sturdily constructed antenna. Superior to any for TV-FM and UHF reception. WRITE today for complete data.

DEALERS — SERVICEMEN —

"TELREX NEWS" can be mailed direct to your place of business. This timely service periodical contains the most authentic antenna technical data available. It's FREE — Write on your Company letterhead or post card with Company stamp.

"CONICAL-V-BEAMS" are produced under Re-issue Patent No. 23,346

CANADIAN PATENT'S PENDING

**THE SKILL TO DESIGN...
THE FACILITIES TO PRODUCE...
THE ABILITY TO DELIVER**

AMERICA'S STANDARD OF COMPARISON

CONICAL-V-BEAMS ASBURY PARK 9, NEW JERSEY

BUILD 15 RADIOS...Only \$19.95

- ABSOLUTELY NO KNOWLEDGE OF RADIO NECESSARY
- NO ADDITIONAL PARTS NEEDED • TOOLS INCLUDED
- EXCELLENT BACKGROUND FOR TELEVISION

10 DAY MONEY-BACK GUARANTEE

The Progressive Radio "Edu-Kit" is a Home Radio Course offered in Kit Form at a rock-bottom price. No previous knowledge of radio is required. All necessary parts, tools and instructions are included. All parts are individually packaged for easy identification. Instructions are simple and extremely easy to follow.

Radio Theory, construction and trouble shooting are included. You will construct 15 Radios, including Receivers, Transmitters and Audio Amplifiers. You begin with a simple circuit and gradually progress to more advanced circuits.

The Progressive Radio "Edu-Kit" has been used successfully by many thousands of individuals with no previous background in radio, by various Radio clubs, Radio Schools, and by the Veterans Administration for job training. The kit actually pays for itself in a few weeks because even a complete beginner can make use of this practical training to do repair jobs for friends and neighbors.

The price of \$19.95 is not a down payment. IT IS THE COMPLETE PRICE OF THE PROGRESSIVE RADIO "EDU-KIT", including the FREE EXTRAS listed below. You keep everything, including all parts, tools, instructions, etc.

FREE 1951 EXTRAS

ELECTRICAL AND RADIO TESTER

ELECTRIC SOLDERING IRON

BOOK ON TELEVISION

RADIO TROUBLE-SHOOTING GUIDE

MEMBERSHIP IN RADIO-TV CLUB

QUIZZES

CONSULTATION SERVICE

ORDER YOUR PROGRESSIVE RADIO "EDU-KIT" TODAY, OR SEND FOR FURTHER INFORMATION. POSTAGE PREPAID ON CASH ORDERS. C.O.D. ORDERS ACCEPTED IN U.S.A.

PROGRESSIVE ELECTRONICS CO., 457 Union Ave., Dept. RE-51, Brooklyn 11, New York

COMPARE OUR PRICES!

DON'T BE MISLED—OURS ARE STANDARD BRANDS

THESE ARE ALL TOP BRANDS. Many in Original Factory Boxes. All individually boxed.

SPECIAL

1B3	.95	6T7	.88
6AL5	.65	6W4	.54
6AU6	.65	12AT7	1.09
6BQ6	1.20	12AU7	.80
		12BH7	.72

STANDARD BRANDS

0Z4	.66	6AH6	1.56	6Y6	.96
1A5	.80	6AK5	1.56	12AX7	.96
1A7	1.00	6AQ5	.75	12BA6	.72
1H5	.80	6AR5	.72	12BA7	.96
1H5	1.00	6AV6	.66	12BE6	.72
1Q5	1.06	6BA6	.72	12SA7	.85
1R5	.85	6BG6	1.92	12SK7	.80
1S5	.85	6BJ6	.80	12SQ7	.72
1U4	.80	6CD6	2.40	14Y4	.96
1U5	.80	6E6	1.16	25A7	1.80
1X2	1.06	6SA7	.80	25L6	.80
3Q5	1.10	6SH7	.65	32L7	1.28
5U4	.66	6SK7	.72	35L6	.80
5Y4	.96	6SN7	.88	35W4	.50
5Y3	.50	6T8	1.28	35Z5	.60
6AC7	1.16	6V6	.80	47	1.16
6AG5	1.06	6W6	.88	50L6	.80
6AG7	1.28	6X5	.60	11Z6	.96

Order other types not listed, out prices are lower!

TELEVISION ANTENNAE

CONICAL 8 ELEMENT	\$ 2.99 ea.
Double Bay Conical (with stacking rods)	6.58 ea.
Quick Rig Folded High and folded low	3.99 ea.
Infinite	3.99 ea.
Indoor V (individually cartoned)	1.99 ea.

(All above six to a carton)

ANTENNAE ACCESSORIES

CHIMNEY MOUNTS SPECIAL	\$.99
3 1/2" wall mount	.29
7" wall mount	.89
12" Eave Bracket	1.99
5 ft. masts	.89
10 ft. masts	1.79

SPECIAL 300 OHM—1st quality 55 mil web, 22 gauge pure polyethylene & 7 strand pure copper. \$17.50 per M

SPEAKERS

4" PM Alnico #5	\$1.29
5" PM Alnico #5	1.49

VOLUME CONTROL "SPECIAL"

1/2 meg. with switch	Standard 2 1/2" shaft 49¢
----------------------	---------------------------

OUTPUT TRANSFORMER

To match any of the tubes below
50L6-6V6-6K6-6F6-3S4-3V4-3Q5
ALL AT ONE PRICE—45¢

Miniature I.F. TRANSFORMER

Standard "K" Trans-456KC—Complete with mntg clip & adapter Input 59¢ Output 59¢

DIAL LAMPS

#47 G.E.—10 to box—\$4.95 for 10 boxes .55 per box of 10

ALLIANCE 3 SPEED PHONO MOTOR

Complete with turntable Special \$5.49

3 TUBE PHONO AMPLIFIER

With tone & Volume controls—uses 12SQ7-50L6-35Z5—less tubes and output transformer \$2.89 with tubes 4.71

SELENIUM RECTIFIER Top Quality

Full Wave Bridge Types

up to 18v in / up to 14v out	up to 36v in / up to 28v out
2 amp. \$ 2.50	1 amp. \$ 2.75
4 amp. \$ 3.75	2 amp. \$ 2.75
11 amp. \$ 5.75	4 amp. \$ 5.50
12 amp. \$ 7.75	8 amp. \$ 7.50
24 amp. \$11.50	12 amp. \$10.00
	24 amp. \$22.00

115v. in 100v. out—2 amp. \$9.49. Complete Power supplies Built to Order. Special Rectifiers built to order. "FAST SERVICE"

CONDENSERS

Electrolytic Tubular type

mfd	W.V.	Price
50-30	150v.	49¢
F. P. TYPE		
40-40	400-475	\$1.10
20-20-20	450-450-25	69¢

PAPER TUBULAR

.01	600v.	8¢
.05	600v.	10¢
.1	600v.	12¢

Television Hi-Volt Ceramic Condensers

.005	10KV	49¢
.005	20KV	69¢

10% Deposit with order, balance C.O.D. All shipments FOB, N.Y.C. Ask for Complete Catalog.
ATLAS TEL-RAD PARTS
153 Chambers St. Dept. RE-9 New York 7, N. Y.
Phone HAover 2-5813

THUMPLESS A.F. SWITCHING

It is becoming increasingly popular to use a single a.f. system for phonographs, recorders, and AM, TV, and FM radios. A selector switch connects the amplifier input to the output of the various devices. The most commonly used switching circuit is shown in the diagram. This circuit has the disadvantage of producing an annoying plop or thump in the speaker each time the selector is turned to a position other than PHONO.

When the selector is turned to any position, the coupling capacitors Cc of the other positions are not charged because one plate is floating. When the selector is thrown to any position having a coupling capacitor, the capacitor

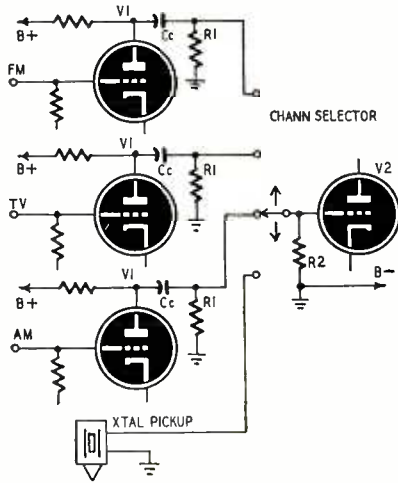

charges to the d.c. potential on the plate of V1 and applies a strong transient pulse to the grid of V2. Since V2 seldom requires more than a volt or two to drive the amplifier to full output, the pulse produces a loud thump in the speaker.

I eliminate this annoyance by connecting a resistor (R1) on the output side of each coupling capacitor. These resistors keep the capacitors charged so the plates on the output side are always at ground potential. Since the grid of V2 is also at ground potential, the various circuits can be switched in and out without thumping. The value of R1 should be fairly high—5 megohms or so—or 8 to 10 times R2, to prevent its affecting the loading and frequency response of the circuit. R1 is not necessary in input circuits for crystal pickups which are at zero d.c. potential.—Norman C. Fulmer

(The amount of thump (sharpness of transient) depends on the size of the coupling capacitor and R1. The time it takes for a capacitor to charge to 63% of applied e.m.f. is the time constant. T = CR; the time combination, .01 x R1, is shorter than .25 x R1.

You may also try using larger coupling capacitors. This reduces charging thump pulse, increases charging time, and also gives better low frequency response.—Editor)

—end—

The Book that takes Drudgery out of Mathematics
Only \$1. postpaid
SOLVES EVERYDAY PROBLEMS HELPS YOU GET AHEAD IN LIFE

How many times have you lost money because of a mistake in figuring? Do you know how to figure quickly and correctly? Can you figure discounts, interest rates, taxes and all the other calculations you meet up with in your daily life?

Are you having trouble qualifying for Civil Service Exams or Armed Services Promotions, because you're not up on mathematics?

Here is the book that gives you a good background in mathematics; that takes all the irritation and drudgery out of it. You don't need to be scared of mathematics, because here's the subject explained without frills, without useless computations. Here's the book for men in radio jobs; for business men; technicians and craftsmen, explaining and answering everyday mathematic problems in easy-to-understand words and illustrations.

The Radio Technician will find information on the following: Ohm's Law—Resistance—Reactance—Capacities—Inductances.

The valuable tables are multiplication and division table. Squares; Square Roots; Cubes and Cubic Roots Tables. Areas of Circles Table. Common Fractions reduced to Decimal Table. Factors and Prime Numbers Table. Table of Multiples.

Yes, it's the key to a simple understanding of mathematics. It's a real home-study course in mathematics for the man who's alert to its importance in the world today.

ELEMENTARY MATHEMATICS

• EASY — SIMPLIFIED — PRACTICAL •

CONTENTS OF BOOK

- CHAPTER I. Arithmetic—Addition—Subtraction—Multiplication—Division.
- CHAPTER II. Factoring and Cancellation—Fractions—Decimals—Percentage—Ratio—and Proportion.
- CHAPTER III. The Metric System.
- CHAPTER IV. How to Measure Surfaces and Capacity (Geometry).
- CHAPTER V. Powers and Involvement—Roots and Evolution.
- CHAPTER VI. Mathematics for the Manual and Technical Craftsman—Thermometer conversions—Graphs or Curve Plotting—Logarithms—Use of the Slide Rule.
- CHAPTER VII. Special Mathematics for the Radio Technician.
- CHAPTER VIII. Commercial Calculations—Interests—Discounts—Short Cut Arithmetic.
- CHAPTER IX. Weights and Measures—Useful Tables.

ONLY \$1. POSTPAID

Send Today for Your Copy of This Indispensable Book. It Can Be Carried Readily in Your Pocket. (Size 6 x 9 in.)
TECHNIFAX
520 N. Michigan Ave., Chicago 11, Ill.

TECHNIFAX, 520 N. Michigan Ave. Chicago 11, Ill.

Enclosed find \$1.00 for which send me ELEMENTARY MATHEMATICS prepaid.

Name _____

Address _____

City & State _____

RE-9-51

HAVE YOU A JOB FOR A TRAINED TECHNICIAN?

We have a number of alert young men who have completed intensive training in Radio and Television Repairing. They learned their trades thoroughly by working on actual equipment under personal, expert supervision. If you need a trained man, we invite you to write for an outline of our course, and for a prospectus of the graduate. No fees, of course. Address:

Placement Manager, Dept. P108-9
COMMERCIAL TRADES INSTITUTE
1400 Greenleaf Chicago 26

SPEAKING AID PORTABLE AMPLIFIER

? A friend suffered a throat injury which left him unable to speak above a whisper. He would like to have a small amplifier which will amplify his feeble voice and radiate it from a small speaker which can be carried on his person. The unit must be battery-operated and should use miniature or subminiature tubes. It should be small enough to be built into a case about the size of a hearing-aid.—D. M. H., Renforth, N. B.

B-battery, remove C1 and ground the lower end of the volume control. Remove R2 and R3 and change R1 to 560 ohms. The output transformer for the 1S4 or 3S4 should have an 8,000-ohm primary and is a standard unit.

If the input stage overloads and causes distortion at high volume levels, replace the present volume control with a 10-megohm resistor. Connect the 5-megohm control directly across the

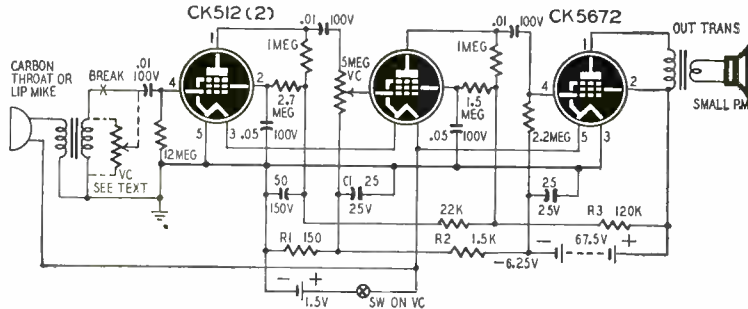

A. A diagram of a small amplifier using subminiature tubes is shown. The CK5672 will deliver approximately 65 milliwatts of power. For higher gain and greater power output—approximately 270 milliwatts—use a 1S5 or 1U5 as speech amplifiers and a 1S4 or 3S4 with parallel-connected filaments as the power amplifier. Use a 90-volt

secondary of the microphone transformer, connect its arm to the input side of the blocking capacitor and break the lead from the top side of the transformer secondary.

We suggest that you try carbon-type lip and throat microphones to determine which works best. These cut down external noise pickup.

STACKING AND PHASING 8-ELEMENT YAGIS

? In the Question Box of the July, 1951 issue you showed how to stack four 300-ohm Yagi antennas. Will it be worthwhile for me to stack eight Yagi antennas for more gain. If so, please show the necessary phasing arrangement.—K. W., Sheboygan, Wis.

A. Stacking Yagi antennas eight elements high will produce a vertical response pattern so sharp that orientation for maximum gain will be extremely difficult. We suggest using the Yagis you have to make an array four elements high and two elements wide and thoroughly brace it.

The connections for the phasing and matching sections for 300-ohm antennas are shown in the drawing. Only the driven elements are shown for simplicity.

The 425-ohm lines can be constructed from 1/4-inch tubing spaced 4 1/2 inches or No. 12 wire spaced 1 1/2 inches. The same phasing arrangement can be used for stacking the antennas eight elements high or wide. We do not recommend using Yagis with more than four elements. A greater number of ele-

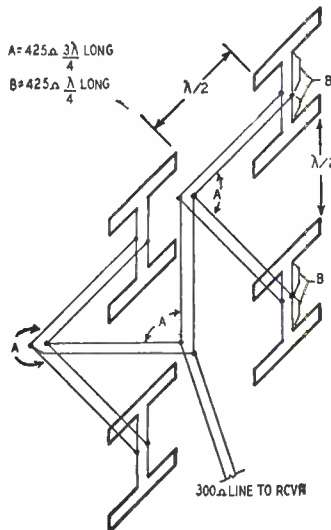

ments with the usual 0.1-wavelength spacing may result in such narrow band width that the antenna will not properly cover the channel for which it is cut.

USING 400-CYCLE SELSYNS ON 60-CYCLE LINES

? I have a pair of 110-volt, 400-cycle selsyns that I would like to use on 117-volt, 60-cycle lines. Is there any way in which I can do this without damaging the units?—E. A. V., Nazareth, Pa.

A. Selsyns, motors, and relays designed for 400-cycle service can often

be operated successfully on 60 cycles by reducing the input voltage to one-half or one-third of the rated voltage. Use a step-down transformer, dropping resistor, or series capacitor to drop the voltage to 55 volts, 35 volts, or even lower. Use the lowest voltage that gives the required torque without heating.



MOST POWERFUL COMBINATION for SINGLE CHANNEL RECEPTION

VEE-D-X

THE LAPOINTE-PLASCOMOLD CORPORATION
Windsor Locks, Conn.

TECH-MASTER TELEVISION

New TECH-MASTER developments!

LO-PRICED
Universal KIT



FOR TUBES UP TO 14" RECT.
First LOW-COST TV Receiver Kit completely engineered exclusively by TECH-MASTER. Features 2-knob control and small, lightweight chassis.
Model 5116 . . . \$89.50
Set of circuit-matched TUBES tested with each individual kit. . . \$16.25

Advanced
630 Type KIT



FOR ALL TUBES 12" Rd. to 20" Rect.
The greatest advance in TV Kits developed by TECH-MASTER!
Model 630D19 (De-Luxe) Principal components assembled.
Resale Price \$159.50
Model 630S19 (Standard) Unassembled.
Resale Price \$154.50
Above Kits supplied with tubes, parts, speaker and pix tube mounting brackets (less Kine, wire and solder).
CONTACT YOUR JOBBER or write Dept. RC-9 for literature.

TECH-MASTER PRODUCTS CO.
443-445 Broadway, New York 13, N. Y.



More leading engineers and technicians have built Tech-Master for their own use than any other Television Kit.

CENTERING TV PICTURE

? *My TV set is a Philco 50-T1403. The volume was low so I checked the tubes and found that the 7F8 was bad. The volume came up to normal but the picture shifted over to the left and there is a crescent-shaped dark area around the left side and bottom of the picture. Can you tell me what causes this condition and describe a means of curing it?*
—J. S. T., Somers Center, Wash.

A. Most likely you accidentally shifted the positions of the deflection yoke and focus coil while installing the new tube. The yoke and focus coil are usually mounted in brackets which permit the units to be shifted slightly in all directions. Moving the deflection yoke toward the rear or shifting the focus coil to one side or rotating it about either axis will produce the trouble that you have.

Check the deflection yoke and make sure that it fits snugly against the flare of the tube. Rotate it so the edges of the raster are square with the mask. Loosen the focus-coil adjusting screws and move the coil slightly toward the base of the tube setting it in the position which gives uniform focus over the greatest picture area. Move the coil up and down, from side to side, and swing it about both axes to obtain proper centering without neck shadow. Do not try to adjust the focus coil for maximum brightness at the expense of focus and centering.

Caution! Adjustments made to the focus coil and deflection yoke should be made carefully so that the position of the ion trap is not disturbed. Improper adjustment of the trap will result in ion-spot burn on the tube face.

USING SELENIUM RECTIFIERS

? *Can selenium rectifiers be used to replace the 5Y3-G and 5U4-G rectifiers in a G-E model 835 TV receiver? If so, please give type numbers of rectifiers that you recommend.*—J. R. K., Cleveland, Ohio

A. Typical radio-type selenium rectifiers are rated at 130 volts r.m.s. for each half-wave unit. The voltage between each of the 5U4-G plates in your set is approximately 335, so three rectifier units must be connected in series to replace each plate of the tube. Each of the rectifier stacks or units should

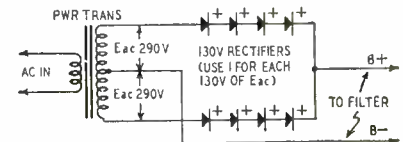

be rated at least 150 ma. Units rated at 200 ma are preferable. You will need six rectifiers to replace the 5U4-G in the full-wave rectifier circuit.

The 5Y3-G operates with 290 volts on each plate and the current drain is approximately 90 ma. Six 150-ma rectifiers are recommended for replacement. The circuit shows how selenium rectifiers can be used to replace a vacuum-tube rectifier in a full-wave circuit.

Over 43,000 Technicians Have Learned

HOW TO GET THE MOST OUT OF BASIC TEST EQUIPMENT

Why Not You, Too?

SERVICING by SIGNAL SUBSTITUTION

A BEST SELLER FOR OVER 9 YEARS! (NEW, UP-TO-DATE, 12TH EDITION)

The Simple, Modern, Dynamic Speed Approach To Receiver Adjustment and Alignment Problems, AM-FM-TV.

- Nothing complex to learn
- Universal — non-obsolete
- No extra equipment to purchase
- Employs Only Basic Test Equipment

Ask for "S.S.S." at your local Radio Parts Jobber or order direct from factory.

PRECISION APPARATUS COMPANY, INC. • 92-27 Horace Harding Blvd., Elmhurst 4, N. Y.



only 40¢

100 pages. Invaluable information that will help you re-double the value of your basic test equipment.

PARTS LISTS

Bills of material for most of the pieces of equipment described in RADIO-ELECTRONICS construction articles are on hand at all radio dealers and distributors who sell the magazine. See your dealer for a complete parts list of any of this apparatus you wish to construct.

CONTROL TRANSMITTER

? I am making a remote-controlled signaling system and would like to have a diagram of a small battery-powered transmitter operating between 400 and 500 kc. Its power must be sufficient for a range of about 50 feet. I want to use a loop antenna.—F. B., Lyons, N. J.

A. The circuit of the transmitter is shown. It is crystal controlled. The loop antenna and tuning capacitor are selected to tune to the same frequency as

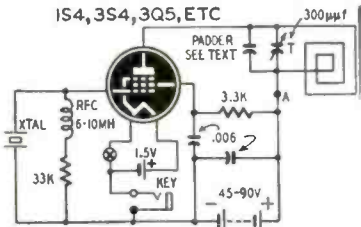

the crystal. The loop antenna may be one designed for a standard broadcast portable set. The circuit can be tuned to resonance by inserting a 10-ma meter at point A and varying the tuning capacitor for minimum plate current. It may be necessary to connect a small mica capacitor of 100 µmf or so in parallel with the trimmer to reach resonance at some frequencies.

Crystals for most frequencies in the 400-kc range can be obtained from surplus outlets for less than \$1.00 each. There are many crystals available for the SSB exciter, for instance, which range in frequency from 400 to 500 kc, at 1-kc intervals.

GARAGE-DOOR OPENER QUERY

? The radio-controlled garage-door opener described on page 62 of the March issue is not sensitive enough for my needs. At the present time, the maximum range is about four feet. Can I increase the sensitivity of the system?—J. L. D., Struthers, Ohio.

A. Try various adjustments of the spacing between the points on the ignition coil and on the spark gap. Replace the 1,000-ohm fixed cathode resistor with a wire-wound potentiometer of the same value. Decrease the resistance to the point where a further decrease will close the relay.



Suggested by M. B. Dunaway, Omaha, Neb.

Superior's *new* TELEVISION BAR GENERATOR

THROWS AN ACTUAL BAR PATTERN ON ANY TV RECEIVER SCREEN!!

TWO SIMPLE STEPS
 1. Connect Bar Generator to Antenna Post of Any TV Receiver.
 2. Plug Line Cord into A.C. Outlet and Throw Switch.

RESULTS—A stable never-shifting vertical or horizontal pattern projected on the screen of the TV receiver under test.

AT YOUR RADIO PARTS JOBBER

DEALERS NET PRICE on y 39⁹⁵

Manufactured and Guaranteed by
SUPERIOR INSTRUMENTS CO.
 227 Fulton Street • New York 7, N. Y.

PERFORMANCE Not Size IS WHAT COUNTS

"LITTLE GIANT" LIGHTNING ARRESTER

PROTECTS Against Lightning Hazards

No. AT 105 \$1²⁵ LIS¹⁵
 For ribbon-type and oval jumbo twin lead.

ONLY JFD Lightning Arresters offer you the exclusive patented features . . .

1. Strain-relief Retaining Lip prevents pulling or straining of lead against contact points.
2. You actually see positive contact made with lead-in wire.
3. No wire stripping or cutting.

Write for Form No. 84 showing the damage lightning can do to a Television Installation.

JFD MANUFACTURING CO., Inc.
 6101-1 16th AVENUE, BROOKLYN 4, N. Y.
LIST in Television Antennas and Accessories

LEARN

Television - Radio - Electricity

OR IN THE GREAT SHOPS OF **COYNE**

COYNE 52nd YEAR

TRAIN QUICKLY! OLDEST, BEST EQUIPPED SCHOOL OF ITS KIND IN U.S. Young and Older Men

Come to the Great Shops of Coyne in Chicago. Get practical training in TELEVISION-RADIO-ELECTRICITY—vital in Defense Program. Prepare now for a better job or better service rating.

START NOW—PAY LATER
 You can finance most of your tuition, pay for it later in easy monthly payments. Special plan for men of Draft Age. Part time employment serv. cv available.

GI APPROVED

FREE BOOK Clip coupon for Big Free Illustrated Book. Indicate below, course that interests you. No salesman will call. Act-NOW.

An Institution not for Profit

B. W. COOKE, Pres.
 COYNE Electrical & Television-Radio School.
 500 S. Paulina St., Chicago 12, ILL. Dept. 61-61H

Send FREE BOOK and full details or:

TELEVISION-RADIO ELECTRICITY

NAME

ADDRESS

CITY

STATE

INDISPENSABLE!

PHOTOFACT BOOKS



Photofact Television Course. Covers TV principles, operation and practice. 216 pages; profusely illustrated; 8 1/2 x 11". Order **TV-1**.....Only **\$3.00**

Television Antenna. New 2nd edition. Describes all TV antenna types; tells how to select, install, solve troubles. Saves time; helps you earn more. 200 pages; illustrated. Order **TAG-1**.....Only **\$2.00**

Television Tube Location Guide. Volume 2. Accurate diagrams show position and function of all tubes in hundreds of TV sets; helps you diagnose trouble without removing chassis. 224 pages; pocket-size. Order **TGL-2**.Only **\$2.00**

Television Tube Location Guide. Vol. 1. Over 200 pages of TV receiver tube position diagrams on hundreds of models. Order **TGL-1**.....Only **\$1.50**

1949-1950 Record Changer Manual. Vol. 3. Covers 44 models made in 1949, including multi-speed changers and wire and tape recorders. Original data based on actual analysis of equipment. 286 pages; 8 1/2 x 11"; paper-bound. Order **CM-3**.....Only **\$3.00**

1948-1949 Changer Manual. Vol. 2. Covers 45 models made in 1948-49. Paper bound. Order **CM-2**.Only **\$4.95**

1947-1948 Changer Manual. Vol. 1. Covers 40 post-war models up to 1948. Order **CM-1**.....Only **\$3.95**

Recording & Reproduction of Sound. A complete authoritative treatment of all phases of recording and amplification. 6 x 9". Order **RR-1**.....Only **\$5.00**



Audio Amplifiers. Vol. 3. Clear, uniform, accurate data on 50 important audio amplifiers, plus full coverage of 22 FM and AM tuners, produced during 1950. 362 pages, 8 1/2 x 11". Order **AA-3**.....Only **\$3.95**

Audio Amplifiers. Vol. 2. A complete analysis of 104 well-known audio amplifiers and 12 tuners made 1949-50. 368 pages, 8 1/2 x 11". Order **AA-2**.....Only **\$3.95**

Audio Amplifiers. Vol. 1. Covers 102 amplifiers and FM tuners made through 1948. 352 pages. Order **AA-1**.....Only **\$3.95**

Auto Radio Manual. Complete service data on more than 100 post-war auto radio models. Covers over 24 mfrs. 350 pages, 8 1/2 x 11". Order **AR-1**.....Only **\$4.95**

Communications Receiver Manual. Complete analysis of 50 popular communications models. 246 pages, 8 1/2 x 11". Order **CR-1**.....Only **\$3.00**

Radio Receiver Tube Placement Guide. Accurate diagrams show where to replace each tube in 5500 radio models, covering 1938-1947 receivers. 192 pages, pocket-size. Order **TP-1**.....Only **\$1.25**

Dial Cord Stringing Guide. Vol. 2. Covers receivers made from 1947 through 1949. Shows you the one right way to string a dial cord in thousands of models. Pocket-size. Order **DC-2**.....Only **\$1.00**

Dial Cord Guide. Vol. 1. Covers sets produced 1938 through 1946. Order **DC-1**.....Only **\$1.00**

Making Money in TV Servicing. Tested proved methods of operating a profitable TV service business. Covers all important phases. Authoritative, valuable guide to success. Over 130 pages. Order **MM-1**.....Only **\$1.25**

Order from your Parts Jobber or write direct to
HOWARD W. SAMS & CO., INC., 2201 E. 46th St., Indianapolis 5, Indiana
HOWARD W. SAMS & CO., INC.

DU MONT RA-112A, -113, -117

In some weak-signal areas it is impossible to obtain a satisfactory picture, even with a very good antenna system. By narrowing the bandwidth and increasing the gain of the video amplifier in these models, it is often possible to obtain a satisfactory picture where one

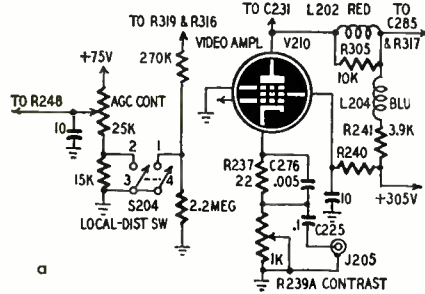

could not be obtained previously. The original circuit is shown at a, the modified circuit at b, and the location of components after modification at c. The LOCAL-DISTANCE switch is rewired so as to obtain normal bandwidth and

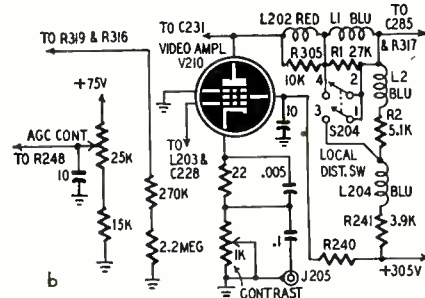

resolution on strong signals. Make the following changes:

1. Remove the black lead which runs from ground to terminals 3 and 4 of the LOCAL-DISTANCE switch S204.
2. Remove the orange lead between terminal 2 of S204 and the a.g.c. control.

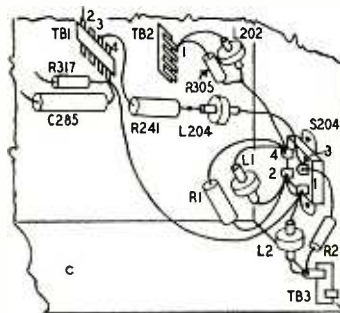

3. Disconnect L202, R305, and L204 from the junction of R317 and C285.
4. Connect the free ends of L202 and R305 together and connect to terminal 4 of S204.
5. Connect R1 (27,000 ohms, 1/2 watt, 10%) and L1 (peaking coil, part No. 21 006 627) in parallel between terminals 2 and 4 of S204.
6. Disconnect the junction of L204 and R241 from the terminal strip.
7. Connect L204 between the free end of R241 and terminal 3 of S204.
8. Mount a single-terminal tie-point in the corner of the chassis nearest S204.

TRANSVISION

CAN SHOW YOU HOW TO

GET IN ON THE GROUND FLOOR of COLOR TV

Now . . . get COMPLETE information on Color Techniques, Color Kits, Sets, Technical Information, etc. Send 25¢ to cover cost of handling and mailing.

SAVE UP TO 50%

on TV KITS, SETS, PARTS, etc.

Transvision makes the finest TV KITS, SETS, and WIRED CHASSIS that money can buy. PRICED AMAZINGLY LOW. Kits are easy to assemble. Give top quality picture and sound. Ideal for both hobbyists and dealers.

BEAUTIFUL NEW CABINETS

Write for Catalog RE

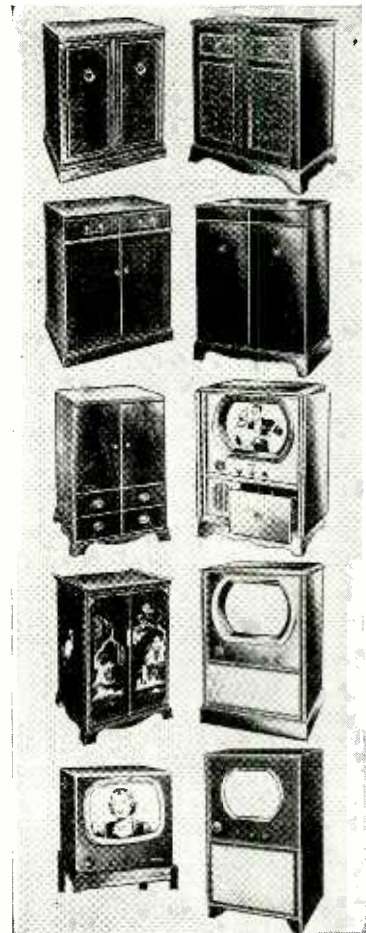

Write for Prices and Details Today!

TRANSVISION, INC.

Dept. RE NEW ROCHELLE, N. Y.

RADIO-ELECTRONICS for

IMMEDIATE DELIVERY ON AUTO RADIOS

Custom built for all popular 1949-1950 and 1951 automobiles: Chevrolet, Ford, Plymouth, Dodge, Studebaker, Henry J, and Hudson.

Every radio is a powerfully built, 6 tube, super-heterodyne with RF stage and 3 gang condenser for sensitive, long distance reception. Latest miniature tubes used, with beam-power output and oversize Alnico V loudspeaker, giving plenty of volume with excellent tone. Includes Automatic Volume Control and has low battery drain.

Each model radio is Custom-Built, designed for the individual automobile and can be mounted within 4 minutes with no cables, no brackets, no holes to drill.

When ordering, indicate type automobile:

Write for big discount prices

YOUR MONEY RETURNED IN FULL—

If the New Regency Television Booster fails to improve your television enjoyment! Bring your picture out of the snow and reduce interference!

- Push-Pull Neutralized triode design assures high gain without adding snow.
- No external impedance matching devices required.
- Inductive tuning assures same high-gain wide-band operation on all channels.
- Single knob tuning control.
- Underwriters approved with 90 day RMA guarantee.

LOWEST Price—ONLY **\$19.11**

MODEL NFRD—RADIO NOISE FILTER

If it doesn't work, send it back!

We absolutely guarantee that our Model NFRD will eliminate all line noises when properly connected to radios, television sets, short wave sets, motors, electric shavers, refrigerators, vibrators, oil burners, transmitters, and all other sources of interference. This unit will carry up to 12 amperes or 1 1/4 KW of power and may be used right at the source of interference or at the radio.

Small size only 3"x1 1/2"x7 1/2". Very low price only

Each **\$1.95**

A SCIENTIFICALLY DESIGNED PHONO SCRATCH FILTER

Resonated at approximately 4500 cycles effectively reducing objectionable needle scratch without altering the brilliancy of reproduction.

Contains a HI-Q SERIES resonated circuit. Tested by means of an audio oscillator and an oscilloscope to give 22 db attenuation with very low signal loss.

EASY TO ATTACH

Just two wires to clip on. Compact **\$1.98**

Price

THREE TUBE PHONO AMPLIFIER

An assembled unit ready for installation using tone and volume control and six feet of rubber cord **\$2.95**

(Not including Tubes)

With Complete Set of Tubes\$3.95

PHONO OSCILLATOR

Wireless phono oscillator transmits recording for crystal pick-ups or voice from carbon mike through radio without wires. Can also be used as an inter-comm by using P.M. speaker as mike.

Price (excluding tubes) **\$2.95**

With Complete Set of Tubes\$3.95

AUTOMATIC RECORD CHANGERS \$11.95

Standard well-known brands. Single speed 78-RPM types guaranteed to be in good working condition. Order while they last!

Satisfaction guaranteed on all merchandise
All prices subject to change without notice.

WRITE FOR FREE CATALOGUE C9

RADIO DEALERS SUPPLY CO.

154 Greenwich St. New York 6, N. Y.

9. Connect switch terminals 1 and 2 together and to the junction of C285 and R317.

10. Connect R2 (5,100 ohms, 2 watts, 5%) and peaking coil L2 (part No. 21 006 627) to the tie-point added in step 8.

11. Connect the free ends of R2 and L2 to terminals 3 and 1 respectively of S204.

12. Dress all components and leads for minimum capacitance.

The LOCAL-DISTANCE switch should be placed in the LOCAL position when receiving strong stations.—*Du Mont Service News*

ADDING PHONO TO ADMIRAL TV

It is simple to add a phonograph attachment to Admiral straight TV receivers. A 3-pole double-throw switch must be installed. One section transfers the input of the a.f. amplifier from the low-impedance ratio detector to the high-impedance phonograph pickup. The second section disables the vertical oscillator to prevent its radiations from entering the audio circuits when the first a.f. amplifier operates with a high-impedance input. The third section of the change-over switch breaks the B-plus lead to the first anode and prevents a bright horizontal line from appearing on the screen of the picture tube and possibly burning it.

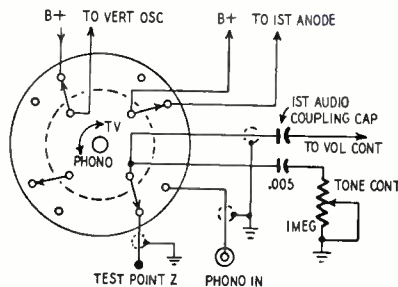

A tone control can be conveniently added to the circuit while the phono connections are being added. A control which operates with the switch in the PHONO or TV position may consist of a .005-μf capacitor and 1-megohm variable resistor in series between ground and the hot lead to the volume control. Choose a tone control with "tone" taper.

The diagram shows how the switch and tone control are connected. A Mal-lory 3242J or equivalent switch is used for change-over between TV and phono-graph. The fourth section of this switch can be used to apply power to the phono motor. The switch and tone control should be mounted in a small plastic or metal box which can be placed on the rear of the receiver in an accessible position.—*Admiral Radio & TV Service Bulletin*

PHILCO 925, CODE 123

If it is impossible to track the FM oscillator in this model and the 926, inspect the r.f. choke in the plate circuit of the 12AT7 oscillator. This trouble occurs when two or more of the turns are shorted together. Separate the turns and hold in place with a few drops of coil dope.—*Milton Margolis*



Learn Radio TELEVISION

through the
UNIT CHASSIS SYSTEM

The exclusive "Unit Chassis System" of teaching television was developed at this 48-year-old College of Electrical Engineering. The TV set is divided into stages on separate chassis. You study one stage at a time, intimately learning the functions of every component of all types and makes of receivers. You are fully prepared to cope with future design changes, including the advent of color television.

**You can become a Radio
Technician in 12 months**

Train here for positions such as Radio Shop Operator or Serviceman, Supervisor of Service Personnel. The Radio Technician's certificate is awarded. You may then advance immediately or at a future date into courses described below.

**Radio-Television Technician
Certificate in 6 additional
months**

Be prepared for such work as Radio TV Service—Audio, Transmitter or Communication Technician—and Broadcast Operator (upon passing FCC examination).

**Also . . . Your Technician Courses are
credited toward the B. S. Degree
in ELECTRICAL ENGINEERING.**

The Radio Technician course, while complete in itself, is one-third of the college program (major in electronics). Further, you may select as an elective: design, research, manufacturing and production, or engineering sales and management.



B.S. Degree in 36 months.
Military, practical or prior
academic, training evaluated
for advanced credit.
Terms open Oct., January,
April, July.

MILWAUKEE SCHOOL of ENGINEERING

Technical Institute • College of Electrical Engineering

FREE—Write for "Occupational Guidance Manual" and 1951 Catalog.



MILWAUKEE SCHOOL OF ENGINEERING
Dept. RE-951, 1020 N. Broadway
Milwaukee, Wis.

Without obligation, mail Occupational Guidance Manual,
 1951 Catalog, Your Career Bulletin on
Radio-TV, Electrical Engineering, B.S.
Degree in Electronics, Electrical Power.
Also bulletin on Electrical Service, Weld-
ing, Refrigeration, Heating, Air Condi-
tioning.

Name.....Age.....
Address.....
City.....State.....

HARVEY has in Stock

Famous "CELOMAT" COLOR WHEEL

For color television on your present TV receiver!



Approved by CBS to receive their color as transmitted. When rotated at 1440 R.P.M. in front of any existing TV receiver up to 10 inches, it will bring color television right into your home, providing the set has been converted for color reception. Outside dimensions 22 1/2 inches. Get yours now... be the first to receive color TV in your community... and, as usual, HARVEY is among the first to make it possible.

\$16⁹⁵

Low Priced at Only... **COLOR CONVERSION MANUAL** Tells you how to convert your set for color reception... **Only \$1.00**

Telephone: **LUxemburg 2-1500**

HARVEY RADIO COMPANY INC.
103 West 43rd St., New York 18, N. Y.

EASY TO LEARN CODE

It is easy to learn or increase speed with an Instructograph Code Teacher. Affords the quickest and most practical method yet developed. For beginners or advanced students. Available tapes from beginner's alphabet to typical messages on all subjects. Speed range 5 to 40 WPM. Always ready—no QRM.



ENDORSED BY THOUSANDS!

The Instructograph Code Teacher literally takes the place of an operator-instructor and enables anyone to learn and master code without further assistance. Thousands of successful operators have "acquired the code" with the Instructograph System. Write today for convenient rental and purchase plans.

INSTRUCTOGRAPH COMPANY

4701 Sheridan Rd., Dept. RC, Chicago 40, Ill.

CROSLY 11-446 MU, 11-476 BU

Several production changes have been made on chassis 325 used in these models. On chassis 325-1, the 6T8 sound detector and audio amplifier tube is mounted on a plate-and-socket assembly (part No. AB-150226). A .005- μ f, 500-volt disc-type ceramic capacitor is connected between ground and pin 2.

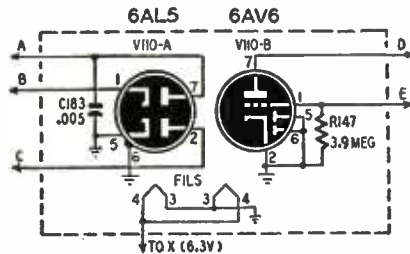

A-TO JUNCTION OF C132 & R143; B-TO LUG C OF T101; C-TO LUG D OF T101; D-TO JUNCTION OF C138, C137 & R142; E-TO JUNCTION OF C136 & R147

On chassis 325-2, a 6AL5 and 6AV6 are mounted on a socket-and-plate (part No. AB-150227) which replaces the 6T8 in earlier models. (See diagram) —Crosley Television Service Bulletin

A.G.C. ON CROSLY TV SETS

Some receivers have an external a.g.c. adjustment on the rear of the chassis. This control determines the voltage level at which the second detector operates. The factory sets this adjustment for a strong signal, so it should be re-adjusted—at the time of installation—for the stations in the area.

Tune in the weakest station in the area and turn the adjustment clockwise or counterclockwise to the point at which the set overloads with the contrast control set at maximum. When the control is set too far counterclockwise, it results in poor sensitivity and a weak picture. When the adjustment is carried too far in the opposite direction, the detector overloads and the picture may be unstable on medium to strong signals.

If the set overloads on a strong signal after the a.g.c. control has been properly set, turn the contrast control toward minimum until the overload is eliminated. If the overload cannot be eliminated with the contrast control, it may be necessary to make a compromise a.g.c. adjustment for the weakest and strongest stations.—Crosley Instruction Sheet

HUM IN COMMUNICATIONS SETS

When you find a communications receiver with a bad case of hum which is not caused by any of the more well-known sources, take a look at the noise limiter. In most of these circuits the cathode of the noise-limiter diode is connected to a high-impedance point in the audio circuit. The slightest leakage between heater and cathode will cause a lot of hum in the audio system. The tube should be replaced with one having negligible heater-to-cathode leakage. Check the tube in the set to be sure.

In many sets this potential trouble spot can be eliminated by replacing the vacuum tube with a 1N34 or similar crystal diode.—Charles Erwin Cohn

—end—

THE



High Quality

AUDIO AMPLIFIER . . .

ALL TRIODES

Distortion and intermodulation extremely low

Wide frequency range, flat from 20 to 20,000 cycles within .5 db

Attractive remote-control pre-amplifier

Compensation for various inputs; Phono, Tuner, Television or Microphone

Exclusive BROOK circuits and transformers



YES, ALL THESE FEATURES . . . but primarily LISTENING PERFORMANCE heretofore not achieved . . .

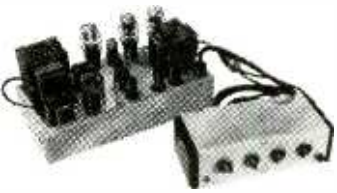

Write for free Technical Bulletin, detailed Distortion Analysis & booklet "Better Listening"

BROOK ELECTRONICS, INC. Dept. EI-1
34 DeHART PLACE, ELIZABETH 2, NEW JERSEY

- 11N21 CRYSTAL DIODES!69c 10/6.50
- T-30V Throat Mikes . . . brand new49c 6/2.49
- CD-508 Ext. Cord & Switch for T-3049c 6/2.49
- T-44A Magnetic Mike (SCR-522) . . . new79c
- G.E. Plate Relay (CR2791-B109P38), 8000 ohm coil, Dble. SPST coil98c 6/5.00

- Leotone Induction Coil #C-31-A 1 3/8" sq. x 3 1/2"75c
- 6 Volt D.C. Motors (Stewart-Warner) . . . 1750 RPM: 1/4"x3/4" shaft, O.D. 2 1/4"x3 3/4" . . . \$2.49
- 1/20 H.P. Motor (GE) . . . 1725 RPM, 110V.DC. 7A. Shunt wound, 4 3/4"x3 1/2"2.95
- Whip Antenna Box . . . 39" steel screw sects.— 1.49
- 18 ft.—\$2.49; 12 ft.—\$1.79; 9 1/2 ft.—1.49
- Metal Utility Box . . . 6" sq. x 6 3/4", hinged lid69
- Masonite Panels . . . 16 1/2"x7"x3/16"39c 3/1.00
- 100K or 250K Pots . . . 1/4" shaft25c 12/2.49
- 6" Spirit Level . . . sliding cover39c 6/1.98
- Watt Hour Demand Meter Movement (G.E. #M-14), 110V, 60 cycle2.49
- SPST Bat Toggles (C-H B5A) . . . Lamin. EP35
- DPDT Bat Toggle . . . 6A/125V/7/16" shank49
- TU-17A Tuning Unit (BC223) . . . like new2.98
- Radio Hardware Treasure . . . FULL POUND CAN OF: NUTS, SCREWS, LUGS, ETC.69c 3/1.98

- Alnico Bar Magnet . . . 1 1/8"x15/16"x5/16"3/1.98
- Alnico Magnet Kit . . . powerful Bar Block, "U", Ring, etc. Kit of 10 asstd.1.98
- Alnico Chip Magnets (Approx. 100/oz.), irreg. shapes15c/oz. 1.50 (WRITE FOR "ALNICO MAGNET" SUPPLEMENT)

- BC-606 Interphone Control Box . . . new50.69
- Gun Sync. Control Box (Fairchild Mk3) . . . "GOLD MINE" of new Toggles, Relay, Fuses, etc.2.95
- Auto Suppressors . . . univ. elbow10c 12/1.00
- 6V. Hi-Freq. Buzzer . . . dble. adjust.69
- 5016 P. Outputs . . . strap mts.39c 6/1.98
- "Polystyrene" . . . 12" lghs.—ROD: 1/4"—10c; 3/8"—20c; 1/2"—36c; 5/8"—55c; 3/4"—79c; 1"—\$1.29; TUBING (O.D.): 1/4"—10c; 3/8"—12c; 1/2"—17c; 5/8"—27c; 1 1/4"
- 50W. Rheostats . . . 1250 Ω —\$1.69; 15"1.29
- 5" Scope Dials . . . 360° calib. Hvy. acetate35
- PL-291/JK-48 Midget Connectorspr. .39
- Single Headset (W.E.) . . . adj. band, 5 ft. cord, 1.98
- Portable Record Player Case . . . Tan leatherette wood, Inside, 17 1/2"x14"x8 1/2"4.95
- High Fidelity Crystal Mike . . . Hi-imped. rubber shock mtd. 1 3/4"x3/4", Less housing1.29
- Aluminum Housing for crystal mike15
- Luminous Tape, "Glow in Dark" . . . 100"x3/4"1.49
- Handy Carbon Mike, RS-93 . . . Press to talk1.49
- ! MORE FOR YOUR MONEY ! . . . NEW "JUMBO RADIO PARTS KIT"—17 FULL POUNDS OF: COILS, WIRE, RESISTORS, CONDENSERS, SOCKETS, ETC., ETC.3.95

DIRECT FACTORY SPEAKER REPAIRS
Write for FREE "SPEAKER PARTS MANUAL"
Min. Order \$3.00 20% deposit on all COD's
Full remittance with foreign orders
Please add sufficient postage—excess refunded

LEOTONE RADIO CO.
67 Day Street, New York 7, N. Y.

TECHNICIAN LICENSES IN NEW YORK CITY PROPOSED

New York City's proposed licensing law for television technicians is expected to pass in revised form without opposition and will probably go into effect in October or November. Though the service technicians are not entirely convinced that licensing is the way out of the industry's dilemma, they have co-operated in framing the bill, and will be represented on the supervisory committee which it will set up.

The new law provides for licenses or permits for three classes: service contractors, technicians, and apprentices. Technicians' permits will be granted those who show proof that they have been engaged for two years in servicing receiver apparatus or testing electronic equipment, or who have completed a course in an approved school and have had one year's experience. This permit must be exchanged for a license before the end of June, 1953. Licenses are obtained on the successful completion of an examination in radio and television repair theory and techniques. Apparently no technician permits will be issued after June, 1953.

Apprentice permits will be issued to anyone employed as a service apprentice by an accredited technician or licensed service contractor.

The proposed law is less specific on the qualifications of a service contractor, but two classes of licenses will be issued. Type A licenses will be granted contractors who "have met the require-

ments prescribed by the commissioner," and Type B licenses to those who have not applied or have not qualified, as the case may be, for the Type A license.

The commissioner will not be the czar provided for in earlier bills; he will be required to explain his actions to a board of supervisors. This board, of seven members, will consist of a member of the board of education, a member of the city's law department, a member of the I.R.E., a skilled service technician, a service contractor, a dealer, and a distributor.

The committee shall recommend to the commissioner such rules and regulations as it deems necessary. While the commissioner is not bound to follow the recommendations of the committee, he must state his reasons in writing whenever he does not do so.

After 1953, all permits and licenses shall expire annually. Issuance or renewal of apprentice permit will cost \$5, technician license \$15, and service contractor license \$25. Beginning July 1, 1953, it shall be illegal to act as a service contractor without a license, or to service radio or television receiving equipment for compensation without being in possession of a technician license or acting (as an apprentice) under the direct supervision of an accredited technician. Punishment for violations are stiff—maximums are a \$1,000 fine and six months imprisonment, or both.

ACTIVE TECHNICIAN PUBLIC RELATIONS IN FLORIDA

Tom Middleton, former president of the Philadelphia Radio Service Men's Association (PR SMA), is now established in Miami, Florida, and has set up his own shop.

Tom reports an active organization of service technicians: The Radio and Television Technicians Guild of Florida. He sends a half-page co-operative

ad in a Miami paper, which features the window emblem of the Guild, and assures prospective customers of the reliability of shops displaying that emblem. Under the head, "Below is the dealer in your neighborhood who subscribes to the ethics and standards set by the Radio & Television Technicians Guild of Florida, Inc.," appear the

THIS EMBLEM IS YOUR ASSURANCE OF RELIABILITY

ORGANIZED & CHARTERED APRIL 28th, 1950

DADE COUNTY CHAPTER

BELOW IS THE DEALER IN YOUR NEIGHBORHOOD WHO SUBSCRIBES TO THE ETHICS AND STANDARDS AS SET BY THE RADIO & TELEVISION TECHNICIANS GUILD OF FLORIDA, INC.

<p>A & M AFFLUENCE CENTER 127 N.W. 7th St. Ph. 74 9123</p> <p>"ACCURATE" RADIO & TELEVISION SERVICE 1925 N.W. 17th St. Ph. 7 4994</p> <p>ARMOR RADIO & SOUND SER. 238 17th St. S.E. Ph. 34 1927</p> <p>ARROW TELEVISION 333 14th St. S.E. Ph. 7 7884</p> <p>L. S. AYARS 214 14th St. S.E. Ph. 5 8332</p>	<p>C. J. BAITE RADIO & APPLIANCE 1714 N. E. 13th St. Ph. 48 9448</p> <p>BEACH RADIO & TELEVISION SHOP 421 Roperwood Way Ph. 54 1111</p> <p>BUTNA VISTA RADIO 60 N.W. 14th St. Ph. 4 6118</p> <p>BILL'S RADIO & APPLIANCE SERVICE 1545 N.W. 80 St. Ph. 48 4621</p>	<p>COLLINS RADIO & SOUND CO. 2943 Grand Ave. Ph. 9 3834</p> <p>DAVIS RADIO SALES & SERVICE 1229 N.W. 17th Ave. Ph. 9 4444</p> <p>DETTEL RADIO SERVICE 77 N.E. 12th St. Ph. 7 4453</p> <p>EAGLE RADIO CO. 1128 N.W. 38th St. Ph. 7 6112</p>	<p>EDDIE O. RADIO SERVICE 3228 N.W. 7th Ave. Ph. 3 4444</p> <p>GLAUBER'S RADIO & TELEVISION 13 N.W. 17th Ave. Ph. 9 2711</p> <p>HAUGLER RADIO & TELEVISION 214 S.W. 8th Street Ph. 47 1521</p> <p>HENSHAW RADIO SERVICE CO. 418 W. Flagler St. Ph. 2 4728</p>	<p>WASSER'S RADIO TELEVISION & APPLIANCE 3177 N. W. 8th St. Ph. 9 8411</p> <p>LACIMAN RADIO—TV SERVICE AGENCY 2923 S.W. 47th Ave. Ph. 9 8411</p> <p>LEO'S RADIO SERVICE 714 N.E. 5th St. S.E. Ph. 18 9213</p> <p>LATTA RADIO 3222 S.W. 8th St. Ph. 43 7024</p>	<p>LAWRENCE RADIO & ELECTRIC 2422 Pierce St. (at Grand Blvd.) Ph. 48 3458</p> <p>LOCHEART RADIO & T. V. SERVICE 11808 N.W. 13th Ave. Ph. 7 9121</p> <p>MIDD'S RADIO & T. V. SERVICE 2171 N.W. 8th St. Ph. 7 8281</p> <p>PETRETTI RADIO SALES & SERVICE 348 N.W. 45th St. Ph. 4 1218</p>	<p>RAND RADIO & TELEVISION CO. 1333 N.W. 8th St. Ph. 9 2038</p> <p>RYAN RADIO & TELEVISION CO. 1333 N.W. 8th St. Ph. 9 2127</p> <p>TED REINER RADIO & T.V. "Rube Reiner for Radio" 3004 W. Flagler St. Ph. 47 1344</p> <p>ROSS RADIO & TELEVISION SERVICE 1184 S.W. 17th Ave. Ph. 4 8200</p>	<p>SARAL PALM TELEVISION CO. Telephone Service 3533 N.E. 2nd Ave. Ph. 34 1723</p> <p>SHAN—THE RADIO MAN, INC. 118 N.W. 12th Ave. Ph. 9 4920</p> <p>DICE SMOTHEY JR. RADIO SALES & SERVICE 3020 N.W. 2nd Ave. Ph. 9 2889</p> <p>TRAIL RADIO & TELEVISION 5805 S.W. 8th St. Ph. 9 1330</p> <p>UNITED RADIO & TELEVISION 4945 N.W. 7th Ave. Ph. 9 3177</p>
---	---	--	---	--	---	--	--

FOR THE BEST IN RADIO & TELEVISION SERVICE LOOK TO THIS EMBLEM IN YOUR SERVICE DEALER'S WINDOW.

Half-page ad in local Florida papers shows good sense in public relations. SEPTEMBER, 1951

NEW! VOL. 2

OF THE BOOK THAT SAVES YOUR TV SERVICING TIME!

HOWARD W. SAMS' "TELEVISION TUBE LOCATION GUIDE"

Gives Tube position and function in hundreds of important TV receivers... saves you hours of TV servicing time

FIND THE TROUBLE—REPLACE TUBES WITHOUT REMOVING THE CHASSIS

You've asked for more—and here it is—the second volume that brings you right up-to-date. There's nothing like it! The *only* book that shows the *position* and function of tubes in hundreds of TV receivers. Helps you save TV servicing time. Often an operational check in the customer's home—looking at the picture and listening to the sound—gives you a clue to the trouble. Many times only a tube failure is the cause. This invaluable Guide makes trouble diagnosis and tube replacement quick and easy, in most cases *without removing the chassis!* Each TV model has its own clear, accurate diagram. Book is fully indexed for quick reference. All new diagrams—takes up where Vol. 1 leaves off—no duplication. 224 pages, handy pocket size 5 1/2 x 8 1/2". Pays for itself on the first job!

ORDER TGL-2. *Only*..... **\$200**

VOL. 1. "TELEVISION TUBE LOCATION GUIDE"

This is the initial volume owned and used daily by thousands of TV Service Technicians. It includes tube location and function diagrams of hundreds of important TV receivers made by 56 manufacturers. Saves hours of servicing time—permits diagnosis of trouble and tube replacement without removing chassis.

Over 200 pages; handy pocket size. Order copies for outside calls and for your bench. Own *both* volumes for complete TV tube location data!

ORDER TGL-1. *Only*..... **\$150**

HOWARD W. SAMS & CO., INC.

Order from your Parts Jobber today, or write direct to HOWARD W. SAMS & CO., INC., 2201 East 46th Street, Indianapolis 5, Ind.

My (check) (money order) for \$..... enclosed. Send the following books:

TGL-2 "TV Tube Location Guide" \$2.00

TGL-1 "TV Tube Location Guide" \$1.50

Name.....

Address.....

City.....Zone.....State.....

*Reg. Trade Mark for Volt-Ohm-Milliammeter

VOLOMETERS

WE CHALLENGE COMPARISON

FOR MAXIMUM INSTRUMENT VALUE INSIST ON

EMC



Model 104
(20,000 ohms per volt meter)

- 4 1/2" SQUARE METER (50 micro-amperes-Alnico magnet)
- Includes carrying strap
- 5 DC Voltage Ranges at 20,000 ohms volt to 3,000 V.
- 5 AC Voltage Ranges to 3,000 V.
- 3 Resistance Ranges to 20 meg.
- Also 3 AC & DC Current Ranges at 5 DB Ranges

\$26.95



Model 102
(10,000 ohms per volt meter)

- 3" SQUARE METER
- 3 AC CURRENT RANGES (0-30, 150, 600 ma.)
- Same zero adjustment for both resistance ranges (0-1000 ohms, 0-1 meg. ohms)
- 5 DC & 5 AC Voltage Ranges to 3,000 Volts
- Also 4 DC Current Ranges

\$14.90



Model 103
(10,000 ohms per volt meter)

- 4 1/2" SQUARE METER
- 3 AC CURRENT RANGES (0-30, 150, 600 ma.)
- Same zero adjustment for both resistance ranges (0-1000 ohms, 0-1 meg. ohms)
- Same Ranges as Model 102
- Also 5 DB Ranges

\$18.75



Model 103-S with plastic carrying strap

\$19.25

All of the above have molded bakelite cases
Write Dept. RE-6 for Free Complete Catalog of these and other instruments.
— See them at your Jobbers —

Electronic Measurements Corp.
280 Lafayette St., New York 12, N. Y.
Export Dept., 303 W. 42nd St., N. Y. C.

names, shop addresses and phone numbers of 34 Guild members each set in one-column display type. The specimen sent was from the Miami Herald, but Tom reports that it appears "in the local papers," so presumably it is carried by others as well to achieve maximum effect.

LICENSES; MILWAUKEE AND L.A.

Licensing continues to be news on two fronts—Milwaukee and Los Angeles. In the City of Angels, councilmen, at last reports, were studying whether licensing would reduce the racketeering for which dishonest television technicians were recently given terms in jail. Meeting with them were representatives of the television and electric industry, the local service technicians association and the city's police and legal department.

After the discussion, the council committee moved that the industry group should come back within 30 days with concrete proposals embodying recommendations laid down at the meeting.

In Milwaukee, vigorous opposition to a proposed city ordinance which would regulate and license all television servicing was reported. Leading the fight were the local radio dealers' and appliance dealers' associations.

It should be noted the condition in Milwaukee is somewhat different from that in some other cities, states Howard Ashworth of the appliance association, since "there never has been, nor is there now, any so-called 'racket' television service association in Milwaukee."

According to a number of Milwaukee dealers, slow and unsatisfactory service has been the lot of many customers. This is believed due to a shortage of trained personnel and shortage of parts, and to the fact that much service time had to be expended on new receivers which came through defective from the distributor or manufacturer. These had to be put into working order before delivery to the customer.

Milwaukee technicians and dealers doubt whether an ordinance of the type proposed (said to be patterned on the New York City bill), would be of any value in Milwaukee.

N.J. CONTRACTORS ASSN. ELECTS

The Television Contractors Association of New Jersey elected as president Gus Friedman of Argus Television & Radio, Newark. Walter Ferry of East Orange was elected secretary, Lester Palmer, vice-president; and Ralph Ter-bush, treasurer.

The association discussed an advertising campaign to educate the public in regard to ethical television contracting. A committee was also set up to investigate and report on subcontract defense work.

87 DINE, TOUR, L.A. PLANT

Members of the Southern California Radio Technicians Association (RTA) were guests of Packard-Bell recently at

YOUR COPY of NEW 1951 COMPLETE GREYLOCK CATALOG

IS NOW **READY!**

Send for it Today!

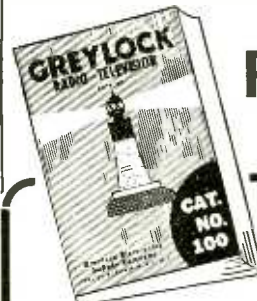

68 Pages

crammed full of Radio—Electronic—Television quality merchandise at

terrific savings! Many standard lines carried, including:

- BOGEN Challenger Line, Boosters
- JACKSON Instruments
- RIDER Publications
- CORNELL-DUBILIER Vibrators, Converters, Rotators
- SPRAGUE
- REGENCY
- HYTRON
- BURGESS
- ELECTRO-VOICE
- JENSEN

High quality Greylock Tubes still available at some of Today's best prices.

If you sell or service Radio, TV or Electronics equipment, you can't afford to be without this GREAT BUYING GUIDE! Write NOW for your copy (unless already on our mailing list).

GREYLOCK ELECTRONICS SUPPLY CO.
115 Liberty Street • New York 6, N. Y.

Replace Your Old TV Aerial With The NEW Snyder 360° MOTORLESS TV AERIAL

SAME CLEAR PIX AS MOTOR ROTATING AERIAL SYSTEMS COSTING TRIPLE THIS PRICE!

Only **\$12.25** Less Mast

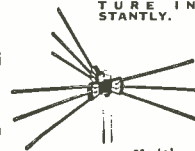

Electronically beams in complete 360° rotation to give clear picture on all channels. You choose direction with Directronic selector switch, mounted on or near TV set. Complete with 9 hi-tensil 3/8" aluminum alloy elements. 75 ft. of 3 conductor cable, and beam selector switch.

ORDER STACKED ARRAY MODEL AX-599 FOR ULTRA FRINGE AREAS

Electronically rotates 360° same as above. 18 elements. Complete with 75 ft. of 3 conductor cable and beam selector switch. **\$21.75** Less Mast

- STEEL MAST SECTIONS weather treated.
 - 10 Ft. 1 1/2" di. \$2.19
 - 5 Ft. 1 1/2" di. crimped end 1.35
 - Chimney Mount Brackets CM-100 1.59
 - Wall Mount Brackets WB-2, Adj. to 18" Heavy Duty 3.75

Order from Dept. RE-9 or call Mulberry 2134
WRITE FOR FREE F.Y.I. BULLETIN

WHOLESALE RADIO PARTS CO., Inc.
311 W. Baltimore St.
BALTIMORE 1, MD.

RADIO-ELECTRONICS for

NEW CONDENSER TESTER



Finds Intermittent Condensers Instantly

Pres-probe's sliding tip with variable resistance prevents condenser heating. Tests with power on. Requires no adjustment. Stops guesswork. Saves time. Convenient probe size (7/8" long). Satisfaction guaranteed.

NET 795
Postpaid U.S.A.

See Your Dist. or Order Direct

PRES-PROBE CO.

4034 N. Sixth St., Milwaukee 12, Wisc.

a dinner meeting and trip through the company's plant in Los Angeles.

The group of 87 who attended the dinner meeting represented the entire Southern California area, including many from Long Beach, San Pedro, Wilmington, Redlands, and Bellflower. RTA President Hal Myers, Vice-President Fred Abrams, Secretary Leo Huckins, and Treasurer Clarence Spencer were among those in attendance.

BOUQUETS TO TV TECHNICIANS

A group of people who believe the television technician has plenty of trouble and is nevertheless doing a good job has at last been found. The department store or furniture store type of television dealer is highly satisfied, in general, to sell television and leave servicing to service organizations.

The television technician will recognize and agree with the following reasons given by a number of St. Louis dealers interviewed by *Retailing Daily*.

"Our customers would expect too much. I never saw any type of merchandise which has as many potential headaches as TV. Every customer who has a little trouble with the adjustment of his picture . . . immediately assumes the set is no good," is the way one dealer sums up the situation. Another puts almost the same story in slightly different words: "Nuisance calls would be terrific . . . And it would be difficult to turn them down, particularly when they are people who have been doing business with you for years."

Department managers, trained in expense accounting, also realize it costs money to run a servicing business, and that organizing a service establishment causes headaches which do not necessarily originate with the customer. One of these points out: "We would have to set up a separate organization to handle TV service. This would mean about \$10,000 to \$15,000 inventory in parts, etc., and hiring a manager. In addition we would have to hire our own men. This is a tough job, and even full-fledged service organizations find it hard to get the right technical help."

Another says: "We would have to have fully as much additional space as my department now occupies. And, don't forget, service is a 24-hour proposition. People want service any time of the day or night."

Possibly some association should present a plaque to the furniture department store TV dealers of St. Louis for the most genuine and sincere appreciation they have received in a long time.

LIMITING WARRANTY TIME

Limitation of warranties to the regular RTMA 90-day period was seen as a solution of one of the service dealers' problems by Frank Moch, president of the Television Installation Service Association (TISA) and the National Alliance of Television and Electronic Service Associations (NATESA), speaking before the RTMA Service

GET YOUR BIG, NEW 1952 CONCORD Catalog

FREE!

Send for it NOW!



ALL-NEW COMPLETE BUYING GUIDE for Every Need!

FAMOUS PRODUCTS—VAST STOCKS—LOWEST PRICES

TV • RADIO • ELECTRONICS

You save time and money—with this bigger, better 1952 Buying Guide! Here is page-after-page full of the latest and greatest values in Television, Radio and Electronics.

It brings right to your finger tips one of the world's largest stocks of nationally known guaranteed quality parts and equipment. You find it quick and easy to get whatever you need—at the very lowest prices! Send for your **FREE Concord Catalog** today! Have it handy for quick reference!

Supplies for Industry, TV and Broadcast Stations, Schools, Servicemen, Hams, Government, Experimenters and Builders

CONCORD RADIO

901 W. JACKSON BLVD. • CHICAGO

Over 30 Years of Service to the Radio World

**CONCORD RADIO CORP., Dept. JJ-51
901 W. Jackson Blvd., Chicago 7, Illinois**

Rush **FREE** Big, New 1952 CONCORD Catalog No. 951

Name _____

Address _____

City _____ Zone _____ State _____

- HIGH FIDELITY TV & RADIOS**
- PHONOS & RECORDERS**
- SOUND SYSTEMS**
- HAM GEAR**
- TEST EQUIPMENT**
- ELECTRONIC TUBES**
- PARTS, BOOKS, KITS**

FAST DELIVERY
Large and varied stocks insure quick shipment on thousands of items.

HELPFUL SERVICE
Our technical experts give personal attention to your problems!

INDUSTRIAL DIVISION
Experienced staff and centralized efficiency speed service on supplies to Industry!

HIGH FIDELITY
Complete systems and custom components for finest reproduction!

EXPORT DIVISION
Special Export Division gives prompt service on orders and inquiries.

POSITIVE SATISFACTION
CONCORD'S policy of quality and value assures you of complete satisfaction!



UP-TO-DATE!



Be the man who can handle any television problem . . . and get well paid for it. Learn time-saving, trouble-shooting methods with this new, up-to-date book of down-to-cases television servicing, written so radio men can work from it! 400 information-packed pages, 300 valuable illustrations show you how to repair, adjust, service all makes—how to use newest testing instruments.

USE IT FOR 7 DAYS FREE

THE FACTS YOU NEED TO GO PLACES!
The PRACTICAL TELEVISION SERVICING AND TROUBLE SHOOTING MANUAL starts right off with trouble shooting, test instruments, adjustments, repair, replacement. Then completely covers tuners, television sound, alignment, picture tubes, antennas, other important phases. Complete section on Color TV and UHF including latest adapter and converters.

SEND NO MONEY—SEE IT FREE!
Get this great book, needed by every radio and television man, Free on 7 days trial. Send no money. Just fill out and mail coupon today. If you keep Manual, pay only \$4.25 plus postage in 7 days. Or return it then and owe nothing. Send the coupon NOW!

MAIL COUPON TODAY!

Educational Book Publishing Division
COYNE ELECTRIC & TELEVISION-RADIO SCHOOL
500 S. Paulina St., Dept. 91-L1, Chicago 12, Ill.
YES! Rush your new PRACTICAL TELEVISION SERVICING and TROUBLE SHOOTING MANUAL on 7-day Free Trial per your offer.

Name Age
Address
City State
() I am enclosing \$4.25. Coyne pays postage. 7-day Money-Back Guarantee.

● THE NEW MODEL 706A RCP
"WIDE RANGE"
SIGNAL GENERATOR
FOR BETTER, OVERALL PERFORMANCE



MODEL 706A
SIGNAL GENERATOR...\$6750

RCP now makes available to you this brand-new, precision-packed "WIDE RANGE" SIGNAL GENERATOR Model 706A for BETTER OVERALL PERFORMANCE in your SERVICE TESTING. New all-exclusive features including continuously variable modulation from 0% to 80%. Excellent for FM alignments. Provides high stability and accuracy with sharp, easy-reading calibrated dial, eight scales from 150 KC to 220 MC. Planetary drive gives vernier tuning with no backlash. Marker calibration—accurate to within 1%. Thorough shielding of all critical circuits and components, including oscillator tube, coil assembly, autotuner, switching circuit, transformer is electrostatically shielded. Output—high and low level. Ladder-type Step Attenuator. Tube Complement: 6B6, 6X4, 6X5. A high-quality instrument in performance, construction and appearance—the NEW MODEL 706A is handsomely finished in Grey and White. Comes complete with tubes and accessories, ready to operate on 105-150 Volts 60 Cycles. Sizes: 15" x 9" x 7". Weight 14 lbs.

Buy from your Jobber ● Insist on RCP Instrument: ● Write for Catalog RE-9

RADIO CITY PRODUCTS CO., INC.
152 West 25th St. New York 7, N. Y.

WANTED FOR DEFENSE
Waste paper is needed in the defense effort. . . Turn your waste paper over to collection agencies.

Committee meeting held in Chicago during June. Under the old plan, which the RMA spent many years to perfect, Mr. Moch stated, the customer would receive all the service to which he might be rightfully entitled. But statistics show that the average television set is used no less than 2,800 hours per year, so it is obvious that with a nominal life of 2,000 hours the 1-year plan gives the customer replacements on parts and tubes that have actually worn out. Warranties were never intended to do that.

SPEEDING TV SERVICE

Tele-Vuers Service Center, Bloomfield, New Jersey, report they find radio very useful in running a radio and television service business. They have equipped a number of their service cars with Link two-way mobile radio, keeping the men in the field in close touch with the office and transmitting service calls as soon as received to a car in the vicinity.

Joseph G. Werner, Jr., one of the owners of Tele-Vuers, reports that the



Service cars use two-way mobile radio.

cost is repaid by the number of calls which were formerly lost due to the owner's habit of calling two or three service companies and giving the job to the first one to arrive. Very often in the past, he says, the service technician would arrive, to be greeted with, "Oh, some other service company has already repaired the set; they got here much

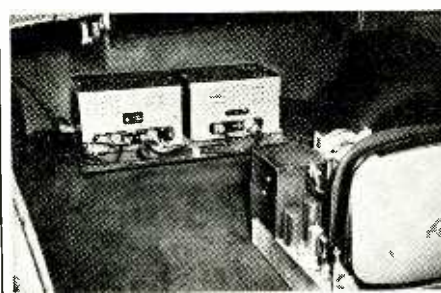

Link units in trunk; TV set for repair.

sooner than you!" He says, "Since installing radio, we haven't lost a call!"

The equipment also pays off in customer prestige, expressed by the considerable surprise often shown by customers at the speed with which calls are handled, and to the advertising value and publicity attendant on the installation. These gains are cinched, says Mr. Werner, by an ethical policy which rests on fair prices and not "pulling" a non-contract-covered set except when absolutely necessary.

—end—

COLLINS ANNOUNCES A NEW POLICY

Direct Factory Sales of Collins Tuners to the Consumer

SAVE OVER 30%!

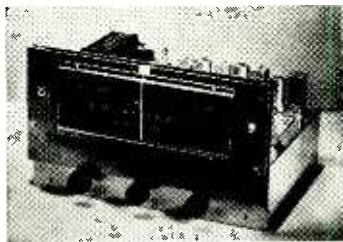

FM-11 Tuner \$59.50

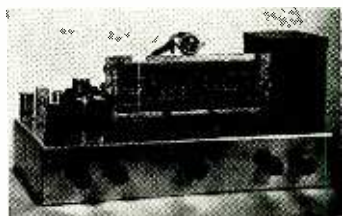

45-D FM/AM Tuner \$139.50

Never before have the famous Collins tuners been made available at these low prices. THERE HAVE BEEN NO CHANGES in design or construction and they are still being manufactured to the same high quality standards. All tuners are full guaranteed by the factory.

Order your Collins tuner today at these rock-bottom prices. Realize these big savings by dealing directly with the factory.

SEND CHECK OR MONEY ORDER TO:
COLLINS AUDIO PRODUCTS CO., INC.
P. O. Box 368 • Westfield, N. J.
Plant located on Route 29, Mountainside, N. J.

★ **WANTED** WE NEED YOUR SURPLUS ELECTRONIC EQUIPMENT ★
★ **WE PAY TOP \$\$\$ FOR:** ★
★ RADIO RECEIVERS ★ CLAMPS ★
★ TRANSMITTERS ★ PLUGS ★
★ ARC-1 ★ CORDS ★
★ ARC-3 ★ RELAYS ★
★ ART-13 ★ TELEPHONE ★
★ CONTROL BOXES ★ MATERIALS ★
★ INDICATORS ★ WE BUY ANYTHING!! ★
★ AN CONNECTORS ★
★ **Write, Wire Today!** ★
★ Tell us what you have ★
★ Box T9-51, c/o Radio-Electronics ★
★ 25 West Broadway New York 7, N. Y. ★

RADIO-ELECTRONICS for

STAN-BURN SPARKS

ANTENNAS	
Conicals, less mast	\$2.98
Circle X, less mast	2.98
Double V, less mast	2.98
Chimney Mounts—1-12	.95
100 ft. roll strapping	2.98
Mast standoffs	.03
10 ft. masts, each	1.59
12 or more, each	1.49
55 mil 300 ohm wire white or black, 1000 ft.	19.97
CIASSIS—630—K2—Famous make	129.50
CATHODE RAY TUBE SPECIALS	
12LP4 \$19.95 17BP4A	27.00
12LP4A 19.95 20CP4	39.95
14BP4 19.95 19AP4A	47.95
16DP4A 26.00 19DP4A	47.95
16GP4 33.00 24AP4A	83.20
16AP4A 39.00 Single ion traps	.39
16RP4A 26.00 Double ion traps	.59
SPEAKER SPECIALS	
4" P.M. \$1.64 4x6 P.M.	2.19
5" P.M. 1.75 6x9	3.73
6" P.M. 2.41 5x7	3.43
8" P.M. 3.41 10" P.M.	5.48
12" P.M.	6.33
OUTPUT TRANSFORMERS	
6L6 & 6V6—8 Watt	\$0.98
6K6—4 Watt	.89
50L6—25L6	.59
TV CORDS	
TV CORDS	\$0.29
AC-DC CORD 6" banded	.21
6" Cube Tapped EXT.	.34
9" Cube Tapped EXT.	.39
COLORTONE ADAPTERS	
List \$19.95—Cost \$13.30	
REGENCY TV SIGNAL BOOSTER	
Model DB110—List \$32.50—net price \$19.11	
We carry a complete line of popular makes of Radio and TV tubes. Also many other special purpose and transmitting types, and all electronic parts at lowest prices.	
Terms: 20% with order. Balance COD. All prices FOB. New York Warehouse. Minimum order \$3.00	
Write for our latest price list to Dept. RE-9.	

OPPORTUNITY AD-LETS

Advertisements in this section cost 35c a word for each insertion. Name, address and initials must be included at the above rate. Cash should accompany all classified advertisements unless placed by an accredited advertising agency. No advertisement for less than ten words accepted. Ten percent discount six issues, twenty percent for twelve issues. Objectionable or misleading advertisements not accepted. Advertisements for November issue must reach us not later than September 21, 1951.

Radio-Electronics, 25 W. Broadway, New York 7, N.Y.

SPEAKERS REPAIRED at wholesale prices. Guaranteed workmanship. Jobbers wanted. Amprite Speaker Service, 70 Vesey St., New York 7, N. Y.

MAGAZINES (BACK DATED)—FOREIGN, DOMESTIC—Arts, Books, booklets, subscriptions, etc. Catalog 10c (refunded). Cicerone's, 86-22 Northern Blvd. Jackson Heights, N. Y.

WE REPAIR, EXCHANGE, SELL ALL TYPES OF electrical instruments, tube checkers and analyzers, Hazlett Instrument Co. (Electric Meter Laboratory), 140 Liberty Street, New York, N. Y. Telephone—Barclay 7-4233.

WANTED: AN/APR-4, other "APR-", "ARR-", "TS-", "IE-", ARC-1, ARC-3, ART-13, everything Surplus. Special tubes, Tech Manuals, Lab quality Test Equipment, etc. Describe, price in first letter. Littell, Fairhills Box 26, Dayton 9, Ohio.

RADIO—TELEVISION—ELECTRONICS—TUTORING \$5 per lesson—Mo. Tech., 3907 North 25th Street, St. Louis 7, Missouri.

START A LITTLE ELECTRIC BUSINESS of your own building our patented radio filters. \$1.00 for blueprints and where to sell same. Clifford Orr, 711-5 Washington, Ludington, Mich.

Five Element TV Yagi Beams, Aluminum Tubing Etc. Write for prices. Willard Radcliff, Fostoria, Ohio.

AMATEUR—RADIO AND ELECTRICAL RESEARCH Engineering. Hy Twillmann, R.R.#1, Chesterfield, Mo.

ANTENNAS AND EQUIPMENT FOR TV AND FM. All Types, lowest prices. Wholesale Supply Co., Lunenburg, Mass.

PEN-OSCIL-LITE

Extremely convenient test oscillator for all radio servicing; alignment • Small as a pen • Self powered • Range from 700 cycles audio to over 600 megacycles u.h.f. • Output from zero to 125 v. • Low in cost • Used by Signal Corps

• Write for information.

GENERAL TEST EQUIPMENT
38 Argyle Ave. Buffalo 9, N. Y.

THE SERVICE BOMBSHELL

Dear Editor:

We read with a great deal of interest your fair evaluation of the current Western Union Services debate as outlined in the editorial "Service Bombshell" in your July issue.

We thought you might be interested in our position as outlined in a letter we recently sent to a servicemen's association in Pennsylvania.

Best wishes for the continued success of your excellent magazine.

Cordially,
ALLEN B. DU MONT Laboratories, Inc.,
Teletest Service Control Dept.
Harold J. Schulman
Director of Service
East Paterson, N. J.

"We are indeed sorry to learn in your letter of May 31 that your organization has expressed its desire not to cooperate with the Du Mont technical meetings because of the entry of the Western Union organization into the service picture.

"We feel that a misunderstanding has arisen which, when cleared up will once again allow your members to continue their cordial relations with this company as in the past.

"As you may know by now, Du Mont did not authorize the Western Union Services, Inc., as a national service organization. The authorization was a limited affair involving three counties.

"No rates or privileges were given to Western Union that were not also given to any other authorized Du Mont service organization. They solicit service on an equal basis with other service companies; they obtain replacement parts through the local Du Mont distributor; their prices follow the recommended Du Mont price list.

"We hope you will agree that the greatest danger to legitimate service companies is the entry into the service field of poorly managed, inefficient, cut-throat service companies. We do not believe that honest competition by a company with the integrity and overhead of Western Union would be detrimental to the best interests and welfare of independent service dealers or organizations.

"At Du Mont we recognize very deeply the part played by service personnel in the maintenance of Du Mont Teletests and the continued enjoyment of television by our customers. We go to great expense to put out the best service manuals, monthly service publications and bulletins to keep service personnel informed. We run a school at our factory at no charge to qualified technicians. We maintain one of the largest staffs of field representatives in the television industry. And, we have no intention whatsoever to antagonize our many friends in the service business on whose good-will we depend so much.

"We hope that after you review the situation as it really exists you will withdraw your protest so that we can continue our friendly relationship in the future as in the past."

—end—



**NEW!
ENLARGED!
REVISED!**

Special Offer On This Complete RADIO ENGINEERING LIBRARY

New, Up-To-Date Edition of Famous Library Covers Whole Field of Radio Engineering. Places Latest Facts, Standards, Data, Practice, and Theory At Your Fingertips

The five big volumes of the new edition of the Radio Engineering Library now include the very latest facts, standards, data, and practice. This Library will help solve hundreds of problems for designers, researchers, engineers, and students in any field based on radio.

Written by leading radio engineers, these books cover circuit phenomena, networks, tube theory, vacuum tubes, amplification, measurements, etc.—give specialized treatment of all fields of practical design and application. They provide you with a complete and dependable encyclopedia of facts.

- 5 Volumes, 3872 Pages, 2770 Illustrations
- Eastman's FUNDAMENTALS OF VACUUM TUBES, 3rd Edition.
- Terman's RADIO ENGINEERING, 3rd Edition.
- Everitt's COMMUNICATION ENGINEERING, 2nd Edition.
- Hund's HIGH FREQUENCY MEASUREMENTS, 2nd Edition.
- Henney's RADIO ENGINEERING HANDBOOK, 4th Edition.

SEND NO MONEY

Special Low Price—Easy Terms

On this special offer you get this Library for \$34.50, instead of \$39.00. You save \$4.50 and may pay on easy terms. Mail coupon below to examine the Library FREE for 10 days. No obligation. These books are recognized as standard works; you are bound to need them. So take advantage of this special money-saving offer. *Mail coupon at once!*

McGraw-Hill Book Co., Dept. RE-9,
327 West 41st St., New York 18, N. Y.

Send for 10 days' FREE trial, the RADIO ENGINEERING LIBRARY. If not satisfied I will return books. Otherwise I will send \$4.50, plus delivery charges, then; and \$5 a month for 6 months. (Reg. price \$39.00; you save \$4.50).

Name

Home Address

City & State

We'll Pay Delivery Charges if you enclose \$4.50 first payment WITH coupon. Same return privilege for full refund.

IT'S THE LOWEST PRICED UNDERWRITERS' LISTED ARRESTOR ON THE MARKET.

**Model R-116
List Price . . .**

90c

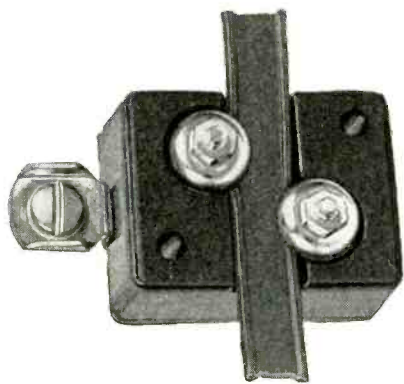

RAD EL CO

QUALITY THROUGHOUT

The new RADELCO R-116 is a combination resistance bleeder and gap-type arrestor. It is small and compact for easy wall installation. The arrestor network is completely enclosed in a molded Bakelite housing. No stripping of insulation . . . positive piercing contacts provide perfect electrical path, regardless of variation in width or thickness of insulation. Does not disturb impedance of twin line. Bleeder resistance is designed to improve both picture and sound by carrying off small static charges. Ground terminal accommodates up to .125" wire. Complete with wood screws. Individually packaged.



Place your order now with your nearest parts jobber.



**7580 GARFIELD BLVD.
CLEVELAND 25, OHIO**

THE FUND TOPS \$8,000.



**HELP -
FREDDIE-WALK
FUND**

The Help-Freddie-Walk Fund seems to have slackened somewhat in the summer months and we would urge our readers to consider once more the unfortunate youngster of Hershel Thomason, Arkansas radio technician, whose son was born completely armless and legless.

While in past months readers of RADIO-ELECTRONICS were responsible for contributing by far the largest sum of money to the Freddie fund, we do not wish to slacken our efforts and our readers are urged once more to help the unfortunate boy to grow up as a radio-man when and if appliances can be fitted on him so that he can take care of himself.

At the present time this is, of course, not possible because Freddie, who just turned three, has only a so-called "leg appliance" which has taught him to



Freddie is three now, and smiling. Won't you help him to keep on smiling?

balance himself. But so far he has not walked and will not until he has mastered the difficult job of coordinating the trunk muscles so he can twist his body from side to side to help walk. These appliances are extremely expensive and it is hoped that our readers will continue to contribute to the Freddie fund as heretofore.

Please send your contributions from time to time—even the smallest donation will be greatly welcome.

Make all checks, money orders, etc., payable to Herschel Thomason. Please address all letters to:

Help-Freddie-Walk Fund
c/o RADIO-ELECTRONICS
25 West Broadway
New York 7, N. Y.

Sky Hi

TELESCOPING TELEVISION MAST

With the SKY-HI Mast, installations are easy to install. No climbing is necessary—telescoping sections and hinged base make it possible to install and service from ground without the use of ladders.

The SKY-HI Television Mast is raised and lowered hydraulically. Double automatic latches on each section hold mast in rigid position and can be released from the ground. Guy wires are attached to each section before raising.

40' to 100' GROUND INSTALLATIONS

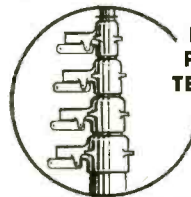

LATCHED POSITION TELESCOPED

Write for descriptive literature

10' to 40' ROOF MOUNTS AVAILABLE. THESE MOUNTS ARE NOT HYDRAULIC. LIMITED TERRITORIES AVAILABLE

THOMAS MOLD & DIE CO.

WOOSTER, OHIO

BUY WITH CONFIDENCE

DYNAMOTORS

Type	Input Volts Amps.	Output Volts Amps.	Ratio Set	Price
PE86	28 1.25	250 .060	RC 36	\$2.95
DM416	14 6.2	330 .170	RU 19	6.95
DM33A	28 7	540 .250	BC 456	4.95
DM42	14 46	515 .110	SCR 506	4.95
		1030 .050		
		2/8		
PE101C	13/26 12.6	400 .135	SCR 515	5.95
		800 .020		
BD AR 93	28 3.25	375 .150		4.45
23350	27 1.75	285 .075	APN-1	3.51
ZA0515	12/24 4/2	500 .050		3.65
B-19 pack	12 9.4	275 .110	MARK II	8.75
		500 .050		
D-104	12	225 .100		12.69
		440 .200		
DA-3A	28 10	300 .060	SCR 522	
		150 .010		
		14.5 .5		
5053	28 1.4	250 .060	APN-1	3.95
PE73CM	28 19	1000 .350	BC 375	
CW21AAX	13 12.6	400 .135		
	26 6.3	800 .020		
		9 1.12		
BD77KM	14 40	1000 .350	BC 191	12.95
PE94	28 10	300 .200	SCR 522	
		150 .101		
		14.5 .5		

Replacement dynamotors for DY 12, DY 13, etc. of ART-13. Brand New.



Xmfrs VFO-5.3 MC Drivers 5.3-7 MC 40 Watts \$5.95 Output 7-9.1 MC \$13.95 274N - Used Good (ARC5)

T.V. Transformer, 7" or 9" scope, 3000 V/5 MA, 220 vac (200 MA, 6.4/8.7A, 5.4/6A, 5/3A, 1.25/3A, 115V 60 cy input. Price . \$3.95

AUDIO TRANSFORMERS

AT 666	INTERCOM INPUT SPRK. (4-8 OHMS) TO GRID (250,000 OHMS)	\$5.99
AT 415	PLATE (18,000 OHMS C.T.) TO LINE (125 OHM) 175 WATTS-500-600 CY	1.95
AT 858	PLATE (10,000 OHMS C.T.) TO LINE & V.C. (500/125/30 OHMS) HI-FI-50W	6.95
AT 070	MIKE-OR-LINE (250 OHMS) TO GRID (250,000 OHMS C.T.)	1.29
AT 765	MIKE-OR-LINE (600 OHMS) TO GRID (50,000 OHMS C.T.)	.89
AT 449	HI-FI DRIVER (5000 OHMS) TO P.P. OUTPUT GRIDS (4,000 OHMS) 100-16,000 CY. 10 WATTS. 6V6 TO PF805'S.	2.39

Send M.O. or CHK. Mds. Guardt. Shop Charges Sent C.O.D. Price F.O.B. N.Y.C. Phone Di. 9-4124
COMMUNICATIONS EQUIPMENT CO.
131 Liberty St., Dept. C-9 New York City 7, N. Y.

We are pleased to report the following:

\$75.00 contributed on behalf of the management and the employees of Lessing Rudner Footwear, Inc., Norwalk, Conn., through E. Ash.

FAMILY CIRCLE CONTRIBUTIONS

Balance as of June 19, 1951 \$417.45
 Mrs. P. Britton—Lackawanna, N. Y. 2.00
 Mrs. L. Mandino—Waterbury, Conn. 1.00

FAMILY CIRCLE Contributions received up to July 19, 1951 \$420.45

RADIO-ELECTRONICS CONTRIBUTIONS

Balance as of June 19, 1951 \$7,949.83

Anonymous—Glendale, Calif. 1.00
 Anonymous—San Francisco, Calif. 1.00
 Anonymous—Everett, Mass. 2.00
 Anonymous—Middletown, N. Y. 1.00
 Anonymous—Everett, Wash. 2.00
 George N. Ashley—Chatham, N. Y. 2.00
 Harry O. de Gourville—Port-au-France, Martinique, F.W.I.85
 George Mackey—The Dalles, Oregon Management and Employees of Lessing Rudner Footwear, Inc.—Norwalk, Conn. 75.00

John Noreiko—Dearborn, Mich. 1.00
 Harold Reed—Hyattsville, Md. 1.00
 Hugh Ridall—Wilkes-Barre, Pa. 5.00
 Schroeders—San Antonio, Texas50
 S/Sgt. William F. Sweet—Burtonwood, England 10.00
 E. Szabo—Defiance, Ohio 2.00
 Wilmar, Calif. 1.00
 RADIO-ELECTRONICS contributions 8,060.18
 FAMILY CIRCLE contributions 420.45
 Total received to July 19, 1951 \$8,480.63

600-TUBE PRECISION FREQUENCY STANDARD

Master timekeeper, recently placed in operation at the Bell Telephone Laboratories (Murray Hill, N. J.), is expected to vary less than one ten-thousandths of a second per day; this corresponds to a precision of 1 second in 30 years.

The secret of this split-second precision lies in four extremely stable quartz crystals which vibrate at 100,000 cycles

Radio Thirty-Five Years Ago
 In Gernsback Publications

HUGO GERNSBACK
 Founder

Modern Electrics	1908
Wireless Association of America	1908
Electrical Experimenter	1913
Radio News	1919
Science & Invention	1920
Television	1929
Radio-Craft	1927
Short-Wave Craft	1930
Television News	1931

Some of the larger libraries still have copies of ELECTRICAL EXPERIMENTER on file for interested readers.

SEPTEMBER, 1917
ELECTRICAL EXPERIMENTER

- U. S. Blows Up Tesla Radio Tower Secret Radio Aerials, by H. Gernsback
- A Remarkable Amateur Radio Station with a Record, by A. F. Pendleton
- A French Radio Controlled Torpedo, by Frank C. Perkins
- The Present Status of the Audion, by Dr. Lee de Forest
- "Radio"—Communication Over Gas and Water Pipes—"Wired Wireless"
- A Victrola Tikker, by F. C. Hamilton
- An Efficient Scheme for Learning the Code, by Joseph Braff
- Seven Years of Wireless, by Howard S. Pyle

per second. Crystal units can be seen at left and right of photo.

The entire apparatus uses about 600 tubes and has over 25,000 soldered connections. The equipment is housed in air-conditioned rooms and the crystals are enclosed in containers from which all the air has been pumped. The temperature of the crystals is controlled to within a hundredth of a degree.



600-tube frequency standard will vary less than one second in next thirty years.

SEPTEMBER, 1951

Hot Fall Specials of Guaranteed Tubes & Condensers

Subject to your inspection. If any of the items you receive do not meet with your wholehearted approval—return for full immediate refund. Quality—Service—Dependability—Our Key-note.

RMA Guaranteed—Boxed STANDARD BRANDS
 Prices subject to change without notice.

SPECIALS

6H6	\$.85	3Q5	\$1.40
6J7	\$.85	50L6	\$.85
7G	\$.49	6SN7	\$.59

01A	.59	7B5	.99
0Z4	.83	7B6	.99
1A3	1.05	7C5	.69
1A4	1.98	7E6	1.15
1A5	.90	7F7	1.36
1A6	1.69	7F7	1.08
1A7GT	1.15	7F8	1.69
1B3GT/8016	1.05	12A6	1.26
1C6	1.49	12A8GT	1.08
1D5GT	1.78	12AT6	.85
1H5GT	.90	12AT7	1.46
1N5GT	.89	12AU6	.99
1R5	.89	12AU7	1.21
1S4	1.19	12AV6	.89
1S5	.98	12AV6	1.36
1T4	.89	12BA6	.89
1T5GT	1.19	12BE6	.89
1U4	.89	12F5GT	.89
1U5	.95	12C5GT	.85
1X2	1.35	12K8GT	1.36
3A8GT	2.25	12Q7GT	.89
3Q4	1.09	12SA7	.89
3S4	.98	12SF5GT	.89
5Y3GT	.74	12SF7	.89
5Z3	.92	12SK7	.89
6A7	1.08	12SN7GT	1.07
6A8	1.08	12SQ7GT	.98
6A84	.95	12Z3	1.49
6AC5GT	1.36	14A7/12B7	1.28
6AC7/1852	1.36	14B6	1.25
6AG5	1.36	14Q7	1.25
6AH6	1.75	19B6G	3.49
6AK5	1.85	25BQ6GT	1.58
6AK6	1.26	25C6	1.46
6AL5	.89	25L6	1.49
6AQ5	.89	25W4GT	.89
6AQ6	.89	25Z5	.96
6AR5	.89	25Z6GT	1.08
6AT6	.82	26	1.05
6AU6	.89	27	.99
6AV6	.89	30	1.28
6B7	1.59	32L7GT	1.84
6B8G	1.59	35/51	1.18
6BA6	.95	35A5	.89
6BE6	.89	35B5	.89
6BG6G	1.74	35C5	.89
6BH6	.89	35L6GT	.89
6BQ6GT	1.58	35W4	.75
6C4	.89	35Y4	.89
6CD6G	3.68	35Z3	.89
6F6GT	.89	35Z4GT	.80
6H6	.89	35Z5GT	.80
6J5	.72	36	1.59
6J6	1.46	37	.99
6K6GT	.85	39/44	1.36
6L7G	1.58	41	1.05
6Q7GT	.98	42	1.05
6R7GT	1.36	43	1.05
6S4	.89	45	1.05
6SA7GT	.98	45Z3	.99
6SC7	.98	45Z5GT	.99
6SH7	1.08	46	1.40
6SJ7GT	.89	47	1.40
6SK7GT	.89	50A5	.98
6SL7GT	1.19	50B5	.89
6SN7GT	.90	50C5	.89
6SQ7	.86	50X6	1.18
6SS7	.89	57	.89
6T7G	1.53	58	.89
6T8	1.53	70L7GT	2.05
6U5/6G5	.89	75	1.05
6W4GT	.85	77	1.05
6X4	.85	80	.69
6X5GT	.85	117K/M7GT	1.95
6Y6G	1.20	117N7GT	1.95
7A8	.99	117Z3	.89
7B4	.99	117Z4GT	1.56

ALL AMERICAN KIT \$3.98

STANDARD BRAND ELECTROLYTICS

Manufacturers Part Number—Guaranteed Brand New

20-20-150V	.41
40-40-150V	.47
50-30-150V	.51
50-50-150V	.53
40-40-20-150V	.57
Kit of 10 Assorted Condensers	.58e

ALL MAIL SALES CO.

100 Park Place • Dept. RC-9
 New York 7, N. Y.

Proved Combination for FINE TV RECEPTION

AMPHENOL -IN-LINE* ANTENNA

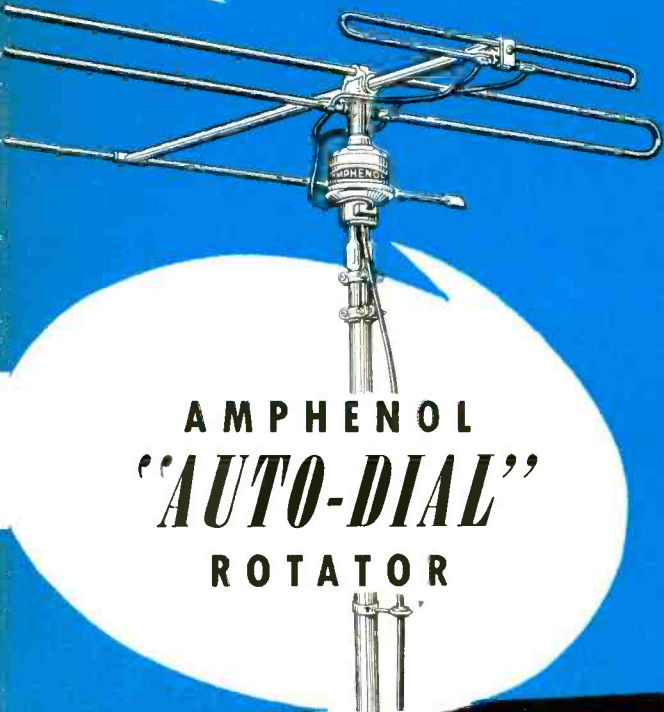

AMPHENOL 'AUTO-DIAL' ROTATOR

*Reissue Pat. No. 23,273

There's nothing equal to it . . . for perfect picture reception . . . the performance-proven design of Amphenol's patented "In-line" Antenna and the Amphenol "Auto-Dial" Rotator. The proved combination for the ultimate in television reception.

BUT—don't wait until the Fall rush. Check your future needs now to insure the best equipment for Fine TV Reception. Specify Amphenol "In-line" Antenna and "Auto-Dial" Rotator . . . a proved picture quality combination.

AMERICAN PHENOLIC CORPORATION
1830 SOUTH 54th AVENUE • CHICAGO 50, ILLINOIS

AMPHENOL

COSINE YOKE

Merit Transformer Corporation, 4427 North Clark St., Chicago, is manufacturing two cosine yokes, MDF-70 and MDF-30.

The MDF-70 is a cosine yoke with distributed winding for edge-to-edge picture focus. A high-efficiency ferrite core permits use with all picture tubes

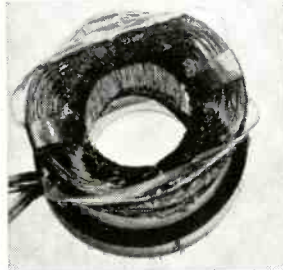

up to and including 24 inch where they require 70° deflection. It is recommended for use with HVO-6 and HVO-7 ferrite-core flybacks.

The MDF-30 is of the same design as MDF-70 but has high horizontal and low vertical inductance for use with HVO-8 air-core flyback in direct-drive systems. All Merit yokes are now equipped with resistance-capacitance network and leads.

SMALL CAPACITORS

Cornell-Dubilier Electric Corporation, South Plainfield, N. J., is introducing a complete metallized paper tubular line, available in three basic types—the Pup, Sealpup, and Metapup. They are extremely small, representing a 50 to 75% size reduction over foil or conventional types of paper dielectric capacitors.

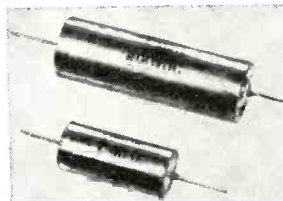

The Pup is a metallized unit available in nine capacitances from .01 to 2.0 μ f. Smallest dimensions are $\frac{3}{8}$ x $\frac{5}{8}$ inch. The Sealpup is a smaller, highly dependable type, with a positive seal against moisture, and ranges in size from 0.175 x $\frac{11}{16}$ inch up. It comes in 11 capacitance ranges from .01 to 2.0 μ f in value.

The Metapup is enclosed in a one-piece metal tubular case, pressure sealed, and available in 12 capacitances from .01 to 6.0 μ f. All three types are available at working voltages up to 600.

VIBRATOR TESTER

P. R. Mallory & Co., Inc., Indianapolis, Ind., announces a vibrator tester as an addition to its line of electronic products. This tester gives direct "good-bad" readings on doubtful vibrators. It is a companion unit to the Mallory 6RS10 and 6RS25.

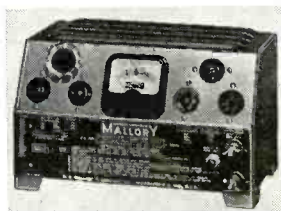

With this tester, a direct test without adapters may be made of most vibrators used in passenger car radios manufactured since 1940. By plugging the rectifier tube into the front panel, interrupter type vibrators can be tested in conjunction with the same rectifier tube used in the car radio.

This tester may be used with the Mallory filtered rectifier power supplies, or will operate from any 6-volt d.c. source which can be adjusted between 4 and 6 volts.

All specifications given are obtained from manufacturer's data.

SPEAKER CABINET

Jensen Manufacturing Co., 6601 South Laramie, Chicago, Ill., is producing a cabinet which simplifies speaker installation and removal.

Known as the Jensen Customode Imperial, the new cabinet has four decorative brass knobs at the corners of the front panel. By removing these knobs, the entire panel, with the speaker, may be removed.

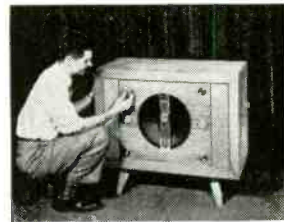

TV BOOSTER

The Turner Company, Cedar Rapids, Iowa, is producing a new television



booster, model TV-1, using a greatly improved circuit which covers television channels 2 to 13 with continuous tuning.

The new booster employs the cascode circuit, noted for its low noise factor. It is supplied complete with ribbon lines for quick connection to a receiver. A terminal strip accommodates either 75-ohm coaxial or 300-ohm flat transmission lines.

FLYBACK UNIT

Allan B. Du Mont Laboratories, East Paterson, N.J., has made available to the trade a new horizontal deflection output and high-voltage transformer, the type H1A1.

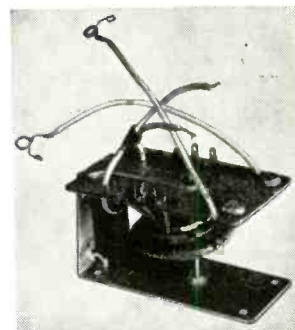

It features a high-efficiency design with a ferrite core and special windings, and is capable of supplying 12 to 13 kilovolts to a 70-degree tube. Mounting is so designed that the unit lends itself to either horizontal or vertical mounting without special hardware.

SMALL AD-A-SWITCH

Clarostat Manufacturing Co., Dover, N. H., announces that the flexibility of choosing the desired combination of control, switch, and shaft, heretofore available with the larger or $\frac{1}{8}$ -inch

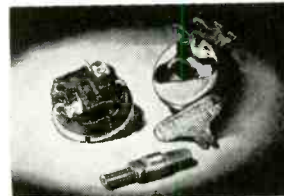

RADIO-ELECTRONICS for

FREE Yours For Examining This New 6-Volume

TV-RADIO LIBRARY

7 DAYS FREE

150 Picture Patterns and RADIO-TV DIAGRAMS Explained

BOOK OF TV-RADIO PATTERNS & DIAGRAMS

1951 EDITION

Now! Get this sensational new TV-Radio servicing book, "150 PICTURE PATTERNS & RADIO-TV DIAGRAMS EXPLAINED," absolutely FREE! Shows actual TV picture tube patterns and wave forms as well as Radio and TV set diagrams. Clearly explains how to use them to analyze and service sets faster. If you act now, you can get this book FREE, just for asking to examine Coyne's 6-volume TV-RADIO LIBRARY on 7 days FREE TRIAL!

More Earning Power For You With The COYNE LIBRARY!

You'll get into the big money faster in TELEVISION-RADIO if you know where to find the answer to servicing problems. Coyne's great new 6-volume library gives you all the answers—quickly! For basic "know-how" that is easy to understand, you'll find everything you want in volumes 1 to 5 which contain over 5000 practical facts and data. They cover every step from principles to installing, servicing, trouble-shooting and aligning all types of radio and TV sets. So up-to-date it includes COLOR TV and UHF, adapters and converters.

And then, for speedy on-the-job use, you get volume 6—the famous Coyne TELEVISION CYCLOPEDIA. It answers today's television problems on servicing, alignment, installation and others; PLUS tomorrow's problems on COLOR TV and

UHF. In easy-to-find ABC order, cross indexed. Use this 6 volume TV-RADIO LIBRARY free for 7 days; get the valuable Servicing Book ABSOLUTELY FREE!

ACT NOW . . . OFFER LIMITED!

Fill out and mail coupon for 6-volume library on 7 days free trial. We'll include book of TV-Radio Patterns & Diagrams. If you keep the set, pay \$3 in 7 days and \$3 per month until \$23.00 plus postage is paid. (Cash price \$22.) Or you can return the library at our expense in 7 days and owe nothing. YOU BE THE JUDGE. Either way, the book of TV-Radio Patterns is yours FREE to keep! Offer is limited. Act NOW!

SEND NO MONEY—MAIL COUPON NOW!

COYNE ELECTRICAL & TELEVISION-RADIO SCHOOL, Dept. 91-T1
500 S. Paulina St., Chicago 12, Ill.

YES! Send 6-volume TV-RADIO LIBRARY for 7 days FREE TRIAL per your offer. Include TV-RADIO PATTERNS & DIAGRAM BOOK as my FREE GIFT.

Name Age

Address

City Zone State

Where Employed

() Check here if you want library sent COD. You pay postman \$22 plus COD postage on delivery. 7-day money-back guarantee.

COYNE ELECTRICAL & TELEVISION-RADIO SCHOOL
500 S. Paulina St., Dept. 91-T1, Chicago 12, Ill.

diameter volume control replacements, is now extended to the smaller 15/16-inch diameter size as well.

The series SW8 or 15/16-inch AD-A-Switch is obtainable in s.p.s.t 3-way no Off position, s.p.d.t., and d.p.s.t. A T-shaped section of the control's dust cap is simply pried off, turned 90 degrees and taken off, exposing the switch-throwing mechanism. The switch readily slips in place.

WATT-VOLTMETER

Triplett Electrical Instrument Co., Bluffton, Ohio, has added the model 660 Load-Chek watt-voltmeter to their line of test equipment.

The wattmeter is designed to aid the service technician in discovering shorts and overloads. By plugging in a set and comparing the wattage used with the nominal wattage of the set, shorts or overloads can be detected immediately. Wattage ranges are 0-500-1,000 a.c. and d.c. The voltage range is 0-130 a.c. or d.c.

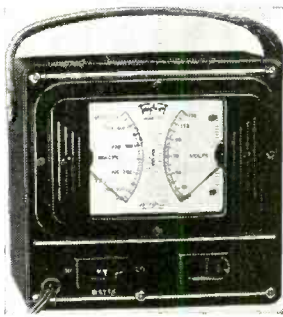

H.V. OUTPUT UNIT

The Standard Transformer Corporation, 3580 Elston Ave., Chicago 18, Illinois, has added a TV replacement unit, the A-8130 horizontal deflection output transformer, to its line.

The unit is for use in pulse-operated, single-rectifier power supplies to deliver up to 14,000 volts with adequate sweep for full horizontal scan of 65-70° kinescopes having up to 24-inch screens. For conversion of older TV receivers to take newer picture tube types, it was announced, it requires a 3-27 mh width-

control coil. Over-all height of the unit is 4 1/16 inches, base 2 3/8 x 2 5/16 inches.

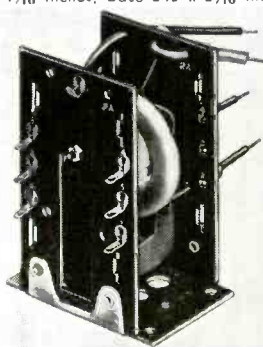

CORNER SPEAKER

Electro-Voice, Inc., Buchanan, Michigan, announces a small-size, low-cost, folded-corner horn enclosure with direct front radiation for 12-inch full-range speakers.

The new E-V Aristocrat unit utilizes the Klipsch principle, using the corner of a room as an extension of the exponential acoustic-horn air load. Extended bass reproduction is achieved down to 35 cycles.

The Aristocrat enclosure has been designed to produce optimum results with Electro-Voice Rodax full-range 12-inch speakers. Compliance and cone resonance of these units match the characteristics of the cabinet. It improves the operation of any 12-inch speaker.

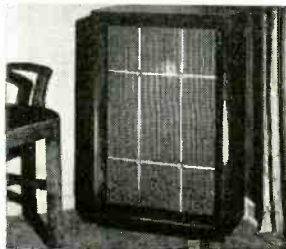

—end—

SPACE was at a premium
...YET EFFICIENCY
HAD TO BE HIGH

THAT'S WHY GRAY CHOSE SELETRON!

There's no room in The Gray Manufacturing Company desk model Autograph® Electronic Sound Writer for components without a big payload factor.

Gray engineers found SELETRON's tiny new selenium rectifier No. 16Y2 a powerhouse of efficiency for all its half-inch square cell size, and incorporated it into the Autograph's compact design. . . . It functions direct at 120 volts to operate the back spacer. No. 16Y2 is rated at 150V input, 100V output, 050 output amps. Weighs less than half an ounce!

Millions of dependable SELETRON Selenium Rectifiers are in service. They are available for every purpose from the miniatures used in radio, TV and other electronic circuits, all the way up to the giant stack assemblies required for heavy industrial purposes.

SELETRON engineers are successful in solving rectification problems. Write us today without obligation. . . . And have you our new 16 page rectifier guide for handy reference? Please request Bulletin 104-R-9.

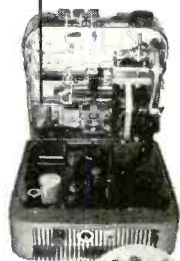

*Autograph, T.M. of The Gray Mfg. Co., Hartford, Conn.

SELETRON DIVISION
RADIO RECEPTOR COMPANY, INC.

Since 1922 in Radio and Electronics

SALES DEPARTMENT: 251 WEST 10TH STREET, NEW YORK 11, N.Y. • FACTORY: 84 NORTH 8TH STREET, BROOKLYN 14, N.Y.



ATLAS Built to take it!



ATLAS DR PROJECTORS, non resonant, uniform response, sturdy, storm proof, compact, demountable.

Regardless of the application Atlas Sound speakers are built to "take it." In the Armed Forces . . . Industrial plants . . . public gatherings . . . under any climatical conditions, Atlas Sound speakers stand up.

Over twenty years' experience in the manufacture of sound equipment goes into every Atlas product.

Years of diligent research in Electro Acoustics and constant experimentation in mechanical developments guarantees quality, complete and lasting satisfaction.



ATLAS PAGING AND TALK BACK SPEAKERS with ATLAS "Alnico-V-Plus" driver unit. A medium size speaker ruggedly constructed 12 watt input power.

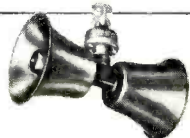

Dual speaker excellent for industrial and talk back applications, simplifies installation in long corridors, hallways, etc.

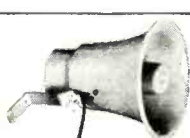

A super efficient sub miniature speaker produces clear intelligible speech at a minimum input power.



ATLAS De-Luxe "Alnico-V-Plus" Driver Units with built in "Uni-match" transformers. 30 watt input.



ATLAS "FULL GRIP VELVET ACTION" MICROPHONE STANDS. No slipping - No noise - No rattle - No scratching - No wear.

Write for new No. 551 catalog

ATLAS SOUND CORP.

1453 - 39th STREET, BROOKLYN 18, N. Y.

in Canada, Atlas Radio Corp., Ltd., Toronto, Ont.



ELEMENT VIII, SHIP RADAR TECHNIQUES, supplement to Radio Operator's License Q&A Manual—2nd edition, by Milton Kaufman. Published by John F. Rider Publisher, Inc., 480 Canal St., New York 13, N.Y. 5 1/2 x 8 1/4 inches, 32 pages. Price 78 cents.

The FCC requires (since Jan. 2, 1951), that to do radar work on ships an "operator must have a first- or second-class radiotelephone or radiotelegraph license plus a ship radar endorsement" (Element VIII is required). This small supplement provides clear answers to the questions of the element, including 17 illustrations. An incomplete index is appended.—*MMK*

ELECTRONIC MECHANISMS OF ORGANIC REACTIONS, by Allan R. Day. Published by the American Book Co., 88 Lexington Ave., New York 16, N.Y. 6 x 9 inches, 314 pages, Price \$3.50.

This book describes the reactions of aliphatic and aromatic compounds on the basis of electrochemical theory. Formation of valence bonds, causes of tautomerization, and isomerization reactions are discussed in addition to a systematic exploration of the hydrocarbons.—*MMK*

LINEs, NETWORKS and FILTERS by William M. Breazeale and Lawrence R. Quarles. Published by International Textbook Co., Scranton, Pa., 6 x 9, inches, 293 pages. Price \$6.50.

This volume deals entirely with communication by wire. It is intended for students or technicians who have the equivalent of two years of college math and who know a.c. theory. Algebra is used throughout to show fundamental properties of transmission lines and lumped networks at low and high frequencies.

Each chapter provides numerical examples which illustrate the use of the equations and show how to design lines and circuits. Rationalized MKS units are employed. Vector diagrams and graphs supplement the mathematics. The important impedance and Smith charts are explained.

Tables of hyperbolic, Bessel and other functions appear at the end of the book. There is also a short list of suggested experiments in line measurement.—*IQ*

HOTTEST TV PACKAGE for "ONE BUCK"!

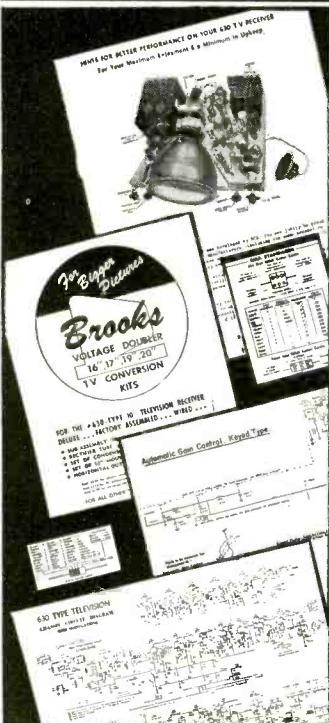

EVERYONE INTERESTED IN TELEVISION should own this TV literature package . . . The information will be found useful on any make TV set. It's different and right to the point! It carries instructions that are up to the minute and not yet found in expensive text books. Indispensable to the TV technician yet easy enough for anyone with even a limited knowledge of TV to understand and follow.

Just think of being able to convert any 10" TV set into a life-size 20" receiver in as little as one hour . . . The ILLUSTRATED TV CONVERSION MANUAL makes that possible.

SAVE MONEY ON REPAIRS—Important common occurrences are carefully analyzed and corrective procedures are suggested. You are told what to do—WHEN THE RECEIVER FAILS TO OPERATE, WHEN THERE ARE GHOSTS, INTERFERENCE, NO PICTURE, PICTURE FOLD-OVER, NO RASTER, PICTURE BLOOMS, DISTORTED PICTURE, PICTURE ROLLS, NO SOUND, DISTORTED SOUND, CORONA EFFECTS, ETC. PICTURE TUBE ASSEMBLY and PATTERN ADJUSTMENTS are outlined in detail (the ion trap adjustment caution may save you the price of a new picture tube). The HORIZONTAL SYNC, RCA TUNER and STANDARD TUNER step by step adjustments alone are worth many times the cost of this package.

TUNING GUIDANCE and ANTENNA ADVICE will enable you to enjoy peak performance at its best. The HIGH VOLTAGE CAUTION will give you that free and easy feeling of safety while handling the chassis or any of its parts.

The ±630 CIRCUIT DIAGRAM, KEYED AGC DIAGRAM, RESISTOR & MICA CODE CHARTS need no emphasis as to their usefulness.

You will also receive our latest catalog and flyer with hundreds of special offers in Television, Chassis, Cabinets, Picture Tubes, Parts, Radios, Portables, Auto Radios, Radio Tubes, Test Equipment, Accessories, Etc., at WHOLESALE PRICES.

USE HANDY COUPON

BROOKS RADIO & TELEVISION CORP.
 84 Vesey St., New York 7, N. Y.
 Send complete package of TV literature
 Enclosed find \$1.00 Cash Check M.O.
 NAME.....
 ADDRESS.....
 CITY..... STATE.....

- HINTS FOR BETTER PICTURES ON 630TV
- 630TV DIAGRAM WITH MODIFICATIONS
- ILLUSTRATED TV CONVERSION MANUAL
- PULSE KEYED AGC CIRCUIT DIAGRAM
- RMA RESISTOR & MICA CODE CHARTS

\$1.00

ALL FOR ONLY POSTPAID

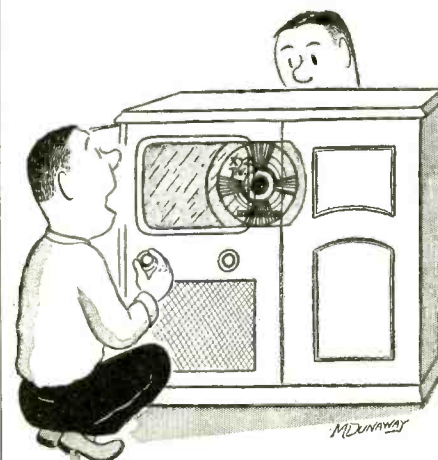

"That's way too far, turn it back quick!"

Suggested by M. Dunaway Omaha 3, Neb.

RADIO-ELECTRONICS for

630 SUPER DELUXE 31-TUBE TV CHASSIS

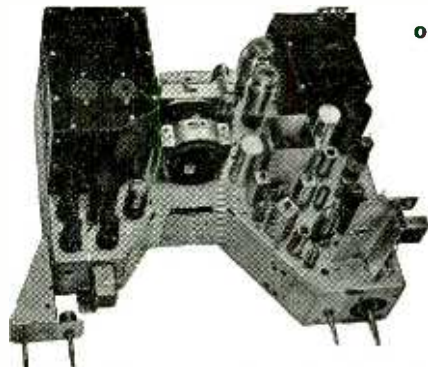

KNOWN MFR. . . . LICENSED BY RCA

OPERATES ALL **16" TO 24"** PICTURE TUBES

Engineered in strict adherence to the genuine RCA #630, plus added features ★ ★ ★ ★ ★
NOTHING BETTER AT ANY PRICE!

- Original 630 synch chain for stability
- 16.5 KV for clarity and brilliance
- Peak sensitivity for fringe areas
- 4 Megacycle bandwidth for definition
- Larger power trans. & voltage doubler
- Fast action pulse keyed AGC
- Choice—STANDARD or DUMONT tuner
- Choice—Universal or 24" CRT brackets
- Large concert-tone 12" PM speaker

Complete ready to play with all tubes, hardware, knobs, etc. (less CRT) **\$167.97**

630 SUPER DeLuxe TV KIT

COMPLETE SET OF PARTS for the 31-TUBE to CHASSIS **\$146.49**
Complete with all tubes, hardware and instructions. (less CRT & wire)

630 STANDARD TV KIT

COMPLETE SET OF PARTS for the FAMOUS ORIGINAL RCA #630 to TELEVISION CHASSIS **\$119.74**
Complete with all tubes, hardware and instructions. (less CRT & wire)

STANDARD GUARANTEED PICTURE TUBES

24AP4	—(Round, Metal, Black)	\$79.49
20CP4	—(Rectangular, Black)	49.74
19AP4A	—(Round, Metal, Black)	49.74
17BP4A	—(Rectangular, Black)	34.63
16TPA	—(Rectangular, Black)	32.97
16DP4A	—(Round, Black)	32.97
16AP4A	—(Round, Metal, Black)	32.97
16GP4A	—(Short Round, Metal, Black)	32.97
14DP4A	—(Rectangular, Black)	29.38
12LP4A	—(Round, Black)	26.72

CUSTOM-BUILT CABINETS FOR 630 AND ALL OTHER TV SETS

4 leading styles in genuine mahogany or walnut (Blonde 10% extra). WINDSOR when open looks like STREAMLINER. Ready drilled for #630 chassis and any 16" to 20" picture tube at no extras in price. Also supplied with blank panel to fit any make TV set. Delivered complete as pictured including hardware, supports and safety glass. Information on cabinets for the 24" picture tube, on request.

THE MANHATTAN

It Has Everything Style, Quality, Price

THE STREAMLINER

Center Drop Panel Conceals Tuning Knobs.

THE WINDSOR

Aristocrat of Cabinets Doors In Genuine Leather Hand Tooled In Gold

THE VOGUE

Most Popular Table Model.



16" —H-24", W-24", D-24"
17" —H-24", W-24", D-24"
20" —H-27", W-24", D-24"

\$47.45

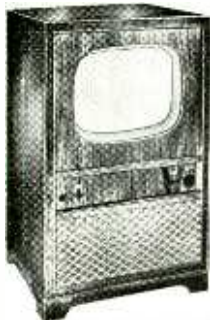

H-41", W-23", D-25"

\$59.37



H-42", W-26", D-25"

\$74.98



H-42", W-26", D-25"

\$117.46

#630 TV PARTS . . . TOP QUALITY . . . LOW PRICES

FOR KIT BUILDERS, REPLACEMENTS AND EXPERIMENTERS

The following list comprises components needed to build the famous #630 TV chassis. PRICES UNLESS MARKED PER SET ARE PER ITEM. Parentheses indicate amounts of parts needed in lots of two or over.

RCA FRONT END TUNER, compl. w/tubes	\$22.49	VIDEO PEAKING COIL, 203L1 \$.18
STANDARD TURRET TUNER, com. w/tubes	22.49	VIDEO PEAKING COIL, 203L218
ESCUTCHEON PLATE, for either tuner	.69	VIDEO PEAKING COILS, (2) 203L3 ea.18
DUMONT INPUT TUNER, compl. w/tubes	22.49	VIDEO PEAKING COILS, (2) 203L4 ea.18
COMPLETE SET OF KNOBS, incl. decals	1.34	ION TRAP BEAM BENDER, (single) 203D179
COMPLETE SET OF KNOBS, (Gold)	2.49	ION TRAP BEAM BENDER, (double) 203D398
POWER TRANSFORMER, 295ma, 201T6	9.97	AUDIO OUTPUT TRANSFORMER (6K6)69
VERTICAL OUTPUT TRANS., 204T2	2.69	HV RECTIFIER SOCKET ASSEMBLY, single79
VERTICAL BLOCKING TRANS., 208T2	1.32	HV RECTIFIER SOCKET ASSEMBLY, double	1.37
HORIZONTAL OUTPUT TRANS., 211T1	2.47	PUNCHED CHASSIS PAN, cadmium plated	4.87
HORIZONTAL OUTPUT TRANS., 211T3	2.98	630-KIT, screws, nuts, rivets, washers 1.69
HORIZONTAL OUTPUT TRANS., 211T5	3.98	HI VOLTAGE CAGE ASSEMBLY, complete	3.73
FOCUS COIL, 247 ohms, 202D1	2.29	VOLTAGE DIVIDER SHIELD & COVER 1.79
FOCUS COIL, 470 ohms, 202D2	3.42	ELECTROLYTIC COND. SUB-CHASSIS94
DEFLECTION YOKE, 60°, 201D1	2.97	SOUND DISCRIMINATOR SHIELD29
DEFLECTION YOKE, 70°, 206D1	3.98	DEFLECTION YOKE BRACKET59
SOUND DISCRIMINATOR TRANS., 203K1	1.12	DEFLECTION YOKE MOUNTING HOOD49
1st PIX I.F. TRANSFORMER, 202K2	1.08	FOCUS COIL BRACKETS per set .49
2nd PIX, I.F. TRANSFORMER, 202K3	1.08	CATHODE TRAP COIL SHIELD39
1st & 2nd SOUND I.F. TRANS. (2) 201K1 ea.	1.02	CHASSIS MOUNTING BRACKETS, set of 444
HORIZONTAL DISCRIM. TRANS., 208T8	1.49	BRIGHTNESS & HOLD CONTROL BRACKET59
FILTER CHOKE, 62 ohms	1.47	WIDTH CONTROL BRACKET16
CATHODE TRAP COIL, 202K4	1.08	TUNER SHAFT BRACKET17
WIDTH CONTROL COIL, 201R1	.44	CATHODE RAY TUBE SOCKET, 18" leads39
WIDTH CONTROL COIL, 201R4	.48	HV KINESCOPE SHIELD, with clip39
WIDTH CONTROL COIL, keyed AGC	.79	TV 6' LINE CORD, with both plugs29
HORIZONTAL LINEARITY COIL, 201R3	.39	INTERLOCK SAFETY CONNECTOR (input)17
HORIZONTAL LINEARITY COIL, 201R5	.49	AMPHENOL CONNECTOR PLUGS, set48
3rd & 4th PIX COILS, (2) 202L1 ea.	.39	OVAL PM SPEAKER, 5"x7" 2.49
FILAMENT CHOKES, (5) 204L1 ea.	.09	12" PM SPEAKER, heavy alnico #5 magnet	6.94

WE ARE HEADQUARTERS FOR #630 TELEVISION CHASSIS, KITS & PARTS . . . All Items are STANDARD BRANDS . . . All Prices Are WHOLESALE (FEDERAL TAXES PAID) . . . Do not Be Misled By Any Lower Offers!

DOLLAR FOR DOLLAR WE BRING YOU YOUR BEST BUYS IN TV!

BROOKS RADIO & TV CORP., 84 Vesey St., Dept. A, New York 7, N. Y.

TELEPHONE
COrtlandt 7-2399

630 PARTS & COMPLETE SETS

VIDEO AND I.F. KIT, 19 items	\$7.84
MICA CONDENSER KIT, 11 condensers	1.38
ELECTROLYTIC COND. KIT, (6)	7.37
TUBULAR CONDENSER KIT, 37 cond.	4.28
CERAMIC CONDENSER KIT, 28 cond.	3.37
CARBON RESISTOR KIT, 107 resistors	6.98
WIREWOUND RESISTOR KIT, (4)	2.31
VARIABLE CONTROL KIT, 9 controls	5.83
COMPLETE SET OF GOLD KNOBS	2.49
BRACKET AND SHIELD KIT, 18 items	8.63
UNIVERSAL CRT MTG BRKTS	6.97

COLOR TELEVISION

Good practical COLOR TELEVISION is still a long way off . . . *The NEW YORK TIMES*, June 24, 1951 reports . . . "CBS executives are no better equipped to sit at home and watch color broadcasts than is the general public . . ." Waiting, for color TV only deprives you of the world's greatest pleasure . . . Hardly anyone hesitates to see a movie in black and white . . . For those who want to experiment with color TV, we have the following items:



COLOR ADAPTER

Brings in color programs in black and white from all stations. Easy to install to any TV set.

Complete with instructions **\$13.30**
Specify make of your TV set.



COLOR WHEEL

Solid one-piece product. Matched for true color. Balanced for smooth performance. CBS specifications.

7" 15 1/2" Diam. \$13.36
10" 22" Diam. 17.69
12 1/2" 27 1/2" Diam 29.47



COLOR WHEEL MOTOR

Precision type 110V, 50-60 cycle, 1.6 Amp. 1650 to 1440 RPM with rheostat. **\$19.16**
4 1/2"x4" . . .

TELEVISION

PREPARE FOR A GOOD JOB!
COMMERCIAL OPERATOR (CODE)
RADIO SERVICEMAN
TELEVISION SERVICING
BROADCAST ENGINEER
 Approved for Veterans
SEND FOR FREE LITERATURE
BALTIMORE TECHNICAL INSTITUTE
 1425 Eutaw Place, Dept. C, Baltimore 17, Md.

- **COMPUTING MACHINERY**
 - **SYMBOLIC LOGIC**
- and other subjects

Courses or guided study, by mail—Beginning or advanced—individuals or study groups; Fitted to your interests and pocketbook. Write
EDMUND C. BERKELEY AND ASSOCIATES
 MAKERS OF SIMON
 World's Smallest Electric Brain
 Author "Giant Brains or Machines That Think"
 John Wiley & Sons, 1953
 36 West 11 St., R9, New York 11, N. Y.

RCA RADIO and TELEVISION

Thorough Training For Men and Women in All Technical Phases
APPROVED FOR ELIGIBLE VETERANS
 DAY-EVENINGS WEEKLY RATES
FREE PLACEMENT SERVICE FOR GRADUATES
 For Free Catalog Write Dept. RC-51
RCA INSTITUTES, Inc.
 A Service of Radio Corporation of America
 350 WEST 4TH STREET NEW YORK 14, N. Y.

Approved for Veterans Bachelor of Science Degree Engineering

Offered in 18 Mo.
 Enroll today. Unlimited opportunity for good paying positions in these rapidly expanding professions.
AUDIO ENGINEERING • RADIO & TELEVISION ENG. • MOTION PICTURE FILM ENG. • BROADCASTING • SOUND RECORDING • UNIVERSITY OF HOLLYWOOD
 STATE CHARTERED NONPROFIT EDUCATIONAL INSTITUTION
 4918 SANTA MONICA BLVD. HOLLYWOOD CALIF.

ON THE SPOT BATTERY RECORDER

WALKIE-RECORDALL 8 in. miniature BATTERY RECORDER-PLAYBACK
 Continuous, permanent, accurate, instant recording at only 5c per hr. Instantaneous, permanent playback. Picks up sound up to 80 ft. Records conferences, lectures, dictation, 2-way phone & sales talks; while walking, riding or flying. Records in closed briefcase with "hidden mike"! Write for details.

MILES REPRODUCER CO., INC.
 812 BROADWAY Dept. RE9 NEW YORK 3, N. Y.

SHOOT TV TROUBLE FAST!

With H. G. CISIN'S RAPID "TV TROUBLE SHOOTING METHOD"

EARN more money! Locate television troubles by this quick, entirely new method. Rapid checks enable you to locate all faults in record breaking time regardless of make or model! 160 Pictures, Raster, Sound trouble symptoms. Over 100 Rapid Checks including over-all alignment checks, 26 illustrations; simplified step-by-step directions!

INCREASE your earning power with the most valuable aid to TV servicing ever written! **SEND YOUR NAME AND ADDRESS TODAY \$1**

WITH ONLY

RUSH COUPON NOW!

H. G. CISIN, CONSULTING ENGINEER, Dept. E-5
 200 Clinton Street, Brooklyn 2, N. Y.

Name
 Address
 City Zone State

RADIO SCHOOL DIRECTORY

V RADIO ENGINEERING

FM—Television—Broadcast

Police Radio, Marine Radio, Radio Servicing, Aviation Radio and Ultra High mobile applications. Thorough training in all branches of Radio and Electronics. Modern laboratories and equipment. Old established school. Ample housing facilities, 7 acre campus. Small classes, enrollments limited. Our graduates are in demand. Write for catalog.

Approved for Veterans

VALPARAISO TECHNICAL INSTITUTE
 Dept. C VALPARAISO, INDIANA

CODE SENDING SPEED RECEIVING SPEED

Be a "key" man. Learn how to send and receive messages in code by telegraph and radio. Commerce needs thousands of men for jobs. Good pay, adventure, interesting work. Learn at home quickly through famous Candler System. Qualify for Amateur or Commercial License. Write for FREE BOOK
CANDLER SYSTEM CO.
 Dept. 3-K, Box 828, Denver 1, Colo., U.S.A.

AUDIO (SOUND) ENGINEERING HOME STUDY TRAINING

Practical, easy-to-understand lessons, written by competent Audio Engineers and Educators, prepare you for a better job and a good future in the Television, Radio, Motion Picture, and Recording Industries.
 Write today for details—Learn while you earn!!

HOLLYWOOD TECHNICAL INSTITUTE

Div. RE
 4923 Santa Monica Blvd., Hollywood 27, California

RADIO ENGINEERING DEGREE IN 27 MONTHS

Intensive, specialized course including strong basis in mathematics and electrical engineering, advanced radio theory and design, television. Modern lab. Low tuition. Self-help opportunities. Also 27-month courses in Aeronautical, Chemical, Civil, Electrical, and Mechanical Engineering. Approved for G.I.'s. Enter, Sept., Dec., March, June. Catalogue.

INDIANA TECHNICAL COLLEGE

159 E. Washington Blvd., Fort Wayne 2, Indiana

BECOME A RADIO AMATEUR

Complete Home-Study Course for Passing FCC Amateur Radio Examinations

- **LOW COST**
- **PERSONAL COACHING**
- **MONEY-BACK GUARANTEE**

Write for Details

FEDERAL ELECTRONICS INSTITUTE
 34 East Putnam Ave., Dept. F1, Greenwich Conn.



EVERY RADIOMAN Can Use These SERVICE HINTS!

Valuable Manual Yours—FREE!

Every page of "How to Simplify Radio Repairs" is packed with on-the-bench, practical ideas. Contains photos, charts, diagrams—no fluff—no vague theory. In plain every-day language it gives you priceless suggestions—new servicing ideas. You'll use and benefit from the experience of experts. Partial list of contents: How to Locate Trouble; How to Service Amplifiers; How to Test for Distortion; How to Test Audio Circuit; How to Test Speakers; How to Find Faults in Oscillators; How to Test Radio Parts—and it's all yours—FREE! No obligation.



SEND COUPON OR PENNY POSTCARD FOR YOUR FREE COPY TODAY!

FEILER ENGINEERING CO., Dept. 9RC1
 8026 N. Monticello Ave., Skokie, Ill. (Suburb of Chicago)
 Please RUSH my FREE copy of "How to Simplify Radio Repairs."
 Name
 Address
 City Zone State

LEARN DAY and EVENING CLASSES TELEVISION

ELECTRONICS-RADIO
 Modern Laboratory Instruction in

- SERVICING
- BROADCAST OPERATING
- ELECTRONIC and TV ENGINEERING

G.I. APPROVED

WRITE FOR CATALOG
ELECTRONICS INSTITUTE, Inc.
 21 HENRY, DETROIT 1, MICH.

RADIO COURSES

Preparatory Mathematics, Service, Broadcast, Television, Marine Operating, Aeronautical, Frequency Modulation, Radar.
 Classes now forming for the Fall term beginning October 1st Entrance exam, Sept. 17th.
Veterans. Literature.
COMMERCIAL RADIO INSTITUTE
 (Founded 1920)
 38 West Biddle Street, Baltimore 1, Md.

RADIO ENGINEERING

B. S. DEGREE IN 27 MONTHS
 Complete Radio Engineering course incl. Telev., U.H.F. and F.M. 85 Degree Courses also in Mech., Civil, Elect., Chem. and Aero Eng.; Bus. Adm., Acct. Extensive campus, modern buildings, well equipped labs. Low cost. Prep. courses. Personalized instruction. Heavy demand for graduates. Placement service. Founded in 1884. Prepare now for the civil and military opportunities ahead. Enter Sept., Jan., March, June. Write for Catalog.

TRI-STATE COLLEGE
 2491 COLLEGE AVE. ANGOLA, INDIANA

ATTENTION...

A NEW department of the DON MARTIN SCHOOL OF RADIO AND TELEVISION ARTS AND SCIENCES . . . for instruction and training in—**TELEVISION**—incorporating:

Production: Writing, Directing, Producing, Acting, Staging, Lighting.

Engineering: Transmission, Receiving, Camera and Studio, Operation, Theory of Video, Pickup and Reproduction.

Approved for veterans.

THE DON MARTIN SCHOOL OF RADIO AND TELEVISION ARTS AND SCIENCES

1655 No. Cherokee, Hollywood 28, Calif. HU. 23281.

RADIO COURSES

- RADIO OPERATING • CODE
- RADIO SERVICING • ELECTRONICS
- F.M. TELEVISION

Preparation for Civilian, Maritime, Army and Navy license requirements.
 Write for Catalog TE

YMCA TRADE & TECH. SCHOOL 15 W. 63 St., N. Y. 23 ENdicott 2-8117

SURPLUS

BOUGHT & SOLD
GOULD GREEN 252 Greenwich St. WOrth 4-8044—NYC 7

MOST-OFTEN-NEEDED 1951 RADIO DIAGRAMS and Complete Index, compiled by M. N. Beitman. Published by Supreme Publications, Chicago, Ill. Volume 11, 8½ x 10¼ inches, 192 pages. Price \$2.50.

Volume 11 is the latest addition to the Most-Often-Needed series. It contains schematic diagrams, alignment charts, socket voltages, dial stringing information, and other pertinent servicing data on approximately 500 different units. These include portables, a.c.-d.c., AM-FM, and automobile sets, combinations, and record changers made by 37 manufacturers. A 3-page volume index appears in the front of the book. A 22-page master index in the rear lists the material covered in volumes 1 through 10 (1928 through 1950) and in volumes TV1 through TV5 (1947 through 1951).—RFS

RADIO HANDBOOK (Thirteenth Edition), edited by R. L. Dawley. Published by Editors and Engineers, Ltd., Santa Barbara, Cal. 7 x 9½ inches, 734 pages. Price \$6.00.

The latest edition is a revised, up-to-date, twice-the-size version of the 12th edition published several years ago. The type is large and easy to read and the material is well illustrated with diagrams, pictorial drawings, design charts, and photographs.

The section on antennas is especially complete. There are 111 pages on this subject alone. Also of interest to hams are the sections on single-sideband generators, TVI elimination, mobile equipment and installations, precision v.f.o.'s, clamp-tube modulation systems, and specialized test and measuring equipment such as standing-wave indicators, and grid-dip meters. Sections devoted to transmitters and transmitter circuits are sufficiently complete to satisfy those interested in both high- and low-power units.

Although various types of receiver circuits and equipment are discussed, there is surprisingly little practical constructional material. The book would be more useful to amateurs, SWL's, and communications engineers if it included practical material on single-sideband and panoramic adapters, crystal-controlled markers for receivers, and a precision frequency meter useful in the v.h.f. range. It could also include details on modernizing and souping-up some of the older receivers and transmitters used in communication circles in the days before World War II. The coverage could be similar to that given surplus equipment in the 11th edition.—RFS

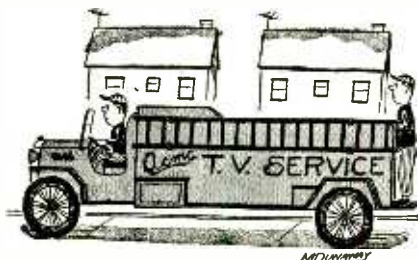

Suggested by M. B. Dunaway, Omaha, Nebraska
SEPTEMBER, 1951

Practical, Popular-priced Books on RADIO•AUDIO•SERVICING

TWO NEW \$1.00 BOOKS



No. 43—MODEL CONTROL BY RADIO. By Edward L. Sanford, Jr., 112 pages. An authority in the field of radio control gives you the first complete book on the subject. For beginner and expert. Tells you what radio control is, how it works and how to construct not only component parts but a complete system as well. Illustrations explain each step.

No. 42—HIGH-FIDELITY TECHNIQUES. By James R. Langham, 112 pages. You've never seen a technical book like it! Just as he'd talk to you across the work bench, RADIO-ELECTRONICS' popular audio writer tells you how to design your own equipment and how to get top performance from it. Takes the double talk out of high-fidelity work.

THREE IMPORTANT 75¢ BOOKS

No. 41—PUBLIC-ADDRESS GUIDE. 80 pages. This handy book shows the service technician the way to extra income in big-paying PA work. Covers installation, maintenance and construction.

No. 40—THE CATHODE-RAY OSCILLOSCOPE. 112 pages. A "must" for servicing TV, FM and AM receivers and in amateur operation! Tells in simple, but technically sound language, how the scope works and how to use it.

No. 39—PRACTICAL DISC RECORDING. 96 pages. Tells you how to make good disc recordings. Covers every phase, theory as well as technique. A full chapter is devoted to each component.



9 POPULAR 64-PAGE BOOKS — 50¢ EACH



No. 29—HANDY KINKS AND SHORT CUTS. A treasury of time savers! Antennas, power supplies, test equipment, phonographs, amplifiers. Easy reference. Illustrated.

No. 30—UNUSUAL PATENTED CIRCUITS. A gold mine of important hook-ups. Control circuits, detectors, amplifiers, power supplies, foreign circuits.

No. 31—RADIO QUESTIONS & ANSWERS. Answers the tough ones on circuit diagrams, amplifiers, receivers, transmitters, meters and test equipment.

No. 32—ADVANCED SERVICE TECHNIQUE. A "must" for the advanced service technician! Covers specialized problems of servicing not usually found in ordinary textbooks.

No. 33—AMPLIFIER BUILDER'S GUIDE. For the designer and builder of audio equipment.

Covers a variety of amplifiers with power outputs from 8 to 30 watts.

No. 34—RADIO-ELECTRONIC CIRCUITS. For the experimenter—circuit diagrams of intercom systems, power supplies, voltmeters, electronic relays, receivers, etc.

No. 35—AMATEUR RADIO BUILDER'S GUIDE. For the "ham" who builds his own. Receivers, transmitters, antennas, converters, etc. Practical construction data.

No. 36—RADIO TEST INSTRUMENTS. Practical construction data on signal tracers, capacity meters, portable and bench multimeters, voltmeters, etc.

No. 38—HOW TO BUILD RADIO RECEIVERS. Describes 18 modern sets including short wave, broadcast, vhf, portable, ac-operated, ac-dc, miniatures—types for every fan.

THE GERNSBACK LIBRARY

SEE YOUR DISTRIBUTOR OR MAIL THIS COUPON TODAY

RADCRAFT PUBLICATIONS, INC.
25 West Broadway, New York 7, N. Y.

Enclosed is \$..... for which please send me postpaid, the books checked below.

- | | | | | | | |
|-----------------------------|-----------------------------|-----------------------------|-----------------------------|-----------------------------|-----------------------------|-----------------------------|
| <input type="checkbox"/> 29 | <input type="checkbox"/> 30 | <input type="checkbox"/> 31 | <input type="checkbox"/> 32 | <input type="checkbox"/> 33 | <input type="checkbox"/> 34 | <input type="checkbox"/> 35 |
| <input type="checkbox"/> 36 | <input type="checkbox"/> 38 | <input type="checkbox"/> 39 | <input type="checkbox"/> 40 | <input type="checkbox"/> 41 | <input type="checkbox"/> 42 | <input type="checkbox"/> 43 |

Name.....

Street.....

City..... Zone..... State.....

REK-O-KUT presents a New Continuously Variable-Speed Turntable of Broadcast Quality



Plays at any speed from 25 to 100 R. P. M., without "wow!"

Speed can be varied while in operation to produce sound effects.

Now for the first time... a continuously variable turntable of broadcast quality at a popular price. Ideal for record collectors, musicians, singers, disc jockeys, broadcast stations, music schools, dance studios, skating rinks, gymnasiums, etc. Plays through amplifier, radio, TV set or phonograph. Operates on 50 or 60 cycles.

Model CVS-12 (illustrated)
Chassis, motor and turntable . . . \$84.95 net.
Model CVS-12P, mounted in portable case with 16" dual stylus pickup . . . \$124.95, net.

3-Speed 12" Transcription Turntable

Recommended by outstanding music critics. Induction-type motor designed for smooth, quiet, vibration-free operation. 3 speeds, 78, 45 and 33 1/3.

Model LP-743 . . . \$54.95 net.

Write for Illustrated Catalog of REK-O-KUT Line of Hi-Fidelity Recording Instruments, Phonographs, Transcription Tables, Accessories.

REK-O-KUT CO.
38 A Queens Blvd. L.I.C. N.Y.

TAB That A Buy

New—Guaranteed Specials This Month to Readers of Radio-Electronics

19¢	69¢	79¢	79¢	89¢	99¢
2C26	3C7	3C4	57	744	12J7
601B	3D5	3E4	75	748	12K8
29B	6AL5	3V4	76	7AF7	14A7
NR74	6AQ5	5X4	HY15	7B7	14B6
954	6V6GT	5Y4	89	788	47
1619	6BC5	6AB4	91E	12AU6	\$1.09
9006	6CA	6AR5	1A7GT	12AX7	6A5
39¢	6V6GT	6AS	635	12BE6	6AC5
843	6W4	6AM5	1C5	12K7	6B8
864	12AV6	6BA6	1D8	12SA7	6J7
956	25L6	6BF5	1G1	12SG7	6K5
49¢	35C5	6C5	11C6	12SN7	6S57
5Y3GT	35Z4	6C6	11L4	45Z5	6T8
6X4	37	6E6	6A6	46	7E7
6X5GT	42	6E7	6AQ6	78	12AT7
35W4	45	6E7	6A6	78	19T8
REL36	50L6	6E7	6B6	1D5	\$1.19
955	53	75	6C8	1L6	2A3
59¢	UX6653	707	6C8	1L6	2A3
504G	79¢	12A67	6D6	1L3	6BG6
6AT6	12A6	6D8	6E8	1N5	6BQ6
6AV6	12A7	6G6	6H6	1N5	25BQ6
6J5	12C7	6H6	1X2	50A5	11726
35Z5	14	12S7	6Q7	6A7	\$1.29
39, 44	1A5	12S7	6S7	6B6	1R4
CRC40	1F5	12SQ7	6S7	6A7	6N7
11723	1G6	35A5	6S7	6B6	6N7
9004	1H6	35A5	6S7	6B6	6N7
69¢	1L6	35B5	6S7	6B6	6N7
1L4	1L6	35L6	6S7	6B6	6N7
1U4	1S5	50B5	6T7	6U5	12BH7
2C34	1T4	50V6	6U4	7A5	5V4
2X2	1U5	50V7	6W6	7A7	6AK5
			6Y6	7C6	6SC7

IN34 XTALS. 69¢ IN35, \$1.95

END EQUIPMENT BUYS!

BC645 (USN Model CG 43AAG) Ideal Citiz'n's Band Conversion, New, Less Tubes, Connectors & Dyn. \$12.95
 RADIO COMP Revr. Less Tubes, As Is. 5.98
 E87 Portable Assy. w/handles, Corroded, As Is. 5.98
 R9/APN4 Revr. Less Tubes, As Is. 14.98
 R10 Code Unit, Less Tubes, As Is. 19.95
 RM29 Control Unit, BRAND NEW, As Is. 9.98
 RT34/AP513 30 Mc IF, Less Tubes, As Is. 7.98
 R55/TP52 Good, As Is, Less Tubes. 29.98
 E65 Telephone Test Set, Fine Cond. 24.98
 R74/CRW Revr. Less Tubes, As Is. 2.49
 R89/ARNSA, Less Tubes, CAA Appvd. 19.98
 PE97 Plate Supply Unit, Less Tubes, As Is. 9.98
 I-108 Range Calibrator, Metal Case Good. 29.98
 PE120 Pwr Supply, Less Tubes, Used. 9.98
 Mackay 108B Radio Xmitter, w/Retal Case, Less Vtwrapack & Tubes, As Is. 2.98
 I-158 Sig. Gen. Good Cond. Less Tubes. 14.95
 BC454 Revr (3-Mc) New, w/Tubes. 3.49
 BC456 Mod, Less Tubes, Dyn, As Is. 1.98
 BC457 Xmitr (4-5-Mc), LT, As Is. 3.49
 BC458 Xmitr (6-7-Mc), LT, As Is. 3.98
 SCR IFF Unit, Less Tubes, As Is. 3.98
 \$5. Min. 25% Dep. P.O.B. N.Y.C. Prices Subject to Change. Dept. 8RE, 6 Church Street New York 6, N. Y. U. S. A. Cor. Church & Liberty Sts. Room 200. Phone Worth 2-7230

TAB

ADVERTISING INDEX

Aerovox Corporation	108
Allied Radio Corporation	17
All Mail Sales	123
American Electrical Heater Co.	103
American Phenolic Corporation	124
Amperite Company	130
Amplifier Corporation of America	96
Anchor Radio Corporation	15
Astatic Corporation	12
Astron Corporation	98
Atlas Sound Corporation	126
Atlas Tel-Rad Corporation	110
Barry Electronics	130
Belden Manufacturing Company	5
Bell Telephone Laboratories	105
Boyer-Roche Book Company	105
Brook Electronics	116
Brooks Radio & Tel. Corp.	126, 127
Buffalo Radio Supply	131
Capitol Radio Engineering Institute	9, 92
Certified TV Labs	66
Cisin, Harry	128
Cleveland Inst. of Radio-Electronics	13
Collins Audio Products Company	120
Commercial Trades Institute	110
Communications Equipment Co.	122
Concord Radio Corp.	119
Cornell-Dubilier Electric Corp.	94
Coyne Electrical School	113, 120, 125
Coronet's Training, Inc.	11
DuMont Laboratories, Allen B.	Inside Front Cover, 53
Electronic Instrument Co.	18
Electronic Measurements Corporation	118
Electro Products Laboratories	107
Electro-Voice Inc.	87
Federal Telephone and Telegraph Co.	95
Feiler Engineering Company	98, 128
G & G Radio Parts Service	55, 62, 63
General Electric Company	55, 62, 63
General Test Equipment Co.	129
Gould Green	128
Graylock Electronic Supply Company	118
Harvey Radio Co.	116
Heath Company	75, 76, 77, 78, 79, 80, 81, 82
Hytron Radio & Electronics Co.	107
Illinois Condenser Company	92
Instructograph Company	116
Jackson Electrical Company	84
JFD Manufacturing Company	113
Kay-Townes Antenna Company	100
Lafayette Radio Supply	94
La Pointe-Plascomid Corp.	111
Leotone Radio Corporation	116
Littelfuse Incorporated	132
Mallory & Company, Inc., P. R.	Inside Back Cover
Master Mechanic Manufacturing Co.	96
McGraw-Hill Book Company Inc.	121
Merit Transmitter Corp.	16
Midwest Radio & TV Corp.	97
Miles Reproducer	128
Milwaukee School of Engineering	115
National Company	106
National Radio Institute	108
National Schools	89
Niagara Radio Supply	109
Ohmite Manufacturing Company	74
Opportunity Adlets	121
Patent Service Institute	66
Penn Boiler & Burner Manufacturing Corp.	90
Penn TV Products Company	98
Perfection Electric Co.	66
Perrin Corp.	68
Planet Manufacturing Company	98
Precision Apparatus Company	112
Pres-Probe Company	118
Progressive Electronics Co.	109
RCA Institutes, Inc.	51
RCA Victor Division (Radio Corporation of America)	Back Cover, 99
Radelco Mfg. Co.	122
Radiart Corporation	59, 61
Radio City Products	120
Radio Corporation of America	71
Radio Dealers Supply	115
Radio Receptor Co., Inc.	125

RADIO SCHOOL DIRECTORY

Page 128

Baltimore Technical Institute	
Berkeley & Associates, Edmund C.	
Candler System Co.	
Commercial Distributors Institute	
Electronics Institute, Inc.	
Federal Electronics	
Hollywood Technical Institute	
Indiana Technical College	
Martin School, Don	
RCA Institutes	
Tri-State College	
University of Hollywood	
Valparaiso Technical Institute	
YMCA Trade & Technical School	

Rauland Corporation, The	93
Raytheon Manufacturing Company	10
Regency (Div. I.D.E.A. Inc.)	66
Rek-O-Kut Corporation	130
Rinehart Books Inc.	83
Rose Company, The	100
Sams & Company, Inc., Howard W.	73, 114, 117
Shure Brothers, Inc.	72
Sprague Products Company	6
Sprayberry Academy of Radio	49
Standard Distributors	121
Standard Coil Products Company	121
Steve-El Electronics Corporation	104
Superior Instrument Company	104
Supreme, Incorporated	85
Supreme Publication	101
Sutton's Wholesale Electronics, Bill	96
TAB	130
Tech-Master Products Company	112
Technifax	110
Tel-A-Ray Enterprises	86
Television Communications Institute	96
Telrex, Incorporated	109
Thomas Mold & Die Company	122
Transvision, Inc.	114
Tung-Sol Lamp Works, Inc.	14
Ward Products Corporation	69
Weller Electric Corporation	102
Wells Sales, Inc.	91
Wholesale Radio Parts Company, Inc.	118

Radio-Electronics does not assume responsibility for any errors appearing in above index.

AMPERITE

Studio Microphones at P.A. Prices



Ideal for
BROADCASTING
RECORDING
PUBLIC ADDRESS

"The ultimate in microphone quality," says Evan Rushing, sound engineer of the Hotel New Yorker.

• Shout right into the new Amperite Microphone—or stand 2 feet away—reproduction is always perfect.

• Not affected by any climatic conditions.

• Guaranteed to withstand severe "knocking around."

Models
RBLG—200 ohms
RBHG—Hi-imp.
List \$42.00



"Kontak" Mikes
Model SKH, list \$12.00
Model KKH, list \$18.00

Special Offer: Write for Special Introductory Offer, and 4-page illustrated folder.

AMPERITE Company, Inc.
BROADWAY • NEW YORK 12, N. Y.
Canada: Radio Receptor Corp., Ltd., 560 King St. W., Toronto

SELENIUM-RECTIFIERS Full-Wave Bridge Types

Continuous Current	18/14	36/28	54/40	110/100
1 Amp.	—	2.75	—	—
2 Amp.	2.40	3.75	6.95	9.95
4 Amp.	3.85	7.00	9.00	—
6 Amp.	5.85	—	—	—
8 Amp.	5.90	9.95	—	—
12 Amp.	7.50	14.00	—	—
24 Amp.	14.00	27.00	—	—

Compare our prices—All new stock—Get our quotations on other sizes & types. New, herm. sealed Selen. Rect. XFMR. 110V to 6, 12, 18, 24, 30, & 36 V. @ 4 amps. \$3.95

Quality, tested tubes, new & guaranteed. In stock now, many others not listed (XMTG, Etc.)—write

024	\$.50	6AV6	\$.55	6X5GT	\$.55
024G	\$.50	6BA6	\$.55	12AV6	\$.55
1B3GT	\$.65	6BE6	\$.55	12AU7	\$.70
1R5	\$.65	6BD6	\$.50	12BA6	\$.65
1U4	\$.65	6BQ6GT	\$.75	12BE6	\$.65
1X2A	\$.75	6CD6G	\$.50	12BH7	\$.75
3A4	\$.65	6GH7	\$.50	25AV5GT	\$.70
3A5	\$.65	6J5GT	\$.50	25L6GT	\$.50
3D6	\$.50	6P8	\$.75	35C5	\$.65
3Q4	\$.60	6T8	\$.75	35L6GT	\$.50
5U4G	\$.50	6SD7GT	\$.75	35Z5GT	\$.50
5Y3GT	\$.50	6SN7GT	\$.60	50C5	\$.60
6AB4	\$.75	6U4GT	\$.75	50L6GT	\$.55
6AL5	\$.45	6U6GT	\$.70	80	\$.50
6AS5	\$.75	6V6GT	\$.55	304TL	\$.13.95
6AS5	\$.75	6W4GT	\$.50	304TH	\$.13.95
6AU6	\$.55	6X4	\$.55	955	\$.50

BARRY ELECTRONICS CORP.
136 Liberty St., N.Y. 6, N. Y. REctor 2-2563
Terms: 25% with order, balance C.O.D.—All merchandise guaranteed. F.O.B. N. Y. C.

274N COMMAND SET
MADE BY WESTERN ELECTRIC

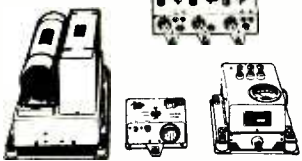
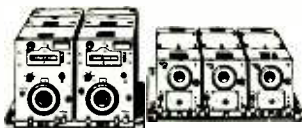

A mountain of valuable equipment that includes 3 separate Communications Receivers, covering up to 9 M.C., 2 separate 40 watt Transmitters including crystals, 4-28V Dynamos (easily converted to 110V AC operation), Presampler and Modulator, 2 Tuning Control Boxes, and 1 Antenna Coupling Box complete with R.F. Ammeter, 29 tubes supplied in all. Receivers and Transmitters instantly detached from mounting racks for use in separate locations. Removed from unused aircraft and in guaranteed electrical condition. A super value at \$59.95 complete.

AUDIO AMPLIFIER

Brand new, dual triode amplifier having 2 of the valuable and scarce owner type audio transformers that sell for \$12.80 apiece. Neat aluminum case, fully enclosed (largest dimension 6 in.). Perfect for intercom systems, phono amplifiers, mike amplifiers, or signal tracer amplifier for testing radio sets. A sensational bargain at only \$3.40 each.

SPAGHETTI

Terrific Bargain in Spaghetti at lower than carload lot prices. Plastic Spaghetti made to U.S. Air Force Specs. Safe for 10,000 volts.

- 3/8" to 1/4" diam. 1c per ft.
- 5/16" to 3/8" diam. 1 1/2c per ft.
- 7/16" to 1/2" diam. 5c per ft.
- 1" 10c per ft.

We can supply continuous lengths up to 100' clear or black in most sizes.

Drillmaster Electric Drill



Pistol Grip electric drill. Ideal for hobbyists. Complete with sander, buffer, grinding wheels, etc. \$9.95

STOP IT'S MOBILE RADIO TIME AT BUFRAD
6 Volt Dynamotor

Made for use with G.E. Equipment. Worth over \$250.00. So husky we can give a standard R.M.A. Guarantee on this item. Satisfaction guaranteed or money refunded if returned prepaid within 5 days.

1000 V. OUTPUT AT 350 MA.

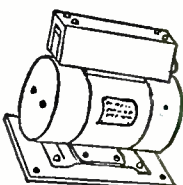

- By running with end bells removed will supply 500 MA. safely.
- Constant output voltage under varying load because of compound winding.
- Low input current (1R to 100 amps, depending on transmitter drain).
- Regular car battery will supply enough power for push-to-talk operation.
- Starting solenoid for remote operation from mike switch.
- Both sides of output voltage insulated from ground.
- Brand new in original factory boxes.
- Both input and output fused.
- Built-in interference filter.

Special . . .
\$39.95

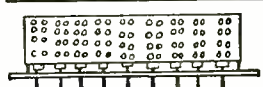

PUSH SWITCH
0 Section. Make Break & SPDT ea. Pressing one releases all others.
98c

BUFFALO RADIO SUPPLY

219-221 Genesee St.,
Dept. RE-7
Buffalo 3, New York

MAGNAVOX HIGH FIDELITY RECORD DEMONSTRATORS

Sensational Bargain in Brand New Record Demonstrators (Built for Columbia by Magnavox)

- Amplifier designed in conjunction with the speaker to be capable of bringing you the storm and fire of Wagnerian opera or the light lilting melody of Debussy with equal realism.
- Oversize 12" speaker • Inclined sounding board
- Mahogany Console Cabinet approximately a yard wide and a yard high
- 2 tone controls—Treble and bass—as well as 2 volume controls
- A pickup that is as gentle as a beam of winter sunshine. Intended to leave records in new condition after demonstration.
- 78 and 33 1/2 R.P.M. Originally a 3 speed motor, but Columbia had the sleeve on the motor shaft for 45 R.P.M. removed, so the R.C.A. doughnuts could not be played. This can be re-installed for a few cents. If you must play the doughnuts.
- No expense was spared in producing these record demonstrators. They were Columbia's weapon in the savage, relentless and costly war between the titans in the record business, that only ended when R.C.A. started to market 33 1/2 R.P.M. records under its own label.
- This buy of a lifetime is guaranteed to please you. Price only \$60.00. A quick sellout is certain at this low price. Rush your order.
- Extra Special—We have a few of the Magnavox amplifiers alone, brand new and identical with the amplifier in the record demonstrator listed above. These have the separate bass and treble tone controls and volume control, and are complete with tubes. Believe it or not, we are letting these prizes go for a \$20.00 bill each. A bargain like this would be unbelievable before Korea. Let alone now.

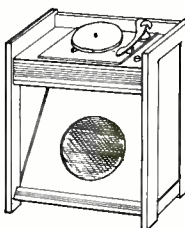

1000 CYCLE AUDIO FILTER

With TOROID Coils

Navy PD52010-1 low pass audio filters as mentioned in the "Peak-to-Arrow" article in June CQ, and designated by the above number, are the exact electrical and physical equivalents of commercial audio filter units selling for \$35.00 wholesale. They are infinitely better than surplus "Radio Range Filters" being sold for reducing QRM, and a 2 KC off resonance, for example, a 2 section filter using PD52010-1 is capable of twice the selectivity available through use of the Q5'er (the BC153 section of the 274N which has provided the amateur's previous highest standard of interference elimination). **EXTRA SPECIAL NAVY PD52010-1 with diagram.....\$2.00**

HOME WORKSHOP AT BARGAIN PRICE.

Accurate and precise 2 speed guaranteed hobby lathe, the essential machine for the home workshop. Sturdy enough for light production work or factory standby service. Supplied with 56" of belting for connecting to any available electric motor or power take-off. Also included in this unbelievably offer are such accessories as 1/2" drill chuck with specially hardened tool steel jaws, a 4" electric furnace high speed grinding wheel, a cotton buffing wheel and a large supply of buffing compound, and a 4" steel wire scratch brush. Your cost \$6.00. Sole export agent. Distributor inquiries invited.

WINDOW ANTENNA COMPRESSED AIR INSTANTLY ANYWHERE

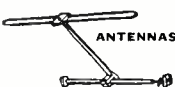

Highest quality telescoping folded dipole antenna with all the features usually expected in such an antenna, including use as a dipole and reflector, and in addition a mounting bracket provided so that the antenna can be installed in any window in two minutes or less. Any slight loss in gain because of the reduction from roof-top height is more than compensated by ability to orient antenna instantly by opening window and adjusting for maximum signal strength. Mounting bar can be installed horizontally or vertically in window frame or even between attic rafters, whichever is most convenient. Your cost \$7.00. With high frequency attachment for channels 7 to 13, \$9.00. Either type 10% less in dozen lots.

Portable Air Compressor and storage tank. Ruggedly built of best materials using lifetime lubricated ball bearing on connecting rod and oil-impregnated main bearing on shaft. Unusual design forever eliminates valve trouble, the most common fault in air compressors. **PATENTED** unique air intake system increases efficiency tremendously. Works from any 1/4 H.P. motor. Useful for spraying paints or lacquers, disinfectants, insecticides, annealing or brazing with natural gas, inflating tires, etc. Price \$14.50 postage prepaid anywhere in the U. S. Efficient, completely adjustable spray gun complete with 12 ft. of 100 lb. tested hose available prepaid, 25% required on all C.O.D. orders, for only \$7.75.



P.M. Auto Speaker for rear seat installation including 3 way switch to turn on front or rear speaker or both. Try to match this bargain at twice the price, \$3.50 each, 2 for \$6.00, 10 for \$27.00. If desired, black crackle metal cabinets to fit above speakers can be purchased with speakers for \$1.50 each.

MIDGET 1 WATT TRANSMITTER supplied complete with polystyrene coil forms for 3 ham bands, 2% over 20 KC high. Includes practically all necessary parts. Your Cost \$1.50

SIGNAL GENERATOR

Genuine Laboratory-type precision signal generator Manufactured and sold for \$68.00 each in large quantities during the war by Northeastern Engineering Corp., one of the top manufacturers of electronic equipment for the U. S. Govt. Five fundamental bands starting at 150 KC. Strong harmonics up to 120 MC. Five step ladder type attenuator as well as potentiometer output control. Regular 1000 cycle audio oscillator using vacuum tube, not a cheap neon sawtooth audio oscillator. Audio output separately available externally. Weight without packing material 16 lbs. which should show what a world of difference exists between this signal generator and the ordinary cheap oscillator used by the average serviceman. Complete with fused plug and coaxial output lead. Super Special \$28.75



COAXIAL SPEAKERS

Latest model coaxial speakers. Woofertweeter design. Response 40-17,500 cps. New efficient speakers represent the result of years of research. Low and high pass filter built in. Only 2 wires to connect. 8 ohms impedance. Only \$13.50 each or 2 for \$26.00.



WORLD'S LARGEST STOCK

Coaxial and "AN." Connectors. Write for prices on types desired. IMMEDIATE DELIVERY

A. C. RELAYS

Coil	Specification	Contact Amperes	Net.
6-8V	S.P.S.T. N.O.	3	\$1.50
12-15V	S.P.S.T. N.O.	3	1.25
25-30V	3P.S.T. N.O.	3	2.00
25-30V	S.P.S.T. Normally Closed	3	2.00
35V	S.P.S.T. Normally Open	10	2.50
110V	D.P.D.T.	3	2.00
110V	3P.S.T. Normally Open	15	3.00
	S.P.S.T. Normally Closed		
	D.P.D.T.		



D. C. RELAYS

Coil	Specifications	Contact Amperes	Net.
800 ohms 10m.a.	D.P.D.T.	3	\$2.00
2000 ohms 4.5m.a.	S.P.D.T. Hermetic	3	2.75
2000 ohms 1 m.a.	S.P.D.T. Hermetic	3	3.75
12 Volts	D.P.D.T. Midget	3	.60
45 Volts	D.P.D.T. & S.P.S.T.N.O.	3	1.70

35MM SLIDE PROJECTOR & ENLARGER

Most terrific photographic bargain of the 20th century. A fine precision instrument with many features!

- Takes roll film or 2x2 slides.
- Automatic slide changer furnished.
- No more waiting for enlargements to enjoy your candid shots. All you need is a flat surface to project on.
- Has 300 V 110 V Bulb, but 6V, 12V, 32V, or 220V available.
- 8 precision ground, optical glass elements in optical system. (No other projector on the market has more.)
- Heat absorbing filter.
- Use as an enlarger for making your own prints of any desired size.
- Plano-Convex Meniscus Condenser
- 5" focus Brown-Violet coated, double anastigmat F3.5 lens.
- Swivel projector head:
- Projector tilts to any angle on base.
- Brand New Society for Visual Education Model AA Projector. Super Special \$50.00.
- Similar S.V.E. Projector less slide injector with uncoated lens \$37.50
- 35 mm 150 V Projector similar to above, less slide injector with uncoated lens \$47.50

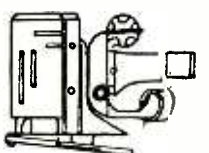

Super Midget Mike Xfrm.

Occupies less than 1/4" of space. This is the tiny, high quality transformer that is used inside outlet dynamic or velocity mikes to match the input of an amplifier tube. Makes a terrific intercom set input xfrm. to couple from the voice coil of a speaker to the amplifier input. Better quality and marked reduction in hum compared to other transformers. A beautiful input xfrm. for a transceiver because of high quality & light weight. Special \$1.00 Postpaid





Servicemen can cover 94% of fuse replacements with this kit



*One-Call Kit Contains 45 TV fuses
(6 most in demand types) and 6 TV
snap on fuse holders in a clear
plastic hinged-cover bench box.*

*Another **LITTELFUSE** first.*

*Call your jobber today. Littelfuse, Inc.,
4757 Ravenswood, Chicago 40.*

LOngbeach 1-4970.



BURTON BROWNE ADVERTISING



Don't take chances with misfits!

In a field survey of servicemen on the subject of desirable volume control features, by far the most comments concerned easy adaptability and installation. If you want a control that is tailored for the job... and one that will deliver thousands of hours of smooth, quiet performance...

Make Sure! Make it Mallory!

When you use the Mallory Midgetrol* you are using a control designed to make your job easier and at the same time give your customer outstanding performance. Here is the unbeatable combination of Midgetrol features:

First, you get a permanently fixed, tubular brass shaft that can be adapted for split-knurl or flatted type knobs in a few seconds by inserting one of the steel shaft ends supplied in every package. This means utmost convenience without sacrificing the stability

of permanent, two-point shaft suspension.

Second, you get the convenience of AC switch design that permits secure attachment, without removing the control housing. Positive indexing assures proper position.

Third, you get exceptionally accurate resistance values and taper curves.

Fourth, you can be sure of years of quiet, satisfactory service life through extremes of humidity and temperature.

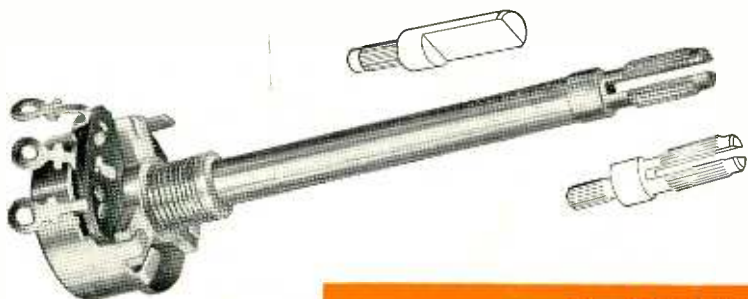

Make it Mallory and make sure! Ask your distributor to show you the time-proved Mallory Midgetrol with the new features that make installation faster and simpler than ever.

In addition to single controls, dual concentric Mallory Midgetrols can be made up easily by combining factory-assembled front and rear sections of desired resistance values. Ask your Mallory Distributor for details!

*Reg. U.S. Pat. Off.

P. R. MALLORY & CO. Inc.
MALLORY
 CAPACITORS • CONTROLS • VIERATORS • SWITCHES • RESISTORS
 • RECTIFIERS • VIBRAPACK* POWER SUPPLIES • FILTERS
*Reg. U.S. Pat. Off.
APPROVED PRECISION PRODUCTS
P. R. MALLORY & CO., Inc., INDIANAPOLIS 6, INDIANA

THE QUALITY OF RCA TUBES IS UNQUESTIONED



4,500,000

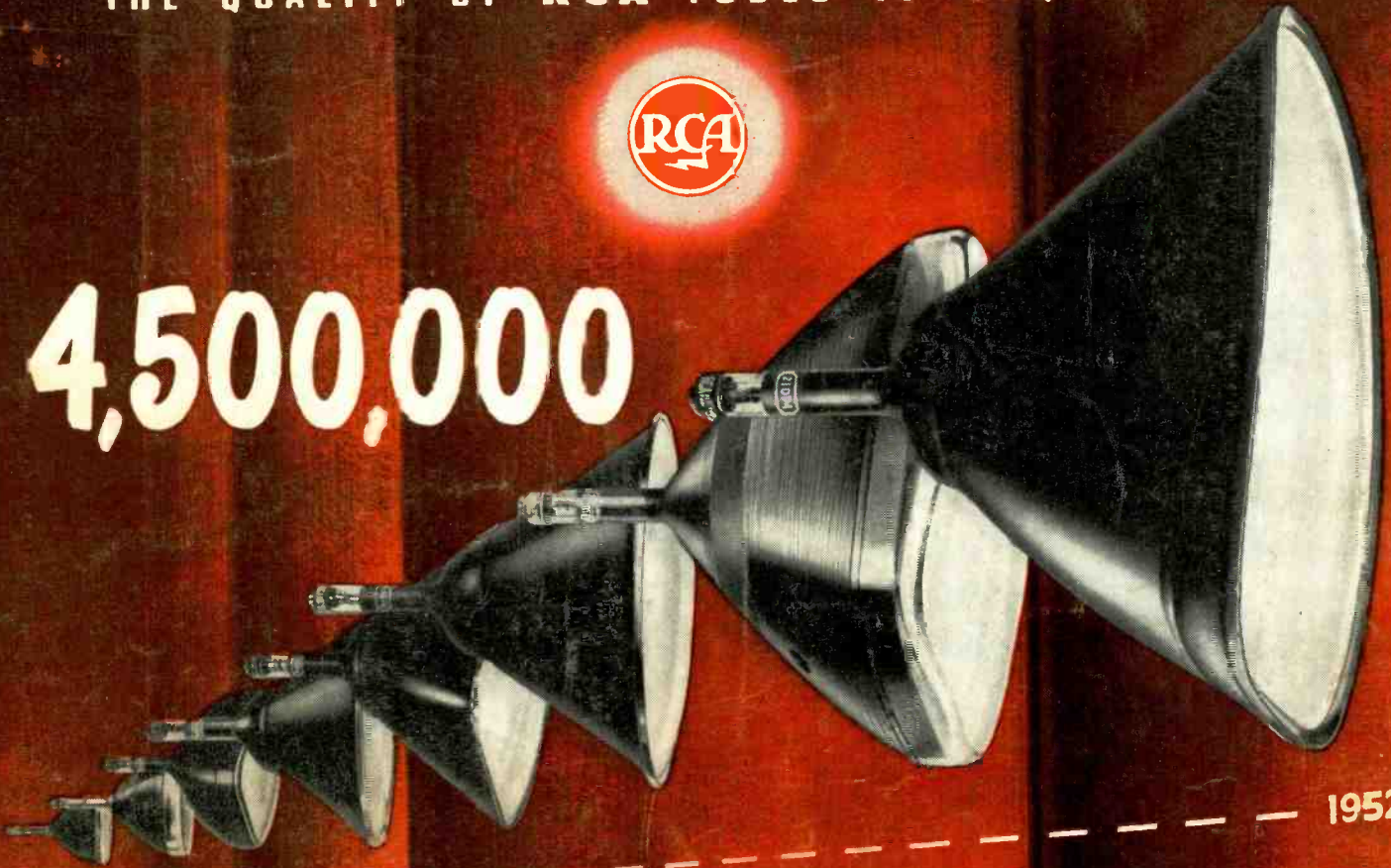

1946

1952

Best Sellers!

Life expectancy... plus!

RCA kinescopes incorporate
the experience of the
oldest mass-producer of
picture tubes in the industry



It is a well-established fact that more RCA kinescopes are now in active service than any other brand . . . over 4½ million since the advent of commercial television, when RCA pioneered the first large-scale production of kinescopes.

Significantly, many RCA kinescopes installed *four and five years ago are still giving good performance today*, providing continuous reliable service year after year. Yes, RCA picture tubes of all types have consistently given outstanding performance.

RCA's kinescope quality means substantial savings to dealers and servicemen, in fewer call-backs and "out-of-pocket" replacements. In the long run, it amounts simply to this . . . stocking RCA picture tubes is good business . . . as any long-term user of RCA kinescopes will tell you.

Your local RCA Tube Distributor carries a complete line of RCA picture tubes. See him the next time you buy kinescopes for replacement.

Keep informed . . . keep in touch with your RCA Tube Distributor



RADIO CORPORATION of AMERICA
ELECTRON TUBES

HARRISON, N. J.

www.americanradiohistory.com