

ANNUAL TELEVISION NUMBER

RADIO — ELECTRONICS

HUGO GERNSBACK, Editor



JAN

1951

50¢

U. S. and
CANADA

↑
HOW COLOR TELEVISION WORKS — SEE SPECIAL COLOR PAGES

www.americanradiohistory.com

Because
They're Free of
Contamination ...



MALLORY CAPACITORS

Give Long, Continuous Service!

One reason why Mallory Capacitors deliver full rated capacity throughout their long life is the unusual care taken in production to prevent contamination, which is the source of corrosion and shortens the life of capacitors.

Even at high temperatures, Mallory Capacitors operate perfectly over extremely long periods of time. Tests consistently show dependable performance for more than 2000 hours at temperatures up to 185°F (85°C). Special design and meticulous production methods make such records possible.

Mallory Capacitors have set new long-life standards for the industry, yet cost no more. You will find it pays to rely on the complete Mallory Capacitor line . . . electrolytic, plastic tubular, paper, mica and ceramic.

See your Distributor for Mallory Precision Quality Parts at Regular Prices.



P. R. MALLORY & CO. Inc.
MALLORY

CAPACITORS • CONTROLS • VIBRATORS • SWITCHES • RESISTORS
• RECTIFIERS • VIBRAPACK® POWER SUPPLIES • FILTERS
*Reg. U.S. Pat. Off.

APPROVED PRECISION PRODUCTS

P. R. MALLORY & CO., Inc., INDIANAPOLIS 6, INDIANA

NEW



I'LL TRAIN YOU FOR YOUR FCC LICENSE

A Federal Communications Commission Commercial Operator's License puts you in line for a good job in Radio or Television Broadcasting, Police, Marine, Aviation, Two-way, Mobile or Micro-wave Relay Radio. Mail coupon below for 64-page book FREE. It will give you complete facts about my NEW Communications course.

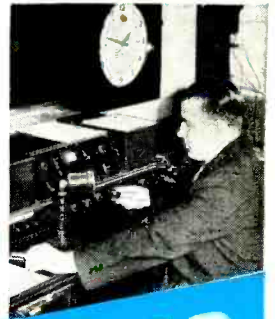

YOU BUILD THIS TRANSMITTER

with parts I send. With this Transmitter you practice how to put a station "on the air." You perform procedures demanded of Broadcast Station Operators, conduct many experiments, make many practical tests.

LEARN COMMUNICATIONS by PRACTICING at Home in Spare Time

with MANY KITS of RADIO EQUIPMENT I SEND



MY COURSE INCLUDES TELEVISION

Course Is New! Different!

Mail coupon now for facts about my NEW, intensely practical course in Radio-Television Communications. Let me send you FREE book. Read outlines of 78 lesson texts written by leaders in Communications and edited for you by my practical staff. See the nine big Kits of Parts I send that "bring to life" theory you learn. Read about the Transmitter you build and operate, about the Electronic Multimeter you get. All equipment yours to keep. My NEW course covers Theory thoroughly and you get Practical Experience building units like those shown at the left. It's backed by N. R. I.—the world's oldest and largest home study Radio-Television school.

Mail Coupon For Book FREE

Send today! See what my NEW course is like. Find out how I get you ready for a brighter future, better earnings, more security in Radio-Television. Send coupon now in envelope or paste on a postal. NO OBLIGATION. NO SALESMAN WILL CALL! My book, sent to you FREE, tells the full story. J. E. SMITH, President, Dept. 1AF National Radio Institute, Washington 9, D. C.



YOU BUILD this Transmitter Power Supply used in the basic experiments in RF and AF amplifiers, frequency multipliers, buffers, etc.

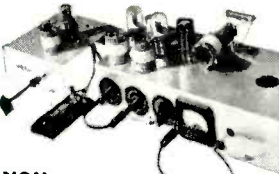

YOU PRACTICE setting up code, amplitude and frequency modulation circuits (put voice, music, etc., on "carrier signals" you produce). You learn how to get best performance.



YOU MEASURE current, voltage (AC, DC and RF), resistance and impedance in circuits with Electronic Multimeter you build. Shows how basic transmitter circuits behave; needed to maintain station operation.

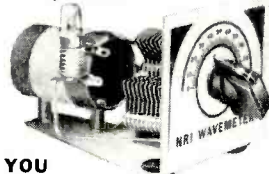

YOU BUILD this Wavemeter and use it to determine frequency of operation, make other tests on transmitter currents.

Ever think HOW FAST Radio-Television Communications is changing, developing, growing? Have you considered what this amazing progress can mean to you?

Look at these facts. In 1946 only 6,000 Television sets were sold. In 1949 almost 3,000,000. By 1954, 20,000,000 Television sets will be in use, according to estimates. 100 Television Stations are operating in 35 states. Authorities predict there will be over 1,000 Television Stations. This rapid growth means new jobs, more jobs, good pay for qualified men all over the U. S. and Canada. Then add development of FM, Two-way Radio, Police, Marine, Aviation and Micro-wave Relay Radio! Think what all this means! New jobs, more jobs for beginners! Better jobs, better pay for experienced men!

Are you a beginner who wants steady work in this growing field? My NEW course can help you get an FCC License and prepare for the job you want. Are you a man with some training in Radio or Radar, or a Licensed Operator? My NEW course modernizes, increases the value of your knowledge and experience!

Servicing Training Also Offered by N. R. I.

If you prefer a good-pay job in Radio-Television Servicing or your own money-making Radio-Television Sales and Service Shop, I'll train you at home. My famous Servicing Course also includes many Kits of Radio Parts. You use them to get PRACTICAL EXPERIENCE with circuits common to Radio and Television. I also show you how to make \$5, \$10 a week or more EXTRA MONEY fixing neighbors' Radios while training. Full information in my 64-page book. Mail coupon.

VETERANS

HURRY!

To get this valuable training under G. I. Bill. Time is Running out. MAIL COUPON NOW!

I TRAINED THESE MEN



"N.R.I. has been my stepping stone from a few hundred to over \$4,000 a year as a Radio Engineer."—ALTON B. MICHAELS, Trenton, Georgia.



"I am employed by WKBO as transmitter operator. Have more than doubled salary since starting in Radio full time."—A. HERR, New Cumberland, Penna.



"Am Broadcast Engineer at WLPM. Your NEW Communications course shows the kind of equipment we use."—J. RANGLE, JR., Suffolk, Virginia.



"4 years ago, I was a bookkeeper with hand-to-mouth salary. Am now Radio Engineer with ABC network."—N. H. WARD, Ridgefield Park, N. J.

MAIL NOW-BOOK FREE

MR. J. E. SMITH, President, Dept. 1AF National Radio Institute, Washington 9, D. C.

Mail me your 64-page Book about Radio and Television Communications opportunities and training. (No salesman will call. Please write plainly.)

Name..... Age.....

Address.....

City..... Zone..... State.....

Check if Veteran Approved Under G. I. Bill

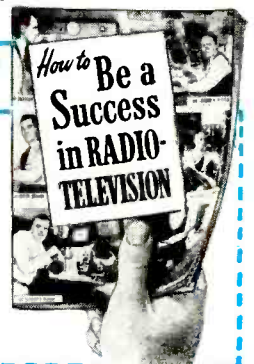

RADIO - ELECTRONICS

Incorporating
SHORT WAVE CRAFTS TELEVISION NEWS*
RADIO & TELEVISION
*Trademark registered U. S. Patent Office

formerly RADIO-CRAFT

MEMBER
AUDIT BUREAU OF CIRCULATIONS

Hugo Gernsback, Editor-in-Chief

M. Harvey Gernsback, Editorial Director

Fred Shunaman, Managing Editor
Robert F. Scott, W2PWG, Technical Editor
Manfred Wentzel, Associate Editor

I. Queen, Editorial Associate
Angie Pascale, Production Manager
Wm. Lyon McLaughlin, Tech. Illustration Director

Lee Robinson, General Manager
John J. Lamson, Sales Manager

G. Aliquo, Circulation Manager
Robert Fallath, Promotion Manager

Annual Television Number

CONTENTS

JANUARY, 1951

Editorial (Page 19)			
The Tele-Theater.....	by Hugo Gernsback 19		
Television (Pages 20-69)			
Color Television Systems.....	by Fred Shunaman 20		
Convert your TV Set for Color Reception..	by Norman L. Chalfin 23		
Linearizing Circuits for Video Deflection..	by Seymour D. Uslan 26		
New Trends in Television.....	by Walter H. Buchsbaum 28		
Industrial Closed Circuit Television.....	30		
Horizontal A.F.C. Circuits Used in Television Receivers	by Henry O. Maxwell 33		
Guided TV Bomb.....	by Hugo Gernsback 36		
Picture Tube List.....	by F. Wilhelm 36		
Charts Identify TV.....	by N. H. Crowhurst 38		
K-C Technicians Organize for TV.....	by Grier Lowry 40		
Servicing Picture Tube Circuits.....	by Carl J. Quirk 41		
TV Station List.....	44		
Trends in Television I.F.'s.....	by Edward M. Noll 48		
Big Tube Conversions are Profitable.....	by Matthew Mandl 50		
TV Progress Abroad.....	by E. Aisberg 53		
Television Service Clinic....	Conducted by Walter H. Buchsbaum 54		
Simple Master Antennas.....	by Wilbur J. Hantz 55		
TV Antenna Equipment.....	56		
Directory of TV Receiver Characteristics.....	58		
Television DX Reports.....	69		
Electronics (Pages 70-72)			
How an Electric Brain Works, Part IV	by Edmund C. Berkeley & Robert A. Jensen 70		
Theory and Engineering (Pages 74-82)			
Electric Space Ships, Part II.....	by Professor Hermann Oberth 74		
Servicing-Test Instruments (Pages 94-107)			
Fundamentals of Radio Servicing, Part XXIII.....	by John T. Frye 94		
Television Service Notes.....	by Michael L. Tortariello 105		
Meter for Power Supply Checks Volts and Amps....	by I. Queen 107		
Audio (Pages 110-119)			
Electronics and Music, Part VII.....	by Richard H. Dorf 110		
Audio Feedback Design, Part IV.....	by George F. Cooper 116		
Broadcasting and Communications (Pages 120-122)			
Doctor Always on Call with Radiopaging Unit.....	120		
New Design (Page 123-124)			
Tubes of the Month.....	123		
Departments			
The Radio Month....	10	Try this One.....	130
Radio Business.....	14	Question Box.....	134
New Devices.....	84	Technotes.....	136
Association News....	125	Miscellany.....	138
New Patents.....	127	People.....	143
Radio-Electronic		Communications.....	145
Circuits.....	132	Book Reviews.....	147

ON THE COVER:

Model Naomi Riordan poses for the three-color camera in a demonstration of Du Mont closed-circuit 18-mc color television. Insert shows her appearance on the screen, with breakup into the three primary colors.
Kodachrome by Avery Slack.

RADIO ELECTRONICS, January 1951, Volume XXII, No. 4. Published monthly. Publication Office: Erie Ave., P to G Streets, Philadelphia 32, Pa. Entered as second class matter September 27, 1948, at the post office at Philadelphia, Pa., under the Act of March 3, 1879. SUBSCRIPTION RATES: In U. S. and Canada, in U. S. possessions, Mexico, South and Central American countries, \$3.50; \$6.00 for two years; \$8.00 for three years; single copies 30c. All other foreign countries \$4.50 a year; \$8.00 for two years; \$11.00 for three years. Allow one month for change of address. When ordering a change please furnish an address stencil impression from a recent wrapper. RADCRAFT PUBLICATIONS, INC. Hugo Gernsback, Pres.; M. Harvey Gernsback, Vice-Pres.; G. Aliquo, Sec'y. Contents copyright, 1950, by Radercraft Publications, Inc. Text and illustrations must not be reproduced without permission of copyright owners.

EDITORIAL and ADVERTISING OFFICES, 25 West Broadway, New York 7, N. Y. Tel. Rector 2-9690.

BRANCH ADVERTISING OFFICES: Chicago: 520 N. Michigan Ave., Telephone Superior 7-1796. Los Angeles: Ralph W. Harker, 1127 Wilshire Blvd., Tel. MA 6-1271. San Francisco: Ralph W. Harker, 582 Market St., Tel. GArdiel 1-2481. FOREIGN AGENTS: Great Britain: Atlas Publishing and Distributing Co., Ltd., London E.C.4. Australia: McGill's Agency, Melbourne. France: Brentano's, Paris 2e. Holland: Trilectron, Heemstede. Greece: International Book & News Agency, Athens. So. Africa: Central News Agency, Ltd., Johannesburg; Capetown: Durban, Natal, Universal Book Agency, Johannesburg. Middle East: Steimatzky Middle East Agency, Jerusalem. India: Broadway News Centre, Dadar, Bombay 214. K. L. Kannappa Mudaliar, Madras 2. Pakistan: Paradise Book Stall, Karachi 2.

POSTMASTER: If undeliverable send form 3575 to: Radio-Electronics, 25 West Broadway, New York 7, N. Y.



FREE!

This New TV REPLACEMENT Capacitor MANUAL by SPRAGUE

From A to Z, from Admiral to Zenith, this 16-page book is jam-packed with complete replacement recommendations for critical TV capacitors in 497 television sets from The Technical Service Division of Sprague, world's largest capacitor maker.

Get your copy FREE from your SPRAGUE DISTRIBUTOR or send 10c directly to Sprague to cover handling and mailing costs.

Remember! Avoid costly call-backs in your service work by sticking to Sprague — the capacitors you can depend upon.

SPRAGUE

PRODUCTS COMPANY

DISTRIBUTORS' DIVISION OF THE SPRAGUE ELECTRIC COMPANY

81 MARSHALL ST., NORTH ADAMS, MASS.

RADIO-ELECTRONICS for



Learn RADIO

TELEVISION, ELECTRONICS

by

SHOP METHOD HOME TRAINING

Let NATIONAL SCHOOLS, of Los Angeles, a practical Technical Resident Trade School for almost 50 years, train you for today's unlimited opportunities.

You receive all parts, including tubes, for building this fine, modern Superheterodyne Receiver. This and other valuable standard equipment becomes your property.

these two FREE books will tell you how



WE BRING NATIONAL SCHOOLS TO YOU!

GOOD JOBS AWAIT THE TRAINED RADIO TECHNICIAN

You are needed in the great modern Radio, Television and Electronics industry! Trained technicians are in constant and growing demand at excellent pay—in Broadcasting, Communications, Television, Radar, Research Laboratories, Home Radio Service, etc. National Schools Master Shop Method Home Study Course, with newly added lessons and equipment, can train you in your spare time, *right in your own home*, for these exciting opportunities. Our method has been proved by the remarkable success of National Schools-trained men all over the world.

You Learn by Building Equipment with Standard Radio Parts We Send You

Your National Schools Course includes not only basic theory, but *practical* training as well—you *learn by doing*. We send you complete standard equipment of professional quality for building various experimental and test units. You advance step by step until you are able to build the modern superheterodyne receiver shown above, which is yours to keep and enjoy. You perform more than 100 experiments—build many types of circuits, signal generator, low power radio transmitter, audio oscillator, and other units. The Free Books shown above tell you more about it—send for them today!



NOW! NEW PROFESSIONAL MULTITESTER INCLUDED



This versatile testing instrument is portable and complete with test leads. Simple to operate, accurate and dependable. You will be able to quickly locate trouble and adjust the most delicate circuits. You can use the Multitester at home or on service calls. It is designed to measure AC and DC volts, current resistance and decibels. You will be proud to own and use this valuable professional instrument.

GET THE DETAILS - SEND THE COUPON →

Lessons and Instruction Material Are Up-to-date, Practical, Interesting

National Schools Master Shop Method Home Training gives you basic and advanced instruction in all phases of Radio, Television and Electronics. Each lesson is made easy to understand by numerous illustrations and diagrams. All instruction material has been developed and tested in our own shops and laboratories, under the supervision of our own engineers and instructors. A free sample lesson is yours upon request—use the coupon below.

TELEVISION TRAINING A complete series of up-to-the-minute Television lessons is an integral part of your course, covering all phases of Television repairing, servicing and construction.

Here are just a few of the interesting facts you learn with the **FREE SAMPLE LESSON**

1. How radio receivers operate.
2. How the antenna circuit is constructed.
3. Converting signal currents into sound.
4. How the R-F transformer handles the signal.
5. How the tuning circuit functions.
6. The Radio "bands."

APPROVED FOR VETERANS
Check coupon below.

NATIONAL SCHOOLS

LOS ANGELES 37, CALIFORNIA EST. 1905



MAIL OPPORTUNITY COUPON FOR QUICK ACTION

National Schools, Dept. 1-RE
4000 South Figueroa Street
Los Angeles 37, California

(Mail in envelope or paste on penny postcard.)

Mail me FREE the book "Your Future in Radio-Television" and the sample lesson of your course. I understand no salesman will call on me.

NAME _____ AGE _____

ADDRESS _____

CITY _____ ZONE _____ STATE _____

Check here if veteran of World War II

Thousands of Expert Technicians

USE **HICKOK** INSTRUMENTS

To successfully service Television..

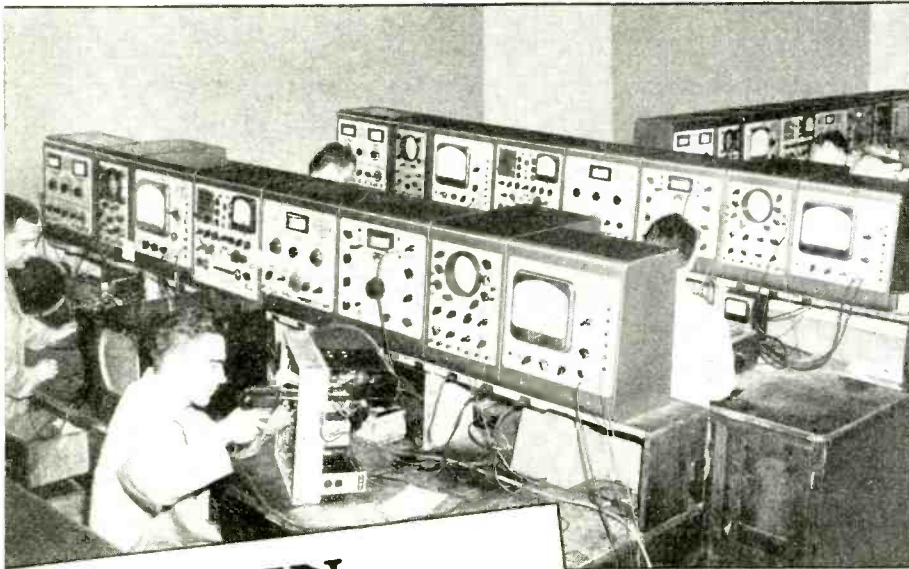

SUN RADIO services
and carries warranty on...

- Admiral
- Bendix
- Capehart
- Emerson
- Farnsworth
- General Electric
- Hallicrafters
- Motorola
- National
- Philco
- R.C.A.
- Stromberg-Carlson
- Westinghouse

SUN
RADIO
WASHINGTON 4, D. C.

Mr. H. D. Johnson, Sales Manager
The Hickok Electrical Instrument Co.
10514 Dupont Avenue
Cleveland 8, Ohio

Dear Mr. Johnson:

Several months ago we were confronted with the problem of building a large radio and television service department. Of necessity we had to provide a rapid, reliable and first-class service for our many customers. Our test equipment problem was solved with over (40) pieces of your Hickok Test Equipment.

Now, after several months of use, we thought you would appreciate knowing that we are completely satisfied in every respect. The ruggedness, reliability, and accuracy of calibration of these many equipments has certainly exceeded our expectations.

Not detracting from equipment performance, the beautifully styled display cases have added much prestige to our service.

We feel that you have a test equipment line of which you can be proud.

Very truly yours,

Lee O. Falwell
Lee O. Falwell
Service Department

HICKOK ACCEPTANCE

There is more HICKOK TV Test Equipment in use today than all other makes combined.

You can build prestige and income when you use HICKOK instruments. Each model is built to the high HICKOK standard for accuracy and dependability—Backed by the HICKOK guarantee.

HICKOK "D" Series display cases are now available, for nearly the entire HICKOK line of Radio-TV instruments . . . *At no extra cost!*

See the latest HICKOK models at your jobber's, or write today for information on the complete line of AM, FM, and TV instruments.

*HICKOK . . . The Standard
of Quality for over 40 years*

THE HICKOK ELECTRICAL INSTRUMENT CO.

[0531] DUPONT AVENUE

CLEVELAND 8, OHIO

1910



40th Anniversary



1950

RADIO-ELECTRONICS for

**Jobs are looking for men again!
Qualified Technicians Needed for**

TELEVISION and FM SERVICING



**TELEVISION
SERVICEMEN
\$100 PER WEEK**

Inside or outside men, with or without car. We pay car expenses! Modern, air-conditioned shop! Vacation with pay! Group hospitalization! 20% employe discount privileges! Time and one-half for all overtime work! Wonderful opportunity for advancement!
See 474-E, Star.

1947 Mercury 91. D st. n.e. FR. 0729.

TELEVISION INSTALLERS

One of Washington's largest television installation companies has an opening for a thoroughly experienced crew. This is a permanent job, averaging better than

\$150 PER WEEK.

Must have car, ladders, tools. EDWARD M. MEYER CO., 6230 3rd st. n.w. No. 7.

TELEVISION SERVICEMAN, TV experience for home service calls: car allowance, excellent pay, permanent.

CREI HOME STUDY

can help you to better jobs in servicing or Armed Services!

ADS LIKE these testify to the demand that exists for qualified TV technicians. As one well-informed industry spokesman puts it, "Technicians may soon be as scarce as certain tubes." With the electronics industry expanding, and with growing military demands cutting sharply into the available supply of skilled personnel, now is certainly the time to improve your electronics know-how. And if you're headed for the Armed Services, your improved technical ability can be recognized and rewarded with interesting supervisory work at higher ratings in vital radar, navigation, or communications units.

Anyone already in the field—if he is to get ahead—can't depend on hit-and-miss methods for TV servicing. Practical knowledge is required. CREI home study offers just the practical course you need to

qualify for the well-paid technical jobs. Designed by teaching specialists—the same group which has made the CREI Residence School outstanding—this practical course is kept up-to-date through daily contact with CREI's affiliated retail sales-and-servicing stores (one of Washington's largest TV retailers).

Now is unquestionably the time to prepare. If you want promotion, more money, and the kind of training that is respected by industry and the Armed Services, investigate CREI. Send for—and study—the free booklet offered below. The sooner you begin your training, the better off you'll be—in TV servicing work, or in military service. The cost is nominal for this training, the terms easy. Send for complete data—right now!

THE THREE BASIC CREI COURSES:

- ★ **PRACTICAL RADIO ENGINEERING**
Fundamental course in all phases of radio-electronics
- ★ **PRACTICAL TELEVISION ENGINEERING**
Specialized training for professional radiomen
- ★ **TELEVISION AND FM SERVICING**
Streamlined course for men in "top-third" of field

ALSO AVAILABLE AS RESIDENCE SCHOOL COURSES

CAPITOL RADIO ENGINEERING INSTITUTE

An Accredited Technical Institute Founded in 1927
Dept. 141C, 16th & Park Rd., N. W. Washington 10, D. C.
Branch Office: San Francisco, 760 Market St.



MAIL COUPON FOR FREE BOOKLET

CAPITOL RADIO ENGINEERING INSTITUTE

Dept. 141C, 16th & Park Road, N. W., Washington 10, D. C.

Gentlemen: Send booklet, "Your Future in the New World of Electronics," together with details of your home study training. CREI self-improvement program and outline of course. I am attaching a brief resume of my experience, education and present position.

- | | |
|--|---|
| <input type="checkbox"/> Check Field of Greatest Interest: | <input type="checkbox"/> Aeronautical Radio Engineering |
| <input type="checkbox"/> TV, FM & Advanced AM Servicing | <input type="checkbox"/> Broadcast Radio Engineering (AM, FM, TV) |
| <input type="checkbox"/> Practical Television Engineering | <input type="checkbox"/> Radio-Electronics in Industry |
| <input type="checkbox"/> Practical Radio Engineering | |
- If Residence School Preferred, Check Here

NAME _____ AGE _____
ADDRESS _____
CITY _____ ZONE _____ STATE _____

Every month

FORCEFUL CONSUMER ADVERTISING BOOSTS YOUR SALES OF G-E TUBES!



Full-page, eye-catching ads like this appear regularly in



[Faded text from the advertisement, likely describing the benefits of GE tubes for television sets.]



You can put your confidence in
GENERAL  ELECTRIC

HERE'S a tube "first" that will put you first in volume, profits, and neighborhood prestige. Feature G-E tubes on your shelves; display them prominently on your counter. Your G-E tube distributor (better phone him, it's quicker) gladly will help you tie in with this national advertising. Or wire or write *Electronics Department, General Electric Company, Schenectady 5, New York.*

You can put your confidence in —

GENERAL  ELECTRIC 181-KA9

RADIO-ELECTRONICS for

NOW... GET EVERYTHING YOU
NEED TO LEARN AND MASTER

TELEVISION

RADIO-ELECTRONICS

...AT HOME!

Use **REAL** commercial-type equipment to get practical experience



Here's the **REAL THING!**

SET UP YOUR OWN HOME LABORATORY



Oscilloscope

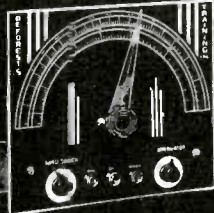

R-F Signal Generator

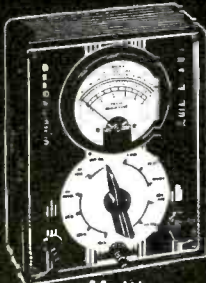

6-Tube Radio



Multimeter



HOME MOVIES

De FOREST'S TRAINING, INC.
CHICAGO 14, ILLINOIS
A DeVRY INSTITUTION

ABOVE: Build and keep a real 16 INCH commercial TV receiver. Optional after completing regular training at slight additional cost.

D.T.I., ALONE, INCLUDES BOTH MOVIES and HOME LABORATORY
In addition to easy-to-read lessons, you get the use of HOME MOVIES — an outstanding training advantage — plus 16 big shipments of Electronic parts. Perform over 300 fascinating experiments for practical experience. Build and keep real commercial-type test equipment shown at left.

MODERN LABORATORIES
If you prefer, get all your preparation in our new Chicago Training Laboratories — one of the finest of its kind. Ample instructors, modern equipment. Write for details!

MILITARY SERVICE!
If you're subject to military service, the information we have for you should prove doubly interesting. Mail coupon today.

Get BOTH of these information packed publications FREE!



ACT NOW! MAIL COUPON TODAY!

DeFOREST'S TRAINING, INC., Dept. RE-1-H
2533 N. Ashland Ave., Chicago 14, Ill.

Without obligation, I would like to earn money in Television-Radio-Electronics ... and how I may prepare to get started in this thrilling field.

Name..... Age.....
Street..... Apt.....
City..... Zone..... State.....

American Beauty

ELECTRIC SOLDERING IRONS

are sturdily built for the hard usage of industrial service. Have plug type tips and are constructed on the unit system with each vital part, such as heating element, easily removable and replaceable. In 5 sizes, from 50 watts to 550 watts.

TEMPERATURE REGULATING STAND

This is a thermostatically controlled device for the regulation of the temperature of an electric soldering iron. When placed on and connected to this stand, iron may be maintained at working temperature or through adjustment on bottom of stand at low or warm temperatures.



For descriptive literature write

**AMERICAN ELECTRICAL
HEATER COMPANY
DETROIT 2, MICH., U. S. A.**

TV PIONEERS Hugo Gernsback, publisher of RADIO-ELECTRONICS, and Isidor Goldberg, president of Pilot Radio Corporation, were presented scrolls by student members of the Institute of Radio Engineers and the American Institute of Electrical Engineers at New



York University in recognition of their contributions to the development of television. The occasion was a demonstration by the students showing how television looked in 1928 when Gernsback's station WRNY began the first regular broadcasting of images in New York. The students used equipment similar to that made for the original station by Pilot Radio Corporation.

The scroll which Mr. Gernsback received was inscribed "Members of student branches of the Institute of Radio Engineers and the American Institute of Electrical Engineers at New York University College of Engineering present this scroll to Mr. Hugo Gernsback, publisher, RADIO-ELECTRONICS, in recognition of his pioneering contribution toward the success of an historic television demonstration which took place on the same site twenty-two years ago in Amphitheatre, Philosophy Hall, University Heights, when station WRNY inaugurated regular daily television broadcast service." Robert Hertzberg, one of the technicians who helped with the original broadcast and now a writer well known to readers of technical magazines, was master of ceremonies.

ILLEGAL TV, the first case discovered by the FCC, was reported recently. Broadcasting intermittently from September 1 to October 19, the station was constructed and operated by the Tube Division of Sylvania Electric Products, Inc., at Emporium, Pa. The station picked up broadcasts from channel 13 station WJAC-TV in Johnstown, Pa., and rebroadcast them on channel 7.

The transmitter was located on a mountain top near Emporium and was built at a cost of about \$7,000. Sylvania officials said they needed such facilities for their work. They did not apply for authority for the station because they knew the FCC could not grant it at the

time (due to the television "freeze") and believed they were not interfering with any other service.

The townspeople of Emporium agreed that the Federal authority must be obeyed, but were somewhat irked at the closing of the station because it left them with no TV service other than erratic fringe reception.

BRAIN DIAGNOSIS with sound waves was disclosed at a recent joint meeting of the IRE and the AIEE. Low-intensity ultrasonic waves are passed through the brain and are picked up on the other side of the patient's head with a detector. The waves are attenuated as they pass through cerebral tissues, but they pass undiminished through the cerebral fluids. The result is a "map" showing the fluid-filled parts of the brain. This technique is superior to X-rays which pass through tissue and fluid with nearly the same strength.

Stomach diagnosis of disease, including cancer, was reported at the annual clinical congress of the American College of Surgeons. Using improved apparatus, the technique measures the electrical potential difference between the empty stomach and some other part of the body. Certain stimuli, such as the ingestion of milk, are then applied to the stomach, and the response is observed. The change in electrical potential is different for different pathological states.

NEW OFFICERS have been elected by the Institute of Radio Engineers. Succeeding Raymond F. Guy as president



Ivan S. Coggleshall, new IRE president.

is Ivan S. Coggleshall, traffic manager of the Western Union Telegraph Co.'s overseas communications. The new vice-president is C. F. Rybner, professor of telecommunications at the Royal Technical University of Denmark in Copenhagen.

608-FOOT TOWER, built at a cost of \$93,000 for radio station KHQ, in Spokane, Wash. crashed to the ground two days before it was to be completed. Built to almost three-fourths its planned height of 826 feet, the steel structure was to replace another tower snapped in half by a windstorm about a year ago.

RADIO-ELECTRONICS for

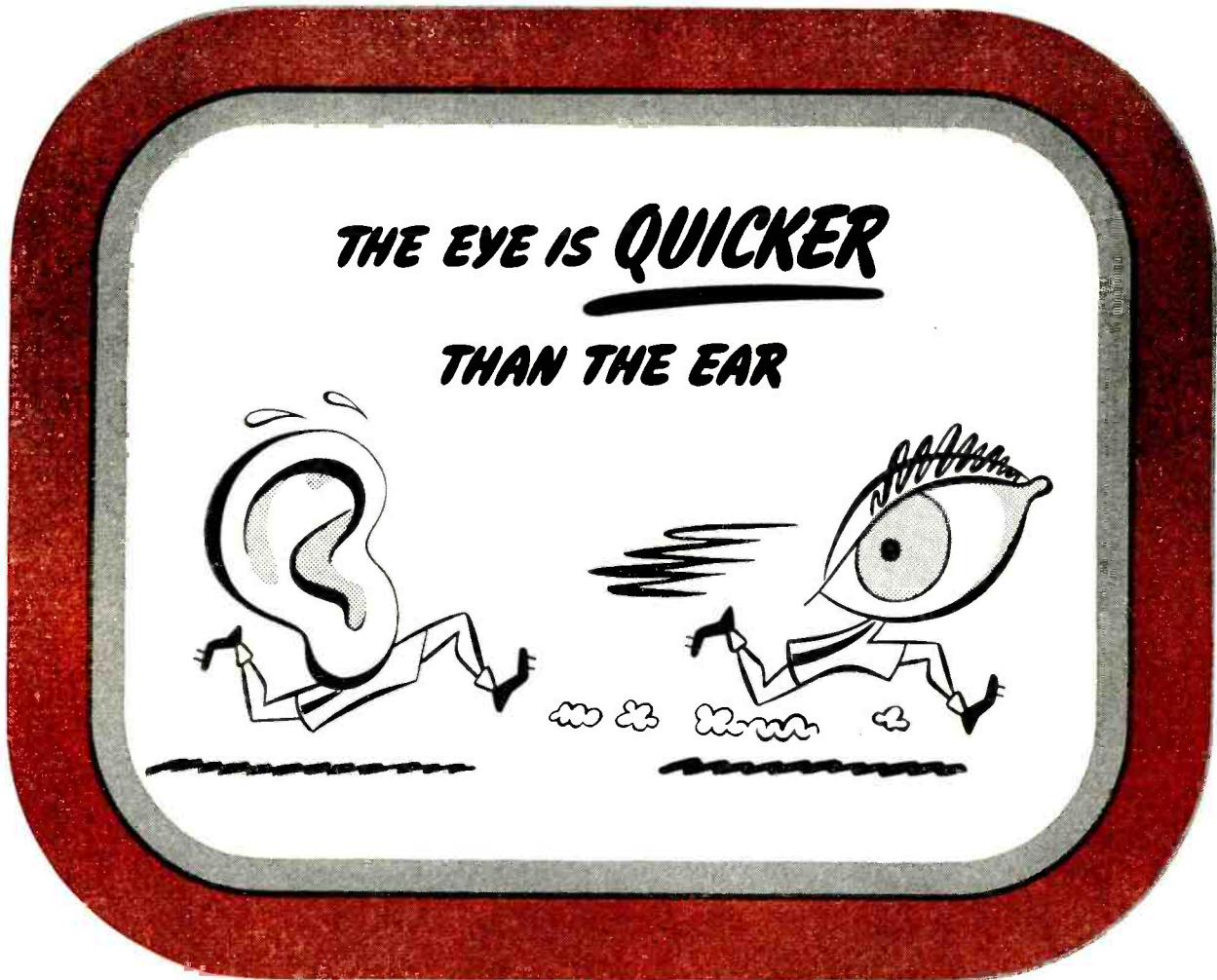

**THE EYE IS QUICKER
THAN THE EAR**

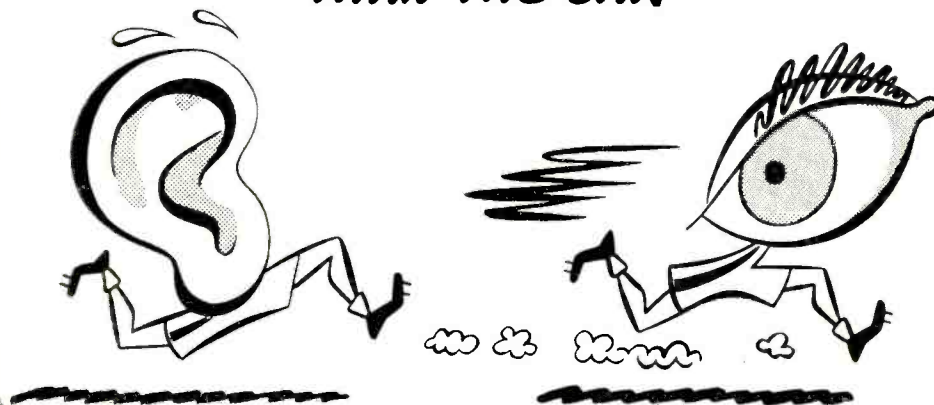

IF YOU SERVICE TV, YOU KNOW THIS!

Customers are quick to *see* imperfections. Much slower to *hear* them. Therefore *premium-quality* Hytron receiving tubes for the tougher TV jobs. *At no extra cost!* You gain also: Through fewer expensive service call-backs. Better customer satisfaction and confidence. More profits.

How does Hytron do it? By working closely with leading TV set manufacturers. By endless striving

to better already superior performance. By improved design...processing...inspection...testing.

Try Hytron TV receiving tubes: 1X2A, 5U4G, 6AG5, 6AL5, 6AU6, 6BC5, 6BG6G, 6BQ6GT, 6CB6, 6SN7GT, 6V6GT, 6W4GT, 12BH7, 25BQ6GT, etc. Also Hytron rectangular picture tubes: 14BP4, 16RP4, 17BP4A, 20CP4. You pay no more for Hytron. But *see* the difference yourself...on the TV screen...on your cash register.

THEY COST PENNIES, BUT SAVE DOLLARS!

Order from your Hytron jobber today



HYTRON SOLDERING AID — 49¢ net. Fork tip effortlessly, quickly unwraps "mechanically solid" joints. Straddles wire, grips, unwraps, pulls it free. Guides new wire; holds it firm while soldering. Spade tip reams solder from lug hole; pushes other wires aside. Tips are hardened, twist-proof, insulated, hard-chromed to shed solder. Tool handles like pencil. Reaches tight spots. Has dozens of other uses.



HYTRON TUBE LIFTER — 15¢ net. Lift 'em all the e-a-s-y prybar way: Tubes (GT, G, standard, lock-in, metal). Vibrators and plugs (Jones, Amphenol) — and knobs. A natural for compact auto radios, etc. Slotted end lifts lock-ins, snap-in trimounts... easily, safely. Of stainless steel with comfortable rolled edges.

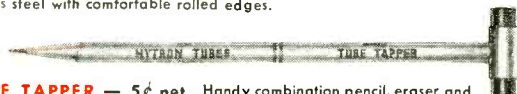

HYTRON TUBE TAPPER — 5¢ net. Handy combination pencil, eraser and tube tapper. Discovers microphonism, shorts, and opens in tubes, etc. Compact, non-metallic, rugged. Doubles in brass for writing orders, etc.



HYTRON TUBE PULLER

— 75¢ net. Pull or insert 7-pin miniatures the e-a-s-y way. Neoprene rubber puller works by suction and friction on top of tube. Positive grip. Reaches tight spots. Another Hytron time-temper- and-money saver.



HYTRON PIN STRAIGHTENERS,

7-Pin and 9-Pin — 55¢ net ea.

You merely press tube gently into Hytron Straightener until button base seats squarely. Presto, pins are straight! Fast... safe. Avoiding one broken tube pays for Straightener twice over. Precise, stainless-steel insertion die. Comfortable knurled aluminum holder. For hand, bench or tube tester use.



HYTRON AUTO RADIO TOOL

— 24¢ net. Substitutes for control cables of universal auto radio. Quickly, precisely turns set on/off, tunes, adjusts volume and tone, re-aligns dial. Square also fits splines. Vee fits spade and other key fittings. Minimum backlash. Compact. Bright-zinc plated. Non-rolling large handle for fine adjustments.



MAIN OFFICE:
SALEM, MASSACHUSETTS



TV NETWORKS may have to share time more equally in communities having only a small number of TV outlets if rules proposed by the FCC are put in effect. In one case, an FCC survey showed that NBC, in one sample week, furnished more network programs to seventeen one-station communities than the other three networks using the same coaxial cables combined.

The proposal would limit the number of hours a station could take from any one network, and this would depend on the number of stations serving the same area.

SHIP COLLISIONS will be reduced by a new method of radar computation developed by Capt. Edward C. Holden, U.S.N.R. Failure of radar officers to determine accurately the course and speed of radar targets and evaluating the targets mentally was partly responsible for the 363 ship collisions during the year ending July 1.

Capt. Holden's new method requires an accurate plot of the target as seen on the radar screen and helps to determine the course and speed of the target. The plot shows the dead reckoning of the observing vessel as well as the course and speed of the target and the distance between the two. Five-minute checks, made possible by special scales on the plotting board, enable the officer to determine how close the vessels will pass each other and the exact time.

HIGH DEFINITION system for black-and-white television was submitted to the FCC by the General Electric Co. Robert B. Dome, G-E engineering consultant, stated that the system will provide upward of 50% increase in horizontal detail when incorporated in transmitters and receivers. Reception by present TV sets would not be affected.

The system provides for the sending and receiving of fine and super-fine detail alternately. Since all precision equipment is at the transmitter, receivers using the system would be relatively low in cost and easy to adjust and maintain, although several more tubes are needed than in present sets.

CLASSROOM TV, now in its third year in Philadelphia public schools, has been so successful that thirty states and four foreign countries have asked the Philadelphia school board how to start educational programs of their own.

The city's three commercial stations broadcast unsponsored, school-planned programs to 200,000 students who look in on 16-inch or larger sets provided by the Home School Council. There are now 40 sets in various elementary and high schools in the city and 60 more in suburban areas.

The children themselves participate in some of the programs which take up four hours a week of school time in half- to one-hour programs. Among the billings are Encyclopaedia Britannica movies, a "science is fun" program, and others dealing in city government, local, national and world affairs.

ROBERT B. DOME, electrical consultant for the General Electric Co. will be awarded the Morris Liebman Memorial Prize for 1951 by the Institute of Radio Engineers for his contributions to intercarrier TV reception, wide-band phase-shift networks, and various innovations in FM receiver circuits.

Alan B. MacNee, brilliant young assistant professor of electrical engineering at the University of Michigan, will receive the Browder J. Thompson Prize for his paper "An Electronic Differential Analyzer," published in the November, 1949, *Proceedings of the IRE*. This award is given annually to the author under thirty years old for that paper

recently published by the IRE which is the best combination of technical contribution and presentation of the subject.

The Harry Diamond Memorial Award, given to persons in government service, will be presented to Marcel J. E. Goay of the Fort Monmouth Signal Corps Laboratories for his contributions to the Signal Corps research program, and for work with the infra-red-radio gap.

Willis W. Harmon, associate professor at the University of Florida, will receive the Editor's Award, established to stimulate good English in technical papers, for his paper "Special Relativity and the Electron", published in the November, 1949, *Proceedings of the IRE*.

THE NEW TURNER



MODEL 50D DYNAMIC
FOR TV - AM - FM
Recording • Broadcast
Public Address

SPECIFICATIONS

FREQUENCY RESPONSE: 50 to 15,000 c.p.s. flat within $\pm 2\frac{1}{2}$ db.

OUTPUT LEVEL: 56 db below 1 volt/dyne/sq. cm.

IMPEDANCE: 15, 200, 500 ohms or high impedance.

POLAR PATTERN: Essentially non-directional in any position.

MOUNTING: Ball and swivel type, tilts in any direction. Standard $\frac{5}{8}$ " — 27 thread.

CABLE: 20 ft., high quality rubber covered, two conductor shielded cable with Cannon quick-disconnect plug.

★ The crown jewel of dynamic microphones. See it, handle it — use it on highest quality recording, public address or broadcast work. New beauty, new styling, new utility and new performance make the Turner Aristocrat the finest of the fine. Use it anywhere, indoors or out — in hand, on stand, suspended, or concealed in stage settings. The Aristocrat is quickly and easily detached from ball swivel coupler for hand use. Non-directional polar pattern picks up sound from any direction. Equally effective for individual or group pickups with wide range, high fidelity reproduction of voice or music. Its high output dynamic generator requires no closely associated auxiliary equipment for outstanding results. Built of finest materials with flawless workmanship, each unit is laboratory calibrated to insure specification standards . . . Write for complete details.

THE TURNER COMPANY

933 17th Street N. E., • Cedar Rapids, Iowa
IN CANADA: Canadian Marconi Co., Montreal, P. Q., and Branches
EXPORT: Ad. Auriema Inc., 89 Broad Street, New York 4, N. Y.



Microphones **BY TURNER**

RADIO-ELECTRONICS for



Train at Home in Spare Time for **RADIO** and **TELEVISION**

**I Send You
18 BIG
KITS
OF RADIO-
TELEVISION
EQUIPMENT**

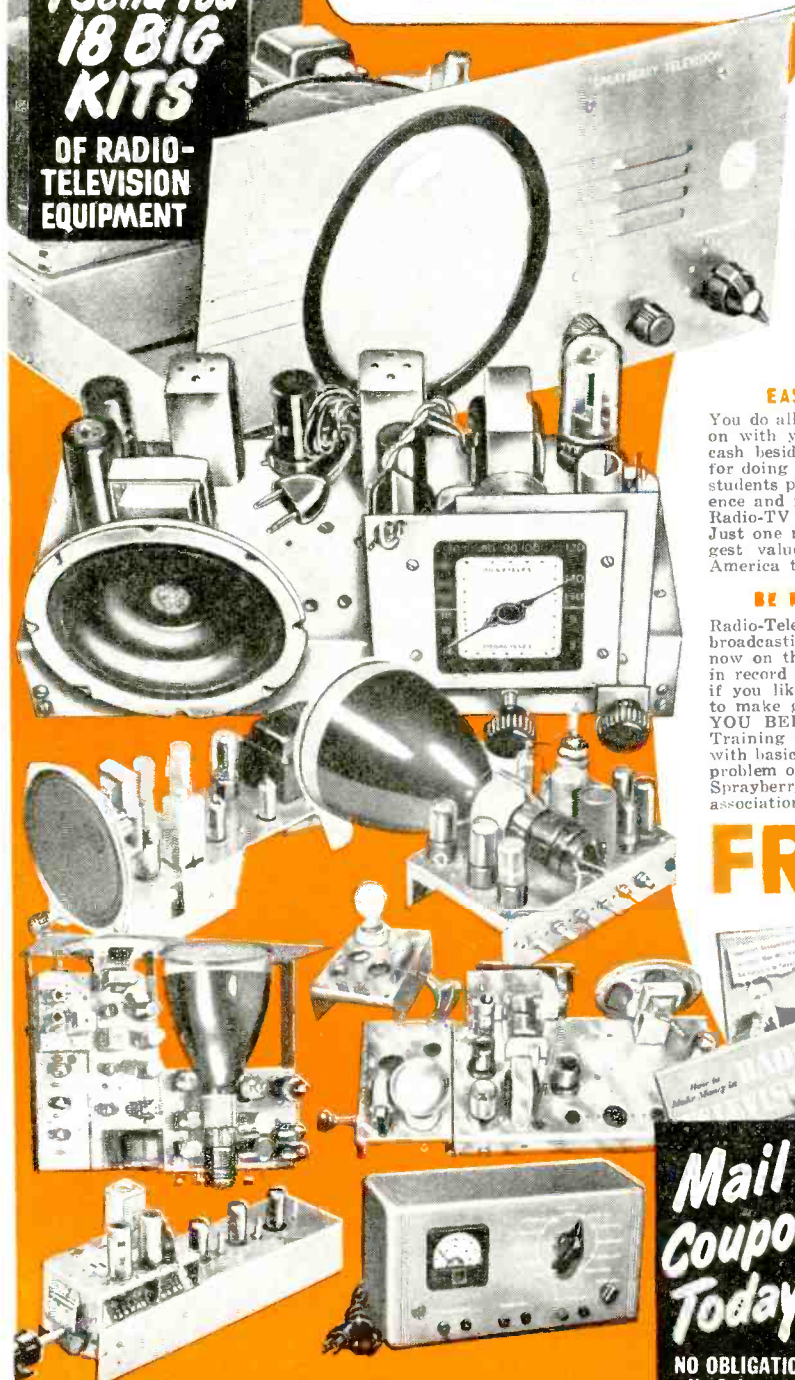

**My Famous Training System Prepares You
Double Quick For a Good Job or Your Own
Profitable Radio-Television Business**

Radio-Television is now America's greatest opportunity field! Trained men are needed to fill good jobs and handle profitable Radio-Television Service work. I have trained hundreds of men for success in Radio-Television—and I stand ready to Train you too, *even if you have no previous experience.* My training is 100% practical—designed to give you the knowledge and experience you need to make money in Radio-Television in the shortest possible time. I Train you with up-to-the-second revised lessons—PLUS many big kits of Radio-Television equipment. You actually do over 300 demonstrations, experiments and construction projects. In addition, you build a Powerful 6-tube-2-band radio, a multi-range test meter and a complete Television receiver! All equipment is **YOURS TO KEEP.**

EASY TO MAKE EXTRA MONEY WHILE YOU LEARN

You do all your training with me AT HOME in spare hours. Keep right on with your present job and income while learning—and earn extra cash besides! The day you enroll I begin sending you plans and ideas for doing profitable spare time Radio-TV work. Many of my Sprayberry students pay for their entire training this way! You get priceless experience and many plans for making extra money. You build all your own Radio-TV Test Equipment from parts I send you—nothing else to buy. Just one more reason why I believe I offer the ambitious man the biggest value in top notch Radio-TV Training available anywhere in America today.

BE READY FOR TOP PAYING RADIO-TELEVISION JOBS

Radio-Television is growing with amazing speed. More than 2000 Radio broadcasting stations PLUS an additional 102 Television stations are now on the air. Radio sets and TV receivers are being made and sold in record breaking numbers. If you enjoy working with your hands . . . if you like to do interesting and varied work . . . if you really want to make good money and work in an industry that has a future . . . **YOU BELONG IN RADIO-TELEVISION.** But you **MUST** have good Training to "cash in" . . . the kind of training that starts you out with basic fundamentals and carries you right through every circuit and problem of Radio-Television Servicing and Repair. In a word . . . that's Sprayberry Training . . . the course backed by more than 20 years of association with the Radio-Television industry!

FREE 3 BIG RADIO AND TELEVISION BOOKS

I want you to have ALL the facts about my complete system of Radio-Television Training! Act now! Rush the coupon for my three big Radio-Television books: "How To Make Money in Radio-Television," PLUS my new illustrated Television bulletin PLUS an actual sample Sprayberry Lesson—all FREE with my compliments. No obligation and no salesman will call on you. Send the coupon in an envelope or paste on back of post card. I will rush all three books at once!

**Sprayberry Academy of
Radio, Dept. 20-S**

111 North Canal St., Chicago 6, Ill.

**Mail
Coupon
Today!**

**NO OBLIGATION
No Salesman
Will Call**

**SPRAYBERRY ACADEMY OF RADIO, Dept 20-S
111 North Canal St., Chicago 6, Ill.**

Please rush to me all information on your Radio-Television Training plan. I understand this does not obligate me and that no salesman will call upon me.

Name..... Age.....

Address.....

City..... State.....

Please Check Below About Your Experience
 Are You Experienced? No Experience

VETERANS: My Radio training is Approved for Veterans

IF YOU ARE EXPERIENCED in Radio I'll qualify you for Television in 4 to 6 weeks. Rush coupon.

Specially Designed

for
TV
Technicians
New OVER/UNDER
WELLER
SOLDERING GUN

For ticklish TV soldering, there's no tool like the new 135-watt Weller Gun. Dual spotlights eliminate shadows. Precision balance assures accurate soldering. Long length reaches deep into chassis. 5-second heating saves time and current. Your Weller Gun pays for itself in a few months.

Check This
Exclusive
Combination
of Features

- **5-SECOND HEATING**—No waiting. Saves power.
- **OVER/UNDER DESIGN**—Tube construction gives bracing action to tip, and improves visibility.
- **DUAL SOLDERLITE**—Prefocused spotlights completely eliminate shadows—let you see clearly.
- **LONGER REACH**—Slides easily into the most complicated set-up. Reaches tight corners.
- **COMPACT DESIGN**—Streamlined and precision balanced for delicate "pin-point" soldering.
- **TRIGGER-SWITCH CONTROL**—Adjusts heat to the job. No need to unplug gun between jobs.
- **DUAL HEAT**—Single heat 100 watts; dual heat 100/135 watts; 120 volts, 60 cycles. Handles all light-duty soldering.

See new Model WD-135 at your distributor, or write for bulletin direct.

- **SOLDERING GUIDE.** Get your new copy of "Soldering Tips"—revised, up-to-date and fully illustrated 20-page booklet of practical soldering suggestions. Price 10c at your distributor, or order direct.

WELLER
ELECTRIC CORP.

828 Packer Street, Easton, Pa.

Merchandising and Promotion

Jensen Industries, Inc., is issuing a colorful new nylon-needle counter display card. The display holds 12 needles with sapphire or osmium tips. The needles



come in three sizes: standard for 78 r.p.m.; microgroove for 45 and 33½ r.p.m., and all-purpose for all three speeds. Display and needles are available through distributors or directly from the company.

Shure Brothers, Inc., has a new cardboard sleeve which holds five phonograph pickup cartridge cartons. The



sleeve permits neat arrangement and easy stock rotation. The company believes this is the first cardboard container sleeve ever devised for pickup cartridges.

RCA Tube Department has shipped the

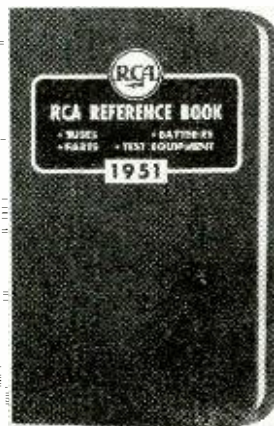

1951 edition of its pocket *Reference Book* to tube and parts distributors for issue to service dealers, engineers, technicians, and purchasing agents. The book contains electronic information as well as a diary, calendar, memo, address book, and world atlas. A feature of the new edition is an article on TV trouble shooting by John Meagher, RCA Tube Division's TV specialist.

Electrovox Co., Inc., has introduced a new aid for phono servicing—a pocket manual with a summary of all phonographs by year, model number, cartridge, and needle. It lists cartridges with drawings and installation notes. Finally the manual includes a selection of 13 basic needles which cover about 90% of replacement demand. Complete with the needles, the condensed Walco Master Control Index, for service technicians is priced at \$10.

Production

The RTMA reported that TV sets in October were produced at an all-time high rate of 203,462 per week, making a monthly total of 813,851. For the first ten months of 1950 production reached 5,777,610 TV sets.

The 10-month total on radio production in 1950 was 11,481,823. A breakdown of this figure shows 6,624,484 home radios, 3,357,544 auto radios, and 1,499,795 portables.

Servicing Business

RCA Service Co. president, E. C. Cahill, recently stated that an additional 10,000 service technicians will be required to install and service the 2,000,000 TV sets produced and sold in the last few months of 1950. He pointed to the incredible growth of the industry, the length of time required to train competent TV technicians, and the drain of defense and government agencies as the three main problems facing the servicing industry. RCA, he explained, is attempting to combat the increasing shortage of technicians by expanding its training program.

The number of homes with radio sets was 41,500,000 as of July 1950—more than 95% of all U. S. homes. About four out of ten homes own more than one set. The total number of radio sets in use is estimated at about 85,000,000. They are served by more than 2,000 AM stations and 500 FM stations.

New Plants & Expansions

Raytheon Manufacturing Co.'s new pilot plant in Quincy, Mass., is now in production. Operated by the company's receiving tube division, the plant manufactures miniature and subminiature tubes for military requirements.

Workshop Associates, Inc., Needham Heights, Mass., moved to a new factory. The new plant will triple the TV antenna production capacity.

Radio Receptor Co., Inc., purchased a 90,000-square-foot factory building in Brooklyn, N. Y. The new four-story concrete building will be used in addition to the company's present 50,000-square-foot plant to step up production of radio and electronic components.

RADIO-ELECTRONICS for



4 ways
RAYTHEON
Helps You to
WIN FRIENDS and
INFLUENCE
CUSTOMERS



The RAYTHEON *Bonded* ELECTRONIC TECHNICIAN PROGRAM provides four compelling ways to create customer confidence—Certificates, Identification Cards, Creed Displays and Decals. Bonded Dealers who use these service-business builders to identify themselves as capable, dependable technicians are finding them positive protection against the recent attacks on the integrity of Television and Radio Service companies.

If you're a Raytheon *Bonded* Dealer, prominently display your *new* 1951 Certificate—be sure your men use their *Identification Cards*. Ask your

Raytheon Distributor for more *Creed Displays* for window and counter use, and get enough *Bonded Decals* to adorn every window and door. These *Bonded* pieces are as important to your business as the tools in your kit.

If you're not a Bonded Dealer, better get in touch with the Raytheon Distributor in your locality. Find out if you can qualify for the Bond! If you can, this great program that cash-protects your 90-day guarantee on TV and Radio repairs is yours *absolutely free*, because *the Bonded Program is Raytheon's investment in your future!*

HERE ARE MORE WAYS TO INFLUENCE CUSTOMERS!
RAYTHEON'S TERRIFIC COLLECTION OF
SALES AND SERVICE AIDS!

ILLUMINATED TEST PATTERN CLOCKS • METAL OUTDOOR SIGNS • EDGELIGHTED SIGNS • DUMMY TUBE CARTONS • DISPLAYS • JUMBO TUBE CARTONS • SHOP JACKETS • STATIONERY • REPAIR STICKERS • SHIPPING LABELS • TUBE DATA CHARTS • AND MANY OTHERS

SEE YOUR RAYTHEON DISTRIBUTOR ABOUT THEM TODAY!



Excellence in Electronics

RAYTHEON MANUFACTURING COMPANY

Receiving Tube Division

Newton, Mass., Chicago, Ill.

Atlanta, Ga., Los Angeles, Calif.

RADIO AND TELEVISION RECEIVING TUBES • CATHODE RAY TUBES
 SPECIAL PURPOSE TUBES • SUBMINIATURE TUBES
 MICROWAVE TUBES

ASTATIC IS FIRST IN PERFORMANCE FIRST IN CABINET STYLING

Booster Model BT-1
List Price \$32.50

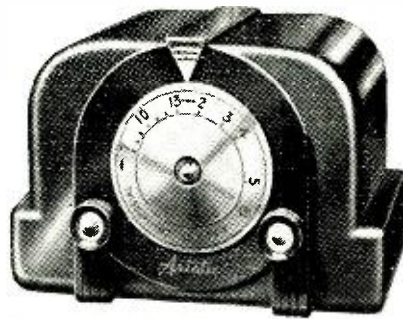

Booster Model BT-2
List Price \$34.95

Compare:
the ability to
improve reception
of these two NEW
ASTATIC TV and FM
BOOSTERS with ANY
others

Note these Quality Features

- 1 Mallory Inductuner for continuous variable tuning.
- 2 High gain, very uniform on both high and low channels.
- 3 Simplified controls—single tuning knob with continuous tuning through both TV and FM bands.
- 4 Band width adequate over entire range.
- 5 Low noise design and construction.
- 6 No shock hazard to user.
- 7 Off-on switch for easily cutting in and out of circuit.
- 8 Selenium rectifier.
- 9 Single 6AK5 Tube.
- 10 Provide for either 72 ohm or 300 ohm impedance input and output.
- 11 Model BT-2 has handsome, dark brown plastic cabinet.
- 12 Model BT-1 has metal cabinet in rich mahogany woodgrain finish.
- 13 Large dial face is easy to see in tuning.
- 14 Model BT-2 has recessed pilot light to show when booster is on.

● Yes, forget their low cost, and make your own comparison of these new Astatic Boosters with others at any price! You'll be amazed at the difference . . . the higher gain and greater reduction of interference and distortion . . . provided by the Astatic BT-1 and BT-2. Astatic engineering leadership has given these new units an unequalled ability to improve both TV and FM reception. But, the final proof is in your own results. Why not put them to the test and see why these new low-cost models are taking the field by storm?

THE
Astatic
CORPORATION
CONNEAUT, OHIO
IN CANADA: CANADIAN ASTATIC LTD., TORONTO, ONTARIO

The Technical Appliance Co., Sherburne, N. Y., manufacturer of TACO antennas expanded its manufacturing facilities to provide for 50% greater production and new and larger quarters for the engineering department.

Financial Reports

First 9 months	1950	1949
American Phenolic Corp.		
Earnings	\$722,710	\$410,750
Sales	\$8,857,700	\$7,358,615
Belden Manufacturing Co.		
Earnings	\$1,121,043	\$275,596
Sales	not given	not given
Electric Auto-Lite Co.		
Earnings	\$9,984,391	\$7,330,652
Sales	\$170,597,077	\$167,975,049
Gabriel Co.		
(Parent Company of Ward Products)		
Earnings	\$611,513	\$278,270
Sales	not given	not given
General Bronze Corp.		
(Parent company of Brach Mfg., Co.)		
Earnings	\$1,083,822	\$355,606
Sales	\$14,239,000	\$7,800,333
Hytron Radio & Electronics Corp.		
Earnings	\$2,514,374	\$312,499
Sales	\$26,619,753	\$9,498,804
Muter Co.		
Earnings	\$774,480	\$34,486
Sales	not given	not given
National Union Radio Corp.		
Earnings	\$606,891	\$75,309 (loss)
Sales	\$9,488,912	\$5,653,082
Sylvania Electric Products, Inc.		
Earnings	\$5,129,080	\$1,911,597
Sales	\$105,778,320	\$73,041,240
Radio Corporation of America		
Earnings	\$33,384,637	\$14,095,186
Sales	\$395,741,391	\$275,673,666

Dividends

Gabriel Co., parent company of Ward Products, voted a 10% stock dividend and a quarterly dividend of 15¢ on common stock.

General Electric Co., announced a special dividend of \$1 per share payable Dec. 6.

Hytron Radio & Electronics Corp., declared a special dividend of 10¢ on common stock. The company also recalled all outstanding preferred stock for conversion to common shares.

Westinghouse Electric Corp., declared an extra dividend of 40¢ plus the regular 40¢ interim payment.

Business Briefs

RTMA officers, committees, and directors met in New York Nov. 14-16 to discuss major problems facing the industry. A public relations program on color, u.h.f. proceedings, a code of advertising ethics, military procurement, and the proposed excess profits tax were among the subjects considered.

... Capehart-Farnsworth Corp., donated a complete television transmitter unit to Indiana Technical College of Fort Wayne, Ind.

... Stromberg-Carlson has eliminated built-in antennas from current TV sets.

... Allen B. Du Mont Laboratories demonstrated its two-way, closed-circuit TV conference system by staging a dealer meeting covering an area from St. Louis to Boston.

RADIO-ELECTRONICS for

Want To Double Your Pay?



How To Pass **FCC** **COMMERCIAL** **RADIO OPERATOR** **LICENSE** **EXAMINATIONS**

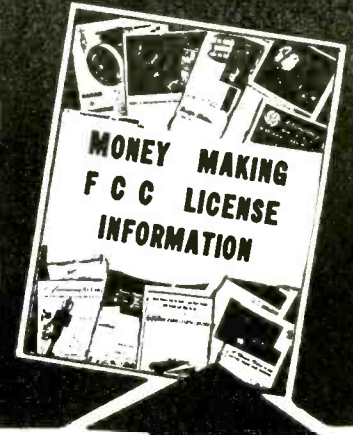

GET THIS AMAZING NEW BOOKLET FREE!

TELLS HOW —

WE GUARANTEE
TO TRAIN AND COACH YOU AT HOME
IN SPARE TIME UNTIL YOU GET
YOUR FCC LICENSE

If you have had any practical experience—Amateur, Army, Navy, radio repair, or experimenting.

TELLS HOW —

Employers make
JOB OFFERS like These
to Our Graduates Every Month!

Telegram, August 9, 1950, from Chief Engineer, Broadcast Station, Pennsylvania, "Have job opening for one transmitter operator to start immediately, contact me at once."

Letter, August 12, 1950, from Dir. Radio Div. State Highway Patrol, "We have two vacancies in our radio Communication division. Starting pay \$200; \$250 after six month's satisfactory service. Will you recommend graduates of your school?"

Letter, August 24, 1950, from radio-television sales and service company, Ohio, "We are in need of a good television man. The pay will be good, also good surroundings to work in. Please let us hear from you."

Telegram, Sept. 7, 1950, from Chief Engineer, Broadcast Station, Georgia, "Have immediate opening first phone engineer. Prefer one with usable voice, experience not necessary. Prefer man from small town. Beginning pay \$48 for 48 hours."

These are just a few of the examples of job offers that come to our office periodically. Some licensed radiomen filled each of these jobs; it might have been you!

HERE'S PROOF FCC LICENSES ARE OFTEN SECURED
IN A FEW HOURS OF STUDY WITH OUR COACHING
AT HOME IN SPARE TIME:

Name and Address	License	Lessons
Lee Worthy, 2210 1/2 Wilshire St., Bakersfield, Cal.	2nd Phone	16
Clifford E. Vogt, Box 1016, Dania, Fla.	1st Phone	20
Francis X. Foerch, 38 Beucler Pl., Bergenfield, N. J.	1st Phone	38
S Sgt. Ben H. Davis, 317 North Roosevelt, Lebanon, Ill.	1st Phone	28
Albert Schoell, 110 West 11th St., Escondido, Cal.	2nd Phone	23

TELLS HOW —

Our Amazingly
Effective job-Finding Service Helps CIRE Students
Get Better Jobs. Here are just a few recent ex-
amples of Job-Finding results:

Gets Five Job-Offer From Broadcast Stations
"Your 'Chief Engineer's Bulletin' is a grand way of obtaining employment for your graduates who have obtained their 1st class license. Since my name has been on the list I have received calls or letters from five stations in the southern states, and am now employed as Transmitter Engineer at WMMT."
Elmer Powell, Box 274, Sparta, Tenn.

Gets Civil Service Job
"I have obtained a position at Wright-Patterson Air Force Base, Dayton, Ohio, as Junior Electronic Equipment Repairman. The Employment Application you prepared for me had a lot to do with me landing this desirable position."
Charles E. Loomis, 4516 Genesee Ave., Dayton, Ohio

Gets Job With CAA
"I have had half a dozen or so offers since I mailed some fifty of the two hundred employment applications your school forwarded me. I accepted a position with the Civil Aeronautics Administration as Maintenance Technician. Thank you very much for the fine cooperation and help your organization has given me in finding a job in the radio field."
Dale E. Young, 122 Robbins St., Owosso, Mich.

OURS IS THE ONLY
HOME STUDY
COURSE WHICH
SUPPLIES FCC-
TYPE EXAMINA-
TIONS WITH ALL
LESSONS AND
FINAL TESTS.

Your FCC ticket is Always Recognized in All
Radio Fields as Proof of Your Technical
Ability.

Get All 3 FREE



CLEVELAND INSTITUTE OF RADIO ELECTRONICS
Desk RE-25—4900 Euclid Bldg.
Cleveland 3, Ohio
(Address to Desk No. to avoid delay.)

I want to know how I can get my FCC ticket in a minimum of time. Send me your FREE booklet, "How to Pass FCC License Examinations" (does not cover exams for Amateur License), as well as a sample FCC-type exam and the amazing new booklet, "Money-Making FCC License Information".

Name.....
Address.....
City..... Zone..... State.....
 Veterans check for enrollment information under G.I. Bill.

**EICO KITS
and INSTRUMENTS**



220K SIG. GEN. KIT \$19.95
Wired \$29.95



New 550K COND.-RES. COMP. BRIDGE KIT \$19.95
Wired \$29.95

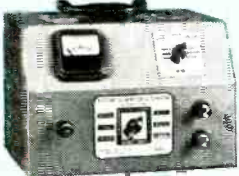

New 1040E BATTERY ELIM. KIT \$22.95
Wired \$29.95



5" K VOM KIT \$14.55
Wired \$17.95



145K Wg. TRACER KIT \$18.95
Wired \$28.95



HV PROBE
(*Fed only) \$6.95

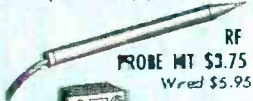

RF PROBE KIT \$3.75
Wired \$5.95



C-5 ZMC CRYSTAL
\$5.95

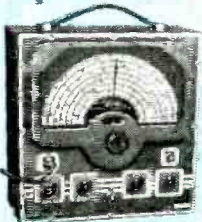

New 315K DELUXE SIG. GEN. KIT \$29.95
Wired \$59.95



EICO
TEST EQUIPMENT

guards **Emerson**
HIGH STANDARDS OF
PRODUCTION QUALITY

Harry R. Ashley, President of EICO, inspecting the use of the EICO Model 425 Oscilloscope and Model 221 Vacuum Tube Voltmeter at one of the important alignment positions on the Emerson television production line, New York plant.

For Laboratory Precision at Lowest Cost—the Leaders Look to EICO!

FOR electronics test equipment, there's no tougher proving ground than the factories where TV sets are made. There's where the pace is fastest, precision requirements the highest, costs the tightest—and day-after-day dependability an absolute must.

In both the giant New York and New Jersey television plants of the Emerson Radio & Phonograph Corporation — at the many critical constant-duty testing positions along the production line—EICO instruments stand guard. For Emerson has found that for speed, accuracy and trustworthiness, at lowest cost, EICO instruments always deliver the fullest measure of value.

From coast to coast, in one leading TV factory after another, this is the experience—this is the proof of EICO superiority—that is repeated again and again. The top-flight TV set makers have discovered—and over 50,000 servicemen have learned—that for the industry's greatest instrument values, at the industry's lowest costs—it's EICO!

Be sure you look at the EICO line before you buy any higher-priced equipment! Each EICO product is jam-packed with unbelievable value. YOU be the judge—compare EICO at your local jobber today—and SAVE! Write NOW for free newest Catalog C.



New 221K VTVM KIT \$23.95
Wired \$49.95

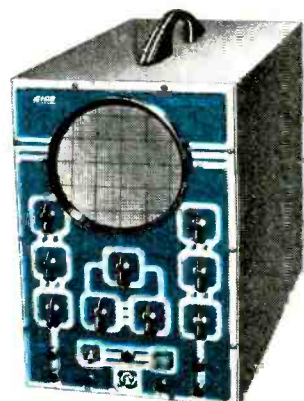

New 425K 5" SCOPE KIT \$39.95
Wired \$69.95



New 625K TUBE TESTER KIT \$29.95
Wired \$44.95

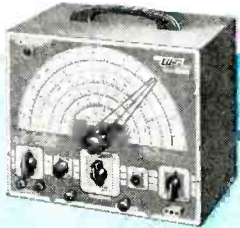

360K SWEEP GEN. KIT \$29.95
Wired \$49.95



ELECTRONIC INSTRUMENT CO. Inc
276 NEWPORT STREET, BROOKLYN 12, NEW YORK

© 1950, Electronic Instrument Co., Inc

Prices 5% higher on West Coast. Due to unsettled conditions, prices and specifications are subject to change without notice.

The Tele-Theater

. . . The next great television development . . .

By HUGO GERNSBACK

TELEVISION in the home is only one of the many phases of a still new art. Commercial television is now in the ascendancy, and no man can predict how far it will go.

Theater television is a term which has been misunderstood by many, even in the television industry. Television in the theater does not necessarily mean the showing in motion picture houses of newsworthy events such as baseball games, football matches, etc., as they take place.

There is, however, a very important TV phase, which, many years ago the writer termed "tele-theater." In this purely commercial aspect of television the plays are not shown in the home, but only in the theater—to persons who paid their admission.

In the United States the legitimate theater is actually represented in only a few of our larger cities. Even in these the hit New York shows are not always to be found. This makes for a unique and deplorable situation with visitors to New York storming the hit shows only to be turned away because no seats are available, frequently not even at a cost of \$50 to \$75 for a pair of tickets to such hits as *South Pacific*, etc.

By means of television, however, it will soon be possible to bring to every city and town in the United States every top-flight drama and show. No one will dispute the fact that New York is the theater's recognized center. By means of television every possible live show will be televised throughout the country at an admission price within the reach of everyone.

With color television now assured within the next few years and by using projection television, it will be possible for an audience in Sioux Falls to witness a New York musical as if the viewers were in New York.

This idea is by no means new. When television was in its infancy, the writer covered this subject under the title of "The Tele-Theater" in the January-February, 1932, issue of TELEVISION NEWS, of which the following is a condensation:

"The great inroads which the motion picture has made on the legitimate stage are becoming more serious right along and, if something is not done soon, we may have nothing but motion pictures left because, from year to year, it becomes more unprofitable for producers to put on legitimate performances. The reason for this is, of course, that it is impossible to give a "legitimate" performance for 50¢—a price which could compete with the motion-picture houses. The prices for the drama in New York, for a good orchestra seat, are from \$3.50 up, and for musical comedy shows from \$6.60 up.

"What, then, is the solution? I propose the following remedy, which I believe is sound, and I am certain that it will come about in the not too distant future. *Television is the key to the situation.*

"Recently, when the Sanabria giant television screen was about to be exhibited at the Broadway Theater in New York City, I was asked by the management to supply some new ideas to attract the public at large and secure favorable publicity for television.

"I suggested, at the time, that an attempt be made to connect the stage of another theater to the one at the Broadway Theater, and televise a distant performance on the Broadway screen. This suggestion was adopted, and the Broadway Theater, by means of a television transmitter, picked up the images of the actors on the stage of the Guild Theater, and showed this performance on the television screen of the Broadway Theater. *This, then,*

was the first time in history that two theaters were connected together by means of television. The results were quite satisfactory. What has been done on a small scale here, will be done on a tremendous scale in the very near future, by the instrumentality which I call the "Tele-theater".

"Imagine a special building, erected in the City of New York, for the sole purpose of supplying the entire country with its daily theater program—not, mind you, motion pictures, which are a "canned" product,—but an actual theatrical performance.

"In order to do so, I visualize a building which will have a series of stages, grouped around a central shaft or pit. The idea behind the multiplicity of stages is that I propose to move the actors rather than move the scenery. At the present time it is necessary for the actors to go behind or before the curtain, when scenes are shifted. This is awkward and always takes up an amount of time for which the public in the future will not stand.

"In the central pit we have the stage director at the top of a skeleton steel structure with his assistant technical directors. Stage No. 1 is lit up and the orchestra located immediately beneath the director starts to play. Below the orchestra is a "battery" of television cameras. Microphones are located in wings in strategic positions. The television cameras are connected to a wire network radiating to all parts of the country, just as the wire network transmits radio broadcast programs to the different radio stations in the country now.

"In Boston, Chicago, Atlanta, San Francisco, and hundreds of other points, we will have local theaters where, for 50¢, audiences can nightly see the latest Broadway production. Instead of only 1,500 or 1,600 people seeing the "Follies", 5 or 10 million people will view them nightly, for one week, or for as long as the local theater feels it commands an audience. Immediately the undertaking becomes tremendously lucrative, because millions now support a production; whereas before only hundreds did so, at prices which only the well to do could afford.

"In the tele-theater, we will, of course, have *both sight and sound*, and the audience will actually see and hear their favorite actors at the exact time when the production is being performed in New York. And it will even be possible to have the actors enjoy the applause, because microphones in the tele-theater can pick up the applause of the audiences and convey it back to New York. Thus the actors will have the satisfaction and incentive of the applause which is now missing—so much to their detriment—in motion pictures.

"Naturally, there will be a number of tele-theaters in the larger cities, all supplied by the great theaters in New York; so that, if you wish to go out in the evening, you need not see a musical show if you do not wish to do so. You may, instead, see a comedy or straight drama in another tele-theater in your own town, because New York City will telecast a multiplicity of productions the same evening.

"To satisfy remote points such as the West Coast, duplicate performances must be put on later in New York, on account of the time difference. Thus, for instance, a man in San Francisco will be seated at 8.30 o'clock (his time), which is 11.30 P.M. in New York, when the second performance for Western points starts."

None of this is more fantastic than television is itself—you may be sure that it will all come about in the foreseeable future.

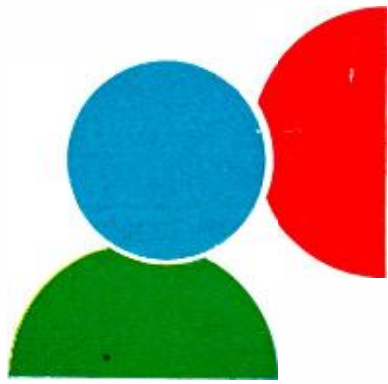

COLOR Television SYSTEMS

By FRED SHUNAMAN

OF THE three main systems of color television that have been battling for FCC and public recognition, the tentatively approved CBS *field-sequential* system is most prominent today. The FCC has stated, however, that the door is not irrevocably closed against other systems, so interest remains strong in the runners-up. These are the *line-sequential* system of Color Television Incorporated (CTI) and the *dot-sequential* system developed by RCA.¹

The pros and cons of these systems have been discussed with so much heat and so little moderation that the radio-man is not quite sure of any one of their technical features. The public—at whom this barrage of facts and near-facts has been directed—is hopelessly confused. The terms “compatible” and “incompatible” have been bandied about to such an extent that many laymen believe that it would be possible to get color pictures without modifying their present sets, if only a “compatible” system of transmission were used. At the other extreme is a sizeable number

who believe that present sets will become useless as soon as color television starts.

Let us review some of the technical facts to help clear up the nonsense. We have one system using relatively simple mechanical apparatus and two systems using more complex electronic equipment to produce roughly similar results. All three systems use standard black-and-white tubes with colored gelatine filters to insert the color into the images.

RCA has, it is true, demonstrated a single tube which produces the three colors with its own phosphors.² This promises a color system without filters and with only one instead of three kinescopes as used in the present RCA setup, but whether a three-color tube can be mass-produced economically enough to be used in home receivers remains to be seen. At least three types of three-color tubes (RCA, Geer, and Du Mont) have been patented; none have yet been proven to be (or not to be) practical.

Another abused catchword is “me-

chanical system.” It is made even more puzzling when CBS spokesmen remark in passing that their system could also work with electronic color tubes. The fact is that the adaptability of any of the systems is a function of the speed of switching from one color to another. Equipment that can be used by the fastest-switching one can be used by the other two, but not vice versa! Colors are switched more than ten million times a second in the RCA system, 15,750 times in the CTI system, and only 144 times per second by the CBS method. Therefore either CBS or CTI could transmit and receive with equipment suitable for the RCA method. CBS could also use equipment of the type required by CTI’s line sequences.

However, should CBS decide to rid itself of the stigma of a “mechanical system” and go electronic, it would have to accept some of the disadvantages as well as the advantages of the more complex systems. An excellent field-sequential system could be built up with three cameras and three kine-

SCANNING SYSTEM

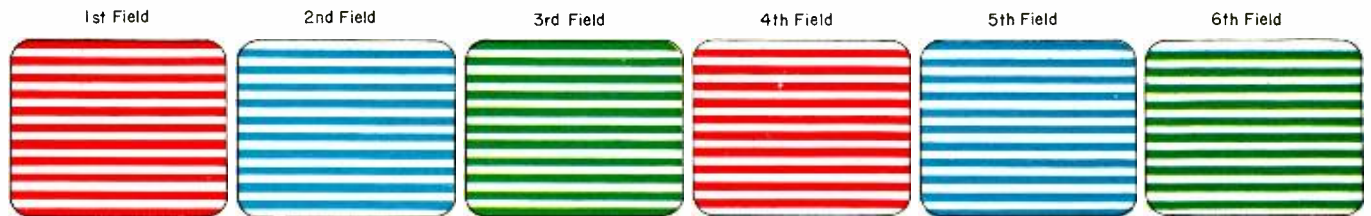

COLOR PICTURE

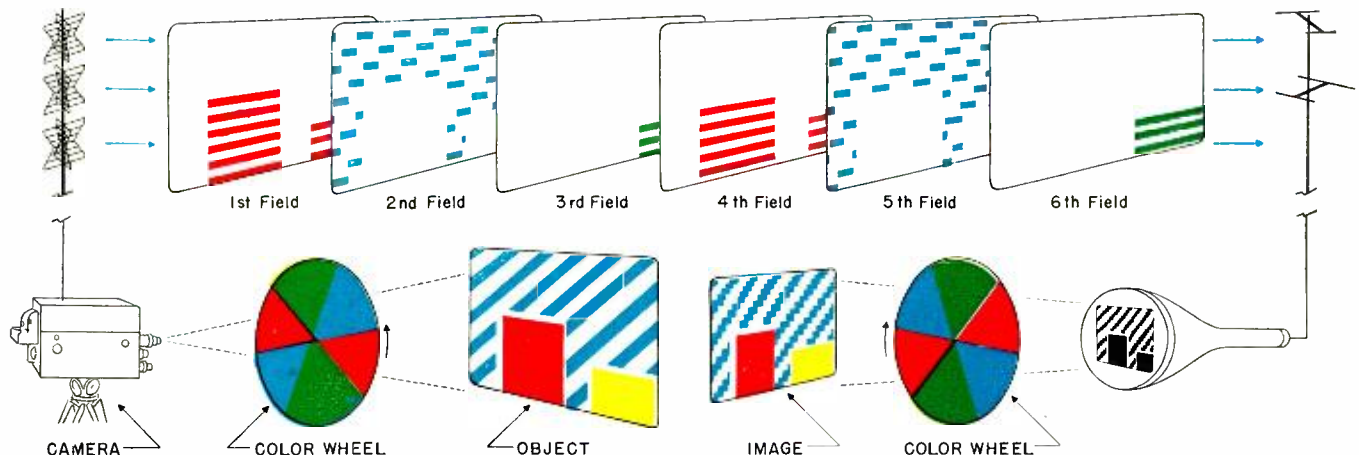

Color Illustration I—The CBS field-sequential system uses six one-color fields to make up a complete color image.

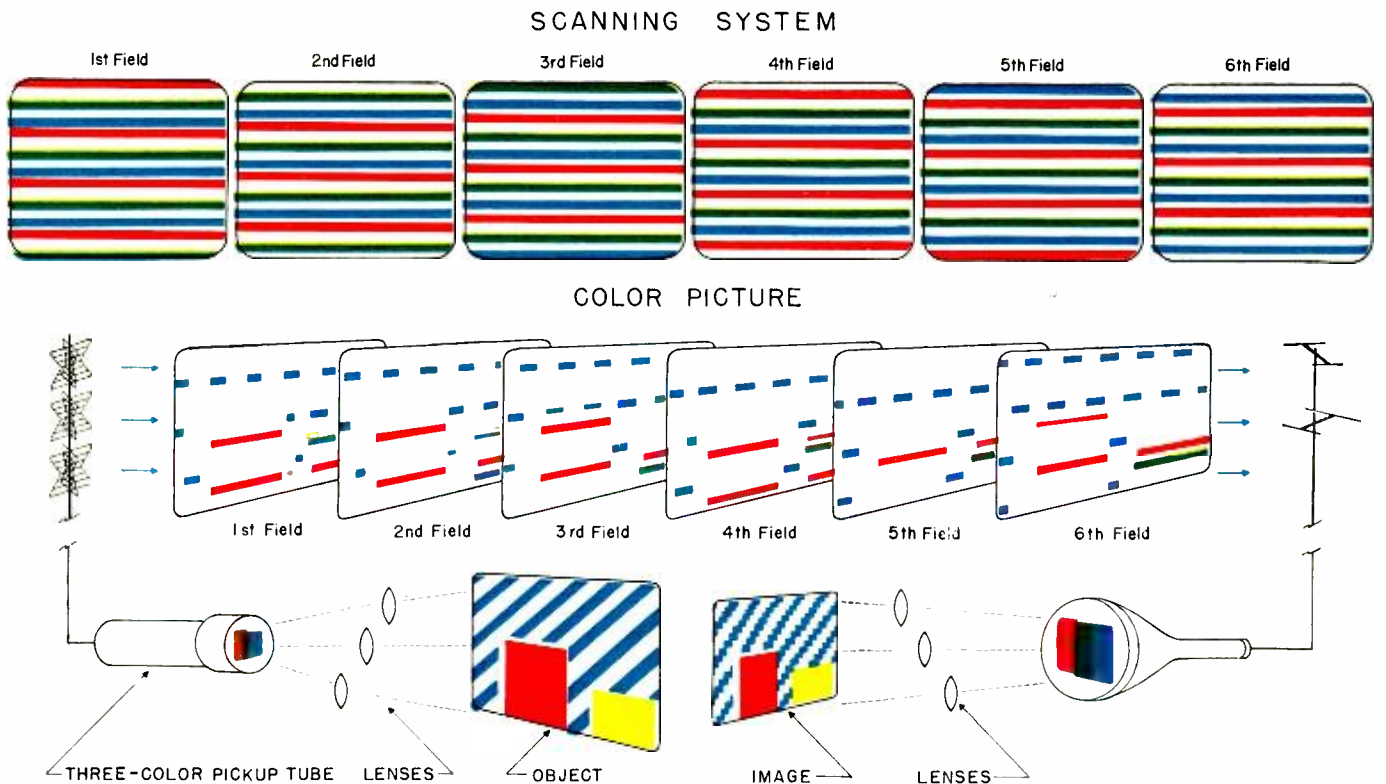

Color Illustration II—The CTI line-sequential system combines all three primaries in each of its six fields.

scopes, but it would be much more costly than the color wheel. A field-sequential system could undoubtedly use a three-color tube if such were available, but would be up against the same problems of color crawl, etc.,

as is the dot-sequential system, and similar complex and expensive methods would have to be used to solve them.

With the color-wheel system now used by CBS (Color Illustration I), receiving and transmitting equipment

differ little from that used for black-and-white.^{1,2} Color is supplied by transparent discs divided into red, blue, and green segments which rotate in front of camera and kinescope. The discs must be synchronized so that each segment

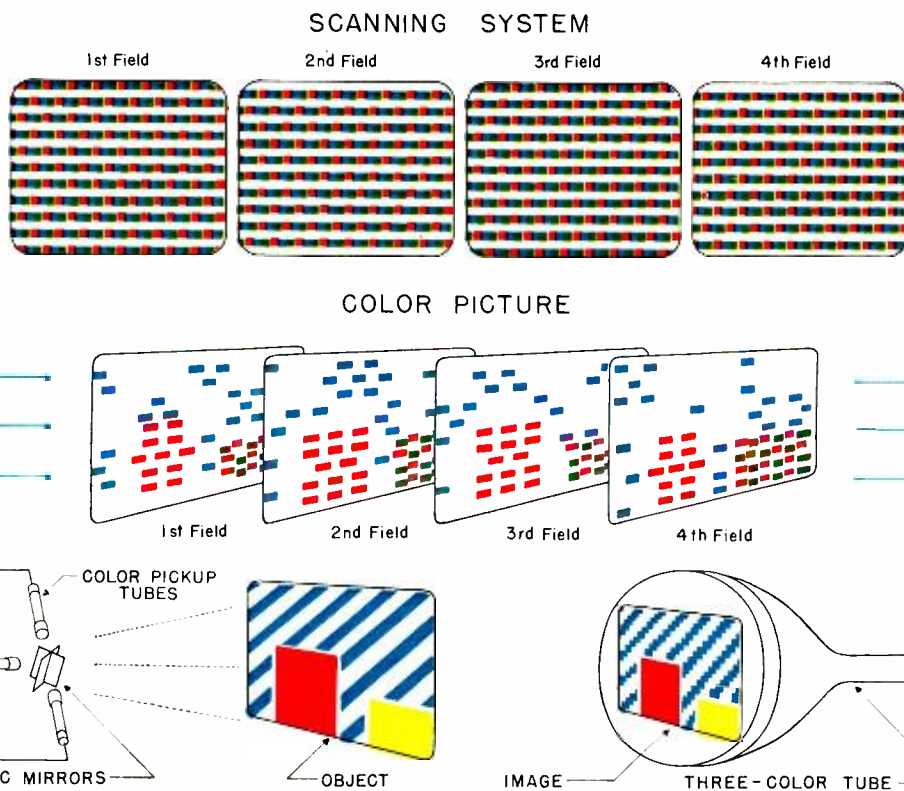

Color Illustration III—RCA's dot sequential system, with four fields per picture, has a complex interlace of dots.

is in position while the corresponding color field is transmitted. Thus, during a red field, a red filter ahead of the camera lens permits it to "see" only the red light from the scene, and the blue and green are not photographed. At the same instant, a red filter in front of the kinescope colors the partial image for the viewer. The same thing happens during the blue and green frames, and the eye receives the red, green, and blue primary images in such rapid succession that it sees a picture in full color.

Instead of black-and-white's two interlaced fields per frame, with 30 complete pictures per second, CBS pictures are composed of two interlaced color frames of three fields each. There

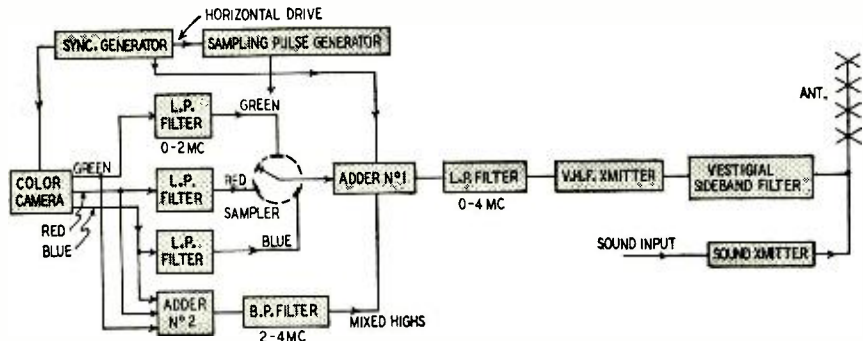

Fig. 1—RCA dot-sequential transmitter, showing mixing of the high frequencies.

are 144 fields per second, with 24 complete pictures. It was necessary to cut the number of lines from the standard 525 to 405 to transmit the 144 fields within the regular 6-mc channel. This is the reason for Columbia's *incompatibility*.

Main advantages of the CBS system are its simplicity and low cost. Since the only modifications required are the above-mentioned changes in the scanning frequency and the addition of a color wheel, the CBS system requires no extensive or complex new equipment. Transmitters and receivers for color—or for color and black-and-white—can be constructed or modified at a fraction of the cost of adapting for either of the other systems.

The chief disadvantage of CBS color is its incompatibility. Because of the different line frequency, a standard receiver tuned to a CBS color broadcast will see nothing, either in black-and-white or color. Another disadvantage is its lower definition, either in black-and-white or color. Its 405 lines cannot reproduce fine detail as well as systems using standard 525-line pictures. When used with a mechanical color wheel, picture size is limited to about 12 inches.

Other disadvantages are *flicker* and *fringing*. Its sponsors claim that the high field rate (144 per second) has fairly well eliminated flicker. Fringing—the breakup of color at the edges of rapidly moving objects—is still something of a problem.

The CTI system

The system demonstrated by CTI (Color Illustration II) is line sequen-

tial. Instead of transmitting a whole field or frame in one of the primary colors, the color is switched at the end of each line. Proponents of CTI's method claim that flicker is reduced enough by line switching to permit the system to be compatible. However, the 525 lines of the standard system introduce a problem. Since 525 is a multiple of 3, the same line in each field would always be scanned in the same color. A system had to be designed to skip lines regularly, so that all parts of the picture would be scanned in three colors. By skipping, line 1 (for example) in the first field may be scanned in red, in the third field in green, and in the fifth field in blue. (Even-numbered lines would be scanned in the second,

fourth, and sixth fields.)

CTI uses three lenses and three color filters ahead of its camera tube, so that three images, identical except for color, are formed on the mosaic. Instead of being speeded up as in the CBS system, the horizontal sweep is slowed down to one-third standard, so that a single sweep will give three lines, one in each primary color. Three cameras could of course be used. In that case a switching system would select lines successively from each of them.

The CTI receiver may consist of three kinescopes, each with a color filter and lens ahead of it. The lenses are so placed as to superimpose the three images on a screen, where they appear as a full-color picture. It may also be a single tube, with the three color rasters side by side on it, and the same optical mixing system.

CTI's great advantage is its compatibility. It uses the old 525-line interlaced system. The disadvantages are complexity (as compared to CBS) and another peculiar to a line-sequential system. This is *line flicker* or *line crawl*, in which the lines seem to be crawling up or down the picture. It can be avoided to some extent by the complex color interlace in which six fields are required for a single color picture. The number of complete pictures is thereby decreased to ten per second, which seems slow. Sponsors of the system say that the line-by-line color switch prevents this from producing objectionable flicker.

RCA dot-sequential color

Probably more has been said about the RCA (Color Illustration III) dot-

sequential system than both others combined. It is the most complex, the hardest to understand, and offers the greatest possibilities for future development of any of the three systems. Instead of breaking the color up into its primaries by fields and lines, the RCA system breaks each line up into dots of primary color. Each color is scanned or "sampled" 3.6 million times per second, and a stream of colored dots appear on the viewing screen. These combine to form a color picture much as do the dots of a color plate used in printing books or magazines. The dots of color printing do not fill the whole area, however, whereas those of RCA color television overlap about 50%. The small size and rapid succession of dots reduces problems of flicker and fringing to where they can be ignored.

Four fields are required for a picture. Two are the standard line interlace; the other two trace over the same lines, but the color dots are displaced so that a dot in field 3 is halfway between two dots of field 1 and one in field 4 halfway between those of field 2. This, plus the 50% overlap, insures that all parts of the scene are scanned in all three colors. There are 15 pictures a second, since the standard 60-field system is used.

RCA's great advantage is compatibility, but it has another—that of greater definition than its rivals. The high frequencies from each of its three color cameras are mixed together, and the low frequencies are sent through the color sampler which transmits the signals to produce color in the received picture. Fig. 1 shows how this is done. Mixing the highs causes the fine detail of a scene to be reproduced in each of the colors, no matter what its original color. Therefore large bodies (which are reproduced by the low-frequency signals) are transmitted in color, while points, edges, and outlines are actually in black and white.

Strange as it sounds, this actually works. If, for example, two adjacent sides of a building appear in deep green, and the fine corner line that separates them appears as black or white (depending on whether it is in sun or shadow) the eye is satisfied. Indeed, there is reason to believe that the eye does not perceive color in fine detail, and the mixed-highs principle may produce pictures closely resembling what the eye sees in nature.

Disadvantages of the RCA system are the complexity and cost of the equipment and its operation. Colors are switched more than 10 million times a second, instead of 144 times as in the CBS system or the 15,750 times of the CTI system. The difficulty of keeping the apparatus in perfect adjustment is enormously increased. Color drift was one of the early problems of this system, and produced some interesting (but to the engineers hair-raising) effects. Thus bananas on a plate might apparently age, turning from yellow to brown as they were being carried to or from the center of the picture.

(Continued on page 32)

Simple changes in the sweep circuits often suffice to convert to CBS color. Circuits for converting popular makes of receivers are described in this article.

WHILE the industry makes up its mind whether to go along on color TV as authorized by the FCC, you can still enjoy the CBS broadcasts on your own receiver by making simple changes in the sweep circuits.

Don't misunderstand me . . . you can get an enjoyable picture for your own use, but it may be unwise to offer to convert a customer's set on a commercial basis. To get a picture of exactly the same brightness, size and with the same scanning linearity as the original 525-line picture is an engineering feat of the first order, and may call for replacing important parts in many receivers.

A 7-inch electrostatically deflected set will be easiest to convert. Larger sets with r.f. power supplies are often simple to handle. TV receivers with flyback high-voltage systems will call for complex circuit switching. For a commercially acceptable job, it would probably be necessary to replace the flyback transformer and yoke in many of these.

The frequencies of the deflection oscillators in present black-and-white (monochrome) TV transmissions are 60 cycles per second for vertical and 15,750 cycles for horizontal sweep frequencies. For the CBS field-sequential color TV broadcasts these oscillator frequencies must be changed to 144 cycles for vertical deflection and 29,160 cycles for the horizontal line generator.

The hold control resistance must be adjusted to a smaller value in the multivibrator or blocking oscillator used to generate the sweep frequencies. The ratio of change will be the reciprocal of that between the monochrome and color sweep frequencies. For verti-

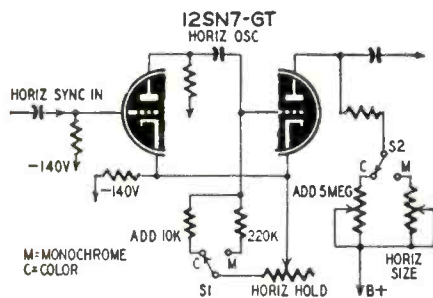
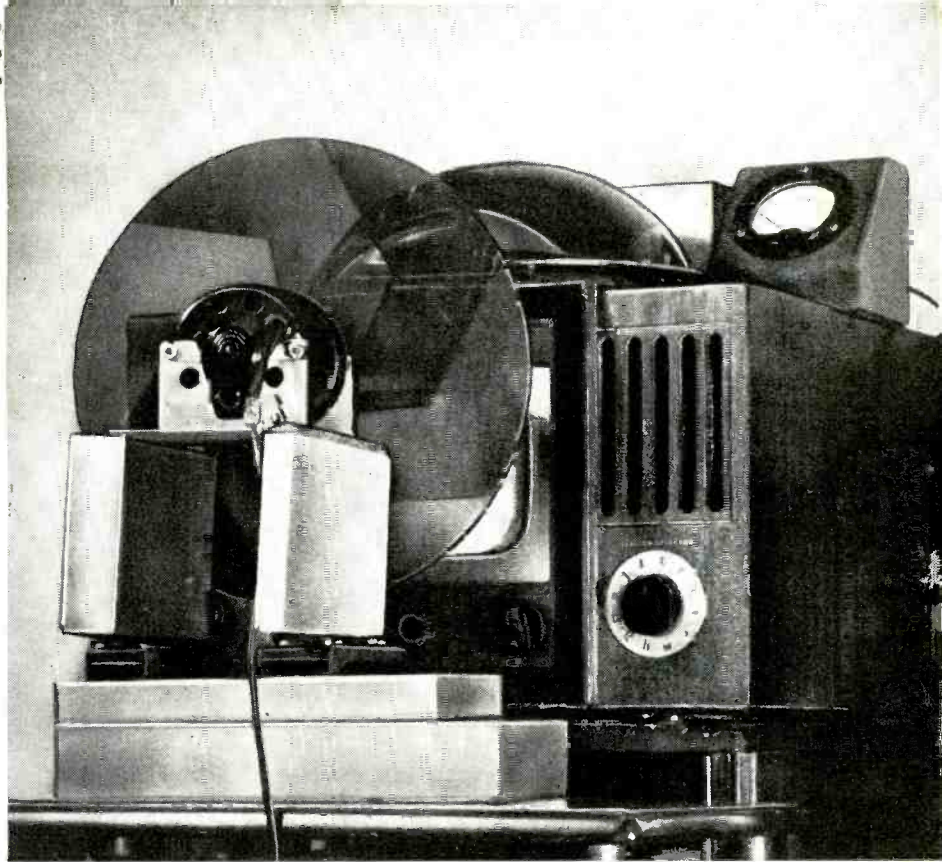

Fig. 1—Converted 7-inch sweep circuit.

cal this will amount to a value of 1/2.4 of the total frequency-determining resistance of the sweep oscillator in the



The color wheel in position in front of the video screen. The wheel may be any place between viewer and receiver, but should be near the receiver for best results.

Convert Your TV Set For Color Reception

By **NORMAN L. CHALFIN**

black-and-white receiver. For horizontal the new value for color will be 1/1.851 times the black-and-white value. With these fractions you will be able to determine the values for any receiver different from those in the circuits illustrated.

In most of the circuits there is a

limiting resistance connected between the frequency-determining grid of the sweep oscillator and the hold control. This connection is broken and a switch inserted. In some of the very early receivers there is only a hold control and in some cases no change is necessary other than the proper adjustment

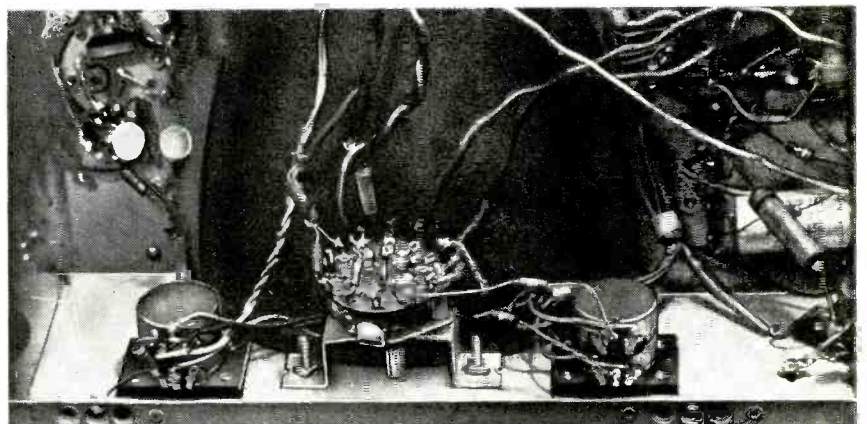

Fig. 2—How the changeover switch was installed on the Teletone TV 149 chassis.

of the hold control. Whether new resistors are switched into the circuit or an adjustment is made directly, the higher sweep frequency usually comes from the oscillator at a lower amplitude than

black and white on an existing receiver. These, in effect, are circuits the manufacturers would have had to include in sets to meet the bracket standards originally proposed by the FCC last fall.

Several circuits similar

A general similarity in the circuits of the 7-inch TV sets simplifies adaptation for color. Fig. 1 shows the Teletone TV 149 deflection circuit in which the horizontal and vertical oscillator circuits are identical with only the values of some components changed to establish the vertical or horizontal oscillator frequency. For this reason only one of the circuits is shown with the switching data that is required.

The photograph (Fig. 2) shows the placement of the switch on the chassis of the TV 149. It is a four-pole, double-throw unit which in one position retains the original circuit components and in the second position gives the color values their place in the circuits.

Fig. 3 shows the wiring arrangement for adapting the Motorola VT 71 7-inch TV sets so that they can receive the CBS color transmissions in black and white. Note, here, that there is no deflection amplifier in the horizontal sweep circuit. The horizontal blocking oscillator is very cleverly arranged to

sary also to switch the output transformer (Motorola No. T-6) with one that will tend to resonate with the two 900- μ f capacitors at the new frequency. The daring experimenter might even consider switching another pair of coils in parallel with the present ones to cut down the inductance.

The Hallicrafters T54 deflection oscillator circuits as shown in Fig. 4, are basically identical with the Teletone. There is a slight variation from the Teletone in size control placement. Horizontal size control in the T54 is connected in potentiometer fashion instead of as a rheostat. It is part of a B-supply bleeder system. The vertical size control is in the grid of the vertical deflection amplifier. The latter connection necessitates an extra switch position, as can be seen in the circuit diagram (Fig. 4) thus requiring a 5-pole, double-throw switch. The horizontal color size control is connected in parallel across the original control and is equal in resistance to it. No serious change in operation takes place as a result of halving the total resistance value. For those who prefer to retain the original operation, a sixth position can be added to the switch. With it, the connections for switching of the horizontal size controls can be made in similar manner to the vertical, by breaking two of the connections to the controls.

The circuit shown in Fig. 5 is the type of blocking oscillator used in the vertical deflection system of many receivers. The commercial variations of the RCA 630 TS use this circuit. RCA's own 630 uses a 6J5, and the discharge action is accomplished in the cathode circuit instead of a second triode, as shown. The 9T246, a similar arrangement, is seen in Fig. 6.

Other receivers

As previously indicated, the 7-inch sets and those with r.f. power supplies are easily adapted to meet the requirements of receiving the CBS color programs in black and white. Sets that have the flyback type of high voltage supply working from the horizontal deflection system will require more complex switching arrangements. Particularly, sets with horizontal a.f.c. systems fall into the more-difficult-to-convert category.

There is shown in Fig. 7 the switch-

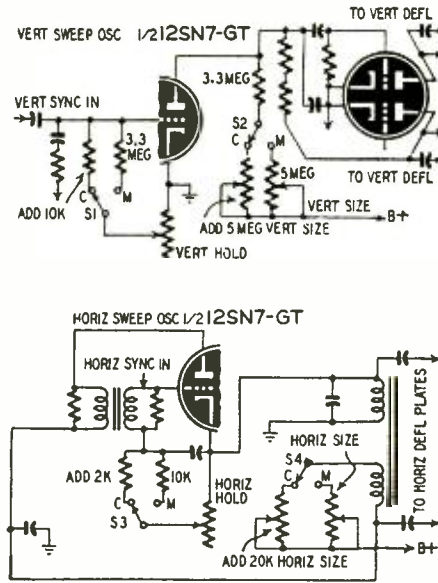

Fig. 3—The sweep circuits of a Motorola VT 71 adapted for color reception.

the original black-and-white sweep frequency. This will result in a smaller image and will require adjustment of the size control each time a change is made from monochrome to color reception, or back again. This problem is overcome by switching separately adjustable size controls (see Fig. 11) at the same time as the hold control values are switched. In some cases it may be advisable also to arrange to switch in separate linearity adjustment controls if they are present in the receiver.

Reference to the several circuits that accompany this article will clearly show the methods that have been developed by the author for making the color images broadcast by CBS visible in

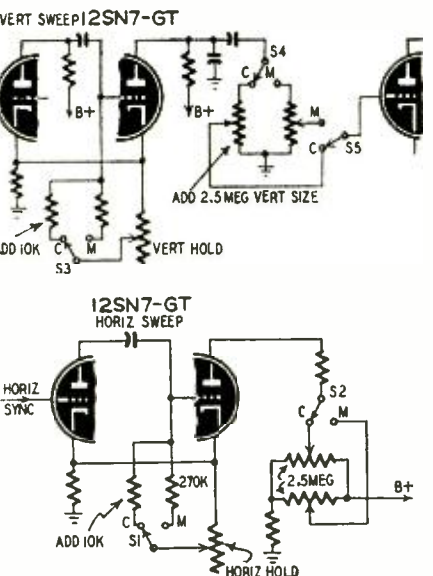

Fig. 4—The Hallicrafters T54 sweeps with alterations for receiving color.

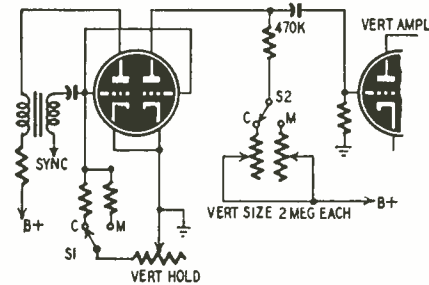

Fig. 5—A converted blocking oscillator of the type used in 630 chassis.

deliver push-pull deflection voltages directly to the cathode-ray tube plates. The vertical system resembles the Teletone previously described. The hold control is in the grid as in the Teletone circuit. The size control is in the plate load circuit. A four-pole, double-throw switch will cover this adaptation as for the Teletone.

In case insufficient horizontal voltage is supplied, however, it may be neces-

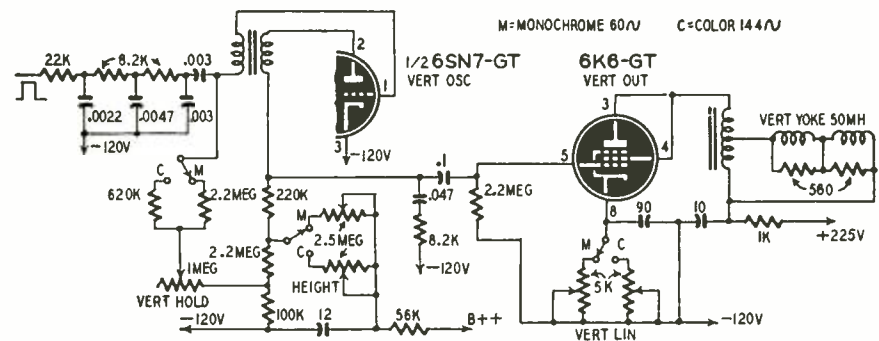

Fig. 6—Vertical deflection circuit of the RCA 9T246. To receive color, the vertical sweep frequency must be 144 cycles and the horizontal 29,160 cycles.

ing of components of the horizontal a.f.c. system employed in the 630 TS type of set. For this alone, three switch points are required: discriminator frequency adjusting capacitance is changed, horizontal oscillator reactance-tube frequency adjusting capacitance is changed, and the values of horizontal drive R-C network are changed. The right side of Fig. 8 shows the rest of the horizontal system changes that will be required for the 6BG6-G and flyback-output transformer system. Fig. 8 shows a typical Synchroguide system as adapted to the 29,160-cycle sweep frequency switching for color from the black-and-white 15,750-cycle sweep. Fig. 9 is a new horizontal output transformer with separate taps for the monochrome and color horizontal output connections to the deflection coils. The changes are necessary because, when the original system is used, there is a deterioration in horizontal output linearity and sweep amplitude in the color position. The new transformer has more turns for the color secondary connection to the horizontal deflection yoke than for the monochrome connection.

The transformer is wound on a square ferrite horizontal output transformer core, with a gap of .015 inch in each leg. The primary (1-2) is wound with 800 turns of No. 28 single-silk enamel insulated wire. The high-voltage winding in series with it consists of another 800 turns of 10-44 litz or No. 36 single-silk or single nylon enamel wire. The secondary is also wound with this wire. Position of the windings is the same as on the transformer it replaces, as is the method of winding. It will be practically impossible to wind such a transformer by hand, but they may become available commercially in the near future.

The modifications indicated in Figs. 6, 7, 8 and 9 were worked out by CBS engineers, to whom thanks are due for supplying the information.

The color converter

If the above changes are made, you will be able to receive color broadcasts in black and white. To see them in color you will need a rotating disc. The most effective disc diameter should be a little more than double the width of the picture to be received. Six sectors are arranged on the disc with the three colors in this order: Red, Blue, Green, Red, Blue, Green. This is shown in Fig. 10. This disc must rotate at a speed of 1,440 r.p.m. before the screen of your set. For three segments (120° each) motor speed would be 2,880 r.p.m. A standard 1,800-r.p.m. phonograph motor would have to be geared or friction-driven to lower the speed. Several methods of synchronization are possible. One of these would be to drive the motor with a 48-cycle oscillator synchronized by some frequency-dividing circuit deriving its sync pulses from the 144-cycle vertical sweep system of the receiver when set for color TV.

When observing the test pattern transmitted by CBS in New York, you

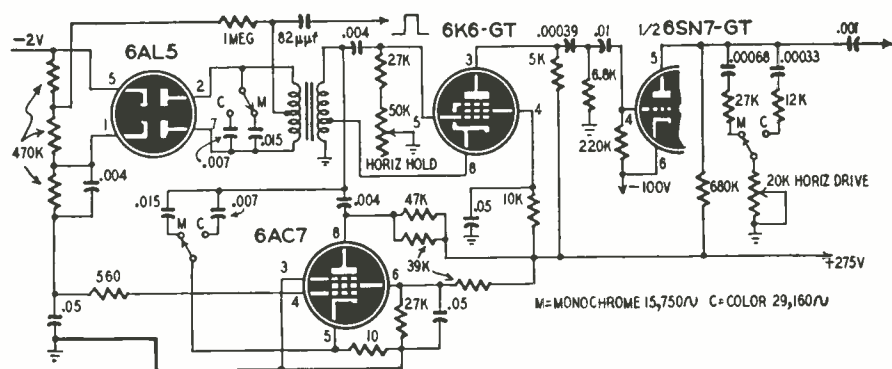

Fig. 7—Circuit showing how the components are switched for color reception in the 630 type receiver. This is the horizontal a.f.c. section of the set.

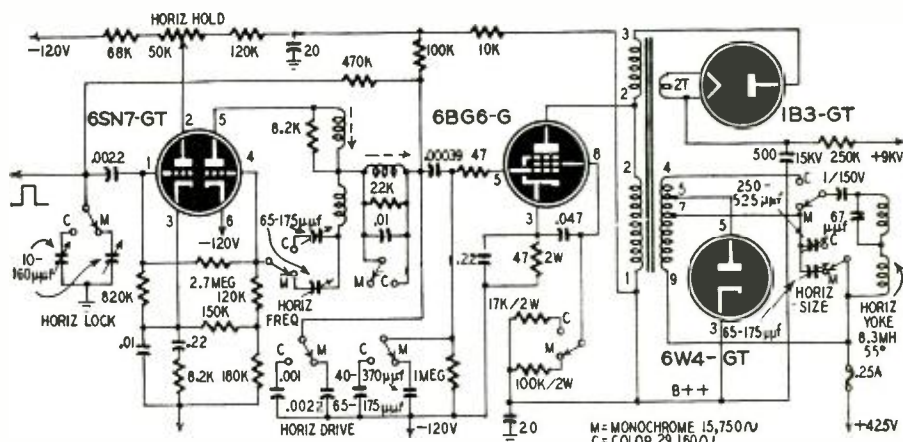

Fig. 8—The horizontal deflection and high-voltage circuit of the RCA 9T-246 type receiver showing the modifications that are made to receive color.

will find it moving in a circular path at a rate of about one revolution in 20 seconds. This was done to prevent the test pattern from burning into the image orthicon on the color camera.

Several plastics suppliers make available colored sheet plastic suitable for color discs. Eastman Kodak is expected to put out a set of color television filters in the near future.

Good results can be obtained with Wratten No. 26 for the red; No. 47 for the blue, and No. 58 for the green. Approximately equivalent Plexiglas numbers are: No. 159 or 160, red; 263, blue; and 260 or 2004, green; and Lucite: No. 10539, red; No. 7456, blue; and No. 3526, green.

A commercial disc is on the market at a cost under \$20. This is the Celomat unit and has a manual speed adjustment. It will hold synchronization for reasonable periods but does require frequent re-adjustment. It is intended that you look at the screen of your adapted TV set through this device where it is nearer to you than to the set. The larger the screen, the further away you will be. Used in this way the color disc has a particularly humorous deficiency. After getting the Celomat device into synchronization, so that flesh tones are of the proper hue, if you move to the left or right of the viewing position in which you first adjusted synchronism these tones turn to a predominantly blue or green tint. Possibly this effect can be used to add proper eeriness to mystery shows.

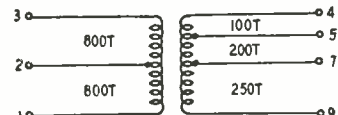

Fig. 9—Horizontal output transformer tapped for black-and-white and color.

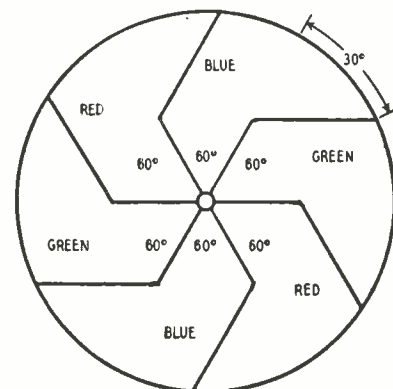

Fig. 10—The color wheel layout. It must rotate at a speed of 1,440 r.p.m.

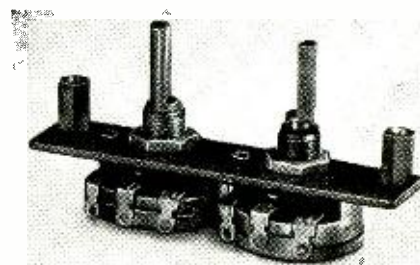

Fig. 11—The adjustable size controls.

Linearizing Circuits for Video Deflection

By SEYMOUR D. USLAN*

UNDISTORTED television pictures require linear scanning. For both horizontal and vertical linear scanning, the displacement of the electron beam in the picture tube must be linear with time. That is, the beam is displaced at a constant rate of speed. This insures the picture elements being spread uniformly over the entire screen.

Correct scanning is produced in electrostatic-type tubes by applying a *sawtooth voltage* to the deflection plates; and in electromagnetic tubes a *sawtooth current* must flow through the deflection coils.

In either case, if the deflection is not

2-b. Note that the repetitious charging point does not start at the very bottom.

The capacitor charge curve is most nearly linear at the bottom rising portion. If the point of discharge occurs at a low voltage compared to the available charging voltage, then the linearity of the sawtooth waveform is improved. However, the charge and discharge conditions within the receiver are such that a certain degree of nonlinearity always exists—enough to cause distortion in the reproduced picture.

Certain other circuit operations, besides that of the sawtooth-producing circuit, may cause a linear curve to become appreciably nonlinear.

The nonlinear amplifier is usually of the remote-cutoff or variable-mu type. The bias on the tube must be correctly adjusted for the input sawtooth to operate over the proper part of the transfer characteristic. In most television receivers using this method of linearization, the bias on the tube is made variable for adjusting linearity. A typical circuit appears in Fig. 4. R1 and R2 are the cathode bias resistors and C1 is the cathode bypass capacitor. By making resistor R2 variable, the bias on the tube can be changed and the correct operating point selected.

Such types of linearizing circuits are found most often in the vertical deflection circuit of television receivers where the tube usually is the vertical output amplifier. Adjustment of the linearity control in this circuit also affects the vertical size of the picture because a change in bias also changes the amplification of the tube.

Damping tube circuits

In kickback horizontal output systems a ringing or oscillation is produced during the retrace period of the electron beam. This is caused by the horizontal output transformer, deflection coils, and associated circuit capacitances breaking into oscillation. Oscillation may continue long enough to affect the linear rise time of the deflection waveform. To reduce this effect, a damper tube is used as shown in Fig. 5.

Immediately after the retrace period of the deflection waveform, a high positive pulse is applied to the plate of the damper tube and causes it to con-

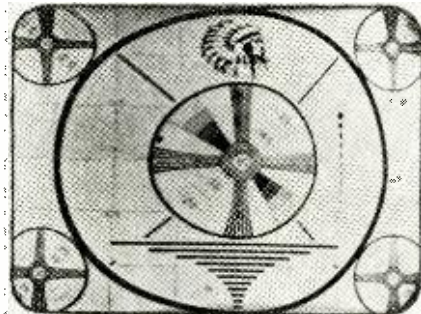
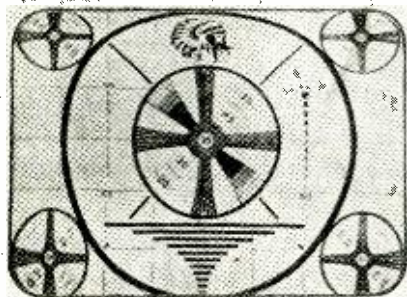

Fig. 1-a, left—Poor vertical linearity causes compression at top of picture. Fig. 1-b, right—Poor horizontal linearity causes compression at the side.

linear, that is, if the rising part of the sawtooth is curved, the reproduced picture is distorted. This distortion is illustrated by the test patterns of Fig. 1. Pattern 1-a shows nonlinear vertical deflection and 1-b shows nonlinear horizontal deflection. The defective scanning causes cramping and flattening at the picture top or side.

Capacitor charge

In practically all cases, a charging capacitor in the deflection circuit (usually of the blocking oscillator or multivibrator type), produces the sawtooth waveform. The charging-voltage-versus-time characteristic of a capacitor appears in Fig. 2-a. This curve is nonlinear. To produce a deflection waveform, the capacitor must be repeatedly charged and discharged at the same point in each case. The point of discharge usually occurs somewhere along the curve, as indicated in Fig.

* Managing Editor, John F. Rider Publisher, Inc., New York. Co-author: Encyclopedia on Cathode-Ray Oscilloscopes and Their Uses; FM Transmission and Reception; and other electronic texts.

To correct these defects, special circuits are used to "linearize" the deflection signals before they are applied to the picture tube. The circuits provide correction by presenting some frequency discrimination to the nonlinear waveform or by causing the waveform to be subject to the characteristics of some deflection amplifier.

Three important types of correction circuits used in television receivers are: nonlinear amplifiers, damper tube circuits, and auxiliary time-constant circuits.

Nonlinear amplifier

If the defective sawtooth wave can be fed through an amplifier that has a nonlinear characteristic just the opposite to that of the wave itself, we can straighten out the wave. Wave A of Fig. 3 is the input nonlinear sawtooth fed to the amplifier and B the output sawtooth signal. By operating the tube over the correct part of its transfer characteristic, the output sawtooth can be made very nearly linear.

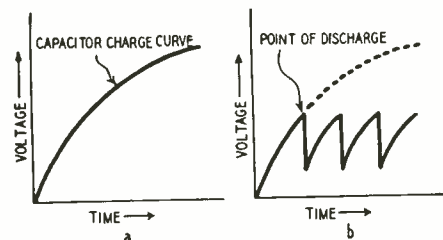

Fig. 2—Charging curves of a capacitor.

duct heavily. This strong conduction loads the oscillatory system, and damps the undesired oscillations. Besides loading the oscillatory circuit, the damper supplies additional voltage to the plate of the horizontal output ampli-

fier as it rectifies the positive pulse. Although the damper tube prevents continued oscillations, enough energy is stored in the magnetic field of the

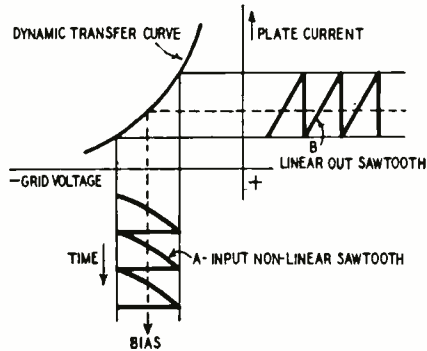

Fig. 3—Transfer characteristic of tube compensates for the nonlinear sawtooth.

oscillatory circuit to keep the tube conducting until this energy is dissipated. This energy dissipation makes the resultant current flow through the deflection coils linear, as indicated from points A to B in Fig. 6. After point B the current is no longer linear, but tapers off rapidly from points B to C.

Now the horizontal output amplifier takes over. The amplifier does not conduct during the retrace period of the beam and remains at cutoff during most of the time the damper tube is conducting because a negative pulse from the sweep oscillator is applied to its grid.

The amplifier starts to conduct when the deflection current, due to damper conduction, starts to become nonlinear. Current in the amplifier causes a continuation of current flow in the deflection coils. This initial current flow is nonlinear as from D to E in Fig. 6, and somewhat opposite in shape to that from points B to C of the same figure. After point E, the deflection current flow is linear. At point F, the retrace begins and the action starts again.

The circuit of Fig. 5 is so arranged that the nonlinear deflection current of the damper tube and of the amplifier (currents B to C and D to E in Fig. 6)

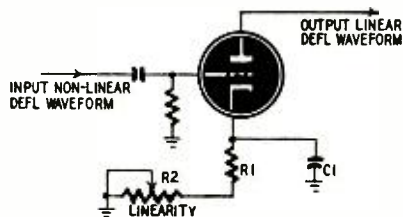

Fig. 4—Linearizing circuit that works on the tube's transfer characteristic.

are opposite in shape and produce a resultant current that is linear. The total trace from A to F is then linear. As an additional function, the damper tube together with the amplifier produces a linear trace and is a method of linearizing the deflection waveform.

We mentioned that the supply voltage on the amplifier plate is increased due to the kickback of the oscillator system. This increased voltage is ap-

plied to the plate of the amplifier by C1 and C2 because these capacitors become charged by the kickback voltage. This kickback voltage is pulsating and, although C1, C2, and L1 smooth out these pulsations, a certain amount of ripple voltage still exists. This ripple voltage is used to control the linearity of the resultant current.

By making L1 of Fig. 5 variable, the phase of the ripple voltage on the plate of the amplifier can be varied with respect to its grid signal. This means that the initial flow of amplifier plate current can be changed. Varying this inductance helps the nonlinear current (D to E in Fig. 6) produced by the amplifier to be exactly opposite to the nonlinear current (B to C) pro-

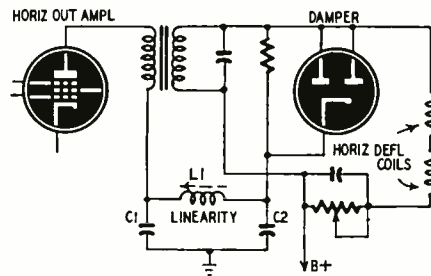

Fig. 5—A damper tube in the horizontal output helps to linearize the sawtooth.

duced by the damper tube. In this way any nonlinearity in the dashed part of the trace is kept to a minimum.

Time-constant circuit

Another way to correct linearity is to use an extra time-constant circuit to offset the one in the circuit producing the sawtooth waveform.

The additional time constant introduces a frequency discrimination to the nonlinear sawtooth waveform to straighten it out. The graph of Fig. 7 shows what is theoretically wanted. Curve A in part "a" of this drawing is the nonlinear trace of the sawtooth waveform. Curve B is the shape of the curve introduced by the time constant. Its shape and location on the graph must be such that when combined with the nonlinear sawtooth, the result is a straight line, as indicated in Fig. 7-b.

The complete circuit appears in Fig. 8. V1 is the discharge tube of the deflection circuit, and V2 is an amplifier to which the corrected waveform is fed for amplification. Components R1 and C1 are the grid resistor and coupling capacitor of tube V2. The sawtooth producing capacitors are C2 and C3 and the resistor through which they charge is R2. Components R3 and C4 are the additional time-constant circuit that corrects the linearity of the sawtooth waveform. Capacitors C2 and C4 are usually equal and C3 is approximately one-half their value. The corrected sawtooth deflection signal is taken across capacitors C3 and C4.

To understand how correction occurs, we will assume capacitors C2, C3, and C4 are being charged from B-plus. Capacitors C2 and C3 charge through R2 alone, but C4 charges through R2

and R3. When the discharge tube starts conducting, all the capacitors begin to discharge. Since C2 and C3 are directly across V1, they discharge very rapidly. However, C4 discharges slowly because the discharge current also flows through R3 which has a high value

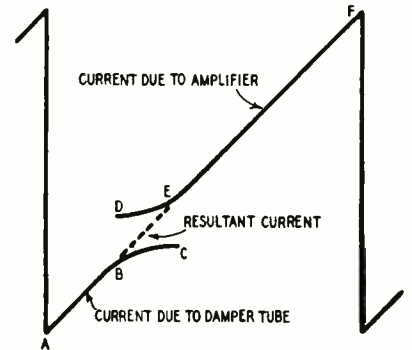

Fig. 6—Damper tube current and amplifier current produce the resultant sawtooth current in the circuit of Fig. 5. compared to the resistance of the discharge tube.

By the time V1 stops conducting, C2 and C3 are practically all discharged, but C4 has only given up a small part of its charge. C2 and C3 begin to charge again, but C4 continues to discharge because its previous charge is high compared to the voltage across C2. The discharge of C4 causes an additional charge on C2. In other words, the

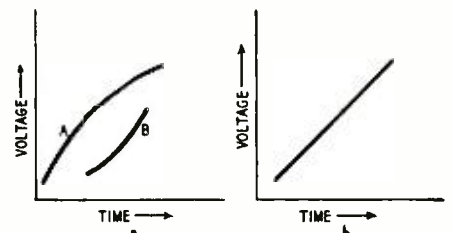

Fig. 7—Curves A and B add together to produce the linear voltage at right.

charge on C2 from the B-supply is an increasing voltage but the charge due to C4 is decreasing. When the total charging voltage on C2 equals that on C4, the latter stops discharging and starts charging through R2 and R3.

Across C3 we have the nonlinear deflection voltage represented by curve A in Fig. 7-a. Across C4, however, is a voltage which includes the action of C2 charging from two sources, plus the later charging action of C4. The result is a curve shaped similarly to that shown in Fig. 7-b.

So that R3 and C4 present the correct time constant to linearize the waveform, R3 is variable.

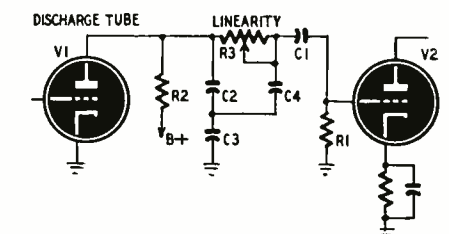

Fig. 8—A circuit for linearizing the sweep wave with an R-C time constant.

New Trends in Television

By WALTER H. BUCHSBAUM* Larger picture tubes, fast-acting a.g.c., and the gated beam discriminator are some of the features found in many of the latest TV sets

TODAY'S television receivers have come a long way since the 441-line, 5-inch sets to be found in some 5,000 homes in 1940. Their quantity and quality has advanced with seven-league boots. Present 525-line standards and greatly improved techniques combine to give the American people entertainment of a quality and at a price that everyone can afford and enjoy.

Since 1946, when television receiver production first started on a large scale, each year has brought improvements in design and price reduction, both important for mass acceptance of television.

The outstanding aim of the television industry during the past months has been to bring television to the low-income groups. Most of the new designs stress low cost without sacrifice of quality and the most pronounced improvement in this respect is the use of large-screen, wide-angle picture tubes. Five years ago the largest direct-view picture tube was a 20-inch, all-glass monster which required a tremendous cabinet and cost several hundred dollars. Today's 19AP4 (Fig. 1)

* Author: *Television Servicing.*



Fig. 1—The 19AP4, a large-screen picture tube used in many 1951 receivers.

fits into most cabinets and costs less than \$50 at the manufacturer's level. Its shorter length is due to a wider deflection angle which in turn requires more deflection power. To get sufficient brilliance on such a large screen the second anode voltage ranges from 12 to 15 kilovolts.

A real cost reduction is possible with the new rectangular picture tubes. Fig. 2 shows a Hytron 16RP4, and Fig.

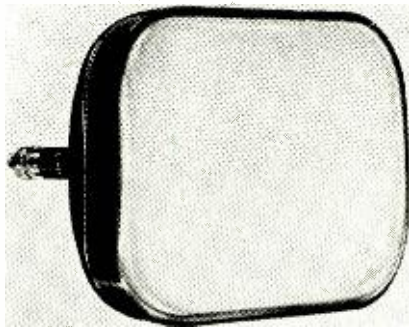

Fig. 2—Rectangular tubes such as this 16RP4 are popular in the new receivers.

3 gives an idea of the dimensions of such a tube compared with a 16-inch round picture tube. While the price of the rectangular tube is not substantially below that of the round type, the manufacturer can use a smaller cabinet, save on shipping and storage space, and use a less expensive mounting harness. The actual difference in cabinet prices at wholesale level ranges from \$5 to \$8, a considerable saving for the manufacturer.

Other new picture tubes are the 14-inch rectangular, giving a 12-inch picture, and the new 17-inch metal-envelope rectangular tube. Reduced weight and prices are the advantages expected from the metal 17-inch, which goes into mass production this month. Rectangular 20-, 21-, and 24-inch tubes are also scheduled for 1951, but so far only the 20-inch is being delivered. Du Mont has announced a 30-inch tube having a deflection angle of 90 degrees.

Most of the new picture tubes have either a "black face" or etched screen which reduces glare but also requires

more brightness. This increased brightness is obtained by using a higher anode voltage, usually from 12 to 13 kilovolts. A higher anode voltage again increases the deflecting power needed to cover the screen. Last year several manufacturers solved the problem of higher voltage and more sweep by using powdered-iron flyback transformers with a voltage doubler in the high-voltage section and two horizontal output tubes in parallel. Aside from being expensive, this system uses more B-plus and filament power, requires more chassis space, and dissipates more heat.

Deflection circuits

New, high-efficiency flyback systems were developed during the past year which furnish the required deflection as well as the higher anode voltage without using more power or using more tubes than the original flyback for the 10- and 12-inch tubes. As a matter of fact, most of the newly developed horizontal output tubes operate with less B-plus power than the old 6BG6-G. Such new tube types are the 6AV5-GT, 6AU5-GT, 6BD5-GT, 6BQ6-GT, and 6CD6-G, the first three of which use no top cap for the plate connection and are of the same physical size as the 6SN7-GT or 6K6-GT.

These high-efficiency flyback circuits depend on a special transformer which has high permeability and a high-Q core made of a ceramic material called Ferrite. The windings and the core material of these transformers keep dissipation losses at the horizontal sweep frequency very low. Several manufacturers are now using these transformers together with wide-angle deflection yokes. A circuit using this high-efficiency flyback system is shown in this issue in the article by Matthew Mandl.

To economize on the vertical deflection system, three new tubes were developed and are used in most 1951 receivers. The 6S4 is a miniature triode used as a vertical output tube. The 12BH7 and the 6BL7 are both double triodes, the former using a nine-pin miniature base and having a tapped filament for either 6.3- or 12-volt operation. The 6BL7 looks like a 6SN7-GT

but is a more rugged version, capable of dissipating more plate power. Several manufacturers use a simple autotransformer with these new tubes to couple the vertical output tube to the deflection yoke.

The deflection yoke used with the new wide-angle picture tubes is different in two respects. First its physical length is reduced to avoid neck shadow (see "Television Service Clinic," RADIO-ELECTRONICS, December, 1950). Second, its Q must be high or it will ruin the high Q of the ceramic-core flyback. Most yokes use a Ferrite or similar material ring instead of the powdered iron or iron wire of older type deflection yokes.

Some of the 1951 receivers use no flyback transformer at all. High-impedance deflection yokes and special air-core autotransformers for high-voltage stepup are used in a few models, while some use paralleled output tubes in circuits familiar from 1949 and 1950. The deflection yoke inductance (horizontal coils only) is 8.3 mh for 10- and 12-inch tubes. The new, high-efficiency circuits use either a 10-, 12-, or 18-mh winding, while the so-called high-impedance yokes have about 30-mh windings.

Fast-acting a.g.c.

Among the more important advances in TV designs is the perfection of a better fast-acting automatic gain control (a.g.c.) system which can compensate for airplane flutter and is almost immune to noise. Referred to as "gated" or "keyed" a.g.c., this system has been described before in RADIO-ELECTRONICS, but now it is being used in so many 1951 television sets that it deserves another brief description.

The circuit shown in Fig. 4 is typical of most of the fast-acting a.g.c. circuits now in use. In this particular circuit a special winding in the width-control coil supplies the keying pulse.

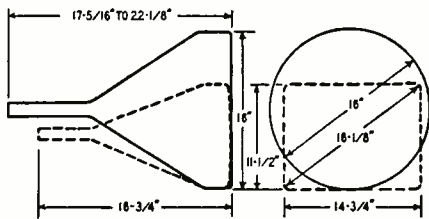

Fig. 3—While picture size is about the same, the rectangular tube has smaller overall dimensions than the round tube.

Keyed a.g.c. operates only on the amplitude of the horizontal synchronizing pulse and is in operation only while that pulse appears on the a.g.c. tube grid. The a.g.c. filter, therefore, need filter out only about 15 kc and can have a much faster charging and discharging rate than in an ordinary a.g.c. system. The rapid changes in signal strength due to airplane flutter are fully compensated as rapidly as they occur.

Noise riding in with the picture signal can hardly affect the a.g.c. bias.

Only those noise elements riding in with the synchronizing pulses can have any effect on the bias. Since the synchronizing pulses occupy only 5% of the total signal, only 5% of the total noise can get through. If the top of the synchronizing pulse is clipped at the first video amplifier, the system will be almost entirely independent of noise.

The 6AU6 a.g.c. tube in Fig. 4 has a constant bias of about 5 volts due to the voltage drop across R1, one of the plate resistors of the first video amplifier. This bias cuts the tube off completely unless a strong positive signal appears on the grid. The plate of the tube is at ground potential, while the cathode is 150 volts positive. No current flows in this condition; but when a 300-volt flyback pulse from the width coil winding appears on the plate, it

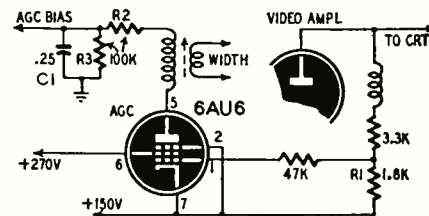

Fig. 4—A simple keyed a.g.c. circuit.

becomes positive and current could flow through the tube. But the bias cuts the tube off unless, at the same instant, a positive synchronizing pulse appears on its grid. Depending on the amplitude of that synchronizing pulse, more or less current flows through the a.g.c. tube.

If a strong station is received, the synchronizing pulse on the grid drives it more positive, permitting more current to flow. This plate current through the a.g.c. tube goes to ground through R2 and R3, setting up a voltage negative with respect to ground. If more current flows, a large negative bias is developed which reduces the gain of the r.f. and i.f. amplifiers and therefore the amplitude of the synchronizing pulse at the video amplifier. A balance is reached almost instantly, giving a constant and steady picture over a wide range of weak and strong signals. C1 and R3 form the a.g.c. filter, and the relation of R2 and R3 determines how much of the total bias is being applied to control the r.f. and i.f. stages.

Keyed a.g.c. is used in Admiral, Andrea, Westinghouse, Air King, Stewart-Warner, Silvertone, Teletone, Stromberg-Carlson, and other well-known receivers. When properly adjusted, this circuit is not only trouble-free but relieves the set owner of having to adjust contrast and brightness for different stations.

Gated beam discriminator

Used in one or two 1950 models, the gated beam discriminator is becoming rapidly the most popular FM detector for low- and medium-priced TV receivers. The two main advantages of this circuit are its economy and its excellent performance in AM rejection and limiting.

The operation of this circuit (Fig. 5)

is based on the internal structure of the tube. Only a narrow beam of electrons travels from cathode to plate. The electron beam is formed by the accelerating grid G_a which is at a constant

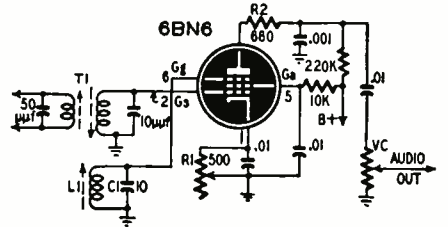

Fig. 5—Gated beam FM detector circuit.

d.c. potential. The FM signal is injected at the usual grid G_s and R1 establishes a self-bias in the cathode circuit. The key element is the tuned circuit L1-C1 which forms the return path of the fourth tube element, the gating or quadrature grid G_g. This tuned circuit resonates at the center frequency and must have a very high Q, at least 150, at that frequency. At resonance, maximum voltage is developed across a parallel tuned circuit, or maximum signal is absorbed by it, so that practically no electrons reach the plate at the resonant frequency. This is especially true in the case of the 6BN6 tube used here, where the internal structure is different from ordinary pentodes.

As the input frequency deviates from the resonant frequency of the gating grid circuit, more electrons reach the plate. In other words, the plate current varies as the input frequency varies, and an audio signal is developed across the 220,000-ohm plate load resistor, depending only on the frequency change of the FM signal.

Especially useful in intercarrier systems, the gated beam FM detector eliminates the need for a 6AU6 i.f. amplifier and limiter, the usual ratio detector transformer, and a double diode with a triode audio driver tube. When properly designed, the output of the 6BN6 circuit shown in Fig. 5 is sufficient to drive any standard audio output amplifier such as the 6V6, 25L6, or 6K6-GT.

The cathode bias potentiometer R1 is adjusted for maximum AM rejection; in other words, for minimum buzz. L1 is tuned to the center frequency (4.5 mc in intercarrier sets) just like T1. While T1 is tuned for maximum audio output, L1 is adjusted to give minimum output voltage when a 4.5-mc unmodulated signal is fed in through T1. This adjustment is as critical and touchy as the ratio detector adjustment in earlier circuits. Once adjusted, the gated beam detector stays aligned and operates properly for a long time.

During the past year only very few large manufacturers have used the gated beam FM detector circuit, but as more 6BN6 tubes become available and as component suppliers tool up for the gating coil, more sets will use this system in 1951. Zenith, Teletone, and many others include the gated beam detector circuit in their intercarrier receivers.

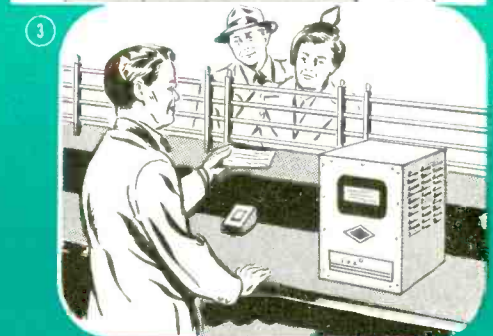
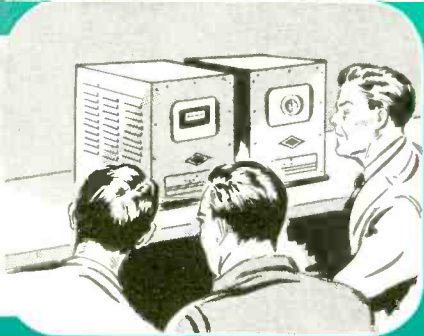
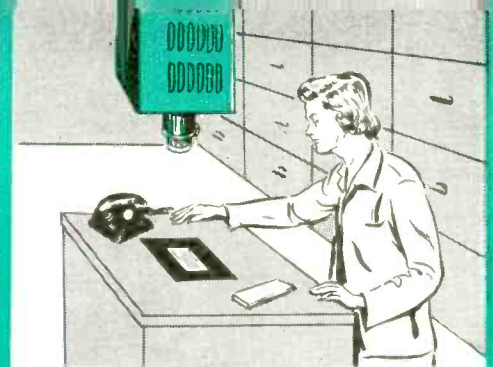
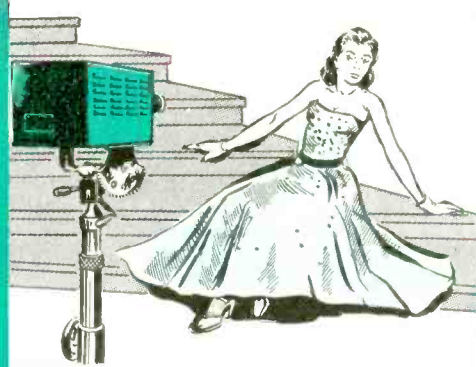
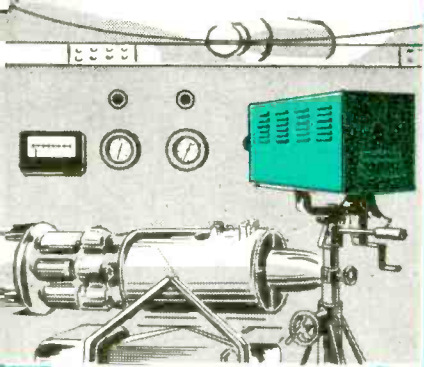

Industrial Closed-Circuit TELEVISION

COLOR increases utility of this rising new medium

WHILE the battle over color television broadcasting rages, another type of color television has been taking over without fanfare or opposition. The field being conquered peacefully is industrial closed-circuit television. Already established in monochrome, it is finding color a valuable adjunct.

The term "industrial television" has been interpreted to mean roughly all non-entertainment uses of the new medium, including its employment at fashion shows and in banks. In a number of applications, industrial television supervises operations too dangerous for human beings. It makes possible certain types of advertising displays and saves manpower in work requiring observation at a number of separate points.

Possibly the most publicized application of closed-circuit color television is televising surgical operations. Since internes can learn operating techniques only by watching skilled surgeons, making the operation visible to larger num-

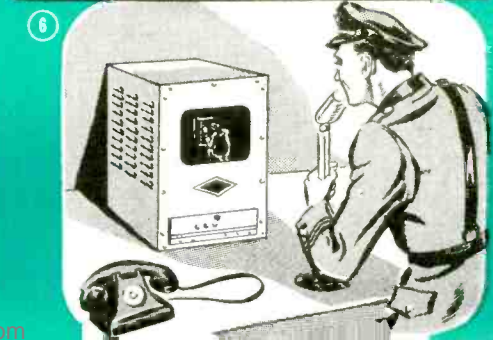
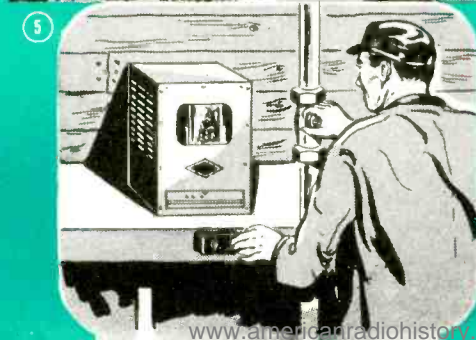
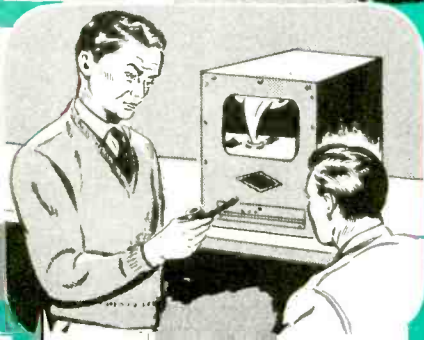
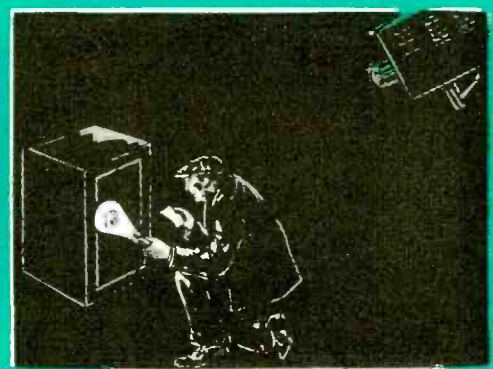
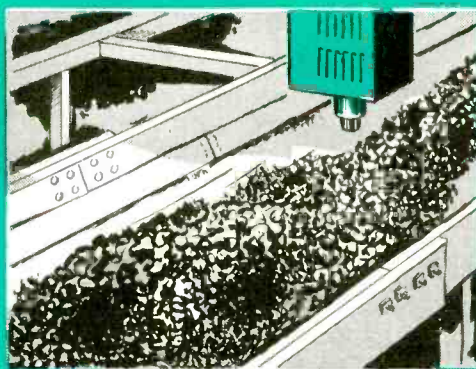
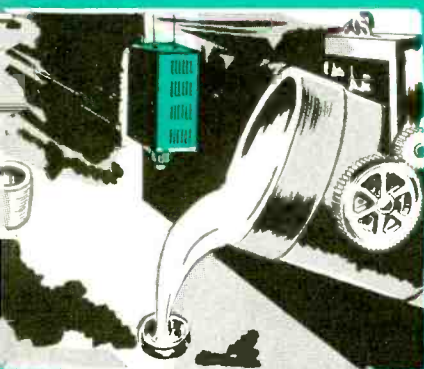

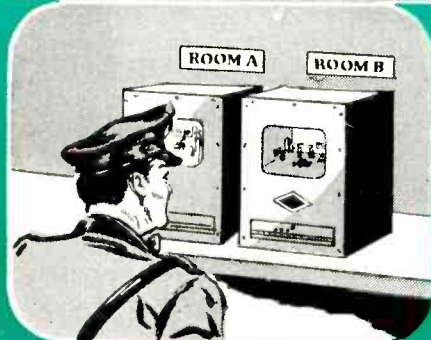
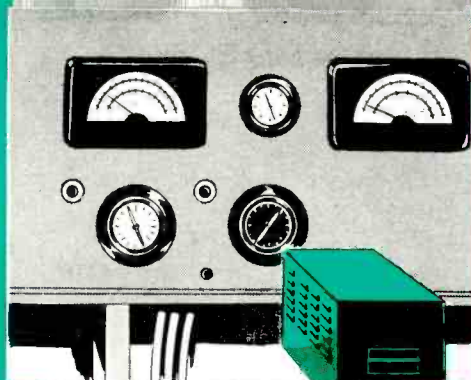
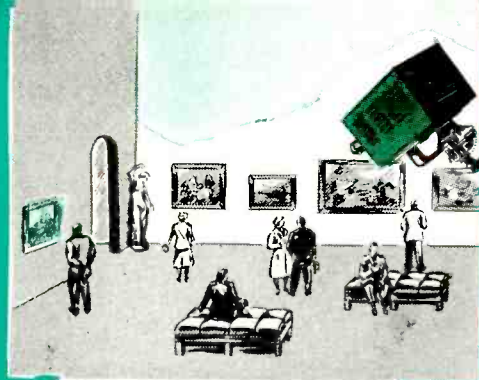

bers is important. The equipment shown on the cover was part of an installation by Du Mont at St. Clare's Hospital, New York City, where it was used during a large meeting of doctors and surgeons, who viewed a number of important operations which otherwise could have been seen by only a few.

Certain tests on machines, such as high speed motors (and now, jet units) used to be made in concrete pits, with engineers watching over a wall. In case of an explosion or a motor flying apart, the engineer's ducking speed was more important than his technical knowledge. Now these tests can be made with a camera focused right on the most important feature of the test; either on the meters as in Image 1 or on some critical part of the equipment itself.

Large department stores have already found use for television in making their displays visible to a larger number of people as well as to bring colorful displays to the attention of customers in other parts of the store or to window shoppers, as indicated in Image 2. Gimbel's of Philadelphia and Gertz' of Jamaica, New York, have done considerable experimental work with store televisers. The scene on our cover also shows how closed-circuit industrial-type television could be used by a model to demonstrate clothes or to advertise other items.

Time is occasionally lost in a bank while a signature is being identified, and under some circumstances good will and a valuable account is lost as well. Image 3 shows how this can be prevented. The clerk can call for a copy of any signature, which can be flashed to him in a matter of seconds. The same equipment can also be used to make records available for inspection at a number of points. The records can then be kept in a central depository.

Some types of inspection, while not perilous in the sense of Image 1, bring hazards of fumes, heat, gases or splash-

ing melted metal which make the inspector's work difficult and unpleasant, if not immediately dangerous. Image 4 shows how the pouring of metal in a mold can be viewed from much closer range than was possible under the old system of stationing a man 50 feet from the operation. Working in comfort at closer effective range, the operators can do a much better job of controlling the work.

Where material is borne along a chute there is always the danger of clogging or piling up. In the case shown in Image 5, coal is moved with the help of water. One person viewing the operation on a television screen and increasing or reducing the flow of water can replace two or more men, who would otherwise be placed at various points along the chute to watch for pile-up.

The television camera can be a more efficient watchman than any human, for it can be made to operate with infra-red light. Thus it may maintain a perfect watch in a "dark" area, throwing a bright and detailed image on the screen. Image 6 is a burglary that didn't quite come off as planned.

Another type of property protection in which television can be particularly useful is that of watching objects in a museum or art gallery as in Image 7. It has a double advantage over direct supervision. The would-be thief cannot see the guard and cannot tell when he is not under direct supervision. Neither can the thieves create a diversion to draw the guard away from a given spot.

Image 8 is another instance of television used for meter reading. In certain cases direct viewing of a number of meters is more advantageous than a telemetering system, and in others optical viewing is required by law, as in the case of water-gauges on steam boilers. Industrial television equipment is the answer.

The portability of the camera is a

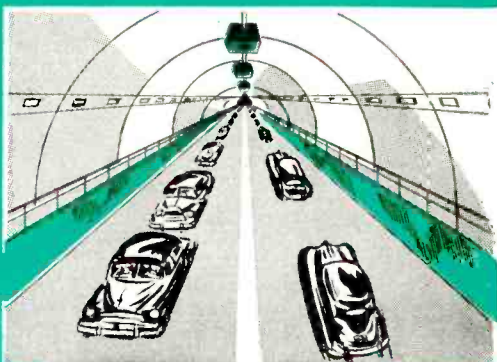
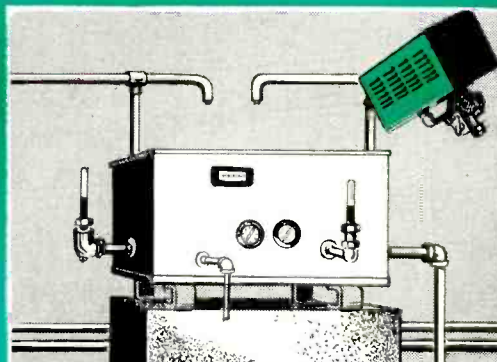

factor in its versatility. It can be used for a short-time job with little expense, as in the meter-viewing project, where setting up a telemetering system would be practical only in a permanent installation. In many cases of disaster, a

tant phenomenon to be observed.

The closed-circuit feature of industrial television has one great advantage. Since there is no broadcasting through space, there is no need of regulating bandwidth. So the industrial color tele-

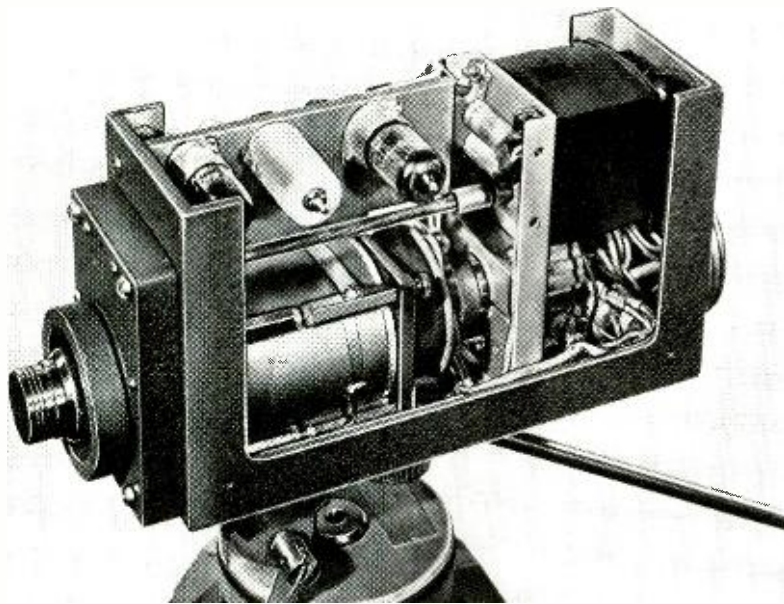

Closeup of the RCA Vidicon, a compact TV camera especially for industrial use.

camera can be placed where humans are not safe, due to obstructions, gases, danger of falling material, etc. Image 9 shows how an industrial television camera might be used in a mine disaster.

Nuclear research and work with radioactive material call for remote control operations in enclosures where no person may enter once the process has started. A television viewer to watch flow of materials, gauges, reactions, and in some instances to control mechanical robots, is of course the natural solution to the problem, as shown in Image 10.

Another version of the "chute" problem is seen in Image 11. Vehicular tunnels pose a problem of traffic control which requires policemen at a number of points along the tunnel. Monoxide gas makes the job dangerous and unpleasant, and accidents pose a hazard, as in the recent case where a guard in a New York tunnel was crushed when a truck got out of control. With the help of television, one man can do the work of a number, and do it in safety and comfort.

In many of these applications, color is quite unnecessary and is not used. In others, it is essential. For example, the effect of the fashion show of Image 2 would be reduced tremendously in black-and-white. Compare the models' dresses with the one on the cover, for example.

Image 4 is another good example where color is extremely useful. In many applications dealing with great heat, temperature is often estimated by color of metals or gases.

The same is true in observing chemical reactions, as in Image 10. Often the color of a solution is the most impor-

tant phenomenon to be observed. The Du Mont system illustrated on the cover uses 18 mc, the equivalent of three 6-mc channels, with a mechanical wheel for color.

Hampered to some extent by its very originality and the fact that it presents previously unheard-of solutions to industrial problems, industrial television got off to a slow start, but has been making steadily increasing progress during the past year. There are now four main brands on the market: Vericon, with its new Vericolor; RCA's

Vidicon; the Utiliscope handled by Diamond Power Specialty Corporation; and the Du Mont 18-mc color equipment.

Of these, the Vericon, made by Remington-Rand, and originally described in RADIO-ELECTRONICS March 1949, has recently added color, using the CBS color disc and a considerably wider band than the older monochrome equipment. Previous users of the equipment have been quick to realize the additional value of color and two large Vericon installations in college medical schools are now switching to Vericolor.

The RCA Vidicon has been used up to the present as a monochrome system, though its designers have pointed out that by using three Vidicon cameras to pick up the three primary colors, it can be adapted to color transmission.

The Utiliscope system is possibly the oldest of those described, and has a number of installations in various types of industry, some of which have been described or shown in photos in past issues of the magazine. No statement as to a proposed switch to color has been received from them as yet.

The Du Mont system uses standard equipment modified to operate at 180 fields per second. Unlike the other systems, it was designed primarily for color. Yet, where color is not needed, it is also available as a monochrome system. For example, the country-wide meeting of Schenley representatives, which was the first closed-circuit program to be "broadcast" was in black-and-white. This meeting consisted of 18 separate groups totalling more than 2,300 persons in cities as far apart as Boston and St. Louis. Transmission over long lines was the reason for use of monochrome in this case, as the frequency limits of the lines would have made color broadcast difficult.

Thanks are due to Diamond Power Specialty Corporation for the ideas underlying the larger number of the illustrations on pages 30 and 31.

COLOR TELEVISION SYSTEMS

(Continued from page 22)

This problem has been solved with a synchronizing system in which timing pulses are transmitted to provide exact dot registry.

Many engineers point to these very problems, and the ones that still exist, as one of the strong points in favor of RCA's system. This admittedly crude development already produces images which some feel are equal to those of any system, and cannot lag far behind by anyone's reckoning. Yet the system is new and at the beginning of its development, whereas others are well in sight of the end of theirs. To say that a system shows great room for improvement may not always be praise, but it is a significant factor when planning for the future.

In typical RCA receiving equipment, three kinescopes are used, one for each of the primary colors. The separate colors are mixed with the aid of dichroic mirrors, which are transparent to two of the primaries and reflect the

third. The viewer sees a full-color picture on what appears to be the screen of the green tube, though actually the red and blue components are reflected from the mirrors. As stated before, a single three-color direct-viewing tube has been demonstrated, but is still in the developmental stage.

Besides the three methods described, a number of other incipient color television systems—not developed to the point of demonstration—have been proposed to the FCC. None of them are likely to replace one of the present systems as the final answer to color television, but the possibility cannot be excluded.

References

- 1 *Television in Color*. Fred Shunaman, *Radio-Electronics*, January, 1950, page 28.
- 2 *New Picture Tube for Color TV*. *Radio-Electronics*, June, 1950, page 27.
- 3 *Color Television*. Harry W. Secor, *Radio-Craft*, Part I, June 1947, page 20.
- 4 *PPM—New Technique*. Fred Shunaman, *Radio-Craft*, February, 1946, page 314. *Pulse Code Modulation*, Fred Shunaman, February, 1948, page 28.

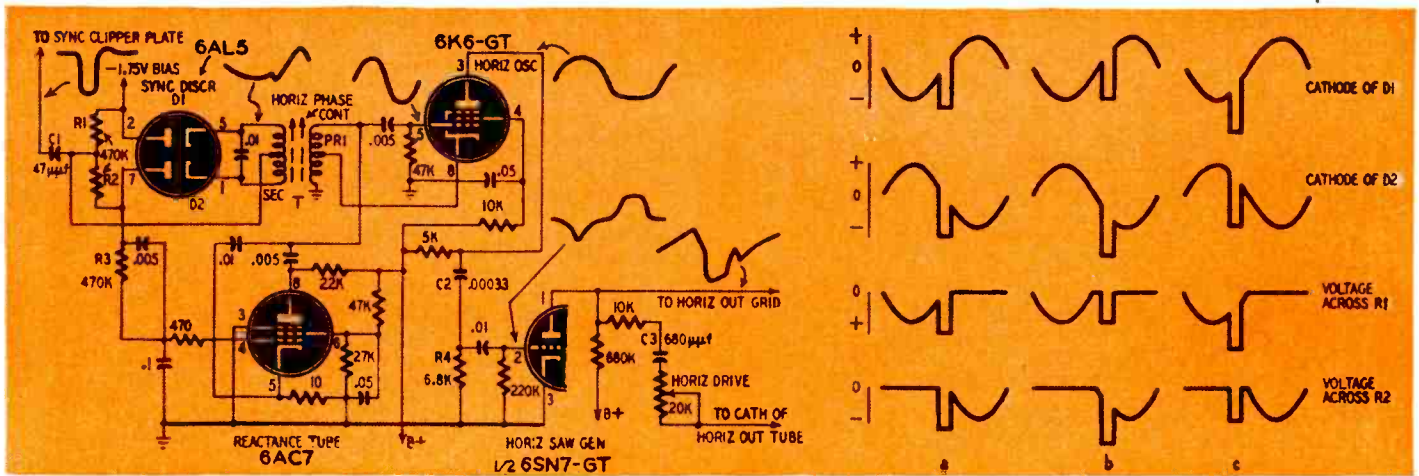

Fig. 1, left—The Stromberg-Carlson TV-12 employs this version of the popular RCA synchrolock a.f.c. circuit. Fig. 2, right—Waveforms show how sync pulses are superimposed on the sine wave output of the 6K6-GT horizontal oscillator.

Horizontal A. F. C. Circuits Used in Television Receivers

By HENRY O. MAXWELL

BECAUSE the horizontal deflection generator is easily affected by weak signals, noise, and some forms of interference, the horizontal sync may be lost because of instability, maladjustments, and minor defects in the antenna, tuner, and video i.f. Several types of automatic frequency controls have been developed to hold the horizontal oscillator in sync with the horizontal scanning generator at the transmitter.

In the receiver, the horizontal deflection signal may be generated by a sine-wave oscillator, multivibrator, or blocking oscillator, and the frequency-correcting voltage may be produced by several types of discriminators and phase detectors. To enable the service technician to give faster and more efficient service, we will discuss the theory of a.f.c. systems and deflection generators in this article.

The Synchrolock

Perhaps the best known of all a.f.c. systems is the RCA Synchrolock used in many versions of the 630-type chassis and in many other sets having 28 or more tubes. The circuit in Fig. 1 is used in the Stromberg-Carlson model TV-12. Other versions are used in the Freed-Eisemann 1620C, Zenith 28F20, and in sets of other makes and models. Com-

ponent values and tube types may vary, but the circuit operation remains the same.

The 6K6-GT is a Hartley-type horizontal oscillator operating at a natural frequency of 15,750 cycles. A 6AC7 reactance tube, connected in parallel with the tuned circuit, acts as a shunt reactance which can control the resonant frequency of the L-C network. The magnitude of the shunt reactance is determined by the bias voltage and transconductance of the 6AC7. With a fixed negative bias of approximately 2 volts, a change of 0.5 volt will change the oscillator approximately 100 cycles. The frequency shifts in one direction when the bias increases and in the other when it decreases.

The horizontal oscillator develops a sine-wave voltage across the secondary of the discriminator transformer T so that the cathode of one diode is negative at the instant that the other is positive. Negative sync pulses are fed to C1, R1, and R2 which have a time constant which develops sharp pulses at the center tap of the secondary winding. These pulses are applied in phase to the cathodes of the 6AL5 sync discriminator. The amplitudes of the sine wave and pulses are constant. The mixture of sine wave and pulse causes D1 and D2 to conduct when their cathodes are driven negative and voltages are developed across R1 and R2, respectively. These resistors are connected so the algebraic sum of their voltages is produced be-

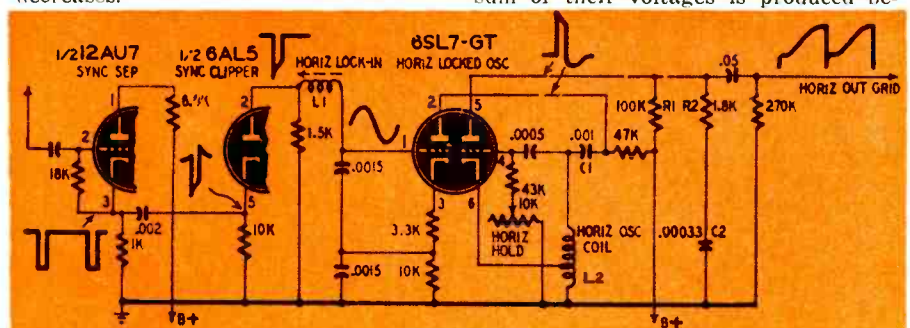

Fig. 3—Another circuit using a sine wave oscillator. Negative pips from the sync clipper are used to control the frequency of the horizontal oscillator.

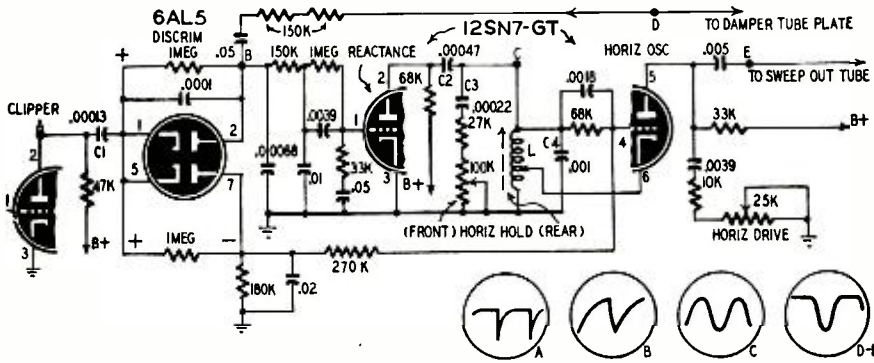

Fig. 4—The Gruen a.f.c. circuit which is used in many of the late G-E models.

tween ground and the junction of R2 and R3. A network consisting of the 470,000-ohm resistor R3 and the .005- and 0.1- μ f capacitors filters the control voltage and applies it to the control grid of the 6AC7.

When the oscillator is in sync, the pulses arrive at the instant the sine wave on the cathodes is crossing the zero axis, as shown at a in Fig. 2. The voltages across R1 and R2 are equal and opposite, and the net voltage is zero.

Consider what happens when the oscillator shifts frequency so the negative sync pulse arrives when the cathodes of D1 and D2 are negative and positive, respectively. (See c in Fig. 2.) During the first half of the cycle, D1 conducts and the voltage across R1 corresponds to the voltage on the cathode of D1. At the same time, the sine wave is positive on D2 and will conduct only for the duration of the pulse which has sufficient amplitude to drive the cathode negative. The voltage across R1 being greater than that across R2, a positive voltage will be applied to the grid of the 6AC7. The reactance tube draws more current, its effective reactance increases, and the oscillator frequency decreases.

The drawings at b show how a negative corrective voltage is produced when the oscillator is running too slow.

The output of the oscillator is coupled to the horizontal sawtooth generator—often called a discharge tube—through a differentiator consisting of C2 and R4. The tips of the differentiated pulse cause the sawtooth generator tube to conduct and discharge the sweep-generating capacitor C3.

The horizontal drive control adjusts

the shape of the sine wave applied to the grid of the output tube and is therefore capable of affecting the linearity and size of the picture as well as the high voltage in circuits using flyback power supplies.

In the 630 and most other sets, the sync pulses are positive and the plate and cathode connections are reversed on the discriminator diodes.

Motorola circuit

Another circuit which uses a sine-wave oscillator is employed in the Motorola TS-30A and similar chassis. In this circuit (Fig. 3), the negative sync pulses appearing at the cathode of the sync separator are differentiated by the .002- μ f capacitor and the 10,000-ohm resistor in the cathode return of the sync clipper. The diode passes the negative pulses and clips the positive pips. The negative pips, which correspond to the leading edges of the sync pulses, are used to control a 15,750-cycle sine-wave oscillator consisting of L1, the two .0015- μ f capacitors, and half of the 6SL7. This oscillator is locked in with the sync pulses.

The negative half of the sine wave across L1 drives the oscillator grid to cutoff and produces a positive pulse in the plate circuit. This plate waveform is differentiated by C1 and L2 to make a pulse which triggers the grid of the blocking oscillator consisting of the other half of the 6SL7. The time constant of the 500- μ f capacitor and the resistance in the oscillator grid return determines the frequency of the blocking oscillator. The sawtooth which drives the horizontal amplifier is devel-

oped by the charging and discharging of C2 through R1 and R2. The voltage across R2 and C2 produces a negative spike which drives the output tube to cutoff during the retrace period.

Note that this circuit does not provide a corrective voltage to hold the blocking oscillator on frequency. Instead, it is triggered by a pulse derived from a sine wave. The locked-in sine-wave oscillator acts as a buffer to prevent noise pulses from riding through and affecting the performance of the blocking oscillator.

The Gruen system

The Gruen a.f.c. circuit used in the G-E 12T7 and other late G-E sets is shown in Fig. 4. This circuit uses a 6AL5 balanced discriminator, and a 12SN7 reactance tube and sine-wave oscillator. The oscillator is controlled by the inductance of the tapped coil L and the capacitance of C2, C3, and C4. The reactance tube acts as a resistance in series with C2 across the tank coil.

In this circuit, the discriminator produces a d.c. voltage having an amplitude and polarity determined by the phase difference between the sync pulses and the negative pulses at the plate of the damper tube. The negative sync pulses are applied to the cathodes and the pulse from the damper tube is integrated into a sawtooth by the 680- μ f capacitor.

The peak-to-peak voltage of the sawtooth on the plates is approximately half that of the sync pulses fed to the cathodes. When the diodes conduct because of the presence of sync pulse or sawtooth alone, the voltages across the 1-megohm load resistors are equal with opposite polarity, making the discriminator output zero.

The sync pulses charge C1 to approximately 60 volts and bias the cathodes positive by this amount. As long as this bias is on the cathodes, the sawtooth cannot cause conduction because its peak value is too low.

If the oscillator is in sync with the pulses from the transmitter, the pulses arrive at the instant that the retrace portion of the sawtooth crosses the zero axis and the voltages across the load resistors are caused by the portion of the sync pulse which is above the bias developed by C1. These voltages cancel

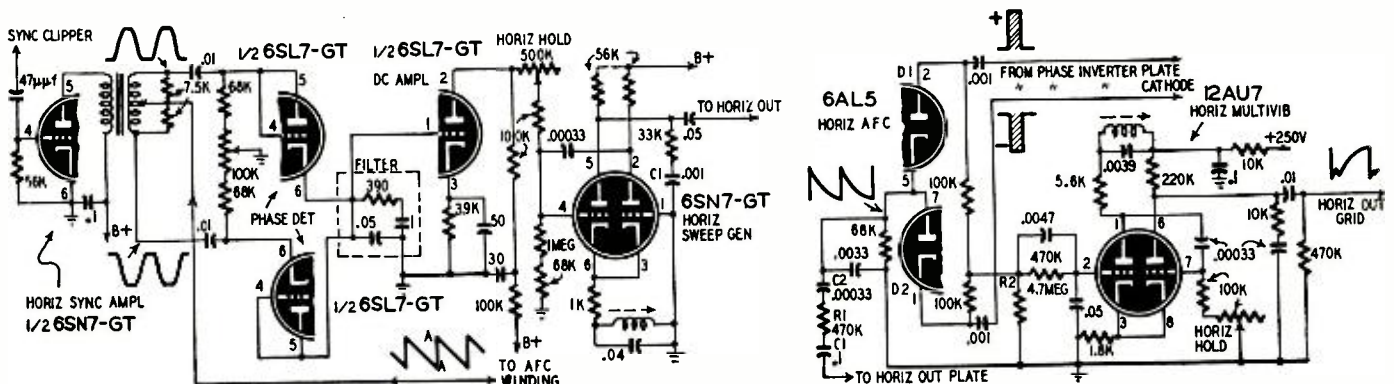

Fig. 5, left—The d.c. amplifier boosts the discriminator output to insure positive control over the horizontal oscillator. Fig. 6, right—A phase inverter does the work of the transformers which the discriminators in Figs. 1 and 5 use.

each other and therefore no d.c. voltage comes out of the discriminator.

When the oscillator is fast or slow, the sync pulse falls on the retrace of the sawtooth. Now, the sawtooth will add to or subtract from the sync pulse on the diodes and cause a difference in the voltages across the load resistors. The algebraic sum of the voltages—positive if the oscillator is fast and negative if it is slow—is filtered and fed to the grid of the reactance tube.

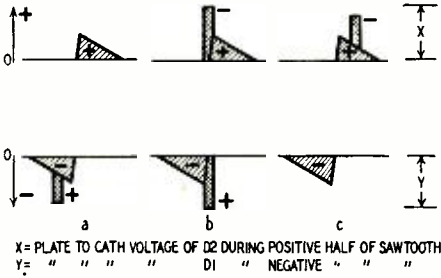

Fig. 7—Waveforms showing how the circuit of Fig. 6 controls the frequency.

If the correction voltage is positive, the plate-to-cathode impedance of the reactance tube will be lower and the capacitance of C2 will have a greater effect on the tuned circuit and lower the oscillator frequency. A negative voltage increases the plate-to-cathode impedance of the reactance tube, the effect of C2 is reduced, and the oscillator speeds up.

The .0039- μ f capacitor and the series resistance to ground produce the sawtooth deflection voltage as do R1, R2, and C2 in Fig. 3.

A G-E circuit

The a.f.c. circuit in Fig. 5 is used in the G-E model 901. Here, an unbalanced discriminator or phase detector, d.c. amplifier, and multivibrator are used. A sawtooth from a special winding on the

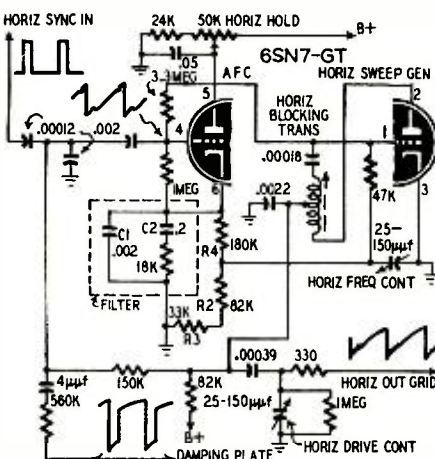

Fig. 8—An a.f.c. circuit of the pulse-width type which is used in some sets.

horizontal output transformer is applied to the center-tapped secondary of the a.f.c. input transformer. This voltage—in phase at the ends of the secondary—is compared with the sync pulses which are out of phase across the halves of the winding. The diodes con-

duct equally when the sync pulses coincide with points A on the sawtooth and the net d.c. voltage is zero.

If the sync pulse falls at any other point, the voltages across the diodes are unequal and a positive or negative correction voltage is produced. After being filtered, the voltage is amplified by a d.c. amplifier and then applied to a grid of the multivibrator-type oscillator. The filter has a time constant which averages voltages over a frame rather than over individual lines, thus making the circuit less sensitive to noise and interference pulses.

The coil and capacitor in the cathode returns of the 6SN7 are shocked into a ringing condition which produces a sine wave. The charge-and-discharge capacitor C1 converts the sine into a sawtooth required for deflection.

Westinghouse a.f.c.

Another interesting circuit is used in the Westinghouse H-223. In Fig. 6, the sync pulses from the sync separator are fed to a phase inverter which develops equal pulses of opposite polarity at its plate and cathode. The positive pulse is fed to the plate of D1 at the instant that the negative pulse is fed to the cathode of D2. A square-wave pulse from the plate of the horizontal output tube is applied to the cathode of D1 and plate of D2 through an integrator (C1, R1, and C2) that converts the signal to a sawtooth which is alternately positive and negative. Note that the voltages on the cathode of D1 and plate of D2 are in phase while the sync pulses on the plate of D1 and cathode of D2 are 180 degrees out of phase.

Fig. 7 shows the operation of this circuit. At a, the arrival of the sync pulses coincides with the leading edge of the negative-going sawtooth. The sum of the negative cathode and positive plate voltages on D1 being greater than the positive sawtooth acting alone on the plate of D2, a negative d.c. voltage appears across R2. The negative sync pulse is not shown at a because it is canceled by the negative sawtooth on the plate of D2.

At b, the pulses are centered over the trailing edge of the negative-going sawtooth and the leading edge of the positive-going sawtooth with the result that the voltages developed during successive halves of the sawtooth cycle are equal and opposite and the net voltage across R2 is zero.

At c, the pulses arrive on the trailing edge of the positive sawtooth, D2 conducts more heavily than D1, and a positive correction voltage is produced.

The sawtooth deflection voltage is generated by the 10,000-ohm resistor and .00033- μ f capacitor just as in the other charge-discharge circuits we have discussed.

Pulse-width system

Fig. 8 is one of several versions of the pulse-width a.f.c. system. This circuit, used in the G-E 810, operates in much the same manner as the RCA

Synchroguide. A single 6SN7-GT is the a.f.c. tube and blocking oscillator. The grid of the a.f.c. tube is biased to cutoff by the negative voltage applied to it through the 3.3-megohm resistor connecting it to the oscillator grid.

Positive pulses from the plate of the damper tube are converted to modified sawtooth waveforms and fed to the grid of the a.f.c. tube along with positive sync pulses. Neither voltage has sufficient amplitude to overcome the bias on the a.f.c. tube but their amplitudes can be combined to cause conduction.

When the oscillator is in sync (see Fig. 9), the leading half of the pulse is on the leading edge of the sawtooth and its trailing edge corresponds to the trailing edge of the saw. Thus the pulse is only half its normal width. The pulse falls higher on the sawtooth and more of it is clipped when the oscillator is fast. If the oscillator is slow, the full width of the pulse may fall on the leading edge of the sawtooth.

C1 and C2 charge during the time that the a.f.c. tube is conducting. The voltage on them is determined by the duration of plate-current flow. A portion of the voltage across these capacitors is applied as bias to the grid of the blocking tube. If the oscillator is slow,

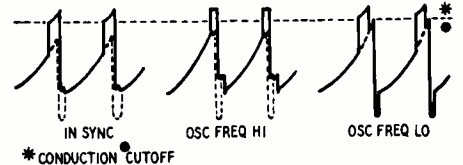

Fig. 9—Waveforms showing pulse width differences of the circuit of Fig. 8

the voltage across the capacitor will be more positive than when the oscillator is in sync, the oscillator speeds up until the grid bias returns to its normal value.

Troubleshooting hints

Troubles in a.f.c. circuits can be numerous and may be caused by minor changes in the values of many components. These few hints are useful when servicing a.f.c. circuits:

1. Always check the damper tube in circuits where the feedback voltage is taken from the plate of the horizontal output or damper tubes.
2. Check the feedback windings for open circuits and shorted turns in circuits like Fig. 5.
3. When replacing resistors and capacitors in the a.f.c. circuit, always use units having tolerances equal to or closer than those of the original. Check the parts list and diagram to be sure.
4. Check all tubes which are even remotely connected with the horizontal deflection circuit. Sync separators, d.c. restorers, clippers, amplifiers, and clamps can affect the operation of some circuits.

We plan to follow this article with another describing some of the tricks and short cuts which can be used in adjusting and servicing horizontal a.f.c. systems.

Guided TV Bomb

By HUGO GERNSBACK



Improved television bombs of this type will certainly be used in future wars. As a guided weapon, such a bomb has a great many advantages which cannot be overlooked in future conflicts.

At present, bombing at very great heights is more or less a hit-or-miss proposition. Far too often only one or two out of ten bombs are effective. Particularly when aimed at a comparatively small target most bombs are ineffective. All bombs are subject to "drift": first because of the motion of the plane from which they fall, and second because of winds over the target. The bombardier is supposed to correct for such drift, but at best his aim is only approximate. Targets such as bridges, railroad tracks, etc., are particularly difficult to hit and usually a large number of bombs must be wasted to make a strike that will actually demolish such objects.

Moreover, the bombardier has to count on overcast weather and erratic flying when pursued by fighter planes or attacked by antiaircraft fire.

All this makes for a large waste of bombs. It is true that toward the end of World War II guided bombs came into use, but even these were not accurate in overcast weather, during fog, etc., even when radar was used.

If, however, radar and television are combined in such a manner that the bombardier can have the target outlined on his radar screen, then during the last stages of the television bomb fall (after it has cleared the clouds), the bombardier then can actually see the target and can make a better strike.

For this reason the television bomb will not only prove a formidable

weapon but will sharply reduce the waste of expensive bombs.

A television bomb for many reasons will have to be a large one, usually of the blockbuster or the large incendiary type. In its nose it will contain a television camera operated either by special powerful batteries or a small electric generator. Such a generator can be powered by an air turbine operated by the airstream as the bomb falls through the air, generating enough current to operate the television transmitter.

The television bomb has special fins and a tail, both of which can be moved by compressed air, stored in a tank in the bomb, to guide the bomb's fall accurately. The bomb is steered from the bomber by radio remote control in the usual manner of guided missiles. Thus the television bomb is a regulation guided weapon except that the television bombardier can watch on his television screen the EXACT progress of the "falling" missile. By radio control he manipulates the bomb's flight accurately toward any target selected. On his television screen the bombardier can watch the bomb's progress through the thickest clouds, rain, fog, or snow up to the instant of the hit.

Nor is the extra cost of equipping such a missile with a television transmitter excessive. Large bombs of this type often cost up to fifteen thousand dollars and over.

As the television bomb is far more accurate than the regulation type, the few hundred dollars spent on a television transmitter is insignificant when the cost of the wasted bombs, normally expended on a target, is taken into consideration.

TELEVISION-CONTROLLED weapons are by no means a novelty. Indeed the first television-controlled plane was proposed by the writer in 1924*.

It became a reality in World War II, when 34 of our B-17 and B-24 bombers, with automatic pilots and TV cameras in their noses were guided by radio right into the mouths of V2 hangars in occupied France.

Flying high over the English Channel our radio control planes guided the bombers accurately into the small openings of the hangars. Each bomber contained 2,400 pounds of TNT and Torpex which exploded on contact, atomizing the bomber as well.

During World War II our Navy and Air Force had also experimented with actual television bombs.

These tests took place at Lake Muroc, Cal. The bomb used had a TV camera in its nose and was steered by a bombardier who corrected the drop by changing the pitch of the fins on the bomb as it fell. But this bomb was not very effective as its direction could not be changed except during the first few seconds of its fall.

* See "The Radio-Controlled Television Plane" by H. Gernsback, in *The Experimenter*, page 22, November, 1924.

Picture Tube List

By F. WILHELM

Listing the physical and electrical characteristics of all magnetically deflected picture tubes, the chart opposite is prepared especially as an aid to planning conversions to bigger tubes. For this reason, the over-all size, deflection angle, type of focusing, and typical operating conditions are pushed toward the front where they won't be overlooked when making comparisons between tube types.

Special notes:
Type numbers of rectangular tubes are in light face type.

Capacitance of inner and outer coatings of some glass tubes may vary widely because of differences in the width of the band and the conductivity of the coatings

Some manufacturers give only the diagonal deflection angle of rectangular picture tubes. Because the horizontal deflection angle is somewhat less than the diagonal some 70° yokes will overdrive the tube. For this reason, the horizontal deflection angle is given for all types of tubes.
The 7AP4, 9AP4, 12AP4, and 12PC4 have 2.5-volt,

2.1-ampere heaters, all others have 6.3-volt, 600-mw heaters.

Footnotes:

- 1—Projection tube with aluminized screen.
- 2—Suffix A indicates a masking aperture.
- 3—Aluminized screen.
- 4—Screen made from special nonreflecting glass.
- 5—Data published by Thomas Electric and Sylvania, specify a single magnet. Du Mont and Tung-Sol specify a double magnet.
- 6—Current in RMA focus coil No. 109, all others for RMA focus coil No. 106.
- 7—Some manufacturers use clear glass on face.
- NG—This tube does not have accelerator (No. 2) grid.

- M5—Medium, 5 pins.
- M6—Medium, 6 pins.
- M9—Miniature, 9 pins.
- MSOB—Medium shell octal, 8 pins.
- SS—Special, 5 pins.
- SSD5—Small-shell duodecal, 5 pins.
- SSD7—Small-shell duodecal, 7 pins.
- 3NP4—Special socket for 3NP4.
 - Dim. A—12 1/2 x 19-11/16 inches.
 - Dim. B—12-17/32 x 9-23/32 inches.
 - Dim. C—14 3/4 x 11 1/2 inches.
 - Dim. D—14 3/4 x 11-17/32 inches.
 - Dim. E—15 3/8 x 12 1/4 inches.
 - Dim. F—15-21/64 x 12-9/64 inches.
 - Dim. G—16-1/16 x 12 3/8 inches.
 - Dim. H—17 x 13-3/32 inches.

Charts Identify TVI

Eliminating arithmetic, charts simplify detection of radiating TV sets

By N. H. CROWHURST

INTERFERENCE with television reception can be caused by a variety of interactions between local oscillator or i.f. and other television channels. Articles have from time to time described methods of identifying the interference, but the tracking down to source involves repeated arithmetical calculations that become somewhat arduous. Use of the charts here presented will not only facilitate the calculations, but also help in getting a better visual understanding of the problem.

This kind of interference can be divided into two groups: Group 1, interference originating in the same receiver, and Group 2, that originating in another receiver. The solution of Group 1 problems is relatively simple, because all the causes of trouble are at the same site; but Group 2 can be more difficult, as cooperation with the owner of the interfering receiver is necessary, unless pickup from it can be eliminated by antenna orientation.

Interference from i.f. harmonic

Under Group 1, the simplest range of possibilities consists of stray coupling from the i.f. stages back into the r.f. section. It is harmonics of the i.f. that cause trouble, either sound or picture i.f. producing harmonics that can stray into the r.f. stages to interfere with either sound or vision channel. Charts 1 and 2 assist in identifying these possibilities. Chart 1 is for the lower band, channels 2 through 6, and Chart 2 for the higher band, channels 7 through 13. The horizontal dotted lines indicate carrier frequencies, the thick horizontal lines the boundaries between adjacent channels. Thin lines divide sound and vision on the same channel. The diagonal lines indicate where the

Use of the chart is simplicity itself. The diagonal lines indicate where the

various harmonics fall. For instance, a receiver has the common video i.f. of 25.75 mc. Locating that point (three-quarters of the way between 25 and 26 on the bottom line) and laying out a vertical line from that point, we cross the 3rd harmonic line in channel 5 very near the picture carrier. Obviously i.f. 3rd harmonic is suspect if channel 5 is being interfered with.

Conversely, if interference is experienced on channel 3, only i.f.'s between 21 and 22 mc would be likely to cause it. If the set's i.f. is higher and there is no other nearby receiver, the trouble is likely to be from some other cause.

Because the vision channels occupy most of the available spectrum, interference is most likely to appear in them, but there are also narrow ranges of i.f. at which interference may appear in a sound channel. The 2nd, 3rd, and 4th harmonics can cause interference in the lower band. Second harmonics of i.f.'s between 27 and 30 mc can cause interference on channel 2. Just below 30 mc the interference will be in the sound channel. Third harmonic can cause interference on channels 3 to 6, according to value of i.f., and the 4th can cause interference on channel 5 or 6. As detailed in Chart 2, the 6th to 10th harmonics can cause trouble in the higher band. Harmonics of the sound i.f. can cause serious picture interference, too.

Image interference

Still considering Group 1, the next possibility is the old second-channel (image) trouble, and other channels that can produce the i.f. by mixing with harmonics of the oscillator instead of its fundamental. Presence of harmonics indicates that the oscillator waveform is poor. All these sources of interfer-

ence usually show up when the interfering channel is strong in comparison with the received channel.

Chart 3, use of which is demonstrated in the key at the right-hand bottom corner, will help in tracking down possible interfering channels for any chosen i.f. and oscillator frequency combination. As represented by the arrow heads showing direction of reference, b is the received channel. (In this particular set the oscillator frequency is below r.f. carrier frequency.) Oscillator frequency is found by connecting with a straightedge the vision carrier in the received channel on the scale at the extreme left of the chart with the i.f. in the section marked OSC. LOW, and interpolating on the OSCILLATOR FUNDAMENTAL scale. The second-channel (image) frequency is indicated at a on the key, using the same i.f. in the section marked OSC. HIGH. Second and 3rd harmonics are located on their respective scales by aligning the zero at the bottom of the TELEVISION CHANNELS scale at the left, with the oscillator frequency already interpolated. From these points, reference through the same i.f. value on the other I.F. REF. scales, as indicated on the key, will show at points c, e, f and h possible channels that can interfere.

For example, interference may be received on channel 4. The receiver i.f. is the familiar 25.25 mc, with the oscillator working on the high side of the fundamental. Drawing a line from channel 4 through OSC. HIGH intersects the fundamental scale just above 90. A line is drawn from zero on the TELEVISION CHANNELS scale through this point, intersecting the 2nd and 3rd harmonic scales. From these latter points lines are drawn through both high and low 25.25 of the I.F. REF. (interference can

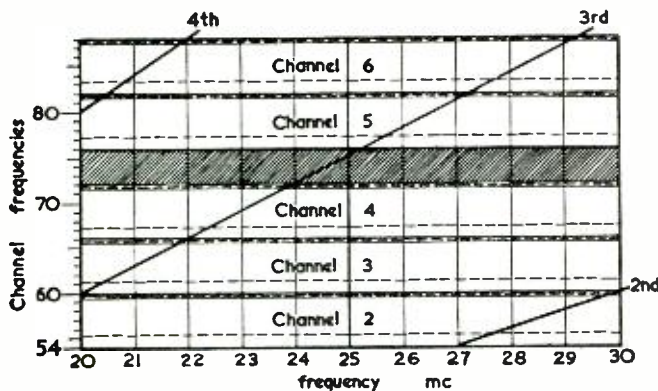

Chart 1—I.f. harmonic interference chart for low-band TV.

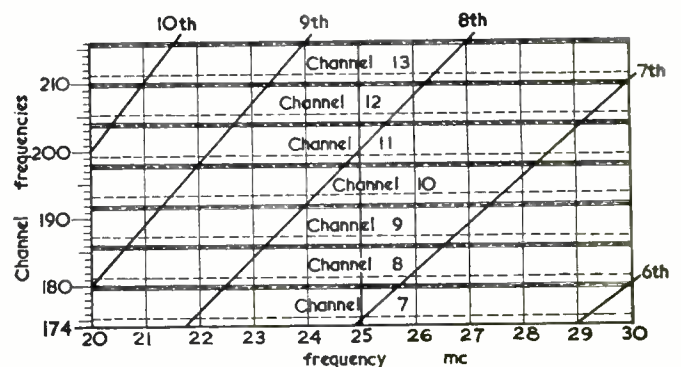

Chart 2—High-band i.f. harmonic interference chart.

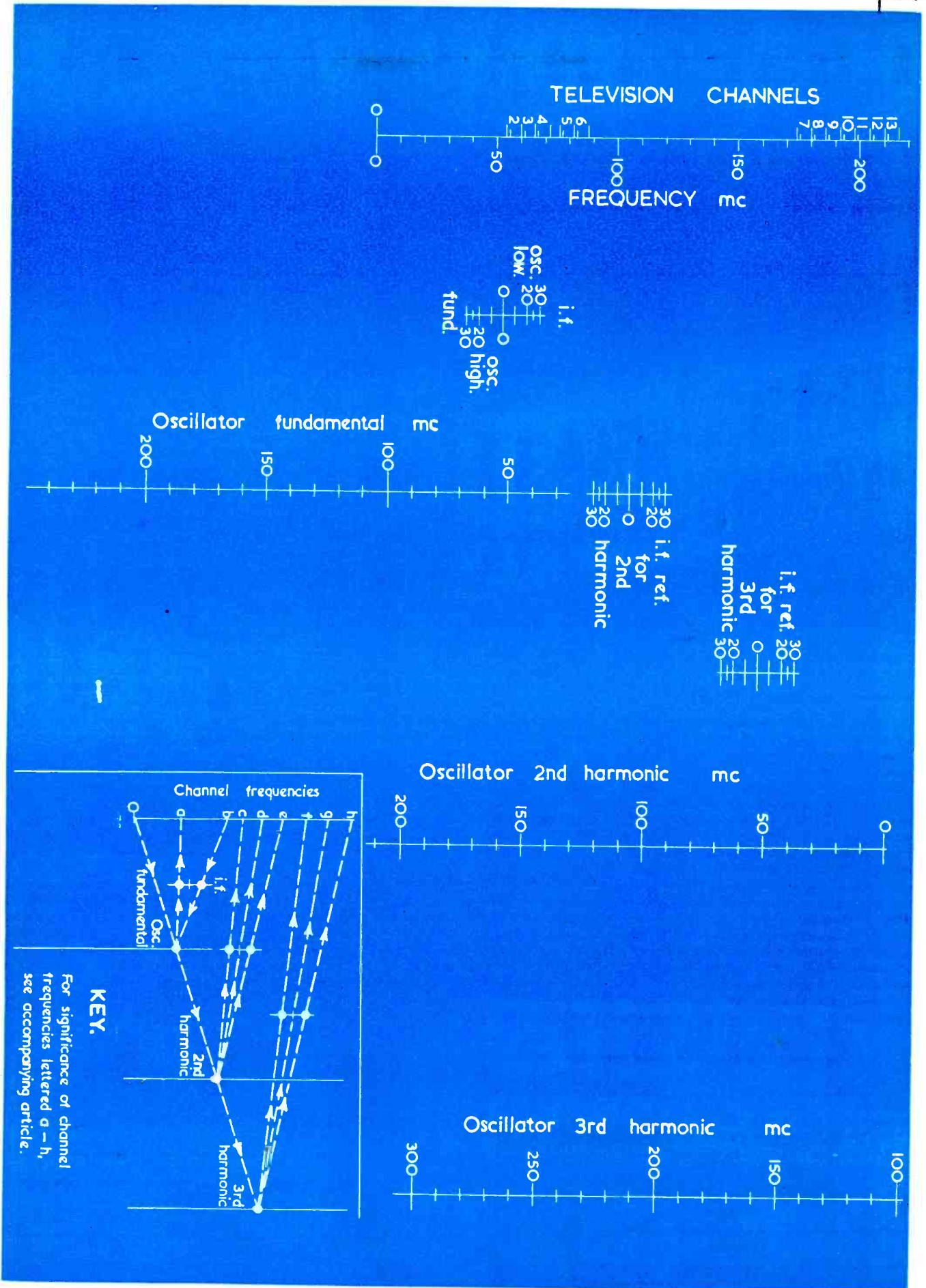

Chart 3—Nomograph for tracking down interference with any combination of intermediate and oscillator frequency.
 JANUARY, 1951

be produced when the oscillator harmonic is either 25.25 mc above or below another station) to the TELEVISION CHANNELS scale. Point *c* is found to be between the television bands, but point *e* falls directly on channel 13. Points *f* and *h* fall above the television bands. The 2nd harmonic of the oscillator is 25.25 mc below channel 13, and this channel is the probable source of interference. Note that an image of the

fundamental (drawn from the fundamental scale through OSC. LOW) would fall between the television bands, and could also be ruled out as a cause of interference.

If the oscillator is on the high side of the video carrier frequency, then the direction of reference indicated on the key will be reversed—a might be the received channel and *b* the second-channel frequency.

Oscillator radiation interference

Finally, in Group 2 comes the interference radiated by the local oscillator in another receiver set for reception of another channel. Chart 3 may be used for working out such possibilities, using the zero points on the I.F. REF. scales for 2nd and 3rd harmonics. As shown on the key, *b* or *a* might be the channel to which the interfering receiver is set, using the oscillator fundamental common to both, and possible channels where interference could be caused on another receiver are indicated by points *d* and *g*.

Starting from the interference received, the construction is shown by Chart 4. The channel where interference is picked up is at *a*. Reference through the zero points on the I.F. REF. scales to their respective harmonic scales, and back to the zero on the TELEVISION CHANNELS scale, gives two possible oscillator frequencies on the OSCILLATOR FUNDAMENTAL scale. Reference through the I.F. FUND. scale will show four possible points on the frequency spectrum, represented in Chart 4 by *b*, *c*, *d* and *e*, for the channel received by the interfering receiver. Generally two or three of these will be eliminated as being outside TV channels or having no service in the area.

Suppose, for example, that interference is being received on channel 12, and a receiver with a 25.25-mc i.f. is suspected. Let channel 12 be *a* and draw lines through the 2nd and 3rd harmonic zeros to intersect the 2nd and

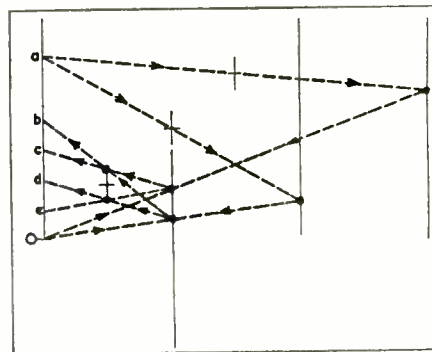

Chart 4—Example of the nomograph's use.

3rd harmonic scales, then back to zero on the TELEVISION CHANNELS scale. The two possible oscillator frequencies intersected are a little above 102 and 68 mc. Drawing lines from these points of intersection through OSC. HIGH 25.25, we find that the receiver could cause such interference by 2nd harmonic radiation when tuned to channel 5, represented by *d* in Chart 4. Point *e* is below the television band.

The author received considerable information and assistance from the August and September, 1950, copies of *Philco Service Merchandiser* and *RCA Data Sheet 1950 T11* (Supplementary information on Models T100, etc.) and wishes to express his appreciation to the publishers of these issues and to the compilers of the television interference articles contained in them.

RADIO-ELECTRONICS for

K-C Technicians Organize For TV

Over 20,000 receivers were in operation within seven weeks after television came to Kansas City, Mo. (the highest count in any area in the same period). This debut was unmarred by unruly technical problems or discontent among the set owners.

Video owes its smooth introduction to Kansas City largely to the foresight of four men who saw the service problems which confronted service companies in other cities and prepared the way for TV by forming a plan to mold a nucleus of qualified technicians to make installations and do service work.

These men are: Robert Samson, executive secretary of the Electrical Association of Kansas City; C. W. Donaldson, president of the Donaldson Radio and Electric Co.; Avery Fouts, service manager of the Jenkins Music Co.; and C. L. Foster, vice president of the Central Radio and Television School. Under their guidance and with the cooperation of other dealers and distributors, a new organization called the Television and Radio Technicians was formed.

Functioning under the wing of the Electrical Association, the primary objectives of this new organization are:

1. To improve the status of the radio service industry through education and association.

2. To prepare for television with an approved course of study.

3. To operate an employment agency for dealers and distributors seeking reliable technicians.

4. To keep membership in TRT open to industry members who measure up to its technical and ethical standards.

A special arrangement was made with the Central Radio and Television School to train 60 selected radio repairmen in a streamlined 42-week night

course. Stripped of all nonessentials, the course included basic electronic and television principles with lectures and study assignments, and laboratory work geared to prepare the student for working with television receivers.

The course is divided into three semesters which cover both lectures and workshop activity. Students go to school two nights a week, with one night devoted to lectures and the other to the laboratory work. Before graduating, each student must demonstrate his fitness in practical work and prove his knowledge before an examining board.

Distributor aid was enlisted to help cover the cost of the course, and 11 of the 14 wholesalers in the area underwrote the course by contributing \$125 apiece. The small balance in tuition is paid by the students.

Believing that one's education is never complete, TRT also runs a weekly clinic for practicing technicians as well as students in the school. Meeting each Thursday night from 6:30 to 9:30, the technicians bring in their tough problems, discuss them, and exchange suggestions. If a problem is too difficult for the clinic to cope with, one of the school's engineers is called in to help.

Regular once-monthly meetings are held for all members of TRT. At these sessions the executive committee sounds out the members on how the organization can improve its program, especially academically. Meetings also include at least one talk by experts in the field.

Publicity is another part of its program. Promotional tie-ups with electrical shows are arranged. A monthly newsletter, decals for shop windows, leaflets, display ads, lapel pins, and tool box emblems help to bring the setup to the public's attention.—Grier Lowry



Joe W. Allen receives first television training diploma from instructor Foster.

Servicing Picture Tube Circuits

By **CARL J. QUIRK***

THE most expensive single item in a television receiver is usually the cathode-ray tube. This—plus the current shortage of these tubes—discourages the average service shop from carrying spares. The many different types used in postwar television receivers further complicate the situation.

Therefore it is very important that the television service technician know how to isolate troubles that might be caused by a defective picture tube. He must know the various picture tube circuits currently in use. He also must understand the adjustments that directly affect the cathode-ray tube and know how to make these adjustments.

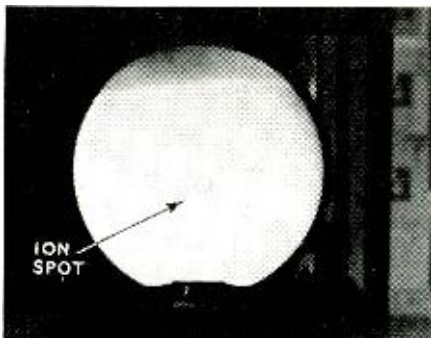

Fig. 1—An ion burn appears as a small round spot at the center of the raster.

The technician who does not have the "know-how" to diagnose picture tube troubles is at a distinct disadvantage if, for example, he is called upon to service a 19- or 20-inch set located in a difficult position (on a wall) in some public place, as a wrong guess that the picture tube is defective will result in a great deal of unnecessary work without fixing the receiver.

In one case an apparently inexperienced service technician diagnosed a condition as a faulty picture tube. The set owner (unimpressed by his apparent ability) called in another and more experienced serviceman. The second technician found a defect in the cable supplying filament power to the cathode-ray tube.

Since the magnetically deflected and focused tube is most common today, this article will deal primarily with defects of this type tube. There will be a few references to electrostatic tubes and certain interesting defects that could exist only in sets with these tubes.

Some of the following troubles are obviously caused by picture tube failure of one sort or another. There are,

however, several conditions that could be the fault of some other component or circuit in the receiver. The important thing is to determine whether the picture tube is at fault or a contributing factor.

Ion spots

The round dark spot that appears in the center of the raster in Fig. 1 is an ion burn or ion spot. Such a spot can exist in any electromagnetic-type tube that does not use some means for preventing it.

As shown in the figure, the spot is at the center of the screen and is about the size of a fifty-cent piece. These ion spots—or ion burns as they are sometimes called—are a result of gas ions forming a cluster on the screen of the cathode-ray tube. With magnetic deflection the amount of deflection is inversely proportional to the mass of the object deflected. Ions are many times heavier than electrons and so are not normally deflected. Thus they form the cluster at the cathode-ray tube face, with the resultant ion spot.

A certain amount of misinformation concerning ion spots has found its way into the field. The following presentation of facts concerning ion spots may help to offset some of it.

Ion spots do not occur in electrostatic deflection tubes. (In electrostatic tubes the ions and electrons are deflected equally.)

Ion spots do not occur in metal-backed (aluminized) tubes. Due to the low velocity at which ions travel as compared to electrons, they do not penetrate the metallic layer as do electrons.

Ion spots *do not* result from the afterglow that occurs on many sets immediately after they are turned off. (In many cases technicians have advised their customers to turn the brightness to maximum before shutting off the set. This eliminates the bright spot at the center of the screen which was thought to produce the ion burn.)

The ion spot is more noticeable if the high accelerating voltage is lower than normal. (This reduces the velocity of the electrons and keeps them from penetrating the ion cluster.) In other words, if the ion spot is visible at 8 kv and the high voltage is raised to 12 kv, it may no longer be present. However, this is not practical, since the higher voltage reduces picture size.

An ion burn is visible only when a raster is present. Thus, if the screen is actually burned due to a sweep failure, the burn is visible whether or not the raster is present.

Ion burns do not normally exist in tubes using ion traps. However, there

have been a few cases of ion burns in such tubes.

A correct conclusion that the reader will undoubtedly come to from the above information is that in an electromagnetic tube that does not use an ion trap, nothing can be done to prevent the condition from occurring. If the condition is annoying, the only cure is to replace the picture tube. Picture tubes using a straight gun with no means for trapping the ions are no longer manufactured. Instead a replacement tube with provision for ion trapping is used. For example, the 12RP4, which has a bent gun, replaced the 12JP4 that used a straight gun. The bent-gun-type 15DP4 replaced the 15AP4, a straight-gun tube.

Ion traps

Ion spots may be eliminated by one of two methods. (This applies to the design of the tubes since there is no field cure other than a tube replacement.)

Use a tube with a metal-backed screen. These tubes, the 12KP4 for example, have a phosphor screen with a very thin aluminum coating on the back surface. As long as the accelerating voltage is high enough, the electrons will pass through this very thin metallic backing. The ions, however, because of their mass, travel much slower and cannot penetrate the metal-

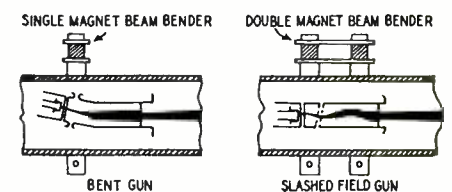

Fig. 2—Two types of electron gun that use magnetic traps to prevent ion burn.

lic backing; consequently no ion spot occurs.

The second and more popular method of overcoming the ion-burn problem is to use either a bent electron gun or what is known as a slashed-field gun.

Fig. 2 illustrates what is meant by a bent gun and a slashed-field gun. From a service technician's viewpoint the important difference between them is that the bent gun, as normally used, requires a single magnet for proper beam bending, while the slashed-field gun, as normally used, requires a double magnet for beam bending.

Cathode-ray tubes with slashed-field guns often use a double electromagnet. The magnet has a large coil and a small coil. The small coil should go forward on the neck of the tube, and the large coil toward the rear. If the

*Technical Service Section, Teleset Service Dept., Allen B. Du Mont Laboratories.

magnets are reversed, the raster, if any, will be very weak.

If a double permanent magnet is used, the weakest magnet is toward the front of the tube.

Ion trap adjustment

Adjustment of the ion trap magnet (or beam bender, as it is sometimes called), although simple, is exacting. Follow the procedure exactly as outlined below. In some cases, even though the procedure is followed carefully, the desired results may not be obtained. Factors that may account for this condition are listed after the procedure. Originally established for adjustment of single-magnet beam benders, this procedure may be used equally as well with the double-magnet beam benders.

Make all initial ion trap adjustments at the lowest possible setting of the brightness control. The correct position for the ion trap magnet is shown in Fig. 3. With the base end of the gun pointing up as shown, slide the magnet over the neck. The north pole should be to the left adjacent to pin No. 12 and the south pole to the right adjacent to pin No. 6. The magnet should be placed about $\frac{1}{4}$ inch in back of the bend in the gun for the first adjustment.

Rotate the ion trap magnet about an eighth of a turn each way and slide it

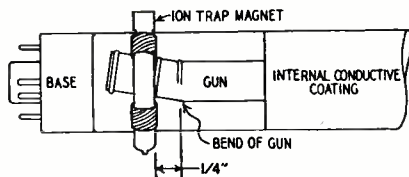

Fig. 3—The correct starting position for the trap magnet when adjusting it is about $\frac{1}{4}$ inch behind the gun's bend.

back and forth along the neck, stopping at the point of maximum brightness. Keep reducing the brightness as the system is brought into line to avoid damage to the tube. After alignment at low brightness, make a final adjustment with the brightness control set to where the raster just starts to "bloom". At this point the raster begins to expand rapidly or to defocus.

If no raster appears and all other conditions are normal, the magnet polarity may be reversed. Rotate the magnet through half a turn around the neck. Then make adjustments as before; if there is still no raster, try another magnet.

Do not leave the tube on any longer than necessary when making preliminary adjustments. If the electron beam is operated at high intensity before being brought into line with the ion trap magnet, it may damage the internal structure of the tube. For the same reason, it is important that the final adjustment of the magnet be made for maximum screen brightness. Failure to do this may result in burning the limiting aperture or the release of gas into the tube.

Sometimes it is possible to get two

brightness maximums when moving the ion trap magnet back and forth along the neck. The correct position is the one closer to the base of the tube. The second maximum is usually found when the magnet is close to the case of the focus coil. The magnetic shunting effect of the focus coil case on the ion trap magnet changes the field strength so that a brightness maximum is obtained in this incorrect location. Tubes should not be operated at the second maximum since spot centering is disturbed and there is a possibility of tube damage.

If the above procedure does not produce the desired results, investigate these possibilities:

The magnet may be bad. If it has been dropped, it may be completely demagnetized. To check, simply bring the magnet into contact with some magnetic metal and note if there is any attraction.

If the magnet has some magnetism, it may not be strong enough. If this is the case, a very dim raster will be present, accompanied by a bluish or greenish glow from within the electron gun. This glow indicates the electron beam is striking the limiting aperture disc instead of passing completely through the aperture. This condition may damage the tube.

The magnet may be too strong. This is not meant to imply that a magnet increases in strength with age. Recently Du Mont redesigned the bent gun used in their Teletrons to obtain better over-all focus. This redesign reduced the magnetic strength necessary for proper beam bending. All Du Mont Teletrons using the new design gun bear the letter X, Y, or Z immediately following the serial number.

Using an accelerating voltage of 12 kv in each case, the magnet strength necessary for the old tube was 58 gauss compared to 42 gauss for the new tube. Thus, if a 58-gauss magnet is used with a new tube, it is necessary to move the

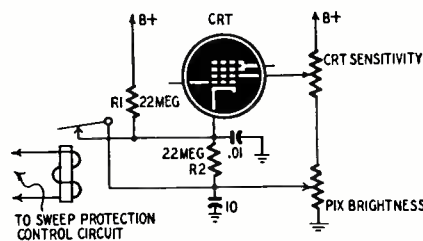

Fig. 4—A protection circuit for the picture tube that prevents the screen from burning in case the sweeps fail.

magnet back toward the base of the tube until the raster appears. In some cases it may be necessary to place the magnet on the base of the tube. If necessary, a magnetic shunt (a paper clip in an emergency) may be used to reduce the magnet strength so it can be put on the neck of the tube instead of the base.

No raster, normal sound

When this occurs, the owner of the television receiver invariably wants to

know if his picture tube has gone bad.

Check to see if the filament of the picture tube is lit. If not, the cause may be one of the following:

The cable connector attached to the base of the CRT may be defective. Press the cable socket against the tube base to make sure that the connection is good. Carefully jiggle the leads in the cable that supply the filament power.

Check the filament continuity of the picture tube. Obviously, an open filament means that a new cathode-ray tube is necessary.

If these two checks reveal no defects, measure the voltage at the cable terminals. If the picture tube is operated in parallel with the other tubes in the receiver and they are all lit, then the trouble must be due to defective wiring. In some receivers a separate transformer or a separate winding on the power transformer is used for the cathode-ray tube filament. In these sets the trouble could be due to the separate transformer or the winding of the power transformer being defective.

Check for the presence of adequate high voltage. The best method, of course, is actually to measure the high voltage with a meter. Certain electronic-type voltmeters have high-voltage probes that can be used for measurements up to 30 kv. If a meter is not available, the presence of high voltage can be checked by drawing an arc from the high-voltage lead with a pencil or a well-insulated screwdriver. The high-voltage lead should not be shorted to ground as it may damage the power supply. Simply bringing the insulated screwdriver in light contact will cause arcing if high voltage is present. Obviously, if there is no high voltage or if the high voltage is very low, the picture tube is immediately eliminated as the cause of the trouble, as it is very seldom that two troubles occur simultaneously.

Check the ion trap adjustment. This possibility, of course, depends upon the conditions under which the receiver is being checked. If the receiver is being operated for the first time in the field or if it has been moved from one place to another, then the ion trap could be at fault.

Check for leaky sweep coupling capacitors in receivers with electrostatic tubes. It is possible that a coupling capacitor between the sweep amplifiers (vertical or horizontal) and the deflection plates in the cathode-ray tube is leaky. This puts excessive d.c. on the deflection plates and positions the beam so far off center that it strikes the side of the tube and produces no raster. The range of the centering circuits is usually insufficient to return the beam to its normal path. This condition may easily be mistaken as being caused by a bad cathode-ray tube.

Measure the d.c. voltage between the grid and the cathode of the cathode-ray tube. Most cathode-ray tubes will cut off if the difference in potential between grid and cathode of the cathode-ray tube is 50 volts or more (grid

negative with respect to cathode).

If the difference in potential between the grid and cathode is more than -50 volts and cannot be lowered by the brightness control adjustment, obviously something is wrong with the circuit and not the picture tube.

Such a condition could possibly occur in some of the early post-war TV receivers. Among the many features found in these sets is a sweep protection circuit. The function of the protection circuit is to prevent the possibility of burning the screen if either horizontal or vertical sweep circuits should fail. If one or both sweeps should fail, the voltage at the cathode is raised so that the beam is cut off.

The portion of the circuit at the picture tube is shown in Fig. 4. A voltage-divider circuit consisting of R1 and R2 is connected from B-plus to the cathode and through the brightness control to ground. With the receiver operating normally, the relay is energized and shorts out R2. The brightness of the tube is then adjusted as usual by the brightness control.

If, however, one of the sweeps fails, the relay coil is de-energized and R2 is re-inserted into the circuit. Under this condition the voltage at the cathode rises to a high value. Since the resistance of the brightness control is so much lower than R2, it has little effect.

If the service technician is not aware of the sweep protection circuit and does not check the grid-cathode voltage, he might think the picture tube is bad.

Distorted raster

Distortion of the raster as shown in Fig. 5 is caused by a tube defect often mentioned in the literature but seldom found in the field.

The photograph is of a 19AP4 metal-cone tube, a portion of which was magnetized. The raster is pulled up in the left corner at point A and to the side at point B. Points A and B constitute the poles of a bar magnet, the bar consisting of a section of the metal cone.

This magnetization of the metal cone is a result of close contact with a strong magnetic field. The most likely strong magnet to be encountered is the magnet of a PM speaker. Obviously, if a metal-cone tube is placed on a workbench, it should not come in contact with a speaker field or any other source of magnetization.

If this condition occurs, the cone may be demagnetized by placing the magnetized portion in a strong a.c. field. The magnetized part can be located with a compass.

An a.c. field capable of demagnetizing the cone may be produced with a focus coil. Remove the case of the focus coil and apply a.c. to it through a Variac. The Variac is used to prevent excessive current flow through the focus coil with resultant overheating of the coil.

To demagnetize the cone, energize the coil and move its flat side over the magnetized area. Do not interrupt the a.c. while the coil is near the cone. The cone should be well out of the field of

the coil before the coil is de-energized.

Unstable sync

Indications of unstable sync vary according to the type of sync circuits used. If the horizontal sync circuit is a simple blocking oscillator, the picture will tear horizontally. Strips of the picture will tear out to the right. This condition is characteristic of the blocking oscillator circuit when no special a.f.c. circuit is used to control its frequency. It is also possible that the picture will jump vertically, indicating loss of vertical sync.

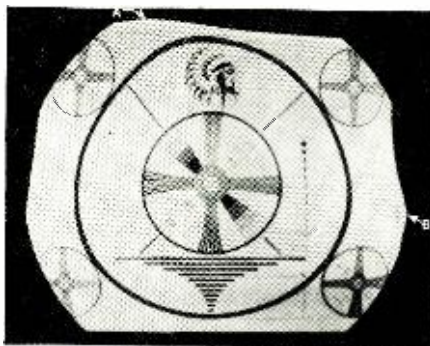

Fig. 5—A metal tube may distort the picture if its envelope is magnetized.

On sets using a horizontal a.f.c. circuit, the picture will try to pull out of sync horizontally, but the effect will not be the same as that for the simple blocking oscillator. The vertical sync will also be affected.

If this condition is a result of grid-cathode leakage in the picture tube, advancing of the brightness control will eliminate the sync instability. The reason for this will be explained later.

In some of the troubles listed previously, the visual indications were such that the picture tube was thought to be at fault before any checks were made. With this trouble, the cathode-ray tube is usually the last thing considered and even then the technician may not be certain exactly how the cathode-ray tube affected the sync.

Fig. 6 is a circuit of the type in which the above-mentioned symptoms would be caused by the C-R tube.

The sync take-off point is at the picture tube grid. The 6AL5 functions both as the d.c. restorer and sync take-off tube. The composite video signal is applied to the 6AL5 cathode, and at this point the video signal is black negative; that is, the portion of the signal that corresponds to black in the picture extends in a negative direction. The sync pulses also extend in the negative direction.

In normal operation, this black negative signal drives the cathode negative and permits the diode to conduct. However, this tube conducts only during the most negative portion of the signal; i.e. during the sync pulses. In this manner the sync signals are removed.

Let us assume that leakage exists between the grid and cathode of the picture tube. When adjusted for beam cutoff, the brightness control is so ad-

justed that the potential of the cathode is about +50 volts. However, with the leakage path between the grid and the cathode, some of this voltage appears at the 6AL5 cathode. In some cases this voltage may be as high as +30. This voltage biases the 6AL5 so that the applied signal must overcome this voltage before the tube will conduct. Thus, most of the sync is lost and the horizontal and vertical sweeps are unstable.

Advancing the brightness control will restore the sync to a stable condition, but this will result in very poor contrast due to excessive brightness. Increasing the brightness results in running the cathode toward ground and thus reduces the voltage at the cathode. If the cathode voltage is zero, the 6AL5 will have no bias due to the grid-cathode leakage.

The circuit shown here was used in the Du Mont RA-103D Teleset. A number of other receivers in the field use a similar circuit arrangement. Similar indications can be expected in any other receiver if there is a d.c. circuit between the grid of the picture tube and the sync separator tube.

No brightness control

If the brightness control fails to affect brightness there may be a heater-cathode short or leakage in the picture tube. In many receivers, the brightness control is located in the cathode cir-

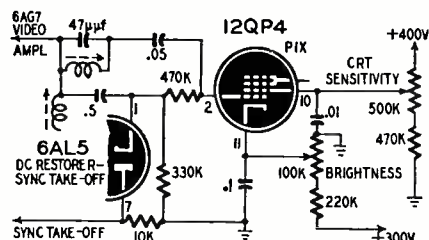

Fig. 6—Grid-cathode leakage may cause sync instability in circuits like this.

cuit and one side of the filament goes to ground. For this reason, a heater-cathode short will short out the brightness control. Fig. 6 shows such a circuit.

This condition sometimes can be cleared by lightly tapping the base of the cathode-ray tube. It is also possible to burn out the short by applying d.c. between the heater and cathode.

A positive solution (other than replacing the tube) is to use a separate filament transformer to supply the cathode-ray tube heater.

Disconnect the filament circuit from ground and its usual filament supply and connect it to the secondary of a 6.3-volt, 0.6-amp transformer. The transformer will permit tying the heater to the cathode. With the filament isolated from ground, the brightness control functions normally.

These troubles do not include all the possibilities involved in picture tube circuits. The service technician should acquaint himself with other possibilities that might exist. Often a little brainwork will save the cost of a new picture tube.

TV Station List

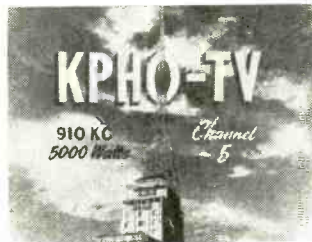

ALABAMA
 Birmingham WAFM-TV 13
 Birmingham WBRC-TV 4

ARIZONA
 Phoenix KPHO-TV 5

CALIFORNIA
 Los Angeles KECA-TV 7
 Los Angeles KFI-TV 9
 Los Angeles KLAC-TV 13
 Los Angeles KNBH 4
 Los Angeles KTLA 5
 Los Angeles KTSL 2
 Los Angeles KTTV 11
 San Diego KFMB-TV 8
 San Francisco KGO-TV 7
 San Francisco KPIX 5
 San Francisco KRON-TV 4

CONNECTICUT
 New Haven WHNC-TV 6

DELAWARE
 Wilmington WDEL-TV 7

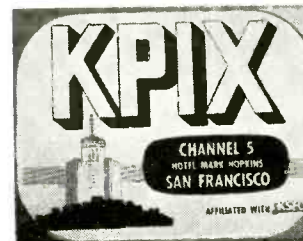
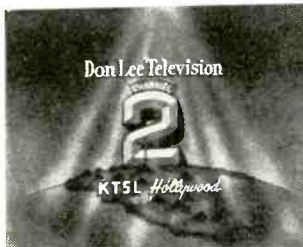

DISTRICT OF COLUMBIA
 Washington WMAL-TV 7
 Washington WNBW 4
 Washington WTOP-TV 9
 Washington WTTG 5

FLORIDA
 Jacksonville WMBR-TV 4
 Miami WTVJ 4

GEORGIA
 Atlanta WAGA-TV 5
 Atlanta WSB-TV 2

ILLINOIS
 Chicago WBKB 4
 Chicago WENR-TV 7
 Chicago WGN-TV 9
 Chicago WNBO 5
 Rock Island WHBF-TV 4

INDIANA
 Bloomington WTTV 10
 Indianapolis WFBM-TV 6

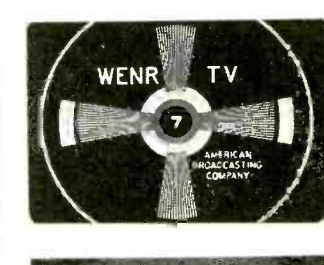
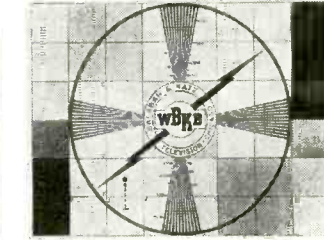
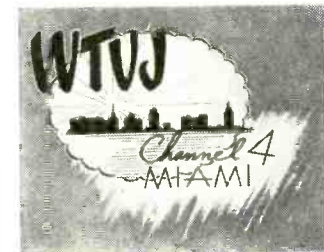
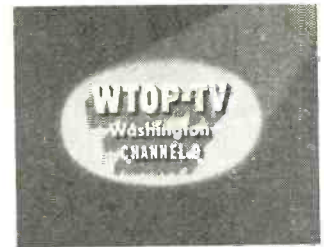
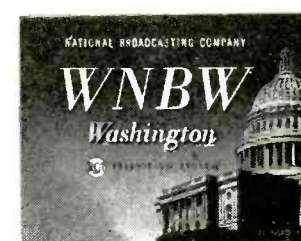
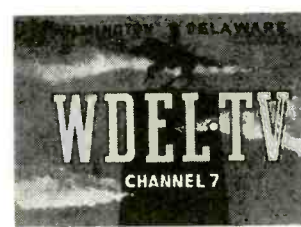

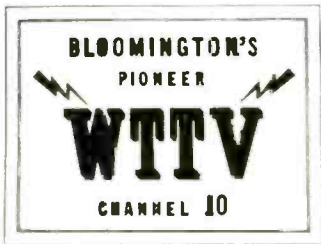

IOWA			
Ames	WOI-TV	4	
Davenport	WOC-TV	5	
KENTUCKY			
Louisville	WAVE-TV	5	
Louisville	WHAS-TV	9	
LOUISIANA			
New Orleans	WDSU-TV	6	
MARYLAND			
Baltimore	WAAM	13	
Baltimore	WBAL-TV	11	
Baltimore	WMAR-TV	2	
MASSACHUSETTS			
Boston	WBZ-TV	2	
Boston	WNAC-TV	7	
MICHIGAN			
Detroit	WJBK-TV	2	
Detroit	WWJ-TV	4	
Detroit	WXYZ-TV	7	
Grand Rapids	WLAV-TV	7	
Kalamazoo	WKZO-TV	3	
Lansing	WJIM-TV	6	
MINNESOTA			
Minneapolis	KSTP-TV	5	
Minneapolis	WTCN-TV	4	

MISSOURI			
Kansas City	WDAF-TV	4	
St. Louis	KSD-TV	5	
NEBRASKA			
Omaha	KMTV	3	
Omaha	WOW-TV	6	
NEW JERSEY			
Newark	WATV	13	
NEW MEXICO			
Albuquerque	KOB-TV	4	
NEW YORK			
Binghamton	WNBF-TV	12	
Buffalo	WBEN-TV	4	
New York	WABD	5	
New York	WCBS-TV	2	
New York	WJZ-TV	7	
New York	WNBT	4	
New York	WOR-TV	9	
New York	WPIX	11	
Rochester	WHAM-TV	6	
Schenectady	WRGB	4	
Syracuse	WHEN	8	
Syracuse	WSYR-TV	5	
Utica	WKTV	13	

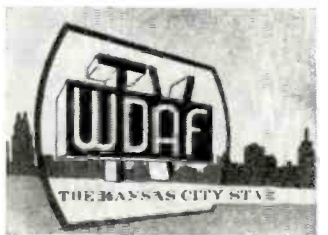

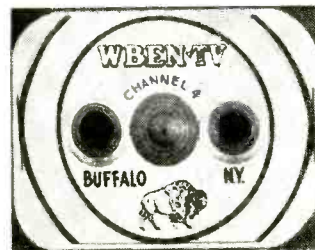
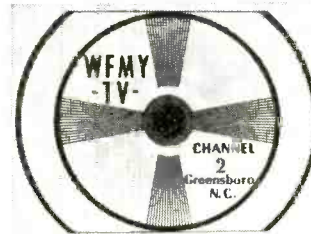
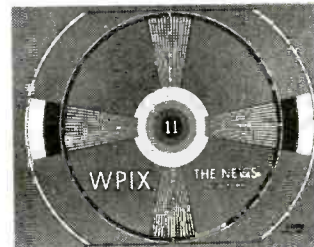
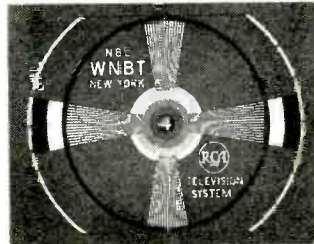
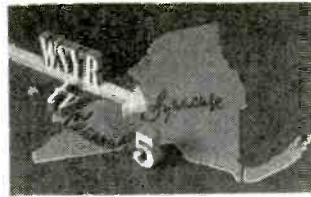
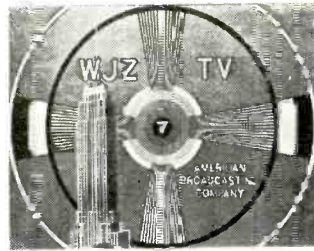
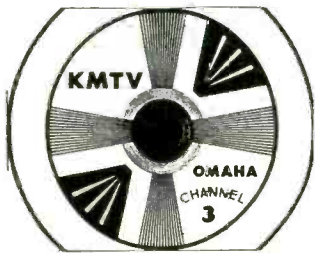

NORTH CAROLINA

Charlotte	WBTV	3
Greensboro	WFMY-TV	2

OHIO

Cincinnati	WCPO-TV	7
Cincinnati	WKRC-TV	11
Cincinnati	WLW-TV	4
Cleveland	WEWS	5
Cleveland	WNBK	4
Cleveland	WXEL	9
Columbus	WBNS-TV	10
Columbus	WLW-C	3
Columbus	WTVN	6
Dayton	WHIO-TV	13
Dayton	WLW-D	5
Toledo	WSPD-TV	13

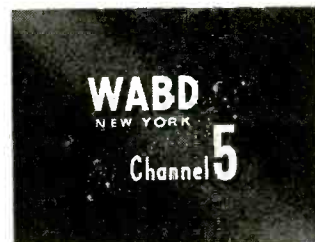

OKLAHOMA

Oklahoma City	WKY-TV	4
Tulsa	KOTV	6

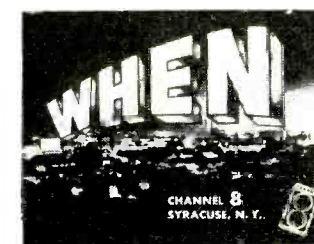

PENNSYLVANIA

Erie	WICU	12
Johnstown	WJAC-TV	13
Lancaster	WGAL-TV	4
Philadelphia	WCAU-TV	10
Philadelphia	WFIL-TV	6
Philadelphia	WPTZ	3
Pittsburgh	WDTV	3



RHODE ISLAND

Providence	WJAR-TV	11
------------	---------	----

TENNESSEE

Memphis	WMCT	4
Nashville	WSM-TV	4

TEXAS

Dallas	KRLD-TV	4
Dallas	WFAA-TV	8
Fort Worth	WBAP-TV	5
Houston	KPRC-TV	2
San Antonio	KEYL	5
San Antonio	WOAI-TV	4

UTAH

Salt Lake City	KDYL-TV	4
Salt Lake City	KSL-TV	5



VIRGINIA		
Norfolk	WTAR-TV	4
Richmond	WTVR	6
WASHINGTON		
Seattle	KING-TV	5
WEST VIRGINIA		
Huntington	WSAZ-TV	5
WISCONSIN		
Milwaukee	WTMJ-TV	3
OTHER AMERICAN STATIONS		
BRAZIL		
*Rio de Janeiro	PRG-3 TV	6
Sao Paulo	PRF-3 TV	3
CUBA		
Havana	CMUR-TV	4
*Havana	CMQ-TV	6
MEXICO		
*Mexico City	XEW	
Mexico City	XHTV	4

*Stations not operating at time list was compiled.

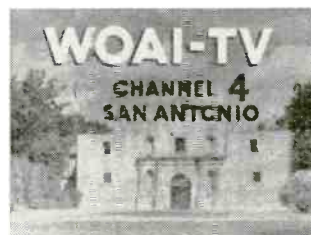
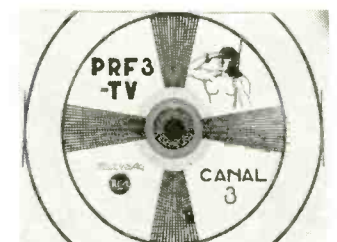
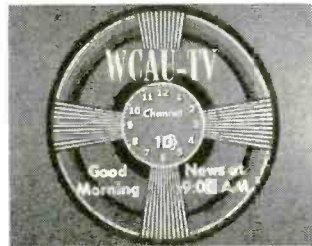
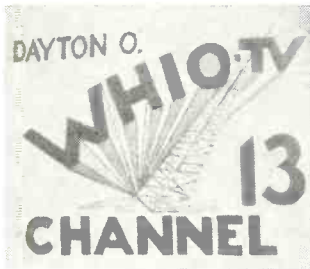
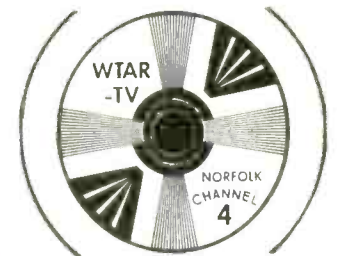
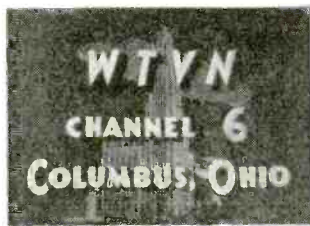
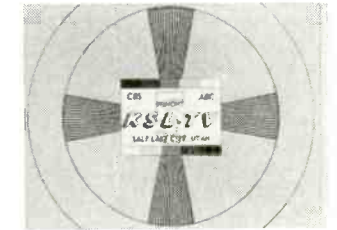
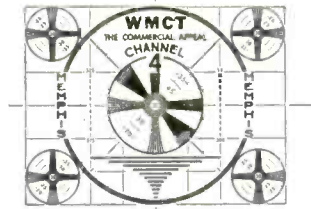
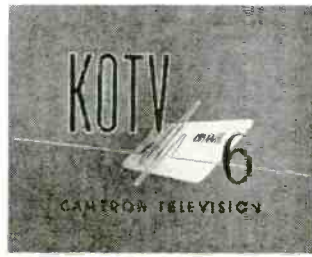

Trends in Television I.F.'s

By EDWARD M. NOLL

THE television receiver i.f. system must receive and amplify the desired television signal while closing the door on all undesired signals. Two types of i.f. systems are used in today's receivers—intercarrier and dual channel, (Fig. 1). Dual-channel systems have separate i.f. sections for picture and sound, which are segregated at the mixer output or in first and second following i.f. stages. Picture and sound intermediate frequencies are, respectively, local oscillator minus received picture carrier frequency and local oscillator minus received sound carrier frequency.

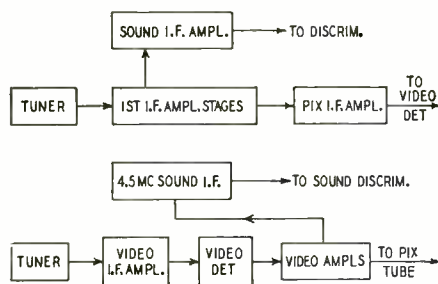

Fig. 1—The two i.f. types compared.

In the intercarrier system, the amplifier tubes that follow the mixer amplify and pass both picture and sound i.f. signals—building up the picture carrier to a higher level than the sound carrier. The picture carrier dominates at the video detector and the sound signal appears to it as a sideband of 4.5 mc. The video detector interprets this intercarrier beat between two carriers. The sound component of 4.5 mc is pulled from the composite video signal at the video detector or first video amplifier output and goes to a 4.5-mc i.f. strip.

Intercarrier system

The intercarrier system has a number of potential advantages:

1. Oscillator drift problems are minimized. Thus oscillator tuning should not be critical because the sound frequency in the 4.5-mc i.f. strip cannot vary with local oscillator tuning but is fixed at the original frequency separation of picture and sound carrier frequencies at transmitters. Thus tuning can have as its major objective—a good picture. Correct sound follows along with this adjustment for best picture.

2. The i.f. system can be simpler, less expensive, and (in some respects) easier to align. For example, sound-channel trap is not needed as sound is not blocked from the i.f. circuit. Absence of traps reduces the susceptibility of the system to phase distortion.

However, intercarrier units have been plagued by high noise levels in sound output. This *intercarrier buzz* level is so much a function of correct alignment,

tuning, and even contrast setting that the good possibilities of the intercarrier method are obscured. The major source of intercarrier noise is the interaction, in fact, the modulation of the sound by picture information. This noise can be minimized (usually it cannot be eliminated) with a superior limiter circuit or gated beam limiter-discriminator, and very careful alignment (particularly the secondary of the discriminator transformer). Note that signal interference in an FM system (the source of interference is picture signal and its relative levels with respect to 4.5-mc FM sound) *not only introduces amplitude modulation of sound but FM and phase-modulated noise components*. Thus a good limiter is not the complete answer. Response patterns of typical dual-channel and intercarrier systems are presented in Fig. 2.

Note that in the intercarrier stages of many models there are no adjacent-channel picture or sound traps. As a result interchannel spillover is very prevalent in those areas where adjacent channels have been allocated or in fringe areas where stations come in from various directions and levels.

Alignment of the typical intercarrier circuit is critical, because position of the picture carrier at 50% level is important from the standpoint of resolution and low-frequency response. Likewise it is very important to position the sound carrier down in the shelf to obtain a high sound level as well as low buzz.

In a video i.f. system, gain is a function of bandwidth and the number of stages. If to economize we reduce the number of stages, the necessary gain is obtainable only with a sacrifice in bandwidth. Speaking generally, resolution up to 4 mc can be obtained with four i.f. stages; 3 to 3.5 mc with three stages; and 2.5 mc with two stages. It is ironic that a few of those manufacturers who criticized the CBS color system because it is limited in geometric or horizontal resolution, market a black-white receiver decidedly inferior to the color resolution. Certainly there is no excuse, economic or otherwise, for an i.f. response down 6 db only 2.5 mc away from picture carrier frequency.

Interstage coupling circuits

Several basic interstage coupling circuits are used in the late model television receivers—stagger single- or double-tuned transformer, overcoupled, and bandpass (Fig. 3). Stagger-tuned types are still the most common, although the bifilar type of winding is widely applied. More gain per stage can be obtained with the double-tuned type of transformer although alignment is slightly more difficult.

The bifilar type of stagger-tuned

transformer has a number of advantages over simple stagger-tuning.

1. There is more effective isolation between output of one stage and input of next. No coupling capacitor is needed and a leakage problem is eliminated.

2. The grid time-constant is very short (no coupling capacitor) and strong noise bursts cannot charge the capacitor. This means that the signals have an open path and noise does not block or lower gain of the i.f. stages for an interval after each noise burst.

A bifilar winding consists of two separate windings positioned very near to each other and wound in the same direction. The usual form of bifilar winding in i.f. strips is a primary and secondary interwound (turn of primary, turn of secondary, turn of primary, etc., down the coil form). Turns are close-wound and often use thin triple insulation to prevent any d.c. leakage. Very close proximity produces almost perfect 1:1 coupling. Thus windings act as single inductor with the same resonant characteristics as a single-winding stagger-tuned stage—only one resonant adjustment is necessary.

The most important advantages of the stagger-tuned type of i.f. circuit are simple alignment procedure and far less trouble with regeneration, as each resonant circuit is tuned to a different frequency. A few receivers use two or three stagger-tuned i.f. stages and a single overcoupled stage. This expedient helps in obtaining a wider and more uniform response curve when just a few i.f. stages are employed.

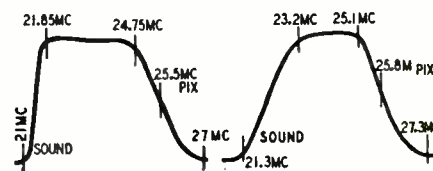

Fig. 2—Response curves of both systems.

There is a definite trend toward higher-frequency i.f. systems to minimize some of the more trying tuner problems. Wider frequency spacing between signal carriers and local oscillator means better tuner selectivity. Consequently, there is weaker oscillator feedback to the antenna system, a better image rejection ratio, and no local oscillator interference is caused on other channels. Although local oscillator frequencies are moved outside of the television band with the higher intermediate frequencies, radiation can still cause interference to other services. The FCC feels this radiation can be held down to 15 microvolts per meter at 100 feet. RMA believes receiver manufacturers can hold it down to 50 microvolts

without too high a cost factor. In spite of these opinions, our present receivers often radiate signals in the *thousands* of microvolts per meter at 100 feet.

Mixer to i.f. amplifier coupling

On the modern TV chassis there is always a substantial physical spacing between the mixer output of tuner and the first i.f. amplifier tube. An appreciable length of line must span the gap. This line is subject to capacitive losses to ground and stray pickup unless it is a low-impedance link. Low-impedance links, as typified by RCA and Zenith in Fig. 4, also minimize feed-through of spurious signals from the tuner as only resonant signals will be transferred. Only a resonant signal sees a low impedance via the link.

Any capacitance added by the link, although this might be rather high on long links, has an insignificant effect on the low-impedance connection. The added capacitance does not cause loss of signal, merely reducing somewhat the impedance of the link. It lowers reactance of the mutual element that controls coupling between the two tuned circuits. This can be compensated for in the design of the coupling arrangement.

A.g.c. system

In the modern receiver an a.g.c. system becomes an integral part of the i.f. unit, maintaining close control over the gain of the i.f. system. This control is fast acting and sets the bias level according to the strength of incoming signal. Thus a constant-level signal reaches the video amplifier. For reasonable differences in station signal levels it should not be necessary to change brightness-contrast settings when switching channels. However, the tuned circuits of the various stages are influenced by the biasing of the various i.f. tubes. Input capacitance of these tubes—because of the influence of Miller effect—varies with stage gain, which in turn is a function of biasing and a.g.c. As the receiver is switched from station to station, bias levels change according to signal strength. This changes resonant frequencies of tuned circuits (shift in input capacitance) and i.f. amplifier response becomes a function of received signal strengths.

Miller effect

Miller effect in an i.f. stage causes a change in input capacitance whenever the operating bias and gain of that stage is changed. As bias is decreased and stage gain increases, input capacitance of the tube also increases. Thus the resonant frequency of the tuned circuit with which this capacitance is associated also decreases, (Fig. 5-a). Resonant frequency increases with an increase in stage bias.

An opposite frequency-bias relation can be set up by using an unbypassed cathode. In such an arrangement effective input capacitance decreases with a decrease in bias and increases with more bias. For example, if bias is in-

creased, gain of stage falls and there is a weaker signal across the cathode resistor. Under this condition, the ratio of signals e_x to e_k is increased and the input capacitance has influence over a greater percentage of the total applied signal e_{in} (the sum of e_x and e_k must always equal applied signal voltage). This means effective input capacitance has increased. See Fig. 5-b.

Since our original bias has been increased, the higher input capacitance causes a decrease in the resonant frequency of tuned circuit—an opposite effect to Miller effect. With a bias decrease a greater percentage of the applied signal appears across R_k and input capacitance becomes less influential. Resonant frequency will then increase.

It is reasonable to expect that if we choose a proper value of R_k and insert a modifying capacitor from grid to cathode, as in Fig. 5-c (reduced capacitance change due to Miller effect) two opposite influences could be repressed and the resonant frequency changed very little with a shift in bias.

We can carry this idea a step further and expect that, with proper control of R_k and C_c , frequency could be made to shift in either way with bias change.

Philco controlled i.f. system

Philco has employed these vacuum-tube input relations to improve their i.f. system (RADIO-ELECTRONICS, Sept. 1950, page 74). It is a fact that in normal signal areas a good picture and good sound occur at the same setting of the fine tuning control with a properly aligned receiver. However, in a weak signal area and with a properly aligned receiver, best picture and best sound do not occur at the same setting. This is because the signal is weak and the picture carrier sets down 40-50% on the response curve. If fine tuning is varied until the picture carrier is up on the

flat-top of the response curve, picture synchronization is improved and the picture has better contrast. At this setting, however, sound is lost because the sound carrier frequency has been raised above the frequency of the sound i.f. or, in the case of intercarrier, is off the response curve entirely.

In the Philco compensated i.f. amplifier a special resonant shift is incorporated (Fig. 6) to raise the level of the picture carrier when a weak signal is received while leaving it at normal amplitude level for strong signals. This is done automatically without any shift whatsoever in the basic i.f. carrier frequencies, and therefore, no loss of sound when the receiver is tuned for the best picture on a weak signal.

A modifying capacitor is used to obtain a controlled amount of frequency shift due to Miller effect. In addition, an unbypassed cathode resistor of the proper value to dominate the Miller effect change by a definite amount is used. Thus when bias along the a.g.c. line decreases upon reception of a weak signal, cathode circuit action causes input capacitance to decrease and raises the tuned-circuit resonant frequency to a value higher than 25.5 mc. This boosts the amplitude level of the picture i.f. carrier frequency of 26.6 mc. In fact the relative amplitude level of picture carrier when a weak signal is received is roughly double that on a weak signal.

In the same i.f. unit Miller effect is accentuated by grounding the cathode of a few of the i.f. amplifier tubes. In these cases it was found helpful to decrease the resonant frequencies of some of the higher-frequency tuned circuits to raise picture and sound carrier levels when weak signals are received, dropping the 27-mc tuned circuit lower to raise picture carrier level and dropping the 23-mc lower to improve sound carrier level at 22.1 mc.

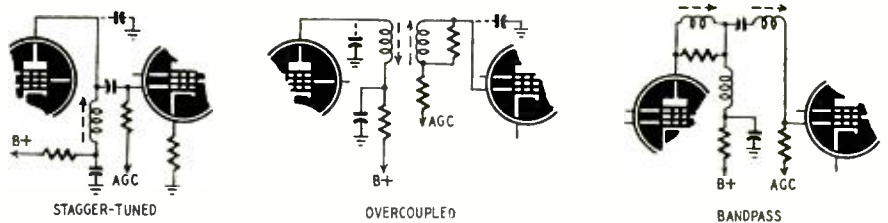

Fig. 3—Above, the three chief types of coupling in television i.f. amplifiers.

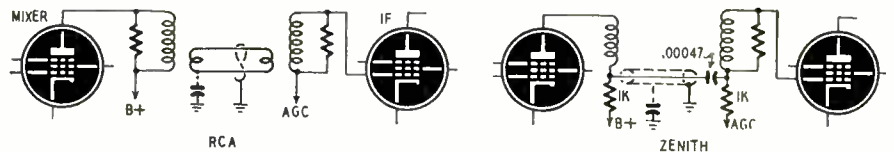

Fig. 4—Open-wire or coaxial links are used to couple mixer and i.f. stages.

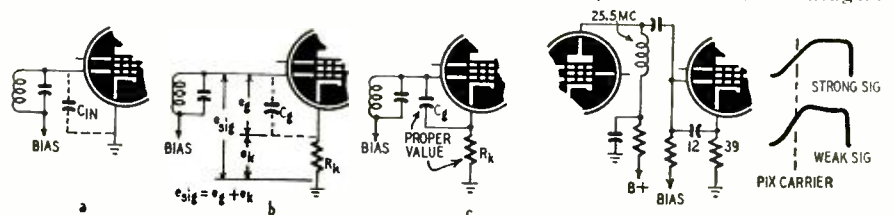

Fig. 5—How Miller effect is controlled. Fig. 6—This i.f. chases the signal.

Big - Tube Conversions are Profitable

Replacing small TV tubes with big ones makes money for the skilled technician
By MATTHEW MANDL*

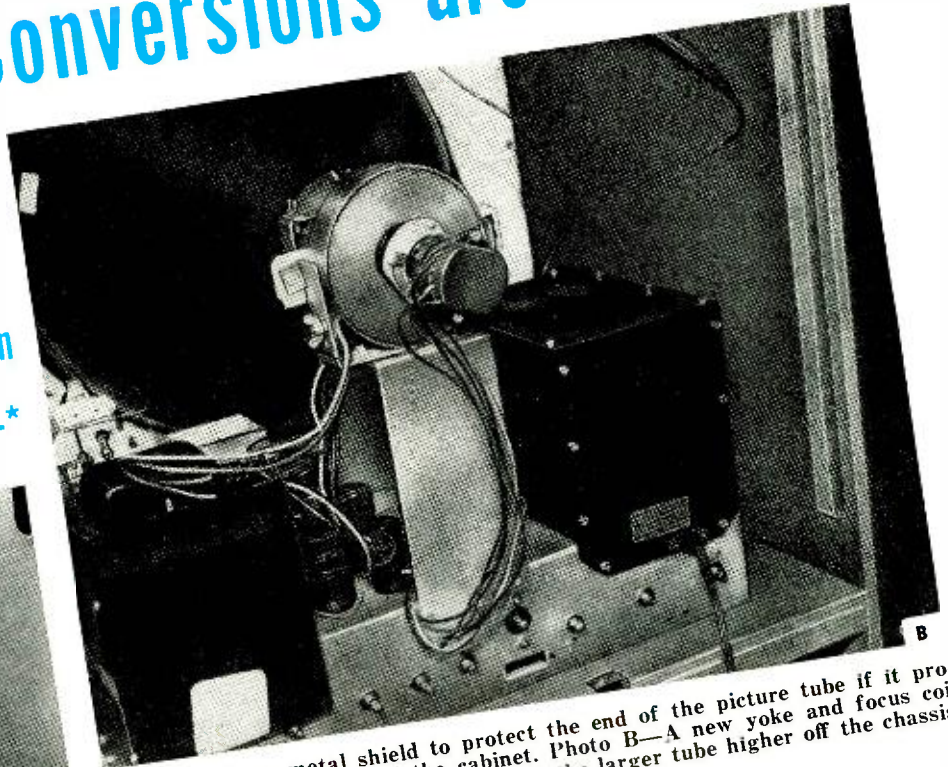
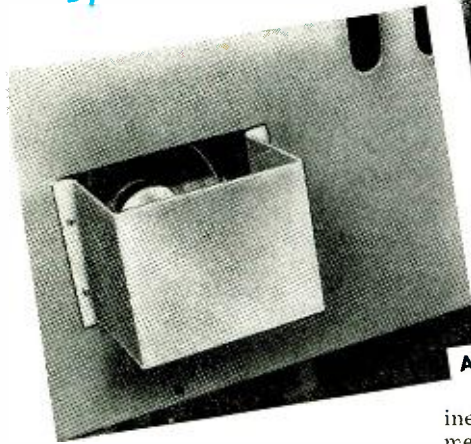

Photo A—Use a metal shield to protect the end of the picture tube if it protrudes through the back of the cabinet. Photo B—A new yoke and focus coil assembly bracket may be needed to raise the larger tube higher off the chassis.

MANY small set owners cannot afford the larger receivers. This means there is a ready market for the competent technician who can install a larger picture tube and make the necessary circuit changes for good performance. In fact, many alert service organizations are already busy with this profitable venture. The cost, compared with the price of a new set, is low enough to attract customers, yet affords a good margin of profit for the technician.

Three factors must be considered for any conversion: the cabinet size, the tube type, the necessary circuit changes. The size of the present cabinet and of the desired screen are very important, for any circuit can be modified to accommodate tubes from the 12- to 19-inch or larger size. If the existing cabinet must be used, then the tube size will be limited to the next larger one unless the cabinet is exceptionally roomy. If, however, the customer is willing to pay for a larger cabinet, tube size is no problem.

Of course some receivers have a very crowded cabinet which would not accommodate any larger tube. In such cases a new cabinet or installing the larger tube in a separate cabinet are the only alternatives. A separate cab-

inet for the tube alone is not recommended because it leaves a dead screen on the original receiver and requires interconnecting cables. A new cabinet is preferable—one that will hold both the old chassis and the new tube.

Cabinet changes

The technician must estimate the maximum usable tube size. The front dimensions of the cabinet will generally set the limit. Most 10-inch tubes have a face diameter of 10½ inches and a length of about 17½ inches. Some of the

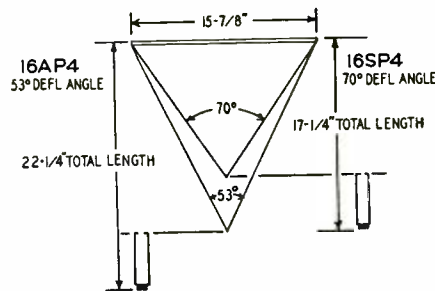

Fig. 1—Using a large deflection angle reduces the length of the picture tube.

old cabinets will take 12-inch tubes easily, for the difference in width is only a couple of inches and some types (such as the 12KP4 and the 12QP4) have the same length as the 10-inch tubes.

The 14-inch rectangular tubes can also be used, because they are actually about an inch shorter than the 10-inch types. They are shorter because they have a greater deflection angle. If the beam is swept over a wider angle, the tube can be made much shorter for a given screen size. This is shown in Fig. 1, which compares the 16AP4 and the 16SP4.

Both tubes have a face diameter of 15 7/8 inches, but the 16AP4, which has a deflection angle of 53 degrees, has an overall length of 22 1/4 inches. The 16SP4, however, is only 17 1/4 inches long because the larger deflection angle (70 degrees) allows shorter construction. (Fig. 1 is for comparison only, since deflection starts at the gun and not the tube base.) Thus, the 16SP4 is actually shorter in over-all length than most of the 10-inch types!

If the new tube is longer than the original tube, it may protrude through the back of the cabinet if the extended part is protected by a metal shield. Make this shield from heavy gauge tin or sheet metal. Cut a hole in the back



Fig. 2—Basing diagrams for kinescopes

RADIO-ELECTRONICS for

*Technical Institute—Temple University

panel of the cabinet to fit the neck of the tube, and bolt the shield on to prevent tube damage as shown in Photo A. This is a sensible procedure, for it is a waste of space to use a deeper cabinet merely for the tube neck alone. Several commercial receivers use this arrangement to decrease cabinet size.

The front of the cabinet will have to be cut out more to provide sufficient opening for the tube face. Some of the older receivers have a removable mask and this simplifies the procedure. With others, a larger opening must be cut and a new mask fitted over it. Panel masks to accommodate all tube sizes (both rounded edge and rectangular) are available from wholesale houses at low cost.

Since the larger tube will set the neck higher above the chassis, a new yoke and focus coil assembly bracket must be installed in place of the small one. These are also available from various wholesale houses, and come in several heights for the type tube used. An assembly bracket for a 16-inch picture tube is shown in Photo B.

The tube type

Tubes with deflection angles up to 65 degrees can usually be interchanged without changing the deflection yoke. If the new tube has a greater deflection angle and it is to replace one having a smaller deflection angle, a wide-angle deflection yoke must be used. This is important to consider for it means that some tubes not only require circuit changes, but parts replacement as well.

All 10- and 12-inch picture tubes have deflection angles of 50 to 56 degrees and can be replaced with larger tubes without yoke change if the larger tubes do not have deflection angles in excess of 65 degrees. Table I lists a representative group of these tubes. This list does not contain any rectangular types, for these all have a 70-degree deflection angle.

Table II lists tubes with deflection angles greater than 65-degrees and this includes the 19- and the 22-inch rectangular types. All tubes (both Tables I and II) have socket connections as shown in Fig. 2-c except the 10DP4, the 10MP4, and the 12VP4 which are shown in Fig. 2-a and 2-b. The 10DP4 uses electrostatic focus.

The new tube should have the same type ion trap magnet (beam bender) as the old tube, particularly if the coil type is used. Replacing the double field coil type with a tube requiring a single magnet means the old beam bender must be fastened to the chassis and a single-magnet type purchased for the new tube.

Another consideration is the outer conductive coating which, with the inner graphite coating and the glass dielectric, acts as the second filter capacitor of the high-voltage system. If the new tube has no outer conductive coating, a 500- μ f high-voltage filter capacitor must be wired into the high-voltage power supply circuit to avoid ripple.

With some tube types being scarce,

however, it may be necessary to use one requiring the beam-bender change and capacitor addition. While these units are not costly, they do involve a little more time for the conversion process.

Tubes with gray filter face plates reduce ambient light reflections. This may be an added selling feature, but is not of prime importance in tube conversion. If all other factors fall into convenient replacement and availability, the gray filter face plate is of secondary importance.

Circuit changes

As a rule, 10,000 volts will operate 12-inch tubes; 12,000 volts is enough for 16-inch tubes; and 14,000 volts is adequate for the 19-inch tubes. Since most 10-inch receivers have high-voltage supplies which furnish about 9,000 volts, few changes are necessary when these are replaced with 12-inch tubes.

Often a 9,000- or 10,000-volt supply can be boosted by slight circuit changes to operate 16-inch tubes such as the 16AP4 or the 16CP4 which have low deflection angles. A number of such changes are possible with the kick-back-type high-voltage system as shown in

Fig. 3 without having to replace the horizontal output transformer.

Measure the potential with a high-range v.t.v.m. (or one with a high-voltage probe) to determine what voltage is

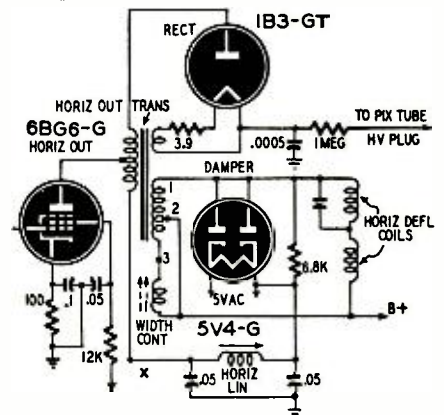

Fig. 3—The kickback type of high-voltage supply used on older 10-inch sets.

available. If it is only about 7,000 volts, a voltage-boost doubler system will be necessary. If 9,000 volts or more are available, two or three thousand more can usually be secured by the proce-

Table I—Small-Angle Tubes

Type	Length (Inches)	Face Diameter (Inches)	Defl. Angle (Degrees)	Envelope	Type Beam Bender
12LP4	18 $\frac{3}{4}$	12-7/16	54	Glass	Double
12QP4	17 $\frac{1}{2}$	12-7/16	55	Glass ¹	Single
12TP4	18 $\frac{3}{4}$	12-7/16	54	Glass ¹	Double
12UP4	18 $\frac{3}{8}$	12-7/16	54	Metal ¹	Double
12VP4	18	12-7/16	55	Glass ¹	Double
15CP4	21 $\frac{1}{2}$	15 $\frac{1}{2}$	57	Glass ¹	Double
15DP4	20 $\frac{1}{2}$	15 $\frac{1}{2}$	57	Glass ¹	Single
16AP4	22 $\frac{1}{4}$	15 $\frac{7}{8}$	53	Metal ¹	Double
16CP4	21 $\frac{1}{2}$	15 $\frac{7}{8}$	52	Glass ¹	Double
16DP4	20 $\frac{3}{4}$	15 $\frac{7}{8}$	60	Glass ¹	Double
16EP4	19 $\frac{5}{8}$	15 $\frac{7}{8}$	60	Metal ¹	Double
16FP4	20 $\frac{1}{4}$	16 $\frac{1}{8}$	62	Glass ¹	Single
16HP4	21 $\frac{1}{4}$	15 $\frac{7}{8}$	60	Glass	Double
16JP4	20 $\frac{3}{4}$	16 $\frac{1}{8}$	60	Glass	Double
16LP4	22 $\frac{1}{4}$	15 $\frac{7}{8}$	52	Glass	Double
16MP4	21 $\frac{3}{4}$	16 $\frac{1}{8}$	60	Glass	Double

¹ Require second high-voltage filter capacitor. Glass types have no outer conductive coating.

Table II—Large-Angle Tubes

Type	Length (Inches)	Face Size (Inches)	Defl. Angle (Degrees)	Envelope	Type Beam Bender
14BP4 ¹	16-13/16	9-11/16 x 12 $\frac{1}{2}$	70	Glass	Double
14CP4 ¹	16 $\frac{3}{4}$	9-23/32 x 12-17/32	70	Glass	Single
14DP4 ¹	16 $\frac{3}{4}$	9-23/32 x 12-17/32	70	Glass ²	Double
14FP4 ¹	16 $\frac{1}{8}$	9-11/16 x 12 $\frac{1}{2}$	70	Glass ²	Single
16GP4	17-11/16	15 $\frac{7}{8}$	70	Metal ²	Single
16KP4 ¹	18 $\frac{3}{4}$	11 $\frac{1}{2}$ x 14 $\frac{3}{4}$	70	Glass	Single
16QP4 ¹	19	11 $\frac{1}{2}$ x 14 $\frac{3}{4}$	70	Glass ²	Double
16RP4 ¹	18 $\frac{3}{4}$	11 $\frac{1}{2}$ x 14 $\frac{3}{4}$	70	Glass	Double
16SP4	17-5/16	15 $\frac{7}{8}$	70	Glass	Double
16TP4 ¹	18 $\frac{1}{8}$	11 $\frac{1}{2}$ x 14 $\frac{3}{4}$	70	Glass	Single
16UP4 ¹	18 $\frac{1}{8}$	11 $\frac{1}{2}$ x 14 $\frac{3}{4}$	70	Glass ²	Single
16VP4	17-3/16	15 $\frac{7}{8}$	70	Glass ²	Single
16WP4	17 $\frac{3}{4}$	15 $\frac{7}{8}$	70	Glass ²	Double
16XP4 ¹	18 $\frac{3}{4}$	11 $\frac{1}{2}$ x 14 $\frac{3}{4}$	70	Glass ²	Double
16YP4	17-5/16	15 $\frac{7}{8}$	70	Glass	Single
17AP4 ¹	18 $\frac{3}{8}$	12 $\frac{1}{4}$ x 15 $\frac{3}{8}$	70	Glass ²	Single
17BP4 ¹	19 $\frac{1}{4}$	15-21/64 x 12-9/64	70	Glass	Single
17CP4 ¹	19	16-1/16 x 12 $\frac{3}{8}$	70	Metal ²	Single
19AP4	21 $\frac{1}{2}$	18 $\frac{5}{8}$	66	Metal ²	Single
19DP4	21 $\frac{1}{2}$	18 $\frac{5}{8}$	66	Glass	Double
19EP4 ¹	21 $\frac{1}{8}$	17 x 13-3/32	70	Glass	Double
19FP4	22	18 $\frac{7}{8}$	66	Glass ²	Double
19GP4	21 $\frac{1}{4}$	18 $\frac{7}{8}$	66	Glass ²	Single
20BP4	28 $\frac{3}{4}$	20	54	Glass ²	None
22AP4	22 $\frac{7}{8}$	21-11/16	70	Metal	Single

¹ Rectangular types—deflection measured diagonally.
² Require second high-voltage filter capacitor. Glass types have no outer conductive coating. Letter A added to the above type denotes gray filter face plate, except for 16GP4 and rectangular types, which all have filter face plates.

dures detailed in the following paragraphs. Try a new 6BG6-G and a new 1B3-GT tube, because low emission from either type in an old set could drop the high voltage below normal.

One method which gives increased sweep and voltage is to place a capacitor across the secondary of the horizontal output transformer. Try values from .01 to .035 μf , for some values work better than others in different circuits. Put the capacitor across points marked 1 and 2 in Fig. 3, or across 2 and 3. The width coil can be removed entirely, and the tap at 2 removed and placed at point

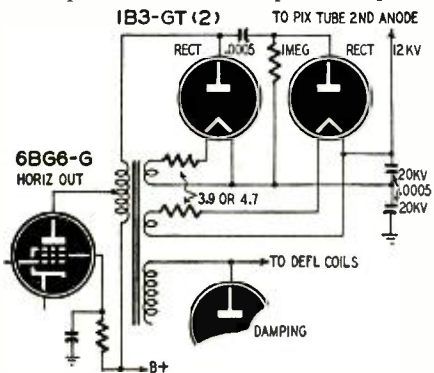

Fig. 4—A high-voltage doubler circuit. This supply delivers as much as 13 kv.

3. Try a capacitor of about .035 μf between these new points (1 and 3). This often increases sweep over 1 inch and raises the voltage more than a thousand. There is usually sufficient latitude in vertical and horizontal sweep (height and width controls) to blow the picture out to proper size for the 12- or 15-inch tubes (and occasionally for the 16-inch also).

A smaller value of screen dropping resistor in the 6BG6-G horizontal output tube will give additional sweep and high voltage. However, if the regulation of the low-voltage supply is poor, the added screen current may drop the plate voltage and actually drop the output. Experiment with different values for the screen resistor to get the desired

amount of increase in the high voltage.

Returning the negative side of the 500- μf high-voltage filter capacitor to terminal 1 of the horizontal output transformer in Fig. 3 instead of to ground will increase the high voltage a little, too. Another way to increase both sweep and high voltage is to return the plate of the horizontal discharge or oscillator tube to the boosted B-plus (X in Fig. 3) through a decoupling and dropping R-C circuit. Returning the plate of the vertical output tube to this point will increase the vertical drive if more is needed. Decreasing the value of the plate resistor of the horizontal discharge tube will also help.

The 6BG6-G can be replaced with a type 6CD6-G for more sweep and higher voltage. These tubes are interchangeable as far as socket connections and operating voltages are concerned. However, the 6CD6-G takes a 2.5-amp filament current compared to 0.9 amp for the 6BG6-G. When making the change, be sure the power transformer can take the added drain, or else install an additional heater transformer.

If the original high-voltage system delivers only 7,000 volts, it must be rebuilt. Fig. 4 shows a voltage doubler circuit with a horizontal output transformer having two filament windings for the rectifier tubes. This system does not actually deliver double the original voltage, but a lesser amount depending on the load. With 7,000 volts initially, however, 12,000 or 13,000 volts will be available for tubes as large as the 19-inch variety. With good emission 1B3-GT tubes, and a 6CD6-G horizontal output tube, the high voltage will be enough for the 19-inch tubes.

For 16-inch tubes, which need only 12,000 volts for high brilliancy, the voltage of the doubler can be reduced by using 250- μf capacitors in place of the 500- μf units. This will decrease the regulation somewhat and drop the potential. A bleeder consisting of ten 10-megohm resistors in series can also be placed across the high-voltage

output for a slight reduction if the voltage is a little too high for the 16-inch tubes. Using ten resistors assures smaller voltages across the individual units, with less danger of flashover.

Another way to increase the high voltage as well as the horizontal sweep is to use a combination horizontal deflection-output and high-voltage transformer, such as the RCA 223T1, in the circuit shown in Fig. 5. Autotransformer action supplies high voltage to the rectifier tube, and the transformer has a separate winding for the rectifier filament.

This circuit, when used with deflecting yokes such as the RCA 209D1, provides ample deflection for 70-degree tubes and it has a high-voltage output of about 14,000.

Excessive high voltage will prevent full deflection and will result in a smaller picture. It also increases the electron beam velocity and the deflection coils cannot sweep the beam fully. For this reason it is important that the high voltage be measured to make sure it does not exceed the nominal value for the tube used.

Some kits on the market furnish complete hardware and other components necessary for conversion. A complete doubler kit runs less than \$15 and many dealers stock these for conversion from 10- to 16-inch tubes. When converting from 10 to 12 inches, however, the yoke and horizontal output transformer need not be changed, and only a few minor alterations are necessary to get satisfactory results.

Wide-angle 70-degree deflection yokes and other components such as larger horizontal output transformers are sold separately and come in a variety of makes and prices. A knowledge of the parts available on the market coupled with conversion know-how is a sure avenue to greater profits for the technician.

Ion trap and focus coil

When installing some types of tubes, it may be necessary to make changes in the focus circuit to provide more or less current through the focus coil. If more current is required, install a bleeder resistor between the low-voltage side of the coil and ground. Adjust the resistance of the bleeder so the sum of the focus and bleeder currents equals the focusing current required for the new tube. When the tube requires less current, a suitable resistor should be connected in parallel with the coil. The resistor is adjusted so the excess current flows through it instead of through the coil.

Adjust the ion trap or beam bender as soon as the new tube is installed. Turn down the brightness so the picture is barely visible. Move the trap back and forth while rotating it slightly from side to side. Position it for the brightest raster. Turn up the brightness to average and adjust the focus coil for sharpest lines. Touch-up the position of the ion trap for brightest raster.

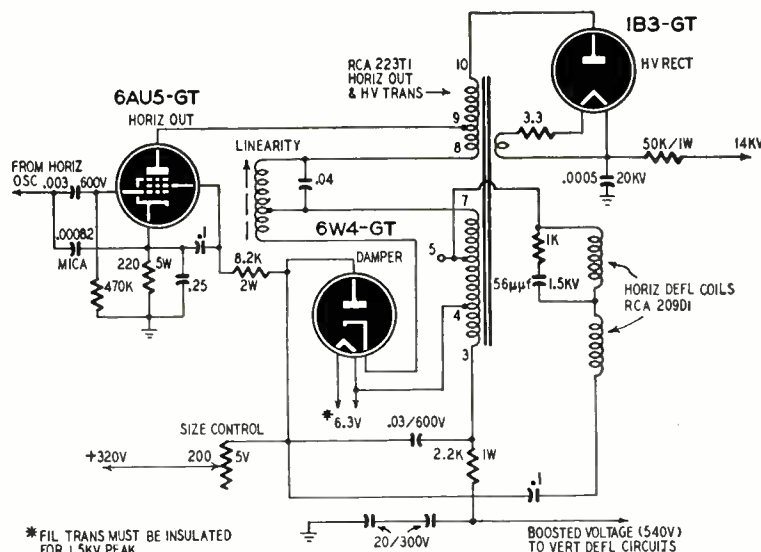

Fig. 5—High-voltage circuit for tubes with large-angle deflection and using up to 14 kv. This supply uses a specially-designed ferrite core transformer.

TV Progress Abroad

By E. AISBERG*

OLD Europe's 10 millions of square kilometers are divided among more than two dozen countries, inhabited by a total of 500 million people. With an area only 20% smaller, the United States forms a single country of 150 million inhabitants.

Here lies the fundamental difference between the development of television on the two sides of the Atlantic. In the United States, a single standard has been adopted over the whole vast territory. We have seen the magnificent advance of television which has resulted from the possibility of producing great numbers of television receivers at a moderate price.

The situation is far different in Europe. There are four principal standards, without counting variations. Television, from a practical point of view, exists only in two countries, France and Great Britain, which already had television service before World War II.

Great Britain maintains its standard of 405 lines. Its programs are transmitted from Alexandra Palace at London and from the newly inaugurated Sutton Coldfield station near Birmingham, which is connected with London by radio relays. A third transmitter is being erected at Holme Mass (near Huddersfield) and will probably be completed by the middle of 1951. The number of television receivers is now greater than 400,000, and they cannot be manufactured fast enough to satisfy the increasing public demand. The success of English television is due to the excellent quality of the programs and relatively low cost of receivers.

In France, after the liberation, television transmissions were resumed from Paris, using 455 lines. Later, after numerous discussions, the definite standard of 819 lines was adopted. Owners of television receivers were reassured by a law guaranteeing 455-line transmissions till 1958. Meanwhile, high-definition 819-line transmissions have commenced from Paris as well as from the new transmitter at Lille, which is linked to Paris by radio relays working on 30-centimeter waves. Another transmitter is being assembled at Lyons.

The number of viewers increases very slowly in France, chiefly because of the high price of receivers—a price which puts them out of reach of the medium-income portion of the population. In addition, the programs are not always interesting. They are composed largely of film—too often old and of mediocre quality.

The total budget devoted to television

in France is very small. The technicians and actors are performing veritable prodigies and making real sacrifices to assure regular and more or less satisfactory television service. Remember that in France (as in England) no advertising is permitted on television or radio, and its resources come entirely from taxes.

It is difficult to estimate the number of French television viewers exactly. A large number of them prefer not to declare their equipment officially, thus avoiding the tax of 2,500 francs per annum. The closest guess is about 20,000 viewers.

There are as yet no regular television programs in European countries other than England and France (and possibly Russia). These countries had been marking time pending the adoption of a European standard. Studies to that end have been made by a commission of the Consultative Committee of Radiocommunications and comprising 60 delegates representing 15 countries. At the final meeting held in London May 8, 1950, the following stage had been reached:

"Systems based on 405, 525, 625, and 819 lines were examined. The delegates of France, the United Kingdom, and the United States have confirmed that their countries will continue to use their present standards.

"France and the United Kingdom maintain their previous proposition envisaging the unification of the standards used by the Paris and London transmitters.

"Austria, Belgium, Denmark, Italy, the Netherlands, Sweden and Switzerland have declared themselves in favor of the 625-line system and have addressed an appeal to their colleagues inviting them to reconsider their position."

Why does 625 lines appear to be the future European television standard? It is, to all intents and purposes, the same as the American standard. In Europe, all the electric power systems operate at 50 cycles. To avoid interference from the 50-cycle hum, all European television systems use 25 images per second, each composed of two interlaced fields.

Thus, the number of lines traced per second in the European standard is:

$$625 \times 25 = 15,625 \text{ lines per second.}$$

The U. S. standard, with 525 lines 30 times per second, is:

$$525 \times 30 = 15,750 \text{ lines per second.}$$

We see that the two standards are practically identical. With the same bandpass the European system will have a little better vertical and the same horizontal definition as the American.

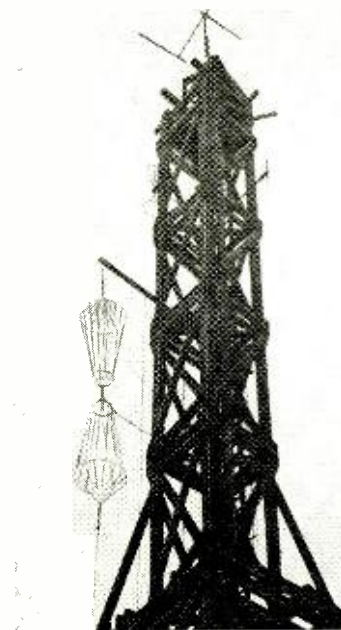

View of the 819-line transmitter tower.

Now that the new European standard's close at hand, several countries are thinking of installing television transmitters. In the forefront are Belgium, Switzerland, and Italy. The situation in Belgium is especially peculiar. In that bilingual country every problem takes on a political aspect. The normally technical question of standards has aroused partisan passions; the Walloons favor the French standard of 819 lines, while the Flemings defend resolutely that of 625!

It is probable that the first European 625-line transmitter will be installed in the Grand Duchy of Luxembourg. Because of its privileged geographical situation, Luxembourg is a sort of European radio center.

Like the transmitters of Monaco and Andorra, two tiny principalities on the frontiers of France, Radio Luxembourg is a private station supported by advertising. Now it is proposed to add to Radio Luxembourg a 625-line television transmitter, with an antenna supported by towers 300 meters high, which will radiate 50 kw of power.

What will be the range of such a transmitter? Only the future can tell. Meanwhile, it appears—as the result of an inquiry we have conducted in several European countries—that the range of television transmitters often exceeds the theoretical range determined by the height of the transmitting and receiving antennas. Instances where the range reaches 150 or even 300 kilometers are not rare. Numerous Belgians receive the programs from Paris as well as those from London.

One cannot count on such exceptional ranges under normal conditions of wave propagation. But, before all Europe is served by a tight network of television transmitters, no doubt plenty of water will have flowed beneath the bridges of the Seine!

*Publisher, *Toute la Radio*, Paris, France

Television Service Clinic

Conducted by
WALTER H. BUCHSBAUM

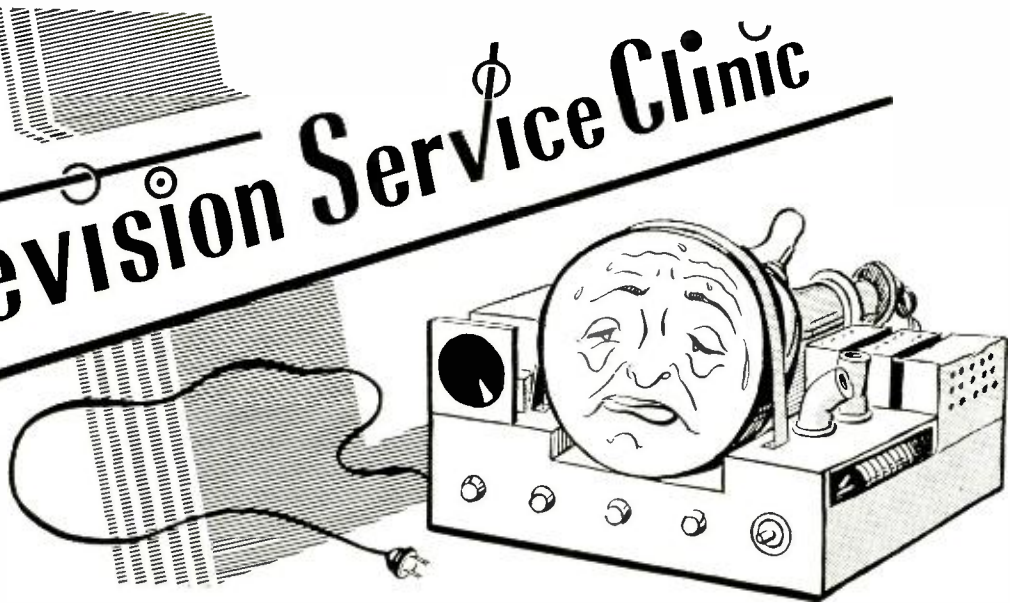

FIRST of all we want to wish all our readers a very Happy and Prosperous New Year. We are greatly flattered by the numerous inquiries regarding our book *Television Servicing*, as well as by the increasing stream of letters to this column. All letters are answered directly and those of general interest are answered on this page as well.

Because of the steel shortage many TV manufacturers are turning away from power transformers to use a circuit with two selenium rectifiers in a voltage-doubler arrangement. While this circuit has been used for several years in less expensive, small-screen receivers, it is now in use for 16- and 17-inch rectangular picture tubes. Operating the horizontal flyback circuit from such a source means that only 250 volts B-plus are available where previously 360 to 400 volts were used. Special flyback transformers, invariably the ceramic-core type, are used to provide sufficient high voltage and deflection.

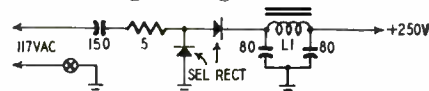

Fig. 1—Voltage doubler circuit of the type used in transformerless receivers.

The circuit in Fig. 1 shows a typical selenium doubler circuit. The output at the filter is 250 volts with 117 volts a.c. input. If the line voltage is low, the output may drop to 230 or even 210. The low line voltage will cause a reduction in width and high voltage, or brightness. Unfortunately many homes suffer from low line voltage in the evening hours when the load on the power generators is greatest. In some locations a.c. line voltage as low as 95. While most transformer types of receiver have some leeway, the majority of selenium-type TV sets will not perform properly at such low values.

One solution is to install a constant-voltage type of transformer or a suitable variable transformer and run the receiver from that source. The cost of

either runs from above \$20 to \$50 and many set owners object to this additional expense. But if you have any old power transformers around, a simple and effective arrangement can be made. Any power transformer having a 117-volt primary and a 6.3-, 5- or 12-volt filament winding can be used.

Connect the a.c. power line to the 117-volt primary winding as shown in Fig. 2. Now make a temporary connection of the filament winding and measure the voltage across 1 and 3. If it is less than the voltage across 1 and 2, reverse the filament winding. Where a 6.3- and a 5-volt winding are used, connect them in series, checking to make sure their voltages add. Mount this auxiliary transformer in the TV cabinet away from the picture tube, possibly in some corner or in the bottom section of a console. Solder all leads and tape them securely before mounting the transformer.

If low line voltage occurs only at certain times of the day, a simple toggle switch can be mounted on the back of the cabinet as shown in Fig. 2. When the picture gets small and dim, the owner throws the switch to connect his set to the higher tap on this auto-transformer. The switch must be returned to the normal position when the set is turned off or when the line voltage goes up.

Almost any transformer can be used, but the windings not used should be disconnected and their leads securely taped. Since the secondaries are not drawing rated current, the primary current can be higher than in other applications and any transformer designed for several amperes of filament current and about 100-ma secondary current will be suitable as an auto-transformer.

Negative picture

Turning the brightness control up on a Bradford (Du Mont) TV set produces a negative picture. Also, I use a lazy-X-type antenna and would like to know

if a Yagi will give me more gain on channel 6.—J. F. S., Marion, Ohio.

Replace the 1B3-GT in the high-voltage supply. Check the high voltage,

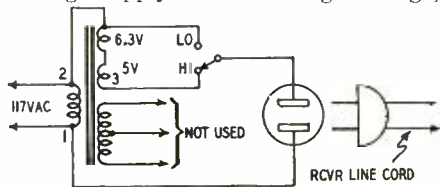

Fig. 2—Simple hookup for stepping up line voltage with a power transformer.

which should be 12 kv with an average picture. Replace the picture i.f. amplifiers and the r.f. amplifier. It is also possible that the 19AP4 tube has become weak. Before replacing it, try re-adjusting the ion trap or using a new ion trap.

Any Yagi, if tuned for a single channel, will give more signal on that channel than a dipole and reflector (lazy X). Orienting the Yagi is rather critical since it has a narrow beam in one direction only.

Unsteady picture

The picture on a 630 TS receiver is unsteady and shifts to the sides and goes out of sync completely. I have tried adjusting the synchrolock, but with no success.—J. G., Philadelphia, Pa.

I suggest you replace the 6AL5 and the 6K6 horizontal oscillator tubes in the high-voltage cage, or the 6AC7. Any of these would cause your trouble. The synchrolock adjustment may fail if the capacitors shunting either winding are defective.

No vertical sweep

Except for a bright horizontal line, the screen of an Admiral 16-inch 16R12 receiver is blank.—C. P., Jr., Auburn, Me.

The defect must be in the vertical sweep section, as there is no vertical deflection at all. A defective tube or capacitor is the most likely cause, al-

Simple Master Antennas

By WILBUR J. HANTZ

though a defect in the vertical deflection coil in the yoke or in the leads running to the yoke will also cause this trouble. Replace the vertical output and oscillator tubes, and measure plate voltages and check the continuity of the windings of the vertical output transformer.

Big-Tube Conversions

We receive numerous queries on converting small-tube television receivers to use bigger tubes. Since each set has its peculiarities, a general answer covering a large number of models is usually insufficient. We have therefore prepared a number of brochures, each describing in detail the conversion of one of the more common models. Send us the name and model number of the set to be converted, plus a stamped, self-addressed envelope, for the brochure desired. If we have none for your particular job, an individual reply will be sent. Address:

Walter H. Buchsbaum
Television Clinic
RADIO-ELECTRONICS
25 West Broadway
New York 7, N. Y.

Weak reception

I get very weak reception on the low band. The set is a 19-inch Du Mont and the antenna is an Amphenol 114-026. The lower half of the dipole is cut away because the antenna is for 300-ohm ribbon line and the set has a 72-ohm input.—W. B., Brooklyn, N. Y.

A folded dipole is intended for a 300-ohm line and your set is designed for 72-ohm input. You should use a single dipole.

Poor reception on the low band may be due to location, orientation, or height of the antenna. Misalignment of the Du Mont tuner, especially poor tracking on the low band, will cause weak pictures. Alignment may be done according to the manufacturer's instructions with an oscilloscope and a sweep generator.

The r.f. bandwidth of this set should be 6 mc and the picture i.f. bandwidth 3.8 to 4 mc.

No brightness

The brightness control on an Admiral 10-inch receiver gives me difficulty.—F. S. B., Jr., Chicago, Ill.

Insufficient brightness may be caused by:

1. Low high voltage. Replace the 1B3-GT, check the 1-megohm resistor on the 1B3-GT socket, replace the high-voltage capacitor.

2. Brightness control shorted. Disconnect the capacitor from the control arm to ground to check. A misadjusted ion trap will also cause lack of brightness.

3. Weak picture tube. Although this is the least pleasant trouble, this is what I suspect. 10BP4's usually get weak after about 18 months of service. If all the above tests fail, I suggest you replace the 10PB4 as the next step in checking the receiver.

Many problems arise in large apartment houses where each TV receiver requires a separate antenna. Two of the more prominent problems are reluctant landlords and inadequate roof space. The landlord who will allow a number of stacked arrays on the roof is still rare. However most landlords can be persuaded to permit the installation of at least one master antenna system.

An efficient master antenna system is a challenging problem. Some of its most important requirements are:

1. A constant impedance match to the receivers;
2. Adequate isolation between receivers to prevent interaction and oscillator radiation;
3. Prevention of reflections and standing waves;
4. Not too much signal attenuation.

If the signal strength is high in the immediate area, all these conditions can be met by using a simple resistive network between the receivers and the antenna as shown in Fig. 1. Some dealers use this system for their TV showroom. The input impedance of most receivers being 300 ohms, the resistor values are so chosen that a constant impedance of 300 ohms is always

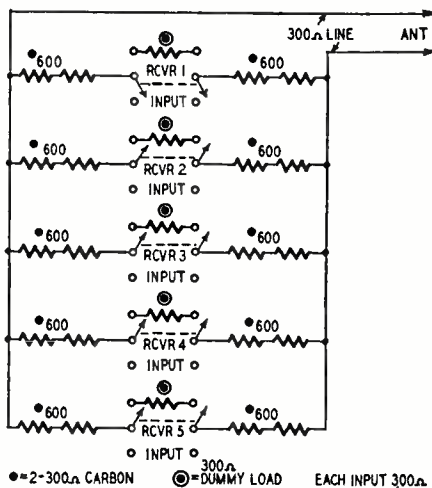

Fig. 1—Hookup for strong-signal areas.

presented even though some of the receivers are turned off. If the five receivers of the figures were connected directly to the transmission line minus the matching resistors, the total impedance presented to the line would be 1/5 of 300 ohms or 60 ohms, which would cause all kind of headaches. In Fig. 1, d.p.d.t. toggle switches are used to switch in either the receiver or a dummy load. Each branch presents a constant impedance of 1500 ohms to the antenna.

The resistive pad inserts quite a loss and cannot be used where the signal

strength is too low. Here, the proper approach to the problem is to use a booster amplifier between the network and the antenna. Commercial boosters generally provide outputs of either 75 or 300 ohms which will match most TV receivers. In Fig. 2, the matching sys-

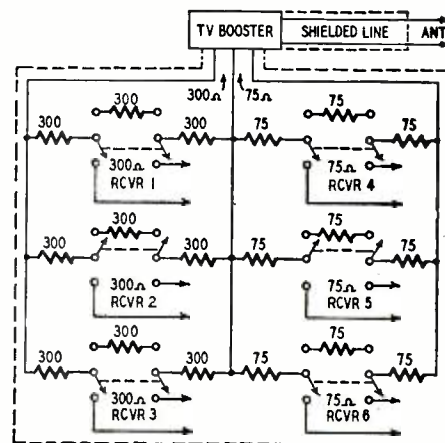

Fig. 2—A more sensitive system. Two boosters or a special booster permits matching both 75- and 300-ohm lines.

tem provides either 75 or 300 ohm outputs. Carbon resistors of the 1/4-watt variety are used. In this installation, shielded line should be used both from the antenna to the booster and the receivers. The matching network can be located at the booster if desired.

If other impedance values are needed than indicated, it is just a matter of using Ohm's law for parallel impedances because most TV receiver inputs can be considered as resistive.

FILTERS AID TV FILMING

Improved picture quality from televised motion picture films has been made possible by a new filter technique developed at the Eastman Kodak Company. The filters prevent the red and infra-red radiation of the projection beam from falling on the iconoscope mosaic.

One filter recommended by the Eastman company consists of a 6 mm layer of Pittsburgh heat-absorbing glass No. 2043 plus a 3 mm layer of Corning No. 9780 or 9788. This combination reduces light with wavelengths greater than 590 millimicrons to less than 10% on the iconoscope mosaic.

The improvements in the reproduced TV pictures are: reduced overall haze or veil; better contrast and resolution and increased brightness or tone range; reduced edge flare; reduced high light saturation; and increased video signal. When the filters are used, the light on the mosaic is reduced by 30%, but the master monitor shows a 20% increase in video signal.

TV ANTENNA EQUIPMENT

Directory of antennas, boosters, towers, and other pre-front-end equipment

Airbyte Electronics Co.
22 Evergreen St.
Bayonne, N. J.

Complete line of TV antennas, chimney mounts and brackets.

All Channel Antennae Corp.
70-07 Queens Blvd.
Woodside, N. Y.

Wide and narrow band arrays, biconicals, amperdrectional fans, folded high, straight low, folded low, Yagi, window antennas, indoor antennas, folded inline, and double V antennas. Thirty models.

Alliance Mfg. Co.
Lake Park Blvd.
Alliance, Ohio

Booster matched with antenna rotator. One model. Antenna rotating devices. Three models.

A'par Mfg. Co.
406 St. Francis
Redwood City, Cal.

Small aluminum TV tower.

Alprodeo, Inc.
Mineral Wells, Tex.
Kempton, Ind.

Aluminum towers for TV. Four models.

American Phenolic Corp.
1830 S. 54th Ave.
Chicago 50, Ill.

Broadband inline and zig-zag folded dipoles, indoor fixed dipoles. Eleven models. Extension mast, matching transformers, lightning arresters, antenna rotators, transmission lines, lightning connectors and an automatic antenna rotator.

Anchor Radio Corp.
2215 South St. Louis Ave.
Chicago 23, Ill.

TV preamplifiers. Two models.

Antenna Products
1909 N. Ashland Ave.
Chicago 22, Ill.

Biconical antenna, dual rotation and uni-rotation arrays, Yagi antennas, chimney and wall mounts. Eleven models.

Astatic Corp.
Harbor & Jackson Sts.
Connecticut

All-channel, two-stage TV boosters. Two models. Single-stage TV and FM booster. Two models.

Baker Mfg. Co.
Evansville, Wis.

Antenna towers and masts. Five models, each in varying heights.

Barb City Industries
4150 S. 4th Ave.
DeKalb, Ill.

Uni-directional and bi-directional arrays, indoor rotatable arrays with universal foot mounts, universal and conventional foot mounts, conduit tubes.

Blender-Tongue Labs.
20 Gunther Ave.
Yonkers, N. Y.

Wide-band, all-channel automatically tuned booster amplifying all 12 TV channels simultaneously.

David Bogen Co.
663 Broadway
New York, N. Y.

TV Boosters. Two models.

Brach Mfg. Corp.
200 Central Ave.
Newark, N. J.

Broadband antennas, bow tie, V, biconical superdirectional fans, T-bar inline, indoor antennas; twelve models. Mast, brackets and installation accessories. Non-amplified master antenna systems for 4 to 16 sets; six models. TV matching transformers with highpass filter; one model. Two- or couplers; one model.

Bad Radio, Inc.
2118 E. 55th St.
Cleveland 3, Ohio

TV tower in roof sections. One model.

Camburn, Inc.
32-40 57th St.
Woodside, N. Y.

Straight and folded dipoles with and without reflectors, stacked conicals, 4- and 8-element Yagis, straight line single and double stacked arrays, window and indoor antennas. Mast mounting brackets, screw eyes, lead-in clamps, guy wire, lightning arresters, standoffs, miscellaneous accessories. 120 models.

Camburn Sales and Mfg. Corp.
502 W. Michigan Ave.
P.O. Box 408
Battle Creek, Mich.

Telescoping 3-sectional 51-foot tower. Guy ring for rotating antenna. Antenna mount for roof or wall. Universal mount.

Channel Master Corp.
Ellenville, N. Y.

Folded and straight dipole combinations, conventional conical combinations, broad-band fan combinations, Yagis, Holo combinations, V antennas. All antennas pre-assembled. Mastings and accessories. 50 models.

Circle-K Antenna Corp.
500 Market St.
Perth Amboy, N. J.

All-purpose circular antennas, masts, ground rods, guy wires, mast clamps, chimney mounts.

Clear Beam Television Antennas
618 N. La Brea Ave.
Los Angeles 38, Cal.

Vaguettes, arrows, 51-lo dipoles, Yagis, clover leaves, pre-assembled kits. Ten models.

Cornell-Dubilier Electric Corp.
South Plainfield, N. J.

Various types of antennas, X rotators, and mounting accessories.

Crown Controls Co.
124 So. Washington St.
New Bremen, Ohio

Compass-indicating rotator.

DeciMeter, Inc.
1430 Market St.
Denver 2, Colo.

Balanced circuit preamplifiers;

two models. TVI wave traps for FM, diathermy, 10-meter amateur, and spurious Ft. in three ranges: 20-26, 26-35, and 35-105 mc.

Delson Mfg. Corp.
126 11th Ave.
New York 11, N. Y.

Window antennas, high and low band, folded telescoping towers, dipoles, conical, open dipole, stacked arrays, chimney and wall mounts and masts.

R. L. Drake Co.
11 Longworth St.
Dayton, Ohio

TVI filters.

East Coast Electronics
40 St. Francis St.
Newark 5, N. J.

Yagi beams, wide and narrow band arrays, biconical antennas and masts. Twenty-two models. Transmission line, coaxial cable, chimney mounts, wall brackets, accessories.

East-Oh Tower Co.
427 Romayne Ave.
Lacine, Wis.

TV towers, 30 models. Mast mountings, pole wire clamps, thimbles, guy rings.

Electro-Voice, Inc.
Buchanan, Mich.

TV Booster.

Energy Farm Equipment Co.
Monticello, Ia.

Hydraulic TV mast.

Gadgets, Inc.
1629 N. Dixie Drive
Dayton 3, Ohio

Indoor circular dipole.

General Cement Mfg. Co.
919 Taylor Ave.
Rockford, Ill.

Telescoping indoor dipole, single double and 4-stack conical.

Don Good, Inc.
1014 Fair Oaks Ave.
S. Pasadena, Cal.

Low-loss 300-ohm television lead-in wire line, television highpass filters, TVI traps. Three models.

Haugen Co.
412 S. Front St.
Manhato, Minn.

Antenna mast hold and roof mount.

Hi-Lo TV Antenna Corp.
3540 N. Ravenswood Ave.
Chicago 13, Ill.

Spiral antenna for high and low band. Indoor and outdoor models.

Hy-Lite Antenna, Inc.
242 E. 137th St.
New York 31, N. Y.

Single and stacked folded dipoles, Yagis, and V antennas.

Industrial Television, Inc.
359 Lexington Ave.
Clifton, N. J.

Untuned booster.

Insuline Corp. of America
38-03 35th Ave.
Long Island City, N. Y.

Wide-band antenna systems, including bi-conical single, double and quadruple arrays in standard and heavy duty models; folded dipole antennas and arrays; window antennas; indoor dipoles and indoor-outdoor folded dipoles. Twenty models.

Jerrold Electronics Corp.
121 W. Broad St.
Philadelphia 7, Pa.

Multiple TV systems with separate 4-element Yagi for each channel, master control and amplifier strips for each of 12 channels, and power supply. Antenna distribution outlets, four models. Wall outlets, three models. FM filter traps, two models. Solderless coax fittings, five types. Terminating resistor kit.

JFD Mfg. Co.
6101 St. Vincent Ave.
Brooklyn, N. Y.

Multiplex and multibeam dipoles, folded dipoles and conicals with special modifications. Yagi beams; window and indoor antennas. Fifty-one antenna models. Masts, extensions, brackets, arresters, and other accessories.

Krepper Aircraft Service Co.
Aero Tower Div.
1016 Linden St.
Allentown, Pa.

Welded tubular aluminum towers and tower sections to 50 feet. Three models. Also poles and pole kits with hardware and mounting accessories.

H. T. Koenig Eng. Co.
126 Southeast Blvd.
Kansas City 3, Kan.

Antenna rotators. Two models.

La Pointe Plascomold Corp.
Windor Locks, Conn.

Antennas, masts, towers, masts, guy wires, guy rings and collars, turnbuckles, cable clamps, lightning arresters, transmission line. Approximately 240 different items.

Louis Bros.
3832 E. 16th St.
Los Angeles 16, Cal.

High and low folded dipoles, inline, conical, Yagis, and V antennas. Ninety models.

Lymann Electronic Corp.
12 Cass St.
Springfield, Mass.

Yagi, folded dipole, single and double stacked.

Lyte Products, Inc.
46 Lawrence St.
Newark, N. J.

Antenna rotators. Conical, stacked phased h. f. antennas, indoor high and low band dipoles, telescopic aluminum mast. Folded dipole with triple reflector. Nineteen models.

Metalace Corp.
2101 Grant Concourse
Bronx 53, N. Y.

Antenna mounting devices. Chimney mounts, 5 types; wall mounts, 4 sizes; mast mounts, 4 sizes; miscellaneous mounts and accessories.

Milner Mfg. Co.
Box 1465 Pondren Station
Jackson, Miss.

All aluminum mast
100-foot installations

National Co.
21 Sherman St.
Malden, Mass.

TV boosters.

Network Mfg. Corp.
213 W 5th St.
Bayonne 7, N.J.

Narrow band and wide band antennas, yagi, conical, folded dipole assemblies. Parabolic masts and wire mesh. 40 models. Free development service. Ship models excluding N.H.T. models.

Oak Ridge Products
Div. of Vision Television Inc.
37-91 Vernon Blvd.
Long Island City 1, N.Y.

High and low band conical, biconical, indoor and outdoor window antennas. Seven models.

Ohio Aerial Co.
4553 Lewis Ave.
Toledo 12, Ohio

All-wave conicals - basic suspension for 4 types of antenna.

Walter E. Peck, Inc.
2842 W. 30th St.
Indianapolis 23, Ind.

Six-element single-channel arrays, 12-element single-band stacked arrays for low channel operation; 16-element high channel arrays. Quadrature phase stacked broad band channels 7 to 13 double stacked closed circuit conicals. Six models.

Peerless Products Industries
815 N. Pulaski Rd.
Chicago 51, Ill.

Indoor dipoles. Two models.

Penn Boiler & Burner Mfg. Co.
Lancaster, Pa.

TV towers in 18 foot sections, tubular construction. Roof mountings, guy rings and spacers.

A. A. Peters
131 N. Seventh St.
Allentown, Pa.

Antenna towers and portable tower rigs.

Phileo Corp.
Philadelphia 34, Pa.

Fan and V antennas. Five models.

Philon Mfg. Co.
30-66 Sackett St.
Brooklyn 31, N.Y.

Narrow band (yagi type) indoor dipoles, folded dipoles, single dipole, stacked arrays of all types. Masts.

Phoenix Electronics, Inc.
50 La'and St.
Lawrence, Mass.

Dipole, inline, conical, Yagi. Seventeen models.

Plymouth Electronic Corp.
58 High St.
Wareham, Mass.

Three-channel transfer switches; 6-strand guy wire chimney mounts, ten models; roof mounts, three models; wall mounts, two models.

Primax Products Div.
Ehismalm-Ryder Co.
Highland & College Aves.
Niagara Falls, N.Y.

Ground rods and fastenings.

Twenty-two types and sizes. Antenna mountings and accessories.

Price Tenna-Trailer Co.
660 E. Walnut St.
Wapakoneta, Ill.

Portable TV demonstration unit. TV masts.

Rosen, Mfg. Co.
7589 Garfield Blvd.
Cleveland 25, Ohio

Wide and narrow-band arrays including high-low, in-line, high gain conical and Yagi dipoles; minor dipoles. Eighteen models.

Rudhart Corp.
3571 W. 62nd St.
Cleveland 2, Ohio

Folded dipoles and reflector, turnable folded dipole hi-lo channels; straight line all channel, single and double stacked, conical all-channel, single, double and 4-stack, Yagi cut to channel, 5-element, single and double stacked, super V end-fire, single double and 4-tended. Indoor two and three-section telescoping masts, and indoor loaded X.

Radio Corporation of America
RCA Victor Div.
Harrison, N. J.

Single loop antenna, reversible beam array, FM, folded-dipole antenna mast mounting brackets, transmission line, matching devices. Three models.

Radio Merchandise Sales, Inc.
1165 Southern Blvd.
New York 23, N.Y.

Conicals, stacked folded dipoles, straight dipoles, window antennas and indoor antennas.

Radion Corp.
1157 Milwaukee Ave.
Chicago, Ill.

Indoor dipole, indoor antenna in shape of photo album, conical window antenna. Three models.

Ramsay Radio & Television Co.
Box 294
Rome, Ill.

Welded steel TV antenna towers in 10-foot sections, with built-in rotor mounts, hinges, feet and lead-in insulators.

Ray Mfg. Co.
441 Summit
Toledo, Ohio

Conical arrays, folded dipoles, special single and double stacked Yagis cut to any channel. Twenty-three models. Chimney mounts, roof saddles, mounting bases, mast connectors and guy rings.

Regency Div.
I.D.E.A. Inc.
55 North New Jersey St.
Indianapolis, Ind.

Television and FM boosters. Three models.

Roglan Corp.
262 E. 44th St.
New York 17, N.Y.

Self-supporting and guyed aluminum towers.

Walter L. Schott Co.
9306 Santa Monica Blvd.
Beverly Hills, Cal.

Wideband conical arrays with and without masts, Yagi.

Mark Simpson Co.
32-28 Forty-ninth St.
Long Island City 3, N.Y.

All-channel TV booster.

Snyder Mfg. Co.
12nd and Ontario Sts.
Philadelphia, Pa.

Conicals, folded and straight dipoles, high portable indoor, double V type, straight bay, biconical, and window antennas.

Spartan Products Co.
62 Grand St.
New York 17, N.Y.

No information supplied.

Square Box Mfg. Co.
391 Saw Mill River Road
Yonkers, N.Y.

Ballistic quadrature phased antennas, three models; rotating rooftop antenna; indoor and window antennas.

Standard North Products Co.
2311-29 North Pulaski Road
Chicago 33, Ill.

TV booster.

Tabet Mfg. Co.
251 W. Tassell St.
Norfolk 10, Va.

Wide-band conicals, single and stacked arrays, window antennas, five models. Aluminum towers, three models.

Taylor Mfg. Co.
Lima, Ohio

Aluminum and steel chimney mounts and antenna bases, aluminum wall mounts, steel saddle and roof mounts. Seven models.

Tech Master Products Co.
443 Broadway
New York 1, N.Y.

TV booster kit.

Technical Appliance Corp.
Sherburne, N.Y.

Twin-driven Yagi arrays, inline and piggy back antennas, conicals, fifty models, antenna amplifier distribution systems, lightning arresters, mast bases and accessories.

Tel-A-Ray Enterprises, Inc.
335 Clay St.
Henderson, Ky.

Wide-spaced Yagi arrays, broad-band butterfly antenna-mounted preamplifier. Twenty-eight models.

Telematic Industries, Inc.
One Joralemon St.
Brooklyn 2, N.Y.

Conicals, folded and straight dipoles, 12 models. Masts, mast couplers, ribboning wire strippers, defect replacement stacking bars, conical element stabilizers, and high gain signal spurs.

Television Equipment Corp.
238 William St.
New York 7, N.Y.

Untuned booster, multiple dwelling coupler and booster networks, color adapters and converters.

Telrex, Inc.
Asbury Park, N.J.

Conical V beams, all channel arrays, outdoor and indoor antennas. Twenty-four models. Accessories.

TELvision Labs., Inc.
5045 W. Lake St.
Chicago 44, Ill.

Built-in and under-the-rug printed circuit antennas. Five models.

Ten Corp.
3332 E. 55th St.
Cleveland 4, Ohio

Five-foot steel mast extensions.

Triumph Products Co.
1355 S. Ashland Ave.
Chicago 24, Ill.

Single-element all-wave array, single, double or 4-stacked, loaded dipoles, loaded dipoles with triple reflectors; hi-lo folded dipole and reflector conical, single, double and 4-stacked, single and double stacked elements Yagi; loaded window and end-fire dipoles; masts (kit and assembled) units. Twenty-three models.

Tris Mfg. Co.
Greenville, Ill.

Yagi, conical antennas, wide-band arrays, two-channel Yagis, phase control and mast. Fifteen models.

The Turner Co.
Cedar Rapids, Ia.

TV booster. One model.

VeriBest Television Products
253 Spring St.
New York, N.Y.

All-band outdoor antennas, Yagis, stacks of all kinds, conicals. Ten models.

Victoria Sales Co.
619 N. Michigan Ave.
Chicago 11, Ill.

Telescoping indoor dipole, under-the-rug antenna.

Waba Mfg. Co.
2310-16 S. Western Ave.
Chicago 8, Ill.

Urce-be-rug antennas. Two models.

Walco Products, Inc.
50 Franklin St.
E. Orange, N.J.

Two-speed 170-degree antenna rotators, with or without indicator. Two models.

Ward Products Corp.
1523 E. 43rd St.
Cleveland 8, Ohio

Folded dipoles, Yagis, stacked arrays.

Warren Mfg. Co.
350 East St.
New Haven, Conn.

Complete line of TV antennas, hardware and brackets.

Western Bell & Electrical Co.
215 State St.
Racine, Wis.

Self-telescoping steel masts, 10 to 55 feet; self-supporting aluminum towers, 33 to 55 feet; guyed aluminum towers; steel lattice type and triangular type towers and tower sections to 100 feet. Fourteen models.

Wheeler Corp.
East 7th at Division
Sioux City 6, Iowa

Guyed and self-supporting roof-mounted towers. Six models.

Wind Machine Co.
260 E. Market St.
West Chester, Pa.

Towers and masts, tripods, antenna support brackets. Ten models.

Workshop Associates
135 Crescent Rd.
Needham Heights 94, Mass.

Double V and cut-to-channel Yagis, matching transformers, coax switches, connectors, and other accessories.

Directory of TV Receiver Characteristics

1	2	3	4	5	6	7	8	9	10	11	12	13	14	15	16
Manufacturer	Model	Chassis number	Cabinet or chassis type	AM-FM-SW	C-R tube type	C-R tube anode	Number of tubes	Intercarrier sound	Type of AGC	Video i.f. stages	Video i.f. megacycles	Built-in antenna	AF output watts % distortion	Speaker size inches	Accessories
Admiral Corp. 3800 West Cortland St. Chicago, Ill.	12X11	20Z1	T	No	12LD4	9	19	Yes	Ord	3	25.75	NT		5	No
	16R12	Z1B1	T	No	16KP4 ¹	12.5	21	No	Ord	3	25.75	NT		5	No
	26R12	Z1B1	T	No	16KP4 ¹	12.5	21	No	Ord	3	25.75	NT		5	No
	26X55, 26X56, 26X57, 26X65, 26X66, 26X67, 26X75 ² , 26X76 ²	24D1	C	No	16GP4	13	24	No	Key	3	25.75	NT		10	No
	29X17, 29X26	24F1	C	No	19AP4	13	24	No	Key	3	25.75	NT		12	No
	34R16	20V1	C	AM	14CP4	12	23	No	Ord	3	25.75	NT		10	P
	36R37	Z1C1	C	AM-FM	16KP4 ¹	12.5	26	No	Ord	3	25.75	NT		12	No
	19X17, 39X25, 39X26	24G1	C	AM-FM	19AP4	13.5	29	No	Key	3	25.75	NT		12	P
	39X35, 39X36	21J1	C	AM	19AP4	13.5	24	No	Ord	3	25.75	NT		12	P
	16CD		C	No	16''		19	Yes				TU		6	P3
Affiliated Retailers, Inc. (Artone) Empire State Bldg. New York, N. Y.	16CD3DR		C	AM-FM	16''		19	Yes			TU			6	No
	16CR		C	No	16'' ³		19	Yes			TU			6	No
	16RD		T	No	16'' ³		19	Yes			TU			6	No
	19CD		C	No	19''		19	Yes			TU			6	No
Air King Products Co., Inc. 170 53rd St. Brooklyn, N. Y.	12C1	700	C	No	12LP4	9	21	Yes	Ord	3	25.75	NT	2.4	5	No
	12T1, 12T2	700	T	No	12LP4	9	21	Yes	Ord	3	25.75	NT	2.4	5	No
	14T1	700-3	T	No	14RP4	9	21	Yes	Ord	3	25.75	NT	2.4	5	No
	16C1, 16C2, 718	700-10, 700-10,	C	No	16RP4	12	21	Yes	Ord	3	25.75	NT	2.4	10	No
	16C3, 16C5	700-70, 700-70,	C	No	16RP4	12	21	Yes	Ord	3	25.75	NT	2.4	5	No
	16K1	700-70, 700-70,	C	AM-FM	16RP4	12	26	Yes	Ord	3	25.75	NT	2.4	8	P3
	16M1, 16T1, 16T1B	700-50, 700-72,	C	No	16RP4	12	21	Yes	Ord	3	25.75	NT	2.4	5	No
	19C1	700-10, 700-10,	T	No	16RP4	12	21	Yes	Ord	3	25.75	NT	2.4	5	No
	20C1	700-40, 700-40,	C	No	19DP4	13	21	Yes	Ord	3	25.75	NT	2.4	10	No
		700-40	C	No	20RP4	13	21	Yes	Ord	3	25.75	NT	2.4	10	No
Andrea Radio Corp. 27-01 Bridge Plaza North Long Island City 1, N. Y.	Caronia 19	V1L19	C	AM-FM	19AP4	13.5	28	No	Key	3	26.2	NT	3.5	12	No
	Fleetwood, Sutton	V1L16	C	FM	16GP4	13	25	No	No	3	26.2	NT	3.5	10	No
	Mayfield	V1L16	T	FM	16GP4	13	25	No	No	3	26.2	NT	3.5	8	No
	Normandy	VK19	T	AM-FM	19AP4	13.5	31	No	No	4	26.2	NT	4	12	No
	Saybrooke	V1L12	T	FM	12QP4	10.5	23	No	No	3	26.2	NT	3.5	5 1/2	No
		703, 604	C	AM-FM	16'' ¹³	13	43	No	Key	4	25.75	No	8	12 ¹	P3
Ansley Radio & Television, Inc. 41 St. Joes Ave. Trenton, N. J.	706	703, 604	C	No	16'' ¹³	13	30	No	Key	4	25.75	No	2.5	12	No
	724	703, 604	C	No	19'' ¹³	13	30	No	Key	4	25.75	No	2.5	12	No
	726	703, 604	C	AM-FM	19'' ¹³	13	43	No	Key	4	25.75	No	8	12 ¹	P3
	727	703, 604	C	No	16'' ¹³	13	30	No	Key	4	25.75	No	2.5	12	No
	729	703, 604	C	No	19''	13	30	No	Key	4	25.75	No	2.5	12	No
	730	703, 604	C	No	19''	13	30	No	Key	4	25.75	No	2.5	12	No
	731	703, 604	C	AM-FM	17'' ¹³	13	42	No	Key	4	25.75	No	8	12	P3
	732	605	C	No	17'' ¹³	13	42	No	Key	4	25.75	No	2.5	12	No
	733	703, 604	C	AM-FM	20'' ¹³	13	42	No	Key	4	25.75	No	8	12	P3
	734	605	C	No	20'' ¹³	13	21	No	Ord	4	25.75	No	2.5	12	No

Company	Call Letters	City	Class	Power	Frequency	Service	Hours	Day	Month	Year	Notes			
Arvin Industries, Inc. Columbus, Ind.	2120CM, 2126CM	No information supplied	TE-289-2	10	12LP4A	No	19	Yes	4	45.75 NT	0.6	5 1/2		
	2121TM, 2123 TM		10	12LP4A	No	19	Yes	4	45.75 NT	0.6	5 1/2	PLD		
	2124CCM		10	12LP4A	AM-FM	19	Yes	4	45.75 NT	0.6	8	8	P3LD	
	2160CM, -CB, 2164CM, -CB		12	16AP4A	No	20	Yes	4	45.75 NT	0.6	8	8	PLD	
	2161TM		12	16AP4A	No	20	Yes	4	45.75 NT	0.6	5 1/2	5 1/2	PLD	
	2162CCM		12	16AP4A	AM	20	Yes	4	45.75 NT	0.6	6x9	6x9	P3LD	
	4080T		8.5	8AP4A	No	18	Yes	3	45.75 No	0.5	4 1/2	4 1/2	No	
	4162CB, 4162CM		12	16AP4A	No	26	Yes	4	45.75 NT	1.3	10	10	PLDT	
	Atwater Television Co. 360 Furman St. Brooklyn, N. Y.													
	Automatic Radio Mfg. Co., Inc. 122 Brookline Ave. Boston 15, Mass.		TV-5019	TV-5116R, TV-5061	C	11-13	19BP4	No	21	Yes	3	25.75 No	4	12
TV-5116R			C	11-13	17BP4A ³	No	21	Yes	3	25.75 No	3	8		
Bace Television Corp. Green and Lenning Sts. South Hackensack, N. J.	630	170C, 170HD, 170FD	C	13.5	17 ^{1/3}	No	30	No	4	25.75 TU	3	12		
	630	170TM	T	13.5	17 ^{1/3}	No	30	No	4	25.75 TU	3	5x7		
	630	20RCH	C	13.5	20 ^{1/3}	No	28	No	4	25.75 TU	3	12		
			C	13.5	20 ^{1/3}	No	28	No	4	25.75 TU	3	PRC		
Bell Television, Inc. 552 W. 53rd St. New York 19, N. Y.	16C3, 16D3, 1603		C	12	16AP4	No	31	No	4	25.75 No	4	12		
	16T3		T	12	16AP4	No	31	No	4	25.75 No	4	8		
	19C4, 19D4, 1901		C	13	19AP4	No	31	No	4	25.75 No	4	12		
	19T4		T	13	19AP4	No	31	No	4	25.75 No	4	8		
Belmont Radio Corp. 5921 W. Dickens Ave. Chicago 39, Ill.	1604		MR	13	16AP4	No	32	No	4	25.75 No	4	8		
	1902		MR	13	19AP4	No	32	No	4	25.75 No	4	8		
			C	16	20CP4	AM-FM	32	Yes	4	26.75 TU	3.0	12		
			C	16	20CP4	No	24	Yes	4	26.75 TU	3.0	10		
Bendix Radio, Television and Broadcast Receiver Division Baltimore 4, Md.	20AY21 & 8AF210	The Adams (RC-2005)	C	16	20CP4	AM-FM	32	Yes	4	26.75 TU	3.0	12		
	20AY21	The Catalina (C-2002), The Clayton (C-2001), The Marquis (C-1714), The Mayfair (C-1715), The Mozart (C-1716)	C	12	17BP4	No	22	Yes	4	26.75 TU	3.0	10		
	17AY21	The Rancho (M-1712), The Revere (M-1713), The Rocket (M-1711), The Santung (RC-1719), The Savoy (RC-1718)	T	12	17BP4	No	22	Yes	4	26.75 TU	3.0	6		
	17AY21		C	12	17BP4	AM	27	Yes	4	26.75 TU	3.0	12		
Bowers Television Co. Box 1262, Reading, Penna.	T5-4		T	12	14BP4 ⁶	No	18	Yes	2	25.75 NT	1.75	4x6		
	T5-3		T	12	16RP4 ¹	No	18	Yes	2	25.75 NT	1.75	4x6		
	T5-4		C	12	14BP4 ⁶	No	18	Yes	2	25.75 NT	1.75	10		
	T5-3		C	12	16KP4 ¹	No	18	Yes	2	25.75 NT	1.75	10		
	T5-2		C	12	16KP4 ¹	AM-FM	18	Yes	2	25.75 NT	1.75	10		
Capehart-Farnsworth Corp. 3702 E. Pontiac Ave. Ft. Wayne, Ind.	270K		C	14-15	17AP4	FM	24	Yes	4	26.25 TU	2.5	12		
	CX-33	Bedford, Nantucket	T	11	160AR ⁷	No	23	Yes	3	26.25 TU	4	8		
	CX-33F	Chicagoan, Wm. Penn	C	11	16GP4	No	23	Yes	3	26.25 TU	4	12		
	CX-33	Georgetown	C	11	160AR ⁷	No	23	Yes	3	26.25 TU	4	6x9		
	CX-33	Monmouth, New Englander	C	11	160AR ⁷	No	23	Yes	3	26.25 TU	4	12		
	CX-33	New Amsterdam	C	11	19AP4	AM-FM	38	Yes	3	26.25 TU	4 ⁸	12 ⁹		
	CX-33	Saratoga	C	11	170AR ⁷	AM-FM	38	Yes	3	26.25 TU	4 ⁸	12		
	CX-33	Spinnet	C	11	170AR ⁷	AM	23	Yes	3	26.25 TU	4	8		
	CX-33	Ticonderoga	C	11	160AR ⁷	AM	37	Yes	3	26.25 TU	4 ⁸	12		
	CX-33	Virginian	C	11	170AR ⁷	No	23	Yes	3	26.25 TU	4	12		
Cascade Television Co., Inc. 153 Chestnut Ave. Irvington 11, N. J.	630	F36-4X3	C	27	5TP4 ¹⁰	No	40	No	4	26.25 No	15	12		
	630	LD17	C	14.5	17RP4	No	30	No	4	26.25 No	4	12		
	630	LD20	C	14.5	20RP4	No	30	No	4	26.25 No	4	12		
	630	LD119	C	14.5	20RP4	No	30	No	4	26.25 No	4	12		

1	2	3	4	5	6	7	8	9	10	11	12	13	14	15	16	
Certified Radio Laboratories 5507-13 Avenue Brooklyn 19, N. Y.	4920	4920	K-WC	No	10BP4 ¹¹	10	20	Yes	Ord	4	25.75	No	2.5	4x6	No	
	4920-12	4920	T	No	12LP4	10	20	Yes	Ord	4	25.75	No	2.5	4x6	No	
	5020-16	5020	C	No	16DP4	12	20	Yes	Ord	4	25.75	No	2.5	12	No	
	Commander Television Corp. 280 9 Ave. New York 1, N. Y.	1701	1700	C	No	17BP4A	12	22	Yes	Ord	4	26.1	No	3	12	No
		1901	1900	C	No	19AP4A	13.5	22	Yes	Ord	4	26.1	No	3	12	No
		1-167		T	No	16RP4	14	19	Yes	Ord	3	24.6	NT	2	8	No
	Concord Radio Corp. 901 W. Jackson Blvd. Chicago 7, Ill.	1-168		C	No	16RP4	14	19	Yes	Ord	3	24.6	NT	2	5	No
		14M36, 14W36, 15P36, 16B36	36	C	No	16GP4	13	24	No	Ord	4	25.75	No	5	12	No
	Contrac, Inc. 649 W. Foothill Blvd. Glendora, Calif.	17P39, 20M39, 21B39	39	C	No	19AP4A	14	24	No	Ord	4	25.75	No	5	12	No
		T-1400		T	No	14BP4	11	20	Yes	Ord	3	25.75	No	3.5	5	CO
Covideo, Inc. 212 Broadway New York 7, N. Y.	Crosley Division, Avco Mfg. Corp. 1329 Arlington St., Cincinnati 25, Ohio	11-441MU, 11-461WU, 11-471BU	320	C	No	12LP4A	8	20	Yes	Key	4	26.4	NT	1	10	No
		11-442MIU, 11-472BIU	331	T	No	17BP4	12.3	24	Yes	Key	4	26.4	NT	1	5 1/4	No
		11-443MU, 11-454MU, 11-458MU,	323	C	No	19AP4A	14.5	24	Yes	Key	4	26.4	NT	1	10	No
		11-473BU, 11-484BU	331	C	AM	17BP4	12.3	32	Yes	Key	4	26.4	NT	1	10	P3
		11-444MU, 11-474BU	321	C	No	16TP4	12.3	24	Yes	Key	4	26.4	NT	1	10	No
		11-445MU, 11-447BU, 11-465WU,	325	C	No	16GP4	12	24	Yes	Key	4	26.4	NT	1	10	No
		11-475BU, 11-477BU	323	C	No	19AP4	14.5	24	Yes	Key	4	26.4	NT	1	10	No
		11-446MU, 11-476BU	323	C	No	16TP4	12.3	24	Yes	Key	4	26.4	NT	1	5 1/4	No
		11-453MU, 11-460MU, 11-470BU,	321	T	No	16GP4 ¹²	12	23	Yes	Ord	4	25.75	NT	3.3	6 1/2	No
		11-459MU		T	No	16GP4 ¹²	12	23	Yes	Ord	4	25.75	NT	3.3	10	No
DeWald Radio Mfg. Corp. 35-15 37 Ave. Long Island City 1, N. Y.	DT162		C	No	19 ¹³	9	22	Yes	Ord	4	25.75	NT	3.3	6 1/2	No	
	DT163		C	No	10BP4	9	22	Yes	Ord	4	25.75	NT	3.3	10	No	
	DT190		T	No	14CP4	11	22	Yes	Ord	4	25.75	NT	3.3	6 1/2	No	
	DT1020, DT1030		T	No	14CP4	11	22	Yes	Ord	4	25.75	NT	3.3	10	No	
	ET140		C	No	17BP4	12	20	Yes	Ord	3	25.75	NT	3.3	6 1/2	No	
	ET141		T	No	17BP4	12	20	Yes	Ord	3	25.75	NT	3.3	6 1/2	No	
	ET170		C	AM	17BP4	12	20	Yes	Ord	3	25.75	NT	3.3	5-10 ⁹	P3	
	ET171		C	No	17BP4	12	20	Yes	Ord	4	26.25	No	1 1/4	10	No	
	Allen B. Du Mont Laboratories, Inc. 35 Market St. E. Paterson, N. J.	RA-117	RA-117	C	FM	19AP4A	13	26	No	Ord	4	26.25	No	1 1/4	10	No
		RA-112	RA-112	C	FM	17BP4	13	26	No	Ord	4	26.25	No	1 1/4	10	No
RA-113		RA-113	C	No	17BP4	9	24	No	Ord	4	26.25	No	1 1/4	5	No	
RA-109		RA-109	C	FM	19AP4A	15	35	No	Ord	4	26.25	No	3 1/4	10	No	
RA-109		RA-109	C	AM-FM	19AP4A	15	39	No	Ord	4	26.25	No	3 1/4	12	P	
RA-113		RA-113	C	AM-FM	19AP4A	13	32	No	Ord	4	26.25	No	1 1/4	12	P	
RA-116		RA-116	C	AM-FM	19AP4A	15	48	No	Ord	4	26.25	No	6	3-12 ⁹	PTRM	
12B		12B	K	No	12KP4	9	18	No	No	3	25.75	No	4	6	No	
14BR		14BR	K	No	14BP4	10	18	No	No	3	25.75	No	4	6	No	
16BR		16BR	K	No	16RP4	13	19	No	No	3	25.75	No	4	6	No	
Electro-Technical Industries 1432 N. Broad St. Philadelphia 21, Penna.	660 ² , 673 ²	120133B	T	No	12LP4A	10	17	Yes	Ord	3	25.75	NT	2	6	No	
	661	120134B-G	T	No	16GP4	12.5	22	Yes	Ord	4	25.75	NT	3	6	No	
	662	120127B	T	No	14BP4	12	21	Yes	Ord	3	25.75	NT	3	5	No	
	663	120128B	T	No	16RP4	12	21	Yes	Ord	3	25.75	NT	3	5	No	
	664 ³²	120133B	C	No	12LP4A	10	20	Yes	Ord	3	25.75	NT	2	12	No	
	665 ³²	120131B ¹⁵	C	AM	12LP4A	10	24	Yes	Ord	3	25.75	NT	2	12	P3	
	666	120135B ¹⁶	C	AM-FM	16GP4	12.5	30	Yes	Ord	4	25.75	NT	3	12	P3	
	667, 668	120134B-G	C	No	16GP4	12.5	22	Yes	Ord	4	25.75	NT	3	12	No	
	669	120129G	C	No	19AP4	13.5	22	Yes	Ord	4	25.75	NT	5	12	No	
	Fada Radio and Electric Co., Inc. 525 Main St. Belleville 9, N. J.	R1025		C	No	16GP4	12.5	27	No	Key	4	25.75	NT	2.2	10	No
R1045			T	No	12LP4A	9.5	25	No	Key	4	25.75	NT	1.5	6	No	
R1050			T	No	16GP4	12.5	27	No	Key	4	25.75	NT	2.2	6	No	
S4C20, S4C40			C	No	14BP4	11.5	22	Yes	Ord	3	26.1	NT	1.5	10	No	

Fada Radio & Electric (contd.)

S4T15, S4T30
S7T65
S9C10
S1055
S1055X
S1060, S6T65
S20C10

Federal Television Corp. 139 Duane St. New York 3, N. Y.	Commodore Dover Essex Manhattan Mohawk New Yorker Pacemaker	1600C 1200D 1600E 1600M 1600N 1200N 1600P	C C C T T T C	No AM-FM FM FM FM FM FM No	14BP4 17BP4A 19AP4 16RP4 16GP4 16RP4 20CP4	11.5 13.5 14.5 13.5 13.5 13.5 14.5	22 22 22 22 22 22 22	Yes No No No No No No	Ord Ord Ord Ord Ord Ord Ord	3 3 3 3 3 3 3	26.1 26.1 26.1 26.1 26.1 26.1 26.1	NT NT NT NT NT NT NT	1.5 1.5 1.5 1.5 1.5 1.5 1.5	6 6 10 10 10 6 10	No No No No No No No
Firestone Tire & Rubber Co., The 1200 Firestone Pkwy. Akron, Ohio	13-G-44 13-G-45 13-G-46 13-G-47 13-G-48	-9123A ¹⁷ -9123B ¹⁷ -9120G ¹⁷ -9120H ¹⁷ -9121C ¹⁷	T C T C C	No No No No AM-FM	14BP4 ⁶ 14BP4 ⁶ 16TP4 ¹ 16TP4 ¹	13 13 13.5 13.5 13.5	26 26 26 26 31	Yes Yes Yes Yes Yes	Key Key Key Key Key	4 4 4 4 4		TU TU TU TU TU	2 2 2 2 2	6 6x9 6 6x9 6x9	No No No No No
Freed Radio Corp. 200 Hudson St. New York 13, N. Y.	54, 55, 56, 68 101, 103, 104	CHT-1620 CHT-1900	C C	No FM	16GP4 19AP4A	12 14	28 30	No No	Key Key	4 4	25.75 25.75	No TU	4 4	12 12	PJ PJ
General Electric Co. Electronics Park Syracuse, N. Y.	14C102, 14C103 14T2, 14T3 16C103, 16C104, 16C113, 16C116 16K1, 16K2 16T5 17C101, 17C102 19C105, 19C106	A ³² A ³² A ³² A ³² A ³² C	C T C C C T C C	No No AM-FM No No No	14 ^{7/3} 14 ^{7/3} 16 ^{7/3} 16 ^{7/3} 16 ^{7/3} 17 ^{7/3} 19 ^{7/3}	11.5 11.5 11.5 11.5 11.5 11.5 14	21 21 21 29 21 21 21	Yes Yes Yes Yes Yes Yes Yes	Ord Ord Ord Ord Ord Ord Key	3 3 3 3 3 3 4	45.75 45.75 45.75 45.75 45.75 45.75 45.75	NT NT NT NT NT NT NT	1 1 1 1 ^R 1 1 5	10 5 1/2 12 12 5 1/4 12 12	No No No P3 No No No
Hallcrafters Co., The 4401 W. 5 Ave. Chicago 24, Ill.	805, 806 810 811 815 818 820, 821 822 850, 861 870, 871 880 890	M800S M800S E800D D800D K800D K800D F800D E800D D800D H800D J800D	C T T T C C C C C C C	No No AM No AM No AM No No No AM	16TP4 ¹ 16TP4 ¹ 16TP4 ¹ 16TP4 ¹ 16GP4 16TP4 ¹ 16GP4 16TP4 ¹ 16TP4 ¹ 19AP4 20CP4	13 13 13 13 13 13 13 13 13 13 13	16 16 24 21 21 24 21 24 21 21 21 24	Yes Yes Yes Yes Yes Yes Yes Yes Yes Yes Yes	Ord Ord Ord Ord Ord Ord Ord Ord Ord Ord Ord	2 2 3 3 3 3 3 3 3 3 3	26.25 26.25 26.25 26.25 26.25 26.25 26.25 26.25 26.25 26.25 26.25	NT NT NT NT NT NT NT NT NT NT NT	1 1 1 2 2 2 2 2 2 2 2	8 5 5 5 8 8 8 8 8 10 12	PJ PJ PJ PJ PJ PJ P PJ PJ P P
Hertner Electric Co., The 12690 Elmwood Ave. Cleveland 11, Ohio	L-10	L-10	C	No	5TP4	27	39	No	Ord	5	25.75	No	20	12	RC
Hoffman Radio Corp. 3761 S. Hill St. Los Angeles 7, Calif.	630, 631 634, 635 866, 867, 868, 876, 877, 878 870, 871, 872 890, 891, 892 950, 951, 952 960, 961	170 171 170 175 172 176	T T C C C C	No No No No AM-FM AM-FM	14CP4 16TP4 16TP4 14CP4 19AP4 16TP4 19AP4	11 13.5 13.5 11.5 13.5 13.5 13.5	21 21 21 21 21 24 27	No No No No No No No	Key Key Key Key Key Key Key	3 3 3 3 3 3 3	26.1 26.1 26.1 26.1 26.1 26.1 26.1	TU TU TU TU TU TU TU	3 3 3 3 3 3 3	8 12x6 12 12 12 12 12	No No No No No No No
Industrial Television, Inc. 359 Lexington Ave. Clifton, N. J.	248 348 761 1161, 1261 1361		C C T C C	No No No No No	16JP4 19AP4 16TP4 16TP4 19GP4	13 15 12 12 14	33 33 19 19 19	No No Yes Yes Yes	No No Ord Ord Ord	4 3 3 3 3	25.75 25.75 25.75 25.75 25.75	NT NT NT NT NT	8 8 3 3 3	12 12 8 12 12	RC RC PJ PJ PJ
International Television Corp. 238 William St. New York 7, N. Y.	1651 1652, 1653, 1653F	F-16 F-16	T C	No No	16RP4A 16RP4A	11 11	20 20	Yes Yes	Ord Ord	3 3	25.75 25.75	NT NT	4 4	4x6 12	No No

1	2	3	4	5	6	7	8	9	10	11	12	13	14	15	16	
Jackson Industries, Inc. 500 E. 40 St. Chicago, Ill.	14T		T	No	14RP4	14	20	Yes	Yes ²⁶	3	25.75	NT	1.5	6	No	
	16C	E	C	No	16RP4	14	20	Yes	Yes ²⁸	3	25.75	NT	1.5	8	No	
	16T	E	T	No	16RP4	14	20	Yes	Yes ²³	3	25.75	NT	1.5	6	No	
	29C	E	C	No	19AP4A	14	20	Yes	Yes ²³	3	25.75	NT	1.5	10	No	
316	E	C	AM	16RP4	14	27	Yes	Yes ²³	3	25.75	NT	1.5	10	P		
Kaye-Halbert Corp. 3555 Hayden Ave. Culver City, Calif.	233B, 233M, 233W	242	C	No	16YP4 ²²	12	24	Yes	Key	3		No	2	12	No	
	234B, 234M, 234W	242	C	No	16YP4 ¹⁹	12	24	Yes	Key	3		No	2	12	No	
	235, 236	242	C	No	16YP4 ²⁰	12	24	Yes	Key	3		No	2	12	No	
	237	242	C	No	16YP4 ²¹	12	24	Yes	Key	3		No	2	12	No	
	238B, 238M, 238W	242	C	No	19AP4	12	24	Yes	Key	3		No	2	12	No	
	240, 241	242	C	No	19AP4	12	24	Yes	Key	3		No	2	12	No	
	731	242	C	No	17BP4	12	24	Yes	Key	3		No	2	12	No	
	American Modern (MV64), American Traditional (MV79), French Provincial (MV67)	103	C	AM-FM	17BP4	13	36	No	No	Ord	4	25.75	TU	13	15 ²⁶	P
	Biltmore (MV31)	102	C	No	16TP4	12.5	20	Yes	Ord	3	25.75	NT	2.4	12	No	
	Contemporary (MV78)	102	C	AM-FM	17BP4 ²⁴	12.5	29	Yes	Ord	3	25.75	TU	2.5	12	P	
Cosmopolitan (MV41)	102	C	No	17BP4 ²⁵	12.5	20	Yes	Ord	3	25.75	TU	2.4	12	No		
Embassy (MV63)	103	C	AM	17BP4	13	40	No	No	Ord	4	25.75	TU	17	15 ²⁷	P	
Hampshire (MV7)	102	T	No	14BP4	12.5	20	Yes	Ord	3	25.75	NT	2.4	8	No		
Hepplewhite (MV36)	103	C	No	17BP4	13	27	No	Ord	4	25.75	TU	4	12	PJ		
Metropolitan (MV21)	102	T	No	16TP4	12.5	20	Yes	Ord	3	25.75	NT	2.4	8	No		
Normandy (MV37)	103	C	No	17BP4	13	27	No	Ord	4	25.75	TU	4	12	PJ		
Playhouse (MV33)	102	C	No	17BP4 ²¹	12.5	20	Yes	Ord	3	25.75	TU	2.4	12	No		
Provincial (MV77)	102	C	AM-FM	16TP4	12.5	31	Yes	Ord	3	25.75	TU	6.5	12	P		
Wedgewood (MV72), Modern Theater (MV40), Shoreham (MV30)	103	C	No	19AP4	13	27	No	No	Ord	4	25.75	TU	4	12	PJ	
Majestic Radio and Television Div. of Wilcox Gay Corp. 170 Washington St. Brooklyn 1, N. Y.	120, 121	99	T	No	12LP4A	9.5	19	Yes	Ord	3	24.75	NT	3	5	No	
	141, 142	100	T	No	14DP4	9.5	19	Yes	Ord	3	24.75	NT	3	5	PJ	
	160, 162	101	T	No	16KP4	12	19	Yes	Ord	3	24.75	NT	3	5	PJ	
	7P1, 7P2, 7P3, 7P10, 7P11	101A	C	No	17AP4	12	19	Yes	Ord	3	24.75	TU	3	10	P3	
	7PR12, 7PR13	101C	C	AM-FM	17AP4	12	27	Yes	Ord	3	24.75	TU	3	10	P3	
	9PR4, 9PR5	103	C	No	19AP4A	12	19	Yes	Ord	3	24.75	TU	3	10	P3	
	9PR8, 9PR9	103A	C	AM-FM	19AP4A	12	27	Yes	Ord	3	24.75	TU	3	10	P3	
	902, 903, 910, 911	103	C	No	19AP4A	12	19	Yes	Ord	3	24.75	TU	3	10	PJ	
	1400	100	C	No	14DP4	12	19	Yes	Ord	3	24.75	NT	3	10	No	
	1600	101	C	No	16KP4	12	19	Yes	Ord	3	24.75	TU	3	10	PJ	
	1605, 1610	102	C	No	16GP4	12	19	Yes	Ord	3	24.75	TU	3	10	PJ	
	1710	101A	C	No	17AP4	12	19	Yes	Ord	3	24.75	TU	3	10	PJ	
	Brighton, Imperial, Winslow Kent	630 630	C C	No No	16-19/ ²⁸ 16-19/ ²⁸	12-13 12-13	30 30	No No	No No	Key Key	4 4	25.75 25.75	No No	2.5 2.5	12 12	No No
	Marathon Radio & Television, Inc. 495 Kent Ave. Brooklyn 11, N. Y.	630 630	C C	AM-FM No	19AP4A 16DP4A	15 13	45 31	No No	No No	Key Key	4 4	22.3 22.3	No No	10 4	12 10	P3 No
Mars Television, Inc. 112-33 Colonial Ave. Corona, L. I., N. Y.	630-4 ²⁹ 630-4 ²⁹ 630-4 ²⁹	C C C	No No No	20DP4A 17XP4A 16DP4A	16 15 14.5	30 30 30	No No No	No No No	Key Key Key	4 4 4	25.7 25.7 25.7	NT NT NT	5 5 4	12 12 12	No No No	
Mattison Television and Radio Corp. 893 Broadway New York 3, N. Y.	9018 9018 9018 9018 9018	C T C T C	No No No No No	14CP4 14CP4 16TP4 16DP4 19FP4 16DP4	13 13 13 13 13 13	18 18 18 18 20 19	Yes Yes Yes Yes Yes Yes	Ord Ord Ord Ord Ord Ord	Ord Ord Ord Ord Ord Ord	3 3 3 3 3 3	25.6 25.6 25.6 25.6 25.6 25.6	NT NT NT NT NT NT	2.5 2.5 2.5 2.5 2.5 2.5	8 8 10 8 10 10	No No No No No No	
John Meck Industries, Inc. 4541 N. Ravenswood Chicago 40, Ill.	MM-614C MM-614T MM-616C MM-616T MM-919C XSB	C C C C C C	No No No No No No	14CP4 14CP4 16TP4 16DP4 19FP4 16DP4	13 13 13 13 13 13	18 18 18 18 20 19	Yes Yes Yes Yes Yes Yes	Ord Ord Ord Ord Ord Ord	Ord Ord Ord Ord Ord Ord	3 3 3 3 3 3	25.6 25.6 25.6 25.6 25.6 25.6	NT NT NT NT NT NT	2.5 2.5 2.5 2.5 2.5 2.5	8 8 10 8 10 10	No No No No No No	

25TV	WC	No	12KP4	12	25	No	No	3	26.4	No	4	5	No
Meissner Mfg. Div. Maguire Industries, Inc. Mt. Carmel, Ill.													
Mercury Radio & Television Corp. 839 S. Wabash Ave. Chicago 5, Ill.	No information supplied												
Midwest Radio & Television Corp. 901-11 Broadway Cincinnati, Ohio	DMA-16 DX-19 DM-16 DXA-19 DJ-19 DR-16	C ³⁰ C ³⁰ C ³⁰ C ³⁰ C ³⁰ C ³⁰	No No No AM-FM AM-FM	12 12.5 12 12.5 12 12	24 25 25 24 32 32	Yes Yes Yes Yes Yes Yes	Key Key Key Key Key Key	4 4 4 4 4 4	25.75 25.75 25.75 25.75 25.75 25.75	NT NT NT NT NT NT	No 4 4 No 4 4	No 12 12 No 12 12	No No No P3 P3 P3
Mitchell Mfg. Co. 2525 N. Clybourn Ave. Chicago, Ill.	T16-B, T16-M	C	No	12.5	20	Yes	Ord	3	26.1	NT	2	8	PJ
Montgomery Ward and Co. 619 W. Chicago Ave. Chicago, Ill.	Airline 3020 Airline 3032 Airline 3034 Airline 3036, 3039 Airline 3038 Airline 3040 Airline 3041	T T T C C C C	No No No AM-FM AM No	12.5 12.5 11 12.5 12.5 12.5 12.5	21 25 22 25 29 27 22	Yes No Yes No No Yes Yes	Ord Key Ord Key Key Key Key	3 3 4 3 3 4 4	25.5 26.2 26.75 26.2 26.2 26.75 26.75	TU TU TU NT NT TU TU	2.2 2.2 2.2 2.2 2.2 2.2 2.2	4x6 6 6 12 12 12 10	No No No No P3 P3 No
Motorola, Inc. 4545 Augusta Blvd. Chicago, Ill.	No information supplied												
Multiple Television Mfg. Co. 987 Hegeman Ave. Brooklyn 8, N. Y.	630-type L-19, LFD-19, TT7-19 19" Remote	C C T	No No No	14 16 16	31 31 33	No No No	Key Key Key	4 4 4	25.75 25.75 25.75	No No No	3.5 3.5 5	12 12 12	No No RC
National Co., Inc. 61 Sherman St. Malden, Mass.	279-292 279-292 16C	T C WC	No No No	12 12 12	23 23 23	Yes Yes Yes	Ord Ord Ord	4 4 4	25.75 25.75 25.75	TU TU TU	2 2 2	4x6 ⁹ 10 4x6 ⁹	No No No
North American Philips Co., Inc. 100 E. 42 St. New York 17, N. Y.	PC50 PC75P, PC75T	C CC	No No	25 25	22 29	Yes No	Ord Ord	3 4		No No	3 5.3	8 12	No RC
Olympic Radio & Television, Inc. Olympic Building Long Island City, N. Y.	752, 752CB, 755, 755CB 753 764, 767 766 769, DX621, DX621C DX931, DX932	T ³² C T C C C	No No No AM-FM AM-FM No	12.5 12.5 12.5 12.5 12.5 12.5	20 20 20 30 30 20	No No No No No No	Ord Ord Ord Ord Ord Ord	3 3 3 3 3 3	25.75 25.75 25.75 25.75 25.75 25.75	NT NT NT NT NT NT	3 3 3 3 ⁸⁷ 3 ⁸⁷ 3	5 10 10 12 12 10	No No PLD P3 P3 PJ
Packard-Bell Co., Inc. 12333 W. Olympic Blvd. Los Angeles 64, Calif.	2001-2 2002-TV 2101 2102 2105 2105A 2202-TV 2204-TV 2301 2601-TV 2602 2801-TV 2803	T C T C C C T C C C C C C	No No No No No No No No AM-FM AM-FM AM-FM AM-FM	9 9 13 13 13 13 13 14 13 14 13 14 14	20 20 21 21 21 21 21 21 26 26 28 28	Yes Yes Yes Yes Yes Yes Yes No Yes Yes Yes Yes	Ord Ord Ord Ord Ord Ord Ord Ord Ord Ord Ord Ord Ord	3 3 3 3 3 3 3 3 3 3 3 3 3	25.0 25.0 25.0 25.0 25.0 25.0 25.0 25.0 25.0 25.0 25.0 25.0 25.0	NT NT NT NT NT NT NT NT NT NT NT NT	1.11 ¹⁴ 1.11 ¹⁴ 1.11 ¹⁴ 1.11 ¹⁴ 1.11 ¹⁴ 1.11 ¹⁴ 1.11 ¹⁴ 1.25 ¹⁴ 1.11 ¹⁴ 1.25 ¹⁴ 1.25 ¹⁴ 1.25 ¹⁴	6 1/2 10 6 1/4 10 6 1/2 6 1/2 10 12 12 12	No No No No No No No No No P3 P3 P3

Station Name	City	Class	Power	Frequency	Service	Day	Time	Yes	Ord	NT	2	6	No	
Radio and Television Inc. 244 Madison Ave. New York, N. Y.	616 1116, 6161	C	No	16XP4 ¹ 16XP4 ¹	14 14	19 19	Yes Yes	Ord Ord	3 3	NT NT	2 2	10 10	No No	
Regal Electronics Corp. 603 W. 130 St. New York 27, N. Y.	19C31, 19D31 19C36, 19D36 22C17, 2217 17T22 17HD36 1708 17HD31 22D19, 2219	C C C T C C C C	No AM-FM No AM-FM No No No No	19AP4A 19AP4A 17BP4A 17BP4A 17BP4A 17BP4A 17BP4A 19AP4A	17 17 12 14 12 14 14 17	31 36 22 22 36 22 31 22	No No Yes Yes No Yes No Yes	Key Key Ord Key Ord Key Key Ord	4 4 4 4 4 4 4 3	25.75 25.75 26.1 26.1 25.75 26.1 25.75 26.1	No No NT NT NT NT NT NT	2 2 2 2 2 2 2 2	12 12 4x6 12 12 12 12 12	No PJ No PJ No No No No
Scott Radio Laboratories, Inc. 4541 Ravenswood Ave. Chicago 40, Ill.	AC-16 AT-16 310TC 510TC 710W 800B-16 800B-19 910W	C T C C C C C C	No No AM-FM AM-FM No All All No	16KP4 16KP4 16KP4 16KP4 16KP4 20DP4 20DP4	11.5 11.5 11.5 11.5 11.5 11.5 11.5	21 21 33 35 26 45 45 26	Yes Yes Yes Yes Yes Yes Yes	Ord Ord Ord Ord Ord Ord Ord	3 3 3 3 3 3 3	26.1 26.1 26.1 26.1 26.1 26.1 26.1	NT NT NT NT NT NT NT	2 2 10 12 12 12 12 10	No No P P PA RPRC RPRC PA	
Sentinel Radio Corp. 2100 Dempster Evanston, Ill.	20E589 20E644 20E644 20E652 20E667	T C C C C	No No No No No	16TP4 16TP4 ²⁰ 16TP4 ²⁰ 19AP4A 19AP4A	12-13 12-13 12-13 13 13	21 21 21 21 21	Yes Yes Yes Yes Yes	Ord Ord Ord Ord Ord	3 3 3 3 3	25.5 25.5 25.5 25.5 25.5	TU TU TU TU TU	2.25 2.25 2.25 1.9 1.9	4x6 10 10 12 12 12	No No No No No
Setchell-Carlson, Inc. New Brighton, Minn.	2500 2500LP	C C	AM AM	17BP4A 17BP4A	14 14	24 24	Yes Yes	Key Key	4 4	26.1 26.1	No No	1.5 1.5	P3 No	
Shevers, Inc., Harold 123 W. 64 St. New York, N. Y.	Barclay, Bryant, Chelsea, Classic, Digby, Rector, Regency (all 031-A) Visionaire (1261) ⁵³ Visionaire (1263) ⁵³ Visionaire (1265) ⁵³	C T C C C	No No No No No	16BP4A ³⁵ 12AP4A 12LP4A 12LP4A	12 10.5 10.5 10.5	31 26 26 26	No Yes Yes Yes	Key Ord Ord Ord	4 4 4 4	No NT NT NT	3.2 1.9 1.9 1.9	12 6 10 12	No No No No	
Sightmaster Television Corp. 111 Cedar St. New Rochelle, N. Y.	16C51 16E51 19C51 20C51	C T C C	FM ⁴⁰ FM ⁴⁰ FM ⁴⁰ FM ⁴⁰	16HP4 17AP4 19DP4 20DP4	14 14 14 14	23 23 23 23	Note40 Note40 Note40 Note40	Ord Ord Ord Ord	3 3 3 3	25.75 25.75 25.75 25.75	TU TU TU TU	3 3 3 3	8 8 8 8	RC ⁴⁰ RC ⁴⁰ RC ⁴⁰ RC ⁴⁰
S. M. A. Co. 4721 N. Kedzie Ave. Chicago 35, Ill.	CT-111-A CT-120-A TV-116-A	C C C	FM FM FM	16HP4 ¹² 16XP4 ¹ 19AP4	10 12 11	21 22 22	No No No	No Ord Ord	3 3 3	25.75 25.75 25.75	TU TU TU	2 2 2	6x9 P3 P3	
Snaider Television Corp. 540 Bushwick Ave. Brooklyn, N. Y.	Auditorium Champion Champion Champion Crusader Crusader Portojector	C T C C T C P	SW-FM SW-FM SW-FM SW-FM No No No	5TP4 ⁸¹ 12LP4 16RP4 19AP4 12LP4 16RP4 5TP4 ⁸¹	27 10 10 10 10 10 30	37 31 31 31 21 21 21	No No No No Yes Yes Yes	Ord No No No Ord Ord Ord	5 5 5 5 3 3 3	26.1 26.1 26.1 26.1 25.75 25.75 25.75	No No No No No No No	6.5 3.2 3.2 3.2 3.2 3.2 3.2	12 12 12 12 10 10 10	No No No No No No No
Sonora Radio & Television Corp. 325 N. Hoyne Ave. Chicago 12, Ill.	302 303 305	T T T	No No No	12LP4 12LP4 16TP4	9.5 9.5 12.5	19 19 20	Yes Yes Yes	Ord Ord Ord	3 3 3	26.1 26.1 26.1	NT NT NT	2 2 2	5 8 5	No No PJ
Sparton Radio-Television 2400 E. Ganson St. Jackson, Mich.	5002, 5003 5006, 5007 5006X, 5007X 5010, 5011 5014, 5015 5025, 5026 5025-B, 5026-B, 5101, 5102, 5103 5029, 5030 5035, 5036, 5037 5052, 5053	T T T T T T T T T C	No No No No No No No No No	10BP4 12LP4 12LP4A 10BP4 12LP4 16KP4 ¹ 17KP4A 16SD160 16KP4 ¹ 12LP4	10 10 10 8-9.5 8-9.5 12.5-14 12.5-14 12.5-14 12.5-14 9-10.5	24 24 24 21 21 26 26 26 26 27	No No No Yes Yes Yes Yes Yes Yes No	Ord Ord Key Ord Ord Key Key Key Key Ord	4 4 4 3 3 4 4 4 4 4	26.25 26.25 26.25 26.25 26.25 26.25 26.25 26.25 26.25 26.25	NT NT NT NT NT NT NT NT NT NT	2.5 2.5 2.5 1.5 1.5 2.5 2.5 2.5 2.5 2.5	4x6 4x6 5x7 5x7 5x7 5 5x7 5x7 10	No No No No No No No No No No

1	2	3	4	5	6	7	8	9	10	11	12	13	14	15	16	
Sparton Radio-Television (Contd.)	5056, 5057	19TW10A	C	No	12LP4	8-9.5	21	Yes	Ord	3	26.25	NT	1.5	10	No	
	5064, 5065	23TB10	C	No	16AP4	10	27	No	Ord	4	26.25	No	2.5	10	No	
	5068, 5069	24TV9C	C	No	12LP4	10	28	No	Ord	4	26.25	No	2.5	10	No	
	5076, 5077	26SS160	C	No	16KP4 ¹	12 5-14	26	Yes	Key	4	26.25	NT	2.5	10	No	
	5076-BB, 5077-BB	26SS160B	C	No	16KP4 ¹	12 5-14	26	Yes	Key	4	26.25	NT	2.5	10	No	
	5079, 5080	26SD170	C	No	17KP4A	12 5-14	26	Yes	Key	4	26.25	TU	2.5	12	No	
	5079-B, 5080-B	26SD170	C	No	17KP4A	12 5-14	26	Yes	Key	4	26.25	TU	2.5	12	P	
	5082, 5083, 5182, 5183	26SD170	C	AM-FM	17KP4A	12 5-14	26	Yes	Key	4	26.25	TU	2.5	12	P	
	5085, 5086	25RD190	C	No	19AP4	13 25-15 27	27	Yes	Key	4	26.25	TU	2.5	10	P	
	5088, 5089	26SD170	C	AM-FM	17KP4A	12 5-14	26	Yes	Key	4	26.25	TU	2.5	10 ^b	No	
	5090	26SD170	C	No	17KP4A	12 5-14	26	Yes	Key	4	26.25	TU	2.5	10	No	
	5104, 5105	26SS170D	C	No	17KP4A	12 5-14	26	Yes	Key	4	26.25	NT	2.5	5	No	
	5152, 5153, 5154	26SS170	C	No	17KP4A	12 5-14	26	Yes	Key	4	26.25	NT	2.5	5	No	
	5155, 5156, 5157	26SD170	C	No	17KP4A	12 5-14	26	Yes	Key	4	26.25	TU	2.5	10	No	
	5170, 5171	25SD201	C	No	20CP4A	12 5-14	27	Yes	Key	4	26.25	TU	2.5	10	No	
	Starrett Television Corp. 601 W. 26 St. New York 1, N. Y.	James Buchanan	17BM1	T	No	17BP4A	12 5	20	Yes	Ord	3	26.1	NT	2	5	PJ
		Peter Cooper	47BM1	C	AM	17BP4A	12 5	20	Yes	Ord	3	26.1	NT	2	8	P
		Patrick Henry	27BM1	C	No	17BP4A	12 5	20	Yes	Ord	3	26.1	NT	2	8	PJ
		Washington Irving	37BM1	C	No	17BP4A	12 5	20	Yes	Ord	3	26.1	NT	2	8	PJ
		James Madison	39AM1	C	No	19AP4	12 5	20	Yes	Ord	3	26.1	NT	2	8	P
John Marshall		59AM1	C	AM	19'/'	12 5	20	Yes	Ord	3	26.1	NT	2	8	P	
Peter Stuyvesant		29AM1	C	No	19AP4	12 5	20	Yes	Ord	3	26.1	NT	2	8	PJ	
Eli Whitney		7BB1	C	No	17BP4A	12 5	20	Yes	Ord	3	26.1	NT	2	8	PJ	
Roger Williams		17BL1	T	No	17BP4A	12 5	20	Yes	Ord	3	26.1	NT	2	5	PJ	
Stewart-Warner Electric 1826 Diversey Pkwy. Chicago 14, Ill.		9120-A	9120-A	T	No	16TP4 ¹	13 5	26	Yes	Key	4		TU	2	6	No
	9120-B, -C, -D, -E, -F	Note 41	C	No	16TP4 ¹	13 5	26	Yes	Key	4		TU	2	6x9	No	
	9121-A	9121-A	C	AM-FM	16TP4 ¹	13 5	31	Yes	Key	4		TU	2	6x9	P3	
	9121-B	9121-B	C	AM-FM	16TP4 ¹	13 5	31	Yes	Key	4		TU	2	12	P3	
	9122-A	9122-A	C	AM-FM	19AP4	13 5	31	Yes	Key	4		TU	2	12	PJ	
	9200-A	9200-A	T	No	14BP4 ⁶	13	19	Yes	Ord	3		No	1	6	No	
		20,000 10,000		C	No	19AP4A 16KP4	13	22	Yes	Ord	3		No	6	No	
Semco 22R51A Semco 22S1R			T	No		13	22	Yes	Ord	3		No	6	No		
Stromberg-Carlson Co. 100 Carlson Rd. Rochester 3, N. Y.	Chinese Classic, 18th Century	119	C	AM-FM	19AP4	12-14	29	Yes	Key	4	26.2	NT	2.5	12	P	
	Chippendale, Imperial, Provincial	17	C	No	17AP4	12-14	26	Yes	Key	4	26.2	NT	2.5	12	No	
	Empire, Georgian	119	C	No	19AP4	12-14	29	Yes	Key	4	26.2	NT	2.5	12	No	
	Kenwood	17	T	AM-FM	17AP4	12-14	26	Yes	Key	4	26.2	NT	2.5	12	P	
	Mercury, Treasure Chest Stancilffe	17 24	C	No	17AP4 24AP4	12-14	26 30	Yes	Key	4	26.2	NT	2.5	5 1/2	No	
Sylvania Electric Products Inc. Colonial Radio & Television Div. Buffalo, N. Y.	090, 247	168	C	No	16LP4	13	24	Yes	Ord	4		TU	3	10	No	
	128	108	C	AM-FM	12VP4	9 5	24	Yes	Ord	4		TU	3	12	P	
	197, 245	227	T	No	12VP4A	9 5	23	Yes	Ord	4		TU	2	10	No	
	246	139	T	No	12VP4A	9 5	24	Yes	Ord	4		TU	3	5 1/4	No	
	1110X	329	T	No	16AP4	13	20	Yes	Ord	3		NT	2	5 1/4	No	
	4120M	260	T	No	14CP4	13	21	Yes	Ord	4		TU	2	8	P	
	4130B, 4130M, 4130W	260	C	No	14CP4	13	21	Yes	Ord	4		TU	4	12	P	
	5130B, 5130M, 5130W, 5140B, 5140M	290	C	No	19AP4A	13	21	Yes	Ord	4		TU	4	12	P	
	5150M	274	C	AM-FM	19AP4A	13	21	Yes	Ord	4		TU	4	12	P	
	6110X, 6120B, 6120M, 6120W	261	T	No	16KP4	13	21	Yes	Ord	4		TU	2	10	P	
	6130B, 6130M, 6030W	261	C	No	16KP4	13	21	Yes	Ord	4		TU	2	10	P	
	6140M, 6140W	271	C	No	16KP4	13	21	Yes	Ord	4		TU	4	12	P	
	7110X	366	T	No	17BP4A	13	21	Yes	Ord	4		TU	2	10	P	
	7020B, 7020M, 7020W	366	T	No	17BP4A	13	21	Yes	Ord	4		TU	2	10	P	
	7130B, 7130M, 7130W	366	C	No	17BP4A	13	21	Yes	Ord	4		TU	2	10	P	
7140M, 7140W	356	C	No	17BP4A	13	21	Yes	Ord	4		TU	2	12	P		
7150M, 7160B	357	C	AM-FM	17BP4A	13	21	Yes	Ord	4		TU	4	12	P		

Company	Model	Frequency	Power	Class	Notes	Key	Power	Class	Notes	Power	Class	Notes		
Tech-Master Products Co. 443 Broadway New York, N. Y.	630C19, 630S19 ¹⁹	14	25.75	No	2.5	No	12	No						
	Blue-Ribbon (1223)	9	25.75	No	2.5	No	5x7	No						
	1630-1930	14	25.75	No	2.5	No	12	No						
	1930D	14	25.75	No	2.5	No	12	PJ						
	1930T	14	25.75	No	2.5	No	12	PJ						
	Universal (5016) ⁵³	9	27.75	No	2	Yes	4x6	No						
	114	14BP4	14	1.8	TU	1.8	No							
	117C, 117L	17BP4	14	1.8	TU	1.8	No							
	117CA	17BP4A	14	1.8	TU	1.8	No							
	162	16RP4A	14	1.8	TU	1.8	No							
Tele King Corp. 601 W. 26 St. New York, N. Y.	201	20AP4A	14	1.8	TU	1.8	No							
	202C	20AP4A	14	1.8	TU	1.8	No							
	416CAF	AM-FM	14	1.8	TU	1.8	P3							
	916C	16DP4A	14	1.8	TU	1.8	No							
	916CAF	AM-FM	14	1.8	TU	1.8	No							
	919C	16DP4A	14	1.8	TU	1.8	No							
	919CAF	AM-FM	14	1.8	TU	1.8	No							
	19	19	Yes	Ord	3	24.0	NT	8	No					
	19	19	Yes	Ord	3	24.0	NT	8	No					
	19	19	Yes	Ord	3	24.0	NT	8	No					
Telequip Radio Co. 2559 W. 21 St. Chicago 8, Ill.	CD514	11.5	19	Yes	Ord	3	24.0	NT	2	2	2	8		
	CD516	12.5	19	Yes	Ord	3	24.0	NT	2	2	2	8		
	CD517	12.5	19	Yes	Ord	3	24.0	NT	2	2	2	8		
	CD519, CD619	12.5	19	Yes	Ord	3	24.0	NT	2	2	2	10		
	TD414	11.5	19	Yes	Ord	3	24.0	NT	2	2	2	5		
	TD416	11.5	19	Yes	Ord	3	24.0	NT	2	2	2	5		
	TD417	12.5	19	Yes	Ord	3	24.0	NT	2	2	2	5		
	TV-310	11-12	27	Yes	Ord	3	37.3	NT	2.5	2.5	2.5	8		
	TV-314	14DP4 ⁶	8	Yes	Ord	3	37.3	NT	2	2	2	5		
	TV-316B	16XP4 ³⁴	11-12	Yes	Ord	3	37.3	NT	2.5	2.5	2.5	4x6		
Tele-Tone Radio Corp. 540 W. 58 St. New York 19, N. Y.	TV-318, -322, -323	8	15	Yes	Ord	3	25.75	NT	1	1	1	4		
	TV-324	16XP4 ³⁴	11	Yes	Ord	3	25.75	NT	1	1	1	4x6		
	TV-325, -326, -335	11	15	Yes	Ord	3	25.75	NT	1	1	1	10		
	TV-325R, -326R	11	15	Yes	Ord	3	25.75	NT	1	1	1	10		
	TV-327	16XP4 ³⁴	11	Yes	Ord	3	25.75	NT	1	1	1	10		
	TV-328, -329	17AP4	11-12	Yes	Ord	3	25.75	NT	1	1	1	10		
	TV-330	19DP4	11	Yes	Ord	3	25.75	NT	1	1	1	10		
	TV-331, -332, -333	16XP4 ³⁴	12	Yes	Ord	3	37.3	NT	2	2	2	4x6		
	TV-334	16XP4 ³⁴	12	Yes	Ord	3	37.3	NT	2	2	2	4x6		
	TV-336	20DP4	11-12	Yes	Ord	3	37.3	NT	2.5	2.5	2.5	12		
Tele-Vogue, Inc. (Muntz TV) 1735 W. Belmont Ave. Chicago 13, Ill.	M31	11	15	Yes	Ord	3	25.75	NT	1	1	1	4x6		
	M32	12.5	17	Yes	Ord	3		NT	1.5	1.5	1.5	5		
	M33	12.5	17	Yes	Ord	3		NT	1.5	1.5	1.5	10		
	TV-17A2	16RP4A	12.5	Yes	Ord	3		NT	1.5	1.5	1.5	10		
	TV-17A2	16RP4A	12.5	Yes	Ord	3		NT	1.5	1.5	1.5	10		
	TV-17A4	19DP4A	12.5	Yes	Ord	3		NT	1.5	1.5	1.5	10		
	T-20	16KP4	11.5	No	Ord	3	25.75	NT	3	3	3	12		
	T-20	19AP4	11.5	No	Ord	3	25.75	NT	3	3	3	12		
	TT-63-SH	16FP4	14	No	Key	4	25.75	No	3	3	3	10		
	TT-63-SH	19AP4	11.5	No	Key	4	25.75	No	3	3	3	10		
Trad Television Corp. 1001 First Ave. Asbury Park, N. J.	CFD1920	11.5	21	No	Ord	3	25.75	No	3	3	3	12		
	D250	14	32	No	Key	4	25.75	No	3	3	3	8		
	KP1260	11.5	21	No	Ord	3	25.75	NT	3	3	3	12		
	KP1920	11.5	21	No	Ord	3	25.75	NT	3	3	3	12		
	P-13, P-14	5TP4 ⁸¹	35	No	No	4	25.75	No	4	4	4	5-12 ⁹		
	A	Note 45	11	No	No	3	26.4	No	3	3	3	6x9		
	A-3 Standard	Note 47	13	No	Ord	4	26.25	TU	3	3	3	6x9		
	A-3 Deluxe	Note 47	13	No	Ord	4	26.25	TU	3	3	3	6x9		
	Aristocrat (1600CD), Winfield (1600C) ⁸ , Phoenix (1600T)		12.5	22	Yes	Key	4		TU	3.5	3.5	8	No	
			12.5	22	Yes	Key	4		TU	3.5	3.5	5	No	
Transvision Inc. 460 North Ave. New Rochelle, N. Y.	A	Note 45	11	No	No	3	26.4	No	3	3	3	6x9		
	A-3 Standard	Note 47	13	No	Ord	4	26.25	TU	3	3	3	6x9		
	A-3 Deluxe	Note 47	13	No	Ord	4	26.25	TU	3	3	3	6x9		
	Aristocrat (1600CD), Winfield (1600C) ⁸ , Phoenix (1600T)		12.5	22	Yes	Key	4		TU	3.5	3.5	8	No	
			12.5	22	Yes	Key	4		TU	3.5	3.5	5	No	
	Trans-Vue Corp. 1139 S. Wabash Ave. Chicago 5, Ill.	A	Note 45	11	No	No	3	26.4	No	3	3	3	6x9	
		A-3 Standard	Note 47	13	No	Ord	4	26.25	TU	3	3	3	6x9	
		A-3 Deluxe	Note 47	13	No	Ord	4	26.25	TU	3	3	3	6x9	
		Aristocrat (1600CD), Winfield (1600C) ⁸ , Phoenix (1600T)		12.5	22	Yes	Key	4		TU	3.5	3.5	8	No
				12.5	22	Yes	Key	4		TU	3.5	3.5	5	No

1	2	3	4	5	6	7	8	9	10	11	12	13	14	15	16	
Travler Radio Corp. 571 W. Jackson Blvd. Chicago, Ill.	16G50	16G50	C	No	16GP4	12	24	Yes	Key	5	26.25	NT	2	6x9	No	
	16R50	16R50	C	No	16RP4	12	24	Yes	Key	5	26.25	NT	2	6x9	No	
	16R60	16R60	C	No	16RP4	12	24	Yes	Key	5	26.25	NT	2	6x9	No	
	16R70	16R70	C	AM	16RP4	12	24	Yes	Key	5	26.25	NT	2	6x9	P3	
	19A50	19A50	C	No	19AP4	12	24	Yes	Key	5	26.25	NT	2	6x9	No	
	62R50	62R50	T	No	16RP4	12	20	Yes	Key	5	26.25	NT	2	6x9	No	
	63R50	63R50	T	No	16RP4	12	20	Yes	Key	5	26.25	NT	2	4x6	No	
	64R50	64R50	C	No	16RP4	12	21	Yes	Key	5	26.25	NT	2	6x9	No	
	65G50	65G50	C	No	16GP4	12	21	Yes	Key	5	26.25	NT	2	6x9	No	
	United States Television Mfg. Corp. 3 W. 61 St. New York, N. Y.	C-16024		C	No	16DP4	11.5	24	No	No	4	25.75	No	4	12	PJ
C-16030P, C-19031P			C	No	16DP4	11.5	31	No	Key	4	25.75	No	4	12	PJ	
C-19032P			C	FM	19DP4	11.5	32	No	Key	4	25.75	No	4	12	PJ	
CFM-16031P			C	FM	16DP4	11.5	31	No	Key	4	25.75	No	4	12	No	
T-16030P			T	No	16DP4	11.5	30	No	Key	4	25.75	No	4	6	No	
T-19031P			T	No	19DP4	11.5	31	No	Key	4	25.75	No	4	6	PJ	
Vidcraft Television Corp. 780 E. 137 St. Bronx, N. Y.		017	017	T	No	16RP4	12	17	Yes	Ord	3		No	2	4x6	No
		017	017	C	No	16DP4A	12	17	Yes	Ord	3		No	2	10	No
		027	027	C	AM-FM	16DP4A	12	26	Yes	Ord	3		No	3	12	P
		Video Corp. of America 229 W. 28 St. New York 1, N. Y.	601		T	No	16RP4	14	18	Yes	Ord	3		NT	2.5	8
	611			C	No	16RP4	14	18	Yes	Ord	3		NT	2.5	10	No
	750			C	No	17AP4	14	18	Yes	Ord	3		NT	2.5	10	No
	912			C	No	19AP4	14	18	Yes	Ord	3		NT	2.5	10	No
	922			C	No	19AP4	14	18	Yes	Ord	3		NT	2.5	10	No
	2020		C	No	20DP4	14	18	Yes	Ord	3		NT	2.5	10	No	
	Video Products Corp. 2061 Broadway New York, N. Y.	630-K3	630-K3	C	No	19AP4	14	30	No	Key	4	26.25	No	3.5	12	PJ
Modern (M-5130), Traditional (R-5130, RL-5130, S-5130, SL-5130)		260-V	260-V	C	No	19AP4	14	30	No	Key	4	26.25	No	3.5	12	PJ
		V-2172	V-2172	T	No	16RP4	13	23	Yes	Key	3	45.75	TU	1.5	5	No
H627K16, H628K16, H629K16		H627K16, H628K16, H629K16	T	No	16JP4A	13	23	Yes	Key	3	45.75	TU	1.5	10	No	
H630T14		V-2171	T	No	14BP4	13	23	Yes	Key	3	45.75	TU	1.5	5	No	
H633C17, H634C17		V-2176	C	AM-FM	17AP4	13	27	Yes	Key	3	45.75	TU	2.8	12	No	
Zenith Radio Corp. 6001 W. Dickens Ave. Chicago 39, Ill.		H2226R, H2227E, H2227R	22H20	T	No	12UP4B	10	22	Yes	Key	4		NT	1.8	5 1/4	RC ⁴⁰
		H2250R, H2255E	22H20	T	No	12UP4B	10	22	Yes	Key	4		NT	1.8	10	RC ⁴⁰
		H2328E, H2328R, H2329R	23H22	T	No	17BP4	10	23	Yes	Key	4		NT	1.8	5 1/4	RC ⁴⁰
		H2352R, H2353E	23H22	C	No	17BP4	10	23	Yes	Key	4		NT	1.8	10	RC ⁴⁰
	H2437E, H2437R	24H20	C	No	16GP4B	12	24	Yes	Key	4		NT	1.8	10	RC ⁴⁰	
	H2438R, H2439R, H2449E	24H20	C	No	16GP4B	12	24	Yes	Key	4		NT	1.8	12	RC ⁴⁰	
	H2445R, H2447R	24H21	C	No	19AP4B	12	24	Yes	Key	4		NT	1.8	10	RC ⁴⁰	
	H3267R, H3469E, H3475R	24H20, 8H20	C	AM-FM	16GP4B	12	34	Yes	Key	4		NT	1.8	12	RC ⁴⁰	
	H3477R, H3478E	24H21, 10H20	C	AM-FM	19AP4B	12	34	Yes	Key	4		NT	1.8	12	RC ⁴⁰	
	H3168R	23H22, 8H20	C	AM-FM	17BP4	10	31	Yes	Key	4		NT	1.8	12	RC ⁴⁰	

1 Also uses 16RP4
2 Uses 16CP4
3 Glass rectangular tube
4 Cabinet speaker
5 Also uses 17BP4, 16KP4, 16RP4, 16TP4
6 Also uses 14CP4
7 Also uses 16AP4
8 Special Farnsworth tube
9 Dual speakers
10 3 x 4 foot projection picture
11 Also uses 17UP4 and 16HP4
12 Also uses 16AP4
13 Metal or glass
14 Watts output at 10% distortion
15 AM chassis type 1201/308
16 AM-FM chassis type 1201/328
17 Current sets, or this make have chassis number beginning with 307-0-
18 5 watts AM radio
19 Also uses 16EP4, 16KP4, 17BP4
20 Also uses 16CP4
21 Also uses 16KP4, 17BP4, 20-inch rectangular

22 Also uses 16GP4, 17BP4, 20-inch rectangular
23 Type of AGC not specified
24 Also uses 16TP4
25 Also uses 16CP4
26 And 5-inch tweeter
27 And high-frequency horn
28 Round tubes
29 Called Silver Rocket
30 Chassis available separately
31 Projection tube
32 75CB and 7255CB have console-type base with 12-inch speaker
33 Also uses 12KP4
34 Also uses 16TP4 and 16RP4
35 Also uses 19AP4A
36 Also uses 16CP4 and 17BP4A
37 10 watts from AM-FM radio
38 Model 1601 does not have built-in antenna, model 1606 has 8-inch speaker.
39 Also uses 17BP4 and 19AP4
40 Optional
41 Chassis number same as model number

CO Coin-operated, operates 30 minutes when 25¢ coin is inserted. Cabinet and coin box have separate locks.
NT Built-in antenna not tunable
MR Metal-cabinet remote unit
P Phonograph, type not specified
PA Separate power amplifier
PJ Phono jack
PLD Phono jack and local-distance switch
PLDT Phono jack, local-distance control
PRC Connections for phonograph and tone control
PS Phonograph, tape recorder, and microphone
PTRM 3-speed phono changer
P3 3-speed changer and local-distance switch
P3RC Remote control
RRC Record player and remote control
T Table model
TL Transformerless low-voltage supply
TU Tunable built-in antenna

Television DX Reports

WE admire the courage of some of our readers who live in areas not yet blessed by the presence of a television station and who must depend entirely on dx for their reception. Some of these write us about their installations and how they manage to get fairly consistent pickup over rather long distances.

One such letter comes from Maurice Dubreuil of Lavaltrie, Quebec, who not only has a fine antenna installation, but has also constructed some elaborate boosters.

"My receiver was built from a Philmore kit," writes Mr. Dubreuil. "It is an RCA 630TS model, realigned to pass only 2.5 mc. I have changed the 6AG5's for 6BC5's and am working all r.f. and i.f. tubes at about 20% more voltage than the original design calls for.

"Building the receiver was easy, but the boosters were a headache. I have tried all commercial boosters that I could get my hands on, but could only get a little sound once in a while, so I started fooling around with building some.

"My first booster was a tuned-plate

6AK5 working into a 6J4 followed by nine 6AK5's. It worked pretty well, but gave a lot of noise. The one I am using now has a 6J6 neutralized push-pull input feeding a pair of 6AK5's in push-pull. This works into a 6AK5 buffer which has no gain and then to two more 6J6 stages. Results with this booster are very good.

"For antennas I use two double-stacked Yagis cut for channel 4 and channel 5 (my boosters are good only on these channels), and a Vee-DX RD13A for all other channels. The antennas are on a tower 80 feet high, and I intend to put up a 150-foot tower soon. With this equipment I get daily reception from WRGB, channel 4, in Schenectady and WSYR-TV, channel 5, in Syracuse, both more than 260 miles distant."

Mr. Dubreuil also reports that he picked up WMBR-TV in Jacksonville and WTVJ in Miami, Florida, quite regularly during warm nights in July and August. The distance to these stations is about 1,200 and 1,500 miles. He has also received KOB-TV, channel 4, in Albuquerque, New Mexico which, according to our atlas, is over 1,850 miles.

Other channel 4 stations that Mr. Dubreuil has picked up during the summer are WLW-T in Cincinnati, Ohio; WTAR-TV, Richmond, Virginia; and WMCT, Memphis, Tennessee. Channel 5 stations are WOC-TV, Davenport, Iowa; KSTP-TV, St. Paul, Minnesota; KSD-TV, St. Louis; WSAZ-TV, Huntington, West Virginia; and WAGA-TV, Atlanta, Georgia.

While this installation is perhaps a little more elaborate than most dx'ers would care to use, it does show that dx can be had fairly consistently with good equipment. We thank Mr. Dubreuil for sending us the details of his TV receiving setup, and also thank all the others who have sent us the dx reports which are listed in the two tables below.

Occasionally we get reports of dx from Europe where television is now becoming more common. One report is of an Italian in Turin who received the British station at Sutton Coldfield, a distance of 1,300 kilometers. Now that a common set of European standards is being accepted by many countries, we should be getting more reports of dx from abroad.

TABLE I—REPORT OF RECEPTION

STATION	REPORTED BY	TIME RECEIVED	MILE-AGE	STATION	REPORTED BY	TIME RECEIVED	MILE-AGE	STATION	REPORTED BY	TIME RECEIVED	MILE-AGE
KMTV Channel 3 Omaha, Neb.	W. L. Thompson	10/27, 1:55 pm	1,200	WLW-T Channel 4 Cincinnati, Ohio	L. A. Canning	8/12/49	1,025	WRGB Channel 4 Schenectady, N. Y.	F. C. Meyers	7/16	1,160
KNBH Channel 4 Los Angeles, Cal.	C. G. Hailey	6/24	1,260	WMAR-TV Channel 2 Baltimore, Md.	F. C. Meyers	7/16	1,050	WSPD-TV Channel 13 Toledo, Ohio	E. Gustafson	10/21, 7-8:30 pm	475
KPHO-TV Channel 5 Phoenix, Ariz.	E. Gustafson	6/21, 5 pm	1,250	WMCT Channel 4 Memphis, Tenn.	C. T. Tripp	7/20, evening	1,000	WTAR-TV Channel 4 Norfolk, Va.	F. C. Meyers	7/6, 6 pm	1,100
WBTV Channel 3 Charlotte, N. C.	L. A. Canning	7/20	1,150	WNBT Channel 4 New York, N. Y.	F. C. Meyers	7/21	1,160	WTCN-TV Channel 4 Minneapolis, Minn.	R. J. Walker	6/11	1,500
WBZ-TV Channel 4 Boston, Mass.	R. J. Walker E. Gustafson F. C. Meyers	6/11 6/30, 6 pm 7/16	1,100 1,050 1,300	WNBW Channel 4 Washington, D. C.	F. C. Meyers	7/21	1,050	WTMJ-TV Channel 3 Milwaukee, Wis.	L. A. Canning	8/5	1,200
WCBS-TV Channel 2 New York, N. Y.	F. C. Meyers H. L. Robins	7/16, 2 pm 10/15	1,160 1,010	WOAI-TV Channel 4 San Antonio, Tex.	R. J. Walker	6/11	1,100	WTTG Channel 5 Washington, D. C.	F. C. Meyers	7/31, noon	1,010
WJAR-TV Channel 11 Providence, R. I.	L. A. Canning	10/30	450	WPTZ Channel 3 Philadelphia, Pa.	F. C. Meyers	7/22	1,110	WTVJ Channel 4 Miami, Fla.	C. T. Tripp	7/21, 6:45 pm	1,440
WLAV-TV Channel 7 Grand Rapids, Mich.	E. Gustafson	10/21, 7-8:30 pm	475					WXEL Channel 9 Cleveland, Ohio	E. Gustafson	10/22	600

TABLE II—RECEIVER DATA

NAME	LOCATION	RECEIVER	BOOSTER	ANTENNA	NAME	LOCATION	RECEIVER	BOOSTER	ANTENNA
L. A. Canning	Halifax, N. S.	Marconi Northern Electric Cossor	National	2-bay conical	W. L. Thompson	Saugus, Cal.	Radio Craftsman	Electro-Voice	rhombic with 2,500 ft open line
E. Gustafson	Keokuk, Ia.	Motorola 12VF4	Masco	conical stacked Yagi ch. 5 Yagi	F. C. Meyers H. L. Robins C. T. Tripp R. J. Walker	Belleville, Kan. Tampa, Fla. Dannemora, N. Y. Daytona, Fla.	Admiral 32X15 Skyrider 513 DeWald Du Mont	Anchor Astatic Anchor Astatic	4-bay array stacked array ch. 4 Yagi 5-element beam
C. G. Hailey	Robstown, Tex.	Motorola 9VT1	Regency Jerrold Anchor	conical					

How an Electric Brain Works

Part IV—Long division with relays—our little electric brain learns how to divide and to convert decimal numbers to binary and back again. Simon is getting an education

By EDMUND C. BERKELEY* and ROBERT A. JENSEN

PREVIOUS articles of this series have shown how an electric brain made of relays can add, subtract, and multiply.

Now we shall carry out division. As before, we shall consider the process in *binary notation*, the scale of two.

As a second topic, we shall consider how to make a relay calculator convert a number from decimal notation to binary notation, and back again. There is every reason in the world why the machine itself should convert any decimal number, say 23, into the corresponding binary number (in this case 10111, one-oh-one-one, or one 16 plus no 8's plus one 4 plus one 2 plus one 1).

Addition, subtraction, and multiplication turned out to be very simple in binary notation as compared with decimal. The same is true with division: binary division is simple as can be.

Suppose we divide 1101 (one-one-oh-one, or 8 plus 4 plus 1, or 13 in decimal) into 10000101 (one-oh-oh-oh-oh-oh-oh-oh-one, or 128 plus 4 plus 1, or 133).

We do this in the same general way as we do in decimal division, except that we act as if we knew only the two digits 1 and 0:

	01010	(Quotient)
(Divisor)	1101)10000101
	0000	(Dividend)
	10000	(1st Partial
	1101	Remainder)
	0111	(2nd Partial
	0000	Remainder)
	1110	(3rd Partial
	1101	Remainder)
	0011	(4th Partial
	0000	Remainder)
	011	(Remainder)

Only two multiples of the divisor are used, one times the divisor, and zero times the divisor—and the latter is of course zero in every digit. No other multiples of the divisor are needed. If we simply compare the divisor with the partial remainder at any point in the division, we can tell whether the digit of the quotient is 1 or 0.

Circuits for division

As before, to keep the circuits simple, let us ignore a number of fine points, such as: fractions; the *binal* point (the analogue in the scale of two of the decimal point in the scale of ten);

positive and negative numbers; size of numbers; etc. Suppose that we have an eight binary digit dividend, and a four binary digit divisor.

The circuit is on the opposite page. In part 1, terminal T1 is energized at the start, and holds up the relays storing the dividend through their hold contacts. (All current-carrying circuits and relay contacts in the energized state are in red.) The actual number which these relays store, of course, depends on something that happened before the time at which we begin. In the same way, the divisor is stored in relays of part 2 of the circuit, and terminal T2 holds them up.

Now different things have to happen at different stages during the division. So we want to have some relays that will tell us at what stage we are during the process of the division. This is the function of the K relays of part 3 of the circuit. The stages that they detect and report are 0,1,2,3,4. The time chart in Fig. 1 shows that stage 0 lasts from time 1 to time 8, stage 1 from times 9 to 16, stage 2 from times 17 to 24, etc. At stage 0, we attend to the first quotient digit; at stage 1, we attend to the second quotient digit; etc. The red parts of the circuit apply to the first stage of the division only.

We have to start off the divisions by selecting some digits, which we can call a *partial remainder* (see part 4). At stage 0, this is the first four digits of the dividend; but at later stages this is the result of a subtraction together with "bringing down" one more digit

of the dividend. The circuit of part 4 shows that at each stage of the division, we have just the partial remainder that we desire stored in the E relays. We have to look ahead to part 8, of course, and take on faith that the G relay contacts in part 4 will express the result of a subtraction that we want.

The next thing that we must do is decide whether the divisor "goes" into the partial remainder, or whether it "doesn't go". To make this decision, we must compare two numbers and decide which is the larger. The divisor "goes" and yields 1 as a digit of the quotient if, and only if, the partial remainder is larger. A circuit that does exactly this is shown in part 5. The red contacts show the original partial remainder (stored in the E relays) and the divisor (A relays). We see that there is no path for the quotient relay Q to be energized, and so the first "quotient digit" is 0.

Before we go any further, we want to store that quotient digit, so that we shall know the whole quotient when we get through with the division. This duty is performed by the circuit of part 6, which shows how the digit quotient is routed, according to the time it is obtained, into the right C relay.

We now want to determine the multiple of the divisor that depends on the quotient digit and the divisor. This is the function of part 7 of the circuit, which will give us the divisor itself if the quotient digit is one and zero in all digits if the quotient digit is zero.

In part 8 of the dividing circuit, the subtraction of the divisor multiple from the partial remainder is indicated schematically, because actual circuits for subtraction were discussed previously.

The timing of the circuits, up to the end of the first two quotient digits, is shown in the timing chart of Fig. 1. The same conventions are used here as in the time chart for multiplication in the previous article. Successive time

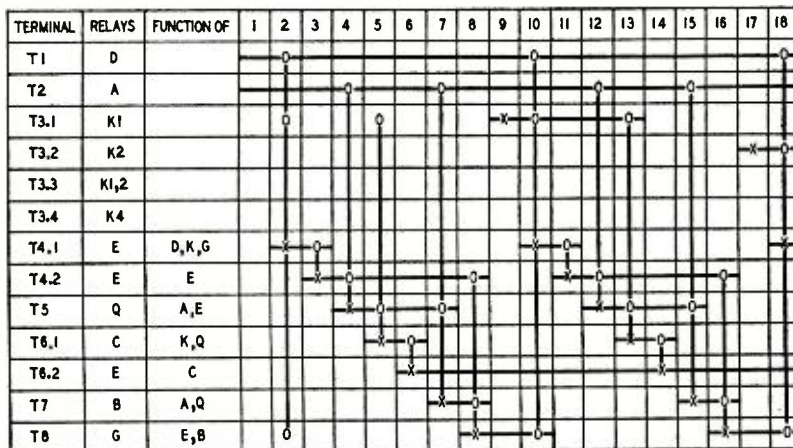
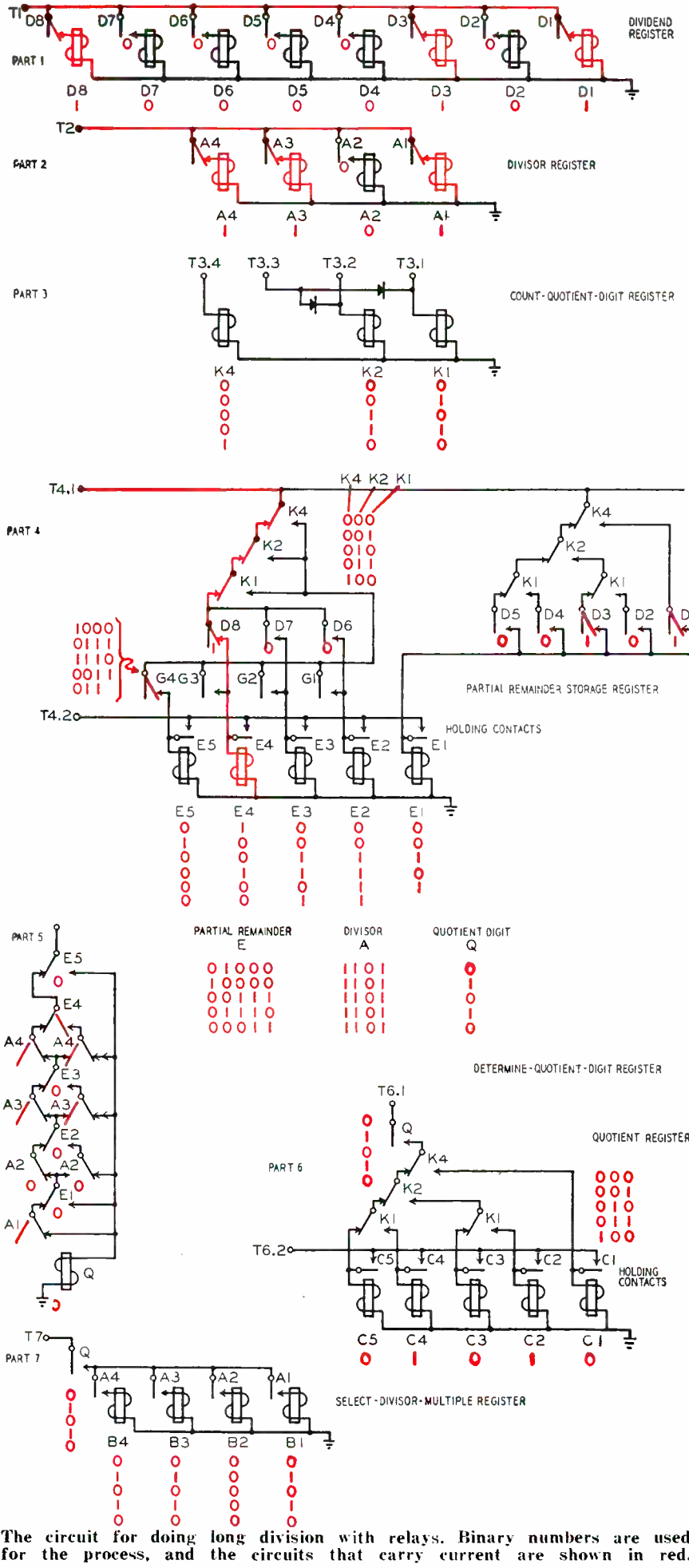

Fig. 1—Timing chart which shows the sequence of operation for the first two stages of the division with binary numbers performed by the circuit of Fig. 1.

*Author: *Giant Brains*



intervals 1,2,3,4, are shown from left to right. In the first column, the different terminals are shown from top to bottom; in the second column, the names of the relays which the terminals energize; in the third column the names of the relay contacts through which the relays are energized. Each horizontal line begins when its terminal is energized, and stops when its terminal ceases to be energized. There are some vertical lines showing X's and O's. X marks the relays energized at a certain time, and the O's mark the contacts through which they are energized.

Now, you may say, it is all very well to be able to add, subtract, multiply and divide in binary notation, but how do we go from decimals to binaries?

In fact, even before we ask this question, we have to ask: how will the machine take in a decimal number? In other words, how will the machine accept it, record it, and store it?

Ordinarily a calculating machine (or some auxiliary part of it) will have a keyboard, containing keys numbered 0,1,2 up to 9. Often the keyboard will have a different column for each column of the number to be inserted in the machine. To put in a number like 593, we press down the 5 key in one column, the 9 key in the next column, and the 3 key in the third column.

In many calculating machines, the result of pressing down a key, say 3, is to turn some little counter wheel $\frac{3}{10}$ of one complete turn. But in our machine we want the result of pressing down the 3 key to be the energizing of certain relays, so that we can use the information later in the machine.

We would reasonably desire to convert any one of these ten decimal digits 0 to 9 into a pure binary number according to Table I.

Fig 2 is a circuit which will do this (using 15 rectifiers and 4 relays).

For example, if we press the 3 key, relays A2 and A1 are energized, but not relays A8 and A4, and so the information produced in the relay register is 0011, which is the binary number three.

In this way the decimal number 593 can be converted into 0101 1001 0011 stored in 12 relays. This form of representing a decimal number by a "code" for each digit is *coded decimal* notation.

Now how do we go from 0101 1001 0011 to what this number is in pure binary notation? 593 of course is 5 times 10 times 10, plus 9 times 10, plus

Decimal	Binary	Decimal	Binary
0	0	5	101
1	1	6	110
2	10	7	111
3	11	8	1000
4	100	9	1001

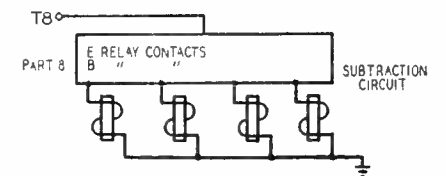

The circuit for doing long division with relays. Binary numbers are used for the process, and the circuits that carry current are shown in red. JANUARY, 1951



**The PROFIT-WISE
Serviceman Specifies . . .**

New
STANCOR PRODUCTS



**8400
POWER
SERIES**

A comprehensive line of 35 part numbers designed for replacement and new construction. Wide range of applications based on a thorough study of today's power transformer needs. Most ratings available in a choice of vertical or horizontal mountings.



**OUTDOOR LINE
TO VOICE
COIL**

Two new units designed to fit most needed outdoor applications. Primary impedances of 3,000/2,000/1,500/1,000/500 ohms; secondary impedances of 16/8/4 ohms. Part Number A-3333 rated at 14 watts. A-3334 rated at 25 watts.

**STANCOR
TRANSFORMERS**

Using Stancor replacement transformers for your radio, TV and sound service jobs is the sure way to fatten your bank account. Here's why —

- Quality comes first with Stancor. Ability to "take it" cuts down call-backs—keeps your customers happy with a good job.
- Stancor has the largest line in the industry. A choice of 450 part numbers, in some 30 mounting and terminal styles, enables you to get exactly the right unit for almost any application.
- Easy-to-read instruction sheets and clearly marked terminals make your job quicker and easier. Saves valuable shop time.

New Stancor units are coming out all the time. Keep posted. Ask your Stancor distributor for our latest catalogs.



Most Complete Line in the Industry

STANDARD TRANSFORMER CORPORATION 3592 ELSTON AVE., CHICAGO 18, ILL.

3, and all we have to do is write this in binary and tell our machine do it:

0101 times 1010 times 1010 plus 1001 times 1010, plus 0011.

And this our machine can do because it has an addition circuit and a multiplication circuit.

It will be neater to program this operation with:

5 times 10, plus 9, all times 10, plus 3.

Thus for a ten-digit decimal number, we shall only need nine multiplications.

Binary to decimal

Now suppose that we have the opposite problem. Given a binary number, we want to find the corresponding

decimal number. We divide this number by 1010 (one-oh-one-oh, or 8 plus 2, or 10 in binary) and find the remainder, which will be less than 10, and store it. Then we take the quotient, and divide that by 1010, and store the new remainder. And so on.

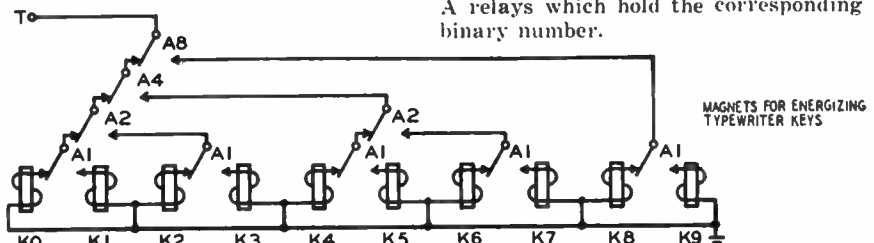

Fig. 3—Circuit for converting 4-digit binary system digits to decimal digits.

For example, suppose we desire to convert the binary number 10000101 into a decimal number.

$$\begin{array}{r} 1101 \\ 1010 \overline{) 10000101} \\ \underline{1010} \\ 1101 \\ \underline{1010} \\ 1101 \\ \underline{1010} \\ 1101 \\ \underline{1010} \\ 1101 \end{array}$$

11, which is 3 in decimal, and becomes our first decimal digit.

$$\begin{array}{r} 1 \\ 1010 \overline{) 1101} \\ \underline{1010} \\ 1101 \end{array}$$

11, which is 3 in decimal, and is our second decimal digit

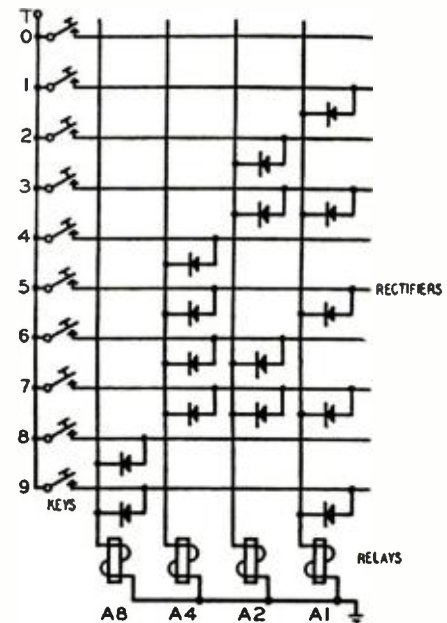

Fig. 2—Circuit for converting a decimal digit to a 4-digit binary number.

1010) 1, our dividend being also our remainder, and becoming the first decimal digit.

Our relay electric brain has division circuits and registers where we can store remainders; and so we can convert from binary into decimal. In this case we obtain the coded decimal form 0001 0011 0011 which is the same as 133.

How do we get this out of the machine? For example, suppose we have ten typewriter keys, bearing the characters 0,1,2,3,4,5,6,7,8,9. We wish to impulse these keys in order. The circuit in Fig. 3 will do this. When terminal T is energized, the appropriate K relay is energized, depending on the state of the A relays which hold the corresponding binary number.

There's Only ONE COMPLETE CATALOG for EVERYTHING IN RADIO, TELEVISION & INDUSTRIAL ELECTRONICS

IT'S YOUR **FREE**
ALLIED 212-PAGE
 VALUE-PACKED CATALOG!

Send For It Today!

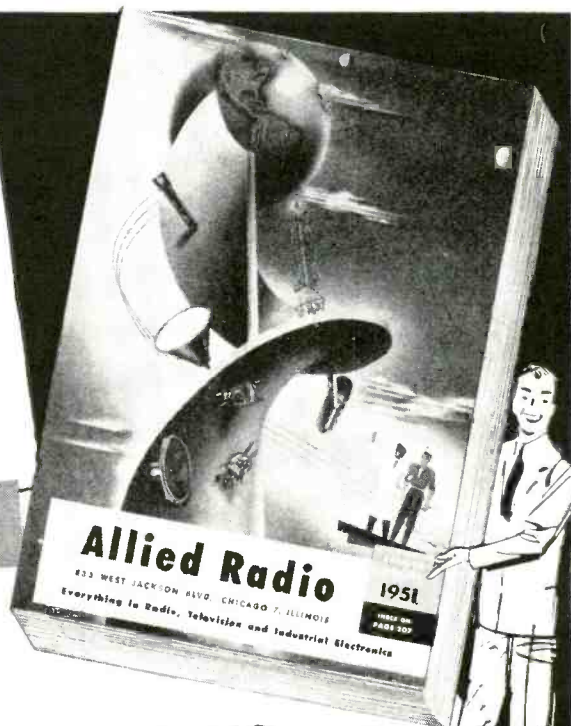

HERE'S the only *complete* Buying Guide to TV, Radio and Industrial Electronics—packed with the world's largest selections of quality equipment at lowest, money-saving prices. See the latest in TV, AM and FM receivers; radio-phonos; new Sound Systems and P.A. equipment; high-fidelity custom sound components; recorders and accessories; full selections of newest Amateur receivers and station gear; test instruments; builders' kits; huge listings of parts, tubes, tools, books—the world's *most complete stocks* of quality equipment.

ALLIED gives you *every* buying advantage: speedy delivery, expert personal help, lowest prices, assured satisfaction, liberal time payment terms. Get the 1951 ALLIED Catalog. Keep it handy—it will save you time and money. Send today for your **FREE** copy!

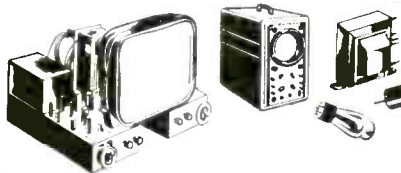

WORLD'S LARGEST STOCKS

- Radio Parts Unlimited
- Test Instruments—All Makes
- Television & Home Radios
- P.A. and Hi-Fi Equipment
- Amateur Station Gear
- Supplies for Industry

QUICK, EXPERT SERVICE



ALLIED IS YOUR TELEVISION HEADQUARTERS



To keep up with TV, depend on ALLIED! Count on us for the latest releases and largest stocks of picture tubes, component parts, antennas and accessories—plus the latest in TV tuners and kits. If it's *anything* in TV—we have it in stock! So remember—for TV—it's ALLIED First!



ALLIED RADIO

THE WORLD'S LARGEST RADIO SUPPLY HOUSE

Everything in Electronics

WRITE TODAY FOR RADIO'S LEADING BUYING GUIDE

ALLIED RADIO CORP.
 833 W. Jackson Blvd., Dept. 2-A-1
 Chicago 7, Illinois

Send FREE 212-page 1951 ALLIED Catalog.

Name.....

Address.....

City.....Zone.....State.....

FREE



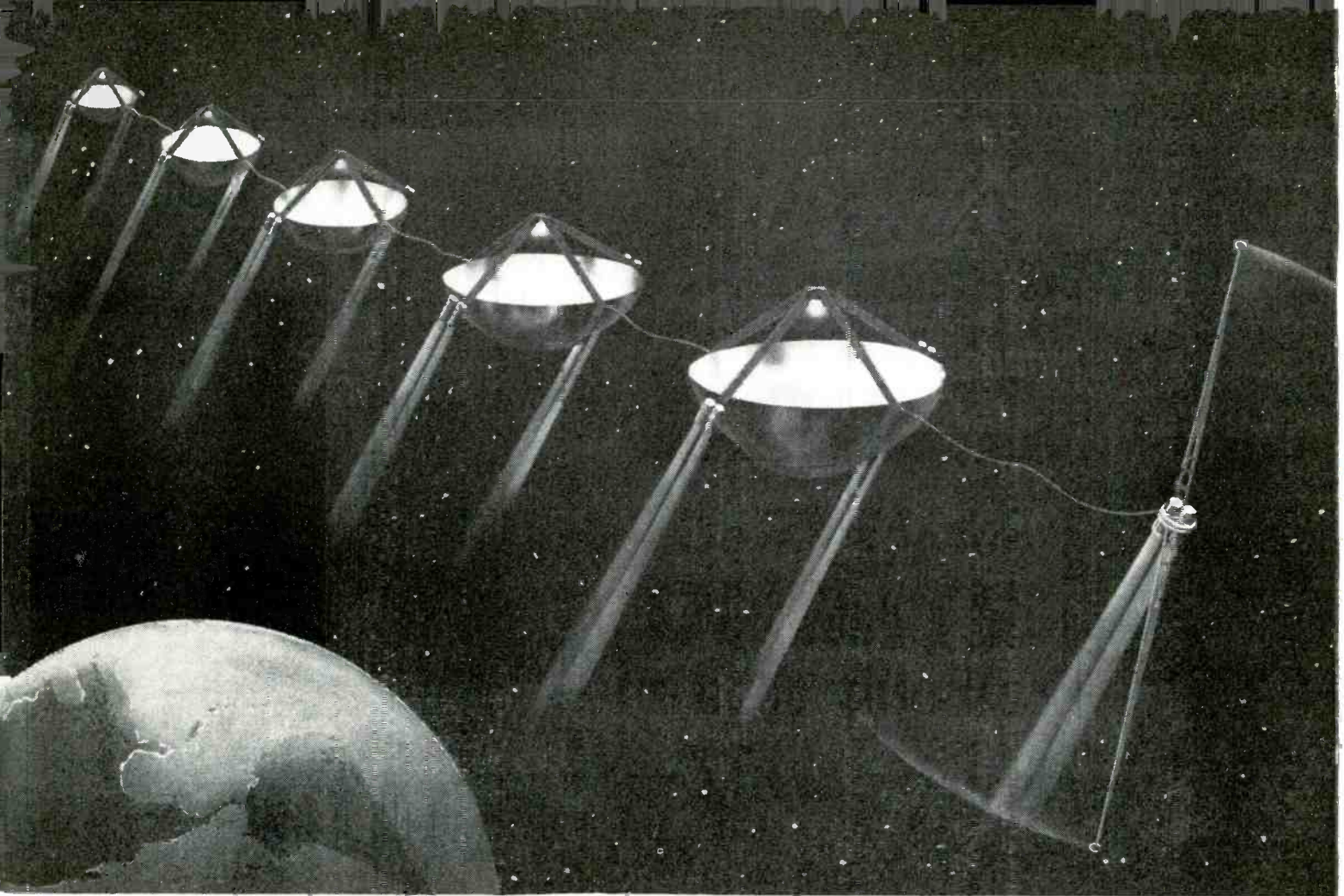

ELECTRIC SPACE SHIPS

Part II—Using the sun's energy

By PROFESSOR HERMANN OBERTH

IN this second article of this series we shall discuss the details of a spaceship and its power plant—the energy source being the sun's rays. A large mirror concentrates solar heat on a specially constructed boiler. The vapor produced by the boiler drives a turbine, and the turbine in turn drives a special electric generator which provides both the propelling force and control for the ship.

The parabolic mirror 1 (see Fig. 1) reflects the sunlight on the boiler 2 which drives the dynamo. (Whether this should be a dynamo or an influence machine of the Wommelsdorf type depends on the behavior of the electrodes in outer space, a factor which cannot

yet be predicted. My present feeling is that the Wommelsdorf machine is most suitable.)

The side of the boiler toward the mirror has a dark surface, while the side away from the mirror has a reflecting surface to reduce heat loss. The elements marked 3 are supporting rods. Like the mirror, these can be very lightly built (by earthly standards) because of the extraordinarily slight acceleration.

An exhaust pipe 4 leads the vapor in a spiral to the shady side of the mirror where the vapor condenses. Another pipe leads the condensed vapor back to the boiler. (I purposely avoid using the terms water and steam because other

The author's concept of a string of the electric spaceships on a flight through outer space. Because there is no gravity, the saucer-like ships can be made extremely light by earthly standards, although they cannot land on a planet.

liquids are better suited for this machine.)

The two electrode couples are marked 5, and are of the type described in the first article. These can be rotated about axis 6. Since the mirror itself can be rotated about its own axis and the direction of this axis is that of the sun's rays, the recoil can be made to work in any direction in space. With the couples in the position shown, acceleration takes place in the direction of the arrow.

The slight acceleration which the recoil imparts to the apparatus is not enough to separate the vapor and the liquid from each other, and even this slight acceleration is available only after the boiler begins to function. Furthermore, the liquid can collect on the side facing the mirror only when the acceleration is toward the sun; otherwise the empty wall would be heated.

A rotating boiler

We can overcome this difficulty as well as gain other constructional advantages by allowing the entire cylindrical boiler to rotate about its own axis. Fig. 2 is a sketch of the boiler. Here 1 is the boiler and 2 is the working liquid which, because of the rapid

PERFECT

Fringe Area

RECEPTION

IS AS SIMPLE AS



You can have nearly perfect TV reception — strong, "snow"-free images — regardless of how faint an image you now receive — with the complete Tel-a-Ray System for fringe areas! It's simple and economical.

The first step in the Tel-a-Ray System is the Tel-a-Ray "T" antenna, which consistently receives images from stations 200 miles away.



To your Model T antenna, mount the new, powerful Tel-a-Ray Pre-Amplifier. This amazing new product of the Tel-a-Ray Research Department eliminates, or greatly reduces, "snow." Because it mounts right to the antenna, it has a high signal-to-noise ratio, bringing you stronger, clearer pictures with less noise. It furnishes consistent reception beyond the fringes and eliminates matching problems and line loss. It is completely weather-resistant, like all Tel-a-Ray products, and sells at a much lower price than other antenna-mounted amplifiers or boosters.

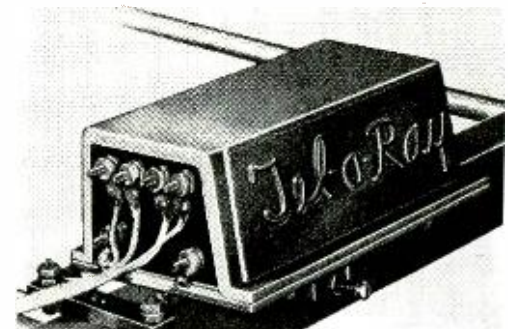
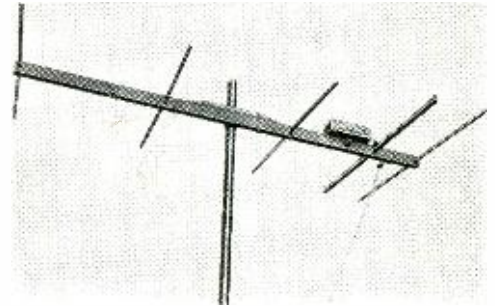

WITH THE COMPLETE *Tel-a-Ray System*

The final step that brings you almost perfect TV reception is your TV receiver. This simple parlay, A-B-C, is your guarantee of hours of television pleasure, unmarred by foggy images and irritating noise.



FOR PRIMARY AREAS



The Tel-a-Ray Butterfly receives 13 channels and FM radio. Guaranteed to be weather-resistant, it will consistently provide the best reception possible. And the price is just \$2.95 (suggested list).

Viewers throughout the country have come to associate the name Tel-a-Ray with good reception through quality products. If you have a particular reception problem, Tel-a-Ray engineers will be glad to help you.

Tel-a-Ray
ENTERPRISES, INC.

P.O. Box 332A HENDERSON, KY.

SURE CURE FOR BATTERY HEADACHES

NO FUSS, NO MUSS WITH



BATTERY ELIMINATORS

SAVE TIME, MONEY...

Servicing DC Equipment From AC Lines!



Model "BJ" POWER SUPPLY with Conduction Cooling

DEMONSTRATE and TEST CAR, AIR, MARINE RADIOS

... also relays, 'phone circuits, instruments, other low voltage devices. End costly storage battery failures with Electro's dependable power supply. Lower-priced; new exclusive conduction cooling assures lowest cost per ampere output and silent long-life operation. 6 volts, 20 amps.

New Low Cost "BJ" JUNIOR DC POWER SUPPLY, 6 volts, 12.5 amps.

OVER 2 MILLION Battery Radios Offer Huge PROFIT Market!



New Model "S" BATTERY ELIMINATOR with Selenium Rectifier

CONVERT BATTERY RADIOS to AC ALL-ELECTRIC

Now is the time your customers want dependable all-electric hum-free performance... Tap this big timely market now! Operates any 1.4 volt 4 to 6 tube battery radio from 115 volt 50/60 cycle source. Fits most radios. Guaranteed 3 years.

SEND COUPON NOW!

ELECTRO PRODUCTS LABORATORIES
4507-BS Ravenswood Ave., Chicago 40, Ill.

Name.....

Address.....

City.....Zone.....State.....

In Canada: Atlas Radio Corp. Limited, Toronto

rotation, collects on the boiler walls. The vapor collects in the middle of the boiler and flows to the turbine 3, which I have taken to be a two-stage machine. The guide vanes of the turbine are rigidly connected to the boiler wall.

The vapor then enters pipe 4 which leads it to the shadow of the mirror, where it is condensed, and the liquid returns through pipe 5. From 5 the liquid enters funnel 6 which is rigidly attached to the boiler and rotates with it. Centrifugal force then drives the liquid out of 6 and into the boiler

17 which is permeable to both heat and light, and the rest of 16 is made of reflecting sheet metal. The outside of the boiler is black. The space between 1 and 16 or 17 is, of course, filled with vapor at the temperature of the boiler and at the same pressure as the exhaust vapor at 4.

Completely sealed

No rotating parts of the machine pierce the outer wall at 4, 5, 16, or 17. The machine can therefore be effectively sealed off against losses of the

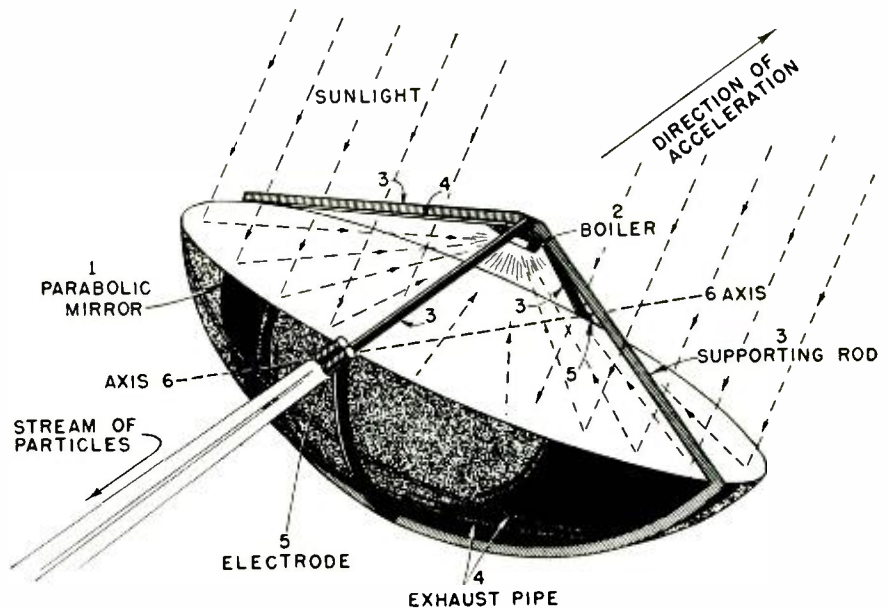

Fig. 1—Drawing showing the essential parts of the solar-powered spaceship.

through the tubes marked 7. Valves to prevent backflow of the liquid are marked 8.

The rotating vanes 10 of the turbine are mounted on shaft 9 which rotates within the boiler but in the opposite direction. The rotor runs at a hypercritical velocity and therefore acts as its own counterbalance.

The source of current, here taken to be a Wommelsdorf machine (an improved influence machine invented in 1922), is indicated by 13, and 12 is a special coupling unit. The space within this machine is at the same pressure as the boiler for better efficiency and simpler construction.

The construction of the machine would be greatly simplified if the vapor within the boiler could flow freely in and out through 11, but this is not possible if water is used as the working fluid. The stator of the current generator 13 rotates in the same direction as the boiler, while the rotor turns with shaft 9. Slip rings are marked 14 and 14', while 15 and 15' are current collectors. The potential difference between these will be in the order of several thousand volts, but it is possible to insulate the rings very effectively in gravitationless space.

In Fig. 2 we also have 16, a casing which contains the whole machine. On the side toward the mirror is a window

working liquid—a most necessary measure.

In this machine three rotations are possible with respect to shaft 9:

- a. Rotation of the shaft and of the rotors;
- b. Rotation of the boiler together with the stators;
- c. Finally, the casing 16 together with all the other equipment, rods, mirror, electrodes, etc., can be brought to rotate about the boiler shaft.

In fact, because of the friction in bearings 18 and 19, the boiler must eventually impart its rotation to the rest of the device, while the turbine rotors 3 and the rotors of the current generator 13 absorb the opposite momentum.

I have therefore provided for another influence machine 20, whose stator is rigidly connected with the outer casing 16 while its rotor is similarly fastened to the shaft of the boiler. Depending on which direction the current flows through this machine, it will exert a turning moment on 16. Thus it is backed up, so to speak, on the boiler and accordingly turns the rest of the machine in the right position.

It would be advantageous to connect several such mirror engines with cables which, because of the small current, can be quite thin. The artist's drawing shows a string of such engines. In the

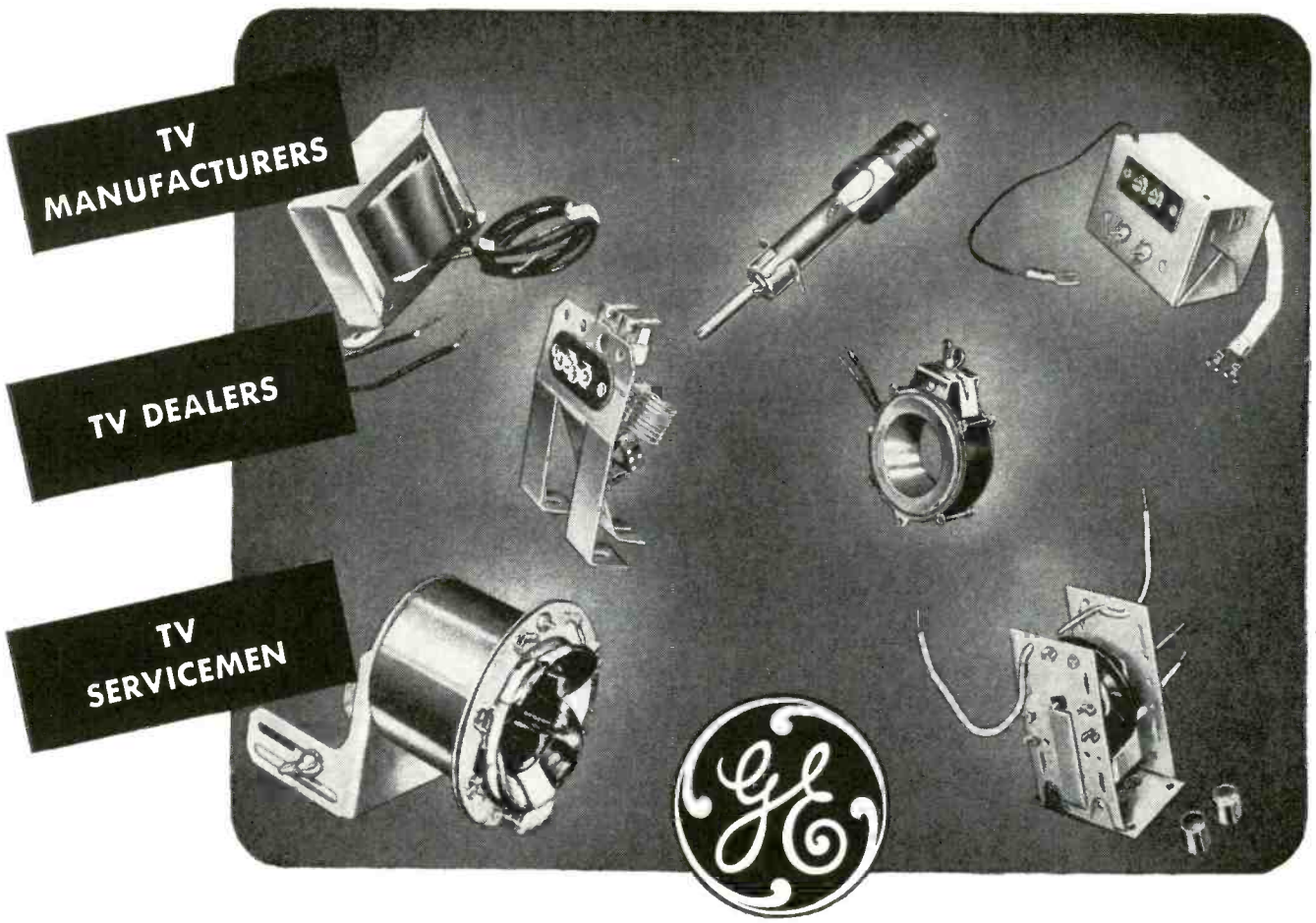

Available Now! CRITICAL TV COMPONENTS

DEALERS AND SERVICEMEN—Your share of today's multi-million dollar TV replacement market is limited only by your ability to handle it. Now you can get *ferrite transformers, ferrite core yokes, linearity controls, focus coils*—the vital TV components you need—from one dependable source—General Electric! Don't wait to cash in on the biggest *new* business in television history—call your distributor today and stock the General Electric line!

RECEIVER MANUFACTURERS—Here's a way to cut production headaches and manufacturing costs! You simplify ordering and delivery when you design G-E components into your sets. Remember, too, that your sets will be serviced *in the field* because G-E distributors and dealers everywhere stock these parts. Let us review your requirements for next year's production right now. General Electric application engineers are at your service.

GENERAL  ELECTRIC



**MAIL COUPON
FOR NEW
FREE
CATALOG**

General Electric Company, Section 4511
Electronics Park, Syracuse, New York
Rush me the new G-E Catalog of TV Components.

NAME _____
ADDRESS _____
CITY _____ STATE _____

Don't
TAKE CHANCES
WITH "JUST-AS-GOOD"
REPLACEMENT PARTS

Be Right with
OHMITE
—IT'S GOOD BUSINESS!

A satisfied customer is your most valuable business asset. You take a chance on losing him with "just-as-good" replacement parts. Standardize on Ohmite resistance components—known the world over for top dependability among servicemen, amateurs, and design engineers. It's smart business!

OHMITE MANUFACTURING COMPANY
4894 Flournoy St., Chicago 44, Illinois



Be Right with

OHMITE®

RHEOSTATS • RESISTORS • TAP SWITCHES



foreground, to the right is the shelter or cabin for the space travelers. Ordinarily they occupy two chambers, connected by a long cable, which rotate about the common center of gravity. In this way the illusion of weight arises. Near the center of gravity is a pair of electrodes which draws its power from the mirror engines through the common cable. One can also imagine a switch point placed between the two electrodes to connect the influence machines either in parallel or in series.

Power and efficiency

We must now say something about the propulsive power and the efficiency of the electric spaceship.

The machines naturally perform better the stronger the sunlight. For example, in the vicinity of Venus they could accomplish twice as much as in the neighborhood of the earth. But of course the exact value of the solar constant outside the earth's atmosphere is unknown. Since the appropriate measurements are not available, I would guess it to be about 2.2 gram-calories per square centimeter per minute, and for our purpose this is close enough. Converted into the corresponding values for square meters and meter-kilograms per second, the radiation falling on each square meter is 156 mkg/sec. We can assume that the boiler can use about 30% of this energy, which might appear to be quite high, but we are justified in assuming a high operating efficiency here. The influence machine would, in turn, convert about 95% of this into electrical energy, which, expressed in m-g/sec per square meter of the mirror surface, comes to 44.5 m-g/secm².

We can assume that without the fuel the apparatus weighs 400 grams per m². This appears to be very small, but because of the slight requirements which they must meet from a static point of view, these machines do not need to be heavier. Naturally one can take as much propellant for such a machine as is desired.

The first problem which could be solved—which, incidentally could be solved with liquid propellants only at great, unnecessary expense—would be the construction of a station circulating about the earth at a distance of 42,100 km (about 25,300 miles) above the center of the earth or 35,700 km (about 21,420 miles) above its surface at a velocity of 1,723 m/sec (3,850 miles an hour). Such a station would always hover above the same point on the equator if its orbit were in the equatorial plane. Otherwise it would describe a figure eight, as seen from the earth, which would bring it over the same point of the equator twice a day.

Such a station would be extremely valuable for television as well as for many other, particularly military, uses.

The next problem for the electric spaceship would be a flight around the moon.

The electric spaceship could also carry out interplanetary flights, and indeed, this could be done in several

RADIO-ELECTRONICS for

Regency
Division, I.D.E.A., INC.
55 N. New Jersey St., Indianapolis 4, Indiana



Regency

THE DB 400

LIST \$32.50

IN BLONDE FINISH AT \$37.50

**TV IS THE LARGEST SELLING
SIGNAL BOOSTER!**

BECAUSE . . . Regency wins all performance tests in nationally-known laboratories . . . Regency is the lowest priced QUALITY Television Signal Booster . . . Regency offers such features as simplified tuning control; easy installation; full coverage on all 12 channels . . . and Regency is UNDERWRITERS'  APPROVED.

REGENCY Division, I.D.E.A. INC. • 55 New Jersey Street, Indianapolis 4, Indiana

USE PHOTOFAC

the world's best Radio-TV service data—it pays for itself every working day

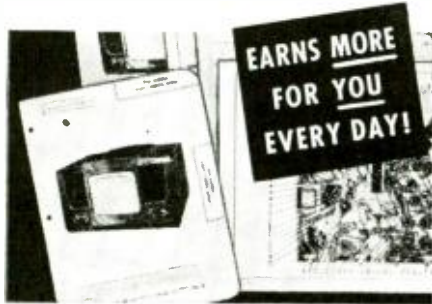

Try **PHOTOFAC!**

FREE We'll send you any Photofact Folder listed in the Photofact Cumulative Index

WE'LL PROVE YOU'LL SAVE TIME and EARN MORE WITH PHOTOFAC

NOW—learn for yourself—at our expense—how PHOTOFAC makes your Radio and TV work quicker, easier, more profitable! Examine an actual PHOTOFAC Folder. Use it. You'll learn first-hand why over 35,000 successful service technicians use PHOTOFAC daily. You'll learn that no other service gives you PHOTOFAC'S completeness, accuracy, uniformity, and lowest cost. PHOTOFAC is the only radio and TV service data prepared from laboratory analysis of the actual equipment. Know the facts—get your FREE Folder now. Examine, use, compare—learn why no modern service shop can afford to be without PHOTOFAC!

WRITE FOR FREE INDEX PAY AS YOU EARN! Ask your distributor about this amazing plan. Only \$18.39 puts the entire profit-boosting Photofact library in your shop now!

NOTE: Our FREE Folder offer is limited to Service Technicians only. Attach coupon below to your letterhead and mention your jobber's name. If you have no letterhead, send coupon to your jobber. Experimenters and others may obtain the Photofact Folder by remitting amount shown below.

HOWARD W. SAMS & CO., INC.
2201 E. 46th St., Indianapolis 5, Ind.

Send FREE Photofact Cumulative Index
 Send Full Easy-Pay Details

I am a Service Technician:
 Send FREE Folder for set model.....

I am an Experimenter: Enclosed \$.....
 Send Folder for set model.....
TV-\$1.00, Record Changer or Comm. Receiver-75c, AM/FM-50c

Name.....
Address.....
City.....Zone...State.....

months, whereas it has been estimated that such voyages would have to be reckoned in terms of years if liquid propellants alone were used (cf. Hohmann: *Die Erreichbarkeit der Himmelskörper*. [The Attainability of the Celestial Bodies]).

In any case this spaceship could not land on one of the larger celestial bodies—it is far too weakly constructed for that. For this purpose it would have to carry a space boat which would be powered with atomic energy or with liquid propellant, while the spaceship itself circled about the celestial body like an observer's station without further expenditure of fuel.

Besides these two possibilities—powering the space boat with fuel or with atomic energy—there is a third, at least for visiting celestial bodies which have no atmosphere, like the moon.

Corpuscular radiations contain very little matter. At high potentials they have only a very slight impact force.

its acceleration can be much greater and its construction heavier and more compact.

Mathematical Analysis

From our estimated solar constant we might expect a kinetic energy of 8.8 to 14.6 mkg sec m². If we wish to give the propellant a velocity of 10 km/sec, then 1 gram of the latter contains kinetic energy equal to 5,100 m/kg. It therefore follows that at a distance of 150 million kilometers from the sun, energy can be radiated at a rate of 8.8 : 5100 = 1.7 mgr sec to 14.6 : 5,100 = 3 mgr/sec per second per square meter of the mirror surface.

If the electric spaceship carries 2 kg (1kg = 2.2 lbs.) of matter per square meter of mirror surface, this would suffice for a period of acceleration of from 670,000 sec. or 8 days to 1,170,000 sec. or 14 days.

The total increase in velocity would be:

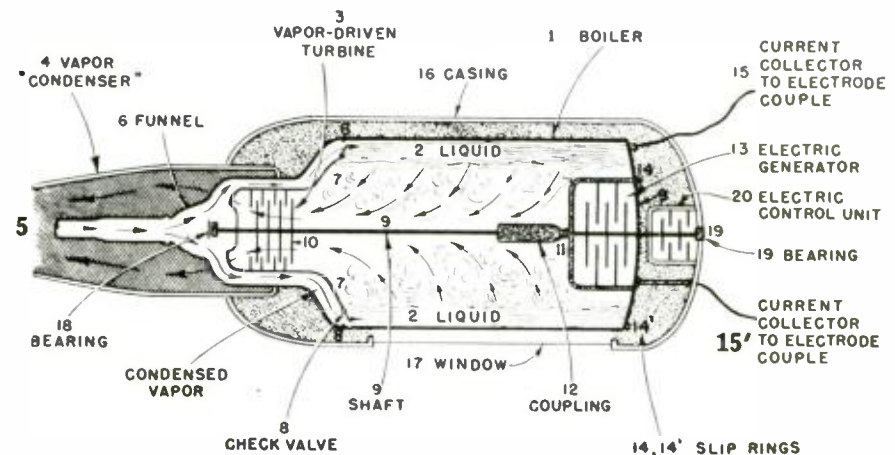

Fig. 2—A simplified cross-section of the vapor driven power plant proposed for the spaceship. The entire unit can be sealed against losses of the vapor.

but they do have a high energy content. We can also assume that, given high enough velocities, the particles would travel a great distance in parallel paths.

Equally charged mass-particles repel each other, but currents traveling in the same direction attract each other. Moving charged particles are electric currents. If we can impart a high enough velocity to streams of particles, it is reasonable to assume that the particles would no longer tend to fly apart. Of course this will have to be tested first on a station in cosmic space, for I would not care to extrapolate blindly the results obtained from Geissler tubes and cyclotron streams to the corpuscular streams from an electric spaceship. I assume that this would certainly succeed with electron streams, but whether it would work with positive rays is something I do not care to affirm.

The spaceboat could receive in a Faraday cage the corpuscles streaming toward it and with this help generate an electric wind whose reaction is sufficient for landing on Mercury, the moon, or Ceres. Since it is also much lighter than the spaceship and does not have to carry the latter's machinery with it,

$$v_1 = 10 \ln \frac{2,400 \text{ gr}}{400 \text{ gr}} = 17,918 \text{ m/sec.}$$

I have added the subscript i to v because the spaceship would attain this velocity only in gravitationless space. If it started out from a station rotating about the earth, it would have to exceed the velocity of the station. In so doing, the original circular orbit (in the sense indicated by the Keplerian laws of planetary motion) would first have to pass over to an elliptical orbit; however, the ellipse would not be completed, but in each instant it would develop into an ever wider ellipse, so long as the machine operates.

Accordingly the spaceship ascends in a spiral path, the differential equation of which cannot be integrated in a closed expression. And its velocity actually diminishes in the process at the same time that its total energy, because of the increment of potential energy, increases. Thus v_i indicates only the so-called ideal velocity. I would also like to point out that of this 17 km/sec only about one-half or 9,000 m/sec can be used for propulsion, while the remainder must be used to check the velocity in the vicinity of the goal.

The following formulas refer to fuel

Smart TV Dealers are

HITTING THE TENNA-ROTOR JACK-POT!



PROOF IS IN RESULTS! *Nation-wide TV Advertising Delivers Thousands of Sales—Every Week!*

Over 50 key TV stations demonstrate Alliance Tenna-Rotor to 7 million viewers! Tenna-Rotor is the only TV accessory backed by a powerful, sustained television campaign—national in scope! Hundreds of thousands of Alliance Tenna-Rotors are in use!

Alliance Tenna-Rotor offers faster installation with Alliance 4-conductor "Zip" cable—Works in all weather—Guaranteed for one year—Approved by Underwriters' Laboratories.

NEW DELUXE MODEL HIR IS FULLY AUTOMATIC!

WINNING COMBINATION!
Just Set It and Forget It!

The only fully automatic rotator. Set the pointer—antenna turns to that point and stops! North—East—South—West—direction indicator dial shows exact antenna position at all times. Extremely accurate!



MODEL HIR TENNA-ROTOR

ALLIANCE TENNA-SCOPE



—the New TV Booster! Features one simple control. Automatic on-off switch. Gives maximum uniform high gain on all channels—quick to install! An excellent companion item to Tenna-Rotor.

TENNA-SCOPE

ALLIANCE MANUFACTURING COMPANY • Alliance, Ohio

JANUARY, 1951

SENSATIONAL TRIO TV YAGI PROVIDES HIGH GAIN ON 2 CHANNELS

Here's the New TV antenna everyone is talking about — the most desirable antenna for two band operation. Unlike customary yagis, where gain falls off sharply on adjacent channels, the new and revolutionary development by TRIO actually provides full 10 DB gain on each of two channels — in a lightweight, compact array. It's the reason it's the most sought after antenna in America today! It's available for channels 4 and 5, in the low band, and channels 7 and 9 in the high band. If it's dual channel performance you want for local or fringe area reception, here's the antenna that out performs them all — in better picture quality, cost and weight.

COMPARE THESE ADVANTAGES

- Provides gain on both channel 4 and 5 (or 7 and 9) Equal to Any Two conventional 4-element yagis!
- One bay replaces bulky stacked array!
- One lead replaces old-style 2-lead systems!
- Less weight-per-gain than any other TV antenna!
- Greatly reduced installation costs for complete TV coverage!
- Can be stacked for additional gain.

HOW IT WORKS

Antenna consists of 4 elements whose functioning is different on the two channels. For example: in Model 445, the elements, on channel 4, act as reflector, dipole, director, director, in that order; while on channel 5, the same elements act as reflector, reflector, dipole and director. Careful design insures proper impedance match with standard 300 ohm lead.

Eliminates Co-Channel Interference — Venetian Blind Effect

... When used with TRIO "Controlled Pattern" System Because of the high gain and front to back ratio of the new 2-channel single or stacked yagi, most co-channel interference is eliminated. When the problem is unusually difficult, such as when the TV receiver is located in the center of several TV stations operating on the same channel, co-channel interference CAN BE COMPLETELY eliminated with the use of the "Controlled Pattern" system. This unique system uses 2 bays, off-set stacked and tuned with the remarkable TRIO "Phasitron". TRIO antennas will give you TV reception when the rest fail.

- Model 445—Single bay Yagi for Channels 4 and 5.
- Model 445-2—Conventional 2 bay stacked array for Channels 4 and 5.
- Model 479—Single bay Yagi for Channels 7 and 9.
- Model 479-2—Conventional 2 bay stacked array for Channels 7 and 9.
- Model 645—"Controlled Pattern" System for Channels 4 and 5, and Model 679 for Channels 7 and 9.

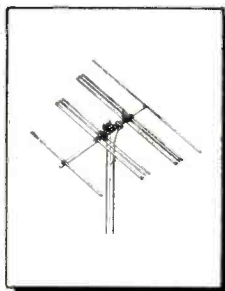

Single 4-element yagi with dual purpose elements. Provides high gain on two channels.

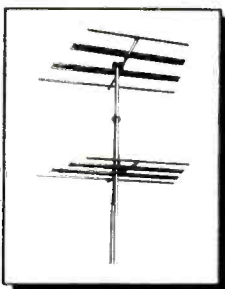

Two of the new TRIO yagis may be stacked to get up to 12 DB forward gain.

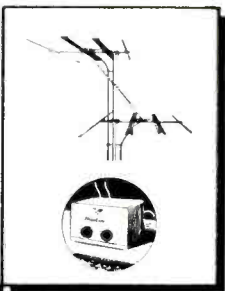

The "Controlled Pattern" System — eliminates "Venetian-Blind effect" when caused by co-channel interference.

Trio

MANUFACTURING CO.
Griggsville Illinois

SENSATIONAL NEW BOOK

ELEMENTS of SINGLE and DUAL TRACK MAGNETIC TAPE RECORDING and 1001 APPLICATIONS

by A. C. Shaney

INFORMATIVE! INSTRUCTIVE! INTERESTING!

ONLY \$1.00 POSTPAID

The book that brings you up-to-date on tape recording. Complete history, theory, design and uses. 144 pages of FACTS!

Order today. Remit with order, please. Booklet mailed same day.

AMPLIFIER CORP. of AMERICA

398-10 Broadway, New York 13, N. Y.

EASY TO LEARN CODE

It is easy to learn or increase speed with an Instructograph Code Teacher. Affords the quickest and most practical method yet developed. For beginners or advanced students. Available tapes from beginner's alphabet to typical messages on all subjects. Speed range 5 to 40 WPM. Always ready—no QRM.

ENDORSED BY THOUSANDS!

The Instructograph Code Teacher literally takes the place of an operator-instructor and enables anyone to learn and master code without further assistance. Thousands of successful operators have "acquired the code" with the Instructograph System. Write today for convenient rental and purchase plans.

INSTRUCTOGRAPH COMPANY

4701 Sheridan Rd., Dept. RC, Chicago 40, Ill.

consumption, increase of velocity, and the duration of the acceleration:

$$m = m_0 + m' t \quad (1)$$

where m is the mass of the electric spaceship, m_0 its initial mass, t the time, and m' the quantity of fuel or propellant expelled during each second. Obviously the spaceship expels the same quantity of propellant in each second, since its distance from the sun does not change so rapidly, and, to save time, the machines are allowed to run at the highest number of revolutions per minute so long as they must operate. From (1) and the equation for velocity increase (see Part I) we obtain the increase in velocity between the times t_1 and t_2 :

$$v = c \ln \frac{m_0 - m' t_2}{m_0 - m' t_1} \quad (2)$$

From this we get:

$$t_2 = \frac{m_0}{m'} (1 - e^{-v/c}) + e^{-v/c} t_1 \quad (3-a)$$

If we substitute m_1 for $m_0 - m' t_1$ and t for $t_2 - t_1$ we get:

$$t = \frac{1}{m'} (m_0 - m_1) \quad (3-b)$$

It is obvious that all the energy derived from the source of current will not be used for the acceleration of the propellant. A large part of it is lost in the charging processes going on. Moreover, not all the corpuscles fly off at the same speed, so that here too a certain amount of energy is lost.

It would take us too far afield, and would also be pointless in view of the uncertainty of the estimates referred to above, to describe exactly how I arrived at the values used. But I estimate that the kinetic energy of the expelled particles constitutes about one-fifth to one-third of the electrical energy supplied. While this may seem a rather low efficiency, it is no problem as we have an unlimited energy source from the sun.

With an exhaust or repulsion velocity of 20 km/sec, v_1 would therefore be twice as great, i.e., 35,836 m/sec; but from 32 to 56 days would then be required for the approach and slowing down for landing.



"—a press this for close-ups."

The World's Finest

Finely decorated vase of blue jasper ware, manufactured in 1785 by Josiah Wedgwood; considered by many to be among the world's finest examples of the pottery-maker's art.

In pottery as in picture tubes, in art as in science, great names are born of great works. Today, as in the eighteenth century, Josiah Wedgwood is recognized as the producer of some of the world's finest pottery. Today too, men have come to know the name of Tel-O-Tube; a great name . . . born of a fine tube . . . the world's finest.



The GREATEST Names In Television
PROTECT Their Names With Tel-O-Tube

Tel-O-Tube Dealers Everywhere.
Write for the one nearest you.



TEL-O-TUBE Corporation of America

EAST PATERSON, NEW JERSEY

Sales Office: TEL-O-TUBE Sales Corporation, 580 Fifth Ave., New York 19, N. Y.

Wedgwood vase courtesy Metropolitan Museum of Art.

for Greatest
TV Picture Quality



AMPHENOL
—INLINE*—
TV ANTENNA

*Reissue Patent Number 23,273

Manufacturer, dealer, serviceman alike benefit when the customer receives the greatest picture quality that his set can produce. Customers expect a good picture on all channels when they purchase a TV set—but even the most expensive set cannot produce a better picture than the antenna brings to it.

Exhaustive laboratory and field tests have proved that the AMPHENOL Inline Antenna gives higher, more uniform gain over the entire TV spectrum. Its full 12-channel coverage insures fine reception for all future, as well as all existing, stations in any area.

Give your customer TV picture quality right from the time of installation by recommending an AMPHENOL Inline Antenna and you will build customer satisfaction.

Send for "The Antenna Story"—a sincere discussion of TV antennas based on actual field tests.



YOURS FOR THE ASKING . . .

AMPHENOL

AMERICAN PHENOLIC CORPORATION

1830 SO. 54TH AVENUE

CHICAGO 50, ILLINOIS

New Devices

TV COMPONENTS

General Electric Co.
Syracuse, N.Y.

TV receiver components in this new line include 70-degree deflection yokes for magnetic deflection circuits, horizontal sweep output and high-voltage



transformers, and other components such as EM-PM focus coils, width and linearity controls, ion trap magnets, etc. These parts are usable with G-E and other receiver makes.

SWEEP GENERATOR

Triplett Electrical Instrument Co.
Bluffton, Ohio

Model 3435 is a sweep generator with continuous range coverage to 240 mc and covers all TV and FM carrier and intermediate frequencies in three bands. The main frequency dial is marked

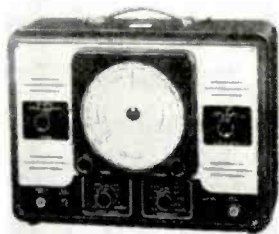

with channels as well as frequencies. The continuously variable, phase-controlled sweep is effective from 500 kc to 12 mc. A standby switch is provided for temporary silencing. Provision is made for connecting an external marker generator.

The instrument is constructed of copper-plated steel throughout. Critical circuits are enclosed, and the power transformer is electrostatically shielded.

V.T.V.M. KIT

Allied Radio Corp.
Chicago, Ill.

This new Knight v.t.v.m. kit has 30 ranges in all: d.c. volts (20 megohms input impedance), 7 ranges; a.c. volts (10 megohms input), 6 ranges; d.c.



milliamperes, 4; ohms, 6; db, 5; capacitance, 6 ranges. It reads up to 5,000 volts d.c., 1,000 volts a.c. (full audio range), and to 1,000 megohms. High-voltage and r.f. probes are available. The instrument has a zero-center scale for FM discriminator alignment and a pilot light for on-off indica-

tion. A 4 1/2-inch meter is used, and the 5 x 6 x 10-inch steel case has a gray hammer-tone finish.

TV WAVE TRAPS

JFD Mfg. Co.
Brooklyn, N.Y.

These wave traps, installed by connecting the leads to the antenna input terminals in parallel with the transmission line and tuning coils, come in four models. No. BR106-10-30 traps amateur harmonics from the 14- and 28-mc bands, No. BR106-80-110 traps FM image interference, No. BR106-30-60 traps amateur harmonics from 30 to

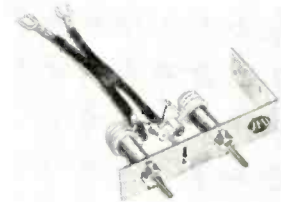

60 mc, and No. BR106-60-90 traps diathermy interference from 60 to 90 mc.

TV ANTENNAS

Telrex, Inc.
Asbury Park, N.J.

The new Monarch series of conical V beams offers standard units for all-channel reception and modified beams for greater selectivity. The series will be available in single-, double-, and four-bay models designated as K2X-TV, K4X-TV, and K8X-TV. All models are available with either doweled, with heat-treated dural tubular elements or solid dural rods.

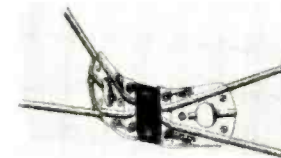

TV BOOSTER

Tel-A-Ray Enterprises, Inc.
Henderson, Ky.

This antenna-mounted booster is easily attached to any folded dipole. When used with a Tel-A-Ray model T antenna, the unit provides a gain of up to 300% to provide better signal-to-noise ratio for fringe reception.

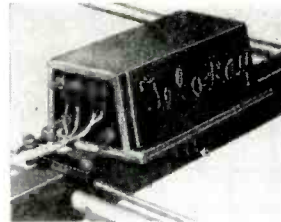

PANEL INSTRUMENTS

Simpson Electric Co.
Chicago, Ill.

Three new panel instruments (models 1029, 1027, and 1127) come in 4 1/2-, 3 1/2-, and 2 1/2-inch sizes. The large scales are easy to read, and the etched faces of these meters extend across the entire front and are protected with unbreakable plastic. Vertical chrome-plated strips are recessed into the plastic, fluted cover.



RADIO-ELECTRONICS for

NEW! The Radio & Television Library Set Containing The BASIC KNOWLEDGE, TECHNIQUES & DATA

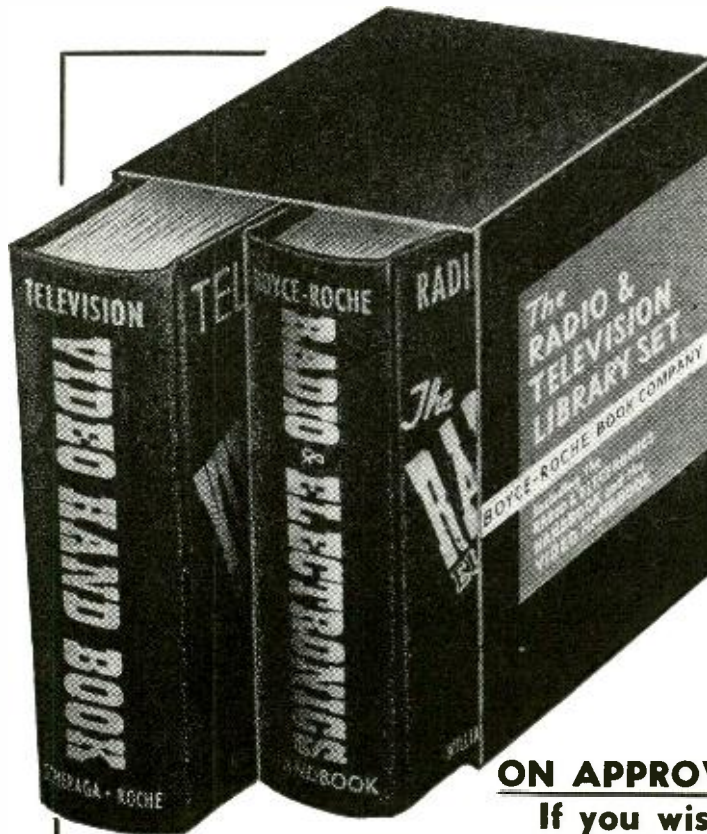

of RADIO TELEVISION ELECTRONICS

LEARN...PLAN...DO...

... everything in Radio, television and electronics with this famous Library Set containing two practical, thorough handbooks: "The RADIO & ELECTRONICS HANDBOOK", second edition, with complete data sections included; and Television's manual,—"The VIDEO HANDBOOK". Both books mounted in a handsome slip case.

Covers the fundamentals, theory, complete technique and on the job know-how with all data of radio, television & electronics. Learn complete ground work; latest developments; how to plan, construct, install, test, troubleshoot, trace, align, engineer the most modern equipment in all three fields.

Entire set was written with instruction and reference for all levels by the same BOYCE-ROCHE staff of experts who write and illustrate electronic manuals for the Signal Corps. Over 25,000 sets are approved and used by leading trade schools, companies, government agencies, shops, technicians and amateurs.

You may SAVE ONE DOLLAR by sending your order in now for the set, including "RADIO & ELECTRONICS HANDBOOK" and "VIDEO HANDBOOK" in handsome slip case for only \$10.90. (The two books alone regularly cost \$11.90.)

Send your order with or without money, but send it today, while the offer lasts!

ON APPROVAL
If you wish.

Improved, Enlarged Second Edition The RADIO & ELECTRONICS HANDBOOK

18 Sections, over 1000 illustrations

Fundamentals of radio and electronics, vacuum tube theory, resistors, capacitors, transformers, chokes, switches, basic circuits, vacuum tubes, rectifiers, amplifiers, oscillators, detectors, converters, filters, AM, FM, television, sound systems, recording, power supplies, antennas,

transmission lines, meters, test equipment, testing, measuring, aligning, codes, charts, graphs, nomographs, formulas, standards, receiving tubes, transmitting tubes, rectifier tubes, cathode ray tubes, regulator tubes, AND MORE.

Send for **RADIO & ELECTRONICS HANDBOOK TODAY! \$5.95**

ON APPROVAL if you wish.



Television ... Complete!

The VIDEO HANDBOOK

Everything in television in one handy volume
14 sections—over 800 patterns, pictures, drawings, schematics and charts.

Teaches television and provides complete condensed handbook reference on all phases. Makeup of television signal, how receiver accepts and passes signal, how picture is developed, how transmitter works, how to operate a television station, how to produce a show, camera and control room techniques, color problems, etc. Antenna selection, installation techniques. How to eliminate ghosts, interference, and noise. How to build up the signal. Pattern pictures for adjustment, positioning, width and height controls, focusing problems and many common faults peculiar to modern sets, AND MORE.

SEND for **VIDEO HANDBOOK TODAY**
ON APPROVAL if you wish. **\$5.95**

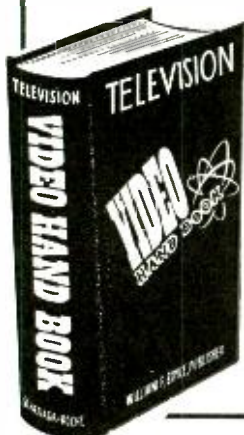

FREE EXAMINATION COUPON

BOYCE-ROCHE BOOK CO. Dept. 41
Caldwell, New Jersey

Please send me () *The Radio & Electronics Handbook*, price \$5.95; or () *The Video Handbook*, price \$5.95; or () *Both Books In Handsome Slip-Case As Illustrated*, price only \$10.90 on this special offer. (Save \$1.00)

Send me book(s) I have checked, for 10-day total approval reading. In 10 days I will remit full price(s) plus postage or return book(s) postpaid.

GOOD ONLY WHILE SPECIAL OFFER LASTS

NAME

ADDRESS

CITY ZONE STATE

SAVE POSTAGE! We pay postage if you enclose full price(s) now. Money back on same return privilege. Amount of money order or check enclosed \$.....

BOYCE-ROCHE BOOK CO.
CALDWELL, N. J.

BUILD 15 RADIOS AT HOME

With the New Improved 1951
Progressive Radio "EDU-KIT"

ONLY
\$19⁹⁵



- FREE TOOLS WITH KIT
- ABSOLUTELY NO KNOWLEDGE OF RADIO NECESSARY
- NO ADDITIONAL PARTS NEEDED
- EXCELLENT BACKGROUND FOR TELEVISION
- 10 DAY MONEY-BACK GUARANTEE

WHAT THE PROGRESSIVE RADIO "EDU-KIT" OFFERS YOU

The Progressive Radio "Edu-Kit" offers you a home study course at a rock bottom price. Our Kit is designed to train Radio Technicians, with the basic facts of Radio Theory and Construction Practice expressed simply and clearly. You will gain a knowledge of basic Radio Principles involved in Radio Reception, Radio Transmission and Audio Amplification.

You will learn how to identify Radio Symbols and Diagrams; how to build radios, using regular radio circuit schematics; how to mount various radio parts; how to wire and solder in a professional manner. You will learn how to operate Receivers, Transmitters, and Audio Amplifiers. You will learn how to service and trouble-shoot radios. In brief, you will receive a basic education in Radio exactly like the kind you would expect to receive in a Radio Course costing several hundreds of dollars.

THE KIT FOR EVERYONE

The Progressive Radio "Edu-Kit" was specifically prepared for any person who has a basic knowledge of the English language, and has the desire to learn Radio. The Kit has been used successfully by young and old in all parts of the world. It is not necessary that you have even the slightest background in science or radio.

The Progressive Radio "Edu-Kit" is used by many Radio Schools and Clubs in this country and abroad. It is used by the Veterans Administration for Vocational Guidance and Training.

The Progressive Radio "Edu-Kit" requires no instructor. All instructions are included. All parts are individually boxed, and identified by name, photograph and diagram. Every step involved in building these sets is carefully explained. You cannot make a mistake.

PROGRESSIVE TEACHING METHOD

The Progressive Radio "Edu-Kit" comes complete with instructions. These instructions are arranged in a clear, simple and progressive manner. The theory of Radio Transmission, Radio Reception and Audio Amplification is clearly explained. Every part is identified by photograph and diagram; you will learn the function and theory of every part used.

The Progressive Radio "Edu-Kit" uses the principle of "Learn By Doing". Therefore you will build radios to illustrate the principles which you learn. These radios are designed in a modern manner, according to the best principles of present-day educational practice. You begin by building a simple radio. The next set that you build is slightly more advanced. Gradually, in a progressive manner, you will find yourself constructing still more advanced radio sets, and doing work like a professional Radio Technician. Altogether you will build fifteen radios, including Receivers, Amplifiers and Transmitters.

The Progressive Radio "EDU-KIT" Is Complete

You will receive every part necessary to build 15 different radio sets. This includes tubes, tube sockets, variable condensers, electrolytic condensers, mica condensers, paper condensers, resistors, tie strips, coil, tubing, hardware, etc. Every part that you need is included. In addition these parts are individually packaged, so that you can easily identify every item.

TROUBLE-SHOOTING LESSONS

Trouble-shooting and servicing lessons are included. You will be taught to recognize and repair troubles. While you are learning in this practical way, you will be able to do many a repair job for your neighbors and friends, and charge fees which will far exceed the cost of the Kit. Here is an opportunity for you to learn radio and have others pay for it.

FREE EXTRAS IN 1951

- ELECTRICAL AND RADIO TESTER
- ELECTRIC SOLDERING IRON
- BOOK ON TELEVISION
- RADIO TROUBLE SHOOTING GUIDE
- MEMBERSHIP IN RADIO TELEVISION CLUB
- CONSULTATION SERVICE
- QUIZZES

The Progressive Radio "Edu-Kit" is sold with a 10-day money-back guarantee. Order your Progressive Radio "EDU-KIT" Today, or send for further information.

Postage prepaid on cash orders—C.O.D. orders accepted in U. S. A.

PROGRESSIVE ELECTRONICS CO.
497 UNION AVE., Dept. RE-43 Brooklyn 11, N. Y.

VOLTAGE REGULATOR

Clarostat Mfg. Co.
Dover, N.H.

Designed to reduce line voltage fluctuations, for better TV pictures, this regulator has male and female Edison connections at either end. It plugs in between the TV set's line plug and the outlet. Two models are available: TV-A rated at 300 watts; and TV-B, rated at 375 watts.

AUXILIARY AUTO AERIAL

Insuline Corp. of America
Long Island City, N.Y.

Tele-Con is a miniature double-conical auxiliary auto antenna patterned after a TV antenna. Its four 10 1/2-inch

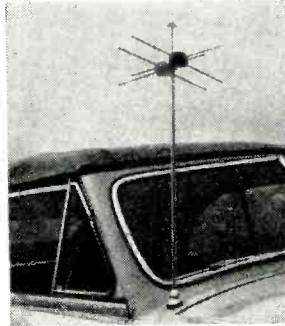

arms are made of chrome-plated brass tubing and are set in red plastic center pieces. The assembly clamps to any vertical auto antenna and is easily installed. This is an eye-catching device.

MULTI-SECTION ELECTROLYTICS

Aerovox Corp.
New Bedford, Mass.

Having a special internal construction which provides low r.f. impedance

and minimum coupling between sections, the type AFH multi-section electrolytic capacitors are said to produce less hum and hash. Especially suited for television, these capacitors are available in a large selection of capacitance and voltage combinations for a variety of uses.

CORNER ANTENNA

Technical Appliance Corp.
Sherburne, N.Y.

Designated as the 1700 series, this new twin-driven corner antenna has narrow directivity, a high front-to-back ratio, and controlled phase relationship of both high- and low-band lobes. The antenna has low wind resistance and is rigidly constructed.

The Technical Appliance Co. also announces *Engineering Bulletin No. 64*, free to service technicians, which contains actual measurements of db gain over half-wave dipoles for all popular antenna types. This information is valuable for selecting the best antenna for any particular installation.

MULTIPLE POWER OUTLET

Sun Radio & Electronics Co.
New York, N.Y.

To eliminate makeshift outlets in labs, shops, homes, and offices, this portable outlet box provides eight standard line cord sockets from one electrical outlet. The box contains two fuses to prevent overloads, a d.p.d.t. switch to turn off both legs of all eight receptacles, and a neon bulb to indicate power flow through the switch. A 12-foot heavy-duty line cord connects the box to the electrical outlet.

RECORD CHANGER SPINDLE

V-M Corp.
Benton Harbor, Mich.

A U.S. patent has been granted on the Tri-O-Matic record changer spindle. This spindle does not drop, but lowers the records to the spindle shelf. The records are then air-cushion-dropped to the turn table.

High score every time with "Safe Centers!"

In Basketball there's no better assurance of victory than a lengthy lay jumping center... and there is nothing that scores higher in radio, TV and other electronic circuits than SELETRON miniature rectifiers with "Safe Center" plates.

When you specify SELETRON Selenium Rectifiers you eliminate arc-over danger, short circuits and heating at the center contact point. Assembly pressure, or pressure applied in mounting the rectifier cannot affect its performance—a SELETRON feature accomplished by deactivating the area of the plate under the contact washer.

The millions of SELETRON Selenium Rectifiers in satisfactory service as original equipment in the products of leading manufacturers are millions of reasons why you can specify SELETRON and be safe!

Look for Howard W. Sam's Red Book Supplement listing SELETRON replacements... and write for Bulletin No. RS-30



Seletron

SELETRON DIVISION
RADIO RECEPTOR COMPANY, INC.
Since 1922 in Radio and Electronics
Factory: 84 North 9th St., Brooklyn 11, N. Y. • Sales Department: 251 West 19th St., New York 11, N. Y.

You GET
THE BEST IN
Heathkits

Heathkits are the Quality Line of TEST INSTRUMENT KITS



Modern STYLING KITS THAT MATCH

Heathkits are styled in the most modern manner by leading industrial stylists. They add beauty and utility to any laboratory or service bench. There is a complete line of Heathkit instruments allowing a uniformity of appearance.

An attractive service shop builds a feeling of confidence. Many organizations have standardized on Heathkits providing uniform service departments.

There is no waste space or false effort to appear large in Heathkits — space on service benches is limited and the size of Heathkit instruments is kept as small as is consistent with good engineering practice.



Accuracy ASSURED BY PRECISION PARTS

Wherever required, the finest quality 1% ceramic resistors are supplied. These require no aging and do not shift. No matching of common resistors is required. You find in Heathkit the same quality voltage divider resistors as in the most expensive equipment.

The transformers are designed especially for the Heathkit unit. The scope transformer has two electrostatic shields to prevent interaction of AC fields.

These transformers are built by several of the finest transformer companies in the United States.

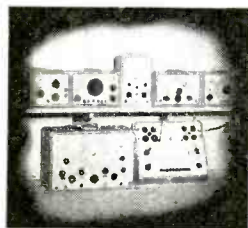

Used BY LEADING MANUFACTURERS

Leading TV and radio manufacturers use hundreds of Heathkits on the assembly lines. Heathkit scopes are used in the alignment of TV tuners. Impedance bridges are serving every day in the manufacture of transformers. Heathkit VTVM's are built into the production lines and test benches. Many manufacturers assemble Heathkits in quantity for their own use thus keeping purchase cost down.

Manufacturers assemble Heathkits in quantity for their own use thus keeping purchase cost down.

Famous HEATHKIT PARTS

- MALLORY FILTER CONDENSERS
- WILKOR PRECISION RESISTORS
- GRIGSBY ALLISON SWITCHES
- ALLEN-BRADLEY RESISTORS
- GENERAL ELECTRIC TUBES
- CHICAGO TRANSFORMER
- CENTRALAB CONTROLS
- SIMPSON METERS
- CINCH SOCKETS

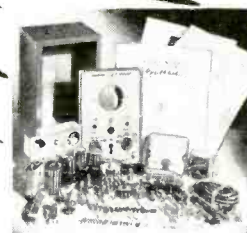

Complete KITS WITH PARTS THAT FIT...

When you receive your Heathkit, you are assured of every necessary part for the proper operation of the instrument.

Beautiful cabinets, handles, two-color panels, all tubes, test leads where they are a necessary part of the instrument, quality rubber line cords and plugs, rubber feet for each instrument, all scales and dials ready printed and calibrated. Every Heathkit is 110 V 60 Cy. power transformer operated by a husky transformer especially designed for the job. Heathkit chassis are precision punched for ease of assembly. Special engineering for simplicity of assembly is carefully considered.



Complete INSTRUCTION MANUALS

Heathkit instruction manuals contain complete assembly data arranged in a step-by-step manner. There are pictorials of each phase of the assembly drawn by competent artists with detail allowing the actual identification of parts. Where necessary, a separate section is devoted to the use of the instrument. Actual photos are included to aid in the proper location of wiring.

Used BY LEADING UNIVERSITIES

Heathkits are found in every leading university from Massachusetts to California. Students learn much more when they actually assemble the instrument they use. Technical schools often include Heathkits in their course and these become the property of the students. High schools, too, find that the purchase of inexpensive Heathkits allows their budget to go much further and provides much more complete laboratories.

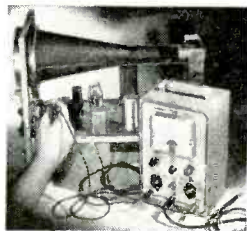

YOU SAVE BY ORDERING DIRECT FROM MANUFACTURER—USE ORDER BLANK ON LAST PAGE

EXPORT AGENT
ROCKE INTERNATIONAL CORP.
13 E. 40th ST.
NEW YORK CITY (16)
CABLE: ARIAB-N.Y.

The HEATH COMPANY

... BENTON HARBOR 20, MICHIGAN

12 Improvements IN NEW 1951

MODEL O-6 PUSH-PULL

Heathkit OSCILLOSCOPE KIT

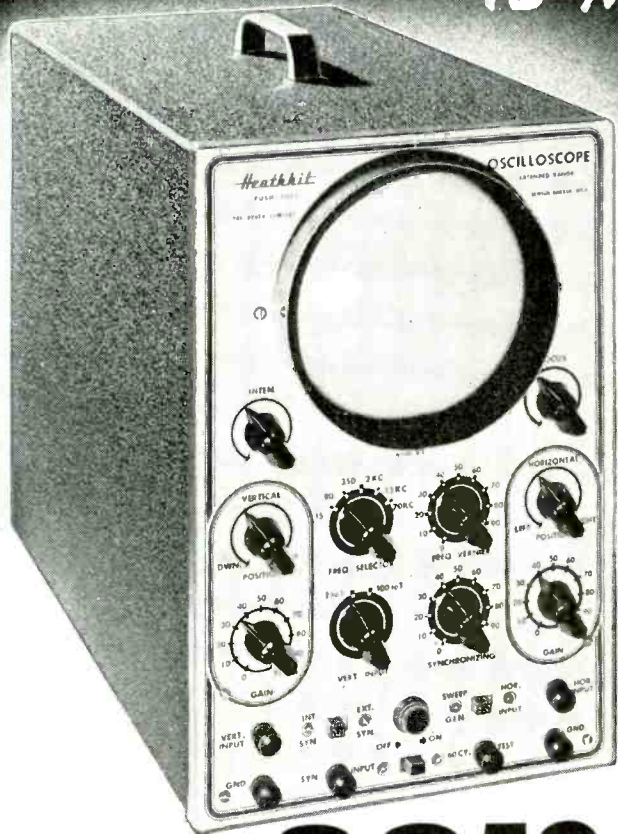

Only **\$39.50**

- ★ New AC and DC push-pull amplifier.
- ★ New step attenuator frequency compensated input.
- ★ New non frequency discriminating input control.
- ★ New heavy duty power transformer has 68% less magnetic field.
- ★ New filter condenser has separate vertical and horizontal sections.
- ★ New intensity circuit gives greater brilliance.
- ★ Improved amplifiers for better response useful to 2 megacycles.
- ★ High gain amplifiers .04 Volts RMS per inch deflection.
- ★ Improved Allegheny Ludlum magnetic metal CR tube shield.
- ★ New synchronization circuit works with either positive or negative peaks of signal.
- ★ New extended range sweep circuit 15 cycles to over 100,000 cycles.
- ★ Both vertical and horizontal amplifier use push-pull pentodes for maximum gain.

New INEXPENSIVE MODEL S-2 ELECTRONIC SWITCH KIT

Twice as much fun with your oscilloscope — observe two traces at once — see both the input and output traces of an amplifier, and amazingly you can control the size and position of each trace separately — superimpose them for comparison or separate for observation — no connections inside scope. All operation electronic, nothing mechanical — ideal for classroom demonstrations — checking for intermittents, etc. Distortion, phase shift and other defects show up instantly. Can be used with any type or make of oscilloscope. So inexpensive you can't afford to be without one.

Has individual gain controls, positioning control and coarse and fine switching rate controls — can also be used as square wave generator over limited range. 110 Volt transformer operated comes complete with tubes, cabinet and all parts. Occupies very little space beside the scope. Better get one. You'll enjoy it immensely. Model S-2. Shipping Wt., 11 lbs.

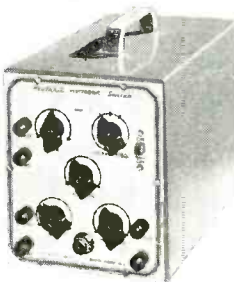

Only **\$19.50**

The new 1951 Heathkit Push-Pull Oscilloscope Kit is again the best buy. No other kit offers half the features — check them. Measure either AC or DC on this new scope — the first oscilloscope under \$100.00 with a DC amplifier.

The vertical amplifier has frequency compensated step attenuator input into a cathode follower stage. The gain control is of the non frequency discriminating type — accurate response at any setting. A push-pull pentode stage feeds the C.R. tube. New type positioning control has wide range for observing any portion of the trace.

The horizontal amplifiers are direct coupled to the C.R. tube and may be used as either AC or DC amplifiers. Separate binding posts are provided for AC or DC.

The multivibrator type sweep generator has new frequency compensation for the high range it covers; 15 cycles to cover 100,000 cycles. The new model O-6 Scope uses 10 tubes in all — several more than any other. Only Heathkit Scopes have all the features.

New husky heavy duty power transformer has 50% more laminations. It runs cool and has the lowest possible magnetic field. A complete electrostatic shield covers primary and other necessary windings and has lead brought out for proper grounding.

The new filter condenser has separate filters for the vertical and horizontal screen grids and prevents interaction between them.

An improved intensity circuit provides almost double previous brilliance and better intensity modulation.

A new synchronization circuit allows the trace to be synchronized with either the positive or negative pulse, an important feature in observing the complex pulses encountered in television servicing.

The magnetic alloy shield supplied for the C.R. tube is of new design and uses a special metal developed by Allegheny Ludlum for such applications.

The Heathkit scope cabinet is of aluminum alloy for lightness of portability.

The kit is complete, all tubes, cabinet, transformer, controls, grid screen, tube shield, etc. The instruction manual has complete step-by-step assembly and pictorials of every section. Compare it with all others and you will buy a Heathkit. Model O-6. Shipping Wt., 30 lbs.

YOU SAVE BY ORDERING DIRECT FROM MANUFACTURER — USE ORDER BLANK ON LAST PAGE

EXPORT AGENT
ROCKE INTERNATIONAL CORP.
13 E. 40th ST.
NEW YORK CITY (16)
CABLE: ARLAB-N.Y.

The **HEATH COMPANY**

... BENTON HARBOR 20, MICHIGAN

New 1951 • • MODEL V-4A

Heathkit VTVM KIT

HAS EVERY EXPENSIVE Feature

- ★ Higher AC input impedance, (greater than 1 megohm at 1000 cycles).
- ★ New AC voltmeter flat within 1 db 20 cycles to 2 megacycles (600 ohm source).
- ★ New accessory probe (extra) extends DC range to 30,000 Volts.
- ★ New high quality Simpson 200 microampere meter.
- ★ New 1/2% voltage divider resistors (finest available).
- ★ 24 Complete ranges.
- ★ Low voltage range 3 Volts full scale (1/3 of scale per volt).
- ★ Crystal probe (extra) extends RF range to 250 megacycles.
- ★ Modern push-pull electronic voltmeter on both AC and DC.
- ★ Completely transformer operated isolated from line for safety.
- ★ Largest scale available on streamline 4 1/2 inch meter.
- ★ Burn-out proof meter circuit.
- ★ Isolated probe for dynamic testing no circuit loading.
- ★ New simplified switches for easy assembly.

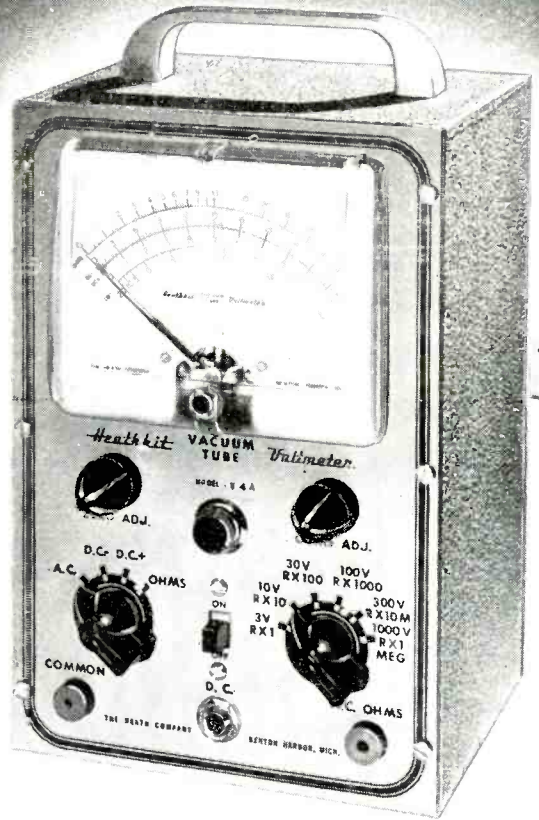

New
LOW PRICE \$23.50

The new Heathkit Model V-4A VTVM Kit measures to 30,000 Volts DC and 250 megacycles with accessory probes — think of it, all in one electronic instrument more useful than ever before. The AC voltmeter is so flat and extended in its response it eliminates the need for separate expensive AC VTVM's. + or - db from 20 cycles to 2 megacycles. Meter has decibel ranges for direct reading. New zero center on meter scale for quick FM alignment.

There are six complete ranges for each function. Four functions give total of 24 ranges. The 3 Volt range allows 33 1/3% of the scale for reading one volt as against only 20% of the scale on 5 Volt types.

The ranges decade for quick reading.

New 1/2% ceramic precision are the most accurate commercial resistors available — you find the same make and quality in the finest laboratory equipment selling for thousands of dollars. The entire voltage divider decade uses these 1/2% resistors.

New 200 microampere 4 1/2" streamline meter with Simpson quality movement. Five times as sensitive as commonly used 1 MA meters.

Shatterproof plastic meter face for maximum protection.

Both AC and DC voltmeter use push-pull electronic voltmeter circuit with burn-out proof meter circuit.

Electronic ohmmeter circuit measures resistance over the amazing range of 1/10 ohm to one billion ohms all with internal 3 Volt battery. Ohmmeter batteries mount on the chassis in snap-in mounting for easy replacement.

Voltage ranges are full scale 3 Volts, 10 Volts, 30 Volts, 100 Volts, 300 Volts, 1000 Volts. Complete decading coverage without gaps.

The DC probe is isolated for dynamic measurements. Negligible circuit loading. Gets the accurate reading without disturbing the operation of the instrument under test. Kit comes complete, cabinet, transformer, Simpson meter, test leads, complete assembly and instruction manual. Compare it with all others and you will buy a Heathkit. Model V-4A. Shipping Wt., 8 lbs. Note new low price, \$23.50



New 30,000 VOLT DC PROBE KIT

Beautiful new red and black plastic high voltage probe. Increases input resistance to 1100 megohms. Reads 30,000 Volts on 300 Volt range. High input impedance for minimum loading of weak television voltages. Has large plastic insulator rings between handle and point for maximum safety. Comes complete with PL55 type plug.

No. 3366 High Voltage Probe Kit.
Shipping Wt., 2 pounds.

\$550

Heathkit RF PROBE KIT

Crystal diode probe kit extends range to 250 megacycles = 10% comes complete with all parts, crystal, cable and PL55 type plug.

No. 309 RF Probe Kit
Shipping Wt., 1 lb.

\$550



YOU SAVE BY ORDERING DIRECT FROM MANUFACTURER—USE ORDER BLANK ON LAST PAGE

EXPORT AGENTS
ROCKE INTERNATIONAL CORP.
13 E. 40th ST.
NEW YORK CITY (16)
CABLE: ARLAB-N.Y.

The HEATH COMPANY

... BENTON HARBOR 20, MICHIGAN

NEW Heathkit T.V. ALIGNMENT GENERATOR KIT



Shipping Wt., 16 lbs.

\$39.50

- ★ New simplified circuit for easy calibration and assembly.
- ★ New 2 band built-in marker covers 19 to 75 Mc.
- ★ New dual spider sweep motor for long life.
- ★ New blanking circuit gives base line for better alignment.
- ★ New variable oscillator gives high output fundamentals on high TV band.
- ★ New standby switch keeps instrument ready for instant use.
- ★ New 6 to 1 slow speed drive on both master oscillator and marker tuners.

The new Heathkit TV Alignment Generator incorporates the new developments required for modern TV servicing. An absorption marker circuit covering all possible IF bands and even several of the RF bands. The new blanking circuit provides a base reference line which is invaluable in establishing proper traces. The new sweep motor incorporates dual spiders in the speaker frame assuring better alignment and long life. The mounting of the speaker sweep motor has been simplified for easy alignment.

The variable master oscillator covers 140 to 230 Mc. thus giving high output fundamentals where they are most needed. Low band coverage 2 Mc. to 90 Mc.

A new step attenuator provides excellent control of output.

Planetary 6 to 1 drives on both oscillator and marker provides smooth easy control settings.

A standby position is provided making the instrument always instantly available.

Horizontal sweep voltage with phasing control is provided. No other sweep generator under \$100.00 provides all these features — comes complete with instruction manual. Model TS-2.

Heathkit CONDENSER CHECKER KIT

Only **\$19.50**

Features

- Power factor scale.
- Measures resistance.
- Measures leakage.
- Checks paper-mica-electrolytics.
- Bridge type circuit.
- Magic eye indicator.
- 110 V. transformer operated.
- All scales on panel.

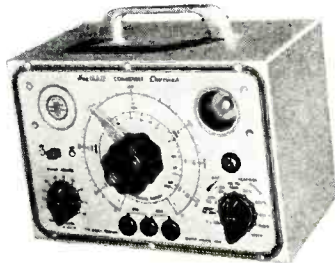

Checks all types of condensers over a range of .00001 MFD to 1,000 MFD. All on readable scales that are read direct from the panel. NO CHARTS OR MULTIPLIERS NECESSARY. A condenser checker anyone can read. A leakage test and polarizing voltage for 20 to 500 Volts provided. Measures power factor of electrolytics between 0% and 50%. 110 V. 60 cycle transformer operated complete with rectifier and magic eye tube, cabinet, calibrated panel, test leads and all other parts. Clear detailed instructions for assembly and use. Model C-2. Shipping Wt., 7 lbs.

NEW Heathkit SIGNAL TRACER AND UNIVERSAL TEST SPEAKER KIT

\$19.50

Features

- High sensitivity
- Complete set of speaker impedances
- Tests microphones and PA systems
- Tests both single and push-pull speaker circuits

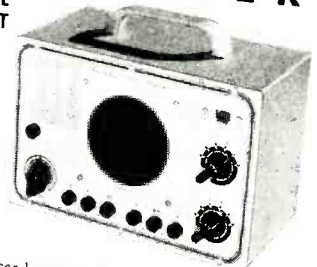

The popular Heathkit Signal Tracer has now been combined with a universal test speaker at no increase in price. The same high quality tracer follows signal from antenna to speaker — locates intermittents — defective parts quicker — saves valuable service time — gives greater income per service hour. Works equally well on broadcast — FM or TV receivers. The test speaker has assortment of switching ranges to match push-pull or single output impedance. Also test microphones, pickups, PA systems — comes complete — cabinet, 110 V. 60 cycle power transformer — tubes, test probe, all parts and detailed instructions for assembly and use. Model T-2. Shipping Wt., 8 lbs.

Heathkit TUBE CHECKER KIT

Features

Sockets for every modern tube — blank for new types.

Fastest method of testing tubes — saves time — makes more profit.

Rugged counter type birch cabinet.

Test your tubes the modern way — dynamically — the simplest, yet fastest and surest method — your Heathkit has a switch for each tube element and measures that element — no chance for open or shorted elements slipping by, all the advantages of the mutual conductance type without the slow cumbersome time consuming setups.

Your Heathkit Tube Checker has all the features — beautiful 3 color BAD-GOOD meter — complete selection of voltages — roller chart listing hundreds of tubes including the new 9 pin miniatures — finest quality Centralab lever switches for each element — high grade birch counter type cabinet — continuously variable line adjust control — every feature you need to sell tubes properly. The most modern power tube checker with complete protection against obsolescence. The best of parts — rugged oversize 110 V. 60 cycle power transformer — finest of Mallory and Centralab switches and controls, complete set of sockets for all type tubes with blank spare for future types. Fast action brass gear driven roller chart quickly locates the settings for any type tube. Simplified switching cuts necessary testing time to minimum and saves valuable service time. Short and open element check. Simple method allows instant setup of new tube types without waiting for factory data. No matter what the arrangements of tube elements, the Heathkit flexible switching arrangement easily handles it. Order your Heathkit Tube Checker Kit today. See for yourself that Heath again saves you two-thirds and yet retains all the quality — this tube checker will pay for itself in a few weeks — better assemble it now. Complete with instructions — pictorial diagrams — all parts — cabinet — ready to wire up and operate. Model TC-1 Shipping Wt., 12 lbs.

Gear driven roller chart gives instant setup for all types.

Tests each element separately for open or short and quality.

Beautiful 3 color meter — reads good-bad and line set point.

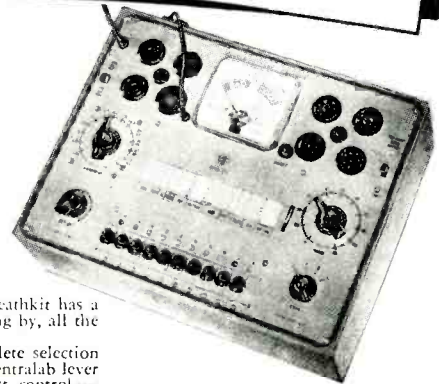

\$29.50

YOU SAVE BY ORDERING DIRECT FROM MANUFACTURER — USE ORDER BLANK ON LAST PAGE

EXPORT AGENT
ROCKE INTERNATIONAL CORP.
175 E. 40th ST.
NEW YORK CITY (16)
CABLE: ARLAB-N.Y.

The HEATH COMPANY

... BENTON HARBOR 20, MICHIGAN

RADIO-ELECTRONICS for

NEW 1951 *Heathkit* SIGNAL GENERATOR KIT

Features

- Sine wave audio modulation.
- Extended range 160 Kc. to 50 megacycles fundamentals.
- New step attenuator output.
- New miniature HF tubes.
- Transformer operated for safety.
- Calibrated harmonics to 150 megacycles.
- New external modulation switch.
- 5 to 1 vernier tuning for accurate settings.

A completely new Heathkit Signal Generator Kit. Dozens of improvements. The range on fundamentals has been extended to over 50 megacycles; makes this Heathkit ideal as a marker oscillator for T.V. New step attenuator gives controlled outputs from very low values to high output. A continuously variable control is used with each step. New miniature HF tubes are required for the high frequencies covered.

Uses 6C4 master oscillator and 6C1 sine wave audio oscillator. The set is transformer operated and a husky selenium rectifier is used in the power supply. The coils are precision wound and checked for calibration making only one adjustment necessary for all bands.

New sine wave audio oscillator provides internal modulation and is also available for external audio testing. Switch provided allows the oscillator to be modulated by an external audio oscillator for fidelity testing of receivers.

A best buy — think of all the features for less than \$20.00. The entire coil and tuning assembly are assembled on a separate turret for quick assembly — comes complete — all tubes — cabinet — test leads — every part. The instruction manual has step-by-step instructions and pictorials. It's easy and fun to build a Heathkit Model SG-6 Signal Generator. Shipping Wt., 7 lbs.



\$19.50

Heathkit SINE AND SQUARE WAVE AUDIO GENERATOR KIT

Either sine or square wave.
Stable RC bridge circuit.
Covers 20 to 20,000 cycles.
Less than 1% distortion.

Hundreds of Heathkit Audio Generators are used by speaker manufacturers—definite proof of their quality and dependability. The added feature of square wave opens up an entirely new field of amplifier testing. Uses the best of parts, 4 gang condenser, 1% calibrating resistors, metal cased filter condensers, 5 tubes, completely calibrated panel and detailed instruction manual. One of our best and most useful kits. Model G-2. Shipping Wt., 12 lbs.

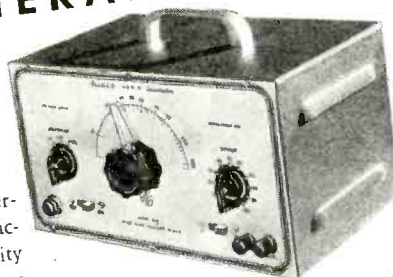

\$34.50

THE NEW *Heathkit* HANDITESTER KIT

- Beautiful streamline Bakelite case.
- AC and DC ranges to 5,000 Volts.
- 1% Precision ceramic resistors.
- Convenient thumb type adjust control.
- 400 Microampere meter movement.
- Quality Bradley AC rectifier.
- Multiplying type ohms ranges.
- All the convenient ranges 10-30-300-1,000-5,000 Volts.
- Large quality 3" built-in meter.



\$13.50

A precision portable volt-ohm-milliammeter. An ideal instrument for students, radio service, experimenters, hobbyists, electricians, mechanics, etc. Rugged 400 ua meter movement. Twelve complete ranges, precision dividers for accuracy. Easily assembled from complete instructions and pictorial diagrams. An hour of assembly saves one-half the cost. Order today. Model M-1. Shipping Wt., 2 lbs.

NEW *Heathkit* BATTERY ELIMINATOR KIT

Features

- Provides variable DC voltage for all checks.
- Voltmeter for accurate check.
- Locates sticky vibrators-intermittents.
- Has 4000 MFD Mallory filter for ripple-free voltage.

Even the smallest shop can afford the Heathkit Battery Eliminator Kit. A few auto radio repair jobs will pay for it. It's fast for service, the voltage can be lowered to find sticky vibrators or raised to ferret out intermittents. Provides variable DC voltage 5 to 7½ Volts at 10 Amperes continuous or 15 Amperes intermittent. Also serves as storage battery charger. Ideal for all auto radio testing and demonstrating.

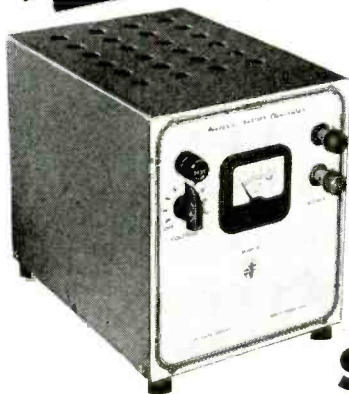

\$22.50

A well filtered rugged power supply uses heavy duty selenium rectifier, choke input filter with 4,000 MFD of electrolytic filter for clean DC. 0-15 V. voltmeter indicates output which is variable in eight steps. Easily constructed in a few hours from our instructions and diagrams — better be equipped for all types of service — it means more income. Model BE-2. Shipping Wt., 19 lbs.

YOU SAVE BY ORDERING DIRECT FROM MANUFACTURER—USE ORDER BLANK ON LAST PAGE

EXPORT AGENT
ROCKE INTERNATIONAL CORP.
13 E. 40th ST.
NEW YORK CITY (16)
CABLE: ARLAB-N.Y.

The **HEATH COMPANY**

... BENTON HARBOR 20, MICHIGAN

New LABORATORY INSTRUMENT KITS

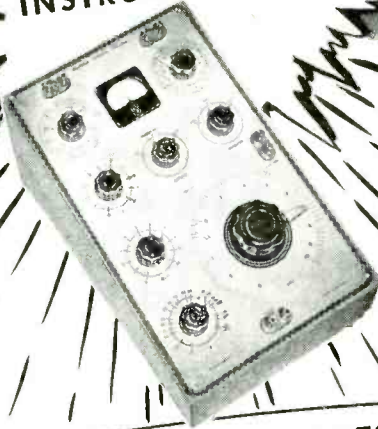

HUNDREDS OF LABORATORIES USE

Heathkit IMPEDANCE BRIDGE as Standard

Features

- Measures inductance 10 microhenries to 100 henries • Measures resistance .01 ohms to 10 megohms • Measures capacitance .00001 MFD to 100 MFD • Measures "Q" and power factor.

Measures inductance from 10 microhenries to 100 henries, capacitance from .00001 MFD to 100 MFD. Resistance from .01 ohms to 10 megohms. Dissipation factor from .001 to 1. "Q" from 1 to 1,000. Ideal for schools, laboratories, service shops, serious experimenters. An impedance bridge for everyone — the most useful instrument of all, which heretofore has been out of the price range of serious experimenters and service shops. Now at the lowest price possible. All highest quality parts. General Radio main calibrated control. General Radio 1,000 cycle hummer. Mallory ceramic switches with 60 degree indexing — 200 microamp type binding posts with standard 3/4" centers. Beautiful birch cabinet. Directly calibrated "Q" and dissipation factor scales. Ready calibrated capacity and inductance standards of Silver Mica, accurate to 1/2 of 1% and with dissipation factors of less than 30 parts in one million. Provisions on panel for external generator and detector. Measure all your unknowns the way laboratories do — with a bridge for accuracy and speed.

\$69.50

Internal 6 Volt battery for resistance and hummer operations. Circuit utilizes Wheatstone, Hay and Maxwell circuits for different measurements. Supplied complete with every quality part — all calibrations completed and instruction manual for assembly and use. Deliveries are limited. Model IB-1. Shipping Wt., 15 lbs.

NEW Heathkit LABORATORY RESISTANCE DECADE KIT



- 1/2% Accuracy
- Birch Cabinet
- Ceramic Switches
- Covers 1 ohm to 99,999 ohms

The new Heathkit Resistance Decade is a handy tool for laboratory, school and service shop. Ideal for test setups, calibrating instruments, bridge measurements, selecting multipliers, etc.

\$19.50

Uses the finest Centralab ceramic switches, 1/2% ceramic decade resistors and heavy birch cabinet matching other laboratory equipment. The range is 1 ohm to 99,999 ohms in one ohm steps.

Finest quality throughout to withstand school usage — heavy aluminum panel — laboratory type binding posts — the line decades are extremely simple to assemble — complete kit. Model RD-1. Shipping Wt., 4 lbs.

NEW Heathkit LABORATORY POWER SUPPLY KIT



- Supplies 6.3 V. AC at 4.5 Amps.
- Heavy duty construction.
- Handy for schools, labs., and service shops.
- Supplies variable DC 50-300 Volts.
- Shows voltage or current on 3 1/2" meter.

This new Heathkit Variable Power Supply Kit fills hundreds of needs — use it for experimental circuits — no need to build a separate power supply — use it for a test voltage to determine proper coefficients in unknown circuits — calibrate instruments with its variable voltage, etc. This new Heathkit supplies 50 to 300 Volts continuously variable DC, together with an AC filament voltage of 6.3 Volts at 4.5 Amperes. A built-in 1 MA 3 1/2" meter has proper shunts to read 0-500 Volts and 0-200 Milliampers. The circuit uses a 5Y3 rectifier, two 1619 tubes as electronic control tubes to vary the output voltage with a single potentiometer. Case measures 7 1/8" x 13" x 7 1/8". Has instruction manual for assembly and use. Model PS-1. Shipping Wt., 18 lbs.

\$29.50

Heathkit RECEIVER & TUNER KITS for AM and FM

TWO HIGH QUALITY Heathkit SUPERHETERODYNE RECEIVER KITS

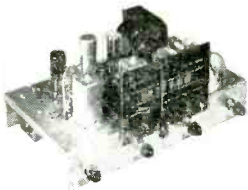

Model BR-1 Broadcast Model Kit covers 550 to 1600 Kc. Shipping Wt., 10 pounds.

\$19.50

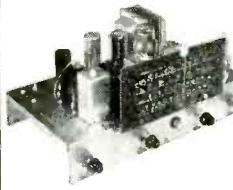

Model AR-1 3 Band Receiver Kit covers 550 Kc. to over 20 Mc. continuous. Extremely high sensitivity. Shipping Wt., 10 lbs.

\$23.50

Two new Heathkits. Ideal for schools, replacement of worn out receivers, amateurs and custom installations.

Both are transformer operated quality units. The best of materials are used throughout — six H.C. calibrated slide rule dial — quality power and output transformers — dual iron core shielded I.F. coils — metal filter condensers and all other parts. The chassis has phono input jack — 110 Volt outlet for phono motor and there is a phono-radio switch on panel. A large metal panel simplifying installation in used console cabinets is included. Comes complete with tubes and instruction manual incorporating pictorials and step-by-step instructions (less speaker and cabinet). The three band model has simple coil turret which is assembled separately for ease of construction.

TRUE FM FROM Heathkit FM TUNER KIT

\$22.50

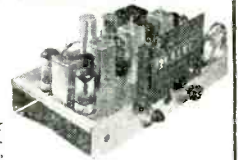

The Heathkit FM Tuner Model FM-2 was designed for best possible tonal reproduction. The circuit incorporates the most desirable FM features — true FM — ready wound and adjusted coils — 3 stages of 10.7 Mc. I.F. (including limiter).

Tube lineup: 7E5 oscillator, 6SH7 mixer, two 6SH7 I.F. stages, 6SH7 limiter, two 7C4 diodes as discriminator, 6X5 rectifier.

The instrument is transformer operated making it safe for connection to any type receiver or amplifier. The R.F. coils are ready wound — mounted on the tuning condenser and the condenser is adjusted — no R.F. coils to wind or adjust.

A calibrated six inch slide rule dial has vernier drive for easy tuning. The finest parts are provided with all tubes, punched and formed chassis, transformers, condensers and complete instruction manual. Model FM-2. Shipping Wt., 10 lbs.

EXPORT AGENT
ROCKE INTERNATIONAL CORP.
13 E. 40th ST.
NEW YORK CITY (16)
CABLE: ARLAB-N.Y.

The HEATH COMPANY

... BENTON HARBOR 20, MICHIGAN

ENJOY MUSIC AT ITS *Finest* WITH *Heathkit* **AMPLIFIERS**

NEW *Heathkit* HIGH FIDELITY 20 WATT **AMPLIFIER KIT**



\$21.50

Features

- Push-pull 6L6's.
- Full 20 Watts output.
- Fully enclosed chassis.
- Provisions for reluctance pickup compensation stage.
- Cased high fidelity output transformer.
- Treble and bass boost tone controls.
- Full range of output impedances 3.2 ohms to 500 ohms.

The finest amplifier kit we have ever offered — check the features. This inexpensive amplifier compares favorably with instruments costing five times as much. Nothing has been spared to provide the best reproduction — an ideal amplifier for the new Heathkit FM Tuner listed below.

Dual tone controls for control of both treble and bass. Bass control is of the boost type for maximum listening pleasure. Optional preamplifier stage for use with G. E. reluctance pickup or microphone. Uses inverse feedback to give excellent response over entire range. Tube lineup: 6SJ7 preamplifier stage, 6J5 phase splitter stage, two 6L6's in push-pull and 5Y3 rectifier. (6SC7 as optional compensation stage).

Uses highest quality Chicago Transformer Corporation cased output transformer with taps of 3.2, 8, 15, 60 and 500 ohms to match any speaker combination. Power transformer is conservatively rated for continuous operation in sound systems. Tone control gives maximum bass boost of 6 db at 70 cycles. Amplifier has maximum gain of 75 db. Response within 3 db 20 to 20,000 cycles. Shipping Wt., 17 lbs. Complete with all parts, tubes and instruction manual. Model A-5A Amplifier with preamplifier for G. E. cartridges or microphone **\$23.50**
12" 20 Watt Speaker, No. 326..... **7.50**

Heathkit ECONOMY 6 WATT PUSH-PULL **AMPLIFIER KIT**



\$12.50

No. 304, 12-inch Speaker... **\$6.95**

This new Heathkit Amplifier was designed to give quality reproduction at a very low price. Has two preamp stages, phase inverter stage and push-pull beam power output. Comes complete with six tubes, quality output transformer (to 3-ohm voice coil), husky cased power transformer and all other parts. Has tone and volume controls. Instruction manual has pictorial for easy assembly. Six watt output with response flat $\pm 1\frac{1}{2}$ db from 50 to 15,000 cycles. A quality amplifier kit at new low price. Better build one. Model A-4. Shipping Wt., 7 lbs.

Heathkit RECEIVERS and TUNER CABINETS



\$4.95

Order No. 350 for FM tuner

Blonde birch veneer cabinet for either the receivers or tuner. Modern styling is an asset to any room. 5" speaker fits in end of cabinet when used with receivers. Size 7 x 13 $\frac{1}{2}$ x 8 $\frac{1}{4}$ inches. Shipping Wt., 5 lbs. Order No. 345 for either receiver

Metal professional type communications receiver cabinet. Finished in deep grey to fit the panel supplied with Heathkit BR-1 and AR-1 Receivers (panel shown not included with cabinet). 5" speaker mounts in end of cabinet. Gives professional appearance to Heathkit receivers. Size 7 x 14 x 7 $\frac{3}{4}$ inches. Shipping Wt., 6 lbs.

5" Permoflux Speaker for either cabinet for use with either Heathkit Receiver No. 320 5" Speaker..... **\$2.75**

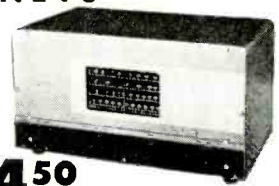

\$4.50

No. 355 Cabinet for receivers only.

ORDER BLANK

To HEATH COMPANY
BENTON HARBOR 20,
MICHIGAN

From _____

SHIP VIA

- Parcel Post
- Express
- Freight
- Best Way

(PLEASE PRINT)

Quantity	Item	Price	Quantity	Item	Price
	Heathkit Oscilloscope Kit — Model O-6			Heathkit VTVM Kit — Model V-4A	
	Heathkit T.V. Alignment Gen. Kit — TS-2			Heathkit R.F. Probe Kit — No. 309	
	Heathkit FM Tuner Kit — FM-2			Heathkit H.V. Probe Kit — No. 336	
	Heathkit Broadcast Receiver Kit — Model BR-1			Heathkit R.F. Signal Gen. Kit — Model SG-6	
	Heathkit Three Band Receiver Kit — Model AR-1			Heathkit Condenser Checker Kit — Model C-2	
	Heathkit Amplifier Kit — Model A-4			Heathkit Handitester Kit — Model M-1	
	Heathkit Amplifier Kit — Model A-5 (or A-5A)			Heathkit Variable Power Supply Kit — Model PS-1	
	Heathkit Tube Checker Kit — Model TC-1			Heathkit Resistance Decade Kit — Model RD-1	
	Heathkit Audio Generator Kit — Model G-2			Heathkit Impedance Bridge Kit — Model IB-1	
	Heathkit Battery Eliminator Kit — Model BE-2			Heathkit Signal Tracer Kit — Model T-2	
	Heathkit Electronic Switch Kit — Model S-2				

On Parcel Post Orders, include postage for weight shown and insurance. (We insure all shipments.)

On Express Orders, do not include transportation charges — they will be collected by the Express Agency at time of delivery.

Enclosed find Check Money Order for _____

Please ship C.O.D. Postage enclosed for _____ lbs.

EXPORT AGENT
ROCKE INTERNATIONAL CORP.
13 E. 40th ST.
NEW YORK CITY (16)
CABLE: RELAS-N.Y.

The **HEATH COMPANY**

... BENTON HARBOR 20, MICHIGAN

Fundamentals of Radio Servicing

Part XXIII—Signals in Space

By JOHN T. FRYE

IN THE last chapter we wrote as though the transmitted radio wave traveled a simple, straightforward path from transmitting antenna to the various receiving antennas. That is not the case! Nothing about this wacky radio business could ever be that simple, direct, and easy to understand!

Fig. 1 shows what really happens. Some of the waves from the transmitter at A travel along the surface of the earth like the one designated G. These

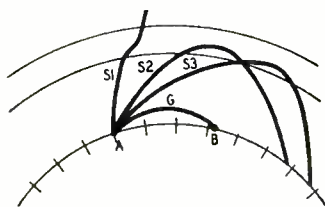
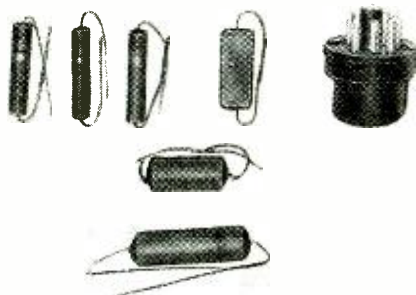

Fig. 1—How radio waves act in space.

“ground waves” induce currents in the earth immediately beneath them, and the resistance of the earth to the passage of these currents cause them to die out rapidly, particularly at the higher frequencies. On the broadcast band these ground-hugging waves account for practically all the daytime reception. They are good for about 50 miles at the high-frequency end of the band and up to 200 miles at the low-frequency end.

Then there are the “sky waves” that travel upward from the transmitter at various angles as shown at S1, S2, and S3. Some of these waves, like the one at S1, imitate the famed traveling salesman and keep right on traveling, never to be heard from again. Others, like S2 and S3, meet a “something” up there in the wild blue yonder that persuades them to turn around and come back to earth.



The components for an a.v.c. circuit.

The “something” that turns them back is a series of ionized layers above the earth's surface at various distances of from 30 to 250 miles. You will recall that an ion is really a positively charged molecule that got that way from having lost some of its negative charge in a collision with a fast-moving electron or through some other molecular mayhem. The gases in the upper reaches of the earth's atmosphere are being constantly bombarded by ultraviolet and cosmic ray radiation, and this bombardment ionizes many of their molecules. Since these gases hover at various heights according to their weight, and since the bombardment is more effective as the atmosphere becomes rarer, it is not surprising that the ionization is in layers, each layer being more intensely ionized than the one below it.

Did you ever see a stick lying half in and half out of a pool of clear water and notice that the stick seemed to be sharply bent right at the point where it enters the water? We learned in

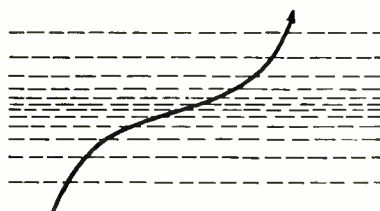

Fig. 2—Wave path in an ionized layer.

high school physics, of course, that it was not the stick but the light rays reflected from it that were bent.

Just as a light ray changes course when it passes from one medium to another, so are radio waves bent when they pass through an intensely ionized layer. The wave behaves as though it hated ions and wants to avoid any concentration of them. This is shown in Fig. 2. Notice that as the radio wave enters the ionized layer from below, it tries to shy away from the more deeply ionized center portion of the layer; but once it is forced to pass through this center portion, it reverses its direction of curvature so as to escape from the layer as soon as possible.

The actual amount of bending depends upon three things: the angle with which the radio wave strikes the layer, the frequency of the wave, and the intensity of ionization of the layer.

If the wave strikes the layer nearly at right angles, as shown at A in Fig. 3, there is very little bending. As this angle decreases, the bending becomes more pronounced, as illustrated at C and D. A low-frequency wave bends or “refracts” much more than one of higher frequency. If a wave of a given frequency strikes the layer at an angle that just permits it to be bent back to earth, one of a little higher frequency will pass on through the layer. Often a wave will penetrate a lower layer only to be turned back by the increased ionization of the layer above it, as pictured at B.

The whole subject of what happens to a radio wave in the ionosphere is a most interesting and complicated one, but we do not need an exhaustive explanation of the various phases of that esoteric matter. For our purposes we need know only that sky waves can be bent back to the earth in the ionosphere; that most broadcast-frequency sky waves are absorbed in this region during the day time but are returned to earth at night; and that the exact spot to which a wave returns depends upon several highly variable factors.

And now we are ready to take up *fading*. As the curtain rises on this drama, we see two portions of the same radio wave perched on the transmitting antenna just prior to taking off. The ground wave is saying to the sky wave, “You take the high road and I'll take the low road, and I'll be there before you.” It is this choice of paths by which the signal can go from the transmitter to the receiving location that causes the trouble.

If the receiver is near the trans-

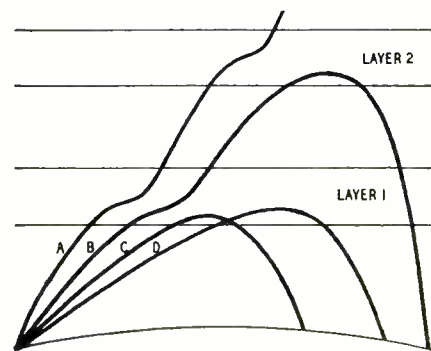

Fig. 3—The amount of bending depends on the angle at which the wave strikes.

RADIO-ELECTRONICS for

QUALITY

You Can Always Depend On

Because...

They're Produced by the World's Largest
Manufacturer of Both Antennas & Rotators

**C·D·R
TELE-ROTOR**

HEAVY DUTY MODEL

This heavy-duty TELE-ROTOR has no match! It's more powerful... turns any TV antenna array under any weather conditions! Recommended by servicemen everywhere because of its dependable, TROUBLE-FREE performance. Handsome control cabinet gives quick, easy control... indicates antenna position instantly.

Model TR-2... rotator with "Compass Control" cabinet having illuminated "perfect pattern" dial... (Uses 8 wire cable) \$44.95

Model TR-1... rotator and control cabinet with end of rotation light... (Uses 4 wire cable) \$39.95

**C·D·R
TELE-ROTOR CUB**

New TELE-ROTOR CUB for average installations. Same husky motor as heavy-duty TELE-ROTOR. **FASTEST, EASIEST ROTATOR TO INSTALL.** All-In-Line design... with true in-line thrust between antenna and mast. 3/4" STEEL shaft rotates on case hardened steel ball... in-line reamed oilless bearings. Plastic control cabinet offers easy, accurate control.

Model 502-A... rotator with control cabinet having indicating meter for "hairline" tuning. (Uses 5 wire cable) \$44.95

Model 501-A... rotator with control cabinet having end of rotation signal. Light flashes every 7.2" showing antenna is turning. (Uses 5 wire cable) \$34.95

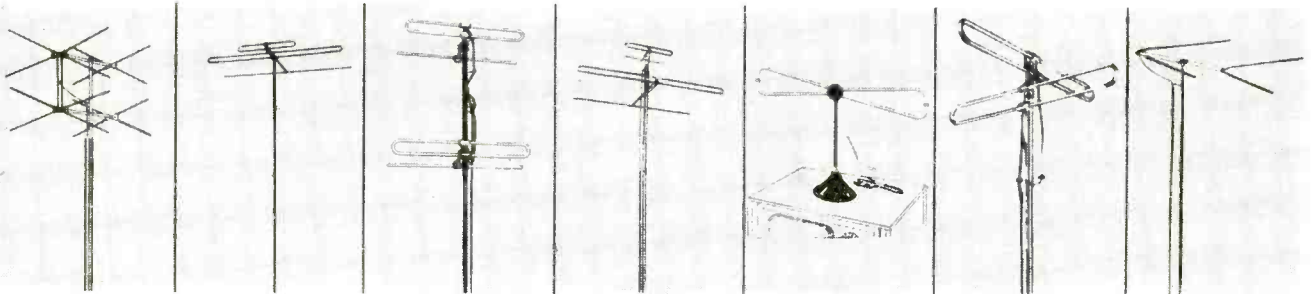

"Lazy-X" Conicals

"Strate-Line" Antennas

Double-Stacked Arrays

"Hi-Lo" Antennas

Indoor Antennas

FM Antennas

"Super-Vee" Antennas

**You Can't Beat a RADIART
Antenna on a TELE-ROTOR
IT'S TOPS**



IT'S RIGHT WHEN IT'S RADIART

THE RADIART CORPORATION
CLEVELAND 2, OHIO



- ROTATORS
- VIBRATORS
- AUTO AERIALS
- TV ANTENNAS
- POWER SUPPLIES

NEW! ALPRODCO ECONOMY ALUMINUM "TOWER-PAC"

36' TOWER IN
ONE COMPACT

PACKAGE

Consisting of

- 4 ea. 6' ASSEMBLED TOWER SECTIONS
- 2 ea. 6' SECTIONS INTERLOCKING MAST
- 1 ea. HINGED BASE PLATE
- 1 ea. MAST KIT
- 3 ea. GUY BRACKETS

Complete (Tower-Pac)
Part No. TP-36

TO DEALERS
ONLY

\$34.85

ALSO AVAILABLE AS
ROTATING TOWER-PAC
Part No. TP36-R

FOR ONLY

\$39.64

ALPRODCO, INC.

**KEMPTON, IND.
MINERAL WELLS, TEX.**

mitter, reception is dominated by the powerful ground wave and is not affected by any sky waves that may or may not be returned from the ionosphere. As the distances from the transmitter increases, the ground wave grows weaker and weaker until finally it cannot be heard at all. At this point and beyond, the station cannot be received in the daytime. At night the waves "reflected" from the ionized layers permit signals to be received.

At a point where the sky wave and the ground wave are received about equally well, we have an area or belt of very bad "fading," or fluctuation in the intensity of the received signal. Since the two portions of the same signal arrive over different paths and cover different distances, they may arrive with a difference in timing or "phasing" that will cause their two separate intensities either to be added together or to buck one another. In the first case, the resulting signal will be

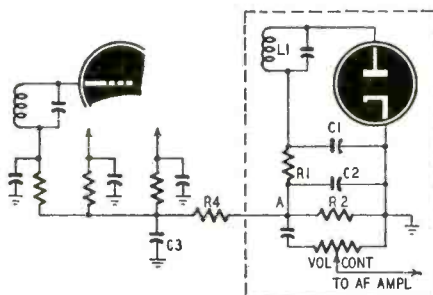

Fig. 4—A detector circuit with a.v.c.

stronger than the one from the ground wave alone; in the latter the two portions may so effectively cancel one another that nothing can be heard. Furthermore, since the path the sky wave travels is constantly changing with shifts in the height and ionization of the refracting layer, the signal intensity may vary constantly between these two extremes.

You might think that once the receiving station was beyond the reach of the ground wave, fading would be at an end, but such is not always the case. You have to remember that the wave-bending ionosphere is as unstable as a bucket of smoke and the path pursued by a radio wave through this ionosphere is constantly changing. At one time the receiver may be getting the full intensity of the refracted wave, while a few minutes later this center of intensity may have shifted to a spot several hundred miles away, and the receiver will be sitting in the weak fringe of the earth-returning wave.

What is even worse, the sideband frequencies of the wave may travel different paths in the ionosphere because of their slightly different frequency, and when they arrive at the receiver the phase of these intelligence-carrying sidebands may be altogether different from what they were at the transmitter. As a result, the music or voice may be very badly garbled by the interaction of these out-of-phase sidebands. This very annoying brand of

(Continued on page 100)

ALPRODCO ALUMINUM TOWERS

The
HEIGHT
of
Perfection!

**LIGHT!
STRONG
EASILY
ERECTED!
ATTRACTIVE!**

NEW!

Economy 6' assembled
Tower Sections for
ONLY

\$6.49

Part No. E-AT-6—
Same as supplied in
'Tower-Pac.' Stand-
ard Alprodco accesso-
ries fit this new light
weight tower.

ALPRODCO, INC.

MINERAL WELLS, TEXAS
KEMPTON, INDIANA

COMMERCIAL HEAVY DUTY
TOWER NOW AVAILABLE.
WRITE FOR INFORMATION

NEW INDICATOR ION TRAP

*A
Rauland
"Exclusive"*



Speeds Service — Builds Profits

Rauland's new Indicator Ion Trap is winning the cheers of more service men and dealers every day—because of the time and trouble it saves in Ion Trap Magnet adjustment, and because it eliminates mirrors and guesswork.

Now it's a matter of seconds to adjust the ion trap magnet with absolute precision. The service man simply moves the magnet until the signal glow is reduced to minimum.

This important new Rauland development is incorporated in all Rauland tubes produced today—as a feature of Rauland's new Tilted Offset Gun. This gun offers the additional advantages of giving only a single Ion Trap Magnet and of maximum sharpness of focus.

Only Rauland offers this advanced feature—one of half a dozen post-war developments from Rauland.

For further information, write to . . .

RAULAND

The first to introduce commercially these popular features:

Tilted Offset Gun

Indicator Ion Trap

Luxide (Black) Screen

Reflection-Proof Screen

Aluminized Tube

THE RAULAND CORPORATION



Perfection Through Research

4245 N. KNOX AVENUE • CHICAGO 41, ILLINOIS



JANUARY, 1951

Learn more! Earn more! 8 GREAT BOOKS



A. A. GHIRARDI
radio-
electronics
most famous
teacher

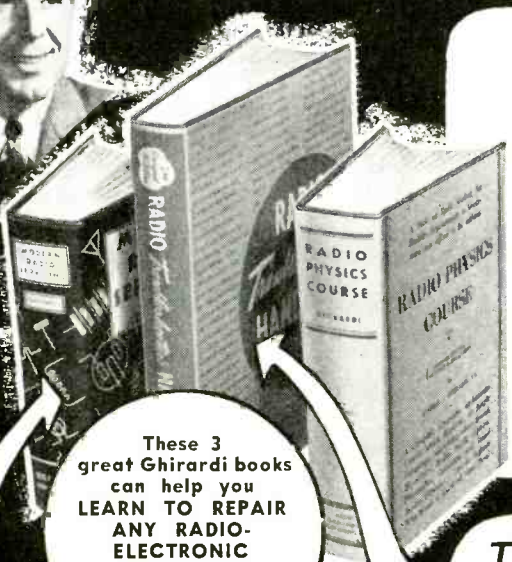

These 3 great Ghirardi books can help you LEARN TO REPAIR ANY RADIO-ELECTRONIC EQUIPMENT easier, better, faster!

This giant book brings you Complete PROFESSIONAL SERVICE TRAINING ...at home...for only \$5 (\$5.50 outside U.S.A.)

A. A. Ghirardi's giant, 1300-page MODERN RADIO SERVICING gives a complete education in truly professional radio-electronic service work—the kind that pays the real money! Radio itself is only the beginning of this big book's usefulness to you. What it teaches you about electronic circuits, test instruments and professional service procedure is exactly the training you need for a good job in modern electronic-radio-television work!

A COMPLETE GUIDE TO INSTRUMENTS—TROUBLESHOOTING—REPAIR

Read from the beginning, MODERN RADIO SERVICING is a complete service course. Used for reference, it is a quick guide to jobs that puzzle you. Explains service test instruments and how, when and why and where to use each type; how to make preliminary trouble checks; how to analyze circuits; how to replace components; how to speed up your work—and literally dozens of other subjects including How to Start and Operate a Successful Service Business of Your Own. 706 illustrations make study easy. Order Book No. 3 in coupon. Return book in 10 days if not more than satisfied! (SEE OUR MONEY-SAVING OFFER!)

HERE IS YOUR COMPLETE TRAINING IN BASIC RADIO-ELECTRONICS

- 36 courses in one!
- No lessons to wait for!
- Learn fast—Learn right!

No matter what part of ELECTRONICS-RADIO-TELEVISION work you plan to enter, a knowledge of basic fundamentals is essential. Ghirardi's world-famous 972-page RADIO PHYSICS COURSE book gives exactly the training you need—for only \$5 complete (\$5.50 outside U.S.A.) If sent as monthly lessons, you'd regard it as a bargain at \$50 or more! Written for beginners, RADIO PHYSICS COURSE starts with Basic Electricity—then takes you step by step through Radio-Electronic principles. You can easily understand it without previous training. Actually it has given more beginners their start than any other book or course. During the war it was more widely used for Signal Corps and Navy basic training than any other book of its kind. Read it for 10 days at our risk. Order Book No. 1 in coupon!

This "AUTOMATIC TEACHER" shows HOW TO REPAIR OVER 4800 RADIO MODELS ... without expensive test equipment

Ghirardi's big manual-size, 744-page RADIO TROUBLE-SHOOTER'S HANDBOOK is a dependable guide to locating and repairing the common troubles in the most widely used radios, auto radios and radio-phonograph combinations. Whether you repair radios for a living or work with them occasionally, this book will save you time and money on thousands of jobs—especially on older sets where data is often lacking. Eliminates useless testing!

SAVES TIME—HELPS YOU MAKE MORE MONEY!

Just look up the case history notes on the old radio you want to fix. RADIO TROUBLESHOOTER'S HANDBOOK tells what the trouble is—what causes it—and exactly how to repair it, often in half the usual time. Hundreds of additional pages contain valuable data on tubes, parts and equipment plus graphs, diagrams and money-making service hints. Ideal for training new service helpers. Worth another man in the average shop! Price only \$5 (\$5.50 outside U.S.A.). Order Book No. 2 in coupon. 10-day money-back guarantee.

MONEY SAVING OFFER!

Make your servicing library really complete! Get BOTH Ghirardi's RADIO TROUBLESHOOTER'S HANDBOOK (Book No. 2) and MODERN RADIO SERVICING (Book No. 3) at the special price of only \$9.50 for the two. (\$10.50 outside U.S.A.) Use coupon today!

IT PAYS TO KNOW HOW TO USE THE OSCILLOSCOPE fully!

Learn to use the oscilloscope fully on service and laboratory jobs—and watch your efficiency and earnings soar! MODERN OSCILLOSCOPES AND THEIR USES makes it easy! First, this great book gets right down to earth in explaining oscilloscopes and showing exactly how and where to apply them on AM-FM and TV jobs. Then, in easily understood terms, you learn all of the tricks of using this handy instrument—from locating receiver troubles to aligning and adjusting the most complicated circuits. Complete chapter sections deal with television and AM and FM servicing and show how the oscilloscope can solve many of your toughest problems.

CHOCK FULL OF HOW-TO-USE-IT DATA

Each oscilloscope operation is carefully explained including the making of connections, adjustment of circuit components, setting controls and analyzing patterns. About 400 illustrations including dozens of pattern photos make things doubly clear. Price \$6 (\$6.50 outside U.S.A.). Order Book No. 4 in coupon. Read it for 10 days at our risk!

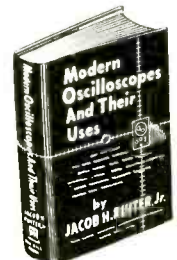

What it is! How it works! Exactly how to use it on the job!

READ ANY OF THEM FOR 10 FULL DAYS.

TO HELP YOU INCREASE YOUR MONEY-EARNING POWER!!



... This big book **MAKES AUTO RADIO REPAIR TWICE AS EASY!**



There are more auto radios in use than ever before. Be the well paid expert who can repair them!

Includes over 500 car radio circuit diagrams

Here—written by a leading auto radio expert—is everything needed to help the beginner or experienced serviceman gain profitable skill in this fascinating field. **SERVICING THE MODERN CAR RADIO** describes installation, testing and repair methods fully. Also, it gives needed special data on car radio circuits, differences between car and home radio servicing problems, shop set-up and business getting methods. Covers antenna installations; loudspeaker servicing, input circuits; power supplies; car radio alignment; circuit features; auto electrical systems; set installations; interference cures; vibrator maintenance and dozens of other subjects. In addition, there are 500 actual car radio circuit diagrams that are worth the entire price of the book to the busy service shop! 702 manual-size pages. Price \$7.50 (\$8.00 outside U.S.A.). 10-Day money-back guarantee. Order Book No. 5 in coupon.

Train for better pay in **TELEVISION SERVICING**

This great book makes TV servicing easy to learn

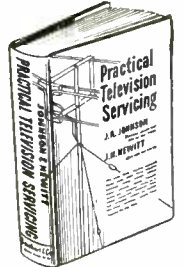

The book that helps you GET WHERE THE BIG MONEY IS!

Here, in one handy, 334-page volume is a complete guide to installing and servicing television receivers. **PRACTICAL TELEVISION SERVICING** tells you what to do—how to do it—how to set up shop—what mistakes to avoid. Clearly explained are the differences between radio and TV work. Included are dozens of actual TV service case histories and full explanations of wiring, repair and component replacement techniques, antenna erection, TV installations, etc. Also, you get dozens of helpful tips on testing, improving picture linearity, getting good fringe area reception, and other vital TV service data. In a way you can easily understand, it shows step by step exactly how to do the work. Price only \$4.00 (\$4.50 outside U.S.A.) Our 10-day money-back guarantee protects you absolutely. Order Book No. 8 in coupon.

LEARN ELECTRIC MOTOR REPAIR

A good-paying modern profession!

There's big money in installing, maintaining and rewinding electric motors! Actually, there are more motors than any other type of electric appliance—and the field is growing fast!

OPPORTUNITIES EVERYWHERE!

Based on what can be learned from this 500-page **ELECTRIC MOTOR REPAIR** book alone, you can train quickly for this profitable field. Explains every detail of motor trouble shooting, repair and rewinding. Covers all types of a-c and d-c motors in common use plus motor control systems. Quick reference guides show how to handle specific jobs. Every type of work is explained in the text AND ALSO visually by more than 900 helpful drawings, photos and diagrams. Practice from the book for 10 days on our money-back guarantee offer. Price \$5.00 (\$5.50 outside U.S.A.). Order Book No. 6.



It pays to specialize in something different!

The book that helps you **BE A WELL-PAID SPECIALIST IN FM**

FM is a mighty important part of radio—and, with its wide use in Television, mobile units and high-fidelity reception—is becoming more so every day! Written by a well-known expert, this book **FREQUENCY MODULATION** makes it easy for you to understand FM fundamentals and equipment clearly. Equally important, it explains how to handle FM service. Basic FM theory, circuits, transmitters, receivers and mobile FM are discussed in an easily understood manner—with special emphasis on modern methods of installing, adjusting and repairing FM receivers. Other subjects include FM circuit peculiarities; tuning indicators; antennas; FM test units; receiver alignment; general servicing procedure and many others. A complete guide to one of electronic's fastest-growing yet least understood developments! 448 pages, over 300 illustrations. Price \$5 (\$5.50 outside U.S.A.). Order Book No. 7 in coupon.

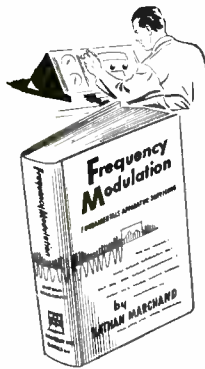

Frequency Modulation theory and service procedure clearly explained

FREE! WITH YOUR PURCHASE OF TWO BOOKS OR MORE

Here's an offer you can't afford to miss! With your purchase of ANY TWO of the eight books shown on these pages, we will GIVE you one of the following famous MHB Manuals in Applied Electricity. Your purchase of four regular books entitles you to two of the Manuals—AT NOT ONE CENT OF EXTRA CHARGE. Indicate your choice of gift books on coupon.

Manual A—INDUSTRIAL ELECTRIC WIRING

Construction, operation and maintenance data on a-c and d-c systems. 336 pages, over 100 illus. (Regular price \$2.75).

Manual B—PRIMARY AND STORAGE BATTERIES

Data on selection, maintenance and use—plus rectifiers, charging generators and battery controls. 168 pages profusely illustrated. (Regular price \$2.25).

Manual C—ELECTRICAL MEASURING INSTRUMENTS

Operating principles and details of all industrial types including guides to instrument selection and use. 284 pages, over 200 illus. (Regular price \$2.50).



10-DAY MONEY-BACK GUARANTEE COUPON

Dept. RE-11, RINEHART BOOKS, INC., Technical Division (formerly MURRAY HILL BOOKS, Inc.) 232 Madison Ave., New York 16, N. Y.

Enclosed find \$... for books checked below: or send C.O.D. and I will pay postman this amount plus postage. In either case, it is understood I may return books after 10 days and you guarantee to refund my purchase price promptly. (No C.O.D.'s if you live outside U.S.A. Cash only, but same 10-day return privilege.)

Send the following books

- Book No. 1 Book No. 2 Book No. 3 Book No. 4
- Book No. 5 Book No. 6 Book No. 7 Book No. 8

As per above offer send following gift Manuals at no extra charge:
 Manual A Manual B Manual C

Name
Address
City, Zone, State.....

PRINT OR WRITE CLEARLY

Read any of them for 10 FULL DAYS... at OUR risk!

... AT OUR RISK!

IT'S **NEW!**
IT'S A **NATIONAL!**



\$49⁹⁵ SW-54

**the most compact
general coverage
receiver
ever built!**

- 540kc — 30mc
- VOICE
- MUSIC
- CODE

Designed especially for the shortwave fan, the new SW-54 covers ship, police, amateur, foreign and standard broadcast bands. Yet it's housed in a smart, modern, unbreakable metal cabinet that measures only 11" x 7" x 7". Uses new miniature tubes in superheterodyne circuit, for astonishing sensitivity. Unique adjustable plastic bandspread dial assures logging accuracy over entire range. AC/DC operation. Write for details and name of nearest supplier.



fading accompanied by distortion is called "selective fading."

Night radio reception in the old days used to be a pretty exasperating affair. The operator had to ride the controls constantly to prevent the received signal from blasting the speaker one minute or fading clear out the next.

The cure, once found, was simple. *Automatic volume control* was the very poor name selected for it. I say "poor" because it is evident that any attempt to hold the volume at a constant level—making the whisper of the flute as loud as the bellow of the tuba—would result in distortion. What really was done was to make the r.f. sensitivity of the receiver inversely proportional to the intensity of the signal. As the signal intensity goes up, the receiver sensitivity goes down, and *vice versa*. The end result is that the signal delivered to the detector is practically independent of variations in the strength of the received signal.

This control is secured by varying the bias voltage applied to the r.f., mixer, and i.f. stages. As the negative bias on the grids of these tubes is increased, their ability to amplify is decreased, and the sensitivity of the receiver is reduced. Since we want this bias voltage to rise and fall with the strength of the received signal, the best place to get such a control voltage is from the signal itself.

Fig. 4 shows how this is done. The portion of the diagram inside the dotted lines is that of the diode detector shown and discussed in the chapter on

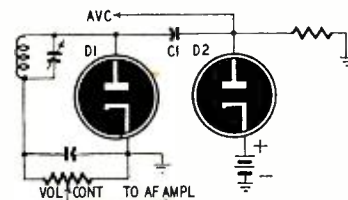

Fig. 5—A basic delayed a.v.c. circuit.

detector action (August, 1950, RADIO-ELECTRONICS). You will recall that the rectifying action of the diode causes three different types of current to flow downward through L1: first, the pulses of rectified r.f. carrier that were filtered out by the combination of R1, C1, and C2; second, the audio fluctuations that appear across R2; and third, the d.c. voltage produced by the one-way movement of electrons through R2 to ground. This last voltage is the one we are interested in.

The d.c. voltage drop across R2 is produced by rectifying the carrier envelope; so it stands to reason that it will be directly proportional to the amplitude of the carrier. If this amplitude increases, point A will become more negative with respect to ground; if it decreases—which is another way of saying the intensity of the signal goes down—point A becomes less negative.

Before this controlling voltage can be applied to the grids of our r.f. and i.f. tubes, however, we must comb out of

the a.f. variations still present at point A. This is done by means of a resistor-capacitor filter R4-C3.

The values of this resistor and capacitor are carefully chosen and should not be changed. When a capacitor charges and discharges through a resistor, as happens here, the time required for the voltage to build up and fall depends upon the values of the two components. The larger they are, the more time is required. What we want here is a combination that will be too slow to follow the voltage variations caused by the lowest audio frequency but fast enough to let the system have time to "recover" in the time required to tune from one station to another. Otherwise, when tuning from a strong station past a weak one, the sensitivity of the receiver might not have time to adjust itself upward after leaving the strong station, and the weak station would not be heard. The usual time constant is 0.1 second.

This negative voltage is fed to the various grids of the controlled tubes through isolating resistors that prevent coupling between the grid circuits. Tubes controlled by a.v.c. are the "remote-cutoff" type, the ones whose amplifying properties respond smoothly to wide variations in bias voltage. These tubes also are provided with a certain amount of minimum fixed bias—such as cathode bias—so that the plate current does not become excessive when no a.v.c. voltage is being produced.

In an ordinary a.v.c. system, the controlling action starts on even the weakest signal and begins to reduce the gain of the receiver when increased sensitivity would really be a help. "Delayed a.v.c.," as diagrammed in Fig. 5, shows the basic circuit for overcoming this problem. One diode D1 of a duo-diode is used for detection in the usual manner. The i.f. signal is also applied, through C1, to D2. The cathode of D2 is positive with respect to ground, which makes the plate negative with respect to the cathode. As long as the peak amplitude of the i.f. signal applied to D2 is less than this bias voltage, there will be no rectification, and consequently no a.v.c. voltage will be developed. As soon as the peak i.f. voltage rises above this bias voltage, rectification begins and the a.v.c. voltage is developed just as before. A battery is used for bias in the diagram, but the cathode may be tapped in at some point on a current-carrying resistor to get the correct bias.

Automatic volume control troubles are almost entirely due to failures of the capacitors, resistors, or diodes that make up a.v.c. circuits. Since the voltages are fed to the grids of the tubes through high-ohmage resistors, even a slightly leaky capacitor will short-circuit the a.v.c. voltage.

A possibly worse trouble is an intermittently leaky capacitor, which will produce its own type of fading. Where the complaint is "fading" or "intermittent," it is often a good idea to replace all capacitors in the a.v.c. circuit and to replace or make sure the resistors are not changing their ohmage.

4 Pages of TEST EQUIPMENT at prices every serviceman can afford!

MONEY BACK?

Every single unit described on this and the following pages is offered on a strict "money-back-if-not-satisfied-basis." No if's—no but's—no maybe's. Simply send your order for any unit

or units you select and try them out for 10 days. If not completely satisfied—return for refund in full. No explanation necessary. You are sole judge.

GUARANTEE?

Every instrument sold by us is covered by a one year guarantee. Guarantee registration card is included with shipment.

KITS?

We have discontinued advertising TEST EQUIPMENT in Kit form. The units offered on these 4 pages are completed instruments, NOT KITS! Every model is factory-wired, calibrated and ready to operate.

TUBE TESTERS

Important Note: The two models described below include slip-on portable hinged covers. This is a very desirable feature in Tube Testers because the multiple switches used on such units indicate properly only when clean. The slip-on covers insure long life because the front panel, including all switches, is fully protected when the instrument is not in actual use.

THE NEW MODEL 247



Check octals, loctals, bantam jr., peanuts, television miniatures, magic eye, hearing aids, thyratrons, the new type H.F. miniatures, etc.

Features:

★ A newly designed element selector switch reduces the possibility of obsolescence to an absolute minimum.

★ When checking Diode, Triode and Pentode sections of multi-purpose tubes, sections can be tested individually. A special isolating circuit allows each section to be tested as if it were in a separate envelope.

★ The Model 247 provides a supersensitive method of checking for shorts and leakages up to 5 Megohms between any and all of the terminals.

★ One of the most important improvements, we believe, is the fact that the 4-position fast-action snap switches are all numbered in exact accordance with the standard R.M.A. numbering system. Thus, if the element terminating in pin No. 7 of a tube is under test, button No. 7 is used for that test.

\$ 29⁹⁰
NET

Model 247 comes complete with new speed-read chart. Comes housed in handsome hand-rubbed oak cabinet sloped for bench use. A slip-on portable hinged cover is indicated for outside use. Size: 10³/₄"x8³/₄"x5³/₄".

SUPERIOR'S NEW MODEL TV-10



Specifications:

★ Tests all tubes including 4, 5, 6, 7, Octal, Lock-in, Peanut, Bantam, Hearing-aid, Thyratron, Miniatures, Sub-Miniatures, Novals, etc. Will also test Pilot Lights.

★ Tests by the well-established emission method for tube quality, directly read on the scale of the meter.

★ Tests for "shorts" and "Leakages" up to 5 Megohms.

★ Uses the new self-cleaning Lever Action Switches for individual element testing. Because all elements are numbered according to pin-number in the RMA base numbering system, the user can instantly identify which element is under test. Tubes having tapped filaments and tubes with filaments terminating in more than one pin

are truly tested with the Model TV-10 as any of the pins may be placed in the neutral position when necessary.

★ The Model TV-10 does not use any combination type sockets. Instead individual sockets are used for each type of tube. Thus it is impossible to damage a tube by inserting it in the wrong socket.

★ Free-moving built-in roll chart provides complete data for all tubes.

★ Newly designed Line Voltage Control compensates for variation of any line voltage between 105 Volts and 130 Volts.

The Model TV-10 operates on 105-130 Volt 60 Cycles A.C. Comes housed in a beautiful hand-rubbed oak cabinet complete with portable cover.

\$ 39⁵⁰
NET

TO ORDER—TURN TO PAGE 104 FOR RUSH ORDER FORM

GENERAL ELECTRONIC DISTRIBUTING CO.

DEPT. RC-1, 98 PARK PLACE

NEW YORK 7, N. Y.

1

BUY WITH CONFIDENCE!!

WE KNOW THE PRICE IS UNBELIEVABLY LOW,

but that's not all! In addition, this finely engineered instrument provides a degree of accuracy never before attained in a unit selling for even double this price. Furthermore—in designing this unit, we took advantage of every recent improvement in components. For example, by using slug-tuned coils, we are able to efficiently adjust each instrument for

perfect accuracy. This feature will also enable you to recalibrate the model 200 periodically without having to return it to the factory. The use of a Noval tube (the 12AU7) with its extremely low inter-electrode capacity enabled us to reach a higher frequency range than was heretofore possible in a unit of this type.

THE NEW MODEL 200

AM and FM

SIGNAL GENERATOR

SPECIFICATIONS

- ★ **R.F. FREQUENCY RANGES:** 100 Kilocycles to 150 Megacycles.
- ★ **MODULATING FREQUENCY:** 400 Cycles. May be used for modulating the R. F. signal. Also available separately.
- ★ **ATTENUATION:** The constant impedance attenuator is isolated from the oscillating circuit by the buffer

tube. Output impedance of this model is only 100 ohms. This low impedance reduces losses in the output cable.

- ★ **OSCILLATORY CIRCUIT:** Hartley oscillator with cathode follower buffer tube. Frequency stability is assured by modulating the buffer tube.

- ★ **ACCURACY:** Use of high-Q permeability tuned coils adjusted against 1/10th of 1% standards assures an accuracy of 1% on all ranges from 100 Kilocycles to 10 Megacycles and an accuracy of 2% on the higher frequencies.

- ★ **TUBES USED:** 12AU7—One section is used as oscillator and the second is modulated cathode follower. T-2 is used as modulator. 6C4 is used as rectifier.

The Model 200 operates on 110 Volts A.C. Comes complete with output cable and operating instructions.

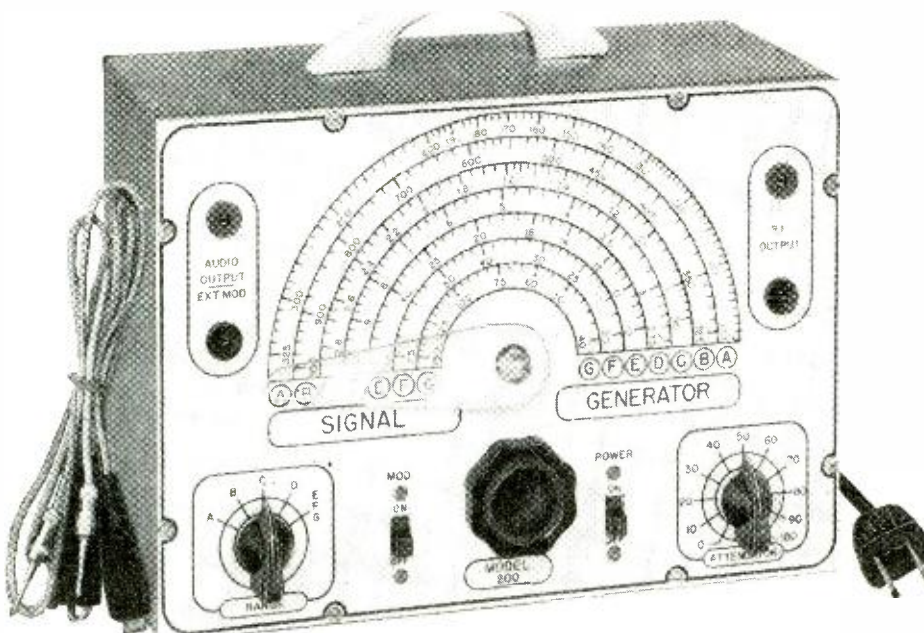

\$ **21**⁸⁵
NET

2

TO ORDER—TURN TO PAGE 104 FOR RUSH ORDER FORM

GENERAL ELECTRONIC DISTRIBUTING CO.

DEPT. RC-1, 98 PARK PLACE, NEW YORK 7, N. Y.

RADIO-ELECTRONICS for

MONEY BACK GUARANTEE!!



Superior's new model 770

AN ACCURATE POCKET-SIZE VOLT-OHM MILLIAMMETER

(SENSITIVITY—1000 OHMS PER VOLT)

FEATURES: Compact—measures $3\frac{1}{8}'' \times 5\frac{7}{8}'' \times 2\frac{1}{4}''$. Uses latest design 2% accurate 1 Mil. D'Arsonval type meter. Same zero adjustment holds for both resistance ranges. It is not necessary to readjust when switching from one resistance range to another. This is an important time-saving feature never before included in a V.O.M. in this price range. Housed in round-cornered, molded case. Beautiful black etched panel. Depressed letters filled with permanent white, insures long-life even with constant use.

SPECIFICATIONS: 6 A.C. VOLTAGE RANGES: 0—15/30/150/300/1500/3000 VOLTS. 6 D.C. VOLTAGE RANGES: 0—7.5/15/75/150/750/1500 VOLTS. 4 D.C. CURRENT RANGES: 0—1.5/15/150 MA. 0—1.5 AMPS. 2 RESISTANCE RANGES: 0—500 OHMS 0—1 MEGOHM.

The Model 770 comes complete with self-contained batteries, test leads and all operating instructions.

\$14⁹⁰
NET



Superior's new
model 670

SUPER-METER

A COMBINATION VOLT-OHM MILLIAMMETER PLUS CAPACITY REACTANCE
INDUCTANCE AND DECIBEL MEASUREMENTS

SPECIFICATIONS:

D.C. VOLTS: 0 to 7.5/15/75/150/750/1,500/7,500 Volts
A.C. VOLTS: 0 to 15/30/150/300/1,500/3,000 Volts
OUTPUT VOLTS: 0 to 15/30/150/300/1,500/3,000 Volts
D.C. CURRENT: 0 to 1.5/15/150 Ma. 0 to 1.5 Amperes
RESISTANCE: 0 to 500/100,000 Ohms 0 to 10 Megohms
CAPACITY: .001 to .2 Mfd. .1 to 4 Mfd. (Quality test for electrolytics)
REACTANCE: 700 to 27,000 Ohms 13,000 Ohms to 3 Megohms
INDUCTANCE: 1.75 to 70 Henries 35 to 8,000 Henries
DECIBELS: —10 to +18 +10 to +38 +30 to +58

ADDED FEATURE:

The Model 670 includes a special GOOD-BAD scale for checking the quality of electrolytic condensers at a test potential of 150 Volts.

The Model 670 comes housed in a rugged, crackle-finished steel cabinet complete with test leads and operating instructions. Size $5\frac{1}{2}'' \times 7\frac{1}{2}'' \times 3''$.

\$28⁴⁰
NET

Superior's
new model TV-20

20,000 OHMS PER VOLT MULTI-METER and TELEVISION KILOVOLTMETER



The Model TV-20 was designed to provide all the multi-meter measurement requirements of A. M., F. M. and Television. Unlike other recent models, which are actually standard V.O.M.'s converted to test the new Television Voltages, the Model TV-20 is a completely new unit. It provides the sensitivity, ranges and accessories which are needed to service F. M. and Television in addition to A. M. Radio. The High Voltage Probe for example, with a range of 50,000 volts and designed to withstand 100,000 volts, is an integral part of the instrument with a special compartment for housing it when not in use.

SPECIFICATIONS

- 9 D. C. VOLTAGE RANGES. (at 20,000 ohms per Volt)
0-2.5/10/50/100/250/500/1,000/5,000/50,000 Volts
- 8 A. C. VOLTAGE RANGES: (At 1,000 ohms per Volt)
0-2.5/10/50/100/250/500/1,000/5,000 Volts
- 5 D. C. CURRENT RANGES
0-50 Microamperes
0-5/50/500 Milliampers
0-5 Amperes
- 4 RESISTANCE RANGES:
0-2,000/20,000 ohms 0-2/20 Megohms
- 7 D. B. RANGES: (All D. B. ranges based on
0 db = 1 Mv. into a 600 ohm line)
— 4 to +10 db + 36 to +50 db
+ 8 to +22 db + 42 to +56 db
+ 22 to +36 db + 48 to +62 db
+ 28 to +42 db
- 7 OUTPUT VOLTAGE RANGES:
0 to 2.5/13/50/100/250/500/1,000 Volts

The Model TV-20 operates on self-contained batteries. Comes housed in beautiful hand-rubbed oak cabinet complete with portable cover, Built-In High Voltage Probe, H. F. Probe Test Leads and all operating instructions. Measures $4\frac{1}{2}'' \times 10\frac{1}{4}'' \times 11\frac{1}{2}''$. Shipping Weight 10 lbs.

ADDED FEATURE:

The Model TV-20 includes an Ultra High Frequency Voltmeter Probe. A Silicon V. H. F. Diode together with a resistance capacity network provides a frequency range up to 1,000 MEGACYCLES. When plugged into the Model TV-20, the V. H. Probe converts the unit into a Negative Peak-Reading H. F. Voltmeter which will measure gain and loss in all circuits including F. M. and T. V.; check capacity and impedance; test efficiency of all oscillator circuits; measure bandwidth of F. M. and T. V.; etc.

\$39⁹⁵
NET

TO ORDER TURN TO PAGE 104 FOR RUSH ORDER FORM

GENERAL ELECTRONIC DISTRIBUTING CO.

98 PARK PLACE

DEPT. RC-1

NEW YORK 7, N. Y.

3

Superior's
model CA-12

SIGNAL TRACER



THE WELL KNOWN MODEL CA-12 IS THE ONLY SIGNAL TRACER IN THE LOW PRICE RANGE INCLUDING BOTH METER AND SPEAKER!!!

SPECIFICATIONS

- ★ Comparative Intensity of the signal is read directly on the meter—quality of the signal is heard in the speaker.
- ★ Simple to Operate—only one connecting cable—no tuning controls.
- ★ Highly Sensitive—uses an improved vacuum-tube voltmeter circuit.
- ★ Tube and Resistor Capacity Network are built into the detector probe.
- ★ Built-In High Gain Amplifier—Alnico V Speaker.
- ★ Completely Portable—weighs 8 pounds—measures 5 1/2" x 6 1/2" x 9".

Model CA-12 comes complete with all leads and operating instructions.....

\$29⁹⁵
NET

Superior's new model TV-30

TELEVISION SIGNAL GENERATOR

ENABLES ALIGNMENT OF TELEVISION I F. AND FRONT ENDS WITHOUT THE USE OF AN OSCILLOSCOPE!

The Model TV-30 represents a radical departure in the design of Television Signal Generators. Unlike the "sweep" type of Generator which requires the use of an Oscilloscope and extensive technical knowledge including pattern interpretation etc., the TV-30 is a self-contained unit which permits alignment of Television Receivers by the use of exactly the same methods employed in the past to align Broadcast and Short-Wave Receivers.

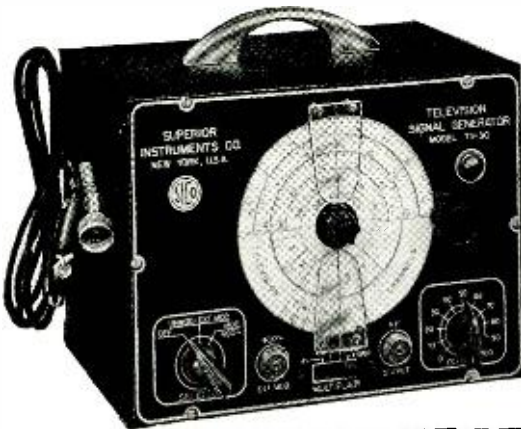

FEATURES

- Built-in modulator may be used to modulate the R. F. Frequency also to localize the cause of trouble in the audio circuits of T. V. Receivers.
- Double shielding of oscillatory circuit assures stability and reduces radiation to absolute minimum.
- Provision made for external modulation by A. F. or R. F. source to provide frequency modulation.
- All I. F. frequencies and 2 to 13 channel frequencies are calibrated direct in Megacycles on the Vernier dial. Markers for the Video and Audio carriers within their respective channels are also calibrated on the dial.
- Linear calibrations throughout are achieved by the use of a Straight Line Frequency Variable Condenser together with a permeability trimmed coil.
- Stability assured by cathode follower buffer tube and double shielding of component parts.

SPECIFICATIONS

Frequency Range: 4 Bands—No switching; 18-32 Mc., 35-65 Mc., 54-98 Mc., 150-250 Mc.
 Audio Modulating Frequency: 400 cycles (Sine Wave). Attenuator: 4 position, ladder type with constant impedance control for fine adjustment.
 Tubes Used: 6C4 as Cathode follower and modulated buffer. 6C4 as R.F. Oscillator. 6SN7 as Audio Oscillator and power rectifier.
 Model TV-30 comes complete with shielded co-axial lead and all operating instructions. Measures 8" x 7" x 9". Shipping Weight 10 lbs.

\$29⁹⁵
NET

**RUSH
ORDER
FORM**

**CUT
OUT
AND
MAIL
TODAY!**

GENERAL ELECTRONIC DISTRIBUTING CO.
DEPT. RC-1, 98 PARK PLACE, NEW YORK 7, N. Y.
GENTLEMEN:

PLEASE RUSH THE MATERIAL LISTED BELOW:

QUANTITY	MODEL	PRICE

TOTAL

\$..... (Payment in Full Enclosed)

\$..... (Deposit Enclosed—Ship Balance C.O.D.)

SHIP TO:

Name

Address

City Zone State.....



Television Service Notes

By MICHAEL L. TORTARIELLO

Speedy television receiver servicing depends on the ability to locate the trouble quickly from the symptoms in the set. This article presents a number of troubles and their cures for some of the more popular TV receivers.

RCA 9T270

All tubes light, sound O.K., picture goes from bright to dim. Upon becoming dim, the picture increases to about 1½ normal size and high voltage goes from a normal 12,500 to about 9,500.

Inspection revealed that one of the 1B3-8016 high-voltage rectifier tubes in the voltage doubler also varied in brightness. The trouble was a defective 3.9-ohm resistor in one leg of the filament circuit of the high-voltage rectifier.

9TC272

Sound O.K., no horizontal sync, no raster on screen. Adjusting the horizontal hold did not remedy this condition.

C-159, a .01- μ f capacitor in the horizontal oscillator, was leaking badly. Replacing it with a new .01- μ f, 600-volt capacitor fixed the trouble.

9T275

Picture and sound O.K., but when a large white or black object or large lettering appeared on the screen, there was a disturbing smear.

Checked second video amplifier tube circuit, a 6K6-GT, and found an open L109, a 180- μ h peaking coil. The smear disappeared when this was replaced.

Westinghouse

11-600T16

A common fault in this set is the simultaneous burning out of these resistors: R-401, a 400-ohm wire-wound focus control; R-407, 560 ohms; and R-410, 110 ohms. This trouble is caused by an internal short in the 6Y6-G high-voltage oscillator tube. Replace the tube and the resistors.

11-613K16

Sound O.K., no raster, no high-voltage on picture tube.

Checking the high-voltage rectifier and the 6Y6-G high-voltage oscillator showed that the 1B3-8016 rectifier did not light. The same tube in another set worked O.K. Further check showed that two turns of wire on the high-voltage oscillator transformer which supplies filament current for the 1B3-8016 had slipped a ½ inch away from the primary. This made the coupling between the two windings too loose for normal operation. Fastening the windings in their proper place with household cement cured the trouble.

11-600T16

Sound O.K., thin vertical line on picture tube.

The 12AU7 horizontal multivibrator showed a normal sawtooth. Checked output of three 7A5 horizontal output tubes and found no signal and no B-plus. Tested R-406, a 5,000-ohm wire-wound variable width control, and found it burned out. Also one of the 7A5's was shorted.

11-605T12

Sound shaky, raster normal, video signal very erratic.

When the outdoor antenna was disconnected from the set, channels 2 and 4 worked normally with a short piece of wire attached to one of the antenna posts. Tubes in the front end were tested and the 6AG5 mixer tube was found gassy. Set worked normally on all channels when this was replaced.

11-600T16

No sound but noticeable hum from speaker, picture showed a crease about 2 inches from the left side.

Audio amplifier checked O.K. with an audio oscillator, but no sound was reaching the audio system from the 6AL5 ratio detector. C-211, the .01- μ f a.f. coupling capacitor, was found shorted. Replacing this corrected the audio trouble and also eliminated the crease in the picture.

After about three or four months of use, the cathode-ray tube in these sets develops a brownish-yellow spot near the center of the screen. This is caused by a charge remaining on the two 500- μ f capacitors in the high-voltage circuit after the set is shut off. This trouble can be eliminated by disconnecting the lead from the 500- μ f capacitor that goes to pin 7 of the 1B3-8016 high-voltage rectifier tube. The manufacturer has already made this change in the late models.

Muntz Model 169

Sound O.K., picture has normal brightness but opens to full width of screen and then shrinks to about 3 inches wide. This repeats about every 15 seconds.

A leaky 0.2- μ f capacitor in the screen circuit of the 6BG6-G horizontal oscillator and output tube causes this trouble. Replace this capacitor.

Ansley Model 703

Sound O.K., no raster, and no high voltage at the cathode ray tube.

The two 1B3-8016 high-voltage rectifiers and the 6BG6-G horizontal output tubes checked O.K. High voltage was present at terminal 3 of the horizontal output transformer. The trouble was finally pinned down to the high-voltage doubler rectifier circuit where the 500- μ f capacitor connecting the two plates of the tubes was found shorted.



Roof-top
WORKER
living-room
SALESMAN



all-in-
ONE!

Callmaster

Electronic 2-Way Communicator

Saves Service Time and Labor
Makes "PLUS" Sales, too!

Cut time and labor in TV servicing . . . cut in on plus sales, too. Use Callmaster on every service call. When TV owners see (and hear) Callmaster used . . . they buy on the spot. Callmaster proves ideal solution to their problem of hearing invalid calls or baby cries while viewing TV. You profit 2-ways. In new servicing efficiency . . . in added sales.



complete set
\$39⁹⁵
with 50' cable

Yes, it's a new, plus market . . . you can't afford to miss . . . can't miss with Callmaster. Homeowners are sold on Callmaster—

SENSIBLE PRICE—economy consistent with quality.

PERFECT PERFORMANCE—a whisper or whimper received true and clear.

PLEASING APPEARANCE—lustrous, mahogany-grain plastic cabinets . . . Lektric-Shok-proof, double-thick.

You'll be sold on its—

PROFIT POSSIBILITIES—generous margin, quantity discounts.

SIMPLE INSTALLATION—easier to hook-up than standard doorbell system.

COMPLETE LINE—Master and Sub' sets (illus.) Multi Sub' sets with Selective Masters—deluxe All-Master systems.

FIND OUT TODAY—how you and Callmaster can make every servicing call a selling call. Ask your favorite Distributor about this proved profit package.

Callmaster
NATIONAL SALES OFFICE

WM. M. SMITH COMPANY
20 FERGUSON AVE., BROOMALL, PA.

..this letter speaks for itself!

Admiral Corporation

SERVICE DIVISION
201 E. NORTH WATER STREET - CHICAGO 11 - TELEPHONE HOHNS 4-4122

Mr. Mel Bushing
Simpson Electric Company
5200 West Kinzie Street
Chicago 44, Illinois

Dear Mel:

This is to tell you how delighted we are here at Admiral with the new Model 303 Simpson Vacuum Tube Volt-Ohmmeter. It certainly is a versatile instrument for television servicing.

The large meter is very legible, and yet the instrument itself is a compact size. I particularly like the AC voltage range, which is the widest I've ever seen on this type of instrument.

Our service engineers think you've done a good job on the Operator's Manual, too, because it is both complete and concise.

Of course, we've used the Simpson Model 260 Volt-Ohm-Williammeter for years. The "303" is a fine companion instrument to the "260".

Congratulations!

Sincerely yours,

M. J. Schinka
ADMIRAL CORPORATION
M. J. Schinka
National Service Manager

MJS:ar

WORLD'S LARGEST MANUFACTURERS OF RADIO PHOTOGRAPHS WITH AUTOMATIC RECORD
AA-18 Radios • Televisions • Radio-Photographs • Radiograms • Home Instruments

Model 303 VACUUM TUBE VOLT-OHMMETER

SPECIFICATIONS

DC Voltage

Ranges 1.2, 12, 60, 300, 1200 (30,000 with Accessory High Voltage Probe)

Input Resistance 10 megohms for all ranges

DC Probe with one megohm isolating resistor Polarity reversing switch

Ohms Ranges 1000 (10 ohms center)
100,000 (1000 ohms center)
1 megohm (10,000 ohms center)
10 megohms (100,000 ohms center)
1000 megohms (10 megohms center)

AC Voltage

Ranges 1.2, 12, 60, 300, 1200

Impedance (with cable) approx. 200 mmf shunted by 275,000 ohms

AF Voltage

Ranges 1.2, 12, 60

Frequency Response Flat to 100,000 cycles

Decibels

Ranges -20 to +3, -10 to +23, +4 to +37,
+18 to +51, +30 to +63

Zero Power Level 1 M. W., 600 ohms

Galvanometer

Zero center for FM discriminator alignment and other galvanometer applications

R. F. Voltage

(Signal tracing with Accessory High Frequency Crystal Probe)

Range 20 volts maximum

Frequency Flat 20 KC to 100 M.C.
105-125 V. 60 cycles

Size

5 1/4" x 7" x 3 1/8" (bakelite case). Weight: 4 lbs.

Shipping Wt.: 6 1/2 lbs.

Dealer's Net Price

Model 303, including DCV Probe, ACV-Ohms probe and Ground Lead—\$58.75;

Accessory High Frequency Probe, \$7.50;

Accessory High Voltage Probe, \$14.85

Also available with roll top case,

Model 303RT—\$66.70



Simpson ELECTRIC COMPANY

5200 WEST KINZIE STREET, CHICAGO 44, ILLINOIS • IN CANADA: BACH-SIMPSON, LTD., LONDON, ONTARIO

Phone: COLUMBUS 1-1221

RADIO-ELECTRONICS for

METER FOR POWER SUPPLY CHECKS VOLTS AND AMPS

By I. QUEEN

Any utility power supply becomes far more useful if it can measure voltage, current, and power into its load. The only parts to be added are a milliammeter, s.p.d.t. switch, and a couple of resistors. Current and voltage are measured separately (see figure). The product of these numbers gives the power.

The shunt S parallels the meter for measuring current. Its resistance is found from the following:

$$S = \frac{MA}{I-A}$$

where M is the meter resistance, I the maximum load current, and A the meter current for full-scale deflection. For an

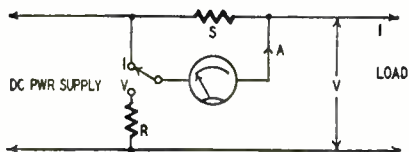

The circuit for using a milliammeter to measure the power supply's output.

example, assume M is 100 ohms, I is 100 ma, and A is 1 ma. The shunt should be 1.01 ohms.

The multiplier R is connected for voltage measurement. Its resistance should be

$$R = \frac{E}{A} - M,$$

where E is the maximum voltage to be indicated.

Only slight errors are introduced by the presence of the meter. Generally they are negligible.

USING SMALL MAGNETS

The chart for my tube tester is on a large cardboard sheet. There are no index lines so it is easy to make a mistake in setting up the tester. To avoid mistakes, I place the chart over a sheet of galvanized iron and use a thin bar magnet as a movable index point or pointer. You can even cement the chart to the metal sheet and hang it on the wall. A strong magnet will remain in position until you move it.—Joseph Amorose



"Remember that old pop-up toaster you were going to throw out?"

JANUARY, 1951

YOU'RE FIRST IN LINE!
FOR TOP VALUES IN TV, RADIO & ELECTRONICS

Be the first to know of the Latest and Best Buys in TV, Radio and Electronic Equipment... Get on Concord's Mailing List. Be sure you get the new Buyer's Guide... issued periodically and packed with the latest available merchandise. This way, when merchandise is available to us... it goes straight to you. Order yours Now.

PUT YOUR NAME ON CONCORD'S MAILING LIST

NOW!

Bargains... Values... Savings. Now you're assured of getting the latest scoops on Radio, TV, and Electronic Equipment First-hand. Send today for your Concord Buying Guide. Just fill in the coupon at the right. Send all orders to Concord - Chicago.

CONCORD RADIO CORP., Dept. JA-51
901 West Jackson Blvd., Chicago 7, Illinois

Please forward your latest Buyer's Guide

Name.....

Address.....

City..... Zone... State.....

OUTSTANDING CONCORD BUYS

MOBILE HIGH VOLTAGE PWR. UNIT



For mobile radios, amateur equipment, PA amplifiers, and many other types of equipment. Well built, made of the finest materials available to meet strict specifications. Especially adapted to furnish plate supply for above mentioned units. Input 12 volts at 10 amps. Output consists of two volt ranges. (1) 275 volts at 10 ma., 12 volts @ 3 amps. (2) 500 volts at 50 ma. Contains two nationally known permanent magnet dynamotors, complete with all hash filters. Each high voltage range is individually fused and the input has an "on and off" switch and an indicating pilot light assembly. Olive drab wrinkle finish. Size: 8-3, 8"x 6-1/4"x 11-5/8".
5-9513R - Shpg wt. 27 lbs. **9.50**

PERMANENT MAGNET DYNAMOTOR

Input 12/24 volts @ 8, 4 amps., output 12/275 volts @ 3/.110 amps.
9-9589R - Shpg wt. 10 lbs. \$3.95

CAL 88 HIGH-SPEED SOLDERING GUN



New Cal-88 Soldering Gun heats in about 5 seconds! Choice of two heats from same trigger: 100 watts or 150 watts. Built-in light shines directly on your work. New single pole electrode lets you work faster in narrow spots. You can see what you are doing. Beryllium copper electrode requires no tinning. Can be replaced in two seconds. Long duty cycle--heats up in about 5 seconds and can be kept on for about 10 minutes. Its off duty cycle is only 5 minutes. Light in weight... only 1-1/2 lbs! This, plus non-tiring pistol grip and perfect balancing make this the easiest-to-use soldering gun yet. Built-in 1.5 amp fuse protects the transformer. All parts of gun are replaceable.
18-14864R--Shpg. wt. 2 lbs. **14.65**

RECORDING TAPE AT TERRIFIC PRICE REDUCTION



Best Recording Tape Buy on the market! Made by a famous national manufacturer to Concord's strict specifications. 1200' long, 1/4" wide with uniform coating of red oxide particles on kraft paper base. Magnetic coating wound facing in. Plastic reel included. Order while our supply lasts.

35-16297R - 1200' Kraft Paper Base Tape. **1.49**

As above but on stronger more efficient plastic base for more uniform output and lower noise level.
33-16296R - 1200' Plastic Base Tape. \$1.95

CONCORD RADIO

EXPORT Service

Mail Order Center and Showroom
901 W. Jackson Blvd., Chicago 7, Ill.
Branch Showroom: 265 Peachtree St., Atlanta 3, Ga.

For prompt service on Export Orders and Inquiries Address to Concord Radio Corp., Export Division, 901 W. Jackson Blvd., Chicago 7, Illinois.

The Most Powerful RADIO - Advertising



See these big-space ads! They're appearing in the *Saturday Evening Post*, *Life*, *Look*, and *Collier's Magazine*. Each is loaded with stop-appeal and sales-appeal. Each one features an endorsement of your service by a famous star such as Paulette Goddard, Marie Wilson, Diana Lynn, or Patrice Munsel.

Marie Wilson says:

"I think it's a really wonderful when you have a television set in your home, it's a wonderful thing to have and you will be surprised how much you will enjoy it."



RADIO TELEVISION SERVICE

SYLVANIA TUBES
RADIO AND TELEVISION PICTURE TUBES

Diana Lynn says:

"The new television sets are a real treat. They are a real treat to the eye and to the ear. They are a real treat to the eye and to the ear. They are a real treat to the eye and to the ear."



RADIO TELEVISION SERVICE

SYLVANIA TUBES
RADIO AND TELEVISION PICTURE TUBES

Paulette Goddard says:

"I'm really enjoying my television set. It's a real treat to the eye and to the ear. It's a real treat to the eye and to the ear. It's a real treat to the eye and to the ear."



RADIO TELEVISION SERVICE

SYLVANIA TUBES
RADIO AND TELEVISION PICTURE TUBES

Patrice Munsel says:

"I'm really enjoying my television set. It's a real treat to the eye and to the ear. It's a real treat to the eye and to the ear. It's a real treat to the eye and to the ear."



RADIO TELEVISION SERVICE

SYLVANIA TUBES
RADIO AND TELEVISION PICTURE TUBES

SYLVANIA

RADIO TUBES; TELEVISION PICTURE TUBES; ELECTRONIC PRODUCTS; ELECTRONIC TEST EQUIPMENT;

RADIO-ELECTRONICS for

TV SERVICE Campaign ever launched!

HERE'S the hardest hitting . . . and the most complete advertising campaign ever planned, to bring service business to every dealer who displays the Sylvania emblem.

All during 1951, your prospects are certain to SEE, HEAR, and READ about your expert service in magazines, on television, and through window displays.

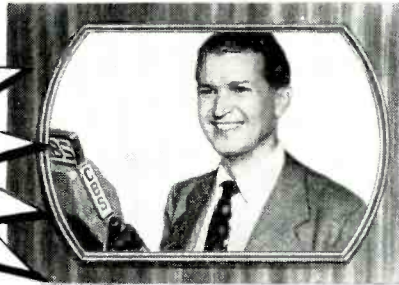

The great Nation-wide TV show, "Beat the Clock," featuring Bud Collyer over CBS-TV, will go to bat for your service and the Sylvania products which you sell. Clever animated cartoon commercials on the CBS-TV station in your area will inform prospects of your expert workmanship and prompt service.

Tying everything together is the greatest and most colorful dealer tie-in program you have ever seen!

You get FREE giant, full-color displays of the featured stars. You get counter cards . . . bright window streamers . . . spot radio announcements . . . mailing pieces . . . all designed to identify you as the Sylvania Service Dealer advertised on television and in the national magazines.

Ask your jobber for full information about the bigger-than-ever 1951 Service Dealer Advertising Program. If he can't give you all the facts, mail the coupon now!



Be sure to display this emblem. Put up these Sylvania decals right now! This seal is the target of the whole Sylvania Service Dealer campaign. Put them on your windows and on your trucks. Made in 8-inch and 12-inch sizes. Order a supply from your jobber TODAY! They're free!

Sylvania Electric Products Inc.
Dept. R-2401, Emporium, Pa.

Please send me full details about the greatest Radio-Television service advertising campaign in the history of the industry.

Name _____
Street _____
City _____ Zone _____ State _____

ELECTRIC

FLUORESCENT TUBES, FIXTURES, SIGN TUBING, WIRING DEVICES; LIGHT BULBS; PHOTOLAMPS; TELEVISION SETS

JANUARY, 1951

WEAK IMAGES

TUBE STRAIN

POOR RECEPTION

GOODBYE TO FRINGE AREA TV TROUBLES

Get the TV antenna up in the air in fringe areas—and watch 9 out of 10 reception troubles disappear!

The famous Trylon TV Mast is dependable, safe,—AND PROFITABLE! It takes less time to install than a make-shift pipe, weighs only 2 lbs. per foot, mounts a handy working platform and can be climbed. Made of galvanized, double-welded steel rods—NOT flat aluminum—for less wind resistance with an absolute minimum of download on the roof. Write today for details.



✓ Supplied in 10 foot sections for heights of 10, 20, 30, 40, 50 or 60 feet.

✓ Mounts easily on peaked roofs or flat surfaces.

✓ Handy mounting hardware packaged individually.

WIND TURBINE CO.
260 East Market St.,
West Chester, Pa.

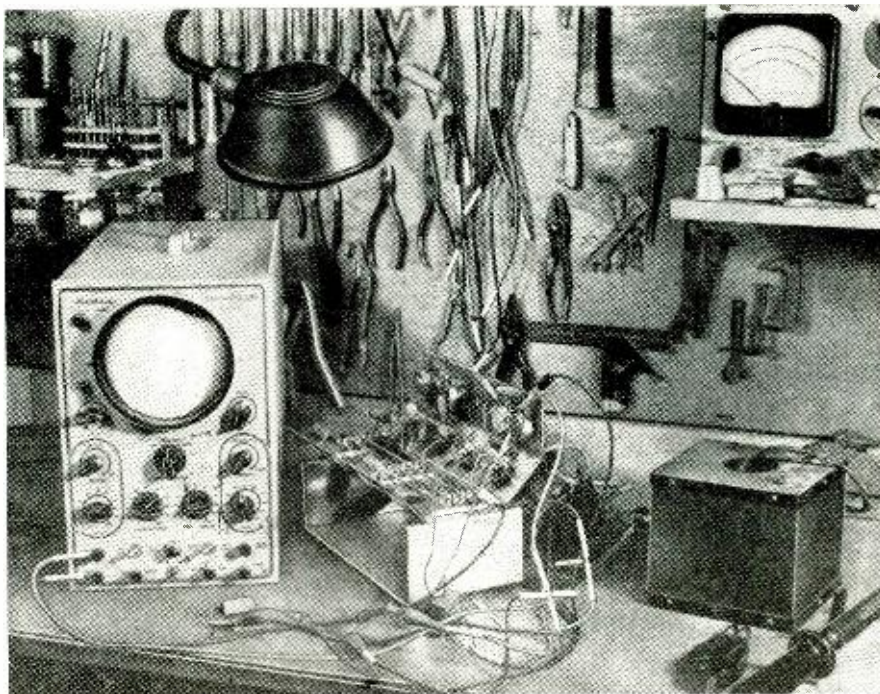

Experimental setup of oscillator in Fig. 1-c used for making oscillograms. Special Unichassis in center is made for experimental work and simplifies breadboard wiring. Experimental power supply appears at the right in the photograph.

Electronics and Music

Part VII—Designing tone generators for electric organs

By RICHARD H. DORF*

CONSTRUCTING a polyphonic electronic musical instrument is a big job compared to building many other electronic devices. Sixty separate tone frequencies must be available for even a single-manual, five-octave instrument. So the number of components will not be small. And after the bare tone frequencies have been provided, the tones must be shaped—varied in quality—and volume-controlled. Keying delay should also be provided; vibrato or tremolo is needed; couplers may be desired between manuals; octave couplers may be wanted; manuals (and pedals) and a console must be secured or made; and so on.

Building an electronic organ is not a job for the novice, nor is the design for such an instrument a decision to be taken in five minutes. But strangely enough, initial generation of the necessary tones, which is what this article deals with, is the easiest part of the job.

There are only two basic requirements. The first is to provide as many tone sources as necessary and the sec-

ond is that each should be of the correct pitch. These requirements indicate that (initially at least) the designer may consider all of the many oscillator circuits brought forth up to date.

Depending on what the designer has in mind, several other conditions may have to be met, and they may be no less important than the basic ones. The tones must be keyed somehow, and it may be desirable to key the oscillators themselves without running into "chirp" or clicks. A keying delay should be included somehow. The oscillators themselves may have to provide it. The desired waveform may be anything from a sine to the most complex and the oscillators rather than following tone-shaping circuits may have to provide it. Frequency stability may be important unless there is some provision for synchronization. And other points may crop up, not the least of which may be the necessity of keeping costs and space requirements down.

For frequency stability it is desirable to have all oscillators tuned to the octaves of each of the 12 notes synchro-

* Audio Consultant

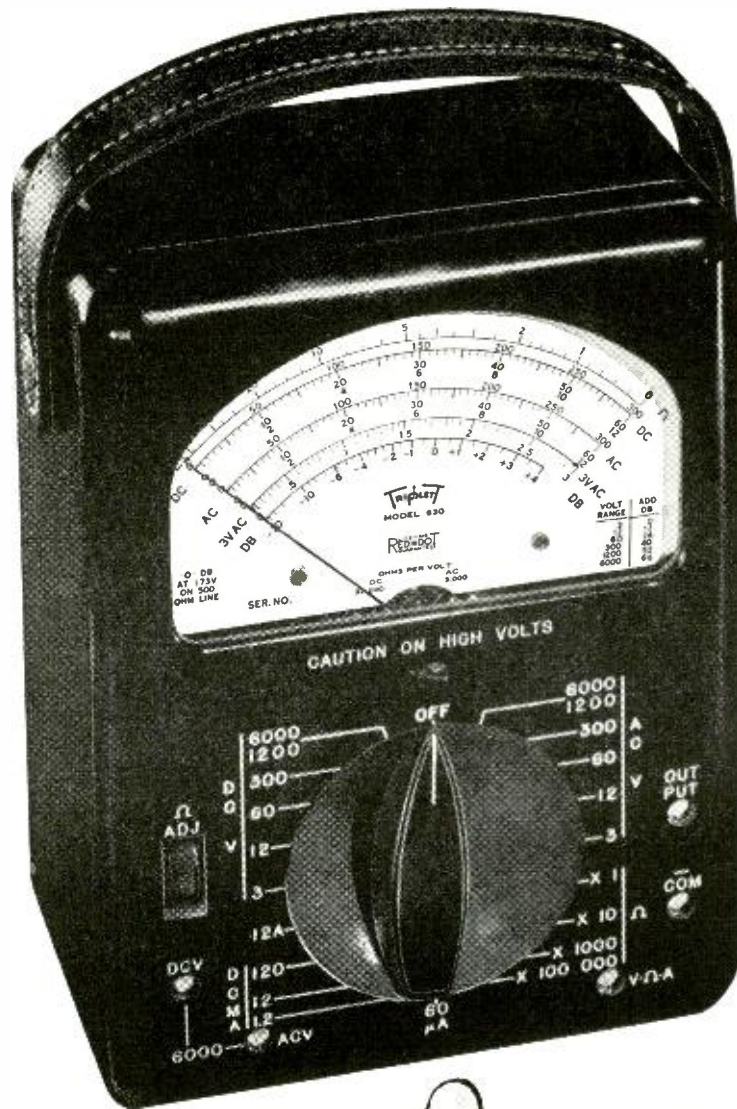

ALL RANGES WITH THIS ONE CONTROL

Just *one* knob—extra large—easy to turn—flush with the panel, controls all ranges. This one knob saves your time—minimizes the chances of “burn-outs” because you don’t have to remember to set another control. You can work fast with Model 630 with your eyes as well as your hands. Look at that scale—wide open—easy to read, accurately. Yes, this is a *smooth TV* tester. Fast, safe, no projecting knobs, or jacks, or meter case. Get your hand on that single control and you’ll see why thousands of “Model 630’s” are already in use in almost every kind of electrical testing

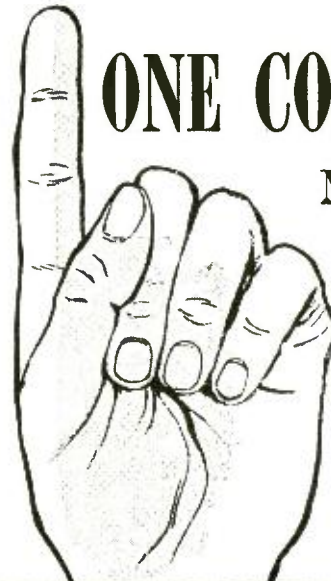

**Model
630**

ONLY \$39.50 AT YOUR DISTRIBUTOR
In Canada: Triplett Instruments of Canada, Georgetown, Ontario

FOR THE MAN WHO TAKES PRIDE IN HIS WORK

Triplett

TRIPLETT ELECTRICAL INSTRUMENT COMPANY • BLUFFTON, OHIO, U.S.A.

VEE-D-X

For all TV Reception and Installation Requirements

THE WORLD'S

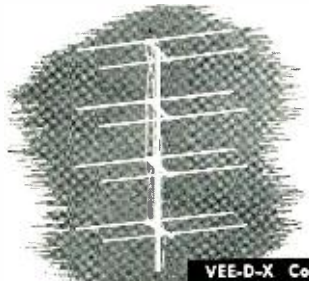

VEE-D-X Colinear

MOST POWERFUL

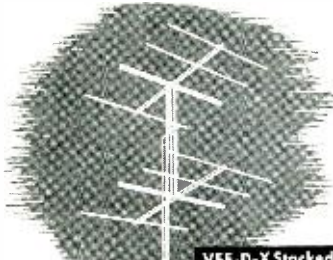

VEE-D-X Stacked Yagi

TV

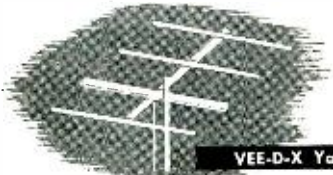

VEE-D-X Yagi

ANTENNAS

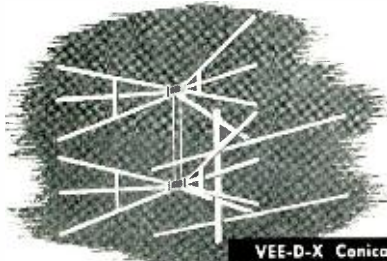

VEE-D-X Conical

LaPOINTE-PLASCOMOLD CORP. 1 WINDSOR LOCKS, CONN.

Please send me new 1951 catalog of VEE-D-X antennas and accessories.

NAME _____
 STREET _____
 CITY _____ ZONE _____ STATE _____

nized so that they will "lock in" with each other. But synchronization has two disadvantages. First and most important to the tonal effect, it eliminates the chorus effect described in the first article of this series since all the oscillators operate in phase. Second, if sine waves are desired, very few oscillators will be found which can be synchronized and which will produce sine waves. Oscillators naturally lock in, of course, when both are at the same frequency, but synchronization is a touchy matter when sine-wave oscillators are required to lock with a harmonic or subharmonic.

Fig. 1 illustrates six representative feedback oscillators, all of which are suitable for electronic organs (though not all have been used in commercial instruments). Fig. 1-a is the tuned-grid (plate tickler) oscillator, in which the

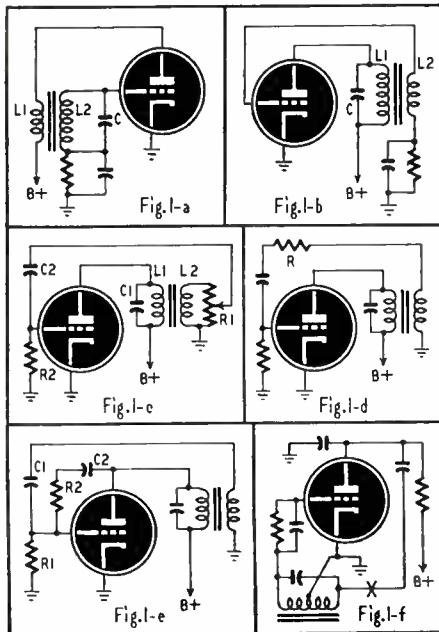

Fig. 1—Six oscillators suitable for producing tones for electronic music.

grid circuit is tuned and a secondary winding on the inductor feeds back energy from the plate. As in all feedback-transformer arrangements, the connection polarity of primary and secondary must be correct for positive feedback; if the circuit does not oscillate, reverse the connections to primary or secondary (not both).

Fig. 1-b diagrams the tuned-plate (grid-tickler) oscillator, which is exactly the same as that of Fig. 1-a except that the plate circuit is tuned. In this case the values of the tank inductor and capacitor play the greatest part in

determining frequency, though the tube characteristics, plate current, tank current, and other factors do influence it. The paralleled resistor and capacitor in each circuit is the grid leak. Values are very noncritical and experiments to find correct values may be begun around 50,000 ohms and .01 μ f. If the time constant (product of R in megohms and C in microfarads) is too long, the oscillator may not start or may go on and off at intervals.

The amplitude of the positive feedback is a very important factor in determining output waveform and frequency stability. It is controlled within limits by the grid-leak arrangement because the increase in grid current which accompanies an increase in feedback amplitude automatically increases the negative bias and lowers the amplification of the tube. The grid leak controls amplitude only within a fairly narrow range, however.

In the two oscillators of Figs. 1-a and 1-b the principal factor controlling feedback is the turns ratio of the transformer. Ideally it should be wound so that the voltage reaching the grid due to the tube output is exactly the same as the voltage at the grid which produced that output. A feedback oscillator is almost a perpetual-motion machine in that it supplies its own input. (The fact that external plate and filament power supplies are necessary, however, prevented the first oscillator inventor from rushing to Washington with a final solution to the perpetual-motion riddle.)

If the feedback is too great, the output waveform distorts and frequency stability suffers. Increased above a certain point, the feedback causes relaxation oscillations with a roughly sawtooth waveform having sharp, needlelike peaks at each apex. The frequency is then extremely sensitive to the slightest changes in supply voltage or heat movement of the tube elements and is not useful for electronic music unless synchronized because of the excessive frequency drift.

The usual noncommercial constructor shies away from winding his own coils for these oscillators and prefers to use available ones. That is made possible by the circuits of Figs. 1-c, 1-d, 1-e, and 1-f.

Fig. 1-c is a tuned-plate oscillator like that of Fig. 1-b. The transformer, however, is a standard interstage unit: L1 is usually the higher-impedance winding, tuned by C1. Normally the voltage across L2, which usually has a stepdown ratio of only a very few times, is much too high for proper feedback.



These oscillograms show what happens when feedback in a conventional oscillator is too great and when the time constant of the grid-leak is too long. The perfect sine wave results when feedback is reduced to the optimum value by any of the methods illustrated in Figs. 1-c through 1-f, or by using a suitable transformer.

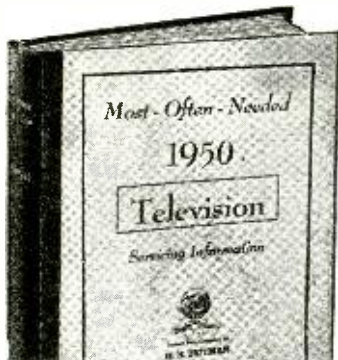

New 1950 Television Manual

This newest giant volume of the series covers 1950 factory data on all popular television sets of all makes. There are circuit explanations, 114 pages of alignment procedure, test patterns, response curves, pages of waveforms, voltage charts, service hints, and ten mammoth 11x15" blueprints. Manual \$3
 1949 T-V Manual. Similar to the volume listed above. Has 160 extra-large pages, plus 9 double-spread giant blueprints. \$3
 To order see coupon below, only.....
 1948 T-V Manual. Earlier volume has material on all popular T-V sets of this period. Large size: 8 1/2 x 11". Remarkable value. \$3
 Including 8 fold-out blueprints, only.....
 1947 FM and T-V Manual. Covers all needed FM and television sets including popular R.C.A. 630TS. Data on 192 \$2
 pages. Only.....

New SUPREME TELEVISION Manuals

INCLUDES ALL POPULAR SETS

AMAZING BARGAIN OFFER

All you need to service any television set are the four SUPREME TV manuals described at left. Every popular television set, from the early 1947 models to the very latest 1950 receivers, are here. Covered in great detail making adjustment and servicing really easy. Manuals have data on circuits, alignment, test patterns, response curves, service hints, voltage charts, waveforms, factory recommended changes, and many mammoth 11 x 15-inch blueprints. These manuals will give you the practical know-how of a TV expert and will repay for themselves with time saved on a single TV job.

The television series manuals are the most remarkable values offered by Supreme Publications in their 17 years of business. These TV manuals at only \$3 and \$2 each are amazing bargains and defy competition. There is nothing else like them. Each manual is a virtual treatise on practical television repairs. By normal standards, each such large manual packed as it is with practical facts, hundreds of illustrations, diagrams, charts, photographs, and expensive extra-large blueprints, should sell for \$10—but as SUPREME special values they are priced at \$3 and \$2 each. Only a publisher who sold over one million TV and radio manuals can offer such bargains based on tremendous volume-sales.

FIND—FIX ALL T-V FAULTS

Use these timely television manuals as your guide to quick fault finding and repair of any television set. Eliminates guesswork—tells you just where to look and what to do. Cuts hour-wasting jobs to pleasant moments. Use test patterns for quick adjustment, or look up probable cause of trouble in the pages of hints after simply observing fault in video picture. No equipment needed with these tests. Or use your voltmeter and compare values with many voltage charts included. With an oscilloscope you can get waveforms similar to hundreds illustrated using test points suggested and in a flash locate what used-to-be a hard-to-find fault. Order at our risk for a 10-day trial. Use coupon at bottom of page.

YOURS TO USE ON TRIAL

Decide to have in your shop all four Television Manuals as described in the first column at the left. Or try the new 1950 TV manual to see what an amazing bargain you get for only \$3. Order on no-risk trial by using coupon at bottom of page.

RADIO COURSE

AMAZING BARGAIN IN HOME-TRAINING

Here is your practical home-study course at a give-away price. The 22 lessons cover all topics just like other correspondence radio courses selling for over \$150.00. Our amazing offer permits you to obtain the course complete for only \$2.50, nothing else to pay. Course covers fundamentals, modern circuits, practical radio repairs. Includes hundreds of diagrams, thousands of repair hints, many trouble-shooting short-cuts.



COVERS EVERY TOPIC OF RADIO SERVICING



"You should get more money for your course. The first week I studied it, I made \$10.00 repairing sets. I built my own test outfit from details given in this course. I have repaired 100 radios to date. . . . Signed: Robert C. Hammel, 120 W. 13th, Davenport, Iowa.

The easy-to-follow lessons of this home-study course will show you quickly how to repair all types of radio sets. There are lessons on how to open a shop and operate a successful radio business. Every lesson is well illustrated, interesting to read, really easy to understand and apply. No special previous knowledge is needed. The early lessons explain important principles. Other lessons cover test equipment, trouble-shooting, circuit tracing, television, and every important topic of radio servicing.



PRACTICAL ON-THE-JOB MATERIAL

Learn new speed-tricks of radio fault-finding, case histories, servicing short-cuts, extra profit ideas. Included are many large lessons on the use of regular test equipment, explanation of signal tracing, use of oscilloscope, transmitters, P.A., television, recorders, etc. Let this information save for you enough time on a single job to pay the full price of \$3.50, for the complete course of these money-making lessons.

EASY TO UNDERSTAND AND APPLY

The practical lessons of this course-manual are easy to follow and apply to actual radio jobs. Hundreds of radio and television facts that puzzle you will be quickly cleared up. You will find yourself doing radio repairs in minutes instead of hours—quickly finding faults or making adjustments. Every new radio development of importance and thousands of time-saving facts are packed into this giant-sized complete course-book.

SATISFACTION GUARANTEED

Use the NO-RISK coupon at right to order the complete COURSE for 10-day examination in your own home. Look over the material, read a few lessons, use this aid to fix several radios. Only then decide to keep the lessons at the bargain price of \$2.50 (full cost), or return the material for a cash refund. Act today, while the price is still only.....

\$2.50



"I am very satisfied with the course. When I was at the twelfth lesson I started repairing radios. It took me two months to master your course." From a letter written by Roger Lanzlots, 1679 Poupart, Montreal, Canada.

SUPREME RADIO MANUALS

New 1950 Radio Diagrams

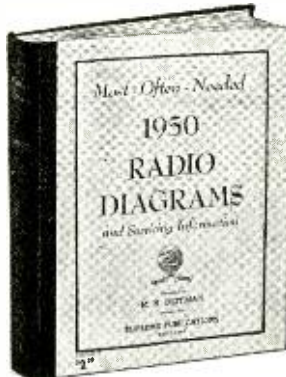

Now you can benefit and save money with Supreme amazing scoop of 1950. This one giant volume has all the service data you need on all recent radio sets. Here you have clearly-printed large schematics, needed alignment data, parts lists, voltage values, and information on stage gain, location of trimmers, and dial stringing illustrations. This is the help you need to find tough faults in a jiffy. The new 1950 radio manual is a worthy companion to the 9 previous volumes used to an advantage by over 128,000 shrewd radio men.

BIGGEST BARGAIN IN SERVICE DATA

Wise servicemen know that Supreme Publications manuals have all the material needed at the lowest prices. For the remarkable bargain price (only \$2 for most volumes) you are assured of having on hand needed diagrams and all other essential repair facts on almost all sets you will ever service. Every popular radio of all makes, from old-timers to new 1950 sets is covered. Select manuals wanted, see list below, and rush no-risk order coupon.

SUPREME RADIO MANUALS for PREVIOUS YEARS



1949	1948	1947	1946	1942	1941	1940	1939	1926-1938
SUPREME Most-Often Needed RADIO DIAGRAMS Each Manual only \$2. (1949 is \$2.50); 192 pages of diagrams, alignment data, voltage values, parts lists, and service hints; large size, 8 1/2" x 11". To order, see coupon below.								RADIO Diagrams 240 Pages Price \$2.50

NO-RISK TRIAL ORDER COUPON

SUPREME PUBLICATIONS, 3727 W. 13 St., Chicago 23, ILL.

Send on trial manuals checked below and at right. You guarantee complete satisfaction.

- 1950 Television Manual, \$3.
- 1948 TV, \$3.
- 1947 TV & FM, only \$2.
- Radio Servicing Course, complete..... \$2.50
- I am enclosing \$..... Send postpaid.
- Send C.O.D. I am enclosing \$... deposit.

- Radio Diagram Manuals**
- New 1950 Manual, \$2.50
 - 1949 Radio Manual, \$2.50
 - 1948
 - 1947
 - 1946
 - 1942
 - 1941
 - 1940
 - 1939
 - 1926-1938 Manual, \$2.50
- PRICED AT ONLY \$2 EACH**

Name:
 Address:

Supreme Publications
 Sold by All Leading Radio Jobbers

However, a potentiometer R1, which may be anywhere between 10,000 and 100,000 ohms or even more, is shunted across L2 and the arm is adjusted until just enough voltage is fed to the grid to sustain oscillations. At this point the waveform will be almost pure sine (if the grid-leak components R2 and C2 are chosen correctly) and the frequency will be most stable and nearest to the resonant frequency of L1 and C1. Once the correct values for the upper and lower halves of R1 have been found, the potentiometer may, of course, be replaced with a pair of ½-watt resistors.

The same trick may be done in a slightly different way by using the circuit of Fig. 1-d. Here resistor R is a series limiter. This, incidentally, is a well-known form of resistance stabilization ordinarily used to stabilize frequency. It is also useful here, of course, to compensate for the fact that the transformer turns ratio is not ideal.

Fig. 1-e illustrates a method of combined stabilization and feedback correction original with the writer (although it was probably original with other workers at prior times). As usual with the standard interstage transformer used, the positive feedback is too great for stable sine-wave oscillation. The positive feedback is produced in the usual way.

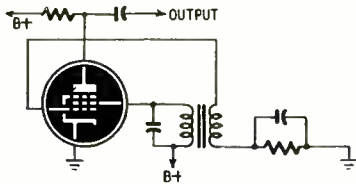

Fig. 2—This stable audio tone generator uses the electron-coupled circuit.

The excess of positive feedback is remedied by adding negative feedback. An oscillator of the feedback type may be considered simply as a perfectly standard amplifier which produces its own input. The amplitude of oscillation depends on two things: the amount of coupling between plate and grid, and the amplification of the tube. The previous circuits have been stabilized by varying the coupling. In Fig. 1-e the feedback voltage is lessened by reducing the amplification of the tube. R2 is a simple negative feedback resistor from the plate to the grid. C2 is a blocking capacitor which should have a low reactance compared to the resistance of R2.

After the circuit is connected, R2 is varied (use a 10-megohm potentiometer) until the circuit just oscillates. The positive feedback voltage is then correct. In addition, since the amplifier is operating with a fair degree of negative voltage feedback (the degree of permissible negative feedback depending on how much too large the transformer secondary voltage is), it is itself stabilized to a large degree against changes in amplification caused by fluctuations of supply voltages. Since, in an audio oscillator of this kind, changes in plate current and

amplification, rather than changes in tube-element capacitances cause most of the undesirable frequency irregularities, stabilizing the amplifier helps matters considerably. An additional effect of the negative feedback is to lower the tube's effective output impedance, reducing the importance of any tube output capacitance that may affect the frequency, especially in the higher octaves.

Fig. 1-f is a standard Hartley oscillator, which is usable for electronic music. Since, however, most tapped inductors ordinarily available are center-tapped (often primaries or secondaries of push-pull transformers), there will be too much feedback. This can be reduced by inserting a resistor at point X.

Output may be taken from the plates of any of the oscillators shown in Fig. 1 without a great effect on frequency, provided the impedance of the load is high and its shunt reactance low. For maximum freedom from loading effects, however, especially where the load is keyed or otherwise altered during operation, electron coupling is desirable. Almost any feedback oscillator may be used in an electron-coupled circuit. The method illustrated in Fig. 2 is to use a pentode tube and employ the screen as the oscillator anode. The circuit of Fig. 2 is exactly the same as Fig. 1-a with those exceptions. The screen does not, of course, draw much current, but

the electron stream passing through it to the plate is modulated by the oscillations. The plate output, taken across a standard load resistor, is of the oscillation frequency and may be passed on to following stages. The output capacitor is uncritical, values between .01 and .05 μf being suitable.

Changes in the load which would affect the plate current have little effect on the oscillator circuit, and reactive loading of the plate has almost none at all. The screen supply voltage should be somewhat less than that supplied to the plate and should, of course, be under the maximum specified by the tube manual. It may be obtained from a tap on the power-supply bleeder resistor. The tap should be bypassed to ground.

The discussion of vacuum-tube oscillators for polyphonic electronic musical instruments will be continued in the next issue.

STABLE TONE GENERATOR

Stable a.f. or ultrasonic signals for test and control purposes can be generated by heterodyning signals from two crystal-controlled oscillators. Any conventional oscillator can be used. Feed the outputs into the grid circuit of an a.f. amplifier and the difference frequency will appear at the plate. Suitable crystals can be obtained on the surplus market for less than one dollar each.—Francis Roberts



COLOR TONE ON YOUR TELEVISION!

Simply attach **TELECOLOR FILTER** to the front of your set, and enjoy favorite programs in a glorious color tone instead of dull black and white.

TELECOLOR FILTER is one of the latest discoveries, its special formula coloring gives brilliant pleasing color tone, life-like color depth, reduced eyestrain and glare. **TELECOLOR FILTER** manufacturer does not claim to give three colors but it guarantees to transform a dull black and white picture into many shades of a glorious color tone. It is also guaranteed to work on any make and model television set.

TELECOLOR FILTER will give contrast similar to the black tube and color tones the high lights on black tubes. It is perfect for daylight or lighted room viewing. Children love the color toned pictures. Wonderful as a gift. Can be enjoyed now and for years to come.

No matter which color system is adopted, **TELECOLOR FILTER** will still continue to give you color toning enjoyment on the stations broadcasting black and white pictures. Results are better than you get with filters costing four times as much. You will find new interest and happiness in favorite programs with the life-like color depth and clarity that is missing in dull black and white. Free information.

HARVARD LABORATORY, 659 Fulton Street, Dept. RE-1, Brooklyn 1, N. Y.

ORDER BY MAIL

HARVARD LABORATORY, 659 Fulton Street, Dept. RE-1, Brooklyn 1, N. Y.

Please send **TELECOLOR FILTER**

Enclosed:

Cash

Check

Money Order

10 Inch \$3.00 • 12 Inch \$4.00 • 16 Inch \$6.00 • 19 Inch \$10.00

Quantity

Screen Size

Amount

NAME

ADDRESS

CITY

STATE

Another reason why your telephone gives so much for so little

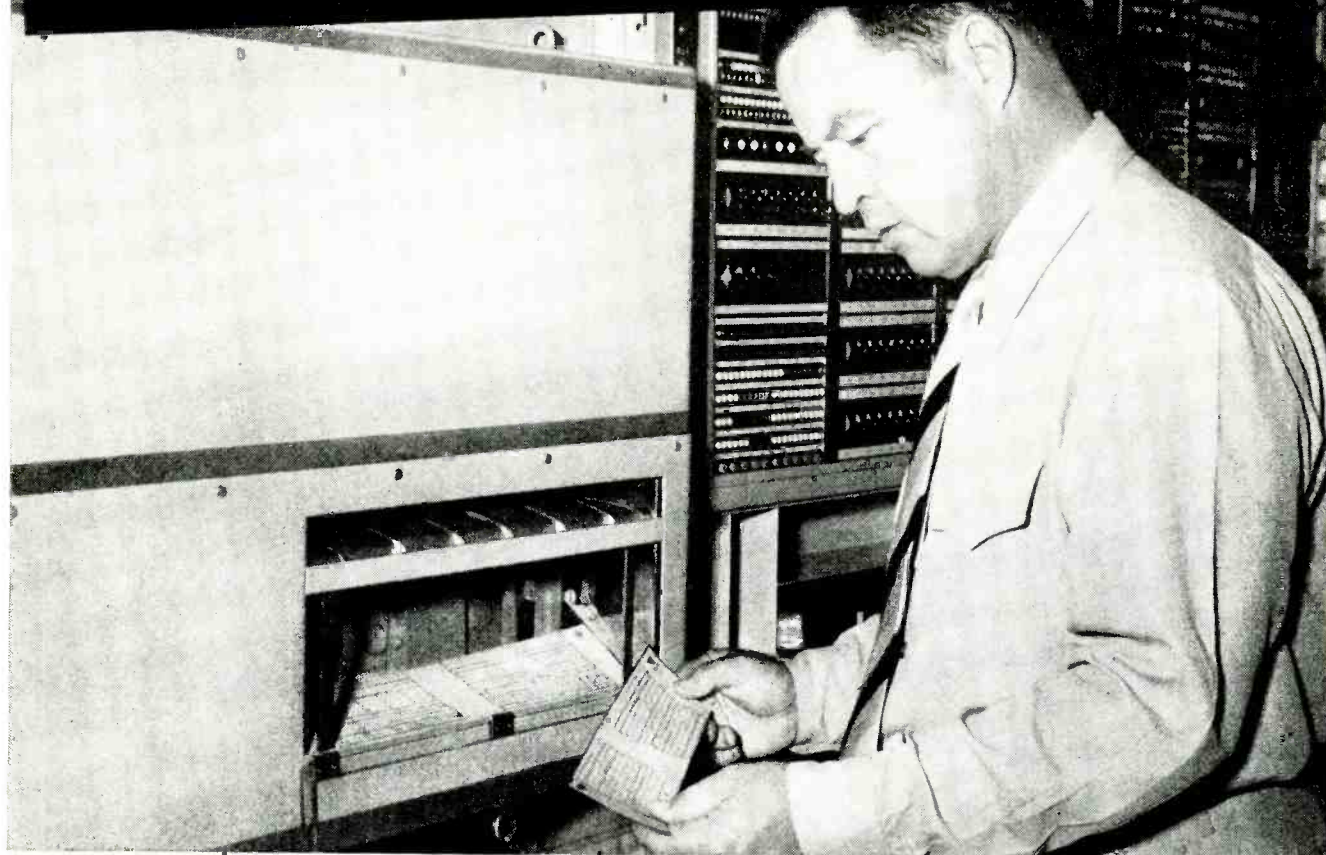

Studying punched card record of dial system operation. Each card (top) can report 1080 items

In a large, modern dial telephone office, 2,000,000 switch contacts await the orders of your dial—and 10,000 of them may be needed to clear a path for your voice when you make a single telephone call. Within this maze of signal paths, faults—though infrequent—must be detected and fixed before they can impair telephone service.

The latest system developed by Bell Telephone Laboratories automatically detects its own faults, detours calls around them without delay—then makes out a “written” report on what happened.

The fault may be a broken wire, or a high resistance caused by specks of dirt on switch contacts. In one second, the trouble recorder punches out a card, noting in detail the circuits involved and the stage in the switching operation where the fault appeared.

Maintenance men examine the reports at intervals and learn what needs attention. Between times they go about their own duties in keeping service moving.

This is another example of how research at Bell Laboratories helps your telephone system operate at top efficiency, so the cost to you stays low.

BELL TELEPHONE LABORATORIES



WORKING CONTINUALLY TO KEEP YOUR TELEPHONE
SERVICE BIG IN VALUE AND LOW IN COST.

Audio Feedback Design

Part IV

By GEORGE FLETCHER COOPER

An amplifier design. Output is ten watts and response flat from 30 to 15,000 cycles

In the previous article we examined Mr. Williamson's amplifier to determine how to apply the design methods described in earlier articles. Now we shall consider a new design from the beginning.

We shall start off with the assumption that the gain of the amplifier is to be 50 db (316 times), that the output power is to be 10 watts, and that the

which is about 12 in voltage gain. A miniature pentode, such as the 6AU6, will do this very nicely. So, for that matter, will a 12AT7 triode.

The so-called seesaw circuit gives a gain of about 40, which means an input of rather less than ½ volt without feedback, or 5 volts with feedback, will be needed. This is at the grid; and if we use a transformer stepping up from 600

that the transformer must have a ratio of 440 to 1, center-tapped, in impedance, or 21 to 1 in turns. The high side inductance is equal to $440 \times 50 \text{ mh} = 22 \text{ h}$ (25 h for 6L6). The air gap must be chosen so that the inductance is not altered appreciably by a current of 20 ma. This is the unbalance current which may be obtained if the two tubes are at opposite ends of the tolerance range. The only effect of a drop in transformer inductance will be an increase in distortion at the lowest frequencies.

The circuit

Before going any further we need to draw the circuit diagram, as far as we know it. This is shown in Fig. 1. Since we have only two stages, there is theoretically no possibility of low-frequency instability: if we want to add another stage to obtain a high-impedance input, we must watch this in the design. The first step is to decide on the value of C2 and C3.

For class-A operation, R9 and R10 can be made 470,000 ohms. This value will be chosen, because the larger R9 and R10, the smaller C2 and C3 for the same R-C product. The output transformer is designed to have a characteristic frequency R/L of 30 cycles which brings its response 20 db down at 3 cycles. The reader can check this for himself, but it is exactly the same as saying that the response falls 6 db per octave.

To provide 20-db feedback, the response must be down 26 db, at least.

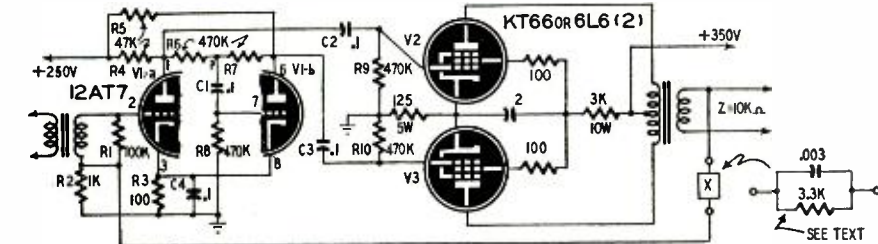

Fig. 1—Circuit of the amplifier whose design is described in this installment.

distortion is to be below 1%. It really is not worth while pressing the distortion below ½ to 1%, because the transmitter distortion is more than this if we take a broadcast signal, while disc distortion is a good deal more than 1%. The response should be uniform from 30 to 15,000 cycles.

To get 10 watts we may use, as Mr. Williamson does, 6L6 or KT66 tubes, but we shall use them as tetrodes with a lower plate voltage. This will save quite a lot in smoothing capacitor costs. I will use figures for the KT66, but the 6L6 values will not be significantly different. Since the distortion requirement suggests that we aim at 20 decibels of feedback, the over-all gain without feedback must be at least 70 decibels, or approximately 3,000 times.

First, then, how many stages? A KT66 has a mutual conductance of 6,150 μmhos (5,200 μmhos for 6L6) and an optimum load of 2,200 ohms (2,500 ohms for 6L6). This gives a gain of just over 26 times for the two tubes. An input transformer, for I have assumed that we use one, will give about 20 db gain, or 10 times (This is not, of course, a power gain). We need, therefore, an additional gain of 3,000/260 times,

ohms to 100,000 ohms, we shall require roughly 0.3 volt at 600 ohms for the input.

The output stage

My main difference in approach from Mr. Williamson is in the design of the output transformer. He keeps the direct current balanced and uses a large inductance. I use the smallest possible inductance and then allow an air gap to avoid dependence on the d.c. balance. It seems easier that way. We begin with the design of the output transformer.

To make life easy, I have assumed that the load impedance is 10 ohms. The lowest frequency is to be 30 cycles, and we want the output transformer to be as small as possible. If the inductance is made too low, however, we shall get distortion in the transformer and the load as seen by the tubes becomes reactive. A fairly sound working rule is to allow the response to drop by 3 db: this rule has the additional merit that it is simple. The reactance must therefore have on its low-impedance side a reactance of 10 ohms at 30 cycles, or $2\pi \times 30 L = 10$, or $L = 50 \text{ mh}$.

The optimum load for each tube is 2,200 ohms (2,500 ohms for 6L6), so

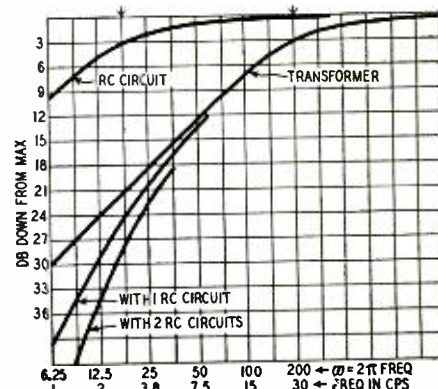

Fig. 2—The low-frequency response of the feedback amplifier.

HERE'S YOUR TV TUBE BUY

DUMONT

16"

ALL GLASS 16FP4 BENT-GUN TELETRON

The Finest C. R. Tube you can buy—at the lowest price!

\$29.95 SPECIAL

FULLY GUARANTEED IN FACTORY-SEALED CARTONS IMMEDIATE SHIPMENT!

SERVICEMEN: ORDER THIS TUBE NOW FOR HOLIDAY DEMAND. BE PREPARED WITH EMERGENCY TUBE REPLACEMENTS.

FREE WITH ORDER **RADIO'S MASTER**
1200 PAGE REFERENCE MANUAL

Federated Purchaser INCORPORATED

66 DEY ST., NEW YORK 7, N. Y. •
Dial 9-3050

NEWARK, N. J. 114 Hudson St.
ALLENTOWN, PA. 1115 Hamilton St.
EASTON, PA. 701 Northampton St.

HOTTEST TV PACKAGE for "ONE BUCK"!

- Hints for Better Performance on your 630TV.
- 630TV Schematic Diagram with Modifications.
- Illustrated Television Conversion Manual.
- Pulse Keyed Type AGC Circuit Diagram.
- RMA Handy Resistor and Mica Code Charts.

ALL FOR ONLY **\$1.00** POSTPAID Stamps accepted
BROOKS, 84 Vesey St., New York 7, N. Y.

Specialized Service Men

CRYSTALS FOR LESS! If you are servicing aircraft, marine, police, mobile or industrial radio you may be entitled to our SPECIAL DISCOUNT on highest quality quartz control units. Write for full details . . . it will mean money to you!

RADIO SPECIALTY MFG CO. Dept. RE
2023 S.E. Sixth Ave. Portland 14, Oregon

If we take the frequency at which $\omega CR = 1$, we have 45 degrees of phase shift, so that for two similar R-C terms (one from the preamplifier stage which we may add), there is a 90° phase shift at $\omega = 1/RC$. The transformer gives 90°, too, so that we must make $1/CR$ less than $2\pi \times 3$ cycles, to allow 26-db feedback at the 180 degrees point. This means a capacitance of at least 0.1 μf must be used. Let us go ahead with this value, and if necessary use a slightly more sophisticated preamplifier stage.

The phase splitter

This reservation has been made because we have not yet considered what happens in the phase splitter V1. This circuit is a rather attractive one, and seems to work very well. The first half of the double triode acts as an ordinary amplifier, with a plate load R4. The second triode is driven by the difference in plate voltages between V1-a and V1-b.

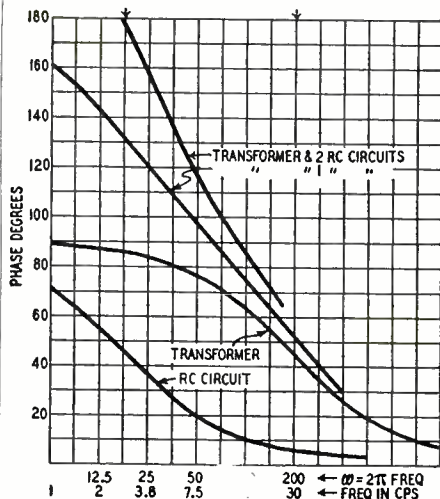

Fig. 3—High-frequency phase curves.

The two tubes seesaw about the fulcrum P. That, at least, is the usual way of describing the operation of the circuit. There is, however, another way of looking at it. The output from V1-a is applied, through the voltage divider R6-C1-R8, to the grid of V1-b. R7 provides feedback to make the gain in V1-b sufficient for pushpull operation.

Looked at like this it is easy to see that the phase shift produced by C1-R8 is greatly reduced by the feedback, which is of the order of 20 db. I should like to go into this more fully, because the usual analysis of this circuit tends to conceal this rather important fact.

The suspicious reader may have noted that I have not mentioned C4 yet. If the two triodes are really operating in pushpull, the current in R3 should not contain any alternating component, and C4 has no decoupling function. It is indeed, a safety term, put in to deal with any tendency of the stage to act as a cathode-coupled multivibrator at very high frequencies. I have not found it necessary, but if there is excessive capacitance across R6, C4 might save the situation.

High and low response

The over-all response curves are shown as Figs. 2 and 3. It will be seen

SERVICE MEN!

WE'RE ALWAYS ON THE LOOKOUT FOR SAVINGS TO PASS ON TO YOU. WE KNOW THEY'RE ESPECIALLY WELCOME WHEN PRICES EVERYWHERE ARE GOING UP. HERE'S OUR LATEST "SCOOP"!

PHILCO

MODEL 7170 AM & FM SIGNAL GENERATOR
A \$97.50 instrument for \$64.50

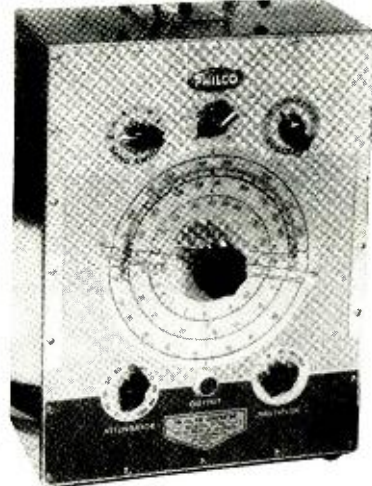

A great help to every Serviceman. Ideal for both AM and FM use. No switching trouble between bands, calibration accurate within $\pm 1\%$. Exceptional stability. Drift not over $\frac{1}{2}$ of 1%.

SPECIFICATIONS

- Frequency Range: R.F. (AM) 100 kc. to 110 mc. (six bands); R.F. (FM) 100 kc. to 170 mc.
- Audio Frequency: 400 cycles
- R-F Output Amplitude: 6-1 volt (r.m.s.), depending upon range
- A-F Output Amplitude: 1 volt (r.m.s.) approximately
- Sweep Width: Variable from 4 kc. to 500 kc.
- Sweep Rate: 60-c.p.s. (fixed)
- Calibration: Direct reading (for AM)
- FM-Oscillator Frequency: 60 mc.
- Operating Voltage: 110-120 volts, 60 cycles a.c.
- Power Consumption: 25 watts
- Tube Complement: 6C4 (1), 7F8 (2), 6X5GT (1)

ORDER NOW!
QUANTITY LIMITED \$64.50
FREE WITH **RADIO'S ORDER MASTER**
1200 PAGE REFERENCE MANUAL

Federated Purchaser INCORPORATED

66 DEY ST., NEW YORK 7, N. Y. •
Dial 9-3050

NEWARK, N. J. 114 Hudson St.
ALLENTOWN, PA. 1115 Hamilton St.
EASTON, PA. 701 Northampton St.

NEW CONDENSER TESTER



Finds Intermittent Condensers Instantly

Pres-probe's sliding tip with variable resistance prevents condenser heating. Tests with power on. Requires no adjustment. Stops guesswork. Saves time. Convenient probe size (7/8" long). Satisfaction guaranteed.

795
Postpaid U.S.A.

See Your Dist. or Order Direct

PRES-PROBE CO.

2326 N. THIRD ST., MILWAUKEE 12, WIS.

OPPONENT:

TIME



A top bobsled team—athletes trained to work as one in handling their balanced, ruggedly built sled—can consistently defeat the clock in negotiating the treacherous, one-mile Mt. Van Hoevenberg run.

Likewise, T. E. I. engineers and production personnel work as a unit with a similar goal—the conquering of TIME's deteriorating effects through the building of an ever-stronger picture tube. For Thomas' highly trained personnel, specially designed equipment, and efficient production techniques are consistently increasing the life of Thomas tubes in the contest with TIME.

For the greatest value in today's television picture tubes—for top operating efficiency and truly LONGER life—specify T. E. I. In all popular rectangular sizes, black-face.

ABSOLUTELY FREE

A penny postcard with your return address will bring you the very latest 1951 colored T.V. chart showing the growth and scope of television in the U. S. Simply address "Dept. B"

THOMAS ELECTRONICS, Inc.
112 Ninth Street Passaic, New Jersey

Over 43,000 Technicians Have Learned
HOW TO GET THE MOST OUT OF BASIC TEST EQUIPMENT
Why Not You, Too?

SERVICING by SIGNAL SUBSTITUTION
A BEST SELLER FOR OVER 9 YEARS! (NEW, UP-TO-DATE, 11TH EDITION)

The Simple, Modern, Dynamic Speed Approach To Receiver Adjustment and Alignment Problems, AM-FM-TV.

- Nothing complex to learn
- No extra equipment to purchase
- Universal — non-obsolete
- Employs Only Basic Test Equipment

Ask for "S.S.S." at your local Radio Parts Jobber or order direct from factory.

PRECISION APPARATUS COMPANY, INC. • 82-27 Horace Harding Blvd., Elmhurst 4, N. Y.

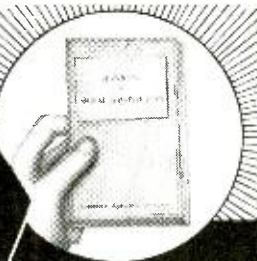

only 40¢
100 pages. Invaluable information that will help you re-double the value of your basic test equipment.

that with two R-C circuits there is 21 db of feedback for the 30-degree phase margin, and that under these conditions the gain margin is just over 6 db. Because these margins can be easily increased by increasing the capacitances, we need not worry about the low-frequency response.

The high-frequency stability is, as always, a problem. The values chosen for R4 and R5, with the total interstage stray capacitance and the tube impedance, about 1,200 ohms, give $R \times C = 40 \times 10^{-12} \times 10,000$, a characteristic frequency $\omega_c = 2 \pi f_c = 2,500,000$. The interstage circuit should therefore be flat up to about 400,000 cycles.

The exact design of the output transformer now comes under consideration. With a factory under my office, I can get any transformer I want. The reader will probably prefer to buy one ready made, or at least use the parts he already possesses. The only thing to avoid is the influence of the output transformer at high frequencies. To do this we shall add a few small components and then determine the limits to be imposed on the transformer.

Feedback resistor

Let us assume that we do not want any frequencies above 14,000 cycles, or at least that the response can roll off there. We shall begin by calculating the feedback resistance, which is in the little box marked X in Fig. 1. Our gain requirements are that 0.25 volt at 600 ohms at the input must give 10 volts across the 10-ohm output.

Assuming a 1 to 10 stepup in the input transformer, we have 2.5 volts across R1. Since we need only 0.25 volt from grid to cathode, across R2 we must have 2.25 volts. Immediately, therefore, $R2 R_x = 2.25 / (10 \cdot 2.25) = 1/3.4$. Let us take $R2 = 1,000$ ohms, and $R_x = 3,400$ ohms. We use a standard value here, 3,300 ohms. To produce the required roll-off at 14,000 cycles connect a capacitor in parallel with this resistor. The capacitor must have a reactance of 3,300 ohms at 14,000 cycles, so that the capacitance will be .003 μ f.

This capacitor is very important, because it produces a phase shift rising to

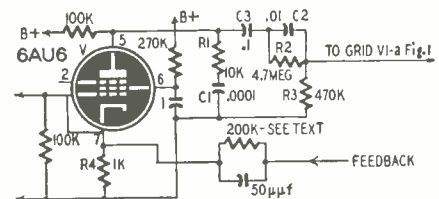

Fig. 4—The preamplifier that may be used in place of the input transformer. 90 degrees and in the opposite sense to the phase shift produced by the transformer. The result is that, without the preamplifier stage, the system must be stable so long as the transformer has no awkward resonances. The practical implications are that we design the transformer for the right low-frequency inductance and use the simplest possible balanced structure. This is necessary if we are to avoid these odd resonances due to partial leakage inductance. Hav-

ing done this, we can very profitably load down the two halves of the primary with capacitance to make the frequency response drop off above 14,000 cycles. Something of the order of .003 to .005 μ f is indicated here, but I have not shown these components.

Does this seem rather vague? It is not really, because now the reader should have acquired some sort of "feel" for these circuits. Gardeners talk about people who have the green finger! The most important thing in this work seems to me to be to acquire the "feedback filter": I dare not give it a color because they all seem to be political nowadays. The important thing is to be able to sketch the phase characteristic on the back of an old envelope, and then to correct it.

My own amplifier, built to this general design, gives about 0.3% distortion at 1,000 cycles at 10 watts output, and 0.5% at 30 cycles and 6 watts output.

A preamplifier stage

The circuit diagram of a possible pre-amplifier stage is shown in Fig. 4. The interstage network is made up of two parts: R1 and C1, for high frequencies; C2, C3, R2, R3 for low frequencies.

I want to discuss this type of inter-stage circuit in detail some time—a little further along in this series. The basic idea is to provide a step in the amplitude response, and this enables more feedback to be used. We saw this, in a simple way, in connection with the cathode and plate decoupling circuits.

INSIST ON TITANCO
All the Way!

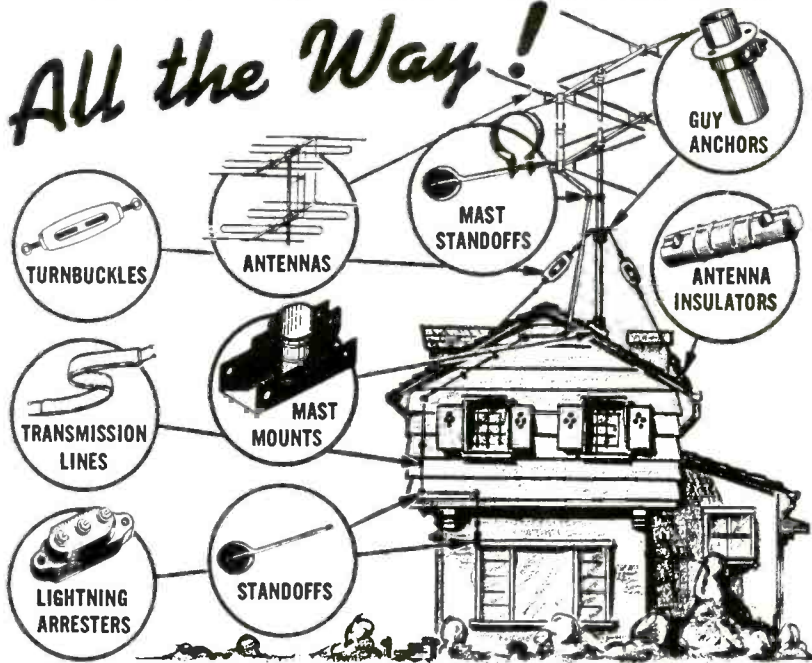

RADIO AND ELECTRONIC EQUIPMENT



TECHNICAL APPLIANCE CORP.
SHERBURNE, N. Y.

In Canada: Stromberg-Carlson Co. Ltd., Toronto 4, Ont.

FREE! BOOK OF TV PICTURE PATTERNS & WAVE FORMS

Quick Reference TV Servicing Book Yours Free Just For Examining Coyne's New 5-Volume Set APPLIED PRACTICAL RADIO-TELEVISION

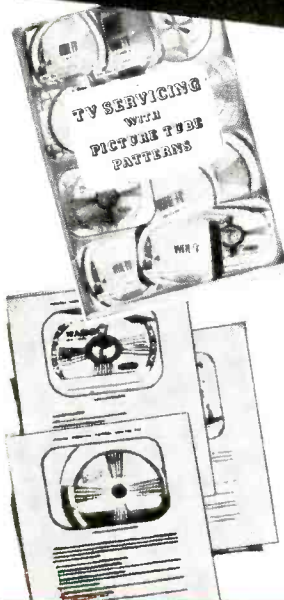

If you want to "go places" in Television and Radio Servicing today, COYNE'S NEW 5-volume set APPLIED PRACTICAL RADIO-TELEVISION can help you. It is the most complete, up-to-date set of reference books in America, giving you the practical working knowledge that brings big money. 1500 jam-packed pages full of latest facts on television and radio—5000 subjects. 1000 illustrations and diagrams. COMPLETE SECTIONS ON COLOR TV WITH 1951 data on color TV adapters and converters—also new UHF channels. Shows how to install, service, shoot trouble, align all types of radio and television sets. "Break-down" photos help you understand quicker. Use this set free for 7 days—get FREE book of Television Picture Patterns for examining set. See sensational offer below.

FREE BOOK OF TV PICTURE PATTERNS If You Act At Once

Here's a sensational "get acquainted" offer. IF YOU ACT AT ONCE, a brand new TV servicing book, "TV SERVICING WITH PICTURE TUBE PATTERNS," is YOURS FREE. Shows dozens of actual TV picture tube photos and wave forms with clear explanations of what they mean and how to analyze and service the trouble faster. NOW YOU CAN GET A COPY ABSOLUTELY FREE just for asking to examine COYNE'S great 5-volume set APPLIED PRACTICAL RADIO-TELEVISION for 7 days. This offer is limited—mail coupon NOW.

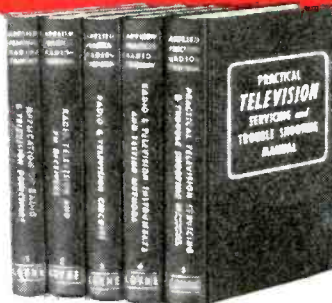

ON 7 DAYS' FREE TRIAL!

OFFER LIMITED—SEND COUPON TODAY!

Mail coupon for 7 days' FREE TRIAL on COYNE'S 5-volume set. I'll include the book of TELEVISION PICTURE PATTERNS. If you keep the set you pay \$3.00 after 7 days trial and \$3.00 a month until \$16.50 plus postage is paid (Cash price \$15.00). If not 100% satisfied with the set send it back and you OWE NOTHING. EITHER WAY, HOWEVER, THE BOOK OF TELEVISION PICTURE PATTERNS IS YOURS FREE TO KEEP. Coupon is just a request to see the set and get the FREE book of picture patterns. This sensational offer is limited—SEND THE COUPON NOW.

SEND NO MONEY • MAIL COUPON NOW!

COYNE ELECTRICAL & TELEVISION-RADIO SCHOOL, Dept. 11-T6
500 S. Paulina St., Chicago 12, Ill.

O.K.! Rush "APPLIED PRACTICAL RADIO-TELEVISION" for 7 days' FREE TRIAL as per offer above. INCLUDE COPY OF TELEVISION PICTURE PATTERN BOOK AS MY FREE GIFT FOR EXAMINING THE SET.

NAME AGE

ADDRESS

CITY ZONE STATE

WHERE EMPLOYED

Check here if you want set sent COD. You pay postman \$15.00 on delivery. Same money-back guarantee of satisfaction.

COYNE ELECTRICAL AND TELEVISION-RADIO SCHOOL
An Institution Organized Not for Profit
500 SO. PAULINA ST. • DEPT. 11-T6 • CHICAGO 12, ILL.

Service Dealers: DO A

\$50,000

TV BUSINESS

ON A \$500 INVESTMENT

WITH THE

TRANSVISION

Factory Agent Plan

Why this Plan is BEST FOR YOU:

- You have **NO INVENTORY PROBLEM** because you work from our **MILLION-DOLLAR** stock.
- You get **SPECIAL PRICES** to enable you to undersell competition at a profit.
- You get **EXCLUSIVE TERRITORY** benefits.

REQUIREMENTS: You must be a **Radio-TV Technician** (experienced only); and you must have a presentable business place.

The TRANSVISION TV Line is of the finest quality. Has the famous "A" chassis, housed in beautiful cabinets. 28 models. 17" or 19" Tubes.

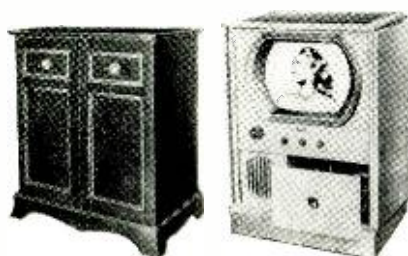

Write for Details on **FACTORY AGENT PLAN** today!
TRANSVISION, INC.
 Dept. RE. NEW ROCHELLE, N. Y.



Receiver is made to be held to the ear.

DOCTOR ALWAYS ON CALL WITH RADIOPAGING UNIT

Radiopaging is the latest comer to the ranks of radio services for the safety of human life. The new service calls a doctor to the nearest phone, wherever he may happen to be. In the past, reports Sherman Amsden, head of the Telanserphone service who originated the new service, many patients have suffered and some have died while telephone answering services have been frantically endeavoring to locate their doctors.

Aircall Radiopaging, as Telanserphone calls it, is the answer to the problem of locating a doctor (or any other person) who is temporarily out of reach by phone. The doctor carries a small radio receiver like the one in the photo. This receiver repeats once every minute a series of numbers, one of which may be his special code call. If, during the minute, the subscriber hears his number, he calls his office from the nearest phone. If not, he knows he is not needed at the moment, and can continue his golf game or auto drive with a free heart and conscience.

The little receivers are fixed-tuned to 43.58 mc. Their range is therefore about that of a low-band televiser, though Telanserphone stresses that the area of 100% reliable service extends only 20-25 miles from the transmitter.

The first station of Aircall Radiopaging, KEA627, is in New York City. Its operation is automatic. The subscribers' numbers are recorded by voice on a 16-mm sound strip on Lucite slides about 6 inches long. These are placed in an ingenious machine known as Mechanical, a development of Reeves Sound Laboratories. Hung on an endless track, each sound strip is carried past a photocell once every minute. The cell is above the track along the top of the Mechanical. The box shown in the photo houses the light which shines up through the strip. The long series of up-and-down loops permits stopping part of the track for a few

YOU CAN STILL Buy—TROUBLEPROOF TELEVISION THE 630 TV WILL WORK WHERE OTHERS FAIL!

Own the Television Set preferred by more Radio and Television Engineers than any other TV set ever made! **THE ADVANCED CLASSIC 630 TV CHASSIS.** With the latest 1951 improvements the 630 TV will out-perform all other makes in every way. The 30 plus tube circuit should not be compared to the cheaply designed 24 tube sets now being sold under standard brand names.

- **Greater Brilliance** Assured by the new 14-16 KV power supply.
- **Flicker-Free Reception** Assured by the new Keyed AGC circuit—no fading or tearing of the picture due to airplanes, noise, or other interference.
- **Greater Sensitivity** Assured by the new Standard Tuner, which has a pentode RF amplifier and acts like a built-in High Gain Television Booster on all channels! The advanced 630 chassis will operate where most other sets fail, giving good performance in fringe Areas, and in noisy or weak locations.
- **Larger—Clearer Pictures—for 16", 17", 19" or 20" tubes** Assured by advanced circuits. Sufficient drive is available to easily accommodate any tube.
- **Trouble-Free Performance** Assured by use of the finest materials such as quality condensers, overrated resistors, RCA designed coils and transformers, etc.
- **RMA Guarantee** Free replacement of defective parts or tubes within 90 day period. Picture tube guaranteed fully for six months at no extra charge!

PRICE COMPLETE, LESS PICTURE TUBE.....NET **\$169.50**

EXTRA CLEAR PICTURE TUBES Standard Brands ONE YEAR GUARANTEE

12 1/2" (Black or White)	\$26.50	Glass 16" Round (Black)	\$39.50
Glass 14" Rectangular (Blk.)	\$29.50	Glass 16" Rectangular (Blk.)	\$39.50
17" Rectangular (Blk.)	\$42.50	19" Round (Blk.)	\$69.50
20" Rectangular (Blk.)	\$73.50		

TELEVISION CABINETS 16" or 17" Table Model Cabinet

A gorgeous table model cabinet for the average size living room. Outside dimensions 23 3/4" Wide x 24" High x 24" Deep. Walnut or Mahogany..... **\$44.50**

16" Economy Console Cabinet

An exceptional buy in a console cabinet made of fine veneers to house the 630 TV chassis, tube and speaker. Outside dimensions are 39" High x 24" Wide x 22 3/4" Deep. **\$49.50**

16" or 17" PERIOD CONSOLE

Handsomely styled for the conventional living room. Has a drop-door panel to conceal control knobs when desired. Outside dimensions are 41" High x 26" Wide x 24" Deep. **\$64.95**

Above cabinets available for 19" or 20" tubes at \$5.00 additional.

We are now authorized Distributors for the famous Masco line of high fidelity Amplifiers, Public Address Systems, Tape Recorders, Inter-Communication Systems, etc. Write for latest Catalog.

All Merchandise Subject to Prior Sale. All Prices Subject to Change without Notice.

WRITE FOR COMPLETE CATALOG C-1

RADIO DEALERS SUPPLY CO.

154 Greenwich St. New York 6, New York

RADIO-ELECTRONICS for

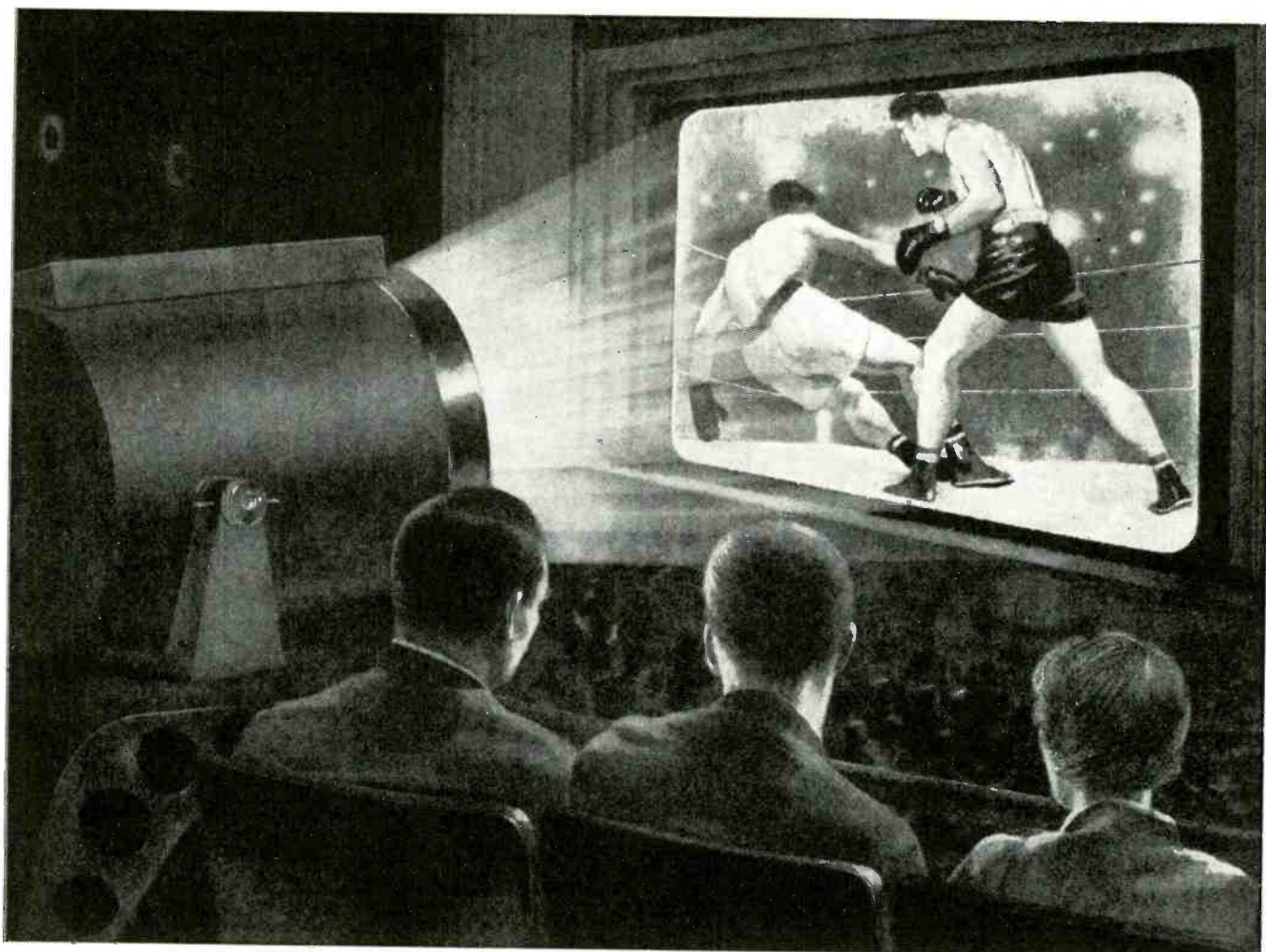

New RCA Theatre Television System projects 15x20 foot pictures of television programs.

Giant size Television— “shot from a barrel!”

• You've seen television. Now you'll see it in its very finest form—giant projections of special events, transmitted *only* to motion picture theatres on private wires or radio beams to make movie-going *better than ever!*

Success of the new system comes from a remarkable RCA kinescope, and something new in projection lenses. The kinescope tube, developed at RCA Laboratories, is in principle the same as the one on which you see regular telecasts. But it is *small*—only a few inches in diameter—and produces images of extremely high brilliance. These are magnified to 15x20 feet by a “Schmidt-type” lens system like those

used in the very finest of astronomical telescopes.

Because of its size and shape, the new projector is referred to by engineers as the “barrel.” It's already going into theatres, where you'll be seeing giant television—shot from a barrel.

See the latest wonders of radio, television, and electronics at RCA Exhibition Hall, 36 West 49th St., New York. Admission is free. Radio Corporation of America, RCA Building, Radio City, New York 20, New York.



Radio Corporation of America

WORLD LEADER IN RADIO—FIRST IN TELEVISION

REAL VALUES!

**RT7/APN1
TRANSCEIVER UNIT**

Used as an altimeter, it may be converted for signaling control circuits, citizes band, etc. Complete with 14 tubes and dynamotor they are in good used condition at the amazingly low price of.....**\$6.95**



SURPRISE PACKAGE

20 lbs. Ass't radio parts, A \$25.00 value for only.....**\$1.95**

BC 906—Frequency Meter

Range 150-225 MC with modification possible for lower frequencies of TV, etc. Contains 0-500 DC microammeter and uses Battery pack of 1.5 V and 45 VDC.....**\$10.95**

BC 620

Receiver-Transmitter—8 crystal channels—30 to 27.0 MC FM—12 tubes. Metered. Plate and Filament. New **\$14.95** Used **9.95**

PE 97 Power Supply for above 6-12 volt vibrator type. Used less tubes, vib. & Con.....**\$2.95**
FT 250 Mount for both BC620 and PE97 New **\$1.50**

**COMMAND (SCR 274 N)
EQUIPMENT**

	Used	New
BC-453	\$12.95	
BC-454	5.95	9.95
BC-455	7.95	2.95
BC-456		5.95
BC-457		8.95
BC-458	14.95	24.95
BC-696 (or T19)		1.95
BC-456—3 Receiver Remote Control	.89	2.95
BC-442		1.95
3 Receiver Rack	1.95	
2 Transmitter Rack	1.50	

Complete Command set as removed from aircraft—3 receivers—2 transmitters—relay unit—control boxes—mounting racks—plugs—modulator and dynamotors—crated Set.....**\$34.50**

R 18/APS 3 Receiver Amplifier containing circuits as follows: Blocking oscillator, CRT rate circuit, Azimuth & Vertical sweep circuit, live stage 3U MC IF strip with AFC circuit. Used—less Tubes.....**\$4.95**

BC 788 Seventeen Stage Receiver Transmitter designed for Radio Altimeter at 430 MC. Contains 30 MC IF Strip. (6 stage.) Excellent internal condition with tubes and crystal removed.....**\$9.95**

1D6/APN4 Scope unit complete with 5CP1 cathode ray tube and shield and all parts except smaller tubes and crystal. Used.....**\$9.95 ea.**

MN 26 Y Compass Receiver twelve stage super-het covering frequencies of 150 to 325 KC; 325 to 695 KC; and 3400 to 7000 KC in three bands. These units are brand new but with Dynamotor, Band switch motor and tubes removed. Schematic Furnished. White they last.....**\$4.95 each**

Miscellaneous Specials

	Used	New
ASB 7 Indicator Scope	\$12.95	\$5.95
BC 1206 Receiver, 200 to 400 KC		24.95
MN 26C	17.50	24.95
RA 10 DA Receiver	17.50	9.95
RT7/APN1 Transceiver	6.95	24.50
APN 1 Complete		12.95
BD 71 6 Pos. Switchboard	9.95	2.95
BC 347 Interphone Amplifier		.89
1-70 Tuning Meter		.59
BC 461 Veeder Root Counter		1.95
BC 442 Less Condenser	1.49	2.95
APS 13 UHF Antenna, Pair		4.95
FL 8 Filter		3.95
1-57 Bias Meter	3.95	9.95
RM 29 Remote Telephone Control	7.95	.98
BC 602 Control Box		7.50
RL 42 Antenna Gearbox Motor and Reel	4.95	6.50
TS 10—Sound powered phones		5.95
BC 1066 B—150 to 225 MC Portable Receiver adaptable to many amateur uses. In Canvas Carrying Bag. Used		7.95
Tuning Units for BC 375—Presently most numbers are available in excellent condition with case at 2.95 ea.		7.95
One Tube Interphone Amplifier—Small Compact aluminum case fully enclosed. 2 1/4" x 3 3/4" x 5 3/4". Less Tube		3.95
BC 709—Battery operated lightweight interphone amplifier. Complete with tube and shock mount, but less battery		New 3.95
Motor—Universal Electric. 24 VDC, will also operate on 24 VAC Diameter 1 5/8"; Length 2 9/16, Shaft 1/4" x 3/4"		New 1.49
MC 385A—Headset Adapter		New 1.49

All shipments FOB warehouse. 20% Deposit required on all orders. Minimum order amount—\$5.00. Illinois residents, please add regular sales tax to your remittance.

ARROW SALES, Inc.

Dept. E
1712-14 S. Michigan Ave., Chicago 16, Ill.
PHONE: HArrison 7-9374

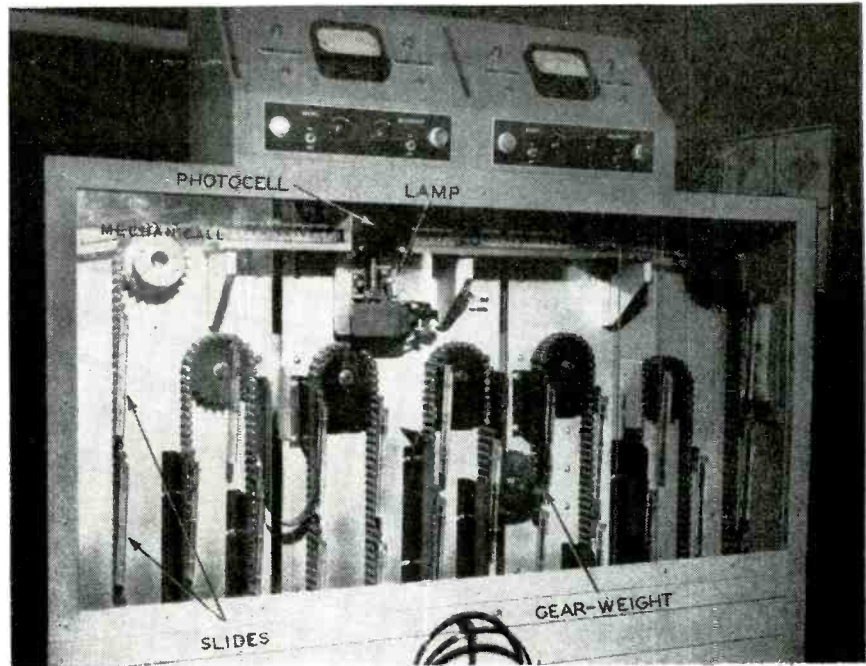

The Mechanical equipment reads each wanted code number once every minute.

seconds to take off or put on a slide without stopping the endless procession of slides under the photocell. When the track is stopped, the long loops (normally held to full length by gear weights like the one shown in the photo) shorten as the machine takes up the slack. Thus a portion of the track can be held motionless for 10 seconds

without interfering with the continuous transmission of messages.

At present, Aircall Radiopaging has something over 200 subscribers, each of whom pays \$10 per month for the service. This includes rental of the small radio receiver, as well as maintenance, should it go out of order during the month.

AMPERITE
Studio Microphones
at P.A. Prices

Ideal for
BROADCASTING
RECORDING
PUBLIC ADDRESS

"The ultimate in microphone quality," says Evan Rushing, sound engineer of the Hotel New Yorker.
• Shout right into the new Amperite Microphone—or stand 2 feet away—reproduction is always perfect.
• Not affected by any climatic conditions.
• Guaranteed to withstand severe "knocking around."



Models
RBLG—200 ohms
RBHG—Hi-imp.
List \$42.00



"Kontak" Mikes
Model SKH, list \$12.00
Model KKH, list \$18.00

Special Offer: Write for Special Introductory Offer, and 4-page illustrated folder.

AMPERITE Company, Inc.

561 BROADWAY • NEW YORK 12, N. Y.
Canada: Atlas Radio Corp., Ltd., 560 King St. W., Toronto

**TWIN LEAD, TELEVISION
LIGHTNING
ARRESTER**

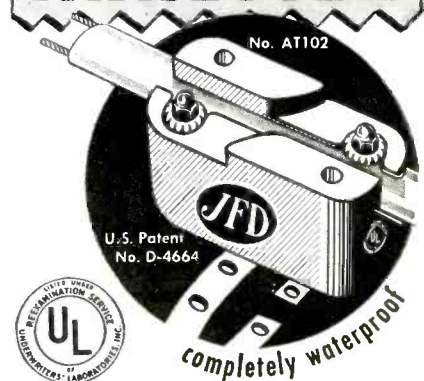

APPROVED for OUTDOOR-INDOOR Use \$ **2.25**
Protects Television Sets
Against Lightning and Static
Charges

Twin Lead
JFD SAFE TV GUARD

Simple to install everywhere and anywhere
...no stripping, cutting or spreading of
wires. More than 300,000 in use today!

SEE YOUR JOBBER OR WRITE TO

JFD MANUFACTURING CO., Inc.
6127 16th Avenue, Brooklyn 4, N. Y.
First in Television Antennas & Accessories

TUBES OF THE MONTH

New tubes this month include a cathode-ray tube, a miniature magnetron, and a double triode.

The C-R tube, announced by RCA, is the 7QP4, a 7-inch direct-view kinescope using magnetic focus and deflection and designed for portable monitor equipment. It has a high-efficiency white fluorescent screen on a relatively flat face and an ion-trap gun requiring a single-field external magnet. The tube takes a small shell 5-pin duodecal base. Typical operating values are: 8,000 volts on the anode; 300 volts on grid



The new 7QP4, for monitor equipment.

No. 2; -33 to -77 volts on grid No. 1 for visual extinction of the undeflected spot; and 80 ma in the focus coil.

The miniature magnetron Z-2061 is a new G-E development. Using an external permanent magnet, the little tube is for use as a local oscillator for u.h.f. television receivers and other applica-

COLOR!
GET YOUR COLOR CONVERSION KIT TODAY!

midway now has *IN KIT FORM* the basic components for color conversion. *IN ADDITION* we have a 10-page illustrated booklet describing the conversion procedures for the **RCA 630, HALLICRAFTER and MOTOROLA 7" set.** The information contained in this booklet is suitable for most conversions.

WRITE TODAY FOR KIT PRICE Specify Make and Model of your set.

Illustrated booklet "E" sold separately for only 50¢.

midway RADIO and TELEVISION CORP.

60 West 45th St., New York 19, N. Y.
Murray Hill 7-5053

FOR BETTER TOWERS AT LOWER COST!
Ask about AERO

- **COST LESS**
Because Aero Towers are aircraft-designed, lower manufacturing costs offer you a lower price. Lower weight and lower shipping costs are passed on as savings to you.
- **LAST LONGER**
Coated *INSIDE* and *OUT*. *DIP-COATED* process keeps Aero Towers Bright and new. Rust resistant. Will not brown.
- **EASY TO CLIMB AND SERVICE**
Strong electric aircraft welds at *EACH* joint (not just one or two) prevents sway. Provides sturdy, safe, ladder-like cross members.
- **QUICKER TO INSTALL**
Aircraft precision tolerances assure accurate fit of components. Light and easy to erect. Strong durability assures customer satisfaction.



Jobber Territories Open
Dealers—Write for **FREE** booklet

AERO TOWER DIVISION
Knepper Aircraft Service
1018 Linden Street
Allentown, Pa.



It's New! **IT'S A "MUST" FOR RADIO-TV MEN!**

IT'S YOURS FOR 7 DAYS FREE TRIAL

R. A. SNYDER, General Manager
Technical Book Division
Coyne Electrical & Television-
Radio School

If you want to get ahead faster in big pay Television work . . . if you want time-saving, money making TV data at your finger-tips . . . you need COYNE'S NEW GIANT "TELEVISION CYCLOPEDIA." 750 fact-packed pages cover every phase of Television. 450 photos, charts, diagrams make it easy to understand. All subjects in alphabetical order for quick reference. Prove to yourself that this is the world's handiest, most complete and up-to-date book yet published in Television by taking advantage of COYNE'S 7 day FREE EXAMINATION OFFER.

PICTURE PATTERNS, COLOR TV, UHF, ALIGNMENT, CONVERTERS, ADAPTERS, TELEVISION FROM A TO Z

Written by H. P. Manly, (author of the Nationally famous "CYCLOPEDIA OF RADIO") and edited by the COYNE instruction staff, the "TELEVISION CYCLOPEDIA" is a "must" for every radio-television man. This brand new book tells you "in a flash" why things happen in television receivers—how to handle any TV problem. If you want to know about Picture Tube patterns you'll find a complete section on the subject. You get complete information (with dozens of actual Picture Patterns) on HOW TO USE THEM IN ANALYZING TV SETS. Completely covers ALIGNMENT, AMPLIFIERS, ANTENNAS, FREQUENCIES . . . UHF and COLOR TV . . . converters, adapters, television r-f . . . ion traps and every other TV subject. Every subject is discussed in A-B-C order with full descriptions and explanations. Mathematics limited to easy arithmetic . . . formulas simplified . . . truly TELEVISION from A to Z.

USE THE CYCLOPEDIA 7 DAYS . . . FREE

See this great "COYNE TELEVISION CYCLOPEDIA" absolutely FREE for 7 days. Send no money! Just fill in and mail FREE TRIAL coupon. Look the book over for 7 days. If you keep it send us \$5.95 plus postage—or return the book and owe nothing. But act now—offer may be withdrawn at any time.

BRAND NEW 1951 PUBLICATION

HERE'S WHAT YOU GET IN THIS GREAT CYCLOPEDIA

- TV from A to Z far "in a flash" reference
- 1951 Publication
- Shop & Field Tested Servicing Data
- Dozens of Picture Tube Patterns
- Complete Set of Wave Forms
- Color TV and UHF
- Over 450 Illustrations
- 750 Pages of "How and Why" in Practical Terms

FREE TRIAL COUPON

COYNE ELECTRICAL & TELEVISION-RADIO SCHOOL, Dept. 11-T1
500 S. Paulina St., Chicago 12, Ill.

I'm interested. Send me a copy of the COYNE TELEVISION CYCLOPEDIA for 7 days FREE EXAMINATION per your offer.

NAME PAGE
ADDRESS
CITY ZONE STATE

Check here if you are enclosing \$5.95 or wish the book sent COD (you pay the postman \$5.95 plus COD fee when delivered). You save postage. Same 7 day examination and money back satisfaction guarantee.

COYNE ELECTRICAL AND TELEVISION-RADIO SCHOOL An Institution Organized Not for Profit
500 SO. PAULINA ST. • DEPT. 11-T1 • CHICAGO 12, ILL.

PICK YOUR OWN REPLACEMENT

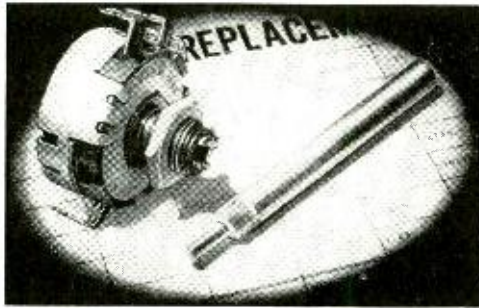

the "PICK-A-SHAFT" way

★ Pick the right Clarostat AM or AT control for resistance, taper, tap. Then pick the right shaft—choice of 11. Slight rap fastens Pick-A-Shaft to control—squarely, solidly, permanently. It's minimum stock for maximum replacement needs!

★ Ask your Clarostat jobber to show you the "Pick-A-Shaft" way. Catalog on request.



CLAROSTAT



Controls and Resistors

CLAROSTAT MFG. CO., INC. • DOVER, NEW HAMPSHIRE • In Canada: CANADIAN MARCONI CO., LTD Montreal, P.Q. and branches

tions requiring a low-power oscillator in the frequency range from 65 to 1,000 mc. An external tuned circuit, of either the lumped-constant or distributed-constant type, controls the frequency. Maximum ratings for the magnetron

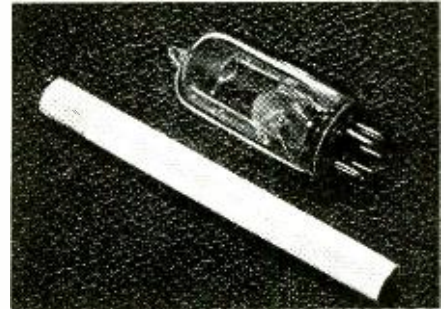

G-E's new magnetron is the first of its type to be used in receiving sets.

are: plate potential, 200 volts; total plate dissipation, 3 watts; total cathode current, 30 ma; and heater-cathode potential, 90 volts. The tube has about 250-mw output within its frequency range. At present this tube is available in limited quantities for experimental work, but G-E sources state that mass production will be timed for the FCC's release of the u.h.f. band for television.

Sylvania has released the double triode 6BL7-GT, intended for wide-



The vertical deflection tube 6BL7-GT.

angle vertical deflection in large TV picture tubes. The tube has two identical triode sections with separate cathodes and has high mutual conductance. It uses an 8-pin octal base.

Typical operating conditions for the 6BL7-GT in a vertical deflection circuit are: d.c. plate potential, 450 volts; cathode bias resistor, 1,200 ohms; peak-to-peak sawtooth input, 36 volts; d.c. plate current, 11 ma; peak-to-peak sawtooth output, 270 volts; and peak positive pulse component output, 600 volts.



Basing diagrams for the latest tubes.

Leotone SPEAKER PARTS SPECIALS!!

- 4" Cones . . . 9/16" V.C. opening 3/4" deep . . . \$46/M 100/\$7.25
- 5 1/4" Cones . . . 9/16" V.C., 13/16" deep . . . \$50/M 100/\$7.95
- 6" Cones . . . 1" V.C., 1 1/4" deep . . . \$65/M 100/\$9.95
- (All cones less rare coils)
- Kits of 12 Asstd. Cones . . . less voice coil, 4" O.D., .98c kit; 5" O.D., \$1.25; 6" O.D., \$1.49
- 4" to 12" Assortment (incl. cross-rod) . . . 12 for \$1.98
- Speaker Repair Kit . . . Liberal assortment of Spiders, Rings, Shims, Cement, Felt, Chamois leather, V.C. Forms & Instructions . . . 2.49
- ★SPECIAL★ . . . \$1.98 CONE + REPAIR KITS 3.95
- 83-1AP (M359) Co-Ax Angle Plug, ea. 23c . . . 5/1.00
- 20" Flexible Shaft & Housing, 1/4" dia. . . .69
- Portable Utility Case . . . 10"x9 1/2"x3 3/4" Steel, hinged, snap-lock lid, 65" web strap, ea. 79c . . . 3/2.00
- 3" Blower Assembly, 24 blade impeller, bakelite housing, Less motor . . . 1.95
- Auto Suppressors . . . for plugs or distrib., 8c . . . 1/1.00
- Aluminum Panels . . . 4.51" x 7 1/8" . . . 69c
- 111"X18"98
- DPDT Toggles . . . 20A/125V, Spring return39
- Experimental Tubes for Testing, Research, Filament tested, 20 asstd. receiving types . . . 1.00
- Cabinet Draw Slides . . . silent, ball-bearing, 1 1/2" dia. ext., \$2.10 int., 1 1/2" dia. . . . 2.25
- 16 1/2" (12 1/2")2.39
- Heavy duty, all-steel 16 1/2" (12 1/2") . . . 3.25
- 2 1/2" Sq. Panel Meters . . . 0-50 V.D.C. . . . 1.29
- 0-100 AMPS-DC & SHUNT98
- Portable DC Ammeter . . . 0-15 AMPS, 3 1/2" mirror full scale, 30" lead, leads & metal case . . . 3.95
- High Fidelity Crystal Mike . . . Hi-imped., rubber shock mt'd., O.D. 1 1/4"x3 1/4", Less housing98
- Aluminum Housing for crystal mike15

T-44A Magnetic Handy Carbon
Mike (HS-83) \$1.98
new, 69c 3/1.98 Press-to-talk .598

- Electrolytics . . . Smd-475V, upright can, 49c 6/2.50
- 10mf-350V, octal base can39c 3/1.00
- 30mf-300V, paper, tubular39c 3/1.00
- 32mf-350V,29c 3/1.00
- 200/200mf-90V, bathtub type29c 4/1.00
- 28 SCE Magnet Wire approx. 300' 22 AWG 4/1.00
- Luminous Tape . . . GLOWS IN DARK, 100 ft. 8 1/2" roll49
- Hand Signal Lamp . . . 5 COLOR TURFET LENS, trigger sw., V-shield, 2 bulbs, Crackle brush, 1.98
- Radio-Amplifier Steel Cabinet (made for RCA) CHROME GRILLE & SPEAKER, Marine Gray, 10" x 10" x 7 1/2", Snap Mt., 12 lbs. 1.98
- "Alnico Magnet" Kit . . . Powerful Bar, Block, 1/2" Ring, Kit of 10 assorted . . . 1.98
- WHITE FOR ALNICO MAGNET SUPPLEMENT
- RG-13, U Co-Ax . . . 74 ohm, 20 ft. lgth, & 2 conn. sw., V-shield3.95
- 2.5 H.P. Reversible Motor . . . 3000 RPM, 5 1/2" shaft, 4 1/2"x7", 27V.DC, 6.5A, Snap Mt., 12 lbs. . . . 1.98
- Moulded Bakelite Condensers . . . 00001-1 . . . 1.98
- 2mf, 200-600WV, KIT OF 50 ASSORTED . . . 1.75
- Voltage Divider Kit . . . 20W, 10 asstd. . . .69
- Radio Cement & Solvent . . . 3 oz. ea. & brush98
- Knobs . . . screw & spring, Kit of 25 asstd. . . .98
- Wafers, Sockets . . . 4 to 8 pin, Kit of 12 asstd. . . .25
- Wire-Wound Resistors . . . 5-20W, 15 asstd. . . .69
- Mica Padders-Trimmers . . . Kit of 15 asstd. . . .1.49
- Rotary Selector Switches . . . Kit of 3 asstd. . . .1.49

FACTORY SPEAKER REPAIRS SINCE 1927
Min. order \$3.00. 20% Deposit on all C.O.D.'s.
Please add sufficient postage—orders refunded.
Full remittance with foreign orders.

LEOTONE RADIO CO.
67 Dey Street,
New York 7, N. Y.

ANOTHER OUTSTANDING JOBBER ARVEDON Electric Supply Co.

73 PORTLAND STREET
Boston 14, Mass.

HAS THE SENSATIONAL NEW
TEICO 425-K 5" SCOPE KIT
IN STOCK!

\$39.95

EVERY RADIOMAN Can Use These SERVICE HINTS!

Valuable Manual Yours—FREE!

Every page of "How to Simplify Radio Repairs" is packed with on-the-bench, practical ideas. Contains photos, charts, diagrams—no fluff—no vague theory. In plain every-day language it gives you priceless suggestions—new servicing ideas. You'll use and benefit from the experience of experts. Partial list of contents: How to Localize Trouble; How to Service Amplifiers; How to Test for Distortion; How to Test Audio Circuits; How to Test Speakers; How to Find Faults in Oscillators; How to Test Radio Parts—and it's all yours—FREE! No obligation.

FEILER SEND COUPON OR PENNY POSTCARD FOR YOUR FREE COPY TODAY!

FEILER ENGINEERING CO., Dept. 1RC1
1601 S. Federal St., Chicago 16, Illinois

Please RUSH my FREE copy of "How to Simplify Radio Repairs."

Name

Address

City..... Zone... State.....

NATIONAL FEDERATION NOW BEING ORGANIZED

Formation of a national radio-electronic technicians' association was voted at a meeting of delegates from four states and the District of Columbia, held in New York City October 19.

After some discussion, the question was put in the form of the resolution: "Resolved that a National Association of electronic technicians' associations be formed," and passed.

A temporary organizing committee was formed, with Dave Krantz, of the Federation of Radio Servicemen's Associations of Pennsylvania (FRSAP), as chairman, Max Liebowitz, of the Empire State Federation of Electronic Technicians Associations (ESFETA), as vice-president, and Norman Chalfin, secretary of the Associated Radio-Television Servicemen of New York (City) (ARTSNY), as secretary.

The next meeting was set for January 28, in Washington, D. C. Messrs. Salinger, of the TV Associates, Washington, D. C., and Fisher, of ARTSNY, were appointed a committee to make arrangements for the meeting. Invitations will be sent to all known radio and television technicians' associations to send delegates to that meeting, at which the permanent foundations of the new organization will be laid.

The New York meeting, at which 31 delegates were present, was the outgrowth of a move to form a national federation initiated at Binghamton, N. Y., a little more than a year ago by ESFETA, and of parallel action on the part of other associations. Delegates in attendance represented a majority of the New York and Pennsylvania Federations, plus two delegates from the Radio Technicians Guild of Massachusetts, one from Trenton, New Jersey, and one from TV Associates of Washington, D. C.

N. Y. HAS LECTURE SERIES

Winter lecture series of the Empire State Federation of Electronic Technicians was inaugurated in late October with a lecture in New York City by John F. Rider. The second N. Y. C. lecture, on November 2, was by Walter H. Buchsbaum, Editor of the Television Clinic in RADIO-ELECTRONICS.

New York State has been divided into four lecture areas: New York City and Long Island, Poughkeepsie-Kingston, Endicott-Binghamton, and Rochester.



Join These Successful Servicemen of Central Television Service — Chicago's Largest

T.C.I. is the only television servicing school connected with such a large organization as Central Television Service. As an optional feature, you get two weeks experience at C.T.S., making service calls and shop repairs. You learn TV servicing from a leading TV servicing company!

Facts Worth Knowing About Central Television Service

- Over 225 practical servicemen.
- Over 100,000 television sets serviced annually.
- Over \$3 million in servicing work every year.
- Largest Master Antenna installer in the Midwest.
- Authorized service agency for all TV manufacturers.

Extra! COMPLETE SECTION INCLUDED ON COLOR TV!

Color TV is here! So up-to-date is TCI practical training, this course includes a complete section on converting present sets to color . . . on servicing color television sets. You get experience-tested, field-tested facts on Color TV from C.T.S. You'll need to know Color TV servicing to go places in this fast-growing field. You learn Color TV with TCI's PRACTICAL TELEVISION training!

MILTON S. KIVER, active president of T.C.I., is a registered professional engineer, Television Consultant, and internationally known author of TV books and magazine articles.

Use your present radio skill to learn television servicing the right way . . . the practical way . . . the way successful TV servicemen do television servicing. Take T.C.I. television training! T.C.I. training is based on the experience gained in the shops of Central Television Service . . . the many homes where TV receivers are located . . . and from the TV set manufacturers themselves. PRACTICAL TELEVISION is not a theory course in servicing, but a non-mathematical training program where you actually practice television servicing procedures used by expert TV servicemen.

LOOK AT THE EXPERIENCE YOU GET!

You learn the experience-tested, field-tested servicing techniques of more than 225 successful servicemen. You learn testing, servicing, trouble-shooting, repairing, set conversion, master antenna installation, field servicing short-cuts and every other phase of TV servicing by actually doing this work. Even COLOR TV, including conversion from black and white as developed by TV engineers. It's part of this practical, up-to-date training. To help you succeed in your own TV servicing business, you learn C.T.S.' successful business methods, too.

TRAIN AT HOME—SET YOUR OWN PACE!

You don't have to leave your present job to get TV servicing training with T.C.I. You learn at home with easy-to-understand practical lessons prepared by Milton S. Kiver. You build and train on a large screen 29-tube RCA 630 TS type television receiver, given to you as part of your course. You learn television servicing the right way . . . the practical way . . . by doing actual television servicing. You don't have to repeat your radio training. Every lesson is on television. You learn easier and remember longer when you set your own pace and let your mind and hands work together.

ACT NOW! Send for FREE catalog and sample lessons. See how T.C.I. practical training can help you. Write NOW!

GET FREE FACTS . . . MAIL COUPON NOW!

MILTON S. KIVER, *President*
TELEVISION COMMUNICATIONS Inst., Dept. RE-1
205 W. Wacker Drive, Chicago 6, Illinois.

O.K., Mr. Kiver! Rush FREE Catalog and sample lesson on your practical TV servicing course. I am not obligated. Salesman will not call.

Name

Address

City

Zone

State

BEGINNERS! Check here for facts on PRE-TV radio course.

HAVE YOU A JOB FOR A TRAINED TECHNICIAN?

We have a number of alert young men who have completed intensive training in Radio and Television Repairing. They learned their trades thoroughly by working on actual equipment under personal, expert supervision. If you need a trained man, we invite you to write for an outline of our course, and for a prospectus of the graduate. No fees, of course. Address:

Placement Manager, Dept. P108-1
COMMERCIAL TRADES INSTITUTE
1400 Greenleaf Chicago 26

\$500 MORE PER YEAR!

REPORTED BY RADIO SERVICE DEALERS who use 4-in-1

JOB CARDS

Write for details

RADIO PRESS
MORGANTOWN, W. VA.

SURPLUS RADIO CONVERSION MANUAL

IN TWO VOLUMES

This set of reference data has become standard for the most commonly used items of surplus electronic equipment. All conversions have been proven by testing on several units; each yields a useful item of equipment. For list of items covered, write us.

\$2.50 FOR EITHER VOLUME

By mail, \$2.60 postpaid.

AT YOUR FAVORITE DEALER
OR DIRECT BY MAIL FROM
Editors and Engineers
LIMITED
1305 KENWOOD ROAD, SANTA BARBARA, CALIFORNIA

TECH-MASTER

TELEVISION

2 latest **TECH-MASTER** developments!

NEW "Universal" AC/DC TV KIT
for tubes up to 14"

The first low-cost TV Receiver Kit designed for Universal AC-DC operation. Can be assembled in approximately 8 hours with easy-to-follow wiring instructions. Pre-wired, Aligned I-F "Synchro-Strip" makes further alignment unnecessary.

New unique circuit design features 2-knob control, providing Automatically Synchronized Picture and Sound Tuning. New Horizontal and Vertical Hold Circuits give remarkably steady, clear pictures on all channels. "Beam Power" Audio Output assures excellent tone quality and volume.

Resale Price \$89.50

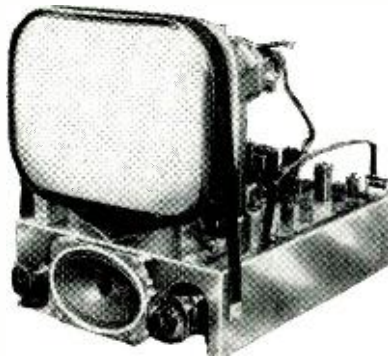

Small chassis (17"x14"x4 1/2") is light in weight (approx. 30 lbs.) and shock-proof, completely "above ground". Tube complement: 3-6CB6, 6AL5, 6AU6, 6T8, 12SN7, 1X2A, 12AT7, 25W4, 25BQ6, 6SR7, 2-25L6, 6AG5, 6J6 and heavy duty selenium rectifier. Supplied complete with tubes, parts and picture tube mounting bracket, less Kine.

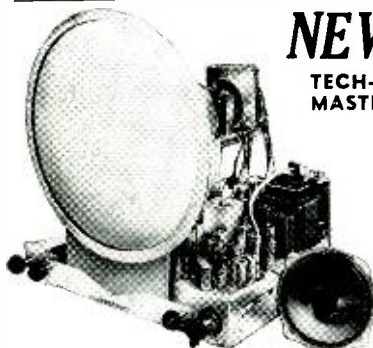

NEW! ADVANCED!

TECH-MASTER 630 Type KIT

for all tubes from 12" round to 20" rectangular

- Featuring Keyed AGC
 - "Hi-Sweep" Voltage Multiplier System
- Indisputably the finest commercial TV circuit in the world! Pictorial diagrams guide each wiring step, making it easy to achieve excellent results. The latest and most advanced TV engineering developments have been added to the time-proven RCA 630 circuit. Two-stage video amplifier, 4 stage picture IF, full 4 mc bandwidth and newest 12-channel turret tuner give a sensitivity of less than 20 microvolts. Chassis size 21 3/4" wide by 15 3/4" deep. Approx. shpg. wt. 65 lbs.

Model 630D19—Resale Price \$159.50
Model 630S19—..... 154.50

Model 630D19—Deluxe Kit supplied with all principal components assembled on chassis.
Model 630S19—Standard Kit, same as above but unassembled.
Both kits supplied with all tubes, parts, picture tube mounting brackets, less Kine.

Contact your jobber or write Dept. RE-1 for literature.

TECH-MASTER PRODUCTS CO.

443-445 Broadway, New York 13, N. Y.

More leading engineers and technicians have built Tech-Master for their own use than any other Television Kit.



N. J. TELECONTRACTORS FORM NEW ASSOCIATION

To protect the public from poor television servicing, 14 service organizations of northern New Jersey have formed the Television Contractor's Association of New Jersey. Managing director of the group is Walter Ferry, former sales manager of D. W. May, G-E, and Westinghouse.

TCA members will be certified and their work will comply with local codes and industry standards. The group will start a campaign to educate the public to the advantages of doing business with members. Set owners are invited to register all complaints with the TCA. If the complaints are justified, the TCA will use legal means to force the offending service contractor to comply with the contract. The suit will be in the name of the person making the complaint, but the association will bear the cost.

Membership in the TCA of New Jersey is open to all TV contractors who have a place of business operating on a full-time basis. The initiation fee is \$50 and additional assessments will be made at a later time.

NORTH CENTRAL OHIO HEARS HUGH A. WHITE

The North Central Ohio's Radio and Television Technician's Association heard Hugh A. White, sales service engineer for the Radio Tube Division, Sylvania Electric Products, Inc., at a meeting sponsored jointly by the Association and the Burroughs Radio Co.

Mr. White discussed six problems of television receiver servicing: comparison of similarities and differences in radio and television receivers; test patterns and their use in frequency analysis; electrostatic and electromagnetic deflection sweep circuits; direct and indirect synchronizing circuits; and the use of test patterns for testing TV sets. He concluded his talk with a question period.

CORRECTION

The meaning of the third sentence in the first column of the "Television Service Clinic," in the December issue, was altered through transposition of words. This sentence, beginning on the eighth line, should read—In many cases a switch from a 10- to 12-inch picture tube can be made without changing the cabinet.

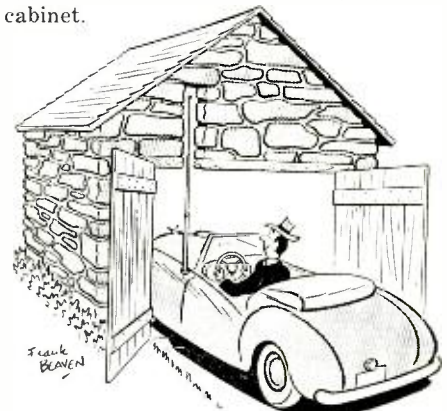

Suggested by Americo Minnari, Marcelles, Ill.

RADIO-ELECTRONICS for

HOT OFF THE PRESS!

TV CONVERSIONS

COLOR & BLACK and WHITE

Latest and authoritative booklet giving complete information, schematics and detailed drawings on how to convert your present TV set to COLOR. Also how to convert your 10" or 12" set to a 16" set or LARGER. Order from your jobber. If he cannot supply you, order direct. Send \$1.00 and receive your booklet PREPAID.

COLOR TELEVISION LABS

1638 WESTCHESTER AVENUE
BRONX 59, NEW YORK

\$1.00
POST PAID

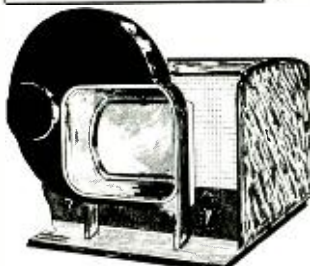

Write for FREE price list on parts for COLOR and BIG PICTURE conversions.

PUSH-PULL FILM RECORDING

Patent No. 2,511,199

John G. Frayne, Pasadena, Calif.

(assigned to Western Electric Co., Inc.)

This is an improved recording system for class B₁ bilateral push-pull tracks. In a class B variable area track, the film positive is almost completely opaque during silent periods. This reduces noise level. The bilateral push-pull feature requires two parallel tracks. Each track records and reproduces alternate half-cycles of the fundamental frequency.

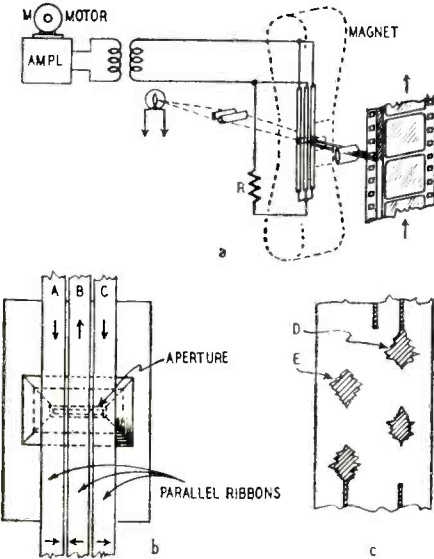

A single aperture is used in this new system. A steady light source is focused through the aperture to expose the moving film. See part "a" of the figure. The beam is modulated by metal ribbons arranged to vibrate in front of the aperture. The center ribbon is in a plane just in back of the other two so it can move without clashing with them. The ribbons are in a strong magnetic field and the current from an a.f. amplifier flows through them.

Normally the ribbons are adjacent to each other so that almost all light is masked off. At some particular instant while sound is impressed on microphone M, currents may flow through the ribbons as shown by vertical arrows in part "b" of the figure. There is a reaction between the magnetic field and these currents which sets the ribbons in motion. At this particular instant the ribbons may tend to move in the direction of the horizontal arrows (part "b"). Ribbons "A" and "B" overlap and mask off all light from the track on the left. "B" and "C" separate and expose the track on the right. As these ribbons vibrate they produce an area such as "D" in part "c" of the diagram.

During the next half-cycle, ribbons "B" and "C" overlap and mask off the light beam. At the same time "A" and "B" move apart and produce an area such as "E" at "c". Complete modulation results when each ribbon moves a distance equal to one-fourth of the aperture length.

Resistor R equalizes the ribbon currents so that the audio signal current flowing through ribbon "B" will have the same value as the current in the other two ribbons, but flow in the opposite direction.

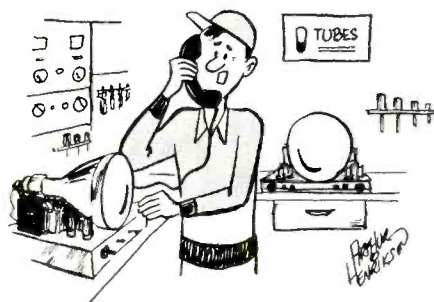

Suggested by Arthur A. Henriksen, Chicago, Ill.

"No sound? No picture? Well—is your set plugged in?"

SWEDGAL'S * B.S. LOWEST PRICES SINCE

SPEAKERS Alnico V Magnets Fresh Stock!

Lots of 5 Asst.		Lots of 10 Asst.	
Size	Price	Size	Price
3 1/2" P.M., .68 oz.	\$1.10	5" P.M., 1 oz.	\$1.13
4" P.M., .68 oz.	1.10	5" P.M., 1.17 oz.	1.25
4" P.M., 1 oz.	1.20	6" P.M., 1 oz.	1.55
4" P.M., 1.17 oz.	1.25	6" P.M., 1.17 oz.	1.65
4" x 6" P.M., 1 oz.	1.74	10" P.M., 6.8 oz.	3.74
5" P.M., .68 oz.	1.07	12" P.M., 4.64 oz.	5.23

VOLUME CONTROLS
Standard Brands, with switch & long shaft.

10,000 ohms	29c
25,000 100,000 500,000 250,000 1 megohm	ea.
50,000 350,000 2 megohms	ea.

Less switch, with short shaft.

20,000 ohms	10c
25,000 100,000 1 megohm	ea.
30,000 200,000 2 megohms	ea.
40,000 250,000 5 megohms	ea.

PAPER TUBULAR CONDENSERS

mfd.	Volts	Price
.015 @ 200	3c	
.02 @ 600	5c	
.005 @ 600	5c	
.1 @ 400	4c	
.025 @ 400	4c	
.02 @ 400	4c	

BUILD YOUR OWN AMPLIFIER
3-Tube Deluxe Chassis: with mounted 3 sockets for GT type tubes and 1 4-lug terminal strip mounted. Also drilled front panel. Sockets partially wired.

Complete 25c

PILOT LIGHTS
Made in USA—10 in a Ctn.

Lamp No.	Ctn.	Price
40	53c	
42	64c	
44	53c	
47	53c	

MICAS 200 MMF/00002 Mfd., 100 V. Size: 1/2" x 1/4".
Lowest price yet! 2c ea.

PORTABLE AMPLIFIER CASE
At A New Low Price!



OUTPUT TRANSFORMERS
Drop to a New Low Price!

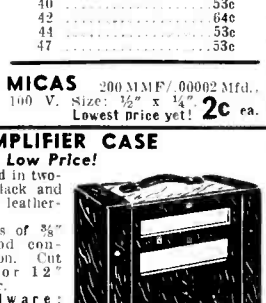

ELECTROLYTIC TUBULAR CONDENSERS
Fresh Stock, with Mounting Strap, CD Type EDL.

20 x 20 150 V.	37c
40 x 40 150 V.	ea.
50 x 30 150 V.	ea.

WIREWOUND RESISTORS

10 W., 4000 ohms, ea.	9c
20 W., 250 ohms, ea.	14c

3-TUBE CHASSIS

With sockets for GT type tubes mounted. Sockets partially wired. Mounting holes for Volume & Tone Controls.
Terrific value!

14c ea.

AC LINE CORDS

6 ft. Molded bakelite plug, ea.	10c
7 ft. Molded bakelite plug, ea.	13c

CRYSTAL CARTRIDGES: Astatic

10, 10, 10, 10 mfd., @ 450 V., 20 mfd., @ 25 V., short leads, ea. 34¢

JEWEL LIGHTS

Miniature bayonet socket, green jewel, 15/16" mounting hole. Easy to mount. One lug grounded and one timed. Length: 1-9/16".
Complete—Only 19c

DRY ELECTROLYTIC BEAVER CONDENSERS: 8 mfd., @ 450 V., short leads, ea. 34¢

IF TRANSFORMERS

Midget Iron Core 456 KC, input or output, ea. 39c

MAGNET CONTACT PICKUPS: FOR MUSICAL INSTRUMENTS: 15¢

KITS! Drop to a New Low Price

POINTER TYPE KNOBS: \$6.95

CARBON RESISTOR KIT: 50 asst.

BAKELITE KNOBS: Black, short holes punched, 1 3/8" wide x 1 1/2" skirt diameter, ea. 3¢

2-TUBE PHONO OSCILLATOR KIT. Complete with schematic diagram, 2 tubes. \$2.99 ea.

CORNISH WIRE: Corlic or No Flame, Stranded #22 hook-up, White with tracer, 1,000 ft. on reel, ea. \$3.49

5-TUBE AMPLIFIER CHASSIS

IRC WIREWOUND RESISTORS: Insulated, 30 ohms, 1/2 Watt, Type BW, ea. 9¢

TRIPLET METER: 2" sq. 0 to 10 V. DC, ea. \$2.35

TRIPOLETT METER: 2" sq. 0 to 10 V. DC, ea. \$2.35

ORDER THIS PORTABLE AMPLIFIER CASE TODAY AND GET THIS 3-TUBE CHASSIS FREE!

7-TUBE AMPLIFIER CHASSIS

Made to be used as a speaker baffle, portable amplifier case, P.A. system, for additional speakers, etc. Sturdy wooden case covered with 2-tone brown leatherette, leather handle.

8-TUBE AMPLIFIER CHASSIS

Complete with baffle board! Dimensions: 16" high x 13 1/2" wide x 5 1/2" deep at top—7 1/2" deep at bottom. INDIVIDUALLY BOXED.

9-TUBE AMPLIFIER CHASSIS

+ PLUS +
3-TUBE CHASSIS
Deluxe model with 3 sockets and 1 4-lug terminal strip mounted. Sockets partially wired. And front panel. \$1.49 Both (complete) for only

*Before Shortages

Present stocks will be shipped at prices listed until exhausted. All prices F.O.B. New York, N. Y. 25% deposit on C.O.D. WRITE FOR NEW CATALOG!

SWEDGAL RADIO, INC.

96 Warren St., Dept. E-11

New York 7, N. Y.

COrtland 7-6753

**HIGH FIDELITY
WIDE ANGLE DISPERSION
and HANDSOME APPEARANCE**

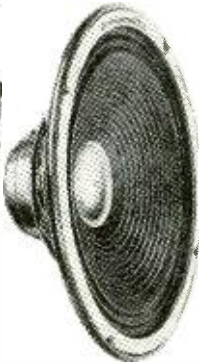
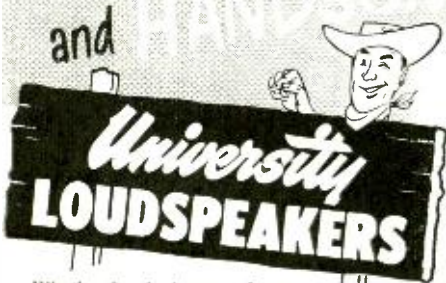

**MODEL 6200
WIDE RANGE
SPEAKER**

**Indisputably
today's best
buy in a
top quality,
high fidelity
12" reproducer**

Whether for the home or for use in a sound re-inforcement installation, specify UNIVERSITY—high fidelity reproducers with a tradition for quality and performance. UNIVERSITY "progressive engineering" assures you exclusive pace-setting design features, reliable factory ratings, and the advantage of specialized manufacturing know-how that brings you top quality products at sensible cost. Investigate, and be convinced that installing UNIVERSITY means installing the best.

Available Now! The TECHNOLOG

New and informative, a technical catalog with valuable hints on sound-casting techniques and installation suggestions. Write today to Desk 17.

**UNIVERSITY
LOUDSPEAKERS • INC**



80 SO. KENSICO AVE., WHITE PLAINS, NEW YORK

Specially shaped one-piece moulded cone provides wide angle dispersion. Cone edge treated for long life, also reduces distorting standing waves. Three inch dural dome at cone apex reinforces "highs", minimizes cone "break-up". Exclusive 1 1/2 lbs. "W" shape Alnico V magnet, shockproof assembly result in unusual conversion efficiency—requires less amplifier power, assures low distortion output. 4" overall depth perfect for P.A. or home wall and ceiling mounting. Response 45 to over 10,000 cps, 8 ohms, 30 watts power capacity.

TORQUE MEASUREMENT

Patent No. 2,511,178
Herbert C. Rofers, Roslyn, N. Y.
(assigned to Fairchild Camera & Instrument Corp.)

This invention is based on a magnetostrictive effect. The rod R made of a magnetic material such as nickel alloy is fixed to a plate P. At the other end of the rod a disc D is arranged to carry a weight W.

The rod is magnetized by a.c. flowing through it. This current is indicated as I. If the weight is taken off, there is no torque on the rod. Under this condition I produces magnetic lines of force which are circular around the rod. Since there is no component of magnetism parallel to the rod, no flux cuts the coil of wire and the meter M shows no deflection.

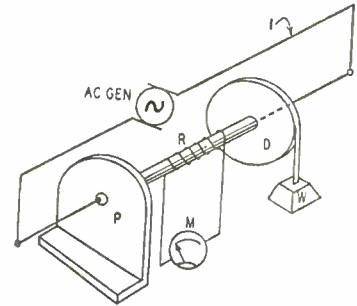

When a torque is present, the circular magnetism is distorted and the flux lines become helical around the rod. This is known as the inverse Wiedeman effect. This magnetic component parallel to the rod induces a.c. into the coil and M deflects. The induced current is directly proportional to the torque on the rod.

This effect is useful in many ways because it permits measurement of a force which does not produce actual motion.

RAILROAD SIGNALLING SYSTEM

Patent No. 2,509,331
Paul M. Brannen, Duquesne, Pa.
(assigned to Union Switch & Signal Co.)

Adding to the safety of railroad travel, this invention is an improvement over the usual block signal system because it indicates actual distance between trains. The illustration shows two trains A and B running in the same direction on the same track.

The first car of A is equipped with the apparatus shown on the right. A keyer modulates the transmitter. It also controls the sawtooth generator which provides the horizontal sweep for the oscilloscope. The transmitter radiates pulses at a high frequency F1.

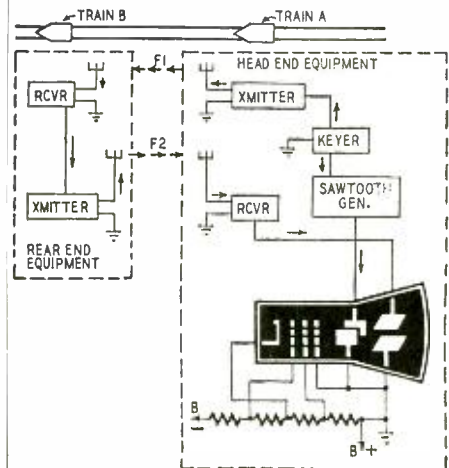

The last car of train B is equipped with a receiver and transmitter as shown on the left. The pulses from A are picked up and passed on to the transmitter which re-radiates them on a second high frequency F2. Train A picks up the signal which appears as a pip on the oscilloscope. As in radar the exact distance between trains is indicated on the screen.

This equipment has been found effective at distances up to about 3,000 yards.

RADIO-ELECTRONICS for



2-way Protection... only with this new

RMS RADIO TV all-weather Arrestor



TAKES REGULAR OR JUMBO TWIN LEAD UL APPROVED FOR INDOOR-OUTDOOR USE

LIST PRICE **\$1.75**

See your jobber



**RADIO MERCHANDISE SALES INC. 1165 SOUTHERN BLVD.
NEW YORK 59, NEW YORK**

Because of the double protection features of neon gas discharge and air gap, you can be dead sure of the new RMS LA-2 Lightning Arrestor. In its positive protection against lightning and static, infinite resistance is maintained before and immediately after discharge — input impedance is constant. It's waterproof and no wire stripping is necessary . . . mounting to walls, sills, and masts is quick. Here is protection at the lowest possible cost!

SECRET REMOTE CONTROL

Patent 2,513,342

Charles J. Marshall, Dayton, Ohio.

(assigned to the United States of America as represented by the Sec'y of the Army)

Remote circuits are here controlled by radio to insure secrecy and prevent operation due to false or interfering signals. As an example, bombs may be released from several airplanes simultaneously by a squad leader. It is obvious that the circuits must be guarded against random noise or enemy transmitter signals.

The transmitter and receiver may be conventional equipment. The transmitter is located at the control point. It is modulated by two audio frequencies when the switch is thrown.

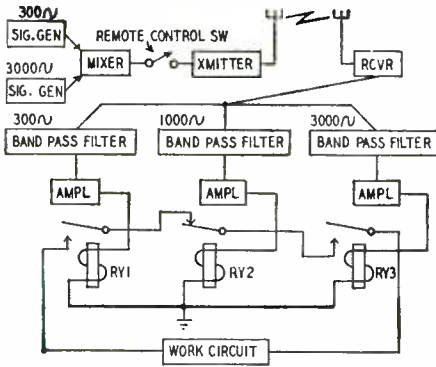

At each receiving location separate narrowband filters are tuned to the modulating frequencies. Their output is amplified and connected to relays RY1 and RY3. A third channel, tuned to 1,000 cycles, feeds RY2. Note that this relay is normally closed.

When the control switch is thrown, RY1 and RY3 contacts are closed. If no 1,000-cycle signal is present, R2 remains closed. The work circuit, for example a bomb release, is operated. If random noise or a voice signal is intercepted, it is quite likely to include 300, 1,000, and 3,000 cycles. In that case all three relays will operate. Since the RY2 contacts will open, the work circuit does not function.

NOISE SUPPRESSOR

Patent No. 2,512,637

Richard E. Frazier, Dayton, Ohio.

(assigned to the United States of America as represented by the Sec'y of War)

As the noise amplitude increases, this suppressor, shown within a dotted box becomes increasingly effective. The diodes may be within a single tube envelope or they may be twin metallic rectifiers. The suppressor is connected across an r.f. or i.f. circuit.

C1 is chosen for low reactance at signal frequency. R2 is relatively large. The time constant of the combination R1-C2 and R3-C3 is much higher than the period of the signal.

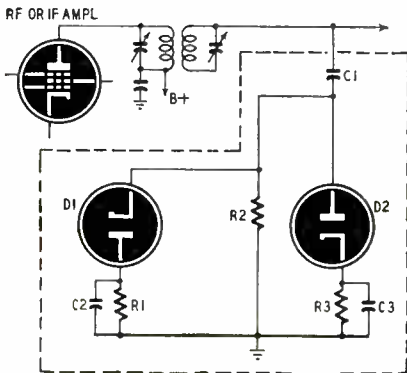

The input polarity determines which of the diodes conducts. With normal r.f. (or i.f.) signal both diodes conduct. C2 and C3 charge to an average potential and slowly discharge through their respective resistors. The capacitor charge is opposite and nearly equal to the constant signal input so there is little loss by shunting through the tubes. In the presence of a noise pulse, either D1 or D2 conducts more heavily. Temporarily the input exceeds the average capacitor potential and the input is effectively shorted to ground.

Magnificent
DURABILITY and CLARITY PUTS EUREKA IN THE LIMELIGHT!

Eureka, foremost name in TV picture tube development, offers you a product achieved through superior technical experience. Every tube manufactured is subjected to rigid laboratory control tests to meet specific requirements for top-notch performance.

EUREKA— the name that stands for the finest engineering skill!

Write, phone, wire us for data sheets and full information on 14", 16", 17" and 20" rectangular tubes.

EUREKA TELEVISION AND TUBE CORPORATION
 Manufacturers of Cathode-Ray Tubes and Electronic Products
 49 Fifth Avenue, Hawthorne, New Jersey * Telephone Hawthorne 7-3908

FOR ALL TAPE RECORDERS

MAGNERASER*
 The Perfect Bulk Tape Eraser
 Provides complete 100% tape erasure on the reel — without rewinding. Portable, light weight, fast, easily operated. Guaranteed to erase tape 3 to 6 db. quieter than unused tape! Also demagnetizes record and erase heads. Size: 4" Diameter; 2" High. Weight 3 lbs. Operates from any AC outlet.
 Net Price \$18.00 (Includes 8 ft. line cord and plug)

MAGNERIBBON*
 Premium Recording Tape
 Magneribbon assures consistently high recording quality. Wider response range; low surface noise; higher output level; greater strength. 1200 ft. lengths on 7" diameter tempered aluminum reels.
 Plastic base tape (red or black oxide) Per reel \$3.95
 Paper base tape (red or black oxide) Per reel 2.55
 Special introductory package offer (1 red plastic; 1 black plastic; 1 red paper; 1 black paper) \$11.80

Order direct from factory, or send for descriptive circulars. *Trademark Reg.

AMPLIFIER CORP. of AMERICA, 398 BROADWAY, NEW YORK 13, N. Y.

**BECOME
EXPERT**

with OSCILLOSCOPES

This practical book tells you everything you should know about an oscilloscope! WHAT it is . . . what it can DO . . . and HOW to use it properly!

**ENCYCLOPEDIA ON CATHODE-RAY
OSCILLOSCOPES AND THEIR USES**

by John F. Rider and Seymour D. Uslan

The **FIRST** and **ONLY** book that so fully and clearly describes the 'scope . . . its construction . . . its capabilities . . . its applications in servicing, engineering, research . . . with thousands of time-saving and labor-saving references, charts, waveforms, etc.



All oscilloscopes produced during the past ten years, a total of more than 70 different models, are accurately described—with specifications and wiring diagrams.

Planning to buy a 'scope? This book will help you select the type best suited to your needs! If you already own one, the book will

show you how to increase your instrument's usefulness and, naturally, its value to you!

We GUARANTEE that it will SAVE and EARN many, many times its cost for you!

992 Pages • 500,000 Words • 3,000 Illustrations
8½ x 11" Size • 22 Chapters • Completely Indexed
Easy to Read • Cloth Bound And only **\$9.00**

with ANTENNAS

TV and OTHER RECEIVING ANTENNAS

(Theory and Practice)
by Arnold B. Bailey



Tells you . . . **WHAT** each type can do **HOW** to use it . . . and **WHICH** is best!

This is a text book on all types of receiving antennas. If you have any questions—you'll find the answers in this book! Teacher, engineer, student, service technician—all can use this text. **WE GUARANTEE IT!** Antenna data never before published anywhere will be found in it. And it's readable—because mathematics has been translated into charts and graphs.

Everything you hoped for . . . and asked for!
606 Pages . . . 310 Illustrations And only **\$6.00**

at TV INSTALLATIONS

Stop wasting time, patience, and money in trying to "dope out" those difficult TV installations!

TV INSTALLATION TECHNIQUES

by Samuel L. Marshall



Order this RIDER book, the **ONLY** text that gives you complete information on all the mechanical and electrical considerations.

KNOW the absolute facts about such things as ice loading, wind surface, and mounting requirements—whether for short chimney-attached mast or an 80 ft. tower, including foundation.

HAVE at your fingertips, accurate data on receiver adjustments in the home . . . municipal regulations governing the installation of TV antennas and masts in all of the major television areas in the U. S.

SURE to help you wherever and whenever an installation becomes a problem! A **TIMELY** and **IMPORTANT** book!

336 Pages • 270 Illustrations • 5½ x 8½" Size
Cloth Bound And only **\$3.60**

10-DAY MONEY-BACK GUARANTEE—Make these books **PROVE** their value! Unless you agree they are the best investments you've ever made—return the books, in good condition, for refund.

RUSH THIS COUPON TODAY

JOHN F. RIDER PUBLISHER, INC.
480 Canal Street, New York 13, N. Y.

Please send me the following books on your 10-day MONEY-BACK GUARANTEE.

- "ENCYCLOPEDIA ON CATHODE-RAY OSCILLOSCOPES AND THEIR USES" \$9.00
- "TV and OTHER RECEIVING ANTENNAS" 6.00
- "TV INSTALLATION TECHNIQUES" 3.60

Name _____
Address _____
City _____ Zone _____ State _____

SAVE POSTAGE. If you enclose check or money-order WITH coupon, we will prepay postage charges. Money back if you return books within 10 days.

Check Encl. Money-Order Encl. C.O.D.

FUSE FOR RECEIVERS

A fuse to protect the rectifier tube and power transformer in case of shorts in the high-voltage supply is worth while in all receivers and is almost a necessity in experimental equipment where there is the added risk of overloads.

The easiest fuse to install and replace is a simple pilot lamp. The 150-ma

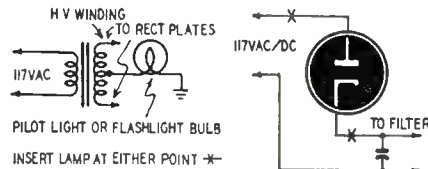

screw type is best in most equipment but an ordinary flashlight bulb will give sufficient protection. Simply wire the socket in series with the center tap of the high-voltage winding of the power transformer in series with the plate or cathode of the rectifier in a transformerless receiver. The drawings show where the bulbs may be inserted.—Eric Leslie

BUILT-IN TV ANTENNA

Constructed of 300-ohm ribbon line and designed for installation in TV receiver cabinets, this all-channel antenna is described in U.S. patent No. 2,514,992, issued to Charles R. Edelsohn.

The system consists of a high-band folded dipole A and transmission line

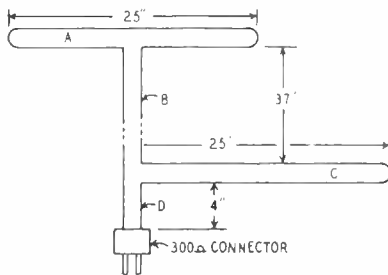

AUTOMATIC M-90 AUTO RADIO

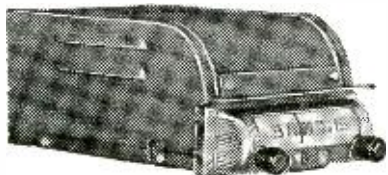

- Six Tube Superheterodyne • Three Gong Condenser • Powerful, Long-Distance Reception • Fits All Cars, Easy Installation
- Mounting Brackets Included Net
- 6 Tube model M90 \$30.11
- 5 Tube model X50 \$28.21

MAIL US YOUR ORDERS

All orders filled within 24 hours. Illustrated parts list on request. Standard Brand tubes 50% off list

Bill Sutton's Wholesale Electronics
Fifth at Commerce Fort Worth, Texas

Consecrated to Quality Output and Golden Rule Service

ASTRON Fixed Capacitors and RF Interference Filters

Write for catalogue

ASTRON CORPORATION — 255 Grant Ave., East Newark, N. J.

31,475



There are 31,475 models covered completely in RIDER TV—AM—FM—PA MANUALS.

And you may be called upon to service any one of these models . . . today . . . tomorrow . . . next week. Make sure you have the **BEST** servicing information—when you need it. Complete your RIDER MANUAL Library now. RIDER MANUALS—PROVEN BEST BY 21 YEARS OF TEST.

**In TELEVISION
5 RIDER TV MANUALS**
★ 10,544 Pages *
★ 1,849 Models
*Equivalent of 8½ x 11 ins. size

RIDER P.A. MANUAL
★ 2,024 Pages
★ 1,285 Models

**In AM-FM-Auto Radio-Phono
21 RIDER MANUALS**
★ 31,382 Pages
★ 28,341 Models

These comprise the world's greatest compilation of **ACCURATE — AUTHENTIC — RELIABLE** Servicing Information . . . as furnished by the Service Departments of the Manufacturers themselves. And all of it is yours . . . at the astonishingly low cost of **LESS THAN 1c PER PAGE!**

Plus an EXTRA feature that is exclusive with RIDER TV MANUALS

CIRCUIT ANALYSIS . . . descriptions of important functions within the receiver . . . pertinent data originating from the manufacturers and presented by RIDER in a manner which makes this added information a valuable aid to the servicing technician—as well as a practical education in the actual design of television receivers.

John F. Rider Publisher, Inc.
480 Canal Street New York 13, N. Y.

**See Your Jobber For RIDER MANUALS
PROVEN BEST BY 21 YEARS OF TEST**

B-D) with a half-wave shorted stub C inserted in one leg. The stub, being one-half wavelength at the frequency of dipole A, has no effect on the performance of the transmission line or antenna at that frequency.

On the low band, the combined length of stub C, the 37-inch line B, and antenna A form a folded dipole for the low band channels. Section D of the transmission line is not symmetrical so it should be kept short. A length of 4 inches is satisfactory.

HALLICRAFTERS 745 TV SET

Early production models of the Hallcrafters model 745 and similar sets use the a.c. input circuit shown at "a" in the drawing. The r.f. chokes in the a.c. line are wound with wire of approximately No. 24 gauge. The voltage drop is approximately 2.5 volts across each choke. This loss in line voltage affects the performance of the set when line voltage is low. Furthermore, these chokes burn out or open when circuit troubles cause excessive

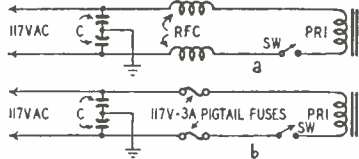

primary current. A shorted damper tube, low-voltage rectifier tube, filter capacitor, or coupling capacitor to the horizontal output tube can cause this trouble.

Performance under low line-voltage conditions is improved and the power transformer protected against shorts and overloads by replacing these chokes with 3-ampere Slo-Blo pigtail fuses as shown at "b."—Hubert L. Frazier

VIBRATING TV ANTENNA

The reflector of my TV antenna would vibrate when the wind was high. This vibration could be felt all over the house and caused an annoying noise.

I cured the trouble by tying a piece of wire from the ends of the reflector to a point on the boom behind the radiator. This did not affect the picture and the antenna seemed to pick us less noise.—Arthur Schweitzer

(Using wire as a tie-down may affect the performance of some antennas. If it does, try using prestretched nylon cord or rope.—Editor)

BE YOUR OWN BOSS!



MAKE MORE MONEY

In "CASH IN" you now get THE real money-makers — dozens of profitable tested mail order plans, confidential business secrets, dozens of practical tested formulas, successful tested schemes — actual experiences of men who have started on a shoestring—with less than \$10 capital. 25¢ a copy postpaid. Send U. S. stamps, money order, or coin.

Money Back Guarantee

NATIONAL PLANS COMPANY

1966 BROADWAY, NEW YORK 23, N. Y.

MAIL COUPON FOR A FREE BOOK & LESSON SHOWING HOW YOU CAN BUILD AND KEEP A POWERFUL GIANT SCREEN TV SET. STUDY IN SPARE TIME AT HOME. THIS SET YOURS TO BUILD AT HOME TAKES 10"-12"-16" PICTURE TUBE. NEVER BEFORE, PERHAPS, NEVER AGAIN, AN OFFER LIKE THIS. The greatest history-making offer in our 15 years! Your chance to get into high-paying Radio, Television field by actual practice on kits so valuable you simply can't afford to pass this up! Just imagine! You build and KEEP beautiful giant screen TV SET... build and keep 6 tube superheterodyne RADIO. We give you professional MULTITESTER you can use in your own service shop. PLUS more than 12 other valuable kits! Also, you get amazing shop-type "learn by doing" training developed by world famed electronic experts, a great new method that has been universally acclaimed as a MARVEL OF SIMPLICITY in over 40 DIFFERENT COUNTRIES! At least INVESTIGATE this marvelous training that has already placed THOUSANDS OF MEN in high-paying RADIO and TV jobs or in business! Graduates in U.S. and Foreign... tries state CERTI easy-to-learn lessons are FAR SUPERIOR TO ALL OTHERS! For your own future you MUST INVESTIGATE TODAY! Mail coupon above for fascinating free book and free lesson thousands have used as stepping stones to big jobs in RADIO-TV! ACT NOW!

CALIFORNIA ELECTRONICS & TELEVISION INSTITUTE DEPT. RE 1121 W. PICO BLVD. LOS ANGELES 15, CALIF.

NAME _____ ADDRESS _____ CITY _____ ZONE _____ STATE _____

MAIL THIS COUPON TODAY!! GET FREE TV FACTS-TV IDEAS BONUS 12 BIG KITS OF RADIO PARTS

CALIFORNIA ELECTRONICS & TELEVISION INSTITUTE DEPT. RE 1121 W. PICO BLVD. LOS ANGELES 15, CALIF.

TELEVISION RECEIVER—\$1.00
Complete instructions for building your own television receiver. 16 pages, 11"x17" of pictures, pictorial diagrams, detailed schematic, 17"x22" complete schematic diagram & chassis layout. Also booklet of alignment instructions, voltage & resistance tables and troubleshooting hints.—All for \$1.00. Write for free catalogue. CERTIFIED TELEVISION LABORATORIES Dept. C, 5507-13th Ave., Brooklyn 19, N. Y.

ANOTHER OUTSTANDING JOBBER HATRY & YOUNG of Lawrence, Inc.
262 Lowell Street Lawrence, Mass.
HAS THE SENSATIONAL NEW **TEICO** 425-K 5" SCOPE KIT IN STOCK! \$39.95

ANOTHER OUTSTANDING JOBBER COAST Electronic Supply Co.
527 West Main Street Alhambra, Calif.
HAS THE SENSATIONAL NEW **TEICO** 221-K VTMV KIT IN STOCK! \$23.95

PEN-OSCIL-LITE
Extremely convenient test oscillator for all radio servicing: alignment • Small as a pen • Self powered • Range from 700 cycles audio to over 600 megacycles u.h.f. • Output from zero to 125 v. • Low in cost • Used by Signal Corps • Write for information.
GENERAL TEST EQUIPMENT 38 Argyle Ave. Buffalo 9, N. Y.

TUBE — OHM — CAPACITY TESTER!

MODEL 202

- Line Voltage Control.
- Checks shorts and leakages.
- Checks resistance to 4 megohms.
- Checks capacity from .01 to 1 Mfd.
- Checks condenser leakage to 1 megohm.
- Individual sockets for every type tube base.
- Built-in roll chart.
- Tests tubes from .75 volts to 117 filament volts.

Complete in sturdy, hand-rubbed portable oak case with carrying handle. **\$46.50 ONLY**
Add \$6.00 for 220V operation

Export Dept., 303 W. 42nd St., N. Y. C.
Write Dept. B-1 for Free Catalog

SHOOT TV TROUBLE FAST!

With H. G. CISIN's RAPID "TV TROUBLE SHOOTING METHOD"

EARN more money! Locate television troubles by this quick, entirely new method. Rapid checks applied in simple, logical steps enable you to classify, sub-classify, diagnose and locate all faults in record-breaking time regardless of make or model!

H. G. CISIN is well-known to radio and television men as a recognized electronic engineer, inventor, technical author and educator. He has trained thousands of television technicians, many of them now owning their own prosperous TV service organizations or holding important positions in television. The results of his years of experience are embodied in this remarkable **TV TROUBLE SHOOTING METHOD**.

INCREASE your earning power with the most valuable aid to TV servicing ever written! SEND YOUR NAME AND ADDRESS TODAY WITH ONLY \$1.00 FOR YOUR POSTPAID COPY.

RUSH COUPON NOW!

H. G. CISIN—CONSULTING ENGINEER
200 CLINTON ST., BROOKLYN 2, N. Y.

Enclosed is \$_____ for which please rush _____ copies (postpaid) of your TV TROUBLE SHOOTING METHOD.

Name _____
Address _____
City _____ Zone _____ State _____

Electronic Measurements Corporation
423 Broome Street, New York 13, N. Y.

Beyond Compare—The Antenna that created New Horizons in Television Reception

Telrex de luxe CONICAL-V-BEAMS

REGISTERED TRADEMARK

THE FINEST TELEVISION ANTENNA EVER MADE!

Manufactured by Telrex and selected Telrex licensees under Pat. No. 2518297

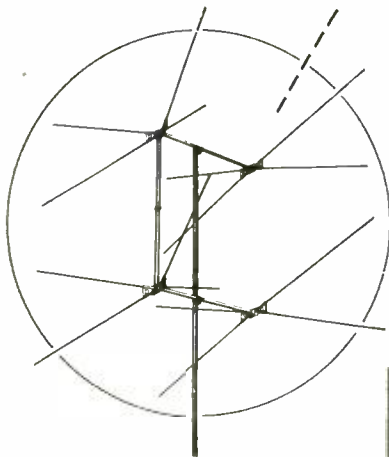

NEW! DOWELLED DURAL ELEMENTS ADD STRENGTH AND DAMPEN VIBRATION — EXTRA-HEAVY DUTY CONSTRUCTION THROUGHOUT

The original Conical-V-Beam that reached beyond the accepted limits of usable reception and produced satisfactory pictures in areas where reception was considered impossible. For maximum TV profits install the antenna that increases your selling area by producing excellent pictures where others fail. Telrex De Luxe is your one best bet for every TV installation near or far. It outperforms, outsells any other antenna at any price! For complete information, contact your local Telrex distributor or write direct for details and new catalog.

DEALERS, INSTALLATION MEN—WRITE TODAY

Receive your free copy of the Telrex Service News every month. Contains timely tips on TV installations and other trade topics. Please write on company letterhead to Department B.



telrex INC.
CONICAL-V-BEAMS



AMERICA'S STANDARD OF COMPARISON
ASBURY PARK 9, N. J.

THE SKILL TO DESIGN
THE FACILITIES TO PRODUCE
THE ABILITY TO DELIVER

TV-RADIO SPEAKER COUPLING

Tonal quality of the average table model TV set is often unsatisfactory because of the size and placement of its speaker. This circuit shows how the a.f. output of a TV set can be coupled into a console FM or AM radio to take advantage of the larger speaker and better baffling. The circuit is arranged so the speaker is coupled to the set that is in operation.

Replace the output transformer in the TV set with a husky universal type. Select the secondary taps to match the impedance of the large speaker or use those which provide the best tone. A small a.c.-d.c. type power supply is in-

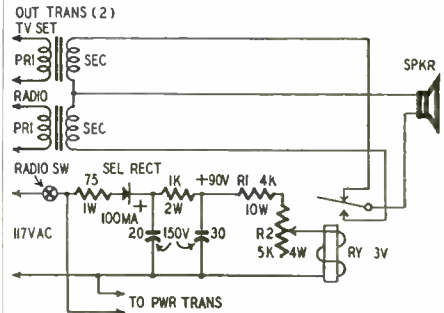

stalled in the console to supply excitation current for the change-over relay. This supply develops approximately 90 volts d.c. R1 and R2 drop the voltage to between 2.5 and 3.5 for the 3-volt relay. Any small s.p.d.t. relay requiring not more than 90 volts can be used by making appropriate adjustments in the values of R1 and R2.

If you pick up a surplus relay, be sure to check its resistance and find out how much current it draws before installing it. Some low-voltage jobs have a low-resistance coil which may draw an ampere or more. Make sure that the current drain can be met by the power supply.

The diagram shows that the speaker connects to the TV set through the normally closed contacts of the relay. The relay is energized and the speaker switches over when the console set is turned on.—Olaf W. Bailey

SIMPLE TIMER CIRCUIT

This darkroom timer is simpler than most electronic timers. With the controlled unit plugged into the receptacle, throw S1 to OFF to remove any residual charge on C1. Throwing S1 to ON removes the 1,000-ohm short circuit from C1 and at the same time energizes the output receptacle through the normally closed contacts of the relay. C1 begins to charge up through R1, R2, and R3. When the voltage across C1 reaches 100

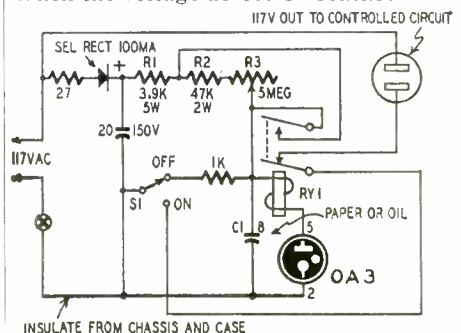

RADIO-ELECTRONICS for

"RADIO-TELEVISION Questions and Answers"

A separate book for each element of the study-guide questions pertaining to the various classes of commercial U. S. A. radio operator licenses. You need buy only those elements required for the license you want.

Element 1: BASIC LAW (mimeographed)	45c
Element 2: BASIC THEORY & PRACTICE	90c
Element 3: RADIO TELEPHONY	90c
Element 4: ADVANCED RADIO TELEPHONY	90c

AT YOUR FAVORITE DEALER
OR DIRECT BY MAIL FROM
Editors and Engineers
LIMITED
1303 KENWOOD ROAD, SANTA BARBARA, CALIFORNIA

Greylock's NEW TELEVISION & ELECTRONIC CATALOG

Crammed full of

- Great Money-saving Values for YOU
- Bargains you can't afford to miss
- More than TWENTY Standard Brand lines of Merchandise

Write TODAY for your copy, to Dept. C-1

GREYLOCK ELECTRONICS SUPPLY CO.

115 Liberty Street New York 6, N. Y.

or so, the 0A3 fires, allowing C1 to discharge through the relay and pull in its armature. The normally open contacts lock the relay closed by shorting R2 and R3, leaving only R1 in series to limit the current to approximately 30 ma. The normally closed contacts are then open, and the output receptacle is de-energized. The cycle is repeated by throwing S1 to OFF and then to ON each time the controlled unit is to be operated. S1 may be a push button if desired. RY1 must be a low-resistance (several hundred ohms), low-current relay with a light armature for fast operation. If a relay with the indicated contact arrangement is not available, a s.p.s.t. sensitive relay may be used to control a more rugged relay with the necessary contacts. The 1,000-ohm resistor prevents a spark at the contacts when the switch is thrown to OFF. R2 limits the maximum current through R3. The values of R3 and C1 shown cover a range of approximately 3 to 30 seconds, but other values could be used for different times. C1 must be fairly large so that the relay will close positively when the 0A3 fires.—
Richard H. Houston. W3MAX

NOVEL CODE OSCILLATOR

This code oscillator uses a modified multivibrator circuit which gives it a richness of tone easy to listen to throughout long practice sessions. C1 governs the range of frequencies covered by varying the setting of the 500,000-ohm potentiometer. The frequency and signal voltage go up as C1 is made larger. When it is 0.5 μf, the range is approximately 700 to 1,000

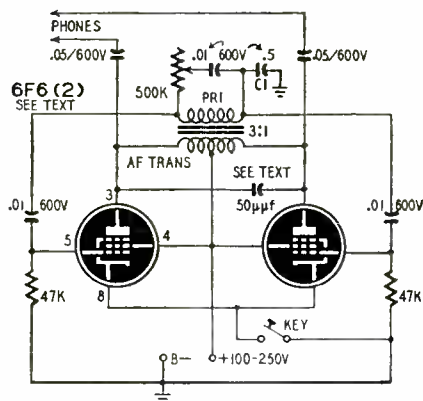

cycles. The 50-μf capacitor is shunted across the secondary to improve the tonal quality at low frequencies.

The audio-frequency transformer can be any interstage unit that has a step up ratio of three to one and a center tap in the secondary. The frequency will vary somewhat with the size transformer used, but C1 can be selected to give the desired pitch.

The selection of tubes is not critical. The diagram shows pentodes which may be 6L6's, 6V6's, 117L7's, 50L6's, and the like. You can use triodes such as 6C5's, 6SN7's, etc., by omitting the connection for the screen grid. In fact, you can use one triode and one pentode. The circuit will work just as well.—
Arthur Manning

To Ambitious Young Men Who Want Profitable Careers



**• RADIO
• ELECTRONICS
• TELEVISION**

**CREI Residence School Trains You for Vital Industry
—qualifies you for better jobs in the Armed Services too!**

Whether you're seeking a career in the electronics industry, where critical shortages of trained men exist, or planning on entering military service, one thing is sure: If you are *qualified* in electronics, you're qualified for the better jobs. Radar, communications, guided missiles, and television work not only offer present employment at high pay—they are keys to lifetime careers.

Recognized as outstanding by engineers, educators, the Armed Services, and important firms like RCA-Victor, Bendix, and United Air Lines (whose technicians have received CREI training at company expense) your electronics course can be completed in approximately 20 months. New classes start twice a month. You work with the latest facilities in modern classrooms, studios, and labs. To insure your training act now. Send for FREE catalog today.

Residence School training in Washington, D. C., at CREI arms you with a priceless asset — electronics know-how!

APPROVED FOR VETERANS

**CAPITOL RADIO
ENGINEERING INSTITUTE**

*An accredited technical institute
founded in 1927.*

16th Street and Park Road, N. W.,
Dept. 301C Washington 10, D. C.

Please send FREE Residence School Catalog 301C

Name

Street

City..... Zone..... State.....

Veteran Non-Veteran Age.....

Send details about Home Study Courses

NOW BETTER, BRIGHTER PICTURES

**insuline
new "BI-CON"
TELEVISION ANTENNA**

Single Type and Stacked Array for fringe areas

An engineering triumph by Insuline . . .
proved outstanding by actual test. Pre-
assembled sections for quick installation.

- * Peak ALL-Channel reception.
- * Suitable for ANY make TV set.
- * Exclusive—separate High Frequency and Low Frequency dipole-reflector elements.
- * Popularly priced.

FREE! New Catalog

Thousands of items including metal goods, radio parts, TV indoor and outdoor antennas and accessories, tools, hardware, etc. Write Dept. RE-1.

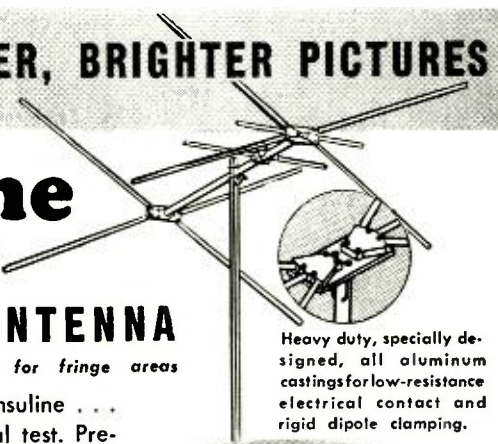

Heavy duty, specially designed, all aluminum castings for low-resistance electrical contact and rigid dipole clamping.

insuline

"meteor"

**INDOOR
TV ANTENNAS**

Installed in a jiffy and quickly adjustable to all channels. Supplied complete with 300 ohm connecting lead and open-end mounting lugs.
Note! Necessary 300 ohm cable available for all INSULINE TV antennas.

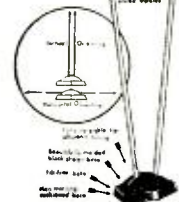

insuline CORPORATION OF AMERICA

INSULINE BUILDING • 36-02 35th AVENUE • LONG ISLAND CITY, N. Y.
West Coast Branch and Warehouse: 1335 South Flower Street, Los Angeles, Calif.
QUALITY PRODUCTS SINCE 1921

BASIC OSCILLOSCOPE

? Please print a circuit of a 5-inch oscilloscope, minus amplifiers, and with provisions for intensity modulation. I have a 5CP1 C-R tube, 2X2 rectifiers with heater transformers, and a 2,200-volt, 2-ma high-voltage transformer. I want to use as many of these parts as possible.—J. A., Ames, Iowa.

A. This basic oscilloscope circuit is taken from tentative data on the 5CP1 supplied by RCA. If the voltages supplied by the 2X2's are higher than those shown on the diagram, insert suitable dropping resistors at points

A and B. The 50-megohm resistor in the positive supply may consist of five 10-megohm, 1-watt resistors connected in series. The filament transformers for the 5CP1 and the 2X2's should be insulated for 2.5 kv or higher.

Take care not to exceed the maximum positive and negative voltage ratings for grid No. 1 when intensity modulation is used. Resistor R limits the positive excursions. Its value should be at least 2,000 ohms for each volt of positive signal voltage.

Dangerous voltages exist in the C-R tube circuits. Pull the line cord, throw

the line switch to OFF, then short the terminals of both high-voltage filter capacitors before working on the set.

ANTENNA MATCHING SYSTEM

? I have an all-channel antenna which does not work well on channel 13 so I want to connect a channel-13 antenna in parallel with it. How can I connect these 300-ohm antennas so there is no interaction between them? Shouldn't a 150-ohm line be used?—S. R. M., New York, N. Y.

A. Mount the antennas 18 to 24 inches apart. Connect them together with a 48-inch piece of 300-ohm line. Tap this line 12 inches from the high-frequency antenna and connect a 300-ohm lead-in at this point. Connect a 12-inch open stub (made from 300-ohm line) across the terminals of the larger antenna.

Being approximately a quarter wavelength long at channel 13, this stub will short circuit any high-frequency signal on the low-frequency antenna.

The 36-inch line between the longer antenna and the antenna terminal block acts as a three-quarter wavelength stub shorted by the longer antenna so it presents an infinite impedance to high-frequency signals arriving at the lead-in from the smaller antenna.

The impedance of each antenna is 300 ohms only at its resonant frequency. In wide-band antennas like this one, 300-ohm lines are used to provide a good match between the lead-in and the set.

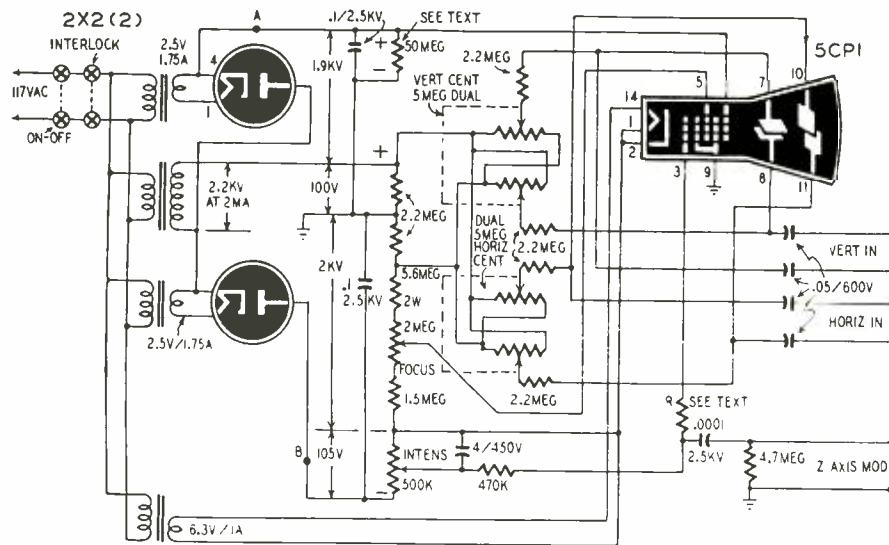

HOIST YOUR PROFITS
with a
JIFFY-UP Antenna HOIST!

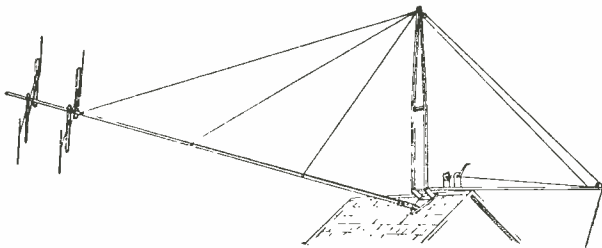

Two men can do the work of six in far less time. Eliminates the necessity of a big crew. Means lower costs, higher profits and savings in valuable time. All this can be achieved in your TV installations with a JIFFY-UP Antenna Hoist. Every dealer who installs TV antennas needs a JIFFY-UP Hoist.

1. Works on flat or gable roofs.
2. Installer uses specially-designed roof mount.
3. Hoist fastens to mount . . . can be put on and taken off in less than 5 minutes.
4. Antenna can be lowered at any time by fastening the hoist to the mount.
5. Will erect or lower masts up to 50' high.
6. Antenna mast can be self-guyed . . . takes only one man to crank it up.
7. Sturdy in construction—light in weight.

JIFFY-UP HOIST—Dealer net. \$49.50 Pat's. applied for on both
JIFFY-UP MOUNT—Dealer net. 6.00 Hoist and Mount

If your jobber cannot supply, order direct from

THE HAUGEN CO.

412 South Front St., MANKATO, MINNESOTA

SAVE

THAT GOOD LOOKING OLD CONSOLE—
REPLACE THE OBSOLETE RADIO

with a modern, easily installed

ESPEY AM/FM CHASSIS

and your favorite console is "right-up-to-date"

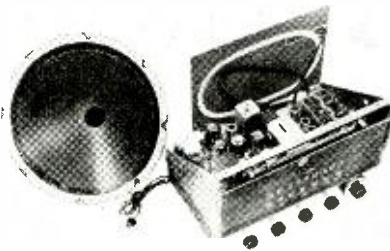

Rated an excellent instrument by America's foremost electronic engineers. Fully licensed under RCA and Hazeltine patents. The photo shows the Espey Model 511-B, supplied ready to play. Equipped with tubes, antenna, speaker and all necessary hardware for mounting.

NEW FEATURES—Improved frequency modulation circuit, drift compensated • 12 tubes plus rectifier, electronic tuning eye and pre-amplifier pick-up tubes • 4 dual purpose tubes • High quality AM-FM reception • Push-pull beam power audio output 10 watts • Switch for easy changing to crystal or variable reluctance pick-ups • Multitap audio output transformer supplying 4—8—500 ohms.

Makers of fine radios since 1928.

Write for literature RN for complete specifications on Model 511-B and others.

ESPEY
MANUFACTURING COMPANY, INC.
528 EAST 72nd STREET, NEW YORK 21, N. Y.

BC-222 CONVERSION

? I have a BC-222 radio set which I wish to convert to a signal generator. Please prepare a diagram showing how this can be done. I would also like to have an a.c. power supply.—C. M. E., Graham, N. C.

A. The diagram shows how the unit can be converted to an a.c.-operated signal generator. Components shown with codes are those found in the BC-222. Parts having values given must be added. The tone of the modulator

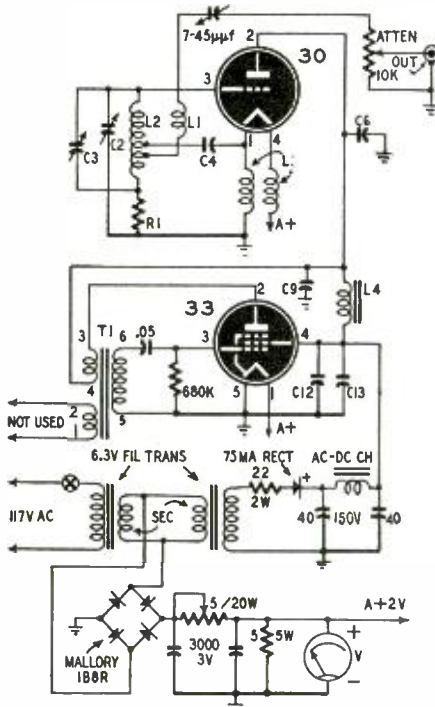

can be varied by using other resistances in place of the 680,000-ohm resistor in the grid circuit of the 33.

The power supply consists of two 6.3-volt, 3-ampere filament transformers connected back-to-back. The secondary voltage of the input transformer is rectified by a Mallory type 1B8R rectifier or its equivalent. Adjust the 5-ohm resistor so the filament voltage is 2 volts under load. The filaments in this circuit must be d.c.-operated so the generator output will not be hum-modulated.



"No, bring the antenna further back on the roof. A little further. More. Hello? Hello?"

NIAGARA'S GIGANTIC WAREHOUSE CLEARANCE "VALUES GALORE"



ARC-5/R-28 (Plus \$2.50 BONUS)* HOTTEST 2-METER RECEIVER

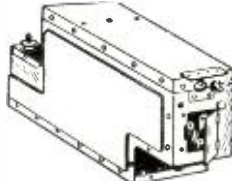

EVER BUILT!

Here is the 2-meter superhet you have been looking for! Absolutely the BEST available today! Tunes from 100 to 150 Mcs in four crystal channels. (Easily converted to continuous tuning.) Tube lineup is as follows:

717A—RF, 717A—Mixer, 2-12SH7—1st and 2nd I.F. (6.9 Mc), 12SL7—Det-AVC-Squelch, 12SL7—1st audio-squelch amplifier, 12A6—2nd audio, 12SH7—RF-Osc—4th Harmonic Gen., 717A—Trip, 12th Harmonic Gen., 717A—Phir, 12th harmonic gen.

A highly desirable superhet, made of rigidly inspected parts and contained in a louvered aluminum cabinet measuring 7-5/32"x4-7/8"x3-1/4". Complete with all tubes in original sealed cartons

\$1995

* FOR A LIMITED TIME ONLY!

—With each order for ARC-5/R-28 Receivers, one copy of Vol. 2 "Surplus Radio Conversion Manual" (Regular price \$2.50) will be shipped, at no additional cost! This volume contains circuit diagrams and full description of above receiver, plus a wealth of additional conversion data on many other popular items of surplus equipment. ACT NOW, for YOUR \$2.50 BONUS!

EXTRA SPECIAL! SELENIUM RECTIFIER AC-DC POWER UNIT



A versatile foundation power supply kit, providing 6 to 24 V. D.C. at 5 Amps., 110 V. A.C. or D.C. input. Kit contains: 1-6 point heavy duty tip switch, 1-DPDT toggle switch, 10-6 Amp. cartridge fuses, 10-3 Amp. cartridge fuses, circuit diagram, parts list, and full description. All this for less than the price of the Selenium Rectifiers! Ship. Weight 50 lbs.

\$1295

JUST ARRIVED! EICO'S FAMOUS NEW BATTERY ELIMINATOR & CHARGER KIT

0-15 V. output, continuous; 5-8 V., 10 Amps.; intermittent; 20 Amps. Metered current and voltage output. Automatic reset for secondary. Variac type Xfmr. MODEL 1040-K Kit.....

\$2250

Model 1040 Wired and Tested.....\$29.95

New Low Price Niagara Famous High Pass Filter



Banish Interference with Niagara's Hi-pass filter! Positive protection against interference from amateur transmitters, diathermy, and all other devices

generating radio frequency interference below 40 MCS. Designed for 300 ohm lead-in. No loss in brightness or clarity.

\$2.50

Wired and tested..... Postpaid if entire amount is included with order.

FREE SAMPLE! TRANSMISSION TWINLEAD

Heavy duty twinlead for transmission line. Will easily handle 3 full KW. Ideal for Ham and industrial users. FREE SAMPLE ON REQUEST! In standard 250 Ft. packaged lengths

8¢ per Ft. 10¢ per Ft.

Cut-to-order lengths less than 250 Ft.

IMPORTANT NOTICE: Minimum Order \$5. Quantity prices on request. All items in stock now—subject to prior sale—prices subject to change without notice. 20% deposit with orders unless rated. All prices F.O.B. our N.Y.C. Warehouse.

Niagara Radio Supply Corp. Phone Digby 9-1132-34
Dept. C-11 160 Greenwich Street, New York 6, N. Y.

RECEIVING TUBE VALUES

Guaranteed New—Branded

1C6	.88	1S5	.89	6K7	.48
1C7G	.88	1T4	.98	6K8	.78
1D5GP	.96	1T5GT	.78	6L7	.78
1D7G	.88	2V3G	.98	6L7G	1.16
1D8GT	.94	3A4	.36	6N7	.78
1E5GT	1.38	3B7	.35	6R7	.78
1E7G	1.56	3D6	.34	6SD7GT	.68
1F4	.74	3Q5GT	1.10	6SF5GT	.89
1F5G	.74	354	.98	6SG7	.98
1F6	1.56	5T4	.88	6SH7	.48
1F7G	1.56	6A3	1.28	6SJ7	.80
1G4GT	.68	6A6	.88	6SL7GT	1.20
1G6GT	.68	6A7	.68	6SR7	.56
1H4G	.68	6AB7	.78	6S7	.89
1H5GT	.53	6AD6	.88	7B4	.56
1H6G	.86	6B5	1.56	7B5	.72
1J6GT	.88	6B7	.88	7B6	.58
1L4	.54	6B8	.88	7C5	.56
1LA4	.78	6B8G	1.28	7C6	.72
1LA6	.88	6C5	.46	12A6	.18
1LB4	.88	6C6	.56	12K8	.58
1LC5	.78	6C8G	.68	12SH7	.34
1LC6	.56	6D6	.46	12SL7GT	.58
1LD5	.78	6F7	.84	12SR7GT	.48
1LE3	.88	6G6G	.88	19	.97
1LG5	.88	6J5	.75	76	.38
1LH4	.64	6J8G	1.28	9001	1.90
1LN5	.66	6K5GT	.96	9005	1.60

TRANSFORMER BARGAINS!

1025-0-1025—500 MA	\$17.95
2500 V.—4 MA	3.95
Filament		
2.5V-5A, 7.5V-4A	\$2.60
2.5V-10A cased	4.95
5V.C.T.-3A, 5V.C.T.-10.5A, 6.3V.C.T.-3.5A	5.95
5V-10A	1.85
5 V.C.T.-15A	5.95
6.3V-3A	1.29
Three 6.3 V.C.T.-4A each	1.80
6.4V-8A	2.05
7.5V-5A	2.49

Power		
40-0-40—250 MA.—5V-3A	\$1.25
175-0-175—150 MA.—6.3V-6A	2.15
275-0-275—70 MA.—5V-5A, 2.5V-10.5A	3.00
325-0-325—40 MA.—5 V.C.T.-2A, 2.5 V.C.T.-4A	2.25
325-0-325—70 MA.—6.3V-1.2A, 5V-3A	2.95
350-0-350—70 MA.—5V-3A, 6.3V-3A	3.05
350-0-350—100 MA.—6.3V-6A, 6.3V-2A	3.25

Modulation		
807 to P.P. 6L6	\$2.49
P.P. 807 to single 6L6, 4D32 (2400 ohms)	3.49
From 200,500 ohms to 5, 6, 7, 8, 9, 10K ohms at 150 MA.	4.49

Driver Xfms.		
200, 10,000 ohm P. to single G.	\$.79
10,000 ohm P. to single G.89
P.P. 45, 2A3, etc. to P.P. 210, 801, etc.	1.95
P.P. 6L6, 2A3, etc. to P.P. grids	1.65

Output		
P.P. par. 2A3, 45, etc. "AB" to 4, 8, 15, 500 ohms	\$1.89
6V6 to 2, 4, 8 ohms69
P.P. par 6N7 Class "B" to 8000 ohms	1.49

Input		
600 ohm C.T. to 300 ohm mike	\$1.49
Mike to Line		
From and to 50, 125, 200, 330, 500 ohms	\$2.49
30 ohm mike to 600 ohm C.T. Bal. line	1.65

Chokes		
.875 HY.	2.5 Amps.	\$8.95
2.5 HY.	4 Amps.	8.95
2.5 HY.	130 MA.	1.10
4 HY.	40 MA.	.25
8 HY.	200 MA.	2.35
10 HY.	180 MA.	3.49
40 HY.	90 MA.	2.49
10 HY.	200 MA.	1.75
12 HY.	150 MA.	1.60
15 HY.	125 MA.	2.65
15 HY.	200 MA.	1.75

FOR TV ASSEMBLIES & CONVERSIONS

(All Dimensions Listed Are Overall Size)

CRYSTAL-CLEAR LUCITE MASKS

FRAME IN RICH GOLD LEAF FINISH
RO-For Round Picture Tubes
RE-For Rectangular Picture Tubes

10"	RO-	9"	x 11 1/2"	\$3.47
12 1/2"	RO-	11 1/2"	x 14 1/2"	4.78
14"	RE-	10"	x 13 1/2"	4.52
16"	RE-	12"	x 15 1/2"	5.84
16"	RO-	13"	x 17"	5.97
17"	RE-	13 1/2"	x 17"	5.97
19"	RO-	15 1/2"	x 20"	7.49
20"	RE-	16 1/2"	x 20 1/2"	7.98

(Including Set of Rosettes)

PLASTIC OPEN MASKS
For recessing in conjunction with safety glass—standard grey color
FOR RECTANGULAR PICTURE TUBES

16"	—14 1/8" x 17 3/16"	\$1.87
17"	—14 1/8" x 17 1/4"	1.87
20"	—17 3/8" x 23 3/8"	2.98

SAFETY GLASS in 5 POPULAR SIZES
Pick the size for your cabinet
Easy to trim to smaller size

12 3/8" x 16"	\$2.98
13" x 16 3/8"	3.56
14 3/4" x 16 7/8"	4.29
14 1/2" x 19 1/8"	4.74
15 1/4" x 19 3/8"	4.98

PICTURE TUBE MOUNTING BRACKETS FOR #630

FOR 12 1/2" PICTURE TUBES

As Pictured Complete



\$1.96

FOR 16" PICTURE TUBES

Complete With Front Supports (pictured above on 12 1/2" set)

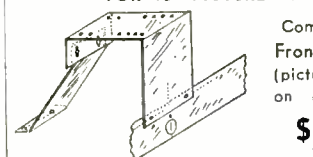

\$2.98

UNIVERSAL MOUNTING BRACKETS

Fits All Picture Tubes

Complete—incl. band that holds picture tube

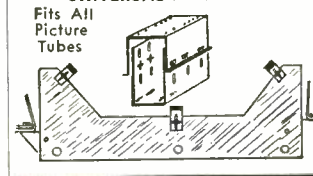

\$6.97

BROOKS RADIO & TELEVISION CORP.
84 Vesey St., Dept. A, New York 7, N.Y.

VIDEO I.F. ALIGNMENT

The test pattern from a local TV station can be used as a convenient signal for aligning the video i.f. circuits of a receiver having separate video and sound i.f. amplifiers.

The vertical and horizontal linearity of the receiver should be good. Turn on the receiver and allow it to warm up before beginning the adjustments. Make sure the set is adjusted for sharpest focus, then adjust it for normal contrast. Beginning at the converter output, peak each i.f. stage for best separation and resolution of the lines in the vertical wedges of the test pattern. A complete alignment of the system will result in maximum picture definition and horizontal detail with minimum distortion and smear.—*Olaf W. Bailey*

(If the set has a.g.c., disable it, replacing it with a negative bias of about 3 volts. Bias should be adjustable. A 10,000-ohm potentiometer across a 4.5-volt, C-battery will do the job nicely.—*Editor*)

WESTINGHOUSE H-600T16

Weak sound accompanied by picture shrinkage is often caused by weak 5U4-G low-voltage rectifiers. Replace one or both to restore the set to normal operation.

If the sound is O.K. and there is no raster on the screen, look for the trouble in the high-voltage circuit. You will probably find that the 6Y6-G is shorted or weak.

A bad or weak 12AU7 vertical vibrator tube will cause a bright horizontal line to appear on the face of the picture tube. Try replacing this tube.—*Michael L. Tortariello*

FARNSWORTH MODEL 651P

The set came in with the complaint that the picture had insufficient height. Advancing the height control caused poor vertical linearity. The trouble was traced to the 1-ohm, 60-cycle, 3-volt capacitor which bypasses the vertical centering control. The set was restored to normal by replacing this capacitor.—*James J. McNumara*

CROSLLEY 10-401, -404, -412

Neck shadow on the picture tube in these models and in the 10-414, -416, and -418 may be caused by reversed polarity of the focus coil. Wrong polarity causes the fields of the focus coil and the ion trap to interact to produce neck shadow and make centering difficult.

If this fault is suspected, reverse the current through the coil by interchanging the focus coil leads at the points where they are soldered under the chassis. If centering is easier and neck shadow diminished, and if the angle the focus coil makes with the neck of the tube is nearer 90°, this is the correct connection. When the coil is connected correctly, the current will produce a north pole on the face of the coil nearest the tube socket.—*Crosley Service Dept.*

SENTINEL 420B, 423, 425, 428
Fold-over on the left-hand side of

the picture which shows up as a horizontal V pointing toward the center of the picture or a faint milky-white area between the center and left side of the picture, is caused by the horizontal hold control being out of adjustment.

To clear this trouble, turn the horizontal centering control until the left-hand edge of the picture is visible. Adjust the horizontal hold control until the fold-over just disappears. If the extreme top of the picture starts bending or jitter is noticed, adjust the hold control for minimum fold-over with acceptable stability. To find this setting, it may be necessary to readjust the horizontal lock control.

Center the picture with the centering control. Do not at any time use the hold control to center the picture.—*Sentinel Service Dept.*

LATE PHILCO TV SETS

Before tearing into the circuit in an effort to find the cause of insufficient picture height, try replacing the 5U4-G rectifier. When the emission drops off the picture height shrinks.—*Millon Margolis*

ADMIRAL 20X122 TV SETS

The built-in antenna fits rather loosely in the cabinets of some models thus causing the picture to distort when anyone walks across the floor or shakes the set. Cure this by taping the antenna firmly to the cabinet with a good adhesive.—*Bruce A. Brown*

G-E 12T7 TV RECEIVER

Excessive contrast which cannot be reduced to normal with the picture control is probably caused by a shorted capacitor between the first and second sections of the sync amplifier and clipper stage. This is a .01-μf capacitor connected to pin 1 of the 6SL7. If it opens, the horizontal and vertical sync circuits will fail.

Excessive contrast and a shaky picture will result if the 220-μuf capacitor at pin 5 of the 6SL7 is open. If the .02-μf capacitor at pin 4 of the 6SL7 is open, bright lines will appear at the top and bottom of the picture.—*General Electric Data*

NO-GLARE TELEVISION FILTERS

For Better, More Clearly Defined Pictures

IMPROVES CONTRAST
ELIMINATES TELEVISION GLARE
SHARPENS PICTURE IMAGE
SIZES TO FIT ALL SETS
IN SMOKE OR BLUE COLORS

FOR ROUND OR RECTANGULAR PICTURE TUBES

10"	8" x 10 1/2"	\$.89
12 1/2"	9" x 12 1/2"	1.26
14"	10 1/2" x 15"	1.47
16"	12" x 16 3/8"	1.92
17"	13 3/8" x 17 3/8"	2.16
19" or 20"	15 1/2" x 19 1/2"	2.44

BROOKS RADIO & TELEVISION CORP.
84 Vesey St., Dept. A, New York 7, N.Y.

RADIO-ELECTRONICS for

Special Relays - OVER A MILLION IN STOCK!

Whether you require large quantities of relays for production runs or single units for laboratory or amateur work, Wells can make immediate delivery and save you a substantial part of the cost.

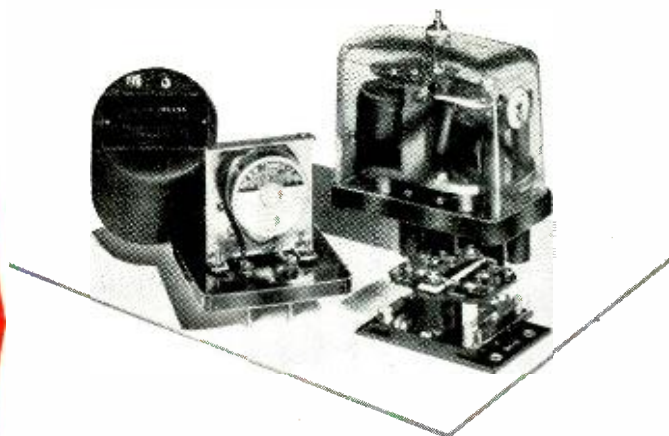

This list represents only a few types of Special Relays. We also have huge stocks of Standard D.C. Telephone Relays, Midget Relays, Contactors, Keying Relays, Rotary and Slow Acting Types as well as many others. Write or wire us about your requirements.

STOCK NO.	VOLTAGE	OHMAGE	CONTACTS	MANUFACTURER & NUMBER	PRICE
R-503	12/32 VDC.	100	3A, 2C	G.E. Ant. Keying 500W 2C6530-653ARI	\$ 2.25
R-749	600 VDC.	...	Max. 28 Amps.	Allen Bradley 810 Dashpot	5.95
R-804	550 VAC.	...	1B/38 Amps.	Culter Hammer C-261173A34 Contactor	3.50
R-250	115 VAC.	...	Adj. Cir. Breaker .04-.16A	Westinghouse MN Overload	12.95
R-579	220 VAC.	...	1B	Adlake 60 Sec. Thermo Delay	6.95
R-294	27.5 VDC.	200	1B	Edison 50 Sec. Thermo Delay	4.25
R-686	115 VAC.	...	2C	Leach 1157T-5, 20 Sec. ADJ. Delay	4.95
R-246	115 VAC.	...	1B	Cramer 2 Min. Adj. Time Delay	8.95
R-246A	115 VAC.	...	1A	Cramer 2 Min. Aoj. Time Delay	8.95
R-611	24 VAC.	...	1A/30 Amps.	Durakool BF-63	4.25
R-283	12 VDC.	125	AC/10 Amps.	Onan Rev. Current 3H4512/R24	1.00
R-614	18/24 VDC.	60	1A/15 Amps.	Rev. Current Cutout 3H2339A/E1	3.50
R-262	...	200	1C	W. U. Tel. Co. 41C Single Current	3.75
R-245	12 VDC.	25	4 In. Micalox Lever95
R-527	6-12 VDC.	50/50	In Series	227668 For Scr-274N	.95
R-544	12-24 VDC.	60/60	1C	G.E. Push Button Remote Relay #CR2791-R-106C8	1.65
R-255	1A	G.E. Pressure Switch #2927B100-C2	.95
R-669	75 VAC.	400 CYC.	1B, 1A	Clare 400	.95
R-660	6 VDC.	...	3/4" Stroke	Cannon Plunger Relay #13672	.95
R-651	24 VDC.	100	Solenoid Valve	2.50
R-295	12 VDC.	275	Annunciator Drop	2.15
R-230	5-8 VDC.	2	2A, 1C	Guardian Ratchet Relay	2.15
R-813	12 VDC.	12	Wafer	Ratchet Relay From Scr-522	4.25
R-275	12 VDC.	750	1A, 1B, 1C	Guardian BK-10	2.75
R-716	24 VDC.	70	2A/5 Amps.	BK-13	1.45
R-620	6-12 VDC.	35	2C, 1A	Guardian BK-16	1.05
R-629	9-14 VDC.	40	1C, 10 Amps.	Guardian BK-17A	1.25
R-778	8 VDC.	4500	1C/5 Amps.	Kurman BK-24	2.10
R-720	24 VDC.	50	2C, Ceramic	45A High Power	1.35
R-500	12 VDC.	10/10	2C/6 Amps.	Str. Dunn. Latch & Reset	2.85
R-816	12 VDC.	10/15	2C/6 Amps.	Guardian Latch & Reset	2.85
R-811	48 VDC.	8000	1C	Sigma 4R	1.65
R-524	24 VAC/DC.	Edwards Alarm Bell	.95
R-838	90/120 VDC.	925	2A	Allen Bradley-Bulletin #702	4.50
R-839	100/125 VDC.	1200	3A	Motor Control	4.50
R-840	115 VDC.	1200	2A	Allen Bradley-Bulletin #200E	4.50
R-841	115 VDC.	1200	4A	Motor Control	4.50
R-842	115 VDC.	925	3A	Allen Bradley-Bulletin #209 Size 1	5.50
R-843	115 VDC.	1200	3A	Motor Control W/Type "N" Thermals	25.00
R-844	115 VDC.	1200	3A, 1B	Allen Bradley-Bulletin #709 Size 2	5.50
R-845	220 VAC.	Intermit.	3A	Motor Control W/Type "N" Thermals	5.50
R-831	7.5/29 VDC.	6.5	1A/250A, 1000A Surge	Allen Bradley-Bulletin #200	4.50
R-837	110 VAC.	...	2A/30 Amps.	Motor Control	4.50
R-835	24 VDC.	2800	1A Dble. Brk./10 Amps.	Allen Bradley-Bulletin #202	4.50
R-836	220 VAC.	...	2A Ddle. Brk./10 Amps.	Motor Control	4.50
R-566	115 VAC.	(Coil only, Not a complete relay)	Allen Bradley-Bulletin #704	4.50
R-710	150-Ohms. Coil Only	Motor Control	4.50
				Leach B-8	3.50
				Leach 6104	2.75
				Wheelock Signal, B1/39	1.95
				Wheelock Signal, A7/37	3.45
				Leach #6104	.75
				Guardian #38187	.50

Wide Selection of Electronic Components at WELLS

Tubes

Resistors

Condensers

Wire & Cable

Volume Controls

Co-ax Connectors

Relays

Rectifiers

Transformers and
ChokesMicro Switches and
TogglesAntennas and Acces-
sories

Electronic Assemblies

Dial Light Assemblies

Write For New Wells Catalog

Each relay is new, individually boxed, and unconditionally guaranteed by Wells

World's Largest Display of Radio and Electronic Components

9,000 Square Feet of Display All On One Floor



320 N. LA SALLE ST., DEPT. Y CHICAGO 10, ILL.

JANUARY, 1951

These Men are Getting PRACTICAL TRAINING



IN TELEVISION-RADIO ON REAL TELEVISION SETS RADIO RECEIVERS F.M. RECEIVERS IN THE GREAT SHOPS OF COYNE

Big opportunities are waiting for men who know the practical and technical end of Television and Radio. That's what you get at COYNE—besides practical Shop Training in F.M., Electronics and other branches of this giant field. Remember, Television is the fastest growing opportunity field today, and Radio is one of the biggest.

NOT "HOME STUDY" COURSES

All Coyne Training is given in our mammoth Chicago training shops. We do not teach by mail. You train on actual equipment, under friendly instructors. Previous experience unnecessary. Hundreds of firms employ Coyne trained men.

START NOW—PAY LATER

Come to the Great Shops of Coyne in Chicago. Established 1899—now in our 52nd Year. Oldest, largest, best equipped school of its kind in America. Fully approved for G.I. training. Finance plan for non-veterans.

MAIL COUPON FOR FREE BOOK

Send today for big new book packed with large pictures taken in Coyne Shops. No obligation. No salesman will call. Get the facts now!

COYNE

B. W. Cooke, Pres.

ELECTRICAL & TELEVISION-RADIO SCHOOL
An Institution not for Profit
500 S. Paulina St., Chicago 12
Dept. 11-8H



B. W. COOKE, Pres.
COYNE Electrical, & Television-Radio School.
500 S. Paulina Street, Dept. 11-8H, Chicago 12, Ill.

Send FREE BOOK and full details on Television-Radio Course.

NAME.....
ADDRESS.....
CITY.....STATE.....

HELP-FREDDIE-WALK FUND

With this issue the Help-Freddie-Walk Fund reached a total of \$3945.73. This fund, as our readers know, is for two-year-old Freddie Thomason, the Arkansas radio technician's son born with neither arms nor legs.

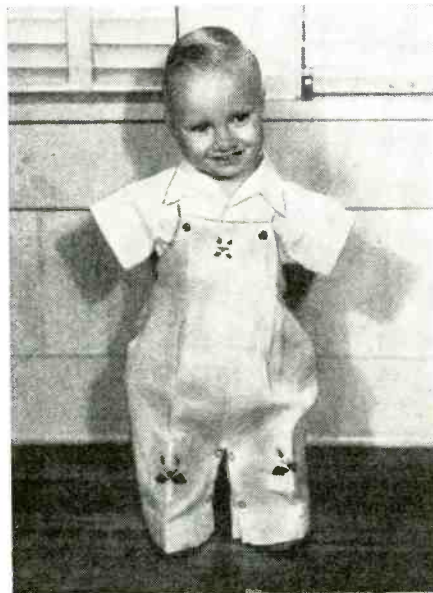

Little Freddie is trying hard to walk.

Reports from Freddie's parents are quite encouraging because the young boy now insists on wearing his special harness practically all the time and he is trying very hard to walk. Of course, he will not be able to walk as we know the term because he has no legs and the only way he can accomplish forward motion is by twisting his body first to the right and then to the left. Once he has mastered this difficult motion he will be able to get around by himself. Long after he has become proficient

ALMO SPOTLIGHT SPECIAL

Tape-Disc Recorder Assembly

By General Industries

NOW! ONLY \$47.70

YOUR COST



Just connect this Model 250 to amplifier and you're equipped for the following: Records tape from records; Records discs from tape; Records microphone on tape; Records radio on tape; Records radio on disc; Plays back both tape and discs; Plays 78 R.P.M. records.

Dimensions: Width—12½", Length—17½". Depth below mounting plate 4". Equipped with dynamically balanced four pole motor. Net Weight 10½ pounds.

Supply is limited. Write for your's today.

10% Cash With Orders

ALMO RADIO CO.
509 ARCH STREET • Philadelphia
6205 MARKET STREET • West Phila.
6th & ORANGE STS. • Wilmington
4401 VENTNOR AVE. • Atlantic City

"NO BOOK

in two generations, no book since Jules Verne, has undertaken to do what Hugo Gernsback in the first decade of our century has here so outstandingly achieved."

LEE DE FOREST
Father of Radio



Forty years ago, Hugo Gernsback, Father of Modern Science Fiction, in this book, RALPH 124C 41+, predicted and described in startling detail, radar, the learn while you sleep method, television, televised operas, plastics, night baseball, blood transfusion, wire recording, micro film and a host of other scientific achievements—all undreamed of in 1911—but part of everyday life today.

All of these and scores more, not as yet realized, are found in his remarkable prophetic book. For Hugo Gernsback's prophesies are based not on fantasy but on the logical projections of established scientific facts.

RALPH 124C 41+ is the first and most remarkable true science fiction novel ever written! A whacking good adventure story that takes place in 2660 AD—but it is far more than fiction!

To technically minded people, RALPH 124C 41+ is the most complete and accurately documented catalog of scientific prophesy ever published. It was originally written in 1911 and published in book form in 1925. Now, because of its tremendous importance as a work of accurate, scientific prediction of the future, it has been reissued in a new, second edition.

Hugo Gernsback's writings were the spark that started many of today's top radio engineers and scientists on their way. Now again, this new edition of RALPH 124C 41+ may well be the inspiration for a new generation of pioneers of science.

RALPH 124C 41+ is the kind of book you should read. Order your copy now, only \$2.50 postpaid. The supply is limited.

RADIO PUBLICATIONS
25 West Broadway New York 7, N. Y.

MAIL THIS COUPON TODAY

RADIO PUBLICATIONS
25 West Broadway, New York 7, N. Y.

Gentlemen:
Send me a copy of RALPH 124C 41+ postpaid, at once. My remittance of \$2.50 is enclosed.

NAME.....
STREET.....
CITY.....ZONE.....STATE.....

RADIO-ELECTRONICS for

in doing so will come the task of another appliance to give him artificial arms and hands, but this is still quite a bit in the future.

In the meanwhile, Freddie's expenses are great day in and day out; and though it is true that while he is very young his parents can take care of him, later on he must have special tools, special appliances bought almost yearly, all of which adds up to quite a lot of money every year. For this reason our readers are urged to contribute as much to the fund as they possibly can afford. Contributions are badly needed.

The Editor is pleased to announce that the largest contribution received was \$180 from Mr. John A. Gardner, a television engineer from Camden, N. J. We were very gratified to receive this very fine donation and RADIO-ELECTRONICS greatly appreciates Mr. Gardner's effort.

Keep up the good work by sending your contributions, even the smallest one will be very welcome.

Make all checks, money orders, etc., payable to Herschel Thomason. Please address all your letters to:

Help-Freddie-Walk Fund
c/o RADIO-ELECTRONICS
25 West Broadway
New York 7, N. Y.

Balance as of October 23, 1950.....	\$3491.56
Louis Abad—Rego Park, N. Y.....	1.00
Adam—Los Angeles, Calif.....	2.00
W. R. Adams—Clarks Hill, Ind.....	1.00
Administrative Department of Owens Corning Fiberglas Corporation—Newark, N. J.....	5.00
Anonymous—Glendale, Calif.....	1.00
Anonymous—New Augusta, Ind.....	2.00
Anonymous—Fort Thomas, Ky.....	1.00
Anonymous—Lawrence, Mass.....	2.00
Anonymous—Worcester, Mass.....	10.00
Anonymous—Poughkeepsie, N. Y.....	4.00
Anonymous—Rochester, N. Y.....	5.00
Anonymous—Columbus, Ohio.....	5.00
Anonymous—Fairborn, Ohio.....	6.40
Anonymous—El Paso, Texas.....	2.00
Anonymous—El Paso, Texas.....	2.00
Anonymous—Cheyenne, Wyo.....	5.00
M. B.—Flushing, N. Y.....	1.00
Barber Motor Company—Worthington, Minn.....	2.00
James H. Baskerville, Amityville, N. Y.....	5.00
Mr. & Mrs. N. A. Basso—Morgantown, W. Va.....	5.27
B. L. Brown—Carlsbad, N. Mex.....	5.00
F. Cardinal—Schenectady, N. Y.....	1.00
Mr. & Mrs. Leo I. Chaisson—Athol, Mass.....	1.00
Class E56-58, Crescent School of Radio & Television—Brooklyn, N. Y.....	8.50
W. Cooper—Schenectady, N. Y.....	1.00
Ralph Cramer—Bellmore, N. Y.....	3.00
William T. Curtis—Syracuse, N. Y.....	1.00
David's Radio Service—Church Point, La.....	3.00
Dow Radio, Inc.—Pasadena, Calif.....	10.00
Bruce E. Duff—Bedford, Ohio.....	2.00
Dutchess & Butch—East Orange, N. J.....	2.00
Kenneth R. Elliott—Dayton, Ohio.....	2.50
Albert Evangelista—Belleville, N. J.....	5.00
Luis C. Fargel, Jr.—Johnsburg, Pa.....	2.50
Harry Fersch—Jersey City, N. J.....	3.00
John A. Gardner—Camden, N. J.....	180.00
Charles Godleski—Utica, N. Y.....	2.00
Mabel Goetz—Monroe, Wisc.....	25.00
Nathan L. Goetz—Monroe, Wisc.....	10.00
T. Goldie—Schenectady, N. Y.....	1.00
Harold T. Goodfellow—St. Albans, N. Y.....	15.00
Harry E. Hall—Detroit, Mich.....	1.00
Paul Heine—St. Louis, Mo.....	5.00
J. F. Holton—Valdosta, Ga.....	1.00
W. Kelly—Schenectady, N. Y.....	1.00
Susan & Henry Jr. Kiertscher—Downers Grove, Ill.....	2.00
Tom E. Kokovikos, WØLJ, Tom's Radio Shop, Morris, Minn.....	5.00
W. J. Kreps—Glenford, Ohio.....	5.00
Luigi & John—Washington, D. C.....	2.00
John McDonnell, WINWP—Jamaica Plain, Mass.....	3.00
Joseph Markowiak—Toledo, Ohio.....	10.00
Dr. Curtis A. Mertz—Ashtabula, Ohio.....	5.00
Merwin Company—Jensen Beach, Fla.....	2.00
Morvin E. Nulsen—Indianapolis, Ind.....	2.00
Dr. Ing. Nino Erald Pellegrini—Biella, Italy.....	1.00
Mrs. Mabel C. Piper—Long Beach, Calif.....	1.00
Princess Theatre—Parkersburg, Ia.....	2.00
Wm. G. Quaster—Sausalito, Calif.....	2.00

6 Easy-to-Build RCP INSTRUMENT KITS

MORE THAN 150,000 RCP INSTRUMENTS IN USE TODAY—PROVE THEIR SUPERIORITY

NOW you can get in kit form the best professional test equipment! Made by Radio City Products one of the outstanding manufacturers of test instruments for 18 years. You get kits that are complete with all necessary parts and easy-to-follow assembly instructions. There is nothing else to buy! Yes, an RCP kit provides an enjoyable few hours in instruction and construction plus a finished test instrument at a tremendous saving!

MODEL 345K SUPER VACUUM TUBE VOLTMETER

Features long scale 4 1/2" meter in burn out proof meter circuit—electronic balanced bridge type push pull circuit—negligible current drawn due to high input impedance of 25 megohms—Isolation Probe—center of ohm scale 10 ohms—5 ohmmeter ranges reading from 2 ohms to 1 billion ohms (1000 megohms). 20 voltage ranges 0-1000 volts including AC and DC—Complete D.B. meter.

Discriminator alignment scale with zero center permitting operation in both directions. Operates on 105-130 volts, 50-60 cycles—Extra heavy panel, case and chassis. Size 10" x 6" x 5". Weight 8 1/2 lbs. Shipping weight 11 lbs.

\$23⁹⁵

MODEL 345K KIT COMPLETE

MODEL 322AK TUBE TESTER KIT

Fully engineered to test all recently developed tubes and television types. Has provisions for checking individual sections of multi-purpose tubes as well as miniature and subminiature receiving tubes. Jack for head-phone noise test to check noisy swinging or high resistance internal tube connections. Neon lamp for rapid short and leakage tests between elements.

\$25⁹⁵

KIT MODEL 322 AK, only

MODEL 447BK MULTI-TESTER KIT

3" square D'Arsonval meter. DC Voltmeter: 0-5-50-250-2500 Volts at 100 Ohm per Volt. AC Voltmeter: 0-10-100-500-1000 Volts. Output Voltmeter: 0-10-100-500-1000 Volts. DC Milliammeter: 0-1-10-1000 MA. DC Ammeter: 0-1-10 Amperes. Ohmmeter: 0-10-100 Ohms—1 Megohm—10 Megohms Ext. Decibel Meter: -8 to +55 decibels. Complete with batteries.

\$12⁹⁵

MODEL 777AK DYNATRACER

New Model Signal Tracer—Ultra Modern circuit design provides exceptionally high amplification so that actual gain measurements may be made. Accurate meter gives calibrated indications. Provides the speediest type of trouble shooting tool for tracing any type of disturbance or circuit defect from the antenna to the speaker. Indicates noise pickup at the aerial—checks AVC—APC, link and filter circuits. Tube Complement 6AU6—6AT6—6AQ5 and 6X4. Crystal Rectifier IN34. Speaker employs Alnico 5 magnet. Beautiful hammer-tone grey steel panel and case with new slenderized probe. KIT supplied complete. 165-130 volts, 50-60 cycles. Size 6 3/4" x 8 3/4" x 1 1/2". Weight 9 1/2 lbs.

\$32⁹⁵

MODEL 777AK

RCP HIGH VOLTAGE MULTIPLIER KIT

Permits multiplying all ranges X100 of Model 345 or any similar impedance V.T. voltmeter. Special ceramic helical high voltage resistor certified safe for all ranges up to 33,000 volts.

\$6⁹⁵

KIT MODEL HVMP-1K, only

RCP ULTRA HIGH FREQUENCY PROBE KIT

Uses germanium crystal with low impedance network permitting measurements up to 400 megacycles.

\$3⁹⁵

KIT MODEL HFP-1K only

Available at your Distributor. Insist on R.C.P. instruments. Write for Catalogue 1RE

RADIO CITY PRODUCTS CO., INC.
152 WEST 25th ST — NEW YORK 1, N. Y.



The "Multicoupler" Master Television Antenna System

T. M. Reg. U. S. Patent Office

- Designed by Engineers with 20 years Experience in the Master Antenna Business.
- Available with or without R.F. Amplifiers.
- Low Cost, Highly Efficient, Attractive Terms.
- Installed in Many Large Housing Developments in New York and New Jersey.

Write for further information

Amy Aceves & King, Inc.

Consulting Engineers

11 West 42 St. NYC.

BUFFALO RADIO SUPPLY

219-221 Genesee St., Dept. RE 1
Buffalo 3, N. Y.

The Radio Amateur's Handbook

(The Biggest Bargain in Radio Literature)

24th Edition.....	\$1.00	26th Edition.....	\$1.50
25th Edition.....	1.25	27th Edition.....	2.00

KITS & ASSORTMENTS

Silver & mica condensers.....	100 for	\$4.95
Ceramic condensers.....	15 for	.95
Resistors 1/2 & 1W.....	100 for	2.95
Wire wound resistors incl. adj. and tapped.....	12 for	1.00
Rotary Switches.....	6 for	1.75
Grid & PL Tube Caps Asst.....	35 for	1.00
Coil Forms Asst.....	50 for	1.00
Knobs Asst.....	100 for	1.95
Fuses Asst.....	100 for	1.00
Spaghetti Sleeving Asst.....	75 for	1.00
Solder Lugs.....	300 for	1.00

"THE BIGGEST SHOW ON EARTH"

A-foot by 7-foot picture—Compact—Self Contained—Portable For Theaters—Auditoriums—Churches—Institutions—Hospitals. Imagine Clear, Bright, Steady TV with figures on the screen—

AS LARGE AS LIFE!!!

Picture can be regulated in size up to 63 sq. ft. Colonial Vision Master projection model TV is complete with all accessories, including movie screen, and is fully guaranteed.

Regular price \$2195.00 Special Net—\$795.00

Bayonet type radio pilot light sockets for model rail-road enthusiasts, etc. \$5.00 a hundred. Mazda licensed bulbs, per 10, 50c.

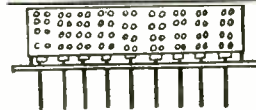
	<p>PUSH SWITCH 4 Section. Make-Break & SPST ea. Pressing one releases all others. 98c</p>
---	---

WINDOW ANTENNA

Highest quality telescoping folded dipole antenna with all the features usually expected in such an antenna, including use as a dipole and reflector, and in addition a mounting bracket provided so that the antenna can be installed in any window in two minutes or less. Any slight loss in gain because of the reduction from rooftop height is more than compensated by ability to orient antenna instantly by opening window and adjusting for maximum signal strength. Mounting bar can be installed horizontally or vertically in window frame or even between attic rafters, whichever is most convenient. Your cost \$7.00. With high frequency attachment for channels 7 to 13 \$9.00. Either type 10% less in dozen lots.

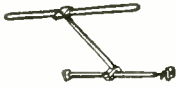

SENSATIONAL, FASCINATING, MYSTERIOUS SELSYS.

Brand new Selsys made by G. E. Company. Two or more connected together work perfectly on 110V A.C. Any rotation of the shaft of one Selsys and all others connected to it will rotate exactly as many degrees in the same direction, following unerringly as if the units were connected together by shafting. Instead of wire. This is true whether you twist the shaft of the master until a fraction of a revolution or many revolutions. Useful for indicating direction of weather vanes, rotating directional antennas, or controlling innumerable operations from a distance. Complete with diagram and instructions. Per Matched pair \$4.95.



Transvision 7" television kits complete with everything but cabinet, regular wholesale price \$149.50. Your special bargain price \$69.95

STROMBERG CARLSON

Power Switching Relay Box. Neat 3 1/2 x 4 5/8" steel case with light fitting cover finished in Stromberg's usual beautiful chocolate color crackle finish—25c.

**Bright Star
"Flashlights of Tomorrow"**

8 beautiful unbreakable plastic 2 cell flashlights on colorful display card with 12 free batteries. Flashlights alone worth \$9.00. Your cost for this bargain \$4.95.

SUPER SCOOP

All Rider Manuals and other Rider Publications 20% off the regular wholesale prices while quantities last.

TV GUY WIRE

Sensational Super Strength Stranded Cable at a MIRACULOUS saving. 350 lb. test. 21 Strands, overall diam. 1/32", twisted in such a way that the cable will resist snarling. Alloy brass plated to resist corrosion. Use for antenna wire, guy wire, captive balloons, dial cable, etc. 6 cables stranded together (slightly over 1/16" total diameter) make an auto tow rope that will lift a ton. While the supply lasts 1000 ft. reel \$2.50. 5000 ft. spool \$10.00.

GENERAL ELECTRIC 15 TUBE TRANSMITTER-RECEIVER SET. This brand new 15 tube transmitter-receiver was designed for mobile storage battery powered service. It's a cinch for the experimenter to connect this unit for 110 volt A.C. operation by following the instructions and diagrams supplied, which cover numerous applications, including FM and amateur television transmission and reception. For those intending to use on car or boat, a new dynamotor, exactly as originally supplied, costs only \$15.00. Don't fail to write for FREE descriptive bulletin. Order our RT-1248 for only \$29.95, or two for \$53.90.

Walter Raymond, Raymond Music Co.—Leavenworth, Kansas.....	2.00
Wilfred Rhodes—Burbank, Calif.....	2.00
E. F. Robinson—Dayton, Ohio.....	1.00
Sandy's Radio Service—Long Beach, Calif.....	2.00
Kathryn K. Scatchard—Philadelphia, Pa.....	2.00
F. W. Schamu—Liverpool, N. Y.....	6.00
Anton Sears—Ft. Harrison, Mont.....	1.00
A. Sikorsky—Alexandria, Va.....	2.00
Mr. & Mrs. J. Simrin—Bronx, N. Y.....	2.00
Thurman L. Slater—Fort Wayne, Ind.....	5.00
Mrs. R. A. Smith—Charlestown, Mass.....	1.00
Henry Stackhouse—Portland, Me.....	1.00
Vernon Tyo—Tupper Lake, N. Y.....	2.00
Mr. & Mrs. E. Raymond Ur—Pottstown, Pa.....	2.00
C. E. D. Varcoe—Detroit, Mich.....	4.00
Mc and Frances Vaughan—Port Arthur, Texas.....	1.00
Charles C. Watkins, W2RVP—Bridgeton, N. J.....	1.00
Wickell's Radio Service—Fulton, Mo.....	3.00
Irving Wilson—Twin Falls, Idaho.....	1.00
Mrs. Leo Wiman—Lubbock, Texas.....	1.00
Harold & Charles Wisler—Hastings, Nebr.....	2.00
Charles E. Young—Fort Wayne, Ind.....	5.00
T. Zak—Schenectady, N. Y.....	1.00

Radio Thirty-Five Years Ago
In Gernsback Publications

HUGO GERNSBACK

Founder

Modern Electrics.....	1908
Electric Experimenter.....	1913
Radio News.....	1919
Science & Invention.....	1920
Television.....	1927
Radio-Craft.....	1929
Short-Wave Craft.....	1930
Television News.....	1931
Wireless Association of America.....	1908

Some of the larger libraries still have copies of ELECTRICAL EXPERIMENTER on file for interested readers.

**JANUARY, 1917
ELECTRICAL EXPERIMENTER**

The Radio Obliterator
The Presidential Amateur Radio Relay
New Wireless Law Planned
Election Returns Flashed by Radio to 7,000 Amateurs
New Audion and Radiophone Apparatus
Long Distance Radio Without Aerials
Radio Detector Development, by H. Winfield Secor
Action of Detectors in Wireless Telegraphy, by Wilder D. Bancroft, (Cornell University)
Marconi Company Sues the U.S. for \$1,000,000 Damages, by A. Press, B. Sc.
The How and Why of Radio Apparatus
How to Make Any Audion Oscillate, by Edgar Felix
Marconi-Type Rotary Gap, by F. F. Lambert
New Audion Apparatus for Radiophony and Amplifying

**RADIATION-PROOF GLASS
SHIELDS ATOMIC WORKERS**

Neutron-absorbing glass, containing cadmium borosilicates with fluorides, is a result of research directed by Dr. Alexander Silverman, head of the University of Pittsburgh's chemistry department. The glass will be used in goggles to protect the eyes of atomic workers, and in peepholes.

Another new glass has X-ray absorbing powers. Tungsten phosphate produces this effect and the glass will not discolor on exposure to high-energy X-rays or gamma rays. By making a composite lens with a layer of each of the two absorbent glasses, the glass will shield against both kinds of radiation.

SOUNDTRONICS SPECIALS

**SARKES TAZIAN
13 Channel T.V. Tuner**

Same type used by leading Mfrs.—West, Magnavox, Teiking, Meck, etc. Ideal for schools, mfrs., etc. Uses 6C4 Osc., 6AG5 Mixer, 6BH6 R.F. Amp.



Guaranteed
\$3.95

Less Tubes, with Shields & Diagram.

3 TUBE KIT FOR TUNER
6C4, 6AG5, 6BH6 **\$2.88**

**NEW ARC 5
CHASSIS - - ONLY \$2.19**

Comprises mixer, 2 IF's, 2nd. Detector, A.V.C. Squelch, & 2 Audio Stages. Shipping Wt. 5 lbs.

14 PIN TV SOCKETS for 38P1, 7JP4, etc.
Black Bakelite 15c
Mica Filled 28c

F. P. ELECTROLYTIC SPECIAL
10-10-10-20 MFD 450-450-450-25 Volts
49c each 2 for 90c

TOP BRAND TUBULAR CONDENSERS
.1 MFD 1000 Working Volts..... 9c
.05 MFD 400 V..... 7c
.035 MFD 600 V..... 6c
.035 MFD 1000 V..... 8c

AEROGLAS #22 1250 V INSUL. WIRE
White with tracer
100' 99c
1000' \$7.98

MUTER CERAMIC CONDENSERS, 600 V.
15, 22, 33, 56, 75, 82, 180, 220 MMFD.
5c each \$4.50 per C

U.T.C. CHOKES P.A. CASES
10 HY @ 66 MA. \$.97
5 HY @ 150 MA. 1.85
10 HY @ 110 MA. \$1.40
10 HY @ 150 MA. 2.25

SPECIAL ASSORTMENTS
50 new pop. type coded res. 50 small pop. ceramic cond., all voltages & cap. 50 postage stamp mica cond. } Your choice \$1.49 each

6 V. 12 Amp Fil. TRANS. 115 V. @ 60 Imp. Open frame, 2 1/2" x 3" x 3 1/2" \$1.65

FALL SPECIAL
New Army Mine Detector AN/PRS—1. Will detect metallic & non-metallic objects, buried cables, etc. Uses 3-45 V. & 1-6 V. bat. Complete w/spare rods, tubes, etc. Less Batteries. **\$19.95**

SELENIUM RECTIFIERS
Single Phase full wave bridge. Input 0-18 V., output 0-14 V.
2.4 AMPS \$3.07
6.4 AMPS 4.09
13 AMPS 7.67
17.5 AMPS 8.69

Min. Order, \$5.00—25% w/order required

**SOUNDTRONICS LABS.
632 Arch St., Phila. 6, Pa. MA 7-2775**

MEASURE HI-VOLTAGE!



**Pocket-Size
"SEG HI-VOLTER"
BALL-GAP
KILO-VOLTMETER**

Perfect For
• Radio • X-Ray
• Television • Radar

Measures high voltage directly in KV—A.C. and D.C. pulse voltages. Retains reading for later use. Pocket-size SEG Hi-Volter is a perfect tester for field work—saves wear and tear on expensive equipment. It is a complete instrument—not a probe! Easy to use. Sturdy. Safe.

ONLY
\$3.95

See your local jobber or send payment direct.

7" LONG

SEG ELECTRONICS CO.

156 E. 56th St., Brooklyn 3, N. Y.

MICROEXAMINATION



Capable of a 500-power magnification, the shadowgraph in the photo is used at Sun Radio and Electronics Co. of New York to examine phonograph stylus wear. The stylus appears on the screen as a sharply defined 6 x 9-inch shadow. This checkup service is offered free to those who bring in their cartridges.

Correction

The grid resistor of the first 6SJ7 in the high-gain amplifier described in the September, 1950 issue should be 220,000 ohms instead of 220 ohms as shown on the circuit, Fig. 1

**SAVE AT WHOLESALE RADIO!
TV ACCESSORIES
IMMEDIATE DELIVERY!**

**TECHMASTER
TV BOOSTER KIT**

Complete with tube, pre-aligned coils, pre-stamped handsome chassis and cabinet... **\$11.95**



Improve TV reception in low signal, low terrain and fringe areas by building this latest design booster. Tested to reduce noise from 3 to 5 db. Get brighter, sharper pictures you hardly thought possible. Simplified step by step wiring instructions included.

**Sensational Antenna Buy!
SNYDER HI-LO ARRAY**



Complete with Mast Sections
Model TV 21

We don't believe you'll find a finer antenna anywhere near this low price. Two folded dipoles (High and Low) with reflectors. Complete with two 3 1/2 ft. mast sections, guy ring. Ready for easy, quick installation. **\$5.95**

STEEL EXTENSION POLES

- 10 Ft. long, 1 1/4" di. \$1.69
- 5 Ft. long, 1 1/4" di. Crimped End.98
- 3 1/2 Ft. long, 1 1/4" di. Crimped End.89
- CHIMNEY MOUNT BRACKETS. Complete with strap. 1.59
- HEAVY DUTY MAST BRACKETS. Model WB-2. Adjustable to 18" Fr. 3.75
- ATTOS JFD LIGHTNING ARRESTOR For Twin Lead Mounts to baseboard.75
- ANTENNA SWIVEL BASE. Aluminum. Fits 1 1/4" O.D. Mast sections.39

Write for Free F. Y. I. Flyer
Address Orders to Dept. RE-1
or call MULberry 2134

**WHOLESALE
RADIO PARTS CO., Inc.**
311 W. Baltimore St.
BALTIMORE 1, MD.

Top-notch technical books - and you can't beat the price

**GERNSBACK
LIBRARY
BOOKS**

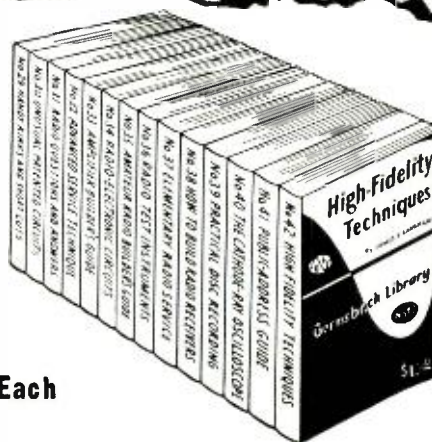

**Priced from
50¢ to \$1.00 Each**

One radio man tells another—GERNSBACK LIBRARY BOOKS are the best technical book buy in the field today! Accurate, concise, easy-to-read—they cover all the important phases of servicing, radio and audio. Check this list of interesting titles and order the books you want today.

TWO GREAT NEW BOOKS JUST ADDED

No. 41—PUBLIC-ADDRESS GUIDE by Guy S. Cornish, 80 p., 75¢—How to make more money from PA work. Getting started, installation, servicing, preventive maintenance, trouble shooting, construction.

No. 42—HIGH-FIDELITY TECHNIQUES by James R. Langham, 112 p., \$1.00. Most unusual book on high-fidelity ever written. How to design and get top performance from your own equipment.

10 POPULAR 64 PAGE BOOKS—50¢ EACH

No. 29—HANDY KINKS AND SHORT CUTS. A treasury of time savers! Antennas, power supplies, test equipment, phonographs, amplifiers. Easy reference. Illustrated.

No. 34—RADIO-ELECTRONIC CIRCUITS. For the experimenter—circuit diagrams of intercom systems, power supplies, voltmeters, electronic relays, receivers, etc.

No. 30—UNUSUAL PATENTED CIRCUITS. A gold mine of important hook ups. Control circuits, detectors, amplifiers, power supplies, foreign circuits.

No. 35—AMATEUR RADIO BUILDER'S GUIDE. For the "ham" who builds his own. Receivers, transmitters, antennas, converters, etc. Practical construction data.

No. 31—RADIO QUESTIONS & ANSWERS. Answers the tough ones on circuit diagrams, amplifiers, receivers, transmitters, meters and test equipment.

No. 36—RADIO TEST INSTRUMENTS. Practical construction data on signal tracers, capacity meters, portable and bench multi-checkers, voltmeters, etc.

No. 32—ADVANCED SERVICE TECHNIQUE. A "must" for the advanced service man! Covers specialized problems of servicing not usually found in ordinary textbooks.

No. 37—ELEMENTARY RADIO SERVICING. How to get started and keep going! Planning the shop, circuit checks, signal tracing—other fundamental servicing problems.

No. 33—AMPLIFIER BUILDER'S GUIDE. For the designer and builder of audio equipment. Covers a variety of amplifiers with power outputs from 8 to 30 watts.

No. 38—HOW TO BUILD RADIO RECEIVERS. Describes 18 modern sets including short wave, broadcast, vhf, portable, ac-operated, ac-dc, miniatures—types for every fan.

TWO IMPORTANT 75¢ BOOKS

No. 39—PRACTICAL DISC RECORDING. The last word in making good recordings. Covers techniques as well as theory. A full chapter devoted to every component. 96 p.

No. 40—THE CATHODE-RAY OSCILLOSCOPE. How the scope works and how to use it in TV and radio servicing and amateur operation. Describes various functions in detail. 112 p.

**RADCRAFT PUBLICATIONS, INC., DEPT. 11
25 West Broadway, N.Y. 7, N.Y.**

Enclosed please find my remittance for \$_____ for the books checked below.

- 29 30 31 32 33 34 35
- 36 37 38 39 40 41 42

Name

Address

City State

See Your Distributor—or use coupon
RADCRAFT PUBLICATIONS, INC.

OUTSTANDING - TV - VALUES

MODEL #300
Folded dipole complete with reflector and high frequency adapter. Covers all 13 channels. All alum. construction. Less mast Shpg. wt. 7 lbs. Price: \$4.95

MODEL #200-D
Stacked array. Consists of 2 complete conicals and connecting bars. Very rigid construction. Covers all 13 channels. Matches 300 Ohm or 72 Ohm. Center impedance 150 Ohm. Ideal for low signal areas. An outstanding buy. Shpg. wt. 12 lbs. less mast. SENS-A. \$9.75 TIONAL OFFER at...

MODEL 200-S
Single array. Same construction as above. Shpg. wt. 7 lbs. Price. less mast. \$4.50

MODEL #500
All-band folded dipole antenna. Ideal for rotor use. Maximum gain on any channel. Alum. construction. Less Mast. Shpg. wt. 8 lbs. Price. \$4.95

MODEL #Y-100
5 element Yagi Hi-Gain beam designed specifically for fringe area use. All alum. construction. Cut to specific channels. Shpg. wt. 4 lbs. Channel #7 \$4.50; Channel #9 \$4.25; Channel #11 \$4.00 and Channel #13 \$3.75. The prices are less mast. "Y" type antenna. Price \$4.25

ANTENNA ACCESSORIES
CM-100 Chimney Mount \$1.50
WV-100 Wall Mount \$1.98
U-100 "Universal" Ant. Mtz. Bkt. Offset to B 3.95
U-200 Same as U-100-But Offset to 12" 6.95
5-ft. 1/2" OD Steel Mast \$1.50
5-ft. 1" OD Alum. Mast \$1.25
1/2" 300-ohm stand-off insulators (fit coax cable) \$3.00 per 100 \$2.00 per 500 \$20.00 per 1000
Best Quality 300-ohm twin lead— Send for prices.
High Quality 72-ohm Coax Cable— Send for prices.
Folded Dipole Hi-Frequency Adapters..... 1.50
Conical Hi-Frequency Adapters..... 1.50
Straight Dipole Hi-Frequency Adapters..... 1.50

TERMS: All shipments F.O.B. Newark, New Jersey. 25% deposit with orders, balance C.O.D. Minimum order \$2.00. Include ample postage.
PRICES SUBJECT TO CHANGE WITHOUT NOTICE.
EAST COAST ELECTRONICS
40 St. Francis Street Newark 5, New Jersey

ELECTRONIC LITERATURE

Any or all of these catalogs, bulletins, and periodicals are available to you if you write to us on your letterhead (do not use postcards) and request them by number. Send coin or stamps where cash is required. We will forward the request to the manufacturers, who in turn will send the literature directly to you. This offer void after six months.

JA-1—AUDAK BROCHURE

The latest brochure issued by the Audak Co. describes their line of Poly-phase and Tuned-Ribbon reproducers, tone arms, and recording cutters.—Gratis

JA-2—RADIO-TV PARTS CATALOG

A 34-page catalog issued by Greylock Electronics Supply Co. lists test equipment, tubes, components, antennas, and other equipment used by service technicians, engineers, and constructors.—Gratis

JA-3—RADIO SHACK CATALOG

Radio Shack Corp. of Boston, Mass., has published its 1951 catalog of electronic parts, complete equipment, and kits. Containing 172 pages, the catalog has major sections devoted to test instruments, public-address and high-fidelity music systems, amateur radio equipment, and electronic components and fittings.—Gratis

JA-4—PARTS CATALOG

Containing approximately 36 pages of switches, connectors, couplers, rectifiers, resistors, capacitors, special transformers, and hundreds of relays, the 1950 catalog issued by Wells Sales, Inc. is a source of special components for new equipment or replacement in military electronic equipment.—Gratis

JA-5—CONTROLS AND RESISTORS

Most types of standard and special controls and resistors are listed in the new Clarostat catalog. Potentiometer-type controls having special shafts, high-voltage couplers, and other features are included along with the standard line of ballasts; Potentiometers; rheostats; fixed, adjustable, and flexible wire-wound resistors; and attenuators.—Gratis

JA-6—AUDIO HANDBOOK

A new edition of Sun Radio's audio equipment handbook is being distributed. A 38-page section is devoted to answering the layman's queries on high-fidelity reproducing equipment for the home. This section is illustrated with photographs and drawings of typical custom installations and includes working drawings showing the construction of typical bass-reflex and corner-type speaker enclosures. The catalog section lists pickups, amplifiers, speakers and enclosures, and other audio equipment.—Gratis

7 HARD TO GET ITEMS AT BIG SAVINGS TO YOU

AMAZING BLACK LIGHT



250-watt ultra-violet light source. Makes fluorescent articles glow in the dark. Fits any lamp socket. For experimenting, entertaining, unusual lighting effects. Ship. wt. 2 lbs. ITEM NO. 87 A SAVING AT \$2.45

LITTLE GIANT MAGNET

Lightweight 4 oz. ALNICO permanent magnet. 1 3/4" x 1 1/2". Lifts more than 20 TIMES ITS OWN WEIGHT! Ideal for hobbyists, experimenters. Shipping weight 3/4 lbs.



ITEM NO. 159 BIG VALUE AT \$1.50

POWERFUL ALL PURPOSE MOTOR

Sturdy shaded pole A.C. induction motor. 15 watts, 3000 rpm. 3"x2"x1 3/4". 4 mounting studs; 3/8" shaft, 3/16" diameter; 110-120 volts. 50-60 cycles A.C. only. When geared down, this unit can operate on 18" turntable with a 200 lb. dead weight. Use it for fans, displays, timers and many other practical purposes. Ship. wt. 2 lbs.



ITEM NO. 147 UNUSUAL BUY \$2.45

WATTHOUR METER

Leading makes — completely overhauled, ready for service. 100-110 volts, 60 cycles, 2-wire A.C. 5 amp. Heavy metal case 8 1/2" x 6 1/4" x 5". Easy to install. Shipping weight 14 lbs. ITEM NO. 33 NOW ONLY \$4.50



WESTERN ELECTRIC BREAST MIKE

Lightweight 1 lb. carbon microphone. Aircraft type. Breastplate mounting, adjustable 2-way swivel. Easily fastened straps. For home broadcasts, communications etc. Complete with 6 foot cord, hard rubber plug. Sheradized plate, non-rusting finish. Ship. wt. 2 lbs. ITEM NO. 152 NEW LOW PRICE \$1.10



TELEPHONE TRANSMITTERS

Genuine transmitters made by Kellogg, Western Electric, Stromberg Carlson. Work on two dry cells for P.A. systems, intercoms, other practical uses. Shipping weight 1 lb.



ITEM 160 REAL VALUE \$2.45

250 POWER TELESCOPE LENS KIT

Make your own high powered 6 ft. telescope! Kit contains 3" diam., .75" focal length, ground and polished objective lens and necessary eye pieces. Magnifies 50x to 250x. Full instructions. Ship. wt. 1 lb. ITEM NO. 123 YOU SAVE AT \$2.95



HUDSON SPECIALTIES CO. 40 West Broadway, Dept. RE-1-51 New York 7, N. Y.

1 am enclosing full remittance for items circled below. Shipping charges included.

OR, my deposit of \$... Ship balance C.O.D. MINIMUM C.O.D. ORDER \$5.00. C.O.D. ORDERS ACCEPTED ONLY WITH 20% DEPOSIT INCLUDE SHIPPING CHARGES.

Circle items wanted 87 159 147 33 152 160 123

Name..... Please Print Clearly

Address.....

City..... Zone..... State.....

AUDIO TRANSFORMERS

ITEM AT566 Input 6 ohms: 250K ohms.....\$7.99
AT 508 Multimatch Sub-ouner 200 ohms/15K ohms C.T.:100K ohms/20K ohms......69
AT070 Input Grid 250 ohms:60K ohms HI F.....1.19
AT566 Input 6 ohms: 20/200 ohms 50K ohms .95
AT227 Output to line, 7500K 500 ohm CT:200-5kcy..... 1.45
AT353 Output PP 616 to 300/20/12/18 ohms 25 Watt..... 2.95
AT871 UNIV. Output, HI F1, Pri 20K ohms Sec. 15/7.5/3/1.75/1.25/500 ohms..... 2.79
AT554 Interstage 150 ohms:250K ohms 15db Level.....1.95
AT765 Input 600 ohms to 50K ohms......79
AT707 Interstage ouner 10K ohms:125K/125K ohms......79
AT750 Input Pri: 15/15 ohm Sec:18/K ohm......59
AT449 Driver BK Ohm..... 1.49
AT449 Driver BK Ohm..... 1.49
MP805 Class B.....3.89

ELECTROLYTICS

Promg Mount D. Y. Type MFD Volt Price
8 450 .25
30 450 .29
30 300 .25
40 450 .30
8-8 450 .40
10-10 450 .40
24-24 400 .45
40-40 400 .70
80-50 450-.50 .69
20 300/250 .60
80-10 450 .69
250 10 1 .98
1000 6 1
20-10 350-300 .40
10-10 450 .29
20 25 .40
10-30 450-400 .59
30 300 .49
10-15 350 .49
20 25 .49
10-50 350-100 .69
100 50 .69
20-20 400 1 .69
20 25 1
20-10 450 .59
50 50 .59
20 150 1 .79
250-100 15 1
40-40 450-150 .79
130 50 .59
40-40 450 .69
90-90 60 1
50-50 150 .49
40 25 .49
50-50 200 .69
40 25 .69
87-40 400 .79
150 50 1
90-90 200 1.10
20 50 .59
120-60 150 1.10
20 25 1

BC-605 INTERPHONE AMPLIFIER
Easily converted to an ideal inter-Communications set for office-home or factory. Original. New w/convertor to Diagram..... \$4.49

WRITE FOR ITEMS YOU REQUIRE
T.U. FOR BCAR 230 OR 430 XMTR
TU-5-1.5-3MC 3.2-4 MC
TU-6-3-4.5MC 5-6.2 MC
TU-7-4.5-6.2MC 1.25-1.5 MC
TU-8-6-7.7MC 1-1.25 MC
TU-9-7-7-10MC 20 50
TU-26-200-500KC Price ea. \$2.79 Full set of 7- \$19.00

GIBSON GIRL
The Emergency Radio Transmitter. Sends S O S signals automatically on 500KC, 150-mile range. No batteries required. Has hand-driven generator, tubes, wire. N.Y.C. it's only...\$3.49

T.V. Trans-former, 7" or 9" scope, 300 Ov / 5 MA, 720Vct 200 MA. 6.4/6.7A 6.4/6A, 5/3A, 1.25/ input. Price. \$3.95

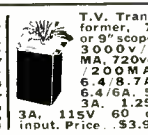

Rated Concerns Send P.O.
Send M.O. or CHK. Mds. Guard. Shpg. Charges Sent C.O.D. Price F.O.B. N.Y.C. Phone Di. 9-4124

COMMUNICATIONS EQUIPMENT CO.
131 Liberty St., Dept. C1 Newark City 7, N. Y.

Join MARCH OF DIMES PATIENT CARE EPIDEMIC AID EDUCATION RESEARCH
JANUARY 15-31

Technical Bulletins

EACH \$1.00 Postpaid Foreign \$1.25

Simplified technical information on many subjects of everyday usefulness, written in simple, easy-to-understand language. They contain no complicated mathematics, chemical and electrical theories, and are not based on the assumption that the reader has had a technical training.

(102) Cleaning Products for Many Purposes—Over 35 effective chemical cleaners that you can make and sell.

(110) Electroplating Non-Metallic Objects—Includes wood, leather, plaster, glass, flowers, insects, fabrics. Complete directions.

(114) Thermostats Easily Made—Designing and making automatic control units of many types for maintaining uniform temperatures, automatic furnace regulation, safety controls to prevent overheating, etc.

(115) Glue Molds for Casting Novelties—Making flexible glue molds for casting small objects, using plastics, magnesite.

(119) Electroplating with Alloys—Bronze, brass and cadmium-silver. Improves finish and provides durable coating.

(123) Mirror Silvering—Make money re-silvering old mirrors and making new ones. Colored, front-surface, transparent and photo mirrors.

(124) Soldering All Metals—Includes aluminum and die-cast alloys. Secrets of using the right flux and correct technique.

(125) Buffing & Polishing—All details on correct polishing. How to select the right abrasive for different kinds of metal. Gives wheel speeds, types and sizes of motors for best results.

(129) Coloring Metals Chemically—Tested formulas and directions to produce durable finishes in many colors on brass, copper, iron, aluminum and their alloys by chemical processes.

(130) Glass-Working Technique—How to cut, drill, grind and mount glass correctly; includes cutting of circles and internal openings.

(132) Working with Plastics—Covers all details of cutting, tooling, bending, cementing and polishing. Enumerates various kinds. Shows how to design articles. Includes using liquid plastics.

(139) Rubber Molds for Casting Novelties—Used for same purpose as glue molds but where greater elasticity is required.

(141) Recording Thermometer—How to make device to record room temperatures over 12-hour periods on a disk. Has alarm-clock mechanism.

(146) Simplified Casting Methods—Making small castings of soft metals without use of sand molds. For novelties, toys, etc.

(147) Drills and How to Use Them—How to use drills in different metals, plastics and other materials. How to sharpen correctly. Includes charts giving speeds and rate of drilling.

(149) Electroplating with Copper, Nickel, Chromium, Zinc, Lead and Cadmium—Enables anyone to do this fascinating work on a small scale.

(156) Home-Maintenance Formulas & Repairs—Includes a large number of simple, effective solutions for everyday household problems.

TECHNIFAX, 520 N. Michigan Ave. Chicago 11, Ill.

Enclosed find \$ for which send the following Technical Bulletin of \$1.00 each (Foreign \$1.25) as indicated by numbers:

Name _____

Address _____

City & State _____

RE-1-51

Walter A. Buck, vice-president and general manager of RCA Victor Division, was elected to the board of directors of the RADIO CORPORATION OF AMERICA. He succeeds Edward J. Nally who retired. Mr. Buck joined RCA in 1948 upon his retirement as a rear admiral in the U.S. Navy. He was president of the Radiomarine Corporation of America until July 7, 1949, when he was elected operating vice president of RCA Victor Division.

M. A. Acheson, former chief engineer of the SYLVANIA RADIO TUBE DIVISION,



M. A. Acheson

was transferred to the staff of E. Finley Carter, vice president in charge of engineering in New York. R. P. Clausen, former assistant chief engineer, succeeds him as chief engineer. Sylvania also announced the appointment of Walter R. Seibert as controller. Mr. Seibert was formerly assistant to the controller.

W. S. Parsons, vice president in charge of sales at the Centralab division of GLOBE-UNION, INC., announced the following promotions: Wickham Harter to sales manager of mechanical-electronic products,



W. Harter

including the sales activities of the variable resistor and switch divisions; Douglas Thatcher to sales manager of ceramic-electronic products; and Robert A. Mueller to sales assistant to Mr. Harter.

Dr. Irving Langmuir, recently retired associate director of the GENERAL



I. Langmuir

ELECTRIC RESEARCH LABORATORY, was awarded the John J. Carty Gold Medal of the National Academy of Sciences for noteworthy contributions to the advancement of science. The award may not be made

more often than once in two years. Dr. Langmuir also holds the Nobel Prize in Chemistry, the Faraday Medal of the British Institute of Electrical Engineers and many other awards.

Glen McDaniel of RCA was appointed Chairman of the RTMA Defense Profits Tax Committee, which will consider effects of the proposed excess-profits tax on the radio-TV industry. Other members of the committee are: Max F. Balcom, SYLVANIA; J. E. Cain, P. R. MALLORY; B. L. Graham, DU MONT; Herbert C. Hamilton, HYTRON; Raymond Herzog, EMERSON; Edward L. Hulse, GENERAL ELECTRIC; W. Myron Owen, AEROVOX; M. G. Paul, PHILCO; Ernest Searing, IRC; Robert C.



TV REMOTE TUNER
for all makes and models T.V. sets

- Easy to Build
- Guaranteed to work

1. Operates up to 100' from set.
2. Remote station selection, fine tuning, volume contrast.
3. No Re-Radiation or local interference.
4. Frequency response distortion is minimized.
5. R.M.A. guarantee on all parts.
6. Uses a standard coil tuner.
7. Complete instructions & wiring diagram.
8. All parts, connections, cabinet etc. included in kit.
9. Adaptable to F.M. Pix. expander, etc.
10. Easily assembled & installed.

- A. KIT (All parts Complete) . . . \$19.95
 B. TUNER (Standard Coil) . . . 18.95
 C. COMPLETELY WIRED-IN, ready to install . . . 45.95
- \$37.95**
(Combined Kit A-B)
Prices Net

PRAGER'S Visible Inventory R/C PARTS-RACK

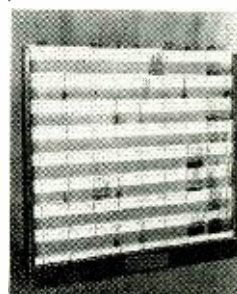

- No need to search for Resistors or Condensers.
- Holds full complement of Resistors and Condensers, Parts, etc.
- 64-2" compartments, all marked, enclosed in a finished wood frame.
- Ready to Use.
- Helps keep perpetual inventory.
- May be hung on wall or placed on bench.
- Used by leading Radio, Television, Service Laboratories, Fies, Experimenters, etc.

Now only \$4.35

Television Technical Slides—Motion Pictures

35mm—MOUNTED 2x2 BLACK & WHITE

1. Television Alignment set of 27 slides \$4.95
2. Waveform Analysis set of 52 slides 9.95
3. Tuners, etc. set of 32 slides 5.35
4. Individual request slides slide .20

16mm MOTION PICTURES BLACK & WHITE

1. Procedure of Television Alignment 858 feet—Sound—33 minutes \$98.95
2. Waveform Analysis 610 feet—No Sound—23 minutes 78.95 (complete with script for instruction uses)

Send for free catalog and literature.

Mail orders filled on receipt of 25% deposit. Balance C.O.D. F.O.B. Los Angeles.

PRAGER MFG. & DIST. CO.
3201 S. La Cienega Blvd., Los Angeles 34, Calif.

BETTER TV RECEPTION

THE "Fringe Area TV" Reference Book

TV signal propagation, evaluation of TV antenna, making a TV signal survey, types of masts and towers and recommended installation practices. Full data on rhombics, how to use open-wire feed line, how to eliminate ghosts, minimizing fading, TVI, etc.

By W. W. Smith and R. L. Dawley

\$2.50

PER COPY — By mail, \$2.60 postpaid.

AT YOUR FAVORITE DEALER

OR DIRECT BY MAIL FROM
Editors and Engineers

1305 KENWOOD ROAD, SANTA BARBARA, CALIFORNIA



TWIN-TRAX TAPE RECORDERS



...give you more

MORE MODELS

the most complete variety of recorders for professional, semi-professional and experimenter use.

MORE FEATURES

for better quality, smoother performance and easier operation.

MORE VALUE

because our direct sales policy saves you dealer markups.

Send today for our catalog 5109 which lists complete technical specifications and performance ratings for all recorder models and accessories. *Trademark Reg.

AMPLIFIER CORP. OF AMERICA
398 Broadway New York 13, N. Y.

Every RADIOMAN can use these SERVICE HINTS!

Valuable Manual Yours—FREE
Write today—no obligation.

FEILER ENGINEERING CO.
1601 S. Federal St.

Every page of "How to Simplify Radio Repairs" is packed with on-the-bench, practical ideas.

Dept. 1RC1-1
Chicago 16, Ill.

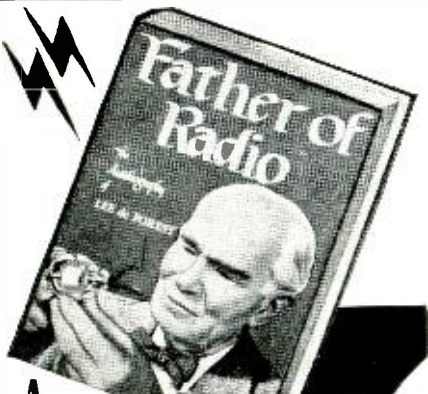

Autobiography of LEE de FOREST Father of Radio

Here's your "code" to radio communications history by the man who made it—Lee de Forest!

In this dramatic life-record of the inventor of the radio vacuum tube, you'll read in his own words a thousand behind-the-scenes facts of radio's Historic Firsts — all aimed to interest "wireless hams," radio and television fans.

528 pages with 16 pages of 6" by 9" photographs. Send now for this great autobiography.

ORDER YOUR COPY TODAY Satisfaction Guaranteed.

Enclosed find \$____, please send ____ copies postpaid.

Name _____

Address _____

City _____

State _____

Wilcox & Follett \$5.
Dept. REF • 1255 So. Wabash • Chicago, Ill.

WAR EQUIPMENT MAIL SALE!

SAVE up to 70% on Electronic, Radio, Mechanical Equipment!

For home experimenters, laboratories, schools, etc. New fully guaranteed. Fraction of original cost. 1000s of items including:

- 2500-w, 60-c, 110-v Plants \$289.20
- 1500-w, 400-c, 110-v (A-C Plant) 129.60
- 1000-w, 800-c, 115-v generator 18.96
- G. E. Wall Heater, 3000-w, 110-220-v 26.80
- Genera Electric Selsys (pair) 3.39
- Raytheon 110-v Electric Timer 8.94
- Meg-A-Lite Continuity Tester 1.99
- Resistor Capacitor Asst. 4 lb. 1.89
- City Desk Telephones 5.98
- Photo Cell Light Control Kit 4.87
- Other bargains—Compressors, Paint Spray Guns, Engines, Pumps, Tools, etc.

18 yrs. in business in Lincoln. Satisfaction Guaranteed. We prepay all shipments.

Card brings catalog. 1000s of bargains.

BURDEN SALES COMPANY
843 "O" ST. LINCOLN, NEBR.

OPPORTUNITY AD-LETS

Advertisements in this section cost 25c a word for each insertion up to and including the March 1951 issue. Beginning with the April 1951 issue the rate will be 35c a word for each insertion. Name, address and initials must be included at the above rate. Cash should accompany all classified advertisements unless placed by an accredited advertising agency. No advertisement for less than ten words accepted. Ten percent discount six issues, twenty percent for twelve issues. Objectionable or misleading advertisements not accepted. Advertisements for February, 1951, issue, must reach us not later than December 24, 1950.

Radio-Electronics, 25 W. Broadway, New York 7, N. Y.

REPRESENTATIVE—Long Island, New York. One million people (equal to Boston). This vast area requires resident coverage. We cover dealers and jobbers like a blanket. Radio, TV supplies only. Ten years experience. Box D1-1, c/o Radio-Electronics, 25 W. Broadway, New York 7, New York.

SPEAKER REPAIRS at wholesale prices. Guaranteed work. Amprite Speaker Service, 70 Vesey St., New York 7, N. Y.

MAGAZINES (BACK DATED)—FOREIGN, DOMESTIC arts, Books, booklets, subscriptions, pin-ups, etc. Catalog free (refunded). Greerone's, 86-22 Northern Blvd., Jackson Heights, N. Y.

WE REPAIR, EXCHANGE, SELL, ALL TYPES OF electrical instruments, tube checkers and analyzers. Hazleton Instrument Co. (Electric Meter Laboratory), 140 Liberty Street, New York, N. Y. Telephone—BARLEY 7-4239.

LANCASTER, ALLWINE & ROMMEL, 436 BOWEN Building, Washington, D. C. Registered Patent Attorneys Practice before United States Patent Office. Validity and Infringement Investigations and Opinions. Booklet and form "Evidence of Conception" forwarded upon request.

WANTED: AN/APR-4, other "APR", "ARR", "TS", "IE", ARC-1, ARC-3, everything Surplus. Special tubes, Tech Manuals, Lab quality Test Equipment, etc. Describe, price in first letter. Littell, Fairhills Box 26, Dayton 9, Ohio.

RADIOMEN, SERVICEMEN, BEGINNERS — MAKE more money, easily, quickly. \$250 weekly possible. We show you how. Information free. Merit Products, 216-32L 132nd Avenue, Springfield Gardens 13, New York.

TECHNICIANS !! ENGINEERS !! Interested in a top-paying electronic position? ? Send post card for information on HOW, WHY, WHERE, MID (MONTGOMERY RESEARCH BUREAU, P. O. Box 121, Wichita, Kansas.

RADIO — TELEVISION — ELECTRONICS — TUTORING \$5 per lesson—Mo. Tech., 3907 North 25th Street, St. Louis 7 Missouri

AUTOMATIC ANTENNA MATCH—Inu spacing line to any load! TV or "ham". Send dime for details. A. L. Muzig, (ex-W6BY), Hawthorne, Calif.

AMATEURS—RADIO AND ELECTRICAL RESEARCH Engineering, Hy Twillmann, R.R. #1, Chesterfield, Mo.

Print Your Own
Cards, Stationery, Advertising, Circulans and Titles. Save money. Print for Others. Good Profit! easy rules. Have home print shop. Raised printing like engraving, too. Sold direct from factory only. Write for free catalog of outfits and all details.
KELEY PRESSES, P-97, Meriden, Conn.

Tait, STROMBERG-CARLSON; Robert C. Sprague, SPRAGUE PRODUCTS. James M. Toney, advertising manager of RCA Victor home instruments department, was promoted to the post of director of public relations of the RCA Victor Division. Thomas J. Bernard continues as assistant director of public relations. RCA also announced the promotion of Warren E. Albright to the post of manager of the general materials division for the company's home instrument department. M. S. Klinedinst was named manager of the industrial equipment sales section of the RCA engineering products department. Lawrence C. F. Horle, prominent in the standardization of radio engineering and equipment, died in St. Barnabas Hospital, Newark, N. J., at the age of 58. Mr. Horle was best known for his work in the field of standardization of terminology and ratings. He was a past president of the IRE and more recently chief engineer and director of the data bureau of the RMA (now RTMA).

Personnel notes

... Charles Edward Wilson, president of GENERAL ELECTRIC Co., was named by President Truman to the 24-man National Science Foundation for the encouragement of basic research.
... Brig. Gen. David Sarnoff was appointed national chairman of the 1951 Red Cross Fund Campaign.
... Larry F. Hardy, president of PHILCO's radio and television division, was elected chairman of the RTMA Public Relations Committee.
... Charles W. Creaser and Kenneth S. Brock were appointed special products sales manager and commercial sales manager of WORKSHOP ASSOCIATES, INC.
... Shannon C. Powers was named general sales manager of RUSSELL ELECTRIC Co., a subsidiary of RAYTHEON MANUFACTURING Co.
... C. M. Breckenridge was appointed assistant to the controller of the SIMPSON ELECTRIC Co.
... Owen K. Lindley and James H. Sweeney were named sales managers for electronic heaters and germanium diodes in the commercial equipment division of GENERAL ELECTRIC.
... Dr. Vladimir K. Zworykin, vice president of RCA LABORATORIES, was awarded the 1950 Progress Medal of the Society of Motion Picture and Television Engineers, the society's highest award, for contributions in a new field.
... John Wood and William Newitt have joined the engineering staff of ELECTRO-VOICE, INC.
... Hulbert C. Tittle was promoted to assistant chief engineer of the Radio & Television Division of SYLVANIA ELECTRIC PRODUCTS in Buffalo, N. Y.

ON-THE SPOT BATTERY RECORDER
WALKIE-RECORDALL 8 in. miniature BATTERY RECORDER-PLAYBACK
Continuous, permanent, accurate, indexed recording at only 5c per hr. Instantaneous, permanent playback. Picks up sound up to 60 ft. Records conferences, lectures, dictation, 2-way phone & sales talks; while walking, riding or flying. Records in closed briefcase with "hidden mike"! Write for details.
MILES REPRODUCER CO., INC.
812 BROADWAY Dep't RE2 NEW YORK 3, N. Y.

TELE SERVICE DATA SLOW

Dear Editor:

Several months ago I finished a course in radio and television, and am now doing part time work in radio with the ambition to go into it full time. I have not been able to obtain servicing data for several new sets of different manufacture without a great waste of time. If manufacturers would make servicing data available, we could service some of the more difficult sets quickly, saving the owner time and money, and make these same owners proud to do a lot of advertising for the manufacturers, instead of grumbling how much it costs to service their sets.

I wish to give you my heartfelt thanks for all you have done, especially your recent editorial, "Manufacturers vs Service Technicians," and hope that you will continue.

EMIL KALAR

South International Falls, Minn.

SEPARATE MEN FROM BOYS?

Dear Editor:

Those technicians who argue that there are too many articles on TV in your magazine make me think of those who argue against the code test as a requirement for an FCC license. If these groups of people would expend one-tenth the energy in studying TV or code that they waste in fighting it, they would get off much easier and know a lot more to boot. Moreover, they would be increasing their earning power and enabling themselves to stay in the electronics field instead of being "washed out" and relegated to repairing electric irons and 117-volt cords.

On the other hand, it may be just as well. TV, code, etc., may be the instruments by which the men in electronics are separated from the boys!

PETER N. SAVESKIE

Baton Rouge, La.

CORRECTION

The value of resistor R7 was not given on the diagram of the remote amplifier on page 26 of the October, 1950, issue. This resistor is a 150,000-ohm, 1/2-watt unit. The value of R8 is incorrect on the diagram. The correct value is 50,000 ohms, 10 watts.

We thank the author, Mr. R. G. Finkbeiner, for this correction.

The author of the article "A High-Gain Amplifier," in the September, 1950, issue is listed as James Rundo. His correct name is John Rundo.

Stop listening to DISTORTED MUSIC



The connoisseur of music listening wants to recognize the clear brilliance of symphonic sound and

BROOK
All Triode High Quality
AUDIO AMPLIFIER
Gives It To Him



(Illus. Model 10C-30 watts)
Also available: Model 12A-10 watts.

with

- Distortion and intermodulation at a new low.
- Reduction of listening fatigue.
- Brilliant, clear tone.
- Separate controls-stepped-for Bass and Treble.
- Extremely low volume without any loss of quality.

Write TODAY for FREE Technical Bulletin and Detailed Distortion Analysis

BROOK ELECTRONICS, Inc.
Sales Agent
Dept. EA-1, 34 De Hart Place, Elizabeth, N.J.

MIDWEST
Presents its NEW 1951 Line of
Mammoth New 19 1/2-Inch
TELEVISION
and
5 WAVE BAND RADIOS
In Beautiful Console and Complete Chassis



MAMMOTH
19 1/2-Inch
PICTURE

30 DAYS TRIAL

EASY TERMS

Midwest offers a complete line of 19 1/2" and 16 1/2" Television models in consoles, console combinations, and ready-to-use chassis complete with 12" speaker. Don't buy any radio or television receiver until you've seen the new 1951 Midwest line—the finest in 31 years.

BUY DIRECT FROM THE MIDWEST FACTORY

SEND THIS COUPON ON 1c POST CARD FOR NEW 1951 FREE 4 COLOR MIDWEST CATALOG

MIDWEST RADIO & TELEVISION CORP.
Dept. 38-G, 909 Broadway, Cincinnati 2, Ohio

NAME _____
ADDRESS _____
CITY _____ ZONE _____ STATE _____

RED ARROW KIT SALE!

IMMEDIATE DELIVERY ON ALL ITEMS
(Manufacturers: ask for our quantity prices.)

- Kit of 50 assorted **KNOBS** \$1.19
- Kit of 25 **TRIMMERS**—single, dual and triple sections 79¢
- Kit of 10 assorted **VOLUME CONTROLS** \$2.79
- Kit of 100 assorted **MICA and CERAMICON CONDENSERS**. 4.75
- Kit of 100 assorted **PAPER TUBULAR CONDENSERS**—from 200 to 800 V 5.75
- SPECIAL! 300 ohm TWIN LEAD TV LINE**, per 100 ft. \$3.89

MINIMUM ORDER—\$2.00. Send 25% deposit with order, balance C.O.D. Shipped F.O.B., N.Y.C. (N.Y.C. residents add 2% sales tax.)

RED ARROW SALES
DEPT. E, 63 EAST BROADWAY, N. Y. 2
PHONE Cortlandt 7-5425

Just Published!

TELEVISION SERVICING

by Walter H. Buchsbaum

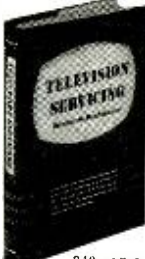

340 pages
170 illustrations



Symptoms of defective operation easily recognized, quickly corrected by illustrations, diagrams and how-to-do-it facts in this new book.

Get this brand new, complete handbook for sure-fire working knowledge of TV installation, maintenance and troubleshooting. Tells you step-by-step procedures for audio IF alignment, video IF alignment, aligning RF amplifiers, mixers, oscillators, etc. All possible defects classified for ready reference, thoroughly analyzed to show what is wrong and why . . . and what to do to correct the defect. No mathematical knowledge needed! Practical, authoritative, up-to-the minute, the perfect handbook for set owners, trainees, and repairmen.

WHERE RADIOMEN MEET, EAT and SLEEP

Visit the **FAMOUS FIESTA LOUNGE** Renowned for Fine Food



HOTEL STRAND
Atlantic City's Hotel of Distinction

The Ideal Hotel for Rest and Relaxation • Beautiful Rooms • Salt Water Baths • Glass inclosed Sun Porches • Open Sun Decks atop • Delightful Cuisine • Garage on premises. • Moderate Rate Schedule.

OPEN ALL YEAR

Exclusive Pennsylvania Ave. and Boardwalk

USE IT 10 DAYS FREE

Coupon below brings you "Television Servicing" on FREE trial for 10 days, without obligation. Mail it NOW.

PRENTICE-HALL, Inc., Dept. M-RE-151
70 Fifth Ave., New York 11, N. Y.

Send me, for 10 DAYS' FREE TRIAL, "Television Servicing." I will return it in ten days and pay nothing—or keep it and send \$1.35 down (plus postage) and \$2 monthly for 2 months.

NAME _____
ADDRESS _____
CITY _____ STATE _____

SAVE! Send \$5.95 with this coupon, and we'll pay postage and packing.

ENTER RADIO-TV thru *This Plan-*

As a young man with a career to build, you may *today* be interested primarily in training for Radio — and perhaps for TV. But — *who knows . . .* you may some day have both the desire and opportunity to climb further and become an Electrical Engineer! Here, then, is a world-renowned educational *plan* that permits you to use your Radio training as a *major stepping-stone* to an even greater career.

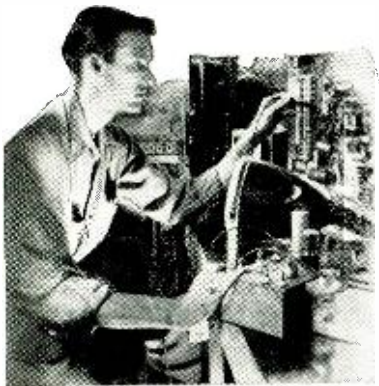

IN 12 MONTHS... become a RADIO TECHNICIAN

You are trained here for functions such as Radio shop operator or Serviceman, Supervisor of service personnel, and Serviceman for Mobile Receivers and all types of Transmitters. The Radio Technician's certificate is awarded. You may then advance immediately or at any future date into courses described below.

IN 6 ADDITIONAL MONTHS you become a RADIO-TELEVISION TECHNICIAN

On completion of the Radio-TELEVISION Technician's course, you are equipped for opportunities in Television — America's fastest growing industry. You are trained for such work as Radio-TV Service—Audio, Transmitter or Communication Technician—and Broadcast Operator (upon passing FCC examination).

ALSO...your radio course is full credit toward a B.S. degree in ELECTRICAL ENGINEERING

Your Radio Technician's course, while complete in itself, is also *one-third* of the program necessary to achieve the Electronics major (with a minor in Electrical Power). In the final stage of this college program you receive an added, important service... your aptitudes and desires are analyzed scientifically — thus guiding you to choose specialized preparation for design or research — manufacturing production — or engineering sales and management.

• Over 1500 students, from all states and 23 foreign countries, annually enrolled in this 47-year-old nonprofit school. Over 35,000 alumni. Faculty of 85 specialists. Terms open April, July, October, January.

• Military, practical or prior academic training will be evaluated for advanced credit. Preparatory and refresher courses available. Laboratory training, on modern equipment, is given immediately and in each term.

MILWAUKEE SCHOOL OF ENGINEERING

Technical Institute • College of Electrical Engineering

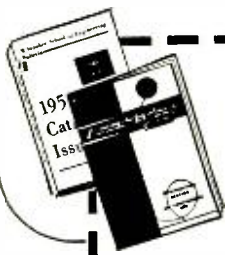

FREE—
Write today for helpful "Occupational Guidance Bulletin" and 1951 catalog. If possible, state course having your interest.

MILWAUKEE SCHOOL OF ENGINEERING
Dept. RE-151, 1020 N. Broadway, Milwaukee, Wis.
Without obligation, rush following: 1951 Catalog; Occupational Guidance Bulletin on Radio Television Electrical Engineering (Electronics) Electrical Service Electro Technician Heating Electrical Engineering (Power) Refrigeration Air Conditioning Welding.

Name.....Age.....

Address.....

City.....Zone.....State.....

Check if World War II Veteran

RADIO SCHOOL DIRECTORY

Your Future in RADIO-TV

Your future in radio-TV begins *right now*, with proper training. The Don Martin School of Radio Arts, established in 1937, offers the training you want . . . for every type of job in Radio-TV—script writer, announcer, disk jockey, newscaster, technician. Free job placement service for graduates. Day and night classes. . . . Write for our FREE booklet, "YOUR FUTURE IN RADIO." Approved for veterans.

Don Martin School of Radio Arts
1655 No. Cherokee, Hollywood 28, Calif. HUdson 23281



RADIO COURSES

Preparatory Mathematics, Service, Broadcast, Television, Marine Operating, Aeronautical, Frequency Modulation, Radar.

Classes now forming for the
Mid-Year term beginning Feb. 1st
Entrance exam, Jan. 15th
Veterans. Literature.

COMMERCIAL RADIO INSTITUTE
(Founded 1920)
38 West Biddle Street, Baltimore 1, Md.

LEARN DAY and EVENING CLASSES

TELEVISION

ELECTRONICS-RADIO
Modern Laboratory Instruction in

- SERVICING
- BROADCAST OPERATING
- ELECTRONIC and TV ENGINEERING

**G.I.
APPROVED**

WRITE FOR CATALOG

ELECTRONICS INSTITUTE, Inc.
21 HENRY, DETROIT 1, MICH.

RADIO ENGINEERING 27 MONTHS DEGREE IN 27 MONTHS

Intensive, specialized course including strong basis in mathematics and electrical engineering, advanced radio theory and design, television, Modern lab. Low tuition. Self-help opportunities. Also 27-month courses in Aeronautical, Chemical, Civil, Electrical, and Mechanical Engineering. Approved for G.I.'s. Enter March, June, Sept., Dec. Catalogue.

INDIANA TECHNICAL COLLEGE
151 E. Washington Blvd., Fort Wayne 2, Indiana

AUDIO ENGINEERING SCHOOL

Practical engineering training in Audio fundamentals, Disc, Film, Magnetic Recording, and Audio frequency measurements. Studio training simulates Broadcast, Motion Picture, Television, and Commercial Recording work. Approved for Veterans.

HOLLYWOOD SOUND INSTITUTE, Inc.
1040 E. North Kenmore, Hollywood 27, Calif.
Specify if Veteran or Non-Veteran

RADIO-ELECTRONICS for

RADIO Engineering

Complete Radio Engineering Course incl. Telev., U.H.F., and F.M. B.S. Degree Courses also in Civil, Elect., Mech., Chem., and Aero. Eng.; Bus. Adm., Acct. Visit campus, see well equipped labs. Low cost. Prep. courses. Personalized instruction. Grads successful. Founded in 1884. Enter Jan., March, June, Sept. Write for catalog.

DEGREE IN 27 MONTHS

TRI-STATE COLLEGE
2411 COLLEGE AVENUE ANGOLA, INDIANA

RADIO ENGINEERING

FM—Television—Broadcast

Police Radio, Marine Radio, Radio Servicing, Aviation Radio and Ultra High mobile applications. Thorough training in all branches of Radio and Electronics. Modern laboratories and equipment. Old established school. Ample housing facilities. 7 acre campus. Small classes, enrollments limited. Our graduates are in demand. Write for catalog.

Approved for Veterans

VALPARAISO TECHNICAL INSTITUTE
Dept. C VALPARAISO, INDIANA

TELEVISION

PREPARE FOR A GOOD JOB!
COMMERCIAL OPERATOR (CODE)
RADIO SERVICEMAN
TELEVISION SERVICING
BROADCAST ENGINEER

Approved for Veterans
SEND FOR FREE LITERATURE

BALTIMORE TECHNICAL INSTITUTE
1425 Eutaw Place, Dept. C, Baltimore 17, Md.

TELEVISION

Laboratory and theoretical instruction covering all technical phases of Radio, FM, Television. Leads to opportunities in Broadcasting, Industry or Own Business.

TOTAL TUITION \$450. NO EXTRAS.

Morn., Aft., or Eve. Small Weekly Payments.
Approved for Veterans. Enroll Now.

RADIO-TELEVISION INSTITUTE
Pioneers in Television Training Since 1938
480 Lexington Ave., N. Y. 17 (46th St.)
Plaza 9-5665 Licensed by N. Y. State

AUDIO (SOUND) ENGINEERING
HOME STUDY TRAINING

Practical, easy-to-understand lessons, written by competent Audio Engineers and Educators, prepare you for a better job and a good future in the Television, Radio, Motion Picture, and Recording Industries.

Write today for details—Learn while you earn!!

HOLLYWOOD TECHNICAL INSTITUTE
Div. RE
4925 Santa Monica Blvd. Hollywood 27, California

RADIO COURSES

- RADIO OPERATING • CODE
- RADIO SERVICING • ELECTRONICS
- F.M. TELEVISION

Preparation for Civilian, Maritime, Army and Navy license requirements.
Write for Catalog TE

Y.M.C.A. TRADE & TECH. SCHOOL
229 W. 64 St., N. Y. 23
EMdicoft 2-8117

Learn TELEVISION RADIO—ELECTRONICS

Prepare for own business or a good paying job. Radio Training Approved for Veterans.

3 BIG RADIO-TV BOOKS FREE!

SEE OUR LARGE AD ON PAGE 13

Sprayberry Academy of Radio
Dept. 20-S, 111 N. Canal St., Chicago 6, Ill.

TELEVISION, VOLUMES V and VI, edited by Alfred N. Goldsmith, Arthur F. Van Dyck, Robert S. Burnap, Edward T. Dickey, and George M. K. Baker. Published by RCA Review, Princeton, N. J. 6 x 9 inches. Vol. V, 461 pages; Vol. VI, 422 pages. Price \$2.50 per volume.

The two volumes contain a collection of papers by RCA research workers, and cover practically all RCA's published work on the subject over the years 1947-1950. In some cases summaries are given.

The two volumes represent an originally projected Volume V, which was to cover 1947-49, but the tremendous amount of work on television (including color) during that period produced far more material than could be contained in a single volume. The period was extended to June, 1950, and two volumes were published.

RADIO AND TV INDUSTRY RED BOOK. Replacement Parts Buyers Guide (Second Edition). Compiled and published by Howard W. Sams & Co., Indianapolis, Ind. 11 x 8½ inches, 623 pages. Price \$3.95.

Like the first edition which appeared in 1948, this book is designed to give the service technician in one volume instant reliable data on replacement parts. It lists parts for approximately 20,000 sets made from 1938 to 1950.

The format is the same as for the first edition. Model numbers are listed down the left side of each left-hand page and repeated on the right side of the opposite page, leaving a 19-inch line for listing replacement parts. Divided into seven sections: Tube Complement and Dial Light, Capacitors, Transformers, Phono Cartridges, I.F. Coils, Speakers, and Controls. The line lists the part numbers of one to four manufacturers, including the original replacement part number. Thus the part or its equivalent can be ordered from the most convenient source. The equivalent listings may be very useful in the face of parts shortages.

TV ELECTROMAGNETIC SERVICING COURSE

Practical Shop and Laboratory Training at **Largest Resident TV School in the East!**

Also **RADIO SERVICE & REPAIR, F-M & TELEVISION**
Preparation for F. C. C. LICENSE EXAMS

★ Approved for Veterans ★

DELEHANTY SCHOOL of TELEVISION
105A EAST 13th STREET • NEW YORK 3, N. Y.

CODE SENDING RECEIVING SPEED

Be a "key" man! Learn how to send and receive messages in code by telegraph and radio. Commerce needs thousands of men for jobs. Good pay, adventure, interesting work. Learn at home quickly through famous Candler System. Qualify for Amateur or Commercial License. Write for FREE BOOK.

CANDLER SYSTEM CO.
Dept. 3-A, Box 928, Denver 1, Colo., U.S.A.

RCA RADIO and TELEVISION

Thorough Training in All Technical Phases

APPROVED FOR VETERANS

DAY—EVENINGS WEEKLY RATES
FREE PLACEMENT SERVICE FOR GRADUATES
For Free Catalog Write Dept. RC-51

RCA INSTITUTES, Inc.
A Service of Radio Corporation of America
350 WEST 4TH STREET NEW YORK 14, N. Y.

NOW! BECOME EXPERT AT RADIO-TELEVISION IN 4 EASY STEPS!



Complete Self-Training Course in RADIO and TV by Famous Experts—Takes You BY SIMPLE STEPS From Basic Theory to Problems of Repair, Installation, Color TV, etc.

NOW you can do ANY Radio-TV installation, service, or repair job like an expert; operate field-testing equipment; understand problems of TV, FM-AM transmission, etc. Step into a good-paying job—or start your own service business. Train yourself AT HOME . . . IN SPARE TIME . . . with the McGraw-Hill Basic Course in Radio and TV.

2296 Pages—1611 Illustrations
Complete 4-volume course by outstanding experts. Every detail clearly explained. Over TWO THOUSAND PAGES of step-by-step instruction. SIXTEEN HUNDRED "how-to-do-it" illustrations, cross-section diagrams, etc. "Trouble-shooting" charts show how to diagnose any radio or TV breakdown. how to repair it expertly and quickly.

Pays for itself many times over. Can qualify a beginner for FCC's 1st-Class License test; shows experienced technician new tricks.

SEND NO MONEY
Mail coupon to examine complete four-volume course FREE for 10 days. No obligation. WITH COURSE, you get ABSOLUTELY FREE (to keep whether or not you keep course) valuable illustrated book, "Successful Soldering." (Reg. price: \$2.00)

Or you may examine individual books FREE for 10 days by checking proper boxes in coupon. Mail coupon at once!

PARTIAL CONTENTS ESSENTIALS OF RADIO.
800 pages, 433 illus. (Circuit Analysis • Vacuum Tubes • Circuits: Detector • Amplifier • Tune Oscillator • Power Supply • Transmitting, Receiving • Etc.)

ELEMENTS OF RADIO SERVICING.
475 pages, 375 illus. Multimeters • AC Power Supply • Speakers • Antennas • Auto Radios • Push-Pull Output Stage

BASIC TELEVISION.
592 pages, 415 illus. Scanning • Synchronizing • Video Signal • Brightness Control • D-C Reinsertion • Picture • FM Alignment • Picture Tubes • VHF and UHF transmission • Reception

TELEVISION SERVICING.
429 pages, 388 illus. Antennas • Transmission Lines • Test-pattern and Picture Analysis • Localizing Reception Troubles • Interference Remedies • Deflection Circuits . . . AND MUCH MORE!

FREE 10-DAY TRIAL COUPON

McGraw-Hill Book Co., Inc., Dept. RE-1,
327 West 41st St., New York 18, N. Y.

Send me for 10 days' FREE EXAMINATION:
 McGraw-Hill's Basic Course in Radio & TV . . . including Essentials of Radio, Elements of Radio Servicing, Basic Television, Television Servicing (Total retail price of four books \$22.50—Special Course Price: Only \$19.95 in easy installments)! Also send, ABSOLUTELY FREE, "Successful Soldering." If not satisfied, I will return books; pay nothing; and keep "Successful Soldering" free. Otherwise, I will send only \$1.95 plus postage then; and balance in 6 monthly installments of only \$3.00 each.

If you wish to examine books individually, check below the ones you wish for 10 days' FREE EXAMINATION:

<input type="checkbox"/> Essentials of Radio, \$6.00	<input type="checkbox"/> Elements of Radio Servicing, \$4.50
<input type="checkbox"/> Basic Television, \$6.50	<input type="checkbox"/> Television Servicing, \$5.50

For each book I keep, I will send \$2.00, plus postage, within 10 days; balance in easy monthly installments.

Name.....
Address.....
City..... State..... RE-1

WE PAY POSTAGE if you enclose first payment of \$1.95 when ordering course, or full price of book when ordering individual books (prices above). Same 10-day Return-Refund Privilege.

The Biggest Tool Kit Value in the Whole World of Television!

JFD TV ALIGNING TOOL KIT

MADE OF UNBREAKABLE NYLON

NO. TK 60 LIST PRICE \$3.95
12 Essential Tools in One Handy Kit



Another JFD first... moulded of tough, unbreakable Nylon to provide the best combination of strength and durability. Each of the six-tools furnishes two different tuning tips, for a total of 12 separate aligning ends to suit every TV or FM servicing adjustment. Each tool has a different color for easy identification. Packed in a handy plastic case.

Each Tool Is Available Separately As Follows:

- JFD TV All-Purpose Aligning Tool; for tuners, trimmers and IF transformer adjustments. No. 5-73. List, Each 45¢
- JFD TV I.F. Oscillator Aligner; for I.F. midjet transformer and oscillator adjustments. No. 5-74. List, Each 75¢
- JFD TV Extra Long Aligner; for tuning nested iron cores that are difficult to reach. No. 5-78. List, Each 95¢
- JFD TV Midget Duplex Aligner; for tight, difficult adjustments where space is limited. No. 5-79. List, Each 65¢
- JFD TV Aligning Wrench; for K-Tran and Midget I.F. transformers. No. 5-80. List, Each 75¢
- JFD TV Tuning Rod; a vital necessity, extra thin and flexible. No. 5-81. List, Each..... 75¢

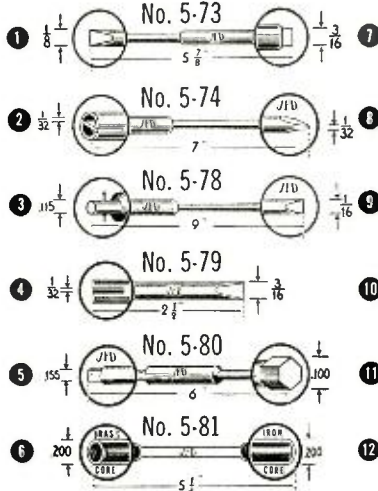

JFD MANUFACTURING CO., Inc. 6117 16th Ave., B'klyn 4, N. Y.
"The 'Exclusiveness' Of JFD Is The Quality Of Its Products"

Be First in TV COLOR

Profits!

Watch for HY-GRADE'S spectacular exclusive scoop on the *newest invention* in COLOR TELEVISION Accessories—in next month's issue! It's your biggest money-making opportunity in TV!

WRITE FOR DETAILS NOW

Send us your name and address on a post card *right now!* We'll mail you the complete details about this sensational new invention on January 15th—a full 2 weeks before the ad itself appears. Then you'll be first to know all about it—and first to cash in on it!

Only HY-GRADE has this terrific new profit-maker! Don't miss this chance-of-a-lifetime to be in on the ground floor—*first* in COLOR TELEVISION in your community! SEND YOUR POST CARD NOW!

Hy-Grade Electronics, inc.
Dept. C, 1509 EAST NEW YORK AVE., BROOKLYN 12, N. Y.
National Distributors of Electronic Parts and Equipment

RADIO TUBES

At bargain prices
Also complete stock of radio parts at low prices
Write for price list

OREGON BARGAIN SUPPLY

Box 31 La Grande, Oregon

TOP DOLLAR \$ \$ \$ for your Surplus TUBES

Receiving • Transmitting • Industrial
New or Renewed from equipment. Immediate Payment.
Send your List & Prices NOW. We buy all Surplus Gear.

"TAB" Dept. C, 6 Church St.
That's a Buy New York 6, N. Y.
Wa. 2-7230

ADVERTISING INDEX

Aero Towers Div.	123
Alliance Manufacturing Company	81
Allied Radio Corporation	73
Almo Radio Corporation	138
Alprodo, Inc.	96
American Electrical Heater	10
American Phenolic Corporation	84
Amperite Company	122
Amplifier Corporation of America	82, 129, 144
Amy, Aceves & King, Incorporated	139
Arrow Sales	122
Arvedon Electric Supply Co.	124
Astatic Corporation	16
Astron Corp.	130
Bell Telephone Laboratories	115
Boyce-Roche Book Company	85
Brook Electronics	145
Brooks Radio Dist. Company	117, 136
Buffalo Radio Supply	140
Burden Sales	144
California Electronics and TV Inst.	131
Capitol Radio Engineering Institute	7, 133
Certified Television Laboratories	131
Cisin, H. G.	131
Clarostat Manufacturing Company	124
Cleveland Institute of Radio-Electronics	17
Coast Electronic Supply	131
Color Television Laboratories	126
Commercial Trades Institute	125
Communications Equipment Company	142
Concord Radio Corporation	107
Coyne Electrical School	119, 123, 138

DeForest's Training, Incorporated	9
DuMont, Allen B. Labs.	Inside Back Cover
East Coast Electronics	142
Editors & Engineers	125, 132, 143
Electro Products Laboratories	76
Electronic Instrument Company	18
Electronic Measurements Company	131
Espey Manufacturing Company	134
Eureka Television & Tube Corp.	129
Federated Purchaser	117
Feiler Engineering Company	124, 144
General Electric Company	8, 77
General Electronic Dist. Company	101, 102, 103, 104
General Test Equipment Company	131
Greylock Electronic Supply	132
Harvard Laboratories	114
Hatry and Young (Lawrence, Mass.)	131
Haugen Company	134
Heath Company	87, 88, 89, 90, 91, 92, 93
Hickok Electrical Instrument Company	142
Hudson Specialties	148
Hygrade Electronics	148
Hytron Radio & Electronics Corporation	11
Industrial Development Engineers Assoc.	79
Instructograph Company	82
Insuline Corporation of America	133
JFD Manufacturing Company	122, 148
Kelsey Company (The)	144
La Pointe-Plascomold Corporation	112
Leotone Radio Corporation	124
Littelfuse, Incorporated	150
McGraw-Hill Book Company	147
Macmillan Company (The)	149
Mallory & Company, Inc., P. R.	Inside Front Cover
Midway Radio & TV Corporation	123
Midwest Radio & TV Corporation	145
Miles Reproducer Co.	144
National Company	100
National Plans Company	131
National Radio Institute	3
National Schools	5
Niagara Radio Supply	135
Ohmite Manufacturing Company	78
Opportunity Adlets	144
Oregon Bargain Supply	148
Prager Mfg. & Dist. Co.	143
Precision Apparatus Company	118
Prentice-Hall, Inc.	145
Pres-Probe Company	117
Progressive Electronics Company	86
RCA Victor Division (Radio Corporation of America)	Back Cover
Radcraft Publications	141
Radiart Corp.	95
Radio City Products	139
Radio Corporation of America	121
Radio Dealers Supply	120
Radio Merchandise Sales	128
Radio Press	125
Radio Publications	138
Radio Receptor Company, Incorporated	86

RADIO SCHOOL DIRECTORY (Pages 146-147)

Baltimore Tech. Inst.	Candler System Co.
Commercial Radio Inst.	Delehanty Inst.
Electronics Institute Inc.	
Hollywood Sound Institute	
Hollywood Technical Inst.	
Indiana Technical College	
Martin School, Don	
Milwaukee School of Engineering	
RCA Institutes	
Radio-Television Institute	
Sprayberry Academy of Radio	
Tri-State College	
Valparaiso Technical Institute	
YMCA Trade & Technical Institute	

Radio Specialty Manufacturing Co.	117
Rauland Corporation (The)	97
Raytheon Manufacturing Co.	15
Red Arrow Sales	145
Rider, Inc., John F.	130
Rinehart Books, Inc. (Murray Hill)	98, 99
Sams & Company, Inc., Howard W.	80
Seg Electronics	140
Simpson Electric Company	106
Smith Company, Wm. M.	105
Soundtronics Laboratories	140
Sprague Products Company	4
Sprayberry Academy of Radio	13
Standard Transformer Corporation	72
Strand, Hotel	145
Supreme Publications	113
Sutton's Wholesale Electronics, Bill	130
Swedgal Radio, Incorporated	127
Sylvania Electric Products	108, 109
Tab	148
Tech-Master Products	126
Technical Appliance Corp.	119
Technifax	143
Tel-A-Ray Enterprises, Inc.	75
Television Communications Institute	125
Tel-O-Tube Corp. of America	83
Telrex, Incorporated	132
Thomas Electronics	118
Transvision, Incorporated	120
Trio Manufacturing Co.	82
Triplett Electrical Instrument Co.	111
Turner Company	12
University Loudspeakers	128
Weller Electric Corporation	14
Wells Sales Company	137
Wholesale Radio Parts Co., Inc.	141
Wilcox & Follett	144
Wind Turbine Company	110

Radio-Electronics does not assume responsibility for any errors appearing in above index.

RADIO AND TELEVISION, AN INTRODUCTION, by Giraud Chester and Garnet R. Garrison. Published by Appleton-Century-Crofts, Inc. 6½ x 9½ inches, 550 pages. Price \$4.75.

This rather original book is divided into two sections: the first deals with the social aspects of radio, and the second with radio and television broadcasting from the studio and program point of view. Its dual nature is the result of a need for a college text to assist in "training students in radio skills and supplying them with a body of information about the field."

Part I begins with a survey of radio in the United States and continues with historical and topical information on programming, stations and networks, international broadcasting, advertisers and agencies, and the FCC, with a specially interesting chapter "What Constitutes the Public Interest?" The second part deals with radio and television broadcasting from the point of view of the student actor, program director, and announcer.

OUTLINE OF RADIO, TELEVISION AND RADAR, a symposium by R. S. Elven, T. J. Fielding, E. Molloy, H. E. Penrose, C. A. Quarrington, M. G. Say, R. C. Walker and G. Windred. Published by Chemical Publishing Co., Brooklyn, N. Y. 6 x 8¼ inches, 688 pages. Price \$12.00.

As implied in the title, this is an outline, beginning with "What Is Electricity" and ending with "A Survey of Radar." The contributors are eminent in the British radio world, and the book as a whole is carefully written. The first eleven chapters apply to fundamental theory and components and there are seven dealing with receivers, their circuits and stages. The rest of the thirty-five chapters cover a range of subjects from accumulators to direction finders.

ADVENTURE INTO THE UNKNOWN, by Laurence A. Hawkins. Published by William Morrow & Co., New York, N.Y. 6¼ x 9½ inches, 150 pages. Price \$3.50.

Adventure into the Unknown is a history of the General Electric research laboratory at Schenectady, from its first home in the barn of the late Charles P. Steinmetz to its present group of specially designed buildings on the shore of the Mohawk, and from the GEM lamp of Willis R. Whitney to the rain-producing silver iodide crystals of Bernard Vonnegut.

The story is told by one of the laboratory staff, who for 36 years was either assistant to the director or executive engineer of the laboratory. He has an independent claim to fame as the author of the "-tron" system of naming and indicating the characteristics of vacuum tubes that de Forest humorously dubbed "Greco-Schenectady."

All the important achievements of the laboratory during the 50 years of its existence are chronicled, together with vignettes of its chief workers, for whom the author has unbounded admiration.

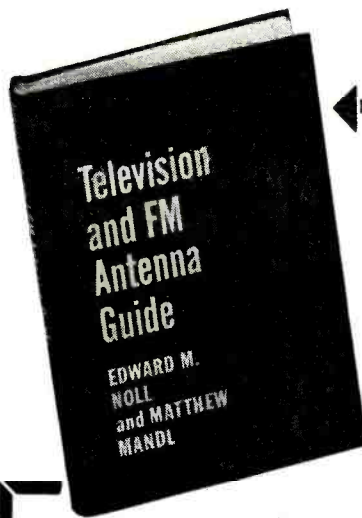

Ready in January

TELEVISION AND FM ANTENNA GUIDE

by E. M. Noll and Matthew Mandl

Here is all the information and practical instruction you need in order to be sure of getting the most out of any antenna system, with a minimum of testing and readjusting. It gives you—

- the characteristics, dimensions, and special advantages and disadvantages of ALL VHF and UHF antennas and allied equipment.
- NEW information on NEW types of antennas recently tested by the authors. Information heretofore unpublished.
- Definite installation procedures:—how to determine the right type of antenna for the particular site; how to locate space loops, determine signal strength, etc.
- Practical directions for mounting different types of antennas on different types of roofs and on window sills.
- Excellent information on transmission lines—how to minimize noise, avoid standing waves. Use of booster amplifiers and input systems.
- Clear, practical explanation of all essential principles, impedance matching, loss factors, etc. ALL the information you need on TV and FM antennas in the most useful, helpful form.

Have you seen



RADIO & TELEVISION MATHEMATICS

by Bernhard Fischer

This unique handbook of problems and solutions provides completely worked-out samples of every calculation commonly required in radio, television, and industrial electronics work of all kinds. It shows you what formulas to use, what numerical values to substitute, each step in the solution of every problem. Conveniently arranged by radio topics and fully indexed so you can find the solution of any problem you encounter quickly and easily. Called "the most useful tool for radiomen this reviewer has ever seen . . . recommended for the place of honor beside its natural partner the slide rule." (*Radio Maintenance*)



TELEVISION FOR RADIOMEN

by E. M. Noll

The outstanding book on television for the serviceman. Explains in clear, non-mathematical terms the operating principles and function of every part and circuit in today's TV receivers, and the chief principles of transmission. Gives complete practical instruction in installation and alignment procedures, testing instruments and their use, adjustment and trouble-shooting, with handy trouble-shooting charts. Three large diagrams (19¼ x 13¼ and 16 x 9¼) of RCA, GE, and Philco receivers are folded into the book. Mathematics are explained in a final chapter for those who need them.

SEE THEM ON APPROVAL

The Macmillan Co., 60 Fifth Ave., New York 11

Please send me the books checked below on 10 days' approval:

- Television & FM Antenna Guide \$5.75 (prob.)
- Radio & Television Mathematics \$6.00
- Television for Radiomen \$7.00

Signed

Address

Look them over at your leisure. If you do not find these books of exceptional value to you in your work, you may return them with no further obligation.

A BETTER DEAL

**You demand TV
Snap On Holders Ten to a Box**



**Here they are in Plastic
And it doesn't cost a penny more
Plastic box is free
Servicemen want to buy 'em by the box
And everyone wants
the box with 100 uses**

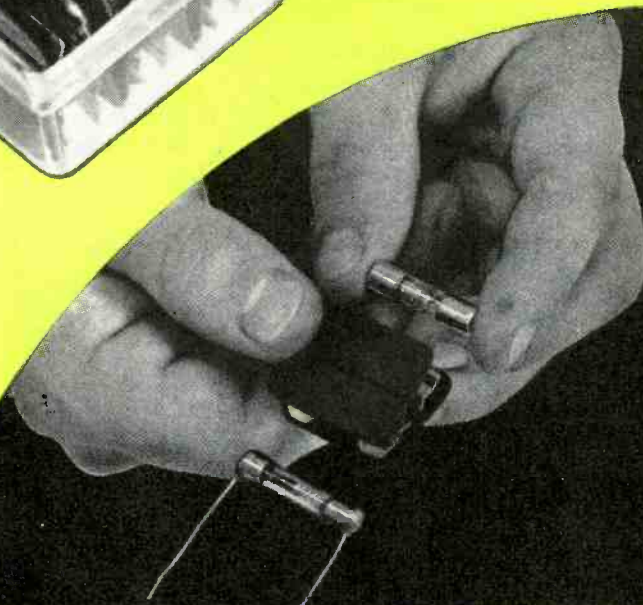

TV SNAP ON FUSE HOLDER

No. 094025

Time saver for pigtail replacement. Snap on blown pigtail, then use regular fuse in other side. No soldering. Demand item with servicemen. Bigger TV profits.

\$3.00 per box, list

LITTELFUSE

4757 N. RAVENSWOOD AVE., CHICAGO 40, ILLINOIS



uniform

Yes, UNIFORM! There's no such thing as a "better tube" or a "poorer tube" when you insist on Du Mont Teletrons. Advanced engineering, precise mechanization second to none, and the most rigid quality control account for *uniformly dependable performance* that has made the Du Mont label symbolic of the finest in TV tubes. Best of all, with a productive capacity in excess of one million BIG picture tubes a year, the giant Du Mont Allwood plant meets *quantity* as well as *quality* requirements. Literature on request.



DU MONT

*Teletrons**

*TRADE-MARK

FIRST WITH THE FINEST IN TV
ALLEN B. DU MONT LABORATORIES, INC.
Cathode-ray Tube Division, Clifton, N. J.

THE QUALITY OF RCA TUBES IS UNQUESTIONED

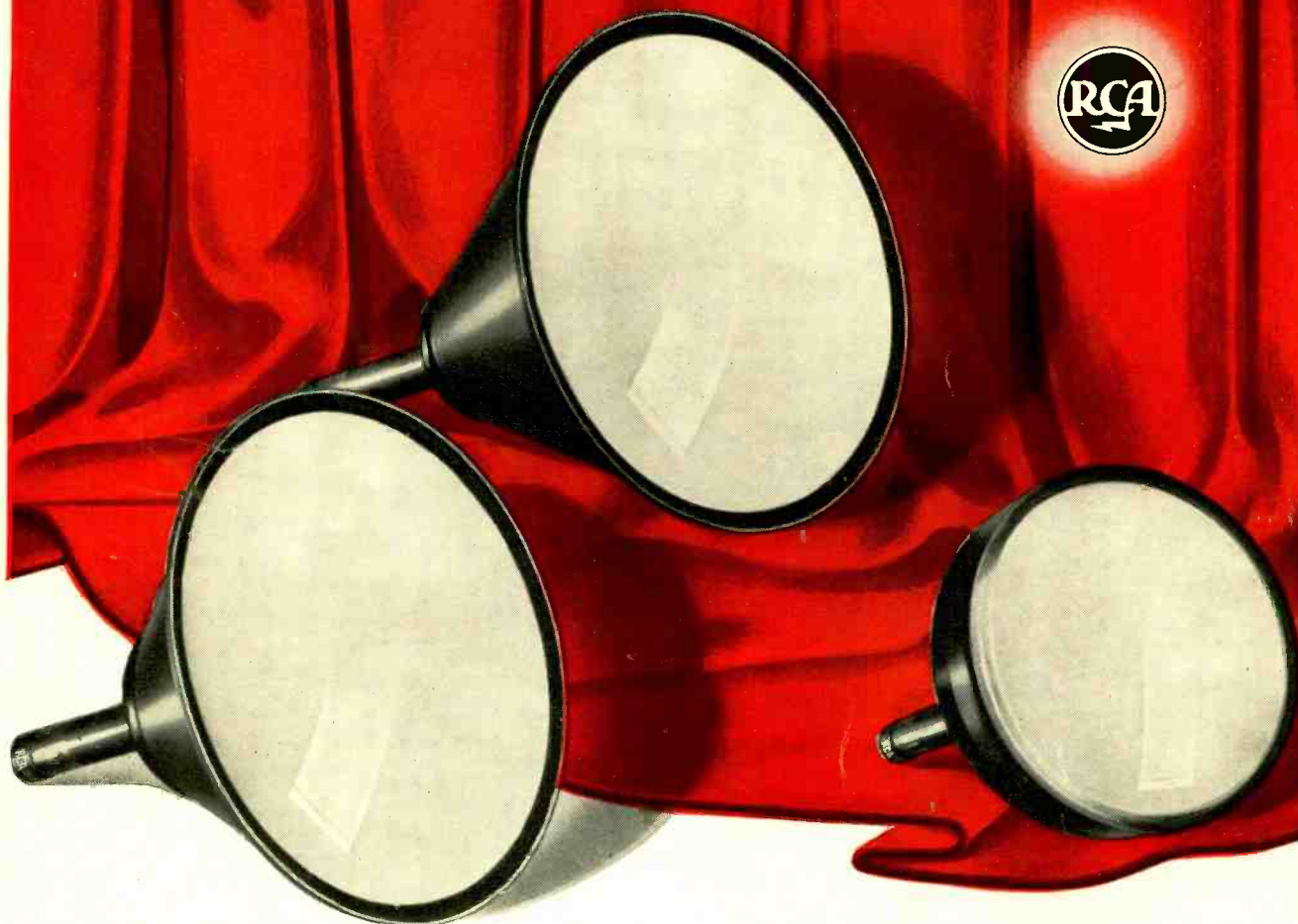

Best Sellers

IN PICTURE TUBES...

**Most used . . . by brand
and by type . . . RCA kinescopes
are the fast-moving
profit makers**

The largest and most profitable replacement business in television picture tubes comes from the types used in most television receivers . . . the Best Sellers.

RCA's types are Best Sellers. There are more of them in actual use in TV receivers than any other brand. Industry choice of these high-volume types reflects to your advantage. Inventory and stocking problems are simplified . . . and you have the assurance of rapid, profitable turnover.

In addition, when you sell RCA kinescopes, you gain from customer confidence in the RCA brand . . . solidly established by the proved performance of RCA kinescopes in millions of television receivers.

Remember, too, that the quality and dependability of RCA kinescopes mean fewer service failures and fewer costly call-backs. There is, therefore, more profit in every RCA kinescope you sell.

Always keep in touch with your RCA Tube Distributor



RADIO CORPORATION of AMERICA
ELECTRON TUBES HARRISON, N. J.