

LATEST IN TELEVISION · SERVICING · AUDIO

RADIO — ELECTRONICS

K

NEW CIRCUITS IN
1951 TV RECEIVERS

TELEVISION
SERVICE CLINIC

HUGO GERNSBACH, Editor



CHRISTMAS PACKAGE FOR FUTURE HAMS — SEE AMATEUR SECTION

DEC
1950
30¢

U. S. and
CANADA

Announcing

RCA WV-97A

Senior VoltOhmyst* reading peak-to-peak voltages

ONLY \$62.50

 Suggested User Price

Includes direct probe and cable,
dc probe, ohms lead, and ground lead



TEN WAYS BETTER!

1. Directly measures complex waves from 0.2 volt to 1400 volts, peak-to-peak.
2. Has an over-all accuracy for dc measurements of $\pm 3\%$ of full scale.
3. Measures dc voltages from 0.02 volt to 1500 volts.
4. Measures rms values of sine-wave voltages from 0.1 volt to 1200 volts.
5. Has 7 non-skip ranges for both resistance and voltage.
6. All full-scale voltage points increase in a uniform "3-to-1" ratio.
7. Frequency response flat from 30 cps to approximately 3 Mc.
8. Negative-feedback circuit provides better over-all stability.
9. Fully enclosed metal case shields sensitive electronic-bridge from rf fields.
10. More convenient to use because of smaller size and new slip-on probes.

The WV-97A measures peak-to-peak voltages directly. Hence, it quickly provides information essential for servicing TV receivers with their pulse-type waveforms.

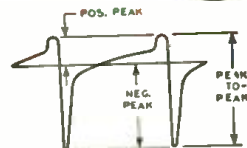

The WV-97A has a range of usefulness extending beyond that of any other instrument in the field. Its quality, dependability, and accuracy make it a true laboratory instrument; it is exactly what is needed for television in the design laboratory, factory, and service shop.

The new Senior VoltOhmyst measures dc voltages in high-impedance circuits, even with ac present. It reads the rms values of sine waves and the peak-to-peak values of complex waves or recurrent pulses, even in the presence of dc. Its electronic ohmmeter has a range of ten billion to one.

Like all RCA VoltOhmysts, it features high input resistance, electronic protection from meter burn-out, zero-center scale for discriminator alignment, molded-plastic meter case, a 1-megohm isolating resistor in the dc probe, and sturdy metal case for good rf shielding.

An outstanding feature is its usefulness as a television signal tracer . . . made possible by its high input resistance, wide frequency range, and direct reading of peak-to-peak voltages.

For complete information on the new RCA WV-97A Senior VoltOhmyst, see your RCA Test Equipment Distributor, or write RCA, Commercial Engineering, Section L49X, Harrison, New Jersey.

*Reg. U. S. Pat. Off.

SPECIFICATIONS

DC Voltmeter:	Seven continuous ranges 0 to 1.5, 5, 15, 50, 150, 500, 1500 volts
Input resistance (including 1 megohm in dc probe):	All ranges 11 megohms
	Sensitivity for the 1.5-volt range 7.3 megohms-per-volt
Over-all Accuracy:	$\pm 3\%$ of full scale
AC Voltmeter—Fourteen continuous ranges:	Peak-to-peak ranges 0 to 4, 14, 40, 140, 400, 1400, 4000 volts
	Maximum peak-to-peak input voltage 1400 volts
	RMS ranges (for sine waves) 0 to 1.5, 5, 15, 50, 150, 500, 1500 volts
	Maximum rms input voltage 1200 volts
Input Resistance and Capacitance with WG-218 Direct Probe and Cable:	
	1.5, 5, 15, 50, 150-volt ranges 0.83 megohm shunted by 85 μ F
	500-volt range 1.3 megohms shunted by 85 μ F
	1500-volt range 1.5 megohms shunted by 85 μ F
Frequency Response with WG-218 Direct Probe and Cable:	
	1.5, 5, 15, 50, 150, 500-volt ranges flat from 30 cps to 3 Mc for voltage source having 100-ohm impedance
Overall Accuracy:	
	1.5, 15, 50, 150, 500, 1500-volt ranges $\pm 5\%$ of full scale
	5-volt range $\pm 0\%$ -10% of full scale
Ohmmeter:	
	Seven continuous ranges 0.2 ohm to 1000 megohms
	Center scale values 10, 100, 1000, 10,000 ohms; 0.1, 1, 10 megohms
Dimensions:	7 3/4" high; 5 1/4" wide, 3 3/4" deep
Available Accessories:	
	WG-264 Crystal Diode Probe. Extends range to 250 Mc (\$7.75 suggested user price)
	WG-289 High-Voltage Probe and WG-206 Resistor to extend range to 50,000 volts. (\$9.95 suggested user price)

Available from your RCA Test Equipment Distributor



RADIO CORPORATION of AMERICA
TEST EQUIPMENT
HARRISON, N. J.

You Practice COMMUNICATIONS

I Send You Parts To Build This Transmitter

As part of my Communications Course you build this low power broadcasting transmitter, learn how to put a station "on the air," perform procedures demanded of Broadcast Station operators, make many tests.



NEW

You Practice Radio SERVICING

On This Modern Radio You Build With Parts I Send

As part of my Servicing Course, I send you the speaker, tubes, chassis, transformer, loop antenna, EVERYTHING you need to build this modern, powerful Radio Receiver! I also send parts to build other Radio circuits, see below. You use for practical experience and to earn EXTRA money in spare time.

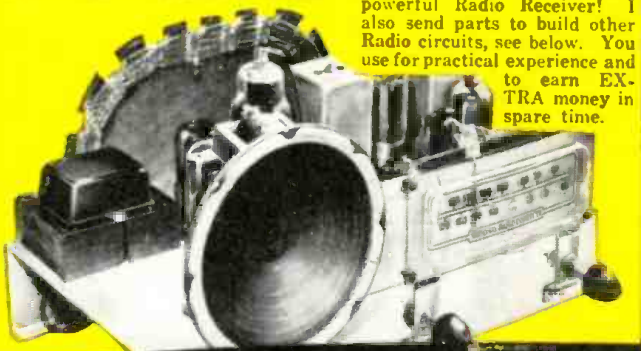

BE A RADIO-TELEVISION TECHNICIAN

Learn Servicing or Communications by Practicing in Spare Time with KITS OF RADIO PARTS I Send

YOU BUILD this Tester with parts I send early in my Servicing Course. Helps you fix neighbors' Radios and EARN EXTRA MONEY in spare time.

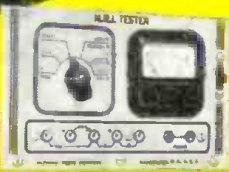

YOU BUILD Vacuum Tube Power Pack as part of my Communications Course; get experience with packs of many kinds. Learn how to correct Power Pack troubles.

YOU BUILD this A. M. Signal Generator as part of my Servicing Course. It provides amplitude - modulated signals for many tests and experiments.



J. E. SMITH, President, National Radio Institute

Do you want good pay, a job with a bright future and security? Would you like to have a profitable shop or store of your own? If so, find out how you can realize your ambition in the fast growing, prosperous RADIO-TELEVISION industry. Even without Television, the industry is bigger than ever before. 81 million home and auto Radios, 2,700 Broadcasting Stations, expanding use of Aviation and Police Radio, Micro-wave Relay, Two-way Radio for buses, taxis, etc., are making opportunities for Servicing and Communications Technicians and FCC-Licensed Operators.

Television is TODAY'S Good Job Maker

In 1949, almost 3,000,000 TV sets sold. By 1954, 20,000,000 TV sets estimated. 100 TV Stations now operating. Authorities predict 1,000 TV Stations. This means more jobs, good pay for qualified men all over the United States and Canada.

Many Soon Make \$10 Extra a Week in Spare Time

Keep your job while training. Hundreds of successful RADIO-TELEVISION TECHNICIANS I trained had no previous experience, some only a grammar school education. Learn Radio-Television principles from illustrated lessons. Get PRACTICAL EXPERIENCE—build valuable multimeter—experiment with circuits common to Radio and Television. Keep all equipment. Many students make \$5, \$10 extra a week fixing neighbors' Radios in spare time. SPECIAL BOOKLETS start teaching you the day you enroll.

Send Now For 2 Books FREE—Mail Coupon

Send now for my FREE DOUBLE OFFER. You get actual Servicing lesson to show you how you learn at home. Also my 64-page book, "How to Be a Success in Radio-Television." Read what my graduates are doing, earning; see equipment you practice with at home. Send coupon in envelope or paste on postal. J. E. SMITH, President, Dept. ONX, National Radio Institute, Washington 9, D. C. Our 37th Year.

I TRAINED THESE MEN

"I have been operating my own Servicing business. In two years I did \$14,000 worth of business; net profit, \$6,850. Have one full time employee, an N.R.I. Student."—PHILLIP G. BROGAN, Louisville 8, Ky.

"Four years ago, I was a bookkeeper with a hand-to-mouth salary. Now I am a Radio Engineer with a key station of the American Broadcasting Company network."—NORMAN H. WARD, Ridgefield Park, N. J.

"When halfway thru the N.R.I. course, I made \$5 to \$8 a week fixing sets in my spare time. Am now selling and installing Television sets and supervising."—E. J. STREITENBERGER, New Boston, Ohio.

"My first job was operator with KDLR, obtained for me by your Graduate Service Dept. I am now Chief Engineer of PoSec Radio Station WQOX. I never hesitate to endorse N.R.I."—T. S. NORTON, Hamilton, G.

Veterans YOU MUST ACT FAST

G. I. Bill gives you valuable training benefits. For each 3 months of training eligibility, you can get a full year of N.R.I. Training. Keep your job while learning. But Act Now! Time is running out!

HURRY!

Mail Coupon Now!

Good for Both—FREE

MR. J. E. SMITH, President, Dept. ONX, National Radio Institute, Washington 9, D. C.

Mail me Sample Lesson and 64-page Book about How to Win Success in Radio-Television. Both FREE. (No Salesman will call. Please write plainly.)

Name..... Age.....

Address.....

City..... Zone..... State.....

Check if Veteran Approved for training under G. I. Bill

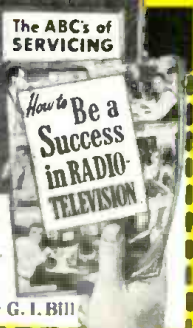

RADIO — ELECTRONICS

formerly RADIO-CRAFT

MEMBER
AUDIT BUREAU OF CIRCULATIONS

Hugo Gernsback, Editor-in-Chief
M. Harvey Gernsback, Editorial Director

Fred Shunaman, Managing Editor
Robert F. Scott, W2PWG, Technical Editor
Manfred Wentzel, Associate Editor

I. Queen, Editorial Associate
Angie Pascale, Production Manager
Wm. Lyon McLaughlin, Tech. Illustration Director

Lee Robinson, General Manager
John J. Lamson, Sales Manager

G. Aliquo, Circulation Manager
Robert Fallath, Promotion Manager

CONTENTS

DECEMBER, 1950

Editorial (Page 21)

Choleric Color TV.....by Hugo Gernsback 21

Servicing—Test Instruments (Pages 22-26)

Radio Set & Service Review (Improved Circuits in
Du Mont's 1951 Receivers)By Ricardo Muniz 22
Fundamentals of Radio Servicing, Part XXII.....by John T. Frye 25

Television (Pages 27-31)

Television DX Reports..... 27
Television Service Clinic....Conducted by Walter H. Buchsbaum 28
Time Base Circuits.....by Wilbur J. Hontz 30
FCC Picks CBS Color..... 31

Electronics (Pages 32-37)

Electric Space Ships, Part I.....by Prof. Hermann Oberth 32
Relays Do Simple Arithmetic, Part III
by Edmund C. Berkeley and Robert A. Jensen 35

Audio (Pages 38-44)

Electronics and Music, Part VI.....by Richard H. Dorf 38
PA Gets Publicity.....by Paul W. Streeter 40
Audio Feedback Design, Part III.....by George Fletcher Cooper 42

Amateur (Pages 46-48)

Christmas Package for Future Hams (Cover Feature)
by Larry Le Kashman, W2IOP 46
40-Meter M Antenna.....by Jerome Maslawski, W8LKM 48

Construction (Pages 50-59)

Hi-Fi AM Tuner and Amplifier, Part II.....by D. V. R. Drenner 50
High-Efficiency Crystal Receiver.....by Robert E. Kelley 52
3-Tube Receiver for Wired Radio.....by Rufus P. Turner 57

New Design (Page 62)

New Tubes of the Month..... 62

Departments

The Radio Month.....	10	Try This One	78
Radio Business	14	Miscellany	82
New Devices	60	Association News ...	84
New Patents	63	People	86
Radio-Electronic		Technotes	88
Circuits	66	Communications	91
Question Box	68	Book Reviews	95

ON THE COVER:

Larry Le Kashman and his daughter Patricia
in a Christmas scene at his station W2IOP.
Kodachrome by Avery Slack.

WATCH FOR THE JANUARY ANNUAL TELEVISION NUMBER



Every
SPRAGUE
TV
dry electrolytic
is processed

FOR
185°F (85°C.)
OPERATION!

Sprague leads again with the largest, most complete line of replacement electrolytic capacitors for television receivers. Each type is engineered especially for tough video applications and will stand up under the high temperatures, high ripple currents and high voltage surges encountered in TV equipment. Every Sprague TV capacitor rated at 450 d-c working voltage or less has been processed for 185°F. (85°C.) operation. Send postcard for special TV Bulletin.

SPRAGUE PRODUCTS CO.
31 Marshall Street
NORTH ADAMS • MASS.

RADIO-ELECTRONICS for

RADIO-ELECTRONICS, December 1950, Volume XXII, No. 3. Published monthly. Publication Office: Erie Ave., 10 to G Streets, Philadelphia 32, Pa. Entered as second class matter September 27, 1948, at the post office at Philadelphia, Pa., under the Act of March 3, 1879. SUBSCRIPTION RATES: In U. S. and Canada, in U. S. possessions, Mexico, South and Central American countries, \$3.50; \$6.00 for two years; \$8.00 for three years; single copies 30c. All other foreign countries \$4.50 a year; \$8.00 for two years; \$11.00 for three years. Allow one month for change of address. When ordering a change please furnish an address stencil impression from a recent wrapper. RADCRAFT PUBLICATIONS, INC., Hugo Gernsback, Pres.; M. Harvey Gernsback, Vice-Pres.; G. Aliquo, Sec'y. Contents copyright, 1950, by RADCRAFT Publications, Inc. Text and illustrations must not be reproduced without permission of copyright owner.

EDITORIAL and ADVERTISING OFFICES, 25 West Broadway, New York 7, N. Y. Tel. REctor 2-9690.
BRANCH ADVERTISING OFFICES: Chicago: 520 N. Michigan Ave. Telephone Superior 7-1786. Los Angeles: Ralph W. Harker, 1127 Wilshire Blvd., Tel. MA 6-1271. San Francisco: Ralph W. Harker, 582 Market St., Tel. GARfield 1-2481. FOREIGN AGENTS: Great Britain: Atlas Publishing and Distributing Co., Ltd., London E.C.4. Australia: McGill's Agency, Melbourne. France: Brentano's, Paris 2e, Holland: Trillectron, Heemstede, Greece: International Book & News Agency, Athens, So. Africa: Central News Agency, Ltd., Johannesburg; Capetown: Durban, Natal. Universal Book Agency, Johannesburg. Middle East: Sitematzky Middle East Agency, Jerusalem. India: Broadway News Centre, Madras, Bombay #14. K. L. Kannappa Mudaliar, Madras 2, Pakistan: Paradise Book Stall, Karachi 3. POSTMASTER: If undeliverable send form 3578 to: RADIO-ELECTRONICS, 25 West Broadway, New York 7, N. Y.



Learn RADIO

TELEVISION, ELECTRONICS

by SHOP METHOD HOME TRAINING

Let NATIONAL SCHOOLS, of Los Angeles, a practical Technical Resident Trade School for almost 50 years, train you for today's unlimited opportunities.

You receive all parts, including tubes, for building this fine, modern Superheterodyne Receiver. This and other valuable standard equipment becomes your property.

these two FREE books will tell you how



WE BRING NATIONAL SCHOOLS TO YOU!

GOOD JOBS AWAIT THE TRAINED RADIO TECHNICIAN

You are needed in the great modern Radio, Television and Electronics industry! Trained technicians are in constant and growing demand at excellent pay—in Broadcasting, Communications, Television, Radar, Research Laboratories, Home Radio Service, etc. National Schools Master Shop Method Home Study Course, with newly added lessons and equipment, can train you in your spare time, *right in your own home*, for these exciting opportunities. Our method has been proved by the remarkable success of National Schools-trained men all over the world.

You Learn by Building Equipment with Standard Radio Parts We Send You

Your National Schools Course includes not only basic theory, but *practical* training as well—you learn by doing. We send you complete standard equipment of professional quality for building various experimental and test units. You advance step by step until you are able to build the modern superheterodyne receiver shown above, which is yours to keep and enjoy. You perform more than 100 experiments—build many types of circuits, signal generator, low power radio transmitter, audio oscillator, and other units. The Free Books shown above tell you more about it—send for them today!



NOW! NEW PROFESSIONAL MULTITESTER INCLUDED



This versatile testing instrument is portable and complete with test leads. Simple to operate, accurate and dependable. You will be able to quickly locate trouble and adjust the most delicate circuits. You can use the Multitester at home or on service calls. It is designed to measure AC and DC volts, current resistance and decibels. You will be proud to own and use this valuable professional instrument.

GET THE DETAILS - SEND THE COUPON →

Lessons and Instruction Material Are Up-to-date, Practical, Interesting

National Schools Master Shop Method Home Training gives you basic and advanced instruction in all phases of Radio, Television and Electronics. Each lesson is made easy to understand by numerous illustrations and diagrams. All instruction material has been developed and tested in our own shops and laboratories, under the supervision of our own engineers and instructors. A free sample lesson is yours upon request—use the coupon below.

TELEVISION TRAINING A complete series of up-to-the-minute Television lessons is an integral part of your course, covering all phases of Television repairing, servicing and construction.

Here are just a few of the interesting facts you learn with the **FREE SAMPLE LESSON**

1. How radio receivers operate
2. How the antenna circuit is constructed.
3. Converting signal current to sound.
4. How the R-F transformer transfers the signal.
5. How the tuning circuit works.
6. The Radio "bands"

PROVED

NATIONAL

LOS ANGELES 37,

MAIL OPPO

National Sch
4000 South
Los Angel

Mail m
vision
stand

NA

*Obviously, in BIG TUBES the
DU MONT, and industry have
eliminated by the 30" Teletron
Du Mont remains in the
and industry made
Du Mont with not
were offered
Du Mont*

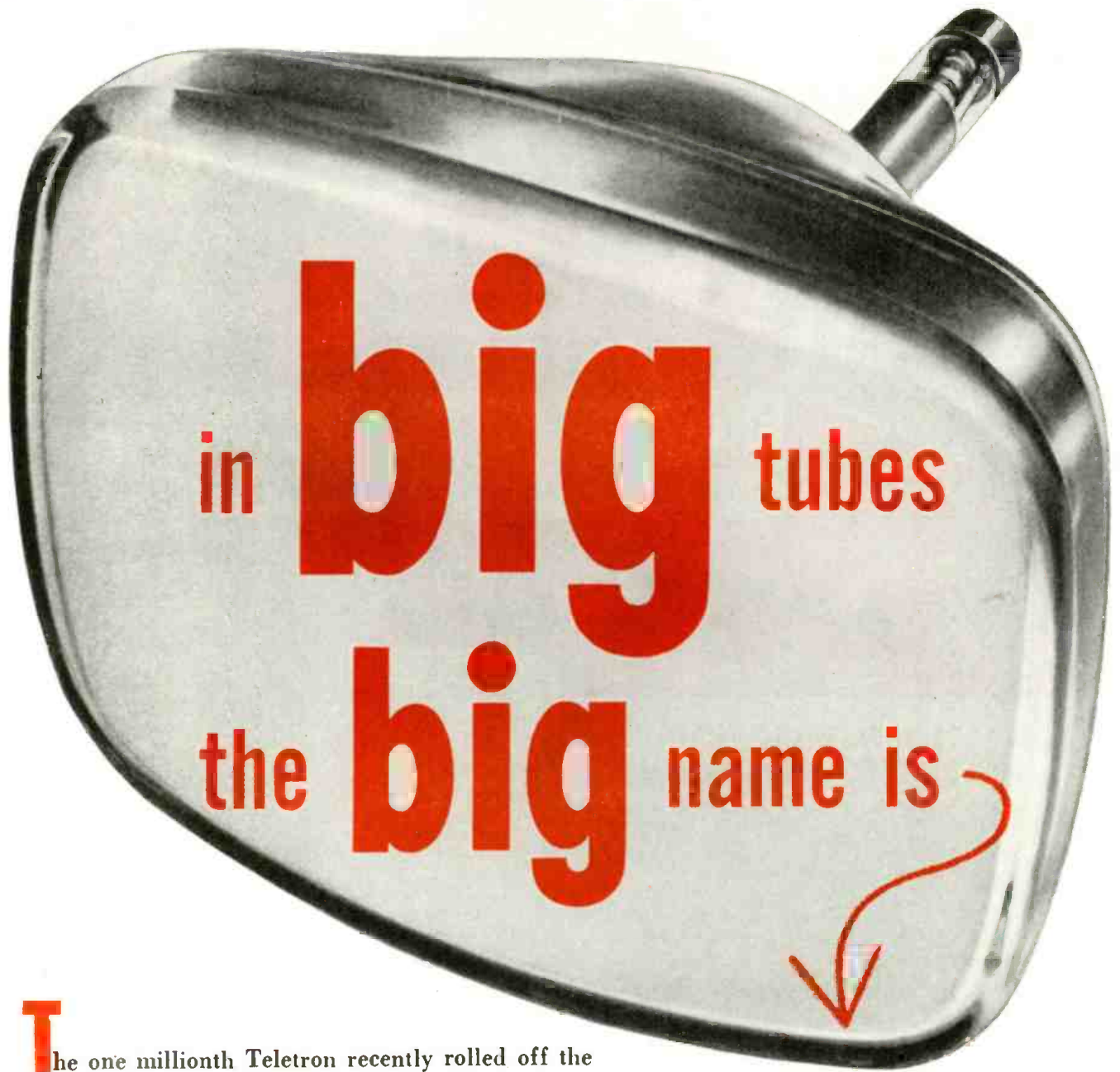

The one millionth Teletron recently rolled off the production line. It was all in the day's work for Du Mont's vast Allwood plant geared to over a million TV picture tubes a year. Yet that tube established a unique record, because it represented the one millionth BIG TUBE. No other manufacturer has made that many BIG TUBES.

Ever since 1939 when Du Mont introduced the first commercial television set with its 14" Teletron, Du Mont has pioneered BIG TV TUBES. While others were offering 7" and 10" tubes, Du Mont was satisfying the public with tubes less than 12". Even as early as 1939, Du Mont introduced 14" Teletrons. Since then the public has followed the Du Mont lead, but other manufacturers have not followed with still larger tubes available shortly.

BIG NAME is

DUMONT
*Teletrons**

First with the Finest in Television

Literature on request

*Trade-Mark

ALLEN B. DUMONT LABORATORIES, INC.
TUBE DIVISION • CLIFTON, N. J.

RADIO-ELECTRONICS for

Are You Preparing for a Good Paying Job in TV-Electronics?

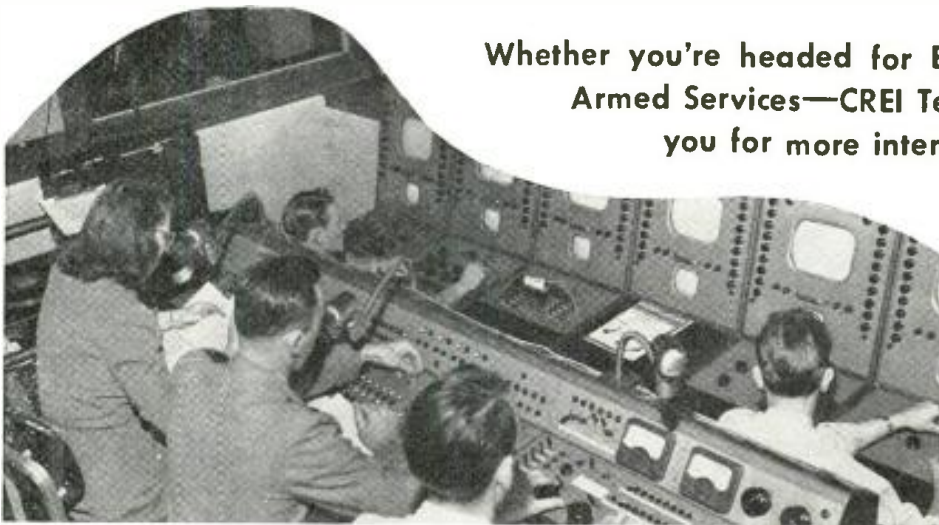

Whether you're headed for Essential Industry—or the Armed Services—CREI Technical Training qualifies you for more interesting jobs at better pay!

Television technicians are in demand in stations, factories, research labs; in installation and trouble-shooting jobs. In the Armed Services, the men who know electronics are sure of interesting, supervisory jobs.

CREI Home Study can help you step ahead!

By **E. H. RIETZKE**
President CREI

YOUR future success can best be assured by the steps you take today to prepare for it. No field offers a properly qualified young man greater opportunity than electronics. In the Armed Services, electronics gives rockets "brains" to make scientific observations, gives airplanes "eyes" and "ears" to navigate, gives explosives target directions.

In industry, electronics prepares the vast number of devices utilized by the Armed Services—the countless radars, two-way radios, and communications equipment used by modern armies, fleets, and planes. In peace, electronics provides good jobs for trained engineers and technicians. Television's fantastic growth from 10,000 sets in 1945 to 8 million by the end of 1950—with set production currently at the rate of 6 million—is typical of the speed at which the electronics band-wagon is moving. It is the *new* field, where know-how is rewarded with excellent jobs and lifetime careers. And authorities are agreed that the one sure way to acquire this training is from a good school.

How can a young man select a "good school"? By its reputation in the industry . . . the professional standing of its faculty . . . the quality of its courses . . . the length of time it has been in existence . . . and its accomplishments.

CREI invites investigation and

comparison. An accredited technical institute founded in 1927, CREI's home-study graduates today fill important engineering, research, and radio-TV posts through the industry. While CREI makes no job promises to its graduates, the Placement Bureau generally has on hand more requests than it can fill. During World War II CREI trained thousands of technicians for the Army, Navy and Coast Guard. Hundreds of thousands of special CREI technical texts were used in the Navy's own training program. Leading industrial firms—RCA Victor, United Air Lines, TWA, Pan American Airways, All America Cables & Radio, Inc., Sears Roebuck & Co., to name only a few—have selected CREI for technical training for their technicians *at company expense*.

CREI, through home study, offers *practical* training that starts with basic principles and goes step-by-step through the more advanced subjects

of TV and its related fields. Each student is grounded thoroughly in the fundamentals required for development work in TV, guided missiles, communications and industrial electronics. You study Optics; Pulse Techniques; Deflection Circuits; RF, IF, AF and Video Amplifiers; FM; Receiving Antennas; Power Supplies; Cathode Ray, Iconoscope, Image Orthicon and Projection Tubes; UHF Techniques, TV Test Equipment, and many other subjects.

There are three basic CREI courses: Practical Radio Engineering (fundamental course in all phases of radio-electronics); Practical Television Engineering (specialized training for professional radiomen); Television and FM Servicing (streamlined course for men in top third of field). Courses are also available at the Residence School in Washington, D. C.

Write immediately for complete information. The cost is within reach of all, the terms easy. *Mail this coupon at once.*

CAPITOL RADIO ENGINEERING INSTITUTE
Dept. 1412B, 16th & Park Rd., N. W., Washington 10, D. C.

Gentlemen: Send booklet, "Your Future in the New World of Electronics," together with details of your home study training, CREI self-improvement program and outline of course. I am attaching a brief resume of my experience, education and present position.

Check the Field of Greatest Interest: PRACTICAL TELEVISION ENGINEERING. PRACTICAL RADIO ENGINEERING. TV, FM & ADVANCED AM SERVICING. AERONAUTICAL RADIO ENGINEERING. BROADCAST RADIO ENGINEERING (AM, FM, TV). RADIO-ELECTRONICS IN INDUSTRY.

NAME.....AGE.....

ADDRESS.....

CITY.....ZONE.....STATE.....



If Residence School in Washington, D. C. preferred, check here

SYLVANIA TV Picture Tubes are natural-born leaders because . . . they come from a leading family



Radio Tubes . . . 25 years' experience in building high quality tubes for every radio and television need.

Electronics . . . wide experience in designing radar and electronic equipment for war-time and post-war commercial use.

Phosphors . . . production of white and colored phosphors for the "Finest in Fluorescent Lighting."

Lighting . . . half a century of research and manufacture of incandescent and fluorescent lamps to meet longest life and highest vision standards.



This unique combination of experience naturally fits Sylvania for top position in the TV Picture Tube field.

Maintaining this leadership is a continuing program of research and engineering. A Sylvania engineer, for example, invented the famous "Ion Trap," now licensed to numerous other picture tube makers.

Sylvania achievements in fluorescent powders, tungsten wire, and precision parts are some of the other reasons which lie behind the consistent color, greater clar-

ity, and longer life of all Sylvania TV Picture Tubes.

Backing up each Sylvania advance is a rigid system of quality control . . . of checking and rechecking every step of every process . . . so that TV set owners everywhere will continue to look to Sylvania for the finest performance possible. New booklet gives information concerning the complete line of Sylvania Picture Tubes. Write for your copy today. Address Sylvania Electric Products Inc., Dept. R-1012, Emporium, Pa.

SYLVANIA ELECTRIC

TELEVISION PICTURE TUBES; RADIO TUBES; ELECTRONIC PRODUCTS; ELECTRONIC TEST EQUIPMENT; FLUORESCENT TUBES, FIXTURES, SIGN TUBING, WIRING DEVICES, LIGHT BULBS, PHOTOLAMPS; TELEVISION SETS

RADIO-ELECTRONICS for

**NOW... GET EVERYTHING YOU
NEED TO LEARN AND MASTER**

TELEVISION

**RADIO-ELECTRONICS
...AT HOME!**

**Use REAL commercial-type equip-
ment to get practical experience**

Your future deserves and needs every advantage you can give it! That's why you owe it to yourself to find out about one of the most COMPLETE, practical and effective ways now available to prepare AT HOME for America's billion dollar opportunity field of TELEVISION-RADIO-ELECTRONICS. See how you may get and keep the same type of basic training equipment used in one of the nation's finest training laboratories... how you may get real STARTING HELP toward a good job or your own business in Television-Radio-Electronics. Mail the coupon today for complete facts — including 89 ways to earn money in this thrilling, newer field.



**Here's the
REAL THING!**

**SET UP YOUR OWN
HOME LABORATORY**

ABOVE: Build and keep a real 16 INCH commercial TV receiver. Optional after completing regular training at slight additional cost.

D.T.I., ALONE, INCLUDES BOTH MOVIES and HOME LABORATORY

In addition to easy-to-read lessons, you get the use of HOME MOVIES — an outstanding training advantage — plus 16 big shipments of Electronic parts. Perform over 300 fascinating experiments for practical experience. Build and keep real commercial-type test equipment shown at left.

**Get BOTH of these
information packed
publications FREE!**

MODERN LABORATORIES

If you prefer, get all your preparation in our new Chicago Training Laboratories—one of the finest of its kind. Ample instructors, modern equipment. Write for details!

MILITARY SERVICE!

If you're subject to military service, the information we have for you should prove doubly interesting. Mail coupon today.



Oscilloscope

R-F Signal Generator

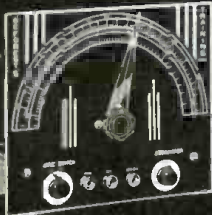

6-Tube Radio

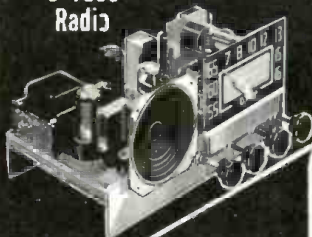

Multimeter



**HOME
MOVIES**

De FOREST'S TRAINING, INC.
CHICAGO 14, ILLINOIS
A De VRY INSTITUTION

ACT NOW! MAIL COUPON TODAY!

DeFOREST'S TRAINING, INC., Dept. RE-G-12
2533 N. Ashland Ave., Chicago 14, Ill.

Without obligation, I would like your late News-Bulletin showing 89 ways to earn money in Television-Radio-Electronics... and how I may prepare to get started in this thrilling field.

Name..... Age.....
Street..... Apt.....
City..... Zone..... State.....

DUAL SPOTLIGHTS
Banish All Shadows

With New Light Duty Soldering Gun

It's the newest convenience in soldering. Twin Spotlights on your new 135-watt WELLER Soldering Gun completely eliminate shadows; you see clearly even in the darkest chassis.

Pull the trigger of your WELLER Gun, heat and light come on together—in just 5 seconds!

No more waiting, wasted current, or blind soldering. Your WELLER Gun pays for itself in a few months!



Specially Designed for TV and Radio Work

- **DUAL SOLDERLITE**—Two prefocused spotlights completely eliminate shadows — let you see clearly what you are soldering.
- **OVER/UNDER DESIGN**—Tube construction braces tip and improves visibility.
- **5-SECOND HEATING**—No waiting. Saves power. Pull the trigger and you solder!
- **LONGER REACH**—Slides easily into deep chassis, reaches the tightest corners.
- **GREATER CAPACITY**—Smaller, lighter, with greater soldering capacity.
- **TRIGGER-SWITCH CONTROL**—Adjusts heat to the job. Saves current—no need to unplug gun between jobs.
- **DUAL HEAT**—Single heat 100 watts; dual heat 100/135 watts; 120 volts, 60 cycles. Handles all light-duty soldering.

See new Models WS-100 and WD-135 at your distributor, or write for bulletin direct.

- **SOLDERING GUIDE**—Get your new copy of "Soldering Tips"—revised, up-to-date and fully illustrated 20-page booklet of practical soldering suggestions. Price 10¢ at your distributor, or order direct.



WELLER
ELECTRIC CORP.

828 Packer Street, Easton, Pa.

WAVELENGTHS are under discussion by committees of the seven-nation North American Regional Broadcasting Conference. Delegates to the conference are from Canada, Cuba, the Dominican Republic, Haiti, Mexico, the United Kingdom (on behalf of the Bahamas and Jamaica), and the United States.

Facing the conference is the problem of dividing up the 108 channels of the broadcast band (540 to 1620 kc) among 3,000 stations, some 2,000 of which are in the United States. An earlier agreement lapsed in March, 1949, but some of the conference members are still abiding by the old terms. However, Mexico and Cuba have complained that their broadcast needs have so increased that new allocations are necessary.

GENERAL ELECTRIC CO. opened the new home of its research laboratory October 9 last. Dedication of the new building coincided with the anniversary of the founding of the laboratory, which came into existence 50 years ago in the barn of Charles Steinmetz, electrical and mathematical genius.

The new laboratory is five stories high, with the lower two stories below ground level. It houses 107 laboratory rooms, an auditorium, various special and office areas and extensive shop space. Movable steel partitions permit considerable flexibility in size and number of laboratory rooms.

Besides the main building, there are four other structures: the low-temperature laboratory; a chemical pilot plant; a radiation laboratory, which will house a 300-million-volt synchrotron; and a heating plant.

Dedication of the laboratory also marked the opening of the annual autumn meeting of the National Academy of Sciences, which commenced technical sessions in the auditorium of the new laboratory on the morning of Tuesday October 10 and continued till Thursday afternoon. It was the first time in its 88-year history that the Academy held one of its regular meetings at an industrial laboratory.



An overall view of G-E's new research laboratory building at Schenectady N. Y.

VIDEOGNOSIS may some day bring big city medical specialists practically to the bedside of patients in rural hospitals. The technique consists of transmitting X-ray pictures via television and has already been worked successfully by Dr. J. Gershon-Cohen and associates of the Jewish Hospital of Philadelphia.

The patient's own physician and the specialist can consult by telephone while viewing the X-ray picture and its TV image. The TV image is said to be better in some respects than the original because the contrast can be adjusted for easier reading.

TV MEMORY TUBE may bring a radical improvement in television receiving apparatus within the next two years. Similar to the memory tubes used in computing machines, the device was described recently by Philo T. Farnsworth, vice-president of the Capehart-Farnsworth Corporation.

Doing away with the present interlace system, the tube will receive two frames every 1/60 second, store these until the picture is complete, and then project the completed picture only once each 1/60 second.

The tube will virtually eliminate flicker because the scan lines are not used. The only movement seen is the change from one complete image to the next, and this takes place so fast that it is not apparent. Another advantage is that the image brilliancy will be up to 5,000 times as great as in present tubes, thus making better projection television possible.

TV CONJUNCTIVITIS is a new ailment resulting from the rigors of modern life. Ben Payne Sr. of Columbus, Ohio, watched his set from 6 to 10 pm one evening with no breaks. When his eyes finally began to smart he went to bed. He woke up after midnight and found that he couldn't open his eyes and his head ached. At the hospital the doctors diagnosed his case as television conjunctivitis or looking too long.



Train at Home in Spare Time for **RADIO** and **TELEVISION**

**I Send You
18 BIG
KITS
OF RADIO-
TELEVISION
EQUIPMENT**

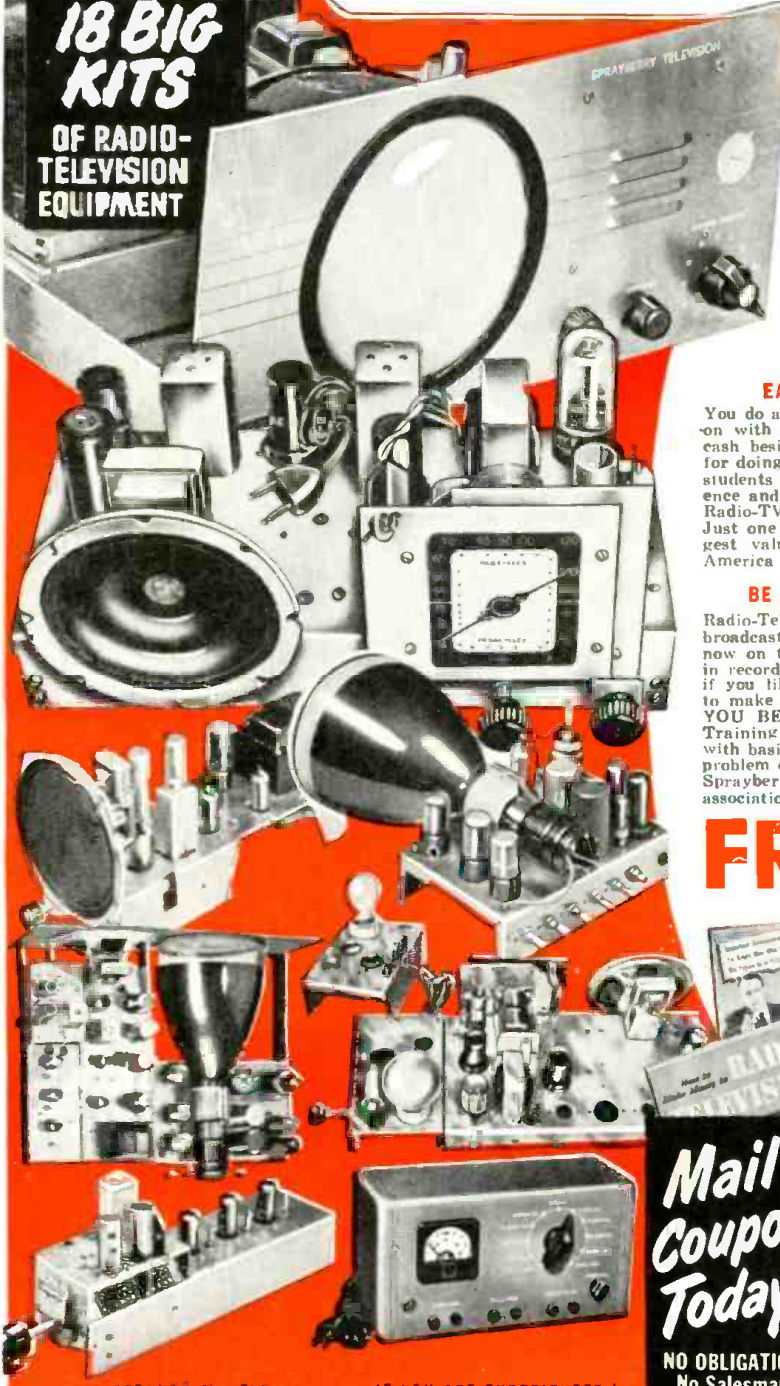

My Famous Training System Prepares You Double Quick For a Good Job or Your Own Profitable Radio-Television Business

Radio-Television is now America's greatest opportunity field! Trained men are needed to fill good jobs and handle profitable Radio-Television Service work. I have trained hundreds of men for success in Radio-Television—and I stand ready to Train you too, *even if you have no previous experience*. My training is 100% practical—designed to give you the knowledge and experience you need to make money in Radio-Television in the shortest possible time. I Train you with up-to-the-second revised lessons—PLUS many big kits of Radio-Television equipment. You actually do over 300 demonstrations, experiments and construction projects. In addition, you build a Powerful 6-tube-2-band radio, a multi-range test meter and a complete Television receiver! All equipment is YOURS TO KEEP.

EASY TO MAKE EXTRA MONEY WHILE YOU LEARN

You do all your training with me AT HOME in spare hours. Keep right on with your present job and income while learning—and earn extra cash besides! The day you enroll I begin sending you plans and ideas for doing profitable spare time Radio-TV work. Many of my Sprayberry students pay for their entire training this way! You get priceless experience and many plans for making extra money. You build all your own Radio-TV Test Equipment from parts I send you—nothing else to buy. Just one more reason why I believe I offer the ambitious man the biggest value in top notch Radio-TV Training available anywhere in America today.

BE READY FOR TOP PAYING RADIO-TELEVISION JOBS

Radio-Television is growing with amazing speed. More than 2000 Radio broadcasting stations PLUS an additional 102 Television stations are now on the air. Radio sets and TV receivers are being made and sold in record breaking numbers. If you enjoy working with your hands . . . if you like to do interesting and varied work . . . if you really want to make good money and work in an industry that has a future . . . YOU BELONG IN RADIO-TELEVISION. But you MUST have good Training to "cash in" . . . the kind of training that starts you out with basic fundamentals and carries you right through every circuit and problem of Radio-Television Servicing and Repair. In a word . . . that's Sprayberry Training . . . the course backed by more than 20 years of association with the Radio-Television industry!

FREE 3 BIG RADIO AND TELEVISION BOOKS

I want you to have ALL the facts about my complete system of Radio-Television Training! Act now! It's the coupon for my three big Radio-Television books: "How To Make Money in Radio-Television," PLUS my new Illustrated Television bulletin PLUS an actual sample Sprayberry Lesson—all FREE with my compliments. No obligation and no salesman will call on you. Send the coupon in an envelope or paste on back of post card. I will rush all three books at once!

**Sprayberry Academy of
Radio, Dept. 20-R**
111 North Canal St., Chicago 6, Ill.

**Mail
Coupon
Today!**
NO OBLIGATION
No Salesman
Will Call

SPRAYBERRY ACADEMY OF RADIO, Dept. 20-R
111 North Canal St., Chicago 6, Ill.

Please rush to me all information on your Radio-Television Training plan, I understand this does not obligate me and that no salesman will call upon me.

Name..... Age.....
Address.....
City..... State.....

Please Check Below About Your Experience
 Are You Experienced? No Experience

VETERAN'S My Radio course is Approved for Veterans

IF YOU ARE EXPERIENCED in Radio I'll qualify you for Television in 4 to 8 weeks. Rush coupon.

NEW!Rectangular
BLACK TUBE**16 in. TELEKIT**TELEKIT
PRICES
START AT **49.95**
LESS TUBES

Jobbers: Write For Confidential Price Information

16 BR Telekit
\$79.95 Less Tubes
Console Cabinet
shown \$29.95

You can build this fine 16 in. rectangular black tube TV set. All you need is pliers, screw driver, and soldering iron. It's easy to assemble; no previous knowledge of TV is required. The tuning unit and hi-voltage supply are factory wired and tested for you. A big 54 page illustrated instruction book guides you through easy assembly. Satisfactory results are **GUARANTEED** by Factory Service Plan and Warranty. Write today for complete information.

**12-B Telekit**
\$69.95
8-B Telekit
\$49.95
Both Less Tubes

Exciting new low prices on Telekits let you have a fine 8 1/2 or 12 1/2 inch set for a price far lower than comparable commercial sets. Over 35,000 Telekits have been successfully assembled by following the big illustrated Telekit instruction book. No previous knowledge of TV is required. Satisfactory results are **GUARANTEED** under the Telekit Factory Service Plan. Write for full information.

**12 CHANNEL TUNER**
\$12.95

Pre-built, factory aligned. Stage of R.F. amplification. Telekit 12 channel tuner equips any TV set with video I.F. of 25.75 to 26.1 Mc and sound I.F. of 21.25 to 22 Mc. Not a kit. Complete with tubes. Only 4 wires to connect.

**TELEKIT BOOSTER**
\$12.95

Brings in TV signals bright and clear. Especially helpful in fringe areas. For use with any TV set. **NOT A KIT.** Completely assembled with tubes.

**TELEKIT****ELECTRO-TECHNICAL INDUSTRIES**
1432 N. BROAD ST. DEPT. B PHILADELPHIA 21 PA.

ALARMING SHORTAGE of engineers is predicted by the American Society for Engineering Education. Based on enrollments of engineering schools, the forecast estimates that the present freshman class of engineering students is only about half what it should be.

300,000,000-VOLT synchrotron to be installed at the General Electric Laboratory at Schenectady, N. Y., works on a new principle.

Dr. James L. Lawson, manager of the Electron Physics divisions of the laboratory, gave details of the new machine, called a "non-ferromagnetic synchrotron," to members of the National Academy of Sciences at their autumn meeting in October.

In the usual synchrotron, a stream of electrons, originating from a heated filament, is accelerated to high energy in a doughnut-shaped vacuum tube between the poles of a powerful iron-core electromagnet. The magnetic field gives them their original acceleration, until they are moving at nearly the speed of light. As they receive further increase in energy, by passing a strongly electrified metal gap, the magnetism guides them in their orbit. At full energy they hit a metal target, generating a beam of X-rays, which emerges from the tube.

In the non-ferromagnetic synchrotron, as developed by Dr. Lawson and his associates, the necessary magnetic fields are produced by current-carrying coils rather than by iron-core electromagnets. There are sets of coils to provide the field for initial acceleration of the electrons (up to about 2.5 million volts) and to continue guiding them as they are further energized by passage through the electrified gap. The high fields which are possible from such coils results in a very compact machine compared with those of conventional type, in some of which the iron core of the magnet may weigh up to hundreds of tons.

SUBSCRIPTION TV began a series of test broadcasts over station WOR-TV in New York recently. Called Subscriber-Vision, the system is being tested by the Skiatron Electronic and Television Corporation, and these first on-the-air trials will be observed by the FCC.

Television receivers will not be able to get a picture from the subscription broadcasts unless equipped with a special decoder. The decoder is equipped with a plastic card which is identical within 1/10,000 inch to one used at the transmitter. These cards control the scrambling and unscrambling of the TV signal, and no telephone lines are needed. These tests will not interfere with WOR-TV's regular programs.

TEST PILOTS will no longer have to risk their necks, thanks to TV. The Air Force stated that planes under test would be equipped with TV cameras focussed on the instrument panel, while the pilot operated the plane by remote control from the ground. The new method will make it possible to get data never before obtainable.

Two war surplus planes equipped with the system are now under test. So far the results indicate that the use of TV is entirely practical and it may even be used on some of the new super high-speed planes.

MULTIPLEXED FM was demonstrated recently by the Multiplex Development Corporation of New York when they transmitted two separate sound programs simultaneously over a single FM station channel. For part of the demonstration, two microphones were used to pick up the program at the transmitter, the sound was divided between the two channels, and was reproduced over two loudspeakers at the receiving end. It was said to give a stereophonic, or presence effect at the receiver.

The system was also used to send program material over one channel and facsimile signals over the other, with no noticeable cross interference.



Scientists make some preliminary tests on G-E's new high-energy synchrotron.

M. A. FOY, PRESIDENT

BY MOOD, SECRETARY

FOY ELECTRIC COMPANY, INC.

305 SOUTH MINT STREET TELEPHONE 3-4934

CHARLOTTE 6, N. C.



August 21, 1950

Hytron Radio & Electronics Corp.,
Salem, Mass.

Dear Sirs:

It is with great pleasure that I write you at this time to compliment you on the superior performance of the Hytron 16RP4 cathode ray picture tube.

I have just purchased one of the NEW _____ 16" table model television sets, model _____, for my own personal use. I was not pleased with the brown spot which is often found in the rectangular tubes so I replaced this new _____ picture tube with one of Hytron's. The result? Amazing! Actually clearer and sharper pictures, more brilliance and no brown spot.

We are authorized service for about 11 different makes of TV sets and _____ is one of the factories we serve. From now on we shall insist upon Hytron for all picture tube replacements.

Yours truly,

J. A. Gupton, Jr.
J. A. Gupton, Jr.
Service Dept. Manager

WHY MR. GUPTON PREFERS

HYTRON RECTANGULARS...

Thanks to Mr. Gupton. His unsolicited appreciation naturally warms our heart. More important, he gives all service-dealers an excellent reason for picking Hytron rectangulars.

Does he choose Hytron? Because the rectangular is Hytron's baby . . . the original leader? Because Hytron's picture-tube plant is the most modern in the country? Because nine out of ten leading TV set makers choose Hytron? Because more and more service-dealers show equal shrewdness?

He has an even better reason: experience. His own experience proves Hytron better. Hytron rectangulars give him amazingly clearer, sharper, more brilliant pictures. They'll do the same for you. Demand original Hytron rectangulars. Prove by your own tests that Hytron is also *your* best choice.

16RP4 Rectangular



MAIN OFFICE: SALEM, MASS.



USE PHOTOFAC

the world's best Radio-TV service data—it pays for itself every working day



Try **PHOTOFAC!**

FREE We'll send you any Photofact Folder listed in the Photofact Cumulative Index

WE'LL PROVE YOU'LL SAVE TIME and EARN MORE WITH PHOTOFAC

NOW—learn for yourself—at our expense—how **PHOTOFAC** makes your Radio and TV work *quicker, easier, more profitable!* Examine an actual **PHOTOFAC** Folder. Use it. You'll learn first-hand why over 35,000 successful service technicians use **PHOTOFAC** daily. You'll learn that no other service gives you **PHOTOFAC**'s *completeness, accuracy, uniformity, and lowest cost.* **PHOTOFAC** is the *only* radio and TV service data prepared from laboratory analysis of the actual equipment. Know the facts—get your **FREE** Folder now. Examine, use, compare—learn why no modern service shop can afford to be without **PHOTOFAC!**

WRITE FOR FREE INDEX

PAY AS YOU EARN! Ask your distributor about this amazing plan. Only \$18.39 puts the entire profit-boosting Photofact library in your shop now!

NOTE: Our **FREE** Folder offer is limited to Service Technicians only. Attach coupon below to your letterhead and mention your jobber's name. If you have no letterhead, send coupon to your jobber. Experimenters and others may obtain the Photofact Folder by remitting amount shown below.

HOWARD W. SAMS & CO., INC.
2201 E. 46th St., Indianapolis 5, Ind.

- Send **FREE** Photofact Cumulative Index
- Send Full Easy-Pay Details

I am a Service Technician:
Send **FREE** Folder for set model.....
I am an Experimenter: Enclosed \$.....
Send **FREE** Folder for set model.....
I am a Comm. Receiver-75c. AM/TM-50c.....

Merchandising & Promotion

Sprague Products Co. issued a new revised edition of its Tell-U-How wall chart. Color lithographed, the chart measures 22 x 28 inches. It gives service data on capacitors; descriptions of common circuit troubles and their remedies; color codes on capacitors, transformers, and resistors as well as electrical formulas and other useful service information. The chart is available to radio and television service technicians without charge from Sprague distributors or directly from the company for a 10¢ handling charge.

Littelfuse, Inc., introduced a counter card display for their Snap-On TV Fuse



Holder. The colorful card holds 24 fuse holders and may be used as either a counter display or wall chart.

Allen B. Du Mont Laboratories, Inc., announced a stepped-up sales training campaign for TV dealers. As a follow-through, the company inaugurated an extensive educational advertising program for service technicians, trade papers, and magazines. The first of the series was devoted to the Du Mont Sensituner.

The Radio-Television Manufacturers Association set up a 16-man committee of radio-television set sales managers which drafted a proposed code of ethics for selling and advertising TV sets. Copies of the code were distributed among members for comment and criticism. The RTMA also announced plans for publicizing the fact that the association has established standards for measurement, manufacture, and rating of microphones, speakers and amplifiers.

Brach Manufacturing Corp. is under way on a nation-wide campaign to acquaint TV dealers with the new Brach antennas and the sales potential of the Brach Mul-Tel System. In each area, local Brach jobbers arrange the showings.

Service Business

New York Better Business Bureau reported a marked improvement in radio and television advertising and selling practices since the adoption of its fair practice standards. The Bureau has already distributed over 100,000 of its consumer booklets on TV receivers.

The Television Service Contractors Association of Detroit was successful in delaying an action by the Detroit City Council to regulate TV installation and servicing companies. The association objected to a clause in the ordinance proposing the licensing of TV service technicians.

Television Associates, Inc., a Washington, D. C., organization of service firms, has requested the District of Columbia License Committee to consider licensing service firms in the District.

The Television Contractors Association of Philadelphia has directed a campaign to the leaders of the television industry pointing up the critical shortages of skilled service technicians in civilian occupation. It suggests that leaders in manufacturing, broadcasting, servicing, and government meet to prevent the disintegration of TV servicing.

Production

The RTMA reported a peak production in August of 702,287 TV sets, bringing the industry total for the first eight months of 1950 to 4,146,602, already 1,100,000 higher than for all of 1949. The RTMA pointed out further that 3,107,000 TV sets had been shipped to dealers during the first seven months of 1950.

The RTMA estimated radio set production at 1,203,447 for August and 8,750,965 for the first eight months of 1950. Breakdown of the radio production figure for August showed 754,232 home radios, 320,960 auto radios, 128,255 portables.

Radio receiving tube sales hit an all-time high in August—36,269,435 bringing the year's total to 227,773,373 as against 198,753,295 for the entire year of 1949. Tube sales were 28,202,620 for new sets in August and 7,017,115 for replacements. The balance were used for export or for government agencies.

August sales of 767,051 TV picture tubes to manufactures more than doubled July sales, the RTMA announced. 87% were 16 inches or larger and 51% were rectangular. Sales of transmitting, communications, and radar equipment to the government increased from \$30,640,943 in the first quarter of 1950 to \$33,393,093 in the second. Government orders went up from \$41,305,390 to \$61,701,467.

New Plants and Expansions

RCA Victor Division announced the purchase of the Cincinnati plant of the Rich Ladder & Manufacturing Co. for the manufacture of miniature receiving tubes.

Simpson Electric Co., Chicago, opened its new plant No. 5 in Aurora, Ill. The new 30,000-square-foot plant will be devoted to the manufacture of panel meters.

La Pointe-Plascomold Corp. purchased an entire new plant in Windsor Locks, Conn. The plant will provide 105,000 sq. ft., doubling the company's facilities for the manufacture of Vee-D-X television antennas and accessories.

PERFECT *Fringe Area* **RECEPTION**

IS AS SIMPLE AS



You can have nearly perfect TV reception — strong, "snow"-free images — regardless of how faint an image you now receive — with the complete Tel-a-Ray System for fringe areas! It's simple and economical.

The first step in the Tel-a-Ray System is the Tel-a-Ray "T" antenna, which consistently receives images from stations 200 miles away.



To your Model T antenna, mount the new, powerful Tel-a-Ray Pre-Amplifier. This amazing new product of the Tel-a-Ray Research Department eliminates, or greatly reduces, "snow." Because it mounts right to the antenna, it has a high signal-to-noise ratio, bringing you stronger, clearer pictures with less noise. It furnishes consistent reception beyond the fringes and eliminates matching problems and line loss. It is completely weather-resistant, like all Tel-a-Ray products, and sells at a much lower price than other antenna-mounted amplifiers or boosters.

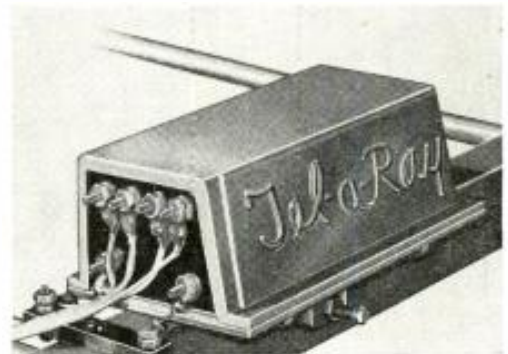
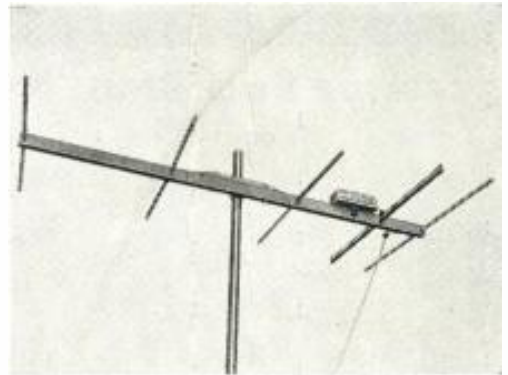

The final step that brings you almost perfect TV reception is your TV receiver. This simple parlay, A-B-C, is your guarantee of hours of television pleasure, unmarred by foggy images and irritating noise.

WITH THE COMPLETE *Tel-a-Ray System*



FOR PRIMARY AREAS



The Tel-a-Ray Butterfly receives 13 channels and FM radio. Guaranteed to be weather-resistant, it will consistently provide the best reception possible. And the price is just \$2.95 (suggested list).

Televiewers throughout the country have come to associate the name Tel-a-Ray with good reception through quality products. If you have a particular reception problem, Tel-a-Ray engineers will be glad to help you.

Tel-a-Ray
ENTERPRISES, INC.
 P.O. Box 332A HENDERSON, KY.

5 Great Books to INCREASE YOUR EARNING POWER!

TRAIN FOR A RICH FUTURE IN RADIO-ELECTRONICS

36 courses in one . . . only \$5 complete



Ghirardi's famous 972-page RADIO PHYSICS COURSE book has given more radio-electronic beginners their start than any other book or course! During the war, it was more widely used in Signal Corps, Navy, etc. training than any other radio text—because it makes everything so perfectly clear and understandable. Contains complete training covering every phase of basic radio-electronics. Over 300 pages make Basic

Electricity easy to learn. Other subjects range from Radio Transmission to Receiving, Vacuum Tubes, Detection, Measuring Instruments, Power Supplies, Public Address Systems, Amplification, Photo Electric Cells, Short Waves—a total of 36 basic training subjects. If broken into lessons and sold as a course, you'd regard this great book as a bargain at \$50 or more—yet you buy it for only \$5 complete. Over 500 illustrations.



A famous Ghirardi book

Don't be a screw-driver mechanic!

LEARN MODERN, PROFESSIONAL SERVICE METHODS!



A famous Ghirardi book

With today's complicated circuits, you're really got to know your stuff to get the good-paying jobs! Ghirardi's 1400-page MODERN RADIO SERVING book teaches you basic, professional service methods from the beginning. Tells how to analyze any circuit and its components; how to make pre-

liminary trouble checks; how, when and where to use test instruments and to interpret their readings in tracking down the trouble—even how to start a successful service business of your own. 706 clear illustrations and 723 self-review questions make study easy. Only \$5 for the complete training.



GET INTO THE FAST-GROWING END OF SERVICING

. . . Be a TELEVISION repair and maintenance specialist!



Here's the book that can pave the way to real profits in the fastest-growing part of the business, PRACTICAL TELEVISION SERVICING! It tells what to do—exactly how to do it in installing modern TV receivers and keeping them working properly. It shows how television differs

from radio, explains what mistakes to avoid; outlines in clear, easily-understood terms how to troubleshoot, diagnose and repair television receiver troubles. Includes dozens of helpful television service case histories, 334 pages, over 230 helpful illustrations. Only \$4. Use coupon.

There's good pay in this uncrowded field

LEARN ELECTRIC MOTOR REPAIR!

If you're looking for something different—something that not everybody and his brother are studying—then here's the book for you! Based on what can be learned at home from this big ELECTRIC MOTOR REPAIR book, you can train for profitable installation, service, repair and even complete armature rewinding of prac-

tically any electric motor in common use. You learn about electric motor control systems, too! Quick reference guides show how to handle specific jobs. Written especially for beginners. Practice from it for 10 days at our risk! 560 pages, over 900 special illustrations. Only \$5. Use coupon today!



Save time—make more money!

LEARN TO USE THE OSCILLOSCOPE FULLY!



Not one radio-electronic man in a dozen really knows how to use the oscilloscope—and, if he did, he'd be worth a lot more money. This Great Instrument saves time, assures far greater efficiency on almost any electronic design or service job. Learn how to use it and watch your earn-

ings soar! MODERN OSCILLOSCOPES AND THEIR USES gets right down to earth in explaining the entire subject in a way you can easily understand. Almost 400 illustrations make things doubly clear. 326 pages. Price only \$6. Use coupon for 10-day money-back guarantee.

ORDER NOW! 10-DAY MONEY-BACK GUARANTEE!

Dept. RE-120, Murray Hill Books, Inc., 232 Madison Avenue, New York 16, N. Y.

Enclosed find \$ for books checked; or send C.O.D. for this amount plus postage and I will pay post-man. If books are not satisfactory, I will return them in 10 days and you guarantee to refund my money. (Cash only outside U.S.A.—same 10-day return privilege).

- RADIO PHYSICS COURSE \$5 (\$5.50 outside U.S.A.)
- MODERN RADIO SERVICING \$5 (\$5.50 outside U.S.A.)
- PRACTICAL TELEVISION SERVICING \$4 (\$4.50 outside U.S.A.)
- ELECTRIC MOTOR REPAIR \$5 (\$5.50 outside U.S.A.)
- MODERN OSCILLOSCOPES \$6 (\$6.50 outside U.S.A.)

Name.....
 Address.....
 City, Zone, State.....

Sylvania Electric Products, Inc., Parts Division, constructed a new plant for the production of plastic and plastic-metal components for the radio, television, and lighting industries. The new plant in Warren, Pa., will provide 30,000 sq. ft. of production space.

Altec Lansing Corp. moved to new and larger quarters in Beverly Hills, Cal. The new plant gives the company an additional 20,000 sq. ft. and enables it to consolidate all three factories under one roof.

Oak Ridge Products moved to a larger plant in Long Island City, N. Y.

Financial Reports

	1950	1949
Allied Electric Products (Year to June 30)		
Earnings	\$160,814	\$2,354
Sales	\$4,126,700	\$1,658,365
Hallcrafters Co. (Year to August 31)		
Earnings	\$1,167,905	\$403,050
Sales	\$28,513,540	\$14,572,008
Hytron Radio & Electronics Corp. (Third quarter)		
Earnings	not reported	
Sales	\$13,350,000	\$3,950,000
Oak Manufacturing Co. (Quarter to Aug. 31)		
Earnings	\$417,018	\$134,543
Sales	not reported	
Raytheon Manufacturing Co. (Quarter to Aug. 31)		
Earnings	\$568,885	\$546,774 (loss)
Sales	\$17,834,124	\$9,003,700
Standard Coil (First Half)		
Earnings	\$3,135,393	\$2,571,779
		(entire year)
Sales	\$16,038,859	\$16,594,626
		(entire year)

Dividends

Clarostat declared a dividend of 8¢ on common stock.
 Cornell-Dubilier announced a special 15¢ extra dividend on common stock.
 Hallcrafters authorized a 15¢ dividend on common stock.
 Hytron declared a regular quarterly dividend of 12¢ on preferred stock.
 Tung-Sol Lamp Works ordered a \$1.25 dividend on common stock.

Business Briefs

RCA Tube Department issued a new edition of the RCA Receiving Tube Manual. . . . RTMA approved membership applications of five new companies: Celco (Constantine Eng. Labs.); General Ceramics & Steatite Corp.; Tele-Tone Radio Corp.; Trad Television Corp.; Wright-Zimmerman, Inc. . . . RCA Service Co. established a special government service division to expedite government requests for technical personnel and the installation and servicing of electronic equipment. . . . Trad Television is making giant TV sets for military and naval training centers. . . . A bill centering all Air Force electronic development activities in Rome, N. Y., was passed by Congress and approved by the President.

Testing for sound lost between telephone receiver and ear. Many subjects were used in these tests.

How to compensate for a curl . . . and add to your telephone value



Bell scientists know that the telephone is not used under ideal laboratory conditions. There is never a perfect seal between receiver and user's ear. A curl may get in the way, or the hand relax a trifle. And ears come in many shapes and sizes. So some sound escapes.

Now, sound costs money. To deliver more of it to your ear means bigger wires, more amplifiers. So Bell Laboratories engineers, intent on a thrifty telephone plant, must know how much sound reaches the ear, how much leaks away. They mounted a narrow "sampling tube" on an ordinary

handset. The tube extended through the receiver cap into the ear canal. As sounds of many frequencies were sent through the receiver, the tube picked up a portion, and sent it through a condenser microphone to an amplifier. That sampling showed what the ear received.

As a result, Bell scientists can compensate in advance for sound losses—build receivers that give *enough* sound, yet with no waste. That makes telephone listening always easy and pleasant.

It's another example of the way Bell Telephone Laboratories work to keep your telephone service one of today's biggest bargains.



Automatic recorder plots sound pressures developed in the ear canal at different frequencies.

BELL TELEPHONE LABORATORIES



Working continually to keep your telephone service big in value and low in cost.

Eye witness reports from a fiery furnace!

A new television development which
adds to industry's efficiency

No. 11 in a series outlining
high points in television history

*Photograph and painting
from the RCA collection*

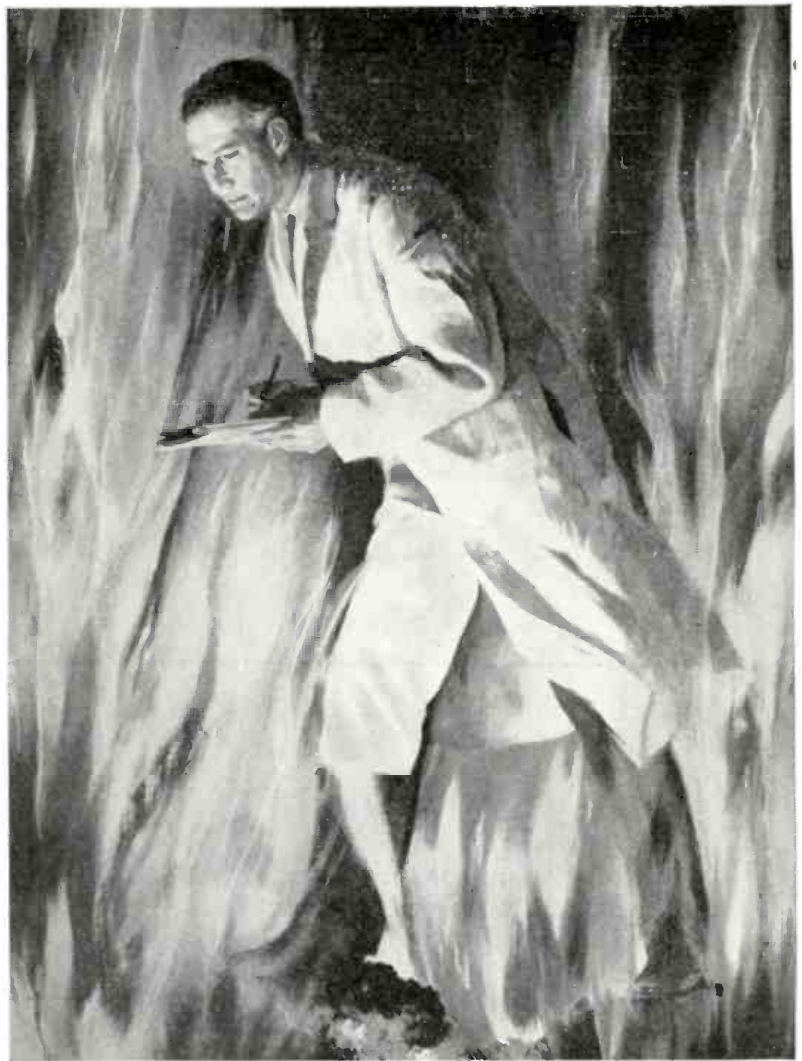

Compact industrial television system—developed at RCA Laboratories—lets us see the unseeable in safety!

● Something's wrong in a big blast furnace, and it is too hot for engineers to approach in safety. But now, with the Vidicon camera of an RCA Industrial Television System focused on the flames, the furnace can be studied closely and carefully on a television receiver.

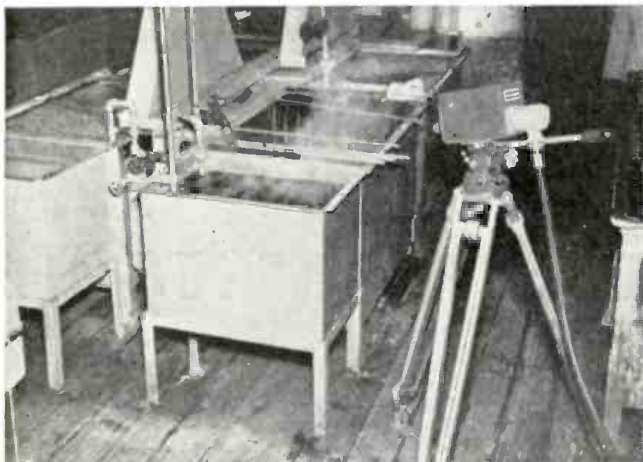

Here's RCA's Vidicon system at work beside a steaming vat. Note how the compact television camera is getting a safe "close-up" of the action.

One of the great advantages of this system—other than its contributions to industrial safety—is its ability to save both time and money. No longer need engineers "shut-down" machines or processes to observe them. Normal operations can continue without waste, while the Vidicon System gathers information.

Key to the success of Vidicon is a tiny television camera—small enough to hold in one hand—and inexpensive. The camera's "eye" is the sensitive Vidicon tube developed by scientists at RCA Laboratories. The only other equipment needed is the Vidicon camera's suitcase-size portable control cabinet, which operates on ordinary household current, and *any* television receiver—on which to view the pictures.

Adaptable to many uses, RCA's Vidicon camera could be lowered under water to watch divers at work—or stand watch on atomic piles, secure from radiation. And this RCA Industrial Television System can also be arranged for 3-dimensional pictures . . . real as life!



Radio Corporation of America

WORLD LEADER IN RADIO—FIRST IN TELEVISION

RADIO-ELECTRONICS for

take it from **EXPERTS**



PAT REID SAYS:

Salesmanager, United Radio Supply, Inc.
Portland and Eugene, Oregon

"Our 379 servicemen and dealers tell us N. U. tubes are best, because their own experience has proved N. U. tubes are reliable, uniform, and above all are properly designed for interchangeability. What's more, costly call-backs are minimized by N. U.'s proven quality control. That's why we've featured N. U. tubes for 15 years. They mean good business for all of us.

renew
with **N.U.**
premium quality tubes

- RADIO AND TELEVISION RECEIVING TUBES
- VIDEOTRON TELEVISION PICTURE TUBES
- PANEL LAMPS
- TRANSMITTING AND SPECIAL PURPOSE TUBES

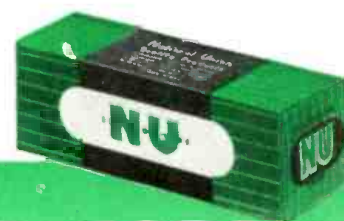

NATIONAL UNION RADIO CORP.

Main Office: 350 Scotland Rd., Orange, N. J.

Research Division: Orange, N. J. • Plants: Newark, N. J. — Hatboro, Pa.

Which Do You Want?



Better Pay



A Nice Home



A New Car



Greater Security



Happy Vacations and Travel

Get Your FCC Ticket
Then Use Our
Amazingly Effective
Job-Finding Service
To Get a Better Job



EDW. H. GUILFORD
Vice President

I can train you to pass your FCC License Exams in a minimum of time if you've had any practical radio experience—amateur, Army, Navy, radio servicing, or other. My time-proven plan can help not only you, but also the road to success.

Just fill out the coupon and mail it. I will send you free of charge, a copy of "How to Pass FCC License Exams," plus a sample FCC-type Exam, and the amazing new booklet, "Money Making FCC License Information."

How to Pass Commercial Radio Operator FCC License Exams

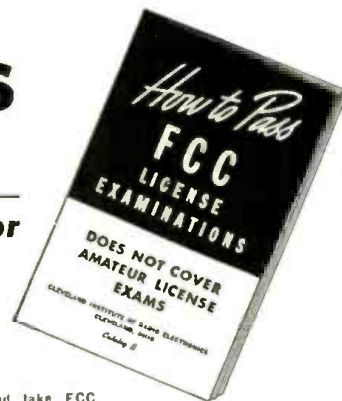

FREE

Tells where to apply for and take FCC examinations, location of examining offices, scope of knowledge required, approved way to prepare for FCC examinations, positive method of checking your knowledge before taking the examinations.

Get this Amazing Booklet FREE

TELLS HOW — WE GUARANTEE
TO TRAIN AND COACH YOU AT HOME
IN SPARE TIME UNTIL YOU GET
YOUR FCC LICENSE

TELLS HOW — Employers make
JOB OFFERS Like These
to Our Graduates Every Month

Telegram, August 9, 1950, from Chief Engineer, Broadcast Station, Pennsylvania. "Have job opening for one transmitter operator to start immediately, contact me at once." Letter, August 12, 1950, from Dir. Radio Div. State Highway Patrol. "We have two vacancies in our Radio Communication Division. Starting pay \$200; \$250 after six months' satisfactory service. Will you recommend graduates of your school?" These are just a few examples of the job offers that come to our office periodically. Some licensed radioman filled each of these jobs . . . it might have been you!

HERE'S PROOF FCC LICENSES ARE OFTEN SECURED IN A FEW HOURS OF STUDY WITH OUR COACHING AT HOME IN SPARE TIME

Name and Address	License	Lessons
Lee Worthy 2210 1/2 Wilshire St., Bakersfield, Cal.	2nd Phone	16
Clifford E. Vogt Box 1016, Dania, Fla.	1st Phone	20
Francis X. Foerch 38 Beuster Pl., Bergenfield, N. J.	1st Phone	38
S/Sgt. Ben H. Davis 317 North Roosevelt, Lebanon, Ill.	1st Phone	28
Albert Schoell 110 West 11th St., Escondido, Cal.	2nd Phone	23

CLEVELAND INSTITUTE OF RADIO ELECTRONICS
Desk RE-24, 4900 Euclid Bldg., Cleveland 3, Ohio
(Approved for Veteran Training Under "GI Bill of Rights")

TELLS HOW —

Our Amazingly Effective
JOB-FINDING SERVICE
Gets Better Jobs for Graduates

Here is just one recent example of Job-Finding Results

GETS FIVE JOB-OFFERS FROM BROADCAST STATIONS
"Your 'Chief Engineer's Bulletin' is a grand way of obtaining employment for your graduates who have obtained their 1st class license. Since my name has been on the list I have received calls or letters from five stations in the southern states, and am now employed as Transmitter Engineer at WMMT, Elmer Powell, Box 274, Sparta, Tenn."

Your FCC Ticket is always recognized in all radio fields as proof of your technical ability.

OURS IS THE ONLY HOME STUDY COURSE WHICH SUPPLIES FCC-TYPE EXAMINATIONS WITH ALL LESSONS AND FINAL TESTS.



Get All 3 FREE
MAIL COUPON NOW

CLEVELAND INSTITUTE OF RADIO ELECTRONICS
Desk RE-24, 4900 Euclid Bldg.,
Cleveland 3, Ohio
(Address to Desk No. to avoid delay.)

I want to know how I can get my FCC ticket in a minimum of time. Send me your FREE booklet, "How to Pass FCC License Examinations" (does not cover exams for Amateur License), as well as a sample FCC-type exam and the amazing new booklet, "Money-Making FCC License Information."

NAME _____
ADDRESS _____
CITY _____ ZONE _____ STATE _____
 Veterans check for enrollment under G.I. Bill.

RADIO-ELECTRONICS for

Choleric Color TV

... Color television should be allowed to evolve normally ...

By HUGO GERNSBACK

ON October 11 the Federal Communications Commission threw a bombshell into the television industry by approving the Columbia Broadcasting System's non-compatible mechanical color television method, as the standard for commercial color telecasting.

As must be well known by this time, the CBS color system consists of a three color spinning disc which when placed in front of the television tube screen gives the viewer color television.

RADIO-ELECTRONICS finds no fault with the CBS system any more than with a Ford Model T. *Both work—both are archaic.* Nor can we imagine that ten years hence a mechanical gadget with a spinning disc will be found in our future television sets.

Indeed, television started in 1884 with the famed Nipkow rotating disc. In 1928 the English television pioneer Baird produced color television with the self-same spinning disc.

To us—as it does to most responsible radio engineers—it seems that the F.C.C. decision is most unfortunate because in the end we will have *electronic*—not mechanical—color television without any doubt whatsoever. It is true that the C.B.S. system *today* produces color television, with better definition than several of the proposed electronic systems. But, tomorrow it is certain that this condition will reverse itself, as it must.

What then will become of the public's investment in the cumbersome spinning disc color television receivers?

Worst of all, at present the CBS system can only produce 10½ inch pictures. To have color television on a 19-inch screen you would require a rotating disc at least 38 inches in diameter, which would increase the television cabinet size by three to four feet—a monstrosity. Such a television set would occupy more room, or almost as much width as a grand piano! Obviously, such a contraption is not evolution—it's a throwback.

Most of the responsible television manufacturers will have none of the revolving disc television sets because they realize that they will not prevail in the future.

Why did the FCC take such an ill-advised step? As a government agency, the FCC felt that it could not stand by idly while millions upon millions of black-and-white television sets were manufactured which the Commission honestly believed would become obsolete on the advent of color. This to us is fallacious thinking. The coming of color—as engineered in the near future—need do no such thing and *we are certain that it will not play havoc with existing television sets.*

In our considered opinion black-and-white sets will always be with us in television, or at least for a long time to come.

We have excellent parallels to the present disturbing situation. It is possible today to print every newspaper as well as every magazine in full color. It has been possible to do so for several generations. *Yet, how many magazines or newspapers are printed in full color? Only a very small percentage.*

Nor are we certain that every reader would want color to the exclusion of black and white, even if it were no more expensive.

The same argument can be made with motion pictures. There is no question that the quality of color in motion pictures today has reached a high state of perfection. But even today with television competition making inroads on motion pictures we only have 14¾ per cent of color motion pictures. It seems that color motion pictures are not universally demanded by the public; otherwise the studios would furnish color exclusively. Furthermore, color motion pictures are more tiring to the eye for most people, particularly when the picture runs for more than one hour.

Perhaps the same reasoning will hold true for future color television as well.

In the meanwhile a most unfortunate situation has arisen in the television industry in that the average layman has become so befuddled on television color that he has no clear idea of what it is all about. The average man believes that if he buys a black-and-white set today it will be obsolete tomorrow. So he refrains from buying.

Actually, in spite of the FCC, no such thing will happen, in all probability.

We have been of the opinion right along that color television—when properly developed—will not disturb in any way our present black-and-white sets. Just as you can take three magazine cover plates and print red, blue and yellow on top of each other to produce a color picture, so you can take the same plates running them in a single color—black—on top of each other. This will produce a good black-and-white picture. Exactly so will your present-day television set continue to receive black-and-white even if "color" is broadcast from every TV transmitter in the land.

As we go to press, Robert C. Sprague, president of the Radio Television Manufacturers Association, predicts a new system in a very short time *which does not require adapters for TV sets for black-and-white reception as the CBS systems now does.* We quote from his statement:

"The vast majority of the engineers and scientists in the electronic field believe that there will be available within a reasonable length of time a satisfactory commercial color system which is *compatible*, i.e. a system which can be received in black-and-white on present day black-and-white sets without any change in or addition to these sets whatsoever."

With such a system, in the near future, when all stations transmit color exclusively you can still use your black-and-white set or you can buy a color receiver. The latter will also have a switch so you can change the color picture to black and white, or switch back to color again.

To repeat, all the present day black-and-white sets will not be affected and will give service as they do now. Television should be allowed to evolve in a normal manner just as did radio. Using forceps to force a premature birth may mutilate the color television child for life.

Radio Set and Service Review

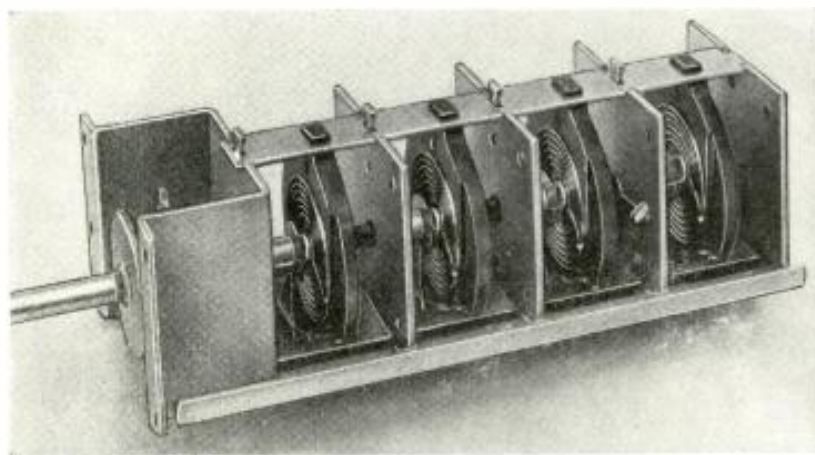

4-gang spiral inductance used in the front ends of current Du Mont TV sets.

Improved circuits in Du Mont's 1951 receivers aim for better performance

By RICARDO MUNIZ*

PRESENT Du Mont television receivers have many interesting circuits, some of which are unique with Du Mont, and all of which contribute to uniform and better performance. Better performance implies better pictures. Better pictures must have high definition, sharp focus, full contrast range, freedom from noise, stable synchronization with immunity to noise impulses, high brilliance, freedom from spurious responses, freedom from interfering signals, and many other characteristics.

minimum phase distortion and maximum skirt selectivity; cathode-coupled vertical blocking oscillator and sawtooth generator to furnish vertical sweep free from oscillator transformer ringing; and continuous tuning for low noise figure, low susceptibility to FM harmonics, and low oscillator radiation.

Narrow-band sync¹

Fig. 1 is the circuit of the narrow-band sync circuit as it is used in the Du Mont model RA-112 TV receiver chassis. The full video bandwidth of the video i.f. amplifiers is not needed to amplify the sync signals adequately. By using a sync amplifier with a considerably smaller bandwidth, the amplified signal will have a lower noise content. Noise is further reduced by grid cutoff and plate saturation limiting in this stage. This tends to increase the sync stability of the picture and, since the a.g.c. voltage is also derived from this amplifier, the a.g.c. is more stable.

The i.f. signal which is applied to the video detector is also amplified by 6BA6 sync and a.g.c. amplifier and then is passed through a 1-mc wide, double-tuned transformer centered on the video carrier. Two detectors then de-

tect the signal: a peak detector for the a.g.c. voltage, and a video detector for the sync signals. The sync detector is much more efficient than the usual video detector because its bandwidth need be only 0.5 mc.

The smaller bandwidth of the interstage transformer reduces the noise content of the signal before detection but has adequate width to reproduce the sync signal as the receiver is tuned across the picture carrier. There is no sync signal or a.g.c. except close to the optimum tuning point. This means that the set owner cannot have his receiver mistuned by very much and therefore cannot receive with degraded sound and picture quality.

Cathode drive

Several of the current Du Mont models use cathode drive on the picture tube with a single-tube video amplifier. Fig. 2 shows this circuit as it is used in model RA-113. The diode video detector is not linear and has a rather sharp curvature as the voltage goes toward zero or, in the case of a TV signal, toward white. This causes the white portion of the video signal to be compressed as shown in Figs. 3-a, 3-b, and 3-c. If this voltage can be counteracted by the grid-voltage-plate-current char-

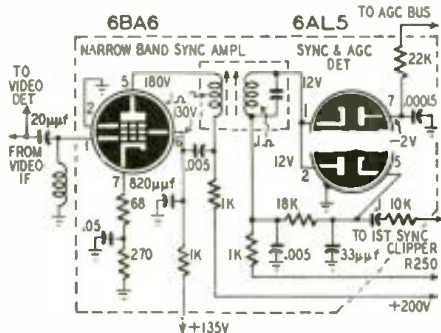

Fig. 1—The narrow-band sync amplifier circuit and sync and a.g.c. detectors.

The circuits discussed in this article are: the narrow-band sync circuit which provides both synchronization and automatic gain control signals with unusual freedom from noise impulses and spurious responses; the cathode drive of the kinescope with a single video amplifier which is free from white compression commonly found in single-stage video amplifiers; a d.c. restoring circuit for the cathode drive; link coupling from the tuner to the first video i.f. stage to provide for use of a u.h.f. tuner and to make lead length and lead dress less critical; double- and triple-tuned video i.f. amplifier stages for

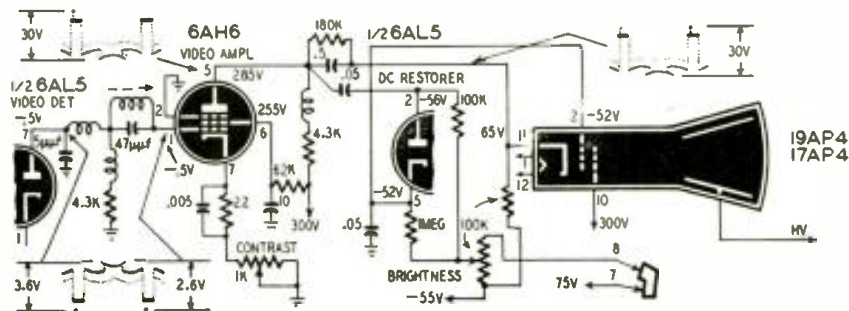

Fig. 2—Schematic showing the cathode-driven kinescope and the d.c. restorer.

*General Manager Television Receiver Mfg. Div. Allen B. Du Mont Laboratories

acteristic of the video amplifier, the over-all characteristic will be more nearly linear and the white compression caused by nonlinearity of the de-

the circuit adaptable to a u.h.f. tuner in place of or in addition to the v.h.f. tuner normally delivered with these receivers. Neither this low-impedance link

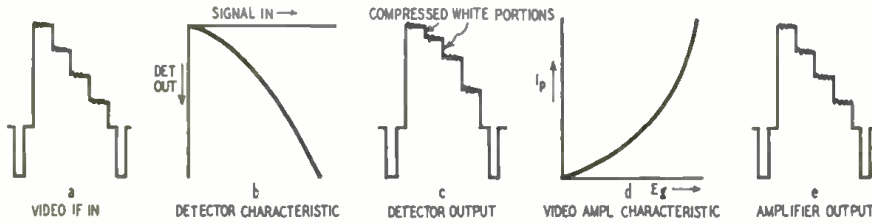

Fig. 3—How tube characteristics are combined to reduce white compression.

tector is minimized as indicated by Figs. 3-d and 3-e.

White compression on a TV receiver is most noticeable at the bull's-eye center of a test pattern. Fig. 4-a shows a test pattern with the gradations as they should be, and 4-b shows white compression which appears as a lack of difference in shading between the two outer and lighter rings. When viewing a picture, white compression shows up as a lack of "snap" or crispness in the picture which leaves the viewer vaguely dissatisfied but not quite sure what's wrong.

D.C. restorer

The conventional d.c. restorer circuits being ineffective with cathode drive, the circuit shown in Fig. 2 is used. D.c. coupling is used between the video detector and the video amplifier. The plate of the video amplifier is also coupled directly to the cathode of the picture tube. This tends to put a high positive voltage on the cathode which may exceed the heater-cathode rating of the tube. To avoid this, a negative voltage is applied directly to the cathode to make the positive voltage on the cathode 65 at no signal. A negative voltage is also applied to the grid of the cathode-ray tube, the net effect being to keep the screen at a gray level when no signal is present. When a signal is applied, the screen becomes black at the black parts of the picture. The d.c. restoration is applied to the grid of the cathode-ray tube because the cathode circuit impedance is too low for efficient operation.

Link-coupled tuner

Link coupling is used between the tuner and the i.f. amplifiers for greater flexibility in chassis layout and to make

coupling, the lead dress, nor the lead length is critical. Fig. 5 shows the circuit from the plate of the mixer tube to the grid of the first video i.f. stage.

Winding L2 is closely coupled to the mixer plate winding L1, and varying L3 varies both the coupling and the bandwidth between the two circuits. Fig. 6 is an equivalent circuit of the coupling network which shows how L3 provides an effective shunt inductance to vary the coupling and bandwidth.

The video i.f. stages

Fig. 7 is the circuit of the video i.f. amplifier. T2, T3, and T5 are top capacitance-coupled transformers. T4 is a triple-tuned stage of which one section is a 21.75-mc sound trap. The 6BC5 is used in the last stage to get more signal at the video detector before sync compression takes place than is possible with a 6AU6. An interesting feature of the top capacitance-coupled stages is that the variable capacitance coupling is achieved by a wire inserted a varying distance in a ceramic sleeve mounted in the i.f. transformer as shown in Fig. 8.

A block diagram of the i.f. amplifier is shown in Fig. 9. Below the blocks are the individual bandpass characteristics achieved in production alignment. This i.f. circuit is designed to get a maximum bandpass with minimum phase distortion and maximum skirt selectivity.

Vertical sweep generator

One of the big problems of vertical sync circuits is furnishing a vertical sawtooth voltage that is free from the ringing or damped oscillations that usually appear in blocking oscillator transformer windings. Fig. 10 is the circuit of the vertical sawtooth generator used

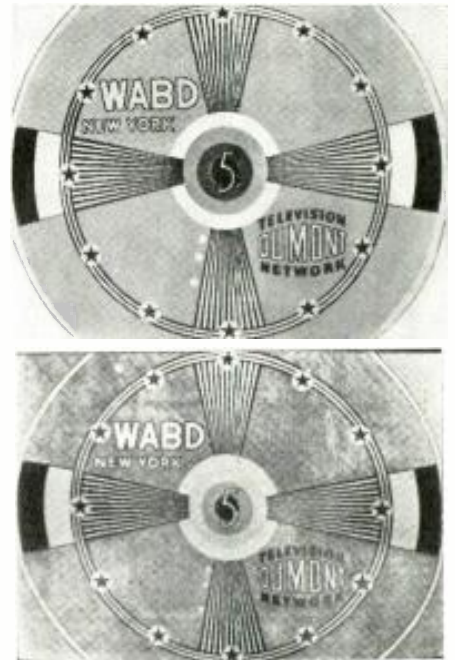

Fig. 4-a, top—Normal tone gradation from black to white at the bull's-eye. Fig. 4-b, bottom—Compression of whites.

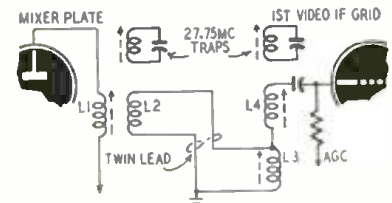

Fig. 5—Link coupling circuit from the mixer plate to the video i.f. amplifier.

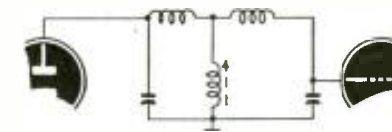

Fig. 6—Equivalent circuit of the link coupling to show how the tuning works.

on Du Mont chassis models RA-112 and RA-113.

This circuit is a typical blocking oscillator except that one side of the transformer is in the cathode circuit of the tube. This isolates the sawtooth voltage at the plate from the ringing voltage that appears in the transformer winding when the tube is in the cutoff condition. This is not true when the transformer winding is in the plate circuit.

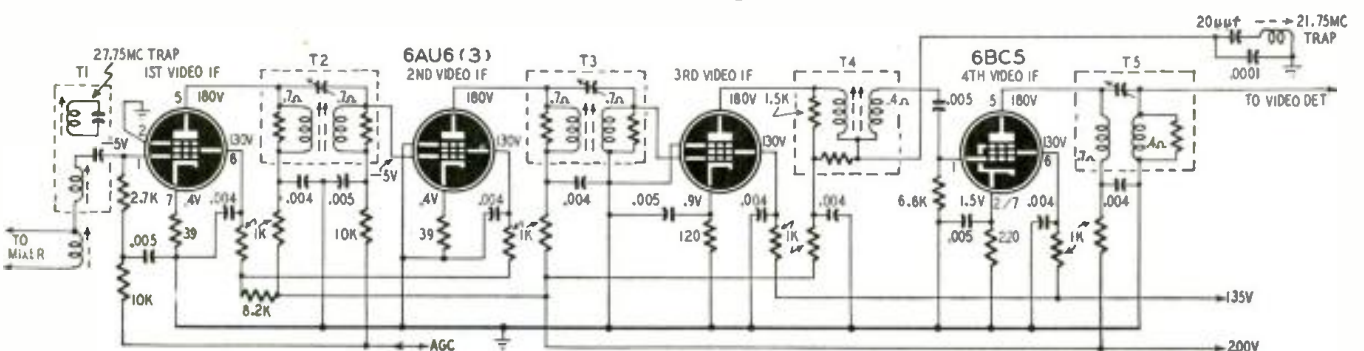

Fig. 7—Circuit of the video i.f. amplifier. The 6BC5 i.f. output is used to get more signal at the video detector before sync compression takes place. The top capacitance coupling of T2, T3 and T5 is varied by the novel method shown in Fig. 8.

Continuous tuning

The Du Mont Inputuners² used in the current TV receiver production use the same principle of continuous tuning by inductance variation as in older

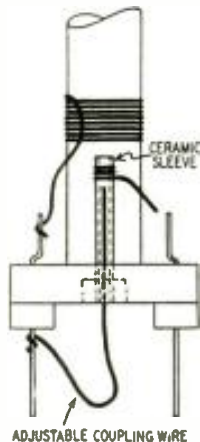

Fig. 8—The i.f. capacitance coupling is varied by moving the coupling wire.

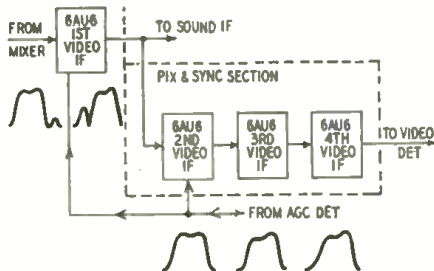

Fig. 9—Block diagram of the video i.f. stages showing alignment waveforms.

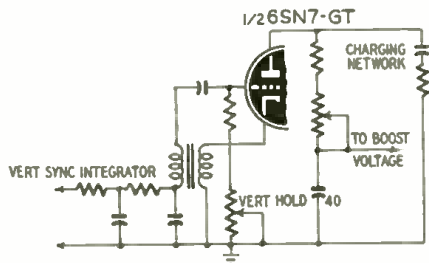

Fig. 10—The circuit of the cathode-coupled vertical blocking oscillator.

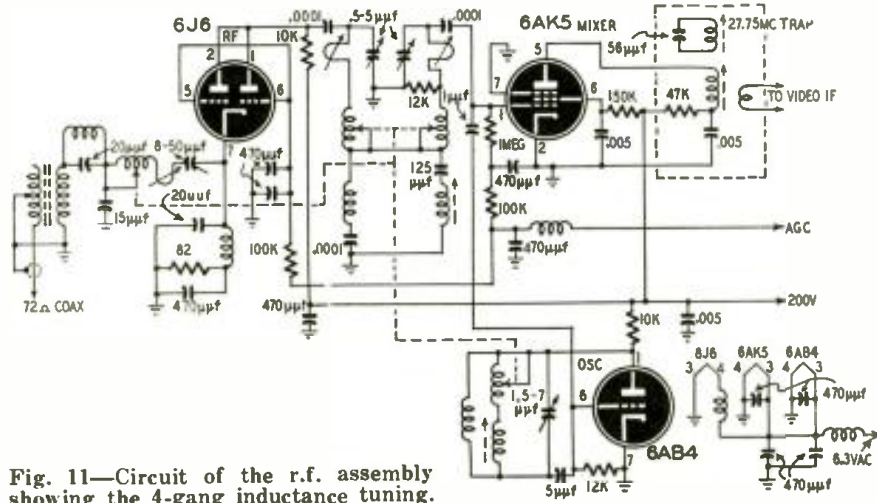

Fig. 11—Circuit of the r.f. assembly showing the 4-gang inductance tuning.

models but have some electrical and mechanical improvements. Among these are an additional tuned circuit without increase in size and a skip tuning device which automatically bypasses the unwanted part of the spectrum between the FM band and channel 7.

The new Inputuners have a sliding-contact gang inductor called the Inductuner³. The latest Inductuner uses flat spiral inductors which allow room for four tuning sections in less space than was used by three sections in the older type. The added section is hooked up between the antenna and the r.f. tube to give better rejection of unwanted signals and to improve gain and signal-to-noise ratio. The circuit of the r.f. assembly is shown in Fig. 11.

The r.f. gain increase is in the order of 2 to 1. Image rejection is improved by five to ten times over that of previous tuners. I.f. rejection is increased by over 100 times due to the trap action of the coupling circuits.

The band-skip feature reduces the number of turns of tuning motion from six to four and improves the tuning curve over the high-frequency channels. This jump from the FM band is accomplished by the design of the contact mechanism in the tuner.

The continuous tuning assures optimum picture and sound setting because the input circuits and the oscillator are shifted together as vernier adjustment is made.

Other than the spiral inductance tuning, the r.f. circuit has no unusual features. A 6J6 triode is used as the r.f. amplifier. This tube generates less noise than a pentode. While more gain could be achieved with a 6CB6 or similar pentode, the added section of the spiral tuner makes this unnecessary. The parallel-connected triode gives the r.f. stage adequate gain.

1. Patent applied for.
2. Trademark.
3. Exclusive trademark of P. R. Mallory & Co. and manufactured under Mallory-Ware patents. The author acknowledges the cooperation of Mr. B. Hexeman of the Television Receiver Manufacturing Division Engineering Department, Mr. S. D. Prensky of the Television Receiver Manufacturing Division Publications Department, and Mr. B. V. K. French of the Electronic Parts Division in collecting material for this article.

ADVICE TO TV OWNERS CUTS NUISANCE CALLS

To cut down the number of nuisance service calls on TV sets, the Akron (Ohio) Merchants Association is distributing a Television Card to set owners with suggestions for checking the set's operation. Compiled by the Television Committee of the Electric Institute of Washington, the list contains this advice:

Before you call your Television Serviceman—

1. If the set is completely dead, is the line cord plugged into the electric outlet? If the cord is plugged in, unplug it and try a lamp in the same outlet. If the lamp lights try the set when plugged in again.
2. Look at the antenna wire on the back of the set. Make sure the leads are firmly connected to the terminals on the set and that the bare leads are not touching each other.
3. If the sound is normal, but you have no picture, turn the brightness and/or contrast control full on and also try another channel.
4. If the picture is normal, but you have no sound, adjust the "fine-tuning" control with the volume control turned full on. Also try another channel.
5. In suggestions 3 and 4, if only one channel is affected, allow the station time to announce any technical difficulty which might have occurred.
6. If sound is normal and picture tube has light with the brightness control full on, but the picture is rolling, tearing out or no picture on all channels, adjust the "horizontal hold" or "vertical hold" controls. Try reducing contrast or picture control and readjust tuning.
7. If sound is weak and noisy, and the picture has excessive snow, see if the antenna is still installed in its original position. Also recheck suggestion No. 2.

After following these seven suggestions, if the trouble has not been corrected, call your service dealer.

Many set owners have very little idea of the complexities of a television receiver. When something goes wrong they will call the service technician whether they need him or not. The seven rules printed above will make both parties happier.

The committee might have included an additional rule: If you get four images at once on the screen when adjusting the hold controls, don't worry—you are picking up a color broadcast.

NEW STEEL FOR TUBES

Larger rectangular picture tubes are promised as a result of a new stainless steel having a heat expansion rate practically the same as that of glass. Developed by the Carnegie-Illinois Steel Corporation, the new alloy retains all the desirable characteristics of stainless steel for picture tubes, but will not crack the glass when the tube heats up.

Fundamentals of Radio Servicing

Part XXII—How to Trap a Signal

By JOHN T. FRYE

WE ARE ready to try out the broadcast receiver we have been studying stage by stage for the past several chapters. What is needed now is a live signal to make our radio set perform. Since the air is filled with transmissions from many broadcast stations, all we have to do is to intercept one of these signals and lead it into the signal grid of our mixer tube. We know what will happen to it from there on.

Before we set out to trap a signal we should, like any good trapper, have some idea of the characteristics and habits of the game we are after. The "trapee" in this instance is a transmitted radio signal; and, while its characteristics are somewhat more complicated than the rules for playing post-office, they are by no means beyond comprehension.

We already know that, when a 60-cycle alternating current flows through a wire, the conductor is surrounded by a panting magnetic field. Part of the electrical energy is alternately stored in this field and then returned to the wire. If the frequency of the alternating current is increased to 10,000 cycles a second and beyond, some of the energy delivered to the field about the wire does not return to the conductor but sails off into space as radiated energy. When a transmitting antenna is substituted for our conducting wire and certain other favorable conditions are established, vast encouragement is given to the high-frequency alternating current to leave home and to keep going.

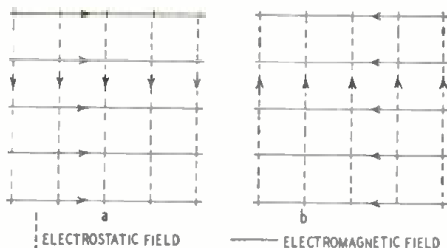

Fig. 1—Patterns showing the electromagnetic and the electrostatic fields of force of a radiated electric signal.

Fig. 1-a gives us a head-on view of this free-wheeling radio wave as it zips through space directly toward us at a speed of 186,000 miles a second. Notice that there are really two fields, which share the energy of the wave equally

between them: an electrostatic or "voltage" field, and an electromagnetic or "current-inducing" field. These two fields are as inseparable as Siamese twins, and they always act at right angles to each other, and both operate at right angles to the direction of travel.

Broadcast-band waves ordinarily have their electrostatic fields producing lines of force in a vertical direction with regard to the earth and are said to be "vertically polarized." Television stations in the United States send out waves whose electrostatic stress is exerted parallel to the earth and are called "horizontally polarized" waves.

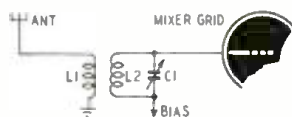

Fig. 2—A simple antenna circuit with inductive coupling to the mixer grid.

At the instant pictured in Fig. 1-a, the electrostatic stress is from top to bottom, and the electromagnetic stress is from left to right. Fig. 1-b pictures the same wave passing the same place at a time interval equal to one-half wavelength later. Note that by now the electrostatic stress is from bottom to top and the electromagnetic stress is from right to left.

The thing to keep clearly in mind is that these two fields are moving and that as they move past a stationary portion of space they produce stresses in that space. For example, as the electrostatic portion of the wave encounters two points in space, one directly above the other, first the top point will be positive with respect to the bottom point and then the bottom point will be positive with respect to the top point. If the two points are connected by a length of wire, an alternating current will flow in this wire as the radio wave zips past it.

Snaring the signal

Fig. 2 shows how we take advantage of this fact to trap a signal for use in our receiver. A vertical wire is connected through coil L1 to the earth. The top of this antenna and the earth constitute the two "points in space" mentioned in the foregoing paragraph. The current flowing in L1 is inductively coupled to the tuned circuit L2-C1. By resonating this tuned circuit to the

signal we want to receive, we can reject all other signals flowing in the antenna circuit and allow only the wanted one to appear on the grid of our mixer tube.

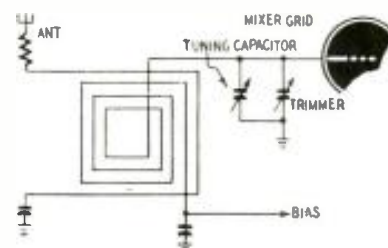

Fig. 3—A high-impedance loop antenna is formed when the antenna transformer is wound in the form of a large helix.

This "outside" antenna provides a good method of intercepting a radio signal, but it has some disadvantages. First, since its effectiveness depends to a large degree on its height, it is difficult to install; second, special precautions must be taken to prevent this elevated antenna from extending the welcome-mat to a bolt of lightning; third, few antennas of this kind do anything for the appearance of a home; and fourth, a radio used with such an antenna is more or less rooted to one spot near where the lead-in is brought into the house.

This last item was particularly exasperating to those housewives—and their name is legion—who dearly love to shuffle the furniture around the house every few weeks. The little women demanded a radio that could be moved! So, the radio engineers sighed, picked up a candle, and disappeared into their attic of discarded electronic lore. A few hours later they reappeared

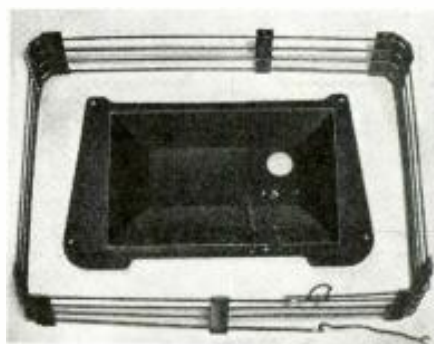

Photo showing examples of low-impedance and high-impedance loop antennas.

triumphantly clutching a dusty and cobwebbed "loop" antenna that they had wrested from one of the earliest console battery receivers.

As can be seen from Fig. 3, the modern *high-impedance loop antenna* is really just an expanded antenna transformer. Instead of occupying only a couple of inches of space, the secondary of the transformer is wound in the form of a spiral or large diameter helix so that it has an area of many square inches. In this enlarged form, it can intercept a sizeable portion of the field of a radio wave and so provide sufficient signal for the receiver without being connected to an outside antenna.

Directional properties

Such a loop antenna is directional; that is, it will receive a signal much better when the loop is arranged so that its plane is paralleled to the line of transmission of the radio signal than it will when this plane is at right angles to the line of transmission. If you will look at the simplified one-turn loop

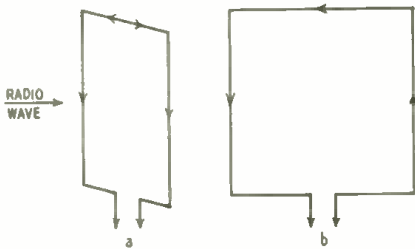

Fig. 4—This diagram shows the directional properties of the loop antenna.

shown in Fig. 4, you can see why. At 4-a the incoming signal strikes both sides of the loop at the same instant. The currents induced in the two sides of the loop by the passing magnetic field—the loop depends upon the electromagnetic field of the radio wave for its action—are equal and opposite in phase; so they simply buck each other out and the signal is received very weakly if at all.

At 4-b, however, the wave strikes one side before the other. If you keep in mind that, as the wave moves through space, its fields are constantly shifting back and forth, you can see that the direction and intensity of the current induced in the first leg of the loop cannot be identical with the direction and intensity of the current induced in the second leg, because the wave has traveled through space between these two encounters and the electromagnetic field that produces the current has changed somewhat during that short trip. Since the two currents are not identical, they cannot balance each other out, and we shall have an alternating current flowing in our loop. Do not think that the two currents are *in phase* when the loop is parallel to the line of transmission—the loop would have to have its two sides a half-wavelength apart for that—but they

are not 180 degrees out of phase as they are when the plane of the loop is at right angles to this line. This slight shift away from the 180-degrees-out-of-phase condition is all that is needed to let a signal be received.

The voltage pickup, as can be easily understood, is proportional to the loop area. The farther the loop is located from the chassis or any other large metal object, the lower is its distributed capacitance, the higher is its *Q*, the sharper it tunes, and the more directional it is. Unfortunately, the usual small receiver permits the loop to be placed only an inch or so from the chassis.

One way of overcoming some of these disadvantages is to have the loop detachable from the receiver and arranged so that it can be held in the best position by suction cups.

Improved loop antennas

An approach that is more electronic and less mechanical is diagrammed in Fig. 5. Here a loading coil *L* is used in series with the loop. This loading coil has a very high *Q* and a low distributed capacitance. Since the distributed capacitance of the loop circuit is thus reduced, the tuning range of the loop is extended for use with a given capacitor. Raising the *Q* of the tuned circuit gives sharper tuning and better signal response. In many receivers, this loading coil is slug-tuned for best tracking over the tuning range.

Provisions are usually made for connecting an outside antenna to these loops for receiving distant or weak stations. A low-cost way of doing this is to place a single turn of wire around the loop at the low-potential side as is shown in Fig. 3. Such an arrangement tends to favor the high-frequency end

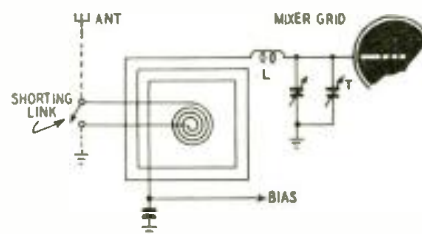

Fig. 5—Adding a loading coil *L* to the loop antenna gives it better response.

of the band, but that can be overcome by inserting a resistor of 500 or 1,000 ohms in series with the single turn. If too much coupling is provided, the signals tend to be hum-modulated and the selectivity suffers.

A high-impedance primary, such as that shown in Fig. 5, gives a more uniform coupling than does the single-turn job of Fig. 3, but it is guilty of the cardinal sin of manufacturing: it costs more! When such a high-impedance primary is used, it is usually provided with a shorting link to be used when an external antenna is not connected. This is to prevent the absorption of energy by the primary coil at its resonant points that fall in the broadcast band.

One manufacturer has still another

system for getting around the disadvantages of the high-impedance loop. He uses a low-impedance loop, as shown in Fig. 6, which consists of two to four turns of large-diameter wire. This is inductively coupled to the grid of the mixer tube through a very high-*Q* autotransformer. The low-impedance loop is relatively insensitive to capacitance effects and to calibration changes due to changing its position. Both the *Q* and the response are practically uniform throughout the broadcast band. An external antenna, when used, is connected directly to the high-potential side of the loop.

Many of the better receivers place loop antennas inside electrostatic shields. This serves the double purpose of cutting down on much man-made interference and of insuring uniformly distributed capacitance effects for the loop.

These directional properties of a loop antenna are very fine for cutting down on interference, either from an unwanted radio station or from a noise source that occupies a single point in space, but like most good features it also has a few drawbacks.

Even those who do understand the operation of a loop are loath to be twisting the set about every time a station is tuned in. When the set is a large console and has a fixed-position loop, taking advantage of its directional properties requires the energy of a fox terrier and the physique of a piano mover.

Fortunately, a lot of movement is not required. The "null" or no-reception points of a loop are very narrow compared to the arcs through which reception can be had. Moreover, all except the cheapest consoles provide some method of varying the position of the loop through a few degrees without moving the cabinet.

While it must be admitted that the loop antenna is not the most efficient device for snatching radio signals out of the ether, there can be no doubt that it is the most popular with radio receiver owners today. Because of the number and power of broadcasting stations, the majority of receiving locations are blanketed with powerful signals that make it unnecessary to have an antenna system of maximum efficiency. A loop antenna will usually pick up enough energy for satisfactory reception—and remember, the little woman can move a loop set to her heart's content!

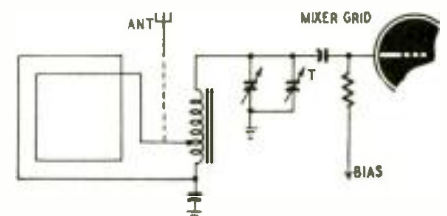

Fig. 6—By using only a few turns on the loop but coupling it to the mixer through a high *Q* autotransformer, the antenna response can also be improved.

Television DX Reports

READERS of this column have noted that in the last three months, the dx reports have all been for the low channels. Dx on the high bands scarcely ever goes over about 300 miles.

This month we do have three reports of dx on the high band. One is from F. J. Glaub of East Moline, Ill., who picked up WHIO-TV in Dayton, Ohio on channel 13, and station WKRC-TV in Cincinnati, Ohio on channel 11 September 5. The airline distance in both cases is about 370 miles. The receiver is an Admiral 30C1 and the antenna a Taco stacked dipole 20 feet off the ground and aimed at Chicago.

The second high band report is from E. Swanson of Rockford, Ill., who received WSPD-TV, channel 13, in Toledo, Ohio, on September 6 and 7. In this case the receiver is a G-E Model 805, the booster an Anchor, and the antenna a 4-bay Radiart conical. The distance is about 300 miles.

One reader in Halifax, Nova Scotia reports several dx receptions, of which three were over 1,000 miles on the low band, and one high band reception of

450 miles. This report includes an interesting observation on cloud formations and their effects on dx receptions.

Apparently dx reception is possible at this location only when alto-cumulus or cirro-cumulus clouds are in the sky. The alto-cumulus, a fleecy cloud formation often seen in flocks or rows, seems to give the long hops; and the cirro-cumulus, clouds in small round masses at high altitudes and usually in lines (called a mackerel sky), seems to give the double hop. An interesting feature of this report is that the strongest signals were received from the most distant stations.

What really happens in these long distance receptions is still not fully understood by the engineers. Part of the radiated energy from the transmitting antenna goes up toward the sky at anywhere between 3 and 90 degrees with the horizontal. These waves soon reach the ionosphere, a region about 70 miles above the earth's surface which contains large concentrations of charged particles, both free electrons and ions, as well as neutral molecules.

The prodigal sky wave may or may

not be reflected back to the earth when it hits this region. This depends on several conditions, of which the most important are the angle at which the sky wave hits the ionosphere, the frequency of the wave, and the concentration of the charged particles of the ionosphere. While the first two of these can be determined exactly, the third is a largely unknown factor which is continually changing. This, of course accounts for the unpredictability of TV dx.

The reason the high band dx is less frequent is that the higher frequencies are not as readily reflected as the lower. It is likely that some of the waves will reflect from cloud formations, as the letter from our reader in Nova Scotia indicates. What seems more likely, is that the cloud formations are an indication of the condition of the ionosphere. In any case, much more must be known about the propagation of radio waves before anything certain can be said.

The low band reports of over 1,000 miles are shown in the two tables below as in the past, and again we thank those who have sent in their dx records.

TABLE I — REPORT OF RECEPTION

STATION	REPORTED BY	TIME RECEIVED	MILE-AGE	STATION	REPORTED BY	TIME RECEIVED	MILE-AGE	STATION	REPORTED BY	TIME RECEIVED	MILE-AGE
KEYL-TV Channel 5 San Antonio, Tex.	H. Brink	8 18	1,000	WBZ-TV Channel 4 Boston, Mass.	R. Roland	7/18, 12-2:30 pm	1,125	WMBR-TV Channel 4 Jacksonville, Fla.	T. E. Rowe A. C. Olberg	7 22 7, 12, 5-5:45 pm	1,300 1,380
KOB-TV Channel 4 Albuquerque, N. M.	W. R. Henry	5 24, 8:45-10 pm	1,200	WCBS-TV Channel 2 New York, N. Y.	A. C. Olberg K. D. Anderson R. Roland	7 31, 2:45-4:15 pm 7 15, noon 7 18, 12-2:30 pm 8/5, 12:30 pm	1,100 1,000 1,035	WNBT Channel 4 New York, N. Y.	R. Roland	8 5, 12-2:30 pm	1,035
KPRC-TV Channel 2 Houston, Tex.	K. D. Anderson	7 13, 7 14	1,000	WDSU-TV Channel 6 New Orleans, La.	A. C. Olberg K. D. Anderson	8 10, 6-8:30 pm 7, 11, noon	1,250 1,000	WOAI-TV Channel 4 San Antonio, Tex.	K. D. Anderson W. E. Bennett	7/13, 7 pm 7 7, 8, 12	1,000 1,000
KRLD-TV Channel 4 Dallas, Tex.	Mrs. W. Callan A. C. Olberg	8 1, 10:30 pm 8 18, 1-1:30 pm	1,120 1,060	WFIL-TV Channel 6 Philadelphia, Pa.	R. Roland	7 18, 12-2:30 pm	1,000	WPTZ Channel 3 Philadelphia, Pa.	A. C. Olberg K. D. Anderson R. Roland	7 9, 3:45-4:10 pm 7 15, noon 7/16, 12-2:30 pm 8 5, 12:30 pm	1,100 1,000 1,000
WAGA-TV Channel 5 Atlanta, Ga.	A. C. Olberg	7 7, 7-8 pm	1,010	WFMY-TV Channel 2 Greensboro, N. C.	A. C. Olberg	7 12, 11 am-2:30 pm	1,000	WTVJ Channel 4 Miami, Fla.	T. E. Rowe	7 22	1,580
WBAP-TV Channel 5 Fort Worth, Texas	A. C. Olberg	6 18, 1-1:30 pm	1,060	WKY-TV Channel 4 Oklahoma City, Okla.	Mrs. W. Callan	8 1, 10-10:30 pm	1,050				
WBRC-TV Channel 4 Birmingham, Ala.	A. C. Olberg	7/7, 7-8 pm	1,080	WMAR-TV Channel 2 Baltimore, Md.	A. C. Olberg K. D. Anderson	7, 14, 5-5:15 pm 7/15, noon 8, 5, noon	1,075 1,000				
WBT Channel 3 Charlotte, N. C.	A. C. Olberg	7 12, 4-5 pm	1,030								

TABLE II — RECEIVER DATA

NAME	LOCATION	RECEIVER	BOOST-ER	ANTENNA	NAME	LOCATION	RECEIVER	BOOST-ER	ANTENNA
K. D. Anderson W. E. Bennett H. Brink Mrs. W. Callan	Kerkhoven, Minn. Augusta, Ga. Dixon, Ill. Altoona, Pa.	Emerson Tech Master Kit Muntz Philco 51-T-1443B	Maaco Anchor	Trio Lazy H 4-bay conical Folded dipole double Vee	W. R. Henry A. C. Olberg R. Roland T. E. Rowe	Warner Robins, Ga. Clearbrook, Minn. Perry, Ia. Aurora, Minn.	Midwest Arvin 5300 Motrola 9L1 Hallcraft	home-made Astatic	two 5-element Yagie 18-element folded dipole JFD stacked conical



Conducted by
WALTER H. BUCHSBAUM

CONVERSION business is becoming an important part of our readers' work, to judge from the increasing number of letters being received. Many small-screen TV sets now require a replacement for the picture tube and naturally the owners want a larger picture. In many cases a tube can be made without changing the switch from a 10- to a 12-inch picture cabinet. Sometimes a rectangular 14- or 16-inch tube can be mounted with only minor changes in the cabinet. Many service dealers are accepting older TV sets as trade-ins and reselling them with a larger tube and a new cabinet.

RADIO-ELECTRONICS has featured several articles on converting TV sets to larger picture tubes, the most recent and comprehensive in the January, 1950, issue. Conversion kits are available at radio supply houses, each with a detailed circuit description. It would be repetitious to go into details of all these circuits, but the principles of converting TV receivers deserve some discussion.

Most of the larger screen tubes differ in two main aspects from the 10- or 12-inch tube found in older sets. First, the new tubes require a higher second-anode voltage for proper brightness and sharp focus. The second requirement is additional deflection, especially horizontal. More horizontal sweep is required because of the higher second-anode voltage and because the new tubes are relatively short and therefore have a larger deflection angle. An illustration of the effect on bulb length and deflection angle is given in Fig. 1.

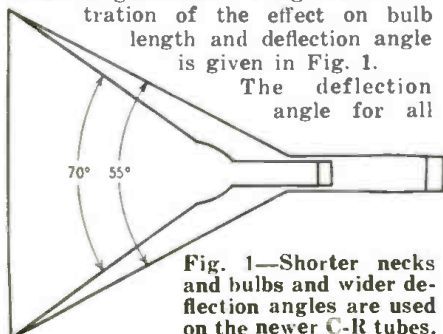

Fig. 1—Shorter necks and bulbs and wider deflection angles are used on the newer C-R tubes.

10-inch tubes is 52 degrees and for most 12-inch tubes it is 55 degrees, which permits direct substitution whenever plenty of horizontal sweep is available for the 12-inch tube. The larger screen picture tubes, however, have a deflection angle ranging from 63 to 70 degrees and 90-degree tubes are

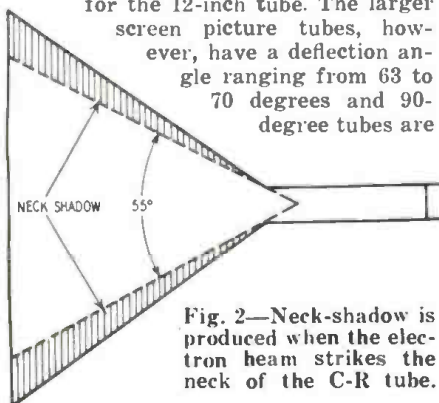

Fig. 2—Neck-shadow is produced when the electron beam strikes the neck of the C-R tube.

being developed. To deflect the wide-angle tubes, the deflection yokes must be shorter and designed to eliminate neck-shadow as shown in Fig. 2.

The vertical deflection circuits of

most receivers have enough reserve power to sweep the new tubes, but in some cases the vertical circuit must be changed. Connecting the plate of the vertical output amplifier to a higher voltage, usually the boost obtained from the horizontal damper tube, or increasing the sawtooth driving the output amplifier is the simplest way to increase vertical sweep.

To get more high voltage and at the same time more horizontal sweep it is necessary to use a suitable flyback transformer and deflection yoke. Most of these transformers are of the high-efficiency type, containing not a powdered iron but a ceramic core which gives higher Q and more permeability. Such a transformer is the G-E 77J1 or its counterparts from other manufacturers. To match the transformer the deflection yoke is of special design, usually also containing a ceramic core and specially shaped windings. The inductance of most of these yokes is higher than the original 8.3 mh, ranging from 10 to 18 mh. The circuit used

Picture-Tube Conversion Data				
Tube Size (inches)	Defl. Angle (degrees)	Anode Volts (kv)	Ion Trap	Remarks
10	52	9.5	double pole	10FP4 needs no ion trap.
12	55	9.5	double or single	Different types of ion traps required. Some need no trap.
14 rect.	63	12	double or single	14CP4 uses single-pole trap.
16 round	63	12	double or single	16AP4 (metal) has 55° angle. 16GP4 (short metal) has 70° angle.
16 rect.	70	12	double or single	Various bulb shapes and lengths available.
17 rect.	70	12	double or single	Same as 16-inch rect. except for screen size.
19 round	70	12-15	single pole	Glass and metal tubes almost identical electrically.
20 round	55	12	none	Obsolete.
20 rect.	70	12-15	single or double	Similar to 16-inch rect.
30 round	90	15	single	Now under development.

with the G-E 77J1 and similar flyback transformers requires a special width-control coil.

In addition to requiring changes in the flyback circuit and the deflection yoke, many of the large screen picture tubes also require more focusing flux. This is obtained by using a larger focus coil or by installing one of the new combination EM-PM units. Lately some all-PM focusing rings have appeared on the market which could be used for some large-screen tubes. Many of the new tubes have a tilted electron gun which needs a single-pole magnet ion trap as compared with the double-pole magnet used on the 10BP4 or the 12LP4. The table shows the different picture tubes and the requirements for conversion.

Horizontal pull

I have especially bad horizontal pull on a 630-type TV set when a close-up appears. I also have a white smear running down the left side of the picture. Tubes and voltages appear to be correct.—E. B. N., San Francisco, Cal.

The best way to find the fault is to observe the different waveshapes on an oscilloscope and compare them with those shown in the RCA instruction manual. If you can improve the condition somewhat by lowering the bias on the 6SK7 sync amplifier, the trouble may lie in the video or the d.c. restorer circuit. Measure the bias voltages on the 6AU6 and 6K6 video amplifier carefully and replace the 6AL5 d.c. restorer with a new tube.

Both slugs on the synchrolock transformer must be properly adjusted before any other circuit can be checked. Also try replacing the 6AL5 sync discriminator and the 6AC7 reactance tube. Emission checks are not good enough with these tubes. As a last resort, replace the synchrolock transformer itself, as it may have some shorted turns.

Poor contrast

I own a 16-inch Transvision TV receiver. The contrast is poor. The picture tube is a 16DP4. Will this tube work with 13.5 kv on the second anode?—S. C. L., Philadelphia, Pa.

The contrast depends on the gain of the receiver, especially the video amplifier. If the i.f. sensitivity is satisfactory, you may need a new video amplifier tube. As a last resort, a higher value plate resistor in the video output tube will give you more contrast.

The 16DP4 may be operated with 13.5 kv on the second anode without damaging it.

Hash

Many 630-type receivers which have been converted for larger picture tubes and keyed a.g.c. have a faint hash. This appears on weak stations and I feel sure that it is not an external interference.—H. W., Brooklyn, N. Y.

There are several possibilities. It may be a 4.5-mc beat which becomes more apparent when a direct connection is made from the detector to the first video

amplifier, necessary for keyed a.g.c. A 4.5-mc trap in the last video amplifier will eliminate this.

The hash may also come from i.f. misalignment, especially the traps. Re-alignment is necessary when a.g.c. is added to the 630. To disable the a.g.c., simply shunt a 3-volt battery across the bias source with the negative side to the bias and the positive side grounded.

A third possibility is that the hash may not be apparent on the smaller screen, but only on the larger picture tube. However, some a.g.c. circuits alter the video amplifier response curve and cause a loss of detail. In that case the fault is not in the a.g.c., but in the values of the video peaking coils. It may be necessary to use new coils.

No picture

I have an RCA 730 TV2 on which I can't get a picture. Sound and raster are O.K. All tubes check good.—E. S., Chicago, Ill.

If sound and raster are O.K., the trouble must be either in the picture i.f. amplifier, the video detector, or the video amplifier. While tubes may check good in a tester, it is better to check them by substituting new ones. This is especially important in the case of the 6AL5 video detector.

Barring tube failure, a close inspection for broken leads, poor tube socket contacts, charred resistors, etc., in the i.f. and video amplifiers may show the defect. Next measure all plate voltages. If the defect still is not apparent, check each coupling capacitor by shunting it with one known to be good. If you have an oscilloscope, you can trace the picture from the second detector to the defect. Measure the detector output. A small d.c. voltage should be developed across the diode load resistor as the set is tuned from one active channel to another. If no change occurs, the trouble can probably be localized in the video i.f. amplifier.

Distorted picture

An Emerson model 571 takes a few minutes before the test pattern becomes round. After another 5 minutes, the picture at the left side stretches while at the right it remains normal. Changing tubes in the horizontal deflection circuit did not help.—B. F., Brooklyn, N. Y.

A defective capacitor is probably the fault. This is most likely one of the coupling capacitors going to the horizontal output amplifier grid. Checking such a capacitor with a meter is not sufficient as it apparently goes bad only when heated up. The best method is to substitute a good capacitor for each coupling capacitor and for the charge and discharge capacitor (C-59) in the plate circuit of the horizontal discharge or sawtooth generator tube.

Paper and electrolytic capacitors are more likely to become leaky than micas or ceramics, although the latter may become intermittent.

Airplane flutter

Whenever an airplane passes over my house, a diagonal white line appears and the picture moves on my De Wald BT100 TV set, chassis 630.—N.B., Elizabeth, N. J.

This set does not have a.g.c., and therefore you get the airplane flutter. When a plane passes over rapidly, the reflected TV signals change slightly in frequency. Unless you are willing to add a special tube and make several wiring changes, you cannot get rid of this effect on your present set.

A special keyed a.g.c. is used in many 1950 TV sets to compensate for airplane interference. Tech-Master Products offers a Keyed A.G.C. Kit, available in most radio supply houses, to eliminate airplane flutter in 630-type sets. This kit contains all parts and mounting brackets to eliminate the need for additional holes in the chassis and major circuit changes. Complete instructions are furnished with the kit.

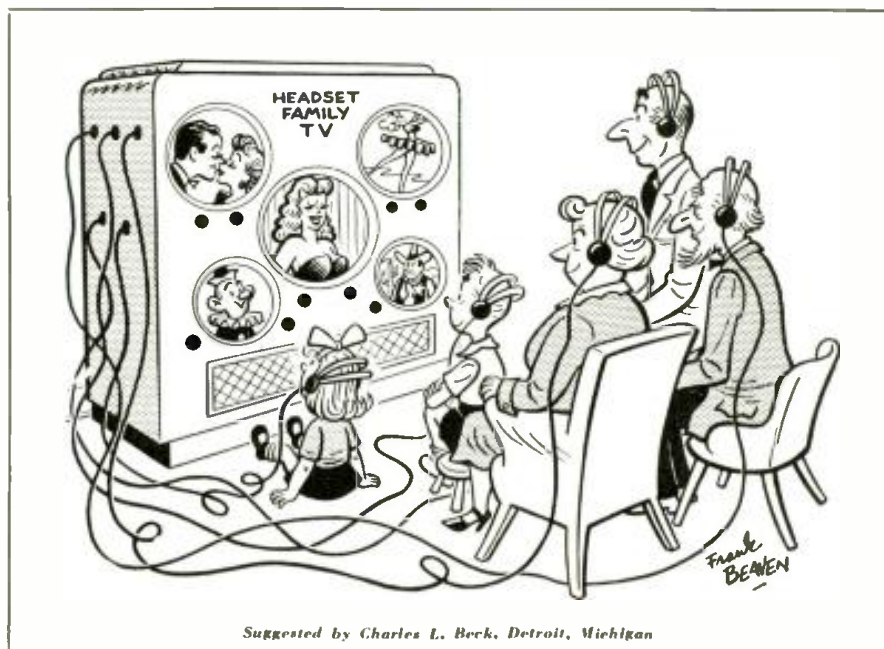

Suggested by Charles L. Berk, Detroit, Michigan

TIME BASE CIRCUITS

By WILBUR J. HANTZ

THE time-base generator is an important part of the cathode-ray oscillograph. The signal to be investigated usually must be plotted as some function of time. This is done by feeding the signal to one pair of deflecting plates while a second voltage, proportional to time, is fed to the other pair. The circuit that generates this latter voltage is called a sawtooth time-base generator. Not only used in oscilloscopes, the saw-tooth generator is essential to TV because it separates the picture for transmission and puts it back together at the receiver.

To better understand the sawtooth generator, suppose we analyze a simple form using a neon bulb as in Fig. 1. The capacitor C charges through R from the supply voltage at a rate depending upon the R-C time constant (the time required for the voltage on the capacitor to reach 63% of the ap-

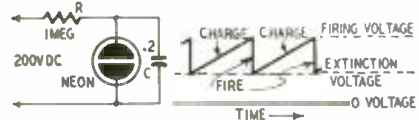

Fig. 1—This neon lamp circuit is the simplest form of time base generator.

plied voltage) which is the product $R \times C$ or 200,000 microseconds. During the charging time, the neon bulb is an open switch. If the conducting point of the neon bulb is 100 volts, it will fire when the capacitor charges to that value and discharge the capacitor. Then this process repeats, charging and discharging the capacitor. The output voltage wavelshape is in the shape of a sawtooth due to the capacitor charging voltage rising along a logarithmic curve to the conducting point and then discharging rapidly to the extinction point. These intervals continue as long as the voltage is applied. The frequency depends upon the supply voltage, the ignition voltage of the lamp, and the R-C

time constant. Usually the R-C time constant is varied by switching in different capacitor values, providing a rough frequency control, while R is varied for a fine adjustment. However, the neon sawtooth generator is not often used because it is difficult to synchronize.

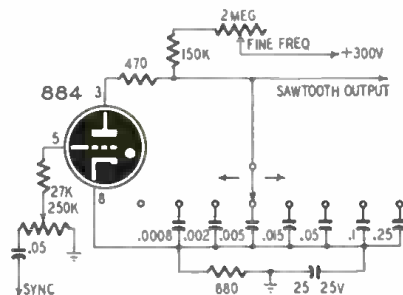

Fig. 2—A thyatron sawtooth generator with frequency from 20 cycles to 30 kc.

In Fig. 2 is shown a circuit that operates in the same way but uses an 884 thyatron. The charging capacitor C consists of a number of capacitors of which any one can be switched in to provide a frequency range of 20 cycles to 30 kc. The higher frequencies are reached by the smaller capacitors. The grid bias may be used to control the firing point but it cannot control the

extinction point. If the grid bias is made less negative, the firing point will be lowered and the capacitor charges to the thyatron's firing point more quickly, increasing the operating frequency. The 884 is easily synchronized by applying part of the observed signal to its grid. If the signal frequency is very nearly a multiple of the frequency of the sawtooth wave, the gas triode will be forced to lock in and the observed pattern will be stationary.

Single sweeps

In some cases the signal to be observed exists only for a short time and then disappears. This is called a transient. If the ordinary sawtooth generator is used for such a signal, the electron beam moving across the face of the cathode-ray tube is independent of the beginning of the transient and there is no way to determine when it occurs. This problem is solved by using a single-stroke sweep generator that generates a time base only when the transient occurs. The sweep is started by the transient itself or some identical signal voltage applied to the sync input terminals.

An ordinary thyatron sweep circuit can be used for this purpose without much change.

In the circuit of Fig. 3, the plate of a diode-connected 6C5 is connected to the plate of the 884 thyatron through a small resistor. The cathode of the diode

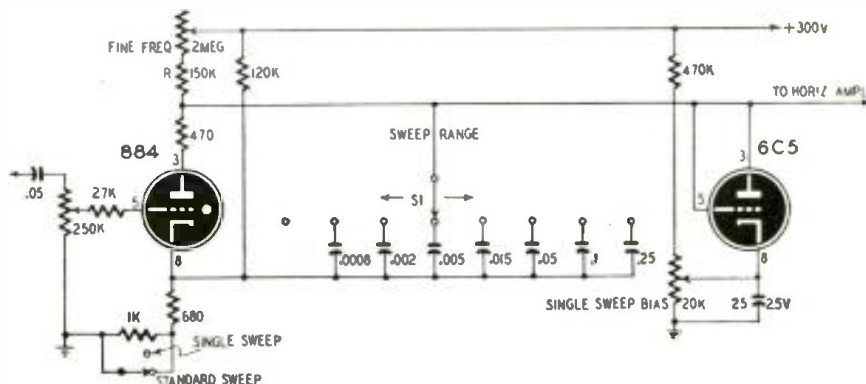

Fig. 3—A thyatron single sweep circuit for observing transient signals.

cally charged particles for their part repel the point with the same force with which they are in turn repelled by it. This is the basis of the electric windmill (Fig. 3).

In denser air the electric wind blows slowly, though this is compensated by a greater impulsive force or impact, compared with the energy used. In thinner air its velocity is higher, but the impulsive force is less compared with the energy produced. In denser air the electrically charged particles (charged molecules, ions, or electrons) pass between the uncharged molecules of the medium and drag them along, at the same time, of course, the particles' initially very rapid flight being thereby slowed down. Accordingly, if there is a great deal of air around the charged particles, a large mass of air is set in motion—but with only a small velocity; if the air is thin, the charged particles encounter fewer uncharged molecules, and the velocity of the gas streaming away is correspondingly higher. In a highly evacuated Geissler tube, for example, the molecules and atoms which fly from the anode develop mean velocities of 30 to 250 miles/sec, whereas in contrast to this the cathode emits free electrons for the most part which, because of their small mass, can reach velocities of 56,000 miles/sec.

For a given quantity of energy supplied, the recoil action increases with the increase in the quantity of matter repelled, but the velocity of repulsion diminishes. This is also true in a vacuum where all the repelled particles are

Table 1—c and m_0/m_1 if $v_1-v_0=6.5$ km/sec

(km/sec)	2	3	4	5	6	10	15
$\frac{m_0}{m_1}$	26	8.6	5.1	3.6	2.96	1.94	1.39

electrically charged and the latter no longer drag along any uncharged molecules in their flight. In this case, when there is very little matter repelled, the electricity carried along will accumulate to form a high potential—causing a more rapid flight of the particles. When more particles are present, one will



Fig. 2—If the electric charge on the point is strong enough, it creates a wind that will blow out the candle.

soon come along which will carry off the charge unit brought in, the potential will no longer rise as high, and the particles will move slowly, but in compensation for this, the current strength increases.

Furthermore, the recoil effect on an electric windmill is greater the denser the air medium. In the case of denser air or lower potential, the particles

need no longer be pointed, and the charged particles are emitted from rounded or flattened surfaces and proceed in a direction perpendicular to the surface.

If air or other gases are completely absent, such a stream of particles can be generated only if the electrodes themselves supply the particles. This is the case, for example, of the hot cathode which surrounds itself with a cloud of electrons, of the potassium-containing photo cell which upon irradiation emits charged particles, or of anodes which either liberate gases or which consist of fused salts as in the von Gehrke-Reichenheim method and from which individual ions are torn loose, etc.

Electrodes

Accordingly, the electrodes of the electric spaceship might look like the model in Fig. 4. This shows a cylinder whose walls and one end are impermeable to both gas and electricity, but the other end of which is fitted with a permeable material. This end can be either porous or at least permeable so far as the contents are concerned. In the cylinder is a substance which, if the end piece is porous, had best be a liquid, though it can also be a solid if its vapor tension is high enough (solid carbonic

acid or ice). This material, or at least its vapor, oozes through the porous end of the cylinder. Since the cylinder is highly charged, the charged particles fly off with considerable velocity.

The quantity of matter which trickles through the porous end of the cylindrical electrodes depends on the nature of the porous material and on the chemical nature and temperature of the contents of the cylinder. It would be most useful to provide the electrode with an electric heating device, which would keep the temperature at the desired level. Then the velocity of efflux and acceleration could be regulated.

Up to now everything pertaining to the invention of the electric spaceship

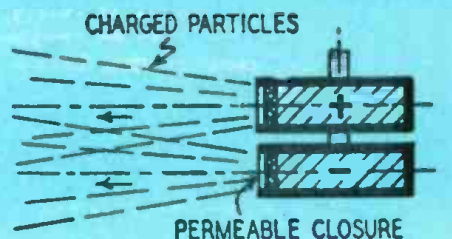

Fig. 4—Electrodes for the spaceship. Charged particles oozing through the end are repelled by the charge within.

WHO IS DR. OBERTH?

Modern rocket research may be said to have two "fathers", the American Prof. Robert H. Goddard and the German Prof. Hermann Oberth. Chronologically the priority belongs to Goddard; he was born in 1882, Oberth in 1894. Goddard published his first work on rocket theory in 1919, Oberth in 1923. The important and significant difference was that Goddard called his book *A Method of Reaching Extreme Altitudes*, while Oberth boldly wrote *The Rocket Into Interplanetary Space* on his title page. The "two fathers" of modern rocket research are, therefore, the fathers of cousins: Goddard got the theory of rockets underway, Oberth the theory of space travel.

Having been associated with Oberth in his "early days" I find it difficult to write just a short introduction about him. Mention of his name naturally invokes countless memories. Of evenings spent at the shore of the Baltic Sea, looking for the planets and talking about their surfaces. Of night walks through the *Tiergarten* in Berlin, discussing long range rockets. Of discussions of moving under lunar gravity, taking place in the shifting sands of the enormous moonscape which Fritz Lang had built in the *Ufa* studios in Neubabalsberg near Berlin for the film *The Girl in the Moon*, all copies of which were hastily called back later by the Nazis when the research institute in Peenemünde was organized.

Whether you want to call Prof. Oberth a German, an Austrian or a Rumanian depends entirely on the definition you have in mind. He was born in the city of Hermannstadt in Transylvania on June 25, 1894. The people in that area constituted a German "colony" much like our so-called Pennsylvania Dutch. Since his father was a physician it seemed indicated that the son would be one too. But, at the University of Munich, where he went to study medicine, he also studied physics and astronomy, gradually with more and more emphasis on their mathematical aspects. When the first World War broke out he was drafted into the Austrian army and finally assigned to the Medical Corps. The periods of idleness to which every man in uniform is subjected were the times when Oberth first thought about space ships and when the foundations of space travel theory began to form in his brain.

After the war he wrote his book *Die Rakete zu den Planetenräumen*. Almost simultaneously with its publication he got his first job: that of professor of mathematics in Tadeush, Transylvania. The book was a small one, as far as volume is concerned, not quite a hundred pages of mostly mathematical type. Judging in retrospect over a quarter century of time one can be sure that it will later be said that this book changed human history, as profoundly as Columbus' trip across the ocean.

After having helped Fritz Lang with his movie and some experimental work on rockets in Berlin in 1929-30, Oberth had to return to Transylvania since nobody then saw any reason for spending money on rocket research. After the Nazis had taken power in Germany Oberth was called to Germany and after several and long delays was finally sent to the rocket research institute at Peenemünde, where the V-2 rocket was created. But while Oberth found many of the principles he had first worked out embodied in that rocket, he also found a virtually finished rocket on arrival, and did not contribute directly to the V-2.

Herr Oberth is the Honorary President of the German Space Travel Society which was re-constituted after the war. He was the first to win the French REP-Hirsch Prize before the war. He was the first man to be made an Honorary Fellow of the British Interplanetary Society. And—most important of all—he was the first who took the idea of space travel out of the realm of dreams and transferred it to the department of science.—Willy Ley.

which are flung off nevertheless remain longer in the neighborhood of the rotating wheel, and therefore have more time in which to exert their repulsive force on it.

Accordingly, as indicated in equation (1), it is possible with the same consumption of material to develop a greater recoil momentum in highly rarefied gases, as a result of the high recoil velocities (though at the cost of greater expenditure of energy).

A perceptible electric wind arises only when enough electrically charged molecules are set in motion. In dense air the electric wind can be produced only in the vicinity of charged points where the charge density is very large, unless the potentials are millions of volts. But if we are dealing with high rarefaction of the surrounding gas, the electric density is sufficient to charge a suitable percentage of the surrounding air molecules; in which case the electrodes



Fig. 3—An electric windmill. Charges leaking off the points create a reaction force that makes the vanes of the mill rotate.

is quite clear. But in the second part of this article, I shall make several reservations. Problems arise which can be solved only when enough measurements and data concerning the nature of interplanetary space are available.

For example, the behavior of the electrodes of Fig. 4 can be predicted only when the effect of various radiations which are absorbed by our atmosphere on the processes taking place at the porous end of the electrode is known. It is therefore pointless to introduce detailed calculations based only on the experience gained from Geissler tubes.

One possibility

This uncertainty is particularly large in the selection of the source of current. It appears that a thermopile would be the simplest and most suitable device. Fig. 5 shows a piece of the thermopile on an enlarged scale and in a rather schematic representation.

The dashed arrows indicate the incident rays of the sun. One junction of the thermopile is turned to the sun and is also irradiated by reflected sunlight from below; the other junction is in the shade. The sheet-metal strips can be soldered together on the earth and wound on a drum in such a way that

they are bent in the proper position on the upper side, which can be done very easily mechanically. If one wants to go further, one can either roughen the strips in those places shown in black in the diagram or paint them black, and at the same time polish the places shown in white. The effectiveness of the arrangement will be increased by this operation. From measurements of the temperature of the surface of the moon it is possible to calculate that the side turned to the sun will be heated to about 140° C., while the side in the shadow will drop to a temperature of 100° C. below zero.

The potential difference between two adjacent metal strips is only of the order of a hundredth of a volt, but when several hundred thousand of these are soldered together in series, a marked difference of potential between the ends can be obtained. These connected strips could be wound about the spaceship in a helical line, and, since the acceleration of the spaceship is small, as has been brought out above, it would hardly be necessary to reinforce or stiffen this helix.

The question now, however, is whether it will fulfill its function; for it is possible that certain cosmic radiations

might cause an equalization of the potential difference between the metals at the ends of the thermopile, somewhat in the way the electron cloud about a hot cathode tends to bring about the same result. It is also possible that the traces of gases found in cosmic space might discharge the electric charge built up in some other way than the desired one (though I do not believe this will happen), and so on.

Uliniski, the first to suggest such a thermopile (though his design was not very promising), thought of providing it with an insulating coat. But an application of this sort would have considerable weight and would tend to prevent the warming and cooling of the proper junctions. Furthermore organic materials would soon be destroyed by

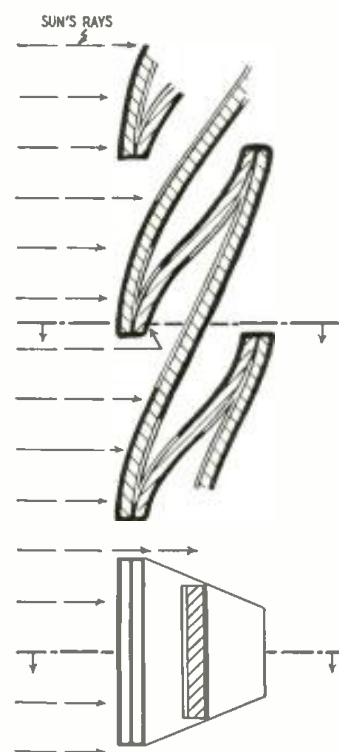

Fig. 5—Series-connected thermopiles have been proposed as a method of collecting energy to drive the spaceship.

the cosmic radiations, an insulating coat of glass or some ceramic material would easily crack and split off, because of the temperature difference and the corrective bending of the metal helix, etc. I do not mean to imply that Uliniski's suggestion cannot be realized, but simply wish to indicate that many questions regarding it remain unanswered, and that the final result might very well be far less promising than it appeared at first sight.

In Part 2 of this article we shall consider the detailed description of a feasible spaceship and its powerplant.

1. Other figures are frequently given for both the distance of the orbit above the earth and for the velocity of rotation. This is due to the fact that the authors concerned have failed to take into account the fact that this station would not travel about the earth in one solar day of 24 hours, but in a sidereal day, if it is to remain over the same meridian.

MATHEMATICAL ANALYSIS

The principles of rocket propulsion are interesting to contemplate.

If the mass of the material expelled each second with a velocity c_1 is m_1 , then the recoil momentum is measured by:

$$P_1 = m_1 c_1 \quad (1)$$

However, the total energy which must be expended on this propellant in each second to set the mass m_1 in motion with the velocity c_1 , to get this recoil effect, is:

$$E_1 = \frac{1}{2} m_1 c_1^2 \quad (2)$$

If we consider another mass m_2 with the velocity c_2 , then the corresponding equations are:

$$P_2 = m_2 c_2 \quad (3)$$

$$E_2 = \frac{1}{2} m_2 c_2^2 \quad (4)$$

If the source of energy does the same work in both cases, then

$$E_1 = E_2$$

and from equations 2 and 4 we have:

$$m_1 c_1^2 = m_2 c_2^2 \quad (5)$$

If we now eliminate m_1 from equations 1 and 5, then divide the result by equation 3 we get:

$$P_1 : P_2 = c_2 : c_1 \quad (6)$$

This means that for equal work performed by the source of energy, the recoil effect is inversely proportional to the velocity of efflux. That is, the smaller the velocity of efflux, the greater the recoil itself.

But it follows from equation 5 that the loss of material depends on the square of the velocity of efflux. This means, in agreement with equation 1, that the mass of propellant is consumed more sparingly the higher the velocity of efflux, but this is at the

cost of greater energy consumption.

For example, if the electric spaceship expels 10 tons of matter at the rate of 10 km/sec and during this time it reaches a velocity of 2 km/sec, it would be able to expel only 2.5 tons of propellant and reach a velocity of only 1 km/sec with a velocity of expulsion of 20 km/sec. But if it worked four times as long, it would again consume the original mass of 10 tons, but would then reach a velocity of 4 km/sec.

We are dealing here with an inverse relationship. For a given amount of energy, the more rapidly the mass is expelled, the smaller is the amount which can be expelled in unit time, and the slighter is the recoil and hence the acceleration. But, using the same quantity of propellant, the spaceship can continue to accelerate for a longer period of time. This longer period of time has the same ratio to the shorter period as the square of the higher velocity of efflux has to the lower velocity of efflux. Therefore the spaceship reaches a velocity at the end of the longer period of acceleration which has the same ratio to the velocity reached in the shorter period as the higher velocity of efflux has to the lower.

The electric spaceship is certainly not very exacting as to the fuel it would use. Anything might serve as propellant—if it will diffuse readily through the porous end of the cylinder and if it is sufficiently inert so it will not attack the walls of the electrodes.

Relays Do Simple Arithmetic

Part III—How to use relay adding circuits for subtraction and multiplication in the binary system

By EDMUND C. BERKELEY* and ROBERT A. JENSEN

IN THE two earlier articles we have seen how an electric brain can:

1. store information in a register;
2. transfer information from one register to another; and
3. add two numbers expressed in binary notation (the scale of two).

Being interested in constructing a relay calculator, in this article we shall consider subtraction and multiplication using relays.

We shall keep to binary numbers for the present for three reasons: It is easy to carry out the operations we are interested in. Also, binary notation is good for electron-tube calculating circuits as well as relay calculating circuits. Finally, it is a good introduction to the circuits needed for calculating in the decimal scale.

Suppose we wish to subtract the binary number 101 (read "one-oh-one," meaning one 4 plus no 2's plus 1, or 5) from the binary number 1110 (read "one-one-one-oh," and meaning one 8 plus one 4 plus one 2 plus no 1's, or 14). We write 101 under 1110 and subtract:

$$\begin{array}{r} 1110 \\ - 101 \\ \hline 1001 \end{array}$$

How do we manage to subtract? We recall the binary addition table:

$$\begin{array}{r} 0 \\ 0 \\ 1 \end{array} + \begin{array}{r} 0 \\ 1 \\ 1 \end{array} = \begin{array}{r} 0 \\ 1 \\ 1 \end{array}$$

Then we say under our breath, for the first column at the right: "1 from 0 does not go, borrow 1; 1 from 10 (read "one-oh" not "ten") is 1. write down 1." For the next column, we say, remembering the borrow: "0 from 0. write down 0." For the third column: "1 from 1 is 0. write down 0." For the last column: "nothing from 1 is 1, write down 1." The result is 1001 (read "one-oh-oh-one," meaning one 8 plus no 4's plus no 2's plus one 1, or 9) just as we would expect it to be.

We could set to work and design a circuit which would reproduce this

process and give the precise result we desire. But isn't there an easier way?

There is an easier way to subtract—by using the addition circuit shown in the last article, and using the mathematical fact that subtracting a number is the same as adding the complement.

To make the idea of complement clear, let us return for a moment to decimal notation (the scale of 10) and consider a desk adding machine having just five columns. Suppose we consider a number 864 (eight 100's plus six 10's plus four 1's). Suppose we set the machine at 0 and subtract 864. We will obtain 99136. This is called the complement of 864 (also called the tens complement of 864). For, if we take 864 and 99136, and add them, we get 100,000; but the extreme left-hand digit (the 1) being beyond the capacity of the five-column adding machine, it vanishes and the result is 00,000 or zero. (In a machine of ten columns instead of five the complement would be 9,999,999,136, correspondingly.)

Now to subtract 864 from any num-

ber—suppose it is 3,145—we add the complement:

$$\begin{array}{r} 3145 \\ - 864 \\ \hline 2281 \end{array} \qquad \begin{array}{r} 3145 \\ + 99136 \\ \hline 102281 \end{array}$$

The extreme left-hand digit in 102,281 will disappear off the machine, giving 2,281 as the result, which is correct.

The complement (such as 99,136) is easily found for any number (such as 00,864) by two rules:

1. take each digit away from 9 (obtaining what is called the *nines complement*, in this case 99,135);
2. add 1 to the result (obtaining in this case 99,136, the *tens complement*).

What is the analogue in binary notation to these complements in decimal notation? In decimal notation we have a *nines complement*, nine being one less than ten, the base of the scale of notation; so, in binary notation, we shall have a *ones complement*, since one is one less than two, two being the base

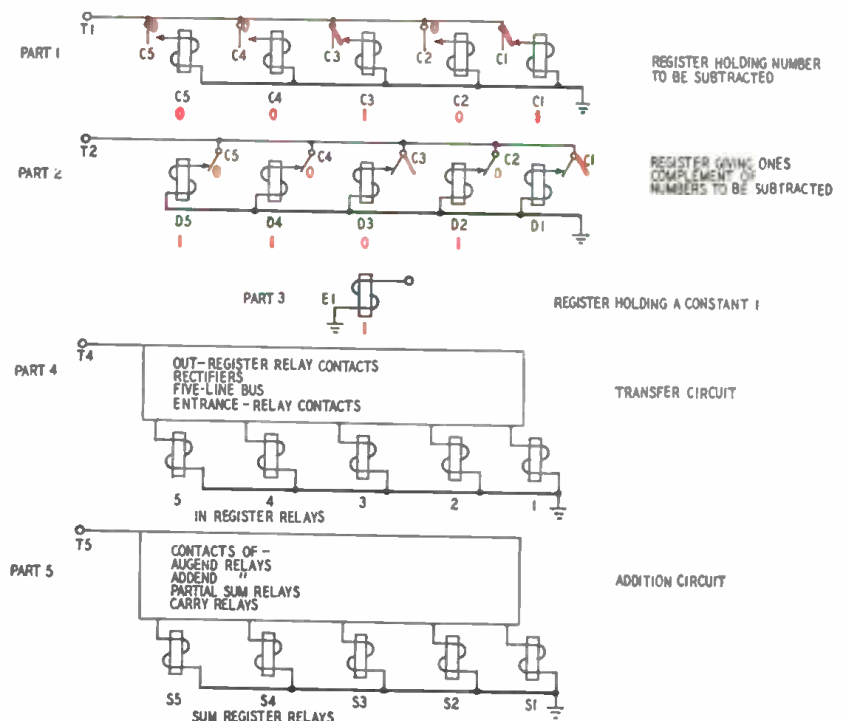

Fig. 1—A relay circuit that subtracts by first obtaining the twos complement.

* Author: Giant Brains

of the scale of notation. We obtain the *ones complement* of a binary number by taking each of its digits away from 1. The *twos complement* is then equal to the ones complement plus 1.

So to subtract in binary:

1. find the *ones complement* of the number, by taking each digit away from 1;
2. obtain the *twos complement* by adding 1 to the ones complement;
3. add the *twos complement*, and discard the extreme digit on the left.

Suppose we do this arithmetically first, and then examine a series of circuits which will produce the same result. Let us return to the example of subtracting 101 from 1110. Let us assume that we have a five-column binary calculator. The *ones complement* of 101, then, is 11010; adding 1, we get the *twos complement*, 11011. We add:

$$\begin{array}{r} 1110 \\ + 11011 \\ \hline 101001 \end{array}$$

The extreme left-hand digit 1 vanishes

("goes off the keyboard") and the result is 1001, the same result as before, as would be expected.

Subtraction circuits

A series of circuits for subtraction is shown in Fig. 1. First (see part 1), the number to be subtracted is stored in the C register in relays C5 to C1. The example shows 101 stored (or 00101) where the first 0 tells us the number is positive. The C3 and C1 relays only are energized as shown in red. At Time 1, terminal T1 holds these relays energized through their hold contacts.

At Time 2 (see part 2), the ones complement of the C number is obtained, by reading out from terminal T2 through normally closed contacts of the C relays, into the D relays. Hence, the number stored in the D relays is 11010, precisely the ones complement of 00101.

All the rest of the calculation is "reduced to the previous case," as the mathematicians say: reduced to transfers and additions, which have been described in earlier articles but are as follows:

The D number—the ones complement—(see part 2) is transferred via the transfer circuits of part 4 into the augend relays of the addition circuits (see part 5). A constant 1 stored in the relay E1 (see part 3) is transferred (see part 4) into the addend relays of the addition circuits (see part 5). The sum obtained in the sum register, the S relays (see part 5), is routed back via the transfer circuits of part 4 (and perhaps via an extra temporary storage register) into the addend relays of the addition circuits. So at this point we have the twos complement of the number to be subtracted, stored in the addend of the addition circuit.

Next, the number to be diminished is transferred from whatever register it is stored in via the transfer circuits of part 4, into the augend relays (see part 5) of the addition circuit.

Then finally we pulse the addition circuit a second time, and the result of the subtraction is produced in the sum register of the addition circuit.

Note that the transfer circuits of part 4 are here assumed to transfer a five-digit binary number from a five-relay register via a five-line bus into another five-relay register. The transfer circuits of Article I of this series show only two-relay registers and a two-line bus; but the extension should give no difficulty.

Plus and minus numbers

At this point we start thinking again and say to ourselves, "It is foolish to have a calculator that can only handle positive numbers. Our calculator should handle both positive and negative numbers. How shall we arrange that?"

A good answer, though not the only one, is to agree that the extreme left-hand digit of the number will tell the

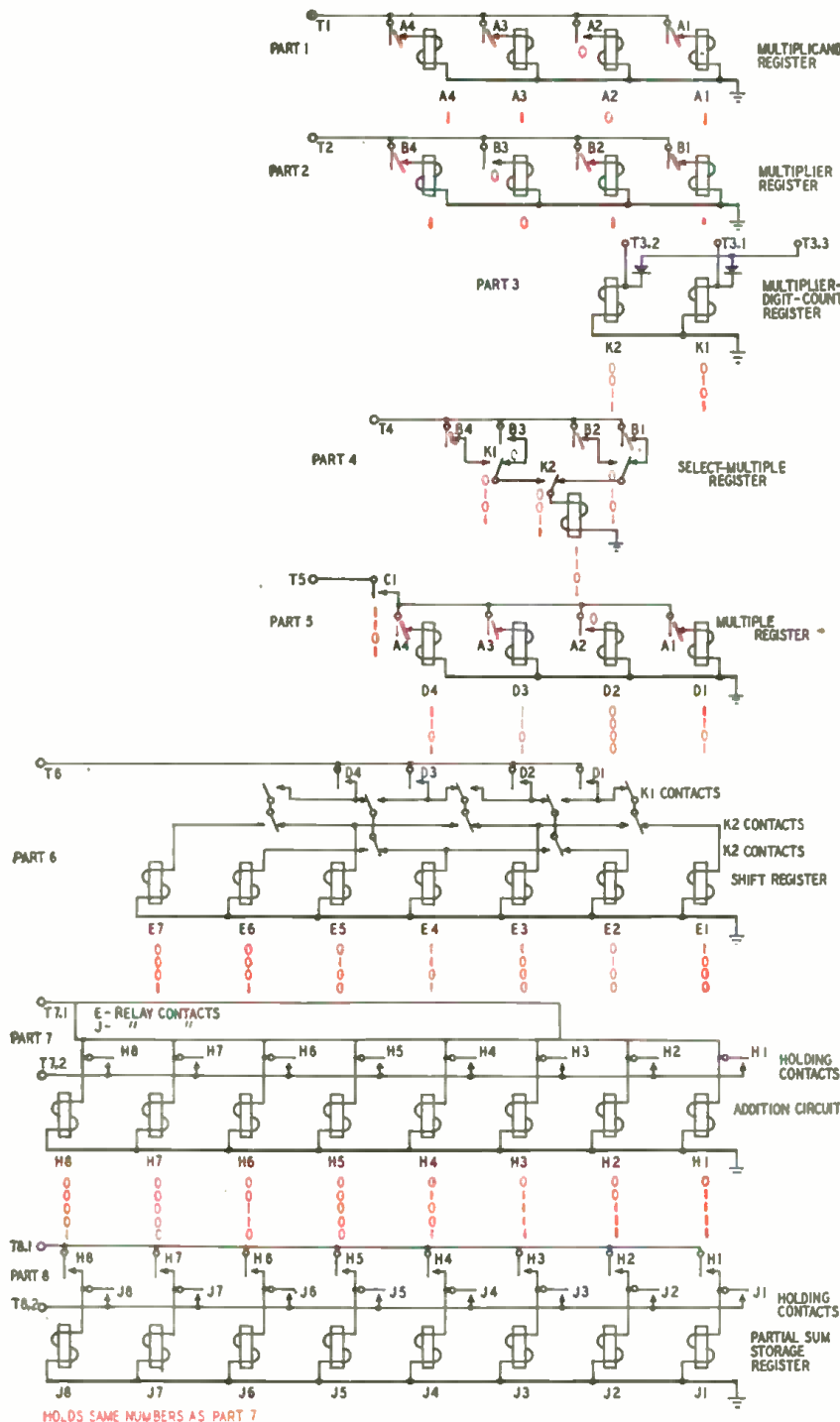

Fig. 2—A relay multiplication circuit. It is really an adding circuit which shifts successive multiples of the multiplicand to the left and adds them.

sign of the number, whether *plus* or *minus*. For example, in decimal notation, with a five-column calculator, we would stop using the fifth column from the right for showing digits. Instead we would say: "If it holds 0, the other four digits are a positive number; if it holds 9, the other four digits are the complement of a negative number." For example, 09136 would mean +9136, but 99136 would mean -864. As a result, the machine would be unable to express any number greater than +9999 or less than -9999.

In binary notation we can do almost the same thing. We say, "If the extreme left-hand digit is 0, the remaining digits make a positive number. If that digit is 1, the remaining digits are the complement of a negative number."

We need to adjust our calculating circuits for adding two numbers which are both positive, or both negative, or one positive and one negative. We also need to adjust our calculator to ring an alarm in cases where the result is beyond the capacity of the calculator—that is, beyond +9999 or -9999 in terms of the example given above. A third consideration is the decimal point or, in binary notation, the "binal" point. In fact, there are a number of little adjustments needed. But it is probably better to neglect them at this stage, and go on to the next main process, multiplication.

Multiplication

In binary notation, the multiplication table becomes simply:

	0 1
0	0 0
1	0 1

or, in other words, 0 times 0 is 0, 0 times 1 is 0, and 1 times 1 is 1. Multiplication becomes either adding or not adding, and shifting.

For example, let us multiply two binary numbers, 1101 (one-one-oh-one: 8 plus 4 plus 1, or 13) and 1011 (one-oh-one-one: 8 plus 2 plus 1, or 11):

1101
1011
1101
1101
0000
1101
10001111

The result is 10001111 (one-oh-oh-oh-one-one-one-one, or, one 128 plus no 64's plus no 32's plus no 16's plus one 8 plus one 4 plus one 2 plus one 1, or 143), which is of course what we would expect from ordinary multiplication of 13 and 11.

Fig. 2 shows circuits with energized relay contacts in red. Fig. 3 is the timing chart, showing how the circuits are to operate one after another, and over again, for successive digits of the multiplier. These circuits are preliminary, and not final.

We have assumed that the multipli-

cand (the number to be multiplied) is the four-digit binary number 1101, and the multiplier is the four-digit binary number 1011. They are stored in the A register (see part 1) and the B register (see part 2).

The general method we have used for obtaining their product is: choose multiples of the multiplicand, either 1101 or 0000, according to the successive digits of the multiplier 1011 taken from right to left 1, 0, 1 (see parts 3, 4, 5); shift these multiples over to the left (see part 6) according to the successive positions of the multiplier digits (0, 1, 2, 3, or in relay language, 00, 01, 10, 11); with an addition circuit and storage register, add successively the shifted multiples (see parts 7, 8).

Proceeding now to examination of the parts of the circuit in detail, let us begin with a look at part 4. The select-multiple circuit (controlling relay C1 in part 4) operates on the multiplier 1011. This circuit yields at different times the successive digits 1, 1, 0, 1 that select the multiple of the multiplicand. How is this made to happen? In part 3, the K relays are energized in the pattern 00, 01, 10, 11. (0, 1, 2, 3 in binary) at successive times.

In part 5, the multiple of the multiplicand is selected. Its successive values are 1101; 1101; 0000; 1101. The contacts used are a contact of the C relay (see part 4) and four contacts of the A relays (see part 1); the multiple is recorded in the D relays.

In part 6, the selected multiple, recorded in the D relays, is shifted 0, 1, 2, or 3 spaces over, according to the position of the multiplier digit, recorded in the K relays (see part 3). The numbers produced by the E relays accordingly are:

- 0001101,
- 0011010,
- 0000000, and
- 1101000.

In Part 7, the addition circuit is indicated in block diagram, since it was treated in full in Part II, of this series. The storage register (part 8) is needed to transfer the result of the addition from the output of the addition circuit back into one of its inputs. Using these two circuits, the shifted multiples are added one after another as indicated in Table I.

The timing of the circuits is shown

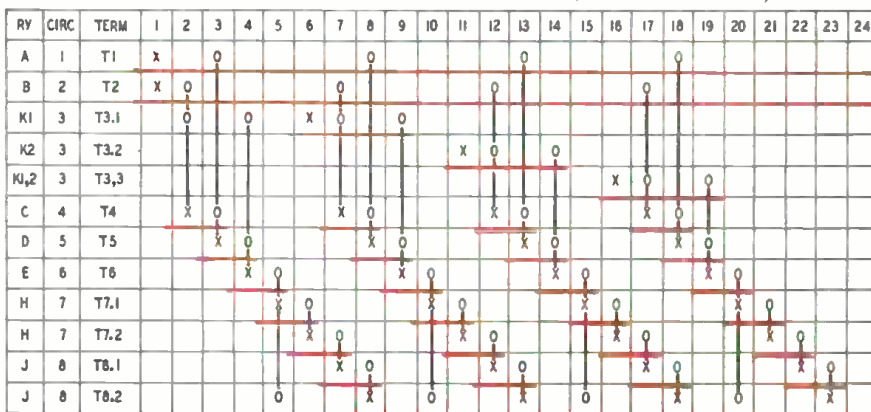

Fig. 3—Multiplying circuit timing chart which shows the sequence of operation.

in the timing chart of Fig. 3. A good deal of useful information is summarized in this chart.

Successive time intervals, 1, 2, 3, 4, etc., are shown from left to right. The different terminals are shown from top to bottom, together with the relays they energize.

Opposite each terminal, the horizontal line begins at the time when the terminal is energized and stops when the terminal ceases to be energized. For example, the three terminals that energize the K relays T3.1, T3.2, and T3.3 are energized from time 6 to 9, from time 11 to time 14, and from time 16 to time 19, respectively. The following parts then complete the multiplication in four similar cycles.

Sections of different horizontal lines are connected by vertical lines showing X's and O's. These vertical lines with their marks summarize the functional relation of circuits. X marks the relays that are energized at a certain time, and O's mark the relay contacts through which these relays are energized. For example, at times 3, 8, 13,

Name	Number	Relays
Partial sum	0000000	H to J
1st multiple	0001101	D
New partial sum	0001101	H to J
2nd multiple	0011010	D
New partial sum	0100111	H to J
3rd multiple	0000000	D
New partial sum	0100111	H to J
4th multiple	1101000	D
Final sum	10001111	H to J

and 18, the D relays of circuit 5 are energized by current flowing from terminal T5 through contacts of the A relays and the C relay. For another example, at time 2, terminal T4 is energized, and the C relay is picked up, reading through B relay and K relay contacts. The K contacts at this time have not been energized; but this is correct, because the first multiplier digit has the position 0.

It should be emphasized! once more that there are many ways of condensing and improving these circuits. For example, parts 4, 5, and 6 can be combined, and the C and D relays eliminated. But the resulting circuit would have been harder to understand than the separate circuits here shown.

(To be continued)

Electronics and Music

PART VI

A nonresonant frequency divider to
make a one-octave instrument cover
the whole audio-frequency spectrum

By RICHARD H. DORF*

VERY few electronic musical instruments of the monophonic or melody type are manufactured commercially. The best known is the Hammond Solovox, which uses a system of master oscillator and frequency dividers to obtain its musical range. A complete article will be devoted to the Solovox in a future issue; meanwhile we shall discuss another frequency divider invented by Nicholas Langer (of neon-tube organ fame) and assigned to Central Commercial Co., maker of the Lowrey Organo, which will also be described in a coming issue. The patent describing the dividers is No. 2,486,039, granted in October, 1949.

The complete circuit diagram of a three-stage divider appears in Fig. 1. This circuit takes oscillations generated by a master oscillator at a frequency one octave above the highest note desired in the instrument and derives from that notes of the top and two successive lower octaves. Additional stages may be added to give as many octave

*Audio and Television Consultant

divisions as desired. In a monophonic instrument, the master oscillator would have a variable frequency over at least one octave. Depending on the switching system used, the corresponding notes of the lower octaves would then be heard, either one octave at a time or several octaves in unison.

How the divider works

Unlike many divider circuits, this one is aperiodic or nonresonant, and is very nearly independent of actual frequency. It will work over almost the complete audio range without any changes. Circuit constants of the three stages are alike, so that a description of the first suffices also for the others.

The input signal is furnished by a master oscillator which should generate a nonsinusoidal waveform. A sawtooth oscillator would be suitable, as would any other furnishing a wave high in upper harmonics. A neon oscillator would do, but like any other source used, its frequency must be stable. The signal at the input to the circuit of Fig. 1 should have predominantly negative

pulse form, which in the case of a sawtooth generator would merely require that polarity be appropriate. If necessary, a crystal rectifier could be placed in the circuit to short out the positive parts of the wave.

C1 and R1 form a simple differentiator circuit. Essentially it is a highpass filter which, when fed a complex wave, tends to remove the fundamental and lower harmonic components and leave only the higher harmonics; the result is a rather sharp waveform.

C1 and R1 form a simple differentiator circuit. Essentially it is a highpass filter which, when fed a complex wave, tends to remove the fundamental and lower harmonic components and leave only the higher harmonics; the result is a rather sharp waveform. The triode sections of the first 6SN7-GT form a pair of cross-connected amplifiers. The plate of the second feeds the grid of the first, and the plate of the first feeds the grid of the second. When the unit is first turned on, therefore, and there is no signal, the first slight electron flow in one tube starts the action. Let us assume that this takes place in V1 and that the grid becomes slightly positive with respect to the cathode. There is, then, a small plate-current flow through V1, which makes its plate become more negative. This negativity is transferred to the grid of V2, decreasing V2 plate current and making the plate more positive. The positiveness is transferred to the grid of V1, adding to the positiveness there at the start. The whole action snowballs in a very short time until V2 is completely cut off and V1 is conducting strongly. At that point, the grid of V1 is receiving the full 150 volts positive which the 150-volt supply is placing on the plate of V2 in the absence of plate current. At the same time it is polarized 100 volts negative by the bias supply. Its net voltage is therefore plus 50 volts, and there the circuit is in equilibrium—V1 conducting and V2 cut off.

Now let us apply a negative pulse from the master oscillator to the input terminals. Passing through the C1-R1

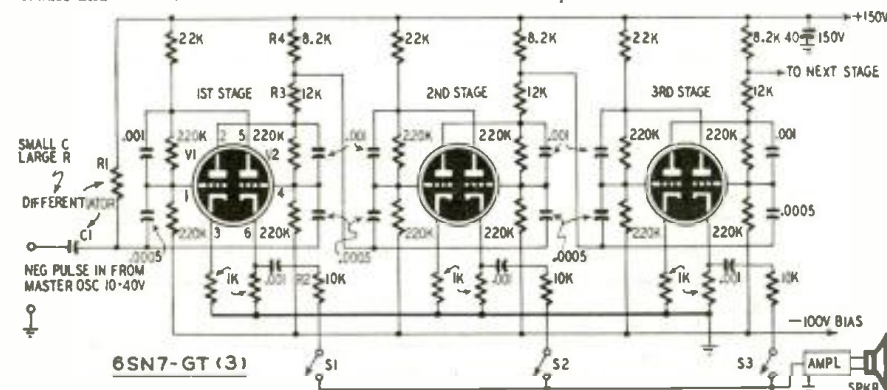

Fig. 1—The frequency dividing network. This circuit provides a total frequency range of three octaves if the master oscillator has a range of only one octave.

network, the pulse is sharpened and transferred through the two 500- μ f capacitors simultaneously to the grids of both triodes. Since V2 is already cut off, it has no effect on V2 plate current. The negative pulse, when applied to the V1 grid, however, reduces the positive potential there, and as a result V1 plate current instantly decreases. The plate of V1 thus produces a positive pulse; transferred to the grid of V2 the positive pulse starts plate-current flow, making the V2 plate negative. The negative voltage at the V2 plate is applied to the V1 grid, assisting the original negative pulse from the master oscillator. Again the action snowballs, until V1 is cut off and V2 is fully conductive.

The next negative pulse from the master oscillator reverses the situation again. It is apparent, then, that each time a negative pulse is applied, the two triodes change states.

The cathode resistors of 1,000 ohms do not change this explanation appreciably. They are there merely to provide an output point of reasonably low impedance which can be connected to outside circuits without harming operation of the divider.

A full cycle of output from a single triode includes one "on" and one "off" of plate current. Since it takes two negative pulses from the master oscillator to make a triode go through this one cycle, obviously the output of the divider is at half the frequency of the master oscillator. Output is taken in Fig. 1 from the cathode of V2 through a d.c. blocking capacitor and a 10,000-ohm isolating and leveling resistor R2.

An additional output is taken from the plate of V1 by effectively tapping down on the plate resistor R3-R4. This output is fed to the grids of the next similar frequency divider, and so on.

Each of the cathode outputs is of substantially square waveshape and contains large amounts of odd harmonics. It may be fed to following amplifiers and tone controls, in which rectifiers may be provided to give some even harmonics.

Switching systems

There are three principal ways in which switching may be arranged with the Langer frequency-divider circuits, though not all of them are suggested in the patent itself.

If the master oscillator itself can be varied over a range of several octaves without losing stability, the scheme of Fig. 1 may be used. Here S1, S2, and S3 select the ranges which are to be sounded. If, for instance, the oscillator covers the top three octaves of the piano keyboard, notes 52 through 88 (see frequency chart on page 42 of the August, 1950, issue), then, if S1 is closed, notes 40 through 76 will be heard. S2 will bring in notes 28 through 64 and S3 will cover notes 16 through 52. The range in which the instrument will work at any given time may thus be selected with the three "stop" switches. Since two or all three of them may also be closed at a time, the player may

bring in unisons with a maximum of three octavely related notes at once.

Fig. 2 shows a switching circuit to be used with master oscillators that cover only one octave. Each playing key actuates two s.p.s.t. switches. The lower switches substitute different tuning components in the master oscillator (shown in the figure as a neon lamp). The upper ones connect the output of the correct divider to the amplifier. This is not a very flexible system, as each key will only sound one note at all times. If there are to be more than the three octaves shown in Fig. 2, as many keys as there will be notes in the instrument must be furnished.

A third system, shown in Fig. 3, utilizes nine relays to make a three-octave keyboard effective over a five-octave range when the oscillator is kept within a one-octave variation range. (This latter condition is often necessary for stability with many types of oscillators. Large tuning range and stable operations do not usually go together.)

As in Fig. 2, the lower bank of keying switches tunes the master oscillator over its one-octave range. The top bank, however, energizes relay coils. Three relays each are provided for high, low,

and middle ranges. With the high-range selector switches (the lower three-ganged units) closed, pressing any key draws sound from its own frequency divider. With the middle-range switches closed, each key draws sound from a divider giving a tone an octave lower. And the low-range switch sounds the lowest-octave dividers. One, two, or all three switches may be closed at once for unison effects. A system like this will give much the same effect as the Solovox, and as a matter of fact an earlier model of the Solovox did use a relay system somewhat like this one.

The relays must, of course, act quickly and quietly. The diagram provides for 6.3-volt a.c. coils, which might well be amateur keying relays. These may be too noisy, however, and it may be better to substitute some small sensitive relays. These normally operate in the plate circuits of vacuum tubes and require very little actuating current. The gaps being small and the armatures light, they make almost no noise.

With next month's article we shall discuss vacuum-tube tone generator systems for use in polyphonic instruments—those which, like the organ, can produce complete harmony.

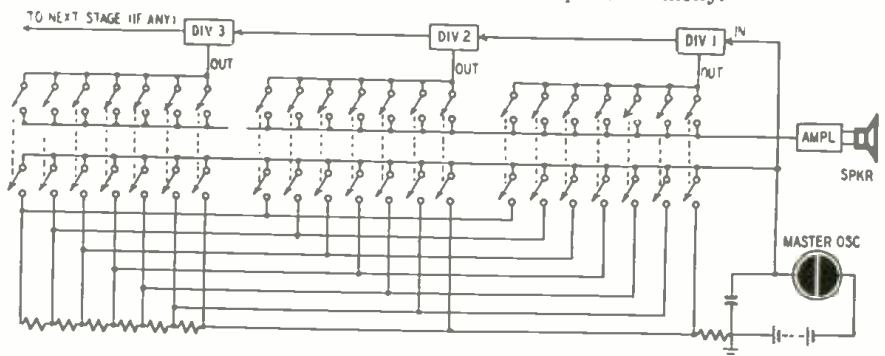

Fig. 2—Switching circuit for a master oscillator that covers only one octave.

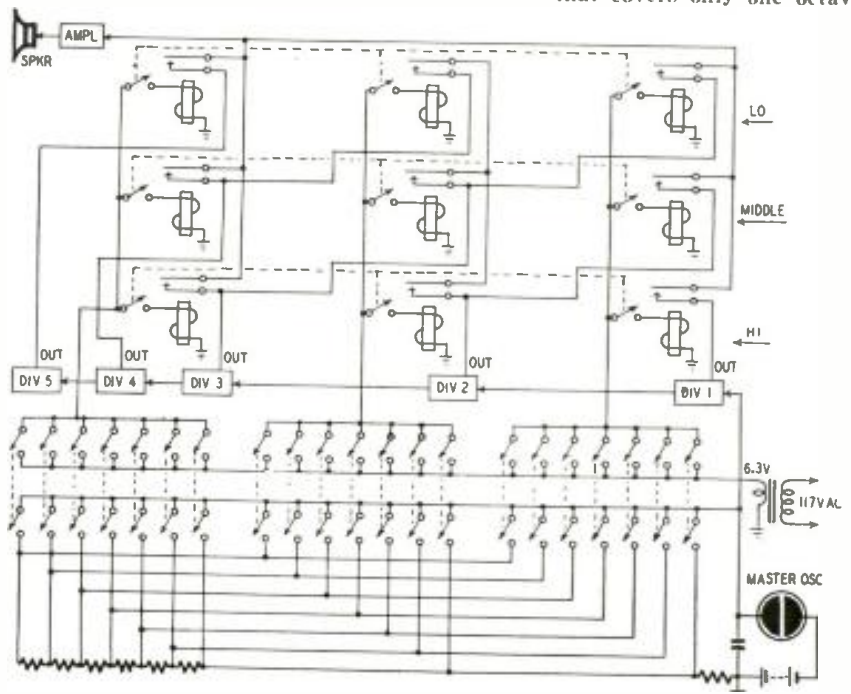

Fig. 3—The lower part of this circuit is like Fig. 2. The relays in the upper part of the figure extend the range of a three-octave keyboard to cover five octaves.

THE SAGA OF SLIM STREETER, OR 'HOW ACTIVE CAN YOU BE?'

Have you ever played a game called Who Am I? One person assumes an identity, usually of a famous person and the others by asking questions about him, try to determine the name of the character.

Radio Slim Inaugurates New Time Service

"Radio Slim" is now giving out time signals every quarter hour with melodious Westminster chimes which are sent out from his "hole in the wall" electric shop on Maine street north of the Younger jewelry store.

"Radio Slim" Streeter to Tour State for Fair

"Radio Slim" Streeter plans to leave early next week on a tour of Nevada and western California towns in the interest of the Nevada State Fair. With his loud speaker outfit, "Radio Slim" hopes to send out the good word about the Fair, the entertainment features which have been planned for the Labor Day week and Joe Hart will take a second to

National Head of Episcopal Church To Be Heard Here

The voice of the presiding officer of the Episcopal churches, the Rev. Henry Knox Sherrill, will be heard in Fallon at 11:32 1/2 Sunday, Feb. 29, the first time any church has heard the national radio to convey a message to its whole constituency. Trinity church at Fallon will take advantage of this opportunity to hear its presiding bishop when Radio Slim will make arrangements for the congregation to listen.

PAUL W. STREETER
"Radio Slim"

Dear Slim,
Several people have commented on the street their enjoyment of your enterprising efforts. Others have been outspoken regarding your public spiritedness and three have called the office urging editorial expressions to encourage your continuation.
If the musical chimes disturb the day-time slumber of Mr. Horton, tell him to take a front room and sleep over street traffic. There are many more annoying than your chimes.
Keep

When the bus drew the team stepped o prepared feed waiting and the kids were sc one of them said, "G won that last game?"

Slim, who paid to feast out of his own that one remark was pension for the w

However, it doesn't baseball tournament ideas in his mind. T popping corn, so fast to keep track of then ent at the city council day (He goes to near ing just so he will kno on in them) to requ enter

Easter Rabbit Calls Hundreds To Oats Park for Egg Hunt

Churchill county's children of all ages turned out several hundred strong to participate in the Lions club annual Easter egg hunt under a clear sky at Oats Park Sunday.

When Radio Slim gave his signal over public address at 1:30 to go after the eggs, it was a repeat performance of the old legend of the Pied Piper, with all the children moving into the egg-hunting great body which Most of the kid

den by the Easter rabbit Sunday morning, and for those who didn't, eggs were provided. At least 50 of the youngsters were lucky enough to turn up with a numbered egg which entitled them to a prize.

Lions Chairman Jerry Donnis and his crew of Paul Osgood, Wayne Mills, Schmaling Walker, George Chambers and Lou Peck expressed thanks to the ladies for their help.

City To Have Float in Parade

It was decided during the meeting of the city council on Tuesday evening that a float representative of the city of Fallon would be entered in the big parade planned in conjunction with the Nevada State Fair and Rodeo.

Appearing before the council urging them to enter a float was "Radio Slim" Streeter who at the same time thanked the city for the fine response to the appeal for telegrams and words of encouragement from Legion boys during the parade. He also thanked the police for their cooperation in the boys

Finals at Vegas

Four days of grueling competition in more than 100 degree temperatures proved too much for Fallon's American Legion junior baseball team at the state tournament held in Las Vegas during the past week end. Shortage of top flight pitchers also proved a handicap as the tournament continued.

Progress of the tournament was reported to interested fans over the loudspeaker system of Radio Slim through information furnished by the local newspapers. He was assisted by Joe Hart of the Virginia City theater.

Games throughout the journey will be arranged and then re- a radio shop on where a low been set up to b- ublic of the Fall- ress.

PA gets Publicity

A mobile PA system can give you efficient, low-cost advertising as well as profit

By PAUL W. STREETER

THE postwar boom in radio sales and repairs has definitely declined for many radio shops in smaller towns, and many radio repairmen have turned to increased advertising in various forms to stimulate sales and repairs. More and more radio shops are using public address systems for advertising, because of their very effective results.

Either direct or indirect advertising is most efficient when the equipment can be taken to the audience. For that reason mobile public address equipment installed in a car or truck is unusually effective. Such equipment does not rely on a commercial power source and can be easily moved from place to place as the movements of the audience dictate.

Direct advertising also may be under-

taken by most radio shops, using equipment mounted at the shop. Some examples are "broadcasting" ball games; using the equipment with Westminster chimes as a time service; giving chimes or carillon concerts at stated times each day; and playing seasonal music or entertainment such as Christmas carols during the Christmas shopping season. This shop-mounted equipment may also be used with window displays in conjunction with light-cell or capacity-operated relays for unusual, pedestrian-stopping displays.

This writer has used one unique stunt with unusual effect. As a matter of fact, one complete set of PA equipment became permanently immobilized and was not available for any other use, but the results more than justified the expense.

Speakers were placed on the roof of the building, facing in all directions. A Westminster chimes mantel clock was obtained and connected to a 35-watt amplifier with a guitar contact microphone, fastened to the clock case with Scotch tape. A time switch, similar to

those used to turn on electric signs, was connected in the amplifier circuit to turn the amplifier on just before 9 am, and off just before 8 pm.

The equipment was placed in a back room, the microphone gain turned up, and comments awaited. They weren't long in coming! They ranged from "ooh's" and "ah's" from old ladies, to nice front page write-ups in both the local papers.

The clock is checked twice a day against standard time broadcasts from WWV, the Bureau of Standards station in Washington, D.C., and is accurate to within 1 second at noon each day. Many clerks in neighboring stores are using the service as a noon whistle!

The Westminster chimes are pleasing, novel, and a source of intense advertising, as everyone within listening distance is reminded four times an hour, all day long, that we are very much in business. Original cost of the equipment is not large, and maintenance is practically nil. Advertising results are tremendous, and we have won a lot of good will.

In addition to the chimes, 15 minutes of recorded carillon music is given each evening just before the motion picture houses open and at 10 o'clock each Sunday morning. These carillon recordings are not expensive and can be obtained in either 33 $\frac{1}{3}$ - or 78-r.p.m. platters. We have about two dozen recordings in stock and have a variety to choose from since only three are played during each evening's concert.

Many shops have made it a practice to have their public address equipment available for community activities at no charge.

One example of this which comes to mind is a parade held recently to publicize a Community Chest campaign being undertaken in the writer's locality. About a month in advance, the parade committee canvassed the merchants (including this writer), asking each to have a float or other entry in the parade. We suggested that we be allowed to "announce" the parade as it passed the judges' stand. Permission was gladly given—those in charge were delighted with the offer, and their whole-hearted cooperation was readily obtained. A letter was secured from them, outlining the permission granted.

We took this letter to one of the local automobile dealers and he agreed to "sponsor" the announcing, and to furnish one of his new demonstrators (with suitable signs, of course), on which we would mount the PA equipment. Other merchants were approached to get information on their entries. This information was for the use of the announcer during the parade.

The chief of police was asked for permission to cruise along the parade route with the sound car before the parade, to entertain the crowd with recorded music, to locate strayed youngsters, to keep the crowd back of the curb line, etc. The event was a great success from every standpoint, and the sponsor wrote out a check for \$75 with a big smile the following day. It was well-spent money for him. He reported later that four sales of new cars resulted from the project.

Every event that we handle is followed up in a few days by form letters sent to sponsors and committees in charge of the events, asking for their comments on our performance. Results of these form letters have shown a remarkable similarity—the public address equipment, being mobile, really reaches the public. Sponsors have been showing the value of this kind of advertising, and today we have but to phone a prospect to get him to sponsor an event.

Every effort should be made to communicate with committees in charge of an event as far in advance of the date of the affair as possible. This should always be done by a personal call, never by mail. It must be done to insure that complete arrangements will be made in time to put on a good, intelligent job of announcing.

The chamber of commerce or some leading merchant will want to sponsor

programs of Christmas music in the business district during Christmas shopping hours. Re-entrant speakers can be placed on lighting poles along downtown Main Street. Driven by a medium-sized amplifier coupled to an automatic record changer, the installation will require a minimum of attention. The "works" can be placed in the radio shop if it is conveniently located, or in the back of some store on the street. The speakers, with the radio shop's name inside the bell, are sign boards advertising the radio shop all along the street.

Many events of local interest are also the subject of local radio broadcasts. Parades, air shows, rodeos, etc., generally can be used as radio broadcast material. The aggressive public address operator whose equipment is used at any event of this kind will also arrange to carry the broadcast station's announcer on his speakers. Since radio station microphones are sensitive, precautions have to be taken to eliminate audio feedback and echo effects from the PA speakers to the microphone. By placing the equipment in position well ahead of time, these problems can be ironed out easily.

Fairs, races, carnivals, air shows, and other events all have considerable use for public address equipment, announcing, and prior publicity from mobile units. Since most of these events occur during local or national holidays, they can become a source of additional income and will occupy time that will not be put to use otherwise. The announcing of these events can be broken down into three distinct divisions: (a) crowd control before the start of the "doings", (b) announcing the event, and (c) crowd and traffic control afterward. Crowd and traffic control before and after the show is all too often unorganized, with the result that patrons are inconvenienced and traffic hazards ensue.

Fire, police and sheriff departments welcome the use of the equipment during emergencies. Every effort should be made to see the local officials to

acquaint them with the possibilities of using the equipment in their work. We have been asked to clear streets of parked cars, assist at road blocks, at mounted posse activities, major fires (both in directing firefighters and in traffic control), and to direct traffic at intersections during rush hours.

Many lodges, fraternal organizations, and clubs hold dances periodically that are open to the general public. Committees in charge of the dances invariably have "intended" to get in touch with us. When the chips are down, however, we notice that *we* made the contacts. It is good policy to go after the business—don't wait for it to come to you.

All *good* publicity helps the radio as well as the public address business. It is well to develop a good "mike voice" and personality. Never inject your personal opinions or relate personal experiences over the system. Be factual in announcing events. During a pause in the activities, it is better to turn on a recording rather than try to keep a mike "hot" when there is nothing to talk about. Proper announcing that keeps an audience interested is strenuous work, and a break is welcome.

The most trying problem in PA work is to determine the proper volume level at which to operate the equipment. Too much volume is extremely annoying to the listener. Not enough volume is as bad, since you cannot be understood. For mobile equipment, volume should never be higher than necessary to be heard for one full city block under most conditions, and a lower setting is often desirable. Have someone on the sidewalk check the volume level while the car is in operation.

Always look at it from the listener's angle, and do everything possible to make your announcing a service, not an annoyance. Remember that demands for regulation of public address equipment have only been advanced in communities where no common sense was shown by one or more PA operators. Don't let that happen to you—or your community!



Radio Slim Streeter, left, and assistant with his mobile public address equipment.

Audio Feedback Design

PART III

A sample analysis of a well-known circuit—the Williamson amplifier

By GEORGE FLETCHER COOPER

IN THE two previous articles of this series the general principles of design of amplifiers with negative feedback were discussed. The procedure, essentially, is to design the amplifier, test it, not in the solid but on paper, and then modify the design if necessary to obtain the final circuit.

In this article we shall consider a concrete design, and I shall try to emulate the Butcher, who—
 . . . wrote with a pen in each hand
 And explained all the while in a popular style
 Which the Beaver could well understand.
 "The method employed I would gladly explain,
 While I have it so clear in my head,
 If I had but the time and you had but the brain—
 But much yet remains to be said."¹

The Butcher took three as the subject to reason about but I am going to use instead a high-quality amplifier which has received much attention in Europe and which is, I think, fairly well known in the United States. Before going any further I must state that as far as I know this is a jolly good amplifier and any criticism which may appear is only a reflection of the fact that one designer's meat is another designer's *Poisson*.

The circuit is shown in Fig. 1. The output tubes, type KT66, are closely equivalent to the 6L6, although being British they are rather more powerful or are less conservatively rated. If we neglect the feedback for the moment we can consider this circuit as our preliminary design and we can calculate how much feedback is permissible if the amplifier is to remain stable. The original designer has given us all the

stage gains, except for the last stage. Here the total load, plate to plate, is 10,000 ohms, so that the peak voltage across the transformer primary must be 173 volts for 15 watts output ($E^2/R = 15$, $R = 10,000$, so that $E_{\text{peak}} = E\sqrt{2} = \sqrt{30,000} = 173$ volts).

Low-frequency response

There are three primary and two secondary factors governing the low-frequency response. The three primary factors are the two resistance-capacitance interstage couplings and the output transformer. At low frequencies the circuit is completely symmetrical, which makes things rather easier. At high frequencies this is not true, because the stray capacitance at the plate of V2 is in parallel with R7 and the impedance of V2, which is high due to

the feedback in the cathode resistor R5. The stray capacitance at the cathode of V2, a different capacitance, is in parallel with the impedance of V2 acting as a cathode follower. This difference could be quite important if the output stage was operating in class B. It is mentioned here merely as an indication of the special difficulties which the high-frequency response presents when compared with the low-frequency response.

Assuming complete symmetry, the primary factors in the low-frequency response are:

1. $C3R8 = C4R9 = 0.05 \mu\text{f} \times 0.47 \text{ meg} = 1/43$;
2. $C6R10 = C7R11 = 0.25 \mu\text{f} \times 0.15 \text{ meg} = 1/27$;

3. L/R in the output transformer circuit. Here R is the resistance produced by the load in parallel with the tube impedance. The load, at the primary side, is 10,000 ohms: reference to data sheets shows that the KT66 has an impedance of 1,250 ohms when connected as a triode. The 6L6 is rather higher, 1,700 ohms, but it has a lower transconductance, so that the main effect of replacing the KT66 with the 6L6 is to reduce the gain without feed-

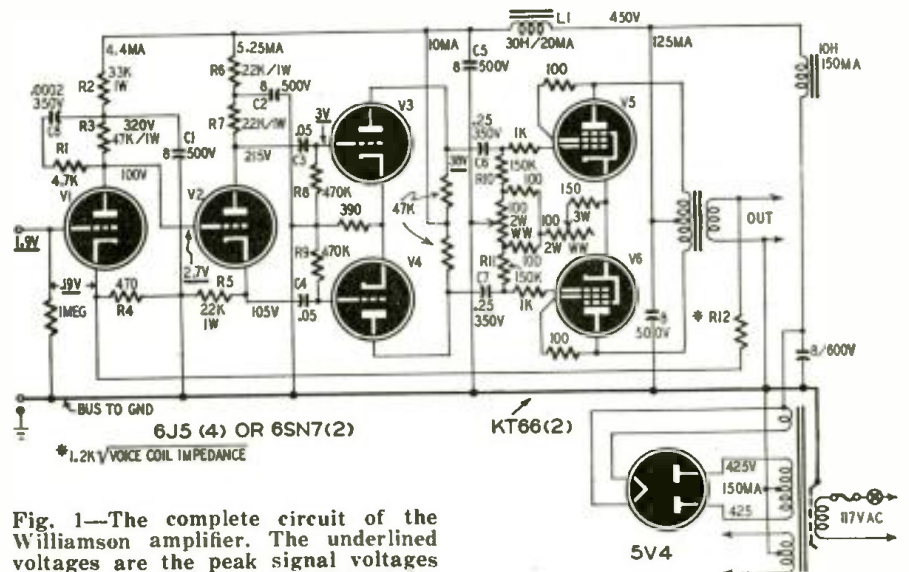

Fig. 1—The complete circuit of the Williamson amplifier. The underlined voltages are the peak signal voltages required for full output of 15 watts.

¹ The Hunting of the Snark. Fit the Fifth. Lewis Carroll

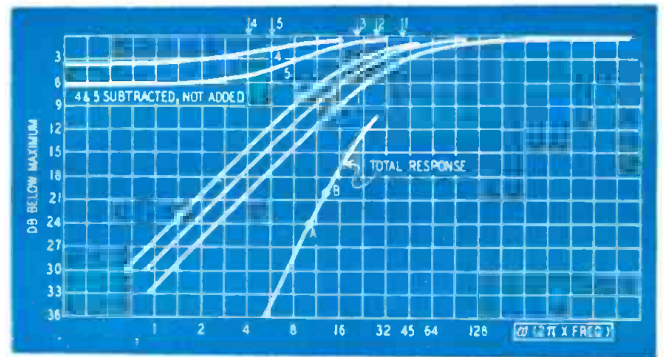
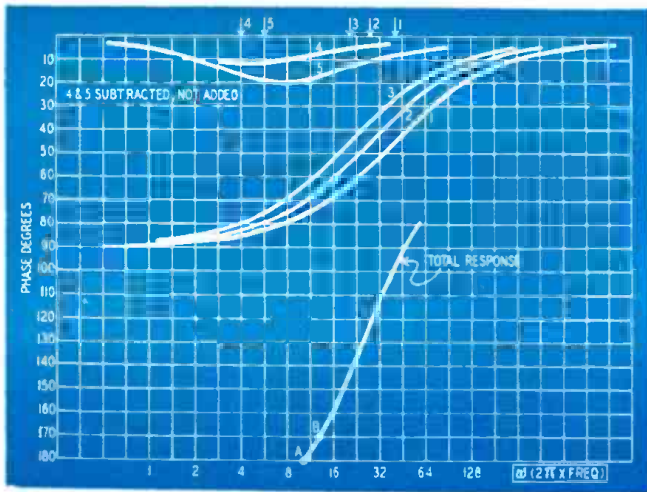

Fig. 2, left—Calculated response curves at the low frequencies of the Williamson amplifier circuit of Fig. 1. Fig. 3, above—The calculated phase characteristic of the amplifier at low frequencies. These curves were plotted by methods described by the author in the second article.

back, and leave the stability about the same as a lower feedback factor.

Two KT66 tubes in series give 2,500 ohms, and this in parallel with 10,000 ohms gives R a value of 2,000 ohms ($1/10,000 + 1/2,500 = 1/2,000$). Using 6L6's, we should have R = 2,500 ohms.

We assume that L = 100 henrics, which gives L/R = 1/20. The choice of 100 h may be because this is the largest inductance obtainable with a reasonable size of transformer, or because we want to keep a very good low-frequency characteristic. In this particular amplifier it was chosen because the designer is doing without an air gap and must allow for the increasing permeability at high flux densities.

The L/R factor must, therefore, be free to increase without equalling either of the R-C factors.

The secondary factors are:

- 4. $C1R2 = 8 \mu f \times 33,000 = 1/4$;
 $R2/R3 = 33/47 = 0.7$;
- 5. $C2R6 = 8 \mu f \times 22,000 = 1/5.7$;
 $R6/R7 = 22/22 = 1.0$.

These secondary factors cause the response to rise at low frequencies, and thus provide a small amount of phase correction. In the critical region this amounts to 30°, and is, in fact, the feature which keeps the amplifier stable.

The response curves

The individual responses are drawn

in Figs. 2 and 3, and the total responses are plotted for the critical region. These responses were plotted by the method described in the previous article, and even drawing them rather carefully to please the editor took only about ten minutes. If the figures are examined, we see that we have a 180° phase shift at $\omega = 10.5$, at which point (A on both curves) the amplitude response has dropped by 24 decibels.

If we wish to have 20 decibels of feedback, we must also consider the phase at the point B, $\omega = 13$. This is 170°. Remembering the definition of margins, we see that the phase margin is 10°, and the amplitude margin is 4 decibels (24-20). The reader will see that these margins are rather narrow.

Two other factors must be taken into account in deciding whether they are safe margins. The first, which may not be very large, is the inner feedback loop produced by the choke L1. At the critical frequencies in the region of $\omega = 10$ (about 2 cycles), C5 is a very high impedance, so that V1 and V2 have a common load in L1. This produces a small amount of negative feedback, which I do not propose to calculate.

The second factor is the increase in inductance produced by any signal in the output transformer. The maximum permeability of the core may be five times the initial permeability, and this

will shift curve 3 to the left. The reader can confirm, if he wishes, that this does improve the margins. He can also confirm that improved margins can also be obtained by moving curve 1 to the right, by reducing C3 and C4. In general, stability can always be increased by moving the extreme curve away from the others.

One more factor should be noted. At 10 cycles the response without feedback is only 3 db down. This means that we still have 17 db of feedback at 10 cycles, so that the full distortion-reducing effect of the feedback is in force.

High-frequency response

The calculation of the high-frequency response is never very easy because of the lack of essential data. We shall ignore in the first calculation the circuit C8-R1 connected to the plate of V1. The response is then settled by the shunt capacitances of each stage and by the output transformer. Unfortunately the capacitances depend on the way in which the components are arranged, while the transformer's response may be complicated by resonances between the capacitance of one section and the leakage inductance of another.

Let us plunge in boldly, however, and assume a stage capacitance of 20 μf . We also have the original designer's figure of 30 mh as the maxi-

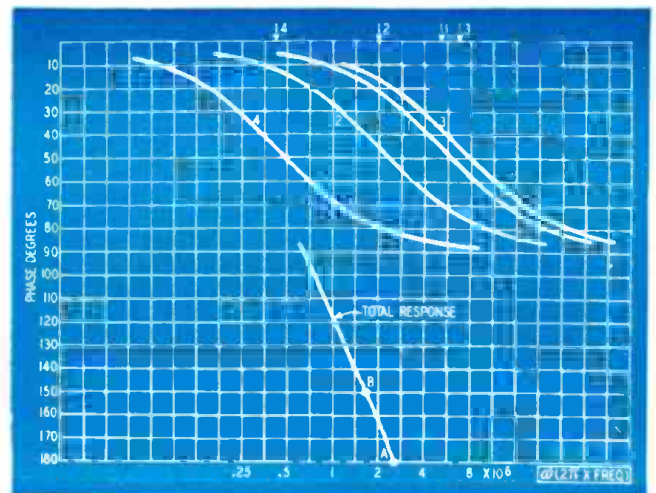
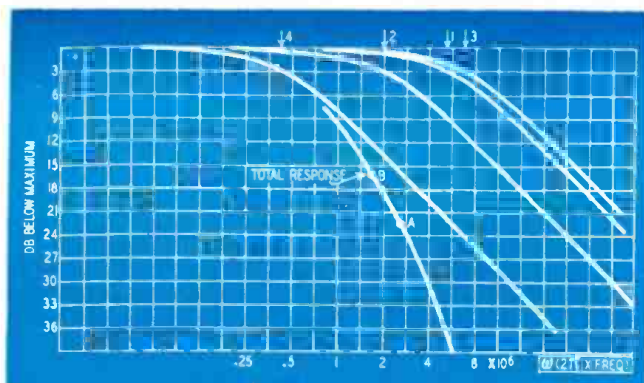

Fig. 4, above—The calculated high-frequency response of the amplifier. At point B the amplitude margin is 6 db. Fig. 5, right—The high-frequency phase characteristic. Maximum feedback for a phase margin of 30° is 16.5 db.

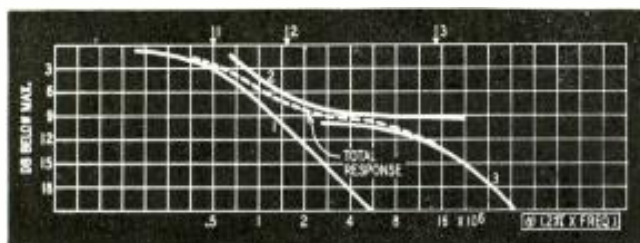

Fig. 6—The high-frequency response of the amplifier including the C8-R1 network. This circuit is added to the amplifier to increase stability at the high frequencies.

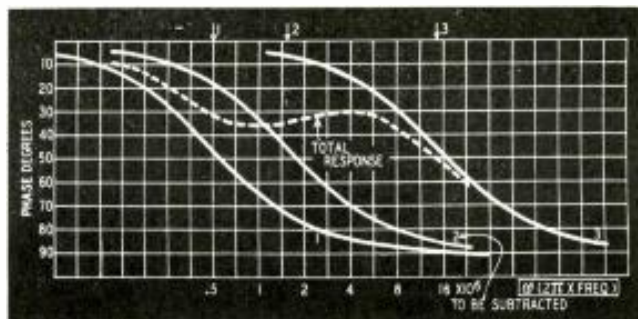

Fig. 7—High-frequency phase characteristic with C8-R1.

imum leakage inductance, measured at the primary side of the output transformer. The factors controlling the high-frequency response are then, if $C = 20 \mu\text{f}$ is the plate-ground capacitance and R_{v1} is the impedance of tube V_1 , and allowance is made for local cathode circuit feedback:

1. $C \times R_{v1} = 20 \times 10^{-12} \times 10,000 = 1/5 \times 10^{-6}$;
2. $C \times R7 = 20 \times 10^{-12} \times 22,000 = 1/2 \times 10^{-6}$;
3. $C \times R_{v3} = 20 \times 10^{-12} \times 7,500 = 1/67 \times 10^{-6}$;
4. $L_v/R = 30 \times 10^{-3}/12,500 = 1/0.4 \times 10^{-6}$.

These factors give the curves which are shown in Figs. 4 and 5. These were drawn in just the same way as before, using the simple templates, and only the important part of the total response characteristic has been drawn. The phase shift reaches 180° at $\omega = 2.6 \times 10^6$ ($f = 300 \text{ kc}$). At this point the amplitude characteristic has fallen by 22.5 db, indicated by the point A in Fig. 4. If we take 150° as the safe limit, we have B, and a maximum feedback is of 16.5 db. The amplitude margin is then 6 db, and the phase margin 30° .

Increasing stability

One way of increasing the stability is to increase the leakage inductance; another is to reduce the stray capacitances, especially that of the first stage. The reader will do well to recalculate these curves for, say, 50-mh leakage inductance and 15- μf capacitance. In the original version of this amplifier it is clear that the margins were rather small for the use of production transformers, for the circuit C8-R1 has been added. Let us see what this does.

The capacitance C8 is 200 μf . At a frequency $\omega = 1/C8 \times R_{v1}$, the response of the first stage will start to drop, and it will run down to meet a curve defined by C8 and R1. At still higher frequencies the response will drop owing to the 20- μf plate capacitance in parallel with R_{v1} and R1. Instead of the curves 1 in Figs. 4 and 5 we will have the curves shown in Figs. 6 and 7. We need the characteristic factors:

1. $1/\omega_1 = C8 \times R_{v1} = 200 \times 10^{-12} \times 10,000 = 1/0.5 \times 10^{-6}$;
1. $1/\omega_2 = C8 (R1 \text{ and } R_{v1} \text{ in parallel}) = 200 \times 10^{-12} \times 3,000 = 1/1.5 \times 10^{-6}$;
1. $1/\omega_3 = C (R1 \text{ and } R_{v1} \text{ in parallel}) = 20 \times 10^{-12} \times 3,000 = 1/15 \times 10^{-6}$.

We could now redraw Figs. 4 and 5, but this would take up too much space for this article, and it is sufficient if we simply compare the curves 1 of Figs. 4 and 5 with the total response curves of Figs. 6 and 7. At $\omega = 2 \times 10^6$, for example, we had a contribution of about 1 db and 20° from the simple circuit, and the addition of C8-R1 has increased the attenuation to 7.5 db and the phase to 32° .

This means that the phase is now just over 180° at this point, and the attenuation is about 26 db. The amplitude margin of 6 db will then allow us to use 20 db of feedback. At $\omega = 1.4 \times 10^6$, the C8-R1 circuit gives us 6 db and 35° instead of 0.5 db and 15° , so that the total response at this point will have a phase shift of 160° and will be 19 db down.

By examining a few more points we can determine the phase margin exactly, but it is a little under 20° . These margins are rather tight; but, as we are making no allowance for the output transformer capacitance and as any assumed capacitance can be in error by $\pm 25\%$ or more, we must not be too critical. In a later article we shall see how to deal with high-frequency instability.

At this point let us look back. We have taken as a design basis the circuit shown in Fig. 1 and have made certain assumptions which have enabled us to draw the amplitude and phase characteristics. These, in turn, showed us that we could apply 20 db of feedback without low-frequency instability, but that we require the stabilizing circuit C8-R1 if the amplifier is not to be unstable at high frequencies. We can also see that, without feedback the response being only 3 db down at 10 cycles, we get the full feedback over this range for the reduction of distortion and intermodulation.

The feedback circuit

One more thing remains to be determined. In the actual design process we must calculate the value of R12 which will give 20-db feedback. Usually, of course, we must just calculate the gain without feedback, but it is assumed that the reader knows how to do this. The designer tells us, or your own calculations will tell you, that the input voltage between grid and cathode for 15 watts output must be 0.19.

We shall ignore the local feedback produced by R4 and assume that with R12 connected we want the gain to drop

20 decibels, making the new input for 15 watts output 1.9. Then we have 1.9 volts from grid to ground, 1.71 volts from cathode to ground, and the necessary 0.19 volt from grid to cathode.

Let us assume that the transformer is designed for a 3.6-ohm secondary load. The 15 watts output then corresponds to $\sqrt{3.6} \times 15$ volts across the load, or 7.4 volts. My calculations give $R12 = 1,570$ ohms to produce this required 1.71 volts at the cathode, while the original designer gives 2,200 ohms.

The reason for this discrepancy is the difference in what is meant by 20-db feedback when the main feedback loop also involves a local feedback of 6 db. Two different answers are obtained depending on whether the feedback is removed by disconnecting R12 or by short-circuiting R4 to alternating current with a very large electrolytic capacitor.

In commercial design one more factor needs to be considered. Is the amplifier open-circuit stable? Often we need to have an amplifier switched on, but idle, and, if it operates from a common supply system with other amplifiers, it cannot be allowed to be unstable even when not in use. To test this we must redraw the characteristics for the amplifier with no load on the output transformer. The general question of load impedance will be discussed in a later article.

These calculated response curves are, of course, not the same as the actual measured response curves of the amplifier. We cannot, without a great deal of cumbersome mathematics, account for such things as tolerances of the components, stray wiring capacitance, and a number of other factors. However, most of these items are rather small, and they also tend to average each other out. That is, the tolerances may be either plus or minus.

What we do get from these curves is a very substantial idea of how the amplifier will behave once it is constructed. We immediately see any important flaws in the basic design so that the necessary corrections can be made at no cost of time or parts.

The next article will describe a loud-speaker amplifier designed by the writer. Unlike Mr. Williamson's amplifier, the design is based on a minimum size of transformer, and a comparison of the two designs will show the reader how flexible the design method is in some ways, and how inflexible are some of the restrictions.

There's Only ONE COMPLETE CATALOG for EVERYTHING IN RADIO, TELEVISION & INDUSTRIAL ELECTRONICS

IT'S YOUR **FREE**
ALLIED 212-PAGE
VALUE-PACKED CATALOG!

Send For It Today!

HERE'S the only *complete* Buying Guide to TV, Radio and Industrial Electronics—packed with the world's largest selections of quality equipment at lowest, money-saving prices. See the latest in TV, AM and FM receivers; radio-phonos; new Sound Systems and P.A. equipment; high-fidelity custom sound components; recorders and accessories; full selections of newest Amateur receivers and station gear; test instruments; builders' kits; huge listings of parts, tubes, tools, books—the world's *most complete stocks* of quality equipment.

ALLIED gives you *every* buying advantage: speedy delivery, expert personal help, lowest prices, assured satisfaction, liberal time payment terms. Get the 1951 ALLIED Catalog. Keep it handy—it will save you time and money. Send today for your **FREE** copy!

ALLIED IS YOUR TELEVISION HEADQUARTERS

TV

To keep up with TV, depend on ALLIED! Count on us for the latest releases and largest stocks of picture tubes, component parts, antennas and accessories—plus the latest in TV tuners and kits. If it's *anything* in TV—we have it in stock! So remember—for TV—it's ALLIED First!

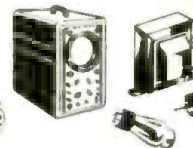
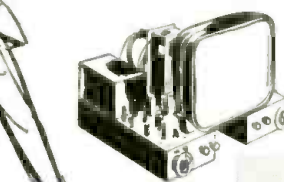

WORLD'S LARGEST STOCKS

- Radio Parts Unlimited
- Test Instruments—All Makes
- Television & Home Radios
- P.A. and Hi-Fi Equipment
- Amateur Station Gear
- Supplies for Industry

QUICK, EXPERT SERVICE



Christmas Package for Future Hams

Novice and experienced technician will benefit from two new classes of license proposed by the FCC

By LARRY LE KASHMAN, W2IOP

AMATEUR radio, like the rest of electronics, has come a long way in the past decade. The electronic hobbyist who is not seriously considering getting into the "new" amateur radio may be denying to himself thrills—and opportunities for self-advancement—that few other modern hobbies can offer. The Federal Communications Commission has recognized the importance of radio amateurs to an even greater degree than heretofore and, as a result of this recognition, is wrapping up one of the best Christmas gifts ever presented to the electronic hobbyist.

The era of haywire is gone. The modern radio amateur has taken advantage of the wide availability of good low-priced commercial components, of technical literature never before obtainable, and of over-all advances in the art. The result is that whether the amateur station is low-power or high-power, it usually represents a neat and business-like approach to electronics. But, of course, the hobby has become more complex.

In the postwar period, faced for the first time with a major service harmonically higher in frequency, the hams came up against television inter-

ference. TVI was long the scourge of hams operating in television centers, but with their customary doggedness the amateurs are licking TVI and, in doing so, pointing ways of harmonic suppression and interference elimination that are becoming standard.

Along with the rush to get back on the air after the war came a host of new techniques including single-sideband phone, practical microwave communication, and the corollary demand for better and more stable equipment design. To the newcomer without technical training the past and current knowledge added up to an almost insurmountable barrier. It almost seemed that the hobby was degenerating into a plaything for engineers. For the technician anxious to experiment with some of the war-born developments and continue their development as a hobby, much of the paraphernalia required for "standard" operation seemed like unnecessary work. So the technician stood on the sidelines, not making his engineering contributions to one of the best hobbies in the world. The Christmas package is for the bewildered novice and the advanced engineer.

Why amateur radio?

Everyone who has had an opportunity to work in amateur radio, or with amateurs, has benefitted from this experience. As have the military services, the entire electronics industry, and virtually every community in the country at one time or another. The problem facing amateurs and their supporters is how to nurture the continued growth of amateur radio in the face of its new-found complexities. One solution is the proposal creating two entirely new classes of amateur license. These licenses, when they are finally enacted into law, will mark the beginning of a

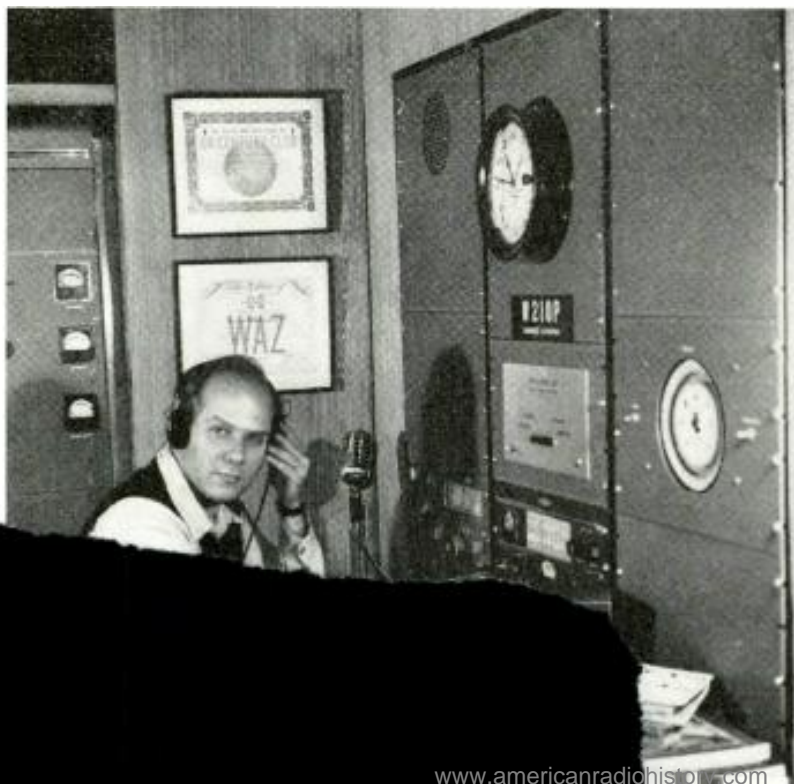

NEW COMPLETELY REVISED SECOND EDITION

THE RADIO & ELECTRONICS HANDBOOK

By WILLIAM F. BOYCE, Publisher
and
JOSEPH J. ROCHE, Editor
and
24 Qualified Experts & Leaders
in The Electronics Field Who Have
Contributed To This Work

MAKES PRODUCTION BETTER, FASTER, EASIER

Plan every operation in radio and electronics with the *Radio & Electronics Handbook*—THE ONLY RADIO HANDBOOK OF ITS KIND. Use it every day on the board, at the bench, in the field!

Use this famous, newly-improved "radio bible" for engineering, construction, troubleshooting, testing, designing, layout . . . any and every operation in radio and electronics!

900 PAGES . . . 18 SECTIONS, EACH A COMPLETE COVERAGE OF ONE RADIO SUBJECT.

Practical engineers and skilled editors worked five years to gather and digest this great storehouse of radio principles and operation . . . statistics . . . newest developments in electronics . . . fundamentals, theory and know-how. Everything is worked out clearly, readably, with every possible detail. The same Boyce-Roche staff, creators of electronics manuals for the U. S. Signal Corps, have made the *Radio & Electronics Handbook* a priceless book for general reference, and most of all for practical on-the-job help.

Use this valuable book ABSOLUTELY FREE for 10 days! Send the coupon now.

HANDSOMELY BOUND IN DURABLE FABRIKOID WITH ALUMINUM STAMPING . . . 18 SECTIONS . . . 900 PAGES . . . COMPLETELY ILLUSTRATED . . . \$5.95

Improved!
Enlarged!

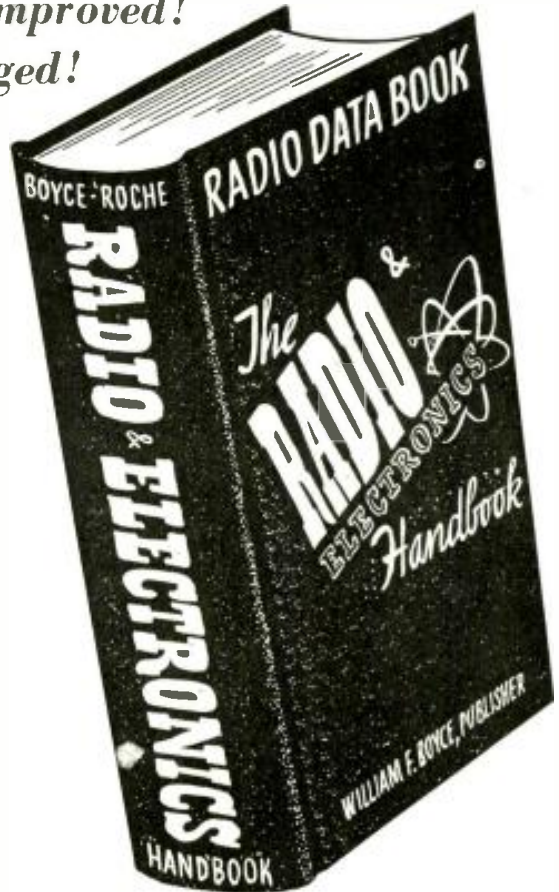

ALSO DON'T MISS

THE VIDEO HANDBOOK

The Complete Television Manual

By MORTON G. SCHERAGA, *Television Research Consultant, Allan B. Du Mont Labs.,* and JOSEPH J. ROCHE, *former Editor, Radio & Television Maintenance.*

More than 900 pages. More than 500 illustrations. Complete with data, diagrams, circuits, photos and time-saving, money-saving know-how! For Technicians, Students & Engineers.

Same durable, handsome Fabrikoid binding as the RADIO AND ELECTRONICS HANDBOOK. \$5.95

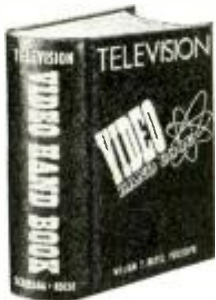

HERE'S WHAT YOU GET IN THE NEW SECOND EDITION OF THE RADIO AND ELECTRONICS HANDBOOK

(6 NEW SECTIONS)

1. Fundamentals of Radio & Electronics
2. Vacuum Tube Theory
3. Resistors
4. Capacitors
5. Transformers & Chokes
6. Switches & Dry Rectifiers
7. Basic Circuits
 - Vacuum Tube Rectifiers
 - R. F. Amplifiers
 - Audio Amplifiers
 - Oscillators
 - Detectors & Converters
 - Filters
8. AM Receivers & Transmitters
9. Frequency Modulation
10. Television
11. Sound Systems—Selection, Installation & Operation
12. Recording
13. Power Supplies
14. Antennas & Transmission Lines
15. Meters & Test Equipment
16. Testing, Measuring and Aligning
17. Radio & Electronic Data Section including 100 Pages of Tables, Codes, Charts, Graphs, Monographs, Formulas and Standards
18. Vacuum Tube Chart and Pin Index including Receiving Tubes, Transmitting Tubes, Rectified Tubes, Cathode Ray Tubes and Regulator Tubes

SPECIAL OFFER
SAVE \$1.00

on this practical, handsome

RADIO & TELEVISION LIBRARY SET

Covers Radio, Electronics and Video—

A Gold Mine of Information!

RADIO & ELECTRONICS HANDBOOK

and VIDEO HANDBOOK

Both in a handsome slip case for ready reference \$10.90 for the set.

We are confident that these books will fill your every expectation and therefore offer to send them to you on approval—mail this coupon today.



BOYCE-ROCHE BOOK CO., Princeton 35, N. J.

----- 10-DAY FREE EXAMINATION COUPON -----

BOYCE-ROCHE BOOK CO.
Princeton 35, New Jersey

For my ten-day approval use, send

RADIO & ELECTRONICS HANDBOOK @ \$5.95
 VIDEO HANDBOOK @ \$5.95
 BOTH THE ABOVE IN LIBRARY SET @ \$10.90

I will send you total price of \$_____ plus postage or I will return book(s) postpaid.

(Offer good only in U. S.)
MAIL TODAY

Name
Address
City.....Zone.....State.....
Employed By

SAVE POSTAGE! We pay postage if you enclose purchase price. Money back with same return privilege.
Enclosed please find \$_____

require only minimum knowledge—knowledge anyone capable of understanding fundamental electricity could easily assimilate.

The novice license will literally lead potential hams by the hand into the fold. It will make possible the practice of code in actual communication on the air, a method greatly superior to ordinary code practice. In a matter of weeks, knowledge and experience can be gained that by any other method might take months. Technical terms which might be meaningless in a book will become very real. The novice license will be of limited duration, but long enough to permit advancement from its simple requirements to the somewhat more complex examination of the standard amateur grade.

Welcome technician

The technician's license on the other hand will be for the "noncommunicating" amateur. It is created primarily to permit the pure experimenter to get on the air without the formality of a code examination. Operation permitted by the technician's license will be limited essentially to the ultra-high frequencies, where much pioneering remains to be done. The new amateur, who will qualify for these technician licenses, promises to bring into the radio hobby much talent and knowledge that will prove useful to all hams, regardless of their particular interest. It opens to many fine technical men the opportunity to participate in amateur

radio on the basis most compatible with their personal interests. It brings men into fields which require additional participation.

What about the potential amateur who says to himself that all of the new license requirements are very fine—but, "The hobby is still too complex and too costly for the average pocketbook?" These are the people who apparently have not kept up with the hobby.

Certainly it is possible to spend thousands of dollars to get on the air. But the average ham operating has a very modest investment in his equipment. A good communication receiver, for example, can be purchased between \$100 and \$200. Stack up that against a TV receiver for value. An excellent transmitter—one capable of world-wide communications—can be put on the air for under \$100. There are many amateurs on the air with good signals and having a whale of a fine time with a total investment of under \$100.

Amateur radio is like any other hobby. You start gradually and build up your equipment as time passes. Furthermore, one of the most important parts of a radio station frequently can be constructed at the least cost. The antenna system is a great "leveler" in ham radio. A properly designed and installed radiating system can give signal gain of many times. Thus, the 100-watt signal can be multiplied in effectiveness to 500, 1,000 watts and even more. It doesn't make much difference whether the original signal

came from a modest basement shack feeding a well-designed antenna system or from a millionaire's palatial mansion feeding a piece of bailing wire. All the receiver can do is pick up the two signals. The best one is going to be the loudest. And, while it is true that high-gain antenna systems are desirable, don't be misled into thinking that a simple dipole won't work.

What it all adds up to is that, while electronics has become increasingly complex and while the ham is constantly adding to his store of knowledge, it is still possible to get on the air and enjoy the many advantages of ham radio without being an electronic expert—without investing a tremendous amount of money and without sacrificing any of the enjoyment. The new FCC licenses just make it that much easier for that many more people to get into the swim.

Plus benefits

What are all these "benefits" we talk about? Of course, there is the natural self-interest that motivates every hobbyist. He is looking for some relaxation. Whether you get your relaxation and enjoyment by working with your hands and building a fine new piece of equipment or from operating, there is no hobby that can rival ham radio. But ham radio offers something that few other hobbies do. It offers the individual an opportunity to add to his own knowledge—to improve his education—and, as a direct consequence, to improve his stature in our economy. There are many successful technicians and even engineers whose only formal training has been through amateur radio. There are many individuals whose mark in life was not very bright until sparked by the knowledge gained through amateur radio.

In almost every great national emergency whether it has been a flood, a tornado, or a world holocaust, the hams have served their community with distinction. Few hobbies offer such an opportunity of service. The hobby offers a fraternity among men and women which is virtually unknown in any other group, because hams can talk to one another over great and small distances on what amounts to private communications channels. They meet other hobbyists in a far more intimate manner than, say, the group whose only common meeting place is an official publication or an occasional convention. And, of course, amateur radio, through its very nature, is a leveler of men because bankers and students, doctors and mechanics talk to one another on the ham bands without regard for the usual social barriers.

What it all sums up to is the irrefutable fact that amateur radio can offer more thrills and more opportunities than any other facet of electronics. And now, for the first time, participation in the hobby is being made so simple that anyone with just a little fundamental interest can get started. Amateur radio might be compared to any gift which keeps on giving, because the benefits are truly endless.

40-METER M ANTENNA

By JEROME MASLOWSKI, W8LKM

A ham for 15 years, the author has put up many so-called sky hooks. Most of these have been quarter-wave and half-wave antennas suitable for operating on 40 and 80 meters.

While trying out other antennas, a folded dipole was put up as a receiving antenna in the attic where it would not be too close to the transmitting antenna. One night after trying many calls and just not getting out, this folded dipole was hooked up to the transmit-

ter to fit a restricted space if the bend does not exceed $\frac{1}{2}$ wavelength at each end.

In this case the bend was more than that. According to the books this reduces the efficiency of the antenna, and having it in the attic doesn't help any. Nevertheless, this antenna outperformed any the author has ever set up.

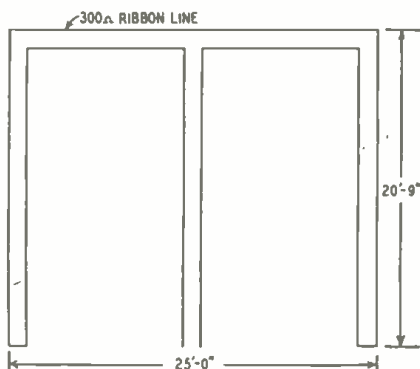

Fig. 1—Dimensions of the M antenna.

ter and the results were surprising.

The antenna in the attic had to be put up in an M shape because of the lack of space. An antenna may be bent

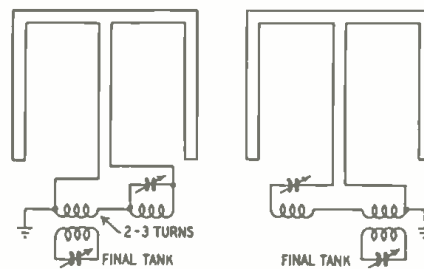

Fig. 2—Two ways to connect the feeder.

Dimensions for the antenna for the 40-meter band are shown in Fig. 1. Made of 300-ohm ribbon line, it may be suspended in any convenient way. The feeder can be any suitable length and should be coupled to the final tank with a tuned and grounded coupling coil. The tuning may be either series or parallel as shown in Fig. 2.

The dimensions given should give good performance on the 40-meter band, and, once tuned, will cover the band.

HEADQUARTERS

THRU THE YEARS



Back in 1922 the first National communications receiver was offered to the public. Model SW-3 was among their first great units, the mention of which may evoke some nostalgia in the old timers of the radio fraternity. Ever since, National has always been in the vanguard with every great receiver development and today their place as undisputed leader in the field of communications equipment is acknowledged by all. The name National on a receiver means the finest in performance, the utmost in value.

Radio Wire Television was proud to offer the first National equipment to its public back in 1922, and its pride has increased many fold since then. R.W.T., where delivery, price and quality of service on National receivers have matched the superb performance of these products, has come to be regarded as National headquarters by radio men everywhere. For the greatest possible satisfaction in your National communications receiver, buy yours from Radio Wire Television.



Model NC-43 \$67.50



Model NC-125 \$149.50

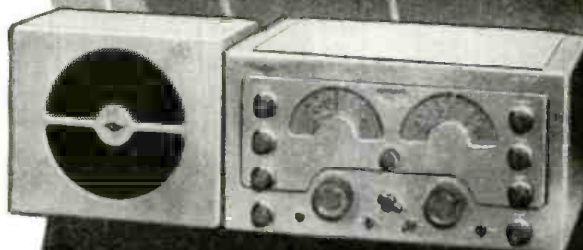

Model NC-183 \$279.00

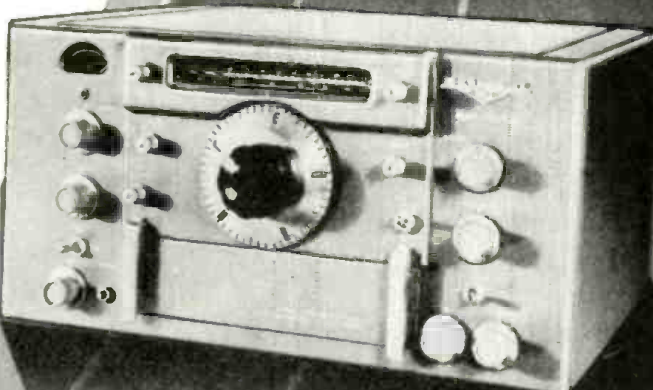

Model HRO-50T \$359.00

Lafayette

Radio Wire Television Inc.

NEW YORK 13, N.Y.
100 SIXTH AVENUE

BOSTON 10, MASS.
110 FEDERAL ST.

NEWARK 2, N.J.
24 CENTRAL AVE.

BRONX 58, N.Y.
542 E. FORDHAM RD.



FREE
NEW BOOK!
HOT-OFF-PRESS
LATEST BUYS!

RADIO WIRE TELEVISION (Lafayette Radio)
100 Sixth Avenue, N. Y., Dept. JL-50

- Enclosed \$..... (Include shipping charge, excess will be refunded). Rush me National Model.....
- Please rush FREE Buying Guide 950F.

Name.....
Address.....
City..... Zone..... State.....

Hi-Fi AM Tuner and Amplifier

By D. V. R. DRENNER

PART II

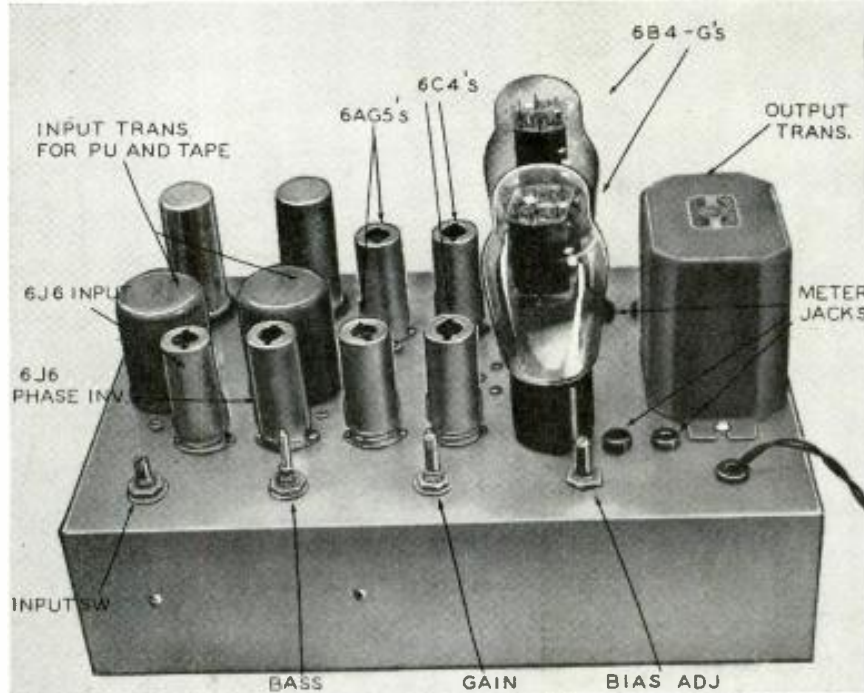

Photo of the amplifier. The two input transformers on the left are for a tape recorder and low-impedance pickup. They do not appear in the schematic diagram.

THIS amplifier, a companion for the AM tuner described last month, is a good high-fidelity unit. Although it departs from the conventional in many respects, it has no fancy hard-to-adjust features. A frequency run with a Hewlett-Packard oscillator and a G-E VU panel shows it to be flat within 1½ db, 20 to 20,000 cycles. The output transformer governs the frequency response, and that depends on what the pocketbook will stand. Fig. 1 is the schematic of the amplifier.

Except for the output tubes, all stages use miniatures. The phase inverter stage—a 6J6 duo-triode—is cathode-coupled; so you don't have to juggle resistors. The only transformer in the amplifier is in the output stage. The final tubes are driven by cathode followers for low driving impedance and a good way to adjust the balance of the final stages. The 6AG5's are triode-connected to make the whole amplifier triodes from input to output! That should satisfy even the most rabid "triodes-are-best" boys.

The first 6J6 is a preamplifier to drive the phase inverter and also an electronic bass-boost stage. The mathematics of the bass-boost stage get rather complicated, but the values shown make it perform well.

The second 6J6 dual triode is the cathode-coupled phase inverter. The grid of one section is fed the audio signal, and the other grid is grounded. The cathodes, being tied together, work in unison. Both plates also vary as the input signal varies, but the signal outputs are 180° out of phase. It's a neat scheme that works nicely. Since the 6J6 is a high- μ triode, good stability and low hum level are important. The phase inverter stage must be shielded with a miniature spring-loaded tube shield to minimize microphonics which 6J6's often develop. The a.c. circuits should be carefully laid out to keep hum pickup low. With these precautions the 6J6 performs well. This type of phase inverter shows no aging effects, as is often the case with other inverter circuits.

The next stage uses two 6AG5's, triode-connected, to drive the 6C4 cathode followers. The fixed bias for the final tubes is fed through the cathode loads of 6C4's; and, by varying a portion of this voltage on the 6C4 grids, the bias can be adjusted so the signal in the final output tubes is balanced.

In the final stage either 6B4-G's or 6A5-G's is can be used. When this amplifier was built, the 6A5-G wasn't available, but it is preferable because the cathode-type construction further reduces hum.

Cathode bias can be used, but the fixed bias gives increased output and

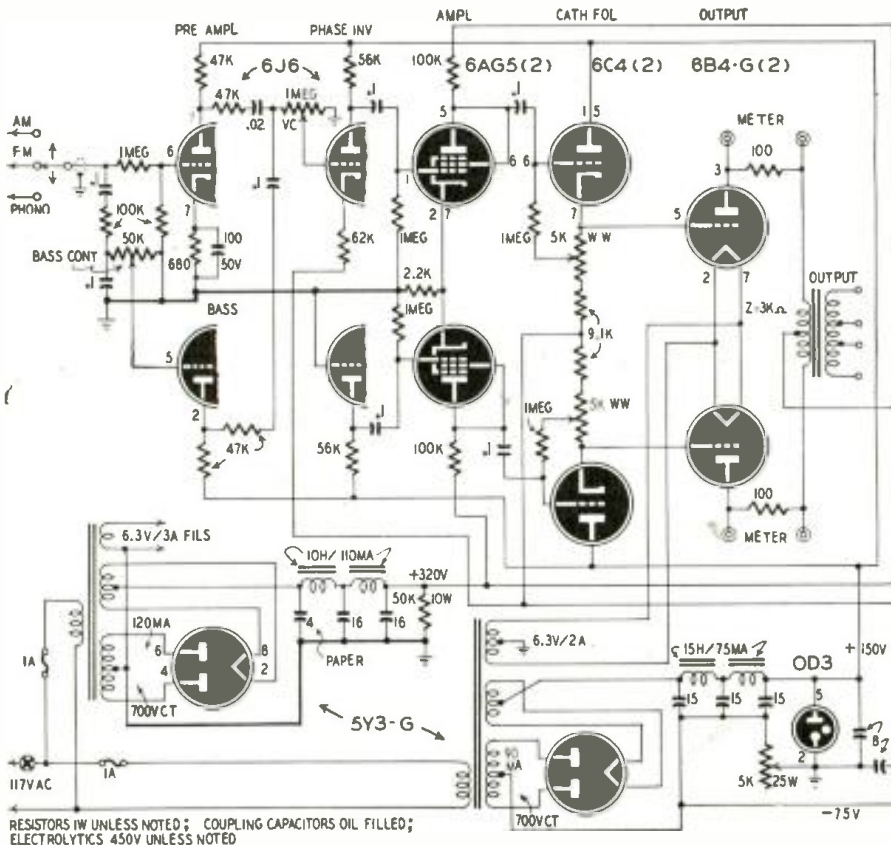

RESISTORS IN Ω UNLESS NOTED; COUPLING CAPACITORS OIL FILLED; ELECTROLYTICS 450V UNLESS NOTED

Fig. 1—The schematic of the all-triode amplifier. Although some of its circuits are rather unconventional, it is an excellent amplifier for good audio systems.

keeps the bias voltage constant under all plate conditions. This bias voltage is stabilized by an 0D3 regulator tube.

For an output transformer you can take your choice. If you want the ultimate in performance, use one of the best quality transformers, so long as it loads the tubes with 3,000 ohms.

The physical layout of the amplifier can take almost any form, provided the usual wiring precautions are observed. Run the a.c. wiring close to the chassis and so that no ground loops are formed. A common-ground bus is better than the usual chassis ground.

While separate chassis were used for the amplifier and for the two power supplies, both could be on the same chassis if the power transformers are mounted away from the input stages. The input operates at relatively low level and has high gain; stray fields are apt to raise the output—of noise!

With a 15-inch speaker bass reflex cabinet or a woofer-tweeter combination, this amplifier will deliver 15 watts of low-distortion, high-fidelity amplification from a tuner or phono pickup.

The author wishes to acknowledge the assistance of D. W. Gillette in the design of this equipment.

Materials for Amplifier

Resistors: 2—100, 1—680, 1—2,200, 2—9,100, 4—47,000, 2—56,000, 1—62,000, 4—100,000 ohm, 5—1 megohm, 1 watt; 2—5,000, 1—50,000 ohm, 1—1 megohm potentiometers; 1—5,000 ohm, 25 watt; 1—50,000 ohm, 50 watt.

Capacitors: 2—0.1 uf, 400 volt, paper; 1—.02, 5—0.1 uf oil filled; 1—4 uf, 600 volt, paper; 2—8, 5—16 uf, 450 volt, 1—100 uf, 50 volt, electrolytic.

Miscellaneous: 1—350-0-350 volt, 90 ma, 1—350-0-350 volt, 120-ma power transformers with filament windings; 2—10 h, 110 ma, 2—15 h, 75 ma chokes; 1—output transformer, 3,000 ohm primary; 2—6J6, 2—6AG5, 2—6C4, 2—6B4-G or 6A5-G, 2—5Y3-GT, 1—0D3 tubes with sockets; 2—1-amp fuses and holders; chassis, hookup wire, switches, assorted hardware.

BLINKER CIRCUIT

A blinker circuit was required to control two strings of lights which were to blink on and off at approximately 5-second intervals. Standard bimetallic blinkers could not be used because one string had to light at the instant that the other went off.

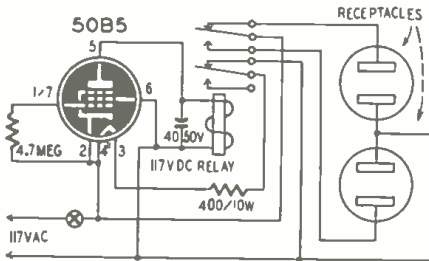

Designed around a d.p.d.t. relay and a 50B5 tube, this blinker does the job. The heater is connected across the line in series with a 400-ohm dropping resistor and one of the normally closed contacts of the relay. As soon as the tube heats up, it conducts to open the heater circuit and switch the lights. The relay remains closed until the charge has leaked off the capacitor. The relay then opens to begin a new cycle.—Albert Szemyak

DECEMBER, 1950

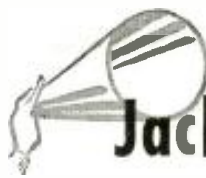

Announcing a NEW Jackson 5-inch Oscilloscope



What's New...

Input Calibration Voltage—provides a standard for measuring unknown voltages. Vertical polarity switch allows you to reverse the polarity of vertical deflection voltage. New return trace blanking—all electronic—provides clearer, sharper image. New styling—helps you locate controls more quickly, matches Jackson Television Generator.

Plus All These Important Features...

Dual purpose vertical amplifier. Wide band, flat within 1.5 db, 20 cycles through 4.5 megacycles. Vertical deflection sensitivity .018 rms volts-per-inch. Saw tooth sweep, 20 cycles to 50 kilocycles. Intensity modulation, either 60 cycle or from external source. Direct connection through capacitors to deflection plates. Removable calibration screen. Many more important features.

See your distributor, or write

JACKSON ELECTRICAL INSTRUMENT CO.
 DAYTON 2, OHIO
 Represented in Canada by: The Canadian Marconi Co.



Get EMERGENCY BAND CALLS At Home!

POLICE FM ALARM
 RADIO APPARATUS CORPORATION
 DEPT. RE-12 310 FOUNTAIN SQUARE THEATRE
 BLDG., INDIANAPOLIS 3, INDIANA

Many fans spend hundreds of happy hours listening to city and state police calls on their Police-Alarm radios. . . . Police-Alarm Model PR-31 is a quality radio which will give years of trouble-free service on the 30-50 mc. band. Can be used on either AC or DC current of 115 volts.

Besides police calls, the 30-50 mc. band also is used by fire departments, ambulances, border patrol, forestry, maritime, railroads, bus lines, and other services. Enjoy the thrill of listening to these vital messages at home. Model PR-31 (illustrated) **\$44.95**

Police-Alarm Model PR-8 is available for 152-162 mc. band reception. Price, complete **\$44.95**

SENSATIONAL TRIO TV YAGI PROVIDES HIGH GAIN ON 2 CHANNELS

Here's the New TV antenna everyone is talking about — the most desirable antenna for two band operation. Unlike customary yagis, where gain falls off sharply on adjacent channels, the new and revolutionary development by TRIO actually provides full 10 DB gain on each of two channels — in a lightweight, compact array. It's the reason it's the most sought after antenna in America today!

It's available for channels 4 and 5, in the low band, and channels 7 and 9 in the high band.

If it's dual channel performance you want for local or fringe area reception, here's the antenna that out performs them all — in better picture quality, cost and weight.

COMPARE THESE ADVANTAGES

- Provides gain on both channel 4 and 5 (or 7 and 9) Equal to Any Two conventional 4-element yagis!
- One bay replaces bulky stacked array!
- One lead replaces old-style 2-lead systems!
- Less weight-per-gain than any other TV antenna!
- Greatly reduced installation costs for complete TV coverage!
- Can be stacked for additional gain.

HOW IT WORKS

Antenna consists of 4 elements whose functioning is different on the two channels. For example: in Model 445, the elements, on channel 4, act as reflector, dipole, director, director, in that order; while on channel 5, the same elements act as reflector, reflector, dipole and director. Careful design insures proper impedance match with standard 300 ohm lead.

Eliminates Co-Channel Interference — Venetian Blind Effect

... When used with TRIO "Controlled Pattern" System Because of the high gain and front to back ratio of the new 2-channel single or stacked yagi, most co-channel interference is eliminated. When the problem is unusually difficult, such as when the TV receiver is located in the center of several TV stations operating on the same channel, co-channel interference CAN BE COMPLETELY eliminated with the use of the "Controlled Pattern" system. This unique system uses 2 bays, off-set stacked and tuned with the remarkable TRIO "Phasitron". TRIO antennas will give you TV reception when the rest fail.

Model 445—Single bay Yagi for Channels 4 and 5.

Model 445-2—Conventional 2 bay stacked array for Channels 4 and 5.

Model 479—Single bay Yagi for Channels 7 and 9.

Model 479-2—Conventional 2 bay stacked array for Channels 7 and 9.

Model 645—"Controlled Pattern" System for Channels 4 and 5, and Model 679 for Channels 7 and 9.



Single 4-element yagi with dual purpose elements. Provides high gain on two channels.

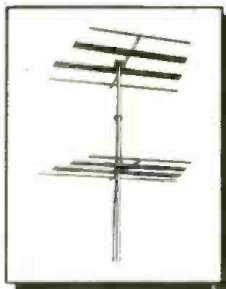

Two of the new TRIO yagis may be stacked to get up to 12 DB forward gain.

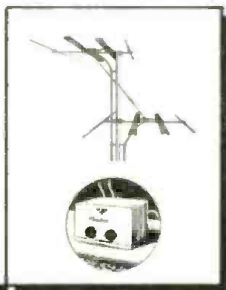

The "Controlled Pattern" System — eliminates "Venetian-Blind effect" when caused by co-channel interference.

HIGH-EFFICIENCY CRYSTAL RECEIVER

By ROBERT E. KELLEY

The crystal detector offers no hope as an amplifier (disregarding such related devices as the transistor). The experimenter must increase the signal input to a maximum for maximum output to the load. The more input to the crystal detector, the more output over the linear range of the crystal.

Many tuned antenna and input coupling systems have been devised to improve the input signal level and, in some cases, the selectivity. The simple input circuit given here illustrates the improvement obtainable with a good load-coupling circuit.

The tuned circuit L2-C1 (Fig. 1) should present an infinite impedance at resonance under ideal conditions. Never obtained of course in practice, it is approached if a high Q coil is used with proper antenna matching and impedance matching. The crystal headphones, on the other hand, offer relatively low impedance to r.f.

To get a good match, simply tap the crystal lead to the coil L2 at the point where maximum current flows in the load circuit. The tap may be adjusted by tuning in a station and adjusting for maximum volume or for maximum indication of a microammeter in the output circuit.

With ordinary headphones (about 2,000 ohms impedance) the author was able to read 18 μ a of rectified d.c. with the crystal lead tapped at the top of the coil. By adjusting the crystal lead to about three-quarters of the way toward the bottom of the coil, the reading was increased to 280 μ a. Both volume in the phones and selectivity were increased tremendously.

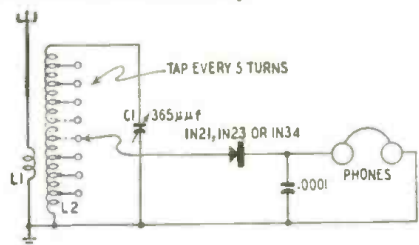

Fig. 1—Hookup of the crystal receiver.

The explanation for this is simply that matching the impedance of the load circuit to the very high impedance of the tuned circuit gives a much higher effective Q and better power transfer to the load.

By using the variable tap, any reasonable load (500 to 20,000 ohms) may be matched to the tuned circuit simply by adjusting the tap for maximum current in the load. High impedance loads will have lower meter readings than low impedances. The meter readings are significant only as comparisons on the same or similar load impedances.

The coil L1 is 16 turns of No. 30 enameled wire on a 1½-inch diameter form. L2 is 95 turns of No. 30 enameled wire on a 1½-inch diameter form and is tapped every five turns.

RADIO-ELECTRONICS for

 **TRIO** MANUFACTURING CO.
Griggsville Illinois

HERE IT IS—

The Issue You've Been Waiting for

**RADIO-ELECTRONICS
ANNUAL TELEVISION ISSUE**

Bigger and Better Than Last Year!

ON SALE DECEMBER 27, 1950

Reserve Your Copy Today

4 Pages of TEST EQUIPMENT at prices every serviceman can afford!

MONEY BACK?

Every single unit described on this and the following pages is offered on a strict "money-back-if-not-satisfied-basis." No if's—no but's—no maybe's. Simply send your order for any unit

or units you select and try them out for 10 days. If not completely satisfied—return for refund in full. No explanation necessary. You are sole judge.

GUARANTEE?

Every instrument sold by us is covered by a one year guarantee. Guarantee registration card is included with shipment.

KITS?

We have discontinued advertising TEST EQUIPMENT in Kit form. The units offered on these 4 pages are completed instruments, NOT KITS! Every model is factory-wired, calibrated and ready to operate.

TUBE TESTERS

Important Note: The two models described below include slip-on portable hinged covers. This is a very desirable feature in Tube Testers because the multiple switches used on such units indicate properly only when clean. The slip-on covers insure long life because the front panel, including all switches, is fully protected when the instrument is not in actual use.

THE NEW MODEL 247



Check octals, loctals, bantam jr., peanuts, television miniatures, magic eye, hearing aids, thyratrons, the new type H.F. miniatures, etc.

Features:

★ A newly designed element selector switch reduces the possibility of obsolescence to an absolute minimum.

★ When checking Diode, Triode and Pentode sections of multi-purpose tubes, sections can be tested individually. A special isolating circuit allows each section to be tested as if it were in a separate envelope.

★ The Model 247 provides a supersensitive method of checking for shorts and leakages up to 5 Megohms between any and all of the terminals.

★ One of the most important improvements, we believe, is the fact that the 4-position fast-action snap switches are all numbered in exact accordance with the standard R.M.A. numbering system. Thus, if the element terminating in pin No. 7 of a tube is under test, button No. 7 is used for that test.

\$ **29**⁹⁰
NET

Model 247 comes complete with new speed-read chart. Comes housed in handsome hand-rubbed oak cabinet slanted for bench use. A slip-on portable hinged cover is indicated for outside use. Size: 10 3/4" x 8 3/4" x 5 3/8".

ONLY

SUPERIOR'S NEW MODEL TV-10



Specifications:

★ Tests all tubes including 4, 5, 6, 7, Octal, Lock-in, Peanut, Bantam, Hearing-aid, Thyratron, Miniatures, Sub-Miniatures, Novals, etc. Will also test Pilot Lights.

★ Tests by the well-established emission method for tube quality, directly read on the scale of the meter.

★ Tests for "shorts" and "Leakages" up to 5 Megohms.

★ Uses the new self-cleaning Lever Action Switches for individual element testing. Because all elements are numbered according to pin-number in the RMA base numbering system, the user can instantly identify which element is under test. Tubes having tapped filaments and tubes with filaments terminating in more than one pin

are truly tested with the Model TV-10 as any of the pins may be placed in the neutral position when necessary.

★ The Model TV-10 does not use any combination type sockets. Instead individual sockets are used for each type of tube. Thus it is impossible to damage a tube by inserting it in the wrong socket.

★ Free-moving built-in roll chart provides complete data for all tubes.

★ Newly designed Line Voltage Control compensates for variation of any line voltage between 105 Volts and 130 Volts.

The Model TV-10 operates on 105-130 Volt 60 Cycles A.C. Comes housed in a beautiful hand-rubbed oak cabinet complete with portable cover.

\$ **39**⁵⁰
NET

TO ORDER—TURN TO PAGE 56 FOR RUSH ORDER FORM

GENERAL ELECTRONIC DISTRIBUTING CO.

DEPT. RC-12, 98 PARK PLACE

NEW YORK 7, N. Y.

1

BUY WITH CONFIDENCE!!

WE KNOW THE PRICE IS UNBELIEVABLY LOW,

but that's not all! In addition, this finely engineered instrument provides a degree of accuracy never before attained in a unit selling for even double this price. Furthermore—in designing this unit, we took advantage of every recent improvement in components. For example, by using slug-tuned coils, we are able to efficiently adjust each instrument for

perfect accuracy. This feature will also enable you to recalibrate the model 200 periodically without having to return it to the factory. The use of a Noval tube (the 12AU7) with its extremely low inter-electrode capacity enabled us to reach a higher frequency range than was heretofore possible in a unit of this type.

THE NEW MODEL 200

AM and FM

SIGNAL GENERATOR



SPECIFICATIONS

- ★ **R.F. FREQUENCY RANGES:** 100 Kilacycles to 150 Megacycles.
- ★ **MODULATING FREQUENCY:** 400 Cycles. May be used for modulating the R. F. signal. Also available separately.
- ★ **ATTENUATION:** The constant impedance attenuator is isolated from the oscillating circuit by the buffer tube. Output impedance of this model is only 100 ohms. This low impedance reduces losses in the output cable.
- ★ **OSCILLATORY CIRCUIT:** Hartley oscillator with cathode follower buffer tube. Frequency stability is assured by modulating the buffer tube.
- ★ **ACCURACY:** Use of high-Q permeability tuned coils adjusted against 1/10th of 1% standards assures an accuracy of 1% on all ranges from 100 Kilacycles to 10 Megacycles and an accuracy of 2% on the higher frequencies.
- ★ **TUBES USED:** 12AU7—One section is used as oscillator and the second is modulated cathode follower. T-2 is used as modulator. 6C4 is used as rectifier.

The Model 200 operates on 110 Volts A.C. Comes complete with output cable and operating instructions.

\$ **18**⁸⁵
NET

2

TO ORDER—TURN TO PAGE 56 FOR RUSH ORDER FORM

GENERAL ELECTRONIC DISTRIBUTING CO.

DEPT. RC-12, 98 PARK PLACE, NEW YORK 7, N. Y.

RADIO-ELECTRONICS for

MONEY BACK GUARANTEE!!



Superior's model 770 AN ACCURATE POCKET-SIZE VOLT-OHM MILLIAMMETER

(SENSITIVITY—1000 OHMS PER VOLT)

FEATURES

- ★ Compact—measures 3 1/8" x 5 7/8" x 2 1/4".
- ★ Uses latest design 2% accurate 1 Mil. D'Arsonval type meter.
- ★ Same zero adjustment holds for both resistance ranges. It is not necessary to readjust when switching from one resistance range to another. This is an important time-saving feature never before included in a V.O.M. in this price range.

★ Housed in round-cornered, molded case.

★ Beautiful black etched panel. Depressed letters filled with permanent white, insures long-life even with constant use.

The Model 770 comes complete with self-contained batteries, test leads and all operating instructions.

SPECIFICATIONS

- | | |
|---|--|
| 6 A.C. VOLTAGE RANGES:
0—15/30/150/300/1500/3000 VOLTS | 4 D.C. CURRENT RANGES:
0—1.5/15/150 MA. 0—1.5 AMPS. |
| 6 D.C. VOLTAGE RANGES:
0—7.5/15/75/150/750/1500 VOLTS | 2 RESISTANCE RANGES:
0—500 OHMS 0—1 MEGOHM |

\$14⁹⁰
NET



Superior's new model 670

SUPER-METER

A COMBINATION VOLT-OHM MILLIAMMETER PLUS CAPACITY REACTANCE INDUCTANCE AND DECIBEL MEASUREMENTS

SPECIFICATIONS:

- D.C. VOLTS: 0 to 7.5/15/75/150/750/1,500/7,500 Volts
- A.C. VOLTS: 0 to 15/30/150/300/1,500/3,000 Volts
- OUTPUT VOLTS: 0 to 15/30/150/300/1,500/3,000 Volts
- D.C. CURRENT: 0 to 1.5/15/150 Ma. 0 to 1.5 Amperes
- RESISTANCE: 0 to 500/100,000 Ohms 0 to 10 Megohms
- CAPACITY: .001 to .2 Mfd. .1 to 4 Mfd. (Quality test for electrolytics)
- REACTANCE: 700 to 27,000 Ohms 13,000 Ohms to 3 Megohms
- INDUCTANCE: 1.75 to 70 Henries 35 to 8,000 Henries
- DECIBELS: —10 to +18 +10 to +38 +30 to +58

ADDED FEATURE:

The Model 670 includes a special GOOD-BAD scale for checking the quality of electrolytic condensers at a test potential of 150 Volts.

The Model 670 comes housed in a rugged, crackle-finished steel cabinet complete with test leads and operating instructions. Size 5 1/2" x 7 1/2" x 3".

\$28⁴⁰
NET

Superior's new model TV-20

20,000 OHMS PER VOLT MULTI-METER and TELEVISION KILOVOLTMETER



SPECIFICATIONS

- 9 D. C. VOLTAGE RANGES. (at 20,000 ohms per Volt)
0-2.5/0/50/100/250/500/1,000/5,000/50,000 Volts
- 8 A. C. VOLTAGE RANGES: (At 1,000 ohms per Volt)
0-2.5/10/50/100/250/500/1,000/5,000 Volts
- 5 D. C. CURRENT RANGES
0-50 Microamperes
0-5/50/500 Milliampers
0-5 Amperes
- 4 RESISTANCE RANGES:
0-2,000/20,000 ohms 0-2/20 Megohms
- 7 D. B. RANGES: (All D. B. ranges based on
Odb = 1 Mv. into a 600 ohm line)
— 4 to +10 db + 36 to +50 db
+ 8 to +22 db + 42 to +56 db
+ 22 to +36 db + 48 to +62 db
+ 28 to +42 db
- 7 OUTPUT VOLTAGE RANGES:
0 to 7.5/13/50/103/250/500/1,000 Volts

ADDED FEATURE:

The Model TV-20 includes an Ultra High Frequency Voltmeter Probe A Silicon V. H. F. Diode together with a resistance capacity network provides a frequency range up to 1,000 MEGACYCLES. When plugged into the Model TV-20, the V. H. Probe converts the unit into a Negative Peak-Reading H. F. Voltmeter which will measure gain and loss in all circuits including F. M. and T. V.; check capacity and impedance; test efficiency of all oscillator circuits; measure bandwidth of F. M. and T. V.; etc.

The Model TV-20 operates on self-contained batteries. Comes housed in beautiful hand-rubbed oak cabinet complete with portable cover, Built-In High Voltage Probe, H. F. Probe, Test Leads and all operating instructions. Measures 4 1/2" x 10 1/4" x 11 1/2". Snipping Weight 10 lbs.

\$39⁹⁵
NET

TO ORDER TURN TO PAGE 56 FOR RUSH ORDER FORM

GENERAL ELECTRONIC DISTRIBUTING CO.

98 PARK PLACE

DEPT. RC-12

NEW YORK 7, N. Y.



Superior's model CA-12



SIGNAL TRACER

THE WELL KNOWN MODEL CA-12 IS THE ONLY SIGNAL TRACER IN THE LOW PRICE RANGE INCLUDING BOTH METER AND SPEAKER!!!

SPECIFICATIONS

- ★ Comparative Intensity of the signal is read directly on the meter—quality of the signal is heard in the speaker.
- ★ Simple to Operate—only one connecting cable—no tuning controls.
- ★ Highly Sensitive—uses an improved vacuum-tube voltmeter circuit.
- ★ Tube and Resistor Capacity Network are built into the detector probe.
- ★ Built-In High Gain Amplifier—Alnico V Speaker.
- ★ Completely Portable—weighs 8 pounds—measures 5½" x 6½" x 9".

Model CA-12 comes complete with all leads and operating instructions.....

\$29⁹⁵
NET

Superior's new model TV-30

TELEVISION SIGNAL GENERATOR

ENABLES ALIGNMENT OF TELEVISION I. F. AND FRONT ENDS WITHOUT THE USE OF AN OSCILLOSCOPE!



FEATURES

- Built-in modulator may be used to modulate the R. F. Frequency also to localize the cause of trouble in the audio circuits of T. V. Receivers.
- Double shielding of oscillatory circuit assures stability and reduces radiation to absolute minimum.
- Provision made for external modulation by A. F. or R. F. source to provide frequency modulation.
- All I. F. frequencies and 2 to 13 channel frequencies are calibrated direct in Megacycles on the Vernier dial. Markers for the Video and Audio carriers within their respective channels are also calibrated on the dial.
- Linear calibrations throughout are achieved by the use of a Straight Line Frequency Variable Condenser together with a permeability trimmed coil.
- Stability assured by cathode follower buffer tube and double shielding of component parts.

SPECIFICATIONS

Frequency Range: 4 Bands—No switching: 18-32 Mc., 33-65 Mc., 54-98 Mc., 150-250 Mc.
 Audio Modulating Frequency: 400 cycles (Sine Wave). Attenuator: 4 position, ladder type with constant impedance control for fine adjustment.
 Tubes Used: 6C4 as Cathode follower and modulated buffer, 6C4 as R.F. Oscillator, 6SN7 as Audio Oscillator and power rectifier.
 Model TV-30 comes complete with shielded co-axial lead and all operating instructions. Measures 6" x 7" x 9". Shipping Weight 10 lbs.

\$29⁹⁵
NET

**RUSH
ORDER
FORM**

**CUT
OUT
AND
MAIL
TODAY!**

GENERAL ELECTRONIC DISTRIBUTING CO.
 DEPT. RC-12, 98 PARK PLACE, NEW YORK 7, N. Y.
 GENTLEMEN:

PLEASE RUSH THE MATERIAL LISTED BELOW:

QUANTITY	MODEL	PRICE

TOTAL

\$..... (Payment in Full Enclosed) \$..... (Deposit Enclosed—Ship Balance C.O.D.)

SHIP TO:

Name

Address

City Zone State.....



3-TUBE RECEIVER FOR WIRED RADIO

By RUFUS P. TURNER

Many hobbyists do not care to obtain amateur radio licenses but wish to enjoy the fun of two-way radio communication over the power lines, wire fences, telephone lines, metal clothes lines, etc. Here is a compact, sensitive wired-radio receiver that the beginner will find easy to build and put into operation. A companion transmitter will appear in an early issue.

To keep within the law, the power output of a carrier current transmitter must be kept low. Its frequency is generally below the broadcast band to prevent radiation and interference with nearby broadcast receivers. For this reason receiver sensitivity must be fairly high. When amateur stations were shut down during the last war, carrier current experimenters tried various types of low-frequency receivers. These tests proved that a hot regenerative receiver is entirely satisfactory for amateur wired radio and in many cases will give a homemade carrier current superhet receiver a run for its money.

This small-sized 3-tube set is complete with a.c. power supply. Its single tuning range is 95 to 400 kc. Loud-speaker operation is provided. The receiver uses parts which are easily obtained, and takes little table space. Its cabinet measures only 11 x 7 x 7 1/4 inches. It has three controls. One dial takes care of all tuning. The only other adjustable items are the volume control and regeneration control. The setting of the regeneration control has little effect on the dial calibration.

A STANDBY (or TRANSMIT-RECEIVE) switch is provided so the receiver may be shut off during transmitting intervals without turning off the tube heaters. A second ON-OFF switch interrupts the power line to shut off the entire receiver.

Regeneration control is smooth and covers a wide range. Regeneration may be eliminated entirely by turning the regeneration control potentiometer all the way down—the receiver then operates as a simple non-regenerative detector and one-stage power amplifier—or it may be increased to maximum where oscillation begins. Between these two extremes there is a wide range of receiver sensitivity to suit all manner of reception conditions.

Fig. 1 is the schematic of the receiver. A special three-coil coupler L1-L2-L3 provides input coupling and inductive feedback. The grid coil L2 is one coil taken from an old 455 kc i.f. transformer.

The other i.f. coil is removed from the wooden dowel on which the two are mounted. The input coil L1 is 15 turns of No. 26 d.c.c. wire closewound around the dowel and separated from L2 by about 1/8 inch as shown in Fig. 1. The tickler coil L3 is the largest honeycomb pie from a National type R-152

DECEMBER, 1950

THE ONLY WAY...

Here it is...Concord's New Buying Guide...The most current listing on leading TV, Radio, and electronic equipment in the field. Concord is issuing periodically, these "guides" to give you the finest buying scoops first-hand. You'll get complete information on all the latest available merchandise...at the lowest possible price. In this way you're assured of only the most up-to-date selection of equipment on the market at the time. When the merchandise is available to us...it goes straight to you. You can't afford to miss an issue...Get on Concord's mailing list now...It's the only way to keep posted!

Put Your Name On Concord's Mailing List

Bargains... Values... Savings. Now you're assured of getting the latest scoops on Radio, TV, and Electronic Equipment First-hand. Send today for your Concord Buying Guide. Just fill in the coupon at the right. Send all orders to Concord - Chicago.

CONCORD RADIO CORP. Dept. JM-50
901 W. Jackson Blvd., Chicago 7, Illinois.

Rush me your Latest Buying Guide

Name.....

Address.....

City..... Zone..... State.....

SOME \$ SAVING CONCORD SPECIALS

SAVE... 12" CO-AXIAL HI-FI SPEAKER

...Expertly engineered to give finest in natural reproduction for high-fidelity audio systems and radios. 12" woofer has heavy duty 31 ounce Alnico 3 magnet for reproducing lower musical register down to 40 cycles. Coaxially suspended tweeter has specially designed cone for higher register of musical and vocal sound...will respond up to 17,500 cps. High pass filter is attached and combined impedance can be hooked to any 8 ohm output-transformer. Rated at 20 watts. 22-19362J - Shpg. Wt. 10 lbs. And only **12.95**



EXCLUSIVE... DIAMOND STYLUS CARTRIDGE

Another Concord Exclusive! A Variable Reluctance Cartridge with a Genuine Long-life Diamond Stylus for Standard 78 RPM recordings. Drastically reduced in price, this cartridge formerly sold at \$21.00. Now only at Concord, you can have it at less than 1/2 the original net price...a 50% saving. Frequency response limited only by record itself. Extremely low needle talk and scratch. Unaffected by varying temperature and humidity conditions. Requires 3/4 oz. to 1-1/4 oz. pressure for optimum tracking. May be used with most standard tone arms. Can also be used with Garrard record changers (old or new), and Webster changers with the exception of those that employ plug in heads. Preamplifier is required between pick-up and input. Size: 1-21/32 x 3/4 x 9/16, mtg. ctrs. 1/2". 99-8015J - List: \$35.00 Your Net Price **9.95**

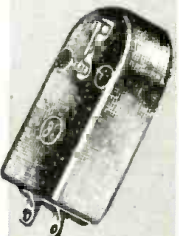

VALUE... NEW CON-CAP CONDENSERS

No.	Capacity Mfd.	Working Volts DC	Lots 10 ea.	Single each
5-682J	20	150	29¢	37¢
5-684J	40	150	35¢	43¢
5-690J	20 + 20	150	47¢	55¢
5-691J	40 + 40	150	59¢	67¢
5-692J	50 + 30	150	59¢	67¢
5-685J	8	450	29¢	37¢
5-686J	16	450	47¢	55¢
5-687J	20	450	59¢	67¢
5-689J	40	450	72¢	82¢
5-696J	8 + 8	450	59¢	67¢

Concord's New Con-Cap capacitors... Rigorously tested for mechanical perfection and electrical stability under severest conditions of shock and vibration. Feature seamless extruded aluminum shell with outer glazed cardboard insulating tube, and easy to manage tinned copper leads; hermetically sealed construction. See complete listing at left ...at the lowest prices anywhere!



CONCORD RADIO

Mail Order Center and Showroom

901 W. Jackson Blvd., Chicago 7, Ill.

Branch Showroom: 265 Peachtree St., Atlanta 3, Ga.

EXPORT

For prompt service on Export Orders and Inquiries Address to Concord Radio Corp., Export Division, 901 W. Jackson Blvd., Chicago 7, Illinois.

INDISPENSABLE!
PHOTOFACT BOOKS



Photofact Television Course. Covers TV principles, operation and practice. 216 pages; profusely illustrated; 8 1/2 x 11". Order TV-1 Only \$3.00

Television Antennas. New 2nd edition. Describes all TV antenna types; tells how to select, install, solve troubles. Saves time; helps you earn more. 200 pages; illustrated. Order TAG-1 Only \$2.00

Television Tube Location Guide. Accurate diagrams show position and function of all tubes in hundreds of TV sets; helps you diagnose trouble without removing chassis. 200 pages; pocket-size. Order TGL-1 Only \$1.50

1949-1950 Record Changer Manual. Vol. 3. Covers 44 models made in 1949, including multi-speed changers and wire and tape recorders. Original data based on actual analysis of equipment. 286 pages; 8 1/2 x 11"; paper-bound. Order CM-3 Only \$3.00

1948-1949 Changer Manual. Vol. 2. Covers 45 models made in 1948-49. Deluxe bound. Order CM-2. Only \$6.75

1947-1948 Changer Manual. Vol. 1. Covers 40 post-war models up to 1948. Order CM-1 Only \$4.95

Recording & Reproduction of Sound. A complete authoritative treatment of all phases of recording and amplification. 6 x 9". Order RR-1 Only \$5.00



Post-War Audio Amplifiers. Vol. 2. A complete analysis of 104 well-known audio amplifiers and 12 well-known tuners made in 1949-50. 368 pages, 8 1/2 x 11". Order AA-2 Only \$3.95

Post-War Audio Amplifiers. Vol. 1. Covers 102 amplifiers and FM tuners made through 1948. 352 pages. Order AA-1 Only \$3.95

Auto Radio Manual. Complete service data on more than 100 post-war auto radio models. Covers over 24 mfgs. 350 pages, 8 1/2 x 11". Order AR-1 Only \$4.95

Communications Receiver Manual. Complete analysis of 50 popular communications models. 246 pages, 8 1/2 x 11". Order CR-1 Only \$3.00

Radio Receiver Tube Placement Guide. Accurate diagrams show where to replace each tube in 5500 radio models, covering 1938-1947 receivers. 192 pages, pocket-size. Order TP-1 Only \$1.25

Dial Cord Stringing Guide. Vol. 2. Covers receivers made from 1947 through 1949. Shows you the one right way to string a dial cord in thousands of models. Pocket-size. Order DC-2 Only \$1.00

Dial Cord Guide. Vol. 1. Covers sets produced 1938 through 1946. Order DC-1 Only \$1.00

HOWARD W. SAMS & CO., INC.

Order from your Parts Jobber Today, or write direct to HOWARD W. SAMS & CO., INC., 2201 E. 46th St., Indianapolis 5, Ind.

My (check) (money order) for \$..... enclosed. Send the following books:

- TV-1 CM-3 RR-1 AR-1 DC-2
- TAG-1 CM-2 AA-2 CR-1 DC-1
- TGL-1 CM-1 AA-1 TP-1

Name.....

Address.....

City.....Zone.....State.....

transmitting r.f. choke. This pie is cemented flat to one face of L2. A long brass machine screw passed through the center hole of the dowel holds the three-coil coupler to the receiver chassis.

The input coil L1 connects directly to the signal input terminals. If the receiver input is connected to the power

adjustment a dull thud or pop should be heard as regeneration begins. As the control is advanced still further, a steady rushing noise should begin and should be followed by a loud whistle that indicates oscillation. If you do not get these effects, reverse the connections of tickler coil L3 and repeat the

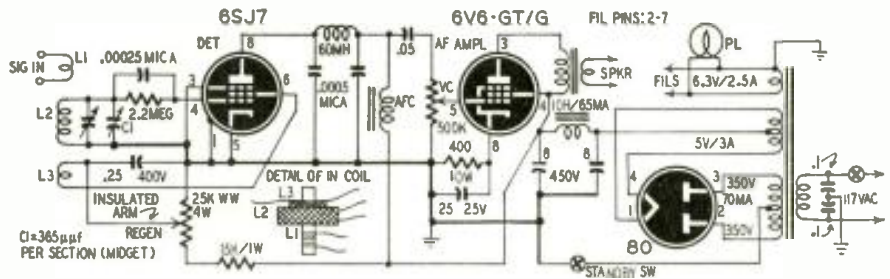

Fig. 1—Circuit of the little 3-tuber. Its tuning range is from 95 to 400 kc.

line, use the fuse-protected coupler shown in Fig. 2 to prevent burning out L1. This isolating unit is not needed when the conducting line carries no high voltage. A pair of 600-volt paper capacitors will then be sufficient.

The tuning capacitor C1 is a two-section midget broadcast-type unit with 365 µmf per section. The trimmers are removed in parallel by a short jumper for a total capacitance of 730 µmf. The vernier tuning dial is a National type AM.

Testing and calibration

After the wiring is completed and inspected, connect the loudspeaker, set the regeneration control to zero, the

test. With the receiver oscillating, run the volume control through its range, to check volume control action.

To calibrate the receiver, connect an amplitude-modulated signal generator

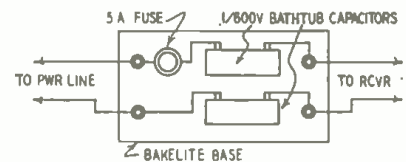

Fig. 2—Fused coupler for the receiver.

or test oscillator to the signal input terminals of the receiver. Set tuning capacitor C1 to maximum capacitance and set the signal generator for 95 kc. Adjust the generator output for a fairly strong modulated signal, advance the volume control to maximum, and advance the regeneration control about one quarter of maximum. If the receiver tunes to 95 kc at considerably less than full capacitance of C1, remove a few turns from grid coil L2. Advance the receiver dial a few divisions at a time, following with the signal generator. The completed calibration will be very nearly identical with the data given in the chart. Always use the minimum regeneration which will sensitize the receiver sufficiently to pick up good signals.

CALIBRATION DATA		
Dial Setting		Frequency (kc)
0		400
10		360
20		295
30		240
40		205
50		175
60		148
70		130
80		115
90		105
95		100
100		95

Materials for receiver

Resistors: 1—2.2 megohm, 1/2 watt; 1—15,000 ohm, 1 watt; 1—25,000 ohm, 4 watt, wirewound potentiometer with insulated contact arm; 1—500,000 ohm potentiometer; 1—4000 ohm 10 watts. Capacitors: 1—250 µmf silver mica; 2—500 µmf mica; 1—.05, 2—.01, 1—.025 µf, 400 volt, paper; 2—8 µf, 450 volt, electrolytic; 1—25 µf, 25 volt, electrolytic; Miscellaneous: 1—audio frequency choke, 1000 h; 1—radio frequency choke, 60 mh; 1—universal output 1—2-gang midget variable, 365 µmf per section; 1—transformer to match 6V6-GT/G; 1—power transformer, 350-0-350 v at 70 ma, 5 v at 3 a, 6.3 v at 2 1/2 a; chassis, vernier dial, tubes, sockets, hookup wire, switches, miscellaneous hardware.

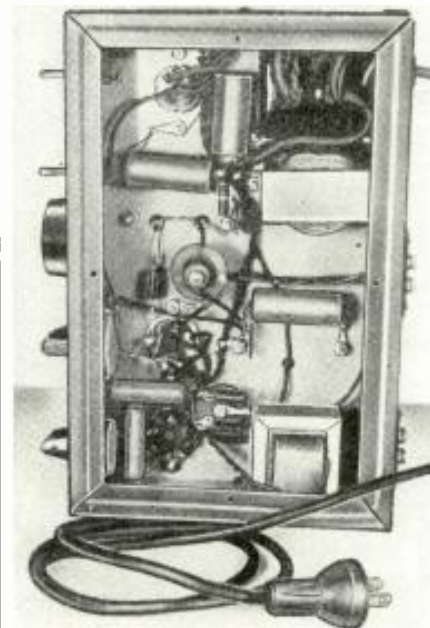

Underside of the wired-radio receiver.

volume control to maximum, and the standby switch S1 to off. Allow about 3 minutes for the tubes to heat. Close switch S1 and slowly advance the regeneration control. At one point in this

Technical Bulletins

EACH \$1.00 Postpaid Foreign \$1.25

Electrical Design and Construction

These bulletins give you easy, accurate, dependable methods of designing and building electrical equipment. You just follow simple charts, tables and step-by-step instructions that tell how to figure correct size units to meet specific requirements.

106 Rewinding Electric Motors—Enables anyone without electrical training to locate trouble, repair and rewind a.c. or d.c. motors and generators of all kinds; how to figure wire size and wind coils.

111 Transformers—How to design and build all types and sizes of transformers including specials for Neon tubes and ultraviolet lamps. Easy methods of determining core dimensions and wire size.

152 House Wiring—Safe, approved way to wire new and old buildings. Shows many different circuits. Explains how to use latest type of materials including fittings, fixtures. Also gives estimating methods.

101 Resistance Wire—How to use Nichrome and similar wire in heating devices, rheostats and resistance coils. Figuring wire size and length; how to wind elements and test. Also supply directory.

113 Solenoids & Plunger Magnets—How to make these a.c. and d.c. magnets having movable plungers to control other equipment. How to figure dimensions, plunger stroke, wire size, etc.

112 Electromagnets—How to design and build all types and sizes for a.c. and d.c. How to figure lifting power, wire size.

148 Relays—Designing and building a.c. and d.c. relays of any size for various purposes where small currents and voltages must control heavy circuits. Includes control systems for motors and machines.

137 Meters—Designing and building ammeters, voltmeters, wattmeters, for a.c. and d.c. Includes complete information on calibrating.

127 Small Electric Light Plants—Easy-to-build, low-cost installations for cottages, camps, etc. Includes a 110-volt, seven 25-watt-lamp system; also a 6-volt system using auto generator.

151 Electric Power from Streams—How to survey streams, estimate requirements and available power, design and build dams, select and install the control system and electrical equipment.

161 Burglar Alarms & Time Switches—Dependable types for various purposes. Time switches made for alarm clocks and arranged to control lights, sprinkler systems, motors and other devices.

144 Choke Coils—How to design and build for many different purposes. How to use these instead of rheostats for voltage control, safely and with much less loss of electricity

131 Remote Control of Electrical Devices—Circuits and applications. How to use telephone line and Stroger switch. For experimenters and model-railroad switching purposes.

134 A.C. Electrical Experiments—Fascinating, home experiments for education and entertainment. Also practical uses.

TECHNIFAX, 520 N. Michigan Ave. Chicago 11, Ill.

Enclosed find \$_____ for which send the following Technical Bulletins at \$1.00 each (Foreign \$1.25) as indicated by numbers:

Name _____

Address _____

City & State _____

RE-12-50

HETERODYNE SIGNAL GENERATOR

There are many uses around the ham-shack or service bench for this crystal-controlled heterodyne signal generator. A few standard parts, a dual triode, and the readily available surplus military-type crystals make the device inexpensive.

Each section of the 6SN7 operates as a Pierce oscillator. Their outputs are mixed in the plate circuits, resulting in four possible output frequencies: f_1 , f_2 , $f_1 - f_2$, and $f_1 + f_2$. It is especially valuable as a substitute for low-frequency crystals in the broadcast and i.f. channels.

By judiciously selecting the crystal frequencies, a number of useful frequencies can be generated. For example, one extra crystal will give five additional frequencies. A total of four crystals will provide 16 different frequencies.

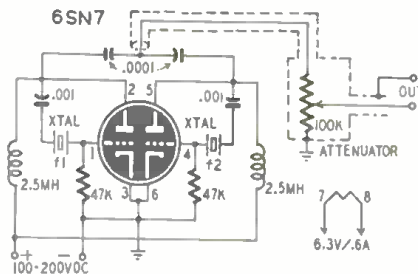

Although the output is shown feeding into an attenuator circuit for signal generator service, any one of the four frequencies has sufficient strength to drive to full output a 6L6 or 6V6 buffer or doubler stage in a transmitter.

This circuit was developed to drive a carrier-current transmitter with 807's in the final at KHSM (St. Mary's College) on 880 kc from available 7-mc crystals of suitable frequencies. The same circuit has since proven its worth as a test oscillator on the bench, being a source of crystal check points throughout the spectrum by using various combinations of crystals.—*Robert D. Oliver, W6SPF*

STATEMENT OF THE OWNERSHIP, MANAGEMENT, AND CIRCULATION REQUIRED BY THE ACT OF CONGRESS OF AUGUST 24, 1912, AS AMENDED BY THE ACTS OF MARCH 3, 1933, AND JULY 2, 1946 (Title 39, United States Code, Section 233) of RADIO-ELECTRONICS, published monthly at Philadelphia, Pa., for October 1, 1950.

1. The names and addresses of the publisher, editor, managing editor, and business managers are: Publisher, Radercraft Publications, Inc., 25 West Broadway, New York 7, N. Y.; Editor, Hugo Gernsback, 25 West Broadway, New York 7, N. Y.; Managing Editor, Fred Shunaman, 25 West Broadway, New York 7, N. Y. Business Manager, none.

2. The owner is: Radercraft Publications, Inc., 25 West Broadway, New York 7, N. Y.; H. Gernsback, 25 West Broadway, New York 7, N. Y.

3. The known bondholders, mortgagees, and other security holders owning or holding 1 percent or more of total amount of bonds, mortgages, or other securities are: None.

4. Paragraphs 2 and 3 include, in cases where the stockholder or security holder appears upon the books of the company as trustee or in any other fiduciary relation, the name of the Person or corporation for whom such trustee is acting; also the statements in the two paragraphs show the affiant's full knowledge and belief as to the circumstances and conditions under which stockholders and security holders who do not appear upon the books of the company as trustees, hold stock and securities in a capacity other than that of a bona fide owner.

H. GERNSBACK, Publisher.
Sworn to and subscribed before me this 28th day of September, 1950. [Seal] Maurice Coyne, Notary Public. (My commission expires March 30, 1952.)

new! amazing
2nd edition Howard W. SAMS
Radio & TV Industry
RED BOOK



NOW Complete
TV & Radio
Replacement Parts Data—
All Yours in One Volume!

Covers 22,000 models from 1938-1950

Lists 22 major components—19 parts mfgs. represented

First complete TV parts compilation

Over 600 pages ONLY \$3.95

NEW Second Edition of the famous RED BOOK tells you in one volume all you need to know about TV and Radio replacement parts for approximately 22,000 sets made from 1938 through 1950! Includes complete, accurate listings of 22 major components. Provides proper replacement listings for 22 product lines produced by 19 leading parts manufacturers. Gives original parts numbers, proper replacement numbers and valuable installation and service notes on TV and Radio Parts: Tubes, Capacitors, Transformers, Controls, IF's, Speakers, Vibrators, Phono-Cartridges, Batteries—plus the first complete TV parts compilation, including replacement parts data for sweep oscillator and horizontal and vertical output systems. Over 600 pages, 8 1/2 x 11", sewed binding. You can't afford to be without the RED BOOK—pays for itself with just a few days' use. Order your copy today!

SAVE 95¢! If you own the First Edition RED BOOK, tear out the first page, present it to your distributor, and receive 95¢ credit or allowance on purchase of Second Edition.

Order from your Parts Jobber today, or write direct to HOWARD W. SAMS & CO., INC., 2201 East 46th St., Indianapolis 5, Ind.

ORDER TODAY!

My (check) (money order) for \$_____ enclosed.

Send _____ RED BOOK (S) \$3.95 per copy.

Page 1 from First Edition RED BOOK is enclosed for 95¢ credit.

Name _____

Address _____

City _____ State _____

New Devices

TOOL HOLDER

Hobby Hill
Chicago, Ill.

Called the GRIP-R, this tool hanger consists of a 22-gauge open end metal shell 18 inches long 2 3/4 inches wide, and 3/8 inch thick. Running along the entire length of the shell is a series of slots for holding sliding ring clips. Directly in front of the line of slots is a 5/16-inch plated coil spring which is held in place by the sliding ring clips, and at each end are screws for wall mounting.

All types of tools, with or without handles, are held on the rack merely by slipping them under the coil spring. The sliding ring clips can be adjusted

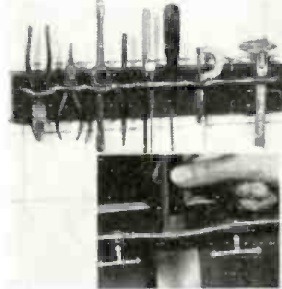

to the size of the tool. The tension in the coil spring holds the item securely and yet allows easy removal.

AUDIO AMPLIFIERS

Altec Lansing Corp.
Beverly Hills, Cal.

This group of amplifiers, the 1400 series, consists of six units; the 1410A preamplifiers, the 35-watt A-1420 power amplifier, the 75-watt A-1430A power amplifiers, the A-1440A line amplifier, the 1450A apparatus unit and the 30A power supply.



The A-1410A preamplifier has two mixing input channels and the gain controls can be removed from the chassis for remote operation. The A-1420A can supply the necessary power for three preamps and provision has been made so that one can be mounted directly on the power amplifier chassis with its two mixer controls appearing on the control panel. The A-1430A will supply power for six preamps and has provision for mounting two preamps on the main chassis. The 30A power supply is used with the A-1410 and A-1440A when they are not used in conjunction with a power amplifier. The 1450A apparatus unit provides input impedances of 30, 250, 500 or 600 ohms for the power amplifiers when they are not used in conjunction with the preamplifiers. Loudspeaker output impedances are provided for RMA70-volt line.

DUO-CONE SPEAKER

RCA Victor Div.
Camden, N. J.

The new 15-inch Duo-Cone speaker type 51552 is designed for high-quality reproducing systems at both high and low levels. It has a useful response range from 40 to 12,000 cycles and will handle 25 watts of audio power. The vibrating system and magnetic structure of this speaker consist of a duo-cone and two voice coils operating in two separate air gaps excited by a

single 2-pound Alnico V magnet. The duo-cone has a large woofer and a small tweeter cone each mounted in its own housing so that the large cone

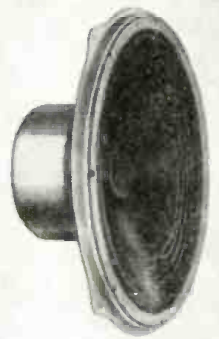

is effectively a continuation of the smaller one. The large cone is driven by a 2-inch voice coil to produce the low frequencies, and the small cone is driven by a 3/4-inch voice coil to produce the highs.

The two cones vibrate as a single unit in the crossover range to avoid crossover interference.

TUBE TESTER KIT

Electronic Instrument Co.
Brooklyn, N. Y.

Incorporating the same features as the previous Eico model 625-K tube tester



this new kit, the 625-CK is designed especially for counter display tube testing as an aid in tube merchandising. Individual switches test each tube element. It tests conventional receiving and TV tube types including 4, 5, 6, and both 7-pin, octal, loctal, novel, Hytron VR, electron-ray tubes and pilot bulbs. It has a blank socket for future tubes, an illuminated gear-driver roller chart, two grid caps, a protective overload bulb, and a full-vision bakelite-cased meter.

This tube tester is also available completely wired.

TV-FM BOOSTER

Sonic Industries, Inc.
New York, N. Y.

The Super Sonic TV-FM Amplifier model IT5 is designed for high gain preselection for any TV or FM receive with adequate bandwidth and with adequate selectivity to reject unwanted



signals. It has one continuous tuning control without vernier and high-low switching. Six turns of the tuning control tune through channels 6 to 13.

The circuit features pure silver inductances and r.f. circuit contacts minimum shunt capacitance, short input and output link coupling, high-quality insulating elements, a copper plated chassis, and a well-filtered power supply. Balanced input and output circuits reduce the noise pickup. The booster has both 72 and 300 ohm input and output impedances.

RAD-IO-ELECTRONICS for

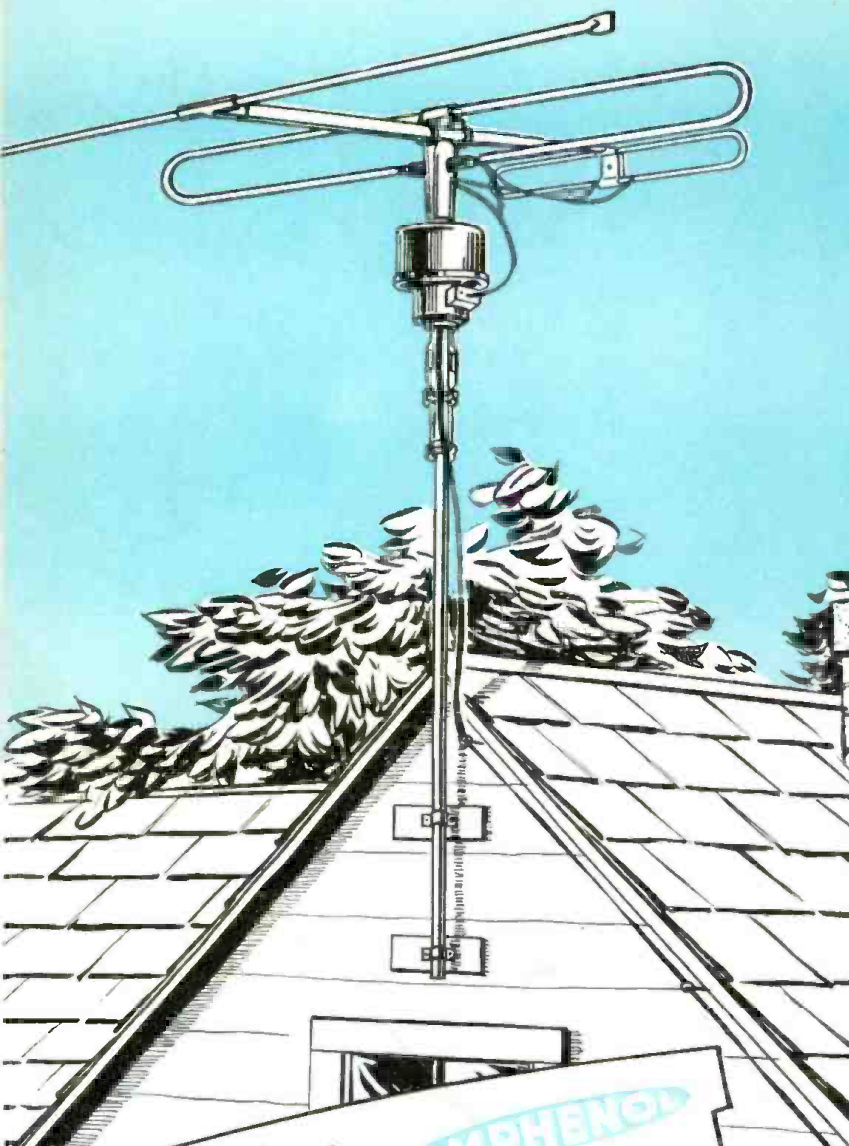

Exclusive "Auto-Dial" ROTATOR

The "ear-phone and crystal" stage of television is over! With the new AMPHENOL "Auto-Dial" TV Antenna Rotator there are no tiresome buttons or switches to hold while the antenna turns—no searching over and over again for the position which provides the best picture. An effortless turn of the knob to the correct setting—as simple as tuning to a radio station—and "Auto-Dial" takes over. Automatically the antenna rotates to point directly at the TV station—then stops! Rotation is in steps of 6 degrees, accurately calibrated on the indicator. Because of this important feature, you can easily "log" the antenna positions where the best picture is obtained and then accurately return to them whenever you wish. Since the antenna can always be brought back to exactly the same direction, servicemen can now determine whether an antenna is functioning properly, whether it has the required front-to-back ratio and whether it is properly located for the best possible picture.

AMPHENOL LEADS AGAIN

The new "Auto-Dial" is made by the originators of the famous AMPHENOL "In-line" TV Antennas. The same precision-manufacturing and quality materials will be found in the "Auto-Dial." The rotator is lightweight and attractively styled yet ruggedly built for years of trouble-free service. The "Auto-Dial" Control Unit is gracefully designed to blend with any decor.

See the completely new AMPHENOL "Auto-Dial" Rotator at your Jobber—or write for illustrated folder.

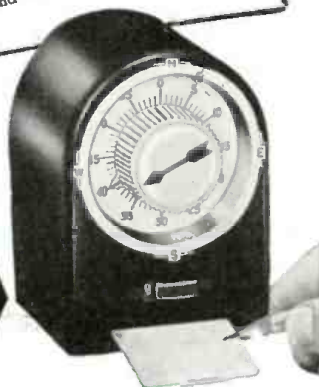

AMERICAN PHENOLIC CORPORATION

1830 SO. 54TH AVENUE

CHICAGO 50, ILLINOIS

TV BOOSTER

Alliance Manufacturing Co.
Alliance, Ohio

The Tenna-Scope, as this new booster is called, has a single tuning control to cover all channels and an automatic on-off switch controlled by the TV re-



ceiver. The circuit uses a 6J6 dual triode for minimum noise and a selenium rectifier. Separate circuits are used for high and low bands, and the input and output impedances are 72 or 300 ohms.

The booster comes in a walnut plastic cabinet with a gold and maroon dial. Its size is 6 1/4 x 5 1/2 x 5 inches and it weighs 4 1/4 pounds.

SELENIUM RECTIFIER

Precision Rectifier Co.
Brooklyn, N. Y.

Called Plastisel, these rectifiers look like paper capacitors and are installed the same way—no mounting holes required. The rectifiers are completely sealed and run cool up to full ratings.



LP CARTRIDGE

Astatic Corp.
Conneaut, Ohio

Designed especially for LP records the new CAC-J crystal cartridge is internally equalized to follow the ideal frequency response of the recording characteristic of Columbia records and it also plays the 45 r.p.m. platters. Its output is .6 volts at 1,000 cycles on Columbia No. 103 test record and 1 volt on RCA 12-5-31-V test record.

The cartridge is housed in a lightweight aluminum case with standard mounting holes to fit most tone arms. An adapter plate is furnished to permit mounting in RCA and similar 45 r.p.m. record changers.



Another model, the CAC-78-J, has a 3-mil needle tip radius for 78 r.p.m. records. Both models use the Astatic type Q sapphire tipped needle.

YAGI ANTENNA

Trio Manufacturing Co.
Griggsville, Ill.

Designed to work on two channels (either channels 4 and 5 on the low band or channels 7 and 9 in the high band), this 4-element Yagi has a gain equal to any two conventional 4-element Yagis on the same channel. The 4 elements have different functions on the two channels. For example, in model 445, the elements on channel 4 act as reflector, dipole, director, director, in that order; while on chan-

nel 5 the same elements act as reflector, reflector, dipole, and director. The gain on the two channels is

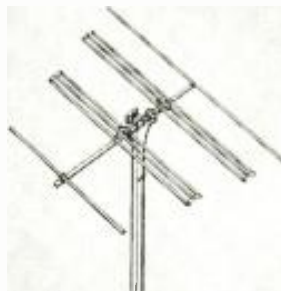

front-to-back ratio is 20 db, 10 db, and the antenna matches a standard 300-ohm line. It is available in single bay, 2-bay stacked array, and in a controlled pattern system using 2 bays offset stacked and tuned with the Trio "phasitron."

LOUDSPEAKER

Sun Radio & Electronics Co.
New York, N. Y.

The new British Wharfedale W10/CSB loudspeaker is being distributed in the United States by the Sun Radio & Electronics Co. Designed for medium

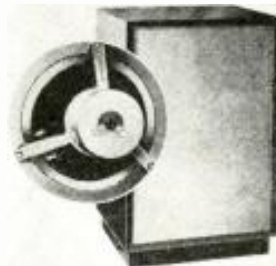

to small rooms, the 10-inch unit handles up to 5 watts and has a response comparable to most 12 to 15-inch speakers without the booming effect caused by the larger speakers when used in small rooms.

A cabinet especially designed for the speaker is available in either blond or mahogany finish.

AUTO ANTENNA

Snyder Manufacturing Corp.
Philadelphia, Pa.

Using army type construction and mounting, the Hot Rod is designed for long-distance and country reception. It has a long 4-section staff of chrome plated brass, a shock absorbing spring mount, red ceramic insulators and a red tenite static ball. It comes complete with 8 feet of u.h.f. polyethylene cable and aircraft type fittings.

HIGH-VOLTAGE PROBE

Industrial Devices, Inc.
Edgewater, N. J.

Using the extinction voltage of a neon lamp in conjunction with a calibrated potentiometer, this test instrument has an accuracy within 5% from 3.2 to 30 kv. The peewee clip is attached to the chassis or similar ground, and the probe tip is applied to the high voltage. When the indicator knob is fully counterclockwise, the neon lamp indicator glows. Clockwise rotation will give an abrupt extinction of the lamp and the pointer indicates the voltage.



Two models are available. Model 500 has a range from 1.6 to 15 kv r.m.s. and draws less than 1 ma at full scale reading, while model 520 covers a range from 3.2 to 30 kv d.c. and draws less than 300 microamps. Model 500 is designed for high-voltage transformers while model 520 is for high-voltage electronic d.c. supplies.

Get This Valuable Book Just for Examining COYNE'S New 7-Volume Set

FREE **"Applied Practical Radio-Television"**

Yes, you get this great big, brand new book, "150 New Radio-Television Diagrams Explained", absolutely FREE! Gives you complete wiring circuits and diagrams on the latest Radio and Television Sets. Easy-to-read, large 8 1/2 x 11" pages, with full instructions on how to read and use the diagrams. This book is a "must" in every Radio and Television service-man's repair kit. You get this valuable book as a FREE Gift just for asking to see Coyne's great new 7-book set, "Applied Practical Radio-Television"!

ON 7 DAYS FREE TRIAL!

JUST OFF THE PRESS!

Here's "Know How" that Makes You Worth More!

Coyne's new "Applied Practical Radio-Television" is written for men who want to get ahead fast in big pay TELEVISION and RADIO work . . . men who know that a practical working knowledge helps bring top earnings. Over 2500 pages, 5000 subjects, of the latest Radio and Television "know how"—with 1200 crystal-clear illustrations and diagrams. Includes separate volume on Electronics and handy Radiomen's Handbook.

Color Television Included

COMPLETE SECTION ON COLOR TV AND UHF! How to install, service, align, balance ALL radio and TV sets . . . how to use testing instruments . . . latest data on UHF adapters and converters, and much MORE. Step-by-step photographs show you what makes it "tick". Fully indexed for ready reference on the job or to study at home. Up-to-the-minute, complete, easy to understand!

COYNE ELECTRICAL & TELEVISION-RADIO SCHOOL
500 S. Paulina St., Dept. CO-T1, Chicago 12, Ill.

SEND NO MONEY! Just mail coupon. We'll send you the 7-volume set on 7 DAYS FREE TRIAL. With it we'll include the book of 150 Radio-TV Diagrams. If you keep set, pay \$3 in 7 days and \$3 per month until \$23.90 is paid. (Cash price \$22.40.) Return the set alone and you OWE NOTHING. Either way, the book of Diagrams is yours to keep. Coupon is just a request to see Set free and get FREE BOOK. Offer limited. Act NOW!

FREE BOOK — FREE TRIAL COUPON!

COYNE Electrical and Television-Radio School
500 S. Paulina St., Dept. CO-T1, Chicago 12, Ill.

YES! Send 7-volume set, "Applied Practical Radio-Television", for 7 days FREE TRIAL per your offer. Include gift of 150 Radio-TV Diagrams Book FREE!

Name Age
Address
Town Zone State
Where employed

PUZZLED?



- TUBE TESTER?
- BATTERY TESTER?
- CONDENSER TESTER?
- AM SIGNAL GENERATOR?
- AUDIO OSCILLATOR?
- FM SIGNAL GENERATOR?
- MULTITESTER?

Here's Your Answer Now
ALL IN ONE!

SERVISHOP

NEW MODEL 8773



EQUIVALENT TO A COMPLETE SERVICE SHOP!

- TUBE TESTER
- SET TESTER
- A.M. GENERATOR
- F.M. GENERATOR
- A.F. GENERATOR
- CONDENSER TESTER

\$99⁹⁵

Every square inch solid-packed with value! Look what you get in this phenomenally low priced tester: a complete latest model obsolescent proof tube tester with approximately 1000 listings on improved roll chart together with an elaborate multitester for measuring all AC & DC voltage DC currents—resistance in ohms and megohms—output in decibels—condenser leakage—signal generators for audio—radio AM and radio FM signals.

- DC Voltmeter: 0-10-50-500-1000-2500
- AC Voltmeter: 0-10-50-500-1000-2500
- DC Milliammeter: 0-10-100-1000
- DC Ammeter: 0-10
- Decibel Meter: —8 to +15, 15 to 29, 29 to 49, 32 to 55
- Ohmmeter: 0-500-5000 ohms, 0-0.1-1-10 meg-ohms

Complete with tubes, batteries and test leads, output leads, etc., and housed in beautiful natural finish oak case.

Buy from your jobber. Insist on R.C.P. Instruments Write for Catalog 11RE

RADIO CITY PRODUCTS CO., INC.

152 West 25th St. New York N. Y.

NEW TUBES OF THE MONTH

Among the few new tubes that have appeared on the market in recent months are three types by RCA: two kinescopes, and a photomultiplier. G-E has brought out a new transmitting tube and a new kinescope.

RCA's 19AP4-B is a direct-view, metal-cone picture tube for TV receivers.



It has a high-efficiency white fluorescent screen on a face made of frosted Filterglass for increased contrast and to avoid specular reflection. Except for its frosted face, this tube is identical with the 19AP4-A.

The other RCA kinescope, the 7NP4, is a projection-type tube for theaters which provides a projected image of 15 x 20 feet at a projection throw distance of about 60 feet when used with a suitable optical system. The tube has a metal-backed white fluorescent screen for increased brightness of the projected image.



Using electrostatic focus and magnetic deflection, the 7NP4 operates with a maximum anode voltage of 80 kv and a maximum focusing electrode voltage of 20 kv. High-voltage design features

include a bulb with corrugated side-walls with insulated leakage coating for a longer external leakage path; an inner cone-neck section for adequate vacuum insulation; and only one high-voltage envelope connection.

The 7NP4 has a 7-inch diameter bulb that is 19½ inches long. Grid No. 2, which draws only negligible current, is used to make the brightness adjustment independent of the focussing adjustment. Similarly, the focussing electrode, grid No. 3, draws only a few microamperes. The tube uses a plastic-filled, diheptal 14-pin base.

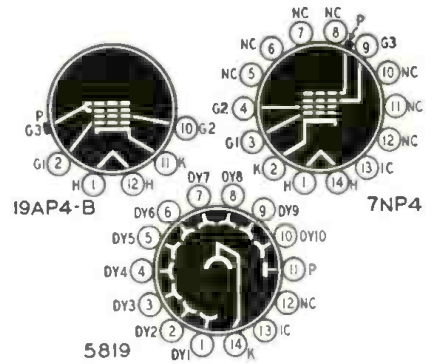

NC=NO CONNECTION; IC=INTERNAL CONNECTION—DO NOT USE

The new 5819 RCA's photomultiplier tube for scintillation counters, has a sensitivity nearly five times better than the original 5819 introduced about a year ago. Other improvements are a greater cathode collection efficiency, higher current amplification, strengthened mount structure, shorter over-all length, and a cathode lead termination in the base pin.

G-E's contribution is the GL-5680, a three-electrode tube for use as a modulator, amplifier, and oscillator. In pulsed r.f. power amplifier service the tube delivers a peak power output of 90 kw at 15 kv under typical conditions. G-E's new kinescope is the 19AP4-C, similar to the 19AP4, but having an aluminized screen. This is the first large metal tube with this feature.



Suggested by Robert W. Gluckstein, Menominee Falls, Wis.

RADIO-ELECTRONICS for

AUTOMATIC MOTOR TUNING FOR RECEIVERS

Patent No. 2,506,869
 Roy A. Gull, Kenmore, N. Y.
 (assigned to Colonial Radio Corp.)

A motor controls the variable capacitors in this automatically tuned receiver. On depressing a button, the motor is started and tuning continues until a signal is intercepted. Due to inertia, the motor tends to coast for a few milliseconds after it is shut off, leaving the receiver detuned by several hundred cycles. This invention eliminates the error by disconnecting the motor just before a signal is correctly tuned in.

energized and its contact closed. Therefore M and RY1 continue to operate when switch PB is released.

A portion of the output from the i.f. amplifier is fed to limiter V1, and then to a crystal filter. The crystal is ground for a frequency slightly lower than the i.f. For example, a 454-kc crystal may be used if the i.f. is 455. This permits a signal to pass through the filter a few milliseconds before it is correctly tuned in

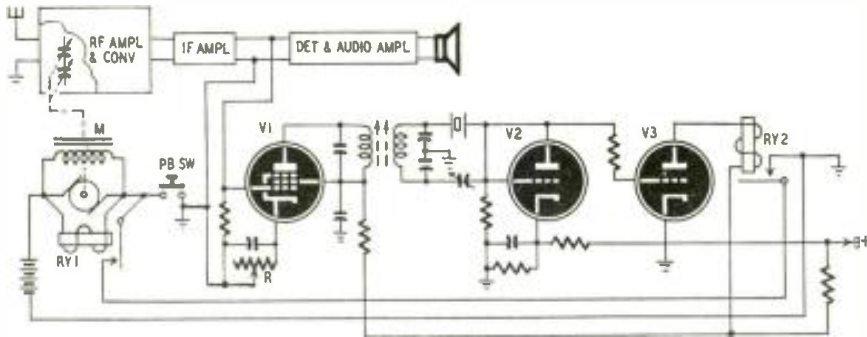

In a typical case the desired band is scanned from the low-frequency end to the upper end. Then the tuning capacitors are snapped back to the i.f. starting point. The broadcast band (535 to 1620 kc) may be scanned in about 5 seconds and the snapback time is about 0.1 second.

Referring to the figure, tuning starts when PB is depressed. This energizes motor M (which rotates the capacitors) and relay RY1 closes its contact. In the absence of signal RY2 is also

the receiver, due to the beat frequency on both sides of zero-beat. Output from the filter is rectified by V2, and the d.c. is sufficient to block V3. As RY2 releases, it opens the ground return to M and RY1 so these also release and scanning ceases.

M should be adjusted to coast just long enough to permit accurate tuning. If the crystal frequency is 1 kc below the i.f. and if the tuning rate is 200 kc/second, this would be equal to 5 milliseconds.

HUM ELIMINATOR FOR RESISTANCE PICKUPS

Patent No. 2,511,665
 Carroll R. Miner, Stratford, Conn.
 (assigned to General Electric Co.)

This circuit is for use with variable-resistance phonograph pickups. The advantage of these pickups is their simple construction, but they require a d.c. supply. If the supply is rectified a.c., the ripple may be objectionable. This invention eliminates this hum without an expensive filter.

The pickup has a metal stylus to which two resistance wires are connected. See part a of the diagram. The wires are wound around snubbing posts and terminate at spring arms. If the stylus is moved slowly, the wires merely wind themselves around the snubbers. When the stylus vibrates rapidly (as its needle follows the record grooves), the wires do not have time to move. Instead, they are alternately compressed and stretched. This changes their resistance and modulates the voltage across the wires.

The a.f. component which appears across transformer T may be amplified as required. This is shown in part b of the diagram.

To balance out hum, a potentiometer R is connected across T. R is adjusted so that equal ripple flows through both halves of the transformer primary. Since this flow is in opposite directions, the hum is cancelled out in the secondary.

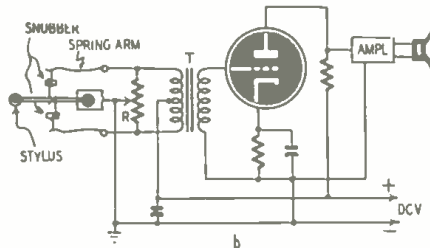
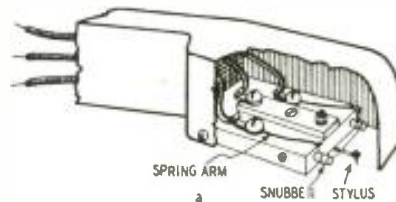

ACCURATE SMALL TIME INTERVAL MEASURING

Patent No. 2,511,868
 Earl G. Newsom, Dayton, Ohio
 (may be used by the Government of the U. S.
 without royalty payments)

A simplified circuit diagram is shown here for accurately measuring small intervals of time. For example, it may be used to measure the interval between a radar pulse and its echo.

A three-way switch is arranged to contact either

D, E, or F. In the first position a capacitor C is charged through a variable resistor R3. When set to E, the capacitor stops charging and its voltage may be compared with the potential across R1. In position F, the switch discharges C and the cycle may be repeated.

At the first pulse (which begins the timed interval) the switch contacts D and the capacitor charges. The voltage continues to rise until the second pulse arrives. This ends the timed interval. At this instant the switch contacts E. Now R1 may be adjusted until the v.t.v.m. shows zero. Then the capacitor voltage equals that across R1. The dial of R1 may be calibrated in microseconds if desired.

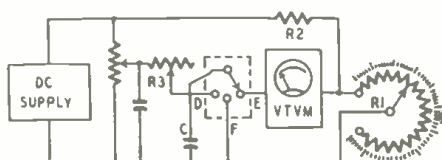

VEE-D-X

For all TV Reception and Installation Requirements

THE WORLD'S

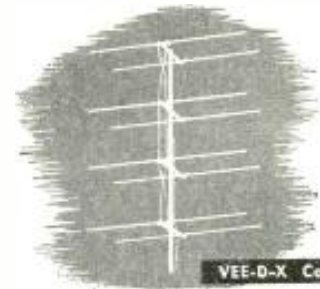

VEE-D-X Colinear

MOST POWERFUL



VEE-D-X Stacked Yagi

TV

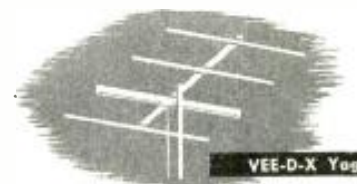

VEE-D-X Yagi

ANTENNAS

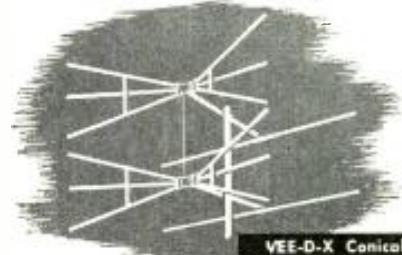

VEE-D-X Conical

LaPOINTE-PLASCOMOLD CORP. 1
 WINDSOR LOCKS, CONN.

Please send me new 1951 catalog of VEE-D-X antennas and accessories.

NAME _____
 STREET _____
 CITY _____ ZONE _____ STATE _____

Service-Dealers:

DO A
\$50,000
TV BUSINESS

ON A
\$500. INVESTMENT!

Get into the TELEVISION BUSINESS in a BIG WAY with the TRANSVISION FACTORY-AGENT PLAN!

YOU GET—

- **EXCLUSIVE TERRITORY**
- **SPECIAL PRICES** to undersell competition
- **NO INVENTORY**

You work from our MILLION-DOLLAR INVENTORY.

Requirements:

- You must be a Radio-TV Technician (experienced only).
- You must have a presentable location.

Write TODAY for complete FACTORY-AGENT PLAN, to—
TRANSVISION, INC.

Dept. RE, NEW ROCHELLE, N. Y.

FIELD STRENGTH METER

- A must for every TV Serviceman!
 - Saves 1/2 the work.
 - Improves installations.



NEW LOW PRICE
Model FSM-1, complete with tubes. Net \$79.50
All Transvision Prices are fair traded; subject to change without notice. Prices 5% higher west of the Mississippi.

TRANSVISION, INC.
Dept. RE NEW ROCHELLE, N. Y.

It is convenient to use a linear winding on R1 and to have a linear calibration on its dial. However, the voltage across C rises exponentially with time. To avoid a complicated taper for R1, a resistor R2 is added. Then the voltage across R1 rises almost exponentially with respect to its time calibration. For example, if the R1 dial is adjusted from one time value to another twice as large, its resistance is doubled; but current through it decreases so the new voltage drop across R1 is less than twice the original value. When R2 has the correct value, this change in voltage is very nearly exponential. A similar increase takes place on the capacitor C. If the time interval is doubled, the potential is less than twice as great.

In the actual instrument, the switch is replaced by two thyratrons. The first pulse fires one tube and begins the timed interval. The second pulse fires the second tube and blocks the first one so the capacitor stops charging. A motor controls a switch which discharges C and repeats the cycle.

VOLTAGE REGULATOR

Patent No. 2,501,263

Robert H. Cherry, Glenside and Albert J. Williams, Jr., Philadelphia, Pa. (assigned to Leeds & Northrup Co.)

Capable of excellent regulation, this circuit is not difficult to build. The output remains constant despite severe fluctuations of input voltage or output load.

R1 is a conventional tungsten lamp, of the 10-watt, 120-volt type. R2 is made up of VR tubes. A tapped resistor R3 is connected across E1.

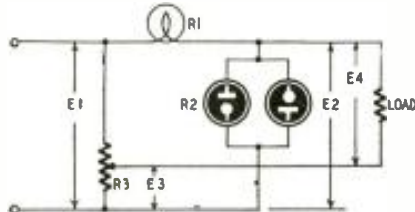

The circuit of the voltage regulator.

The three curves illustrate the regulation characteristics. E3 is the voltage across the tapped portion of the resistor. This voltage is proportional to E1 at all times. E2 is the voltage across R2. It shows some regulation but the voltage continues to rise as E1 increases. From the schematic note that E4 (the output) is the difference be-

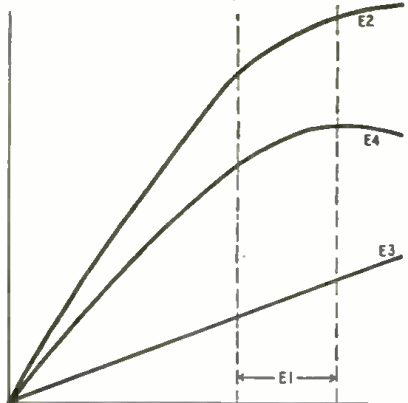

Curves showing the regulation action.

tween E2 and E3, or $E4 + E3 = E2$. When E4 is plotted, it is seen to be practically constant over some region of E1. R3 may be adjusted so that the concave portion of E4 is symmetrical over some desired range of input. In this way the output can be made to show less than 1% variation over this range.

Due to the opposing polarity of the VR tubes, this circuit is equally effective on d.c. or a.c.

TELEPHONE—RADIO COUPLING CIRCUIT

Patent No. 2,511,948

Twen S. Wang, New York City (assigned to Radio Corp of America)
A telephone circuit may be coupled without complicated apparatus to a radio circuit by means of this invention. A telephone line needs only two

7 HARD TO GET ITEMS AT BIG SAVINGS TO YOU

AMAZING BLACK LIGHT



250-watt ultra-violet light source. Makes fluorescent articles glow in the dark. Fits any lamp socket. For experimenting, entertaining, unusual lighting effects. Ship. wt. 2 lbs. ITEM NO. 87 A SAVING AT **\$2.45**

LITTLE GIANT MAGNET



Lightweight 4 oz. ALNICO permanent magnet. 1 1/4" x 1 1/2". Lifts more than 20 TIMES ITS OWN WEIGHT! Ideal for hobbyists, experimenters. Shipping weight 3/4 lbs. ITEM NO. 150 BIG VALUE AT **\$1.50**

POWERFUL ALL PURPOSE MOTOR



Sturdy shodded Dale A.C. induction motor. 15 watts, 3000 rpm. 3"x2"x1 3/4". 4 mounting studs; 7/8" shaft, 3/16" diameter; 110-120 volts. 50-60 cycles. A.C. only. When geared down, this unit can operate on 18" turntable with a 200 lb. dead weight. Use it for fans, displays, timers and many other practical purposes. Ship. wt. 2 lbs. ITEM NO. 147 UNUSUAL BUY **\$2.45**

WATTHOUR METER



Leading makes — completely overhauled, ready for service 100-110 volts, 60 cycles, 2-wire A.C. 5 amp. Heavy metal case 8 1/2" x 6 1/4" x 5". Easy to install. Shipping weight 14 lbs. ITEM NO. 33 NOW ONLY **\$4.50**

WESTERN ELECTRIC BREAST MIKE



Lightweight 1 lb. carbon microphone. Aircraft type. Breastplate mounting, adjustable 2-way swivel. Easily fastened straps. For home broadcasts, communications etc. Complete with 6 foot cord, hard rubber plug. Sheradized plate, non-rusting finish. Ship. wt. 2 lbs. ITEM NO. 152 NEW LOW PRICE **\$1.10**

TELEPHONE TRANSMITTERS



Genuine transmitters made by Kellogg, Western Electric, Stromberg Carlson. Work on two dry cells for P.A. systems, intercoms, other practical uses. Shipping weight 1 lb. ITEM 160 REAL VALUE **\$2.45**

250 POWER TELESCOPE LENS KIT

Make your own high powered 6 ft. telescope! Kit contains 3" diam., 75" focal length, ground and polished objective lens and necessary eye pieces. Magnifies 50x to 250x. Full instructions. Ship. wt. 1 lb. ITEM NO. 123 YOU SAVE AT **\$2.95**

HUDSON SPECIALTIES CO.
40 West Broadway, Dept. RE-12-50
New York 7, N. Y.

I am enclosing full remittance for items circled below. SHIPPING charges included.
OR, my deposit of \$..... Ship balance C.O.D.
MINIMUM C.O.D. ORDER \$5.00.
C.O.D. ORDERS ACCEPTED ONLY WITH 20% DEPOSIT
INCLUDE SHIPPING CHARGES.
Circle items wanted

87 150 147 33 152 160 123
Name..... Please Print Clearly.....
Address.....
City..... Zone..... State.....

wires along which messages pass in both directions. In radio, however, the transmitter and receiver are entirely separate units. If the receiver output is permitted to flow back into the transmitter input, feedback problems may appear. The telephone line must be coupled to both the radio receiver and the transmitter. At the same time the radio receiver and transmitter channels must be isolated from each other.

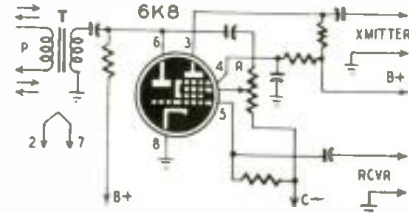

The figure shows a 6K8 tube. The signal from the radio receiver is applied to both control grids. The triode output is connected to transformer T which couples to the phone line P. A signal which originates in P is passed through the transformer to the screen-grid of the hexode. From here the signal flows into the radio transmitter line. Thus P is coupled both to the receiver and transmitter.

One portion of the signal from the receiver is amplified by the hexode and it appears across the transmitter line. Another portion is amplified by the triode and coupled to the screen grid of the hexode. Since the screen grid signal has passed through a triode stage, it is 180° out of phase with the signal on the control grid. When R is correctly adjusted, these signals produce equal and opposite components of plate current. The result is complete balance, and the receiver is effectively isolated from the transmitter.

U.H.F. TUNING

Patent No. 2,511,586

Merle R. Hubbard, Cedar Rapids, Iowa.
(assigned to Collins Radio Co.)

Inductance and capacitance are tuned by this system simultaneously to get a more constant Q over a wide range. The inductor is a transmission line. The capacitor is of the conventional variable type.

In the model illustrated here, C is the variable capacitor. It shunts the transmission line conductors marked T. The shorter line is fixed to an insulated shaft S and is carried around with it. This conductor ends in a brush contact which slides around the metal ring R. Therefore the conductors T are shorted at this end.

As the knob is rotated the capacitance is varied. Simultaneously the spacing between conductors T is varied to change their inductance. Each conductor should be less than one quarter-wave in length and preferably silver-plated.

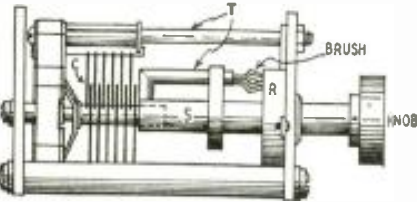

TELEPHONE WIRE

Sensational purchase means new low prices!
Telephone Handsets: TS-13, TS-15, TS-9, . . . \$5.95 ea.
Sound Powered Handsets: 12.50 ea. 24.50 pr.
This is Genuine W110B Army Field Wire. It comes to you on original steel reels, 2-conductor, twisted pair. Each conductor has 3 copper, 4 steel strands for extra tensile strength. Rubber insulated. Impregnated fabric outer covering.

- NEW, unused, excellent condition—per Mile (Wt. 160 lbs.) . . . \$16.00
- 1/2 Mile (Wt. 80 lbs.) . . . \$8.25
- NEW, unused, good serviceable condition—per Mile . . . \$12.50
- 1/2 Mile . . . \$6.75

Excellent for all-weather, all-purpose communication. Used extensively by telephone companies, industry, engineering projects, ranches, etc., for extended field communication systems.
NEW W130 Lightweight Assault Wire
1/2 mile reels (2600 ft.) wt. 16 lbs. . . . \$9.95
1/4 mile reels, wt. 9 lbs. . . . 4.95
All prices FOB Sacramento. No COD. (California residents add 5% for sales tax.)
Send check or money order to

LORIS SALES
P. O. Box 1898-RE-12, Sacramento, Calif.

PRESENT STOCKS WILL BE SHIPPED AT THESE LOW PRICES UNTIL EXHAUSTED!

SPEAKERS

Alnico V Magnets Fresh Stock!

Size	Weight	Price	Quantity
3 1/2" P.M.	.68 oz.	\$1.00	5 Asst. Lots of .94
4" P.M.	.68 oz.	1.00	.94
4" P.M.	1 oz.	1.10	1.04
4" P.M.	1.47 oz.	1.15	1.09
4x6" P.M.	1 oz.	1.64	1.54
5" P.M.	.68 oz.	.97	.94
5" P.M.	1 oz.	1.03	.98
5" P.M.	1.47 oz.	1.13	1.09
6" P.M.	1 oz.	1.43	1.37
6" P.M.	1.47 oz.	1.55	1.47
10" P.M.	6.8 oz.	3.74	3.64
12" P.M.	4.64 oz.	4.80	4.55

3-TUBE ALUMINUM CHASSIS
Prices Slashed!



24c ea.

With sockets for 6T type tubes mounted. Sockets partially wired.

PILOT LIGHTS

Lamp No.	Price	Quantity
48	55c	10 in a Ctn.
42	56c	
44	55c	
46	55c	
47	55c	

WIREWOUND RESISTORS
10 W., 4,000 ohms ea. 25c
20 W., 250 ohms ea. 25c

PORTABLE AMPLIFIER CASE
Priced For Quick Sale!



Front View

Case: 3/4" plywood construction. Cut out for 12" speaker.
Dimensions: 18 1/2" long x 9 1/2" deep x 2 1/4" high.
Covering: Two-tone black and cream leatherette, slightly soiled.
Hardware: large non-rattle carrying handle with 4 metal dome feet.



Back View

\$7.95 Complete

ADDED FREE: Blank 3-tube chassis that fits perfectly!

ELECTROLYTIC TUBULAR CONDENSERS
Fresh Stock! With mounting strap. CD Type EDL.
20 x 20 150 V. 39c ea.
40 x 40 150 V.
50 x 30 150 V.

ANTENNA LOOP
Low priced for rapid turnover! Four-terminal, for AC/DC, battery, portables and small receivers. Extra powerful. Recommended for use instead of antenna coil.
Grab'em for **17c** ea.

3-TUBE CHASSIS
Deluxe model has 3 sockets and 1 4-lug terminal strip mounted. Sockets partially wired. Front panel slightly scratched.
39c Complete

PORTABLE CASE: 2 tone brown leatherette with speaker compartment made to fit this chassis. **\$1.95**

CORNISH WIRE: Curlic or No Flame. Stranded #22 hook-up. White with tracer. 1,000 ft. on reel. \$3.99
IRON CORE RESISTORS: Insulated, 30 ohms. 1/2 Watt. Type RV. Only 9c ea.
BAKELITE KNOBS: Black skirt type with finger-rip knob. Similar to Davies Moulding Co. #4103. 1 1/2" shaft, 1 1/8" wide, 1 1/4" skirt diameter. ea. 8c
POINTERS: 1 1/2" knobs, bar type, black knob. ea. 29c
ELECTROLYTIC BEAVER CONDENSERS: 8 mid. @ 450 V. Short leads. ea. 29c
MAGNET CONTACT PICKUPS FOR MUSICAL INSTRUMENTS: Model MM. With built in volume control and 20 ft. cable. Mfrd. by Turoer. Complete for only **\$9.95**

SLUG TUNERS: Complete with dial face and pointer. Takes place of variable condenser. ea. 39c
CATHODE CONDENSERS: 25 mid. 25 V.W., 40 V.P. Short leads. ea. 15c
MIDJY SINGLE OPEN CIRCUIT JACK: Tinned lugs. ea. 29c
BUSH CRYSTAL PHONE: (Single Unit) 60-10,000 CPS, high impedance. Also be used as mike. Includes shielded 4 ft. cord. \$2.99
F.P. CONDENSERS: 10, 10, 10, mid. @ 450 V., 20 mid. @ 25 V. ea. 39c
CRYSTAL CARTRIDGES: Astatic Nylon 11. ea. \$2.29
Weather N:10 new dating, exact fit. Placement for L82A & L72 ea. \$1.99

5-TUBE AMPLIFIER CHASSIS
Sturdy durable metal—all holes punched; 13 1/2" wide x 6" deep x 3 1/4" high. 2 for 55c
Buy Many, Save Plenty! 10 for \$2.50

AC LINE CORDS
6 ft. Molded bakelite plug **10c** ea.
7 ft. Molded bakelite plug **14c** ea.

Down Go Meter Prices!
WESTINGHOUSE: 10" Round, 0 to 600 and 0 to 15 DC Volts. 100 microamp movement. \$2.95
TRIPLET: 1" sq. 0 to 40 V. DC. SUN: 2" Round, 0 to 300 V. DC. SWEDGAL's Lower Price: ea. \$2.49

SWEDGAL Shaves Price Down on JEWEL LIGHTS
Miniature bayonet socket. Green Jewel; includes 2 fibre washers which compensate for panel thickness. 15/16" mounting hole. Easy to mount requires little space. One lug rounded and one tinned. Length: 1-9/16". Complete for **34c**

MICAS TOGGLE SWITCH
200 MMF/.0002 Mfd., long shank. Hat handle. **21c**
size 1/2" x 1/4" SPNT.
Down to 6c ea

IF TRANSFORMERS
Precision Wound Radio Coils. Medium size 450 KC. Input or Output ea. 35c
Midget Iron Core 456 KC. Input or Output. ea. 48c

3-SPEED PHONO MOTOR
Popular Brand
110 V. AC. 60 Cycles. Needs: 33 1/4, 45 & 78 R.P.M. With turntable. **\$4.75**
Complete for only

ELECTRO-VOICE DYNAMIC MICROPHONE #615
Complete with cable, desk stand and adaptor for floor stand. **\$4.95**
Complete only

Heavy Gauge—All Metal TOOL KIT
Reinforced handles on both ends. Base for lock, card holder in lid for index. Handsome gray finish. 12 1/2" wide x 8 1/4" high x 6 1/4" deep. Brand new! **99c** ea.

Minimum Order: \$5.00.
25% deposit on C.O.D.'s.
All prices F.O.B. New York, N. Y. Write for Complete listings today!

VOLUME CONTROLS
Standard Brands, with switch and long shaft.

10,000 ohms	100,000	500,000	33c
25,000	250,000	1 megohm	ea.
50,000	350,000	2 megohms	
Less switch, with short shaft			
ohms			
25,000	200,000	1 megohm	12c
50,000	250,000	2 megohms	
100,000	500,000	5 megohms	ea.

PAPER TUBULAR CONDENSERS Short Leads
mfd. Volts. Ea.
.015 @ 200 4c
.02 @ 800 6c
.01 @ 600 8c
.005 @ 600 8c
.1 @ 400 5c
.025 @ 400 5c
.02 @ 400 5c

3-TUBE PHONO AMPLIFIER
110 V., AC. 60 Cycles. Full range tone & vol. controls with "on" and "off" switches. Complete wiring. ADDED FREE: 3 round brass dial plates marked "Volume" & "Tone". (1000000) **\$2.25**

OUTPUT TRANSFORMERS
305 13V4 P.P. 8P6 P.P. **59c**
45 P.P. 43 P.P. 6K6 P.P.
184 P.P. 25A P.P. 6V6 P.P. each
384 P.P.
6V6 55c
50L6 44c
8L6 69c
25L6 P.P. **49c**
35L6 P.P.
50L6 P.P. each

6V6 Push Pull 15 Watts
Secondary taps 4, 8, 15, 250 & 500 ohms. Fully shielded. **\$1.49** ea.

POWER TRANSFORMERS 60A:
#F1043-1, Pri. 115 V. @ 230 V. Sec. 5V. @ 3 A. 800 V. CT @ 300 MA. Bias tap 55 V. ea. \$9.95
POWER TRANSFORMERS 2A-12:
Pri. 115 V. AC. Sec. 5 V. @ 2 A., 6.3 V. CT @ 2.5 A., 800 V. CT @ 120 MA. ea. \$6.95
POWER TRANSFORMERS: #F74-1, C & L, Pri. 115 V. Sec. 6.3 V., CT @ 2 A., 580 V. CT @ 750 MA. ea. \$3.95
POWER TRANSFORMERS: 350 V., CT @ 50 MA. Filament Voltage 5 V., @ 2A. ea. 9c
ISOLATION TRANSFORMERS: With 6 V. heater winding. 115 V. pri. 250 V. @ 60 MA., 6.3 V. @ 2 amp. ea. 69c

AUTOTRANSFORMERS
117 V. AC
(Can also be hooked up to deliver screen bias V. → 0 V., 4.5 V., (taper control ratings). **59c**

OUTPUT TRANSFORMERS: #F30-1, 200 W. P.P., #11 to 125 ohms or 500 ohms. Pri. 12, 400 ohms. @ 117 V. Dual sec. 125 ohms. ea. \$9.95
OUTPUT TRANSFORMERS 60 W.: #17-1, P.P. Parallel 8L6's @ 500 250, 15, 8, 4 ohms. ea. \$4.95
OUTPUT TRANSFORMERS: #F215-1, Pri. 8,000 ohms P. to 60 MA. DC det section Sec. 250, 60, 15, 7.5, 4 ohms. ea. \$3.95
FILAMENT TRANSFORMERS 2A W.: #F126-1, 10,000 V. insulation on 5 V. winding. Pri. 115 V. AC. Sec. 6.3 V. @ 10 A., 5 V. @ 2 A. ea. \$3.95
DRIVER TRANSFORMERS: #F310-1, 1/4 OSN 7 to P.P. Parallel grids (1.6). Pri. 10 1/2, Sec. 1, 42, ea. \$4.25
DRIVER TRANSFORMERS: #F10-2, 6V6 to PP. #11, Pri. to 1/2 Sec. 1, 42, ea. \$3.95
DRIVER TRANSFORMERS: #10-6, Turns ratio Pri. to 1/2 Sec. 1, 7 1/2, 4, 2, ea. \$2.95
6 V. VIBRATOR POWER TRANSFORMERS: #260-2, Sec. 700 V. CT Will supply 350 V. DC with vibrator and filter. ea. \$4.95
VIBRATOR POWER TRANSFORMERS: #F60-3, Input 6V. DC. Output 117 V. AC. ea. \$1.95
SWINGING CHOKE 200 W.: #F74-7, 125 ohms, 5.25 HV, 300 MA. ea. \$4.95
FILTER REACTOR: #F87-2, 7 H. 25 MA. ea. 88c

7-TERMINAL STRIP 9c ea.
No markings on strip! Save a dime. Order 10 for 80c!

VOLT-OHM MILLIAMMETER
POCKET-SIZE
3" Square meter—1 ml D'Arsenval type meter 2% accurate. 3 AC Current Ranges, Round cornered, bakelite, molded case. Same zero adjustment for both resistance ranges. SPEC'S: 3 AC Voltage ranges: 0-12, 120, 600/1200 OHMΩ. 3 DC Voltage ranges: 0-6, 60, 300 600 3000 V. 4 DC Current ranges: 0-6, 3, 120, 12.4 amp. 3 AC Current Ranges: 0-10/150 600 ma. 2 Resistance ranges: 0-1000 ohms 1 megohm. Complete with batteries. **\$13.90** & instructions.

SWEDGAL RADIO, INC.
96 Warren St., Dept. E-10 New York 7, N. Y. Cortland 7-6753

Beat the Tube Shortage!

This Sensational New RIDER Book Shows You HOW to Do It!

RECEIVING TUBE SUBSTITUTION GUIDE BOOK

by H. A. Middleton

For AM-FM-TV Receivers and Allied Equipment!



URGENT! Receiving tubes are very scarce... and will get scarcer. There is a wide scramble for every type of tube, and you can't always get what you need. What can you do when you can't find a tube replacement? How can you get a set working again? How can you substitute one tube for another?

HERE!

HERE Are The Answers To All Tube Problems!

- 2500 Radia And TV Tube Substitutions Are Listed!
- TV Receiver Filament Wiring!
- Heater Substitution Wiring Instructions!
- Tube Types Classified By Functions!
- And A Wealth Of Other Priceless Data!

Here the serviceman will find 2500 radio and TV tube types systematically listed in numerical sequence with accompanying wiring instructions for making the substitutions. There are views of original and substitute tube sockets, and clear explanations for whatever changes may be necessary. In this, one of the most important servicing books ever published, and certainly a most timely one right now, the serviceman will find the way to turn out jobs that would otherwise remain on the shelf because of lack of proper tubes.

EXTRA! EXTRA! In addition to tube information... this sensational book contains material on Cathode-Ray Tube Characteristics, Complete Tube Characteristics Chart, Ballast Tube Data, Pilot Light Information, Resistors—Capacitors—Transformer Color Codes, Transformer Substitution, Fixed Condenser Substitution, and Converting Farm Radio for Electrified Operation.

208 Pages in Heavy Durable Paper Cover. 8 1/2 x 11 inches. Only **\$2.40**

10 DAY MONEY BACK GUARANTEE
 Make this book **PROVE** its value!
 Unless you agree that it is the best investment you've ever made—return it, and we will refund your money.

Rush This Coupon Today

JOHN F. RIDER PUBLISHER, INC.
 480 Canal Street, New York 13, N.Y.

Please send me..... copies of "RECEIVING TUBE SUBSTITUTION GUIDE BOOK" at \$2.40 per copy. I am enclosing check money-order in the amount of \$..... If, within 10 days, I am not satisfied—I will return the book(s) in good condition, for refund.

Name.....
 Address.....
 City..... Zone..... State.....

PORTABLE ELECTRONIC INSULATION TESTER

Most portable megohmmeters have a hard-driven high-voltage generator which develops the potential required for the test. Such instruments are bulky and rather impractical in some applications.

An electronic megohmmeter which can be constructed compactly is described in patent No. 2,510,691 issued to R. W. Gilbert. The instrument has a logarithmic scale calibrated from 100,000 ohms to 10,000 megohms. The circuit is shown.

The cathode current of the 1LH4 flows through cathode resistors R1 and R2. The plate voltage is equal to the battery voltage minus the drop across the resistors. Therefore, the plate voltage varies inversely as the cathode current. In a high-mu triode like this one, the grid voltage is low compared to the other elements so the grid-to-plate voltage follows closely the plate-to-cathode voltage. The voltage applied

to the resistance under test is inversely proportional to the cathode current. Thus, the applied voltage is zero for zero resistance, half the battery voltage for center-scale resistance, and full

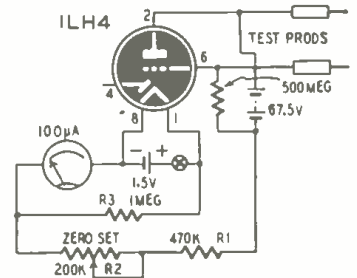

battery voltage for infinite resistance. Plate current falls because of reduced plate voltage but the cathode current continues to increase logarithmically because the grid current increases as the plate current decreases.

BASS ATTENUATION IMPROVES SPEECH

Radiotelephone engineers and amateurs have long realized that frequencies outside the range of 300 to 2,500 cycles contribute little or nothing to the intelligibility of transmitted speech. When signals are received with the aid of a crystal filter or other circuits which reduce the high-frequency side-

speech easier to read through crystal filters and Q5'ers are described by G2TA in *Short Wave Magazine*. The circuit modifications consist of inserting a switch which cuts out the normal coupling capacitors and replaces them with units having one-tenth the capacitance.

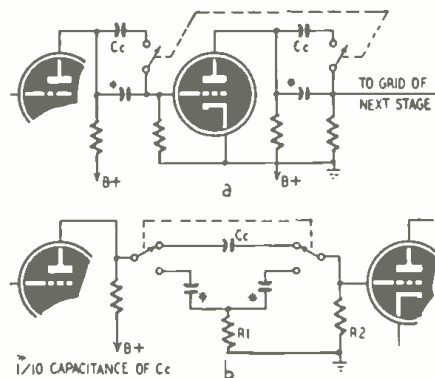

bands, speech is often boomy and difficult to read because of the apparent bass boost.

Circuit modifications which attenuate frequencies below 300 cycles and make

The circuit at a in the drawing is for receivers having two R-C coupling networks. Capacitors Cc are the normal coupling units. When there is only one resistance-coupled circuit in the amplifier, use the circuit at b. In this case, a high-pass filter consisting of two small capacitors and a resistor is switched into the circuit. R1 should equal R2, the normal grid resistor.

Some amateurs can increase the "talk power" of their phone transmitters by installing these bass-cutting circuits in their speech equipment. Because most of the modulating power of a wide-range a.f. system is in the low frequencies, these determine the maximum or 100% modulation point. When frequencies below 300 cycles are removed, the modulation level is determined by the intelligence-bearing frequencies.

UNUSUAL FEEDBACK CIRCUIT IN 50-WATT AMPLIFIER

In most circuits where inverse feedback is applied to a single transformer-coupled stage, the driver transformer has balanced secondary windings to insure proper operation.

In this circuit used in the Omega 50-watt amplifier described in *Toute La Radio* (Paris, France), the transformer does not require balanced secondaries or even a center tap on the single secondary. Instead, two 220,000-ohm resistors are connected across the secondary and grounded at their junction. Feedback voltage is fed from plates to grids through R-C networks.

Core saturation in the driver transformer is eliminated by employing resistance-capacitance coupling between the plate of the 6V6 and the primary.

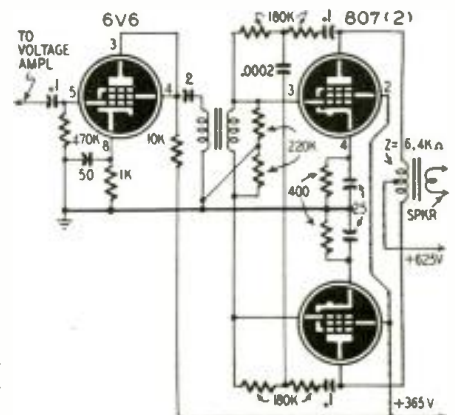

UTILITY TESTER

Designed for high- and low-voltage continuity testing, measuring a.c. power consumption, and checking capacitors, this instrument is a useful addition to a radio service test bench.

When the selector switch is in position 1, 117 volts a.c. is fed to the primary of an 18-volt filament transformer having a 12-volt tap—you can probably find one at your favorite surplus outlet. Six, 12, or 18 volts can be taken directly from the transformer.

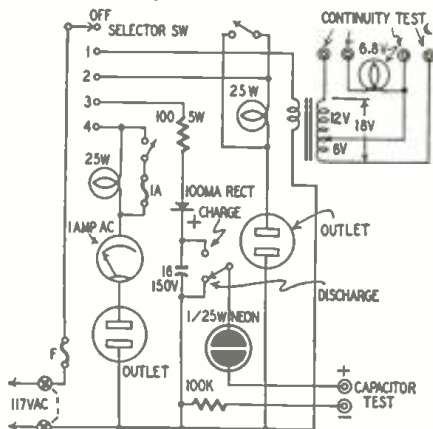

A 6-8-volt pilot lamp is in series with one side of the 12- and 6-volt windings for low-voltage continuity tests and for checking 6-volt heaters, pilot lamps, and filaments.

Throwing the selector to position 2 applies voltage to a 117-volt receptacle which has a 25-watt lamp and bypass switch in series for short testing.

Position 3 is for testing capacitors by the familiar charge-and-discharge method. The 100-ma selenium rectifier supplies d.c. for the capacitor test, and an s.p.d.t. switch is used to charge and discharge the capacitor. The neon lamp serves as indicator.

Position 4 places a 25-watt lamp, fused bypass switch, and 1-ampere a.c. meter in series with a second 117-volt outlet for measuring power drain. The initial test is made with the bypass switch closed so the lamp will limit the current in the event that the device being tested is shorted.—Wm. R. Blaylock

ALMO SPOTLIGHT SPECIAL

THE "HIGH-TONE" PORTABLE P-TX

- 3 section telescopic dipoles
- All channel
- All way orientation
- Admiralty Brass Staffs
- Heavy Cast Base
- Walnut crackle finish
- Complete with cable

10% Cash With Orders

ALMO RADIO CO.
 309 ARCH STREET • Philadelphia
 6205 MARKET STREET • West Phila.
 6th & ORANGE STS. • Wilmington
 4401 VENTNOR AVE. • Atlantic City

WOULD YOU SEND \$1.50 TO GET \$9.50 ?

Well, here's even more for your money!

For only \$1.50, you get —

Your own personal copy of the world famous Radio's Master Buyers Guide, priced by the publishers at — **\$5.50**

AND Four Credit Slips, each worth \$1.00 on orders of \$5 or more **4.00**

PLUS All you can save with this book and Harrison's low prices! **\$\$.\$**

Total Value — Over \$9.50

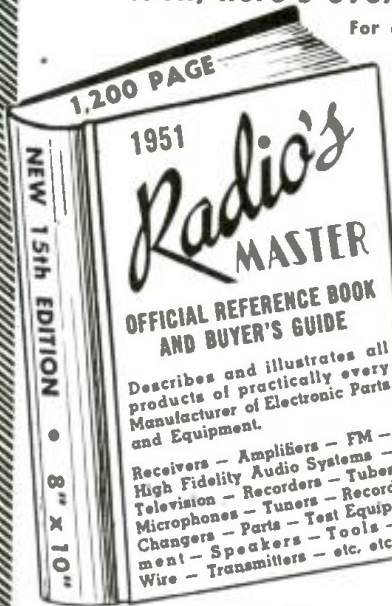

Describes and illustrates all products of practically every Manufacturer of Electronic Parts and Equipment.

- Receivers — Amplifiers — FM — High Fidelity Audio Systems — Television — Recorders — Tubes — Microphones — Tuners — Record Changers — Parts — Test Equipment — Speakers — Tools — Wire — Transmitters — etc. etc!

YOU'VE undoubtedly seen previous editions of this indispensable book at the right hand of important Engineers and busy Purchasing Agents. Now, here is your opportunity to put it to work for you — to save you real money and time in your purchases of Radio-Electronic equipment and parts.

AND, who alone brings you this sensational offer? — HARRISON RADIO, of course! Your Quality source of supply since 1925! As Authorized Factory Distributor for all leading Manufacturers, we give you fast and dependable store and Mail Order service! And we guarantee our prices to be the lowest obtainable anywhere!

Our reputation for integrity is your assurance of complete satisfaction.

List prices have **SECRET TRADE DISCOUNT CODE** to enable you to resell at a substantial profit!

YOUR MONEY BACK if you don't agree that this is the biggest bargain you have ever seen!

CLIP and MAIL NOW

HARRISON RADIO CORP.,
 225 Greenwich St., New York 7, N. Y.

Mail me, postpaid, the new Radio's Master, discount code, and those four \$1 vouchers, with 10 day return for refund privilege. Here's my \$1.50

Name _____

Address _____



WHIP ANTENNA—MAST BASES, INSULATED:

MP-132—1" heavy coil spring, 2" insulator. Overall length: 11 1/2". Wt. 2 1/2 lbs. Price . . . \$3.95

MP-22—Spring action direction of bracket. 4" x 8" mounting. Price . . . \$2.95

MAST SECTIONS FOR ABOVE BASES:
 Tubular steel, copper coated, painted, 3 foot sections, screw-in type. MS-53 can be used to make any length. MS-52-51-50 49 for taper. Any section . . . 50¢ Ea.
 Sections MS-54 or MS-55 (larger than MS-53) 75¢ Ea.
 BAG BG-56 /carrying 5 mast sections.50¢

MARK II TRANSMITTER & RECEIVER

Ideal for mobile or stationary use. 15 Tube Set transmits and receives 2 to 8 MC. Phone, CW and MW. 25 Watt Master Oscillator Control. Transmits and receives 240 MC. Phone. Also an intercommunicating set. Comes complete with 15 Tubes, Headset, Micro. Antennas, Control Box 12/24 Volt Power Supply, and instructions—ready to operate. Set size: 27"x10"x13 1/4". Price USED (TERRESTRIAL) . . . \$29.50 Available—All Parts and Accessories for Mark II Sets.

BC-223 TRANSMITTER and SPARE PARTS

30 Watt Transmitter with crystal or Mo control on four pre-selected channels. 2000 to 5250 KC. by use of three plug-in coils. Five Tubes: two 80L & \$23.50

OPERATING MANUAL for BC-223 . . . \$2.00

SPARE TUBE KIT for BC-223—Contains 5 spare tubes in metal box. Price . . . \$4.95

TUNING UNITS: TU-17—2 to 3 MC.; TU-18—3 to 4.5 MC.; TU-25—4.5 to 5.2 MC. NEW: \$3.50 Ea. USED: \$2.50 Ea.

PE-125 VIBRATOR POWER SUPPLY for BC-223 Transmitter. 12/24 Volt input; output 500 Volt 150 MA. Price . . . NEW: \$9.95

SHOCK MOUNTING for PE-125 . . . 1.50

SPARE VIBRATOR & TUBE KIT. For PE-125—Contains 2 spare tubes, 2 spare vibrators and fuses in metal box. Price . . . \$4.95

CABLE only—Transmitter to Power Supply . . . 1.75

BLOWER 115 Volt 60 cycle Blower, approx. 100 Cubic Ft. Dis. 3 1/2" Intake, 2" outlet. Motor size: 3 1/2" x 3". 1525 R.P.M. Complete with mounting bracket. Govt. surplus. Brand New and Boxed. Order **\$7.95** No. RE-3604

FAN OR BLOWER MOTOR—110 Volts, 1550 RPM Motor size: 3" x 3". Shaft size: 3/16" x 1" . . . \$3.95

AC ELECTRIC MOTOR—110 V. 60 cycle ball bearing motor, approx. 3500 R.P.M. 1/25 HP. Shaft size: 3/16" x 1/2". Motor size: 7" x 4". Ideal for models, fans, etc. Converted from Govt. surplus. Only . . . \$3.00

Address Dept. RE • Prices F.O.B., Lima, Ohio • 25% Deposit on C.O.D.'s • Minimum Order \$2.00

COMMAND RECEIVERS AND TRANSMITTERS:

	USED:	NEW:
BC-1206C Receiver—200-400 KC.	\$ 5.95	
BC-458 Receiver—190-550 KC.	61.95	
BC-454 Receiver—3 to 6 MC.	5.95	
BC-455 Receiver—6 to 9.1 MC.	6.95	6.95
BC-457 Transmitter—4 to 5.3 MC.	5.95	8.95
BC-458 Transmitters—5.3 to 7 MC.	5.95	8.95
BC-459 Transmitter—7 to 9 MC.	14.95	24.95
BC-696 Transmitter—3 to 4 MC.	14.95	24.95
T-23/ARC-5 Transmitter—100 to 156 MC.		29.50



3/4 RPM ANTENNA ROTATOR MOTOR

High torque, reversible motor —operates directly from 110 Volt 60 cycle by use of condenser. Light weight, quiet running, ruggedly built, positive stop, easily mounted. Normally operates from 110 V. 400 cycle. Complete, with instructions New: \$4.95

10 MFD 400 Volt Cond., \$1.00; SPST Momentary Switch, 35¢; DPDT Momentary Switch, 75¢; Resistor, 100 ohm 25 Watt 50¢; 4 Wire Cable, 5¢ per Ft. COMPLETE KIT OF PARTS: Motor, Cond., SPST Switch, and Resistor \$6.50

DYNAMOTORS:

INPUT:	OUTPUT:	STOCK NO.	PRICE
9 V. DC	450 V., 60 MA.	DM-9450	
@ 6 V. DC	275 V., 50 MA.	w/Blower	\$3.95
12 or 24 V. DC	410 V., 200 MA.		
	220 V., 100 MA.	D-104	9.95
12 V. DC	600 V., 300 MA.	BD-86	7.95
12 V. DC	350 V., 150 MA.	BD-87	5.95
12 V. DC	375 V., 150 MA.	BD-83	6.95
12 V. DC	1000 V., 300 MA.	BD-77	7.95
12 or 24 V. DC	275 V., 110 MA.	USA/0516	3.95
12 or 24 V. DC	500 V., 50 MA.	USA/0515	2.95
@ 6 V. DC	240 V., 50 MA.		

BC-645-A TRANSCIEVER

15 Tube Transceiver, ideal for conversion to 460 MC. Citizens Band. Frequency coverage 435 to 500 MC. With conversion instructions—New and Boxed. BC-645-A **\$14.95**

TRANSFORMERS—110 Volt 60 cycle Primaries:

Sec. 24 V., 1 amp.	\$1.95	Sec. 21 V., .5 amp.	\$1.50
Sec. 36 V., 2.5 amps	2.95	Sec. 24 V., 4 1/2 amps.	3.95

FAIR RADIO SALES 132 SOUTH MAIN ST. LIMA, OHIO

SOLVE your hi-fidelity problems with **University TWEETERS**
WIDEST SELECTION • BEST VALUE • HIGHEST QUALITY
SINGLE UNIT TWEETERS

MODELS 4408, 4409—600 CYCLE TWEETERS: Recommended for highest quality reproduction systems requiring a low crossover frequency. Cobra shaped horn results in perfect wide angle distribution. Frequency response 600 to 15,000 cycles. Model 4408 handles 6 watts and 4409 25 watts.



MODEL 4407 ADAPTER MOUNTS 4401 TWEETER IN ANY 12" CONE UNIT: Converts any 12" cone speaker into a wide-range coaxial reproducer in a few minutes. Installation is extremely simple and results in a dual speaker occupying 1/10 the more space than the original cone speaker. Complete with 4401 tweeter.



MODEL 4401—2000 CYCLE TWEETER: An economical 6 watt unit for converting any good 10-15" cone speaker for extended response to 15,000 cycles. Wide Angle horn, compact design and low price bring excellent high fidelity well within the popular price range.



DUAL TWEETERS



MODEL 4402, MODEL 4404: Model 4402 reproduces to 15,000 cycles. Crossover at 2000 cps. Horizontal dispersion 100°, Vertical 50°. Handles 12 watts. Compact design mounts in any radio, phono, or speaker cabinet. Model 4404 incorporates 4402 tweeter in handsome walnut cabinet complete with high-pass filter and high frequency volume control. Any one can install.

CROSSOVER NETWORKS



MODEL 4405 HIGH PASS FILTER: An effective and economical unit for preventing lows reaching the tweeter unit. Contains high frequency control to balance highs and lows. Cutoff frequency 2000 cycles.

MODEL 4410, 4420 LC CROSSOVER NETWORK: Genuine LC frequency dividers for segregating highs and lows. Not to be confused with ordinary high-pass filters. Crossover frequencies: Model 4410 600 cycles, Model 4420 2000 cycles. Attenuator controls included and wired.

Write today for illustrated literature—address inquiries to Department D

University LOUDSPEAKERS • INC

80 SO. KENSICO AV., WHITE PLAINS, N.Y.

HI-FI AMPLIFIER FOR RECORDING AND PLAYBACK

I have a disc recorder and playback unit manufactured by General Industries Co. Please show a diagram of an amplifier using push-pull 6V6's which I may use with this unit. Also show how the speaker level can be reduced for monitoring the recordings.

three common values of output and voice-coil impedances when using a crystal cutter. Values given in the speaker-level columns of the tables are in decibels below the recording level. Values given in the tables were supplied by General Industries Co.

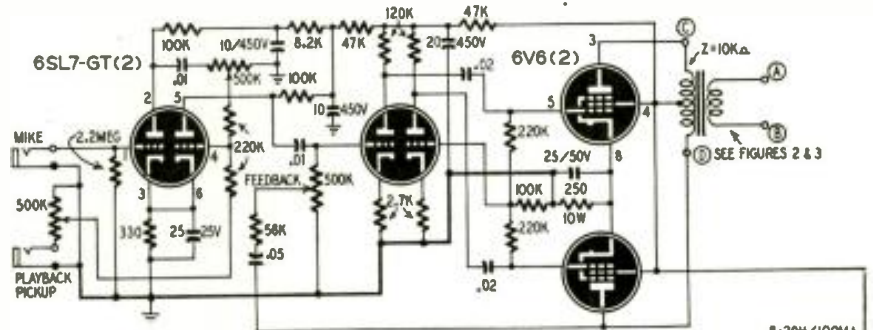
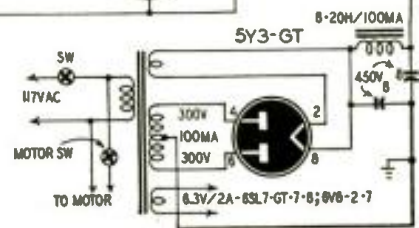

Fig. 1—A 10-watt recording amplifier.

Is a volume-level indicator necessary? If so, what type shall I use?—M. V., Chicago, Ill.

A. The amplifier circuit is shown in Fig. 1. Inverse feedback has been included to improve the performance of the push-pull pentodes. Adjust the 500,000-ohm feedback control to the point which gives the minimum acceptable output level when the microphone and phono volume controls are at maximum.

Not knowing which type of cutter you have, connections for magnetic and crystal types are shown in Figs. 2 and



A volume-level indicator is recommended in the interest of good recordings. The level indicator for a magnetic cutter may be a 1-ma d.c. meter having a resistor and 1N34 or meter rectifier connected in series with it across the

TABLE I

Z1 and Z2 (ohms)	R1 (ohms)	R2 (ohms)	Speaker level (decibels)
3.2	10	0.4	17.0
4.0	10	0.5	16.5
6.0	10	1.0	13.0
8.0	16	2.25	11.0
10.0	16	5.50	5.0

TABLE II

Z1 and Z2 (ohms)	R1 (ohms)	R2 (ohms)	Speaker level (decibels)
3.2	5.5	5.5	8.5
3.2	10	4.5	12.0
6.0	10	10	8.5
6.0	15	8.0	11.0
8.0	11	14	7.5
8.0	20	11	11.0

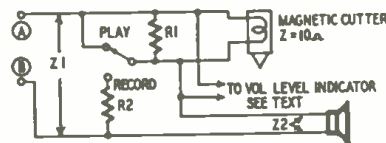

Fig. 2—Input circuit for low-Z cutter.

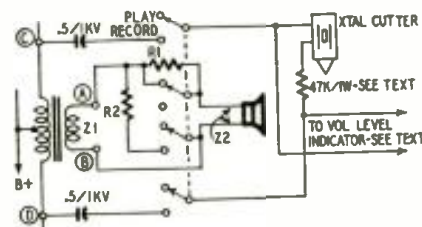

Fig. 3—Crystal cutter input connections.

3, respectively. Table I shows the values for shunting resistors for different values of Z1 and Z2 when using 10-ohm magnetic cutters as in Fig. 2.

Shunt the 47,000-ohm resistor in series with the crystal cutter in Fig. 3 with a .001-to .01-μf capacitor to boost highs. Vary its value up to 250,000 ohms to boost lows. Table II shows the values of R1 and R2 for fixed values of attenuation in the speaker circuit for

cutter terminals. The value of the resistor should be selected so the meter reads 2 or 2.5 volts full scale.

A 1,000-ohm-per-volt or better, 150-volt a.c. meter can be used with the crystal cutter. The average level will probably run to approximately 100 volts; however, the best value can be determined by making a few trial recordings.

XTAL SET COIL DATA

The push-pull crystal receiver in the November, 1949, issue works so well that I want to give it a try on the shortwave bands. Please print winding data for coils covering from 550 kc to approximately 15 mc. I plan to use five-prong, 1 1/4-inch, plug-in forms.—S. S., Peru, Ill.

A. The table gives the number of turns and the approximate tuning range of each coil. Experiment with the number of turns on L1 to obtain maximum volume.

Tuning range (megacycles)	L1	L2—L3	Wire size
0.55-1.6	40	110	32
1.5-4.5	16	35	24
4.0-15	5	11	18

FM SET CONVERSION

? I have a standard FM receiver which I wish to convert for reception in the 152-162-mc band. Please supply coil winding data.—B. J. H., Birmingham, Ala.

A. Tuning components for these frequencies are so critical that it is almost impossible to supply winding data which will prove useful in any one circuit. It is possible to make your own coils if you have a good grid-dip meter or a high-frequency v.t.v.m. and a signal generator which covers the required range. You may be able to make the conversion merely by removing turns from the coils in the set.

With the grid-dip oscillator, prune the oscillator coil until its range is 162.7 to 172.7 mc when connected across the oscillator section of the tuning capacitor. The antenna and r.f. coils are adjusted to tune from 152 to 162 mc.

If you use the v.t.v.m. and signal generator method, connect the generator and a 270,000-ohm resistor in series across the coil and tuning capacitor in parallel. Connect the v.t.v.m. across the combination. Close the tuning capacitor and tune the signal generator for maximum voltage on the meter. Note the frequency, then make the same test with the tuning capacitor open. The two frequencies are the high- and low-frequency limits of the coil and capacitor combination. Vary the number of turns, the diameter, and spacing between turns until you have the desired tuning range.

If you want to try winding your own coils, the antenna and r.f. coils may consist of three turns of No. 12 tinned wire wound to an inside diameter of 3/8 inch and spaced 1/2 inch long. As a start, the oscillator coil may consist of two turns of No. 12 wire having an inside diameter of 1/2 inch and a winding length of 1/4 inch. If you use National XR-50 or Millen 69040 series coil forms, it will be easier to adjust the inductance of the coils to fit the tuning capacitors.

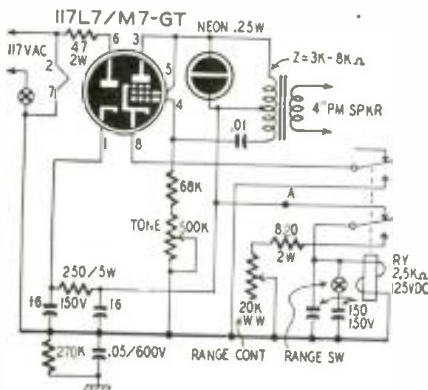

ELECTRONIC METRONOME

? I want to construct an electronic metronome but haven't found a circuit I like. One was described in your January, 1947, issue but it emits clicks. I want a tone or beep. I would also like



to incorporate a visual indicator. Can you give me a simple circuit?—W. S., Waukesha, Wis.

"OUR SERVICE BUSINESS HAS INCREASED CONSIDERABLY, DUE TO THE INFLUENCE OF THE RAYTHEON BONDED DEALER PROGRAM" ... says *Mort Farr*

Right: Mort Farr's modern, well equipped establishment in Upper Merion, Pennsylvania.

Below: Service dealers in the Philadelphia area get dependable personalized attention from Almo Radio Company, exclusive Raytheon tube distributor. Pictured is Al Margolis of Almo, checking us under with Mort Farr (right).



Customer confidence is the key to volume service business. The RAYTHEON Bonded ELECTRONIC TECHNICIAN PROGRAM provides this vital asset for Mort Farr, just as it does for thousands of other dealers who have adopted this exclusive Raytheon business builder. Raytheon Radio and Television Tubes help, too, because Raytheons are Right ... for Sound and Sight! Every time a worn out tube is replaced with a Raytheon, the service dealer gains another satisfied customer.

What the Raytheon Bonded Program does for Mort Farr it can do for you! Ask your RAYTHEON distributor how you can become a Bonded ELECTRONIC TECHNICIAN ... how you can get your Television and Radio service backed by the bond that creates customer confidence in you and your work. If you qualify, it's yours at no cost to you—the Bonded Program is Raytheon's Investment In Your Future.



RAYTHEON MANUFACTURING COMPANY
Receiving Tube Division
Newton, Mass., Chicago, Ill., Atlanta, Ga., Los Angeles, Calif.

RADIO AND TELEVISION RECEIVING TUBES, CATHODE RAY TUBES, SPECIAL PURPOSE TUBES, SUBMINIATURE TUBES, MICROWAVE TUBES

A. This circuit is the metronome described in the January, 1947, issue combined with a vacuum-tube oscillator. Large capacitors are connected across the relay coil. As soon as these charge, the relay armature pulls down and stays down until the capacitors discharge through the 820-ohm resistor and the range control. Auxiliary contacts on the relay close the cathode circuit of the oscillator. If the beeps are too long, insert a 500,000-ohm variable resistor at A, then adjust it for the desired effect.

The neon lamp across one side of the primary of the output transformer is the visual indicator. It may be necessary to place it across the entire wind-

WAR EQUIPMENT MAIL SALE!

SAVE up to 70% on Electronic, Radio, Mechanical Equipment!

For home experimenters, laboratories, schools, etc. New fully guaranteed. Fraction of original cost. 100s of items including:

• 2500-watt A-C Power Plants.....	\$279.00
• G.E. Selsyns (pair)	3.39
• Raytheon 110-v Electronic Timer	8.94
• Meg-A-Lite Continuity Condenser 110-v Tester	1.99
• Register, Capacitor Asst. 4 lb.....	1.89
• City Desk Telephones	5.98
• Photo Cell Light Control Kit	4.87
• Other bargains — Compressors, Paint Spray Guns, Engines, Pumps, Tools, etc.	

18 yrs. in business in Lincoln. Satisfaction Guar. We prepay all shipments.
Card brings catalog. 1000s bargains.

BURDEN SALES COMPANY

843 "O" St., Lincoln, Nebr.

IT'S A TAPE RECORDER

IT'S A DISC RECORDER

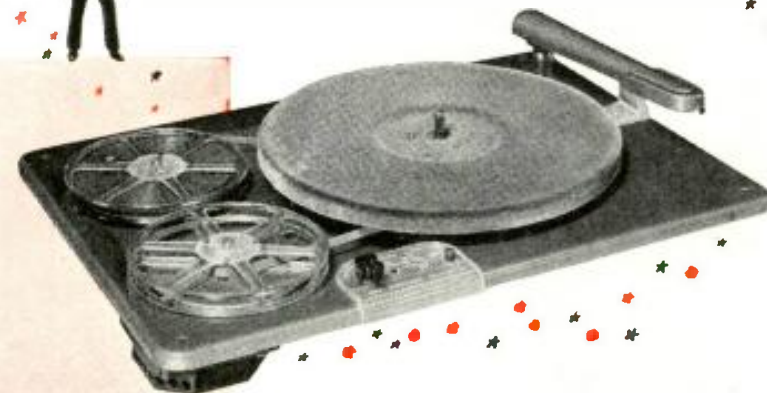
It's GENERAL INDUSTRIES' latest
sound reproduction triumph

MODEL 250

TAPE-DISC Recorder Assembly

- * Records on tape
- * Records on discs
- * Plays back both
- * Plays any 78 R.P.M. Record

(*) when connected with the proper amplifier.

Here's a fast-moving money-maker that's loaded with all the features a home-recording enthusiast could ask for. It records on tape or disc . . . records from tape to disc or disc to tape . . . makes possible a solid hour of selected uninterrupted entertainment.

Representing years of development by General Industries—oldest name in the phonomotor field—the Model 250 contains many design innovations, including foolproof operating features that anyone can understand.

Comprehensive, easy-to-understand service manual is included with each Model 250 unit. Included in manual is a suggested amplifier circuit as well as a complete amplifier parts list. New catalog sheet, describing all of the Model 250 recording and playback features will be sent upon request. Write for your copy today.



The GENERAL INDUSTRIES Co.

DEPARTMENT C • ELYRIA, OHIO

TWIN-TRAX* TAPE RECORDERS

designed... with the **ENGINEER** in mind

A COMPLETE SERIES

... of high-fidelity, dependable tape recorders—from transport mechanisms to highly specialized instruments, including the one YOU want. Write today for catalog 5101. Includes ALL technical specifications and direct factory prices.

AMPLIFIER CORP. of AMERICA
398-10 Broadway, New York 13, N. Y.

*Trademark Reg.

BETTER TV RECEPTION

THE "Fringe Area TV"
Reference Book

TV signal propagation, evaluation of TV antenna, making a TV signal survey, types of masts and towers and recommended installation practices. Full data on rhombics, how to use open-wire feed line, how to eliminate ghosts, minimizing fading, TVI, etc.

By W. W. Smith and R. L. Dawley

\$2.50

PER COPY — By mail, \$2.60 postpaid.

AT YOUR FAVORITE DEALER

OR DIRECT BY MAIL FROM

Editors and Engineers

1305 KENWOOD ROAD, SANTA BARBARA, CALIFORNIA



SHORTWAVE CONVERSION

? I am interested in using the simplified shortwave conversion described on page 124 of the January, 1950, issue, but I cannot work out values for the shortwave coil and the frequency to which the receiver must be tuned for reception of a 2490-kc signal. My receiver has a 262-kc i.f.—L. W. S., Buena Park, Calif.

A. Your receiver should be tuned to 852 kc as found by the formula

$$\frac{F1 - F2}{2} - F2,$$

where F1 is the frequency of the shortwave station and F2 is the i.f. of the receiver.

You may use an antenna coil consisting of 25 turns of No. 28 wire close-wound on a 3/4-inch form. This winding may be shunted with a single-section 365- μ f capacitor or a small trimmer of the same value. The primary of the antenna coil may have approximately 18 turns of No. 28 or smaller wire wound over the grid winding. Because of the short antenna used on auto radios, it may be necessary to experiment with the number of turns on the primary to get optimum performance. You may get good results by tapping the grid coil at a few turns above the grounded end and connecting the antenna to the tap through a 100- μ f blocking capacitor.

SURPLUS CRYSTALS

? I purchased a flock of surplus crystals which were marked with channel numbers between 0 and 79 and frequencies ranging from 20 to 27.9 mc. I want to use some of these in a 10-meter transmitter but can't get any of them to take off in any of the usual oscillator circuits. I've tried them in oscillators having circuits tuning as low as 2 mc without any luck. A friend tells me that these rocks are from the BC-604 but I can't get any dope on it.—E. K. W., Bronx, N.Y.

A. If the crystals are from the BC-604, they will probably be in FT-241 holders marked Western Electric on the bottom. To get the fundamental

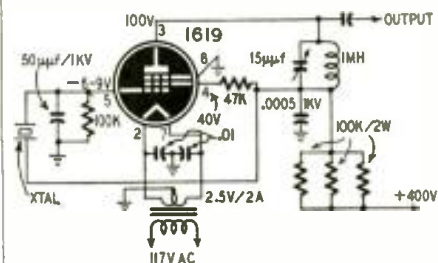

frequency, divide the frequency marked on the crystal—the output frequency—by 54. The fundamentals of these units range from 370.370 kc for channel 0 to 516.667 kc for channel 79.

The basic circuit of the oscillator in the BC-604 is shown in the diagram. We'll bet that this one will put your rocks to work. They may even work in the average Pierce oscillator circuit if you replace the usual 2.5-mh plate choke with a choke of 6 or 10 mh.

RADIO-ELECTRONICS for

You GET
THE BEST IN
Heathkits

Heathkits are the Quality Line of TEST INSTRUMENT KITS



Modern STYLING KITS THAT MATCH

Heathkits are styled in the most modern manner by leading industrial stylists. They add beauty and utility to any laboratory or service bench. There is a complete line of Heathkit instruments allowing a uniformity of appearance.

An attractive service shop builds a feeling of confidence. Many organizations have standardized on Heathkits providing uniform service departments.

There is no waste space or false effort to appear large in Heathkits — space on service benches is limited and the size of Heathkit instruments is kept as small as is consistent with good engineering practice.



Accuracy ASSURED BY PRECISION PARTS

Wherever required, the finest quality 1% ceramic resistors are supplied. These require no aging and do not shift. No matching of common resistors is required. You find in Heathkit the same quality voltage divider resistors as in the most expensive equipment.

The transformers are designed especially for the Heathkit unit. The scope transformer has two electrostatic shields to prevent interaction of AC fields.

These transformers are built by several of the finest transformer companies in the United States.

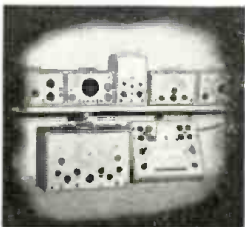

Used BY LEADING MANUFACTURERS

Leading TV and radio manufacturers use hundreds of Heathkits on the assembly lines. Heathkit scopes are used in the alignment of TV tuners. Impedance bridges are serving every day in the manufacture of transformers. Heathkit VTVM's are built into the production lines and test benches. Many manufacturers assemble Heathkits in quantity for their own use thus keeping

purchase cost down.

Famous HEATHKIT PARTS

- MALLORY FILTER CONDENSERS
- WILKOR PRECISION RESISTORS
- GRIGSBY ALLISON SWITCHES
- ALLEN-BRADLEY RESISTORS
- GENERAL ELECTRIC TUBES
- CHICAGO TRANSFORMER
- CENTRALAB CONTROLS
- SIMPSON METERS
- CINCH SOCKETS

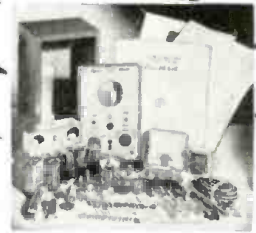

Complete KITS WITH PARTS THAT FIT...

When you receive your Heathkit, you are assured of every necessary part for the proper operation of the instrument.

Beautiful cabinets, handles, two-color panels, all tubes, test leads where they are a necessary part of the instrument, quality rubber line cords and plugs, rubber feet for each instrument, all scales and dials ready printed and calibrated. Every Heathkit is 110 V 60 Cy. power transformer operated by a husky transformer especially designed for the job. Heathkit chassis are precision punched for ease of assembly. Special engineering for simplicity of assembly is carefully considered.

Complete INSTRUCTION MANUALS

Heathkit instruction manuals contain complete assembly data arranged in a step-by-step manner. There are pictorials of each phase of the assembly drawn by competent artists with detail allowing the actual identification of parts. Where necessary, a separate section is devoted to the use of the instrument. Actual photos are included to aid in the proper location of wiring.



Used BY LEADING UNIVERSITIES

Heathkits are found in every leading university from Massachusetts to California. Students learn much more when they actually assemble the instrument they use. Technical schools often include Heathkits in their course and these become the property of the students. High schools, too, find that the purchase of inexpensive Heathkits allows their budget to go much further and provides much more complete laboratories.



YOU SAVE BY ORDERING DIRECT FROM MANUFACTURER—USE ORDER BLANK ON LAST PAGE

REPORT AGENCY
ROCKE INTERNATIONAL CORP.
12 E. 40th ST.
NEW YORK CITY (16)
CABLE: ARLAB-N.Y.

The HEATH COMPANY

... BENTON HARBOR 20, MICHIGAN

12 Improvements IN NEW 1951

MODEL O-6

PUSH-PULL

Heathkit OSCILLOSCOPE KIT



Only **\$39.50**

New INEXPENSIVE MODEL S-2 ELECTRONIC SWITCH KIT

Twice as much fun with your oscilloscope — observe two traces at once — see both the input and output traces of an amplifier, and amazingly you can control the size and position of each trace separately — superimpose them for comparison or separate for observation — no connections inside scope. All operation electronic, nothing mechanical — ideal for classroom demonstrations — checking for intermittents, etc. Distortion, phase shift and other defects show up instantly. Can be used with any type or make of oscilloscope. So inexpensive you can't afford to be without one.

Has individual gain controls, positioning control and coarse and fine switching rate controls — can also be used as square wave generator over limited range. 110 Volt transformer operated comes complete with tubes, cabinet and all parts. Occupies very little space beside the scope. Better get one. You'll enjoy it immensely. Model S-2. Shipping Wt., 11 lbs.



Only
\$19.50

- ★ New AC and DC push-pull amplifier.
- ★ New step attenuator frequency compensated input.
- ★ New non frequency discriminating input control.
- ★ New heavy duty power transformer has 68% less magnetic field.
- ★ New filter condenser has separate vertical and horizontal sections.
- ★ New intensity circuit gives greater brilliance.
- ★ Improved amplifiers for better response useful to 2 megacycles.
- ★ High gain amplifiers .04 Volts RMS per inch deflection.
- ★ Improved Allegheny Ludlum magnetic metal CR tube shield.
- ★ New synchronization circuit works with either positive or negative peaks of signal.
- ★ New extended range sweep circuit 15 cycles to over 100,000 cycles.
- ★ Both vertical and horizontal amplifier use push-pull pentodes for maximum gain.

The new 1951 Heathkit Push-Pull Oscilloscope Kit is again the best buy. No other kit offers half the features — check them. Measure either AC or DC on this new scope — the first oscilloscope under \$100.00 with a DC amplifier.

The vertical amplifier has frequency compensated step attenuator input into a cathode follower stage. The gain control is of the non frequency discriminating type — accurate response at any setting. A push-pull pentode stage feeds the C.R. tube. New type positioning control has wide range for observing any portion of the trace.

The horizontal amplifiers are direct coupled to the C.R. tube and may be used as either AC or DC amplifiers. Separate binding posts are provided for AC or DC.

The multivibrator type sweep generator has new frequency compensation for the high range it covers; 15 cycles to cover 100,000 cycles. The new model O-6 Scope uses 10 tubes in all — several more than any other. Only Heathkit Scopes have all the features.

New husky heavy duty power transformer has 50% more laminations. It runs cool and has the lowest possible magnetic field. A complete electrostatic shield covers primary and other necessary windings and has lead brought out for proper grounding.

The new filter condenser has separate filters for the vertical and horizontal screen grids and prevents interaction between them.

An improved intensity circuit provides almost double previous brilliance and better intensity modulation.

A new synchronization circuit allows the trace to be synchronized with either the positive or negative pulse, an important feature in observing the complex pulses encountered in television servicing.

The magnetic alloy shield supplied for the C.R. tube is of new design and uses a special metal developed by Allegheny Ludlum for such applications.

The Heathkit scope cabinet is of aluminum alloy for lightness of portability.

The kit is complete, all tubes, cabinet, transformer, controls, grid screen, tube shield, etc. The instruction manual has complete step-by-step assembly and pictorials of every section. Compare it with all others and you will buy a Heathkit. Model O-6. Shipping Wt., 30 lbs.

YOU SAVE BY ORDERING DIRECT FROM MANUFACTURER — USE ORDER BLANK ON LAST PAGE

EXPORT AGENT
ROCKE INTERNATIONAL CORP.
13 E. 40th ST.
NEW YORK CITY (16)
CABLE: ARLAB-N.Y.

The HEATH COMPANY

... BENTON HARBOR 20, MICHIGAN

RADIO-ELECTRONICS for

New 1951 • • MODEL V-4A

Heathkit VTVM KIT

HAS EVERY EXPENSIVE Feature

- ★ Higher AC input impedance, (greater than 1 megohm at 1000 cycles).
- ★ New AC voltmeter flat within 1 db 20 cycles to 2 megacycles (600 ohm source).
- ★ New accessory probe (extra) extends DC range to 30,000 Volts.
- ★ New high quality Simpson 200 microampere meter.
- ★ New 1/2% voltage divider resistors (finest available).
- ★ 24 Complete ranges.
- ★ Low voltage range 3 Volts full scale (1/3 of scale per volt).
- ★ Crystal probe (extra) extends RF range to 250 megacycles.
- ★ Modern push-pull electronic voltmeter on both AC and DC.
- ★ Completely transformer operated isolated from line for safety.
- ★ Largest scale available on streamline 4 1/2 inch meter.
- ★ Burn-out proof meter circuit.
- ★ Isolated probe for dynamic testing no circuit loading.
- ★ New simplified switches for easy assembly.

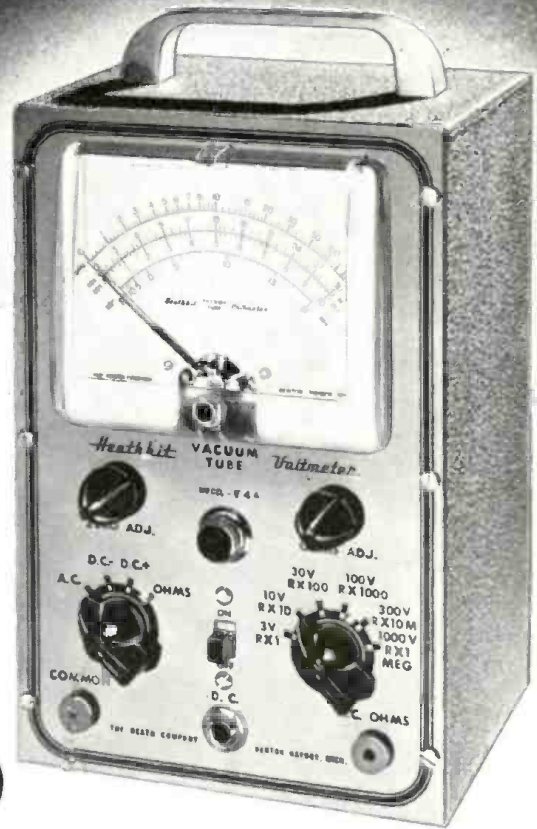

New
LOW PRICE **\$23.50**

The new Heathkit Model V-4A VTVM Kit measures to 30,000 Volts DC and 250 megacycles with accessory probes — think of it, all in one electronic instrument more useful than ever before. The AC voltmeter is so flat and extended in its response it eliminates the need for separate expensive AC VTVM's. + or - db from 20 cycles to 2 megacycles. Meter has decibel ranges for direct reading. New zero center on meter scale for quick FM alignment.

There are six complete ranges for each function. Four functions give total of 24 ranges. The 3 Volt range allows 33 1/3% of the scale for reading one volt as against only 20% of the scale on 5 Volt types.

The ranges decade for quick reading.

New 1/2% ceramic precision are the most accurate commercial resistors available — you find the same make and quality in the finest laboratory equipment selling for thousands of dollars. The entire voltage divider decade uses these 1/2% resistors.

New 200 microampere 4 1/2" streamline meter with Simpson quality movement. Five times as sensitive as commonly used 1 MA meters.

Shatterproof plastic meter face for maximum protection.

Both AC and DC voltmeter use push-pull electronic voltmeter circuit with burn-out proof meter circuit.

Electronic ohmmeter circuit measures resistance over the amazing range of 1/10 ohm to one billion ohms all with internal 3 Volt battery. Ohmmeter batteries mount on the chassis in snap-in mounting for easy replacement.

Voltage ranges are full scale 3 Volts, 10 Volts, 30 Volts, 100 Volts, 300 Volts, 1000 Volts. Complete decading coverage without gaps.

The DC probe is isolated for dynamic measurements. Negligible circuit loading. Gets the accurate reading without disturbing the operation of the instrument under test. Kit comes complete, cabinet, transformer, Simpson meter, test leads, complete assembly and instruction manual. Compare it with all others and you will buy a Heathkit, Model V-4A. Shipping Wt., 8 lbs. Note new low price, \$23.50



**New 30,000 VOLT DC
PROBE KIT**

Beautiful new red and black plastic high voltage probe. Increases input resistance to 1100 megohms. reads 30,000 Volts on 300 Volt range. High input impedance for minimum loading of weak television voltages. Has large plastic insulator rings between handle and point for maximum safety. Comes complete with PL55 type plug.

No. 3366 High Voltage Probe Kit.
Shipping Wt., 2 pounds.

\$550



**Heathkit
RF PROBE KIT**

Crystal diode probe kit extends range to 250 megacycles — 10% comes complete with all parts, crystal, cable and PL55 type plug.

No. 309 RF Probe Kit
Shipping Wt., 1 lb.

\$550

YOU SAVE BY ORDERING DIRECT FROM MANUFACTURER—USE ORDER BLANK ON LAST PAGE

EXPORT AGENTS
ROCKE INTERNATIONAL CORP.
12 E. 40th ST.
NEW YORK CITY 10 (10)
CABLE: ARAB, N. Y.

The **HEATH COMPANY**

... BENTON HARBOR 20, MICHIGAN

NEW Heathkit T.V. ALIGNMENT GENERATOR KIT

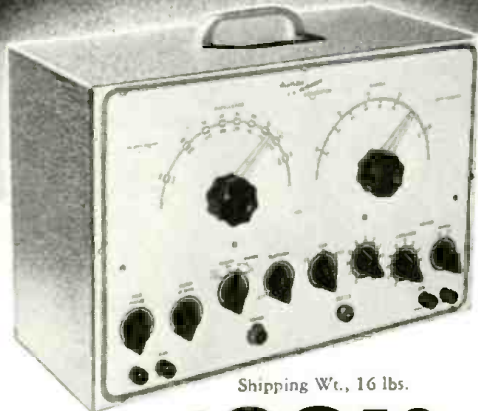

Shipping Wt., 16 lbs.

\$39.50

- ★ New simplified circuit for easy calibration and assembly.
- ★ New 2 band built-in marker covers 19 to 75 Mc.
- ★ New dual spider sweep motor for long life.
- ★ New blanking circuit gives base line for better alignment.
- ★ New variable oscillator gives high output fundamentals on high TV band.
- ★ New standby switch keeps instrument ready for instant use.
- ★ New 6 to 1 slow speed drive on both master oscillator and marker tuners.

The new Heathkit TV Alignment Generator incorporates the new developments required for modern TV servicing. An absorption marker circuit covering all possible IF bands and even several of the RF bands. The new blanking circuit provides a base reference line which is invaluable in establishing proper traces. The new sweep motor incorporates dual spiders in the speaker frame assuring better alignment and long life. The mounting of the speaker sweep motor has been simplified for easy alignment.

The variable master oscillator covers 140 to 230 Mc. thus giving high output fundamentals where they are most needed. Low band coverage 2 Mc. to 90 Mc.

A new step attenuator provides excellent control of output.

Planetary 6 to 1 drives on both oscillator and marker provides smooth easy control settings. A standby position is provided making the instrument always instantly available.

Horizontal sweep voltage with phasing control is provided. No other sweep generator under \$100.00 provides all these features — comes complete with instruction manual. Model TS-2.

Heathkit CONDENSER CHECKER KIT

Only **\$19.50**

Features

- Power factor scale.
- Measures resistance.
- Measures leakage.
- Checks paper-mica-electrolytics.
- Bridge type circuit.
- Magic eye indicator.
- 110 V. transformer operated.
- All scales on panel.

Checks all types of condensers over a range of .00001 MFD to 1,000 MFD. All on readable scales that are read direct from the panel. NO CHARTS OR MULTIPLIERS NECESSARY. A condenser checker anyone can read. A leakage test and polarizing voltage for 20 to 500 Volts provided. Measures power factor of electrolytics between 0% and 50%. 110 V. 60 cycle transformer operated complete with rectifier and magic eye tube, cabinet, calibrated panel, test leads and all other parts. Clear detailed instructions for assembly and use. Model C-2. Shipping Wt., 7 lbs.

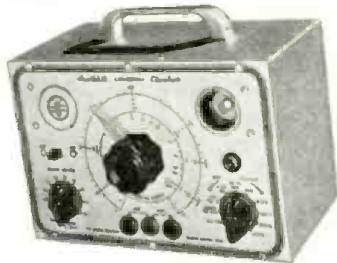

NEW Heathkit SIGNAL TRACER AND UNIVERSAL TEST SPEAKER KIT

\$19.50

Features

- High sensitivity
- Complete set of speaker impedances
- Tests microphones and PA systems
- Tests both single and push-pull speaker circuits

The popular Heathkit Signal Tracer has now been combined with a universal test speaker at no increase in price. The same high quality tracer follows signal from antenna to speaker — locates intermittents — defective parts quicker — saves valuable service time — gives greater income per service hour. Works equally well on broadcast — FM or TV receivers. The test speaker has assortment of switching ranges to match push-pull or single output impedance. Also test microphones, pickups, PA systems — comes complete — cabinet, 110 V. 60 cycle power transformer — tubes, test probe, all parts and detailed instructions for assembly and use. Model T-2. Shipping Wt., 8 lbs.

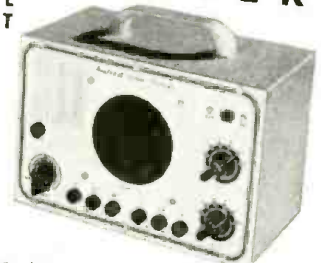

Heathkit TUBE CHECKER KIT

Features

Sockets for every modern tube — blank for new types.

Fastest method of testing tubes — saves time — makes more profit.

Rugged counter type birch cabinet.

Test your tubes the modern way — dynamically — the simplest, yet fastest and surest method — your Heathkit has a switch for each tube element and measures that element — no chance for open or shorted elements slipping by, all the advantages of the mutual conductance type without the slow cumbersome time consuming setups.

Your Heathkit Tube Checker has all the features — beautiful 3 color BAD-GOOD meter — complete selection of voltages — roller chart listing hundreds of tubes including the new 9 pin miniatures — finest quality Centralab lever switches for each element — high grade birch counter type cabinet — continuously variable line adjust control — every feature you need to sell tubes properly. The most modern type tube checker with complete protection against obsolescence. The best of parts — rugged oversize 110 V. 60 cycle power transformer — finest of Mallory and Centralab switches and controls. Complete set of sockets for all type tubes with blank spare for future types. Fast action brass gear driven roller chart quickly locates the settings for any type tube. Simplified switching cuts necessary testing time to minimum and saves valuable service time. Short and open element check. Simple method allows instant setup of new tube types without waiting for factory data. No matter what the arrangements of tube elements, the Heathkit flexible switching arrangement easily handles it. Order your Heathkit Tube Checker Kit today. See for yourself that Heath again saves you two-thirds and yet retains all the quality — this tube checker will pay for itself in a few weeks — better assemble it now. Complete with instructions — pictorial diagrams — all parts — cabinet — ready to wire up and operate. Model TC-1 Shipping Wt., 12 lbs.

Gear driven roller chart gives instant setup for all types.

Tests each element separately for open or short and quality.

Beautiful 3 color, meter — reads good-bad and line set point.



\$29.50

YOU SAVE BY ORDERING DIRECT FROM MANUFACTURER — USE ORDER BLANK ON LAST PAGE

REPORT AGENT
ROCKE INTERNATIONAL CORP.
13 E. 40th ST.
NEW YORK CITY 100
CABLE ARIAR-N.Y.

The **HEATH COMPANY**

... BENTON HARBOR 20, MICHIGAN

RADIO-ELECTRONICS for

NEW 1951
Heathkit

SIGNAL GENERATOR KIT

Features

- Sine wave audio modulation.
- Extended range 160 Kc. to 50 megacycles fundamentals.
- New step attenuator output.
- New miniature HF tubes.
- Transformer operated for safety.
- Calibrated harmonics to 150 megacycles.
- New external modulation switch.
- 5 to 1 vernier tuning for accurate settings.

A completely new Heathkit Signal Generator Kit. Dozens of improvements. The range on fundamentals has been extended to over 50 megacycles; makes this Heathkit ideal as a marker oscillator for T.V. New step attenuator gives controlled outputs from very low values to high output. A continuously variable control is used with each step. New miniature HF tubes are required for the high frequencies covered.

Uses 6C4 master oscillator and 6C4 sine wave audio oscillator. The set is transformer operated and a husky selenium rectifier is used in the power supply. The coils are precision wound and checked for calibration making only one adjustment necessary for all bands.

New sine wave audio oscillator provides internal modulation and is also available for external audio testing. Switch provided allows the oscillator to be modulated by an external audio oscillator for fidelity testing of receivers.

A best buy — think of all the features for less than \$20.00. The entire coil and tuning assembly are assembled on a separate turret for quick assembly — comes complete — all tubes — cabinet — test leads — every part. The instruction manual has step-by-step instructions and pictorials. It's easy and fun to build a Heathkit Model SG-6 Signal Generator. Shipping Wt., 7 lbs.



\$19⁵⁰

Heathkit SINE AND SQUARE WAVE AUDIO GENERATOR KIT

Either sine or square wave.
Stable RC bridge circuit.
Covers 20 to 20,000 cycles.
Less than 1% distortion.



Hundreds of Heathkit Audio Generators are used by speaker manufacturers — definite proof of their quality and dependability. The added feature of square wave opens up an entirely new field of amplifier testing. Uses the best of parts, 4 gang condenser, 1% calibrating resistors, metal cased filter condensers, 5 tubes, completely calibrated panel and detailed instruction manual. One of our best and most useful kits. Model G-2. Shipping Wt., 12 lbs.

\$34⁵⁰

THE NEW *Heathkit* HANDITESTER KIT

- Beautiful streamline Bakelite case.
- AC and DC ranges to 5,000 Volts.
- 1% Precision ceramic resistors.
- Convenient thumb type adjust control.
- 400 Microampere meter movement.
- Quality Bradley AC rectifier.
- Multiplying type ohms ranges.
- All the convenient ranges 10-30-300-1,000-5,000 Volts.
- Large quality 3" built-in meter.

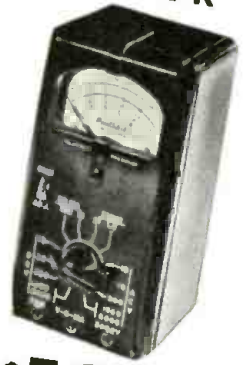

\$13⁵⁰

A precision portable volt-ohm-milliammeter. An ideal instrument for students, radio service, experimenters, hobbyists, electricians, mechanics, etc. Rugged 400 ua meter movement. Twelve complete ranges, precision dividers for accuracy. Easily assembled from complete instructions and pictorial diagrams. An hour of assembly saves one-half the cost. Order today. Model M-1. Shipping Wt., 2 lbs.

NEW *Heathkit* BATTERY ELIMINATOR KIT

Features

- Provides variable DC voltage for all checks.
- Locates sticky vibrators-intermittents.
- Voltmeter for accurate check.
- Has 4000 MFD Mallory filter for ripple-free voltage.



\$22⁵⁰

Even the smallest shop can afford the Heathkit Battery Eliminator Kit. A few auto radio repair jobs will pay for it. It's fast for service, the voltage can be lowered to find sticky vibrators or raised to ferret out intermittents. Provides variable DC voltage 5 to 7½ Volts at 10 Amperes continuous or 15 Amperes intermittent. Also serves as storage battery charger. Ideal for all auto radio testing and demonstrating.

A well filtered rugged power supply uses heavy duty selenium rectifier, choke input filter with 4,000 MFD of electrolytic filter for clean DC. 0-15 V. voltmeter indicates output which is variable in eight steps. Easily constructed in a few hours from our instructions and diagrams — better be equipped for all types of service — it means more income. Model BE-2. Shipping Wt., 19 lbs.

YOU SAVE BY ORDERING DIRECT FROM MANUFACTURER — USE ORDER BLANK ON LAST PAGE

EXPORT AGENT
ROCKE INTERNATIONAL CORP.
12 E. 40th ST.
NEW YORK CITY (16)
CABLE: ARLAB-N.Y.

The **HEATH COMPANY**

... BENTON HARBOR 20, MICHIGAN

Get set for ACTION!

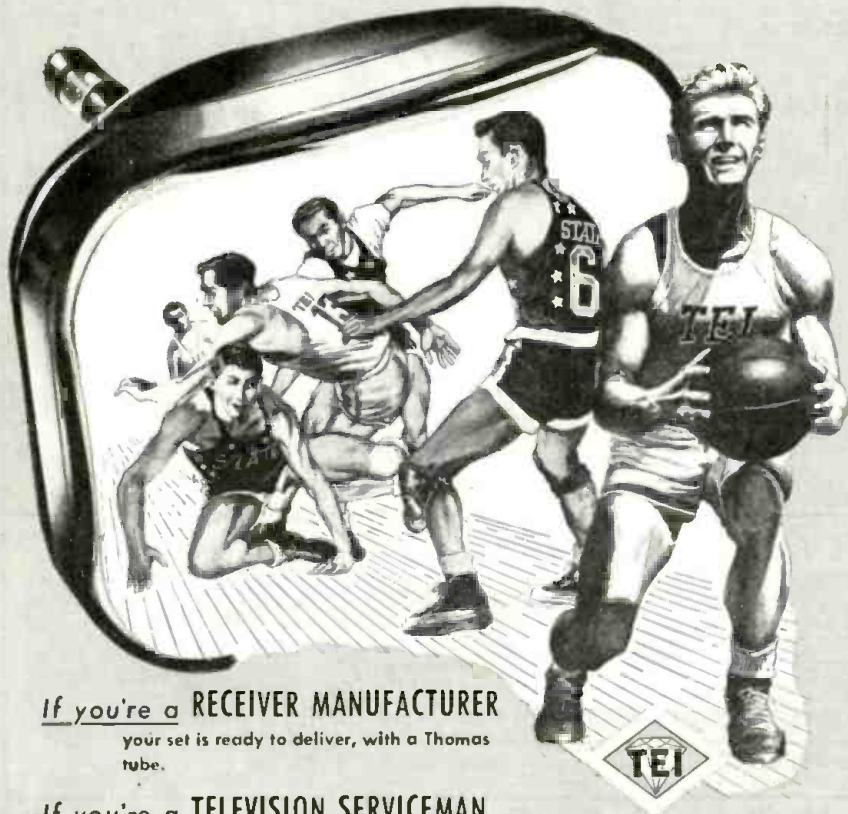

If you're a RECEIVER MANUFACTURER
your set is ready to deliver, with a Thomas tube.

If you're a TELEVISION SERVICEMAN
you're prepared to send those use-worn receivers back into the game fresh and rarin' to go, with a Thomas tube.

If you're a JOBBER OR DISTRIBUTOR
you're stocked to meet servicemen's increasingly heavy demands for the fastest-moving tube in the game, with Thomas tubes.

For, business-wise and performance-wise, "Action" in television picture tubes demands Thomas — the strongest tube in anybody's line-up!

THOMAS ELECTRONICS, Inc.

118 Ninth Street

Passaic, New Jersey



OUTPUT INDICATOR

A sensitive output indicator for use when aligning receivers can be constructed with a minimum of time and parts. As shown in the diagram, it consists of a small PM speaker and output transformer mounted on a small base which can be placed close to the speaker in the set being aligned.



Connect a low-range v.t.v.m. to the terminals and use it as the output indicator. With the meter set to the 0.25-volt a.c. range, the signal from the test oscillator can be turned low enough to prevent the set's a.v.c. from operating and broadening the output peaks.—*W. M. Finley, Jr.*

HANDY SERVICING TOOL

One of the biggest headaches in radio servicing is the job of realigning scraping plates in a variable capacitor. In trying to straighten a bent plate by usual methods, adjacent plates may be bent and the technician finds himself in a vicious circle.

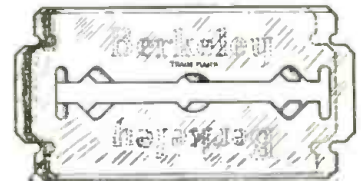

SWEATED TOGETHER WITH SOLDER $\frac{1}{16}$ "

An old-timer gave me a simple jig which does the job miraculously. Two double-edged razor blades are soldered together at one end with a $\frac{1}{16}$ -inch overhang as shown. When the blades straddle the suspected plate, they make a tight width gauge on either side without undue pressure on adjacent plates. The jig can be held in the hand, needle-nose pliers, or fastened to the end of a small rod.—*William R. Brown, Jr.*

REPAIRING VOLUME CONTROLS

Here is a simple method of removing the C-rings or retaining collars, used in rotary switches and potentiometers, without gouging a hunk out of your thumb.

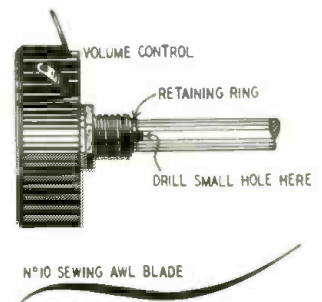

Drill a small hole in the shaft close to the retaining ring as shown in the drawing. Slide a prying tool under the ring and lift it out. A shoemaker's No. 10 sewing awl blade is an ideal tool for the job. Its shape and sharp point make it a handy tool for cleaning up soldering lugs and socket pins.—*Frederick Box*

RADIO HANDBOOK

IN TWO EDITIONS



11TH EDITION: The standard work on practical and theoretical aspects of all radio communication.
12TH EDITION: Detailed constructional information on a wealth of radio communication equipments; all brand-new.
BOTH these top-notch books are a necessity for everyone interested in radio communication. There is little overlap in coverage; each is a perfect companion volume to the other.

FOR EITHER EDITION

\$3.00

By mail, \$3.25 postpaid. Foreign, \$3.50.

AT YOUR FAVORITE DEALER

OR DIRECT BY MAIL FROM

Editors and Engineers
LIMITED
1305 KENWOOD ROAD, SANTA BARBARA, CALIFORNIA



TWIN-TRAX* TAPE RECORDER

Available to you direct from the factory at savings that make TWIN-TRAX the only professional-type recorder in the popular-price field. More than a dozen model variations for portability, long-play, continuous operation, etc. For a better tape recorder that combines professional quality with operating ease and trouble-free construction, it's TWIN-TRAX. Write today for complete literature. *Trade Mark Registered

AMPLIFIER CORP. OF AMERICA

398-10 Broadway • New York 13, N. Y.

#630 Chassis Still the Best in TV
NOW... More Outstanding than Ever!

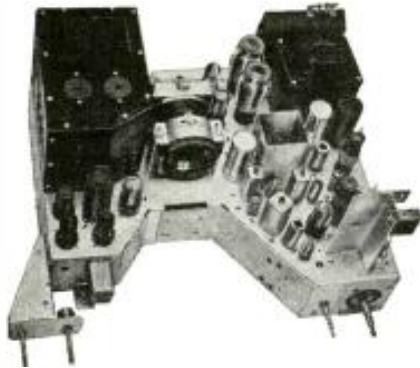

KNOWN MFR... LICENSED BY RCA

Engineered in strict adherence to the genuine RCA #630 plus ADDED FEATURES... LARGE POWER TRANSFORMER... VOLTAGE DOUBLER... PULSE KEYED AGC... UNIVERSAL MOUNTING BRACKET... 70° DEFLECTION YOKE.

- A NEW 31-TUBE SUPER DELUXE EDITION**
DESIGNED FOR THE NEW LATEST TYPE **20"** RECTANGULAR PICTURE TUBE
Delivered (as pictured) complete ready to play with all tubes, hardware, knobs and large 8" PM speaker (less CRT) **\$187.97**
- SAME 20"—31-TUBE SUPER DELUXE KIT** Major parts mounted and aligned complete (less CRT) **166.49**
- 16"—31-TUBE DELUXE CHASSIS.** READY to plug in and play, complete (less CRT) **169.74**
- 10" or 12½" 30-TUBE STANDARD KIT** Unassembled, incl. instructions, complete (less CRT) **139.62**

STANDARD GUARANTEED PICTURE TUBES

20DP4A — (Rectangular Black)	\$74.89
19AP4A — (Round Metal Black)	64.74
19CP4A — (Round Glass Black)	64.74
17RP4A — (Rectangular Black)	46.78
16RP4A — (Rectangular Black)	39.63
16DP4A — (Round Glass Black)	39.63
16AP4 — (Round Metal)	38.14
14LP4 — (Rectangular Black)	31.38
12LP4A — (Round Black)	28.72
10BP4 — (Round)	22.46

TV PARTS FOR #630 IN COMPLETE SETS

VIDEO AND I.F. KIT (19 items)	7.84
ELECTROLYTIC CONDENSER KIT (6)	7.37
TUBULAR CONDENSER KIT (37)	4.28
CERAMIC CONDENSER KIT (28)	3.37
MICA CONDENSER KIT (11 condensers)	1.38
CARBON RESISTOR KIT (107 resistors)	6.98
WIREWOUND RESISTOR KIT (4 resistors)	2.31
OCTAL WAFER SOCKET KIT (13 sockets)	.72
MIN. WAFER SOCKET KIT (10 sockets)	.63
MIN. MOLDED SOCKET KIT (2 sockets)	.22
COMPLETE SET OF GOLD KNOBS	2.49
BRACKET AND SHIELD KIT (18 items)	8.63
TERMINAL STRIP KIT (19 strips)	.59
VARIABLE CONTROL KIT (9 controls)	5.83

VOLTAGE DOUBLER PARTS

LUCITE SUB-CHASSIS, formed & drilled	2.49
3 - 20K H.V. FILTER CONDENSERS, set	2.22
RESISTORS, set of 7	.98
TUBULAR & MICA CONDENSERS, set of 3	.46
TERMINAL & WIRE STRIPS & CLIPS	.48

(Add the doubler system to the standard 630 circuit with these parts plus the 16" bracket kit, the plastic sleeve and ring a 1B3 and 21IT5. Easy to follow instructions included)

- FREE—WITH ORDERS OF \$10 OR OVER**
- 630TV Circuit Diagram with Modifications
 - Hints for Better Performance on your 630TV
 - Illustrated Television Conversion Manual
 - Pulse Keyed Type AGC Circuit Diagram
 - RMA Handy Resistor and Mica Code Charts

#630 TV PARTS...TOP QUALITY...LOW PRICES
FOR KIT BUILDERS, REPLACEMENTS AND EXPERIMENTERS

The following television parts list comprises all the components needed to build the famous #630 television chassis plus added features. PRICES UNLESS MARKED PER SET ARE PER ITEM. Parentheses indicate amounts of parts needed in lots of two or over. THE PRICES SPEAK FOR THEMSELVES.

RCA FRONT END TUNER, compl. w/tubes	\$22.49	PUNCHED CHASSIS PAN, cadmium plated	\$4.87
STANDARD TURRET TUNER, com. w/tubes	22.49	630-KIT, screws, nuts, rivets, washers	1.69
ESCUTCHEON PLATE, for either tuner	.69	HI VOLTAGE CAGE ASSEMBLY, complete	3.73
COMPLETE SET OF KNOBS, incl. decals	.98	VOLTAGE DIVIDER SHIELD & COVER	1.79
COMPLETE SET OF KNOBS, (Gold)	2.49	ELECTROLYTIC COND. SUB-CHASSIS	.94
POWER TRANSFORMER, 295ma. 201T6	9.97	SOUND DISCRIMINATOR SHIELD	.19
VERTICAL OUTPUT TRANS. 204T2	2.69	TUBE CRADLE PRACKET	.57
VERTICAL BLOCKING TRANS. 208T2	1.32	DEFLECTION YOKE BRACKET	.29
HORIZONTAL OUTPUT TRANS. 211T1	2.47	DEFLECTION YOKE MOUNTING HOOD	.59
HORIZONTAL OUTPUT TRANS. 211T3	2.98	FOCUS COIL BRACKETS...per set	.49
HORIZONTAL OUTPUT TRANS. 211T5	3.98	CATHODE TRAP COIL SHIELD	.39
FOCUS COIL, 247 ohms, 202D1	2.29	CHASSIS MOUNTING BRACKETS, set of 4	.44
FOCUS COIL, 470 ohms, 202D2	3.42	BRIGHTNESS & HOLD CONTROL BRACKET	.59
DEFLECTION YOKE, 60° 201D1	2.97	WIDTH CONTROL BRACKET	.16
DEFLECTION YOKE, 70° 206D1	3.98	TUNER SHAFT BRACKET	.17
SOUND DISCRIMINATOR TRANS. 203K1	1.12	TERMINAL STRIPS, 4-LUG...set of 11	.48
1st PIX I.F. TRANSFORMER, 202K2	1.08	TERMINAL STRIPS, 3-LUG...set of 2	.08
2nd PIX I.F. TRANSFORMER, 202K3	1.08	TERMINAL STRIPS, 2-LUG...set of 2	.06
1st & 2nd SOUND I.F. TRANS. (2) 201K1 ea.	1.02	TERMINAL STRIP, 1-LUG	.02
HORIZONTAL DISCRIM. TRANS. 208T8	1.49	ANTENNA TERMINAL STRIP	.19
FILTER CHOKE, 62 ohms	1.47	3-SCREW TERMINAL STRIP	.19
CATHODE TRAP COIL, 202K4	1.08	CORONA TERMINALS...set of 2	.08
WIDTH CONTROL COIL, 201R1	.44	CORONA RING	.09
WIDTH CONTROL COIL, 201R4	.48	TUBE SHIELD & CLIP...2 sets	.22
WIDTH CONTROL COIL, keyed AGC	.79	MINIATURE WAFER SOCKET (10)	.07
HORIZONTAL LINEARITY COIL, 201R3	.39	MINIATURE MOLDED SOCKETS (2)	.12
HORIZONTAL LINEARITY COIL, 201R5	.49	OCTAL WAFER SOCKETS (13)	.07
3rd & 4th PIX COILS, (2) 202L1 ea.	.39	CATHODE RAY TUBE SOCKET, 18" leads	.39
FILAMENT CHOKES, (5) 204L1 ea.	.09	AMPHENOL CONNECTOR PLUGS, set	.48
VIDEO PEAKING COIL, 203L1	.18	OVAL PM SPEAKER, 5"x7"	2.49
VIDEO PEAKING COIL, 203L2	.18	8" PM SPEAKER, heavy alnico #5 magnet	3.97
VIDEO PEAKING COILS, (2) 203L3 ea.	.18	12" PM SPEAKER, heavy alnico #5 magnet	5.63
VIDEO PEAKING COILS, (2) 203L4 ea.	.18	SPEAKER CONNECTOR PLUGS...set of 2	.18
ION TRAP BEAM BENDER, (single) 203D1	.79	12½"—CRT MOUNTING BRACKET SET	1.96
ION TRAP BEAM BENDER, (double) 203D3	.98	16"—CRT MOUNTING BRACKET SET	2.98
AUDIO OUTPUT TRANSFORMER (6K6)	.69	UNIVERSAL MOUNTING BRACKET SET	6.97
HV RECTIFIER, SOCKET ASSEMBLY, single	.79	PLASTIC SLEEVE, for insulating 16AP4	1.88
HV RECTIFIER, SOCKET ASSEMBLY, double	1.37	PLASTIC SLEEVE, for insulating 16GP4	1.88
TV 6' LINE COPE LEAD, with clip	.39	PLASTIC RING, for insulating rim 16" CRT	1.97
INTERLOCK SAFETY CONNECTOR (input)	.17	PLASTIC SLEEVE, for insulating 19" CRT	1.96
		PLASTIC RING, for insulating rim 19" CRT	2.08

VARIABLE CONTROLS

PICTURE & SOUND, 10K ohms 1 meg. & switch	1.14
VERTICAL & HORIZ, 50K ohms 1 meg.	1.04
BRIGHTNESS CONTROL, 50K ohms	.44
HORIZ. CENTERING, wirewound, 20 ohms	.57
HEIGHT CONTROL, 2.5 megohm.	.48
VERTICAL LINEARITY, 5000 ohms	.44
VERTICAL CENTERING, wirewound, 20 ohms	.96
FOCUS CONTROL, wirewound, 1500 ohms	.98
HORIZONTAL DRIVE, 20K ohms	.44

MICA CONDENSERS—85°C Operation

270 MMFD — 500 W.V. (7)	ea. .12
390 MMFD — 500 W.V.	.12
470 MMFD — 500 W.V.	.12
680 MMFD — 500 W.V.	.16
4700 MMFD — 500 W.V.	.29

ELECTROLYTIC CONDENSERS—85°C

40/10/80MFD — 450/450/150 VOLTS	1.37
40/40/10MFD — 450/450/450 VOLTS	1.49
80/50MFD — 450/50 VOLTS	1.49
40/10/10MFD — 450/450/350 VOLTS	1.37
20/80MFD — 450/350 VOLTS	1.49
250/1000MFD — 10/6 VOLTS	.98

TUBULAR CONDENSERS—85°C

.002 — 600V	.09	.005 — 400V (3) ea.	.07
.0025 — 600V (2) ea.	.09	.01 — 400V (5) ea.	.09
.004 — 600V	.11	.015 — 400V (2) ea.	.11
.005 — 600V	.11	.05 — 400V (5) ea.	.12
.01 — 600V (2) ea.	.12	.1 — 400V (2) ea.	.14
.05 — 600V (6) ea.	.15	.001 — 1000V	.14
.1 — 600V	.17	.004 — 1000V (2) ea.	.14
.25 — 400V (2) ea.	.21	.035 — 1000V	.18
		.05 — 1000V	.18

CERAMIC CONDENSERS

10 MMFD, 10% Tolerance	.12
51 MMFD, 10% Tolerance	.12
56 MMFD, 10% Tolerance	.12
82 MMFD, 10% Tolerance (2)	ea. .12
1200 MMFD, not less than rated capacity	.14
1500 MMFD, not less than rated capacity (2) ea.	.14
6800 MMFD, not less than rated capacity	.19

H.V. FILTER CONDENSERS (Cartwheels)

10KV — 500 MMFD	.48
15KV — 500 MMFD	.67
20KV — 500 MMFD	.79

WIREWOUND RESISTORS

5000 ohms, 5 watts	.22
VOLTAGE DIVIDER, 1360/250 ohms	.74
VOLTAGE DIVIDER, 5300/2,500 ohms	.89
VOLTAGE DIVIDER, 6750/12/93 ohms	.72

CARBON RESISTORS

½ WATT, 5% TOLERANCE, 10, 150(5), 3900	
4700, 5600, 10K(2), 18K 680K(2), 820K OHMS,	
1.2 & 1.5 MEG	ea. .09
½ WATT, 10% TOL., 3.3, 39(3), 330, 560(3)	
680, 1800, 2700(2), 3300, 4700, 6800(4), 8200(4),	
10K(3), 22K, 27K(2), 47K, 56K, 100K(3), 150K,	
270K, 470K(3) OHMS,	
1(2), 2.2(2), 4.7, 6.8 MEG	ea. .07
½ WATT, 20% TOL., 100(2), 1000(9), 3300,	
22K(3), 100K, 150K, 220K(2), 330K, 470K(3)	
OHMS, 1(3), 10 MEG	ea. .05
1 WATT, 5% TOL., 2.2, 39K, 47K OHMS	ea. .14
1 WATT, 10% TOL., 1800, 3300, 4700(2) 10K	
(2), 18K, 22K, 27K, 39K OHMS, 1 MEG	ea. .12
1 WATT, 20% TOL., 10K OHMS	ea. .10
2 WATT 10% TOL., 100, 270 OHMS	ea. .18
2 WATT, 20% TOL., 2200(2) OHMS	ea. .14

#630 TV TUBES—STANDARD MAKES

6J6	R.F. Amplifier	1.97
6J6	R.F. Oscillator	1.97
6J6	Converter	1.97
6BA6 (2)	1st and 2nd Sound I.F.	ea. 1.08
6AU6	3rd Sound I.F.	1.69
6AL5	Sound Discriminator	1.69
6AT6	1st A.F. Amplifier	1.08
6K6GT	Audio Output	1.08
6AG5 (4)	1st, 2nd, 3rd, 4th Pix I.F.	ea. 1.74
6AL5	Pix. Det. & DC restorer	1.69
6AU6	1st Video Amplifier	1.69
6K6GT	2nd Video Amplifier	1.08
6SK7	1st Sync. Amplifier	.98
6SH7	Sync. Separator	1.69
6SN7	2nd Sync. Amp & Hor. Dis	1.62
6J5	Vert. sweep osc. dis.	.87
6K6GT	Vertical sweep output	1.08
6AL5	Hor. Sync. Discriminator	1.69
6K6GT	Hor. Sweep Oscillator	1.08
6AC7	Hor. Sweep Osc. Control	2.29
6BG6G	Horizontal Sweep Output	2.89
5V4G	Reaction scanning	1.87
1B3/8016	High Voltage Rectifier	1.94
5U4G (2)	Power Supply Rectifier	ea. 1.08

BROOKS RADIO & TELEVISION CORP., 84 Vesey St., Dept. A, New York 7, N.Y.

HI-V

TUBULARS

● The ever-popular Aerovox Type 84 paper tubulars are now available in 85°C extended-voltage ratings — 2500, 3500, 5000, 7500, 10,000 and 15,000 V.D.C.W. From .0001 to .15 mfd. Measuring 3/8" dia. by 1 1/2" long for smallest, to 1 1/2" by 3" long for largest.

Oil impregnated. Wax filled. Sturdy insulating tube. Sealed ends. Bare pigtail leads that

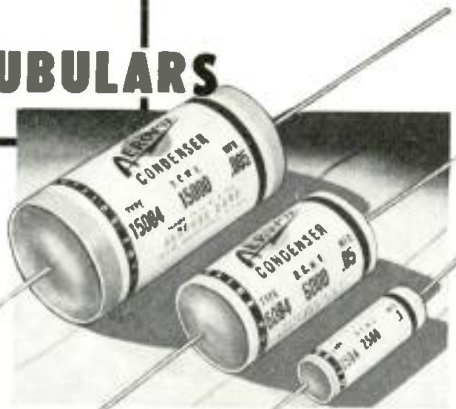

won't pull out. And dependable!

See Your Jobber...

Insist on Aerovox HI-V tubulars for initial equipment or replacements in TV sets, oscillographs, transmitters, etc. Ask your local jobber for the new Aerovox Catalog.



CAPACITORS • VIBRATORS • TEST INSTRUMENTS

For Radio-Electronic and Industrial Applications

AEROVOX CORPORATION, NEW BEDFORD, MASS., U. S. A. • Sales Offices in All Principal Cities
Export: 41 E. 42nd St., New York 17, N. Y. • Cable: AEROCAP, N. Y. • In Canada: AEROVOX CANADA LTD., Hamilton, Ont.

TECH-MASTER

TELEVISION

There is no finer
TV made!

De Luxe
630 type

CHASSIS

FOR ALL PICTURE TUBES
FROM 12" ROUND TO
20" RECTANGULAR



Discriminating custom builders choose TECH-MASTER for they know from long experience that "there is no finer TV made" than a TECH-MASTER chassis. Every TECH-MASTER is designed by top-notch TV engineers... and constructed of the finest components. Automatic Gain Control is built into every chassis to provide the ultimate in picture quality.

Supplied "ready-to-operate" with TECH-MASTER guarantee and seal of rigid test. Contact your nearest jobber or write Dept. RC today for complete literature on TECH-MASTER chassis... a model available for every type of custom installation.

**TECH-MASTER
PRODUCTS CO.**

443-445 Broadway, New York 13, N. Y.

More leading engineers and technicians
have chosen Tech-Master for their
own use than any other Television Kit!



BATTERY-DRAIN REBUTTAL

In the "Try This One" column of the July, 1950 issue, Mr. Cohn suggested replacing 300-ma tubes with their 150-ma equivalents to reduce drain on automobile batteries. I have found that 150-ma tubes do not last long in vehicular service because their heaters are too fragile to take the pounding and vibration. On the other hand, 150-ma tubes are fine for a.c.-operated equipment.

If you must save heater current in a battery set, do not replace a 6X5 or similar rectifier with an 0Z4. Use smaller pilot lamps and economize elsewhere. These tubes generate a hash which defies description. It starts shortly after a new tube is placed in service.

If an auto radio comes in with a complaint of odd-sounding whistles, hisses, or hash; check to see if it uses an 0Z4. If so, a new one will provide temporary relief. For a more effective cure, try shunting each of the filter capacitors with a 500- μ f, 1,000-volt capacitor and connect a hash filter—a parasitic choke and 500- μ f capacitor in parallel—in series with each plate of the 0Z4. The choke may be made by winding No. 18 enameled wire over a 10,000-ohm, 2-watt resistor.—James Charles Soukup

SELF-LOCKING RELAY

If you need a special locking relay with electrical release, you can make one from two surplus relays. Mount the relays side by side and connect their armatures together with a mechanical linkage. If the armatures do not carry current, they can be linked by a metal strip soldered to each. If either carries current, then you can use a plastic rod drilled for short lengths of bus bar or metal strips which are soldered to the armatures.

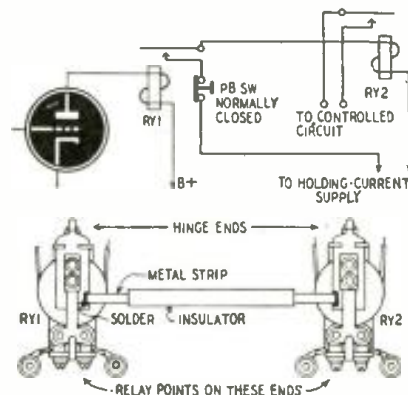

The drawings show the construction of the relay and a typical circuit. RY1 may be a s.p.s.t. sensitive relay in the output of a capacitance relay, photocell, etc. When a pulse is applied to the coil of RY1, it pulls in and closes the holding circuit to the coil of RY2. The contacts of both relays will stay closed until the circuit is opened with the normally closed push-button switch.

The coil of RY2 may match any convenient source of current for the holding current. It should have enough contacts to handle the controlled circuits. Use this system as a push-to-start, push-to-stop control for your transmitter.—O. C. Vidden

RADIO-ELECTRONICS for

PHASING LOUDSPEAKERS

Having enjoyed reading the article "Connecting Loudspeakers" in the June, 1950, issue, I would like to add a few words on the subject.

When a number of speakers are mounted on a common baffle or close to each other, it is necessary that they be phased or connected so that they work as one unit. Before connecting each speaker, momentarily connect a 1.5-volt dry cell across the voice coil. Note the polarity of the battery and the direction the cone moves.

If matching transformers are used with the speakers, connect a high-resistance voltmeter across the secondary. Touch the leads of a 22.5-volt battery to the primary and note which direction the meter reads. In either case, connect the speakers so the cone movements or meter deflections are in the same direction.—C. J. Laughlin

MORE USE FOR WELLER IRON

Weller-type soldering irons are useful in determining which parts of a radio or amplifier are sensitive to 60-cycle hum. Hold the tip of the iron close to transformers, chokes, and any other components suspected of picking up hum. (The radio and iron must be on for this test.) Not only will the strong magnetic field around the tip show which parts are sensitive to hum, it will also show which side of the component is most sensitive. Thus it is simple to orient transformers and other components for minimum pickup.

We worked on a phono amplifier which had a low-level a.c. hum which resisted all the standard hum-elimination practices. By using the method outlined above, we traced the hum to a small iron-cored choke in the scratch-filter assembly. A grounded metal shield around the assembly cleared up the trouble.—O. C. Vidden



EVERY RADIOMAN Can Use These SERVICE HINTS!

Valuable Manual Yours—FREE!

Every page of "How to Simplify Radio Repairs" is packed with on-the-bench, practical ideas. Contains photos, charts, diagrams—no fluff—no vague theory. In plain every-day language it gives you priceless suggestions—new servicing ideas. You'll use and benefit from the experience of experts.



SEND COUPON OR PENNY POSTCARD FOR YOUR FREE COPY TODAY!

FEILER ENGINEERING CO., Dept. 12RC5
1601 S. Federal St., Chicago 16, Illinois
Please RUSH my FREE copy of "How to Simplify Radio Repairs."
Name
Address
City Zone ... State

HICKOK Leads!

WITH NEW TELEVISION VTVM

MODEL 209A

ELECTRONIC VOLT OHM CAPACITY MILLIAMMETER

FEATURES

- Easy to read, long scale 9" meter.
- Zero-center DC scale for faster alignment.
- Resistance measurements as low as 1/10 ohm.
- New 1200 Volt AC range.
- Low capacity, high frequency probe. Peak-to-Peak or RMS — Flat frequency response to 300 megacycles.

• Now even more sensitive — Especially designed to save you time in television servicing. Measures any resistance, capacitance, voltage or current you would ever encounter in AM, FM or TV receivers.

New Peak-to-Peak voltage measurements—An absolute necessity for TV servicing. Zero-center DC scale increases speed and accuracy of TV and FM readings.

Model 209A is a quality instrument built to the high HICKOK standard, with lasting accuracy for years to come.

The most used instrument on the technicians bench, where top-quality is the most economical buy.

See the 209A at your jobber's or write for literature Today!

THE HICKOK ELECTRICAL INSTRUMENT COMPANY

Dupont Avenue • Cleveland 8, Ohio

Send me full information on the New HICKOK Model 209A.

NAME _____
ADDRESS _____
CITY _____ STATE _____

BUILD 15 RADIOS...Only \$14.75

- ABSOLUTELY NO KNOWLEDGE OF RADIO NECESSARY
- NO ADDITIONAL PARTS NEEDED
- EXCELLENT BACKGROUND FOR TELEVISION

The PROGRESSIVE RADIO EDU-KIT will help you, if you want an EDUCATIONAL AND INTERESTING HOBBY, or if you want to get into a WELL-PAYING BUSINESS, or if you want to INCREASE YOUR KNOWLEDGE OF RADIO.

Absolutely no knowledge of radio is necessary. The PROGRESSIVE RADIO EDU-KIT is the product of many years of teaching and engineering experience. The detailed instructions and quizzes are clearly written and illustrated, so that they can be understood by anyone between the ages of 12 and 80.

The PROGRESSIVE RADIO EDU-KIT is not merely a collection of radio parts accompanied by a radio diagram. IT IS PRACTICALLY A RADIO COURSE, offered at a mere fraction of its real value. You will be taught to build radios in a progressive manner. First, you will build a very simple 1-tube receiver. The next set is a little more advanced. Gradually you will find yourself constructing elaborate radio sets, and doing work like a professional radio technician. Every part is illustrated. EVERY STEP INVOLVED IN BUILDING THESE SETS HAS BEEN CAREFULLY PLANNED. YOU CANNOT MAKE A MISTAKE.

Each of the 15 radios you will build operates on 110-120 volts, AC or DC. These sets have been designed to teach you the PRINCIPLES OF RADIO. Therefore, you will build a variety of circuits. The PROGRESSIVE RADIO EDU-KIT IS EXCELLENT FOR LEARNING THE PRINCIPLES OF RECEIVER, TRANSMITTER, AND AMPLIFIER DESIGN. It is used in many Radio Schools and Colleges in U.S.A. and abroad. It is used by the Veterans Administration for veteran training.

Quizzes are provided as part of the PROGRESSIVE RADIO EDU-KIT. They will be corrected by our staff at no extra cost.



FREE 1950 EXTRAS:

- ELECTRICAL AND RADIO TESTER
- SCREWDRIVER
- BOOK ON TELEVISION
- GENEROUS WINK OF WIRE

- ELECTRIC SOLDERING IRON
- ALIGNMENT TOOL
- SPOOL OF ROSTIN CORE SOLDER
- MEMBERSHIP IN RADIO-TV CLUB

ORDER YOUR PROGRESSIVE RADIO KIT TODAY, OR SEND FOR FREE "KIT-KATALOG" POSTAGE PREPAID ON CASH ORDERS. C.O.D. ORDERS ACCEPTED IN U.S.A.
PROGRESSIVE ELECTRONICS CO., 497 Union Ave., Dept. RE-42, Brooklyn 11, New York

TECH-MASTER

TELEVISION

NEW DELUXE KITS 630 TYPE

with keyed AGC
FOR PICTURE TUBES FROM 10"
ROUND TO 20" RECTANGULAR

TECH-MASTER KITS are acknowledged by the radio industry as the finest for quality and performance. Avoid the danger of buying untested brands . . . insist on TECH-MASTER . . . indisputably the finest of them all. All components are factory mounted. Easy to follow instructions assure perfect performance in comparatively short time.



TECH-MASTER TV ACCESSORY KITS



BOOSTER



"Hi-Sweep" VOLT-AGE MULTIPLIER.



KEYED A. G. C. CIRCUIT for 630-Type chassis.

Contact your nearest jobber or write Dept. RC for literature on complete TECH-MASTER line of Kits.

TECH-MASTER PRODUCTS CO.

443-445 Broadway, New York 13, N. Y.

More leading engineers and technicians have built Tech-Master for their own use than any other Television Kit.



HELP FREDDIE WALK FUND

It is most pleasing to state this month that the Freddie Fund has reached almost \$3500.00 in contributions to Freddie, the Arkansas radio technician's two-year-old son born without arms or legs.

Freddie returned South last month after a stay of several months in West Orange, N. J. where he was fitted with his artificial legs. This, as previously



Freddie is now learning how to stand.

reported, is the first stage in rehabilitating the child so he can become a useful citizen and, we hope, an excellent radioman in due time.

The artificial legs so far have enabled him only to balance himself, which for a person born without legs is a task in itself. It should always be remembered that Freddie is only two years old. His father reports that Freddie is doing fine at this particular point and he believes that with just a little more practice he will be able to take a step. This he will be able to do by twisting the lower part of his body. It will take a lot of patience on the part of his parents and others, but his doctors believe that it won't be long before he will learn how to walk. It will be several years before any attempt will be made to fit Freddie with artificial arms as he must first learn how to use his legs which will be quite a task to master.

In the meanwhile we hope that our readers will do their utmost with contributions which are badly needed to rehabilitate the boy so that he will be able to take care of himself.

The Editor was particularly pleased to receive a letter from a young college student who is organizing a Help-Freddie-Walk Fund through his college. We hope to report more on this particular effort in the near future.

Keep up the good work by sending your contributions—even the smallest one will be highly welcome.

Make all checks, money orders, etc., payable to Herschel Thomason. Please address all letters to:

Help-Freddie-Walk Fund
c/o RADIO-ELECTRONICS
25 West Broadway
New York 7, N. Y.

RADIO-ELECTRONICS for

OUTSTANDING - TV - VALUES

MODEL #300
Folded dipole complete with reflector and high frequency adapter. Covers 13 channels. All alum. construction. Less mast Shpg. wt. 7 lbs. Price: \$4.95

MODEL #200-D
Stacked array. Consists of 2 complete conicals and connecting bars. Very rigid construction. Covers all 13 channels. Matches 300 ohm or 72 ohm. Coax impedance 150 Ohm. Ideal for low signal areas. An outstanding buy. Shpg. wt. 12 lbs. less mast. **SENSATIONAL OFFER at . . . 9.75**

MODEL 200-S
Single array. Same construction as above. Shpg. wt. 7 lbs. Price, less mast. . . . \$4.50

MODEL #500
All-band folded dipole antenna. Ideal for rotor use. Maximum gain on any channel. Alum. construction. Less Mast. Shpg. wt. 8 lbs. Price. . . . \$4.95

MODEL #Y-100
5 element Yagi Hi-Gain beam designed specifically for fringe area use. All alum. construction. Cut to specific channels. Shpg. wt. 4 lbs. Channel #7 \$4.50; Channel #0 \$4.25; Channel #11 \$4.00 and Channel #13, \$3.75. The prices are less mast. "Y" type antenna. Price \$4.25

ANTENNA ACCESSORIES

CM-100 Chimney Mount 1.50
8-ft. 1 1/2" OD Steel Mast, Plated 75
5-ft. 1 1/2" OD Alum. Mast \$1.60
5-ft. 1" OD Alum. Mast 1.25
3/4" 300-ohm stand-off insulators (for coax cable)—\$3.00 per 100 \$12.00 per 500 \$20.00 per 1000

"U" Bolt Assemblies—ideal for most couplings—12 for \$1.50 50 for \$5.00

Best Quality 300-ohm twin lead— Send for Prices.

High Quality 72-ohm Coax Cable— Send for Prices.

Folded Dipole Hi-Frequency Adapters 1.35

Conical Hi-Frequency Adapters 1.50

Straight Dipole Hi-Frequency Adapters 1.25

TERMS: All shipments F.O.B. Newark, New Jersey. 25% deposit with orders, balance C.O.D. Minimum order \$2.00. Include ample postage.

PRICES SUBJECT TO CHANGE WITHOUT NOTICE.

EAST COAST ELECTRONICS

40 St. Francis Street Newark 5, New Jersey

DON'T MISS
RADIO-ELECTRONICS ANNUAL
TELEVISION ISSUE
January 1951

Television -Radio Electricity

OR
IN THE GREAT SHOPS OF COYNE

COYNE
51st Year!
OLDEST, BEST EQUIPPED
SCHOOL of ITS KIND in U.S.
2 Opportunity Fields

TRAIN QUICKLY!
Come to the Great Shops of COYNE in Chicago. Our 51st Year! Get quick, practical training in TELEVISION-RADIO or ELECTRICITY. G.I. Approved. Finance plan for non-veterans. Mail Coupon Today for complete details.

NOT "HOME-STUDY" COURSES!
You learn on real, full-size equipment, not by mail. Finest staff of trained instructors to help you get ready quickly for a better job, a fine future.

FREE BOOKS Clip coupon for big illustrated Coyne book on either TELEVISION-RADIO or ELECTRICITY. Both books sent FREE if you wish. No obligation; no salesman will call. Act NOW!

B. W. COOKE, Pres.
COYNE Electrical & Television-Radio School.
500 S. Paulina St., Chicago 12, Ill. Dept. 90-81H

Send FREE BOOK and full details on:
 TELEVISION-RADIO ELECTRICITY

NAME.....
ADDRESS.....
CITY..... STATE.....

Balance as of September 22.....	\$3134.21
Wilbur M. Abel—Lawpoint, Ill.....	\$ 25.00
Ack Radio Supply Co.—Birmingham, Ala..	10.00
E. H. Allen—Belmont, Mass.....	1.00
Anonymous—Escandido, Calif.....	2.00
Anonymous—Los Angeles, Calif.....	2.00
Anonymous—Redwood City, Calif.....	10.00
Anonymous—Washington, D. C.....	10.00
Anonymous—Bellewood, Ill.....	1.00
Anonymous—Rantoul, Ill.....	2.00
Anonymous—Rutherford, N. J.....	5.00
Anonymous—Brooklyn, N. Y.....	10.00
Anonymous—Brooklyn, N. Y.....	1.00
Anonymous—Buffalo, N. Y.....	2.00
Anonymous—New York, N. Y.....	1.00
Anonymous—Philadelphia, Pa.....	1.00
Anonymous—Roscoe, Pa.....	5.00
Anonymous—Memphis Tenn.....	2.00
Anonymous—Houston, Texas.....	1.00
Anonymous—Seattle, Wash.....	1.00
Borbara and Ernie Baker—Wellesley, Mass.	1.00
R. P. Battle—Boyside, N. Y.....	3.00
Virgil E. Beck—Omaha, Neb.....	3.00
Patty Box—Downey, Calif.....	1.00
Ernest E. Case KL7WK—Yocaville, Calif.....	5.00
Charles Cerami—Newark, N. J.....	1.00
Peter Cerasoli—South Plainfield, N. J.....	1.00
L. D. Clemmans—Thomasville, N. C.....	2.00
Communications Equipment Co.—New York, N. Y.....	20.00
P. M. Canroy, Canroy Radio & Television—Detroit, Mich.....	10.00
R. W. D.—Short Hills, N. J.....	5.00
J. C. W. Dick—Detroit, Mich.....	2.00
Lila and Ronnie Driver—Pikeville, Ky.....	2.00
Leiland M. Duke—Vicksburg, Miss.....	1.00
Eddie Etienne—Brussels, Belgium.....	1.00
Laurence M. Eugene—Chicago, Ill.....	1.00
Friends from Yonkers—Yonkers, N. Y.....	5.35
Dr. William H. Grace—Branxville, N. Y.....	15.00
N. X. Herman, W6ZSA—San Diego, Calif.....	5.00
Louis H. Hippe, W6APQ—No. Hollywood, Calif.....	10.00
Roy Johnston—Detroit, Mich.....	5.00
Stanley C. Kukla—Honolulu, T. H.....	5.00
Jim Lawson—Lebanon, Mo.....	1.00
W. W. Ledli—Bartlesville, Okla.....	1.00
D. B. Lones—Los Angeles, Calif.....	1.00
Mr. & Mrs. Robert E. McCullaugh, Grove City, Pa.....	2.00
H. McK.—Longmont, Colo.....	10.00
Mrs. June Madden—Detroit, Mich.....	2.00
Johnny and Billy Martin—Jeffersonville, Pa.	2.00
William G. Martin—Cincinnati, Ohio.....	5.00
Mid-West Associated—Rockford, Ill.....	10.00
Alice Sally Miller—Rochester, N. Y.....	1.00
W. Maehring—Charlotte, Mich.....	2.00
D. Nestor—Detroit, Mich.....	1.00
Jahn J. Pacosky—Pittsburgh, Pa.....	10.00
J. F. Papi—Framingham, Mass.....	2.00
J. C. Pape—Philadelphia, Pa.....	1.00
Psalm 100—New York, N. Y.....	15.00
John Rabuse—Brooklyn, N. Y.....	1.00
C. S. Rasmussen—Evansville, Ind.....	3.00
Raessler Radio Service—Ridgewood, N. Y.....	2.00
Rosicrucian Sunshine Circle—Dayton, Ohio.	5.00
Jerome Salinger—Easton, Pa.....	5.00
San Francisco Radio & Supply Co.—San Francisco, Calif.....	10.00
Henry A. Savard—Queens Village, N. Y.....	1.00
E. Schoenike—Cedar Rapids, Ia.....	3.00
Serva-Tek Products Co., Inc.—Paterson, N. J.	10.00
Caryl, Marvin and Douglas Shales—Pleasantville, N. J.....	2.00
Swift All-Steel Body Company, Inc.—Saginaw, Mich.....	25.00
Elbert L. Taylor W2EWD—Monsey, N. Y.....	5.00
George M. Todd—Philadelphia, Pa.....	2.00
F. Tamosek—Bronx, N. Y.....	5.00
J. C. Vargo—Cleveland, Ohio.....	4.00
W0SD—Fergus Falls, Minn.....	1.00
Burton O. Williams—Seattle, Wash.....	5.00
Paul Wing—Detroit, Mich.....	5.00
Mrs. J. J. Workheiser—Rock Island, Ill.....	1.00
Total Contributions received up to October 23, 1950.....	\$3491.56

Radio Thirty-Five Years Ago
In Gernsback Publications

HUGO GERNSBACK
Founder

Modern Electrics.....	1908
Electric Experimenter.....	1913
Radio News.....	1919
Science & Invention.....	1920
Television.....	1927
Radio-Craft.....	1929
Short-Wave Craft.....	1930
Television News.....	1931
Wireless Association of America.....	1908

Some of the larger libraries still have copies of ELEC-TRICAL EXPERIMENTER on file for interested readers.

DECEMBER, 1950



**The PROFIT-WISE
Serviceman Specifies . . .**

New
STANCOR PRODUCTS



**8400
POWER
SERIES**

A comprehensive line of 35 part numbers designed for replacement and new construction. Wide range of applications based on a thorough study of today's power transformer needs. Most ratings available in a choice of vertical or horizontal mountings.



**OUTDOOR LINE
TO VOICE
COIL**

Two new units designed to fit most needed outdoor applications. Primary impedances of 3,000/2,000/1,500/-1,000/500 ohms; secondary impedances of 16/8/4 ohms. Part Number A-3333 rated at 14 watts. A-3334 rated at 25 watts.

**STANCOR
TRANSFORMERS**

Using Stancor replacement transformers for your radio, TV and sound service jobs is the sure way to fatten your bank account. Here's why —

- Quality comes first with Stancor. Ability to "take it" cuts down call-backs—keeps your customers happy with a good job.
- Stancor has the largest line in the industry. A choice of 450 part numbers, in some 30 mounting and terminal styles, enables you to get exactly the right unit for almost any application.
- Easy-to-read instruction sheets and clearly marked terminals make your job quicker and easier. Saves valuable shop time.

New Stancor units are coming out all the time. Keep posted. Ask your Stancor distributor for our latest catalogs.



Most Complete Line in the Industry

STANDARD TRANSFORMER CORPORATION 3592 ELSTON AVE., CHICAGO 18, ILL.

**DECEMBER, 1916,
ELECTRICAL EXPERIMENTER**
Eyes and Ears for the Sub-Sea Fighters, by Thomas W. Benson
Transmitting Your Photo Over a Wire, by Jacques Boyer
Western Radio Amateurs Offer Their Stations to Army
The Arlington Radio Station (NAA), by Capt. W. H. G. Bullard, U.S.N.
The Revolving Mirror for Determining Spark Characteristics, by Samuel Cohen
Anent the Audion, by Dr. Lee deForest
Efficient and Economical Method of Utilizing the Armstrong Regenerative Audion System for Damped and Undamped Waves, by Samuel Cur-

ANOTHER OUTSTANDING JOBBER
MIDWAY Radio & Television Corp.
60 WEST 45th STREET
New York 19, N. Y.
HAS THE
SENSATIONAL NEW
EICO 320-K SIGNAL
GENERATOR KIT
IN STOCK!
\$19.95

tiss, Jr.
Electrolytic Rectifiers and How They Work
An Adjustable Fixed Condenser, by Raymond Sutcliffe
A Sounding Board Microphone, by Len K. Wright
Standard Radio Terms Defined

TECHNICIAN'S EXHIBIT

Philadelphia radio technicians held their second annual show and exhibit in that city's Broadwood Hotel September 25-27. Technical sessions were held throughout the second two days, and a number of excellent technical papers were read.

Attendance was disappointing, due apparently to last-minute publicity difficulties, though some blamed the rush of sets being repaired for important sport events for keeping technicians away. In any case, not more than 3,000 of the expected 8,000 technicians registered for the affair, and a number of important papers were read to small audiences.

A number of interesting exhibits were entered by manufacturers, representatives and publications. Most impressive was the very complete demonstration of the use of electronics in defense by the Armed Forces.

The technical lectures were on a higher plane than most of those previously presented at service technicians' meetings. Highlight of the convention was possibly the paper on color television systems by Charles J. Hirsch of the Hazeltine Research Corp. Illustrated with color slides which showed exactly how the "mixed highs" principle is applied, and with tables comparing the more common color systems as to efficiency, spectrum use, and detail, it was the most educational lecture that has been delivered to radio technicians for some time. Second only to it was John Rider's discussion "Radio or TV" in which he proved that AM and FM radio will be with us for a considerable number of years to come. A film which drove home the correct methods of television installation by showing how *not* to install a receiver also obtained the convention's unqualified approval.

NEW GUILD FORMED

A new organization, the Electronic Technicians' Guild of Pennsylvania, has been formed in Philadelphia. The organization is the first of its type, in that it takes in all phases of the servicing industry. The Guild comprises four groups: employees, employers, "neutral members" and student members. All individuals and organizations that are members of the Guild are classified as to the membership group to which they belong.

The purpose of the Electronic Technicians' Guild may be best summed up in the words of its constitution:

"The Guild exists for the purpose of aiding its members in improving and uplifting their social, professional and economic status in life through cooperation, registration and informative advertisements; the adoption of an enlightened educational program; the classification of employees according to their skills, talents and qualifications; the establishment of a recommended wage schedule consistent with the skills involved; the encouragement of the adoption of fair trade pricing policies;

RADIO-ELECTRONICS for

EFFICIENCY IS THE KEYNOTE!

NEW DRIVE FOR PRODUCTION EFFICIENCY MEANS NEW DEMAND FOR INTER-COM SYSTEMS!

Our expanding anti-aggression effort calls for quick conversion of many plants to war production. New levels of efficiency must be attained.

For full efficiency, a modern inter-com and paging system is a must.

The demand for good sound equipment will be heavy. Will you be ready? NOW is the time for you to establish yourself as a dependable source of industrial electronic equipment.

ATLAS can help you build a profitable sound equipment business. We are ready to supply you with equipment to meet every conceivable inter-com and paging requirement.

Model HU-15V
HU-24V

The model HU-15V is a medium sized speaker suitable for all paging and talk-back applications. All ATLAS paging speakers are designed to offer a maximum sensitivity in talk-back systems.

The weather proof universal line matching transformers are easily attached to any model. Designed for constant impedance, constant voltage systems and 50 ohm lines.

The model HU-24V is an oversized speaker having the obvious advantage of a longer air column length. Suitable for music as well as speech in industrial applications.

Model TP-15V . . . TP-24V

The TP type speakers are available in two sizes. These dual two-way speakers produce two speaker results from a single location for long corridors, hallways, etc.

All ATLAS speakers are priced Right! COMPARE! But remember, we make no compromise with quality.

Don't miss your best new business opportunity in years. Write us TODAY for full details.



ATLAS Sound Corp.

1443—39th Street, Brooklyn 18, N. Y.

in Canada: Atlas Sound Corp., Ltd., Toronto, Ont.

TRIPLEX WAVE MASTER

YOUR BEST ANTENNA BUY!!!!

TRIPLE DIRECTORS

1/4 Wavelength Stacked

Conical with 3-Element Dipole

GHOST FREE RECEPTION ALL CHANNELS

NO BOOSTER REQUIRED

YOUR COST \$7.70

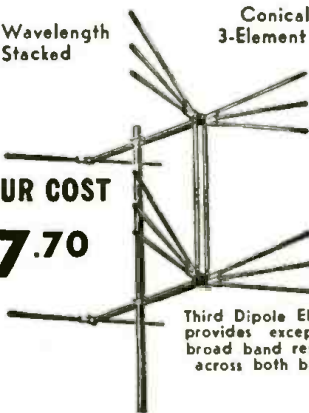

Third Dipole Element provides exceptional broad band response across both bands.

INSTANT ASSEMBLY

EASY INSTALLATION APPROX. WT. 7 POUNDS

MATCHES ANY OHM WIRE 75-150-300

SOLD DIRECT—WRITE—WIRE—CALL—FAIRFAX 9171

RAY MANUFACTURING CO.

441 SUMMIT ST. TOLEDO, OHIO

DON'T MISS RADIO-ELECTRONICS ANNUAL TELEVISION ISSUE

January 1951

Reserve Your Copy Today

AUTOMATIC M-90 AUTO RADIO



- Six Tube Superheterodyne • Three Gang Condenser • Powerful, Long-Distance Reception • Fits All Cars, Easy Installation
- Mounting Brackets Included **Net \$27.97**
- 6 Tube model M90 \$27.97
- 5 Tube model X50 \$24.36

Approx. shipping weight either unit (11) eleven pounds.
MAIL US YOUR ORDERS
 All orders filled within 24 hours. Illustrated parts list on request. Standard Brand tubes 50% off list

Bill Sutton's Wholesale Electronics
 Fifth at Commerce Fort Worth, Texas

WANTED TO BUY

Large and small quantities of new or used electronic government or manufacturers' surplus tubes and equipment. Highest prices paid. State quantity, condition and best price in first letter.

Box No. F-2 c/o Radio-Electronics
 25 West Broadway
 New York 7, N. Y.

NEW CONDENSER TESTER



Finds Intermittent Condensers Instantly

Pres-probe's sliding tip with variable resistance prevents condenser heating. Tests with power on. Requires no adjustment. Stops guesswork. Saves time. Convenient probe size (7/8" long). Satisfaction guaranteed.



See Your Dist. or Order Direct

PRES-PROBE CO.

2326 N. THIRD ST., MILWAUKEE 12, WIS.

EASY TO LEARN CODE

It is easy to learn or increase speed with an Instructograph Code Teacher. Affords the quickest and most practical method yet developed. For beginners or advanced students. Available tapes from beginner's alphabet to typical messages on all subjects. Speed range 5 to 40 WPM. Always ready—no QRM.



ENDORSED BY THOUSANDS!

The Instructograph Code Teacher literally takes the place of an operator-instructor and enables anyone to learn and master code without further assistance. Thousands of successful operators have "acquired the code" with the Instructograph System. Write today for convenient rental and purchase plans.

INSTRUCTOGRAPH COMPANY

4701 Sheridan Rd., Dept. RC, Chicago 40, Ill.

the elimination of sweat shops and unfair and cut-throat competition, securing the compliance with statutory, federal, state and local laws and regulations as they pertain to labor, business and health and fire underwriter policies; the amicable settlement of disputes between Guild members and the public or between Guild members and outside organizations; legal aid services and such other benefits, programs or policies the membership of the Guild may adopt for the purpose of securing the individual and collective interests of the membership."

The Philadelphia Section of the Guild has already begun to function. The present officers are: Paul Lau, president; Karl Vogelsang, vice-president; John Zagury, corresponding secretary; Stan Myers, secretary treasurer; and Frank Gerhard, recording secretary.

SHORTAGES DISCUSSED

Labor and parts shortages were discussed at the October meeting of the Television Contractors Association in Philadelphia. Two methods to help ease these problems were approved.

A central employment bureau will be established to make it easier to get labor, particularly qualified television service technicians. The facilities of this bureau will be open to potential employees without charge and it will operate for the benefit of TCA membership.

The failure of manufacturers to set aside sufficient parts and tubes to meet service needs was severely criticized. To reduce the problem in Philadelphia, the association will establish a cooperative buying agency. In the beginning, association members will band together to buy large offerings of much needed items that could not be handled by individual contractors. If this meets with success, the cooperative buying plan will be expanded. The association hopes that this scheme will reduce the cost of servicing and help the contractor to stay in business.

N. Y. TECHNICIANS MEET

The Empire State Federation of Electronic Technicians Associations held their fall meeting at Kingston, N. Y., September 24. Twenty-four delegates, representing ten local associations, were present, as well as 30 guests.

Discussion centered around the fall educational program, in connection with which the following resolution was adopted:

"Any local association so requesting, shall have the educational lectures made available to their membership, even if they have only a small membership and can get only a small attendance."

The secretary reported that no answer had been received to letters sent the industry concerning distributor and jobber malpractices. These letters are being followed up with the idea of obtaining some satisfaction.

The next meeting of ESFETA is scheduled for Binghamton, January 14, 1951.

CHRISTMAS SPECIAL!!

AUTOMATIC RECORD CHANGERS

Only **\$11.95**

We have a limited quantity of these standard brand 78 RPM fully automatic changers. 115 Volts AC Operation. Order at Once!

CUSTOM AUTOMOBILE RADIOS

To Match Popular Cars

RADIOMEN! Here's your chance to make large extra profits with practically no work! All you have to do is get in touch with the local Ford, Studebaker, Hudson, Plymouth, Dodge and Chevrolet dealers telling them that you can supply custom-built radios to perfectly match the 1949 and 1950 models of these cars for about 1/2 the price that is usually charged! Very simple installation—no holes to drill. **SPECIFICATIONS**—Powerful 6 tube superheterodyne; 3 gang condenser with extra stage of RF; latest miniature tubes; oversize loud speaker. When ordering specify make of automobile.

WRITE FOR DEALERS' PRICES

3 WAY PORTABLE KIT

- For operation on 100 volt AC or DC and battery
- Superheterodyne circuit
- Full vision dial
- High gain loop
- Two-Tone brown leatherette cabinet, size 7x12 1/2x6 1/2"
- Tubes used: 1R5, 354, 1S5, 2-1T4, plus rectifier

PRICE \$13.75 Not including tubes
 Extra for kit tubes \$3.75

New! Flexible Flashlight! Flexlite

Consists of a thin 7" flexible gooseneck attached to small battery case with a pre-focused bulb at end of gooseneck. Light can be directed in the finest corners, around obstructions, inside grill, etc. The gooseneck can be clamped around pipes to direct light without holding lamp—leaving hands free—or stuck out of your pocket, etc.

One of the handiest flashlights we have ever seen and sold at a price of only **\$9.95** with batteries.

SCIENTIFICALLY DESIGNED PHONO SCRATCH FILTER

Resonated at approximately 4500 cycles effectively reducing objectionable needle scratch without altering the brilliancy of reproduction. Contains a HI-Q SERIES resonated circuit. Tested by means of an audio oscilloscope and an oscilloscope to give 22 db. attenuation with very low signal loss.

EASY TO ATTACH

Just two wires to clip on. Compact. Price **\$1.90**

MODEL NFRD—RADIO NOISE FILTER

If it doesn't work, send it back!

We absolutely guarantee that our Model NFRD will eliminate all line noises when properly connected to radios, television sets, short wave sets, motors, electric shavers, refrigerators, vibrators, oil burners, transmitters, and all other sources of interference. This unit will carry up to 12 amperes or 1/4 KW of power and may be used right at the source of interference or at the radio.

Small size only 3"x1 1/2"x7 1/2". Very low price only **Each \$1.95**

SPECIAL! SPECIAL!

Mammoth assortment of radio and electronic parts, not less than **TEN POUNDS** of new transformers, chokes, condensers, resistors, switches, coils, wire, hardware, etc. A super-buy for experimenters, servicemen, and amateurs for only **\$1.25**

Satisfaction guaranteed on all merchandise.
 All prices F.O.B. New York City
WRITE FOR FREE CATALOGUE T12
RADIO DEALERS SUPPLY CO.
 154 Greenwich St. New York 6, N. Y.

BUFFALO RADIO SUPPLY

219-221 Genesee St., Dept. RE 12
Buffalo 3, N. Y.



Multi-Range AC-DC Volt-Ohm-Milliammeter with Output Ranges Specifications

Volts DC: 0-5/10/50/100/500/
2000-1000 Ohms per volt
Volts AC: 0-125/25/125/150/
200/1250
Milliamperes DC: 0-1/10/100
Milliamperes AC: 0-2.5/25/200
Ohms Full Scale: 1000/200,000/
2,000,000
Ohms Center Scale: 50/2250/
22,500

Output: 5 to Plus 55 Decibels
This versatile instrument has a large 5/8" rectangular metal with two-tone aluminum scale set at a 45° angle to facilitate greater reading ease. 1% Multipliers. Furnished with test leads. Shipping weight 8 lbs. Special—\$26.00

RELAYS

Double pole. Double throw supersensitive 800 ohm D.T. relay in silver plated case \$1.50
Triple make. Single break. Tiny midget. 250 ohm DC relay. 9/16" mounting centers \$1.00
4 pole make. 5V to 24V. 30 ohm AC relay \$1.25
Single make and single break 115V. 550 ohm AC relay with 15 amp contacts \$1.95

MICA CONDENSERS

100 Assorted Mica Condensers Special \$3.95

TRANSFORMERS

AUTO-TRANSFORMER—Steps up 110v. or steps down 220v to 110v.—\$2.95
UNIVERSAL FIL. TRANSF.: 6.3 v. 3 amps.—\$1.35; Universal Output Trans. 8 Watt—39c; 18 Watt—\$1.29; 30 Watt—\$1.69. **AUDIO TRANSFORMER**: S. Plate to S. Grid. 3:1—79c; S. Plate to P.P. Grids—79c; Heavy Duty Class AB or B. P.P. inputs—\$1.49; Midget Output for AC-DC sets—69c; **MIKE TRANSFORMER** for T-17 Shure microphone, similar to UTC output type—\$2.00. Stancor 8B or DB mike to line or grid—\$1.95

Fully shielded GE single button mike transformer in beautiful silver finish case 99c
POWER TRANSFORMERS—Half-shell type. 110v. 60 cy. Centertapped HV winding. Specify either 2.5 or 6.3v filament when ordering.

For 4-5 tube sets—650V. 40MA. 5V & 2.5 or 6.3V \$1.75
For 5-6 tube sets—650V. 45MA. 5V & 2.5 or 6.3V \$1.90
For 6-7 tube sets—675V. 50MA. 5V & 2.5 or 6.3V \$2.35
For 7-8 tube sets—700V. 70MA. 5V & 6.3 or two 2.5V \$3.00
For 7-8 tube sets—700V. 70MA. 5V & 6.3 (25 Cycles) \$4.50
For 8-9 tube sets—700V. 90MA. 5V 3A. 2.5V. 3.5A. 2.5-10.5A \$3.50
For 9-11 tube sets—700V. 5V & 6.3V. 4A \$3.50
For 9-15 tube sets—600V. 150MA. 5V & 6.3V \$4.00

PHONOGRAPH SCRATCH ELIMINATOR

Consists of 2 condensers, resistor, and powdered iron core choke connected in a filter network. Same as used in most jukeboxes to improve low note response and eliminate scratch. Connects instantly between pick-up and amplifier. A super bargain at \$2.00

A Better Rat Trap (Or from Blind Mice to Electric Eyes)



We offer a limited quantity of sensitive photocell amplifiers complete with tubes, including the photocell. These were part of an ingenious rat trap manufactured by the Kryptar Optical Company of Rochester, N.Y., and used in flour and food mills, etc., all over the world in killing rats, as many as 40 per day. This was done when the rodents interrupted a light beam, setting off a mechanism which electrocuted them. These amplifiers are useful for traffic counting, checking units on a production line, for opening garage doors, for burglar alarms, for smoke detectors on chimneys or fire alarms; and many other applications.
Super Special, completely wired \$9.95
Kit Form \$6.95

HEAT GUN

Streamlined, pistol-grip heat gun, in fire-engine red blasts 20 cubic feet of hot air per minute, at 160°. Big rugged vacuum cleaner type AC-DC motor that also blows cold air. Has many uses including cleaning radio chassis, heating carburetors, drying ignition systems, quick-drying paint, thawing out radiators or frozen water pipes, etc. Fully guaranteed. Postage prepaid. \$12.95.



SUPER SPECIAL CONDENSER BARGAINS
40, 20 20 MFD—150V, condensers with common negative 35c or 10 for \$5.00
20, 20, MFD—150V plug in condensers 40c or 10 for \$3.50

MUSICAL INSTRUMENT or CONTACT MICROPHONES



Assembly complete with 2 Microphones, On-Off Switch, Amplifying Transformer, Batteries, Battery Case and Connector to attach to any radio, AC, DC, or battery portable. Tremendous amplification, up to the full volume output of the radio or sound system used. Perfect for watch and clock repair diagnosis, diesel engine injector adjustment, gasoline engine trouble shooting, or for use on any musical instrument with dance band or orchestra. Worth \$30.00. Your cost \$4.95

Howard E. Anthony, president of HEATH MANUFACTURING Co., was awarded an honorary degree of Doctor of Science in Electronics by the University of Hollywood. The degree was conferred upon Mr. Anthony at Benton Harbor, Mich., in recognition of his contributions to the field of industrial electronics.



Charles Odorizzi, former vice president in charge of service for the RCA VICTOR division, was elected operating vice president. Mr. Odorizzi joined RCA in 1949 as administrative head of service activities. RCA also announced the election of Edward M. Tuft as vice president and director of the personnel department. Mr. Tuft has been with RCA since 1930.



Peter L. Jensen, president of JENSEN INDUSTRIES, INC., received the Order of Knight of the Flag from King Frederick of Denmark on his recent trip to Denmark. Mr. Jensen was knighted for his contributions to the field of radio.



Sketch by Otto C.

Curtis A. Haines, former general manager of the photoflash division of SYLVANIA ELECTRIC PRODUCTS, was appointed general manager of operations for the radio and television picture tube divisions. Sylvania also announced the appointment of L. R. Wanner to the post of plant manager in charge of plastics operations for the parts division.

Dr. Vladimir K. Zworykin, director of electronic research and vice president of RCA Laboratories, will be awarded the 1951 Medal of Honor, the highest award of the Institute of Radio Engineers, at the IRE convention in March, 1951. Dr. Zworykin will be given the medal for his outstanding contributions to the development of television.



The Radio-Television Manufacturers Association named several important committees. The committees and their membership are:

JOINT ELECTRONICS INDUSTRY COMMITTEE: F. R. Lack, WESTERN ELECTRIC, chairman; Benjamin Abrams, EMERSON; C. F. Adams, RAYTHEON; W. R. G. Baker, GENERAL ELECTRIC; Max F. Balcom, SYLVANIA; William Balderston, PHILCO; W. J. Barkey, COLLINS RADIO Co.; Harold Buttner, I. T. & T.; John W. Craig, CROSLBY; Allen B. Du Mont, Du Mont; Harry A. Ehle, INTERNATIONAL RESISTANCE CO.; Walter Evans, WESTINGHOUSE; Malcolm P. Ferguson BENDIX; Frank Folson, RCA; Paul V. Galvin, MOTOROLA; R. E. Gilmour, SPERRY; W. J. Halligan, HALLICRAFTERS; H. L. Hoffman,

Get the Genuine! GENERAL ELECTRIC TV COMPONENTS



Horizontal Sweep Output and HV Transformer

RTO-085. For 66 to 70 degree tubes such as 14CP4, 16GP4, 19AP4, 24AP4. Max. HV to CRT anode 15KV. \$5.37
RTO-092. For 52 to 60 degree tubes. Max. HV 15KV to load. Long leads. \$5.37

DEFLECTION YOKE RLD-024
To sweep 70 degree tubes—\$4.17

EM-PM FOCUS COILS—\$1.17

RLF-026 for 10"-52° tubes
RLF-028 for 12"-52° & 16"-53° tubes
RLF-038 for 16"-70° round and rect. tubes

RTO-064 VERTICAL SWEEP OUTPUT TRANSFORMER (10:1 Ratio) \$2.67

WIDTH & LINEARITY COILS—\$7c

RLD-014—Width/Linearity—4-27 Mh
RLD-016—Linearity—1.3-11.5 Mh
RLD-019—Width—6.5-40 Mh
RLD-020—Linearity—0.3-3 Mh

HORIZONTAL OSCILLATOR COIL
RLC-081 Ferrite core oscillator coil is center-tapped for use in sine wave horiz. oscillator circuit with AFC. \$1.05

SINGLE ION TRAP MAGNETS 87c

RET-005 for 10" and 12" round 11KV and 19" round 14KV. Gauss—35
RET-003 for 14" and 16" rect. 13 KV and 24" round 18 KV. Gauss—42

Write for Free F. Y. I. Flyer
Address Orders to Dept. RE-12
or call MULberry 2134

WHOLESALE RADIO PARTS CO., Inc.
311 W. Baltimore St.
BALTIMORE 1, MD.

LET US PUT THIS Magnificent NEW 1951 MIDWEST TELEVISION



MAMMOTH 19 1/2-inch PICTURE TUBE
AM-FM Radio and 3-Speed Phonograph

Be your own judge! See and hear Midwest Television in your own home. Then decide whether to keep it or have your money refunded. Low Factory Prices.

Also Available on 30 DAYS TRIAL!
The Sensational New 5-Band World-ranging 1951 Model **MIDWEST RADIOS**

SEND THIS COUPON IN POST CARD FOR NEW 1951 FREE 4 COLOR MIDWEST CATALOG

MIDWEST RADIO & TELEVISION CORP.
Dept. 38-E, 909 Broadway, Cincinnati 2, Ohio

NAME _____
ADDRESS _____
CITY _____ ZONE _____ STATE _____

Leotone

HIDDEN MIKE—SPEAKER! (O. D. 1 — 1/2" x 9/16")... \$1.98
Block "U" Ring, Kit of 10 asstd. \$1.98
 (Write for Latest "Ainico Magnet" Supplement.)
Moulded Bakelite Components... 1.98
 .0001 to .2mfd. 200-600V. Kit of 50 asstd. .98
Knobs... Screw, spring, Kit of 25 asstd. .98
Water Sockets... 4 to 12" dia. Kit of 12 asstd. .25
Mica Padders—Trimmers... Kit of 15 asstd. .69
Potentiometers... W.W., Carbon, Less sw. 10/1.49
Rotary Selector Switches... Kit of 6 asstd. 1.49
Wire-Wound Resistors... 5-20watt. 15 asstd. .98
Dial Scales... P.M., A.M., 25 asstd. 2.49
Dial Windows... Acetate & Glass, Kit 12 asstd. 1.29
Speaker Repair Kit... Liberal assortment of Spiders, Rings, Felt, V.C. forms, Shims, Cement, Chamois Leather & Instructions, ALL FOR Speaker Cones... voice coil, Ass'tment of 12... 1.98
SPECIAL!—BOTH CONE & REPAIR KITS... 3.95

CHRISTMAS SPECIALS!—POWER RHEOSTATS

100W-350 Ohm... Pointer knob, steel case... \$0.98
 50W-15 ohm... 1.29
 50W-50 ohm... 1.49
 12-14W... Bulbs (21813), Bay. base... 8/1.00
DPDT Toggle... ea. 15c 8/1.00
 6A/125V. Split Ball... .39
 1/2" Red Jewel Assembly... bay. 29c 4/1.00
 Needle Contact Bypassing... Kit of 12 asstd. 1.00
4 TUBE Amplif. Foundation... PAITS GALONE!
 Slide-in chassis & cab. 8 1/2" x 4 1/2" x 3 3/4" \$0.98
 Blank Steel Chassis (2 1/2") 10" x 17" x 3" Cad. 1.89
 5PST Microswitch... Dim. N.O. 10A/125V. 1.39
 .05-600V Oil Condenser... 1" x 1 1/2" .10c 12/1.00
 Selenium Rect. F.W. Bridge, 18V. 6A... .98
 Push-Button Station Tabs... All U.S. Stations. 39
 Grille Cloth... 12"x17", rich mahogany. 49c 5/1.98
 Hi-Frequency Buzzer... 6V, fully adjust. .69
 Tube Carbons... Plain white (price per 100)
 Min. (1" sq. x 1 1/2") \$1.20; GT (1 1/2" sq. x 3 1/4") 1.45
 Med. (1 1/2" sq. x 4 1/4") \$1.85; Large (2" sq. x 5") 1.98
"Polytrens" Rod & Tubing... 12" lengths
 Rod: 1/4"-9c; 3/8"-19c; 1/2"-24c; 5/8"-33c; 3/4"-42c; 7/8"-51c; 1"-59c
 Tubing: 9c; 3/8"-12c; 1/2"-16c; 5/8"-21c; 3/4"-25c; 7/8"-34c; 1"-42c; 1 1/4"-51c; 1 1/2"-60c
High Fidelity Crystal Mike... Hi-imped. Rubber shock-mtd. 1 1/2" x 3/4". Less housing... .98
 Aluminum Housing for crystal mike... 1.15
 HS-23 Headset... hi-imped. 13" cord & PL-54 1.69
 Rubber Phone... 13" cord & PL-54 pair 2.59
 30 P.E. Magnet Wire... 400 ft. roll. 23c 5/1.00
 50W-25 Ohm "Dividohm" adjust. .29
 JK-33A Jacks... for PL-68... 23c 5/1.00
 Brown Bakelite Panel (1/16")... 1 1/2" x 1 1/2" 39c
 7"x14"-49c; 7"x18"-59c; 9"x15"-68c
115V. AC Induction Motor... 1750 RPM. Fract. HP. 2 1/2" x 3 1/2" x 1 1/2". Objc. 4" x 4" 1.39
 Mercury Switch... 1A/115V... .39c 3/1.00
 Antenna Base... all-steel. Adjusts over 180° .59
 Ceramic Octal Sockets... 1 1/2" x 1 1/2" x 1 1/2" 8/1.00
 18 Ft. Whip Antenna... 6 steel screw sects. 2.49
 Army Gas Mask... NEW. Adjust. less can. 39
 Min. Order \$3.00. 20% deposit on all COD's.
 Please add sufficient postage—excess refunded.
 Full remittance with foreign orders

LEOTONE RADIO CO.
 67 Dey Street,
 New York 7, N. Y.

OPPORTUNITY AD-LETS

Advertisements in this section cost 25¢ a word for each insertion. Name, address and initials must be included at the above rate. Cash should accompany all classified advertisements unless placed by an accredited advertising agency. No advertisement for less than ten words accepted. Ten percent discount six issues. Twenty percent for twelve issues. Objectionable or misleading advertisements not accepted. Advertisements for January, 1951, issue, must reach us not later than November 24, 1950.
 ..Radio-Electronics, 25 W. Broadway, New York 7, N. Y.

MAGAZINES (BACK DATED)—FOREIGN, DOMESTIC arts, Books, booklets, subscriptions, pin-ups, etc. Catalog 10¢ (refund). Clecron's, 86-22 Northern Blvd., Jackson Heights, N. Y.

FOR SALE: 10HP4 & 10FP4 \$8. 12LP4, 12K1P4 \$12. with 30 day guarantee. Shipped prepaid. David Furnish, 5920 Elston, Chicago 30, Illinois.

WE REPAIR ALL TYPES OF ELECTRICAL INSTRUMENTS, tube checkers and analyzers Hazleton Instrument Co. (Electric Meter Laboratory), 140 Liberty Street, New York, N. Y. Telephone—BARclay 7-4239.

LANCASTER, ALLWINE & RUMFEL, 436 BOWEN Building, Washington, D. C. Registered Patent Attorneys. Practice before United States Patent Office. Validity and infringement investigations and opinions. Booklet and form "Evidence of 'conception'" forwarded upon request.

RADIOMEN, SERVICEMEN, BEGINNERS — MAKE more money, easily, quickly. \$250 weekly possible. We show you how. Information free. Merit Products, 216-32L, 132nd Avenue, Springfield Gardens 13, New York.

RADIO — TELEVISION — ELECTRONICS — TUTORING \$5 per lesson—Mo. Tech., 3907 North 25th Street, St. Louis 7, Missouri

BRONZED BABY SHOES AT WHOLESALE. Retail Outlets Wanted. Texas Bronzecraft, Joinerville, Texas.

101 RADIO REPAIRING TIPS (BOOKLET). SEND 50 cents U.S. Radio, 135 E. 28 St., New York 16, N. Y.

ANOTHER OUTSTANDING JOBBER
RADIO SUPPLY, INC.
 724 NORTH HUDSON
 Oklahoma City 1, Oklahoma
 HAS THE
SENSATIONAL NEW
EICO 425-K 5"
SCOPE KIT
 \$39.95
IN STOCK!

HOPPMAN RADIO; J. J. Kahn, STANDARD TRANSFORMER; Arle Liberman, TALK-A-PHONE; W. A. MacDonald, HAZELTINE; E. F. McDonald, Jr., ZENITH; A. D. Plamondon, Jr., INDIANA STEEL PRODUCTS; Ross Siragusa, ADMIRAL.
"TOWN MEETINGS" COMMITTEE: Harry A. Ehle, INTERNATIONAL RESISTANCE CO., Chairman; Benjamin Abrams, EMERSON; A. T. Alexander, MOTOROLA; H. C. Bonfig, ZENITH; A. A. Brandt, GENERAL ELECTRIC; Leonard F. Cramer, DU MONT; J. B. Elliott, RCA; G. M. Gardner, WELLS-GARDNER; H. L. Hoffman, HOFFMAN RADIO; J. J. Kahn, STANDARD TRANSFORMER; Stanley H. Manson, STROMBERG-CARLSON; Leslie F. Muter, MUTER CO.; Henry T. Paiste, PHILCO; A. D. Plamondon, Jr., INDIANA STEEL PRODUCTS; Edward C. Tudor, INDUSTRIAL DEVELOPMENT ENGINEERING ASSOCIATES.

SALES MANAGERS COMMITTEE: Clifford J. Hunt, STROMBERG-CARLSON, Chairman; Stanley M. Abrams, EMERSON; A. A. Brandt, GENERAL ELECTRIC; William Dunn, BELMONT RADIO; V. C. Havens, CROSBY; William H. Kelley, MOTOROLA; E. G. May, SENTINEL RADIO; Allan Mills, RCA; John M. Otter, PHILCO; Stewart Roberts, MAGNAVOX; R. J. Sherwood, HALLICRAFTERS; Raymond P. Spellman, ARVIN; Walter L. Stickle, DU MONT; E. L. Taylor, STEWART-WARNER; L. C. Truesdell, ZENITH; J. F. Walsh, WESTINGHOUSE.
R. G. Zender, LENZ ELECTRIC MFG. CO., Chairman of the RTMA parts division named heads of the various Parts Division Section. These are
ANTENNA: G. O. Benson, PREMAX PRODUCTS.
CERAMIC CAPACITOR: K. E. Rolfeison, MUTER CO.
COIL: Edwin I. Guthman, EDWIN I. GUTHMAN CO.
FIXED CAPACITOR: W. Myron Owen, AEROVOX.
FIXED RESISTOR: D. S. W. Kelly, ALLEN-BRADLEY.
INSTRUMENT & TEST EQUIPMENT: R. L. Triplett, TRIPLETT ELECTRICAL INSTRUMENT CO.
METAL STAMPINGS & SPECIALTIES: Jay H. Johnson, JOHNSON & HOFFMAN, INC.
PHONOGRAPH CARTRIDGES: S. N. Shure, SHURE BROS.
RECORD CHANGERS: H. E. Moon, GENERAL INDUSTRIES.
SOCKETS: Lester W. Tarr, CINCH MFG. CO.
SPEAKERS: Matt Little, QUAM-NICHOLS.
SPEAKER PARTS: Wm. H. Welsh, WM. H. WELSH CO.
SPECIAL PRODUCTS: W. R. MacLeod, KING LABS.
SWITCHES: W. S. Parsons, CENTRALAB DIV. Globe-Union.
TRANSFORMERS: L. S. Racine, CHICAGO TRANSFORMER DIV. Essex Wire Corp.
TUBE PARTS: S. L. Gabel, SUPERIOR TUBE.
VARIABLE CAPACITORS: Russell E. Cramer, Jr., RADIO CONDENSER CO.
VARIABLE RESISTORS: Victor Muehler, CLAROSTAT.
WIRE: John S. Miller, CORNHILL WIRE.
WIREWOUND RESISTORS: Roy S. Laird, OHMITE.
BUDGET: Charles A. Hansen, chairman; Samuel J. Spector; Herbert C. Clough, BELDEN MFG. CO.; Lew Hairy, HATRY & YOUNG and Lew Howard.

Jerome J. Kahn, president, STANDARD TRANSFORMER CORP., was elected for a second term as president of the Radio Parts and Electronic Equipment Shows board of directors. Samuel J. Spector, INSULINE, was elected vice president; Lew Howard, TRIAD TRANSFORMER, secretary; and Charles A. Hansen, JENSEN MFG. Co., treasurer. Mr. Kahn appointed the following committees:



PUBLICITY: John H. Cashman, RADIO CRAFTSMEN, INC., chairman; Tom Jenkins, RADIO SUPPLY CO.; Jerry Kirshbaum, PRECISION APPARATUS CO.
HOUSING: Samuel J. Spector, chairman; John H. Cashman; Lew Howard and Tom Jenkins.
ARRANGEMENTS: Entire board of directors and Charles Golenpaul, AEROVOX; Walter W. Jablon, ESPEY MFG. Co.; Harry Kalker, SPRAGUE ELECTRIC; and William O. Schoning, LUKKO SALES.
ENTERTAINMENT: Jerry Kirshbaum, Lew Howard, and Charles Hansen.
CREDENTIALS: Lew Hatry, Charles Hansen, Jerry Kirshbaum, and Tom Jenkins.
EDUCATIONAL: Jack Berman, SHURE BROS.; Herbert C. Clough, John Cashman; John F. Rider, JOHN F. RIDER, Publisher; and Howard W. Sams, HOWARD W. SAMS & Co.
MANUFACTURER-DISTRIBUTOR ADVISORY COMMITTEE: Herbert C. Clough, chairman; William O. Schoning; W. D. Jenkins, RADIO SUPPLY CO., Richmond, Va.; L. W. Hatry; W. A. Wilson, HUGHES-PETERS; George Barbey, GEORGE D. BARBEY CO.; Lew Bonn, LEW BONN CO.; H. L. Dalis, H. L. DALIS, Co.; Sam Poncher, NEWARK ELECTRIC; Charles Golenpaul, AEROVOX; Milton Deutschmann, RADIO SHACK; Walter W. Jablon, ESPEY COMPANY; John Stern, RADIO ELECTRIC SERVICE Co.; Les Thayer, BELDEN MFG. Co.; Robert Sprague, SPRAGUE ELECTRIC.

QUAM Adjust-A-Cone SPEAKERS



LOOK FOR the U-Shaped COIL POT

FIRST IN REPLACEMENT FIELD
FIRST FOR ORIGINAL EQUIPMENT

You can always tell a Quam Adjust-A-Cone Speaker by the U-Shaped Coil Pot—and its superior performance!

This exclusive coil pot design provides an unbroken path for the magnetic lines of force, producing a stronger magnetic field, increasing efficiency and improving performance. It's another one of the superior features that service-men consider when they

REPLACE WITH QUAM
WRITE FOR CATALOG
 of complete QUAM line

Also makers of Quam Focalizer Units and ION Traps

QUAM-NICHOLS COMPANY

531 E. 33rd Place
 Chicago 16, Illinois

MAKERS OF QUALITY SPEAKERS FOR 27 YEARS, UNDER THE SAME MANAGEMENT

antenna manual

The most practical, comprehensive book on antennas. 300 pages of down-to-earth help on antenna, feed line, radiation and propagation for all frequencies up to 1000 Mc. Including FM and TV. Plain language; no need to brush up on math. A necessity for everyone interested in transmission or reception.

\$3.50 PER COPY —
 By mail, \$3.65 postpaid. Foreign, \$3.75

AT YOUR FAVORITE DEALER
 OR DIRECT BY MAIL FROM
Editors and Engineers
 1355 KENWOOD ROAD, SANTA BARBARA, CALIFORNIA

REAL VALUES!

BC 906—Frequency Meter
Range 150-225 MC with modification possible for lower frequencies of TV, etc. Contains 0-500 DC microammeter and uses Battery pack of 1.5 V and 45 VDC. **\$10.95**
Like New—Less Batteries.....

Miscellaneous Specials

	Used	New
ASB 7 Indicator Scope.....	\$12.95	
BC 1206 Receiver, 200 to 400 KC		\$5.95
MN 26C	17.50	24.95
RA 10 DA Receiver	17.50	24.95
RT7/APNI Transceiver	6.95	9.95
APN I Complete		24.50
BD 71 6 Pos. Switchboard	9.95	12.95
BC 347 Interphone Amplifier		1.89
1-70 Tuning Meter		New .59
BC 461 Vocoder Root Counter		1.49
BC 442 Less Condenser		1.95
AFS 13 UHF Antenna, Pair		2.95
FL 8 Filter		4.95
1-97 Bias Meter	3.95	7.95
RM 29 Remote Telephone Control		7.95
BC 602 Control Box		7.98
RL 42 Antenna Gearbox Motor	4.95	7.50
TS 10—Sound powered phones	6.50	
BC 1068 B—150 to 225 MC Portable Receiver adaptable to many amateur uses. In Canvas Carrying Bag, Used		\$5.95
Tuning Units for BC 375—Presently most numbers are available in excellent condition with case at 2.95 ea.		
BC 308—Antenna Tuning Unit for BC 375. Excellent Condition		1.50 ea.
One Tube Interphone Amplifier—Small Compact aluminum case fully enclosed. 2 1/2" x 3 3/4" x 5 1/2". Less Tube		79c
BC 709—Battery operated lightweight interphone amplifier. Complete with tube and shock mount, but less battery		3.95
Motor—Universal Electric. 24 VDC, will also operate on 24 VAC Diameter 1 1/2"; Length 2 9/16. Shaft 1/4" x 3/4"		New 1.49
MC 385A—Headset Adapter		New .49

BC 620

Receiver-Transmitter—2 crystal channels—20 to 27.8 MC FM—13 tubes. Metered. Plate and Filament. **\$14.95**
Used 9.95
PE 97 Power Supply for above 6-12 volt vibrator type. Used less tubes, vib. & Con. **\$2.95**
FT 250 Mount for both BC620 and PE97 New **\$1.50**

Portable VHF Communication Unit

Two-way radio telephone equipment designed for operation between 152 and 162 mcycles. Adaptable for many uses, a complete unit including the rechargeable storage battery weighs but fifteen pounds, and is housed in a sturdy case 11 1/2"x9"x4 1/2", provided with shoulder straps. This brand new set of big name manufacture comes complete with battery, battery tray, and handset but less crystal **\$89.50**
Battery charger is extra at **\$19.95**

Mobile VHF Communication Unit

Adaptable for many mobile uses, this is a compact unit 3 1/2"x8"x1 1/2", operating on 152 to 162 mcycles. It is six-volt powered direct from storage battery, and is complete with the tone filter and crystal; handset, control box, antenna and installation **\$129.50**
kit. Brand new, ready to go.
Extra 18" stub type antennae are available... **\$2.95**

SURPRISE PACKAGE

20 lbs. Ass't radio parts. A \$25.00 value for only **\$1.95**

COMMAND (SCR 274 N) EQUIPMENT

	Used	New
BC-453	\$12.95	
BC-454	5.95	9.95
BC-455	7.95	2.95
BC-456		2.95
BC-457	5.95	
BC-458	5.95	8.95
BC-459 (or T19)	14.95	24.95
BC-450—3 Receiver Remote Control	.89	1.95
BC-442		2.95
3 Receiver Rack	1.95	
2 Transmitter Rack	1.50	
Complete Command set as removed from aircraft—3 receivers—2 transmitters—Relay unit—control boxes—mounting racks—plugs—modulator and dynameters—crated Set		\$34.50

RT7/APNI TRANSCEIVER UNIT

Used as an altimeter, it may be converted for signaling control circuits, citizens bands, etc. Complete with 14 tubes and dynamotor they are in good used condition at the amazingly low price of **\$6.95**

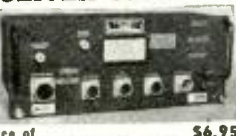

All shipments FOB warehouse. 25% deposit required on all orders. Minimum order accepted—\$5.00. Illinois residents, please add regular sales tax to your remittance.

ARROW SALES, Inc.
Dept. E
1712-14 S. Michigan Ave., Chicago 16, Ill.
PHONE: HARRISON 7-9374

TRUETONE RECEIVERS

When aligning these receivers, don't pass up the r.f. or antenna trimmers if you can't peak them. Most of these sets are designed to have a definite peak with r.f., oscillator, and antenna trimmers. Replace the converter (and r.f. tube, if necessary) even when they check O.K. on a tester. An aged tube might change its input capacitance so much that the tuned circuits can't be peaked.—*David Gnessin*

PHILCO MOPAR SETS

Lack of volume and distortion often show up after Mopar custom-built sets have been operating for about an hour. These troubles are almost invariably caused by the tiny 47,000-ohm resistors in the plate and cathode circuits of the phase-inverter tube. These resistors are under strain and sometimes open intermittently. Replace them with standard 1/2-watt units.—*T. M. Ferreira*

LICKING AN INTERMITTENT

If you are still stuck with an intermittent receiver after trying all the tricks in the book, subject the set to several cycles of heating and cooling. In winter, leave the set near a radiator or furnace for one day, then put it outside for another. Do this several times. In summer, use a sunny spot and a refrigerator. A few cycles of heating and cooling will almost invariably show up the faulty part.—*Leonard Pfeiffer*

AUTOMOBILE RADIOS

Many automobile radios, particularly the 1947 Chevrolet models, have dynamic speakers with the hot 6-volt lead connected to an insulated eyelet which is used as a tie-point. These eyelets invariably twist around and short to the speaker frame, making the fuses blow. This won't happen again if you drill out the eyelet and replace it with a small, one-lug, insulated terminal strip.—*Bob Williams*

THE RADIUM ATOMIC SPINTHARISCOPE

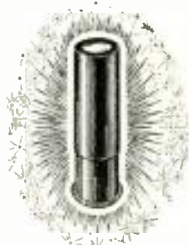

THE SPINTHARISCOPE is one of the most amazing scientific instruments ever invented. The SPINTHARISCOPE demonstrates that radium actually destroys atoms. Look into the SPINTHARISCOPE and you see a whole firmament lit up like a brilliant night sky. You observe thousands of "stars" and untold bright flashes similar to showers of shooting stars. Every flash is the result of the destruction of one atom of radium. These fast moving Helium atoms (also called Alpha rays) produce a minute flash of light when they strike a crystal of zinc sulphide contained in the SPINTHARISCOPE. The magnifying lens of the instrument makes these flashes visible to your eye. The actin keeps on going for over 1800 years. Our SPINTHARISCOPE actually contains a small quantity of radium. If you want to see a most awe-inspiring sight, witness the actual destruction of thousands of worlds (atoms are miniature worlds), by simply looking through the lens of the instrument.

See RADIUM DISINTEGRATED AND DESTROYED RIGHT BEFORE YOUR EYES!

The RADIUM SPINTHARISCOPE
Item No. 100

Price, Postpaid 75c

HUDSON SPECIALTIES CO., 40 West Broadway, New York 7, N.Y.

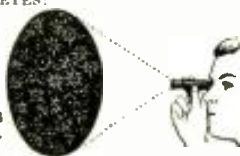

3 TUBE PHONO AMPLIFIER

Designed for use with all types of records. 2 1/2 watt output, completely wired, has 2 controls. Volume and on-off switch, and tone control. Compact—that it is easy to mount anywhere.



ONLY **\$2.39**

	\$1.89
SET OF TUBES FOR ABOVE AMPLIFIER	\$1.89
50L6 output Trans. for above	.99
4" PM Speaker	1.15
5" PM Speaker	1.55
6" PM Speaker	1.95
12" PM Speaker	1.95
Hi-Volt Phono Pickup & Hardware	1.79
Med-Volt Phono Pickup & Hardware	1.79
Hi-Volt Crystal Cartridge	1.79
Med-Volt Crystal Cartridge	1.79
78 RPM Phono Motor & Turntable	2.89
3 Speed Phono Motor & Turntable (78, 33 1/3, 45 RPM)	4.95
3 Speed Pickup with Hardware	5.25

WE CARRY A COMPLETE LINE OF CONDENSERS, RESISTORS, RECEIVING TUBES, RADIO & TV PARTS.

Write for free descriptive literature—Dept. 12RE. All Prices F.O.B. New York. 25% deposit required on all orders. Minimum order \$5.00.

THE ROSE COMPANY 98 Park Place
(Corner Greenwich St.) New York 7, N. Y.

WE GOT EM! TUBES—TUBES

WE CAN MAKE IMMEDIATE DELIVERY ON THE FOLLOWING TUBE TYPES IN REASONABLE QUANTITIES

2A5	1.10	6J5	.90	12SL7	1.40
2X2	1.50	6J6	1.74	26	.80
5V4	1.44	6K6	.99	27	.80
3V3	.75	6K7	.99	32L7	1.50
5Z3	1.08	6L6	1.60	50	1.25
6AC7	1.74	6R7	1.59	56	.85
6AJ5	2.34	6SA7	.99	76	.89
6AK5	2.34	6SC7	1.20	77	.89
6AK6	1.44	6SD7	1.40	78	.80
8B7	1.50	6SF5	.80	80	.69
6C4	.80	6SK7	.80	84	.90
6CB	1.20	6SQ7	.75	84	.90
6D6	.99	10 or 210	1.25	85	1.05
6F7	1.73	12AT6	.90	117L7	2.34

Many of the above are JAN tubes. Manufacturers quantities on some of the above. No reduction while present shortage lasts.

BUFFALO RADIO SUPPLY

219-221 Genesee St., Dept. RE 11
Buffalo 3, N. Y.

GREYLOCK'S NEW CATALOG!

- ★ Crammed full of
- ★ Great Money-Saving Values for YOU
- ★ Bargains you can't afford to miss
- ★ More than TWENTY Standard Brand lines of Merchandise

Write TODAY for your copy, to Dept. C-12
GREYLOCK ELECTRONICS SUPPLY CO.
115 Liberty Street New York 6, N. Y.

CANDD "ON-THE-SPOT" RECORDER-TRANSCRIBER

WALKIE-RECORDALL
8 lb. miniature BATTERY RECORDER PLAYBACK Continuous, permanent accurate, indexed recording at only 5c per hr. Instantaneous, permanent playback. Picks up sound up to 80 ft.
Records conferences, lectures, dictation, 2-way phone & sales talks; while walking, riding or flying. Records unclosed briefcase with "hidden" mike.
MILES REPRODUCER CO., INC. Dept. RE1
812 8'way New York 3, N. Y. SP 7-7670

PEN-OSCIL-LITE

Extremely convenient test oscillator for all radio servicing. Alignment • Small as a pen • Self powered • Range from 700 cycles audio to over 800 mcycles u.h.f. • Output from zero to 125 v. • Low in cost • Used by Signal Corps • Write for information.

GENERAL TEST EQUIPMENT
38 Argyle Ave. Buffalo 9, N. Y.

BLINKING PILOT LAMPS

Pilot lamps which blink intermittently in a.c.-d.c. sets can be caused by an intermittent heater in one of the tubes. Locate the faulty tube by connecting a fast-acting a.c. voltmeter across each heater until you come to one which causes the meter to rise above normal when the pilot is off. Replace this tube.—*DeLoss Tanner*

TRAV-LER 5028-A

If this set comes in with an open filament in the 3V4 power amplifier tube, check the filament dropping resistor which is located above the chassis, behind the speaker. Its bottom lug sometimes cuts through the insulation and shorts the red lead going to the top of the resistor. Reinsulate the lead and turn the lug away from it.—*Hurley D. Robinson*

FORD RADIO MODEL 6MF780

If this set will not play or will not receive stations except at one spot on the dial, the trouble may be traced to the shunt coil in the oscillator circuit. This coil has been found open due to improper soldering and waxing. The connections of the oscillator coil are shown.

To locate the trouble measure the resistance across the 6.2-ohm section of the coil with a low-range ohmmeter. Since the 3-ohm shunt coil parallels this section of the coil, the meter will read approximately 2 ohms if the coil is good. A 6-ohm reading indicates that the shunt coil is open.

Cleaning and resoldering the connections usually clear up the trouble.—*Adams Radio Service*

KILLING BIRDIES AND OSCILLATION

To determine the source of oscillation in a receiver, tune the set for a good beat note or birdie. Use a metal tool such as a screwdriver to probe around the grid and plate leads of the r.f., mixer, and i.f. stages until there is an abrupt change in the audio note. Verify your findings by detuning the suspected circuit. This will also change the frequency of the beat. Check the alignment, shielding, lead dress, bypass capacitors, and decoupling networks for causes of oscillation. Do not overlook possible coupling between a loop antenna and the mixer or i.f. stages.—*Charles Buscombe*



Tops in Quality, Value and Dependability!
HUDSON
RADIO & TELEVISION CORP.

Our Giant Store and Warehouse features Every Modern Shopping Convenience, including a Complete Line of RCA Tubes, Test Equipment, Batteries, Radio and TV Replacement Parts, etc. Visit our Elaborate Sound Studio and New York's First "Radio Super-Market"—Serve Yourself and Save on Thousands of Standard and Surplus Items! Mail Orders Shipped to All Parts of the World—Quickly, Completely!

NEW RCA WO-56A 7" OSCILLOSCOPE

Unequaled in Performance, Unmatched in Versatility! This new extremely sensitive RCA 7" Scope features DUAL CONTROLS for Coarse and Fine adjustments, Identical Vert. and Horiz. Amplifiers... for response flat down to DC... for measuring DC component in AC signal circuits. Push-Pull throughout, High Amplifier Output and Gain, Phase Equality. Advanced sweep facilities include preset fixed positions for TV vert. and horiz. waveforms, plus or minus sync for easy lock-in of upright or inverted pulse waveform, line-frequency sweep and sync, with phasing. Frequency Response of both amplifiers flat within —2 db from DC to 500 Kc; within —6 db at 1 Mc; useful beyond 2 Mc. Square wave response — no tilt and over-shoot. Both amplifiers have frequency-compensated and voltage-calibrated attenuators. Peak-to-peak calibrating voltage source.
No. A19, Ship. Wt. 31 lbs.....Net **\$197.50**

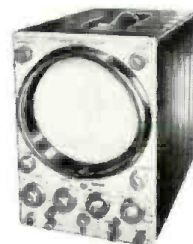

TERRIFIC! RCA 51552 15" Duo-Cone SPEAKER

Engineers and professional sound technicians have nothing but praise for this sensational new RCA unit. A development of Dr. H. F. Olson, famous RCA speaker authority, it provides remarkable listening quality at a moderate price. Employs two voice coils, each driving one of the duo-cones, which vibrate as a single cone, at crossover frequencies (around 2,000 cps), avoiding "crossover" interference. Has high sensitivity at high power levels — will handle up to 25 watts. Delivers superb, high fidelity performance from 40 to 12,000 cps, over 60° angle. Requires no crossover network. Magnetic structure contains a bridge network to supply equal flux density to the air gap for each voice coil, from a 2 pound Alnico V magnet. 16 ohms impedance.

No. A53, RCA 51552 Speaker, Ship. Wt. 18 lbs.....Net **\$48.50**
Price Includes 2% Discount



RCA TV COMPONENTS

All RCA Television Components are "originals," designed with characteristics which are correct both electrically and mechanically for the tubes and circuits. They are competitively priced!

RCA TUBES

RCA's unparalleled research facilities and manufacturing experience contribute to the quality, dependability, and operating economy of EVERY RCA tube. The Quality of



FREE
SEND FOR C...
NEW 19...
CATAL...

HUDSON
RADIO & TELEVISION CORP.

... if you are commercially or professionally interested in TV, read

TELEVISION ENGINEERING

for news of all that's NEW in the lab, plant and station involving design, manufacture, operation and maintenance of TV equipment for research, production, testing, receiving and transmitting.

Special Rate: 3 yrs. (36 issues) \$5

Bryan Davis Publishing Co., Inc.
(Publishers of SERVICE)
52 Vanderbilt Ave., New York 17, N. Y.

Over 43,000 Technicians Have

HOW TO GET THE MOST OUT OF BASIC TEST EQUIPMENT

Why Not You, Too?

SERVICING by SIGNAL SUBSTITUTION

A BEST SELLER FOR OVER 9 YEARS! (NEW, UP-TO-DATE, 11TH EDITION)

The Simple, Modern, Dynamic Speed Approach To Receiver Adjustment and Alignment Problems, AM-FM-TV.

- Nothing complex to learn
- Universal — non-obsolete
- No extra equipment to purchase
- Employs Only Basic Test Equipment

only **40¢**

100 pages. Invaluable information that will help you re-double the value of your basic test equipment.

Ask for "S.S.S." at your local Radio Parts Jobber or order direct from factory.

PRECISION APPARATUS COMPANY, INC. • 92-27 Horace Harding Blvd., Elmhurst 4, N. Y.

BEST WISHES and BEST VALUES from NIAGARA
ONE OF AMERICA'S GREAT ELECTRONICS STORES

TRANSFORMER BARGAINS!

Plate

750-0-750—300 MA.	\$ 7.50
1025-0-1025—500 MA.	17.95
2500 V.—4 MA.	3.95

Filament

2.5V-5A, 7.5V-4A.	\$2.60
2.5V-10A cased	4.95
5 V.C.T.-3A	1.35
5V-10A	1.85
5 V.C.T.-10.5A	2.15
5 V.C.T.-15A	5.95
6.3V-3A	1.29
6.3 V.C.T.-3.5A	1.49
Three 6.3 V.C.T.-4A each.	1.80
6.3 V.C.T.-6A	1.85
6.4V-8A	2.05
7.5V-5A	2.49

Power

40-0-40—250 MA.—5V-3A	\$1.25
55-0-55—250 MA.—5 V.C.T.-3A, 5 V.C.T.-3A	1.35
175-0-175—150 MA.—6.3V-6A	2.15
275-0-275—70 MA.—5V-5A, 2.5V-10.5A	3.00
325-0-325—40 MA.—5 V.C.T.-2A, 2.5 V.C.T.-4A	2.25
325-0-325—70 MA.—6.3V-1.2A, 5V-3A	2.95
350-0-350—70 MA.—5V-3A, 6.3V-3A	3.05
350-0-350—100 MA.—6.3V-6A, 6.3V-2A	3.25

Modulation

807 to P.P. 6L6	\$2.49
P.P. 807 to single 6L6, 4D32 (2400 ohms)	3.49
From 200 500 ohms to 5 000 1000	2.49

ORDERS FOR TUBES IN THIS LISTING will be honored at these prices if post-marked no later than Jan 1st 1951. SEND IN YOUR ORDER TODAY!

RECEIVING TUBES

0A2	\$1.75	6F6	.80	12SJ7	.48
0A3/VR75	1.30	6F7	.84	12SK7	1.25
0A4C	.94	6F8	1.25	12SL7	.98
0B6	1.74	6G5	.85	12SN7	1.10
0B3/VR90	1.30	6Q8	.68	12SQ7	.78
0C3/VR105	1.30	6J5	.98	12Z3	.98
0D3/VR150	.80	6J7	1.24	12X3	.68
0Y4	.88	6J8	.96	14A7	.88
1A3	.60	6K5	.78	14B8	.68
1A3P	1.08	6K6	1.06	14F7	.88
1ASGT	.48	6K7	.65	1486	.68
1A6	.78	6K8	.78	1488	.68
1A7CT	.88	6L6	2.10	14C7	.88
1B4	1.18	6L6G	.78	14E6	.72
1B5/255	.88	6L7	1.18	14F7	.88
1B7	1.25	6M7	.98	14F8	.68
1C5	.66	6N7	.96	14F9	.98
1C7	.88	6P5	.96	14F8	.98
1D5	.88	6Q6	1.06	14M7	1.06
1D7	.88	6Q7	.78	14J7	.88
1D8	.94	6R7	.78	14N7	.88
1E5	1.38	6S7	.96	14Q7	.68
1E7	1.36	6S8	1.06	14R7	1.06
1F4	.74	6SA7	.98	14S7	1.06
1F5	.74	6S7	.62	14T7	.88
1F6	1.52	6S7	.98	14X4	1.06
1F7	1.56	6S7	.98	14X7	.98
1G6	.68	6S7	.58	22	.95
1M4	.68	6S7	.98	24	1.66
1M5	.90	6S7	.62	25A6	1.16
1M6	.88	6S7	.80	25AC6	1.25
1J6	.88	6SK7	1.20	25L6	1.25
1L4	.68	6SL7	.98	25Z6	.98
1L4A	1.25	6SR7	.98	25Z6	.98
1LA6	1.25	6SR7	.98	25Z6	.98
1L84	1.25	6ST1	.88	27	.40
1LC5	1.25	6SV7	.88	28D7	.75
1LC6	1.25	6SV7	.98	31	.86
1LD5	.90	6T5 GS	.98	32	.96
1L5	.88	6U6	.58	32L7	1.06
1LGS	.88	6U7	1.50	33	.68
1LM4	.84	6U7	.88	34	.68
1LNS	.95	6V6	.75	35	.51
1LNSGT	.68	6X4	1.25	35A5	.98
1P5GT	1.20	6Y6	1.25	35B5	.98
1R4	.95	6Y7	1.14	35C5	.98
1R5	.98	6Z5	.68	35L6	1.25
1R7	.78	7A4 XXL	.58	35T4	.89
1V	.88	7A6	.66	35Z4	.89
2A3	.68	7A7	.56	35Z5	.75
2A4	1.95	7AD7	.98	36	1.25
2A5	.68	7AF7	.72	36	.38
2A6	.78	7AG7	.98	39/44	.26
2A7	.88	7AH7	.88	41	.75
2B7	.88	7B4	.58	42	.48
2V3	.68	7B5	.72	43	.48
2X2	.68	7B6	.54	45	.75
2X2A	.55	7B7	.58	45Z3	.75
2S	.98	7B8	.72	45Z5	.75
3A5	1.98	7C4 1203A	.36	46	1.28
3A5A	.34	7C5	.98	47	.68
3A5B	.34	7C6	.72	48	3.95
3A5C	1.24	7C7	.78	49	.88
3A5D	.90	7E5	.65	50	1.28
3A5E	1.10	7E6	.58	50A5	1.25
3A5F	.98	7E7	.68	50B5	1.50
3A5G	.80	7F7	.98	50C5	1.50
3A5H	1.50	7F8	1.06	50L6	1.50
3A5I	.98	7G7	1.06	50Y6	.90
3A5J	.70	7H7	.75	53	.86
3A5K	.58	7J7	1.06	56	.43
3A5L	.75	7K7	1.06	57	.37
3A5M	1.25	7L7	.68	58	.48
3A5N	.88	7N7	.98	59	.88
3A5O	1.28	7Q7	.58	70L7	1.98
3A5P	.68	7R7	.68	71A	.66
3A5Q	.98	7S7	1.06	75	.98
3A5R	.88	7T7	1.25	76	.38
3A5S	.88	7W7	.88	77	.42
3A5T	.98	7X7 XXFM	.88	78	.44
3A5U	1.16	7Y4	.56	79	.88
3A5V	.88	7Z4	.56	81	1.28
3A5W	1.28	10	.69	82	.86
3A5X	.78	12A	.96	83	1.35
3A5Y	.78	12A6	.39	83V	1.60
3A5Z	1.06	12A7	.97	84	.90
3B5	.88	12A8	.98	85	1.10
3C5	.88	12AM7	1.30	89	.72
3D5	4.98	12AL5	.80	89Y	.38
3E5	1.59	12C8	.48	117L M7	1.56
3F5	.68	12F5	.57	117N7	1.75
3G5	.78	12H6	.35	117P7	1.26
3H5	.88	12J5	.35	117Z3	.75
3I5	.88	12J7	.80	117Z4	1.16
3J5	.55	12K7	.53	117Z6	1.20
3K5	.55	12K8	.58	9001	1.50
3L5	1.28	12Q7	.48	9002	1.50
3M5	.68	12S47	1.25	9003	1.50
3N5	.67	12SC7	.98	9004	1.50
3O5	.87	12SF5	.58	9005	1.50
3P5	1.10	12SF7	.58	9006	.35
3Q5	1.06	12SG7	.56	1273	1.25
3R5	.98	12SH7	.35	1280	1.25

8	HY.	40 MA.	1.25
10	HY.	200 MA.	2.35
40	HY.	180 MA.	3.49
10	HY.	90 MA.	2.49
12	HY.	200 MA.	1.75
15	HY.	125 MA.	1.60
15	HY.	200 MA.	2.65
20	HY.	125 MA.	1.75

IMPORTANT NOTICE: Minimum Order \$5. Quantity prices on request. All items in stock now—subject to prior sale—prices subject to change without notice. 20% Deposit with orders unless rated. All prices F.O.B. our N.Y.C. Warehouse.

Niagara Radio Supply Corp. Phone Dlgby 9. 1132-3.4
Dept. C-120 160 Greenwich Street, New York 6, N. Y.

GE MODEL G61
This set came in with the complaint that it would play when push-button tuning was used but could not be tuned manually on the broadcast or short-wave bands. Checking the oscillator circuit with a dynamic analyzer, we found it to be operating properly on

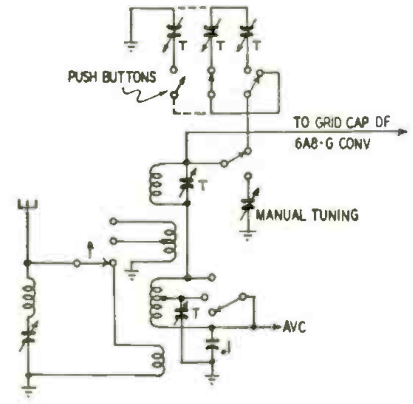

manual and push-button tuning. After setting the receiver for touch tuning, we connected an ohmmeter across the antenna tuning capacitor and found it shorted. The short was cleared by separating the plates, which were touching. The diagram shows the antenna circuit when the set is adjusted for push-button tuning.—*Manuel E. Silva*

RCA 26X1
Intermittent noises and squealing are frequent complaints on this and similar models. Trouble-free perform-

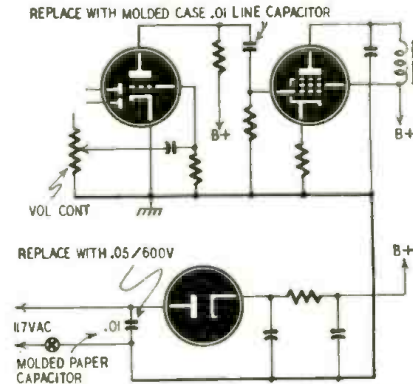

ance can sometimes be had by replacing the 600-volt capacitor between B-minus and the chassis.—*Peter Bedrosian*

CROSLEY 10-401 AND OTHERS
The horizontal oscillator in the models 10-401, -404, -412, -414, -416, and 10-418 has a tendency to drift, thus causing the receiver to lose horizontal sync after it has warmed up. If the horizontal sync adjustment is made after the set has warmed up, the picture will not fall in sync when the receiver is cold.

This trouble is caused by a molded capacitor C160 (type 487) which may change capacitance with temperature. The capacitance change is sufficient to cause the receiver to lose horizontal sync.

Correct the trouble by replacing it with a .01- μ f, 600-volt paper capacitor (part No. 39001-13).—*Crosley Service Department*

EXPERIMENTAL ARTICLES

Dear Editor:

Regarding your query in the January issue "Shall we abandon experimental articles?" I feel that it would be a great loss to those readers interested in all phases of electronics. The growth of science is based largely on experiment and without it knowledge and industrial growth would stagnate. Anything that will stimulate thinking is worthwhile.

Here is a short list of some problems that need further working on. None of them are new, but they all are in need of development.

Simplified full-color three-dimensional television; more efficient loudspeakers; improved transistors; uses for electrets; biological electronics—diagnosis and cure of disease; electronic weather forecasting; high power-to-weight ratio storage batteries; power from the sun's energy; radio transmission of power; electronic rain-making; electronic insect extermination; efficient hearing aid battery.

VANCE PHILLIPS

Santa Barbara, Cal.

SIG GEN TABULATION

Dear Editor:

I have made good use of the tabulation of multitesters you printed in May, 1949, comparing the testers shown before buying one. Now I need a standard signal generator and have been

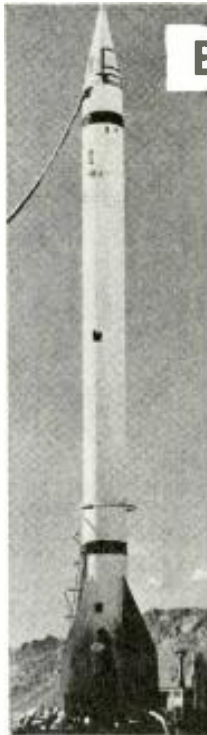

APPROVED FOR VETERANS — New classes start twice a month. High level home study training also available for professional radio men.

**CAPITOL RADIO
ENGINEERING INSTITUTE**
16th Street and Park Road
Dept. 3012B, Wash. 10, D. C.

Whether you're in the Armed Services or in Industry
**ELECTRONICS TRAINING PAYS OFF
WITH INTERESTING JOBS AND HIGHER EARNINGS**

CREI Residence School training offers quick promotion in uniform as well as profitable civilian careers

IN or out of the armed services, the best jobs go to the men with technical training. If you are prepared with electronics training, you're fortified for the future, whether you're headed for a berth in the armed services or a career in essential industry. Because of the critical shortages that exist today in the electronics industry, the *qualified* technicians and engineers can practically choose their own futures. Because of the dependence of modern armies, navies, and air forces upon electronics—for radar, communications, and navigation—the man with even limited knowledge of electronics gets ahead quickly in uniform. In case you're called to active duty before completion of your CREI course, you'll still be way ahead, for the armed services will choose you for further electronics training in place of the completely un-trained man.

At CREI you'll work with the latest equipment—over 120,000 square feet of modern class rooms, TV and radio broadcasting studios, transmitters, control rooms, and experimental labs. Here you're grounded in the fundamentals required for work in guided missiles, TV, and all the other important fields of communications and electronics. CREI's experience in training thousands of men for the Army, Navy and Coast Guard in World War II, coupled with pioneering background in technical education and close industry connections, assure you of the best in technical preparation. To insure your training ACT RIGHT NOW. Send today for free Residence School catalog.

FOR FREE CATALOG, MAIL COUPON NOW!

CREI—16th & Park Rd., Washington 10, D. C.
Please send free Residence School Catalog.
Name.....
Street.....
City..... Zone State.....
Veteran Non-Veteran Age.....
Send details about Home Study Courses 3012 B

FATHER OF RADIO

THE STORY OF LEE DE FOREST — AS HE HIMSELF TELLS IT.



ONLY \$5.00 One of the great books on electronics

One of the most remarkable books on radio ever written! The inside story by the man who made modern radio possible—Lee de Forest, the "Grand Old Man" of Radio himself. Facts that he alone could tell, details only he knows—gathered together in one complete, monumental volume! This story of the greatest radio genius of our day makes the FATHER OF RADIO "must" reading for every technician, engineer, experimenter, hobbyist and student. A glance at the titles of some of the 51 fact-packed chapters shows you what a tremendous book it is—"Beginning Wireless," "1903-Historic Firsts," "Conception of the Audion," "Radio," "Transcontinental Telephony," "Pioneering in Talking Pictures," "Early Television Work," "Diathermy," "Television." 528 pages bulging with vital facts about the birth and growth of electronic science. 16 pages of technical and historical photos and diagrams. Thoroughly indexed. Appendix presents an historic paper on the Evolution of the Audion.

Lee de Forest traces the conception and development of his 203 inventions from an apparatus for space communications in 1902 to a high voltage generator in 1949. Here is just a smattering of the impressive "firsts" on which he holds patents:—Wireless Telegraphy, Magnetic Detector, The Audion and its Successors, High Frequency Oscillator, Amplifier for rf Currents, Oscillating Current Generator, Range Teller, Radio Telephony, Radio Receiving Systems, Talking Motion Picture Film, Television Reception and Projection, Radial Scanning Television System, Color Television, Cathode Beam Tube.

And, that's just a few. The FATHER OF RADIO not only describes their technical development but tells the inside personal story behind them. Over and above his unparalleled scientific greatness, Lee de Forest is a fine writer. From his first word to the final paragraph, the FATHER OF RADIO captures and holds interest.

This is one of the greatest historical electronics books ever written. For the wealth of invaluable information it presents, the low \$5.00 cost of FATHER OF RADIO makes it the greatest book value ever offered in this field.

WILCOX & FOLLETT
1255 S. Wabash Ave., Chicago, Ill.

MAIL THIS COUPON TODAY

WILCOX & FOLLETT
1255 S. Wabash Ave., Chicago, Ill.

By all means send me Lee de Forest's FATHER OF RADIO at once. My remittance for \$5.00 is enclosed. Book will be sent postpaid.

NAME.....
STREET.....
CITY..... ZONE..... STATE.....
RE

RADIO-INTERCOM ADAPTER

CONNECTS TO
ANY RADIO



\$9.95 Complete

(READY TO BE ATTACHED TO YOUR RADIO)

- Listen to baby.
- From room to room.
 - Answer Doors.
 - Between office and warehouse.
 - Garage to home.

Selector switch allows for talk to remote, listen to remote, or normal radio play. Easily attached in a few minutes—complete with illustrated easy-to-read instruction sheet. All ready to use—includes remote speaker and 25' of wire. Equal to units selling for 5 times the amount!

KEYSTONE ELECTRONICS CORP.
423 BROOME ST., NEW YORK 12

Every RADIOMAN can use these SERVICE HINTS!

Valuable Manual Yours—FREE
Write today—no obligation.

FEILER ENGINEERING CO. Dept. 12RC5
1601 S. Federal St. Chicago 16, Ill.

Every page of "How to Simplify Radio Repairs" is packed with on-the-bench, practical ideas.

Dept. 12RC5
Chicago 16, Ill.

TELEVISION RECEIVER—\$1.00

Complete instructions for building your own television receiver. 16 pages—11"x17" of pictures, pictorial diagrams, clarified schematics. 17"x22" complete schematic diagram & chassis layout. Also booklet of alignment instructions, voltage & resistance tables and troubleshooting hints.—All for \$1.00. Write for free catalogue. CERTIFIED TELEVISION LABORATORIES Dept. C, 5507-13th Ave., Brooklyn 19, N. Y.

HAVE YOU A JOB FOR A TRAINED TECHNICIAN?

We have a number of alert young men who have completed intensive training in Radio and Television Repairing. They learned their trades thoroughly by working on actual equipment under personal, expert supervision. If you need a trained man, we invite you to write for an outline of our course, and for a prospectus of the graduate. No fees, of course. Address:

Placement Manager, Dept. P108-12

COMMERCIAL TRADES INSTITUTE
1400 Greenleaf Chicago 26

hoping you would print a similar table of their characteristics. The advertisements are some help, of course, but they almost never give the detailed, factual information that one of your tabulations affords. Are you likely to run such an item soon?

JOHN J. LA BRIER

Burston, Calif.

(We published a tabulation of sweep generators in the February issue. Other readers interested in a survey of standard generators should let us know. If the demand is real, we'll run one.—Editor)

ELECTRONICS AND MUSIC

Dear Editor:

Apparently the subject of electronic music has a good number of highly interested adherents, judging from the mail I have received as a result of my electronic music series in RADIO-ELECTRONICS I have been answering each letter and want to suggest that readers let me know whenever they think I have left out material.

A common query is for information on books dealing with the subject. I think readers will be interested to know of the two books I have uncovered so far, one with the help of an enthusiastic correspondent in West Wales, Great Britain, Mr. Stanley Lewis. The first is *Electronic Musical Instruments*, by S. K. Lever, available at 3 shillings sixpence from Electronic Engineering, 28 Essex Street, London W.C.2. The second is *The Electronic Musical Instrument Manual*, by Alan Douglas, priced at 18 shillings and available from Sir Isaac Pitman & Sons, Ltd., Pitman House, Parker Street, Kingsway, London W.C.2. Both books are small and consist principally of some theory and description of existing commercial instruments, but any electronic music enthusiast should find them interesting.

RICHARD H. DORF

New York, N. Y.

WANTS PORTABLE PURR

Dear Editor:

I like cats: I have a cat. But my cat has a very quiet purr. I like to hear cats purr.

I have thought of putting a throat mike on my cat and hooking it up to an amplifier. But I don't think my cat would like a throat mike or would purr at all.

Would you please print a circuit for a low-variable-frequency oscillator that would sound like a cat's purr? To be really good, it should have a random "long breath" effect.

The best would be a pocket-size portable so that I can carry it around and turn on when I feel like hearing a cat purr. It needn't lap milk.

PHILIP WALKER

Washington, Conn.

(We have an old solution, more than 100 years old, but regret there is no diagram available. We suggest you read "The Purrloined Letter" by Edgar Allan Poe.—Editor)

ELECTRONICS TECHNICIANS WANTED

The RCA Service Company, Inc., a Radio Corporation of America subsidiary, needs qualified electronics technicians for U. S. and overseas assignments. Candidates must be of good character and qualified in the installation or maintenance of RADAR or COMMUNICATIONS equipment or TELEVISION receivers. No age limits, but must have at least three years of practical experience.

RCA Service Company offers comprehensive Company-paid hospitalization, accident and life insurance programs; paid vacations and holidays; periodic review for salary increases; and opportunity to obtain permanent position in our national and international service organization, engaged in the installation and maintenance of AM, FM and TV transmitters, electronic inspection devices, electron microscopes, theatre and home television, r-f heating equipment, mobile and microwave communications systems, and similar electronic equipment.

Base pay, overseas bonus, payments for actual living and other expenses, and benefits mentioned above add up to \$7,000 per year to start for overseas assignments, with periodic review of base salary thereafter. Openings also available at proportionately higher salaries for specially qualified technicians with supervisory ability.

Qualified technicians seeking an advantageous connection with a well-established company, having a broad-based, permanent peacetime and wartime service program, write to:

Mr. G. H. Metz,
Personnel Manager,
RCA Service Company, Inc.,
Camden 2, New Jersey

STROBOSCOPE

SIMPLIFIES TROUBLE SHOOTING OF ANY
ROTATING OR RECIPROCATING PARTS

Read the complete story in the Oct. 1950
Radio Electronics—Page 65

This is NOT A KIT! Completely assembled ready to use. Operates on 110 V. AC 60 cycles.

Limited Quantity **\$34.95**
Order Today! ea.

25% Deposit with order—Balance C.O.D.

A. M. RADIO SALES 5 LISPENARD ST.
NEW YORK 13, N.Y.

ANOTHER OUTSTANDING JOBBER MIDWAY Radio & Television Corp.

60 WEST 45th STREET
New York 19, N. Y.



\$29.95

HAS THE
SENSATIONAL NEW
TEICO 625-K TUBE
TESTER KIT
IN STOCK!

Print Your Own
Cards, Stationery, Advertising, Circulars and
Titles. Save money. Print for Others. Good Profits
easy to make. Have home print shop. Raised printing like
engraving, too. Sold direct from factory only. Write
for free catalogue of outfits and all details.
KELSEY PRESSES, P-27, Meriden, Conn.

RADIO-ELECTRONICS for

NEW... **EICO**

Instruments and KITS

Over 50,000 **SERVICEMEN** must be right!

give you Laboratory Precision at Lowest Cost!

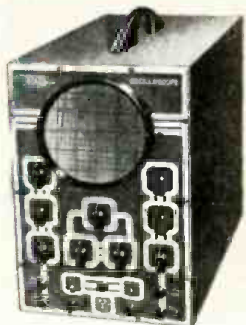

NEW 5" PUSH-PULL OSCILLOSCOPE

All-new laboratory-precision scope with all the extra sensitivity and response for precise servicing of TV, FM & AM sets. Push-pull undistorted vertical and horizontal amplifiers. Boosted sensitivity, .05 to .1 rms volts/inch. Useful to 2.5 MC. TV-type multivibrator sweep circuits, 15 cps—75 KC. Z-axis intensity modulation feature. Dual positioning controls move trace anywhere on screen. Complete with 2-6J5, 3-6SN7, 2-5Y3, 58P1 CRT. 3-color etched rubproof panel; steel case. 115 v., 60 cycle AC. 8½ x 17 x 13".

Model 425-K, KIT, only \$39.95
Model 425, factory wired, \$69.95

NEW VACUUM TUBE VOLTMETER

Laboratory-precision VTVM for trigger-fast operation and lifetime service. 15 different ranges. Large 4½" meter, can't-burn-out circuit. New zero center for TV & FM discriminator alignment. Electronic AC & DC ranges: 0-5, 10, 100, 500, 1000 v. (30,000 volts & 200 MC with HVP-1 & P-75 probes). Ohmmeter ranges, 2 ohms to 1000 megs. DB scale. New stable double-triode balanced bridge circuit—extreme accuracy. 26 megs DC input impedance. 3-color etched rubproof panel; steel case. 115 v., 60 cycle AC. 9-7/16 x 6 x 5".

Model 221-K, KIT, only \$23.95
Model 221, factory wired, \$49.95



NEW TUBE TESTER

Brand new professional tube tester and merchandiser EICO Service-Engineered for unbeatable value! Large 4½" full-vision meter. Tests conventional and TV tubes including 9 pin miniatures. New lever-action switches—tests every tube element. Illuminated "Speed Roll-Chart." 2 grid caps. Short and open-element tests. Spare socket for new tubes. Protective overload bulb. Electronic rectifier. 3-color etched panel; rugged steel case. 115 v., 60 cycle AC. 12½ x 9½ x 4½".

Model 625-K, KIT, only \$29.95
Model 625, factory wired, \$44.95

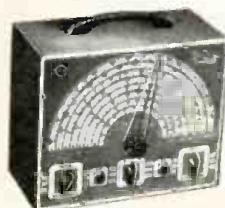
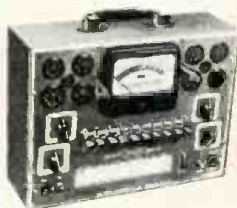

NEW SIGNAL GENERATOR

For FM-AM precision alignment and TV marker frequencies. Vernier Tuning Condenser. Highly stable RF oscillator, range: 150 KC—102 MC with fundamentals to 34 MC. Separate audio oscillator supplies 400-cycle pure sine wave voltage. Pure RF, modulated RF or pure AF for external testing. Attractive three-color etched rub-proof panel; rugged hammertone steel case. 115 v., 60 cycle AC. 10 x 8 x 4½".

Model 320-K, KIT, only \$19.95
Model 320, factory wired, \$29.95

NEW BATTERY ELIMINATOR, CHARGER & BOOSTER

For all auto radio testing. Latest-type full-wave bridge circuit. 41-amp manganese copper-oxide rectifiers. Specially designed transformer, variable from 10 to 15 volts. Continuous: 5.8 v., 10 amps. Intermittent: 20 amps. 10,000 mfd filter condenser. Meter measures current and voltage output. Fused primary; automatic reset overload device for secondary. Hammertone steel case. 115 v., 60 cycle AC. 10½ x 7½ x 8¾".

Model 1040-K, KIT, only \$22.95
Model 1040, factory wired, \$29.95

NEW SWEEP GENERATOR

Covers all TV-FM alignment frequencies, 500 KC—228 MC. Vernier-driven dial; center of each of 13 TV channels marked on front panel. Sweepwidth variable 0-30 MC with mechanical inductive sweep—permits gain comparison of adjacent RF TV channels. Crystal marker oscillator, variable amplitude. Provides for injection of external marker. Phasing control. Complete with HF tubes: 6XSG1, 12AU7 (dual-triode), 2-6C4. Less crystal. 10 x 8 x 6¾". 5 MC Crystal, ea. \$3.95.

Model 360-K, KIT, only \$29.95
Model 360, factory wired, \$49.95

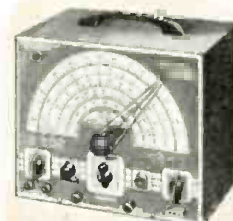

NEW DELUXE SIGNAL GENERATOR

A laboratory-precision generator EICO Service-Engineered with 1% accuracy. Extremely stable, frequency 75 KC—150 MC in 7 calibrated ranges. Illuminated hairline vernier tuning. VR stabilized line supply. 400-cycle pure sine wave with less than 5% distortion. Tube complement: 6X5, 7F7, 6C4, VR-150. 3-color etched panel; rugged steel case. 115 v., 60 cycle AC. 12 x 13 x 7".

Model 315-K, KIT, only \$39.95
Model 315, factory wired, \$59.95

VOLT-OHM-MILLIAMMETER

Pocket-size VOM cramp-packed with value! 22 different ranges. 3" D'Arsonval movement. Ring-type shunts. Germanium crystal rectifier. Ranges—DC: 0-5, 50, 250, 500, 2500 v. AC & Output: 0-10, 100, 500, 1000 v. DC Ma: 0-1, 10, 100. DC Amp: 0-1, 10. Ohm: 0-500, 100,000; 0-1 Meg DB: -8 to +55. 3-color etched panel; rugged hardwood case. 8 x 4½ x 3".

Model 511-K, KIT, only \$14.95
Model 511, factory wired, \$17.95



MULTI-SIGNAL TRACER

Highest gain and flexibility in lowest field. Audibly traces all IF, RF, Video and Audio from AMT to SP8B or CRT without switching. Response well over 200 MC. Integral test speaker. Provision for visual tracing with VTVM. Complete with 6SJ7, 6K6, 6X5. Germanium crystal diode. 3-color etched panel; rugged steel case. 115 v., 60 cycle AC. 10 x 8 x 4¾".

Model 145-K, KIT, only \$18.95
Model 145, factory wired, \$28.95

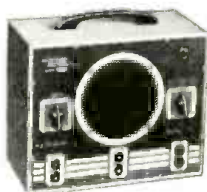

RF
PROBE

Sensitive Germanium crystal probe for signal tracing and measurements to over 200 MC. Extends range of VTVMs and scopes.

P-75K KIT, for VTVM;
P-76K for Scope; ea. \$3.75
P-75 or P-76, factory wired, ea. \$7.50



HIGH
VOLTAGE PROBE

New professional EICO-engineered MV probe carefully designed and insulated for extra safety and versatility. Extends range of VTVMs and voltmeters up to 30,000 v. Lucite head. Large flash guards. Multi-layer processed handle. Complete with interchangeable ceramic Multiplier to match your instrument.

HVP-1 (wired) only \$6.95

Due to unsettled conditions, prices are subject to change without notice.

EICO—SUPER-SIMPLIFIED INSTRUCTIONS

Easy-to-follow step-by-step EICO pictorial and schematic instructions—most explicit and comprehensive in electronics!—supplied with each Kit. **Anyone** can build the EICO Kits!

ELECTRONIC INSTRUMENT CO., Inc.
276 NEWPORT STREET, BROOKLYN 12, N. Y.

© 1950, Electronic Instrument Co., Inc., Brooklyn, N. Y.

the exclusive EICO Make-Good GUARANTEE

Each EICO Kit and Instrument is doubly guaranteed, by EICO and your jobber, to contain only selected quality components. EICO guarantees to replace any component which might become defective in normal use if returned to the factory transportation charges pre-paid within 90 days of purchase. EICO guarantees all kits assembled according to EICO's simplified instructions will operate as specified therein. EICO guarantees service and calibration of every EICO Kit and Instrument at the nominal charge as stated in the instructions.

Be sure to look at the EICO line before you buy any higher-priced equipment! Each EICO product is jam-packed with unbelievable value. **YOU** be the judge—compare EICO at your local jobber today, and **SAVE!** Write **NOW** for free newest Catalog C.

Prices 5% higher on West Coast

BECOME AN ELECTRONIC TECHNICIAN IN 12 MONTHS

TRAIN NOW FOR IMPORTANT RESPONSIBILITIES

Do you have 12 months to invest in a training program that can bring immediate and life-long opportunities?

Then investigate the Technician courses available at this College of Electrical Engineering. For example, in those valuable 12 months you can earn your Electronic Technician's Certificate. You enter the fascinating field of Industrial Electronics. You are trained for responsibilities of tremendous growing importance to the strength and welfare of the nation.

This world-famous course also supplies the basic fundamentals so that you can progress into studies of radar, television and other branches of Communication Electronics.

Faculty of 85 specialists • 1555 currently enrolled from 48 states and 23 foreign countries • Over 35,000 alumni.



MILWAUKEE SCHOOL of ENGINEERING

Technical Institute • College of Electrical Engineering



A SPECIAL PREPARATORY program is offered.

MILITARY, ACADEMIC OR PRACTICAL training will be evaluated for advanced credit.

NEXT TERMS OPEN
JANUARY 8 . . . APRIL 2

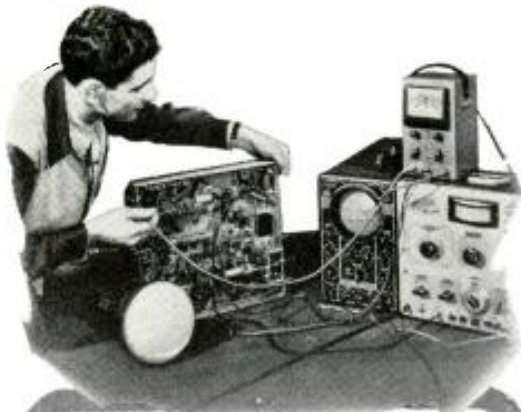

6 additional months make you a RADIO-TELEVISION TECHNICIAN

It is academically possible for the Electronic Technician to complete this course in 6 months of study. You are then ready for vital assignments in the fields of Communication Electronics.

TV and other branches of advanced Electronics requires men who are trained under the daily, personal guidance of specialists — through an intensive course such as offered here.

In 24 additional months become an ELECTRICAL ENGINEER

Under this internationally-known educational system, the Technician courses described here are complete in themselves but also serve as units of the College program leading to the B.S. degree with a Major in Electronics. Thus, if you must leave school after completing your Technician course, you are ready for immediate employment or specialized services. Or, you can continue here immediately or at any time and your Technician Course will be credited toward your B.S. degree.



Write today for new MSOE
RADIO AND TELEVISION
BULLETIN, indicating course
that interests you.

MILWAUKEE SCHOOL OF ENGINEERING

Milwaukee, Wis.
Dept. RE-1250, N. Broadway and E. State
Without obligation send your NEW RADIO AND
TELEVISION BULLETIN.

Name.....

Address.....City.....State.....

Check if Veteran of World War II

RADIO SCHOOL DIRECTORY

RADIO COURSES

Preparatory Mathematics, Service, Broadcast, Television, Marine Operating, Aeronautical, Frequency Modulation, Radar.

Classes now forming for the Mid-Year term beginning Feb. 1st Entrance exam, Jan. 15th

Veterans. Literature.

COMMERCIAL RADIO INSTITUTE
(Founded 1929)
38 West Biddle Street, Baltimore 1, Md.

LEARN DAY and EVENING CLASSES

TELEVISION

ELECTRONICS-RADIO
Modern Laboratory Instruction in

- SERVICING
- BROADCAST OPERATING
- ELECTRONIC and TV ENGINEERING

G.I. APPROVED

WRITE FOR ILLUSTRATED CATALOG

ELECTRONICS INSTITUTE, Inc.
21 HENRY, DETROIT 1, MICH.

Your Future in RADIO-TV

Your future in radio-TV begins *right now*, with proper training. The Don Martin School of Radio Arts, established in 1937, offers the training you want . . . for every type of job in Radio-TV—script writer, announcer, disk jockey, newscaster, technician. Free job placement service for graduates. Day and night classes. . . Write for our FREE booklet, "YOUR FUTURE IN RADIO." Approved for veterans.

Don Martin School of Radio Arts
1655 No. Cherokee, Hollywood 28, Calif. HUDSON 23281

AUDIO ENGINEERING SCHOOL

Practical engineering training in Audio fundamentals, Disc, Film, Magnetic Recording, and Audio frequency measurements.

Studio training simulates Broadcast, Motion Picture, Television, and Commercial Recording work.

Approved for Veterans

HOLLYWOOD SOUND INSTITUTE, Inc.
1040-E North Kenmore, Hollywood 27, Calif.
Specify if Veteran or Non-Veteran

CODE SENDING SPEED

Be a "key" man. Learn how to send and receive messages in code by telegraph and radio. Commerce needs thousands of men for jobs. Good pay, adventure, interesting work. Learn at home quickly through famous Candler System. Quality for Amateur or Commercial License. Write for FREE BOOK

CANDLER SYSTEM CO.
Dept. 3-0, Box 928, Denver 1, Colo., U.S.A.

RADIO-ELECTRONICS for

Learn TELEVISION RADIO—ELECTRONICS

Prepare for own business or a good paying job. Radio Training Approved for Veterans.

3 BIG RADIO-TV BOOKS FREE!

SEE OUR LARGE AD ON PAGE 11

Sprayberry Academy of Radio

Dept. 20-R, 111 N. Canal St., Chicago 6, Ill.

RADIO ENGINEERING

FM—Television—Broadcast

Police Radio, Marine Radio, Radio Servicing, Aviation Radio and Ultra High mobile applications. Thorough training in all branches of Radio and Electronics. Modern laboratories and equipment. Old established school. Ample housing facilities. 7 acre campus. Small classes, enrollments limited. Our graduates are in demand. Write for catalog.

Approved for Veterans

VALPARAISO TECHNICAL INSTITUTE

Dept. C VALPARAISO, INDIANA

RADIO ENGINEERING!

Complete Radio Engineering course incl. Telev., U.H.F., and F.M. B.S. Degree Courses also in Civil, Elect., Mech., Chem., and Aer. Eng.; Bus. Adm., Acct. Visit campus, see well equipped labs. Low cost. Prep. courses. Personalized instruction. Grads successful. Founded 1911. Enter Jan., March, June, Sept. Write for Catalog.

DEGREE IN 27 MONTHS

TRI-STATE COLLEGE 24120 College Ave. ANGOLA INDIANA

TELEVISION

PREPARE FOR A GOOD JOB!

COMMERCIAL OPERATOR (CODE) RADIO SERVICEMAN

TELEVISION SERVICING BROADCAST ENGINEER

V. A. Furnishes Books and Tools SEND FOR FREE LITERATURE

BALTIMORE TECHNICAL INSTITUTE

1425 Eutaw Place, Dept. C, Baltimore 17, Md.

TV ELECTROMAGNETIC SERVICING COURSE

Practical Shop and Laboratory Training at Largest Resident TV School in the East!

Also RADIO SERVICE & REPAIR, F-M & TELEVISION Preparation for F. C. C. LICENSE EXAMS

★ Approved for Veterans ★

DELEHANTY SCHOOL of TELEVISION

105A EAST 13th STREET • NEW YORK 3, N. Y.

RCA RADIO and TELEVISION

Thorough Training in All Technical Phases

APPROVED FOR VETERANS

DAY-EVENINGS WEEKLY RATES

FREE PLACEMENT SERVICE FOR GRADUATES For Free Catalog Write Dept. RC-50

RCA INSTITUTES, Inc.

A Service of Radio Corporation of America

350 WEST 4TH STREET NEW YORK 14, N. Y.

TELEVISION

Laboratory and theoretical instruction covering all technical phases of Radio, FM, Television. Leads to opportunities in Broadcasting, Industry or Own Business.

TOTAL TUITION \$450. NO EXTRAS.

Morn., Aft., or Eve. Small Weekly Payments. Approved for Veterans. Enroll Now.

RADIO-TELEVISION INSTITUTE

Pioneers in Television Training Since 1938

480 Lexington Ave., N. Y. 17 (46th St.)

Place 9-5665 Licensed by N. Y. State

ELEMENTS OF SINGLE AND DUAL TRACK MAGNETIC TAPE RECORDING AND 1001 APPLICATIONS (Second Edition), by A. C. Shaney. Published by Amplifier Corp. of America, New York. 5½ x 8½ inches, 128 pages plus 16-page supplement. Price \$1.00.

The first edition of this book was published in 1947 under the title *Elements of Magnetic Recording—and 999 Applications*. With this edition, the title was changed and its scope enlarged to cover dual-track recording.

Starting with the history of magnetic recording, the author traces the development of the art from early single-track recorders to the most modern dual-track instruments. Among the 21 chapters are those devoted to recording, playback, and erasing processes, magnetic tape nomenclature, performance specifications, tape-handling mechanisms.—RFS

TELEVISION SERVICING, by Walter H. Buchsbaum. Published by Prentice-Hall, Inc., New York, N. Y. 6½ x 9½ inches, 340 pages. Price \$5.35.

Too few of the television books aimed at the student or service technician are written from the servicing viewpoint. In this one, the service technician's viewpoint crops up even in the part devoted to theory, where such practical points as voltage and current values appear regularly, in happy contradistinction to the generalization loved by so many theorists.

The section on theory is Part I of three; the other two are "Alignment, Installation" and "Troubleshooting." These two strictly service sections occupy 152 pages of the book. This does not mean that Part I is unimportant to the television technician; indeed, the technician reading chapter 19 on r.f. alignment finds that chapter 11 on television tuners complements it to give as complete a picture of television front ends as he has been able to find in the literature. The same close twinning of theory and practice is observable in other chapters.

Readers of the "Television Clinic" in **RADIO-ELECTRONICS**, conducted by Mr. Buchsbaum, are familiar with his style and approach. The same clear-cut, down-to-earth language is used in this book, especially in Parts II and III.

TRAVELING-WAVE TUBES, by J. R. Pierce. Published by D. Van Nostrand Co., New York, N. Y. 6¼ x 9¼ inches, 260 pages. Price \$4.50.

A thoroughly mathematical and tech-

AUDIO (SOUND) ENGINEERING HOME STUDY TRAINING

Practical, easy-to-understand lessons, written by competent Audio Engineers and Educators, prepare you for a better job and a good future in the Television, Radio, Motion Picture, and Recording Industries.

Write today for details—Learn while you earn!

HOLLYWOOD TECHNICAL INSTITUTE

Div. RE

4925 Santa Monica Blvd. Hollywood 27, California

RADIO ENGINEERING DEGREE IN 27 MONTHS

Intensive, specialized course including strong basis in mathematics and electrical engineering, advanced radio theory and design, television. Modern lab. Low tuition. Self-help opportunities. Also 27-month courses in Aeronautical, Chemical, Field, Electrical, and Mechanical Engineering. Approved for G.I.'s. Enter Dec., March, June, Sept. Catalogue.

INDIANA TECHNICAL COLLEGE

1512 E. Washington Blvd., Fort Wayne 2, Indiana

*** VOLOMETERS**

MODEL 102

(1000 ohms per volt meter)

- 3" SQUARE METER
- 3 AC CURRENT RANGES (0-30/150/600 ma.)
- Same zero adjustment for both resistance ranges (0-1000 ohms, 0-1 megohms)

5 DC & 5 AC Voltage Ranges to 3,000 Volts. Also 4 DC Current Ranges. **\$1390**



MODEL 104

(20,000 ohms per volt meter)

- 4½" SQUARE METER (50 micro-amperes—alnico magnet)
- Includes carrying strap

5 DC Voltage Ranges to 20,000 ohms/volt to 3,000 V.; 5 AC Voltage Ranges to 3,000 V. 3 Resistance Ranges to 20 megs. Also 3 AC & DC Current Ranges & 5 DB Ranges. **\$2695**



All of the above have round cornered, bakelite, molded cases. (*Reg. Trade Mark for Volt-Ohm-Milliammeter)

Prices subject to change without notice. Export Dept., 303 W. 42nd St., N.Y.C. Write Dept. B-12 for Free Catalog

Gives More Measurement Value Per Dollar

EMC ELECTRONIC MEASUREMENTS CORPORATION

423 Broome Street, New York 13, N.Y.

RED ARROW XMAS BARGAINS

No shortages here—RED ARROW has what it advertises. If you don't see what you want listed, please write. We specialize in Ceramics, Resistors and Condensers. (Manufacturers: ask for our quantity prices.)

SPECIAL!

300 ohm TWIN LEAD TV LINE, per 100 ft. ONLY \$2.69

ZIP CORD, per 100 ft. SPECIAL \$1.49

6 ft. LINE CORDS, mated plugs, per 100 NOW \$14.75

FILTER UNIT

This unit is an excellent buy for the parts alone. Some parts are worth more than we're asking for the whole unit. Here's what you get:

- 1—40 MFD @ 450V
- 1—1600 MFD @ 12V
- 1—.5 MFD @ 400V
- 2—.5 MFD @ 50V
- 1—.01 MFD @ 400V
- 2—20 watt Resistors
- 2—Filter Chokes
- 3—RF Chokes
- 1—DPST Toggle Switch
- Miscellaneous hardware, wire, etc.

BRAND NEW, ORIGINAL PACKING... 89¢ ea. (10 for \$7.50)

EE-8 FIELD TELEPHONES

Tested and Guaranteed. Ideal for TV Installations. \$9.95 ea.

TERRIFIC VALUES!

Kit of 25 assorted KNOBS 59¢

Kit of 100 assorted PAPER TUBULAR CONDENSERS, from 2 to 800 V. \$5.75

SLEEVEING, various colors and sizes, 3 ft. lengths. 10 for 25¢ (100 for \$2.00)

3 GANG TRF VARIABLE CONDENSER

365 per section with push buttons. 89¢ ea. (10 for \$7.25)

MINIMUM ORDER—\$2.00. Send 25% deposit with order, balance C.O.D. Shipped F.O.B., N.Y.C. (N.Y.C. residents add 2% sales tax.)

RED ARROW SALES

DEPT. E, 63 EAST BROADWAY, N. Y. 2

PHONE—Cortlandt 7-5425

**SHOOTS TROUBLE
FASTER!** **MAKES MORE MONEY
FOR YOU ON THE JOB
OR AT SERVICE BENCH**



**PRICE
\$9.95**

at distribu-
tor or post-
paid, direct.

No C.O.D., please.
Ohioans add 3%
State Sales Tax.

Signalette

MULTI-FREQUENCY GENERATOR

In radio service work, time means money. Locate trouble faster, handle a much greater volume of work with the SIGNALETTE. As a trouble shooting tool, SIGNALETTE has no equal. Merely plug in any AC or DC line, start at speaker end of circuit and trace back, stage by stage, listening in set's speaker. Generates RF, 1F and AUDIO Frequencies. 2500 cycles to 20 Megacycles. Also used for checks on Sensitivity, Gain, Peaking, Shielding, Tube testing. Wt. 13 oz. Fits pocket or tool kit. Satisfaction, or your money back. See at your distributor or order direct.

Clippard INSTRUMENT
LABORATORY,
INC.

DEPT. B, 1125 BANK STREET
CINCINNATI 14, OHIO
Qualified Jobbers write, wire for details.

**FOR BETTER TOWERS
AT LOWER COST!
Ask about AERO**

COST LESS

Because Aero Towers are aircraft-designed, lower manufacturing costs offer you a lower price. Lower weight and lower shipping costs are passed on as savings to you.

LAST LONGER

Coated INSIDE and OUT. DIP-COATED Process keeps Aero Towers Bright and new. Rust resistant. Will not brown.

EASY TO CLIMB AND SERVICE

Strong electric aircraft welds of EACH joint (not just one or two) prevents sway. Provides sturdy, safe, ladder-like cross members.

QUICKER TO INSTALL

Aircraft precision tolerances assure accurate fit of components. Light and easy to erect. Strong durability assures customer satisfaction.

Jobber Territories Open
Dealers—Write for FREE booklet

AERO TOWER DIVISION
Knepper Aircraft Service
1018 Linden Street
Allentown, Pa.

ADVERTISING INDEX

A. M. Radio Sales	92
Aero Towers and Rotator Division	96
Aerovox Corporation	60
Allied Radio Corporation	45
Almo Radio Corporation	67
American Phenolic Corporation	60
Amplifier Corporation of America	70, 78
Arkey, Incorporated	97
Arrow Sales Company	88
Atlas Sound Corporation	84
Bell Telephone Laboratories, Inc.	17
Boyce-Roche Book Company	47
Brooks Radio Dist. Company	79, 97
Bryan-Davis Publishing Co., Inc.	89
Buffalo Radio Supply	86, 88
Burden Sales	69
Capitol Radio Engineering Institute	7, 91
Central Electronics	97
Certified Television Laboratories	92
Cleveland Institute of Radio Electronics	20
Clippard Instrument Lab., Inc.	96
Commercial Trades Institute	92
Communications Equipment Company	96
Concord Radio Corporation	57
Coyne Electrical School	61, 82
DeForest's Training, Incorporated	9
DuMont, Allen B., Labs.	6
East Coast Electronics	82
Editors & Engineers	70, 78, 87
Electro-Technical Industries	12
Electronic Instrument Company	83, 87, 92, 93, 97
Electronic Measurements Corp.	95
Fair Radio Sales	67
Faier Engineering Company	81, 92
General Electronic Dist. Company	53, 54, 55, 56
General Industries Company	70
General Test Equipment Company	88
Graylock Electronic Supply	88
Harrison Radio Corp.	67
Heath Company	71, 72, 73, 74, 75, 76, 77
Hickok Electrical Instrument Company	81
Hudson Radio and Television Corp.	89
Hudson Specialties Company	64, 88
Hytron Radio & Electronics Corporation	13
Instructograph Company	85
JFD Manufacturing Company	97
Jackson Electrical Instrument Company	51
Kelsey Company (The)	92
Keystone Electronics	92
La Pointe-Plascomold Corporation	63
Leatone Radio Corporation	87
Loris Sales Company	65
Mallory and Co., Inc. P. R.	Inside Back Cover
Midway Radio & TV Corporation	96
Midwest Radio & TV Corporation	86
Miles Reproducer	88
Murray Hill Books, Incorporated	16
National Plans Company	97
National Radio Institute	3
National Schools	5
National Union Radio Corporation	19
Niagara Radio Supply	90
Opportunity Adlets	87
Precision Apparatus Company	89
Pres-Probe Company	85
Progressive Electronics Company	81
Quam-Nichols Company	87

RADIO SCHOOL DIRECTORY
Pages 94-95

Baltimore Technical Institute	
Candler System Company	
Commercial Radio Institute	
Delehanty Institute	
Electronics Inst., Inc.	
Hollywood Sound Institute	
Hollywood Technical Institute	
Indiana Technical College	
Martin School, Don	
Milwaukee School of Engineering	
RCA Institutes	
Radio-Television Institute	
Sprayberry Academy of Radio	
Tri-State College	
Valparaiso Technical Institute	
RCA Service Company	92
RCA Victor Division (Radio Corporation of America)	Inside Front Cover, Back Cover
Radio Apparatus Corporation	51
Radio City Products	62
Radio Corporation of America	18
Radio Dealers Supply	85
Radio Wire Television	49
Roy Manufacturing Company	84
Raytheon Manufacturing Company	67
Red Arrow Sales	95
Rider, John F., Publisher	66
Rose Company (The)	88
Sams & Company, Inc., Howard W.	14, 58, 59
Sprague Products	4
Sprayberry Academy of Radio	11
Standard Transformer Corporation	83
Sutton's Wholesale Electronics, Bill	85
Swedgal Radio, Incorporated	65
Sylvania Electronic Products	8
Technifax, Inc.	80, 82
Techniflex	59
Tel-A-Ray Enterprises, Inc.	15
Thomas Electronics	78
Transvision, Incorporated	64
Trio Manufacturing Co.	52
University Loudspeakers	68
Weller Electric Corporation	10
Wells Sales	98
Wholesale Radio Parts	86
Wilcox & Follet	91

midway YOUR
MIDTOWN
SYLVANIA DISTRIBUTOR

You can furnish better service faster . . . Faster service better . . . with

Sylvania's Polymer—

Sensitive VTVM Resistance .552 to 1000 megohms AF & RF 0-300 volts. AC & DC 0-1000 volts.



\$99.50
NET

Model 221 with probe . . .
And the \$139 Counter Tube Checker

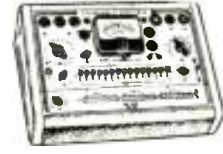

Smartly designed to check all tubes accurately under dynamic conditions

\$59.50

Send for your Free Sylvania "SE" folder today
Complete stock of Radio, Electronic and TV parts

Prices subject to change without notice

midway RADIO &
TELEVISION CORP.

60 W. 45 St., New York, N. Y. MU 7-5053

696 Xmters VFO Drivers
40 Watts Output
3-4 Mc \$6.95
Used Good Cond. Sold As Is.

SPECIAL XFMRs
Trans 1.5V/60 cy. Sec. 24V/1.5A. For ARC 5, etc. . . . \$1.95
Trans 1.5V/60 cy. Sec. 36V/3.5A. For Rect. . . . \$2.75
Tubes 6A4/6. 5V/3A. 125V/3. \$2.95
Pri. 110V 60cy. Sec. 9V/1.6A . . . \$1.00
Pri. 110V/60V 60cy/Sec. 125V/2MA. 6 V/4A. 650VCT/85. 2.5V 1.75. 8V/6 . . . \$4.95
Sec. 220V/40 Sec. 2.3 VCT 60A . . . \$12.95
Pri. 220/440 Sec. 1.38 VCT 3.5A . . . \$10.95
Pri. 115V Sec. 7.5VCT 2.5A. 10VCT/6.5. 10 VCT/12A . . . \$10.95
Pri. 1200V/125MA. 2.5 VCT/6A. 6.3 VCT/1A . . . \$7.95
Pri. 110V. Sec. 2.5V/5A. 2.8V/5A for 866 Tubes . . . Price \$2.95

CERAMIC TRIMMER
Stack of 6 Ceramic Trimmers 110-460Mmf. Can be used singly or ganged
69c

Collins ART-13
FRED. MULT. UNIT
2-18 Mc for two 1625 Tubes. Comp Assy less Tubes & Coils w/ckt diag. . . . **\$8.95**
Price . . . **\$9.95**

GIBSON GIRL
The Emergency Radio Transmitter. Sends S O S signals automatically on 500KC. 150-mile range. No batteries required. Has hand-driven generator. New. It's only . . . **\$3.40**

KITS
Silver & Mica Crystals . . . 30 for \$1.50
Electrolytic Ass'd. . . . 12 for 1.00
Vitreous W/V Resistors . . . 20 for 1.00
Rotary Switches, Ass'd. . . . 6 for 1.75
Coil Forms, Third Sm.HF. . . . 50 for 1.00
Iron Core Sluz & Screw . . . 50 for 1.00
Elastic Stop Nuts, Ass'd. . . . 50 for 1.00
Lugs, Large Radio/Elec. . . . 100 for 1.00
Lugs, Small Radio Type . . . 200 for 1.00
Grommets, Rubber Ass'd. . . . 100 for 1.00

Write for latest flyer or list of items required

BC 429 Receiver
High sensitivity: 3 gain
P. R. P. Complete with one dual tuning unit. Covering: 200-400 KC and 2510 to 4700 KC with tubes. An ideal marine receiver for small boats and yachts. Now only . . . **\$3.95**
Extra tuning unit . . . **1.95**

COMMUNICATIONS EQUIPMENT CO.
131 Liberty St., Dept. C12 New York City 7, N. Y.

Noted Concerns Send P.O. Minimum Order \$3.00
Send M.O. or CHK. Mde. Gu'd. Shpg. Charges
Sent C.O.D. Price F.O.B. N.Y.C. Phone DI. 9-4124

nical treatment of new traveling-wave tubes, with a chapter each on double-stream and magnetron amplifiers. Of interest to advanced students or tube engineers who wish to understand the new tube, or to design engineers who may wish to apply it in their work.

PRIMARY BATTERIES, by George Wood Vinal. Published by John Wiley & Sons, Inc., New York, N. Y. 6 x 8 1/2 inches, 336 pages. Price \$5.00.

Written by the author of the standard text on storage batteries just before his retirement as a physicist with the National Bureau of Standards, this work may become as authoritative as the earlier *Storage Batteries*.

The whole field is covered, from the voltaic pile to the mercury and vanadium cells. Other new types discussed are silver and lead primary cells, each of which receives a chapter.

A historical introduction opens the book, followed by a chapter on the elementary theory of electric cells. Materials and production of dry cells, their operating characteristics, and effects of temperature are discussed in separate chapters. Standard cells, air-cells and other batteries with special polarizers, and copper oxide cells also receive a chapter each.

Characteristics of various types of primary batteries are given in 87 tables scattered throughout the book, and there is an extensive index.

SERVICING TV RECEIVERS, compiled and published by Sylvania Electric Products Inc. New York, N. Y. 5 x 7 inches, 119 pages plus a few end pages and large fold-in schematic. Price \$2.00.

A handy little work of the ring binding, open-flat type. The characteristic page has a photograph of an abnormal test pattern, with a statement of the probable causes and the remedies.

The list of illustrations can be used as a handy trouble-shooting chart. Altogether the screen patterns number 53. There are also seven schematic drawings, including the large fold-in.

TELEVISION SIMPLIFIED, third edition, by Milton S. Kiver. Published by D. Van Nostrand Company, Inc., N. Y. 6 x 8 1/2 inches, 608 pages. Price \$6.50.

Nearly twice the size of the first edition, this new edition closely follows the pattern of the previous two. A new chapter discusses the principles of intercarrier television and the chapter on color television includes the latest material on the CBS, RCA, and CTI systems.—*MW*

500 FORMULAS TO SUCCESS

MANY million dollar firms started with a single formula, for which they paid a big price. Here you have 500—no less—tried and tested formulas, recipes and processes for making things . . . all at the ridiculously low price of 25¢. Here is your opportunity to start a business with but a few dollars' capital and with undreamed-of profits in prospect. You can also use these formulas in your own home to cut household expenses to the bone. Or you can put them to use in your workshop to cut costs as much as 100%. Quit paying out many dollars in profits to manufacturers, wholesalers, and dealers when you can write the same thing yourself for a few cents. It's so easy when you follow our simple instructions.



66 PAGES, 47,000 WORDS IN TEXT
Send for "500 FORMULAS AND RECIPES" today. Enclose 25¢, that's all! You won't be asked for another cent now or later. Sold on a money-back guarantee.

NATIONAL PLANS COMPANY
1966 R Broadway, New York 23, N. Y.

DECEMBER, 1950

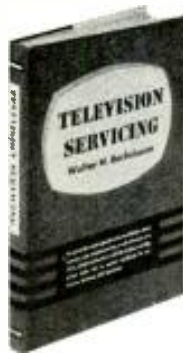

Published by
Prentice-Hall, Inc.

HOT off the press!

See this Month's Book Reviews

Easy to understand, practical, up-to-date "Know How" on **TELEVISION SERVICING**. No Knowledge of Higher Mathematics Needed! Covers the newest designs and servicing techniques. Chock full of illustrations, diagrams and schematics. Very latest circuit data. If you are interested in television

servicing **YOU NEED THIS BOOK**. All your questions answered by Walter H. Buchsbaum, your author of Television Service Clinic. **NO RISK**. Send for your postpaid copy today. If not satisfied, return within 10 days and your money refunded. Free descriptive folder giving full details available.

CENTRAL ELECTRONICS CO., P.O. Box 55, Rego Park, N. Y.

Enclosed find \$5.35 for my TV SERVICING, postpaid
 Send descriptive folder

NAME _____
ADDRESS _____
CITY _____ ZONE _____ STATE _____

MAIL COUPON TODAY 10 DAY MONEY-BACK GUARANTEE

TWIN LEAD, TELEVISION LIGHTNING ARRESTER



APPROVED for OUTDOOR-INDOOR Use \$ **2.25**
Protects Television Sets Against Lightning and Static Charges

JFD SAFE TV GUARD

Simple to install everywhere and anywhere...no stripping, cutting or spreading of wires. More than 300,000 in use today!

SEE YOUR JOBBER OR WRITE TO
JFD MANUFACTURING CO., Inc.
6127 16th Avenue, Brooklyn 4, N. Y.
First in Television Antennas & Accessories

ANOTHER OUTSTANDING JOBBER
ARVEDON Electric Supply Co.
73 PORTLAND STREET
Boston 14, Mass.
HAS THE SENSATIONAL NEW **TEICO** 425-K 5" SCOPE KIT IN STOCK!
\$39.95

Your Choice of **4**
RADIO KITS
HOUSED IN THIS BEAUTIFUL BAKELITE CABINET



They look Wonderful—They sound Wonderful!

LUXURIOUS CABINET is made of fine quality, sturdy bakelite with handy slide rule dial 6" long and magnificently finished in a most beautiful design that is distinct, attractive and practical. A shining beauty that looks much more expensive than it actually is! Weight: 4 lbs. (approx.). Dimensions: 15" x 10" x 8 1/2". It was made to house any of the following radio kits:—

- Model P-120: 5-Tubes, AC/DC, 3-Bands, 535 KC to 1800 KC; 1.8 MC to 6.0 MC; 6 MC to 18 MC. Built in volume control that assures excellent tone and plenty power. Sturdy construction for long use.
- Model P-83X: 4-Tubes, Battery Pack, 3-Bands, 540 KC to 1700 KC; 2.3 MC to 7.2 MC; 7.1 MC to 22 MC. Skillfully engineered for perfect reception with tremendous power and amazing clarity. Sensational value!
- Model P-AC2X: 5-Tubes, AC, 2-Bands, 110 or 220 Volts, 550 KC to 1700 KC; 6.0 MC to 18 MC. Speaker: 6", 1.47 oz. Alnico V Magnet. Handsomely designed for top performance on all bands. Patent signal strength!
- Model P-5X: 5-Tubes, 2-Bands, AC/DC, 110 or 220 Volts, 550 KC to 1650 KC; 6 MC to 18 MC. Uses miniature tubes. Precision engineered to give terrific reception on short wave!

Kits are complete with instructions and wiring diagrams

Write TODAY for attractive LOW PRICES!

ARKAY—By: Radio Kits, Inc.
120 Cedar St., New York 6, N. Y.

THE THINGS A TV SERVICEMAN DREAMS ABOUT!

- 630TV CIRCUIT DIAGRAM WITH MODIFICATIONS
- HINTS FOR BETTER PERFORMANCE ON YOUR 630TV
- ILLUSTRATED TELEVISION CONVERSION MANUAL
- PULSE KEYED TYPE AGC CIRCUIT DIAGRAM
- RMA HANDY RESISTOR AND MICA CODE CHARTS

All in Handy Package for Only **\$1.00**
POSTPAID

BROOKS RADIO & TELEVISION CORP. 84 Vesey St., Dept. A, New York 7, N. Y.

Special Relays— OVER A MILLION IN STOCK!

Whether you require large quantities of relays for production runs or single units for laboratory or amateur work, Wells can make immediate delivery and save you a substantial part of the cost.



This list represents only a few types of Special Relays. We also have huge stocks of Standard D.C. Telephone Relays, Midget Relays, Contactors, Keying Relays, Rotary and Slow Acting Types as well as many others. Write or wire us about your requirements.

STOCK NO.	VOLTAGE	OHMMAGE	CONTACTS	MANUFACTURER & NUMBER	PRICE
R-503	12 32 VDC.	100	3A, 2C	G.E. Ant. Keying 500W 2C6530-653AR1	\$ 2.25
R-749	600 VDC.	...	Max. 28 Amps.	Allen Bradley 810 Dashpot	5.95
R-804	550 VAC.	...	1B 38 Amps.	Culter Hammer C-261173A34 Contactor	3.50
R-250	115 VAC.	...	Adj. Cir. Breaker .04-.16A	Westinghouse MN Overload	12.95
R-579	220 VAC.	...	1B	Adlake 60 Sec. Thermo Delay	6.95
R-294	27.5 VDC.	200	1B	Edison 50 Sec. Thermo Delay	4.25
R-686	115 VAC.	...	2C	Leach 1157T-5 20 Sec. ADJ. Delay	4.95
R-246	115 VAC.	...	1B	Cramer 2 Min. Adj. Time Delay	8.95
R-246A	115 VAC.	...	1A	Cramer 2 Min. Adj. Time Delay	8.95
R-611	24 VAC.	...	1A 30 Amps.	Durakool BF-63	4.25
R-283	12 VDC.	125	AC 10 Amps.	Onan Rev. Current 3H4512 R24	1.00
R-614	18 24 VDC.	60	1A 15 Amps.	Rev. Current Cutout 3H2339A E1	3.50
R-262	...	200	1C	W. U. Tel. Co. 41C Single Current	3.75
R-245	12 VDC.	25	4 In. Micalox Lever95
R-527	6 12 VDC.	50 50	1n Series	227668 For Scr-274N	.95
R-544	12 24 VDC.	60 60	1C	G.E. Push Button Remote Relay	1.65
R-255	1A	-CR2791-R-106C8	.95
R-669	75 VAC.	400 CYC.	1B, 1A	G.E. Pressure Switch 2927B100-C2	.95
R-660	6 VDC.	1/2" Stroke	Clare 400	.95
R-651	24 VDC.	100	Solenoid Valve	Canon Plunger Relay -13672	2.50
R-295	12 VDC.	275	Annunciator Drop	2.15
R-230	5 8 VDC.	2	2A, 1C	Guardian Ratchet Relay	2.15
R-813	12 VDC.	12	Wafer	Ratchet Relay From Scr-522	4.25
R-275	12 VDC.	750	1A, 1B, 1C	Guardian BK-10	2.75
R-716	24 VDC.	70	2A 5 Amps.	BK-13	1.45
R-620	6 12 VDC.	35	2C, 1A	Guardian BK-16	1.05
R-629	9 14 VDC.	40	1C 10 Amps.	Guardian BK-17A	1.25
R-778	8 VDC.	4500	1C 5 Amps.	Kurman BK-24	2.10
R-720	24 VDC.	50	2C, Ceramic	45A High Power	1.35
R-500	12 VDC.	10 10	2C 6 Amps.	Str. Dunn. Latch & Reset	2.85
R-816	12 VDC.	10 15	2C 6 Amps.	Guardian Latch & Reset	2.85
R-811	48 VDC.	8000	1C	Sigma 4R	1.65
R-524	24 VAC DC.	Edwards Alarm Bell	.95
R-838	90 120 VDC.	925	2A	Allen Bradley-Bulletin -702	4.50
R-839	100 125 VDC.	1200	3A	Motor Control	4.50
R-840	115 VDC.	1200	2A	Allen Bradley-Bulletin -200E	4.50
R-841	115 VDC.	1200	4A	Motor Control	4.50
R-842	115 VDC.	925	3A	Allen Bradley-Bulletin 209 Size 1	5.50
R-843	115 VDC.	1200	3A	Motor Control W Type "N" Thermats	25.00
R-844	115 VDC.	1200	3A, 1B	Allen Bradley-Bulletin -709 Size 2	5.50
R-845	220 VAC.	Intermit.	3A	Motor Control W Type "N" Thermats	5.50
R-831	7.5 29 VDC.	6.5	1A 250A, 1000A Surge	Allen Bradley-Bulletin 709	4.50
R-837	110 VAC.	2A 30 Amps.	Motor Control	4.50
R-835	24 VDC.	2800	1A Dble. Brk. 10 Amps.	Allen Bradley-Bulletin 202	4.50
R-836	220 VAC.	2A Ddle. Brk., 10 Amps.	Motor Control	4.50
R-566	115 VAC.	(Coil only. Not a complete relay)	Allen Bradley-Bulletin 704	4.50
R-710	150-Ohms. Coil Only	Motor Control	4.50
				Leach B-8	3.50
				Leach 6104	2.75
				Wheelock Signal, B1/39	1.95
				Wheelock Signal, A7 37	3.45
				Leach 6104	.75
				Guardian .38187	50

**Wide Selection
of Electronic
Components
at WELLS**

- Tubes
- Resistors
- Condensers
- Wire & Cable
- Volume Controls
- Co-ax Connectors
- Relays
- Rectifiers
- Transformers and Chokes
- Micro Switches and Toggles
- Antennas and Accessories
- Electronic Assemblies
- Dial Light Assemblies

Write For New Wells Catalog

Each relay is new, individually boxed, and unconditionally guaranteed by Wells

World's Largest Display of Radio and Electronic Components

9,000 Square Feet of Display All On One Floor



320 N. LA SALLE ST., DEPT. Y CHICAGO 10, ILL.

**For
Long Life**
in spite of heat...



MALLORY CAPACITORS

Give Outstanding Service!

Every Mallory FP Capacitor is designed to perform consistently during more than 2000 hours of operation at a temperature of 85°C.

One reason why Mallory Capacitors operate so long at high temperatures is the unusual care taken in production to prevent *contamination*, which causes corrosion . . . shortens the life of ordinary capacitors.

Result: with the Mallory FP line you may service

both radio and TV sets, without the need for buying special types for the high temperature jobs. Yet Mallory Capacitors cost no more!

You will find it pays to rely on the complete Mallory capacitor line . . . electrolytic, paper, ceramic and Mallory Plascap plastic tubulars.

See your Mallory Distributor, now. Remember, you pay no premium for Mallory Precision Quality!

The Amazing MALLORY PLASCAP*—The New Standard in Plastic Tubular Capacitors



These four exclusive features make your service jobs surer . . . easier. No oil leakage, no unsoldered leads, no messy wax coatings, no insulation problems!

✓ **TRISEAL CONSTRUCTION.** Sealed three ways . . . with moisture-free Mallochol, tough outer plastic shell, exclusive Mallozene!

✓ **FASTITE LEADS.** Permanently fastened . . . sealed with Mallozene . . . unaffected by soldering-iron heat!

✓ **DISTORTION-FREE WINDING.** No flattened cartridges due to molding pressures . . . no failure due to "shorts"!

✓ **TRU-CENTER CARTRIDGE.** Cartridge centered every time . . . uniform insulation guaranteed at all points!

Your Mallory Distributor is ready to serve you!

*Trade Mark



P. R. MALLORY & CO., Inc.
MALLORY

CAPACITORS • CONTROLS • VIBRATORS • SWITCHES • RESISTORS
• RECTIFIERS • VIBRAPACK® POWER SUPPLIES • FILTERS

*Reg. U. S. Pat. Off.

APPROVED PRECISION PRODUCTS

P. R. MALLORY & CO., Inc., INDIANAPOLIS 6, INDIANA

THE QUALITY OF RCA TUBES IS UNQUESTIONED

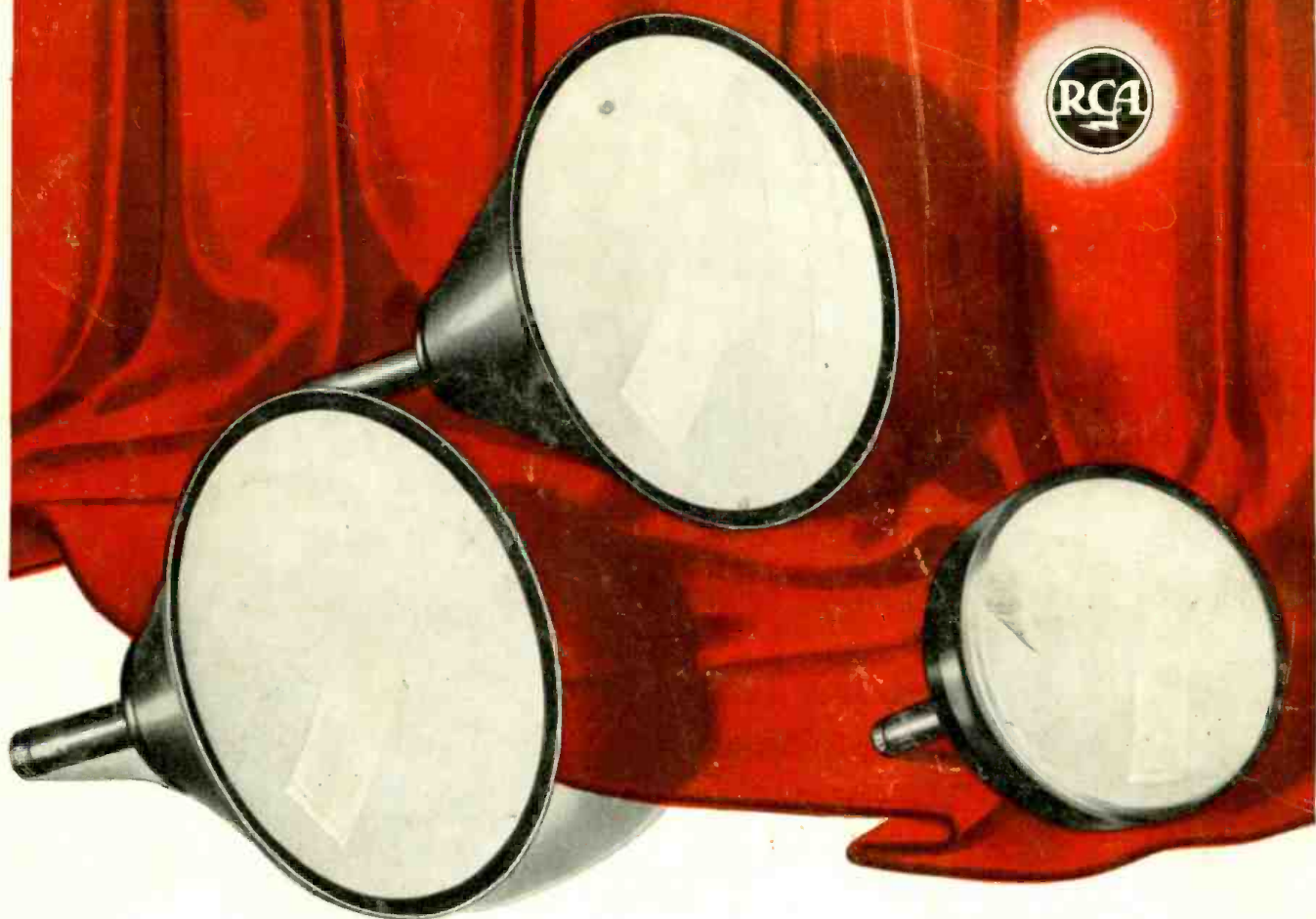

Best Sellers **IN PICTURE TUBES...**

Most used... by brand
and by type... RCA kinescopes
are the fast-moving
profit makers

The largest and most profitable replacement business in television picture tubes comes from the types used in most television receivers... the Best Sellers.

RCA's types are Best Sellers. There are more of them in actual use in TV receivers than any other brand. Industry choice of these high-volume types reflects to your advantage. Inventory and stocking problems are simplified... and you have the assurance of rapid, profitable turnover.

In addition, when you sell RCA kinescopes, you gain from customer confidence in the RCA brand... solidly established by the proved performance of RCA kinescopes in millions of television receivers.

Remember, too, that the quality and dependability of RCA kinescopes mean fewer service failures and fewer costly call-backs. There is, therefore, more profit in every RCA kinescope you sell.

Always keep in touch with your RCA Tube Distributor



RADIO CORPORATION of AMERICA
ELECTRON TUBES

HARRISON, N. J.