

RADIO — ELECTRONICS

K

HUGO GERNSBACH, Editor

formerly

**RADIO
CRAFT**



**CUSTOM SOUND
INSTALLATION**
SEE AUDIO SECTION

LATEST IN RADIO — ELECTRONICS — TELEVISION

APRIL

1950

30¢

U. S. and
CANADA

A clear selling



field



You can sell **MORE** RCA Batteries because...

RCA BATTERIES give you a clear selling field—they're distributed primarily to the radio trade!

You have less competition from non-radio neighborhood stores. Sell RCA Batteries and repeat sales stay with YOU!

RCA Batteries are *radio-engineered* for extra listening hours. The completely rounded line covers *virtually all renewal requirements*.

Closely co-ordinated production meets seasonal demand, assures fresh stock always.

RCA provides the greatest array of battery selling aids in the industry—all geared to the *radio trade*.

Smart packaging, competitive prices and "the greatest name in radio" are compelling reasons why RCA Batteries are your best buy by far.

See your RCA Battery Distributor for fast, reliable service.



RADIO CORPORATION of AMERICA
RADIO BATTERIES
HARRISON, N. J.

NEW



I'LL TRAIN YOU FOR YOUR FCC LICENSE

A Federal Communications Commission Commercial Operator's License puts you in line for a good job in Radio or Television Broadcasting, Police, Marine, Aviation, Two-way, Mobile or Micro-wave Relay Radio. Mail coupon below for book and catalog (both FREE) about my NEW Communications course.



YOU BUILD THIS TRANSMITTER

with parts I send. This low-power broadcasting transmitter shows you how to put a station "on the air." You perform procedures demanded of Broadcast Station Operators, conduct many experiments, make many practical tests.

LEARN COMMUNICATIONS by PRACTICING at Home in Spare Time

with MANY KITS of MODERN EQUIPMENT I SEND



MY COURSE INCLUDES TELEVISION

Course Is New! Different!

Mail coupon now for facts about my NEW, intensely practical course in Radio-Television Communications. Let me send you FREE books. Read outlines of 78 lesson texts written for you by leading Communications experts, edited by my practical staff. See the nine big Kits of Parts I send that "bring to life" theory you learn. Read about the transmitter you build and operate, about the Electronic Multitester you get. All equipment yours to keep. My BRAND NEW course includes BOTH Theory and Practical Experience, with result-getting kits, in Radio-Television Communications. It's backed by N. R. I.—the world's oldest and largest home study Radio school.

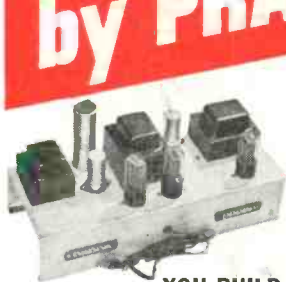

YOU BUILD this Transmitter Power Supply used in the basic experiments in RF and AF amplifiers, frequency multipliers, buffers, etc.



YOU MEASURE current, voltage (AC, DC and RF), resistance and impedance in circuits with Electronic Multitester you build. Shows how basic transmitter circuits behave; needed to maintain station operation.



YOU SET UP code amplitude and frequency modulation circuits (put voice, music, etc., on "electrical signal" you produce). You introduce, correct defects, learn how to get best performance.

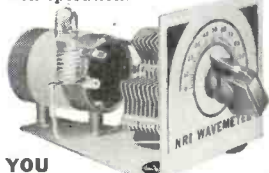

YOU BUILD this Wavemeter and use it to determine frequency of operation, make other tests on transmitter currents.

Ever think HOW FAST Radio-Television Communications is changing, developing, growing? Have you considered what this amazing progress can mean to you?

In 1945, there were 943 Broadcasting Stations. Today 2,694 are on the air! Result—THOUSANDS OF QUALIFIED MEN STEPPED INTO GOOD JOBS. Only 19 Television Stations were on the air in 1947. Today there are more than 50 and experts say there will be 150 in a few months, 1,000 within three years. That means thousands of well-paid jobs for trained Operators and Technicians. Then add development of FM, Two-way Radio, Police, Marine, Aviation and Micro-wave Relay Radio! Think what all this means! New jobs, more jobs for beginners! Better jobs, better pay for experienced men!

Are you a beginner who wants steady work in this growing field? My NEW course can help you get an FCC License and prepare for the job you want. Are you a man with some training in Radio or Radar, or a Licensed operator? My NEW course modernizes, increases the value of your knowledge and experience!

Servicing Training Also Offered by N. R. I.

If you prefer a good-pay job in Radio-Television Servicing . . . or your own money-making Radio-Television Sales and Service Shop, I'll train you at home. My famous Servicing Course also includes many Kits of Parts. You conduct experiments and tests with modern Radio and other circuits you build. I also show you how to make \$5, \$10 a week or more EXTRA MONEY fixing neighbors' Radios while training. Full information in my 64-page catalog. Mail coupon.

Mail Coupon For Book FREE

Send today! See what my NEW course is like. Find out how I get you ready for a brighter future, better earnings, more security in Radio-Television. Send coupon now in envelope or paste on penny postal. NO OBLIGATION. NO SALESMAN WILL CALL! My books, sent to you FREE, tell the full story. J. E. SMITH, President, Dept. ODX, National Radio Institute, Washington 9, D. C.

I TRAINED THESE MEN



"I am now Chief Engineer of Radio Station WORD, in charge of four engineers. Owe all I know about Radio to N. R. I."—C. J. BURDETTE, Spartanburg, S. C.



"I have been in several kinds of Radio work. I am now specializing in Marine Radio telephone installations and service."—MURRAY DICKSON, Paducah, Ky.



"Thanks for splendid Home Study Radio Course, a large factor in my getting present position as Senior Radio Operator of Station WRGP."—C. LISTER, Pensacola, Fla.



"When I enrolled, I had no idea of entering Commercial Radio. Now Operator, Police Radio Station WASP and Highway Station WKSJ."—G. DeRAMUS, Selma, Ala.



"Hold a Radio telegraph Second Class License. Now with Civil Service as P-4 Electrical Engineer."—OTIS L. WRIGHT, Albuquerque, N. M.



"Am now Chief Engineer at Radio Station WAGC. Still using my N. R. I. texts as well references."—CHAS. W. STOKELY, Chattanooga, Tenn.

VETERANS GET THIS TRAINING UNDER G. I. BILL. MAIL COUPON.

MAIL NOW-BOOK FREE

MR. J. E. SMITH, President, Dept. ODX National Radio Institute, Washington 9, D. C.

Mail me FREE Catalog and Book about Radio and Television Communications opportunities and training. (No salesman will call. Please write plainly.)

Name..... Age.....
 Address.....
 City..... Zone..... State.....
 Check if Veteran Approved Under G. I. Bill

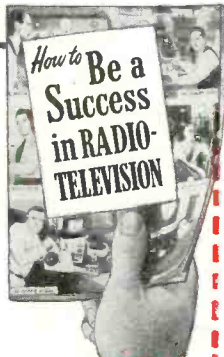

RADIO-ELECTRONICS

formerly RADIO-CRAFT

MEMBER
AUDIT BUREAU OF CIRCULATION

Incorporating
SHORT WAVE CRAFT* TELEVISION NEWS*
RADIO & TELEVISION
*Trademark Registered U. S. Patent Office

Hugo Gernsback, Editor-in-Chief

Fred Shunaman, Managing Editor
Robert F. Scott, W2PVG, Technical Editor
I. Queen, Editorial Associate

M. Harvey Gernsback, Editorial Director
Angie Pascale, Production Manager
Wm. Lyon McLaughlin, Tech. Illustration Director

Lee Robinson, General Manager
John J. Lamson, Sales Manager

G. Aliquo, Circulation Manager
Robert Fallath, Promotion Manager

CONTENTS — APRIL, 1950

Editorial (Page 23)	
Unprofessional Servicing.....	by Hugo Gernsback 23
FM (Pages 24-25)	
Wide-Band FM Adapter Reduces Interference....	by Peter G. Sulzer 24
Television (Pages 26-33)	
Television Equipment Standards.....	by Matthew Mandl 26
Television Dx.....	27
A DeLuxe Teviser, Part IV.....	by Charles A. Vaccaro 28
Electronic Brain Servicing.....	by Ulysses Fips, IRE 30
Velocity—Modulated TV.....	32
Television Dictionary (Continued).....	by Ed Bukstein 33
Construction (Pages 34-37)	
Photoelectric Relays Use Cold-Cathode Tubes.....	by Bob White 34
Portable Broadcaster.....	by Otto Woolley 37
Audio (Pages 38-41)	
Custom Sound Installation (Cover Feature).....	by William Rivkin 38
Phono Equalizer Design Plus Preamplifier Data....	by K. E. Forsberg 40
Test Instruments (Pages 42-45)	
Television Test Equipment Kits.....	42
Quick Tuning Generator.....	by M. Rabinowitz 43
Battery Signal Generator.....	by J. C. Anderson 44
Theory and Engineering (Pages 46-47)	
Voltmeters and Wave Shapes.....	by Irving Dlugatch 46
Servicing (Pages 48-63)	
Fundamentals of Radio Servicing Part XIV.....	by John T. Frye 48
Radio Repair Licensing: Pedro Takes A Dim View..	by Guy Slaughter 58
Electronics (Pages 64-67)	
Static Troubles in Aircraft Radio.....	by Teresa M. Korn 64
Amateur (Pages 68-75)	
A Simple Electronic Key.....	by Jack D. Gallagher, W5H2B 68
A Radiationless Method for Transmitter Tuning....	by Philip Johnson, W7MHU 72
Departments	
The Radio Month.....	8
Radio Business.....	10
New Devices.....	76
New Patents.....	78
Try This One.....	80
Radio-Electronic Circuits....	82
Book Reviews.....	95
Association News.....	84
Miscellany.....	85
Question Box.....	88
People.....	90
Technotes.....	91
Communications.....	92

ON THE COVER: Technician John Flood checks the radio end of the installation described on page 38. Kodachrome by Avery Slack.

another
NATIONAL
TELEVISION
FIRST!

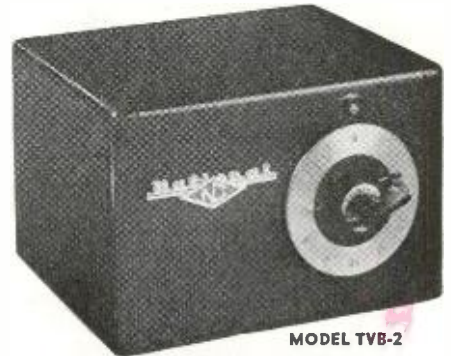

A SENSATIONAL NEW BOOSTER FEATURING A TURRET TUNER

The turret tuner is recognized as the most efficient television input tuning device yet designed because of (1) its exceptionally high gain and (2) its uniform bandwidth on all channels. It is used in today's finest television receivers. Now, for the first time, National makes available all the advantages of a turret tuner in a truly sensational-performing new television booster.

COMPARE THESE FEATURES:

- (1) Turret tuner with an individually tuned set of coils for each channel.
- (2) Removable polystyrene coil-mounting contact panels.
- (3) A single 6AK5 for maximum usable gain.
- (4) A built-in power transformer (not AC-DC — no "hot" chassis).
- (5) Selenium rectifier for long life.
- (6) Channel selector and fine tuning in a single, easy-to-operate, dual-purpose control.
- (7) Pilot light illuminates selected channel.



\$39.95
list price

P.S. No other booster has a turret tuner!



RADIO-ELECTRONICS for

RADIO-ELECTRONICS, April, 1950, Volume XXI, No. 7. Published monthly. Publication Office: Erie Ave. E to G Streets, Philadelphia 32, Pa. Entered as second class matter September 27, 1948, at the post office at Philadelphia, Pa., under the Act of March 3, 1879. **SUBSCRIPTION RATES:** In U. S. and Canada, in U. S. possessions, Mexico, South and Central American countries, \$3.50; \$6.00 for two years; \$8.00 for three years; single copies 30c. All other foreign countries \$4.50 a year, \$8.00 for two years, \$11.00 for three years. Allow one month for change of address. When ordering a change please furnish an address stencil impression from a recent wrapper. **RADIO-CRAFT PUBLICATIONS, Inc.** Hugo Gernsback, Pres.; M. Harvey Gernsback, Vice-Pres.; G. Aliquo, Sec'y. Contents copyright, 1950, by Radio-Craft Publications, Inc. Text and illustrations must not be reproduced without permission of copyright owners. **EDITORIAL and ADVERTISING OFFICES, 25 West Broadway, New York 7, N. Y.** Tel. REctor 2-9690. **BRANCH ADVERTISING OFFICES:** Chicago: 308 W. Washington Street. Telephone Randolph 6-7363. Los Angeles: Ralph W. Barker, 1127 Wilshire Blvd., Tel. MA 6-1271. San Francisco: Ralph W. Barker, 582 Market St., Tel. CArfield 1-2481. **FOREIGN AGENTS:** Great Britain: Atlas Publishing and Distributing Co., Ltd., London E.C.4. Australia: McGill's Agency, Melbourne. France: Brentano's, Paris 2e, Holland: Trilectron, Heemstede, Greece: International Book & News Agency, Athens. So. Africa: Central News Agency, Ltd., Johannesburg; Capetown; Durban. Natal: Universal Book Agency, Johannesburg. Middle East: Steimatky Middle East Agency, Jerusalem. India: Broadway News Centre, Dadar, Bombay #14. K. L. Kannappa Mudaliar, Madras 2. Pakistan: Paradise Book Stall, Karachi 3.



Get Into

TELEVISION, RADIO ELECTRONICS

Master ALL Phases



YOU RECEIVE THIS PROFESSIONAL MULTIFESTER YOU BUILD ALL THESE AND MANY OTHER UNITS WITH PARTS WE SEND YOU!

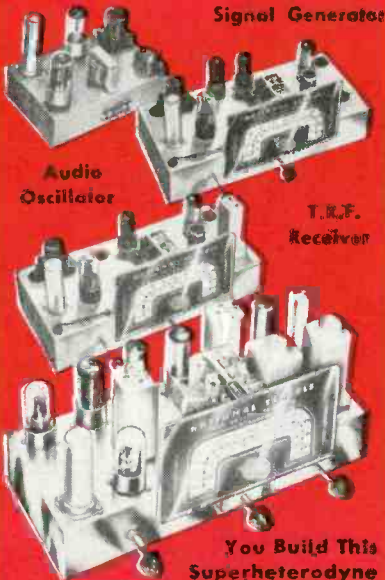

Signal Generator

Audio Oscillator

T.R.F. Receiver

You Build This Superheterodyne

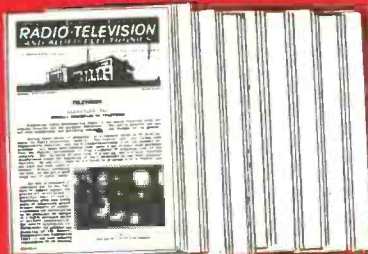

You Receive a Special Series of Modern Lessons in TELEVISION, all a part of your course; you master all phases.

Get Complete Training. You Receive and Keep All Tubes, Equipment, Parts and Lessons. No Extra Charges.

GOOD PAY and Unlimited Opportunities in JOBS LIKE THESE:

Business of Your Own
Radio Manufacturing, Sales, Service
Broadcasting, Telecasting
Television Manufacturing, Sales, Service
Laboratories: Installation, Maintenance of Electronic Equipment, Electrolysis, Call Systems
Garages: Auto Radio Sales, Service
Sound Systems and Telephone Companies; Oil Well and Drilling Companies; Engineering Firms
Theatre Sound Systems, Police Radio

And scores of other good jobs in many related fields

YOU CONDUCT MANY EXPERIMENTS LIKE THESE!

Checking action of condensers
Experiments with AF and RF amplifiers
Experiments with resonance
Producing beat frequencies
Calibrating oscillators
Experiments with diode, grid-bias, grid-leak and infinite impedance detectors
Practical experience in receiver trouble shooting
Application of visual tester in checking parts and circuits
Experiments with audio oscillators
Advanced trouble-shooting
... and many, many others

Complete Training by Practical Resident Trade School, Est. 1905

The same highly trained faculty, instruction materials and methods used here in our large, modern resident school, are adapted to your training in your own home. Shop Method Home Training has been proved by hundreds of successful graduates.

Both Resident and Home Study Courses Offered

YOU LEARN BY DOING

You receive special laboratory experiment lessons to show you how to build with your own hands various experimental units such as those shown at left, and how to conduct many tests.

You will find all lessons easy to understand because they are illustrated throughout with clear diagrams and step-by-step examples that you work out yourself. Every piece of the equipment and complete lesson material we send you is yours to keep and enjoy, including the multimeter, experimental equipment, all parts of the Superheterodyne, tube manual, radio dictionary, and complete, modern Television texts. All parts are standard equipment.

Shop Method Home Training . . . Earn While You Learn

With our practical resident Shop Method Home Training, you study in your spare time. You receive Spare Time Work Lessons, which show you how to earn while you learn. Service neighbors' radios and TV receivers, appliances, etc., for extra money and experience. Many National students pay all or part of their training with spare time earnings!

DON'T DELAY! The Radio-Television Industry needs trained men NOW!

APPROVED FOR VETERANS!
Check coupon below!

For quick action, mail coupon today and we'll rush you full information.

Free!

NEW, ILLUSTRATED OPPORTUNITY BOOK AND SAMPLE LESSON SHOW YOU HOW WE TRAIN YOU . . . SEND FOR THEM TODAY! NO COST. NO OBLIGATION.



NATIONAL SCHOOLS
LOS ANGELES 37, CALIF. • EST. 1905



FIND OUT NOW . . . MAIL COUPON TODAY

National Schools, Dept. RE-4
4000 South Figueroa Street
Los Angeles 37, California

Mail in envelope or paste on penny postal.

Send me your FREE book "Your Future in Radio" and the sample lesson of your course. I understand no salesman will call on me.

NAME..... AGE.....

ADDRESS.....

CITY.....ZONE.....STATE.....

Check here if Veteran of World War II

<p>2" x 3" PM Speaker—0.125 watt; resonant frequency, 250-365 cps; 1.5 oz. magnet; voice-coil impedance, 11.8 ohms (at 1000 cps); rim mounting.</p>		<p>5" PM Speaker—3 watts; resonant frequency, 150-200 cps; 1.47 oz. magnet; voice-coil impedance, 3.2 ohms; rim or pot mounting.</p>		<p>5" Field-Coil Speaker—3 watts; resonant frequency, 150-200 cps; 450-ohm, 65-ma. field; voice-coil impedance, 3.2 ohms; rim or pot mounting.</p>	
	<p>4" PM Speaker—3 watts; resonant frequency, 170-225 cps; 1.47 oz. magnet; voice-coil impedance, 3.2 ohms; rim or pot mounting.</p>	<p>High Fidelity at a new low price ...</p>  <p>The new 51551 15" Duo-Cone Speaker—Frequency response, 40 to 12,000 cps; 25 watts power-handling capacity; wide-angle radiation. Suggested list price, \$55.00.</p>			<p>4" x 6" Field-Coil Speaker—3 watts; resonant frequency, 150-200 cps; 450-ohm, 65-ma. field; voice-coil impedance, 3.2 ohms; rim mounting.</p>
<p>4" x 6" PM Speaker—3 watts; resonant frequency, 150-200 cps; 1.47 oz. magnet; voice-coil impedance, 3.2 ohms; rim or pot mounting.</p>				<p>5" x 7" PM Speaker—6 watts; resonant frequency, 120-140 cps; 1.47 oz. magnet; voice-coil impedance, 3.2 ohms; rim mounting.</p>	
	<p>12" PM Speaker—12 watts; resonant frequency, 70-85 cps; 2.15 oz. magnet; voice-coil impedance, 3.2 ohms; rim mounting.</p>		<p>12" Field-Coil Speaker—12 watts; resonant frequency, 70-85 cps; 1000-ohm, 70-ma. field; voice-coil impedance, 3.2 ohms; rim mounting.</p>		<p>8" PM Speaker—8 watts; resonant frequency, 75-95 cps; 2.15 oz. magnet; voice-coil impedance, 3.2 ohms; rim mounting.</p>

Now... a quality line of replacement speakers from one dependable source

Quality-engineered for dependable performance . . . and priced for replacement needs . . . the RCA line of standard speakers offers you a great selling potential.

From the superb 15" high-fidelity duo-cone to the 2" x 3" elliptical—each RCA speaker is designed with top engineering skill, made of the best materials, and mass-produced under rigid quality-control methods.

RCA's PM and field-coil types meet practically all replacement requirements. All 4", 4" x 6", and 5" speakers are supplied with a universal mounting bracket that

saves time in mounting either clinch-type or strap-type output transformers.

Look to RCA—and your RCA distributor—as a dependable

source for all of your replacement speaker requirements. For full details on the complete line, ask your RCA distributor for Bulletins 2F892 and 3F620.

Check these important features!

- ✓ Moisture-resistant voice-coil suspension—unaffected by humidity changes.
- ✓ Rugged mechanical construction with welded housing assembly.
- ✓ Exclusive clamping spring permanently locks Alnico V magnet in larger sizes of PM speakers.
- ✓ Mechanical filter ring in 12" speakers cuts needle scratch and 10-kc. whistle.
- ✓ Rugged—Dustproof resistant—Rustproof resistant.
- ✓ Adjustable voice-coil mounting in 12" speakers.
- ✓ Rim mounting designed to RMA standards.



RADIO CORPORATION of AMERICA
ELECTRONIC COMPONENTS

HARRISON, N. J.

RADIO-ELECTRONICS for

★ TO A MAN INTERESTED IN ★ A Better Paying Job in Television

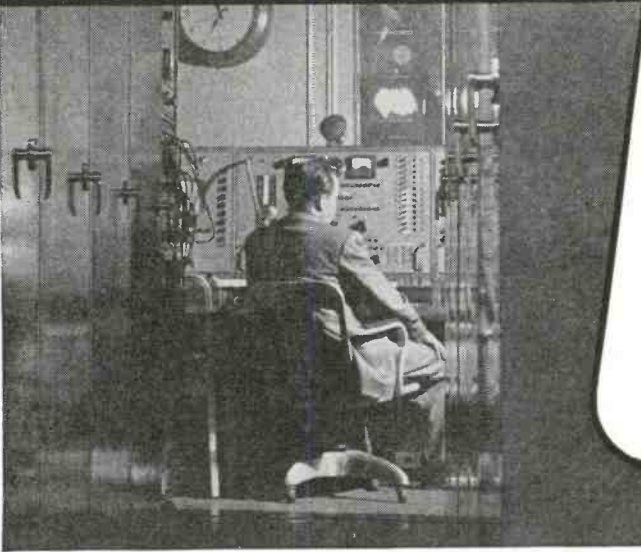

ASK YOURSELF THESE QUESTIONS:

1. Are new men—with less experience than yourself—passing you by?
2. Has it been "too long" since you have received a satisfactory raise?
3. Are you tied down to a routine, production-line job?
4. Does your future seem limited to small stations and small salaries?
5. DO YOU GENERALLY FINISH WHAT YOU START?

If your answer is YES to most of these questions, CREI'S Home Study Course can help you get a BETTER JOB in Television

WHAT YOU DO to keep yourself abreast of new developments is what counts toward advancement in television. Obviously, everyone cannot qualify. *Those who do are well rewarded.* The television industry offers almost unlimited opportunity to trained engineers and technicians. CREI training helps all levels, from novice to experienced engineer, because its specialized individual instruction brings out the best in a man and takes him as far as his own aptitude and effort will let him go.

CREI is an accredited technical institute founded in 1927. Its home study graduates fill important jobs throughout the radio, television and electronics industries. Leading industrial firms—RCA Victor, Pan American Airways, United Air Lines, to name only a few—have CREI group training programs now in opera-

tion. Industry welcomes CREI grads—CREI training is recognized as a respected reference.

Make your own opportunity in television! Add CREI technical training to your present experience — start either at the beginning or at an advanced stage. Get yourself a better TV job—make more money—enjoy increased security. The next two years can be the most important of your lifetime. Write today for complete information. The cost is popular, the terms easy.

VETERANS: CREI training is available under the G.I. Bill. For most veterans July 25, 1951 is the deadline—so act now!

FREE SAMPLE LESSON

Send for "The Orthicon and Image Orthicon" which describes the development, theory and operation of the orthicon and image orthicon TV camera tubes.



THE THREE BASIC CREI COURSES:

- ★ **PRACTICAL RADIO ENGINEERING**
Fundamental course in all phases of radio-electronics
 - ★ **PRACTICAL TELEVISION ENGINEERING**
Specialized training for professional radiomen
 - ★ **TELEVISION AND FM SERVICING**
Streamlined course for men in "top-third" of field
- ALSO AVAILABLE AS RESIDENCE SCHOOL COURSES

CAPITOL RADIO ENGINEERING INSTITUTE

An Accredited Technical Institute Founded in 1927
Dept. 144B, 16th & Park Rd., N. W. Washington 10, D. C.
Branch Offices: New York (7) 170 Broadway • San Francisco (2) 760 Market St.



MAIL COUPON FOR FREE BOOKLET

CAPITOL RADIO ENGINEERING INSTITUTE

Dept. 144B, 16th & Park Road, N. W., Washington 10, D. C.

Gentlemen: Send me FREE SAMPLE LESSON and booklet, "Your Future in the New World of Electronics," together with details of your home study training. CREI self-improvement program and outline of course. I am attaching a brief resume of my experience, education and present position.

- | | |
|--|--|
| <input type="checkbox"/> Check the Field of Greatest Interest: | <input type="checkbox"/> Aeronautical Radio Engineering. |
| <input type="checkbox"/> Practical Television Engineering. | <input type="checkbox"/> Broadcast Radio Engineering (AM, FM, TV). |
| <input type="checkbox"/> Practical Radio Engineering. | <input type="checkbox"/> Radio-Electronics In Industry |
| <input type="checkbox"/> TV, FM & Advanced AM Servicing. | |

NAME _____ AGE _____

ADDRESS _____

CITY _____ ZONE _____ STATE _____

I am entitled to training under G.I. Bill. Send details on Residence School.

COLOR TELEVISION fully compatible with black-and-white standards was demonstrated by the Radio Corporation of America in Washington February 8. The color registry, or "color phasing", was controlled by a special development which prevents the "color drifting" that caused objects



to change color gradually in earlier tests.

As explained by Dr. E. W. Engstrom, who conducted the tests, registry of the color dots is controlled by a pulse sent at the end of each line. Thus all colors start each line in perfect registry.

While the tests were conducted with standard RCA 3-tube experimental receivers roughly similar to those described in the January RADIO-ELECTRONICS, Dr. Engstrom announced that RCA intended shortly to submit to the FCC for test a color receiver with only one cathode-ray tube to reproduce the three primary colors. This type of tube, he suggested, would probably be a prototype of those which will actually be used in future commercial color receivers, when such become feasible.

TAPE RECORDING standards are being submitted to the National Association of Broadcasters Board for approval. New proposals will include a recommended standard hub and flange for use with magnetic tape reels as well as a standard of fidelity and quality which will enable broadcasters to interchange reels and establish central tape libraries.

13,000 POLICE CARS have yet to be licensed for radio communications in this country according to a report made by the Marketing Services Division of the General Electric Company. The majority of these cars will be licensed within three years if the present growth of radio communications continues at the same rate.

Five thousand police radio licenses have been granted in the United States and the total number of licensed vehicles for two-way radio police radio now approximates 40,000. Currently eleven state police organizations are

licensed to use over 300 mobile units in their respective systems.

SUBMARINE DETECTORS and other sound and ultrasonic equipment will be using barium titanate, a war-developed material with exceptional electrical behavior, instead of older types of crystals. This unusual compound shows a remarkably quick response to the slightest changes in pressure, temperature, or electric field. Even light shining on it will cause the molecules to rearrange themselves.

DIAL TELEPHONES for small cities will be made possible with a new electric "brain" developed by Bell Telephone Laboratories engineers. The new equipment lends itself to mass production methods, is easily maintained, and is more nearly self-checking than any previous dial system. Initial installations are now being made, and the equipment will be integrated with the nationwide communications network.

300,000 TRANSMITTERS are covered in non-broadcast authorizations by the FCC. Of these, nearly one-third are fixed stations, and the rest are portable or mobile units.

Most of these—over 290,000—are in the Safety and Special Services, which has some 94,000 land or fixed stations and 196,000 portable or mobile units. The common carrier services have nearly 26,000 transmitters of which 2,200 are fixed and 23,600 portable.

UPPER ATMOSPHERE showers large amounts of radio noise on us from all directions. These bursts of noise can be picked up by a sensitive radio receiver as increased background noise. This discovery was disclosed last month by Herman V. Cottony of the National Bureau of Standards.

This phenomena was found when a solar radiometer, an instrument to measure the amount of radiation from the sun, was directed toward different parts of the sky on Nov. 23. On that day radio noise had increased to about six times normal, but the solar radiometer, when pointed toward the sun, showed no unusual disturbances. Dr. Cottony concludes that the exceptionally large amounts of radio noise are coming from somewhere in the outer atmosphere of the earth.

CHEESE can now be pasteurized by r.f. heating as a result of recent experiments conducted by scientists at Cornell University. The delicious cheddar flavor is best obtained by aging cheese made from raw milk, and it is much easier to pasteurize ten pounds of cheese than the 100 pounds of milk from which it is made.

The experimenters had hoped to be able to treat old cheese with this process, but so far, the radio frequencies pasteurize only very young raw milk cheese. The cheese is placed between two electrodes which carry a high-frequency current. The temperature goes up to 132° F. in about two minutes. This pasteurizes the cheese, yet leaves enough enzymes and bacteria to develop flavor.

Get Set for LAND OFFICE BUSINESS on the *Astatic* TELEVISION BOOSTER Soon to be Advertised Nationally on TELEVISION

OWNERS OF TV RECEIVERS, and their friends, the nation over, will soon see the Astatic Television Booster in operation . . . and hear its exclusive advantages explained . . . from their favorite TV stations. It doesn't take a crystal ball to forecast the impact of TV advertising on sales of Astatic Boosters. When set owners in your area actually see weak, washed-out pictures on a TV screen changed to bright, clear action by the Astatic Booster, the skyrocketing of sales will be automatic. They'll be asking—by the thousands—for the "four-tube booster" with "variable gain control," "dual-tuning," "handsome furniture-finish mahogany cabinet," and other exclusive features they've seen and heard about ON TELEVISION. They'll ask by name for the Astatic Booster.

If there is anything you don't know about the Astatic Booster, write for specifications and complete details. Get behind this surefire program to help you sell. Check your stock. Order TODAY for your needs.

Astatic Crystal Devices manufactured under Brush Development Co. patents

THE *Astatic* CORPORATION
ASTATIC
CONNEAUT, OHIO
IN CANADA: KAMBER-ASTATIC LTD. TORONTO, ONTARIO



ROBERT D. HICKOK, president and founder of The Hickok Electrical Instrument Company, died January 23 at the age of 70.

Since founding his company in 1910, Mr. Hickok had been actively interested in it and had supervised the development of many instruments used by electrical manufacturers and radio



technicians. Some of his best known instruments are an astatic uniform scale wattmeter, an expanded scale photoelectric exposure meter movement, and the original dynamic mutual conductance tube tester (known to technicians as the AC-47).

Mr. Hickok was an active RMA member and Fellow of the American Institute of Electrical Engineers.

KARL GUTHE JANSKY, radio research engineer known for his discovery of radio waves from interstellar space, died on February 14 at Red Bank, N. J.

An expert on radio transmission and on atmospheric and other types of radio interference, Mr. Jansky is credited with several basic discoveries and was recently awarded an Army-Navy Certificate of Appreciation for his work during World War II. He joined the Bell Laboratories in 1928 and concentrated his research on shortwave radio-telephone transmission. He guided the development of special recorders and directional antennas with which he discovered interstellar radio waves in 1933.



RADIO PROPAGATION will be studied by the National Bureau of Standards at a new site near Boulder, Colorado. Laboratory facilities costing about \$4,500,000 will be constructed on the 210-acre site during the summer of 1951. A research staff of about 300 people will be employed there.

This location was chosen because the Bureau's work is best carried out near a small town or city which is not congested by electrical and radio facilities. The site is near a major university which is expected to provide a source for competent new personnel and an opportunity for graduate training of junior staff members.



Mr. Gernsback receives Marconi Award. Pres. Wm. J. McGonigle is on the right.

MARCONI MEMORIAL Wireless Pioneer's Medal was awarded to Hugo Gernsback by the *Veteran Wireless Operators Association* at its annual Dinner Cruise held in New York February 25.

The award was made to the veteran technical publisher for "pioneering achievements in the radio art." It was recalled that Gernsback was the pioneer radio manufacturer as well as publisher

of this country, having sold the first radio set to the public (a portable spark transmitter and receiver) in 1905. His Electro Importing Co. was during that period and later the Mecca of the radio experimenter. It manufactured The Pioneer's Medal and sold numerous radio parts (many of them invented by Gernsback himself) absolutely unobtainable elsewhere.

He published the country's first radio magazine, *Modern Electrics*, in 1908, and has continued as a publisher of radio magazines and books ever since that date. Gernsback was also one of the first to promote radio associations in 1909, and fostered the early amateur radio movement both personally and through his publications, parts of one of his editorials having been incorporated in the first law passed to regulate radio, which was enacted in 1912.

TV INSURANCE, covering service renewal contracts, is becoming a "necessary evil," in New York, according to several contractors and dealers. More and more customers are demanding insurance coverage of their second year service contracts, but dealers and contractors are not certain that they will gain by having coverage by a surety company.

Retailers and service firms seem to be confused as to whether the New York State Insurance provision is a law or merely the opinion of an Attorney General.

The New York State Insurance Department has announced that TV service contracts are definitely insurance contracts and that present rulings have had the status of law for some months.



2 IMPORTANT NEW PHOTOFAC BOOKS

"TELEVISION TUBE LOCATION GUIDE"



Gives Tube position and function in hundreds of important TV receiver models, made by 56 manufacturers.

FIND THE TROUBLE AND REPLACE TUBES WITHOUT REMOVING CHASSIS

Nothing like it! The only book that shows the position and function of tubes in hundreds of TV receivers. Often an operational check in the customer's home . . . looking at the picture tube and listening to the sound . . . can give you a clue to the trouble. Many times only a tube failure is responsible. TGL-1 makes trouble diagnosis and tube replacement quick and simple, in most cases *without removing the chassis!* Each model has its own clear, accurate diagram. Book fully indexed for quick reference. Over 200 pages, handy pocket size, 5½ x 8½". Get two copies . . . one for outside calls and one for your bench. Pays for itself on the first job!

ORDER TGL-1 Only. \$1.50



"DIAL CORD STRINGING GUIDE"

NEW!
SECOND VOLUME
Covers models from 1947 to October 1949

Over 45,000 servicemen bought the first volume of this invaluable book! New second volume includes 511 different dial cord stringing diagrams used in almost 1000 receivers produced from 1947 to October, 1949 (all new data continuing from where the first volume left off). There's only *one right way* to string a dial cord . . . and here's the *only* book that shows you how. Saves time—saves effort. Handy pocket size. Order copies for your tool kit and work bench today.

ORDER DC-2 Only. \$1.00

HOWARD W. SAMS & CO., INC.

Order from your Parts Jobber today, or write direct to HOWARD W. SAMS & CO., INC., 2201 East 46th Street, Indianapolis 5, Ind.

My (check) (money order) for \$..... enclosed. Send the following books:

- TGL-1 "TV Tube Location Guide" \$1.50
- DC-2 "Dial Cord Stringing Guide" \$1.00

Name
Address
City..... Zone..... State.....

RCA Engineering Products Department, Sound Equipment Section, has announced a newly engineered revenue-producing radio and sound distribution system for hospitals.

The new hospital equipment, designed to entertain patients in hospitals of 50 to 500 beds, consists of a basic four-channel AM-FM central station installation and special hospital reproducer equipment which requires no operating personnel.



There are several methods of distributing both radio and recorded music programs in the various hospital locations. Beds may be equipped with pillow speaker and plug selector switch assembly, allowing the patient to select his own program without disturbing others in the room or ward. Individual monoset earphone equipment provides the same individual reception for patients who are able to sit up or be out of bed, or wall speakers may be provided as reproducer equipment.

Sylvania Electric Products, Inc., radio division, is continuing to promote radio and television service technicians during 1950 in a new series of national ads in the *Saturday Evening Post*, *Life*, *Look*, *Collier's*, and *Radio & Television Best*, starting in January. The new campaign increases the size of previous Sylvania ads about repairmen from one-quarter to one-half page in black and white.

Sylvania is supplementing the ads with a cooperative campaign kit for technicians and dealers which includes four-color window posters based on the monthly ad, two-color streamers, three-color postal cards, free mats for local newspaper advertising, and radio spot announcements.

Emissoras Associadas, Brazil's largest radio network, plans to introduce television at the fast-growing business center of Sao Paulo. All equipment will be supplied by the RADIO CORPORATION of AMERICA, it was announced by MEADE BRUNET, a vice president of RCA and managing director of the RCA International Division. The station is expected to be on the air in the summer of 1950.

Arrangements for the installation of the television transmitter, as well as associated studio and mobile pickup equipment, were begun in 1948 and concluded during the recent visit to the United States by Dr. ASSIS CHATEAUBRIAND, Director General of the Brazilian network, according to Mr. Brunet. He said the transmitter and antenna will be located atop Sao Paulo's highest edifice, the State Bank Building.

Erie Resistor Corp., Electronics Division, has created a Research and Development Department for the investigation of new principles, methods, and materials which may be applied to new and existing products. The department will be headed by J. D. HEIBEL as Director of Research and Development. Heibel has been with Erie Resistor for 13 years as chief electrical engineer, and has pioneered many engineering developments.

J. C. VAN ARSDELL, Electrical Engineer, has been promoted to the position of Manager of the Sales Engineering Department. He will work with the sales department in the proper interpretation of customers' specifications, as well as in the development of new products and of new applications for existing products.

General Electric, Syracuse, N. Y., has installed a two-way radio system to prevent the spread of forest fires in the area of Bar Harbor and Mt. Desert Island, Maine.

The residents of those areas, who suffered hundreds of thousands of dollars in damage in the great forest fires of 1947, purchased 10 mobile radio units and two remote control units from the General Electric Company in an effort to combat this ever-present threat of fire.

The ten G-E units are installed in such vehicles as the jeep patrol, which makes routine checks on forest fires, in the fire chief's car, in two pumping



engines and in the county medical examiner's car.

Included in the two-way radio hookup are Bar Harbor, Town Hill, Southwest Harbor and Somesville. Southwest Harbor also has ordered two

G-E walkie-talkie radio sets to use with the mobile unit.

The American Gage & Machine Co. has announced its merger with the Simpson Electrical Co. of Chicago, manufacturers of electrical and radio meters and test equipment.

RAY SIMPSON, founder of the Jewell Electrical Instrument Co., Simpson Optical Co., and the present Simpson Electric Co., will remain as chairman of the Simpson Electric Division. HERBERT BERNREUTER, meter and test equipment engineer, has been elected a vice president of the American Gage & Machine Co., and will act as operating head of the Simpson Division, with which he has been identified since its inception.

The Sightmaster Corp., New York, has announced the issuance of patent no. 2,492,224, covering its newly developed *Sightmirror*.

With the issuance of this patent, Sightmaster, according to MICHAEL L. KAPLAN, president, plans to make Sightmirror available for public use for any television receiver now in existence. Sightmirror, which serves as a filter to eliminate glare and the possibility of eyestrain and to soften the picture, is a decorative mirror when the set is turned off.

General Electric Company, Syracuse, N. Y., announces that the latest in G-E television test equipment and techniques for alignment of television receivers will be demonstrated by R. H. RUDOLPH, G-E sales manager for equipment, in a tour of cities in the South and West.

The new G-E equipment, includes a five-inch oscilloscope, a marker generator and a sweep generator with a new balanced output adaptor.

The twelve cities Rudolph will visit are: Oklahoma City, Tulsa, New Orleans, Houston, San Antonio, Fort Worth, Dallas, Albuquerque, Salt Lake City, Los Angeles, San Francisco and Seattle.

Radio Manufacturers Association reported that sales of communications equipment, radar and other radio transmitting apparatus to the U. S. Government during the third quarter of 1949 totalled \$35,489,327. Sales of radar equipment amounted to \$23,914,281 and accounted for the largest portion of the U. S. Government radio transmitting equipment purchases. Third quarter government purchases were slightly under the second quarter total of \$40,140,586.

Sales of communications transmitters, receivers and transceivers during the third quarter totalled \$4,752,395, and laboratory and test equipment purchases by the government amounted to \$3,563,910. RMA member-company sales of radio navigational aids to the government accounted for another \$2,620,516 and sonar apparatus sales for \$595,037, while quartz crystals sales totalled \$43,188.

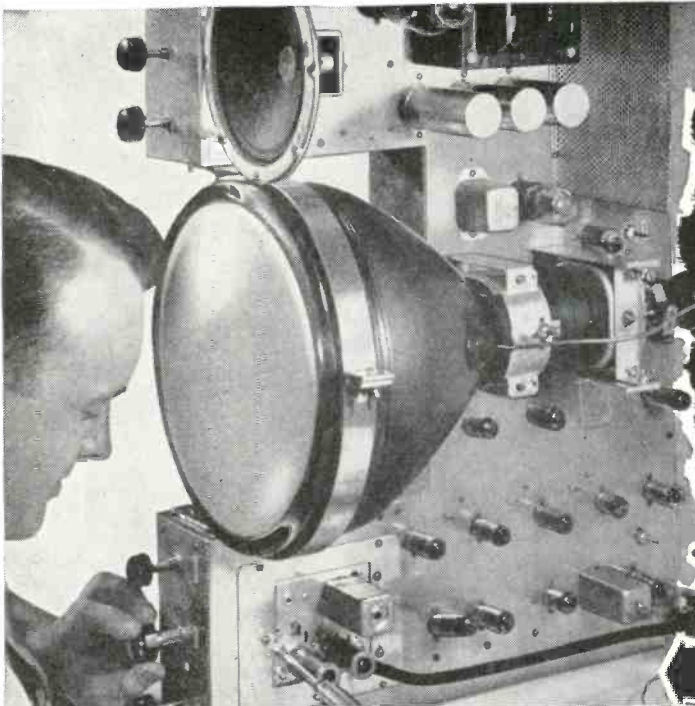

Only D.T.I. offers you the "BIG 5" TELEVISION RADIO-ELECTRONICS Laboratory Type HOME TRAINING



Build and Keep 10, 12½ or 16 inch Picture Tube Quality TELEVISION RECEIVER as you prepare for a Profitable Future

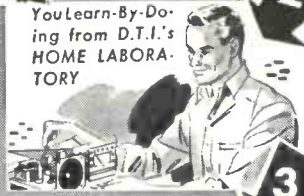

You Learn-By-Doing from D.T.I.'s HOME LABORATORY



R-F Signal Generator

Here is everything you need to prepare you at home for FASCINATING WORK, GOOD MONEY and a THRILLING FUTURE in one of America's most promising fields.

This includes the opportunity to build and keep the top quality Television Receiver shown above—with choice of a 10, 12½ or 16 inch picture tube that gives big, bright, sharp, steady pictures. Get the complete facts. This is an optional feature — available when you complete your training described below. See how D.T.I.'s wonderfully practical "BIG 5" method meets industry's needs. No previous experience needed. Mail coupon today!

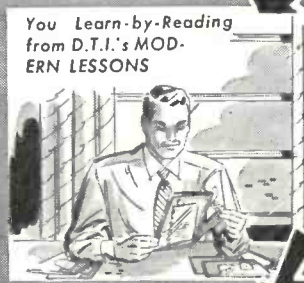

You Learn-by-Reading from D.T.I.'s MODERN LESSONS

16 Big Shipments of Parts — Plus Lessons

Work over 300 electronic experiments and projects from 16 big shipments of parts. This includes building and keeping all test equipment and radio set shown at left side of page. Modern easy-to-read lessons with handy fold-out diagrams simplifies your entire training.

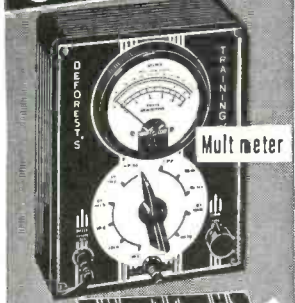

Multimeter

You Also Use Home Movies

D.T.I., alone, includes the modern, visual training aid . . . MOVIES to help you learn faster, easier at home. See electrons on the march and other fascinating "hidden action"—a remarkable home training advantage that speeds your progress.



You Learn-by-Seeing from D.T.I.'s HOME MOVIES

EMPLOYMENT SERVICE

When you complete your training, our effective Employment Service helps you get started toward a real future in Television-Radio-Electronics.

Modern Laboratories

If you prefer, you can get All your preparation in our new, Chicago training laboratories . . .

6 Tube Radio Receiver

one of the finest of its kind. Ample instructors . . . modern equipment. Write for details!

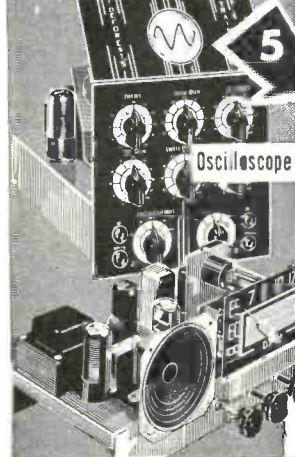
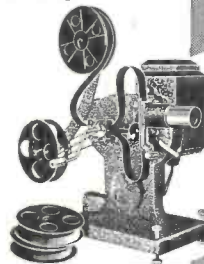

Oscilloscope

MAIL THIS COUPON TODAY!

DeFOREST'S TRAINING, INC.
2533 North Ashland Avenue, Dept. RC-G-4
Chicago 14, Illinois.

Without obligation, give me complete facts showing how I may make my start in Television-Radio-Electronics.

Name _____ Age _____

Street _____ Apt. _____

City _____ Zone _____ State _____

DeFOREST'S TRAINING, INC.

Chicago 14, Illinois
A DeVry Institution

NEW 1950 Heathkits

have all the Features

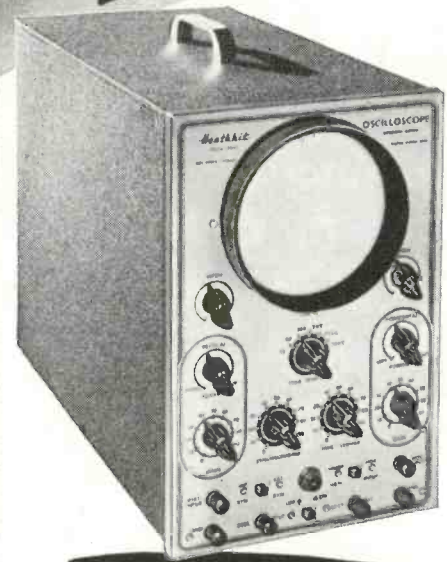

\$39.50

New 1950 Heathkit
**PUSH-PULL EXTENDED RANGE
 5" OSCILLOSCOPE KIT**

Features

- The first truly television oscilloscope.
- Tremendous sensitivity .06 Volt RMS per inch deflection.
- Push-pull vertical and horizontal amplifiers.
- Useful frequency range to 2 1/2 Megacycles.
- Extended sweep range 15 cycles to 70,000 cycles.
- New television type multivibrator sweep generator.
- New magnetic alloy shield included.
- Still the amazing price of \$39.50.

The new 1950 Push-Pull 5" Oscilloscope has features that seem impossible in a \$39.50 oscilloscope. Think of it—push-pull vertical and horizontal amplifiers with tremendous sensitivity only six one hundredths of a volt required for full inch of deflection. The weak impulses of television can be boosted to full size on the five inch screen. Traces you couldn't see before. Amazing frequency range clear response at 2 1/2 Megacycles made possible by improved push-pull amplifiers. Only Heathkit Oscilloscopes have the frequency range required for television. New type multi-vibrator sweep generator with more than twice the frequency range. 15 cycles to 70,000 cycles will actually synchronize with 250,000 cycle signal. Dual positioning controls will move trace over any section of the screen for observation of any part. New magnetic alloy CR tube shield protects the instrument from outside fields. All the same high quality parts, cased electrostatically shielded power transformer, aluminum cabinet, all tubes and parts. New instruction manual now has complete step by step pictorials for easiest assembly. Shipping Weight 30 lbs. Order now for this winter's use.

CONVERSION FOR OTHER MODEL HEATHKIT OSCILLOSCOPES

A conversion for all 03 and 04 scopes is available changing them to the new push-pull amplifiers (does not change the sweep generator). Complete kit includes new chassis, tubes and all parts. For a small investment, add the latest improvements to your present oscilloscope (Except C.R. Tube Shield). Shipping weight 10 lbs. Order 05 Conversion Kit No. 315..... **\$12.50**

THE NEW *Heathkit*
HANDITESTER KIT
 MORE *Features* THAN EVER BEFORE

- Beautiful streamline Bakelite case.
- AC and DC ranges to 5,000 Volts.
- 1% Precision ceramic resistors.
- Convenient thumb type adjust control.
- 400 Microampere meter movement.
- Quality Bradley AC rectifier.
- Multiplying type ohms ranges.
- All the convenient ranges 10-30-300-1,000-5,000 Volts.
- Large quality 3" built-in meter.

The instrument for all—the ranges you need—beauty you'll enjoy for years and you can assemble it in a matter of minutes—an instrument for everyone. The handiest quality volt ohmmeter of all. Small enough to put in your pocket yet a full 3" meter. Easy pictorial wiring diagrams eliminate all assembly problems. Uses only 1% precision ceramic divider resistors and wire wound shunts. Twelve different ranges. AC and DC ranges of 10-30-300-1,000-5,000 Volts. Ohms ranges of 0-3,000 ohms and 0-300,000 ohms. Milliampere ranges of 10MA and 100MA. Hearing aid type ohms adjust control fits conveniently under thumb for one hand adjustment. Banana type jacks for positive low resistance connections. Quality test leads included. The high quality Bradley instrument rectifier was especially chosen for linear scales on AC. The modern case was styled by Harrah Engineering for this instrument. The 400 microampere meter movement comes already mounted in the case protected from dust during assembly. An ideal classroom assembly instrument useful for a lifetime. Perfect for radio service calls, electricians, garage mechanics, students, amateurs and beginners in radio. The only quality volt ohmmeter under \$20.00. An hour of assembly saves you one-half the cost and quality parts give you a better instrument. Order today. Shipping weight 2 lbs.



\$13.50

Note
**HANDY
 OHMS
 ADJUST.**

EXPORT DEPT.
 13 East 40th St.
 NEW YORK CITY (16)
 CABLE: ARLAB-N.Y.

The HEATH COMPANY
 ... BENTON HARBOR 20, MICHIGAN

MORE QUALITY in

1950 Heathkits

The NEW V-4 Heathkit

VACUUM TUBE VOLTMETER KIT

Features

- Meter scale 17% longer than average 4½" meter.
- Modern streamline 200 ua meter.
- New modern streamline styling.
- Burn-out proof meter circuit.
- 24 Complete ranges.
- Isolated probe for dynamic testing.
- Most beautiful VTVM in America.
- Accessory probes (extra) extend ranges to 10,000 Volts and 100 Megacycles.
- Uses 1% precision ceramic divider resistors.
- Modern push-pull electronic voltmeter circuit.
- Electronic AC circuit. No current drawing rectifiers.
- Shatterproof plastic meter face.

The new Heathkit Model V-4 Vacuum Tube Voltmeter has dozens of improvements. A new modern streamlined 200 microampere meter has Alnico V magnet for fast, accurate readings. The new electronic AC voltmeter circuit incorporates an entire new balance control which eliminates contact potential and provides greater accuracy. New simplified switches for quicker assembly. New snap-in battery mounting is on the chassis for easy replacement.

The Heathkit VTVM is the only kit giving all the ranges. Check them—DC and AC—full scale linear ranges of 0-3V, 0-10V, 0-30V, 0-100V, 0-300V, 0-1000V and can be extended to 0-3000V and 0-10,000V DC with accessory probe at slight extra cost. Electronic ohmmeter has six ranges measuring resistance accurately from .1 ohm to one billion ohms. Meter pointer can be offset to zero center for FM alignment.

The DC probe is isolated for dynamic measurements. Has db scale for making gain and other audio measurements.

The new instruction manual features pictorial diagrams and step-by-step instructions for easy assembly. The Heathkit VTVM is complete with every part—110V transformer operated with test leads, tubes, light aluminum cabinet for portability, giant 4½" 200 microamp meter and complete instruction manual.

Order now and enjoy it this entire season. Shipping weight 8 lbs., Model V-4

Accessory: 10,000V high voltage probe, No. 310, \$4.50.

Accessory: RF crystal diode probe kit extends RF range to 100 Mc., No. 309, \$6.50.



\$24⁵⁰

New 1950 VERNIER TUNING R.F. Heathkit

SIGNAL GENERATOR KIT

Features

- New 5 to 1 ratio vernier tuning for ease and accuracy.
- New external modulation switch—use it for fidelity testing.
- New precision coils for greater output.
- Cathode follower output for greatest stability.
- 400 cycle audio available for audio testing.
- Most modern type R.F. oscillator.
- Covers 150Kc. to 34Mc. on fundamentals and calibrated strong harmonics to 102 Mc.

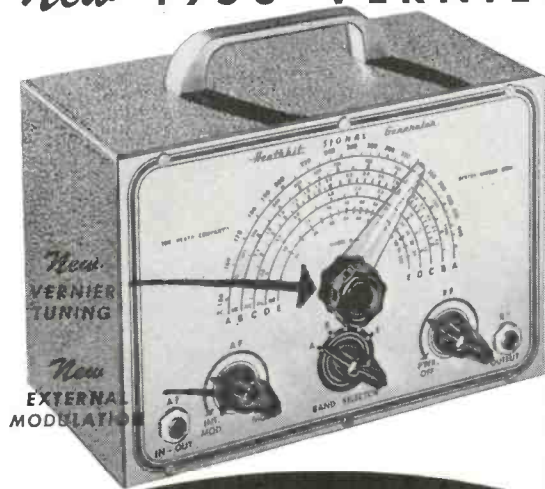

\$19⁵⁰

The most popular signal generator kit has been vastly improved—the experience of thousands combined to give you the best. Check the features in this fine generator and consider the low price \$19.50. A best buy for any shop, yet inexpensive enough for hobbyists. Everyone can have an accurate controlled source of R.F. signal voltage.

The new features double the value—think of being able to make fidelity checks on receivers by inserting a variable audio signal. Internal 400 cycle saw-tooth audio oscillator modulates R.F. signal and is available externally for audio testing. The new 5 to 1 ratio vernier drive gives hairline tuning for maximum accuracy in scale settings. The coils are already precision wound and calibrated. Uses turret type coil and switch assembly for ease of construction. The generator is 110 V. 60 cycle transformer operated and comes complete in every detail—cabinet—tubes—coils—beautiful two color calibrated panel and all small parts—new step-by-step pictorial diagrams and complete instruction manual make assembly a cinch even for novices. Why try to get along without a signal generator when you can have the best for less than a twenty dollar bill. Better order it now. Shipping weight 7 lbs. \$19.50

CONVERSION KIT FOR G-1 GENERATORS

Conversion kit for G-1 generators for vernier tuning and external modulation includes new high band coil for greater output. Gives all the features of new G-5 listed above. Order G-5 Conversion Kit No. 316. \$4.50

EXPORT DEPT.
13 East 40th St.
NEW YORK CITY (16)
CABLE: ARLAB-N.Y.

The **HEATH COMPANY**

... BENTON HARBOR 20, MICHIGAN

Beauty · Quality · Economy



Only
\$69⁵⁰

Nothing
ELSE TO BUY

New Heathkit

IMPEDANCE BRIDGE KIT

A LABORATORY INSTRUMENT NOW WITHIN
THE PRICE RANGE OF ALL

Measures Inductance from 10 microhenries to 100 henries capacitance from .00001 MFD to 1000 MFD. Resistance from .01 ohms to 10 megohms. Dissipation factor from .001 to 1. "Q" from 1 to 1000.

Ideal for schools, laboratories, service shops, serious experimentors.

An impedance bridge for everyone — the most useful instrument of all, which heretofore has been out of the price range of serious experimentors and service shops. Now at the lowest price possible. All highest quality parts. General Radio main calibrated control. General Radio 1000 cycle hummer. Mallory ceramic switches with 60 degree indexing — 200 micro-amp zero center galvanometer — 1/2 of 1% ceramic non-inductive decade resistors. Professional type binding posts with standard 3/4" centers. Beautiful birch cabinet. Directly calibrated "Q" and dissipation factor scales. Ready calibrated capacity and inductance standards of Silver Mica, accurate to 1/2 of 1% and with dissipation factors of less than 30 parts in one million. Provisions on panel for external generator and detector. Measure all your unknowns the way laboratories do — with a bridge for accuracy and speed.

Internal 6 volt battery for resistance and hummer operation. Circuit utilizes Wheatstone, Hay and Maxwell circuits for different measurements. Supplied complete with every quality part — all calibrations completed and instruction manual for assembly and use. Deliveries are limited. Shipping weight, approximately 15 lbs.

Heathkit CONDENSER CHECKER KIT

\$19⁵⁰



Features

- Power factor scale
- Measures resistance
- Measures leakage
- Checks paper-mica-electrolytics
- Bridge type circuit
- Magic eye indicator
- 110V. transformer operated
- All scales on panel

Checks all types of condensers, paper-mica-electrolytic-ceramic over a range of .00001 MFD. to 1000 MFD. All on readable scales that are read direct from the panel. **NO CHARTS OR MULTIPLIERS NECESSARY.** A condenser checker anyone can read without a college education. A leakage test and polarizing voltage for 20 to 500 volts provided. Measures power factor of electrolytics between 0% and 50%. 110V. 60 cycle transformer operated complete with rectifier and magic eye tubes, cabinet, calibrated panel, test leads and all other parts. Clear detailed instruction for assembly and use. Why guess at the quality and capacity of a condenser when you can know for less than a twenty dollar bill. Shipping weight, 7 lbs. Model C-2.

New Heathkit

TELEVISION ALIGNMENT GENERATOR KIT



\$39⁵⁰

Nothing ELSE TO BUY

Everything you want in a television alignment generator. A wide band sweep generator covering all TV frequencies 0-46.54 to 100 — 174 to 220 Megacycles, a marker indicator covering 19 to 42 Megacycles, AM modulation for RF alignment — variable calibrated sweep width 0-30 Mc. — mechanical driven inductive sweep. Husky 110V. 60 cycle power transformer operated — step type output attenuator with 10,000 to 1 range — high output on all ranges — band switching for each range — vernier driven main calibrated dial with over 45 inches of calibration — vernier driven calibrated indicator marker tuning. Large grey crackle cabinet 16 1/8" x 10 3/8" x 7-3/16". Phase control for single trace adjustment. Uses three-high frequency triodes plus 5Y3 rectifier — split stator tuning condensers for greater efficiency and accuracy at high frequencies — this Heathkit is complete and adequate for every alignment need and is supplied with every part — cabinet — calibrated panel — all coils and condensers wound, calibrated and adjusted. Tubes, transformer, test leads — every part with instruction manual for assembly and use. Actually three instruments in one — TV sweep generator — TV AM generator and TV marker indicator.

EXPORT DEPT.
13 East 40th St.
NEW YORK CITY (16)
CABLE: ARLAB-N.Y.

The **HEATH COMPANY**

... BENTON HARBOR 20, MICHIGAN

RADIO-ELECTRONICS for

all in HEATHKITS . . .

Heathkit TUBE CHECKER KIT

Features

1. Measures each element individually
2. Has gear driven roller chart
3. Has lever switching for speed
4. Complete range of filament voltages
5. Checks every tube element
6. Uses latest type lever switches
7. Uses beautiful shatterproof full view meter
8. Large size 11" x 14" x 4" complete
9. Checks new 9 pin piniaures

Check the features and you will realize that this Heathkit has all the features you want. Speed—simplicity—beauty—protection against obsolescence. The most modern type of tester—measures each element—beautiful Bad-Good scale, high quality meter—the best of parts—rugged oversize 110V. 60 cycle power transformer—finest of Mallory switches—Centralab controls—quality wood cabinet—complete set of sockets for all type tubes including blank spare for future types—fast action gear driven roller chart uses brass gears to quickly locate and set up any type tube. Simplified switching cuts necessary time to minimum and saves valuable service time. Short and open element check. No matter what arrangement of tube elements, the Heathkit flexible switching arrangement easily handles it. Order your Heathkit Tube Checker today. See for yourself that Heath again saves you $\frac{2}{3}$ and yet retains all the quality—this tube checker will pay for itself in a few weeks—better build it now.

Complete with detail instructions—all parts—cabinet—roller chart—ready to wire up and operate. Shipping Wt., 15 lbs.



Only
\$29⁵⁰

Nothing
ELSE TO BUY

Heathkit SINE AND SQUARE WAVE AUDIO GENERATOR KIT

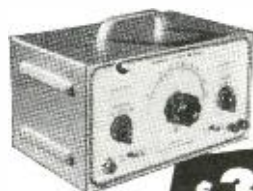

Nothing
ELSE TO
BUY

\$34⁵⁰

Experimenters and servicemen working with a square wave for the first time invariably wonder why it was not introduced before. The characteristics of an amplifier can be determined in seconds compared to several hours of tedious plotting using older methods. Stage by stage, amplifier testing is as easy as signal tracing. The low distortion (less than 1%) and linear output (\pm one db.) make this Heathkit equal or superior to factory built equipment selling for three or four times its price. The circuit is the popular RC tuning circuit using a four gang variable condenser. Three ranges 20-200, 200-2,000, 2,000-20,000 cycles are provided by selector switch. Either sine or square waves instantly available at slide switch. All components are of highest quality. cased 110V. 60 cycle power transformer. Mallory F.P. filter condensers, 5 tubes, calibrated 2 color panel, grey crackle aluminum cabinet. The detailed instructions make assembly an interesting and instructive few hours. Shipping Wt., 13 lbs.

New Heathkit BATTERY ELIMINATOR KIT

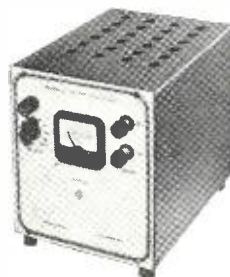

Nothing
ELSE
TO BUY

\$22⁵⁰

Now a bench 6 Volt power supply kit for all auto radio testing. Supplies 5 - 7 $\frac{1}{2}$ Volts at 10 Amperes continuous or 15 Amperes intermittent. A well filtered rugged power supply uses heavy duty selenium rectifier, choke input filter with 4,000 MFD of electrolytic filter. 0 - 15 Volt meter indicates output. Output variable in eight steps. Excellent for demonstrating auto radios. Ideal for servicing—can be lowered to find sticky vibrators or stepped up to equivalent of generator overload—easily constructed in less than two hours. Complete in every respect. Shipping Wt., 18 lbs.

NEW Heathkit SIGNAL TRACER AND UNIVERSAL TEST SPEAKER KIT

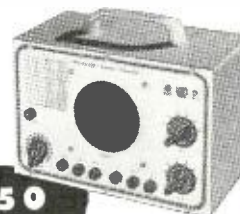

Nothing
ELSE
TO BUY

\$19⁵⁰

The popular Heathkit signal tracer has now been combined with a universal test speaker at no increase in price. The same high quality tracer follows signal from antenna to speaker—locates intermittents—defective parts quicker—saves valuable service time—gives greater income per service hour. Works equally well on broadcast—FM or TV receivers. The test speaker has assortment of switching ranges to match push pull or single output impedance. Also test microphones, pickups—PA systems—comes complete—cabinet—110V. 60 cycle power transformer—tubes, test probe, all parts and detailed instructions for assembly and use. Shipping Wt., 8 lbs.

EXPORT DEPT.
13 East 40th St.
NEW YORK CITY (16)
CABLE: ARLAB-N.Y.

The **HEATH COMPANY**

... BENTON HARBOR 20, MICHIGAN

The GREATEST TELEVISION *Buy!*

A 18 TUBE *Complete* TV RECEIVER KIT

WITH 12 CHANNEL TUNER
Actually LESS THAN COST OF TUNER ALONE

\$34.50

less TUBES AND CABINET



Think of it. A beautiful factory engineered 18 tube television receiver with all parts (less tubes and cabinet) for the cost of the tuner alone, \$34.50. Now you can afford to learn the fascinating secret of this new industry by actually assembling a high quality receiver. This TV receiver kit has everything, 12 channel Defiance tuner using 6BH6 RF stage and 6J6 as oscillator and mixer, all assembled and adjusted. Completely assembled 5000 Volt high voltage power supply ready to operate. A circuit incorporating the latest developments. The panel controls are station selector, volume, vertical and horizontal hold and contrast. At the rear are brightness, vertical and horizontal size, focus, vertical and horizontal centering. The circuit uses three stages of high gain I.F. with 6AG5 tubes, 12AU6 limiter, 6AL5 second detector, 12AU6 syn. separator, 12AU6 video amplifier, 12SN7 horizontal multivibrator, 50L6 horizontal output, 12SN7 vertical multivibrator, 12SN7 vertical output, 50L6 high voltage oscillator, 1B3 high voltage rectifier, 19T8 as FM detector and audio amplifier, 25L6 audio output.



COMPLETELY ASSEMBLED 5000 VOLT PICTURE TUBE POWER SUPPLY
This husky 5000 volt supply provides adequate voltage for the picture tube and gives perfect black and white reproduction. It is of the R.F. type and comes complete with the 50L6 R.F. oscillator and the 1B3 rectifier tubes installed.

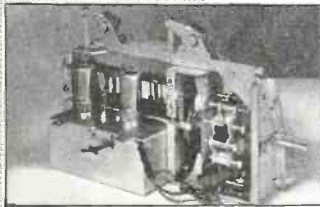

COMPLETELY ASSEMBLED 12 CHANNEL TUNER
One of the finest tuners available is supplied completely assembled. The tuner has three permeability tuned circuits for both the high and low bands. A 6BH6 is used as R.F. amplifier while a 6J6 twin triode operates as mixer and oscillator. The tuner is adjustable from the front of the set and can be peaked while observing the station.

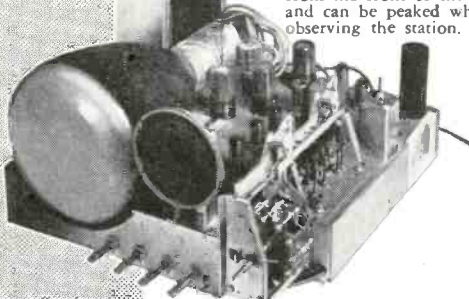

This quality TV receiver uses latest type miniature television tubes 6AG5 - 6BH6, etc. The chassis comes complete with all brackets, CR tube mounting, I.F. coils, speaker — everything to build a powerful factory quality television receiver.

The cadmium plated chassis is punched and formed ready to assemble — every coil, condenser, resistor supplied. Comes complete with large (18 x 24) pictorial and manufacturer's instruction manual.

BEAUTIFUL STYLING

This modern beautifully styled TV receiver will bring untold pleasure and entertainment to the entire family. The pleasant appearance compliments any living room while the steadily improving programs will please the entire family. There are excellent vaudeville programs to entertain your friends, excellent children's programs, Arthur Godfrey, United Nations programs for serious thinkers. A television set aids in the education of the family and by building it vast technical knowledge of this new profitable field is obtained.

Remember we have a limited quantity. Order now while still available.

- Complete 7" Television Receiver Kit
(less tubes and cabinet) **\$34.50**
- Complete set of tubes as outlined above with RCA 7JP4 picture tube (18 tubes for less than price of picture tube) **20.00**
- Beautiful piano finish mahogany cabinet for above TV set **20.00**
- Buy all at one time and save. Complete Receiver Kit with tubes and cabinet **69.50**

EXPORT DEPT.
13 East 40th St.
NEW YORK CITY (16)
CABLE: ARLAB-N.Y.

The HEATH COMPANY

... BENTON HARBOR 20, MICHIGAN

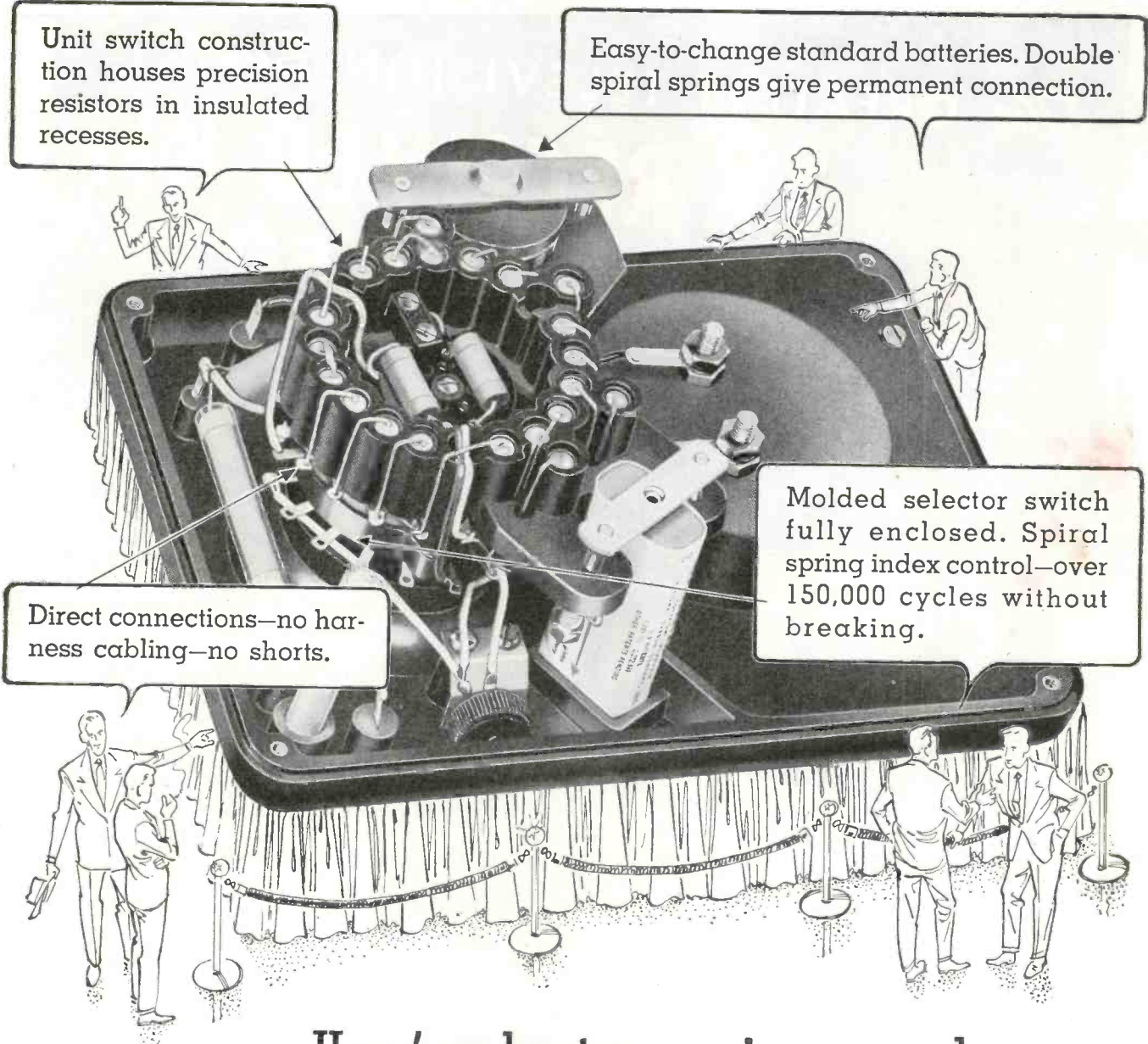

Here's why top engineers and technicians use Model 630

Features like those shown above are what make this popular V.O.M. so outstandingly dependable in the field. The enclosed switch, for instance, keeps the silvered contacts permanently clean. That's rugged construction that means stronger performance, longer life. And tests show that the spiral spring index control, after more than 150,000 cycles of switch rotation, has no disruption or appreciable wear! Investigate this history-making Volt-Ohm-Mil-Ammeter today: 33 ranges, large 5½" meter.

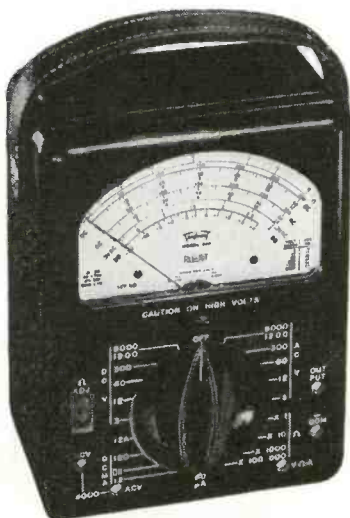

ONLY
\$37.50
 AT YOUR DISTRIBUTOR

FOR THE MAN WHO TAKES PRIDE IN HIS WORK

Triplett

TRIPLETT ELECTRICAL INSTRUMENT COMPANY • BLUFFTON, OHIO, U.S.A.

RADIO-ELECTRONICS for

ANOTHER **HYTRON FIRST** YOU'LL BE BUYING SOON



new HYTRON 12BH7

does more for less

- **Ideal Sweep Amplifier**
- **Higher-Perveance Twin Triode**
- **Designed for TV**
- **Permits Lower-Cost TV Sets**
- **Another Hytron TV First**

Here's another Hytron original you'll be buying soon. New 12BH7 twin triode is enthusiastically hailed as tops for sweep circuits by leading makers of TV sets. One half 12BH7 sweeps wide-angle 16-inch picture tube at 14 kilovolts. One section alone matches performance of: Paralleled 6SN7GT. Or equivalent single triode. Or triode-connected beam pentode. Other half of 12BH7 is free for other uses—such as blocking oscillator.

How does Hytron do it? Higher perveance (lower tube loss)? Yes. Also the Hytron 12BH7 is: designed for TV. Rated for TV. Tested for TV. Again a Hytron TV first. Again a Hytron contribution to lower-cost TV for the mass market. Watch for the 12BH7. Write for Bulletin E-149.



AND NOW THE HYTRON

16TP4 Another Hytron 16-inch rectangular picture tube. Follows closely on heels of original Hytron rectangular tube, the 16RP4. Write for Bulletin E-150 for complete data. Watch also for early announcements of new Hytron 14-inch and 19-inch rectangular tubes.

MODERN LOW-COST 16-IN. DESIGN

A Hytron contribution to lower TV costs. All-Hytron: 1X2, 6BQ6GT, 6U4GT, 12BH7, 16TP4 or 16RP4. For application and circuit details, write for Bulletin E-151.

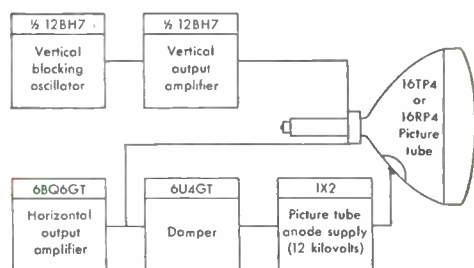

MAIN OFFICE: SALEM, MASSACHUSETTS



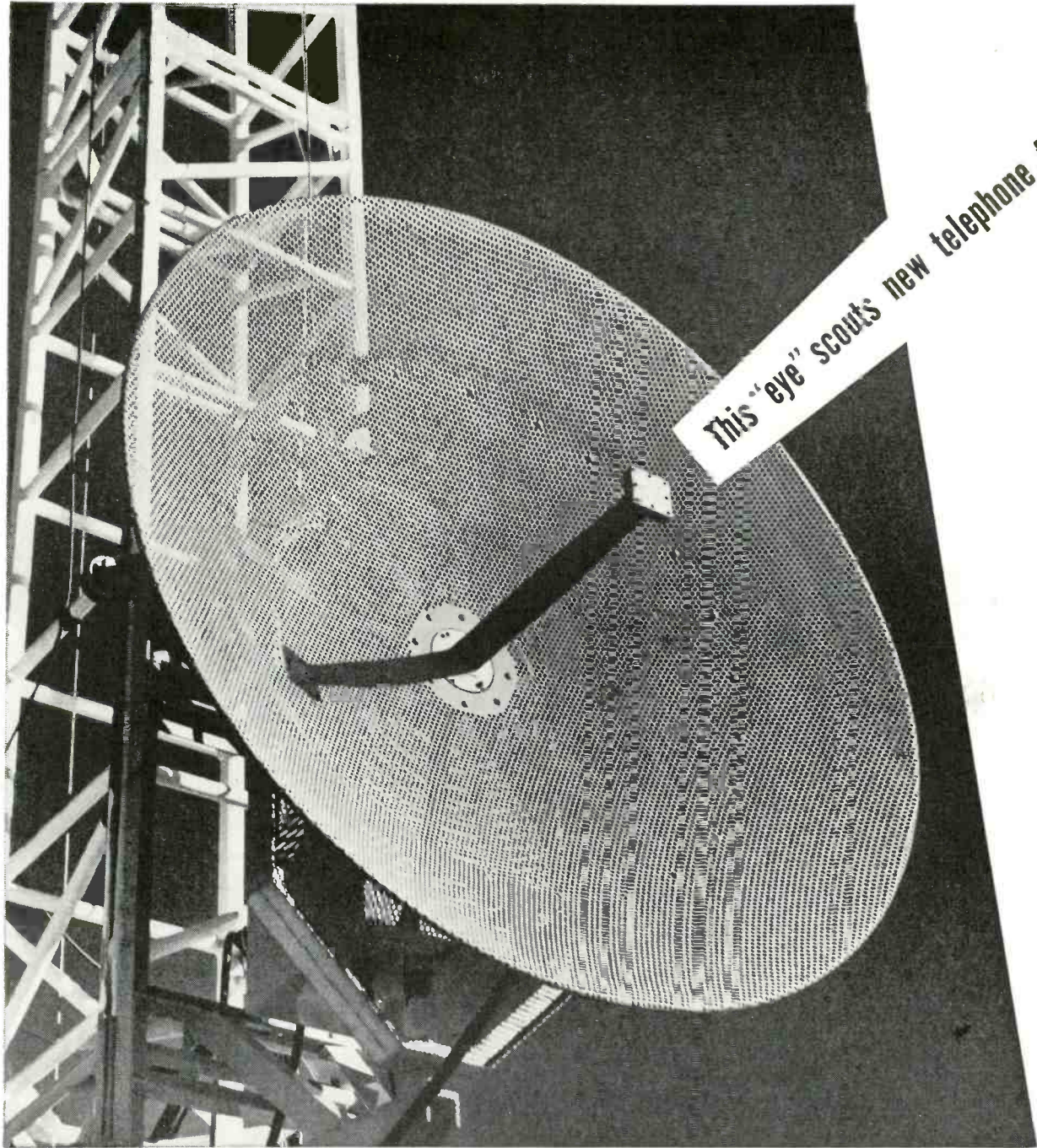

This "eye" scouts new telephone frontiers

Throughout history, scouting parties have gone out ahead of man, ahead of settlements, ahead of civilization itself. Today, Bell System scouts are engaged in a new kind of exploration — charting a path for microwaves — using equipment specially designed by Bell Telephone Laboratories.

The portable tower shown is constructed of light sections of aluminum and in a few hours may be built up to 200 feet. Gliding on roll-

ers, the "dish," with its microwave transmitter or receiver, is quickly positioned for line-of-sight transmission, then oriented through electric motors controlled from the ground.

Test signals show how terrain and local climate can interfere with microwave transmission. Step by step, Bell's explorers avoid the obstacles and find the best course for radio relay systems which will carry television pictures or hun-

dreds of simultaneous telephone conversations.

A radio relay link similar to the one between New York and Boston will be opened this year between New York and Chicago. Later it will be extended, perhaps into a nation-wide network — another example of the way Bell Telephone Laboratories scientists help make the world's best telephone system still better each year, and at lowest cost.

BELL TELEPHONE LABORATORIES



EXPLORING AND INVENTING, DEVSING AND PERFECTING, FOR CONTINUED IMPROVEMENTS AND ECONOMIES IN TELEPHONE SERVICE

RADIO-ELECTRONICS for

Wins 30% more business with SYLVANIA DEALER CAMPAIGN

"Last summer we obtained your coordinated campaign and mailed the postal cards to just certain sections. Then we kept track of service business, and found we received 30% more from the sections which got the cards.

"We're convinced . . . your campaign is the best insurance against a summer slump in service business.

"This year, May, June, July, and August are going to be our big profit months."

Albert Gale

Gale Radio and Television Lab., New Rochelle, N. Y.



You, too, will cash in BIG with this powerful, new summer campaign

Right now is the time to send for the new, complete advertising campaign that's bound to bring you extra business . . . all through May, June, July, and August.

Look at all the colorful, sales-making material you get! Everything from large 3-dimensional window- and counter-displays, to complete newspaper ad mats and postal cards. Even radio spot announcements to be broadcast over your local station. It's all yours . . . and it's all FREE . . . you pay only the postage on the postal cards, 1¢ for each card.

Written and designed to tie in with Sylvania's big national magazine advertising which your customers will see in the Saturday Evening Post, Collier's, Look, Life and other publications.

So, don't delay! Mail the coupon for full details TODAY!

- 1—Displays
- 2—Window Streamers
- 3—Post Cards
- 4—Ad Mats
- 5—Radio Spots



RADIO TUBES; CATHODE RAY TUBES; ELECTRONIC DEVICES; FLUORESCENT LAMPS, FIXTURES, WIRING DEVICES, SIGN TUBING; LIGHT BULBS; PHOTOLAMPS

SYLVANIA ELECTRIC

Sylvania Electric Products Inc.
 Advertising Dept. R-1004A, Emporium, Pa.
 Please send me full information about the May-June-July-August Service Dealer Campaign.

Name _____
 Company _____
 Street _____
 City _____ Zone _____ State _____

Which Do You Want?

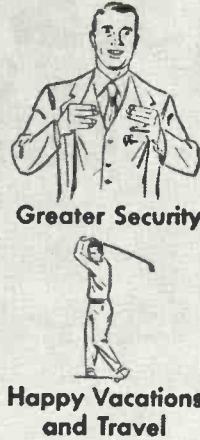

Get Your FCC Ticket
Jobs leading to
\$3,000 to \$7,500
(Average Pay Reported by FCC
Nationwide Survey)
are opening up
right now for
FCC Licensed Radiomen.



Edw. H. Guilford
Vice President

I can train you to pass your FCC License Exams in a few short weeks if you've had any practical radio experience—amateur, Army, Navy, radio servicing, or other. My time-proven plan can help put you, too, on the road to success.

Let me send you **FREE** the entire story

Just fill out the coupon and mail it. I will send you, free of charge, a copy of "How to Pass FCC License Exams," plus a sample FCC-type Exam, and the amazing new booklet, "Money Making FCC License Information."

How to Pass FCC

COMMERICAL RADIO OPERATOR

License Exams

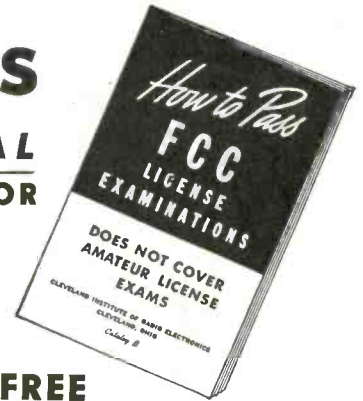

FREE

Tells where to apply for and take FCC examinations, location of examining offices, scope of knowledge required, approved way to prepare for FCC examinations, positive method of checking your knowledge before taking the examinations.

Add Technical Training to Your Practical Experience & Get Your COMMERCIAL RADIO OPERATOR LICENSE in a Few Short Weeks...

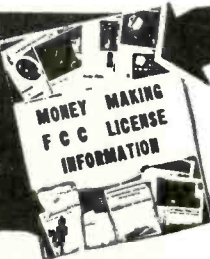

Get This Amazing New Booklet

1. Tells of Thousands of Brand-New, Better Paying Radio Jobs Now Open to FCC License Holders.
2. Tells How We Guarantee to Train and Coach You Until You Get Your FCC License.
3. Tells How Our Amazing **JOB-FINDING** Service Helps You Get the Better Pay Job Our Training Entitles You to Hold.

It's **EASY** IF you use **CIRE Simplified Training and Coaching AT HOME** in **SPARE TIME**

Get your license easily and quickly and be ready for the jobs open to ticket holders which lead to \$3000 to \$7500 (average pay reported by FCC nationwide survey).

OURS IS THE ONLY HOME STUDY COURSE OF COACHING AND TRAINING PRIMARILY PLANNED TO LEAD DIRECTLY TO AN FCC Commercial LICENSE

Your FCC Ticket is always recognized in all radio fields as proof of your technical ability.

CIRE Job-Finding Service Brings Amazing Offers of Jobs!

"Have found and accepted a position at KWAD in Wadena, Minn. I am indebted to CIRE for I secured this position through the help of the CIRE Job Finding Service. I had six other offers from stations receiving by employment application and CIRE reference. I am sincerely under obligation to you."

Student No. 2760 AT

CLEVELAND INSTITUTE OF RADIO ELECTRONICS
Desk RE-16 4900 Euclid Bldg. Cleveland 3, Ohio

Approved for Veteran Training under "G.I. Bill of Rights"



Get All 3 FREE Send Coupon Now!

CLEVELAND INSTITUTE OF RADIO ELECTRONICS
Desk RE-16, 4900 Euclid Bldg., Cleveland 3, Ohio
(Address to Desk No. to avoid delay)

I want to know how I can get my FCC ticket in a few short weeks by training at home in spare time. Send me your amazing new **FREE** booklet "Money Making FCC License Information," as well as a **FREE** sample FCC-type exam and **FREE** booklet, "How to Pass FCC License Examinations" (does not cover exams for amateur License).

Name

Address

City..... Zone..... State.....

Veterans check for enrollment information under G.I. Bill

RADIO-ELECTRONICS for

Unprofessional Servicing

... There is still too much poor servicing in this country ...

By HUGO GERNSBACK

A SHORT time ago I was a house guest with some friends in a city on our Eastern seaboard, which now has several television stations. The television receiver had gone out of order and my friends had to call a service technician to fix it in a hurry. I was present when the service technician arrived. I ascertained that he was in business for himself; in other words he was his own boss.

I was immediately struck with his exceedingly seedy appearance. He wore an old frayed suit, badly in need of repairs. Unkempt, unshaved, he smoked a big cigar from which ashes continually dropped on the floor.

He looked at the receiver and after a few preliminary tests which showed that the audio seemed to be all right but there was no picture, he announced that he would have to take it out of the case.

Without much ado, he proceeded to put the television chassis right on an expensive oriental rug, much to the disgust of my host who stopped him and insisted that some wrapping paper be put on the rug before the televiser was placed on it. This request seemed to surprise the repairman.

The technician then went on with his work. He volunteered several disparaging remarks about the receiver, stating that he would not give such a set house-room and making other gratuitous observations of that ilk.

He never asked for an ashtray, but flipped his cigar ashes on the wrapping paper provided by my host.

The tool kit—if such it could be called—was a disgrace. He emptied it on the floor to find his tools, and I noticed that they were mixed up with resistors, by-pass capacitors, metal tubes, etc. He also had a roll of black adhesive tape which had acquired a coating of cigar ashes from previous occasions, bits of metal, stripped insulation, and assorted dirt.

The only good thing I can say about this individual was that he seemed to know what he was doing. It did not take him long to make his repairs, which included a burned-out tube in the high-voltage circuit and a loose connection which he soldered.

The soldering operation, incidentally, was the sloppiest I have ever witnessed. I still do not understand why the dropping hot globules of solder did not cause some trouble in the televiser.

When the receiver was tested, it seemed to work as well as ever according to my host. The service technician proceeded to put it back into the cabinet. In this operation some cigar ashes fell into the open chassis, which he cleaned out by blowing hard into it. This caused some of the ashes to fly all over the room, to which he also did not seem to object. My host grumbled about it loudly.

After the television set was back in its customary position, the service technician made out a bill on a scrap of paper, which was paid by my friends. He then departed, never even thinking of rolling up the soiled wrapping paper and cleaning up the mess which he had left behind. I walked over to the televiser and saw that his greasy fingers had left marks all over the beautiful mahogany cabinet.

One might think that I am putting it on pretty thick and that I exaggerate. I assure you I do not, and as a matter of fact I have left out a number of other incidents.

After he had left, my host told me that he had sent

for this man because the card which he sent promised speedy repairs on the spot and reasonable prices. It was the first time he had serviced my friend's set, but the latter assured me that he would never have such a "disgraceful character" in the house again—even if his work *was* satisfactory.

After the mess which the so-called service technician had left behind had finally been cleared away, my friend wanted to know if all radio service people were of this particular type. He mentioned that he had dealings with several others, and they all seemed alike.

I assured him that this was not the case, but evidently some of the repairmen in this particular town did not care either for appearance or what they did to the houses where they made repairs.

The writer has spoken of these things before. While this particular case may seem exceptional, it is not. I have seen too many sloppy service technicians not to know that there is a high percentage of this particular tribe—an unhappy group who are forever bemoaning their fate that business is bad and lamenting that they cannot seem to get along.

What really prompted the writing of this article was that a few days ago I asked the telephone company to make a new telephone extension in my home. The excellent appearance of the telephone man, his neat kit, his courteous approach, the efficiency with which he worked made me furious when I compared him to some of the radio service technicians I have seen in the past.

When my telephone man was finished with his work, he asked for a broom to clean up the little dust that he had made in stringing his wires. He polished the instrument and asked me if there was anything that needed to be repaired on the existing telephone. He was all business, all unobtrusive courtesy. He was efficient and inspired confidence. When he left, there was not a speck of dust nor a scrap of wire left. He had removed it all. He did not smoke on the premises either!

The telephone companies train their men to work in just this manner. I have yet to see a telephone installation or service man who does not work in this efficient, businesslike way. *Why can't the radio service industry take a hint from the telephone people?*

A great many radio service technicians are a credit to their trade. But, unfortunately, the percentage of sloppy, careless, inefficient, garrulous radio repairmen is much too high today. These are the ones who send letters scrawled in pencil on scraps of paper, and then are surprised that when they write similar letters to big radio set manufacturers and others, they do not even get a reply.

Service technicians are judged not only by their appearance, but by their letters as well. People who have nice homes as a rule look askance at sloppy, unbusinesslike service technicians and learn to avoid them. Not only that, but this minority group gives the entire radio servicing business a black eye.

Incidentally, it is the unprofessional type of service technician who never makes out well. He is always behind in his bills, and, because of his appearance, has a psychological handicap that prevents him from getting as well paid as his more efficient and better operating competitors.

WIDE-BAND FM ADAPTER REDUCES INTERFERENCE

MOST frequency-modulation receivers can be modified to improve greatly their interference-rejection capabilities. The adapter described was successfully used by the author in a Hallicrafters S-55 receiver.

There are four important types of interference in a frequency-modulated system: impulse noise, adjacent-channel, co-channel, and multipath.

Impulse noise contains both amplitude and frequency modulation, because of its random nature. There is amplitude modulation because two successive noise peaks rarely have the same height; frequency modulation results from the fact that the peaks are not uniformly spaced in time. A good limiter will take care of the amplitude modulation if it is provided with sufficient signal, but some frequency-modulation noise is bound to come through. The receiver itself contains a form of FM limiting, however, because of its relatively narrow bandwidth (perhaps 200 kc). As a result, frequency swings in excess of 100 kc are clipped; thus the noise is limited to a low value.

Adjacent-channel interference, which is usually troublesome when a station on the next channel is much stronger than the desired station, must be taken care of by the receiver's i.f. selectivity. Although the selectivity of the adapter could have been bettered by adding a couple of sharply tuned i.f. amplifiers, the consequent slight improvement might not have been worthwhile.

Reduction of co-channel and multipath interference is, however, quite another problem. Here is a possibility for real improvement in receiver performance.

Assume that there are two FM signals coming in on the same channel. These may be two separate stations carrying different programs (co-chan-

By **PETER G. SULZER***

nel interference), or they may be two signals arriving at different times from the same transmitter (multipath interference). In either case, the two signals are picked up by the antenna, amplified, converted, and amplified again. Since the r.f. and i.f. amplifiers are linear and have sufficient bandwidth, the signals appear in their original form at the input to the limiter.

Here, however, the picture changes. Since the limiter is *nonlinear*, the signals combine, in much the same way that two signals combine in a detector to produce a beat note. There are no longer two separate signals with two separate frequencies. The one signal present, the resultant signal, depends on both the desired and the interfering signal. Since the discriminator is operated by the resultant signal, the audio output from the discriminator contains, in part, the interfering signal. The question is, what can be done about it?

Arguimbau¹ has shown that even if the desired signal is only slightly stronger than the interfering signal, the *average* frequency of the resultant signal at the limiter output is exactly that of the desired signal. The *instantaneous* frequency of the resultant signal, however, may deviate very widely, as much as 1.5 mc if the interfering signal is 9/10 as strong as the desired signal. It is desirable, therefore, that the circuits following the limiter—and this includes the second limiter and the discriminator—have a bandwidth of at least 3 mc. The wide frequency deviations produced in the limiter will then be passed by the discriminator, and will appear as voltage variations at the discriminator output. The voltage variations can be smoothed out by the normal de-emphasis circuit. Since this is, in a sense, an averaging process, the output of the de-emphasis network

depends on the average frequency rather than on the instantaneous frequency. It is, therefore, a nearly undistorted replica of the desired signal.

Consider what happens in a normal FM receiver. The discriminator has the same bandwidth as the i.f. amplifier. The wide instantaneous frequency deviations are clipped, and the average output voltage of the discriminator (after de-emphasis) is no longer independent of the undesired signal. As a result, crosstalk will be noted when there are two stations operating on the same channel, and serious interference will be obtained under multipath conditions.

The two requirements for the proposed adapter are, then, the best possible limiter or limiters and a discriminator at least 3 mc wide.

The adapter

The photographs of the adapter show that it was constructed on a long, narrow chassis for positioning inside an S-55 receiver. In the schematic diagram of the complete unit, the first stage V1 operates at the normal 10.7 mc intermediate frequency of the receiver. The first tuned circuit T1 has a bandwidth of about 300 kc, which is sufficient because limiting has not yet taken place. The plate circuit of V1 is tuned to 10.7 mc by T2, a double-tuned transformer with a bandwidth of 3 mc. This great bandwidth is necessary because limiting takes place in the secondary circuit of T2.

Various types of limiters were tried in the breadboard model of the adapter. Although the ordinary pentode class-C amplifier-limiter is economical to use (it can give a fair amount of voltage gain) it is inferior in suppressing ignition noise. This is a result of the time constant necessary in the grid circuit to give class-C bias. When an ignition-noise pulse appears, a very high bias is built up. It takes

* Engineering Experiment Station The Pennsylvania State College.

Under-chassis view of the FM adapter is shown below. Photograph below shows layout of all major components.

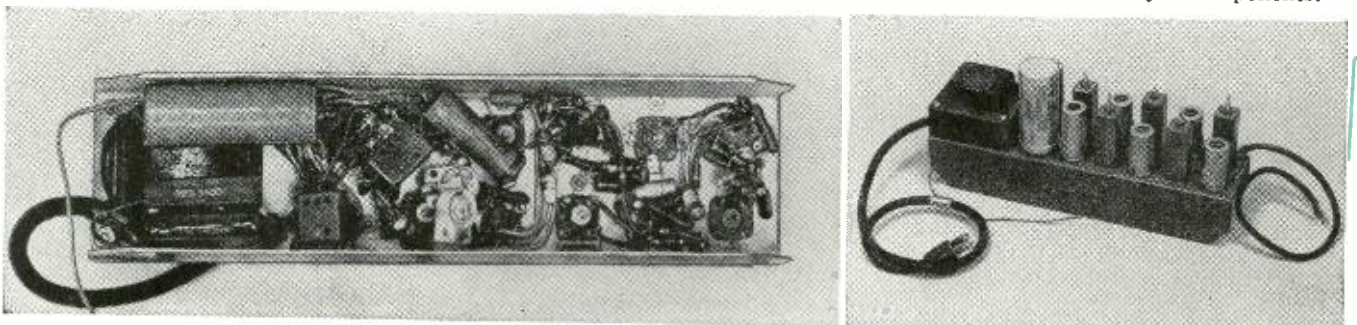

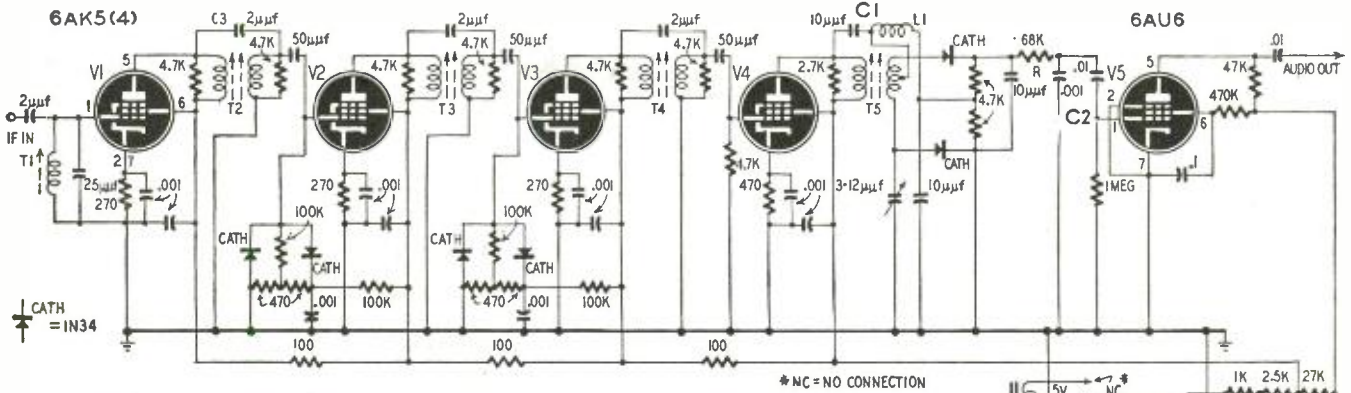

Schematic of the adapter. Novel double conversion system gives wide bandwidth.

an appreciable time for this bias to return to normal after the pulse disappears. Therefore, a large "hole" is punched in the signal, accentuating the effect of the pulse.

The limiter finally chosen, shown connected in the grid circuit of V2, consists of two 1N34 crystal diodes connected as a biased, full-wave clipper. Since there are no time constants important to the operation of the limiter, the grid voltage of V2 is a square wave whenever there is sufficient signal, and more constant output results.

V2 is operated as a frequency doubler. Although it is unusual to find doublers in receivers, their use is recommended where a large amount of gain is necessary, especially an FM receiver. By having some of the gain at twice that frequency, there is much less trouble with feedback or regeneration. V2 could be operated as a tripler with somewhat greater efficiency, since the input to its grid is a symmetrical square wave, which does not normally contain even harmonics. This would put the remainder of the system at 32.1 mc, which would be convenient for use with surplus i.f. transformers.

The third and fourth stages V3 and V4 respectively, operate at 21.4 mc. Since the frequency has been doubled, the deviation is also doubled, and T3 and T4 must have a bandwidth of 6 mc. There is another limiter connected in the grid circuit of V3. The use of two limiters has been found very helpful against ignition noise.

The discriminator, which is really the heart of the unit, consists of T5 and two 1N34 crystal diodes. The circuit is of the Foster-Seely type. Instead of the usual magnetic coupling between primary and secondary, capacitive coupling was used with the aid of C1, which unbalances the secondary circuit. The variable coupling obtained makes adjustment much easier.

As a result of the great bandwidth of the discriminator, its audio output is very low. For this reason, V5 was included as an amplifier to bring the audio level up to about 1 volt for driving the S-55 receiver. The de-emphasis circuit R-C2 is placed in the grid circuit of V5. The time constant is 68 microseconds, very close to the stand-

ard value, which is 75 microseconds.

The power supply includes a resistance-capacitance filter. Since the high-voltage requirement is only 120 volts at 45 ma, a choke filter was not found necessary.

Construction

The photographs show the parts layout, which is not particularly critical because the unit operates at comparatively low frequencies. The heater wiring should be kept close to the chassis, but the signal-carrying leads should be up in the clear to minimize stray capacitances.

The intermediate-frequency transformers are surplus items which happened to be available. Winding data for these transformers is as follows:

L1: 100 turns No. 36 enameled, scramble-wound on 1/2-watt resistor.

L2, L3: 30 turns No. 26 enameled, wound on 1-watt resistor.

T1: 40 turns No. 30 enameled, close-wound on 3/16-inch-diameter slug-tuned form.

T2 primary and secondary: Same winding as T1, wound on 3/16-inch-diameter, double-slug-tuned form, with 3/8 inch spacing between windings.

T3, T4 primary and secondary: 28 turns each No. 30 enameled, close-wound on 3/16-inch-diameter double-slug-tuned form, with 1/2 inch spacing between windings.

T5 primary: 22 turns No. 30 enameled, close-wound. Secondary: Two windings of 11 turns each, No. 30 enameled wire. One half of secondary is wound over the other. Spacing between primary and secondary is 3/4 inch. Both windings are slug-tuned.

Standard 10.7-mc transformers could be used for T1 and T2 without modification except for a slightly higher value of C3. T3, T4, and T5 could be television intermediate-frequency transformers, with a centertap added to the secondary of T5.

The grid wiring of V5 (and this includes the discriminator secondary circuit) must be kept away from the heater circuits.

After the wiring is finished, the power should be turned on and the heater and plate supply voltages checked. If these are satisfactory, the discriminator can be aligned by standard methods. Increasing the value of

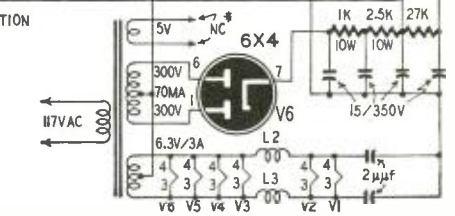

C1 will increase the coupling, making the discriminator broader. When adjusted properly, the discriminator characteristic should be linear over a range of 6 mc, with a spacing of 8 mc between peaks.

With the discriminator operating properly, the remainder of the i.f. amplifier should be aligned. Again, this can be readily accomplished with the sweep generator. Remember that the input to V3 and V4 should be at a center frequency of 21.4 mc, while the input to V1 and V2 is at 10.7 mc.

After the alignment is complete, the unit can be installed in the receiver. The adapter will work with any FM receiver having a 10.7 mc intermediate frequency. The i.f. input lead should be connected to the plate circuit of the last i.f. stage in the receiver. If a long lead is necessary, it should be shielded, and another 2-µf capacitor should be placed at the receiver end of the lead to prevent detuning.

The adapter cuts automobile ignition noise to the point where it is almost negligible. With an automobile running within 20 feet of the antenna, the noise is just barely noticeable. This is a decided contrast to the performance of the original receiver, which was useless under similar circumstances.

As far as co-channel interference is concerned, the new system exhibits very interesting properties. With fading, only the louder of the two signals is heard. As the louder signal fades, there is a sudden changeover, the original signal disappearing and the other one coming in without interference. This indicates that interference-free reception will be obtained if the desired signal is only very slightly stronger than the other signal.

With the original receiver, bad distortion was noted on some stations, whether they were weak or strong. The addition of the adapter reduced the distortion to a negligible amount.

¹L. B. Argumbeau and J. Granlund, "The Possibility of Transatlantic Communication by Means of Frequency Modulation," *Proceedings of the National Electronics Conference, 1947*; "Sky-Wave F-M Receiver," *Electronics, December, 1949*.

Television Equipment Standards

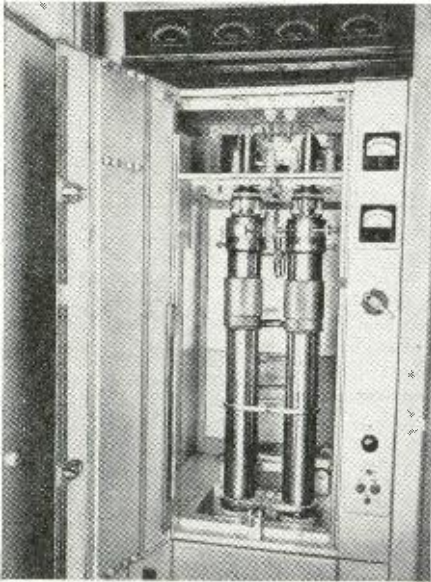

Final air-cooled power stage of Federal 5-kw television broadcast transmitter.

TELEVISION, like any other form of radio broadcasting, operates within certain set standards; thus any television receiver can receive satisfactorily the broadcasts of any transmitter within range. Due to its greater complexity, television requires a longer list of more rigid standards than other types of transmission. Besides these, some practices in use today—particularly in receiver design—are so nearly universal that every technician should know them.

An explicit understanding of how a television system works requires knowledge in terms of "numbers" rather than just a general comprehension of vague principles. To provide a ready reference to the standard numbers, this article lists current transmission standards imposed by the FCC, to which every receiver must be synchronized, and some of the practices used in standard receiver design.

Channel allocations

Each of the 12 television channels (Nos. 2-13, No. 1 having been deleted) is 6 mc wide and contains both sound and picture transmissions. Table I lists all the channels, with the sound and picture carrier frequency for each. Notice that channels 2, 3, and 4 are consecutive, with 5 and 6 together and separated from the first three by 4 mc (72-76 mc). Channels 7 through 13 are consecutive, but separated from the lower ones.

FCC allocations are governed in part by interference possibilities. For that reason, no service area is assigned two adjacent-frequency channels. Channels 4 and 5 or 6 and 7 may be assigned to a single community, however, because

*Technical Institute, Temple University.

of their frequency separation. Fig. 1 illustrates how each television channel is subdivided. The amplitude-modulated picture carrier is 1.25 mc above the lower limit of the channel. Video-frequency modulation components as high as 4.5 mc are transmitted, but those above 4 mc are attenuated in the transmitter fairly sharply.

With effectively 4 mc as the top modulation limit, a symmetrical transmitter output would require 8 mc for the picture information alone. To conserve spectrum space, only 0.75 mc of the lower sideband is transmitted, with another 0.5 mc in the attenuation region. Since a part of the lower sideband is transmitted, that is, a vestige of it remains, the system is known as *vestigial-sideband transmission*, as distinguished from single-sideband transmission, where one sideband is almost totally filtered out.

The sound carrier (FM center frequency) is 0.25 mc below the top of the channel. Maximum deviation is 25 kc (.025 mc) above and below center, giving the signal a bandwidth of 50 kc. (This is one-third the swing of an FM broadcast transmitter, which is allowed ± 75 kc.)

Transmission standards

The center frequencies of both carriers are maintained within $\pm .002\%$. The picture transmitter is amplitude-modulated, the sound FM. Picture transmission is negative (a decrease in light intensity in the picture causes increased r.f. output). The advantage of this system is that interference impulses produce dark spots on the screen, which are considered less annoying than the white spots which are produced in a positive system, such as is used in Britain.

The level of the *pedestal* beneath the sync pulses—which corresponds as

Uniform standards insure reception regardless of transmitter or receiver designs.

By MATTHEW MANDL*

nearly as possible to the black level—is 75% of maximum peak carrier amplitude $\pm 2.5\%$. Sync pulses extend from here into the *blacker-than-black* region between 75% and 100% modulation. Maximum white picture elements bring the carrier level down to or below 15% modulation. The exact modulation percentage corresponding to maximum white during any frame depends on the average illumination of the scene at the moment. (This is what makes the

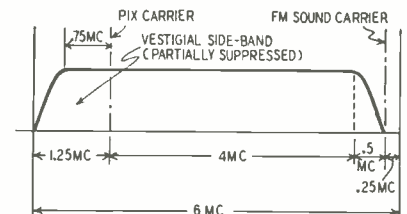

Fig. 1—Vestigial-sideband TV channel.

d.c. restorer necessary in the receiver.) The transmitter output varies approximately in inverse logarithmic relation to the brightness of the scene.

The number of frames per second is 30, each consisting of 525 horizontal lines. Interlaced scanning is used, with one field or half a frame transmitted every 1/60 second. The number of lines per second is 15,750, the product of the frame rate (30) and the number of lines per frame (525). This requires a 15,750-cycle horizontal sweep oscillator in the receiver. The vertical oscillator must operate at 60 cycles.

The aspect ratio of the transmitted picture is four horizontal units to three vertical units. The direction of picture scan is left to right and top to bottom.

Sound transmission

The FM sound transmitter must be capable of transmitting an audio range of 50-15,000 cycles. Since maximum deviation is 25 kc, the modulation index is 25,000/15,000 or 1.66. The peak radiated power of the FM transmitter

must be between 50% and 150% of the peak power of the video transmitter. Normally, the FM transmitter radiates less power than the picture transmitter. The signals radiated by both transmitters are horizontally polarized.

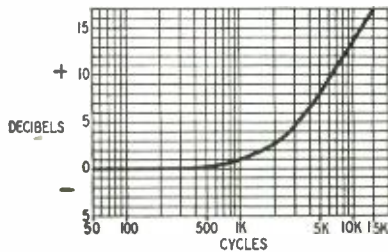

Fig. 2—Sound pre-emphasis curve.

As in FM broadcasting, the higher audio frequencies are *pre-emphasized* before reaching the modulator. This allows the receiver design to include a high-frequency roll off in the audio circuits, reducing noise but allowing the full sound range to come through. The 75-microsecond pre-emphasis curve is given in Fig. 2. The permissible error is about 3 db at all points except the extremes, where it is somewhat more. Every receiver should include a de-emphasis network complementing the curve of Fig. 2 to restore the higher audio frequencies to their original level.

Intermediate frequencies

There is no such thing as a standard intermediate frequency in receivers, though most of them are in the same general range. Table II shows the design trend in this respect. It lists the sound and picture i.f.'s of a number of representative receivers. Notice that almost all are in the 20-25-mc range, though one or two deviate. Where "all models" has been indicated under a manufacturer's name, there may still be deviations in some models, especially ones marketed since the table was compiled.

On practically all present receivers except those using intercarrier sound, the oscillator operates above the r.f. In intercarrier, it may operate above on the lower channels and below on the upper channels.

TABLE I
TELEVISION CHANNELS

Channel Number	Channel freq. (mc.)	Picture carrier freq. (mc.)	Sound carrier freq. (mc.)
2.....	54-60	55.25	59.75
3.....	60-66	61.25	65.75
4.....	66-72	67.25	71.75
5.....	76-82	77.25	81.75
6.....	82-88	83.25	87.75
7.....	174-180	175.25	179.75
8.....	180-186	181.25	185.75
9.....	186-192	187.25	191.75
10.....	192-198	193.25	197.75
11.....	198-204	199.25	203.75
12.....	204-210	205.25	209.75
13.....	210-216	211.25	215.75

The picture i.f. channel of a receiver should have a bandpass of 4 mc to accommodate all the picture detail obtainable from the signal. Most of the better receivers are said to have this; but a few, especially those with 7-inch

and smaller C-R tubes, pass only a 3.5-mc band. The smaller screen is unable, of course, to reproduce the same detail as the larger ones.

The minimum required bandpass for the FM sound i.f. channel is equal to the maximum frequency swing, which is 50 kc (25 kc each side of center). Almost invariably, however, the sound i.f.'s will pass 200 to 300 kc or more. The advantage here is that normal frequency drift will not wash out the sound completely or clip off some sidebands. Excessive drift of the oscillator will bring the center frequency of the FM far enough away from the discriminator frequency to cause distortion, and for this reason many sets must be retuned a few minutes after a cold start. Drift rarely affects the picture noticeably, due to the comparatively wide video band. Receivers containing a.f.c. require a wide FM i.f. band for correct operation.

TABLE II
INTERMEDIATE FREQUENCIES

Make and model	Sound	Picture
Admiral		
All models	21.25	25.75
Belmont		
22A21	22.25	25.25
Bendix		
235M1, 235B1, 325M8.....	31.625	36.125
Capehart		
501P, 502P, 504P.....	21.25	25.75
610P, 651P, 661P.....	21.75	26.25
Crosley		
9-403M, 9-413B, 9-403M-2,		
9-413B-2	21.9	26.4
348CP	32.8	37.3
Du Mont		
All models	21.9	26.4
Emerson		
571	21.25	25.75
Farnsworth		
GV-260	21.75	26.25
General Electric		
810, 814.....	21.8	26.3
803, 910.....	21.9	26.4
Hallicrafters		
All models	21.75	26.25
Magnavox		
CT214, CT218, CT221.....	21.25	25.75
Motorola		
TS-9, 9A, 9B, 9C, 9-D,		
TS-15, 15A, 15C1.....	21.9	26.4
TS-14, TS-23	21.6	26.1
TS-16, TS-30	21.7	26.2
National		
All models	32.8	37.3
Olympic		
TV-922	21.25	25.75
Philco		
All models	22.1	26.6
RCA		
All models	21.25	25.75
Sentinel		
412, 413, 415.....	21.25	25.75
Stewart-Warner		
AVT1, AVC1, AVC2.....	22.25	26.75
Sylvania		
1-108	21.25	25.75
Ward		
All models	21.75	26.25
Westinghouse		
H-196, H-217, H-217A.....	21.6	26.1
Zenith		
All models	21.6	26.1

TELEVISION DX

Additional letters reporting long-distance television reception have come in during the month.

John W. Hull, Fort Recovery, Ohio, reports receiving KLEE, channel 2, Houston, Tex., at various times under widely different weather conditions. His "prize dx" is WJAC, channel 13, Johnstown, Pa., which he received on the afternoon of September 3 with perfect picture and sound.

David C. Graves, Barnesville, Ohio, sent in a long list, mostly of stations within a couple of hundred miles. He received WTVJ, channel 4, Miami, Fla., dozens of times all summer and WMAL, channel 7, and WTTG, channel 5, Washington, D.C., once each. He reports consistent reception from WBAP, channel 5, Fort Worth, and the inevitable KLEE, Houston, Tex.

KLEE-TV, which we are about to dub the "nationwide station," was the cause of a letter from Lewis R. Christy of Lake Elsinore, Calif., though not one addressed to the dx department. Receiving KLEE-TV was an unsolvable problem, as far as he was concerned. Mr. Christy wants to know how he gets KLEE-TV when he should be getting KFMB-TV in San Diego, which is not received in his area, though it goes over his head to Los Angeles.

Homer W. Snyder, Miami, Fla., sends along a lengthy log. Among the stations listed, most of them several times, are: WMAR-TV, channel 2, Baltimore, Md., WCBS-TV, channel 2, New York, WPTZ, channel 3, Philadelphia, WRGB, channel 4, Schenectady, N. Y., WBZ, channel 4, Boston, Mass., WNBW, channel 4, Washington, D.C., WJBK, channel 2, Detroit, WBEN, channel 4, Buffalo, N. Y., WDTV, channel 3, Pittsburgh, WNBK, channel 4, Cleveland, WLW-T, channel 4, Cincinnati, and—surprise—KLEE-TV, Houston, Tex.

This KLEE-TV is beginning to intrigue us and we are going to write the station a letter asking just what kind of Wheaties they feed to the transmitter instead of electrons. KLEE-TV is responsible for about 50% of the dx letters we receive and it is among the stations received in almost all the others. We will pass along the reply as soon as we get it.

It is getting a bit monotonous but Dr. George R. Meyer of Oshkosh, Wis., is entitled to his day in RADIO-ELECTRONICS, so here he is. What station did he receive from way down in Texas? You guessed it! His list includes seven other stations more than 150 miles from Oshkosh.

WOAI-TV, channel 4, in San Antonio, Tex., was snagged during December by Clarence P. Miller of Portsmouth, Ohio. He remarked in his letter that he was using the circular antenna described by Noll and Mandl in the February 1949 issue of this magazine. He wants to know how to make the antenna directional. Directors and reflectors tried with it don't seem to have any effect.

A DeLuxe Televiser

Part IV—Some additional features of sweep circuits and audio stage

By

CHARLES A. VACCARO

THE construction of this de luxe televiser having been covered in the January, February, and March issues, we will now discuss its operation and circuit features. The i.f. strip is shown in Fig. 1 of the January issue, the tuner in Fig. 7 in the February issue, and the complete schematic in Fig. 17 of the March issue.

The tuner receives channels 2 through 7, and channels 8 or 9, 10 or 11, and 12 or 13. Its input circuit, designed to match a 300-ohm line, consists of a high-pass circuit in parallel with the cathode inductor of a 6AG5 grounded-grid r.f. amplifier. One triode of a 7F8 is a modified Colpitts oscillator tuned to the high side of the video and sound carriers, and the other triode is a mixer with its plate circuit tuned to 22 mc.

The video i.f. strip has four stages which are tuned to different frequencies to produce the desired over-all response curve. The constructor may use 6AC7's or 6AG5's as video i.f.s. The 6AG5's are interchangeable with the new 6BC5's which have a higher transconductance.

The last coil in the video i.f. stage is coupled to the video detector—half of a 6H6 diode rectifier. The detector output is negative and is directly coupled to the 6AC7 video amplifier. The 6AC7

on the cathode, the grid will never go more positive than -5 v with respect to the cathode. The grid will never draw current; therefore tube life will be longer.

One of the reasons for selecting this system of modulating the picture tube and of setting the intensity is the feeling that you have something "solid" in your hand when you are operating the contrast and intensity controls. Video modulation being applied to the grid instead of the cathode as in some sets, the initial setting of the intensity control is such that the raster is not seen when the grid is unmodulated—contrast turned down or no signal from a station. Then when the grid is modulated, whiter or brighter as the picture becomes, signal strength increases. Thus when the contrast control (picture gain) is increased, you have the feeling that you might be turning the intensity control. This is because you are actually setting the black level and thus the maximum whites are determined by the maximum video signal.

With the system used here the setting of the intensity control actually sets the maximum white level and variations in signal will not increase it. Turning the contrast control increases the picture gain, driving the cathode more positive (the grid toward cutoff) so the blacks become a deeper black.

After the sound has been tuned in, set the intensity at the desired brightness level, then increase the contrast control until the retrace lines disappear. This eliminates glare which is a common fault in some circuits.

Returning to the 6H6 video detector, we see that the other half of this tube rectifies the 6.3-volt a.c. to obtain a bias voltage for controlling the gain of the first three tubes in the i.f. strip. The contrast control varies this bias between the limits of -8 volts near cutoff and up to -2 volts at full gain.

Dual sweep circuits

Two separate horizontal sweep control circuits—called d.s.c. and a.s.c.—are built into the set. The d.s.c. (direct sync control) circuit consists of a cathode-coupled multivibrator directly synchronized by the sync pulses from the transmitter. The a.s.c. (automatic sync control) system is conventional. It uses a 6F6 Hartley oscillator controlled by a d.c. voltage developed by the a.f.c. discriminator.

A part of the video signal from the 6AC7 video amplifier is capacitance-coupled to a 6SH7 whose bias and

plate voltage are adjusted so that the synchronization signals are clipped and separated from the composite video signal. Part of the output of this tube is fed directly to the 6SN7 horizontal multivibrator (MVB in the drawings) through a $47\text{-}\mu\text{f}$ capacitor and across a 240-ohm resistor. This combination shapes the horizontal sync and attenuates it to a level just below that needed to synchronize fully the horizontal multivibrator. It also attenuates frequencies below 15,750 cycles so that they have practically no effect on the horizontal oscillator frequency.

The 15,750-cycle tuned circuit in the cathode circuit forms a pedestal for the sync signal to raise it to the level required to lock the horizontal multivibrator in sync. This circuit further attenuates other unwanted frequencies. The second half of the 6SN7 multivibrator contains the 150,000-ohm charging resistor, the $1,400\text{-}\mu\text{f}$ capacitor, and 15,000-ohm resistor forming the sawtooth horizontal sweep voltage which terminates at one of the d.s.c. terminals on the d.p.d.t. switch. When the switch is on d.s.c. the 6BG6-G horizontal output tube is driven by a sweep voltage synchronized directly from the transmitter sync signals.

In the a.s.c. circuit, a $68\text{-}\mu\text{f}$ capacitor couples the horizontal sync signals into the centertap of the secondary of the sync discriminator transformer. Also coupled to the secondary of this transformer is a sine-wave voltage from its primary. This primary along with the 6F6 and associated circuits make up a Hartley oscillator circuit operating near or at 15.75 kc, the horizontal sweep frequency. Therefore on the plates of the 6H6 discriminator we have out-of-phase sine-wave voltages which have in-phase sync pulses superimposed on them.

If a difference in time (phase) exists between the 6F6 oscillator frequency and the incoming sync pulse, the pulse voltage may ride down near the negative peak of the sine wave on the top diode and up near the positive peak of the sine wave on the bottom diode as in Fig. 19-a. The larger output of the bottom diode will appear across its 470,000-ohm load resistor and the sum of the two load resistors will be positive. If we assume that the above condition existed when the sine-wave oscillator was faster than the sync pulse, then, when the oscillator is slower or a phase difference exists in the other direction, the sync pulse will ride up the slope near the positive peak of the sine wave on the top diode and down the slope near the negative

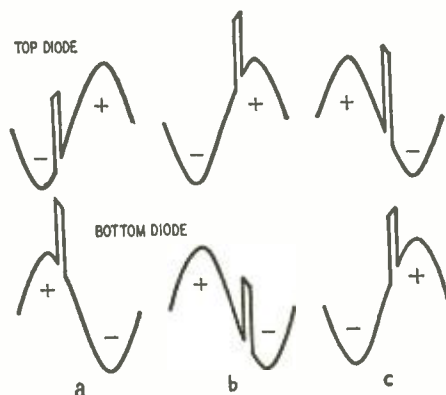

Fig. 19—Correction voltage from the discriminator is determined by phase difference between sine and sync voltages.

is directly coupled to the cathode of the 10FP4 picture tube, thus eliminating the need for d.c. restorers. High-frequency peaking coils extend the range of the video amplifier to slightly above 4 mc.

The intensity control, in the grid circuit of the picture tube, controls the brilliancy of the raster by varying the d.c. voltage of the grid with respect to the cathode. Values are such that, regardless of the position of the intensity control and the amount of signal

peak of the sine wave on the bottom diode as in Fig. 19-b. Now the output of the top diode will be larger and the total across the two load resistors will be negative. If no time difference exists between the oscillator frequency and the incoming sync pulse, then the sync pulse voltage will appear about halfway up the slope of the sine wave on both the top and bottom diodes (Fig. 19-c) and the d.c. output is zero.

Any d.c. output from the 6H6 discriminator is applied directly to the grid of the 6AC7 reactance tube across the primary of the transformer or the oscillator coil. As its grid becomes more or less negative, 6AC7 causes the frequency of the oscillator to increase or decrease, bringing it back in step with the transmitted sync signal.

The cathode, grid, and screen grid comprise the oscillator section of the 6F6. Because the peak-to-peak voltage on the grid is high, a square wave appears across the 5,000-ohm plate load resistor. This is shaped into a pulse by the 400- μ f capacitor and 6,800-ohm resistor and then coupled to the grid of the 6J5 discharge tube. The 680,000-ohm charging resistor and 680- μ f charging capacitor are in the plate circuit of this tube. When the pulse appears on the grid, this tube conducts and discharges the charging capacitor rapidly. The voltage drops to nearly cathode potential; however, the voltage across the 680- μ f capacitor does not discharge completely because of the 15,000-ohm resistor in series with it. As soon as the pulse is gone from the grid, the tube becomes nonconducting due to the bias built up across the .01- μ f capacitor and the 220,000-ohm resistor in the grid circuit. The plate voltage now rises immediately to the value of voltage remaining across the 680- μ f capacitor. The rest of the spiked waveform is now formed as the plate voltage rises linearly and slowly while the capacitor is charged through the 680,000-ohm charging resistor. This voltage drives the 6BG6-G horizontal output amplifier when the sweep switch is in the a.s.c. position.

Horizontal output circuit

The spiked sawtooth horizontal sweep is fed to the grid of the 6BG6-G output amplifier, which in turn is transformer-coupled to the horizontal deflection coils. At the end of each sweep the plate current of the 6BG6-G is cut off and the field in the secondary of the transformer collapses. This collapsing field induces a positive pulse in the primary transformer winding which is connected as an autotransformer to increase the total voltages to approximately 10 kv. This high-voltage pulse is rectified by the 1B3-GT, and the resulting pulsating d.c. is filtered by a resistor-capacitor filter, including the 500- μ f (minimum) capacitance between the internal anode coating and the external coating of the picture tube. The 300-megohm bleeder consisting of 15 20-megohm resistors in series pro-

vides safe means of measuring the anode voltage. It eliminates the danger of either of the capacitors' retaining their charge and removes the bright spot which is usually seen on the picture tube for several minutes after the set is turned off. This is useful, as the bright spot can burn the phosphor sufficiently to cause that part of the screen surface to have a shorter life than the rest of the screen face.

The 6AS7-G booster and damper is across the horizontal deflection coil. This tube is adjusted to permit a power gain of approximately two to the sweep while efficiently damping any oscillations which might persist after the retrace pulse—the first half-cycle of oscillation. Horizontal linearity control No. 1, in the cathode circuit of the 6AS7-G, affects the linearity of the sweep by shifting the operating point of this tube along its characteristic curve.

The horizontal linearity control No. 2 varies the time constant of the grid circuit and affects linearity by controlling the portion of the sweep over which the damping action is most effective. The 55-250- μ h coil shunted across a portion of the secondary winding of the horizontal output transformer decreases the width of the picture by shunting a part of the sweep current.

Vertical sweep circuit

A portion of the output of the first sync amplifier is fed to the vertical sync amplifier and noise attenuator through a resistor-capacitor network which attenuates the higher frequencies and passes the 60-cycle sync signals. The output of this amplifier passes through another network which further attenuates frequencies above 60 cycles and shapes the sync pulses which synchronize the 6SN7 vertical multivibrator. The 200,000-ohm vertical hold control varies speed of the multivibrator by changing the grid bias on one of the 6SN7 triodes. The plate voltage on pin No. 2 of the 6SN7 and the cathode voltage of the 6Y6-G vertical output amplifier have been adjusted so that the two stages can be directly coupled. The two 0.1- μ f capacitors in series and the 1.8-megohm resistor are the charging capacitor and resistor, respectively. A tubular-type, dual, 0.1- μ f capacitor was used here because of its mounting; however, a single .05- μ f capacitor can be used. Vertical linearity control No. 1 changes the operating point along the characteristic curve of the 6V6-G, making it possible to obtain good vertical linearity. Vertical linearity control No. 2 varies the amount of spike necessary to produce the correct waveform for a sawtooth current in the deflection coils. The height control varies the amount of voltage across the charging capacitor, changing the size of the spiked sawtooth coupled to the 6V6-G.

Operating as a triode, the vertical amplifier is transformer-coupled to the vertical deflection coils which are

shunted with 470-ohm damping resistors.

The audio circuits

Returning to the mixer plate coil, we find coupled to it a coil resonated at 21.25 mc which carries the audio i.f. to the 6SG7 audio i.f. amplifier. This tube in turn is coupled to the following 6SH7 limiter by a slightly overcoupled i.f. transformer, resulting in approximately 300-kc bandwidth. The limiting action is accomplished in this stage by the bias, which varies with the incoming signal due to the 51- μ f capacitor and the 220,000-ohm resistor in the grid circuit and by plate saturation due to the low plate voltage. The FM discriminator transformer is between this 6SH7 limiter and the 6H6 ratio detector. This type of discriminator circuit was chosen because it is easy to align, the transformer is easily constructed, the quality is good, and the possibility of using a tube with a single cathode allows for flexibility in future changes. This will be discussed in a later installment.

The audio voltage is coupled to a 6SF5 audio amplifier through a de-emphasis filter consisting of an 82,000-ohm resistor and 330- μ f capacitor and also through a selector switch and a bass-boosting volume control.

The de-emphasis filter used here only partly restores the original level. The 1-megohm tone control in the plate circuit of the 6SF5 then permits adjustment of the high-frequency audio to the same level, to a slightly higher level, or to a more attenuated level with respect to the lower-frequency audio that resulted from the original sound.

The output of the 6SF5 is capacitance-coupled to the 6V6 audio power amplifier, which in turn is transformer-coupled to a 12-inch PM speaker.

When the TV-OFF-RADIO selector switch is in the OFF position, it disconnects the a.c.-supply from the receiver. When switched to TV, the audio amplifier tubes obtain their heater, plate, and audio-input voltages from the rest of the television circuits. In the RADIO position, the a.c. line is switched from the TV power supply to jack J3. The radio line cord plugs into J3. The switch also disconnects the heater, plates, and audio input of the amplifier and connects them to a four-circuit female connector. This requires that four wires carrying 6.3 volts a.c., 250 volts d.c., ground, and audio be brought from the radio through a four-circuit plug. This radio unit or tuner can be left out, as the circuits are all complete when the selector switch is in TV position, or the radio unit can be added at any time and be as elaborate as desired. It can consist of AM, FM, shortwave, and phono, or any one or combination of these functions, the only requirement being that the power supply in the unit can stand an additional drain of 250 volts at approximately 40 ma and 6.3 volts at 0.75 amp.

Electronic Brain Servicing

A Revolution in Robot Radio Servicing

By MOHAMMED ULYSSES FIPS, IRE*

RECENTLY I inspected the huge electronic brain—the electronic computer designed and constructed by the *International Business Machines Corporation*. (For further data see *RADIO-CRAFT*, May, 1948.) This almost human machine not only can actually “think,” but also has a memory. Costing \$750,000 to build, it has 12,000 radio vacuum tubes, 20,000 relays, 4,000 neon tubes, and tens of thousands of resistors and capacitors. This calculating machine can solve in a matter of minutes complex problems that would take a topnotch mathematician years to solve using ordinary calculating means.

What impressed me particularly was that this huge electronic calculator—which takes up a large room—“services itself.” If one of the tubes burns out or some part in that tube’s circuit goes out of order, a neon tube in that circuit flashes immediately, making it easy to discover any trouble whatever

**Independent Radio Explorer.*

in that vast electronic network.

Other automatic means provided in these electronic calculators make it simple to locate trouble when the machine stops due to an internal breakdown.

You can feed the computer any problem, no matter how complex, and the electronic calculator will answer it. If you supply your own problem, the I.B.M. Corporation will charge you \$300 an hour for the use of the machine. Usually it is fed a punched card which states the problem. From there on the computer does the rest. When it has finished all the calculations, it types the final answer to the problem on a special typewriter.

Service technicians waste a lot of useful time hunting trouble in radio and particularly in television sets. Why not simply hook up a defective television receiver to the electronic calculator, state the problem to the machine and let it find the trouble?

I talked to the chief engineer about this. He was of the opinion that the idea was quite feasible and that an electronic calculator could no doubt solve most servicing troubles in a few seconds, no matter what the failure in a given televiser might be. Thus encouraged, I proceeded at once to look into the possibilities of electronic-brain servicing.

The price of \$300 an hour for the use of the machine would be very low because each televiser would take only a few seconds to service. I envisaged a servicing assembly line on which defective televisers would roll along slowly on a moving belt. A girl would take out the diagnosis card from the special typewriter, then attach it to the corresponding televiser. Now the radio servicing technicians—knowing exactly where the trouble was—would repair the set within minutes.

Every service technician knows that it sometimes takes hours to locate a given fault, which, once found, can be cleared in a few minutes. So why waste the valuable time of a good service technician if we can have electronic brains?

The more I thought of the problem the more fascinated I became.

With the facilities of an electronic calculator in a large city, an electronic-brain servicing firm could get all the business, because it could work for so much less than the regular service house.

There was but one little problem that had me worried, but I solved this (in all due modesty, brilliantly). How could the electronic brain service a set in the owner’s home? Naturally, you can’t transport the electronic brain into a private home to do the servicing. (It takes up two freight cars.)

The problem was resolved very simply. I knew that it would be a simple matter to hook up a televiser to the electronic calculator. All you require is a heavy cable with a number of connections made to the strategic points in the televiser. Then in five seconds your answer is supplied by the computer.

This then led me to the invention of a special unit which I term the *Telepulsor*. This is shown in one of the photographs and works as follows:

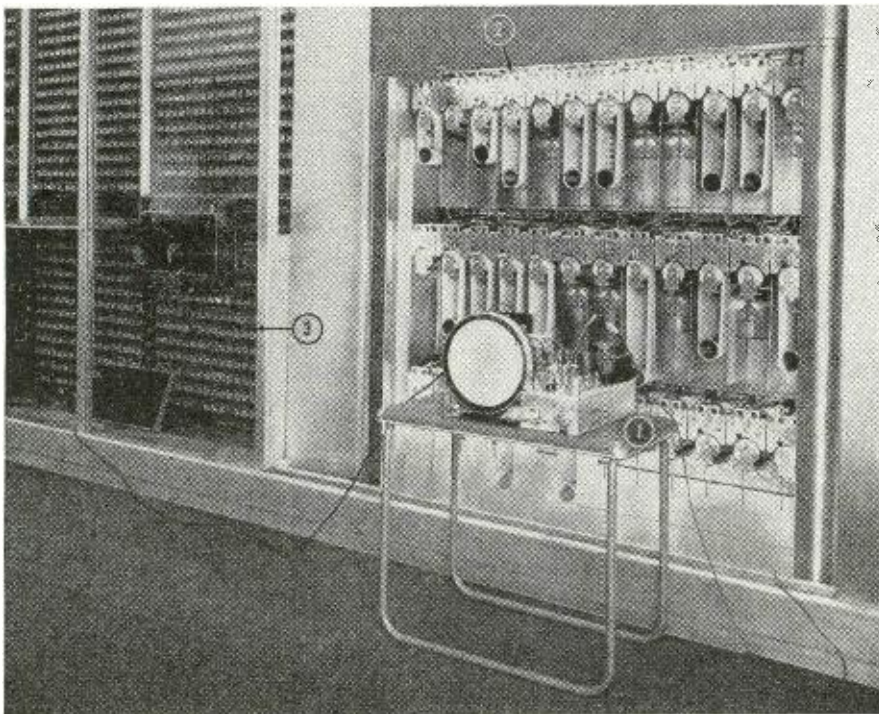

Connecting defective televiser (1) to electronic computer. (2) is “Table Look-Up Unit.” (3) shows a small part of the insides of the electronic brain, which has over 12,000 vacuum tubes, 20,000 relays and 4,000 neon tubes.

In the owner's home, the telephone handset is connected to an ordinary microphone as shown in one of our illustrations. Its cable is connected with the telepulsor, and the latter is connected with the televiser.

The service technician now calls up the home office of the electronic calculator. At headquarters, an ordinary handset is placed on an amplifier which amplifies the sounds coming from the telephone of the handset. The amplifier in turn is connected with the electronic calculator.

Now the latter sends impulses over the telephone line which go to the telepulsor, thence by a cable to the televiser. The impulses sent by the electronic calculator via the telepulsor act exactly as if the televiser were connected to the electronic brain by direct cable.

The telephone line has become the distant physical link and the computer works exactly as if a televiser were in the same room.

In a matter of seconds the electronic calculator has located the trouble in the televiser. Headquarters now tells the service technician by phone just what is wrong with his unit.

Inasmuch as it only takes a few minutes to set up the telepulsor and make the telephonic connection and as it takes only a few additional seconds to get the answer to the televiser's failure, you can see what a great advantage the radio technician has in servicing a set. In a very short time he will have remedied the trouble. While in some cases it might be necessary to remove the televiser to the service station, in most instances the receiver can be repaired right on the spot.

For this reason I figured a standard charge of \$3.50 for all radio televiser diagnosing. This, of course, does not include replacements of defective parts. Electronic-brain servicing should prove a gold mine for those lucky enough to get in on the ground floor.

Furthermore, inasmuch as this electronic calculator cost \$750,000, the original servicing firm shrewd enough to make contact with the computer's owners would not have to worry much about competition. Not many other servicing firms would be willing to spend the more than a million dollars which it would cost to manufacture a new electronic calculator at present high prices.

After I had made my preliminary trials and got all my facts together on paper, I sent out a lot of publicity releases to service technicians and others so they could see my new wonder under actual working conditions. I did this purposely as my big boss was away in Europe and I thought if there ever was a beat for a radio magazine, this would be it. My first public demonstration was timed to take place the day after the boss returned from Europe. I sent invitations to all the newspapers and to various local radio service firms to bring their defective televisers and have them robot-analyzed free of

charge for this demonstration. Nearly a hundred televisers were received to be analyzed and over 400 people were on hand that memorable morning when the first public demonstration took place.

I had reserved the best seat in the room for the boss so he could watch the whole demonstration with ease. He seemed puzzled at first because I had not told him exactly *what* the occasion was, but I had intimated that this was going to be the biggest journalistic coup ever undertaken by any radio magazine. Everything, down to the smallest detail, came off exactly as I had planned.

I delivered my lecture to the assembled audience, explaining to them how servicing was going to be completely revolutionized and how much the public would benefit by means of this new invention. I told them that most of the television receivers would not have to be removed at all from the premises and that they could be repaired and put into use again in such a very short period, that owners would not be deprived of their beloved televisers for more than a few short minutes at the most.

Next the television receivers were put on the servicing belt and slowly started down the line. It took only a few seconds to attach the special cable that went to the electronic calculator—the electronic brain. A special card was fed into the hopper of the computer and within a few seconds the neatly typed answer came out. Then a pretty girl attached the card to the correct televiser.

I looked expectantly at the big boss—pride glowing in my eyes. I was, how-

ever, disturbed and puzzled by the ferocious expression on his face. He chewed his big cigar nervously, and, slowly the color in his face changed from a pink to a sort of queer purple. This, I could not understand, but I attributed it to the fact that he perhaps was jealous of my accomplishment so I paid little attention to him. All went well till the fifteenth televiser was connected to the electronic brain. Then, something dramatically happened. An ominous growling noise came from the great vacuum-tube panels of the machine. The normal hum and click from the relays rose to a high-frequency staccato pitch. The relays clicked and clacked with frightening intensity. Neon lights flashed all over the big panels and suddenly smoke started to curl from some of them. Soon flames began to shoot from the *table lock-up units* (memory units). Some of the paper rolls began to burn. . . . Attending engineers of the electronic brain by this time were running around frantically. Some of them grabbed fire extinguishers and shot streams at the flames. Now the commotion became catastrophic and in a panic all the frenzied guests ran for the doors.

The boss had gotten up in a hurry too. I saw him snatch away the card on which the answer came out of the computer.

He next grabbed me by the collar and pulled me out to safety onto the sidewalk on 57th Street. Everything had happened so suddenly and with such speed that I was practically a nervous wreck.

We were still trying to catch our breath when someone approached the

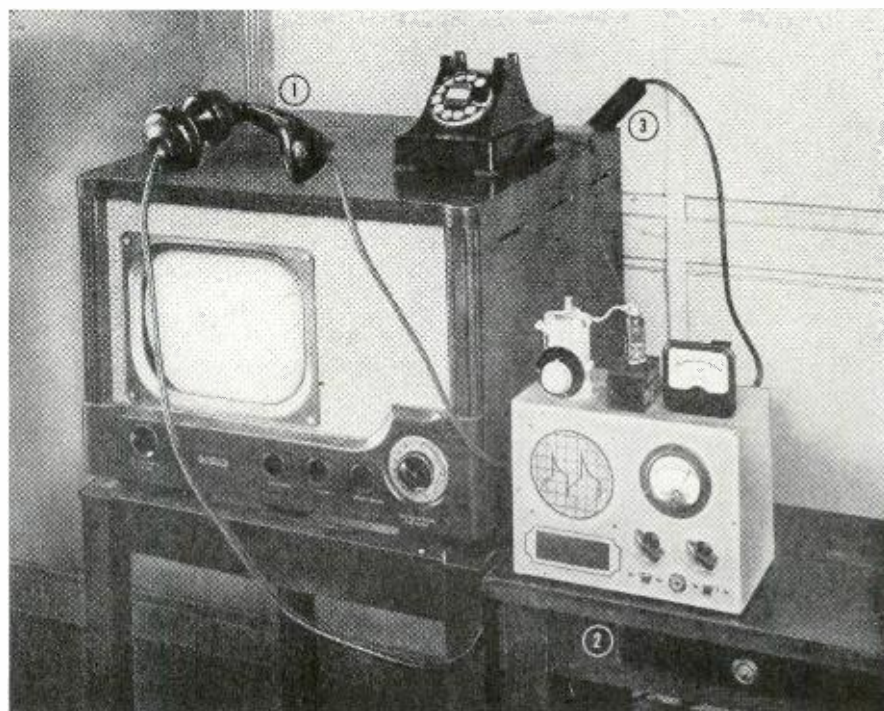

Home televiser hooked up to distant electronic brain. (1) is handset of telephone attached to microphone which in turn is connected with the telepulsor, (2) sending impulses over telephone line. (3) is how televiser is connected to telepulsor. Distant electronic brain now searches out faults in televiser.

boss, quickly put a slip of paper in his hand and disappeared in the gathering crowd, which was augmented by the two fire companies who had already rolled out their fire hoses intent upon putting out the conflagration. The boss glanced briefly at the note, gave a nasty grunt, and pulled me by the arm into a nearby café.

As soon as we had settled down he bellowed:

"Fips, this is the end of all the crazy

"You should also have thought of the fact that such a machine, if it became a reality overnight, would put out of business most of the servicing instrument makers, analyzer companies, etc., which after all are our bread and butter. How do you think the country's servicing trade would feel if this radiotic cock-eyed scheme of yours had become a reality overnight?"

"Fortunately, one of the local radio servicing firms cooked your goose."

brain was not prepared. We know this will fix you and Fips, but good!

The Electronic Servicing Avengers."

"So you see, my electronic imbecile," continued the boss, "they spiked you good and proper, much to my unbounded pleasure. When the gimmicked televiser was connected to the electronic brain, something totally unexpected happened. Instead of analyzing a number of dead circuits, the electronic brain was now connected with the televiser's powerful shocking machine which sent several hundred volts into the computer's totally unprepared brain. This was so unexpected that the electronic brain was completely shocked out of its routine. It went absolutely haywire and electronically berserk. In short, it had an electronic nervous breakdown, which in turn made it an electronic psychopath, the most dangerous robot we have as yet seen."

"Naturally everything in the machine went haywire too. There were thousands of short circuits, thousands of relays fused, wires started to heat up, and in only a few seconds the entire machine was in flames, as you yourself have seen."

"Now I will probably be sued for a million dollars or more, thanks to this little escapade of yours." In saying so, the boss' right fist shot out and closed my best left eye. In his anger he threw down a piece of cardboard as he went out, snarling over his shoulder:

"See what the electronic brain answered before it had its final psychic breakdown."

Completely stupefied by this time and rubbing my closed, swollen eye, I looked at the electronic-brain answer card in front of me. I sadly read:

"APRIL FOOL"

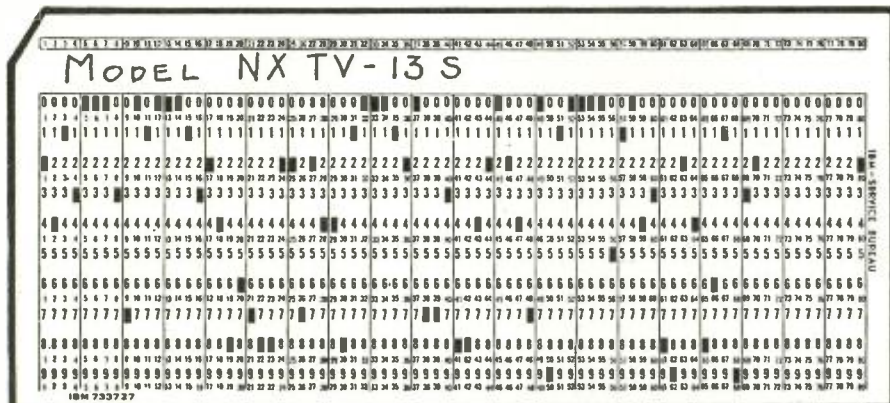

This is the "answer card" of the electronic brain. It has 800 spaces provided for 800 possible failures in a given televiser. Machine punches holes in card, which when translated give the technical failure or failures in the television receiver.

sap stunts you have ever pulled. This one is the asinest of them all. You have the brain of a burnt-out vacuum tube, and your capacity for thinking is not equal to a blown capacitor. Every time I turn my back you go haywire with some of your electronic contraptions. Only an electronwit could cook up such idiocities. While I do admit that *some day in the future* it will be possible to have electronic-brain servicing, you should have thought of what this would do NOW to the servicing trade to which your magazine caters.

Here the boss pulled out the slip which had been handed to him on the sidewalk. He read:

"Editor, RADIO-ELECTRONICS, If you don't fire that electromonic ass Fips within 24 hours, we will take him for a ride and electrocute him in a lone spot in gratitude for his hare-brained schemes. Fortunately we 'gimmicked' one of the sets with a small battery-operated shocking machine for which we know the electronic

VELOCITY-MODULATED TV

An interesting method of producing an image on a television cathode-ray tube was described by M. A. Honnell and M. D. Prince in a recent issue of *The Research Engineer*, published by the Georgia Institute of Technology.

In the usual system, the rates of vertical and horizontal scan are kept constant, while the brightness of the spot is varied by feeding video to the

C-R tube grid. In the velocity-modulation technique the brightness of the spot is kept constant, and the horizontal scanning velocity varies from instant to instant. When the velocity is high, almost no light shows on the screen; when low, the light is bright.

It was found that details of a shaded image do not reproduce well but that the outlines of "line" material—silhou-

ette drawings, printed matter, and other black-and-white images—are extremely sharp.

The method was investigated during research on characteristics of a military airborne TV system. Scanning circuits in the receiver and all the transmitter circuits are conventional. The video signal in the receiver, however, instead of being fed to the C-R tube grid, is superimposed on the horizontal deflection voltage.

The two photographs show reception of a printed letter group by the standard system on the right and the velocity method on the left. Notice that the velocity system produces very sharply defined printing. The appearance of relief modeling is particularly interesting. It is caused by a light band on the left and a dark band on the right each time the beam traverses a two-toned image. The additional contrast thus provided, which shows only the outlines of the image, enhances readability, especially for thin areas.

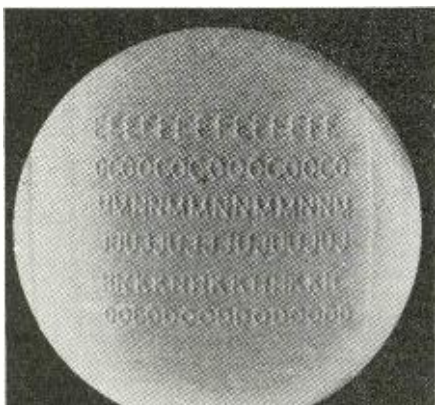

Television Dictionary

(Continued from page 28 of the March issue)

Horizontal flyback

The return of the spot after each horizontal sweep. It is also known as horizontal retrace.

Horizontal frequency

The number of times per second the spot sweeps across the screen in the horizontal direction. It is also referred to as the horizontal repetition rate. In standard television practice, the horizontal frequency is 15,750 sweeps per second.

Horizontal resolution

That quality of an image which enables an observer to distinguish the individual picture elements in each horizontal line.



Iconoscope

A television pickup tube in which the scene to be televised is optically focused upon the photosensitive mosaic. The mosaic consists of a rectangular plate of mica or other insulating material upon which a large number of individual globules of photosensitive cesium-silver have been deposited. The back surface of the mica is coated with a conducting film. A small value of capacitance thus exists between each globule and the metallic film. When light falls upon the mosaic, the globules emit electrons, thus producing a charge on the globule-capacitances. Each is charged in proportion to the intensity of the light falling upon it. The tube also contains an electron gun, and the electron stream is made to scan the mosaic. As the stream strikes each globule in turn, it replaces the electrons lost by photoemission and thus discharges the globule-capacitance. The discharge currents, taken out from a lead to the metallic film, constitute the signal currents.

Image dissector

A type of television pickup tube which converts the optical image to an equivalent electron image and then scans this electron image by allowing a small portion of it at a time to pass into an electron multiplier tube. (See Dissector.)

Indirect view

A type of television receiver in which the image is optically projected from the cathode-ray tube to a larger viewing screen.

Integrator

A circuit having an output proportional to the cumulative value of

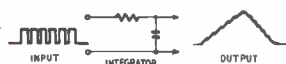

the input. It is the opposite of the differentiator.

Intensifier ring

The third anode in a cathode-ray tube. Consisting of a "painted" coating on the inside of the glass

By ED BUKSTEIN

envelope, it is the element closest to the fluorescent screen. The application of a high positive potential to the intensifier ring increases the velocity of the electron stream, consequently increasing the intensity of the light.

Intensity modulation

The process of applying a voltage to the grid or cathode of a cathode-ray tube, varying the intensity of the spot as it sweeps across the screen. For instance, in the television receiver, the incoming video signal is applied to the control grid of the cathode-ray tube to vary the intensity of the spot and produce the dark and light portions of the image.

Intensity of illumination

The brightness of an illuminated surface. Intensity of illumination is normally indicated in foot-candles and is inversely proportional to the square of the distance from the source.

Interlaced scanning

A system of scanning in which only a fraction of the image is scanned during each field. In the standard interlaced scanning system, the odd lines and the even lines are scanned as separate fields. Each field therefore contains 262.5 of the total 525 lines.

Ion

An atom having more or less than its normal number of electrons. A balanced atom has an equal number of protons and electrons. If such an atom loses one of its electrons, it assumes a positive charge (positive ion). If the atom should gain additional electrons, it assumes a negative charge (negative ion).

Ion spot

An insensitive dark spot on the screen of a cathode-ray tube due to ionic bombardment of that spot. This condition may be prevented by use of an ion trap which allows electrons to pass to the screen but obstructs the ions.

Ion trap

A coil or permanent magnet placed near the neck of the cathode-ray tube for the purpose of removing ions from the electron stream. The magnetic field is able to deflect the electron stream, but has little effect on the heavier ions. In this way, it is able to separate the electrons from the ions and to prevent an ion spot on the screen.



Keystone distortion

A form of distortion which causes the television image to take the shape of a trapezoid even though

the mosaic in the pickup tube is rectangular. Keystone distortion is due to the fact that the electron stream does not strike the mosaic at right angles. This distortion is normally corrected in the transmitting equipment.

Kickback

The counter-electromotive force produced in a coil when the current through it is stopped and the magnetic field collapses.

Kickback power supply

A type of high voltage power supply used extensively in television

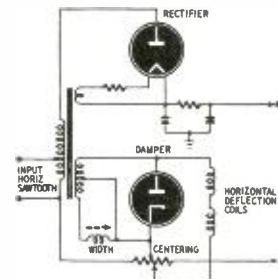

receivers. The horizontal sawtooth is applied to a transformer, and the high counter-e.m.f. produced by the inductive kickback is rectified.

Kinescope

The commercial name for television cathode-ray tubes manufactured by RCA.



Latent image

Stored picture information such as that contained in the charged globule-capacitances of the iconoscope. (See Iconoscope.)

Light

Electromagnetic radiations having wavelengths between 4,000 and 7,000 Angstrom units and therefore visible to the eye.

Light flux

The total amount of light produced by a source. Light flux is usually measured in lumens. The term is sometimes used to describe invisible radiations such as infrared and ultraviolet rays.

Line

The picture information contained in one horizontal sweep of the electron beam.

Linearity

The uniform distribution of picture elements over the total area of the image. Such uniformity can be achieved only if the sweep waveforms are linear. (See Linearity control.)

Linearity control

An adjustment in the vertical or horizontal sweep oscillator which controls the linearity of the sawtooth and consequently the uniform distribution of the picture elements of the image. If the saw-



tooth is not linear, the spot sweeps across the screen at a varying rather than at a constant rate, with the ultimate result that the image is spread out near one edge of the picture and crowded toward the opposite edge.

Lumen

The unit of light flux. A 1-candle-power source produces a flux of 12.57 lumens.

Luminous intensity

The term used to describe the candlepower of a source of light.



Magnetic focus

The process of focusing the electron stream in a cathode-ray tube by means of a magnetic field.

Magnetic sensitivity

The relationship between the current passing through the deflection coils and the physical distance by which the electron stream is displaced.

Mechanical scanning

The process of breaking down an image into a number of picture elements is called scanning. If this scanning is accomplished by mechanical means such as a Nipkow disc, the system is called mechanical scanning. Electronic scanning used in modern television practice is more satisfactory than mechanical scanning.

Microwave relays

A system of increasing the range of television coverage by reception and rebroadcast of the signal over a chain of towers located 10 to 25 miles apart. Each tower contains a receiver to pick up the signal from the preceding tower and a transmitter to rebroadcast it to the following tower. These receivers and transmitters operate in the microwave region, which extends from 3,000 to 30,000 mc.

Minimum resolving distance

The distance an observer may move away from a television image and still be able to distinguish the individual horizontal lines of the picture.

Monitor

A cathode-ray tube used at the studio or transmitter to enable the operator to judge the content and quality of the image.

PHOTOELECTRIC RELAYS USE COLD-CATHODE TUBES

THE safe current flow through an ordinary phototube is but a few microamperes, which is much too small to operate an ordinary relay directly. Most phototube relay circuits resort to thermionic-tube amplifiers. Such circuits, using heated-cathode tubes, always waste power unnecessarily. This article presents several simple and practical phototube relays which use cold-cathode tubes exclusively.

A gas-filled phototube consists of a central wire-rod anode, a large sheet-metal cathode with light-sensitive surface, and an atmosphere of some inert gas such as argon. The anode wire collects the electrons liberated from the cathode upon exposure to light and the additional electrons liberated by the resulting collisions with gas molecules. With the anode at a positive potential so that there is an electron flow between electrodes, the phototube can be considered as a resistance which changes its value with exposure to light. The resistance is high and the current passed is feeble, so electronic trickery is needed to make the ordinary relay respond.

The Cold-Cathode Diode

Fig. 1 reveals the first phototube relay circuit using two cold-cathode diodes. A 918, 921, 923, or 930 photo-



Relay constructed according to Fig. 1.

By **BOB WHITE**

tube is the first and an OA3 (VR75) glow-discharge voltage-regulator tube the second. With the selenium rectifier and the 40- μ f electrolytic capacitor, a d.c. potential of well over 100 volts is developed. The voltage forces a trickle of current through the potentiometer and its series resistor to charge the 0.5- μ f capacitor. The voltage across the terminals of the capacitor increases directly with the charge until a critical value is reached. At this point the gas within the OA3 tube, which normally serves as a good insulator, becomes ionized and passes a current which rapidly discharges the capacitor through the coil of the adjustable-contact relay. The cycle repeats itself, for the circuit is a relaxation oscillator.

The phototube controls the relay indirectly by regulating the capacitor's charge rate. With switch S2 in position A, the phototube is in effect connected across the glow-discharge tube and paper capacitor. With exposure to light, decreased resistance of the phototube tends to discharge the capacitor and by so doing slows down or completely stops the pulses through the gas tube.

In actual use, the potentiometer is adjusted so that no glow discharge occurs when the phototube is illuminated; then, upon extinguishing the

light, the capacitor becomes charged so that a pulse occurs and the relay closes. Switching S2 to position B reverses the operation. Upon exposure to light, the charging current is increased; the potentiometer is adjusted for no discharges with no illumination. Upon exposure to light, a discharge takes place and the relay is energized.

At the time of a discharge, the sensitive adjustable relay is momentarily operated. This rapid closing and opening of contacts being unsuitable for most devices, a delaying arrangement is employed. The surge of current through the coil of the adjustable relay closes contacts which allow current to flow from the 40- μ f filter capacitor through both relay coils in series. This new energizing current maintains the contact originated by the pulse and also closes the output-controlling contacts. With switch S1 closed, the 40- μ f capacitor is kept charged and the relay contacts are held closed until the switch is opened or the power supply disconnected.

With S1 open, the 40- μ f capacitor is connected to the rectified power source by the normally closed contact of the s.p.d.t. relay; when a pulse is received and the relays are energized, the supply connection is broken and the relays are held closed for only a few seconds by the discharging filter capacitor. After the contacts return to their normal positions, the capacitor is again charged by the power supply and the phototube circuit is ready to start a glow-discharge impulse at any time.

Ample constructional information is given by the schematic diagram of Fig. 1 and photographs. The potentiometer can best be adjusted for different lighting conditions with a piece of paper inserted between the normally open contact and the armature of the adjustable relay. This permits observation of the oscillation rate by the flashes within the OA3 tube. The reason for specifying an adjustable s.p.d.t. relay is to allow setting the contact spacing and spring tension for positive action on the first discharge pulse. With feeble illumination the discharge pulses may occur as far spaced as a minute and with ordinary lighting they may occur many times per second.

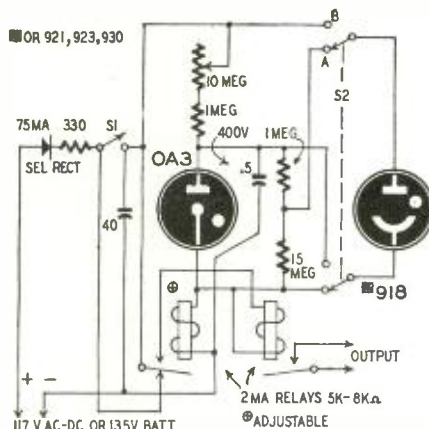

Fig. 1—Pulses caused by OA3's discharge trip the adjustable 2-ma relay.

The applications for this device are numerous and, because of the difference in operating principle from the ordinary phototube relay, much more unusual. A typical use would be to operate a display window light; with the phototube controlled by the sun, during the night the contacts would close and open each few seconds and cause the electric sign to flash on and off. Another very suitable application would be as an alarm. A concentrated beam of light could be directed across a doorway or other open space to the phototube unit. Switch S1 could be left open, and any interruption of the beam of light would cause a bell to be operated by the output contacts for about 2 seconds. Or instead, if S1 were closed, an interruption of the beam would ring a bell continuously until S1 were opened. In such an operation involving a brief break in the light beam, it is vital to have illumination of sufficient intensity to allow setting the glow-discharge rate to complete one pulse cycle before light is restored.

The Cold-Cathode Triode

A change to a more conventional type of phototube-relay operation is made possible through the use of the OA4-G cold-cathode triode. The physical form of the elements within this tube differ somewhat with the manufacturer. In general, this triode consists of a glass bulb containing an atmosphere of an inert gas, a cathode in the form of a large metal disc or cylinder, an anode of a straight wire enclosed except for a short length by a glass tube, and a starter anode of a small wire. The starter anode is mounted much closer to the cathode than the anode because the required voltage between electrodes for ionization of the gas is much less with a shorter spacing distance. Once the discharge between the closely spaced starter anode and cathode has begun, free ions are produced which trigger the main discharge between the anode and cathode.

An interesting and useful action of the OA4-G tube is its ability to rectify alternating current. The current flow within such a tube is roughly proportional to the negative, electron-emitting electrode area. When the cathode element is made negative by the impressed a.c. supply, a much greater current can flow, because of the large area difference, than when the anode wire is made negative. This action allows the use of d.c. relays with appropriate capacitors in shunt to filter the current. With an a.c. supply the applied voltage drops to zero many times each second and the starter anode is capable of determining whether or not the OA4-G should conduct each time. With d.c. the voltage ordinarily never reaches zero; and once a discharge is started, the starter anode has no control over it until conduction can be stopped by momentarily breaking the supply connection.

The cathode of such tubes as the

OA4-G is coated with oxides of active metals which become partly reduced during manufacture and which continue to be reduced slowly during its conducting period. The gradual using up of the active metal gives the tubes

through its negative alternation.

This circuit was constructed on an aluminum chassis measuring 4 x 2 1/4 x 1 11/16 inches, and the complete unit with power cord weighs less than 1 pound. Components worth honorable

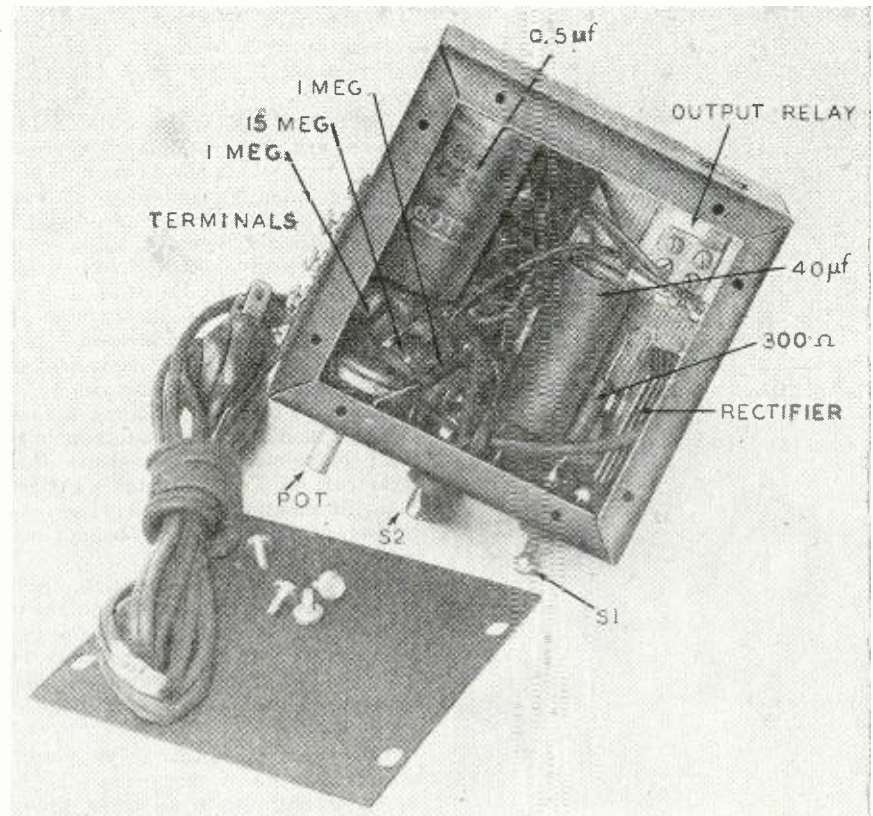

Under-chassis view of the relay constructed from the schematic shown in Fig. 1.

a definite length of life. For this reason it is only sensible, in the case of a great unbalance of the illuminated and unilluminated time, to choose the shorter period for the OA4-G to conduct. This is the reason for providing two circuits; the first conducts when the phototube is exposed to light, the other when it is removed from light.

Fig. 2 is the simpler circuit. Illumination has the effect of decreasing the resistance of the phototube and causing an increase in the applied voltage to the starter anode. Upon reaching the critical glow-discharge voltage, the starter anode enables the main discharge to take place and the relay to become energized. Absence of light lowers the control voltage below the critical value; the starter anode then fails to renew the conduction after the alternating current source has passed

mention are the 0.5- μ f capacitor shunted across the relay coil to prevent chatter and the 500-ohm resistor to limit the conduction current to a safe value. The output terminal strip provides switching action through posts 2-4 or 2-3 and by joining 1-2 provides controlled line voltage from 3-5 or 4-5.

Fig. 3 shows another phototube relay. It is made in the form of an alarm system, but can easily be adapted for other uses. Without illumination the 5.1-megohm resistance maintains the starter anode above its critical value and causes conduction in the OA4-G tube; the relay is energized and the

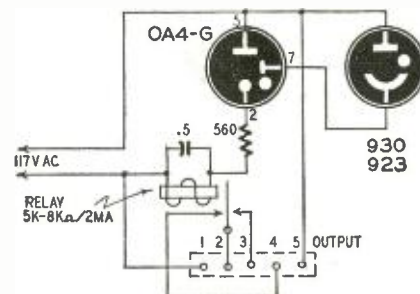

Fig. 2—Several control actions are available if this relay circuit is used.



Photograph of the simpler unit. Note its compactness and placement of tubes.

bell sounded continuously. Exposure of the photocell to light increases the current flow through the resistance and thereby decreases the starter-anode potential in respect to the cathode to below the lower critical value; the discharge is stopped, the relay is unenergized, and the bell is silenced.

The entire alarm unit can be housed

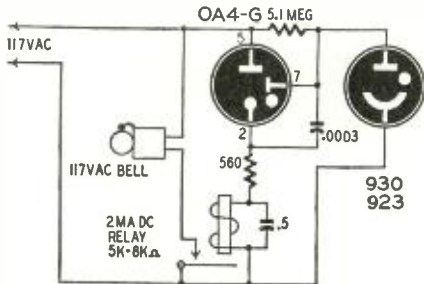
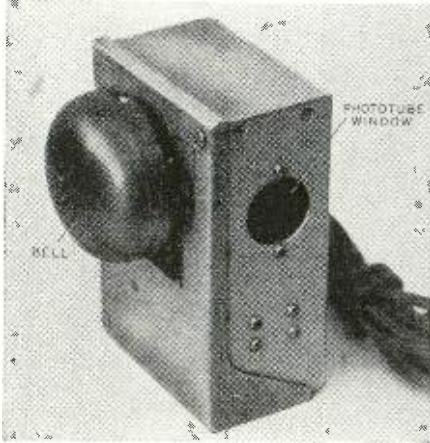

Fig. 3—Breaking light ray rings bell.



Bell-ringing relay in surplus jack box.

within a small metal cabinet such as the surplus interphone amplifier box measuring $5\frac{1}{2} \times 4 \times 2\frac{1}{2}$ inches shown in the photographs. This phototube relay was constructed to be mounted on one side of a doorway with a concentrated beam of light directed at it from a source on the opposite side. The bell sounds when the beam of light is interrupted.

An important characteristic of the cold-cathode triode is that a higher control voltage is needed to start a glow discharge than is required to maintain it. In Fig. 2 this means that a brighter light is necessary to start conduction than is actually required to continue it, once started. In Fig. 3 a brighter light is required to silence the bell than is actually needed to keep it from starting to sound. This behavior of the OA4-G in the alarm circuit can be put to practical use. By including a series rheostat or a tapped transformer in the light-source circuit, the intensity of the light can be made adjustable. At normal illumination the bell rings only whenever the source is being interrupted.

With dimmed illumination, at a momentary interruption of the light the bell sounds continuously until the light intensity is restored to normal. The dimmed burglar-alarm connection would conserve power and would be less easily seen.

The three phototube-relay circuits are given in decreasing order of sensitivity. Of interest in all three circuits is that no ground or electrical connection of any kind need be made to their chassis or cabinets.

Sources of light

For operating a device from natural daylight or darkness, good indirect sunlight is all that is required as a source. For applications involving such a function as opening a garage door upon exposure to headlights of a car, there is again no concern about a source of illumination.

An incandescent lamp located at the focal point of a good circular-paraboloid reflector makes an excellent source of illumination. The purpose of the reflector is to direct as much of the radiation as possible into a narrow beam.

A good and inexpensive source is provided by the lamp and reflector of a flashlight operated through a small step-down transformer. Where a great distance is to be covered, a higher-powered source such as a sealed-beam spotlight will be required. Ordinarily, as the shaft of light leaves its source, it diverges; the area illuminated increases greatly with distance. At the phototube the sensitized cathode is not large enough to benefit from all of the energy reaching the relay unit and for this reason it is sometimes advisable to employ a large condensing lens to collect part of the wasted light. The plano-convex condensing lens is placed a short distance in front of the cell with its flat surface toward the cell so that the light is converged as uniformly as possible upon the cathode. To make the relay insensitive to stray light, place a tube or hood over the opening in the front of the case. Coat the inside of the tube with flat black paint to reduce reflections.

Connect TV Sound to Hi-Fi Amplifier

A FRIEND wanted to connect the a.f. output of his TV receiver to the a.f. system of a high-fidelity radio-phonograph console, with all controlling done at the TV receiver when it was in use. No additional controls could be added to either set. Furthermore, he wanted to be able to detach the TV set and use it with its own speaker at any time. The drawing shows how the problem was solved.

A small s.p.d.t., d.c. relay was mounted near the volume control on the combination and connected as shown. A four-prong male connector was mounted on the rear of the combination chassis and a connecting cable was made from a shielded lead and a length of high-voltage insulated wire. One end terminated in a male octal plug and the other in a four-prong female connector. The octal plug replaced the power amplifier, a 6V6, in the TV receiver. The shielded conductor was connected to the grid pin and the insulated line to the plate pin on the plug. An a.c. receptacle was connected across the primary of the power transformer

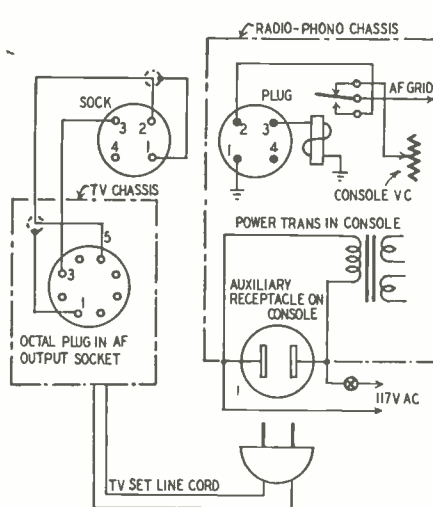

Neither set needs additional controls.

in the combination and mounted on the chassis where the TV line cord could be plugged in.

Current for the relay is taken from

the plate pin of the output tube socket. The relay used drew approximately the same current as the 6V6; however, if its resistance had been too low or too high, a limiting resistor could have been used in series with its coil or a shunt resistor across it. The relay should draw the same current as the 6V6 so that the focusing and other voltages are not disturbed.

The TV set is operated by first turning on the combination. This will operate normally until the TV set is turned on. When this is done, the relay coil is excited and the a.f. grid in the combination is switched from its volume control to the audio line from the TV set.

Both sets can be turned off at the console but the radio or phono will not play until the TV set is turned off.

If the audio output from the TV set is at too high a level, it will not be possible to get good volume control using the control on the TV set. This can easily be remedied by adding a voltage divider ahead of the relay in the audio line.—Ross H. Snyder

Portable Broadcaster

By OTTO WOOLEY, WØSGG

BUILT to provide fun and amusement for the family and friends, this tiny home broadcaster was so well received that we believe that others may care to duplicate it. As a source of amusement, its applications are limited only by the user's ingenuity and imagination. Solid construction insures frequency stability which permits the unit to be operated while being carried in the hands, so we named it Carry-Talky.

A very minimum of parts is required, and the little rig can be built

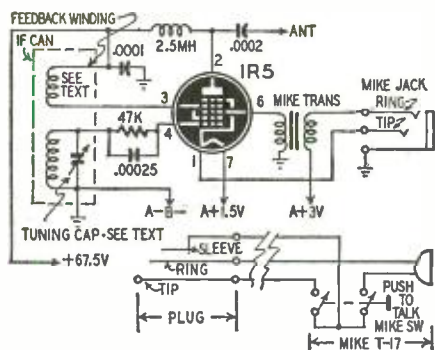

A diagram of the portable broadcaster. Control switch is in the microphone.

in a pleasant evening's work. The schematic is shown in the diagram. The basis for construction is a Signal Corps BC-1366 jack box. These boxes and the T-17 microphone are readily available in the surplus market. The box comes with a wafer switch, volume control, and phone and microphone jacks. All parts are removed except the microphone jack. The switch hole is enlarged to accommodate a seven-pin miniature socket for the IR5 tube. A discarded i.f. transformer with one good winding was used for the frequency-determining circuit. An additional winding was placed on the form to provide a feedback coil. The i.f. can and the microphone transformer are mounted on top of the jack box lid, and the remaining components are wired in place on the bottom side of the lid. The midget 67.5-volt B-battery is secured to the back of the box by wires passed through holes in the rear wall.

The antenna post is a feed-through insulator mounted in the hole that originally held the phone jack. An antenna of 18 or 24 inches will give sufficient signal for use about the house. For more power, use a loading coil at the lower part of the radiator as shown in the photographs. Of course a longer piece of wire may be used as an antenna, but it will make the unit inconvenient to use when walking around.

The filament and microphone switches are built into the T-17 microphone, and all that is necessary to insure proper operation is to make the microphone jack connections as shown. There being no battery drain until the microphone button is depressed, the batteries should last a long time. The B-battery current is less than 6 ma. The unit will operate on only one 1½-volt A-battery if a jumper is used between the A-plus terminals; however, fairly strong talking will be required for good modulation. The addition of the second A-battery in the microphone circuit allows very full modulation at low voice levels. The tone quality and modulation are good.

No trouble should be experienced in getting the rig to work. The feedback coil, 25 turns of No. 32 d.s.c. wire, is placed close to the i.f. winding with its turns wound in the same direction. It may be necessary to reverse the leads to this winding to secure oscillation. The rig is tuned by the i.f. trimmer capacitor. The model shown is tuned to about 550 kc and its second harmonic may be heard at 1100 kc. It may be necessary to remove a few turns from some i.f. coils to permit tuning into the lower end of the broadcast band. It is possible to set the transmitter on the receiver's intermediate frequency so the signal may be heard regardless of the receiver dial setting. However, a receiver with a high-gain

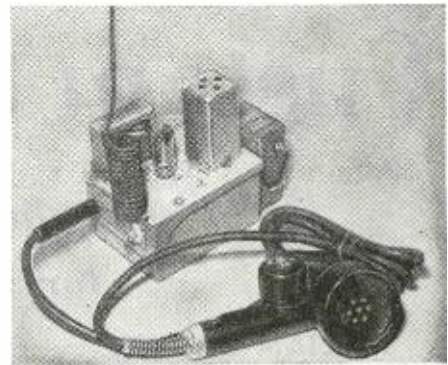

Carry-Talky and microphone. Antenna and loading coil are push-back wire.

i.f. stage will be required for satisfactory reception.

With the exception of the filament voltage and the coil specifications, the component values are not at all critical and may be varied as much as 50% with no appreciable effect in performance of the unit.

Inasmuch as the total B-battery input to the tube in transmitting is approximately 0.3 watt, there is little likelihood of interference to nearby receivers. However, *no attempt should be made to send a signal beyond the immediate premises. FCC rules are very strict regarding any unnecessary interference that might be intentional. But it may be pointed out that this rig operates on the same principle as phono oscillators (wireless record players) and similar devices, so the prospective builder need have no cause for concern when using the unit in the manner intended.* It does in fact make a good phono oscillator if a crystal pickup is inserted in the circuit instead of the mike transformer secondary.

As an inexpensive source of enjoyable entertainment the Carry-Talky is hard to beat!

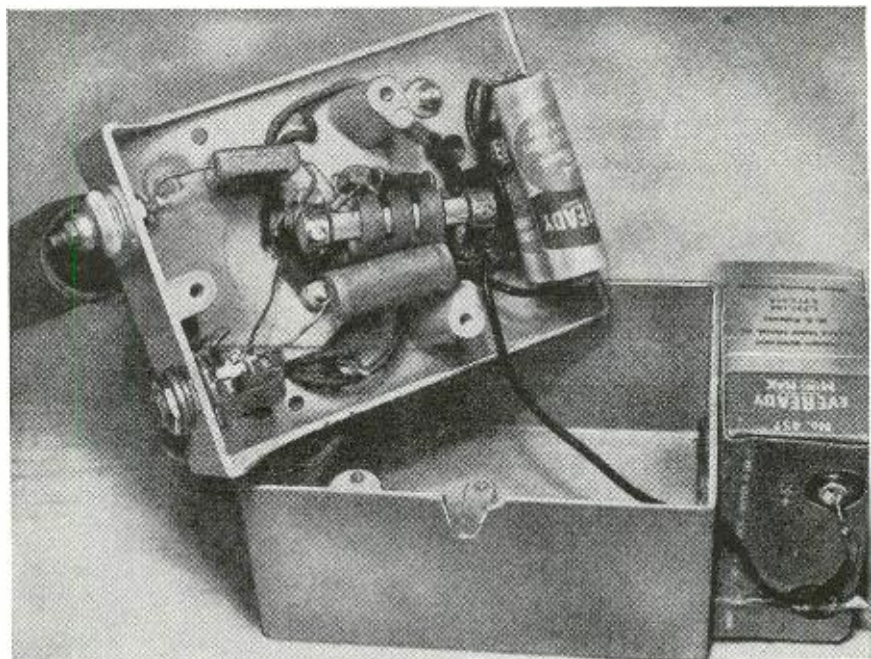

Under-chassis view of the broadcaster. All parts are on the top of a BC-1366.

Custom Sound Installation

Profitable opportunities are waiting

By for capable sound technicians in the

WILLIAM RIVKIN* *field of individually engineered home
phonograph (and also radio) equipment*

MORE and more owners and purchasers of radio and phonograph equipment are looking with favor on the idea of "built-in" radios and music systems. There are advantages both of style and economy. Custom sound installation is accounting for a continually increasing portion of our business, and a correspondingly larger share of the profits. The field offers an excellent opportunity for the average radio technician, particularly if he has ability and experience with sound. While he should generally confine himself to the electronic and acoustic angles of the installation, leaving the woodworking to a skilled carpenter or cabinetmaker, he should have a knowledge of what can be done, and what provisions must be made in the construction for housing the electronic equipment. Then he

can act as a consultant to the customer, or to the carpenter or cabinetmaker who does the work. In many cases, alterations in bookcases or other existing construction can be made by anyone handy with woodworking tools—and the radioman may find himself capable of doing the complete job.

The illustration on this month's cover is a good example of one type of custom installation. The wall unit was built specifically to house a complete high-fidelity system and blend perfectly with the room decoration. Although the room was designed with the help of an architect, the construction was done by carpenters with materials commonly available at any lumber yard. The radio unit, matching bookcases along the other two walls, and the room and cabinet doors all are finished in combed plywood paneling. For the door panels the plywood was cut in pie-slice sections to form the corrugations into concentric squares.

The system installed in the radio unit consists of a Webster-Chicago three-speed changer, an RJ-20 Browning FM-AM tuner, a Lafayette high-fidelity amplifier, and a 15-inch Stephens speaker. The record changer, mounted on slide-drawer brackets, is housed in the upper left of the cabinet spaces. The door is hinged on the left side to allow easy access to the changer. On the right, also behind a side-hinged door, is the tuner unit. Both these units are placed at convenient operating height. The amplifier is mounted below the tuner unit so that its controls and the remote speaker jack can be brought up to the tuner control panel. All units are connected by plug-in cables and are easily extractable for servicing. This is an important feature. Proper provision for future servicing included in the planning and installation stage can save many headaches later on.

The large speaker baffle at the top of the unit has a Venetian-blind grille which blends well with the over-all design. Walls and sides behind the baffle are insulated with Tufflex sound-absorbing material to reduce vibrations. A portable speaker was also installed to bring listening pleasure to either of the two porches adjoining the room. It is rigged with a remote volume control on a T-pad hookup. Convenience features like these are often big selling points.

Another feature is a sliding shelf just above the generous and well-placed record spaces. Records and albums may be set on the shelf while making selections and loading the changer. The shelf slides back into the unit when not in use.

An installation may be improved almost without limit. For instance, in this case the lower-left cabinet section is not now being used, but perhaps it could be utilized to increase the convenience of the installation as a storage space for the remote speaker or for small items such as record cleaner.

A neat installation

In another recent installation, a complete system was housed within the wall itself (see Fig. 1), saving floor space and avoiding blocking a rather

*Manager High-Fidelity Sound Dept., Lafayette Radio, New York, N. Y.

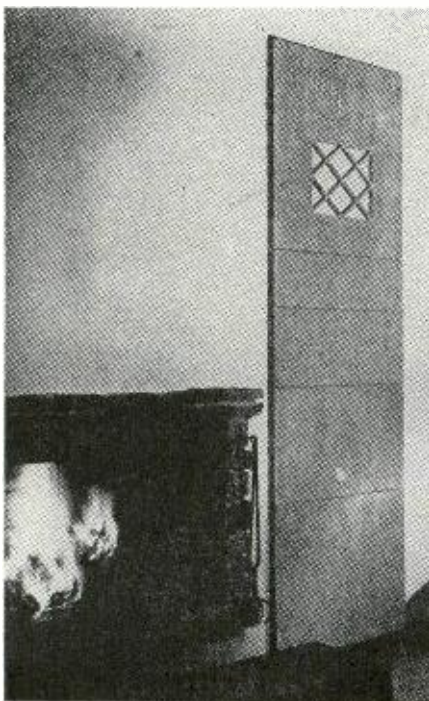

All photographs courtesy Lafayette Radio

Fig. 1—Two views of an installation which makes the most of available space.

narrow passageway. A deep wall was used in building this ceiling-to-floor unit which is directly opposite a set-in bookcase of similar design. The system includes a Radio Craftsmen RC-8 tuner and amplifier, an Altec 603B speaker, and a Webster-Chicago 356-27 record changer with G-E variable-reluctance cartridges, and a G-E pre-amplifier.

The controls and record changer are mounted at a convenient height for tuning and record handling, with the amplifier and preamp behind the tuner unit. This provides service accessibility to all three units at the same time and leaves more space for storage. The large storage spaces above and below the units will accommodate almost any record library.

Good results were obtained with the FM dipole and AM loop mounted on the inside wall behind the amplifier. This eliminated the need for concealing lead-in wires from the outside.

The baffle for the 15-inch speaker is mounted behind the grille panel. It is a separate piece set at an angle to direct the sound down into the room. The grille panel opens on a piano hinge to provide access to the speaker. Varied effects and more flexibility in speaker arrangement can be obtained in this way.

Demountable Custom Installation

Still another installation recently developed by the engineering staff of Lafayette Radio consists of rather simple bookcase sections set into a wall recess (Fig. 2) giving the effect of an in-the-wall job. The units included a Browning FM-AM tuner, an Altec amplifier, a Webster-Chicago 356-1 record changer, and an Altec speaker and cabinet. Due to room layout, it was decided to place the system in the recessed section at one end. But arranging the components presented a problem. The speaker cabinet alone was not wide enough to fill the wall space and the tuner and amplifier together were too wide for the top of the speaker cabinet.

The arrangement which finally proved satisfactory consisted of cabinets and bookcases built around the speaker cabinet in four separate sections. Convenient and sufficient record space was provided, the controls are readily available, the finished job is attractive and can be disassembled easily. This is an important feature for apartment dwellers, since the entire system can be removed whenever necessary. The front panels on the tuner and on the amplifier are also removable to permit easy servicing. Good results and short lead-in wires were obtained by mounting the FM and AM antennas in the cabinet closet to the left.

In this case the record changer was installed as a chairside piece to suit the owner's personal taste. This is another important point: the personal preference of the owner, where practi-

cal, is the primary consideration in determining the over-all layout.

Various Techniques

Other ideas have been used to personalize and improve custom-built systems. In one case involving a very large record collection, the available space was too small for sufficient storage. A small cabinet was built into the unit to accommodate the records most often used and a drawer for 3 x 5-inch file cards was built into it. A convenient card index was kept at the installation, and the records were stored elsewhere.

Frequently small items such as a cleaning brush, liquid renewer, or perhaps replacement needles, are to be kept near a phonograph. Where a magnetic recorder is used, there will be recording tape, wire, or spools. In such cases a small drawer, rack, or cabinet space for these things will add real convenience to the installation.

Special features can sometimes be added by taking into consideration the height of the control panel and record changer. Installation a little lower than usual will make operation by children easier; a little higher than usual may be more convenient for a particularly tall customer. A remote speaker—stationary or portable—or remote controls are often added attractions.

Many of the techniques suggested here are not possible in all cases. They do serve to show how custom installations can be adapted to fit widely different conditions and how advantage can be taken of existing conditions. Whether installed completely within the wall, in cabinets, or in a combination of both, the components can be ar-

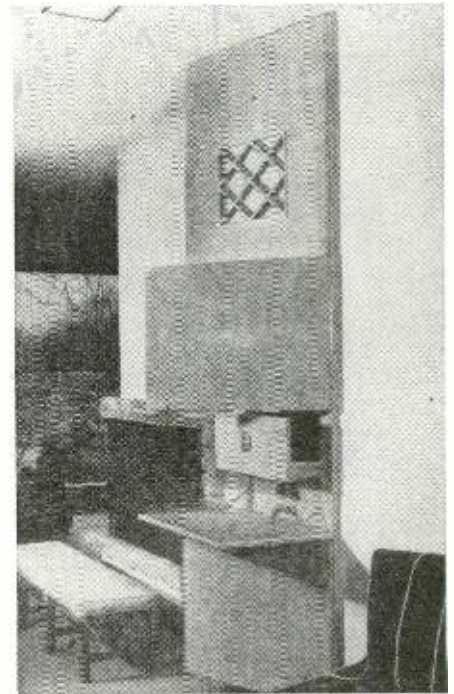

Installation of Fig. 1 with phono extended and record cabinet door open.

ranged to improve the performance and appearance of the installation. Special features can be added to give the customer a job specifically designed to please him. This type of work is usually done for a customer who wants excellent results and is willing and able to pay for them. Quality work and apparatus is therefore indicated and prices which yield a fair return for the work may be charged. Emphasis should be placed on fulfilling the requirements of the owner.

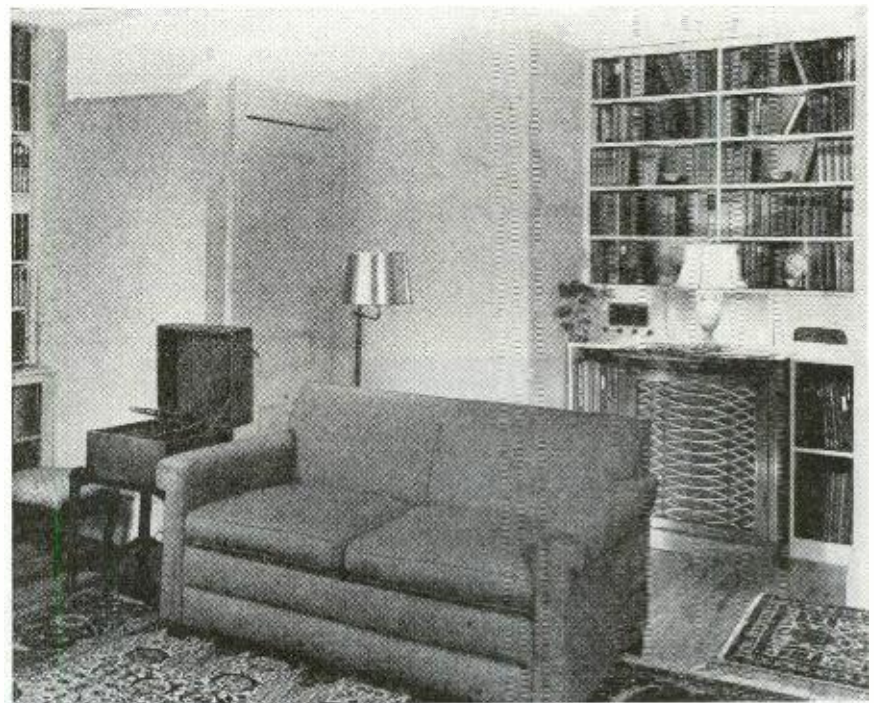

Fig. 2—removable installation which gives the effect of an in-the-wall job.

PHONO EQUALIZER DESIGN PLUS PREAMPLIFIER DATA

How to reproduce various recordings with
velocity and amplitude-actuated pickups

By K. E. FORSBERG

MECCHANICAL limitations of the disc recording medium have led record manufacturers to adopt a somewhat complex recording characteristic. At frequencies below crossover, a constant-amplitude recording characteristic is utilized to prevent cutting through the lands separating the grooves. Above the crossover frequency, recording is at constant velocity. At the highest frequencies, pre-emphasis is superimposed on the constant-velocity characteristic to minimize the surface noise of the record.

Phonograph pickups may be either amplitude- or velocity-actuated. Crystal and strain-gauge pickups are examples of the amplitude-actuated reproducer, which generates an output proportional to the stylus displacement. Magnetic and variable-reluctance pickups are velocity-actuated reproducers whose output is proportional to the stylus velocity. Because a single reproducer cannot be both amplitude- and velocity-actuated, equalizers are necessary to complement the recording characteristic.

Amplitude-actuated reproducers

Considerable variance exists between the recording characteristics used by the different record manufacturers. However, the NAB lateral characteris-

tic may be used as an average for American-made records.

The NAB lateral characteristic utilizes constant-amplitude recording below a crossover of 500 cycles and constant-velocity recording between 500 cycles and 1500 cycles. Above 1500 cycles the use of pre-emphasis results in a return to a constant-amplitude characteristic. The idealized equalizer requirements for the reproduction of a record based on the NAB lateral characteristics by an *amplitude-actuated* pick-up are presented by the dashed line of Fig. 1. A suitable equalizer is diagrammed in Fig. 1, and the equalizer frequency response is shown by the solid curve.

The solid curve indicates the actual NAB characteristic. The dashed idealized curve is no longer used, even for reference, but it is useful for instruction.

The equalizer design is based on a constant-voltage source and an infinite load impedance. The latter may be had by connecting the equalizer output to the grid of a vacuum tube. The constant-voltage source may be approximated with a low- μ triode preamplifier or by using a plate load resistance of less than 50,000 ohms with a pentode or high- μ triode preamplifier.

British (London frr) recordings differ from the NAB characteristic in the use of a 250-cycle crossover frequency

and in less high-frequency pre-emphasis beginning at 3,000 cycles. The idealized equalizer requirements for the reproduction of British recordings with an amplitude-actuated reproducer are illustrated by the dashed curve of Fig. 2. The solid curve of Fig. 2 is the frequency response of the equalizer circuits shown. (The range of frr's actually goes up to 14,000, with a sharper pre-emphasis after 12,000 cycles.—*Editor*)

A complete equalizer circuit for use with an amplitude-actuated pickup is diagrammed in Fig. 3. This unit may be constructed as a separate preamplifier or the design may be incorporated in a complete phono amplifier. The low- μ twin-triode results in a net equalizer gain of 20 db. A three-position switch permits selection of the NAB, British, or a flat curve. A variable treble-cut scratch filter is included. The dotted curves of Figs. 1 and 2 show the effects of the scratch filter when $R_2 = 0$.

The input resistor R_1 should be selected in accordance with the manufacturer's specifications for the particular pickup used. C_1 must have a reactance, at the lowest frequency to be amplified, of less than one-fifth the input impedance of the amplifier following the equalizer.

If the plate supply is taken from the following amplifier stages, it will be necessary to insert a 10,000-ohm, 10- μ f plate decoupling circuit in the B-plus line to prevent feedback.

The values of the components are not particularly critical, and small alterations in values may be made to complement the idiosyncrasies of the individual pickup. Decreasing the values of R_3 and R_4 will increase the amount of treble boost. Decreasing C_3 and C_4 will move the response curve to the right, raising the frequency at which treble boost begins.

Velocity-actuated reproducers

The idealized equalizer requirement for the NAB characteristic with a

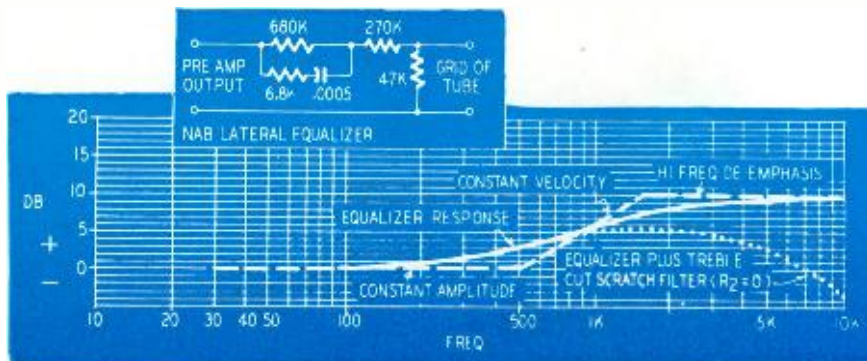

Fig. 1—Crystal equalizer for records made with the NAB characteristic curve.

magnetic or variable-reluctance pickup is shown by the dashed curve of Fig. 4. A bass boost of 6 db per octave below a 500-cycle crossover and a treble roll-off of 6 db per octave above 1500-cycle crossover are required. The two separate equalizer circuits presented in Fig. 4 are recommended. The solid curves represent the individual equalizer frequency response characteristics. The combined effect is shown by the dotted curve of the figure.

The circuits and curves for equalizing British frr recordings with velocity-actuated reproducers are presented in Fig. 5.

Preamp for velocity pickup

A complete equalizer-preamplifier circuit for use with a velocity-actuated pickup is diagrammed in Fig. 6. Two three-position selector switches permit the selection of any combination of bass boost and high rolloff. A variable treble-cut scratch filter is provided for use with noisy recordings. Low- μ triodes provide a constant-voltage generator for the equalizer networks as well as provide a net gain in the order of 30 db.

R1 should be selected to accord with the manufacturer's specifications for the pickup. The reactance of C1 at the lowest frequency should be less than one-fifth the input impedance of the following amplifier. The values of the equalizer components may be altered to provide additional correction for the peculiarities of the pickup. Decreasing R2 will increase the amount of bass boost. Increasing C2 and C3 will lower the frequency at which bass boost begins. Increasing C5 and C6 will lower the frequency at which treble rolloff begins. Capacitor C4 and the 10,000-ohm resistor form a decoupling network to insure circuit stability by preventing any feedback through the high-voltage circuits.

Frequency test records

The over-all performance of the pickup and equalizer-preamplifier combination may be checked most conveniently with a frequency test record¹. The author recommends the Columbia 10003M and 10004M. The response curves obtained with these records should be substantially flat to the point at which high frequency de-emphasis begins. Beyond that point the frequency response should follow either the NAB equalizer curve in Fig. 4 or the British equalizer curve in Fig. 5, depending upon the particular equalizer settings.

Above all, do not be discouraged by deviations of your experimental curves from the ideal. At best, equalization is a compromise between recording characteristics and pickup response variations. The best criterion for the effectiveness of any equalizer is listening pleasure, and the optimum equalizer is the circuit which achieves the most realistic record reproduction.

¹ See "Frequency Test Records" by Richard H. Dorf, RADIO-ELECTRONICS, October, 1948.

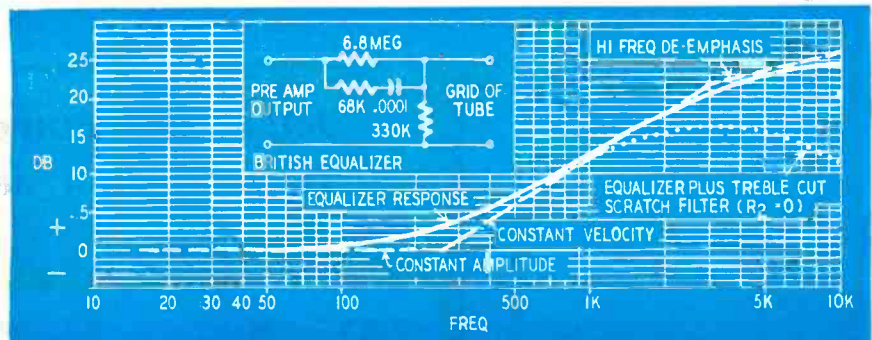

Fig. 2—Frr records played with amplitude pickups require this equalizer.

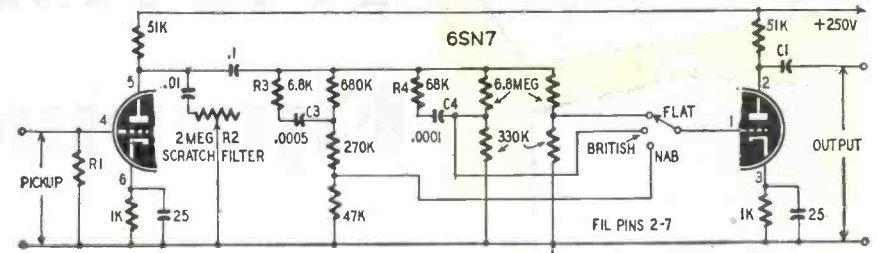

Fig. 3—Selective equalizer for amplitude-actuated pickups has rolloff switch.

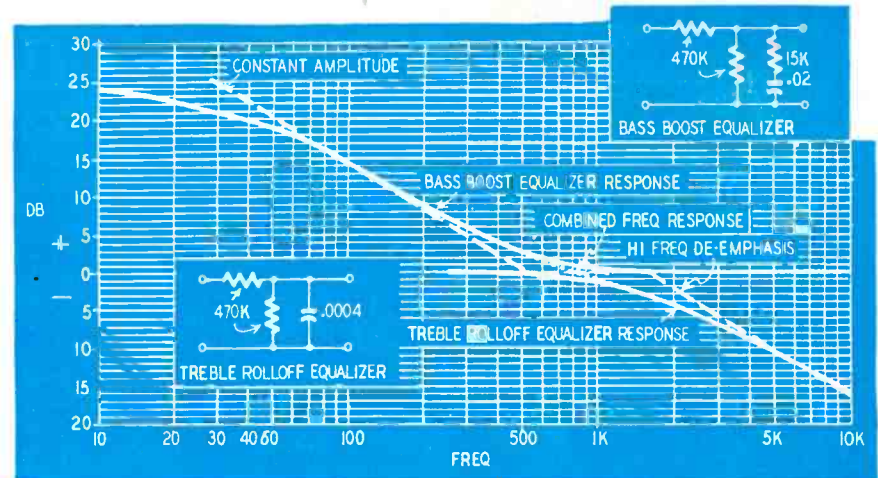

Fig. 4—Velocity-sensitive pickups require these equalizers for NAB records.

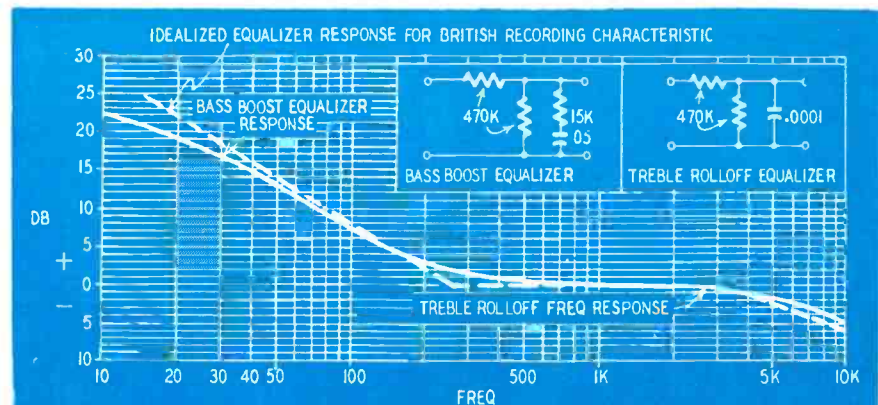

Fig. 5—British frr records played with magnetic pickups require these equalizers.

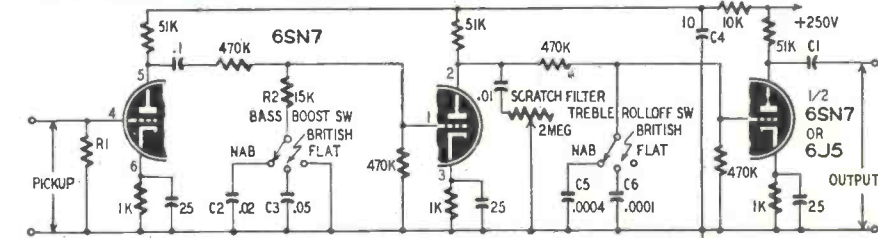

Fig. 6—Constant-velocity equalizer has three-position bass and treble switches.



Kit manufacturers are now turning to television service instruments

Television Test Equipment Kits

CONSIDERABLE interest in our February survey of sweep generators and oscilloscopes for television testing has been expressed by readers. A number have urged that we print a similar article covering the television test instruments sold in kit form.

At the moment of writing, it appears that only three manufacturers are selling kits for sweep generators or television-type oscilloscopes. Radio City Products was about to put kits on the market, but did not have complete specifications ready in time for the article.

The only two sweep generator kits offered are by Eico and Heath. Complete specifications for both are given in the table. Each uses a combination of fixed and variable oscillators to cover the wide band of frequencies required in such instruments. Eico's model 360 uses a variable oscillator with a range from 54 to 114 mc and a 114-mc fixed sweep oscillator. The two oscillators produce difference and sum frequencies to cover the 0-60 and the 168-228-mc spectra. The second harmonic of the difference frequencies covers the range from 0 to 120 mc.

The Heathkit TS-1A has a variable sweep oscillator which provides the signal from 174 to 220 mc. The band from 0 to 46 mc is provided by beating the sweep oscillator against a fixed 174-mc

oscillator, and the band between 54 and 100 mc is covered by beating against a 274-mc oscillator. The sum frequencies fall outside the television frequencies.

A loudspeaker-type motor supplies the FM (sweep) modulation in both generators. This method provides a sweep range 30 mc wide.

Both generators have internal provision for marker pips. The Eico generator uses half a 12AU7 as a crystal oscillator for use with external crystals, producing strong marker pips at the fundamental and at several of the harmonics of the crystal used. (The other half of the 12AU7 is a mixer tube for the output of the fixed and variable oscillators, providing a cathode follower output tube for the generator.)

The TS-1A has an ingenious absorption circuit—in effect a wavetrap tuned to the desired marker frequency. A sharply defined notch is cut out of the output wave at the frequency of the marker. The marker tuning capacitor is adjusted for calibration before shipment, and can be used for calibrating the generator ranges.

The most important special feature required in an oscilloscope for television use is wide vertical amplifier bandwidth. An ordinary "broad-band" scope

SWEEP GENERATORS

MODEL	Heathkit TS-1A	Eico 360-K
Frequency coverage	0-46 54-100 mc 174-220 mc	0-120 mc 168-228 mc
Fundamental ranges	all	0-60 mc 168-220 mc
Sweep width	0-30 mc	0-60 mc
Fundamental marker range	19-42 mc (absorption)	uses ext. crystals
Phasing control	yes	yes
Number of tubes	3 + rect	3 + rect
External crystal provision	no	yes
Price	\$39.50	\$29.95

OSCILLOSCOPES

MODEL	Eico 425	Feiler TS-7K	Heathkit O-5
Vert. and Horiz. amp. band-width	5 c.p.s. to 400 kc (Useful to 2.5 mc at max gain)	20 c.p.s. to 0.5 mc (Uniform within $\pm 20\%$ to 100 kc)	Useful to 2.5 mc at max gain
Vert. and Horiz. amp. def. sensit. v/in.	.05-0.1	0.4	.06
C-R tube size	5 in.	5 in.	5 in.
No. tubes (plus C-R)	5 + 2 rect.	4 + 2 rect.	5 + 2 rect.
Sweep range	15 c.p.s. to 75 kc	10 c.p.s. to 35 kc	15 c.p.s. to 70 kc
Provision for intensity modulation	yes	yes	yes
Price	\$39.95	\$46.50	\$39.50

is useful for observing i.f. response curves where only the low-frequency modulation pattern is under observation. As the width increases, the scope becomes more useful in tracing troubles in the sync and sweep circuits whose steep-fronted pulses make wide frequency response necessary. The ideal would be an oscilloscope with a 4.5-mc response, which would show the complete modulation pattern. Unfortunately, such scopes are too expensive for the average service technician, and

the practical service scope represents a happy medium between technical perfection and economic reality.

Three TV oscilloscope kits were on the market at the time of writing—the Eico 425, Feiler TS-7K, and the Heathkit O-5. The tendency is toward a bandwidth of about half a megacycle though the Heathkit is listed as “useful to 2.5 mc.” An interesting feature in the Feiler kit is provision for connecting headphones. In many cases, puzzling interference can be identified immediately

by simply listening to it, and this feature is worth adding to existing scopes.

A noteworthy feature both in the scope and generator kits is the explicit and detailed assembly information, clarified in all cases by “pictorial” wiring diagrams or photos with call-outs. The ultracomplete set of assembly instructions, for which much credit is due the television kit manufacturers, is likely to do much for all types of kits, for they assure the constructor of easier assembly and better results.

Quick Tuning Generator

By M. RABINOWITZ

A REAL necessity, in the author's opinion, for the service technician, this signal generator takes the place of ordinary variable-frequency generators, having greater accuracy on the frequencies most used for broadcast-receiver alignment. It is a terrific time saver, too, in lining up push-buttons on sets that have them.

The generator is entirely controlled by push-buttons. Crystal-controlled signals are provided for the four most common i.f.'s: 455, 460, 465, and 470 kc. The crystals were obtained on the surplus market. When you buy them, do not be misled by the white markings on the holders; these crystals were used in Signal Corps equipment on the 54th harmonic of the fundamental crystal frequency. Another i.f., 262 kc, and six broadcast-station frequencies are available by making the oscillator self-controlled.

The push-button feature is a product of the writer's servicing experience. Re-adjusting station-selector buttons on large receivers ordinarily requires switching from manual to buttons and back again many times to make sure of getting the right button for the right station and tuning it on the nose. On i.f. alignment, the thought always crops up, “How many kc off calibration is my generator dial?” Moreover the switching and tuning are nuisances. All these items are time killers to the man whose time is his stock in trade. With the push-button generator, a single motion brings the desired frequency and (on the i.f.'s, where it is most important) with crystal accuracy.

The basis of the circuit is an electronic-coupled oscillator, which can be either self-controlled or crystal-operated, and a triode modulator. The power supply is “transformerless,” but to isolate the chassis from the line—an absolute necessity for test equipment—we included a pair of 6.3-volt filament transformers back-to-back, as the diagram indicates. The 6.3-volt windings supply voltage for the tube filaments.

It would be much simpler to use a 1-to-1 transformer with a 6.3-volt winding, but the writer has yet to see one.

Two push-button assemblies were needed, one with a trimmer strip. All are RCA receiver replacement units, though surplus stores offer many suitable miscellaneous assemblies at rock-bottom prices. On this particular trimmer strip, one side of each trimmer is bonded to the support, so that was insulated from chassis by ceramic stand-offs.

The cabinet is a standard metal one 5x6x9 inches, with a hinged lid, allowing ample room for parts. The top row of buttons selects station frequencies. The left button on the lower row transfers control to the upper row, and the others in the lower row select i.f.'s.

The schematic diagram gives all the necessary information for the wiring. The photograph gives an idea of the front panel layout.

Adjustment

The first step is to see that the audio oscillator is working. Ground one lead from a pair of phones and touch the other, through a .05- μ f capacitor, to pin 7 of the 6BJ6. If you hear no audio

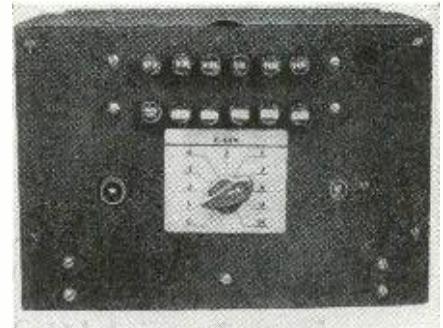

Push-button tuning is very convenient.

note, reverse the connections to the plate winding of the transformer. To change the pitch of the tone, replace the .05- μ f 6C4 grid capacitor with a different value.

To determine if the r.f. oscillator is running, connect a high-resistance voltmeter or v.t.v.m. from grid of the 6BJ6 to ground. There should be a negative reading for all push-button settings.

Next adjust the station buttons on the top row. Press the lower left button to place them in the circuit. Six stations are allowed for, the larger trimmers being for the lower-frequency stations. To calibrate them, tune in the desired stations successively on a receiver and adjust the trimmer until you hear zero beat in the speaker. Adjust for the lowest frequency first.

To adjust the 262-kc trimmer, plug a pair of phones into the closed-circuit jack. Couple the output of an accurate 262-kc generator loosely to the 262-kc coil with a few turns of wire placed a few inches from it, and tune the 262-kc trimmer for zero beat.

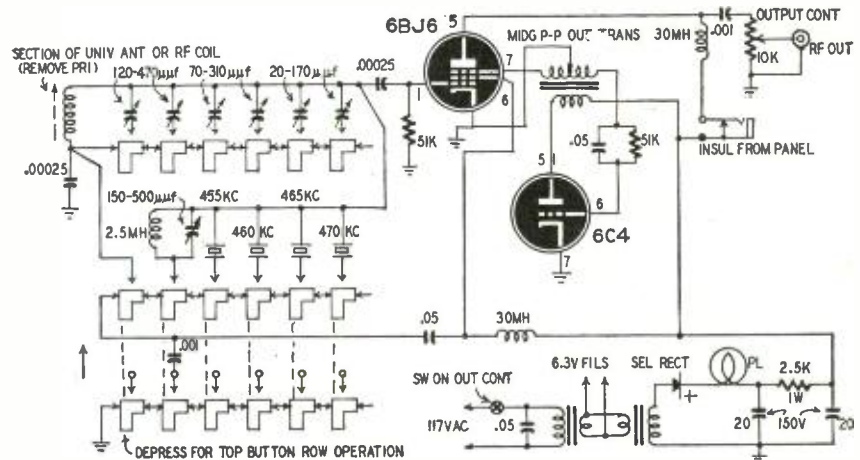

Two push-button assemblies are used. Crystals provide the most common i.f.'s.

Battery Signal Generator

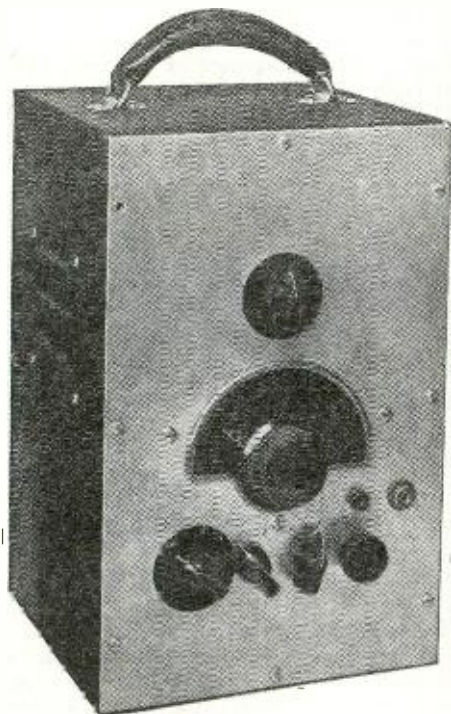

Easily built portable test generator covers range of 130 kc to 16 mc in 5 steps

◀ This case makes the instrument portable. Batteries are inside and a handle is on the cover.

By J. C. ANDERSON

IDEAL for the rural service technician and experimenter, this battery-powered, portable, all-wave signal generator tunes from 130 kc to 16 mc in 5 ranges. It has a 1N5-GT r.f. oscillator and a 1G4-GT a.f. oscillator

that can be used alone or as a modulator for the r.f. generator. Power is supplied by a 1½-volt A-battery and a 45-volt B-battery. Most of the parts can be found in the junkbox or salvaged from old receivers.

The r.f. generator is a standard Hartley oscillator with the 1N5-GT connected as a triode. The grid is returned to the mid-point of two 100,000-ohm resistors across the filament supply. This places an initial bias of +0.75 volt on the grid. This tube is plate-modulated by the 1G4-GT when a modulated signal is desired. The range switch is in the center of the panel above the tuning control. The other controls are in a row across the bottom. From left to right these are the function switch, modulator switch, multiplier, and attenuator.

When the function switch is in position 1, the filaments of both tubes are lighted and the 1N5 generates a signal whose frequency is determined by the setting of the range switch and the tuning control. An unmodulated signal is obtained when the modulator switch is open. When it is closed, the signal is modulated at about 1,000 cycles. Moving the function switch to position 2 grounds one end of the transformer secondary, and the signal is modulated at about 400 cycles. The 400-cycle a.f. signal is available at the output terminals when the function switch is turned to the No. 3 position. The modulation frequencies are determined by the size of the capacitor across the plate side of the audio transformer.

Two r.f. output levels are available, selected with the multiplier switch. The low-level voltage is taken from the plate circuit of the 1N5-GT through a .05-μf blocking capacitor. When the signal is taken from the pickup loops, it is about

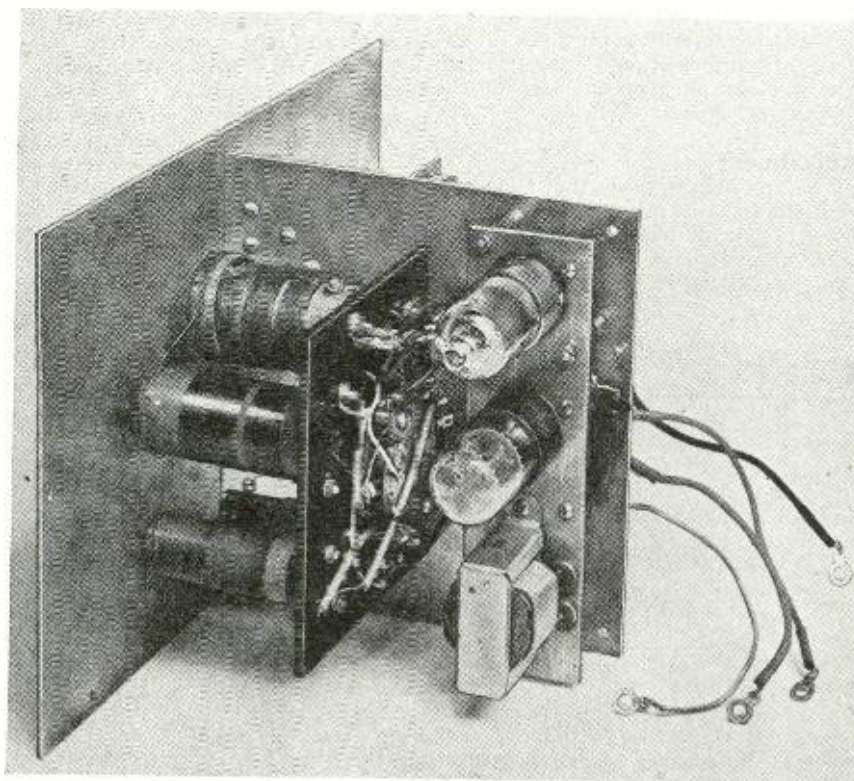

Instead of a standard chassis, author fastened metal strips to rear of panel.

10 times stronger than the low-level signal. The attenuator controls the strength of the signal at the output terminals.

If only a single output level is sufficient, remove the .05- μ f capacitor from across the plate winding of the audio transformer. This will raise the level available directly from the r.f. plate coils almost to that obtained from the small pickup coils, which may then be omitted. There will also be some change in the audio modulation frequency.

The oscillator tuning capacitor is a standard two-section broadcast tuning capacitor with its sections connected in parallel. The low-frequency coil used in the 138-520-kc range is a three-pie coil salvaged from an old European receiver. We isolated one pie and used it as the tickler. A tap was made at the connection between the remaining pies and connected to the range switch.

When this switch is in position A, both pies are used and the tuning range extends from 130 to 520 kc. When the switch is in position B, a single pie is used and the tuning range is 230 to 680 kc. We used an old broadcast oscillator coil to cover the 550-1800-kc range.

The two high-frequency coils were wound on 1-inch forms. The grid coil of the 1600-5600-kc coil has 36 turns of No. 24 s.c.c. wire, and its tickler has 23 turns of No. 28 s.c.c. The two coils are spaced $\frac{3}{16}$ inch apart. The 5000 to 16,000-kc coil has seven turns of No. 18 wire on the grid winding and nine turns of No. 28 s.c.c. on the tickler.

The pickup coils for the two low-frequency coils are four turns each. Pickup coils for the 1600-5500-kc and 5000-16,000-kc coils have one turn and one-half turn, respectively. The ticklers are on one end of the coil forms, and the pickup coils on the other.

The low-frequency coil can be made from an i.f. transformer or r.f. choke. The broadcast and shortwave coils may be standard three-band antenna, r.f., or oscillator coils.

The simple circuit of this signal generator can be constructed by almost anyone who can follow a schematic diagram.

Construction

As shown in the photographs, the oscillator was built into a standard metal carrying case (often known as a "utility box") obtainable in radio parts stores. A standard chassis was impractical because of the shape of the case, so several strips of aluminum were cut up to support the components.

There are not many parts in the instrument but nevertheless the constructor should be very careful to lay out the "chassis" in such a way that the batteries have plenty of room. The main point is to get the assembly as high in the cabinet as possible.

The batteries may be clamped to the removable rear panel with metal straps or angle brackets can be used to make brackets for them. They should be fastened down solidly so they don't rattle around.

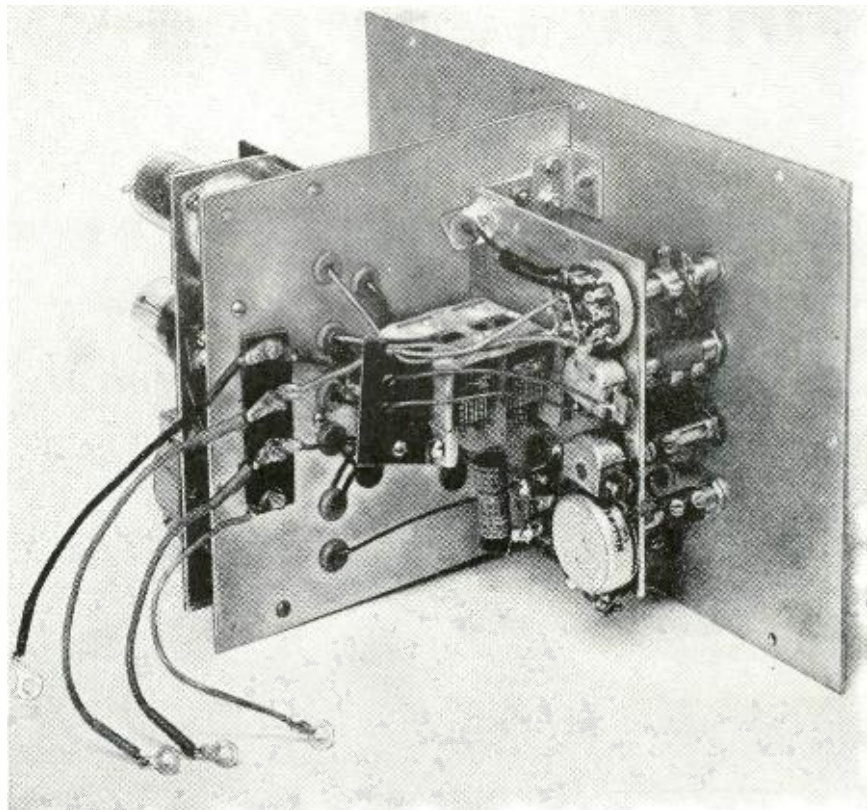

Controls submounted on metal strip have extensions. Leads are for power.

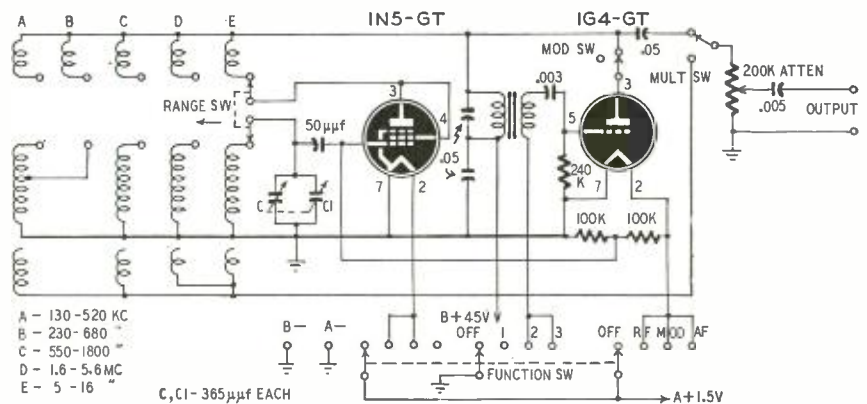

Each range coil has three parts—oscillator tuning, tickler, and output coupling.

EXTENDING RANGE OF V.T.V.M.

Range and utility of an electronic voltohmmeter can be extended by adding two banana jacks and a s.p.d.t. switch. Mount the switch and jacks on the panel and connect them as shown in the diagram. Operation is normal when the s.p.d.t. switch is in position 1. To increase the resistance range of the meter, set the range selector to R \times 1, throw the s.p.d.t. switch to position 2, then insert a suitable precision multiplier resistor in the jacks.

Care must be taken when using a soldering iron near the precision resistors in the ohmmeter, because overheating them is likely to change their values permanently.

Two resistors can be matched by connecting one across the ohmmeter test leads and plugging the other into

the jacks. They are equal when the needle rests in the center of the scale,

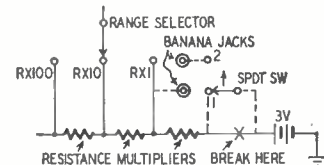

having previously been zeroed with the jacks open.

The precise value of a resistor can be ascertained by connecting it to the resistance test leads and connecting a decade resistor box to the jacks. The unknown resistor is equal to the setting of the decade when the needle is centered. The accuracy will be as great as that of the decade resistors.—L. M. Dillely.

Voltmeters and Waveshapes

The author explains how waveforms and meter design can affect the accuracy of the technician's voltage measurements.

By IRVING DLUGATCH

A VOLTMETER is supposed to supply vital information about an electrical circuit. It can do its job well only when used for the type of measurement for which it is specifically designed. Too often, the technician is unaware of the narrow limitations of his meters.

In radio work, the instruments are usually correctly applied. In television

servicing, one needs to know the frequency and waveshape to interpret the strange results sometimes obtained with ordinary meters.

Let's begin with a conventional D'Arsonval-movement d.c. voltmeter. Current flowing through the meter's coil produces motion by reaction between the coil's magnetic field and a fixed magnetic field. It is the *average* value of the current which produces the deflection.

This is best illustrated by imagining the voltage of Fig. 1-a being measured by our voltmeter. The coil swings in one direction for the positive half of the cycle and in the opposite direction for the negative half. If both alternations are equal in amplitude, we have equal swings. The average of the two swings is, of course, zero, which is what the meter reads. The swinging of the needle is visible only if the frequency is very low. The meter reading is the average of the instantaneous motions of the needle, the average of the currents flowing through the coil over a short period of time. All d.c. meters are calibrated in average values.

Average and r.m.s. values

What is the significance of the *average value*? Vacuum-tube potentials and currents may vary with instantaneous signal level but proper operation is often determined by the average values. On the other hand, circuit components and the tubes themselves must be selected on the basis of the heating effect of the currents passing through them, which depends on the effective or r.m.s. value. For Fig. 1-b, a d.c. "wave," the average, effective, and peak values are alike. The d.c. meter is designed to measure this type of voltage accurately for only then can it register the heating effect directly. Compare this with Fig. 1-a where the meter would read nothing, yet we know the effective value is as great as for Fig. 1-b.

Before going any further, it is necessary to understand how the average and effective values are calculated for any wave. We will then better appreciate the results that are to be expected in making pulse measurements with

conventional meters. Step 1 in our calculations is to divide one cycle of any wave into a number of equal time intervals. The greater the number, the better the accuracy. In Fig. 1, the waves are divided into eight parts, though this is far too few for any accuracy. We will then note the amplitude at each of these intervals.

The direction of the current flow has no bearing on its heating effect. Both the negative and positive alternations of a current heat equally a resistor through which it flows. (Note that Fig. 1-g has the same effective value as 1-a.) In other words, polarity is ignored for r.m.s. calculations, but not for averages.

Step 2 is to calculate the average value by adding all the amplitudes and dividing the sum by the number of intervals. Table I lists the data for four of the waves illustrated in Fig. 1. The others are obtained similarly.

As a sample of the calculation of the average value, for Fig. 1-d, the sum of the amplitudes is 400 volts. Dividing by the number of points taken, 8, we arrive at an average value of 50 volts. For 1-a we get zero volts.

The *effective* value is next calculated. The heat produced by a current varies directly as the square of the current ($P = I^2R$), or of the voltage ($P = E^2/R$). The term r.m.s. means "the square root of the average of the squared amplitudes." That is, the effective current is that whose square is the average of all the heating effects. For a sample calculation, for Fig. 1-d (see Table I), the sum of the squared values is 40,000. Dividing by 8, the average of the squares is found to be 5,000. The square root of 5,000 is 70.7 which is the r.m.s. value for the wave. Calculating for Fig. 1-h, we find the effective value is equal to the peak, and the average value to zero.

It is somewhat simpler to understand this last, if we imagine any a.c. wave as it would appear *after full-wave rectification* as in Fig. 1-g compared with 1-a. This is in agreement with what has been said about the direction of the current flow being unimportant. The calculations are based on this "rectified"

	DEGREES 0 45 90 135 180 225 270 315 360	PEAK VALUE	AVERAGE VALUE	EFFECTIVE (RMS) VALUE
A		100	0	70.7
B		100	70.7	70.7
C		100	32	50
D		100	50	70.7
E		100	50	58
F		100	0	50
G		100	63.6	70.7
H		100	0	100

Fig. 1—Shape of the waveform affects peak, average, and effective values.

wave. For 1-h we would get a straight line or pure d.c., which accounts for the peak, r.m.s., and average values being the same.

Coming back to our d.c. voltmeter, let's see what happens in the measurement of pulsating d.c. voltages. If Fig. 1-d were the plate voltage of a tube, the 50-volt average value would be used in determining the gain or power-handling ability of the tube. The 70.7-volt r.m.s. value would be needed to calculate the wattage of the load resistor. The peak value of 100 volts should be known to select tubes and capacitors that won't break down. The meter, however, is giving us only the



Fig. 2—Circuit of a d.c. voltmeter.

average value of 50 volts. Usually a large safety factor is used in selecting components so that this is not too important. It does indicate, however, how little information a d.c. meter may supply about an electronic circuit. (Other effects may make the reading inaccurate even for the average values.)

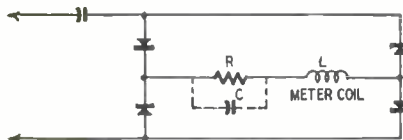

Fig. 3—Basic a.c. voltmeter circuit.

The square wave of Fig. 1-d is formed by the addition of a great many harmonics. It is very possible that many of the harmonics will be lost due to bypassing capacitance in the meter circuits. Something like Fig. 1-c might result. Assume that the peak value remains as high as that of the original square wave. (This is very unlikely.) Then the average value is 32 volts and the effective value is 50 volts, as calculated from Table I. Our meter would read too low. This extreme case indicates what is to be expected and is not to be taken as a practical example.

There is yet another cause of error in using the meter on pulses. Look at Fig. 2, the electrical circuit for the d.c. voltmeter. R is the large value of resistance used as a multiplier and L the inductance of the meter coil (usually small in value). Such a circuit is a differentiator. The voltage across the inductance might look like Fig. 1-f if the square wave were applied to the input terminals. It is easy to see that the average and r.m.s. values might be far different from those of the original square wave.

The inaccuracies noted above seem to be avoided by the use of a d.c. vacuum-tube voltmeter operating on peak values. From Fig. 1 it is obvious that, regardless of wave shape, the same peak value will be read for c, d, and e. Unfortunately, the meter is intended to be used with voltages such as Fig. 1-b where the peak value is also the average and r.m.s. value. This is not true

in c, d, and e. Therefore, the v.t.v.m. will give a voltage reading higher than the true average or r.m.s. value of the special waveform being measured.

Special a.c. problems

With a.c. measurements, further complications appear. Fig. 3 represents a bridge-type a.c. voltmeter circuit. The sine wave of Fig. 1-a is changed by the rectifiers to the shape of 1-g and is ap-

with a new dial or a new multiplier, is not correct for any but sine waves.

For example, r.m.s. value = form factor X average-value meter reading. For the sine wave of Fig. 1-a, meter reading = 1.11 × 63.6 = 70.7 volts.

Let us assume a square wave similar to Fig. 1-d with an average value of 63.6 volts. Then its meter reading would be 1.4 × 63.6 = 89.04 volts. However, the meter is calibrated on the basis of

TABLE I

Interval (Degrees)	Fig. 1-a		Fig. 1-c		Fig. 1-d		Fig. 1-h	
	Amplitude	Squared amplitude	Amplitude	Squared Amplitude	Amplitude	Squared amplitude	Amplitude	Squared amplitude
0	0	0	0	0	+100	10000	+100	10000
45	+70.7	4999	+70.7	4999	+100	10000	+100	10000
90	+100	10000	+100	10000	+100	10000	+100	10000
135	+70.7	4999	+70.7	4999	+100	10000	+100	10000
180	0	0	0	0	0	0	-100	10000
225	-70.7	4999	0	0	0	0	-100	10000
270	-100	10000	0	0	0	0	-100	10000
315	-70.7	4999	0	0	0	0	-100	10000

plied to the same basic d.c. meter circuit as discussed previously. There can be no loss of harmonics since a sine wave contains none, so we would expect no error from that source. The average value for this wave is 63.6 volts. The meter, being essentially a d.c. voltmeter, will show a deflection corresponding to this voltage. However, we are interested in r.m.s. values in a.c. work and this particular wave has an r.m.s. value of 70.7 volts. In other words, the meter reading is too low.

There are two ways of correcting this error. The first solution is to use two dials, one for a.c. and the other for d.c. The a.c. dial has higher values marked on it for the same deflection of the needle. The same multipliers are used for both a.c. and d.c.

The other method of calibrating a.c. meters to read r.m.s. values is to reduce the multipliers on the a.c. ranges to increase the deflection for a given average value. This permits the use of the same dial for both d.c. and a.c. readings. In some meters, a complete set of special multipliers is used for the a.c. scales. Other manufacturers shunt the d.c. multipliers with capacitors as shown dotted in Fig. 3. The capacitors have no effect on d.c. but reduce the opposition to a.c.

Now, consider the effect of the special waveforms on these a.c. meters. Since rectifiers of some sort are used with all a.c. meters, we shall consider only the pulsating d.c. waves. Remember, too, that when full-wave rectification takes place, the pulsating d.c. has the same average and effective values as the original a.c. wave. (Meters rarely use half-wave rectifiers for this reason. When they do, additional calibration correction must be applied. Otherwise, as we note from comparing Figs. 1-c and 1-g, the reading will be too low). For Fig. 1-c, the ratio of the r.m.s. to the average is 1.24; for 1-d, 1.4; and for 1-e, 1.16. These, incidentally, are called form factors for the waves. Important to us is that the calibration for r.m.s. values, whether it be

a sine wave's form factor. Therefore, we will read 70.7 volts instead of 89.04 volts for the square wave.

Where the multiplier is shunted with a capacitor, there is additional error due to the effect of the capacitor on the waveshape. It tends to block the low frequencies in the special wave. In addition, it is possible for resonance to occur at certain frequencies because of L and C in series (Fig. 3). Of course, shunt capacitances still exist to bypass higher frequencies. At high frequencies, many rectifiers will not operate. All of which stresses the fact that even a knowledge of the form factor of a wave is not sufficient to correct a reading obtained with such an instrument.

The solution seems to be the use of an a.c. v.t.v.m. Again calibration introduces error. Most v.t.v.m.'s operate on the peak value of a wave. This must be converted to an r.m.s. value to be useful. In other words, the needle deflection must be reduced by increasing the size of the multipliers or the dial must be marked with lower values since the reading is too high. For sine waves, the ratio between the peak and r.m.s. is 1.41. Compare this with 2.0 for Fig. 1-c, 1.41 for 1-d, and 1.72 for 1-e. It would be correct for the square wave but too low for the other two. The v.t.v.m., too, has the same faults as the rectifier instrument as far as waveshape changes, resonance, and shunt capacitance. In addition, for waves with unequal alternations, we may get different readings when the test leads are reversed. This does not take into consideration error due to poor grounding of the meter. Some of the troubles are avoided by using special probes.

All of this may frighten the technician away from the use of meters for signal tracing in television sweep circuits. However, they are valuable for quick comparison checks on equipment with which the technician is familiar, or for determining whether the pulse is present. Interpretation of the meter reading should be attempted only with the assistance of an oscilloscope.

Fundamentals of Radio Servicing

Part XIV—More on Power Supplies

By JOHN T. FRYE

THE last chapter discussed the common garden variety of power supply diagrammed in Fig. 1. While this supply does an excellent job, there are at least three things wrong with it from the point of view of the radio manufacturer: it is heavy, it is bulky, and—most important of all—it costs too much.

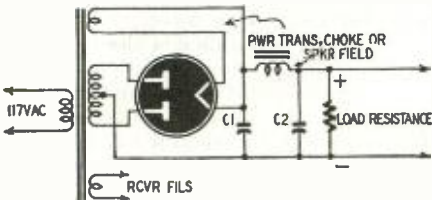

Fig. 1—A basic full-wave power supply.

All three of these complaints point accusing fingers at the bulky, heavy, expensive transformer and iron-core choke. To get rid of these two items—especially the transformer—was a *must* for compact, lightweight, cheap receivers.

Disposing of the choke was easy. As we shall learn in the next chapter, many speakers have *field coils* that consist of thousands of turns of wire wound on an iron core. Direct current must pass through this coil to make the speaker perform as it should. If we replace our filter choke with this field coil, such a current will pass

through its turns; furthermore, the ready-to-hand inductance of the iron-core coil will perform exactly the same filtering job that the choke has been doing. Thus, by making the field coil do double duty, we can discard the filter choke.

Getting rid of the transformer, however, is like trying to put on *Uncle Tom's Cabin* without Simon Legree. It may be a villain, but it plays important parts in both the A- and the B-supplies. Radical changes must be made in both of these before the transformer can be torn out by the roots and discarded.

Fig. 2 shows the first step in accomplishing this. The filaments of all the tubes and a *ballast resistor* are connected directly across the 117-volt a.c. line. As can be seen, the voltage needed across the string of tube filaments is the sum of the individual tube requirements. The difference between this voltage and the line voltage is accounted for by the voltage drop across the ballast resistor.

In Fig. 2, for example, are two tubes with 25-volt filaments and three using 6 volts on the filaments. That means that 68 volts is needed across the filament string. The ballast resistor, then, must be designed so there will be a 49-volt drop across it when the tubes are drawing their rated filament current.

The tubes used in the first a.c.-d.c. sets had filaments that drew 0.3 ampere. When this current is multiplied by the 49-volt drop across the resistor, the resistor dissipates 14.7 watts in doing its voltage-dropping chore.

This amount of heat being constantly released within the close confines of a small cabinet did the capacitors and

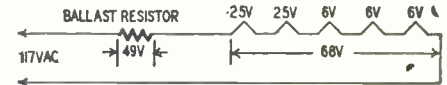

Fig. 2—Transformerless heater string.

other parts no noticeable good; so the ballast resistor was fabricated as a separate, asbestos-sheathed resistance wire right into the line cord. This took the heat out of the cabinet, all right; but unfortunately the resistance wire did not take too kindly to the twisting, bending, and tying-into-knots that most line cords suffer.

Then the tube manufacturers came dashing to the rescue. They brought out sets of tubes whose total filament

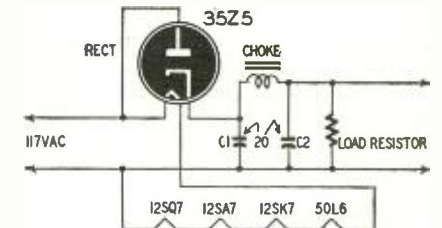
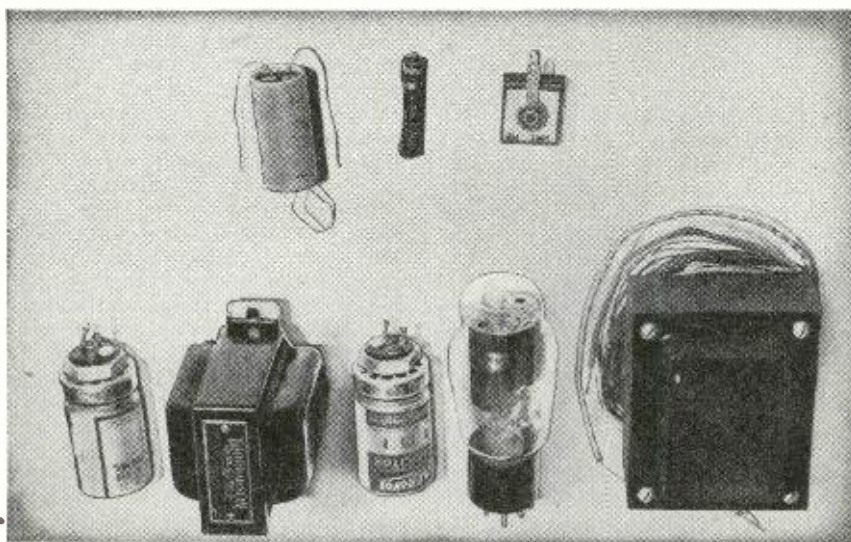

Fig. 3—A typical a.c.-d.c. supply.

voltages were exactly equal to the line voltage; and, to reduce the heat dissipated by the tube filaments, they reduced the current requirements to 0.15 ampere. This got rid of the ballast resistor as well as the filament-heating portion of the transformer; and these tubes, with their various octal, loktal, or miniature bases, are the ones used in most a.c.-d.c. sets today.

There is only one flaw in the setup—it is hard on tubes. Any service technician knows that he will put three tubes into a transformerless receiver for every one he replaces in a set using a transformer. The fault is that the cold filament resistance is much less than the hot filament resistance. As a result, when the set is first turned on, a heavy surge of current passes

(Continued on page 52)



Parts for transformer-type B-supply are replaced by the a.c.-d.c. parts above.

THERE'S ONLY ONE COMPLETE CATALOG FOR EVERYTHING IN RADIO AND TV!

IT'S YOUR **FREE**
ALLIED 196-PAGE
 VALUE-PACKED CATALOG!

SEND FOR IT TODAY



Here's the only *complete* Buying Guide to everything in TV, Radio and Electronics—packed with the world's largest selections of quality equipment at lowest money-saving prices! See the latest in TV, AM and FM receivers; radio-phonos; new Sound Systems and P.A. equipment; high-fidelity custom sound components; recorders and accessories; full selections of newest Amateur receivers and station gear; test instruments; builders' kits; huge listings of parts, tubes, tools, books, diagrams—all in stock for immediate shipment.

ALLIED gives you every buying advantage: speedy delivery, expert personal help, lowest prices, assured satisfaction—plus the most liberal Time Payment plan in radio. Get the 1950 ALLIED Catalog—it will save you time and money. Send today for your FREE copy!

ALLIED IS YOUR TELEVISION HEADQUARTERS



You keep up with TV when you depend on ALLIED! Count on us for the latest releases and largest stocks of picture tubes, component parts, antennas and accessories—plus the latest in TV receivers, tuners and kits. If it's *anything* in TV—we have it in stock! So remember—for TV—it's ALLIED First!

ALLIED RADIO

THE WORLD'S LARGEST RADIO SUPPLY HOUSE

Everything in Radio, TV and Electronics

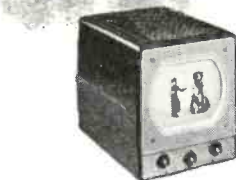

WORLD'S LARGEST STOCKS

*Radio Parts Unlimited
 Test Instruments—All Makes
 Television & Home Radios
 P. A. and Hi-Fi Equipment
 Amateur Station Gear
 Experimenters' Supplies*

QUICK, EXPERT SERVICE



Send for Radio's Leading Buying Guide

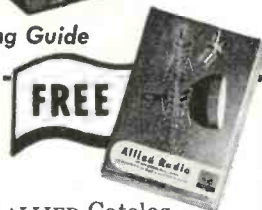

ALLIED RADIO CORP.
 833 W. Jackson Blvd., Dept. 2-D-0
 Chicago 7, Illinois

Send FREE 196-page 1950 ALLIED Catalog.

Name

Address

City..... Zone.... State.....

2 Pages of TEST EQUIPMENT at prices every serviceman can afford!

OUR POLICY

MONEY BACK? Every unit we advertise is offered on a strict "money-back-if-not-satisfied-basis". No if's—no but's—no maybe's. If you are not

completely satisfied after a 10 day trial—return for complete refund. No explanation—you are the sole judge. Plain enough?

GUARANTEE? Every unit sold by us is covered by a one year guarantee.

KITS? We have discontinued advertising Test Equipment in kit form. After handling kits for a period of three months, we have come to the conclusion that it is impractical to successfully complete instrument

kits at home without the expensive calibration standards and other equipment available when instruments are factory produced.

THE NEW MODEL 200

AM and FM

SIGNAL GENERATOR



Specifications

- **R.F. FREQUENCY RANGES:** 100 Kilocycles to 150 Megacycles.
- **MODULATING FREQUENCY:** 400 Cycles. May be used for modulating the R.F. signal. Also available separately.
- **ATTENUATION:** The constant impedance attenuator is isolated from the oscillating circuit by the buffer tube. Output impedance of this model is only 100 ohms. This low impedance reduces losses in the output cable.
- **OSCILLATORY CIRCUIT:** Hartley oscillator with cathode follower buffer tube. Frequency stability is assured by modulating the buffer tube.
- **ACCURACY:** Use of High-Q permeability tuned coils adjusted against 1/10th of 1% standards assures an accuracy of 1% on all ranges from 100 Kilocycles to 10 Megacycles and an accuracy of 2% on the higher frequencies.
- **TUBES USED:** 12AU7—One section is used as oscillator and the second is modulated cathode follower. T-2 is used as modulator. 6C4 is used as rectifier.

The Model 200 operates on 110 Volts A.C. Comes complete with output cable and operating instructions

\$18⁸⁵
NET

SUPERIOR'S NEW MODEL TV-10

TUBE TESTER



Specifications

- Tests all tubes including 4, 5, 6, 7, Octal, Lock-in, Peanut, Bantam, Hearing Aid, Thyratron, Miniatures, Sub-Miniatures, Novals, etc. Will Also test Pilot Lights.
- Tests by the well-established emission method for tube quality, directly read on the scale of the meter.
- Tests for "shorts" and "leakages" up to 5 Megohms.
- Uses the new self-cleaning Lever Action Switches for individual element testing. Because all elements are numbered according to pin-number in the RMA base numbering system, the user can instantly identify which element is under test. Tubes having tapped filaments and tubes with filaments terminating in more than one pin are truly tested with the Model TV-10 as any of the pins may be placed in the neutral position when necessary.
- The Model TV-10 does not use any combination type sockets. Instead individual sockets are used for each type of tube. Thus it is impossible to damage a tube by inserting it in the wrong socket.
- Free-moving built-in roll chart provides complete data for all tubes.
- Newly designed Line Voltage Control compensates for variation of any line voltage between 105 Volts and 130 Volts.

The Model TV-10 operates on 105-130 Volt 60 Cycles A.C. Comes housed in a beautiful hand-rubbed oak cabinet complete with portable cover.

\$39⁵⁰
NET

--- TO ORDER—USE RUSH ORDER FORM ON NEXT PAGE ---

GENERAL ELECTRONIC DISTRIBUTING CO.

98 PARK PLACE
DEPT. RC-4
NEW YORK 7, N. Y.

RADIO-ELECTRONICS for

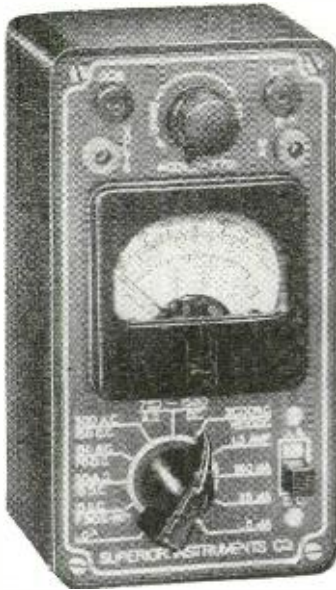

Superior's new model 770

AN ACCURATE POCKET-SIZE VOLT-OHM MILLIAMMETER

(SENSITIVITY: 1000 OHMS PER VOLT)

FEATURES

- ★ Compact-measures 3 1/8" x 5 7/8" x 2 1/4".
- ★ Uses latest design 2% accurate 1 Mil. D'Arsenal type meter.
- ★ Same zero adjustment holds for both resistance ranges. It is not necessary to readjust when switching from one resistance range to another. This is an important time-saving feature never before included in a V.O.M. in this price range.
- ★ Housed in round-cornered, molded case.
- ★ Beautiful black etched panel. Depressed letters filled with permanent white, insures long-life even with constant use.

The Model 770 comes complete with self-contained batteries, test leads and all operating instructions.

SPECIFICATIONS

- 6 **A.C. VOLTAGE RANGES:**
0—15/30/150/300/1500/3000 VOLTS
- 5 **D.C. CURRENT RANGES:**
0—1.5/15/150 MA. 0—1.5 AMPS.
- 6 **D.C. VOLTAGE RANGES:**
0—7.5/15/75/150/750/1500 VOLTS
- 2 **RESISTANCE RANGES:**
0—500 OHMS 0—1 MEGOHM

\$13⁹⁰
NET

Superior's new model 670



SUPER-METER

A COMBINATION VOLT-OHM MILLIAMMETER PLUS CAPACITY REACTANCE INDUCTANCE AND DECIBEL MEASUREMENTS

SPECIFICATIONS:

- D.C. VOLTS:** 0 to 7.5/15/75/150/750/1,500/7,500 Volts
- A.C. VOLTS:** 0 to 15/30/150/300/1,500/3,000 Volts
- OUTPUT VOLTS:** 0 to 15/30/150/300/1,500/3,000 Volts
- D.C. CURRENT:** 0 to 1.5/15/150 Ma. 0 to 1.5 Amperes
- RESISTANCE:** 0 to 500/100,000 Ohms 0 to 10 Megohms
- CAPACITY:** .001 to .2 Mfd. .1 to 4 Mfd. (Quality test for electrolytics)
- REACTANCE:** 700 to 27,000 Ohms 13,000 Ohms to 3 Megohms

- INDUCTANCE:** 1.75 to 70 Henries 35 to 8,000 Henries
- DECIBELS:** —10 to +18 +10 to +38 +30 to +58

ADDED FEATURE:

The Model 670 includes a special GOOD-BAD scale for checking the quality of electrolytic condensers at a test potential of 150 Volts.

The Model 670 comes housed in a rugged, crackle-finished steel cabinet complete with test leads and operating instructions. Size 5 1/2" x 7 1/2" x 3".

\$28⁴⁰
NET



The model CA-11

SIGNAL TRACER

SIMPLE TO OPERATE . . . BECAUSE IT HAS ONLY ONE CONNECTING CABLE—NO TUNING CONTROLS!

FEATURES

- ★ SIMPLE TO OPERATE—only 1 connecting cable—NO TUNING CONTROLS.
- ★ HIGHLY SENSITIVE—uses an improved Vacuum Tube Voltmeter circuit. Tube and resistor-capacity network are built into the Detector Probe.
- ★ COMPLETELY PORTABLE—weighs 5 lbs. and measures 5"x6"x7".
- ★ Comparative Signal Intensity readings are indicated directly on the meter as the Detector Probe is moved to follow the Signal from Antenna to Speaker.
- ★ Provision is made for insertion of phones.

Introduced in 1939-1940 Signal Tracing, the "short-cut" method of Radio Servicing quickly became established as the accepted method of localizing the cause of trouble in defective radio receivers. Most of the pre-war testers (including ours) were bulky requiring a number of connections before the unit was "set for operation" and included a tuned amplifier which had to be "retuned" to compensate for signal shift.

The new Model CA-11 affords all the advantages offered by the pre-war models and only weighs 5 lbs. and measures 5" x 6" x 7". Always ready for immediate use without the necessity of connecting cables, this amazingly versatile unit has NO TUNING CONTROLS.

The Model CA-11 comes housed in a beautiful hand-rubbed wooden cabinet. Complete with Probe, test leads and instructions

\$13⁵⁰
NET

GENERAL ELECTRONIC DISTRIBUTING CO. DEPT. RC-4, 98 PARK PLACE, NEW YORK 7, N. Y.

RC-4

GENTLEMEN: PLEASE RUSH THE MATERIAL LISTED BELOW:

QUANTITY	MODEL	PRICE	
TOTAL			

Name

Address

City..... Zone..... State.....

\$ (Payment in Full Enclosed)

\$ (Deposit Enclosed... Ship Balance C.O.D.)

light or
HEAVY
soldering

DO
BOTH
WITH

**New 250-watt
WELLER GUN**

RIGID-TIP

5-SECOND HEATING

LONGER REACH

SOLDERLITE

STREAMLINED

DUAL HEAT
single heat
200 watts;
dual heat
200/250 watts;
115 volts
60 cycles.

You'll save on tools and time with the new Weller Soldering Gun WD-250. Whether the job is rugged or delicate, your Weller Gun does it with the same ease and efficiency. Chisel-shaped RIGID-TIP provides more soldering area for faster heat transfer. New "over-and-under" terminal design gives bracing action to tip. Your Weller Gun is light-weight and compact, gets into the tightest spots.

Weller Guns actually pay for themselves in a few months. Fast 5-second heating saves time on every job. Trigger-switch control saves power—no need to unplug gun between jobs. Prefocused spotlight and longer length mean easy soldering, even when the job's buried deep. No other soldering tool gives you so many time-and-money-saving features. Order your new 250-watt Weller Gun from your distributor today, or write for bulletin direct.

SOLDERING GUIDE Get your copy of "SOLDERING TIPS"—new fully illustrated 20 page booklet of practical soldering suggestions. Price 10c at your distributor's or order direct.



WELLER
MANUFACTURING COMPANY

828 Packer Street, Easton, Pa.

► **FUNDAMENTALS OF RADIO SERVICING** (Continued from page 48)

through the filament wires. The strong magnetic fields that surround adjacent loops of the filament wire inside a cathode act upon each other, making the filament "wriggle" violently under the influence of this heavy current; and often the movement either fractures the filament or causes it to short out to the cathode sleeve.

The only reason the transformer is easier on tubes is that the regulation of the voltage delivered by the filament secondary is much poorer than is that of the line. When there is a demand for heavy current, the transformer secondary voltage sags and so cannot deliver it; but the 117-volt line can and does put it out—much to the detriment of the tube filaments.

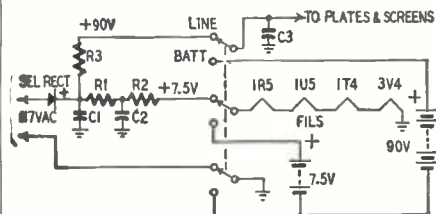

Fig. 4—Supply for three-way portable.

Just to show how radio engineering progresses in spirals, a new type of ballast resistor just introduced has a cold resistance several times its hot resistance. With such a resistor in series with the tube filaments, the initial current is quite low and rises slowly to the rated value as the filaments come up to their proper operating temperature. Since this arrangement is said to be even more gentle on filaments than a transformer, do not be surprised if we go back to ballast resistors.

But now let us look at Fig. 3, which is the essential power supply circuit of an a.c.-d.c. receiver, and see how the B-voltage is secured. All of the tube filaments are hooked in series directly across the line. The plate of the half-wave rectifier tube is connected to the top side of the line. The cathode of this tube is connected through the filter choke and the load resistance to the other side of the 117-volt a.c. main. Outside of the fact that our rectifier has a cathode, this rectifier circuit is very similar to the half-wave transformer circuit described in Chapter XIII. In that circuit, however, the electrons that flowed to the plate from the cathode during the portion of the cycle when the former was positive returned to the cathode by flowing around through the transformer secondary and the load resistance. In this circuit, there is no such apparent low-resistance return path from the plate to the "B-Minus" lead.

There is a return path, nevertheless, even though you do not see it. This path is through the windings of the generator producing the 117-volt a.c. The fact that this generator may be several miles away from the point where the receiver is operating means nothing to an electron that cruises at

a rate of about 186,000 miles a second!

The filter circuit operates just as did those described last month. The working voltage of the filter capacitors does not need to be so high, because the rectifier puts out only slightly more than 100 volts of filtered d.c. Capacitors of 150 working volts are normally used. Quite often the filter choke is replaced by a 1,000-2,000-ohm resistor. While such a resistor is cheaper, it is not so good at filtering as is the choke; thus it is necessary to increase the size of the capacitors to around 50 μ f each.

If this a.c.-d.c. radio were plugged into a 117-volt d.c. main with the positive side of the line connected to the plate, current would flow through the rectifier continuously instead of in pulses as it does on a.c. The d.c. would heat the filaments just as well as a.c., and our set would operate quite satisfactorily. A transformer set could not operate on such current, for the d.c. would quickly burn out the transformer primary.

That is why manufacturers call these transformerless sets "a.c.-d.c." Of course, the possibility that the ordinary buyer will use the set on d.c. (except in a few large cities) is about equal to that of his winning the Irish sweepstakes, but it is much better sales psychology to talk about even the most useless "extra" your product may have than it is to mention what has been left out!

The *three-way portable* does still better. It will work on 117 volts of either a.c. or d.c., or on self-contained batteries. Fig. 4 shows the basic power supply of such a receiver. When the 3-gang switch is thrown to the battery position, the 7.5-volt A-battery heats the four filaments hooked in series, and the 90-volt B-battery supplies the plate and screen voltages.

When the switch is thrown the other way, the selenium rectifier permits the 117-volt a.c. across it to pass in only one direction. By chemical action, this compact little rectifier does the same job that a diode vacuum tube would perform—and does it without drawing filament current!

One branch of the rectified output flows through R1 and R2 and the filament string back to ground. The drop across the two resistors is such that just the required 7.5 volts of d.c. appear at the ungrounded end of the filament string. C1 and C2 work in conjunction with the resistors to filter the voltage used on the slender, battery-saving, 50-ma filaments. This pure d.c. is necessary to prevent hum with such tubes, because they are very sensitive to filament-voltage changes (so sensitive, in fact, that most of these sets go dead on a.c. if the line voltage falls below 100!).

R3 and C3 provide further filtering for the other branch of the rectifier's output that supplies the plates and screens of the tubes.

(Continued on page 54)

**YOU BUILD 'EM
IN ONE EVENING
BUT...**

THEY LAST A LIFETIME!

SAVE 50% WITH

**LABORATORY
PRECISION**



**INSTRUMENTS
& KITS**

SENSATIONAL NEW

**EICO Model 360-K TV-FM SWEEP
SIGNAL GENERATOR**

• Crystal marker oscillator with variable amplitude. • Covers all TV and FM alignment frequencies between 500 kc. and 228 mc. • Sweepwidth variable from 0-30 mc. with mechanical inductive sweep. • Extremely wide sweepwidth allows gain comparison of adjacent RF TV Channels. • Provides for injection of external signal generator marker. • Phasing control included. • Large, easy-to-read dial is directly calibrated in frequencies. • Vernier Tuning Condenser. • Comes complete with all tubes (including new, high-frequency miniature types): 6X50T, 12AU7, two 6C4's. Crystal not included. 10"x8"x6 3/4". 5 Mc. Crystals available for above, each \$3.95.

\$29.95

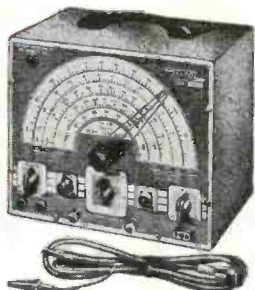

**ANYONE
CAN BUILD
THEM!**

FACTORY-WIRED AND TESTED \$39.95
Model 360. Ready to use Sweep Signal Generator. See it at your local jobber!

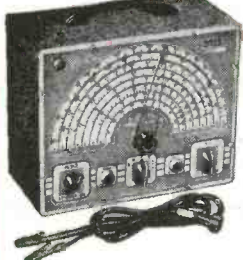

**NEW! MODEL 320-K
SIGNAL GENERATOR**

For FM, AM alignment and to provide TV marker frequencies. Highly stable Hartley oscillator has range of 150 kc. to 102 mc. with fundamentals to 34 mc. Colpitts audio oscillator supplies pure 400 cycle sine wave voltage for modulation. Vernier Tuning Condenser. Use audio oscillator voltage to test distortion in audio equipment, bridge measurements, etc.

FACTORY-WIRED AND TESTED \$29.95
Model 320. Ready to use. . . .



**VERSATILE MULTI-SIGNAL
TRACER**

Model 145-K. High gain—high frequency. Self-contained test speaker permits audible signal tracing of RF, IF, FM, audio and video circuits. Provision for visual tracing with VTVM. Response is well over 200 mc. 3-color hammertone panel. 110-125 V. AC. Size: 10"x8"x4 3/4". Comes complete with tubes and diode probe in kit form.

\$18.95

FACTORY-WIRED AND TESTED \$28.95
Model 145. Ready to operate. . . .

**NEW PUSH-PULL 5"
TV OSCILLOSCOPE**

Model 425-K Kit

\$39.95

ALL-NEW Laboratory precision scope has Push-Pull deflection and .05 to .1 volts per inch sensitivity. Wide-range, flat from 5 cps to 500 kc. with full gain setting, useful to 2 1/2 mc. Wide-range, multi-vibrator, sweep circuit from 15 cps to 75,000 cps. Direct connection to plates of CRT available at rear of cabinet. Z axis intensity modulation feature included. Size: 8 1/4"x17" high. Complete with 3-6SN7s, 2-6J5s, 2-5Y3s, and 5BP1 CRT.

FACTORY-BUILT OSCILLOSCOPE \$69.95
Model 425. Fully wired and tested

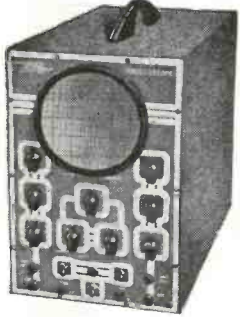

**HIGH PRECISION
VACUUM TUBE
VOLTMETER**

Model 221-K

\$23.95

Tops in workbench versatility—15 different ranged AC and DC ranges: 0/5/10/100/500/1000 volts. Electronic ohmmeter ranges from .2 ohms to 1000 megohms in 5 steps. New features include Zero Center for TV discriminator alignment. 26 Meg. DC input impedance. Accurate, 4 1/2" meter cannot burn out. Double triode balanced bridge circuit assures guaranteed performance. Sturdy portable steel case with etched rubberproof panel. Will measure up to 30,000 V. and 200 Mc. when used with our EVE-1 or P-75 probes. 110-130 V. AC 50-60 cycle. Size: 9 7/16"x6"x5 1/2".

FACTORY-WIRED AND TESTED \$49.95
Model 221. Same, but completely wired, calibrated, and tested. . . .

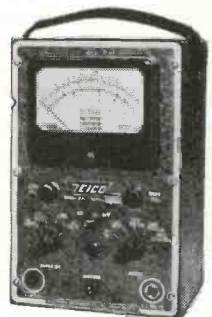

**DELUXE SIGNAL
GENERATOR**

MODEL 315

Completely wired, ready-to-use Signal Generator with 1% accuracy! A wonderful instrument with dozens of expensive features. Frequency range: 75 kc to 150 mc. Has microcycle band-spread vernier tuning for FM, AM, and TV. Voltage regulation. Write for full details.

\$59.95



Model 511-K. A "Must" for every serviceman! Small, handy instrument used a thousand times a day. Large 3" meter, beautifully etched panel. A perfect kit for beginners. Simple to assemble. Ranges: DC 0/5/50/250/500/2500 volts. AC 0/10/100/500/1000 volts. Output—0/10/100/500/1000 v. DC Ma.—0/1/10. DC Amps.—0/1/10. Ohmmeter—0/500/100,000 ohms/0/1 meg. DB meter—8 to +55 Db. **\$14.95**

ASSEMBLED—READY TO USE \$17.95
Model 511—Completely wired, tested, and assembled at the factory. Rugged, built for heavy duty. . . .

**VOLT-OHM
MILLIAMMETER
Complete Pocket Kit**



\$14.95

WRITE FOR NEW CATALOG C



HIGH VOLTAGE PROBE

Complete top-quality Voltage Test Probe Measures up to 30,000 Volts. Special Helical-Wound Ceramic HV Multiplier Resistor adaptable to most VTVM's and all 20,000 ohms per volt meters with 1000 or 5000 volt scales. Lucite head, plywood bakelite handle, large flashguards for additional safety. Specify your instrument. Complete, ready to use. **\$6.95**

**SEE THEM—TRY THEM—
AT YOUR LOCAL JOBBER!**

EICO Instruments and Kits are on display at your local jobber—the nationally advertised kits which you can see and use before you buy. You take no chances with EICO!

Prices Higher on West Coast

**Model
HVP-1**

HIGH FREQUENCY RF PROBE



Model P-75K germanium crystal probe for visual RF signal tracing and measurements to over 200 megacycles. Can be used with models 221 or 113A Eico instrument (state which when ordering). 8 1/2" long, 1/2" O.D., with wire, plugs, and all components. **\$3.75**
IN KIT FORM. . . . **\$3.75**
Model P76K same as above, but for oscilloscopes; in kit form. . . . **\$3.75**
Models P75 or P76 similar to above but factory wired, ready to operate. Each. . . . **\$7.50**

EASY-TO-FOLLOW SCHEMATIC & PICTORIAL DIAGRAMS

Come complete with every EICO Instrument Kit. Each kit fully guaranteed to operate perfectly when assembled according to our simple instructions!

EXCLUSIVE LIFE-TIME REPAIR SERVICE: For a nominal charge, we will repair and service your EICO instrument, regardless of its age!



ELECTRONIC INSTRUMENT CO., INC.
276 Newport Street, Brooklyn 12, N. Y.



..How to STOP GARBLED TV due to poor capacitor retrace

IN ONE EASY LESSON

You carefully adjust the tuning of a TV receiver. Then—zingo! A few days later, the customer complains about garbled pictures. The set hasn't retraced properly. The difference between its operating temperature and the room temperature has been enough to affect the capacitance stability of the coupling and bypass capacitors and thus upset the critical alignment or synchronization.

Many competitive *molded* tubular capacitors are not sufficiently stable to guard against this annoyance—**BUT SPRAGUE TELECAPS MOST CERTAINLY ARE!** The reason? These famous molded tubulars are made by an exclusive "dry process", then impregnated under high vacuum. In other words, they're made just like expensive metal-encased oil capacitors. You can use Sprague Telecaps in every TV circuit position. They're as stable as the Rock of Gibraltar—and a sure-fire way to lick capacitor retrace troubles for good! Telecaps have the best temperature coefficient and retrace characteristics of any tubular made.

SPRAGUE PRODUCTS COMPANY

81 Marshall Street, North Adams, Mass.
(Distributors' Division of the Sprague Electric Company)

SPRAGUE TELECAP[®] PHENOLIC-MOLDED TUBULARS



The transformerless power supplies so far discussed have outputs roughly equal to the line voltage, but it is possible to secure an output voltage twice the line voltage without using a step-up transformer. This is done by a gadget called a voltage doubler, one form of which is shown in Fig. 5.

When the side of the line connected to the plate of the upper diode is positive, electrons attracted from the cathode leave C1 with a charge nearly equal to the line voltage. When this same side of the line swings negative, current flow ceases in the upper diode;

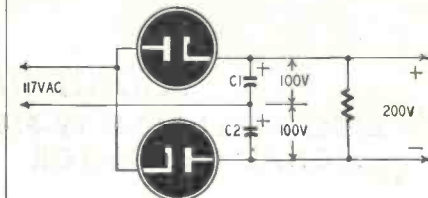

Fig. 5—A full-wave voltage doubler.

but as the cathode of the lower diode becomes more and more negative, electrons flow from it to the plate and charge C2 to the line voltage. C1 and C2 are connected so their charges are in series and add together; therefore, twice the line voltage appears across the load resistance.

In practice, instead of separate tubes, a twin diode with individual cathodes is normally used. Probably voltage doublers would be more popular if it were not for the fact that the output voltage is very dependent upon the capacitance and condition of C1 and C2. Too, the output voltage falls off rapidly when the load current is increased.

Auto-radio supplies

The typical American cannot long enjoy doing anything unless he can do it in his car, so he began to demand an automobile radio. The first ones used the car battery to heat the filaments of the tubes and B-batteries to supply the other electrode voltages. But the radio engineers began schem-

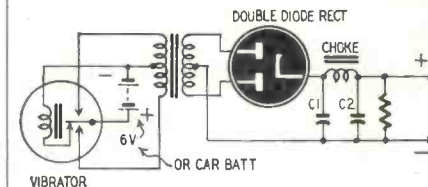

Fig. 6—Non-synchronous power supply.

ing to add the burden of the B-supply to the already long-suffering car battery. What was needed was some way to step up the battery's 6 volts of direct current in the same way a transformer steps up alternating voltage.

Then they remembered that pulsing d.c. in the primary of a transformer results in an expanding and contracting magnetic field that reacts upon the secondary winding in very nearly the same manner as does a.c. across the primary. They devised the circuit shown in Fig. 6.

The vibrator is simply a buzzer-mechanism that keeps the reed vi-

SAVE 25 TO 52% BY BUILDING YOUR OWN LABORATORY PRECISION TEST INSTRUMENTS!

*"You build 'em in
one evening—
they last a lifetime"*

NEW TV-FM SWEEP SIGNAL GENERATOR KIT

EICO
Model 360-K
\$29⁹⁵



Crystal marker oscillator with variable amplitude. Covers all TV and FM alignment frequencies between 500 kc. and 228 mc. Sweepwidth variable from 0.30 mc., with mechanical inductive sweep. Extremely wide sweepwidth allows gain comparison of adjacent RF TV Channels. Provides for injection of external signal generator marker. Phasing control included. Vernier dial calibrated in frequencies. Complete with tubes (6X5GT, 12AU7, 2-6C4). In sturdy steel case. Less Crystal. Size: 10 x 8 x 6 3/4". 110-125 v., 60 cycles AC. Shpg. wt., 12 lbs. IN KIT FORM.
No. 32P24370: Lafayette's Price.....\$29.95
No. 32P24371: 5 Mc. Crystal for above....\$ 3.95

NEW SIGNAL GENERATOR KIT



EICO
Model 320-K
\$19⁹⁵

For FM, AM alignment and to provide TV marker frequencies. Highly stable Hartley oscillator has range of 150 kc. to 102 mc. with fundamentals to 34 mc. Colpitts audio oscillator supplies pure 400 cycle sine wave voltage for modulation. Use audio oscillator voltage to test distortion in audio equipment, bridge measurements, etc. In sturdy steel case. Size: 10 x 8 x 4 3/4". 110-125 v., 60 cycles AC. Shpg. wt., 10 lbs. IN KIT FORM.
No. 32P24562: Lafayette's Price.....\$19.95

Complete with
STEP-BY-STEP INSTRUCTIONS
and
EASY-TO-FOLLOW DIAGRAMS



Each EICO kit fully guaranteed to operate perfectly when assembled according to the simple directions.

NEW 5" OSCILLOSCOPE KIT Push-Pull, Wide-Range, High Sensitivity!

EICO
Model 425-K
\$39⁹⁵



All-new laboratory precision scope has Push-Pull deflection and .05 to .1 volts per inch sensitivity. Wide range, flat from 5 cps to 500 kc. with full gain settings, useful to 2 1/2 mc. Wide-range, multi-vibrator, sweep circuit from 15 cps to 75,000 cps. Direct connection to plates of CRT available at rear of cabinet. Z axis intensity modulation feature included. Size: 8 1/2" x 17" x 13" high. Complete with 3-6SN7, 2-6J5, 2 of 5Y3, 5BP1 CRT, 110-125 v., 60 cycles AC. Shpg. wt., 30 lbs. IN KIT FORM.
No. 32P24552: Lafayette's Price.....\$39.95

HIGH VOLTAGE PROBE
EICO Model HVP-1 \$6⁹⁵
(Not a K.it)



Measures up to 30,000 volts. Special HV Multiplier Resistor for all 20,000 ohms per volt meters with 1000 or 5000 volt scales and most VTVM's. Lucite head, plywood bakelite handle, large flashguards for additional safety. Assembled, ready to use. Supplied for 221-K VTVM unless other instrument is specified. Shpg. wt., 1 lb.
No. 25P21463: Lafayette's Price.....\$6.95

order your
EICO
INSTRUMENT
KITS
direct from
Lafayette
Radio

VACUUM TUBE VOLTMETER KIT
EICO Model 221-K
\$23⁹⁵



Tops in workbench versatility—15 different ranges! AC and DC ranges: 0/5/10/100/500/1000 volts. (Use HVP-1 probe to get 30,000 volt range.) Electronic ohmmeter ranges from .2 ohms to 1000 megohms in 5 steps. Uses double triode balanced bridge circuit. New features include Zero Center for TV discriminator alignment. 26 Meg. DC input impedance. Accurate 4 1/2" meter cannot burn out. Sturdy portable steel case with etched, rubproof panel. 110-125 v., AC, 60 cycles. Size: 9 1/2" x 6" x 5". Shpg. wt., 10 lbs. IN KIT FORM.
No. 32P24540: Lafayette's Price.....\$23.95

**HIGH FREQUENCY RF
PROBE KIT**
EICO Model P-75K \$3⁷⁵



Germanium crystal probe for visual RF signal tracing and measurements to over 200 megacycles. 6 1/2" long, 12" O.D. Shpg. wt., 8 oz. IN KIT FORM.
No. 32P24533: Lafayette's Price.....\$3.75

Lafayette
Radio

100 Sixth Avenue, New York 13, N. Y.
901 W. Jackson Blvd., Chicago 7, Ill.
(Showrooms also in Boston, Newark and The Bronx)

LAFAYETTE RADIO, Dept. JD-50
100 Sixth Avenue, New York 13, N. Y.
901 W. Jackson Blvd., Chicago 7, Ill.
Enclosed is \$———. (Include shipping charges. Any excess will be refunded.) Rush me the following EICO equipment:
 Send me FREE Lafayette's 1950 catalog. (Please do not check if you have already received a copy).
Name
Address
City Zone State

**DO YOU
HAVE
LAFAYETTE'S
1950
CATALOG?**



—The most famous jobber catalog in the field for 29 years!
All well-known makes at the market's lowest prices.
TV and Radio Parts—High Fidelity Equipment—P.A. Systems—Test Equipment—Tools—etc.
NO RADIO MAN CAN AFFORD TO BE WITHOUT THIS VALUABLE 164-PAGE BUYING GUIDE
SEND FOR YOUR FREE COPY TODAY!

Applications Unlimited!

University POWRMIKE

POWRMIKE SYSTEM PC-66

THE POWRMIKE

- AMPLIFIES WITHOUT VACUUM TUBES
- OPERATES FROM ANY 6 VOLT D.C. SOURCE
- INSTANTANEOUS OPERATION
- DEPENDABLE, FOOL-PROOF, ECONOMICAL

ALSO FOR MOBILE AND SPECIAL INSTALLATIONS

The new UNIVERSITY POWRMIKE opens a new field for sound distribution. Low in cost, requiring no amplifier, completely portable, POWRMIKE can be used in thousands of applications where power supply or high cost rule out sound amplification. POWRMIKE has a maximum output of 1.5 watts, reproduces speech with excellent fidelity and is instantaneously operated by handy press-to-talk switch. Additional speakers may be added for broader coverage and special switching arrangements.

POWRMIKE is the perfect answer for voice amplification in stores, carnivals, rallies, waiting rooms, auctions, outdoor markets, sight seeing buses and boats, school group activities, police and fire department work, etc. Get the complete story on sensational POWRMIKE, today.

MODEL PC-66 — Far applications requiring portability. Includes: POWRMIKE microphone wired to loudspeaker, "Hot-Shot" type battery mounting bracket with volume control, and automobile current adapter.

MODEL PC-60 — For mobile operation and special installations. POWRMIKE microphone, loudspeaker, and automobile cigarette lighter adapter, supplied unwired.

WRITE DEPT. D FOR ILLUSTRATED CATALOG



University
LOUDSPEAKERS, INC.
80 SO. KENSICO AVE., WHITE PLAINS, N. Y.

Famous World-Wide for LOUDSPEAKERS • DRIVER UNITS • TWEETERS • PORTABLE POWRMIKES

brating back and forth so that it touches first one contact then the other. When the top one is touched, current flows from the battery through the contact points then *down* through the top half of the transformer primary. When the lower one is touched, current flows through it then on *up* through the bottom half of the primary. The effect of these two regular, opposite-going pulses of current is practically equal to an a.c. voltage across the primary. Consequently, the voltage is stepped up, rectified, and filtered just as it would be if the transformer were operating on a.c. The steady d.c. from the battery has been changed to pulsating d.c., then converted and elevated to a much higher a.c. voltage, next rectified and so changed back to a pulsating d.c., and finally smoothed out by the filter so that it once more is pure d.c.! That is really making electricity jump through the hoop!

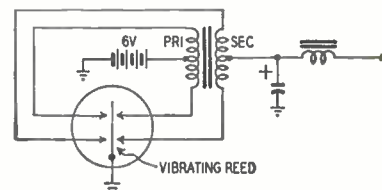

Fig. 7—Synchronous (self-rectifying) vibrator has an extra set of contacts which replace a vacuum-tube rectifier.

Fig. 7 shows how a *synchronous vibrator* can be used to do away with even the rectifier. Two sets of contacts are employed to ground one end of the primary and one end of the secondary simultaneously. The grounding is done in such a sequence that the d.c. pulse in the primary produces a voltage in the secondary that makes the ungrounded end of this winding positive by a certain value. This means that the centertap of the secondary is positive by half of this value with respect to ground.

Then when the reed swings the other way and grounds the other ends of the primary and secondary, the end of the secondary that had been grounded becomes positive; but this change still leaves the centertap positive with respect to ground. The result is that every complete cycle of the reed causes two pulses of d.c. voltage to appear at the centertap with respect to ground. All that is required is to filter out this pulsating voltage and apply it to our plates and screens. No electronic or chemical rectifier is necessary in this circuit. Most vibrators operate at 115 cycles so filtering is simpler.

An interesting noncar use of the vibrator power supply is in the storage-battery three-way portable receiver. This set uses a small 2-volt storage battery and a synchronous vibrator for power. The battery is kept charged by a trickle charger operated from the 117-volt line. The set actually operates from the battery at all times; but if the line cord is kept plugged in, the input from the charger to the battery just about equals the output used to power the portable receiver.



SMASH HIT BARGAINS

\$12.95 TAKES ALL 3 BIG BARGAINS

- 1. SENSATIONAL, FASCINATING, MYSTERIOUS SELSYNS.** Brand new Selsyns made by G. E. Company. Two or more connected together work perfectly on 110V AC. Any rotation of the shaft of one Selsyn, and all others connected to it will rotate exactly as many degrees in the same direction, following unerringly as if the units were connected together by shafting instead of wire. This is true whether you twist the shaft of the master unit a fraction of a revolution or many revolutions. Useful for indicating directions of weather vanes, rotating directional antennas, or controlling innumerable operations from a distance. Complete with diagram and instructions. Per Matched pair \$4.95.
- 2. ALUMINUM GEAR BOX 18x8x7** that contains two powerful electric motors and two matched gear trains, 62 gears in all varying in size from 1/2 to 4 inches in diameter. This unit is readily converted to rotate a beam antenna or any other similar use. \$5.00
- 3. HOME WORKSHOP AT BARGAIN PRICE.** Accurate and precise 2 speed guaranteed hobby lathe, the essential machine for the home workshop. Sturdy enough for light production work or factory standby service. Supplied with 56" of belting for connecting to any available electric motor or power take-off. Also included in this unbelievable offer are such accessories as a 1/2" drill chuck with specially hardened tool steel jaws, a 4" electric furnace high speed grinding wheel, a cotton buffing wheel and a large supply of buffing compound, and a 4" steel wire scratch brush. Your cost \$6.00. Sole export agent. Distributor Inquiries invited.

Universal 4 lead broadcast band oscillator coil (can be converted to 3 lead type by addition of jumper). Ten for \$1.00

3 gang broadcast band PERMEABILITY TUNER was \$3.50, NOW \$1.50

SENSATIONAL BUY

RT-1711 Brand New 12 Tube, 110 Volt Receiver-Indicator-Oscilloscope complete with all tubes and power supply (Govt. APA1 Radar Set). Scope tube is equipped with a detachable calibrated screen. \$39.95

SOS EMERGENCY TRANSMITTER

Famous Gibson Girl Transmitter that saved so many lives during the war. Ideal for boats and airplanes. No external power supply required. Turn the crank on top of transmitter and power is generated and distress signal is automatically sent out on international distress frequency. Brand new, complete with tubes. \$9.95

ANTENNA KIT

For Gibson Girl Transmitter, 300 ft. antenna wire, 2 balloons, 2 hydrogen generators, box kite for windy weather, searchlight. Complete kit \$9.95

DELUXE AC-DC RADIO KIT

High quality standard production line radio in kit form with complete instructions. Features 2-gang condenser, 2 iron core I.F. transformers, and polyethylene insulated edgewise-wound antenna loop. Tubes include 12AT6, 12BA6, 12BE6, 601B5 and 35V4. Receives broadcast band from 550 to 1700 KC. Kit form \$8.75 or 2 for \$17.00. Assembled, wired and tested \$12.95 or 2 for \$25.00.

PHONO SCRATCH ELIMINATOR

Consists of 2 condensers and powdered iron core choke connected in filter network. Same as used in most jukeboxes. Connects instantly between pick-up and amplifier. \$2.00

NEW G.E. TRANSMITTER

Brand new General Electric BC-375, BC-191 transmitters, including both 12 and 24 V. dynamotors, export packed, absolutely complete and including complete set of spare tubes as well as 10 and 20 meter conversion instructions. \$100.00
BC-312, BC-348 or BC-224 receivers sold with the above transformers (unit for unit). \$125.00

SCR610 PORTABLE

6, 12 and 24V crystal-controlled transmitter receiver with built-in loudspeaker on receiver, complete \$59.95

AC-DC POCKET TESTER

This analyzer, featuring a sensitive repulsion type meter housed in a bakelite case, is the result of 15 years achievement in the instrument field by a large company specializing in electronic test equipment. Specifications of the AC-DC Model Volt-Ohmmilliammeter: AC and DC Volts—0-25, 50, 125, 250. Milliampers AC—0-50. Milliampers DC—0-50. Ohms Full Scale—100,000. Ohms Center Scale—2400. Capacity—.05 to 15 Mfd. Total price, prepaid anywhere in the USA—\$7.00. Similar DC Meter, lacking AC operated ranges of above, \$5.50 prepaid.



TUBE TESTER

New, different, sensational 1950 Model Mutual Conductance Tube Tester. Checks all tubes for gas, microphonics, hum, emission, shorts and mutual conductance in microohms. Completely new switching arrangement that is really obsolescence proof. Imagine the advantage of a tube tester with the astounding ability to instantly test future tube types or tube types not listed on the built-in roll chart. NO OTHER TESTER CAN MAKE SUCH A CLAIM!! Portable Model \$68.50; Counter Model \$64.50.



"DRILLMASTER" ELECTRIC DRILL

Ideal for hobbyists. Complete with sander, buffers, grinding wheels, etc. Only a few are available. A sensational bargain at \$9.95. Satisfaction guaranteed or money refunded if returned prepaid within 5 days.



BUFRAD SECTIONAL TOWER

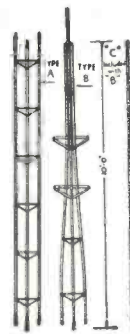

This addition to the famous line of BUFRAD antenna products makes up to a hundred foot tower from any number of strongly welded ten foot sections, which are shipped assembled and painted. Erection is a matter of minutes. Assembly is a one man job, and is accomplished by climbing up the completed portion of the tower with the next 25 lb section to be installed. Hand and foot-holds are provided for safety and ease. Cap at top of tower provides bearing surface for rotating, and prevents water from entering tubes. Useful for police or amateur transmitters. In addition, tower provides satisfactory TV reception where otherwise impossible. Ideal for supporting temporary or permanent power lines, wind generators, stadium public address speakers or spotlights for gas stations or parking lots. "B" and "C" sections together cost a total of \$15.75 and total 20 feet. "A" sections, which make up the entire tower top, are each ten feet long and cost but \$12.75 apiece. Mast base (not shown) is obtainable for only \$6.00. Base is especially useful when erecting tower on a sloping roof.

PORTABLE AIR COMPRESSOR \$14.50

Portable air compressor and storage tank. Ruggedly built of best materials using lifetime-lubricated ball bearing on connecting rod and oil-impregnated main bearing on shaft. Unusual design forever eliminates valve trouble. PATENTED unique air intake system increases efficiency tremendously over other compressors. Will deliver approximately 3500 cu. in. of air per minute at maintained pressure of 30 lbs. Comes complete with 100 lb. gauge. Finger-tip adjustment allows setting of output pressure at any value, which is automatically maintained. Works from any 1/4 H.P. motor. Useful for spraying paints or lacquers, disinfectants, insecticides, annealing or brazing with natural gas, inflating tires, etc. Price \$14.50 prepaid anywhere in the U.S. Efficient, completely adjustable syphon type spray gun complete with 12 ft. of 100-lb. tested hose available for only \$7.75 with pint container, also prepaid. 25% required on all C.O.D. orders.

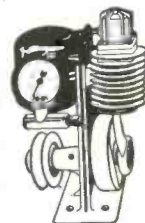

TOROIDAL COIL FILTERS

Are the answer to any Network Problem

- Sharp Cut-off • Compact • Low Insertion Loss • Hum Proof • High Stability • Highest "Q"
- 1000 Cycle Audio Filters • "Q"-55 At 100 CY.; 150 At 3000 CY. Navy PD52010 • 1 low pass audio filters that are the exact electrical and physical equivalent of commercial audio filters selling for \$35.00 wholesale. Far superior to surplus Radio Range Filters now being offered. Twice as selective as Q-filter section of 27-N, which has previously provided the amateur's highest standard of interference elimination. With diagram \$2.00

BUFFALO RADIO SUPPLY, 219-221 Genesee St., Dept. RE 4, BUFFALO 3, N. Y.

American Beauty

ELECTRIC SOLDERING IRONS

are sturdily built for the hard usage of industrial service. Have plug type tips and are constructed on the unit system with each vital part, such as heating element, easily removable and replaceable. In 5 sizes, from 50 watts to 550 watts.

TEMPERATURE REGULATING STAND

This is a thermostatically controlled device for the regulation of the temperature of an electric soldering iron. When placed on and connected to this stand, iron may be maintained at working temperature or through adjustment on bottom of stand at low or warm temperatures.

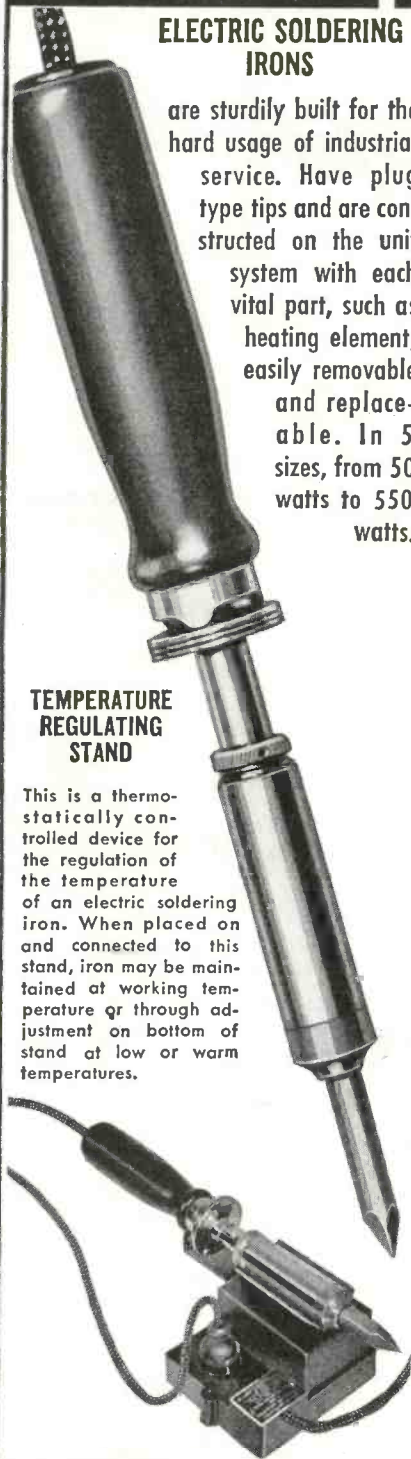

For descriptive literature write

**AMERICAN ELECTRICAL
HEATER COMPANY**
DETROIT 2, MICH., U. S. A.

Radio Repair Licensing: Pedro Takes A Dim View

By GUY SLAUGHTER



... "How many lectruns in the orbutts of a merkry adam?"
he stumbles

"HI, Pedro," I chirp, walking in and flinging my hat toward the rack in the corner. "You're early this morning."

"Yeah," he responds distastefully, shoving the push-broom across the floor. "You guys sure can be messy sometimes."

"Messy?"

He jerks his thumb at the litter of cigar and cigarette butts scattered over the floor.

"Oh that! Technicians' Association meeting last night."

"Yeah," Pedro mutters glumly, making with the broom. "I can tell. Must have been a hot discussion."

"It was." I riffle through the pickup cards on my desk, and deal them into piles according to their respective neighborhoods. "We decided to ask the City Council to start a licensing program."

"Hunh?" Pedro stops sweeping, and leans gratefully on his broom. "For what?"

"For radio technicians," I explain. "Every repairman has to pass an exam

before he gets a license. No license, no business."

"You're kidding, hunh?" Pedro asks hopefully.

"No, I'm not kidding. There's too many screwdriver mechanics in town. They gyp the public and the public gets it in for all of us."

"So?" Pedro asks sarcastically.

"So if a guy don't know enough radio to pass the exam, he gets no license," I declare smoothly. "Just as simple as that!"

"How about crooks?" Pedro wants to know, still leaning casually on his broom.

"Meaning what?"

"Guys that know radio, pass the exam, and still gyp people."

"We thought of that," I elucidate. "If the City Council's licensing bureau gets too many complaints on a technician, then they go ahead and revoke his license."

"Won't work," Pedro says complacently. "Some people complain all the time."

"True," I admit, feeling a little irri-

RADIO-ELECTRONICS for

tated. "But our Technicians' Association will act as an advisory board. We can tell whether complaints are justified or not."

"I get it." Pedro nods his head, and stares at me accusingly. "The old freeze-out, hunh?"

I think I see what he's driving at, but I choose to play dumb.

"Freeze-out?"

"Freeze-out," he repeats. "If a guy belongs to your club, you protect him. But if he doesn't, you get his license revoked and freeze him out of business."

"Pedro," I command, my plate current zooming, "you start shoving that broom instead of leaning on it, and I'll take care of the thinking around here." I go back to my bench, muttering to myself, and dig into a TV set that some amateur repairman has tinkered up. The audio is dead, and the video i.f. has been misaligned.

"Look here, Pedro," I yell. He drags his broom up to the bench, his face an emotionless mask. His feelings are hurt. "See what I mean?" I query. "Some screwdriver mechanic tried to fix this set, and just messed it up."

"Yeah," Pedro says. "Uh-huh."

"Not only couldn't he fix it," I continue, "but he jimmied up all the tuned circuits to boot. Now the owner'll have to pay for a complete realignment on top of the original repair."

"Too bad," Pedro murmurs.

"And he'll probably jump me for charging him too much."

"Tell him," Pedro says reasonably.

"Tell him why the extra charge."

"Licensing would keep such tinkers out of the business," I argue, pursuing the point.

"It doesn't take licensing," Pedro shakes his head. "The bum is all through in that neighborhood. The set owner'll tell his friends and they'll tell their friends, and that's that. A few jobs like this one, and he'll be out of business."

"I guess that's right. But the customers have to learn the hard way."

"Advertise," Pedro suggests disinterestedly. "Can I get back to my sweeping?"

He waltzes off with his broom, and I go to work on the TV set. When it is finished, I gather up my tools and get ready to start my pickups and deliveries.

It's almost closing time when I get back. Pedro is sitting at my desk, his feet resting comfortably on its top, talking on the telephone. He hangs up hurriedly when I walk in, and jumps to his feet self-consciously.

"Hi, Herk," he greets. "How did it go?"

"Okay," I say wearily, heading for the bench and setting down my tool box. "There's a bunch of chassis in the

truck. Want to lug them in?"

"Sure," he answers cheerfully, disappearing out the door.

It Pays to Advertise?

I check the "to-be-repaired" rack to see what's come in during the day, and then go out front to look over the call cards on the desk. I find a sheet of paper rolled into my typewriter, and read it curiously. "Wanted!" it says. "Information concerning gyp-artists. The Sequin Radio Technicians Association will welcome the opportunity to investigate any complaint you, the public, may wish to lodge against any of the local radio shops. Excessively high charges or inferior workmanship. . . ." It ends there, and just then Pedro bustles through the door with an armload of chassis.

"Hey, Pedro," I demand as he lugs them through the door to the service bench. "What's this all about?"

"What, Herk?" he asks innocently, reappearing without the sets. Then he sees what I'm looking at, and starts to color a little. "Oh, that," he shrugs, trying to be nonchalant. "Just an ad I was working on."

"For what?" I ask, mystified.

"Well," he says, leaning on the counter and staring out the window self-consciously, "I figure if your association ran an ad like that in the paper and listed all the member shops, the

IN THE SETS OF THE BEST MANUFACTURERS FOR YEARS...

NOW!

it's **TEL-O-TUBE** for **REPLACEMENT!**

PRODUCTION 1800 PER DAY!
IMMEDIATE DELIVERY ON ALL TYPES!
PROVED SUPERIORITY!

For manufacturers, Tel-O-Tube has long meant higher picture tube quality at lower cost. The list of famous TV set makers who have specified Tel-O-Tubes for their production is a virtual who's who of the industry—Admiral, Ansley, Crosley, Emerson, Garod, Olympic, Starrett, Tele-King, Tele-Tone, Sightmaster, Video Corporation of America, etc. Again and again, Tel-O-Tubes meet the critical approval of these receiver manufacturers. Here is indisputable proof of Tel-O-Tube superiority!

Now Tel-O-Tube means more replacement sales at lower costs for more profits for you. We have stepped up our production to a new high of 1800 a day, and are pushing higher every week—to fill your replacement needs for the finest picture tubes of every type—with immediate delivery!

Tel-O-Tubes are made in our 3 new modern plants under the newest, most stringent quality controls and test tolerances, backed by the latest engineering "know-how." That's why you get more dependable performance and longer life—for more sales and more profits—with Tel-O-Tubes.



New Tel-O-Tube 16XP4 16" Rectangular

Take a tip from the quality-conscious receiver manufacturers—specify Tel-O-Tube. We have a "honey" of a sales story for every TV serviceman interested in profits in picture tubes. For full details, write NOW to Dept. E-1.

TEL-O-TUBE SALES CORPORATION

469 SEVENTH AVENUE, NEW YORK 18, N. Y.

Telephone: Pennsylvania 6-7385-6-7



Approved by Underwriters Laboratories Inc.

VEE-D-X TWIN LEAD LIGHTNING ARRESTOR

1. For outdoor or indoor use
2. High frequency — low loss
3. Easy to install
4. Unnecessary to cut transmission line for installation
5. Unnecessary to change spacing of transmission line
6. Does not vary impedance
7. High dielectric — low loss plastic material. Will not absorb moisture.

\$2.00 list

The Pioneer Lightning Arrestor for Television and FM

VEE-D-X

VEE-D-X means video distance

LA-POINTE-PLASCOMOLD CORP., Unionville, Conn.

Please send me further information about your TV antennas and accessories.

Name _____
 Address _____
 City _____ Zone _____ State _____

public would steer clear of the other outfits.”

“Oh?”
 “Sure,” he continues. “And the ad would make the nonmembers sit up and take notice, specially the crooked ones. They’d probably straighten up and want to join your association.”

“Yes,” I say patiently. “And I suppose you have some other ideas on the subject, too?”

He nods vigorously.
 “If your outfit would hold classes for the guys who don’t know enough radio, you could help them and the public.”

“Pedro,” I tell him, smiling broadly. “You’ve got an idea there!”

His face lights up like a 6-volt pilot bulb across the a.c. line, and his grin touches his ear lobes.

“Only,” I continue, “we’ve already voted for the licensing program, and that makes all your suggestions unnecessary.”

His grin fades like a scanning raster when the high voltage breaks down.

“It’s not too late, is it, Herk?” he asks breathlessly. “You can still call an emergency meeting and change it, can’t you? You’re the president.”

“Yeah,” I gloat, grinning at his discomfiture. “I could, but I’m not going to!”

“It’s a mistake, Herk,” he wails. “Once you get this license thing started, you can’t stop it!”

“We won’t want to,” I tell him.

“When’s your committee going to the City Council?” he wants to know, and I can see an idea working in his head.

“Wednesday. Why?”

“This is Saturday,” he mutters thoughtfully. Then he changes the subject abruptly, and brightens up again. “Saturday! Hey, Herk, this is payday.”

“Yeah! So it is.” I dig deep and pay him off. He starts for the door, but he stops with his hand on the knob.

“Herk,” he says apologetically, “I can’t come in after school Monday.”

“Why not?”

“I’m student mayor for the day. Got to run the city.” He opens the door, and starts out.

“Congratulations, Pedro,” I answer with a laugh. “Don’t take any bribes.” I go back to the bench, and knock out some work.

Up Against the Law

Monday morning I’m plugging away at the bench, and the gong rings for the dozenth time, announcing a customer. Only this time it’s just a kid, maybe fifteen or so, and he’s looking very tough. His police cap sets down around his ears, and he’s not too clean.

“Hi, chum,” I greet him cheerily. “What’s on your mind?”

“Ya Hercules Newton?” the kid growls.

“Yeah,” I acknowledge, surprised. “Who’re you?”

“Chief a pleece,” he snarls. “Where’s ya license?”

“What license?” I ask, remembering Pedro’s remark about being mayor for the day, and deciding this kid’s playing cop in the same game.

“Ya technician license,” the kid snaps, putting his hands on his hips belligerently. “Have ta close ya up if ya ain’t got one.”

I decide to humor him.
 “I don’t have one yet, chief,” I say. “But I’ll be happy to apply for it. What do I have to do?”

The kid whips out a piece of paper, and reads it to me. It’s copied right out of a physics book, apparently, and the kid has trouble reading it.

“How many lectruns in the orbutts of a merkry adam?” he stumbles.

“You mean how many electrons in the orbits of a mercury atom?”

“At’s what I said.”

“I haven’t the faintest idea.”

“Too bad,” the kid declares, stuffing the paper back in his pocket. “Ya flunked the exam. No license. Gotta close ya up.”

\$1,200.00 PRIZE CONTEST RADIO-ELECTRONICS IN THE HOME

Midnight of May 1, Eastern Standard Time marks the closing of the second month's Radio-Electronics in the Home contest. Entries for the May contest must be postmarked before this date. The closing date for the April contest is midnight, April 3.

FIRST PRIZE	\$50
SECOND PRIZE	\$25
THIRD PRIZE	\$15
FOURTH PRIZE	\$10

Monthly prizes totaling \$100 are given for the best ideas on applications of radio-electronics in the home.

Prizes will be awarded in accordance with novelty, general importance of the application or device, smallness of cost involved in building it, and practicability.

Any ideas may be submitted. Highest prizes will be awarded to contestants who have actually built the device and submit photographs to prove it. Lesser prizes will be given for "ideas" and entries not accompanied by photographs.

For complete details and rules of the contest see page 35 of RADIO ELECTRONICS for March.

The electron tube that rivals the human eye

Invention of the iconoscope—
TV's first all-electronic "eye"—led to
supersensitive RCA image orthicon
television cameras

No. 3 in a series outlining high
points in television history

Photos from the historical collection of RCA

● Had you attempted to invent a television camera from scratch, odds are you'd have followed the same path as early experimenters—and tried to develop it on mechanical principles.

Illogical? Yes, in the light of what we now know about electronics. But electronics was young in television's infancy. At that time the best way to take television pictures was with a mechanical scanning disk, invented in 1884.

Revolutionary was the invention of the *iconoscope* by Dr. V. K. Zworykin, now of RCA Laboratories. Here was an all-electronic "eye" for the television camera... no moving parts, no chance of mechanical failure!

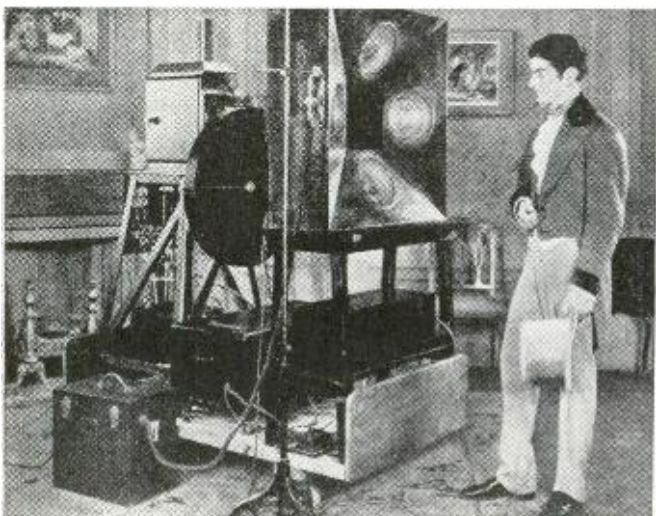

Mechanical scanning equipment, used at RCA-NBC experimental television station W2XBS in 1928, long before the present RCA image orthicon camera came into existence.



Dr. V. K. Zworykin of RCA Laboratories with his iconoscope tube. Its successor, the image orthicon, has been developed by RCA scientists to have up to 1000 times greater sensitivity.

Carrying forward the development of television pick-up tubes, RCA scientists have developed the image orthicon—eye of today's supersensitive RCA image orthicon television camera. So keen is this instrument's vision that it sees by candlelight or by the faint flicker of a match.

Despite its simplicity of operation, the RCA image orthicon tube is a highly complex electronic device. Integrated, within its slim 14-inch length, are the essentials of 3 tubes—a phototube, a cathode ray tube, and an electron multiplier!

The phototube converts a light image into an electron image which is transferred to a glass target, and scanned by an electron beam to create a radio signal. The electron multiplier then takes the signal, and greatly amplifies its strength so that it can travel over the circuits which lead to the broadcast transmitter.

Inside the tube itself, more than 200 parts are assembled with watchmaker precision. For example, a piece of polished nickel is pierced with a hole one-tenth the thickness of a human hair... a copper mesh with 250,000 holes to a square inch is used... and the glass target is bubble-thin! Yet all are assembled and made to work—at RCA's Lancaster Tube Plant—with precision.

Actually 100 to 1000 times as sensitive as its parent the *iconoscope*, RCA's image orthicon pickup tube literally rivals the human eye. And when an outdoor telecast may start in daylight and wind up in the dim light of dusk—that's a necessity!



Radio Corporation of America
WORLD LEADER IN RADIO—FIRST IN TELEVISION

THIS ONE BOOK ANSWERS THOUSANDS OF TV QUESTIONS... USE IT TO INCREASE YOUR INCOME!

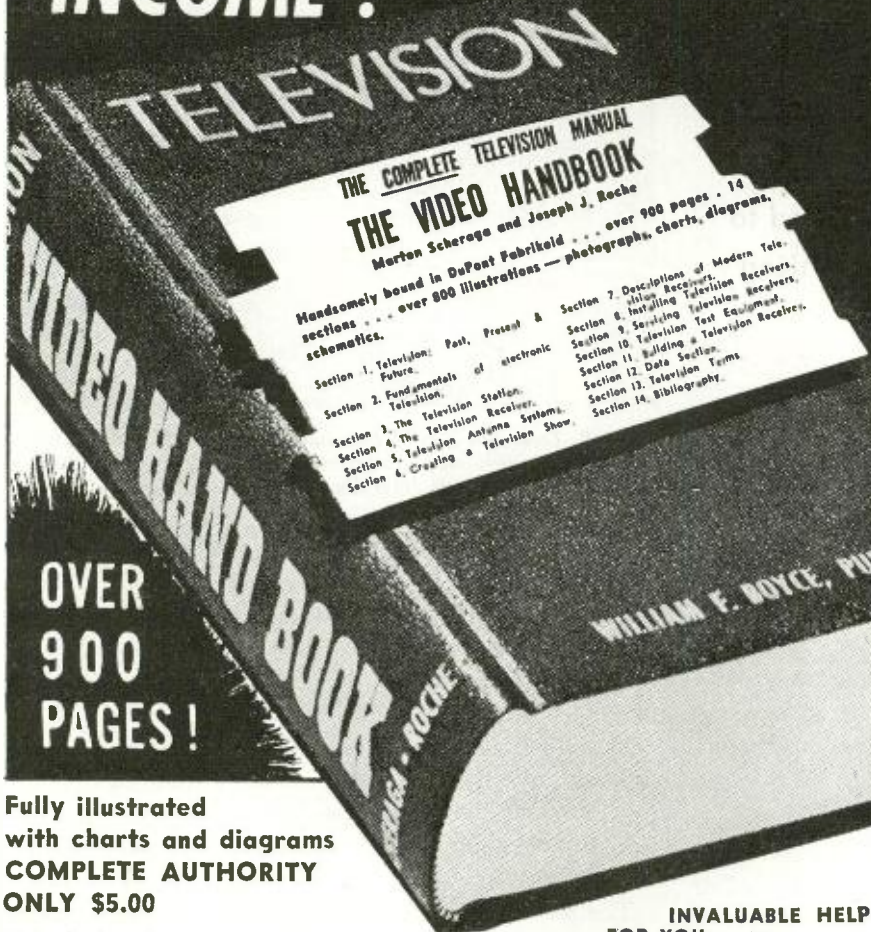

Fully illustrated with charts and diagrams COMPLETE AUTHORITY ONLY \$5.00

14 Books Complete in one volume . . . saves you time.

When trouble shooting, testing, installing, constructing, either receivers or transmitters, you can use the data and basic knowledge found in this one handy reference book. It can help you solve basic problems quickly in your shop, drafting room, studio, or in the field. You have just one source to find the answers quickly to all problems. If your income depends on any one of the many phases of television you cannot afford to be without this reference book.

Get them at your favorite dealers. If he cannot supply you, order direct, using the coupon.



RADIO DATA BOOK

Over 900 pages. 12 sections, completely illustrated **ONLY \$5.00.**

COMPLETE RADIO & TV LIBRARY

Both Radio and Video Handbook. Make an attractive valuable reference set. Buy both books and save money. **ONLY \$9.00.**



INVALUABLE HELP FOR YOU . . .

If you are an engineer, technician, student, or in television work of any kind.

MAIL ORDER COUPON NOW

BOYCE-ROCHE BOOK CO. MONTCLAIR, NEW JERSEY

RE-4

Please send me the following, postpaid:

-Radio & Video Library @ \$9.00
 -Radio Data Book @ \$5.00
 -Video Data Book @ \$5.00
- Check or M. O. enclosed in amount of \$..... Send them C.O.D.....

Name.....
Address.....
City.....State.....

"Wait a minute," I argue. "What difference does it make to a radio man how many electrons there are in any atom?"

"Ya oughta know," the kid snarls. "Can't have no dummies in the bizness ta gyp the public. Wanta try the other exam?"

"Sure," I say, smiling in spite of myself. "I'll give her a whirl."

He digs out another scrap of paper.

"What's ohums law?"

"Ohm's law," I translate. "That's more like it. 'I equals E over R'."

"Don't tell me about it," the kid growls. "Fer this exam ya gotta write yer answers." He pauses and scowls at me. "On a hunderd dollar bill!"

I go to the telephone and call the city hall, not quite sure whether I should laugh or get mad. I ask for the mayor, and sure enough, Pedro answers.

"Pedro," I say. "This is Herk."

"Hi, Herk. Call me Your Honor."

"Okay, Your Honor. Your chief of police is trying to shake me down," I say, eyeing the kid in front of the counter. He is still glaring at me, but not in the least perturbed otherwise. "He wants me to write my license exam answers on a hundred dollar bill. Bribery."

"No, Herk," Pedro says calmly. "Not bribery. That's to defray the cost of operating expenses in this licensing procedure. Perfectly legitimate. Better do like he says if you want your license." He hangs up on me. I sit there a minute with a dead phone, and then I slam it down on its cradle.

"Look, chief," I falter, facing the kid again. "There's some cheaper way for me. What is it?"

The kid gives me a long look, and then whistles shrilly. Another boy about the same age answers the call by walking in the door, planting his feet wide apart in front of the counter, and winking solemnly at the chief of police.

"This here guy," explains the chief, "has got a technician license. If ya hire him ta run yer store for a finn a week, we won't hafta close ya up."

"Hi," I ask the newcomer. "You know any radio?"

"Nope," he says cheerfully. "Don't know nothin' about it."

"Then how," I ask him, "did you manage to get a technician's license?"

"Politics," the squirt replies, in a confidential tone of voice. He leans an elbow on the counter, spits on the floor, and whispers at me. "Me cousin's a alderman."

"Here's a buck for you guys," I say, suppressing a smile. "Now beat it and leave me alone." They both grab the bill I hold out, and run through the door together, clutching the money between them.

I stand there at the counter a minute, scratching my head, and then I reach for the telephone again.

"Pedro," I say when my connection is completed. "I mean, Your Honor."

"Yes, Herk," he says sternly. "Speak

RADIO-ELECTRONICS for

up, please. I'm a busy man."

"I'm convinced," I confess humbly. "It could happen. You write that ad for me, will you?"

There is dead silence for a minute. Then a little laugh sounds in my ear.

"Sure, Herk," he says happily. "I'll do it right away."

"That's swell, Pedro. Because I'm going to call an emergency meeting of the association for tonight. I'd like to read them your ad."

"Okay, Herk."

"And I'd like you to give your views on licensing at the meeting, too."

"Me?" Pedro gasps. "I'm just a kid."

"I'll have a ten dollar bill here with your name on it," I say softly.

"But there's one thing," Pedro continues hurriedly. "I'm awfully old for my age."

UNIQUE CRYSTAL PROBE

Many owners of such d.c. vacuum-tube voltmeters as the RCA Volt-Ohmyst have constructed a.c.-r.f. test probes for their instruments, using 1N34 crystal diodes. These probe circuits are peak-operated and are of the shunt-diode type.

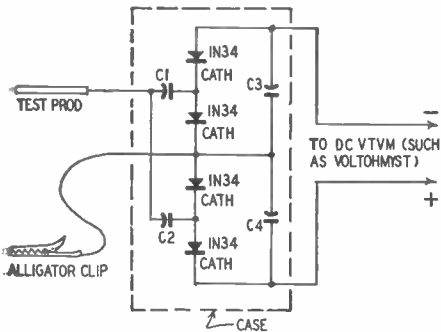

C1, C2, C3, C4 = .01µf POSTAGE STAMP MICA

The probe circuit shown in the accompanying circuit diagram is unusual in that it has an a.f.-r.f. voltage-quadrupler arrangement. Voltage stepup is obtained without a transformer. The d.c. output voltage of this probe is equal to approximately 5.66 times the r.m.s. value of the input voltage. This results in a much increased meter sensitivity. For example, the full-scale deflection on the 0-3-volt d.c. range of the v.t. voltmeter will indicate an a.f. or r.f. input voltage of only 0.53 volt r.m.s. when this probe is used.

Although the voltage-quadrupling probe uses four 1N34 crystals and four 0.01-µf postage-stamp mica capacitors, it may be built into a small-sized container. The crystal polarities indicated in the schematic must be followed exactly or the circuit will not multiply correctly.

It is advisable to make an individual voltage calibration after the probe has been completed and plugged into the d.c. vacuum-tube voltmeter, since the rectification efficiency of production-lot crystals varies and the 5.66 multiplication factor might not hold exactly for a particular quartet of crystals.—

Rufus P. Turner

NEW!

DIRECTION INDICATOR



TV ANTENNA ROTATOR

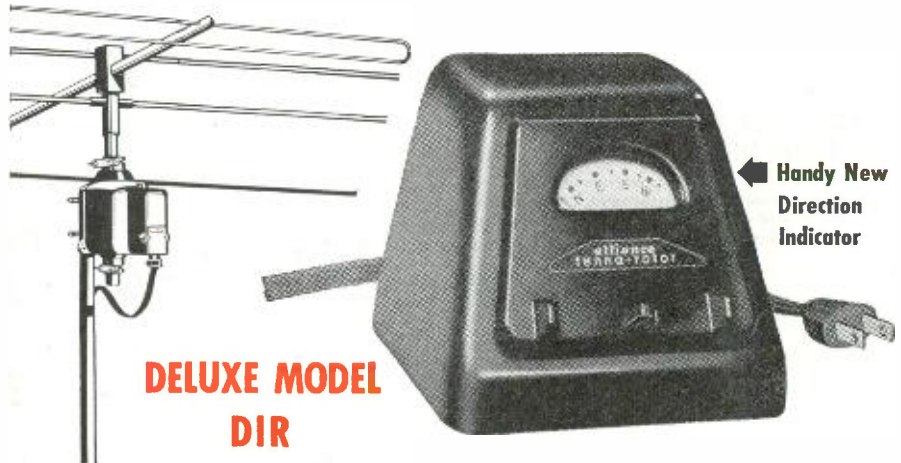

DELUXE MODEL DIR

• This deluxe model Alliance Tenna-Rotor is in use and on sale in every TV market! Priced only slightly higher than the standard ATR, it provides a direction indicator which quickly shows where the antenna is pointed!

Here's why it pays to sell Tenna-Rotor!

- The only rotator proved by thousands of users in major TV markets from coast to coast!
- Tenna-Rotor is demonstrated in over 2 million TV homes each week! Millions see the Alliance films now scheduled on 52 TV stations!
- Tenna-Rotor has Underwriters' Laboratories' approval!
- Tests conducted by Electrical Testing Laboratories Inc. prove Tenna-Rotor works in sub-zero—rainy, snowy and icy weather!

The only rotator featuring the Alliance 4-conductor cable with "Zip" feature which makes for faster, easier installations!

Guaranteed for one year!

Write for your copy of "Fastest profit maker in Television today."

Alliance Manufacturing Company • Alliance, Ohio

Export Department: 401 Broadway, New York, N. Y., U. S. A.

30-50 Megacycles FM

New PR-31 Receives More MOBILE CALLS

Emergency thrills... hear "news in the making" ... as it happens.

6 Tube superheterodyne, 115 volts AC or DC. Now you may enjoy.....

- POLICE
- FIRE
- HIGHWAY TELEPHONE
- MARITIME
- FORESTRY

\$44.95

LIST PRICE

PR-8 POLICALARM tunes 152-162 mc. \$39.95

See your dealer or write Dept. RE-5

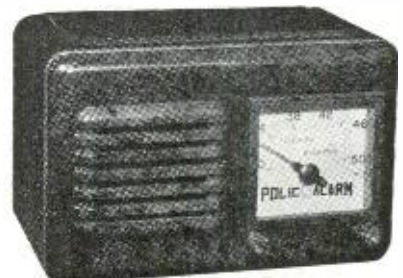

POLIC FM ALARM RADIO APPARATUS CORP.
303 FOUNTAIN SQ. THEATER BLDG.
INDIANAPOLIS 3, INDIANA

NEW! FOR FIELD OR BENCH WORK ...

OAK RIDGE miniatures

work like **GIANTS** for You!

EASIER, FASTER, MORE PROFITABLE
TV-FM SERVICING... at lowest cost!

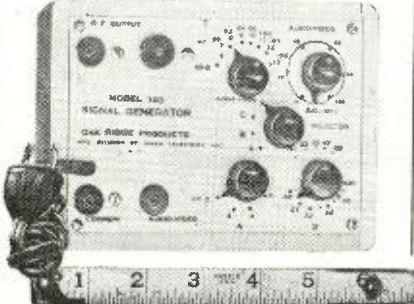

**OAK RIDGE 10-in-1 MINIATURE
TV-FM SIGNAL GENERATOR**

Pinpoints any signal failure from antenna to CRT or speaker in 2 minutes flat! Incorporates 3 separate tuning bands and modulation output and attenuator for TV & FM. Generates a signal to perform as complete .

• RF, OSC, and Mixer (1st Det.) Tester • Video IF Tester • Audio IF Tester • Video & Audio 2nd Detector Tester • Video & Audio Amplifier Tester • Sound Trap Aligner or Tester • Adjacent Picture Trap Aligner or Tester • Marker Generator • Antenna Orientation Tester • Antenna Sensitivity Tester.

You get ALL TEN IN ONE with this extremely adaptable, precision-made Model 103! Size: 5½x4x2¼". Dealer's Net \$29.95.

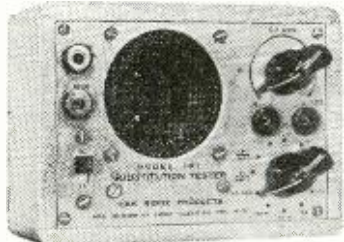

**OAK RIDGE 7-in-1 MINIATURE
TV-FM-AM SUBSTITUTION TESTER**

Which of these Servicing Aids do You Need Most?

- Test Speaker Without Transformer • Test Speaker With Transformer
- Paper Condenser Substitutor • Electrolytic Condenser Substitutor
- Fixed Resistor Substitutor • Variable Potentiometer Substitutor
- Audio Signal Tracer for Video, Audio & Sweep Circuits in TV, FM, AM, Audio Amplifiers, etc.

You get ALL SEVEN IN ONE with the versatile, precision-made Model 101! Size: 5½ x 4 x 2¼" Dealer's Net \$16.25.



**OAK RIDGE
3-in-1
MINIATURE
TV HIGH
VOLTAGE
TESTER**

Accurately checks all high voltages in any direct-view or projection TV set. Has precision 10,000 ohm/volt movement, three scales: 0-500V, 0-15KV, 0-30KV. Complete with special high voltage test lead. Size: 5¾ x 4 x 2¼". Dealer's Net \$14.95.

Boost your efficiency and earnings! Ask your parts jobber for these amazing new MINIATURES today! Write for free Catalog T-E.

OAK RIDGE PRODUCTS
239 EAST 127th STREET NEW YORK 35, N. Y.
Manufacturing Division of VIDEO TELEVISION, INC.
Makers of the famous OAK RIDGE Patented
SNAP-LOCK TV-FM Antennas and Accessories.

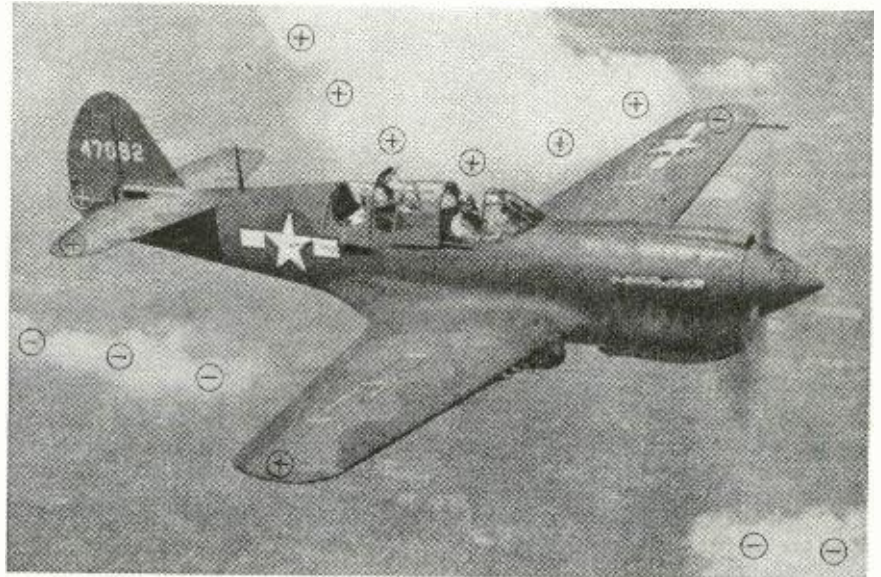

Aircraft flying through storm accumulates both positive and negative charges.

Static Troubles in Aircraft Radio

By **THERESA M. KORN**

RADIO interference can be so destructive to communications in modern aircraft as to result in crashes. This is true, in particular, of aircraft navigated by radio. Visual indications of radar and other navigational devices can be obliterated by radio noise.

The air force and commercial services are keenly aware of the effect radio noise has upon the morale and efficiency of air crews. They have found that even small quantities of radio noise can become so annoying that, to escape it, crews turn down receiver sensitivity to such dangerously low levels that communication is unreliable.

Radio noise includes periodic corona discharges from the aircraft, atmospheric electrical discharges, and man-made noise.

Corona discharges produce *precipitation static*, which resembles frying, crackling, and musical "crying" sounds together with rumbling background noise.

Precipitation static results when large electrical charges on propeller tips, antennas, and other aircraft extremities discharge into the surrounding atmosphere. These large charge densities are produced by the rapid impact and friction of rain, snow, sleet, hail, or dust upon the aircraft skin.

Another type of precipitation static, *external field static*, occurs during flight through the strong electrostatic fields of thunderstorms. By induction, large

concentrations of positive or negative charges accumulate on some portions of the aircraft while other portions acquire an opposite charge, as shown on the Curtiss P-40 in the photo. Radio noise results when the charge concentrations reach the critical breakdown point of the adjacent atmosphere and corona discharges occur.

Corona discharge, or St. Elmo's fire, is sometimes visible to the occupants of the aircraft as streamers of bluish flame up to 6 inches long. To prevent such corona discharges, ten to twelve dry-wick dischargers are mounted on aircraft extremities to drain off electrostatic charges to the surrounding atmosphere as they accumulate. The use of dielectric-covered wire in the new antistatic antennas also greatly reduces precipitation static.

Atmospheric static occurs in receivers as random bursts or crashes of varying amplitudes during the lightning discharges of thunderstorms. The intensity of this radio noise depends on the geographical location, season, and weather. It is most severe in the tropics during the rainy season.

Man-made noise

The most troublesome sources of man-made noise are the electrical transients caused by electrical rotating machinery, ignition systems, and other current-interrupting devices.

Of these, the worst radio offender is the ignition system. Each time a spark

plug is fired, a steep-wavefront voltage, rich in harmonics, is set up. This interference may be severe unless the entire ignition assembly is effectively shielded to prevent radiation to receivers.

Ranking close to ignition noise in production of radio interference are various pulsed electronic devices, including radar equipment, which produces periodic pulses of high amplitude. Adequate shielding and placement of these units as far from receivers as possible is absolutely necessary.

Machinery with moving contacts (vibrators, relays, and voltage regulators) can produce clicks in receivers each time they make or break contact. These current interruptions cause transients that are not usually serious unless they are repeated frequently.

Less-important sources of man-made noise are industrial areas on the ground, electrical equipment in nearby aircraft, and interfering transmitter signals.

Although some hash may occur in receivers in the vicinity of large industrial areas, it is not a serious hazard since the intensity is usually low and the duration short. This is also true of radio noise from nearby aircraft, but this source can be very troublesome if the noisy aircraft is one of many other planes flying in close formation.

Radiation from other transmitters presented a special problem to military aircraft during the last war. Although some of the signals were from friendly transmitters, others were jamming signals from enemy sources that required special remedial action.

Receiver internal noise appears as a random sizzling, hissing, or crackling sound. In visual output devices, it causes the spurious indications called hash or grass. This background noise, inherent in the circuit components, is caused by thermal agitation in the receiver input resistance, tube hiss, and shot effect in radio-frequency stages. Leaky capacitors, defective batteries and tubes, poor contacts, and noisy carbon resistors are also noise sources. A periodic check of the equipment will help to keep these effects at a minimum.

When radio noise enters a receiver,

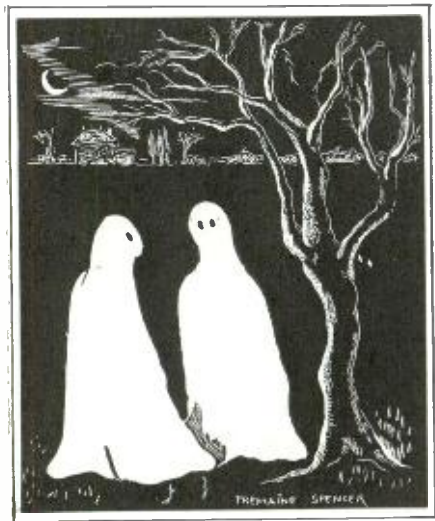

"Didn't I see you on television the other night?"

WE'RE BEING SWAMPED



WITH ORDERS



BLEEP
BLOOP
BLAP

FOR THE NEW NIAGARA HI-PASS FILTER KIT. You don't have to be plagued with TV Interference. We guarantee positive protection against amateur, diathermy, industrial and all other R.F. interference. No loss in brightness or clarity. Money back if it does not work. Designed for 300 ohm antenna feedline.

*Cat. No. C-281 (We can supply everyone at the fabulously low price of) **\$1.95 plus** ^{15c shpg.} in U.S.A.

HAMS—DON'T BE BLAMED FOR TVI!

Tests have proven that Niagara's NEW LOW-PASS FILTER KIT Attenuates frequencies above 40 MCS. Passes ALL frequencies below 40 MCS. Less than 1/60 of 1 DB. insertion loss. Fits any 72-50 ohm line. Will take up to a full KW. Directions included. *Cat. No. C-279 \$4.95 plus 25c shipping in U.S.

BARGAINS IN SOUND POWERED PHONES

Talk up to 10 miles without batteries. Ample volume. May be paralleled. Two types—both complete with cord and plug. Type "O" Chest set mike with headset phones, RCA #MI-2475. Our Cat. No. C-299. Special \$4.95. Type "Q" Headset with "Swing-Away" Mike attached. RCA #MI-2454. Our Cat. No. C-300. Special **\$9.95 each**

T-24 CARBON HAND MIKE

A rugged mike with push-to-talk switch, ideally suited for mobile or marine use. Features—7 ft. flexible rubber cord PL-106, anti-noise choke and JK-38 jack into which two other mikes may be plugged, making a 3-way parallel talking circuit.



Cat. No. C-278
Very special. .

\$1.00 each
Postpaid in U.S.A.

BT CUT 1000 KC. CRYSTAL



Fine precision crystal originally used in frequency standard. Low drift, moisture sealed, BT cut. Brand new in 3/4" pin spaced holders. LAST CHANCE! Cat. No. C 189..... **\$4.95**
YOUR COST..... **\$4.95**

BRAND NEW TUBES

TRANSMITTING		RECEIVING	
E1148	\$.34	1H5GT	\$.50
2C26	.28	3A4	.27
5BP1	1.70	3B7	.29
10Y	.28	3D6	.29
211	.28	6C4	.20
803	3.63	6AR5	.54
805	3.63	6D6	.42
813	6.90	6K7GT	.43
815	1.37	85H7	.27
843	.30	6SS7	.53
954	.18	7C4	.28
955	.18	12A6	.15
957	.18	12H6	.22
958A	.18	12K7GT	.49
1619	.18	12SH7	.29
1625	.18	12SR7	.29
1626	.18	28D7	.29
7193	.47	35L6GT	.40
9004	.18	50B5	.40
9006	.18	50L6GT	.51

ALL QUANTITIES LIMITED

Send for complete new Tube listing "C"

*Dealer
Inquiries
invited

Niagara Radio Supply Corp.
Phone Digby 9, 1132-3-4
Dept. C40 160 Greenwich Street, New York 6, N. Y.

No C.O.D.'s.
All prices
F.O.B.
our N.Y.
warehouse.
Minimum order
\$2.00

MORE BARGAINS IN SURPLUS EQUIPMENT

1-2 or 3 of each • Check every line!

- Wileox CW-3-110V Superhet Revr. New \$75.00
- Antenna rotating Motor RL-42A Reel Exc. 2.95
- W. E. XMTR MOD. Comp. w/controls spares
New 225.00
- MN 26C Radio Compass—New 32.00
- MN26C Radio Compass—Used 26.95
- 733D Localized Receiver Exc. 6.95
- AN-APN-1 Altimeter—L.N. 18.95
- 274N Modulator BC456A w/tubes Exc. 2.65
- 274N Modulator BC456A Pair less tubes. 1.68
- SCR 522 Receiver BC624 Exc. less tubes. 7.95
- BC 1000A Transceiver New 300.00
- BC 645 Transceiver. Contr. Box, Dyn. In-
struction book, New 17.95
- T-17 Handtalker 200 Ohm Imp. Exc. 3 for \$1.95
- PE 94 24V. DKN. for SCR522 Used L.N. 2.95
- Surplus radio conv. Manual Vol. 1 or 2 2.90
- BC 654 80 Meter XMTR & RCVR. w/tubes
XTAL L.N. 24.95
- ASD Radar Set Complete—New (Price on Request)
- ASD Parabolic Antenna—Rotable—L.N. (Price on Request)
- 2601A Parabolic Rot. Ant.—L.N. (Price on Request)
- R784 APS 15A Electronic Camera (Price on Request)
- BC221 Freq. Mtr. w/XTAL & Calib. Book
L.N. \$75.00
- LM Freq. Mtr. w/XTAL, Book, Mod. Exc. 90.00
- TBY, Navy 6 & 10 Mtr. Bat. Transceiver 34.95
- RME69 RCVR. w/SIKR—VY. GD. 59.00
- BC-375 Tuning Units New—cased 4.95
- BC-375 Tuning Units Used—cased 3.95
- GE 25 Watt Phone XMTR Model GF4A Pow.
Sup. Exc. 29.95
- ATD 50 Watt XMTR New 49.95
- JQ Navy 6V. Port. Audio Ampl. w/VIB. Sup. 9.95
- Gibson Girl Emergency XMTX. New 2.89
- BC 614 Speech Amplifier For BC610 L.N. 55.00
- W1252 Electronic Wavemeter 22-30 Mcs. Exc. 44.95
- BC Ant. Tuner for RC610 L.N. 59.90
- BC 342 Navy Comm. RCVR. Exc. 69.95
- McMurdo Silver RCVR. Mod. 801 G-80 Mtra.
w/tubes L.N. 29.95
- Gen-Set 50-54 Mc. Conv. L.N. 24.95
- Beach 80 Meter VFC New 19.95
- Handy 28.5-29.7 Mc. Conv. New 24.95
- BC-347C Interphone Amplif. L.N. 2.95
- Dynamotor SA 5088 Imp. 18V./Out P. 450V. 4.95
- GP7 Tuning Units—New—cased range A-D. 4.95
- GP7 Tuning Units—Used—cased range A-D. 3.95
- GP7 Tuning Units—Used—no case range A-D 2.95
- BC 610 Plug-in tuning units TU47 to TU54. 3.50
- AN-APN-4 Revr. Exc. 14.95

**GENERAL
INDUSTRIES**

... covers the

3-Speed

PHONOMOTOR MARKET

"A motor for every phonograph requirement". . . this General Industries slogan is as true today as it was thirty years ago when it was first introduced. Today General Industries manufactures a complete line of single-speed, dual-speed and three-speed motors for use in every type of record player and automatic record changer.

General Industries offers you the popular belt-drive Model TS 3-speed motor for both automatic record changer and manual use, and the turret model 3-speed motor illustrated for automatic record changer applications. Write today for complete details.

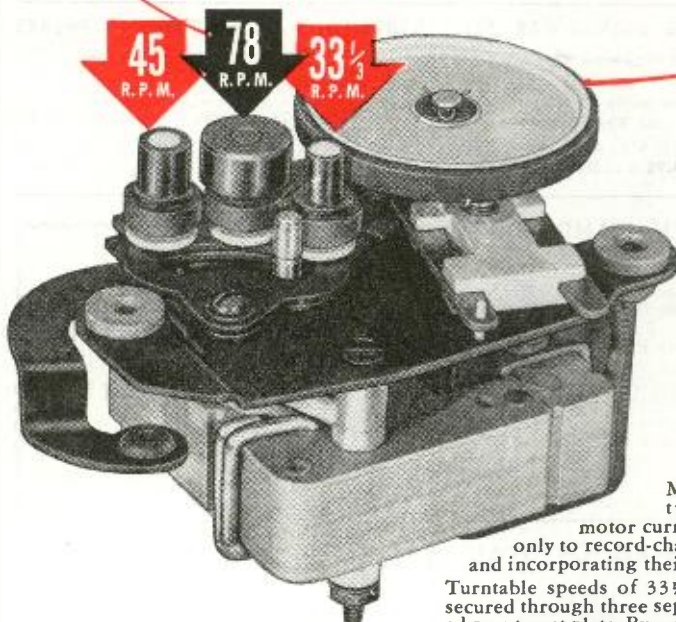

Model illustrated is a turret-type 3-speed motor currently being supplied only to record-changer manufacturers, and incorporating their own specifications. Turntable speeds of 33 $\frac{1}{3}$ —45—78 RPM are secured through three separate pulleys mounted on a turret plate. By means of a simple lever, the desired pulley is brought into contact with the idler wheel. The two pulleys not in contact with the idler wheel remain stationary.

G

The GENERAL INDUSTRIES Co.

DEPARTMENT C • ELYRIA, OHIO

it does so by either conduction, induction, or radiation.

Man-made noise, for instance, reaches the receiver through the common bus of the electrical system by conduction. Conductive coupling occurs only in circuits close to the noise source, since its effectiveness decreases as the square of the distance from the source.

As currents flow through the conductors, electromagnetic fields are set up around them. These fields are capable of inducing interference currents in the receiver. Parts of the fuselage, compartments, and bulkheads can be used as shields against inductive coupling.

Some of the electromagnetic fields about conductors of radio noise are radiated at the speed of light, just as radio-frequency energy is radiated from a transmitting antenna.

Paths of entry to the receiver for noise energy include the antenna and its lead-in, the receiver power and control wiring, as well as the receiver case and output leads. Radio noise energy can be kept out by suppressing it at its source, by adequate shielding and filtering, and by wisely selecting installation locations.

Extensive experiments have been conducted to determine the thresholds of intelligibility of speech under various noise conditions. The threshold of intelligibility is that speech-to-noise ratio at which the listener is just able to follow the gist of conversation through electrical noise. A speech-to-noise ratio of 4 to 1 is generally accepted, although then a listener misses almost 10% of the single, isolated words spoken. For reliable communication, a speech-to-noise ratio considerably greater than 4 to 1 is essential.

Ambient acoustical noise is not radio interference in the strict sense of the word, but it has an important bearing on the problem. A sufficiently large speech-to-noise ratio must be maintained despite the noise generated by the engine, propellers, exhaust, and slipstream. To do this, the receiver output must be greatly increased. However, increasing the receiver output amplifies the electrical noise as well as the signal. The resulting din is very annoying and lowers the crew's efficiency.

Until just a few years ago, the task of radio noise elimination amounted to merely attaching a filter here, adding a bit of shielding there, and assuming the remaining noise was a necessary evil. Today extensive research and experimentation show that a surprisingly large amount of radio noise can be eliminated on the designers' drafting boards even before the airplane or its components are built. The responsibility for low-noise design in aircraft lies with three key men: the radio and electronic equipment designer, the electrical equipment designer, and the radio installation designer.

Even with good design, however, there is sometimes a certain amount of radio interference that must be eliminated. The amount of this noise can be measured only by testing the completed installation under flight conditions.



**SOUND
POWER**

**PHONE AND
CHEST SET**

RCA MI-2454-B

Complete with 24' of
Rubber Covered Wire
New export packed
Shipping weight 6 lbs.

\$6⁹⁵ Per Set 2 Sets **\$13⁵⁰**

Each Set Fully Guaranteed

Brand New Government Cost, \$42.00 ea.

XTALS 500KC standards 2 pin holder
CR-28/U brand new \$1.50

McCONNELL'S 3834 Germantown Ave.,
Phila., Penna. RA5-6033

TELEVISION RECEIVER—\$1.00

Complete instructions for building your own television receiver. 16 pages—11"x17" of pictures, pictorial diagrams, clarified schematics. 17"x22" complete schematic diagram & chassis layout. Also booklet of alignment instructions, voltage & resistance tables and troubleshooting hints—All for \$1.00.

CERTIFIED TELEVISION LABORATORIES
Dept. C. 5507-13th Ave., Brooklyn 19, N. Y.

SEE RADIO-ELECTRONICS

at

THE RADIO PARTS SHOW

Chicago, May 22-25

Hotel Stevens, Room 602

RADIO-ELECTRONICS for

GEIGER TUBE FEEDBACK

RESPONSE amplitude of many Geiger-Muller-counter amplifiers may be increased, sometimes spectacularly, by adding surge-type feedback to the circuit. Click amplitude increases greatly, and very little is added to the weight of the equipment.

One method of introducing very effective feedback is to insert the primary of a small interstage transformer (approximately 1:1 ratio) into the B-plus lead of the amplifier tube, and to connect the secondary in the grid return, as in the diagram. The secondary is so polarized that an increase

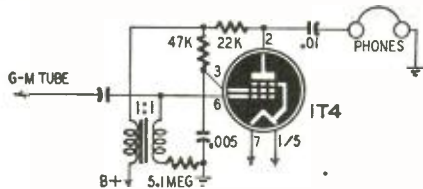

in plate current makes the grid positive momentarily. When an incoming pulse from the G-M-tube circuit puts a small negative pulse on the grid of the 1T4, the plate current decreases slightly. This reduces current in the secondary of the transformer, which continues to drive the grid more negative as long as the plate current decreases. The resultant plate current is very strong surge, producing a loud click in the headset.

This circuit is very effective in portable equipment, but will respond to any impulse anywhere in the circuit; therefore, a "clean" plate supply is essential. The amplifier will respond to plate circuit "hash" just as effectively as it will to a G-M-tube discharge.

The same principle is applicable to stationary equipment, but usually requires limiting resistors in the circuit so that a really good surge will not melt plates in the amplifiers, with accompanying pyrotechnics and shut-down for repairs.—*Ronald L. Ives*

(Another method uses a 1U5 for the amplifier, coupling the diode section plate to the amplifier plate with a small trimmer and to the grid through a 5-megohm resistor. Electrons drawn by the diode plate go to ground through the resistor, thus adding to the impulse on the grid.—*Editor*)

TRANSMITTING TUBE CHECK

Only very large commercial tube users have equipment to test transmitting tubes. However, a simple and satisfactory check can be made as follows.

Detune the final or multiplier circuit in which the tube is being used, noting the plate current. This current rises at either side of resonance. With a new tube the rise will be much higher than with a much-used tube. Emission drops with use; therefore the rise is more limited in a tube that needs replacement.

If the operator takes periodic off-resonance readings, he can judge the condition of his tubes. No circuit should be left detuned longer than necessary, of course.—*I. Queen*

APRIL, 1950

HICKOK Television
LINEARITY-PATTERN GENERATOR

MODEL 620

SERVICE MAN'S INCOME BUILDER...

Provides Stable Pattern for Aligning TV Anytime... Anywhere HOME OR SHOP



● Here is the instrument for television trouble-shooting that is completely independent of station operation.

A new portable instrument especially designed to make TV Warranty Servicing simpler and more profitable.

Now you can prove to any customer in his home, by an electronic instrument that his set is properly aligned. Then, if reception is still faulty, you are able to show the receiver is not at fault. Perhaps a better antenna installation is needed.

Model 620 is a compact, portable instrument built to the high HICKOK standard. Technicians who seriously considered dropping warranty servicing now use the 620 and profit by it. Ask any technician who owns one.

See your jobber for complete information.

Features

- High output to 5,000 microvolts.
- Checks relative receiver sensitivity; horizontal and vertical deflection circuits.
- Permits alignment of linearity, drive, width, height, hold and horizontal AFC controls.
- Connects to receiver antenna.
- Blue hammertex portable steel case.

THE HICKOK ELECTRICAL INSTRUMENT CO.

10531 Dupont Avenue · Cleveland 8, Ohio

Please send me complete details on the new HICKOK 620 Television Linearity Pattern Generator

NAME _____
ADDRESS _____
CITY _____ STATE _____

1910

Our 40th Anniversary

1950

NEW LOW PRICES ON TELEVISION CONDENSERS

.05	—2500V	\$.52
.1	—2500V57
.05	—3000V54
.003	—6000V49
.01	—6000V58
.05	—6000V79
.0005	—7500V48
.03	—7500V68
.003	—7500V52
.005	—7500V57

ONE POUND ECONOMY ROSIN SOLDER	... \$.49
ONE POUND DELUXE ROSIN SOLDER54
\$3.95 SOLDERING IRON, 100 watts 1.77
VM 2-SPEED RECORD CHANGER, 78 & 33 1/2 19.94
APPROVED ZIP CORD, 18 gauge, 500 feet 6.89
FM CONDENSER & COIL KIT, w/instructions 4.95
OUTPUT TRANSFORMER, matches 3Q544
OUTPUT TRANSFORMER, pushpull 2-6V669
SELENIUM RECTIFIER, 75 mills54
VOLUME CONTROL, less switch, 250000 ohms16
VOLUME CONTROL, less switch, 1/2 meg16
VOLUME CONTROL, less switch, 1 meg16
TOGGLE SWITCH POPULAR TYPE DPDT36
50¢ BOTTLE PHILCO FURNITURE POLISH09
TELEVISION NO GLARE FILTER 16" 1.85
TELEVISION TWIN LEAD-IN, 300 ohms, 100 ft. 1.39
RG59U COAXIAL CABLE, 72 ohms, 100 feet 3.95

BROOKS RADIO DIST. CORP. 80 VESEY ST., DEPT. A • NEW YORK 7, N. Y.

A Simple Electronic Key

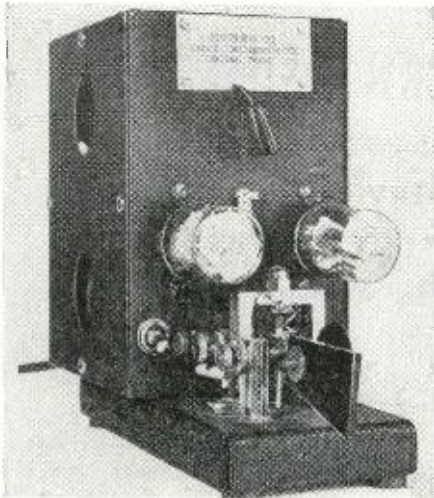

The electronic key, a compact assembly.

Construction problems eliminated by using bug in an electronic key.

By JACK D. GALLAGHER, W5HZB

AN electronic key based on a multivibrator circuit was described in "A Deluxe Electronic Key," by Wilbur R. De Hart, in the September, 1946, issue of *QST*. Such an arrangement is well worth consideration if good results are to be obtained from the multivibrator circuit. Other circuits may perform just as well, but most of them require more than one adjustment to change speed, while others are less dependable in operation. In both keyers described in this article, the basic multivibrator circuit and speed-switching arrangement have been followed. The mechanical construction has been simplified by utilizing the keying mechanism of a regular bug instead of a separately constructed mechanism, which would be a tedious job without proper tools and other equipment.

Since the keyer diagrammed in Fig. 1 was constructed with a semi-portable feature in mind, such space-consuming items as a vacuum-tube keying arrangement and an audio oscillator were purposely omitted. The second unit (Fig. 2) contains an audio

oscillator used for monitoring purposes.

The smaller unit is assembled in a small metal box that is mounted on the back of the base of the bug. A minimum of drilling is required for the mounting, and the result is a very compact unit that is easy to handle.

As shown in the circuit diagram of Fig. 1, the keyer will function as a multivibrator if the cathode resistor of V1-b is shorted out by pushing the key lever either to the right or left. In the multivibrator circuit it is necessary to establish both equal and unequal conducting periods as well as a neutral position for keying. These requirements can be met by making the grid resistances of V1 equal, C1 and C2 equal, and C3 twice the value of C1. When C3 is connected in parallel with C2, as it is for producing dashes, the total capacitance becomes three times that of C1 and the conducting period is three times as long as when dots are produced. However, in order that the first dash be the correct length, C3 must be charged to the correct potential just before the dash is made. This is achieved by leaving C3 paralleled with C2 except when dots are made.

The combination of the speed selector switch and its resistors is a very useful part of the keyer, because almost instantaneous speed changes can be made with minimum adjustment. Many keyers have used potentiometers for

speed control, but unless these potentiometers are properly matched for all positions of adjustment, the dots and spaces will not be the same length.

The circuit of Fig. 1 or Fig. 2 will produce dots and spaces or dashes and spaces, depending upon the position of the lever arm of the keying mechanism. These dots and dashes are transmitted to the keying amplifier V2-a through the coupling capacitor C4. V2-a conducts with the key in the neutral position. Due to the voltage drop in the V1-a plate resistor, a negative potential is applied to the grid of the keyer tube V2-b, causing plate current cutoff in the keyer tube.

When a dot or a dash is made, the following events take place: The negative voltage applied to the grid of the amplifier tube is sufficient to drive the amplifier grid beyond cut off. At this point the amplifier tube stops conducting, and a positive voltage with respect to the cathode is impressed on the grid of the keyer tube. The keyer tube then conducts and produces dots or dashes which operate the relay.

In both units (Figs. 1 and 2), V2-b serves to actuate the relay, which keys the transmitter (and keys the audio oscillator in Fig. 2). The neon bulb in Fig. 1 is simply an indicator which glows when the relay operates;

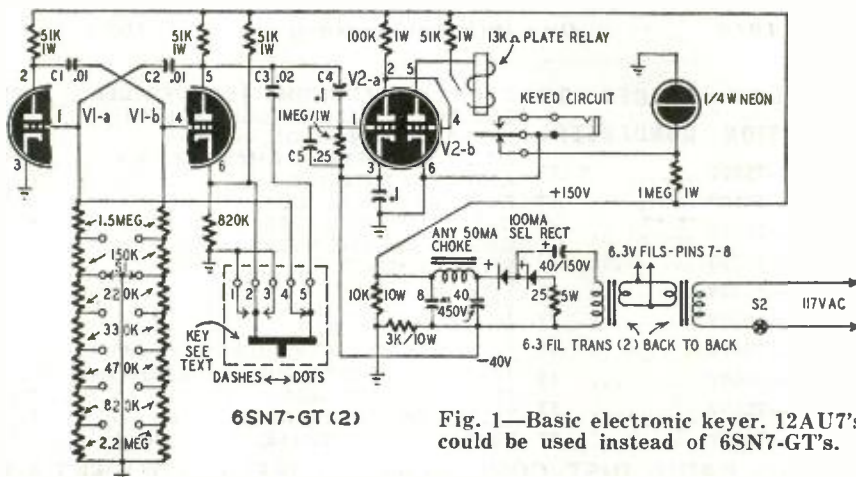
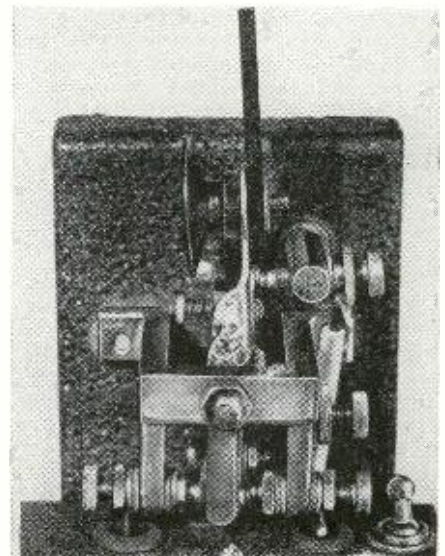

Fig. 1—Basic electronic keyer. 12AU7's could be used instead of 6SN7-GT's.



Bug was adapted for key mechanism.

the relay armature removes the ground and allows positive voltage to be placed across the lamp. At slow speeds this system can be used as a good visual monitor.

Several types of audio-frequency keying oscillators were tried before the circuit shown in Fig. 2 was used. The multivibrator type keyed well but had a disagreeable tone. The feedback type had the disadvantage of slow starting when keyed. The circuit of Fig. 2 allows the oscillator to operate at all times, but it is cut off from the grid of the amplifier tube V3-b by the ground on the relay armature. This arrangement provides clean, fast keying and a desirable tone. Any pitch may be produced by selecting the proper values of C6 and C7. The values shown in Fig. 2 produce a frequency somewhat less than 1,000 cycles. The transformer T was removed from a 274-N surplus receiver and is suited for its purpose in the oscillator because of its size, but almost any i.f. transformer can be used. The terminal numbers given are for the 274-N unit.

Construction

Ordinarily the key mechanism would probably be the most difficult part of the mechanical construction; but if a standard bug is used, no mounting problems are encountered. The drilling consists of making one hole through the rear arm and reaming out two holes on the rear of the main support so that two thumbscrews can be insulated. It is also necessary to remove everything on the bug base from the rear arm back so that the 4 x 5 x 6-inch metal box can be mounted on the base. In Fig. 2, the metal box measures 6 x 6 x 6-inches.

As shown in Fig. 1, the key mechanism must short out the V1-b cathode resistor for either dots or dashes, disconnecting C3 for producing dots. In the neutral position, C3 must remain paralleled with C2 to keep C3 charged to the correct potential for making the first dash the right length.

Each key contact in the diagram can be seen in the photograph with the exception of the regular dash contact, which is just forward of the main sup-

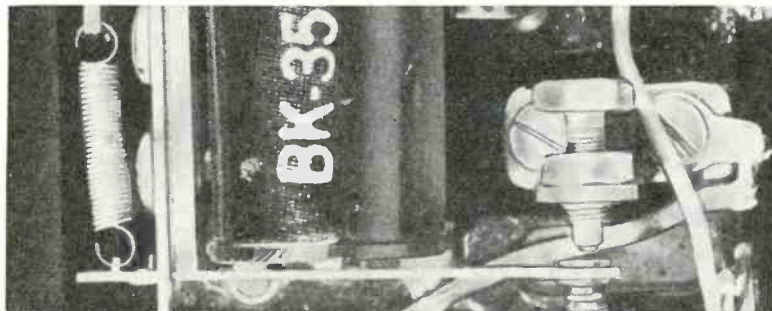

Note contact spacing for the plate relay. Surplus relays can be adapted easily.

The closed-circuit jack is insulated from the metal box and is installed for the purpose of keying a relay which is mounted on the back of a receiver for break-in operation. This relay is the same type as used in both of the keyer units.

The power supplies of Fig. 1 and Fig. 2 provide both positive and negative voltages for each keyer. Two 6.3-volt filament transformers are used in each supply to prevent the a.c. line voltage from being connected to the framework.

port and not visible. The thumbscrew on the right side of the main support is represented in Fig. 1 by point 4.

Two contacts are mounted on the rear arm. The contact (point 5 in Fig. 1) on the right side of the rear arm is mounted on a tinned brass terminal lug and held in place by the screw which passes through the rear arm. It is insulated from the rear arm by a fiber bushing and two fiber washers on each side. Also, a terminal lug is mounted on the same screw to connect the contact to C3.

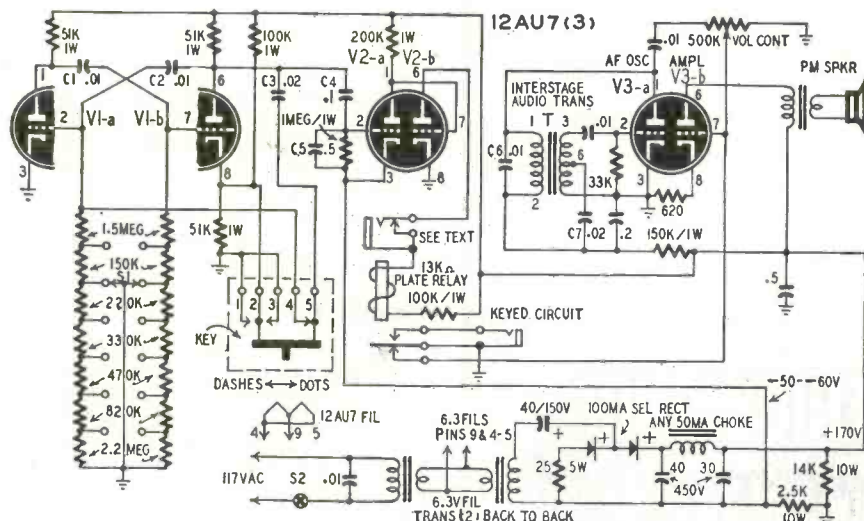

Fig. 2—This keyer is like that of Fig. 1 except that it includes an a.f. monitor.

TELEVISION SCOPE

SUPERIORITY AT A GLANCE!

The vertical response of this economy TV scope is usable to 5000 kc, not 50 kc. Response is flat to 750 kc, down 3 db at 1000 kc. Amplifier supplies a voltage gain of 20 at 5000 kc.



AR-3

Check this necessary feature before you buy any scope for TV use.

The R.S.E., AR-3 Scope has been built by Ross Armstrong to our rigid specifications. It's a complete unit that embodies standard horizontal amplifier and sweep circuits with normal sensitivity.

The case is 8" high x 5" wide x 14" long, attractively finished in "hammered" opalescent blue enamel. Operates on standard 110 volts—60 cycles—40 watts. Tubes, 3BP1-6AC7-6SJ7-6X5-5Y3-884. Instructions included. Complete specifications upon request. Satisfaction or your money back.

PRICE \$4995

AVAILABLE TO JOBBERS IN QUANTITY

F. O. B. DETROIT

INTERCOM & RADIO

AT A PRICE THAT CAN'T BE BEAT



6 tube superhet—3 tube intercom permits communication between radio-master and up to 4 sub-stations.

WHILE THEY LAST \$2995

With 1 sub-station and 50 feet of cable Extra Sub-stations \$3.95 each

Original cost \$64.50

PUSHBACK WIRE



25% BELOW MILL COST!

1st class, Essex or Lens, ALL SOLID tinned copper, double cotton serve, waxed finish.

SIZE	COLORS	100 feet	1000	Production Reel
22	BLACK-BROWN	.39	3.79	3.65M
20	RED-WHITE-BLUE	.49	4.49	3.95M
18	BROWN	.69	5.98	



ORDER INSTRUCTIONS

Minimum order—\$2.00. 25% deposit with order required for all C.O.D. shipments. Be sure to include sufficient postage—excess will be refunded. Orders received without postage will be shipped express collect. All prices F.O.B. Detroit.

Quantity and Export Orders Solicited

RADIO SUPPLY & ENGINEERING CO., Inc.
85 SELDEN AVE. DETROIT 1, MICH.



CLIMB ABOARD!

for **EXTRA PROFITS**

and
GREATER SALES

with the

Super Sonic

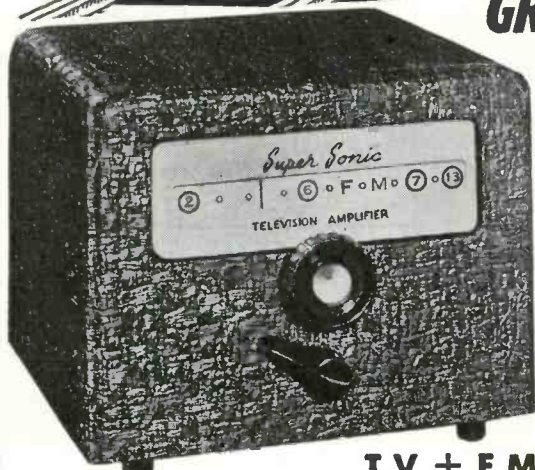

MODEL IT4

TV + FM AMPLIFIER

(2 INSTRUMENTS IN 1)

Impartial and exhaustive tests prove that the new SUPER SONIC—MODEL IT4 TV+FM AMPLIFIER delivers a higher usable gain with full bandwidth and higher signal to noise ratio than other leading brands at ANY PRICE!

\$32⁵⁰
List

- Improves TV reception in weak signal areas, with indoor or outdoor antenna.
- Continuous tuning of all 12 TV channels, also FM with ONE knob control.
- Reduces electrical, diathermy interferences and minimizes "ghosts and snow" effects.
- Frequency range: 50 mc to 220 mc, continuously tuned.
- Bandwidth: Adequate at all channels.
- Insertion gain: Minimum of 18 db at any frequency with 300 input and output impedances.
- Highest signal to noise ratio.
- Input and Output Impedances: 300 ohm balanced to ground and 72 ohms unbalanced.
- Inductances wound with PURE SILVER wire.
- All moving contacts heavily silver plated.
- Isolation transformer.

CHOICE TERRITORIES STILL AVAILABLE

Write for Free Brochure to Dept. RE-2

SONIC INDUSTRIES INC.

"MANUFACTURERS OF DUOSONIC PHONOGRAPHS"

221 WEST 17th STREET, NEW YORK 11, N. Y.

The contact represented in Fig. 1 by point 2 is shown on the left side of the rear arm and is soldered to a copper strip, which in turn is soldered firmly to the rear arm. The thumbscrew on the left side of the main support is insulated from the main support and is represented in Fig. 1 by point 3. Point 1 in Fig. 1 is the regular dash contact; it is connected to point 3. Connections to the insulated thumbscrews on either side of the main support from inside the box can be seen in the closeup view of the key.

The description of the key mechanism applies to both units, but the photograph was taken of the unit shown in Fig. 1.

A relay used for keying a transmitter is usually considered untrustworthy, since adjustments must be made and contacts must be kept clean. However, very satisfactory performance has been obtained with the relay found in the surplus aircraft beacon receivers. The relay may be purchased from some radio surplus stores for less than \$2. It has a d.c. resistance of about 13,000 ohms, and it will work very satisfactorily on 500 μ a.

Since the relay does not have a contact on the back-stop thumbscrew, it is necessary to provide one for clean-cut keying of the audio oscillator in Fig. 2. Such a contact was found on a surplus relay taken from a BC-459 transmitter. The back-stop thumbscrew of the relay in Fig. 2 was removed and the end was filed to a flat, clean surface and tinned. Then the contact spring from the relay in the BC-459 was cut off about $\frac{1}{4}$ inch from the contact. The back side of the contact was tinned and soldered to the tip of the back-stop thumbscrew. When the thumbscrew had cooled, the remaining part of the contact spring was cut off and the edges filed down to a smooth surface. The surface of the contact was cleaned and the back-stop thumbscrew was screwed back into the screw mount.

The contacts which are already on the relay, and almost any contact found on other surplus relays, are quite suitable for keying oscillator and light buffer stages; but if heavy currents are keyed, an additional spark filter should be used across the armature contacts to eliminate sparking.

Many small parts can be found in surplus receivers and transmitters; the compact capacitor units, such as those found in the 274-N surplus receivers, proved most useful because of their size and the fact that they were so easily mounted. There is no reason why 12AU7's cannot be substituted for the 6SN7's.

Adjustment

The fact that there must be both equal and unequal conducting periods if dots and dashes are to be produced must not be overlooked. Since these conducting periods depend upon the V1 grid resistors and the values of C1, C2, and C3, it is important that the grid resistors in both sections of V1 have equal values. They do not have to

be exact values, but they can be made close enough with the aid of an ohmmeter by measuring several resistors and selecting two whose values are most nearly equal. On the other hand, it is important that the values of C1, C2, and C3 can be as close to the values given in Fig. 1 and Fig. 2 as possible. Build up with several good micas.

The relay may be adjusted as follows: First, the current passing through the relay coil is measured to make sure that it is not too high. A current of 1 ma is sufficient. Then the key is pressed; if the contact arm slaps the pole piece, it should be backed away with the closed-contact thumbscrew until it just misses the pole piece. From the closeup view of the relay, it can be seen that the distance between the contact arm and the pole piece is practically nil. By advancing the back-stop thumbscrew, the distance between the contact arm and the closed contact can be reduced to the point where it is almost impossible

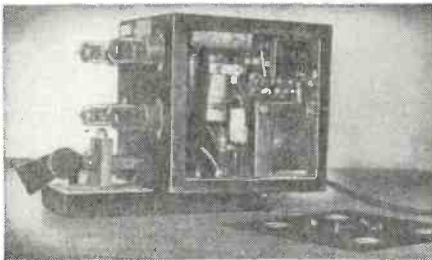

Careful planning fits parts in metal box.

to hear the relay operate. However, the distance between the contact arm and the closed contact should be a little more than twice the thickness of this paper for best results. The percentage break of the keying relay can be checked by connecting an ohmmeter to the output jack and pressing the key.

If the ohmmeter is adjusted to read full scale with the contact arm held against the closed contact, it should read close to 80% of full scale when dashes are produced, and about 55% of full scale when dots are made. If these values deviate greatly, increasing the value of C5 will increase the percentage. The key mechanism can be adjusted to suit the individual, but better performance results if distance between the contacts is kept small.

In closing, the writer wishes to thank W5FRE for his contributions to the development of the two keyers.

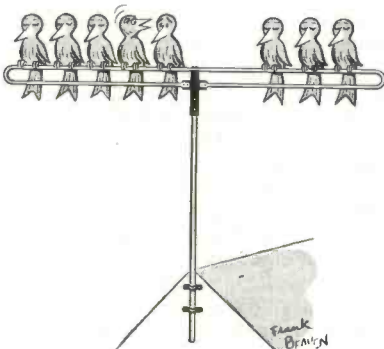

"Move over, Stupid! You're unbalancing the dipole!"

FREE!! SWEDGAL Has A FREE GIFT For YOU

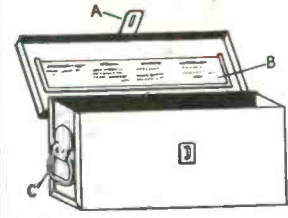

A—Hasp, B—Framed card holder, C—Handle (on both ends) 12 1/2" wide x 6 1/8" high x 6 1/2" deep.

This heavy gauge, all-metal Kit that has almost 101 uses. Worth twice-as-much, SWEDGAL's usual low-low price would be \$2.49 if you order it alone. For a limited time only the supply is limited... we are giving this sturdy, reinforced, metal kit FREE with any purchase of \$20 or more. Just a few of its many uses: Tool kit, gadget box, spare parts box, protects valuable papers, strong box, etc. It's brand new, perfect condition, finished in attractive gray, has reinforced handles on both sides, has a hasp for your lock and a card holder frame in the lid to index the contents. You'll have to act quickly to take advantage of this great offer! It's free!

RCA Low Noise Level CRYSTAL PHONO PICK UP ARM. No. 209X1 with permanent sapphire \$2.95 stylus. Complete

TUBES PRICED SO LOW THAT YOU'LL WANT TO ORDER QUANTITIES!

Order any assortment of 20 and save! FULLY GUARANTEED... BRAND NEW ONE-IN-A-CARTON... IMMEDIATE DELIVERY.

Each	20 Asst.	Each	20 Asst.
OZ4	57c	6X4	32c
1C7G	24c	6X5	37c
1F4	24c	7A4	39c
1LN5	57c	7B6	39c
1R5	32c	7B7	39c
1S5	39c	7C6	39c
1T4	39c	7H7	39c
1U4	37c	12A6	24c
1U5	32c	12BA6	35c
3Q4	45c	12BE6	39c
3S4	43c	12SA7	45c
5Z3	49c	12SN7GT	37c
5Z4	49c	12SQ7	49c
6AG5	39c	14B6	45c
6AK5	39c	14Q7	44c
6AL5	39c	25L6GT	39c
6AR5	32c	25Z5	48c
6AT6	37c	35W4	39c
6BA6	37c	35Z5	39c
6BG6G	95c	36	24c
6BE6	37c	46	19c
6C4	24c	50A5	65c
6J5	32c	50L6	54c
6J6	37c	50L6	44c
6K5	32c	76	37c
6L6	89c	1625	39c
6SA7GT	37c	1632	44c
6SH7	39c	1642	44c
6SK7GT	37c	2051	37c
6S07GT	37c	9002	39c
6SN7	39c	9006	39c
6S87	39c	117Z3	39c
6V6	32c	VR150	54c

Prices slashed on OUTPUT TRANSFORMERS

10,000 ohms, center tapped to 3.2 ohms voice coil, channel mounting, Push-Pull	25c ea.
30.5 Output	34c ea.
50L6 Output	38c ea.
50L6 Push-Pull Output	49c ea.
6V6 Output	49c ea.
6V6 Push-Pull Output	49c ea.

6V6 PUSH-PULL OUTPUT
RATED 15 WATTS
 Secondary taps are 4, 8, 15, 250, and 500 ohms. Fully shielded.
only 89c ea.

IF TRANSFORMERS

Precision Wound Radio Coils, Medium Size	
456 KC. Input or Output	32c ea.
Midget Iron Core 456 KC Input or Output	48c ea.

COMPARE THESE BARGAIN BUYS!

- MALLORY ROTARY SWITCH, 2-pole, 5-position. Short-ink type, for meters or bandswitches, 3/8" shaft ea. 29c
- DIAL PLATE, Round Brass, oxidized finish, diameter 1 3/4", your choice, marked "Tone" or "Volume" ea. 2c
- ANTENNA LOOP, 4-terminal for AC/DC, battery, portables and small receivers. Extra powerful. Used instead of antenna coil. Only 12c ea.
- CRYSTAL CARTRIDGE, Astatic Nylon II \$2.25
- FILTER CHOKE, 3/4" stack, 5 henries @ 75 ma. A true bargain buy at only 48c ea.
- SOCKETS, Cinch #9319. Miniature shock shielded type, 7 prongs, 7/8" mounting centers, mica lilled bakelite, beryllium copper contacts. 29c
- CRYSTAL RADIO, Piet-O-Graph Kit, complete... 88c
- AIR TRIMMERS, Variable, 75 mmfd max... 14c
- BAKELITE KNOBS, Black, skirt type with finger grip knob, 3/4" shaft, 1 1/4" wide, skirt diameter 1 1/4" 5c ea.
- WESTON DC VOLTMETER, 2" Round, 0 to 600 and 0 to 15 DC Volts, 500 microamp movement... ea. \$2.49

TO SPEED DELIVERY. Order Now! Minimum, \$2.50. For C.O.D. shipments enclose 25% deposit. Include adequate postage, excess will be returned. All prices F.O.B., New York, N. Y. WRITE FOR FREE CIRCULAR!

SWEDGAL RADIO, INC.

96 Warren St., Dept. E-2 New York 7, N. Y. COrtlandt 7-6753

VOLUME CONTROLS

Centralab-Mallory-Stackpole, etc.
 With Switch and long shaft

100,000 ohms	34c ea.
250,000 ohms	
350,000 ohms	
1 megohm	

Any asst. of 10 \$3.00
SPECIAL BUY! 9c ea.
 100,000 ohms, 1 1/2" shaft

BRAND NEW SPEAKERS

Compare these figures... specs and prices! New magnet, made this year, top quality. Guaranteed!

All Alnico V

	Ea.	Lots of 5
3 1/2" P.M. .68 oz.	\$.79	\$.75 ea.
4" P.M. .68 oz.	.89	.85 ea.
4" P.M. 1 oz.	.99	.95 ea.
4" x 6" P.M. 1.47 oz.	1.05	.99 ea.
4" x 6" P.M. 1 oz.	1.49	1.39 ea.
5" P.M. .68 oz.	.95	.89 ea.
5" P.M. 1 oz.	1.23	1.19 ea.
6" P.M. 1 oz.	1.39	1.29 ea.
6" P.M. 1.47 oz.	1.39	1.29 ea.
5" P.M. .68 oz. w/50L6 Output 1.24	1.15 ea.	

CARBON RESISTORS

Order \$5.50 worth of any asst. resistors, pay only \$5.00! Mfr'd. by I.R.C. & Continental All ± 5% Tolerance... Insulated

Watt	1 Watt	4c
400 ohms	4,700 ohms	
4,000 ohms	5,000 ohms	
4,700 ohms	38,000 ohms	
10,000 ohms	39,000 ohms	
40,000 ohms	60,000 ohms	
50,000 ohms	500,000 ohms	

2 Watt, 4,700 ohms 4c ea.

WIRE WOUND RESISTORS

Mfr'd. by Shallcross. Non-inductive, ± 1% Tolerance, 1/2 Watt Rating

4,500 ohms	25c	45,000 ohms	45c
50,000 ohms	45c	450,000 ohms	75c

IRC Wire Wound Resistors, Insulated, 30 ohms, 1/2 watt, Type BW Each 5c

Cornell-Dubilier ELECT. TUBULAR CONDENSERS

Fresh Stock!

20 x 20-150 V.	39c ea.
40 x 40-150 V.	
50 x 30-150 V.	

PANEL BEARINGS

At a new low price!
 Smooth operating, precision made, flatted shaft extends 1 3/8", bushing for 3/8" hole. Now only 6c ea.
 Order 10 for 50c

CORNISH WIRE CONDENSERS

CORLAC or NO FLAME
 Stranded, #22 hook-up wire, white with tracer. On metal spool. 1,000 ft. for only \$3.4c

Cornel Dubilier—Aerovox. Etc.—fresh!
 .015 mfd @ 200 V. 3c ea.
 .015 mfd @ 400 V. 4c ea.
 .05 mfd @ 400 V. 5c ea.
 1 mfd @ 400 V. 19c ea.

AC LINE CORDS

7 ft., Molded bakelite plug... 12c ea. 10 for \$1.10
 6 ft., Reinforced rubber plug... 14c ea. 10 for \$1.25

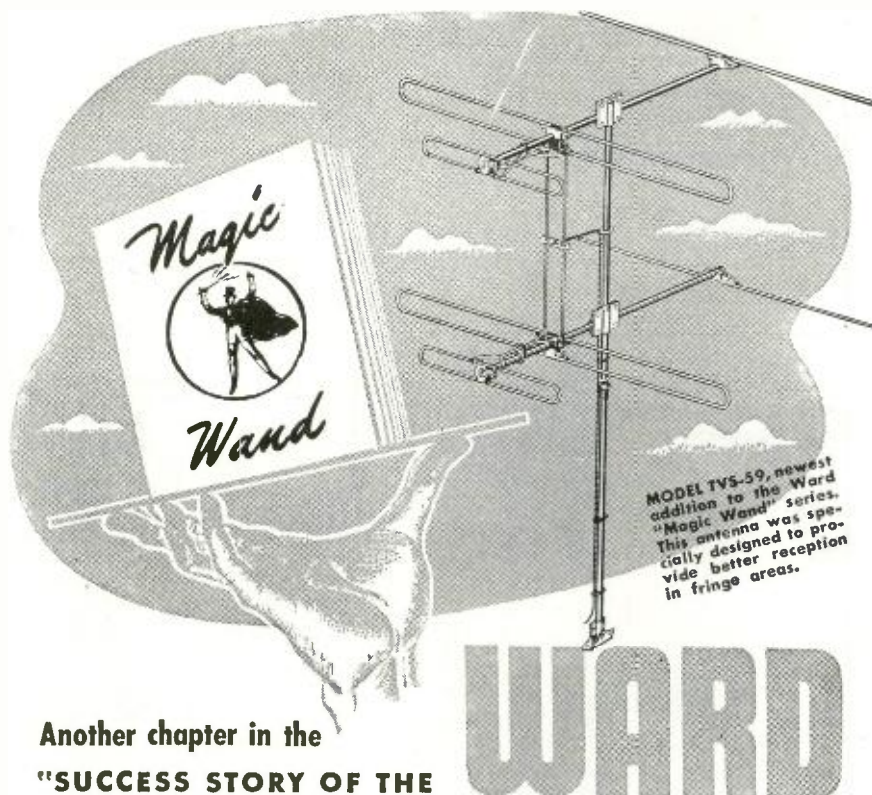

Another chapter in the
**"SUCCESS STORY OF THE
 MAGIC WAND ANTENNAS"**

More than a thousand power lines snapped! Street car service disrupted by broken trolley wires! Thousands of tree branches crashed to the ground!

But the Chicago area's worst ice storm did not affect a single Ward Products "Magic Wand" TV antenna.

"Magic Wand" antennas are made of Perma-Tube, a special alloy expressly developed for Ward Products by the Jones & Laughlin Steel Corporation. Perma-Tube is a rugged alloy designed to withstand the harmful, corrosive effects of ice, sleet, snow, wind, and rain.

In good weather or bad, your TV set will give you the best reception if you have a Ward "Magic Wand" antenna. Tests have proved a medium-priced TV set with a good antenna performs better than an expensive set with a cheap antenna.



Write for our free booklet, "The Story of the Magic Wand." It contains interesting, authoritative information about TV and FM antennas.

WARD PRODUCTS CORPORATION

1523 E. 45th STREET, CLEVELAND, OHIO

Division of the Gabriel Company

Ward is the largest and oldest exclusive maker of television and auto radio aerials.

**A RADIATIONLESS METHOD
 FOR TRANSMITTER TUNING**

By PHILIP JOHNSON, W7MHU

GOOD operating procedure requires that radio transmitters should not radiate energy during tuning operations. A dummy antenna may be used in making adjustments on the transmitter itself. It is commonly believed, however, that transmitting antennas cannot be tuned and adjusted properly without being energized. Thus, interference is produced, and one of the rules of good operating technique is broken.

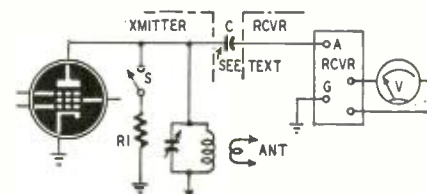

Fig. 1—Setup for radiationless tuning.

But there is a way in which transmitting antennas may be tuned without energizing them. Devised by U.S. Navy radio technicians to tune antennas during periods of radio silence, the method is easy to understand and apply.

The antenna is tuned to resonance and the proper coupling determined by utilizing the static noise voltage picked up by the antenna.

Only three items of equipment are required: a good receiver, a fairly high-impedance a.c. voltmeter having a 1- or 2-volt scale (or other output meter), and a 1/2-watt carbon resistor.

The circuit connections are shown in Fig. 1. The receiver is loosely coupled to the plate lead of the transmitter tank circuit by capacitor C, which consists of approximately 1 inch of insulated wire wound around the plate lead. The receiver is tuned to the operating frequency of the transmitter, and the static noise voltage picked up by the transmitter antenna is read on the output meter.

Antenna resonance is indicated by adjusting the antenna tuning controls for a maximum reading on the output meter.

Correct antenna coupling is determined by adjusting the coupling controls until the received noise voltage, as indicated by the output meter, drops to about one-half its peak value when a resistor equal to the load resistance required by the transmitter output tube is connected from the plate of the transmitter output tube to ground. Resistor R1 in Fig. 1 is the load resistor used for this purpose. It is the 1/2-watt carbon resistor previously specified as required equipment.

The method can be used for adjusting any type of tuned antenna, irrespective of the type of coupling to the tank circuit. For antennas with un-

CHOICE OF ENGINEERS EVERYWHERE

**TWIN-TRAX*
 TAPE
 RECORDER**

Available to you direct from the factory at savings that make TWIN-TRAX the only professional-type recorder in the popular-price field. More than a dozen model variations for portability, long-play, continuous operation, etc. For a better tape recorder that combines professional quality with operating ease and trouble-free construction, it's TWIN-TRAX. Write today for complete literature. *Trade Mark Registered

AMPLIFIER CORP. OF AMERICA
 398-10 Broadway • New York 13, N. Y.

PROGRESSIVE NOW! BUILD 15 RADIOS \$14.75
COMPLETE KIT ONLY...

PROGRESSIVE RADIO "EDU-KIT" teaches amplifier, receiver and transmitter design and construction principles. Excellent background for television. No knowledge of radio necessary. Used by radio schools and the Veterans Administration. Quizzes provided, and corrected at no extra charge. Free Electrical and Radio Tester and tools. Order today or send for free "Kit-Katalog". Postage prepaid on cash orders. Cod orders accepted in U.S.A. Dealerships available.

PROGRESSIVE ELECTRONICS CO.
 497 Union Ave. Dept. RE-34 Brooklyn 11, N. Y.

tuned feeders, only the coupling need be adjusted.

Theory of operation

The action is simple, and for the tuning adjustments is obvious. No amateur requires any elaboration of the point that, when transmitter antenna and tank circuit are both tuned "on the nose," a maximum noise voltage will be induced into the receiver, which is tuned to the operating frequency.

The coupling principle is equally simple, though not quite so obvious. Every amateur also knows that tuning an antenna neutralizes or opposes its reactive components, so that at resonance it appears as a pure resistance. The tuned tank circuit also looks like a pure resistance; therefore, a perfectly tuned output circuit looks to the output tube like R2 in Fig. 2. (E is the noise voltage generated in the antenna, used to obtain the indications on the a.c. output meter.)



Fig. 2—A perfectly tuned output stage.

If the circuit is properly coupled, the output tube will see R2 as a resistor of the correct value for proper tube loading. Now, if this resistor is shunted by another of the same value, the voltage indicated on the a.c. voltmeter will drop to one-half its former reading, by Ohm's law. The switch makes comparison between R1 and R2 easy.

Tuning procedure

1. With the transmitter operating, properly tuned, and feeding into a dummy antenna, tune the receiver to the operating frequency of the transmitter.

2. Shut down the transmitter plate supply, leaving the filaments of the transmitter tubes energized.

3. Couple the receiver input to the plate circuit of the transmitter final amplifier tube as indicated in Fig. 3, a simplified form of Fig. 1. (As previously stated, capacitor C, the coupling unit, consists of approximately 1 inch of insulated wire wrapped around the plate lead. This is quite sufficient for the frequency ranges used for amateur communication. The lead from C to the receiver antenna terminal should be a shielded wire not over 4 or 5 feet long. The shield must be grounded.)

4. With the receiver a.v.c. off, retune the transmitter tank circuit until maximum noise output is indicated by maximum reading on the a.c. voltmeter.

5. Couple the antenna to the transmitter, and adjust the antenna tuning capacitor until maximum noise output is again indicated on the a.c. voltmeter. This indicates antenna resonance. It may be possible to increase the resonant voltage reading by retuning both the transmitter tank capacitor and the antenna capacitor a trifle. The receiver should not be retuned.

Next adjust the antenna coupling.



FOR . . .

- RADIO SERVICING
- TELEVISION SERVICING
- AMATEUR RADIO
- HIGH FIDELITY SOUND

Stancor transformers are original components in thousands of radio and television receivers made by the biggest names in the industry—they have to be good to be specified by critical design engineers and value-conscious purchasing men!

Why shop around? Specify Stancor for your replacement work. You will get a dependable, honestly-rated transformer. You'll cut down on expensive call-backs. You will keep your customers.

FREE For complete, accurate specs and prices of the complete Stancor stock line, write for your copies of the literature illustrated above. Just ask us for the Stancor transformer library. Standard Transformer Corporation, 3592 Elston Avenue, Chicago 18, Illinois.

It's Stancor

FOR TRANSFORMERS

MOST COMPLETE LINE IN THE INDUSTRY



25 WATT AUDIO AMP. KIT
 P.P. 6L6 Output. The best buy on the market to-day. Make up an amplifier worth \$50. Powerful enough for auditoriums. Separately controlled Mike and Phono inputs. All parts—drilled chassis—hdwr., etc. **\$11.95**
(all prices f.o.b. our plant)
 MATCHED OUTPUT AFMR \$1.49—Set of New Tubes \$3.95. less tubes

TWO-WAY INTERCOM KIT
 NOTHING ELSE TO BUY—2 spkrs.—3 tubes—chassis—hdwr.—everything to make a fine system for the home, office, school, shop, ideal "baby-sitter" . . . **\$9.95**

CODE PRACTICE OSC. KIT \$5.95
(all prices f.o.b. our plant)

Send Name & Address For Our Mailing List

Universal/general corp
 365 J CANAL ST. N. Y. 13.
 Walker 5-9642

EASY TO LEARN CODE

It is easy to learn or increase speed with an Instructograph Code Teacher. Affords the quickest and most practical method yet developed. For beginners or advanced students. Available tapes from beginner's alphabet to typical messages on all subjects. Speed range 5 to 40 WPM. Always ready—no QRM.

ENDORSED BY THOUSANDS!

The Instructograph Code Teacher literally takes the place of an operator-instructor and enables anyone to learn and master code without further assistance. Thousands of successful operators have "acquired the code" with the Instructograph System. Write today for convenient rental and purchase plans.

INSTRUCTOGRAPH COMPANY
 4701 Sheridan Rd., Dept. RC, Chicago 40, Ill.

Le-Hi

Guaranteed
Pre-tested
RADIO TUBES
for QUALITY, PERFORMANCE
and DEPENDABILITY

Every individual tube must undergo rigid tests before it leaves the Le-Hi plant. This guarantee of pre-testing is but one assurance of the BEST BUY from Le-Hi. Rugged construction, dependable performance and economical service at LOWEST PRICES make our tube even MORE DESIRABLE. Compare performance, quality and price with any standard tube—and remember EVERY Le-Hi Tube is FULLY GUARANTEED.

Type	Price	Type	Price	Type	Price	Type	Price	Type	Price
1A5	.57	5Y3GT	.39	6C6	.55	6SN7GT	.53	12Q7GT	.50
1A7GT	.57	5Z4M	.86	6D6	.59	6SQ7GT	.39	12S8GT	.72
1B3GT	.82	5Z3	.48	6E5	.39	6T8	.79	12SA7GT	.46
1B4P	.39	6A7	.69	6F5GT	.39	6U7G	.59	12SF5GT	.52
1C5GT	.70	6A8G	.56	6F6GT	.41	6V6GT	.46	12SF7GT	.53
1C6	1.05	6A84	.52	6F7	.39	6W4GT	.47	12SJ7GT	.49
1C7G	.39	6AC5GT	.77	6F8G	.39	6X4	.39	12SK7GT	.44
1F4	.39	6AG5	.56	6H6GT	.45	6X5GT	.39	12SL7GT	.61
1G4GT	.39	6AK5	.87	6J5GT	.39	7A7	.59	12SN7GT	.53
1H5GT	.45	6AL5	.43	6J6	.70	7B6	.59	12SQ7GT	.39
1H6G	.39	6AQ5	.46	6J7GT	.49	7C4	.49	12SR7	.49
1N5GT	.57	6AR5	.40	6K5GT	.60	7C5	.59	12Z3	.39
1P5GT	.86	6AS5	.47	6K6GT	.39	7F7	.59	19B6G	1.53
1R5	.55	6AT6	.39	6K7GT	.49	7Y4	.49	19T8	.77
1S5	.46	6AU6	.46	6K8GT	.59	12AL5	.43	24A	.59
1T4	.56	6AV6	.47	6L5G	.39	12AT6	.39	25A7GT	2.02
1T5GT	.86	6BA6	.44	6L6G	.78	12AT7	.72	25AC5GT	.87
1U4	.55	6AW6	.65	6N6	.90	12AU6	.46	25B06	.85
1U5	.45	6BA7	.59	6P5GT	.55	12AU7	.58	25L6GT	.47
1V	.39	6BE6	.46	6Q7GT	.50	12A8GT	.59	25W4GT	.47
1X2	.68	6BF6	.40	6S7	.72	12AV6	.39	25Z5	.41
2A7	.69	6BH6	.57	6SA7GT	.46	12AX7	.61	25Z6GT	.39
2X2	.69	6BJ6	.48	6SC7GT	.59	12BA6	.44	26	.50
3A4	.39	6B5	.59	6SD7GT	.56	12BA7	.59	27	.39
3A5	.39	6B8	.39	6SF5GT	.52	12BE6	.46	30	.39
3Q4	.62	6BQ6	.85	6SF7GT	.59	12BF6	.40	32L7GT	.91
3Q5GT	.65	6BC6G	1.35	6SH7GT	.39	12BG6	.40	33	.59
3S4	.59	6C4	.39	6SJ7GT	.44	12J7GT	.55	35/51	.35
3V4	.60	6C5GT	.48	6SK7GT	.44	12K7GT	.47	35B5	.47
5U4G	.39	6BC6	.51	6SL7GT	.61	12K8GT	.49	35C5	.47

Distributors' and Jobbers' Inquiries Solicited

Each tube individually boxed. 50¢ handling charge on orders under \$5. Save 5% discount on orders of 100 tubes or more! All orders shipped C.O.D. Prices subject to change without notice.



Le-Hi ELECTRICAL COMPANY

412 Halsey Street

Newark 2, N. J.

Telephone MArket 3-8294



NEW!

COLOR ON YOUR TELEVISION!



(Without Filter) Simply attach TELECOLOR FILTER to front of your set and enjoy favorite programs in a glorious color tone, instead of dull black and white. "TELECOLOR" Filter is one of the latest discoveries. It has a special formula fluorescent coloring, that gives brilliant, pleasing color tone. You will find new happiness in the enjoyable color depth, reduced glare, fog, snow and less eye strain. Everyone is talking about and waiting for 3 color Television costing hundreds of dollars. For a small sum you can enjoy color toning now.

TELECOLOR FILTER is a wonderful gift to friends or relatives who own sets.

10" tube—\$3.00; 12 1/2" tube—\$4.00;
16" tube—\$6.00

HARVARD LABORATORY

Dept. RE4, 659 Fulton St., Brooklyn 1, N. Y.

PEN-OSCIL-LITE

Extremely convenient test oscillator for all radio servicing; alignment • Small as a pen • Self powered • Range from 700 cycles audio to over 600 megacycles i.f.f. • Output from zero to 125 v. • Low in cost • Used by Signal Corps • Write for information.

GENERAL TEST EQUIPMENT
38 Argyle Ave. Buffalo 9, N. Y.

HOW

Learn how to simplify radio repairs FREE! Send penny postcard for big 32-page illustrated FREE MANUAL. No obligation.

FEILER ENGINEERING CO., Dept. 4RC5B
1601 S. Federal St. Chicago 16, Illinois

GREYLOCK RADIO TUBE BARGAINS!

GT. Glass and Miniature Types

1A4P	1U5	6BA6	6SK7GT
1A6	3A4	6BA7	6SQ7GT
1C6	3Q4	6BE6	6U7G
1F4	6AG5	6BH6	6V6GT
1S5	6AG5	6C5GT	6X4
1T4	6AT6	6J6	12A8GT
1U4	6AU6	6K6GT	12A6

\$3295

per 100 asstd.



SPEAKER SPECIALS!
3", 4", or 5" PM. less output, Alnico 5, each 97c
In cartons of 30, each 87c
6" x 9" Oval PM. Alnico 5, 3.16 ohm magnet, each \$2.59
In cartons of 24, each \$2.39

TERMS: Net C.O.D., F.O.B. NYC. MINIMUM ORDER \$10.00.

Write for terrific CR tube prices and Bargain Catalog C-4

Greylock Electronics Supply Co.
30 Church Street New York 7, N. Y.

This adjustment is entirely independent of, and does not affect, the previously made resonance adjustment.

1. Adjust the receiver output sensitivity to 1 volt or some other convenient value on the a.c. voltmeter.

2. Switch R1 into the circuit and observe the receiver output voltage. If the receiver output voltage is about one-half its former value, the antenna loading is nearly correct. If the value is less than one-half, R2 is greater than R1 and the coupling must be increased if the value is greater than one-half, R2 is less than R1 and the coupling must be decreased.

Determination of R1:

The value of R1 is very easily determined either by calculation or experimental work.

To determine the value of R1 by calculation, use the formula:

$$R1 = \frac{P}{I^2}$$

In the above formula, I is the current input to the plate of the final r.f. amplifier, and P is the power consumed by the tuned tank circuit of the transmit-

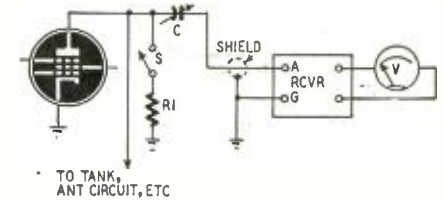

Fig. 3—Circuit showing tuning method.

ter final amplifier. The value of P is then equal to the d.c. power input to the transmitter final amplifier tube minus the d.c. plate dissipation of the tube.

For example, suppose the class-C constants for a given transmitter tube were, as stated on the tube data sheet:

- Plate dissipation: 25 watts
- Plate current: 100 ma
- Plate voltage: 700 v

The normal d.c. power input to the final amplifier tube is then 70 watts. Subtracting the plate dissipation of 25 watts from the power input, a figure of 45 watts is obtained. This value represents the total power consumed by the tank circuit of the transmitter final amplifier. It is the value of P in the formula for determining R1. The plate current of 100 ma is the value of I in the formula. Substituting these values,

$$R1 = \frac{45}{.01} = 4,500 \text{ ohms.}$$

Experimental method

If tube data is not available, R1 may be determined experimentally by using an actual antenna:

1. Tune the transmitter and the antenna by one of the common methods.
2. Tune the receiver to the operating frequency of the transmitter; shut the transmitter down, but leave the transmitter filaments energized.
3. Couple the receiver to the transmitter plate circuit and adjust its output to some convenient value.

4. Connect different values of resistance from the plate lead of the transmitter final amplifier tube to ground until the audio noise voltage reading of the a.c. voltmeter is about one-half the noise voltage reading obtained without the resistor. This is the value of resistance R1.

With this method, the antenna need be energized only once—all succeeding tune-ups may be made without radiating any energy.

Irrespective of whether R1 is found by calculation or experiment, its value will vary with the frequency of operation and the transmitting tube in use. With most transmitting tubes operated on the common shortwave frequencies, R1 ranges from 1,000 to 5,000 ohms.

Operating suggestions:

Static noise voltage is often very erratic, especially in large metropolitan areas. Under such conditions, tuning by this method is very difficult and often quite unreliable. A slight modification eliminates the difficulties and improves the accuracy of the system.

The modification consists of tuning a small signal generator to the transmitter frequency and inducing its signal into the transmitting antenna. This can be done by feeding the signal generator into a wire mounted close to and parallel with the antenna leads. The signal so induced in the antenna circuit is larger than the static noise voltage, but small enough that it cannot radiate more than a few feet from the antenna.

Considerably greater accuracy can often be obtained if the receiver speaker is not disconnected during tuning operations. Ease of adjustment is increased when it is possible to hear the signal as well as to see it on the a.c. voltmeter.



safe UL approved TV-FM LIGHTNING ARRESTER

Combined Bleeder and Gap Design

For Flat or Round 300 Ohm and Twin-x Cables

Outstanding Features

- Quickly — easily installed without cutting line.
- Universal Base—Accommodates all types of lead-in cable.
- Absolutely does not affect signal strength on any channel.
- Prevents static build-up in antenna.
- Maintains constant antenna potential relative to ground.
- Acts like a switch in bypassing high, harmful voltages.
- Thoroughly insulated—Underwriters Lab. approved.
- Weatherproof—Built to last. List Price \$2.25

● The first arrester to successfully combine bleeder and gap principles for FM-TV.

Electrically balanced to ground—The balanced bleeder resistors prevent any static build-up in the antenna.

Keeps the antenna and all surrounding conductors, reflectors, directors and masts at a constant potential relative to ground. Momentary, high and harmful voltages break the gap and are by-passed harmlessly to ground.

A lightweight unit, easily mounted or installed by hanging on the lead-in cable.

With a Cletron Arrester, any antenna installation is safe.

Order out a stock today—Build more satisfied customers.

*** CLEVELAND ELECTRONICS, INC. ***

6612 EUCLID AVENUE, CLEVELAND 3, OHIO

MORHAN EXPORTING CORP. 458 Broadway, New York

CHANNEL CHIEF

High Gain Square Corner Radar Type T.V. Antenna. Broad Band Response Covers All High Band Channels But Peak May Be Chosen To Boost Your Weakest Channel. "Mirror Focus" Beam Action Increases Gain And Decreases Ghosts, And Noise. All Aluminum Construction For Durability And Quick Assembly.

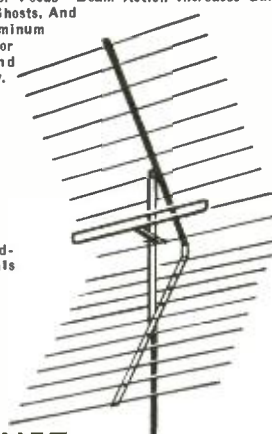

300 ohm impedance. Channels 7 through 13.

ONLY 10.95 NET (MAST NOT INC.)

Order Direct and Save. Factory to You. State Weakest Channel. 25% Deposit with C.O.D. orders.

CHANNEL CHIEF CO., Dept. RE-4 37 Mall Drive, N. Plainfield, N. J.

WANTED

Junction Box JB70A as used with Hallicrafters BC610-SCR399. State Condition, Quantity & Price.

Box A-1, c/o Radio-Electronics 25 West Broadway New York 7, N. Y.

NEW YORK'S RADIO TUBE EXCHANGE We buy, we sell, we exchange. Write for lists.



SAVE MONEY—BUILD YOUR OWN SPEED LIGHT EQUIPMENT

FOR PROFESSIONAL AND AMATEUR Easy to follow . . . step-by-step Instructions Write for FREE list of complete Kits and Components **CINEX, INC.** Dept. RE-4 165 W. 46th St., N.Y. 19, N. Y.

\$3.00 FOR CARTOON IDEAS

RADIO-ELECTRONICS prints several radio cartoons every month. Readers are invited to contribute humorous radio ideas which can be used in cartoon form. It is not necessary that you draw a sketch, unless you wish.

Address **RADIO CARTOONS. RADIO-ELECTRONICS 25 West Broadway, New York 7, N. Y.**

New Devices

LIGHTNING ARRESTER

Cleveland Electronics, Inc.,
Cleveland, Ohio

The new Cletron lightning arrester for television and FM antenna transmission lines is a combined bleeder and gap design. It has a universal base to accommodate all types of cable. It may

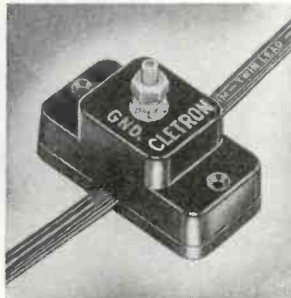

be installed quickly without cutting the cable and does not affect signal strength. Approved by Underwriters Labs, the arrester keeps the antenna and conductors at a constant potential with respect to ground. The balanced bleeder resistors prevent any static buildup in the antenna. Momentary high voltages break the gap and are bypassed to ground.

DISC CAPACITOR

Erie Resistor Corp.,
Erie, Pa.

A new .01- μ f disc Ceramicon is only 19/32 inch in diameter. Capacitance is held to within +100% and -0%. Voltage rating is 400 d.c., based on a life test of 800 volts d.c. at 85 degrees Cen-

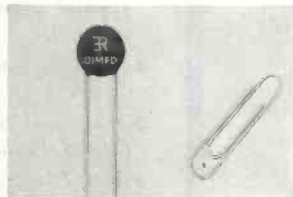

trigrade for 1,000 hours. The power factor is 2.5% maximum at 1 kc, at not more than 5 volts r.m.s. Insulation resistance is 7,500 megohms minimum. The capacitor is insulated with red dipped phenolic.

V. T. V. M.

Transvision, Inc.,
New Rochelle, N. Y.

This meter enables the television technician to measure every voltage in a TV receiver. Ranges are as follows: D.c. volts: 0-3-10-30-100-300-1,000 (input resistance 11 megohms); 0-30 kv (input resistance 1,100 megohms, with high-voltage probe).

A.c. volts: 0-10-30-100-300-1,000 (1,000 ohms per volt).



Resistance: 0-1,000-10,000-100,000 ohms; 1-10-1,000 megohms.

R.f. volts: 0-3-10-30-50 (good to over 100 mc with r.f. probe).

The meter uses a bridge amplifier individually calibrated for use with the test leads, d.c. probe, and batteries supplied. The steel case measures 9 5/16 x 6 x 4 3/4 inches.

PAGING SPEAKER

Racon Electric Co., Inc.,
New York, N. Y.

Since each PA installation requires an individual solution, for a long time sound technicians have had to carry a large inventory of loudspeakers. To simplify selection and help reduce the sound technician's inventory, Racon now has in production the new model MN-15B.

This one speaker handles 65% of all paging requirements. The greater efficiency is due to its incorporation of true exponential design for its complete length—for the tone arm, the reflector and the bell. The advantage of this construction is that it assures uniform response throughout its entire transmission range.

The low-frequency cutoff provides a rising response characteristic for greater intelligibility in high-noise-level areas. The lowered mass of the special aluminum-wound voice coil assures greater efficiency of the loudspeaker, especially where increased diaphragm sensitivity is needed for talk-back.

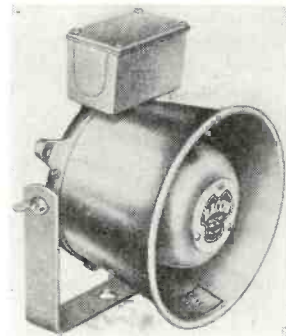

Specifications are: 20 watts continuous capacity; 35 watts peak capacity; frequency range, 450-6,000 cycles. The speaker is available in 8, 15 or 45 ohms.

HIGH-VOLTAGE PROBE

Electronic Instrument Co.,
Brooklyn, N. Y.

A new Eico high-voltage probe, model HVP-1 has a special helical-film, statite-rod-type multiplier resistor, which may be removed and replaced with different resistance values. As is, the probe matches most 20,000-ohms-



per-volt meters and v.t.v.m.'s. Safety features of the probe include a plywood bakelite handle and large flashguards.

NEW INPUTUNER

Allen B. Du Mont Laboratories, Inc
Passaic, N. J.

The new four-section Inputuner incorporates the latest Mallory-Ware spiral-type inductuner. It has much greater gain than previous inputuners and more selectivity. The tuning range is continuous from 54 to 216 mc, covering both TV bands and FM broadcast.

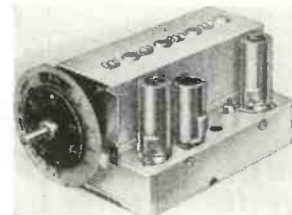

Only 5.9 turns of tuning motion are required against 10 turns for previous models. A new dial illuminates the TV channel numerals on an outer circle and automatically switches the illumination to the FM designations on an inner circle when the tuner traverses the FM band.

The tuner operates efficiently on either 300- or 72-ohm antenna systems and is completely shielded.

"You can't get any more out of a TV set than you put into it. And that means signal strength supplied by the antenna. That's why we always recommend the antenna accepted as standard by the whole TV industry — the Amphenol INLINE* Antenna."

*U. S. PATENT NO. 2,474,480

The booklet as is showing gives the whole TV story. Write for your copy — a postcard will do it.

AMERICAN PHENOLIC CORPORATION
1830 SC. 34TH AVENUE • CHICAGO 50, ILLINOIS

AMPHENOL

RADIO-ELECTRONICS for

ALIGNMENT TOOLS

Insuline Corp. of America,
Long Island City, N. Y.

Nine specially designed television servicing tools are included in the new TV Handi-Kit. They are furnished in a



pocket-size leatherette carrying case. The tools will fit the adjusting screws of all types of r.f. and i.f. transformers, padder and trimmer capacitors, etc., found in current TV receivers. With their assistance, a service technician can align circuits in a minimum of time.

TELEVISION TUNER

Standard Coil Products Co., Inc.,
Chicago, Ill.

Model TV-250 is the same electrically as the models TV-101 and 201 used in many receivers but has a longer shaft. The shaft is concentric,

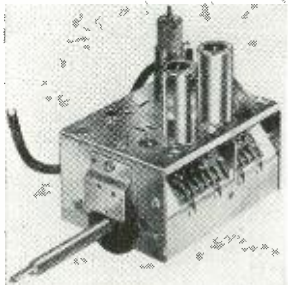

controlling coarse and fine tuning. Both sections are flattened along their lengths so they may be cut to any desired measurement.

HIGH-VOLTAGE TESTER

Oak Ridge Products,
New York, N. Y.

The new model 102 miniature TV high-voltage tester checks all high-voltages in any television receiver. It has



three 10,000-ohms-per-volt scales: 5,000-15,000-30,000 volts, and comes with a special high-voltage test lead. Its pocket-size case measures 5 3/4 x 2 1/4 inches.

TELEVISION TOWERS

Penn Boiler and Burner Mfg. Corp.,
Lancaster, Pa.

Teletowers are triangular steel masts for mounting television antennas. They are composed of 18-gauge steel tubing welded together with 1/4-inch steel tie-pieces, which also serve as climbing rungs. The towers come in 10-foot sections weighing about 20 pounds each, which may be put together for heights as great as 100 feet. Fittings of various types are available for basing, guying, and supporting masts and rotating motors at the top.

ANTENNA ROTATOR

The Radiart Corporation
Cleveland, Ohio

The Radiart Tele-Rotor will handle up to a 150-pound load with ease, and takes any size mast from 7/8 inch to 2 inches.

Control boxes for the Tele-Rotor come in two models. Model TR-1 has an "end of rotation" light and uses a 4-wire cable. Model TR-2 is the compass control rotator with the illuminated "perfect pattern" dial control unit. The face is two-tone, reproducing an illuminated TV test pattern and giving instant indication of antenna position as it is rotated by the fingertip control. It uses an 8-wire cable between control box and rotator.

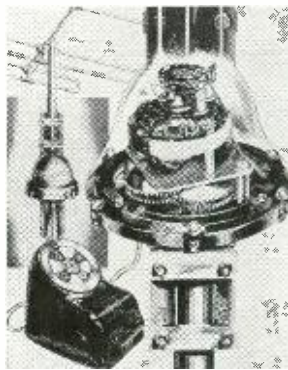

CROSSOVER NETWORK

University Loudspeakers, Inc.
White Plains, New York

Model 4410 is a new filter network of the L-C type for use with co-axial or duplex loudspeaker systems. It provides a proper attenuation rate at a crossover of 600 cycles.

The filter is housed in a cast aluminum container. A high-frequency attenuator is supplied for balancing the highs and lows to suit acoustic conditions and the listener's pleasure. Ample cable permits mounting the attenuator in any convenient location remote from the speaker.

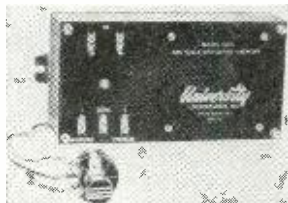

This filter was designed primarily for use with the new high-frequency tweeters and is particularly efficient when used with University speaker models 4408 and 4409.

INSULATORS

Hot Nails, Inc.,
New York, N. Y.

These specially shaped nails of high-carbon steel may be driven into brick and mortar or into steel and aluminum

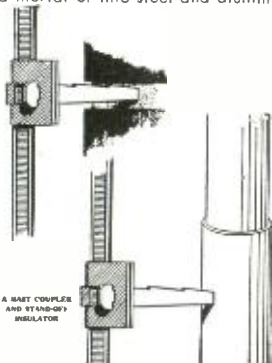

television antenna masts. Each nail is equipped with a specially slotted piece of polyethylene which holds any type of transmission line commonly used for television. The nails are especially designed for antennas, but have many other uses.

RADIO-ELECTRONICS MAGAZINE LIBRARY

INGENIOUS, CUSTOM-BUILT STORAGE FILE... Another WALTER ASHE Value Scoop!

Only **25¢**

each plus 6¢ each to cover packing and postage (anywhere in U. S.)

Holds 12 complete issues of magazine in its present 82 to 98 page size. Measures 12" x 8 1/2" x 2 3/8"



Made of high quality Kraft fibre board, printed and constructed to look like a Buckram-bound book. Affords neat, orderly, flick-of-the-finger convenience. Handy Reference Index, printed on back, records the location of selected articles, wiring diagrams, etc. At the low price you'll want several of these serviceable, attractive Magazine Libraries.

Order now for immediate delivery

Walter Ashe
RADIO CO.
1125 PINE ST. • ST. LOUIS 1, MO.

FREE
NEW
1950
CATALOG

NEEDLE CLIP

Mueller Electric Co.,
Cleveland, Ohio

The new solid-bronze needle clip makes quick electrical contact by piercing the insulation of wire. A sharp



needle is a part of one jaw. The non-corroding clip has a brass screw for connection. The Mueller No. 49 Insulator may be slipped over it.

CRYSTAL DIODES

General Electric Co.
Syracuse, N. Y.

A low-priced, ultra-high-frequency welded germanium diode and two new types for use in v.h.f. television receivers have been announced.

The u.h.f. germanium diode is self-healing under temporary overvoltage conditions, and requires no special handling. New snap-in construction eliminates the need for soldering and speeds installation. The only germanium diode currently available for use in the ultra-high frequencies of 500 to 1,000-mc range, it is designed for use as a converter.



The two new diodes for use in present v.h.f. television receivers are the IN64 designed and selected for optimum efficiency in video detector circuits, and the IN65 which is for use as a d.c. restorer in TV circuits and is especially selected to provide high back-resistance.

TWEETER UNIT

Mark Simpson Mfg. Co.
Long Island City, N. Y.

The Masco model HFT-100 high-frequency tweeter is designed to provide wide-range frequency response in the upper register to 15,000 cycles.

Installation is simple and requires no additional space. The existing cone speaker is unscrewed, the screen with high-frequency unit attached placed

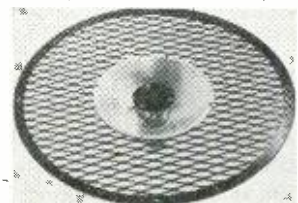

over the corresponding holes of the cone speaker, and the assembly screwed back in place. The two speakers are then series-connected.

ATTIC TV ANTENNA

Trio Manufacturing Co.
Griggsville, Illinois

This all-channel television antenna can be installed in an attic, on the rafters, floor joists or on the floor itself. It gives better reception than the average indoor antenna and meets with the approval of landlords who object to roof installations or owners who prefer not to encumber their buildings with outside television antennas.

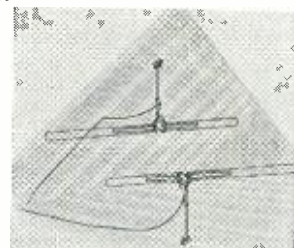

CONSTRUCT A PICTURE TUBE HOLDER

Complete Plans and Instructions
in the APRIL Issue of:



the APRIL issue is on sale at your
jobbers' counters

No more problems of what to do to safeguard the picture tube that must be removed from cabinet in order to service some TV sets. Here now is presented a complete working drawing and detailed instructions for building a cushioned, stable and safe holder for TV picture tubes. Designed to fit any and all CRT's in current TV sets, this holder will save you time and money, make your work easier and put your mind at rest—no worrying about breakage!

This is another in the series of valuable construction articles appearing in RADIO & Television Maintenance magazine in addition to the regularly featured technical articles and news about AM-FM-TV. Get your copy today and subscribe now by sending in the coupon below!

DON'T MISS ANY OF THE FORTHCOMING ISSUES!

Here is a list of future construction articles:

- How to make receiving dollies for incoming radios
- How to construct a truck interior for efficient field work
- Building an auxiliary bench for tube testing, minor repairs, operating observation, etc.
- Shop planning and layout for steps, time and money saving.
- Auxiliary HV power supplies for operating tests on picture tube
- Design and arrangement of a portable parts, tool and text box for servicing
- Design and construction of TV antenna location tester

There are in addition to the regular content of technical articles on TV-FM and AM receivers, test equipment tools, etc.—news articles on current happenings, trends of the industry, new products and new literature,—sales methods and advertising programs,—business methods

35,000

radio servicemen read **RADIO & TELEVISION MAINTENANCE** regularly—**PROOF** of its value to the trade!

Don't miss any of these issues. Send in your order at the new low price of \$1.00 per year. Send it Today.

BOLAND & BOYCE INC. RE 4
MONTCLAIR, N. J.

Send me **RADIO & TELEVISION MAINTENANCE**
 for 1 year \$1.00 2 years \$2.00.

NAME _____

ADDRESS _____

CITY _____ ZONE _____

STATE _____

MONEY ENCLOSED BILL ME LATER*
(check one)

I am in a radio sales & service business
 sales only
 service only
 other (explain) _____

(check one)
I am owner
 manager
 employee

FULL REFUND WITHIN 90 DAYS IF NOT COMPLETELY SATISFIED

* If money is enclosed, thus eliminating billing expense, we will add one extra issue FREE.

HIGH-VOLTAGE POWER SUPPLY

Patent No. 2,490,733
Ralph C. Kennedy, Arlington, N. J.
(assigned to Radio Corp. of America)

Basically different from power supplies now in practical use, this supply operates on the following principle. If a definite charge of electricity is placed on a capacitor, the voltage produced is inversely proportional to the capacitance. For example, the same charge on a small capacitor gives

is reduced, but the charge is not changed. The result is a step-up of the original voltage applied to the capacitor.

The figure shows a vibrator within dotted lines. When the coil is excited by a.c., the reed swings alternately to the left and right. In the latter position it closes the circuit to a d.c. source, which may be the 250-volt power supply of a TV receiver. This voltage charges the capacitor formed by the movable contact and fixed contact of the vibrator (shown shaded). The surfaces of these contacts are insulated so there can be no electrical contact between them.

As the reed swings back to the left, it opens the circuit to the low voltage and the capacitance between contacts is greatly decreased. Since the same charge remains on them, the potential between the reed and ground is stepped up many times. This high voltage is transferred to an R-C network for filtering and may then be applied to a kinescope or other high-voltage device using small currents.

This vibrator is inexpensive to make, requires little maintenance, and takes up a very small space.

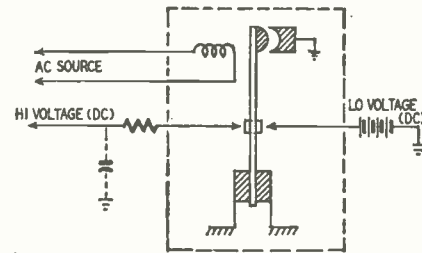

a larger voltage than it would if applied to a large capacitor.

In this invention the capacitor is relatively large during the charging period. Then the capacitance

VIDEO MODULATOR

Patent No. 2,490,428
Thomas M. Gluyas, Jr., Collingswood, N. J.
(assigned to Radio Corp. of America)

The design of a TV modulator is difficult because the r.f. carrier is being modulated by video signals which are themselves in the r.f. region. The modulator must be shunted as little as possible, and the r.f. carrier must be kept out of the modulator circuits.

In the circuit shown here the usual r.f. transformer between driver and power amplifier is eliminated. Instead an autotransformer T provides the necessary step-up with less distributed capacitance.

The modulator is coupled to the amplifier through a peaking coil and damping resistor network instead of a transformer. This type of network is often used in TV receivers and is equivalent to a low-pass filter. It transmits video signals but prevents passage of carrier voltage. The r.f. choke is designed for frequencies in the carrier band.

The driver is designed for higher gain than usual, making it possible to use a very small capacitor at C. Its value should be about 2 μf. C and C_{in} are a voltage divider which feeds the amplifier grid. Since each shunts the modulator circuit

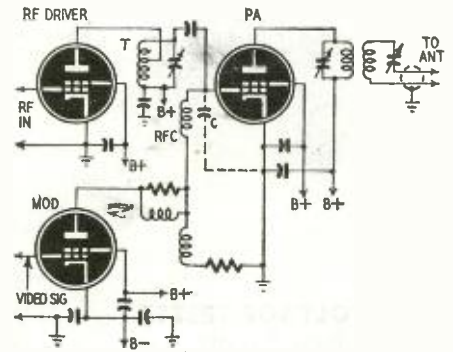

(through a small r.f.c.), they must be small.

It is found that the improvements described result in a linear response over a wider range of video frequencies.

FIELD INTENSITY CALIBRATOR

Patent No. 2,489,908
Charles V. Larrick, Richland, Wash.
(assigned to General Electric Co.)

Field-intensity measurements are required by the FCC and are necessary for correct design and adjustment of radio apparatus. The measurements are often made with portable instruments previously calibrated at a laboratory. However, there is danger of upsetting the calibration when the

be checked every time it is used. It contains an oscillator, voltmeter, potential divider, and receiver.

The receiver picks up a signal either from the antenna or from the calibrated oscillator. The signals are, of course, equal when they produce equal outputs.

The input impedance across the receiver coaxial cable should equal the sum of resistors R1 and the antenna resistance, which is approximately 75 ohms. If the input impedance is known, the value of R1 is fixed. This impedance should also equal the sum of R4 and resistors R2. R4 may be fixed arbitrarily at some small value such as 5 ohms, in which case R2 is known.

The small resistor R4 together with resistors R3 form a voltage divider to reduce the voltage at V to the much smaller potential received from the antenna. Therefore R3 will depend upon the voltage output of the oscillator.

The resistance of R5 is such a value as to make the resistance of the attenuator network equal to the surge impedance of the line from the calibrated oscillator.

The calibrated oscillator may be checked for accuracy with laboratory equipment at frequent intervals to insure accuracy. No other laboratory calibration of the equipment is needed.

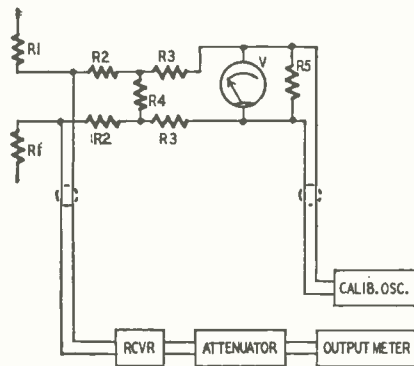

instrument is moved from one location to another, is jarred, etc.

This circuit carries its own calibrator so it may

FREE

with purchase of
100 Sylvania Receiving Tubes...
or 3 Sylvania TV Picture Tubes

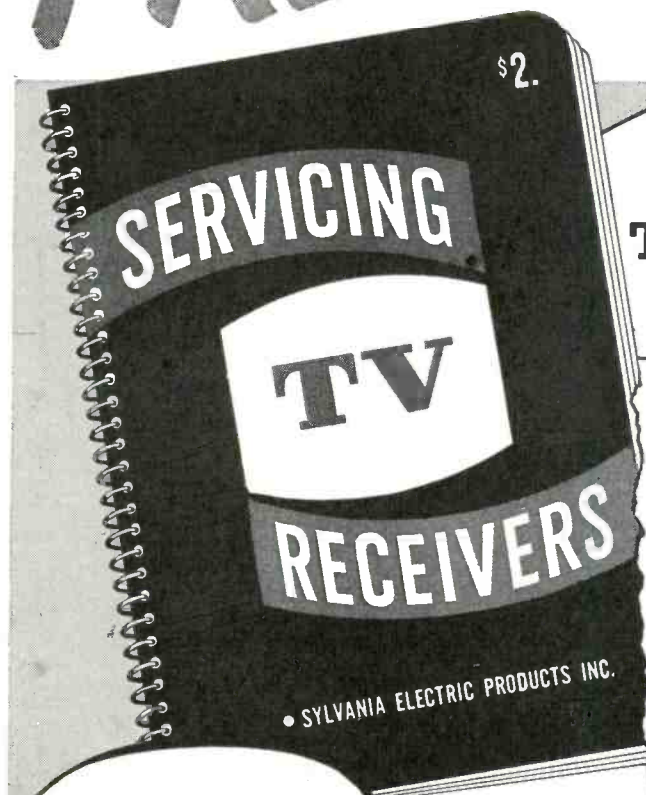

The clearest
and most complete
Television Servicing Book
ever printed

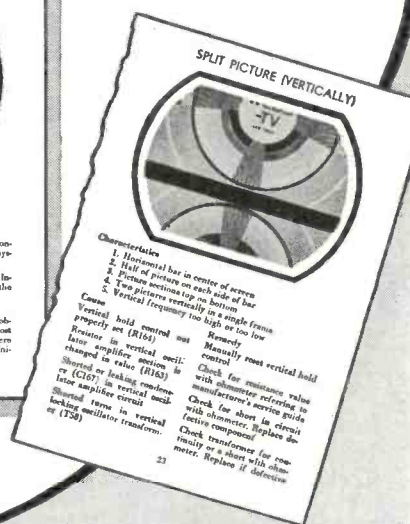
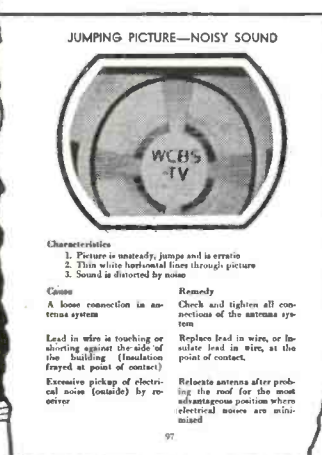

FREE

during April, May, June, July and August

Here are 2 sample pages from "Servicing Television Receivers." Note the easy-to-read type arrangement and the simplified photographic instructions.

HERE at last is a guidebook to help simplify TV set service for you. You'll be amazed how it will enable you to quickly identify trouble . . . solve tricky problems.

Contains more than 100 pages with scores of actual photographs and easy-to-read diagrams, to help you increase and improve your TV set repair business.

Not for sale . . . it's FREE!

This valuable book is yours absolutely free, from your regular Sylvania distributor, with your order of 100 Sylvania receiving tubes . . . or just 3 TV Sylvania picture tubes. Spirally bound with a sturdy board cover to stay open and lie flat on your bench.

NOTE: This important booklet offer is open for a limited time only. So don't delay. Send your order for the tubes you need today to your Sylvania distributor and he'll mail this free, helpful guidebook to you immediately.

**Quickly answers
scores of questions**

- Shows more than 80 actual photos of screen test patterns. Shows how to identify trouble by pattern behavior.
- Gives simple, concise instructions for making repairs, proper adjustments.
- Contains complete circuit diagrams of typical television receiver.
- Explains latest television developments such as "Intercarrier sound."
- Tells about television test equipment and what each instrument will do.
- Provides a practical dictionary of television set trouble.

SYLVANIA ELECTRIC

RADIO TUBES; CATHODE RAY TUBES; ELECTRONIC DEVICES; FLUORESCENT LAMPS, FIXTURES, WIRING DEVICES, SIGN TUBING; LIGHT BULBS; PHOTOLAMPS
APRIL, 1950

it's yours for the asking

FREE

SENCO'S
New ... 1950
RECEIVING TUBE
INTERCHANGEABILITY
CHART

Lists over 150 tube types that are directly interchangeable. Saves you time ... save you money.

NOTHING TO BUY ... Just Fill In Coupon ... MAIL TODAY!

NAME

ADDRESS

CITY..... ZONE... STATE...

SENCO RADIO INC., Dept. T
73 West Broadway, New York 7, N.Y.

Radio Men Who Know
SAVE AT SENCO

New for 1950
FACTORY-TO-YOU
MIDWEST TELEVISION

NEW GIANT 16" PICTURE TUBE

Immense 151 square-inch screen on new 16" metal-glass tube ... clear, steady, bright pictures ... Synchronized sound and picture that a child can tune in perfectly ... Long Distance FM Circuit ... Big 12" Electro-Dynamic Panasonic Speaker ... Available in beautiful consoles or in complete chassis (not a kit). Buy direct at Low Factory Prices, with Low Down Payment and Long Easy Terms ... and on 30 Days Trial! Send for 32-page, 4 color catalog today

30 DAYS TRIAL

EASY TERMS

BUY DIRECT FROM FACTORY and SAVE!

Also a Complete New 1950 Line of
MIDWEST RADIOS
with new long distance FM Circuit and new 3-Speed Phonograph.

Send This COUPON on 1¢ Post Card for NEW 1950 FREE 4 Color 32 Page MIDWEST CATALOG

MIDWEST RADIO & TELEVISION CORP.
Dept. X249, 909 Broadway, Cincinnati 2, Ohio

Please send me your new FREE 1950 Catalog.

NAME

ADDRESS

CITY..... ZONE... STATE...

CAMERA SHUTTER TIMER

If your oscilloscope has a calibrated driven sweep, use it in conjunction with a photoelectric cell to check the speed of your camera shutter. A typical setup is shown in Fig. 1. The auxiliary lens is not needed if the camera is focused on the lamp and the emissive surface of the cell is in the plane of the film.

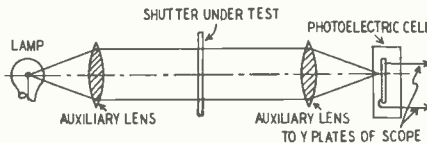

Fig. 1—Setup for shutter speed check.

When the shutter is tripped, the cell generates a pulse which triggers the sweep on the scope. Applied to the Y plates of the scope, the pulse bends the horizontal trace in a vertical direction. A typical trace for a radial shutter is shown in Fig. 2-a and a focal plane shutter in Fig. 2-b. Because the sweep is linear, the length of the sweep can be measured with a rule and compared with the length of the shutter trace.

A camera with a fast lens and high-speed film is used to photograph the trace on the C-R tube. It may be possible to record the trace by fastening a piece of high-speed pack or cut film

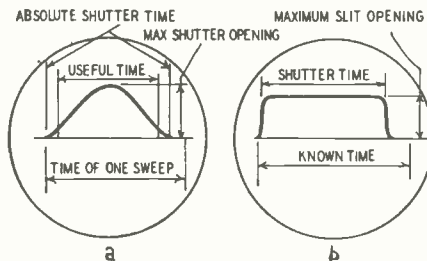

Fig. 2—Showing typical shutter traces.

to the face of the C-R tube. Keep the intensity control turned off until a moment before the shutter is snapped; then turn it down immediately after the exposure.

The sweep oscillator should be adjusted so that the duration of one sweep is longer than the assumed speed of the shutter; thus the shutter opens and closes during the sweep interval. I use 20- and 200-cycle sweeps when testing 1/25- and 1/250-second shutters.—Ronald G. Berlya

TUBE SUBSTITUTIONS

When a 6H6 goes bad and a replacement is not immediately available, check the circuit. If only one diode is used or if both diodes are connected in parallel, a 6C5, 6J5, or 6P5 can be used as a replacement.

Connect one jumper between pins 3 and 5 and another between pins 4 and 8 on the base of the triode. The jumpers make it possible to use any of these triodes as replacements.

The replacement triodes may be those which would normally be discarded because of microphonism or grid-to-plate shorts.—Charles Erwin Cohn

THE FINEST 16" TELEVISION SET EVER DESIGNED!

With Automatic Gain Control (AGC)
Now you can have the finest 1950 model Voltage Doubler Giant Screen Television Set ever designed. Custom built and improved with unusually high brilliance—will give you thousands of hours of fine entertainment during day or evening hours. A bright, clear steady picture is assured by the most famous television set ever produced, the RCA designed 630 type chassis. This identical type TV set is used by more Radio & TV Engineers than any other set ever manufactured!

The 30 tube circuit is more sensitive than any of the cheaper sets having less tubes and the new Standard Tuner has a pentode RF stage which acts as a high-gain built-in Television Booster on all channels. Also featured is an automatic frequency control system that keeps the picture steady and makes tuning easier.

Factory wired and tested, ready to operate. Shipped complete with tubes, less 16" picture tube **\$149.50**
Extra-Clear 16" glass picture tube—guaranteed for one year— **\$39.50**

SPECIAL!

Super-Giant 19" Television Set. 630 type similar to above, but modified to provide a whopper-sized picture. Factory-wired and tested, ready to operate. Shipped complete with tubes, less 19" picture tube. Price... **\$169.50**
Extra-Clear 19" glass picture tube—guaranteed for one year— **\$79.50**

12 1/2" 630 chassis—\$149.50;
12 1/2" tube—1 year guarantee—\$24.95

DE LUXE TELEVISION CABINETS

Beautifully designed to match the 630 chassis without any cutting or drilling. Solidly constructed like the finest furniture with a satiny piano finish. Shipped complete with mask and protective glass window.

- 16" Table Model—Mahogany or Walnut **\$39.95**
- 19" Table Model—Mahogany or Walnut **\$44.95**
- 16" Console—with drop panel to conceal knobs when desired. Mahogany or Walnut... **\$69.50**
- Blonde... **\$79.50**
- 19" Console—with drop-panel as above—Mahogany or Walnut... **\$79.50**
- Blonde... **\$89.50**

4-TUBE AC/DC TELE-BOOSTER

CHECK THESE FEATURES

- Uses type 6AK5's in an extremely stable and efficient wide-band amplifier circuit.
- Self-contained power supply.
- Covers all television channels in use.
- Eliminates need for outdoor antennas in many locations.
- Will actually make difference between "Flat" and very bright pictures on weak stations.
- Improves receiver immunity to off-channel interference. Can be tuned to boost weak station or turned off to provide normal reception.
- Simple to install and operate, requires only external connection to receiver.
- Operates on 110 volts AC or DC.

ONLY \$16.95

TWO STATION INTER-COMMUNICATION SYSTEM

Radiomen—provide yourself with an additional source of income by selling and installing these high quality—low cost intercoms.

Selling Features: • For the nursery (baby sitting) or sickroom • In private homes—room to room—garage to house—basement to attic, etc. • Busy businessmen • Ideal for use in television antenna installation and servicing—instead of unhandy earphones • Simple installation—only 2 wires to connect • Housed in an attractive walnut case, 1 master and 1 slave station, complete with tubes.

Price... **\$10.95**
Extra for 50 feet twin-lead cable... **\$1.00**

For complete listings of special buys for experimenters, radio technicians, laboratories, schools and engineers. Write for catalog T4.

RADIO DEALERS SUPPLY CO.
154 GREENWICH ST. NEW YORK 6, N. Y.

SIMPLE S-METER CIRCUIT

An S-meter can be added to the average superheterodyne receiver merely by adding three resistors and a 1-ma d.c. meter. Two 47,000-ohm resistors and a 50,000-ohm potentiometer are connected as a bleeder across the high-

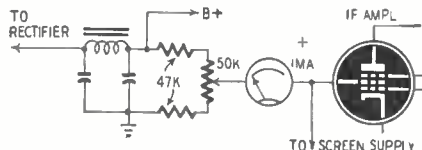

voltage supply. The meter is connected between the arm of the pot and the screen grid of an i.f. tube controlled by the a.v.c. voltage. The circuit is shown in the diagram.

The arm of the pot is adjusted until the meter zeros with the r.f. gain control on full and the antenna terminals shorted. If the meter is too sensitive, a variable resistor may be shunted across it.—*John A. Bishop*

WIRELESS INTERCOM

I live on the floor above a store which I operate. Being unable to remain in the store at all times, I rigged up a wireless intercom which enables me to listen in when anyone enters the store.

I used a battery-operated set as a transmitter. The primary of its output transformer was disconnected from the output tube and one lead was connected to the arm of the volume control and the other to ground. Another output transformer was installed with its primary in the output circuit and its secondary connected between ground and the grid cap of the 1A7 mixer-oscillator. A short antenna was connected to the 1A7 plate through a small capacitor. This set was then tuned to a spot on the low-frequency end of the broadcast band. A standard receiver upstairs was tuned to the oscillator frequency of the transmitter.

The speaker on the transmitter picks up sounds in the store and feeds them to the a.f. circuit where they are amplified and used to modulate the 1A7.

Adjust the transmitter so its signal falls on a quiet spot on the band. Keep the antenna as short as possible for good results, and above all, don't try for distance records with this unit or the FCC may have a few things to say about it.—*John W. Graves*

BATTERY CONNECTORS

The next time you need connectors for a 6-volt storage battery when servicing an automobile radio, try the sliders from a 50-watt adjustable resistor. These sliders are inexpensive and fit the terminals on most vehicular storage batteries.

Another connector useful for the workbench is made by drilling 3/16-inch holes about 1/2 inch into each post. Tap in 8-32 screws and saw off their heads. Then screw on nuts from ordinary dry cells, making very convenient terminals.—*W. M. Finley, Jr.*

four channels from 40 miles clearly with new low-cost C-Series

Tel-a-Ray



These pictures were taken of a 10" Crosley screen in Aurora, Ill., 40 miles southwest of Chicago. A C-Series antenna on a 15-foot mast was in use . . . bringing in clearly the four channels pictured above. No booster of any type was used. (All photos unretouched. Documented evidence on file.)

Here is the antenna you want — for sharp images — wide range — easy assembly — low cost! Tel-A-Ray's C-Series is new . . . designed after extensive tests to give you the best performance possible at the lowest cost.

Tel-A-Ray antennas are durable . . . made from Dural with stainless steel fittings. The C-Series can be assembled and erected in a few minutes, yet its electrical efficiency in simple arrangements is superb. Available in a complete Hi-Lo Channel Kit with mast, guy wire lead-in, and mounting for \$24.50 list.

WRITE TODAY FOR COMPLETE INFORMATION

TEL-A-RAY ENTERPRISES, INC.
P. O. BOX 332, DEPT. C, HENDERSON, KY.



• This is IT—Sun Radio's great all-triode amplifier—engineered from design published by Consumer's Research, Inc., Washington, N. J. Definitely TOPS in its price class.

Flat frequency response from 20 to 15,000 cycles. Distortion less than 2.5%. 10-watt 7-tube all-triode amplifier provides highest reproductive fidelity. Tube complement: 1-6SC7, 2-6SN7, 1-6J5, 2-6B4G and 1-5U4G Rectifier.

Available alone (\$42.50 in kit form; \$69.50 laboratory wire and tested, ready for use). This amplifier is exclusive with Sun Radio of New York. Order by mail for your convenience.

FREE . . .

"Audio Equipment" — 68-page manual catalog — gold mine of sound-system dope. Yours on request.



Sun Radio
& ELECTRONICS CO. INC.
122-C DUANE ST. • NEW YORK 7, N.Y.
2 Blocks North of Chambers St.
BARCLAY 7-1840

PUZZLED?



- TUBE TESTER?
- BATTERY TESTER?
- CONDENSER TESTER?
- AM SIGNAL GENERATOR?
- AUDIO OSCILLATOR?
- FM SIGNAL GENERATOR?
- MULTITESTER?

Here's Your Answer Now
ALL IN ONE!

SERVISHOP MODEL 8573

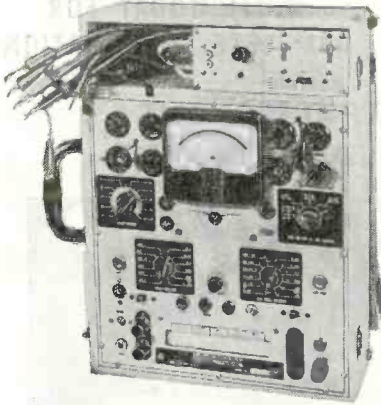

EQUIVALENT TO A COMPLETE SERVICE SHOP!

- TUBE TESTER
- SET TESTER
- BATTERY TESTER
- CONDENSER TESTER
- AUDIO R. F. - F. M. SIGNAL GENERATOR

\$99.95

Every square inch solid-packed with value! Look what you get in this phenomenally low-priced tester: (1) A complete tube tester with over 800 listings in its famous Rollindex roll chart, (2) a battery tester indicating actual voltage under rated load, (3) A capacitor tester, (4) A fixed point calibrated AM-FM signal generator, (5) An audio oscillator; and a dozen additional features.

Readable scale divisions on the ohm meter start at 0.05 ohm to 25 megohms.
DC Volts: 0, 2.5, 10, 50, 250, 1000, 5000
AC Volts: 0, 10, 50, 250, 1000, 5000
DC Milliamps: 0, .5, 2.5, 10, 50, 250, 1000
DC Amps: 0, 10
Ohms: 0, 250, 2500, 25000
Megohms: 0, 2.5, 25

Decibels: -8 to +15, 15 to 29, 29 to 49, 32 to 55
Output Voltmeter: 0, 10, 50, 250, 1000, 5000
Complete with tubes, batteries and test leads, output leads, etc., housed in natural finish oak case; hammertone gray panel. See this outstanding buy at your jobber today—or write for new catalogue RE-4.

RCP INSTRUMENTS—BEST FOR EVERY TEST

RADIO CITY PRODUCTS CO., INC.

152 West 25th St. New York 1, N. Y.

REPEATING INTERVAL TIMER

Various on-off interval timers have been described for use on welders, photographic printers, and enlargers, and other industrial devices. This unit, described in an *RCA Application Note*, is unusual in that it automatically repeats a sequence consisting of adjustable on and off intervals. Such a device can be used to control animated window displays, mechanical toys such as electric trains, or many types of electric

plates and grids are interconnected so that when one tube conducts, the other will be turned off because its plate and grid voltages are reduced below the levels required for firing. The on and off intervals are adjusted between 0.3 and 40 seconds with the variable resistors in the grid returns. A d.p.d.t. switch transfers the relay from one plate to the other to interchange the timing of the preset on and off intervals.

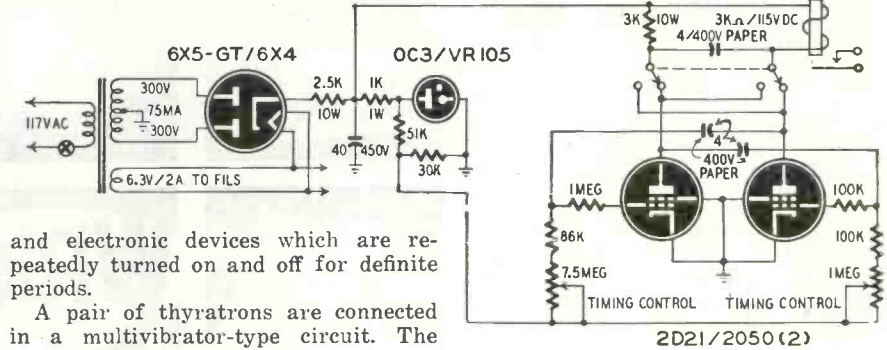

and electronic devices which are repeatedly turned on and off for definite periods.

A pair of thyratrons are connected in a multivibrator-type circuit. The

CRYSTAL DIODE CIRCUITS

Germanium diodes such as the 1N34 have been used to replace vacuum tube diodes in many interesting applications. Their use as video detectors in

makes possible a more completely balanced and stable circuit. This circuit also eliminates the possibility of the 60-cycle hum sometimes present in vacuum-tube discriminators because of heater-to-cathode leakage. If the hum is strong enough, it will frequency-modulate the oscillator and produce non-linearity or a distorted raster.

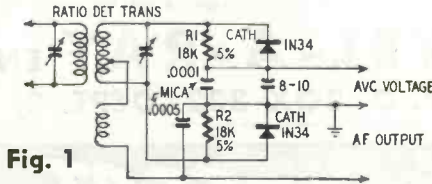

Fig. 1

Values for C1, C2, R1, R2, and R3 are critical and should be as shown on the diagram. The unmarked values and their exact circuit arrangement may vary in different makes and models of TV sets.

quite a few television receivers is well known. Two circuits which are not as familiar were described in *Sylvania Electric Engineering News Letter*.

Besides eliminating a possible source of 60-cycle hum, the germanium diodes have a very low shunt capacitance of about 3 μmf when mounted in a chassis as compared to about 15 μmf of a 6H6 diode in a rectifier circuit. This low capacity makes them useful in circuits

Fig. 1 is a ratio detector circuit using shunt-connected 1N34's. Experimenters may wish to use it in the sound i.f. section of their TV receiver, or in an FM receiver or tuner.

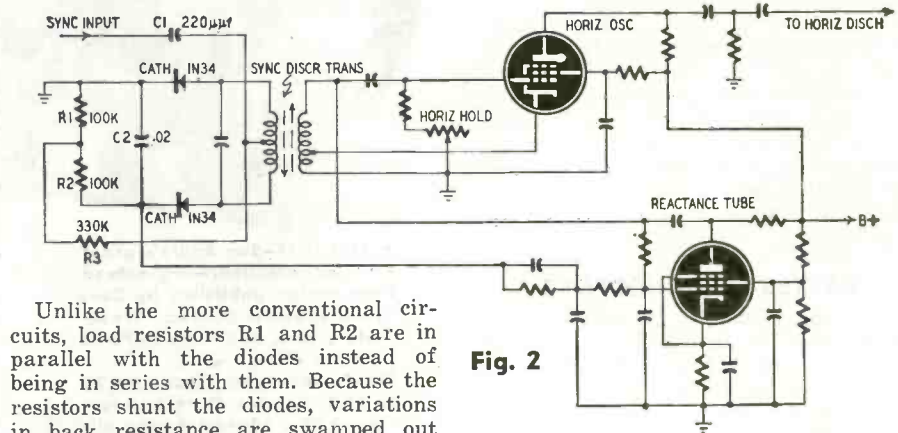

Fig. 2

Unlike the more conventional circuits, load resistors R1 and R2 are in parallel with the diodes instead of being in series with them. Because the resistors shunt the diodes, variations in back resistance are swamped out and the static balance of the circuit is maintained.

operating up to several hundred megacycles.

Fig. 2 shows how the 6AL5 or 6H6 horizontal sync discriminator may be replaced by 1N34's in the a.f.c. circuit of a popular type of horizontal sweep circuit. It is claimed that the use of germanium diodes in the discriminator

The 1N34 is rated at 50 volts maximum peak inverse voltage and the average current rating is 22.5 ma. The forward resistance is about 50 ohms and the back resistance is about 1/2 megohm.

CROSSOVER NETWORK

The crossover network shown in the diagram was taken from a bulletin published by Racon Electric Co., Inc. It is designed for a crossover at 1,000 cycles. The table gives values for the capacitors, tweeter level control, and inductors as well as winding data.

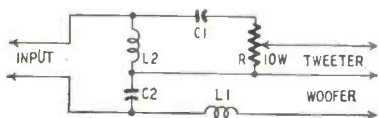

The inductor design is based on a nonmetallic winding form 1 1/4 inches in diameter with 3/4-inch winding space. The inductors are wound with No. 16 enameled wire with approximately 13 turns per layer. The form may be a 3/4-inch length of 1 1/4-inch wooden dowel

Voice coil (ohms)	C1 (µf)	C2 (µf)	L1		L2		R (ohms)
			mh	turns	mh	turns	
4	32	50	0.5	112	0.3	90	6
6	22	35	0.8	140	0.5	112	10
8	16	25	1.0	160	0.65	130	12
10	13	21	1.3	175	0.8	140	15
12	11	18	1.5	200	0.97	155	20
16	8	13	2.0	212	1.3	170	25

with 3-inch squares or circles of stiff cardboard or Masonite nailed to the ends.

For the inductors in the 4-, 6-, 8-, 10-, and 12-ohm networks 1 pound of wire will be sufficient. The 16-ohm network requires 1 1/2 pounds of wire.

The capacitors should be of the non-polarized type (paper). Their voltage ratings may be as low as 25.

All Conicals Look Alike, but

only OAK RIDGE Fringemaster

GIVES YOU: LOWEST COST AND HIGHEST QUALITY FOR GREATEST PROFIT!

HIGHEST GAIN FOR LOCAL AND FRINGE AREAS!

Here's why you get lowest installation costs, fewest call-backs, best performance—and highest profits—with the new Oak Ridge FRINGEMASTER Conicals:

for Metropolitan Areas:

The X-66 gives you the highest gain and lowest cost for its type on the market! 6 forward and 6 reflector elements.

for Fringe Areas:

The superb sensitivity of the XX-66 is unmatched by any other conical! Lowest-priced! 6 forward and 6 reflector elements, double-stacked.

- Highest gain conical beam
- Highest signal-to-noise ratio
- Major lobe in line of frequencies
- Highest front-to-back ratio
- Matched to 72, 150 or 300-ohm transmission lines
- Supplied with any combination of antenna or reflector elements

- Sensitivity and directivity instantly changeable by inserting different ratio of antenna to reflector elements
- Non-flattened tubular rigid support for all elements
- "U"-bolt assembly—Easy stacking
- Speedy Assembly

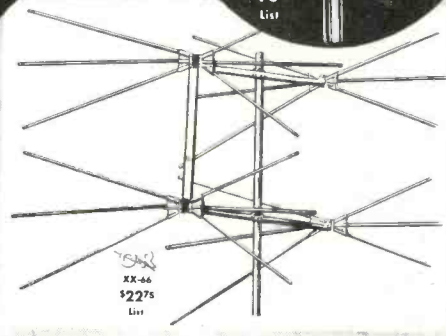
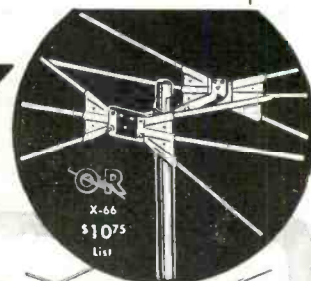

OAK RIDGE PRODUCTS

239 EAST 127 STREET, NEW YORK 35, N. Y.

Manufacturing Division of VIDEO TELEVISION, INC.

Makers of the famous SNAP-LOCK Patented TV-FM antennas and accessories and the Oak Ridge MINIATURE TV test equipment

See why the new Oak Ridge FRINGEMASTER Conical is the greatest profit-maker of them all! Place your order for it with your parts jobber NOW Write for your free Catalog E-2.

BIG MONEY IN RADIO and TELEVISION NOW!

See COYNE'S Brand New 7 Volume Set

APPLIED PRACTICAL RADIO-TELEVISION

FREE!

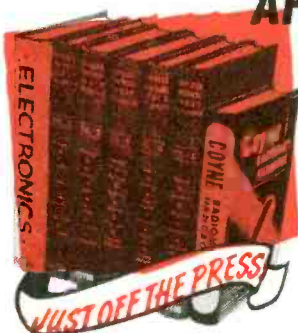

A BRAND NEW Set of books written for men who want to "go places" in TELEVISION and RADIO . . . men who know how a PRACTICAL working knowledge helps to get the BIG MONEY. Over 2500 pages of the latest Radio and Television "know how"; easy to understand with hundreds of crystal-clear illustrations. It's ALL here! EVEN COLOR TELEVISION AND UHF. How to install, service, align, balance ALL radio and TV sets . . . how to use new and old testing instruments for TV service . . . latest data on adapters, converters and MORE. Complete volume on Electronics and handy Radiomen's Handbook included. You name it and COYNE'S GOT IT, in this amazing new money-making 7-Volume Radio-Television Library.

**PRACTICAL!
CLEAR!
COMPLETE!**

7 fact-packed volumes — 1400 illustrations and diagrams with step-by-step photographs which "break down" the equipment to show what makes it "tick." Up-to-the-minute, complete, easy to follow.

Color Television Is Here!
Set contains most complete section ever published on Color Television and UHF, adapters and converters. FULLY ILLUSTRATED AND PRINTED IN 4 COLORS.

Act Now and Get FREE Book
Now you can see these new Coyne books for 7 days without cost and get Coyne's book of 150 Radio and Television Diagrams FREE. It's free just for examining the new 7-Volume Set. Full details of this sensational Coyne "prove it" offer are given below. Mail the coupon at once.

SEND COUPON—SEE SET FREE FOR 7 DAYS

You must SEE these new books to know how easy it is to prepare for the big jobs in radio and television. Here's our special offer: — we'll send the complete 7-volume set for your 7-Day FREE Examination. And with it, we'll include our valuable, new guide for all radiomen, "150 New Radio-Television Diagrams Explained," absolutely FREE! If you keep the 7-volume Set all you pay is \$3.00 within 7 days after the books arrive and \$3.00 per month until \$23.50 is paid — or you can pay \$22.00 cash price. If you don't want the set, return it and you OWE NOTHING. But either way you keep "The Radio and Television Diagrams Book" as a gift. That book is ABSOLUTELY FREE.

SEND NO MONEY Coupon is just a request to see Set free and get FREE BOOK. Offer limited—act now.

COYNE Electrical and Radio-Television School
500 S. Paulina St., Dept. 40-TI, Chicago 12, Ill.

Mail This Coupon NOW

Educational Book Publishing Division
COYNE ELECTRICAL & RADIO-TELEVISION SCHOOL
500 S. Paulina St., Dept. 40-TI, Chicago 12, Ill.
O.K. Send me postpaid, your new 7-volume set, "Applied Practical Radio-Television", on 7 days Free Trial per your offer. Be sure to include as a gift the book of 150 Radio-Television Diagrams absolutely FREE.

NAME _____ Age _____
ADDRESS _____
TOWN _____ ZONE _____ STATE _____
Where employed _____

MICROWAVE

Receiver Front End, complete, C/O Dual 723AB Klystron mount, TR-ATR Duplexer Section, 2 Stage 20 MC. Pre-amplifier, new, with all tubes \$59.50

TEST EQUIPMENT

- CG-176/AP Directional coupler X Band, 20 DB nominal, type "N" take off, choke to choke, silver-plated \$17.50
- X Band 1 3/4"x3/4" absorption type wavemeter, micrometer head, 6000 to 8500 mc. Demornay-Budd, #358 185.00
- C Band "T" gold-plated at 97.00
- C Band Flap attenuator Demornay-Budd type #339, gold-plated 100.00
- X Band 1 3/4"x3/4" Klystron mount with tunable termination, gold-plated 75.00
- X Band 1 3/4"x3/4" low power load, gold-plated 45.00
- X Band 1 3/4"x1/2" waveguide to type "N" adaptor, gold-plated 22.50
- X Band 1 1/8"x1/2" "T" Section, gold-plated 55.00

X BAND

- Directional coupler, UG-40/U take off, 20 DB, silver plated \$17.50
- Directional coupler, APS-6, type "N" take off, 20 DB, calibrated 17.50
- Broad Band Directional coupler, type "N" take off, choke to cover, 35 DB, calibrated 18.50
- Directional coupler, APS-31, type "N" take off, 25 DB 17.50
- Bi-directional coupler, type "N" take off 22.50
- Flexible Section 18" long 12.00
- Straight Sections 2 1/2 ft. long choke to cover, silver plated 6.50
- Pressure Test Section with 15 lb. gauge and pressurizing nipple 10.00
- Bulk Head Fed Trough, choke to cover 12.00
- Mitered Elbow, choke to cover or choke to choke 12.00
- Right Angle Bend 2 1/2" Radius, choke to cover 7.50
- 90° Twist, 6" long 7.50
- 45° Twist, 6" long 7.50
- 90° Twist, 5" long with pressurizing nipple 7.50
- 15° Bend 10", choke to cover 5.00
- 5 ft. Sections UG-39 to UG-40, silver plated 5.00
- 180° Bend, 20" Choke to cover 2 1/2" radius, SWR measuring Section 4" long, 2 type "N" probes mounted full wave apart 1 1/4"x3/4" guide 8.50
- WE attenuator (P/O TS 35) 0 to 20 DB, less cards, bell size guide 12.50
- 90° Bend E Plane 18" 4.00
- Rotary Joint, choke to choke 10.00
- Rotary Joint, choke to choke with deck mounting TR-ATR Duplexer Section for 1B24 and 724B 12.50
- Wavemeter-Thermistor Mount 6.00
- K25/723 AB Receiver, Local Oscillator Klystron Mount, complete, with Crystal Mount, Iris Coupling with Choke Coupling to TR 22.50
- TR-ATR Duplexer Section for above 8.50
- 723AB Mixer-Beacon Dual Oscillator Mount with Crystal Holder 12.00
- 723AB Mixer-Beacon Dual Oscillator Mount Matching Slugs and tunable termination, new Bi-Directional Coupler, type "N" terminator, 20 DB, calibrated, 1 1/4"x3/4" guide 24.50
- 12" Flexible Section 1 1/4"x3/4" guide 17.50
- Crystal Mount in Waveguide 10.00
- 50-3 Echo Box, Transmission type cavity with bellows 17.50
- 180° Bend with pressurizing nipple 28.50
- 1 1/2" Curve 18" long 5.00
- 1 1/2" Curve 6" long 3.25
- APS 31 Mixer Section for mounting two K25's, Beacon Reference cavity, 1B24 TR Tube 42.50
- Transition 1 1/4"x1/2" to 1 1/4"x3/4", 14" long 8.00
- Random Lengths of Waveguide 6" to 18" long per ft. 1.00

SEND FOR FLYER OF RADIO PARTS

Rated Concerns Send P.O.

Send M.O. or CHK. Mds. Guard. Shps. Charges Sent C.O.D. Price F.O.B. N.Y.C. Phone Di. 9-4124

COMMUNICATIONS EQUIPMENT CO.

131 Liberty St., Dept. C4 New York City 7, N. Y.

PENNSYLVANIA MAKES ANNUAL AWARD

The plaque awarded annually by the Federation of Radio Servicemen's Association of Pennsylvania was given to the Sylvania Electric Products Corporation at a banquet luncheon held February 19 at Harrisburg.

The plaque, which carried the wording: For consistence in promotion and advertising to the public in effort to promote public confidence and to assist the radio-television technician was presented by Richard Devaney of the

Philadelphia organization and accepted by Mr. R. H. Bishop on behalf of the Sylvania organization.

More than 30 persons, representing eight of the Pennsylvania local organizations, the New York state radio technicians federation (ESFETA) representatives of the technical press and visitors from Sylvania and a number of radio technicians' associations, were present at the presentation.



Holding the award is R. H. Bishop. At his left, Dave Krantz, the Federation's president, and between them (rear) T. L. Clarkson of the Mid-State Association.

OKLAHOMA CITY ASSOCIATION ACTIVE

The Oklahoma City Radio Servicemen's Association elected R. B. Cherry as its president for 1950. Vice president is Walter Cox, secretary-treasurer L. G. Deering, program chairman E. J. Snyder, and publicity director James H. Jackson.

A campaign to publicize and stress the decal of the organization was planned at the annual meeting, and arrangements made to have technical speakers address the group throughout the year, a committee being entrusted with the work.

PHILIPPINE AMATEUR ASSOCIATION



Photo above is of a Philippine hamfest, held at the home of Jess Escalante, DU1VVS, of Cavite City. The hams in the front row (kneeling) are Pedro Auginaldo, Jr., DU1DO, and Gregorio Orbeta, DU1AW; the second row, left to right: Jorge Illenberger, DU1JI, David K. Pope, W3IJW, Mary E. Pope, Rose Illenberger, Celestina Marcelo Illenberger, Mrs. Jess Escalante, Lita Contreras, Nunilon Lim, DU1NL,

and Jess Escalante, DU1VS. In the back row are Jack Santoromana, DU1JS, Gregorio Trinidad, DU1GT, Fred Hashim, Miguel Contreras, DU1MC, Victor Valenzuela, DU1AQ, Emmet M. Johnston, W7CEV, and Frank Tunison. We thank Mr. Elpidio de Castro, secretary of the Philippine Amateur Radio Association, for the photograph.

LEARN

Radio-Television, Electricity
OR
Electricity
IN THE GREAT SHOPS OF **COYNE**

COYNE 51st ANNIVERSARY
TRAIN QUICKLY!
OLDEST, BEST EQUIPPED
SCHOOL of ITS KIND in U.S.
2 Opportunity Fields

Come to the Great Shops of COYNE in Chicago during our 51st Anniversary Year! Get quick, practical training in RADIO-TELEVISION or ELECTRICITY. G.I. Approved. Finance plan for non-veterans. Mail Coupon Today for complete details.

NOT "HOME-STUDY" COURSES!
You learn on real, full-size equipment, not by mail. Finest staff of trained instructors to help you get ready quickly for a better job, a fine future.

FREE BOOKS Clip coupon for big illustrated Coyne book on either ELECTRICITY or RADIO-TELEVISION. Both books sent FREE if you wish. No obligation; no salesman will call. Act NOW!

B. W. COOKE, Pres.
COYNE Electrical & Radio-Television School,
500 S. Paulina St., Chicago 12, Ill. Dept. 40-81H
Send FREE BOOK and full details on:
 RADIO-TELEVISION ELECTRICITY
NAME
ADDRESS
CITY STATE

IMPROVE YOUR TV SIGNAL

Easy new method tunes your Antenna to prevent standing waves. Plug-in type stubs Cover All channels. Kit \$3.95. Complete instructions.

ACE TV CO., 801 3rd St., Ocean City, N. J.

Review of Recently Issued Tubes

This month's crop of new tubes includes the shortest 3-inch electrostatic cathode-ray tube ever manufactured commercially, a group of "ruggedized" tubes, and an improved photo-tube.

The little 3MP1 tube was originally

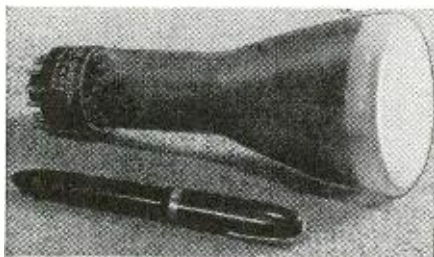

designed for use in small industrial oscilloscopes, but its manufacturer, General Electric, reports that it is expected to find numerous applications in television servicing as well as testing industrial equipment.

Maximum ratings of the new tube are: anode No. 1, 1,000 volts; anode No. 2, 2,500 volts; maximum negative bias 200 volts, and maximum positive bias 2 volts d.c.

"Ruggedized" tubes are standard types designed to give reliable service under conditions of severe vibration and shock. Five out of a proposed total of 20 have been announced by Sylvania. These are the 6SN7-WGT, 6X5-WGT, 28D7-W, 6L6-WGA and 6SL7-WGT. Characteristics of the tubes are identical with their standard equivalents.

Sylvania also announces a new all-glass 16-inch picture tube. The tube,

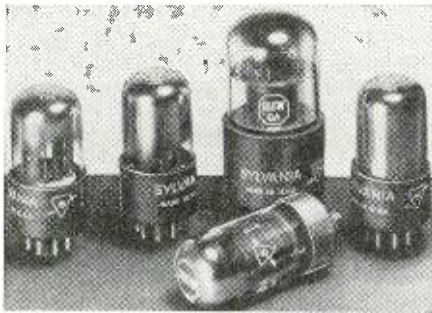

the 16LP4, which is 22 1/4 inches long, employs an ion trap for use with an external magnet. Deflection angle is approximately 52 degrees. Anode voltage is 12,000, No. 2 grid voltage 300, No. 1 grid voltage (for cutoff) -33 to -77. Heater voltage is 6.3 and current 0.6 ampere. Focus coil current is 110 ma and ion trap magnet current 120 ma. A smaller tube, the 8BP4 has electrostatic focus and deflection, and is designed to replace the 7JP4, with which it is directly interchangeable. Its useful screen area is roughly 50% greater than that of the 7JP4. The deflection sensitivity provides full scan in circuits designed for 7-inch tubes. Operating voltages are 6,000 on anode No. 1, 1,620 to 2,400 on anode No. 2, and zero to -72 to -168 on grid No. 1.

Another Sylvania contribution of the month is a miniature high-voltage rectifier for television receiver high voltages. The 1X2 may be used where d.c.

voltages up to 15,000 are required. Filament voltage is 1.25, filament current, 200 ma. Peak plate current rating is 10 ma, and maximum load current, 1 ma. It is designed for a supply frequency of 300 kc maximum when used in r.f. power supplies.

Improvements in multiplier photo-tubes have been announced by RCA. The 1P21, already a useful tube of this type, has been improved by reducing its "equivalent noise output" about six times to permit a corresponding reduction in the lower limit of measurable light intensities.

This extension of range makes the tube of great value to astronomers studying light intensity of distant stars, to nuclear scientists studying atomic radiation, and in other research work requiring low intensity light measurements.

Further information (technical data sheets) on any of the tubes described above may be obtained by writing direct to the manufacturer.

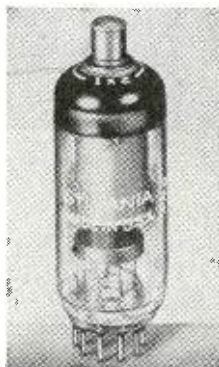

Radio Thirty-Five Years Ago

In Gernsback Publications

HUGO GERNSBACK Founder

Modern Electrics.....	1908
Electrical Experimenter.....	1913
Radio News.....	1919
Science & Invention.....	1920
Television.....	1927
Radio-Craft.....	1929
Short-Wave Craft.....	1930
Television News.....	1931
Wireless Association of America.....	1908

Some of the larger libraries still have copies of ELECTRICAL EXPERIMENTER on file for interested readers.

APRIL, 1916, ELECTRICAL EXPERIMENTER

How the Blind May Read by Sound, by Professor F. C. Brown

A Writing Machine that Responds to Voice

Use of The Braun-Tube for Research Work on Electric Oscillating Currents, by Prof. Dr. Ferdinand Braun

The Radio League of America Radio Range and Direction Now Found by Instruments

Sensitive Micro-Ampere Wireless Relay Electrical Losses in Radio Transmitting and Receiving Sets, by James L. Green

Sealed-Point Electrolytic Detector Hints

How To Erect an Aerial Mast, by Rudolph Karl

Magnetic Key from Buzzer, by Earl Ryder

Improvement on Silicon Detector, by John T. Corcoran

A Detector that Tunes Itself Synchronous Spark Gap

Plating Quartz Fibers by a Cathode Spray

WHERE TO BUY IT...

WHOLESALE RADIO

of Baltimore

TV INTERFERENCE FILTERS

DRAKE HIGH PASS FILTERS

FOR TV
RECEIVERS



Suppresses interference (50 mc and lower) from amateur transmitters and many other sources which enter TV set through antenna.

\$3.57

Either Model

Model TV-300-50HP For 300 Ohm twin lead
Model TV-72-50HP For 72 Ohm small Coax.

DRAKE HIGH PASS FILTERS FOR TRANSMITTERS

Model TV-52-40LP For 52 ohm Coax.
Model TV-300 LP For 300 ohm twin lead.

\$12.95

STOPS PICTURE JUMPING

NEW! AGC for 630 type TV CHASSIS
Techmaster Keyed AGC Kit

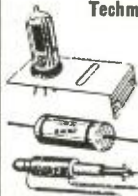

Install It In 15 Minutes!

For any 630 type TV receiver. Keyed automatic gain control eliminates picture jumping caused by noise and overloading by strong signals. Special bracket mounts on existing holes in chassis. Operates from sync pulse simplifying tuning and adjustment. Complete with 6AU6 tube, bracket with mounted tube socket resistors, condenser, coil and pictorial wiring instructions.

\$4.45

UNBEATABLE TV RECEPTION

BEST FOR THE FRINGE AREAS

Snyder Lazy XX
TV ANTENNA

Complete with three
3 1/2 ft. masts &
adj. mounting base



Extremely hi-gain. Superior construction. Designed to withstand all weather conditions. Easily stacked double conical lazy XX type. Just unfold, tighten and erect. All TV channels and FM. You also get guy wire rings, stand-off pole insulators and connecting stubs. Completely pre-assembled. Can be used with any type lead-in 72 to 300 ohms. Order model TX-2.

\$15.95

T.V. ANTENNA ACCESSORIES

High in Quality! Low in Price!

STEEL EXTENSION POLES. Weather treated.	
10 Ft. Long. 1 1/4" di.	\$1.49
5 Ft. Long. 1 1/4" di. Crimped end.	.89
3 1/2 Ft. Long. 1 1/4" di. Crimped end.	.69
ANTENNA SWIVEL BASE. Aluminum	.39
Fits 1 1/2" O.D. mast section.	
GUYWIRE. 6 stranded No. 20 per 50 ft.	.29
24 reels, 50 ft. each, interconnected	6.00
72 OHM COAXIAL CABLE RG59	
4c per ft. Per 100 ft.	3.75
300 OHM TWIN LEAD (\$1.45 per 100 Ft.) 1000 ft.	11.75
CHIMNEY MOUNT BRACKETS. Complete with strap	1.39
3 1/2"-300 OHM STAND-OFF INSULATORS	
Wood screw-in type. 3c ea. per 100	2.75
WALL BRACKETS. Adj. un to 18" from wall.	
Will hold masts 1" to 1 1/2" di. WB-2	3.75
RAMS TV ANTENNA MANUAL	1.25
RINGS-ON TWIN LEAD INSULATORS. Fits 1 1/2" masts	.06
HI-BAND ADAPTER. Folded dipole and reflector.	
Clamps on existing pole. HF-3	1.49
MAST COUPLINGS. Galvanized steel 8" long.	
Will couple masts of 1 1/4" or 1-5/16" di.	.45

Boosts TV Signals 10 Times

STANDARD TV BOOSTER

High Gain! Boosts signal at least 10 times on high or low band. Low signal to noise ratio. Adaptable to 300 or 72 ohm line. Simplified 2 knob control.



ANCHOR (ARC-101-50) \$22.50
RMS SP-4 22.50
ASTATIC Channel Chief AT-1 29.70

WRITE FOR FREE "FYI" BULLETIN
Address Orders to Dept. QR-25 or Call
Mulberry 2134

**WHOLESALE
RADIO PARTS CO., Inc.**
311 W. Baltimore St.
BALTIMORE 1, MD.

JUST OFF PRESS!

Now you'll really know **HOW TO USE AN OSCILLOSCOPE**



Don't let the oscilloscope "stump" you!

Learn to use it fully — and watch your efficiency soar. This easy-to-understand book by an expert gives you the facts and how-to-use-it data you've been wanting.

MODERN OSCILLOSCOPES AND THEIR USES

by JACOB H. RUITER, Jr.,

of Allen B. Du Mont Laboratories, Inc.
326 pages, 370 illustrations, \$6.00

This big book gets right down to earth in explaining oscilloscopes (cathode ray oscillographs) and showing exactly how to apply them to specific AM-FM-TV service jobs. No involved mathematics! First the author explains oscilloscopes fully. Then, in easily understood terms, he tells exactly how to employ them on specific jobs—from locating receiver troubles to aligning and adjusting the most complicated circuits.

WHAT IT IS—HOW IT WORKS

1. Introduction to Oscilloscopes
2. History of the Oscillograph
3. Development of the Cathode Ray tube
4. Principles of Cathode Ray Tube Operation
5. Details of the Modern Cathode Ray Tube
6. The General Purpose Oscilloscope
7. Power-Supply Circuits
8. Amplifiers, Attenuators, and Positioning Circuits
9. Time-Base Circuits



HOW TO USE IT ON THE JOB

- | | |
|---|--|
| <ol style="list-style-type: none"> 10. Operation of the Oscilloscope 11. Interpretation of Basic Patterns 12. Auxiliary Equipment 13. Typical Applications in the Electronic Industry 14. Servicing A-M Radio Receivers 15. Servicing F-M Radio Receivers | <ol style="list-style-type: none"> 16. Servicing Television Receivers 17. Use of the Radio Transmitter 18. Using the Oscilloscope in Teaching 19. Additional Industrial Uses of the Oscilloscope 20. Photographing Cathode Ray Patterns |
|---|--|

MAKES THE OSCILLOSCOPE EASY TO UNDERSTAND

Each operation is carefully explained including the making of connections, adjustment of circuit components, setting the oscilloscope controls, and analyzing oscilloscope patterns. About 400 illustrations, including literally dozens of pattern photos, make things doubly clear.

Besides its radio and TV uses, you learn about many oscilloscope applications in industry and teaching. Send coupon today for your copy of **MODERN OSCILLOSCOPES AND THEIR USES**. If not more than satisfied, return it after 10 days and we'll gladly refund the purchase price.

10 DAY MONEY-BACK GUARANTEE

Dept. RE-40, Murray Hill Books, Inc.
232 Madison Ave., New York 16, N. Y.

□ Send me a copy of **MODERN OSCILLOSCOPES AND THEIR USES** for which I enclose \$6 (\$6.50 outside U.S.A.) or

□ Send book C.O.D. (U.S.A. only) for \$6 plus postage. I will pay postman.

In either case, if book is not satisfactory, I will return it in 10 days and you guarantee to refund my \$6.

Name

Address

City, Zone, State



The 40-inch focal length lens is no longer than other standard TV camera lenses.

New TV Lens Has Mirrors

A NEW kind of lens for television cameras made its debut several months ago in a CBS football broadcast. The lens has a 40-inch focal length and will make the figure of a man more than a block away from the camera completely fill the television screen.

The new device, known as the Video-Reflector, was invented by Dr. Frank G. Back, whose company, F. G. Back Video Corp., is producing it.

From this the rays are sent to another tilted flat mirror at the top, thence to a third at the bottom and rearward to the image orthicon target.

Until the new invention, lenses with focal length greater than about 25 inches could not be used on television camera turrets. The lens had to be actually 25 inches long. It required multiple elements which added weight and was likely to project into the field of view of other lenses on the turret.

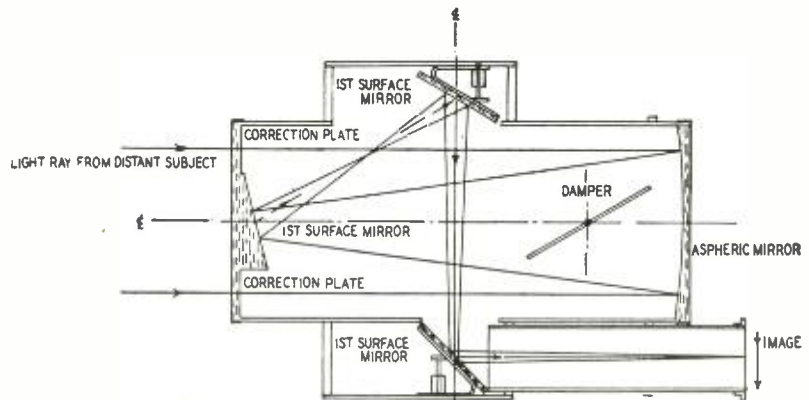

Increased focal length is achieved by the use of mirrors. Note path of light rays.

It is built on an entirely new principle, using mirrors instead of lenses, as indicated in the diagram. The light from the distant subject enters the housing through a correction plate whose position corresponds to the front element on a conventional lens. It passes through the housing to the rear, where it strikes an aspherical mirror. This tends to concentrate the rays so that when they reflect back to the front of the unit they strike a tilted flat

Resolution was poor.

The total length of the new lens, from mounting to tip, is 16 inches. The 40-inch focal length is made possible by the technique of passing the light several times through the same space.

As the photo shows, the Video-Reflector looks more like a stereopticon than a lens. It is shown mounted on a standard TV camera lens turret with three other standard lenses.

ELECTRONIC LITERATURE

Any or all of these catalogs, bulletins, and periodicals are available to you if you write to us on your letterhead (do not use postcards) and request them by number. It is necessary to send only the number of item you want. We will forward the request to the manufacturers, who in turn will send the literature directly to you. This offer void after six months.

A-1—TRANSFORMER CATALOG

The 15-page Catalog No. 49A, published by Audio Development Co., describes power and audio transformers, power-supply, bandpass, and sound-effects filters, patch cords, and plugs. Electrical and mechanical specifications are given where necessary.—*Gratis*

A-2—SHIELDING INFORMATION

Mechanical Aspects of Electronic Assemblies, a reprint from *Product Engineering* issued by the New York University Bureau of Public Information. This 4-page folder deals with parts placement, wiring methods, grounding, sub-assemblies, etc., but most particularly with shielding problems. A table of recommended shielding, wiring, and grounding practice for 25 types of electronic equipment and a chart showing thickness of shielding required for frequencies from 10 kc to 10 mc form part of the presentation.—*Price 10 cents*

A-3—MAGNETAPE RECORDERS

A publication of the Amplifier Corp. of America describes their 1950 line of magnetic-tape recorders. Two introductory pages are devoted to a technical discussion of the features of Twin-Trax recorders, illustrated with mechanical drawings and schematics.—*Gratis*

A-4—MULTI-ANTENNA SYSTEM

Catalog No. 149 of the Jerrold Electronics Corp. describes their Mul-TV Antenna System, also accessories and associated equipment. 8 pages.—*Gratis*

A-5—SERVICE EQUIPMENT

The Superior 1950 test equipment catalog covers the complete Superior line. Besides a complete line of radio test equipment, an industrial analyzer, with ranges up to 6,900 watts, 3,000 volts a.c. and d.c., and direct and alternating current up to 30 amperes, is described.—*Gratis*

A-6—AMPLIFIER CATALOG

The latest Bogen catalog contains 19 pages, listing public-address amplifiers and accessories—microphones, speakers, matching transformers, and so on. Two of the amplifiers have the anti-feedback control which "tunes out" acoustic feedback from loudspeaker to microphone.—*Gratis*

A-7—TRANSFORMER REPLACEMENT GUIDE

Stancor replacements for the transformers used in 108 popular television receivers are listed in this four-page reference. Power and audio transformers, filter chokes, deflection yokes, and focus coils are included.—*Gratis*

APRIL, 1950

AUTOMATIC 1949 & 1950 CUSTOM-BUILT AUTO RADIOS

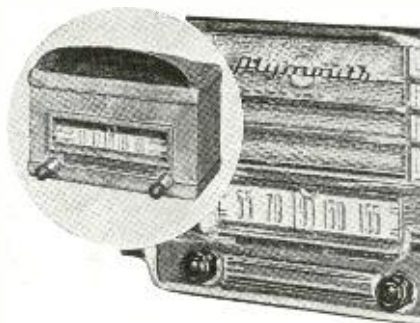

The perfect factory look of the Plymouth (illustrated) is equally as nice on the Ford, Dodge or Chevrolet. COMPLETE . . . SIMPLE TO INSTALL . . . FULLY GUARANTEED

FEATURES

- 6-Tube Superheterodyne (8-tube performance)
- Beam Power Output & Automatic Volume control
- 3 Gang Condenser—Large Dynamic Speaker

DEALER'S PRICES

FORD	\$34.97
DODGE	34.97
PLYMOUTH	34.97
CHEVROLET	36.49

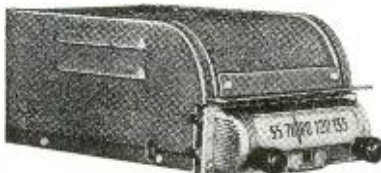

UNDERDASH 6-TUBE AUTO RADIO

Same features as above, streamlined, fits any car. Complete with mounting brackets and instructions **\$29.97**

CHROME AUTO ANTENNA, 3-section, side cowl mount, complete with hardware.... **\$1.98**
CHROME AUTO ANTENNA, 3-section, fender mount, complete with hardware.... **2.74**

BROOKS RADIO DISTRIBUTING CORP.
80 VESEY ST. (DEPT. A) NEW YORK 7, N. Y.

Over 43,000 Technicians Have Learned
HOW TO GET THE MOST OUT OF BASIC TEST EQUIPMENT
 Why Not You, Too?

SERVICING by SIGNAL SUBSTITUTION
 A BEST SELLER FOR OVER 9 YEARS! (NEW, UP-TO-DATE, 11TH EDITION)

The Simple, Modern, Dynamic Speed Approach To Receiver Adjustment and Alignment Problems, AM-FM-TV.

- Nothing complex to learn
- No extra equipment to purchase
- Universal — non-obsolete
- Employs Only Basic Test Equipment

Ask for "S.S.S." at your local Radio Parts Jobber or order direct from factory.

PRECISION APPARATUS COMPANY, INC. • 92-27 Herace Harding Blvd., Elmhurst 4, N. Y.

only 40¢

100 pages. Invaluable information that will help you re-double the value of your basic test equipment.

If you don't receive our
FREE BARGAIN CATALOGS
you're losing money!

A RADIONIC SPECIAL!
Stacked, All Band Conical TV array ... at Lowest Cost

It's here! Scientifically designed, precision made, all-band conical TV array—giving tremendous gain and absolute minimum interference at a cost no greater than the usual dipole. Permits direct coupling to 72, 150, or 300 ohm line with minimum loss. All dural construction. 10 foot mast included. Amazingly low price of only **\$11.75**

In lots of 3, \$11.45 each
 Best quality, 300 ohm twin-lead, 100 feet, \$1.10. 1000 feet \$9.95.
 20% deposit with order, balance C.O.D.

RADIONIC EQUIPMENT CORPORATION
 Tribune Theater Entrance
 170-EE Nassau Street :: New York 7, N. Y.
 WORTH 2-0421 :: Open daily 9 to 6—Saturday 9-5

TUBE SPECIALS

IR-4	15c	6J5GT	29c
6H6GT	19c	36	29c
1A5GT	19c	2X2	49c
6C4	19c	OZ4	49c
12K8	29c		

ALMO RADIO CO.
 Four Stores To Serve You
 509 Arch St. Philadelphia, Pa.
 6205 Market St., West Phila., Pa.
 6th & Orange Sts., Wilmington, Del.
 4401 Ventnor Ave., Atlantic City, N. J.

A Brooklyn television dealer cuts down nuisance service calls by running free television classes for his customers, teaching them to distinguish between real faults and bad reception conditions.

EMC PRESENTS KITS



EMC MODEL 500K
R. F. SIGNAL
GENERATOR
\$18.75

- Employs electrostatically shielded transformer for 115V 60 cycle operation.
- All coils not in use are automatically shorted out.
- Provision for external modulation.
- Attractive 3 color panel.
- Covers range from 150 KC to over 30 megacycles on fundamentals—over 100 megacycles on harmonics.
- 400 cycle internal modulation available.

EMC MODEL 300
VACUUM TUBE
Volt-Ohm-Capacity
METER



\$23.95

- Hammertone Metal Carrying Case
- DC VOLTS—6 ranges to 1000 volts!
- AC VOLTS—5 ranges to 1000 volts!
- RESISTANCE—6 ranges to 1000 megohms
- CAPACITY—4 ranges (1.000025 mfd to 20 mfd)
- ZERO CENTER POSITION
- INCLUDES LEADS

Completed Unit\$39.50
CAPACITY RANGES and ZERO CENTER POSITION are features not available in competitive VTVM kits.



EMC Model 120
20,000
ohms-per-volt
VOLTMETER
\$22.95

- Portable Model Illustrated 26.95
The ONLY 20,000 ohms-per-volt instrument that gives you . . .
- 6 D.C. Volt ranges at 20,000 ohms/volt to 6000 volts
 - 6 A.C. Volt ranges at 10,000 ohms/volt to 6000 volts
 - 5 current ranges to 6 amps
 - 4 resistance ranges to 300 megs
- Completed Unit (open face) . . . \$29.95
Completed Unit (portable) . . . \$34.95

Export Dept., 303 W. 42nd St., N.Y.C.
Write Dept. B-4 for Free Catalog

Give More Measurement Value per Dollar!

EMC ELECTRONIC MEASUREMENTS CORP.

423 BROOME STREET, NEW YORK 13, N. Y.

BRAND NEW GUARANTEED
TUBES

1R5	6AU6	6X5	Any 15 for \$5.00
1U5	6BA6	6T8	100
2X2	6BE6	12AT6	for \$29.95
5Y3	6BG6	12BA6	
6AC5	6BH6	12BE6	OUR POLICY
6AC7	6C4	12AU7	All orders acknowl-
6AG5	6C6G	12SQ7	edged. • Immediate
6AL5	6J6	19T8	delivery of entire orde
6AQ5	6SN7	50B5	or refund. • We do
6AT6	6SQ7	50C5	not use back orders or
			credit slips. • Satis-
			faction guaranteed.

TERMS: 20% with order, balance C.O.D.
Order NOW limited quantities.
New listings monthly.

GREENWICH SALES CO.

59 Cortlandt St. New York 7

SURPLUS A.F. TRANSFORMERS

? I have the driver and modulation transformers from an ART-13 transmitter. I want to use these to modulate an 813; however, I do not have sufficient information on the transformers or the conditions under which they were designed to operate. Please prepare a diagram of the ART-13 speech

to an 813 with 1250 volts at 170 ma on the plate. An additional secondary winding is used to modulate the screen of the final amplifier. Because the modulation transformer is small, the 811's are held down to a little more than 100 watts output—sufficient to fully modulate a 200-watt final.

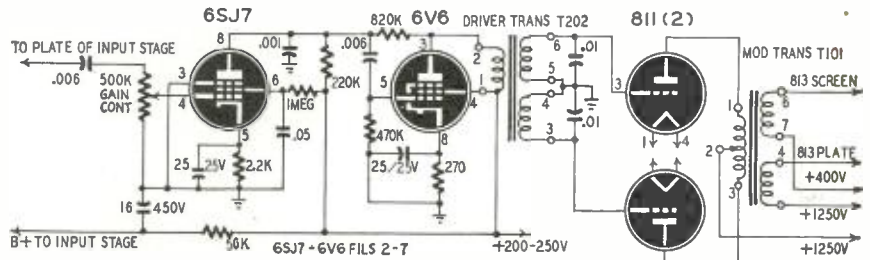

amplifier and driver and show the terminal numbers on the transformers. —W. W. W., Bronx, N. Y.

A. The diagram shows a speech amplifier, driver, and modulator much like those used in the original transmitter. The modulation transformer is designed to match the 15,000-ohm plate-to-plate impedance of push-pull 811's

The driver is a 6V6 with inverse feedback to lower its apparent load impedance. A single 6S77 or similar speech amplifier will drive the 811's to full output when fed by a microphone having high output. A speech amplifier stage is needed in front of the 6S77 shown on the diagram if a low-output dynamic or crystal microphone is to be used.

CRYSTAL-CONTROLLED CONVERTER

? Please print a circuit of a crystal-controlled converter for use with my automobile radio for reception of 39.42-mc signals. I would like to be able to turn the converter off and switch the antenna to the receiver at the same time. —J. V. D., Brooklyn, N. Y.

grid circuits for good mixer performance. If not, then connect a lead to the tripler plate and couple it to the mixer grid through a two- or three-turn twist of wires to form a capacitor.

If the broadcast antenna is found to give good results on 39 mc, it may be used for high-frequency and broadcast reception. A three-pole, double-throw switch transfers the antenna from receiver to converter and controls the filament circuit of the converter. If a separate high-frequency antenna is used for 39-mc reception, then a d.p.d.t. change-over switch can be used. One section will switch the receiver input circuit to the broadcast antenna or to the output of the converter, and the other controls the converter filament circuit. The 39-mc antenna may then be connected permanently to the converter. Shield all leads to the receiver's input circuit to prevent stray 1500-kc pickup when the converter is in use.

A. The converter is shown. Its tube lineup consists of a 6AK5 r.f. amplifier, 6J6 mixer, and a 6J6 crystal oscillator and tripler. The input and output circuits of the 6AK5 are tuned to the same frequency, so take care in laying out the circuit to prevent oscillations. Use a shield between the antenna and the mixer grid circuits. R.f. stability is insured by tight coupling to the antenna and through the use of the r.f. gain control.

A 12.64-mc crystal oscillator is followed by a tripler tuned to 37.92 mc. There may be sufficient coupling between the tripler plate and the mixer

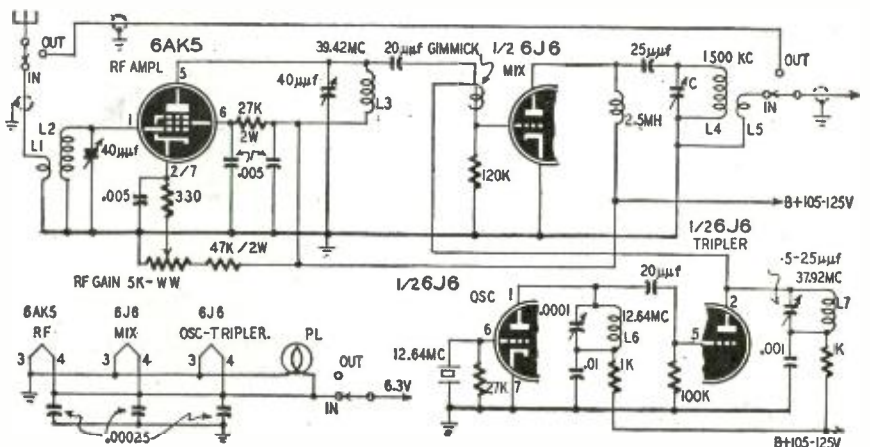

L2 and L3 are 10 turns of No. 12 enameled wire, 1/2 inch in diameter and approximately 2 inches long. L1 is 6 turns of No. 14 d.s.c. wire interwound with the grounded end of L2. L4 and L5 are primary and secondary of a standard 1500-kc converter output transformer. The primary is tuned by capacitor C.

L6 is 10 turns of No. 18 enameled wire, 3/4 inch in diameter and approximately 5/8 inch long. L7 is 5 turns of No. 18 enameled wire, 3/4 inch in diameter and 5/16 inch long. L6 and L7 may be cut from a 2-inch length of B & W type 3011 Miniductor.

A grid-dip meter or sensitive wavemeter is used when tuning the oscillator and tripler circuits. Tune L6 and L7 for maximum indication on the wavemeter at frequencies shown in the diagram. Adjust the mixer plate circuit to resonance by connecting the converter to the antenna post on the receiver. Tune the receiver to 1500 kc. Set a modulated signal generator to 1500 kc and adjust C for maximum output from the receiver. If a signal generator is not available, connect an antenna to the mixer grid and tune in a 1500-kc broadcast station. Peak the output circuit as described for the signal generator.

Adjust L2 and L3 with a 39.42-mc signal from the transmitter or signal generator. Adjust the tuning capacitors for maximum signal.

Plate and heater voltages may be taken from the average automobile receiver. It may be necessary to use heater and plate chokes in the leads.

SUBMINIATURE TUBE TESTER

I would like to construct a simple battery-operated tester for Raytheon subminiature hearing-aid tubes having 5J-type base connections.—W. T. T., St. Catherines, Ont.

A. An emission-type tube tester which should meet your needs is shown in the diagram. A five-prong subminiature

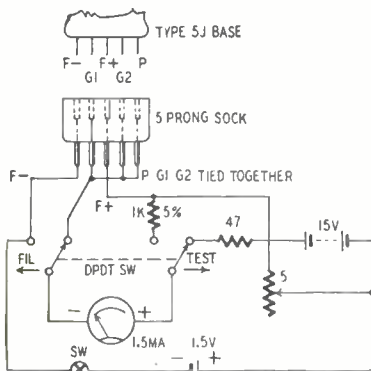

socket is used for checking all tubes having 5J base connections. A 1.5-ma meter is used to read filament voltage and cathode current directly. When the switch is in the FIL position, the 1K resistor is in series with the meter to make it read the filament voltage.

Adjust the setting of the rheostat for correct filament voltage before inserting the tube in the socket. The meter may be calibrated for various tubes by testing new ones.

APRIL, 1950

HOT CLAMPS
Ground & Guy Wire

the **HOT** TV LINE

Adjustable, Positive Contact

Used by leading TV installers!

NON-CORROSIVE
FITS 5/8" to 3 1/2" PIPE
NO PIPE CLEANING
LOW COST

FREE: Write TODAY for illustrated catalog and prices!

THE HOUSE OF TELEVISION
INCORPORATED

40 WEST FOURTH STREET
NEW YORK 12, N. Y.

BE YOUR OWN BOSS!

MAKE MORE MONEY

In "CASH IN" you now get THE real money-makers — dozens of profitable tested mail order plans, confidential business secrets, dozens of practical tested formulas, successful tested schemes — actual experiences of men who have started on a shoe-string—with less than \$10 capital. 25¢ a copy postpaid. Send U. S. stamps, money order, or coin.

25¢

40,000 WORDS IN TEXT

NO ADS ALL "MEAT"!

Money Back Guarantee

NATIONAL PLANS COMPANY
1966 R BROADWAY, NEW YORK 23, N. Y.

HOW

Learn How to Simplify Radio Repairs!

FREE MANUAL

Nothing complex to learn, no calculating. Used by beginners and experts. Send for FREE manual, "THE INSIDE STORY," today. 32 pages—illustrated—easy to read! Shows how obsolete methods prevent full use of your real ability. Explains use of NEW techniques. You owe it to yourself and your future to "get out in front" in your work.

FEILER SEND COUPON OR PENNY POSTCARD FOR FREE MANUAL TODAY!

FEILER ENGINEERING CO. Dept. 4-RCS
1601 S. Federal St., Chicago 16, Illinois
Please RUSH my FREE copy of "The Inside Story."

Name.....
Address.....
City..... Zone..... State.....

Leotone FACTORY SPEAKER
REPAIRS SINCE 1927

BRAND NEW METER SPECIALS!

0-9V. DC. 2 1/2" sq. 1.29
0-100 Amps. DC. 2 1/2" sq. With shunt. 98
0-8 RF Amps. 2" sq. (Triplet) Thermocouple. 4.95

PORTABLE DC AMMETER 0-15 AMPS.
COMPLETE WITH CONVERSION DATA TO MAKE "VOLT-OHM-MILLIAMMETER." 3 1/2" mirror scale, int. shunt. PERFECT FOR TESTING Electric Appliances, Batteries, Auto, Industrial & Medical Eqpt. With 36" leads & hinged lid metal case. SHPG. With wood lbs. **3.95**

BIGGER & BETTER THAN EVER!!
LEOTONE "JIMBO RADIO PARTS KIT"
17 FULL POUNDS of selected new & dismantled Radio & Electronic parts. COILS, TRANSFORMERS, WIRE, RESISTORS, CONDENSERS, SPEAKER ACCESSORIES, ETC., ETC. All these (shpg. wt. 21 lbs.) and MUCH MORE ONLY **2.95**

50 WATT POWER RHEOSTATS . . . 15 ohm **89c**
Brand New (IRC) SPECIAL! . . .
CABINET DRAW SLIDES for CONSOLE CHANGERS, RECORDERS, XMTR RACKS, etc. Smooth ball-bearing action. Shpg wt. 2 lbs. pr. . . .
9" extension (13" overall) . . . 1.89 pr.
11" extension (15" overall) . . . 1.98 pr.
12 1/2" extension (16 1/2" overall) . . . 2.19 pr.
Hvy. duty, all-steel 12 1/2" x 16 1/2" . . . 2.89 pr.

RADIO HARDWARE TREASURE A FULL POUND OF NUTS, SCREWS, WASHERS, LUGS, ETC. All in handy SELF-SEALING HINGED LID CAN. **49c**
Shpg. wt. 1 lb. . . .
HS-33 HEADSETS . . . 13" cord and TL-54 plug **1.49**

TUBE CARTONS:
Miniature (1 1/2" sq. x 2 1/4") Per 100. . . . 98c
GT size (1 1/4" sq. x 3 1/4") Per 100. . . . 1.25
Medium (1 1/2" sq. x 4 1/4") Per 100. . . . 1.49
Large (2" sq. x 5") Per 100. . . . 1.79

4 WAY CONNECTOR SET . . . PL-179 plug & cable jack **49c**
EXPERIMENTAL TUBES for Servicemen, Experimenters, Students. Fil. tested. Kit of 20 ass'd. revolv. types . . . **1.00**
4 RPM MOTOR . . . 115V. 60 cycle. 1/4" shaft. 2 1/2" sq. x 2 1/4" . . . **2.75**
W-108 ARMY FIELD WIRE . . . Twisted pair, weather-proof. Avail. only in rolls 150-350 ft. ea. Shpg. wt. 4 lbs. 100 ft. . . . Perfect Condition **1/2c ft**
T-30 THROAT MIKES . . . Brand New! . . . ONLY **39c**
3 for 1.00
EXTENSION CORD & SWITCH for T-30 mike **1.39c**
3 for 1.00

DM-36D DYNAMOTOR . . . 24V. DC to 220V. DC @ 80 ma. Complete with filter system. Shpg. wt. 7 lbs. NOW ONLY. **98c**

SAG FUSES . . . 1 or 3 amps. @ 250V. . . . 9c ea.
3 for 1.00

Min. order \$2.00 20% deposit on all COD's
Please add sufficient postage—express refunded.
Full Remittance with Foreign Orders.

LEOTONE RADIO CO.
65 Dey Street,
New York 7, N. Y.

ADSON
FOR VALUE!

SAVE \$\$\$ ON TV ACCESSORIES!

ANCHOR TV BOOSTER
Recommended By Famous Consumer Research Lab.
Boosts signal in fringe areas and trouble locations. Gives 2 1/2 times more gain in signal strength across all channels. Minimizes ghosts. Features exclusive impedance matching of its output to input of set. . . . **\$22.00**

DIETZ ENLARGING LENS
4-Way Adjustable Bracket
Optically perfect picture magnifier gives bigger and better pictures for your TV enjoyment. Compare these prices and order today! . . . \$ 8.95
7" . . . 11.95
10" . . . 13.95
12" . . . 15.95

TV WAVE TRAPS
An amazing device for improving TV reception. Connects to lead-in line. Choose one of three to eliminate interference from FM, diathermy, or amateur stations. Each, only \$2.89

Low Priced! EMC MULTITESTER
A versatile, compact tester for radio receiver servicing. 3 1/2" square meter. Ranges—Volts AC: 0-12/120/600; 1200/3000. Volts DC: 0-6/60/300/600/3000. Mill Amps DC: 0-6/30/120 ma., 0-1.2 amps. Mill Amps AC: 0-30/300/600 ma. Ohms: Up to 1 megohm. **MODEL 102 . . . \$13.90**

"RADIO KITS"
5-Tube Superhet Kit
Crystal clear reception thru entire tuning range of 550 Kc. to 1600 Kc. 5 tube advanced design circuit. 115V AC-DC. Full size Alnico PM speaker. Complete with handsome cabinet, nothing else to buy. Easy to assemble. Portable. **KIT MODEL S-5. \$13.95**

2-BAND 6-TUBE RECEIVER KIT, standard and foreign broadcast, Kit Model S-6X, complete. . . . \$18.45

Satisfaction guaranteed. Send check or money order. 25% deposit with C.O.D. All orders shipped within 24 hours, F.O.B. New York. Please include postage.

ADSON RADIO & ELECTRONICS CO.
221 Fulton Street, New York 7, N. Y.

NEW TELEKITS NOW \$49.95

Jobbers: Write for Confidential Price Information

- NEW TELEKITS
- 12-B \$79.95
- 10-B \$69.95
- 8-B \$54.50
- 7-B \$49.95
- LESS TUBES



Sparkling new Telekit 12-B has 90-inch screen. Brand new compact lay-out has video tube mounted on chassis. Big illustrated easy-to-follow instruction book guides you step by step through easy assembly. No special knowledge of television is required. All you need is a soldering iron, pliers, and screw driver. 12-B kit can be used with 16 inch tubes. Telekit cabinets \$24.50 to \$35.00. Satisfactory Telekit performance guaranteed by Factory Service Plan. 12-B Telekit (90 inch screen) \$79.50. 10-B Telekit (61 inch screen) \$69.95. 8-B Telekit (48 inch screen) \$54.95. 7-B Telekit (25 inch screen) \$49.95. Write for catalogs listing Telekits and TV accessories.

TELEKIT BOOSTER \$12.95



This Telekit booster will bring in TV signals bright and clear in the fringe areas. Will give brilliant performance with any receiver. NOT A KIT. Completely assembled. With tubes. Works with Telekit or any TV receiver.

13 CHANNEL TUNER \$12.95



This compact front end has a stage of RF for extra distance. Made to conform with Telekit or any TV set having a video I.F. of 25.75 Mc. Complete with tubes, pre-wired, pre-assembled. Only four connections to make.

Write for catalog of Telekit antennas, boosters, television kits, tuners, television parts and tubes.

TELEKIT

ELECTRO-TECHNICAL INDUSTRIES
1432 N. BROAD ST. DEPT. B PHILADELPHIA 21 PA.

Jerome R. Steen, director of quality control for SYLVANIA ELECTRIC PRODUCTS, INC., has been elected to grade of Fellow by the board of directors of the INSTITUTE OF RADIO ENGINEERS. He will receive a Fellowship Award during the Institute's National Convention in New York for his work "in the introduction and development of statistical quality control techniques in electron tube manufacturing."



R. L. Grove has been appointed chief engineer of CORNELL-DUBILIER'S Ceramic Division in New Bedford, Massachusetts, according to announcement from OCTAVE BLAKE, president. This new activity includes setting up the manufacture of a line of ceramic capacitors and the establishment of a ceramic research and control laboratory.



Dr. William F. Meggers, Chief of the spectroscopy section of the NATIONAL BUREAU OF STANDARDS, has been elected President of the OPTICAL SOCIETY of AMERICA at the Society's thirty-fourth annual meeting. The Optical Society serves as a common meeting ground of physicists, chemists, physiologists, psychologists, engineers and mathematicians in the general field of optics. Election to the presidency is the highest honor the Optical Society of America can render to a scientist in this field of optics.



Dr. Dayton Ulrey, chief engineer of the Lancaster, Pa., plant of the RCA Tube Department, has retired, but is retained as consultant to the company.



An early researcher into vacuum tube design whose life's work has paralleled the development of the radio and television art, Dr. Ulrey is also well known as an administrator and teacher. In this capacity, he was instrumental in securing needed facilities for many young scientists engaged in radio and television research, some of whom are the leaders of the industry today.

Joseph A. McDonald, vice president, general attorney and secretary of the AMERICAN BROADCASTING COMPANY, has been elected a member of the Board of Directors of the TELEVISION BROADCASTERS ASSOCIATION, INC. He succeeds ROBERT E. KINTNER, ABC president, who has resigned.

McDonald is a veteran of the radio industry. Between 1932 and 1945, he served on the legal department of the NATIONAL BROADCASTING COMPANY in New York and Chicago, becoming assistant general counsel of NBC in 1943. In February, 1945, he was named vice president and general attorney of ABC.

John Bentia, sales manager of the ALLIANCE MFG. CO., has been given direction of the company's greatly expanded 1950 Tenna-Rotor advertising campaign. Mr. Bentia reports that over



50 radiostations will be used for chain-break spot announcements and that distributors throughout the country's TV trading area are tying up with the campaign through point-of sales promotion for the Tenna-Rotor.

Robert D. Hickok, Jr., has been elected president of the Hickok Instrument Co., succeeding his father, who died January 23. WALTER WEISS was made vice president in charge of engineering at the same time as the younger Hickok was elevated to the presidency of the company.



The new president has been a vice president and acting general manager of the company for the last ten years.

Dr. John McElhinney has joined the staff of the Radiation Physics Laboratory of the NATIONAL BUREAU OF STANDARDS. He will use the Bureau's new 50-million volt betatron to carry on investigations of nuclear reactions and high-energy X-rays.

Antony Wright has joined CAPEHART-FARNSWORTH CORPORATION, Fort Wayne, Indiana, as chief engineer for the Consumer Products Division. For the last two years, he has been chief engineer for the MAGNAVOX COMPANY.

PHILCO UN6-400

Intermittent noise and loss of sensitivity were traced to shorted capacitor C-407 between the plate of the 7A7 and the control grid pin (No. 6) of the 7B8. The shorted capacitor (250 μmf) was

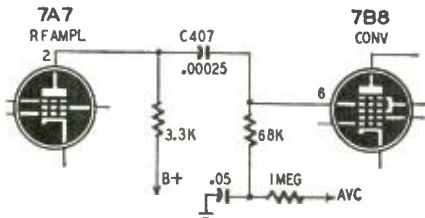

discovered when a v.t.v.m. showed positive voltage on the 7B8 grid.—*T. Horiuchi*

HUM IN A.C.-D.C. SETS

If hum cannot be eliminated in a.c.-d.c. sets using the volume control circuit shown in Fig. 1, C2, R1, or the grid of the tube directly to the arm of the control from adjacent a.c.-carrying leads. If this is the case, the hum level is not controlled by the setting of the volume control.

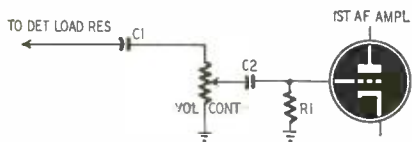

Fig. 1—Components in this circuit may pick up hum which is hard to eliminate.

This trouble can be eliminated or at least considerably reduced by removing C2 and R1 and connecting the grid of the tube directly to the arm of the control as shown in Fig. 2. In this circuit, hum picked up by the control grid of the tube will get louder as the control is advanced. In most cases, the signal is loud enough to mask the hum.

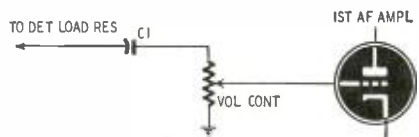

Fig. 2—Changing Fig. 1 to this circuit may reduce hum to a tolerable level.

This conversion cannot be made on sets having the volume control in the diode load circuit. C1 in both circuits decouples the volume control from the detector load.—*James W. Essex*

RCA 630TS

Horizontal distortion could not be corrected with the linearity control. This component, L-201, was found defective when checked with an ohmmeter (its normal resistance is 37 ohms). A factory replacement restored the set to normal operation.

When horizontal nonlinearity is not caused by a defective control, check capacitors C-186 and C-188 on a capacitance bridge. Their values should be .05 and .035 μf, respectively. These capacitors are connected between the ends of the control and the high-voltage center tap.—*Wilbur J. Hantz*

**The BROOK
All Triode High Quality
AUDIO AMPLIFIERS**

Provide the Key to



Model 12A3-10 watts.

Model 10C3-30 watts

All Low Mu Triodes
Plus
Brook made
Transformers
Plus
Brook's own Circuits

Finest Audio Quality
you ever listened to
Minus
Listening Fatigue
Plus
High Quality at
extremely low volume
Plus
High Quality at the full
loudness of a band or symphony

“You can believe your ears when you listen with a Brook Audio Amplifier.”

Write today for FREE Technical Booklet and detailed distortion analysis.

BROOK ELECTRONICS, Inc.

Dept. ED-0 • 34 DeHart Place • Elizabeth, N. J.

NOW ...

A TELEVISION TOWER YOU CAN AFFORD TO BUY!

All steel, welded construction, made of 1/4" Thinwall conduit, 1/4" Rod Braces, and 1" Steel Bands. Made in 10 Ft. triangular shaped sections, tapered, 18" at base to 3 1/2" at top. Hinged mounting plates and 2" mounting hole for Mast, with Guy Rings. 30 foot Tower is self supporting when mounted on ground. Weight: 75 lbs. Towers dipped in aluminum paint for weatherproof protection and long life. PRICE: 30 Foot TOWER \$38.40 delivered anywhere U.S.A. Additional 10 Foot Sections, delivered Each: \$11.70 GUY WIRE: 3/32" 7 x 7 Strand Aircraft Type, only 2c per Ft. SWIRE CABLE CLAMPS: 10c Ea. TURNBUCKLES: 5 1/2" @ 25c Ea.; 9 1/2" @ 70c Ea.

PM FIELD DYNAMOTORS: POWER SUPPLY

Completely filtered 12/24 Volt input; output 275 Volt 110 MA. & 500 Volt 50 MA. housed in a metal case 8" x 6" x 10". Contains: 2 PM Dynamotors (as listed below), 2 Switches, 12 Conds., Fuses, Light, Brushes, Chokes, Resistors, Plugs, etc. Shipping weight: 62 lbs. Order No. RE-#3 \$5.00

PM FIELD DYNAMOTORS

12/24 V. input; output 275 V. 110 MA.\$3.95
12/24 V. input; output 500 V. 50 MA.\$2.95

WHIP ANTENNA EQUIPMENT MAST BASES—INSULATED:

MP-132—1" heavy coil spring, 2" insulator. Overall length: 11 1/2". Wt. 2 1/2 lbs. Price \$3.95
MP-22—Spring action direction of bracket, 4" x 6" mounting. Price \$2.95

MAST SECTIONS FOR ABOVE BASES:

Tubular steel, copper coated, painted, 3 foot sections, screw-in type. MS-53 can be used to make any length. MS-52-51-50-49 for taper. Any section.....50c Ea. BAG BG-56 (carrying 3 sections)50c

BC-1206 RECEIVER—200-400 KC. 5 Tubes. Operates from 24-28 VDC. If Freq. 185 KC. Size: 4"x4"x5" LN\$6.95
POWER SUPPLY KIT—110 Volt AC to 24 VDC. \$6.95

MARKER BEACON RECEIVERS—Receive 75 MC. modulated signal (can be varied from 62 to 80 MC. which actuates self contained sensitive relay and can be used to operate equipment from a remote point. Requires 12-24 Volt DC only:

RC-357—2 Tubes—USED:\$2.95
BC-1023—4 Tubes—NEW:\$4.50
BC-301—Similar to above, Less Tube—USED:\$1.95

Address Dept. RE • Prices F.O.B., Lima, Ohio • 25% Deposit on C.O.D.'s • Minimum Order \$2.00

Car Shaver Motor

Use your electric shaver in your car. Dynamotor will supply 110-120 Volt DC approx. 15 Watts from 6 Volt DC auto battery and will operate most types of AC-DC shavers. Order No. RE-4 Price—only \$2.00

Sewing Machine Conversion Kit

It's easy to convert your treadle type home sewing machine to an up-to-date electric machine. This big value kit comes complete with motor, rheostat control, light, adapter bracket, and instructions. Brand New. \$12.95 Order Stock No. RE-320. Price—only

PHONOGRAPH MOTOR only—110 Volt 60 cycle. 78 RPM for automatic record changers\$1.50

GEAR TRAIN MOTOR—Low inertia reversible type. Can be used to operate small displays, models, etc. Operates from 12 V. AC with use of condenser. Normally operates 26 Volt 400 cycle. Motor 588 RPM; low speed 14 RPM; separate gear 1/4 RPM. Complete motor, gear train, condenser, & instructions\$2.50

MODEL MOTOR—12 Volt AC-DC, 1/2" double end shaft. Motor size: 2 1/2" L x 2 1/2" W x 1 1/2" H. Price.....\$1.50

HAND TOOL MOTOR—12 Volt AC-DC 5600 RPM. Size: 3 3/4" L x 1 1/4" D with splined shaft 1/4" D x 1/2" L. Price\$2.95

6 VOLT AC OR DC MOTOR—Ideal for auto heaters, defrosters, fans, models, etc. Used by Govt. in aircraft. Shaft size: 1/2" x 3/8". Price.....\$1.50

DYNAMOTORS AND INVERTERS

Write us and tell your requirements. We have big stock to select from.

TRANSFORMERS—110 Volt 60 cycle Primaries: Sec. 12 V. 1 amp...\$1.50 Sec. 24 V. 2 amps...\$2.25 Sec. 24 V. 1 amp. 1.95 Sec. 24 V. .5 amp...1.50 Sec. 36 VAC. 2.5 amps.\$2.95 Sec. 14-14 or 28 V. 7/2 or 15 amps.4.95

SELSYN TRANSMITTER & INDICATOR SYSTEM—Ideal for antenna direction indicator to remote position. Complete with Autosyn Trans, 3" 1-81 Indicator, Transmitter, and instructions. Price \$6.75 Autosyn Trans. only: \$2.95 Plug 1/1-81: \$1.00

MARK II B-19 TRANSMITTER & RECEIVER 15 TUBE SET 2-8 MC.; 240 MC.; AND INTERCOM. FOR MOBILE OR STATIONARY USE!

Set transmits and receives 2 to 3 ME. Phone. C W and M C W 25 Watt Master Oscillator Control. Transmits and receives 240 MC. Phone. Also an intercommunicating set. Comes complete with 15 Tubes, Headset, Micro., Antennas, Control Box, 12/24 Volt Power Supply, and instructions—ready to operate. Set size: 27" x 10" x 13 3/4". Price—USED (TESTED).....\$39.50

FAIR RADIO SALES 132 SOUTH MAIN ST. LIMA, OHIO

SERVICEMEN!

We'll Prove You'll Save Time & Earn More with PHOTOFACT!

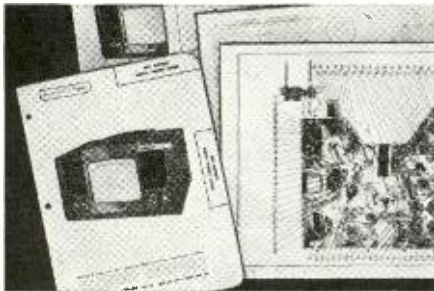

We'll send you absolutely

FREE

any PHOTOFACT Folder listed in the Photofact Cumulative Index

NOW—learn for yourself—at our expense—how PHOTOFACT makes your service work quicker, easier, more profitable! Examine an actual PHOTOFACT Folder. Use it. You'll learn first-hand why this indispensable service data is used daily by over 35,000 successful service technicians. You'll discover quickly that no other service gives you PHOTOFACT's outstanding advantages: *completeness, accuracy, uniformity and ease-of-use* at the lowest cost to you! PHOTOFACT alone is the only radio service data prepared from laboratory analysis of the actual equipment. Nothing in the field equals PHOTOFACT. Know the facts—get your FREE Folder now. Examine it—use it—compare it—learn why no modern service shop can afford to be without PHOTOFACT!

NOTE: This FREE offer is limited to Service Technicians. Attach coupon below to your letterhead and mention the name of your jobber. If you have no letterhead, send coupon to your jobber. Experimenters and others may obtain the Photofact Folder by remitting amount shown below.

HOWARD W. SAMS & CO., INC.
2201 E. 46th St., Indianapolis 5, Ind.

Send FREE Photofact Cumulative Index

Send Full Easy-Pay Details

I am a Service Technician:

Send FREE Folder for set model.

I am an Experimenter: Enclosed \$.....

Send Folder for set model.
TV—\$1.00; Record Changer or Comm. Receiver—75c; AM/FM—50c

Name.....

Address.....

City.....Zone.....State.....

THE AMATEUR ALIBI

Dear Editor:

Re "TV Interference Problems" by William L. Kiser in your January issue, I say Amen, brother! to the paragraph, "The Amateur Alibi." Being both a ham and a serviceman, I can truly vouch for what he says. Sad as the fact may be, the amateur alibi used by many service technicians is merely a manifestation of incompetence.

PETER N. SAVESKIE

Baton Rouge, La.

RMA COLOR CODING

Dear Editor:

Under "Electronic Literature," item D-8 on page 89 of the December 1949 issue of RADIO-ELECTRONICS, it stated that the Aerovox Duranite Decoder Chart lists "RMA color coding for molded tubular capacitors." This statement is incorrect. There is no RMA standard for molded tubular capacitors, nor any color coding for them.

In checking over the subject chart very carefully, I can find no reference made on it nor any of the Aerovox literature to the effect that this color code is supposed to be "RMA standard." The same observation pertains to Sprague literature on molded tubulars. This color coding is a development of the manufacturers and though based on similar RMA coding for molded composition resistors, cannot rightfully be called RMA standard.

This is for your information. I doubt whether there would be any point in retracting the statement, but should similar reference recur you will be in a position to avoid a misstatement.

PAUL S. SMITH

Chairman, RMA R14 and CC Committees on Color Coding

Motorola, Inc.
Chicago, Ill.

Approved MODEL A-460

TELEVISION FIELD STRENGTH METER

\$79.50
ONLY



Model A-460 is housed in a heavy gauge steel cabinet, bottleless grey finish with 6 tubes (standard brands) IN34 Crystal, operating instructions, circuit diagram and guarantee. Weight 25 lbs. D-8" x H-10" x W-12".

Write for 12-page catalogue.

APPROVED ELECTRONIC INST., CORP.
142 Liberty St. N.Y.C.

Field Strength Meter; television 12 channel tuner; video IF channel; large 6" directly calibrated meter; hammer tone finished panel ideal for locating antenna systems; testing transmission lines; testing efficiency of indoor antennas; checking booster efficiency, etc.

INVENTORS

IF YOU WISH TO PROTECT YOUR INVENTION

YOU SHOULD TAKE STEPS TO PROTECT IT BY A U. S. PATENT

Whether an invention is patentable can be substantially determined by a search of the U. S. Patent records. Without obligation, write for information explaining the steps you should take to secure a patent.

GEORGE B. OUJEVOK

Registered Patent Attorney

509 FIFTH AVENUE NEW YORK 17, N. Y.

Like peas in a pod



except for

QUAM

Only Quam offers more! The U-Shaped Coil Pot, providing an unbroken path for the magnetic lines of force, thus producing a stronger magnetic field with higher efficiency and improved performance, is an exclusive Quam feature.

The Quam Adjustable Voice Coil, permitting accurate centering after assembly and virtually eliminating rubbing voice coils, is also found only on Quam Speakers.

No other speaker offers such outstanding extra features—such extra value. For all your replacements, specify Quam.

Mail This Coupon For Free Catalog



Quam-Nichols Co.
521 E. 33rd Place
Chicago 16, Illinois

Please send me Quam catalog.
Name.....
Address.....
City.....State.....

ON THE EUROPEAN TV SITUATION

Dear Editor:

We read with interest the European Report in your January issue but cannot compliment your correspondent on his knowledge of the TV situation in Europe. He states that "Holland is developing 449 lines, the Iron Curtain countries 625, Italy 441 and Denmark 657." This is definitely incorrect!

The facts are as follows. Britain has chosen 405 lines as their definition for the next ten years; France has done the same with 455 lines while at the same time beginning with the new French standard of 819 lines which nowhere met with a favorable reception, not even in France.

The other European countries tend towards a "European" definition of 625 lines (which at 25 frames per second corresponds to the American standard of 525 lines at 30 frames per second). Holland adopted that stand-

ard for a period of ten years and other countries such as Switzerland, Denmark, Sweden, Czechoslovakia and Western Germany had already done the same thing. It is believed that Spain, Portugal and Italy will also adopt the "European" definition. Thus there is a majority in Europe for the 625 lines, opposed only by England and France because they already have committed themselves to other definitions either higher or lower.

In Belgium the general feeling is that the 625 lines definition is the most businesslike which can be realized at once. However, our country has not yet made a decision but will try to mediate at a conference to be held in London on January 10.

MME. P. BRANS
Directrice
Radio & Television Revue
Antwerp, Belgium

CTI COLOR TV USES SEQUENTIAL LINE

Dear Editor:

There is an apparent misunderstanding of the CTI color system in Dr. de Forest's article on color television on page 24 of your January issue, where he likens the CTI to the RCA system.

Color Television, Inc., of San Francisco, employs a sequential color line system in contrast to the sequential color dot system of RCA and the sequential color field system of CBS. CTI utilizes a single pickup tube in the camera with a single electron beam which scans the three optical images focused on its photo cathode. In reproduction at the receiver it utilizes likewise only a single cathode-ray tube with a single electron beam. The beam reproduces three images on its fluorescent screens—one image falls in the red phosphor area—the next image falls in the green phosphor area and the third image falls in the blue phosphor area. The three images are superimposed into the final color picture by

means of an optical system on a projection screen.

Black-and-white programs as now being transmitted may be received on CTI color receivers without any change as well as their receiving any CTI color transmissions. Also, the present black-and-white receivers owned by the public can pick up CTI color transmissions as black and white without any modifications. The unique characteristic of the CTI system is that it accomplishes 100% compatible color television with the present black-and-white standards and it is far less complex than the other fully electronic system—that of RCA.

I take the liberty of passing this information on since there is not much data available on the CTI system outside of the FCC record of hearings. My information comes to me as a stockholder in CTI and I hope it will be of interest to your readers.

ARTHUR L. BOLTON, JR.
Berkeley, California



"I had them made especially for television"

Suggested by: Hugh Lineback, Stillwater, Oklahoma

OUTSTANDING TV VALUES

ANTENNAS **ACCESSORIES**



MODEL #300
Folded dipole complete with reflector and high frequency adapter. Covers 13 channels. All alum. construction. Includes 5' section alum. mast. Shipping wt 5 lbs. Price: \$4.95

MODEL #200-D

Stacked array. Consists of 2 complete conicals and connecting bars. Very rigid construction. Covers all 13 channels. Matches 300 Ohm or 72 Ohm. Center impedance 150 Ohm. Ideal for low signal areas. An outstanding buy. Shipping wt. 8 lbs. SENSATIONAL OFFER at \$8.25 less mast.

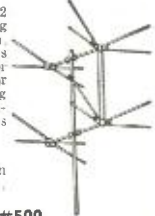

MODEL #200-S

Single array. Same construction as above. Shipping wt 4 lbs. Price \$3.75 less mast.



MODEL #500

All-band folded dipole antenna. Ideal for rotator use. Maximum gain on any Channel. Alum. construction. Complete with 5' alum. mast. Shipping wt. 5 lbs. Price: \$4.9

Antenna rotator complete with control unit and 60' coil of

3 wire insulated interconnection cable. Shipping wt. 11 lbs. Price: \$17.5

Complete package consisting of Type #500 antenna with mast and antenna rotator kit. Shipping wt 16 lbs. SPECIAL PRICE: \$22.00

MODEL #Y-100

5 element Yagi Hi-Gain beam designed specifically for fringe area use. Guaranteed to get the station you want. All alum. construction. Cut to specific channel's. Shipping wt. 2 lbs. Channel #7. \$6.50; Channel #9. \$6.35; Channel #11. \$6.25 and Channel #13. \$6.00. The prices are less mast.



ANTENNA ACCESSORIES

- Type CM 100 Chimney Mount \$1.25
- Type WM 100 3" Wall Bracket (pr.) 60c
- High Quality 300 Ohm Transmission line—100 ft. \$1.25, 1,000 Ft. \$11.00.
- 72 Ohm Coaxial Cable—100 feet \$3.50
- 5 foot 1 1/4" Plated Steel Mast 75c
- 10 foot 1 3/4" Plated Steel Mast 1.20

TERMS: All shipments F.O.B. Newark, New Jersey—25% deposit with orders, balance C.O.D. Minimum order \$2.00.

ELECTRONIC ASSOCIATES

40 St. Francis Street Newark 5, New Jersey

**SHOOTS TROUBLE
FASTER!** **MAKES MORE MONEY
FOR YOU ON THE JOB
OR AT SERVICE BENCH**



PRICE \$9.95

at distributor or postpaid, direct.

No C.O.D.'s, please. Ohioans add 3% State Sales Tax.

Signalette

MULTI-FREQUENCY GENERATOR

In radio service work, time means money. Locate trouble faster, handle a much greater volume of work with the SIGNALETTE. As a trouble shooting tool, SIGNALETTE has no equal. Merely plug in any AC or DC line, start at speaker end of circuit and trace back, stage by stage, listening in set's speaker. Generates RF, IF and AUDIO Frequencies. 2500 cycles to 20 Megacycles. Also used for checks on Sensitivity, Gain, Peaking, Shielding, Tube testing. Wt. 1 1/2 oz. Fits pocket or tool kit. Satisfaction, or your money back. See at your distributor or order direct.

Clippard INSTRUMENT LABORATORY, INC.

DEPT. B. 1125 BANK STREET CINCINNATI 14, OHIO

Qualified Jobbers write, wire for details.

Enter a dynamic profession! Become an
ELECTRICAL ENGINEER



- MAJOR IN POWER OR ELECTRONICS
- B. S. DEGREE IN 36 MONTHS

Look at the powerful trends which influence your future in these fields.

Men specializing in *Electronics* enter a science of tremendous, growing value—in communications, radio, television, broadcasting, high-frequency heating, power system control, printing and other fields.

Men specializing in *Power* become equipped to serve the electrical power industry, which must face an 80% expansion of its generating capacity by 1960.

This 47-year-old Technical Institute and College offers important advantages to the young man preparing for these opportunities. He saves a valuable year by gaining his B. S. degree in 36 months of continuous study. He receives extensive technical laboratory experience on modern equipment. This is integrated, in each successive term with fundamental education in engineering and the humanities.

The World-famous course in *Power* covers 24 technical specialty subjects in Electrical Power, including 8 in Electrical Design.

MILWAUKEE SCHOOL OF ENGINEERING
Founded 1903 by Otis Werwath



Over 35,000 alumni and 1,555 students. Faculty of 85 specialists.

Practical, military or academic training evaluated for advanced credit. Preparatory programs also available.

TERMS OPEN JULY, OCT., JAN., APRIL

V RADIO ENGINEERING
FM—Television—Broadcast

Police Radio, Marine Radio, Radio Servicing, Aviation Radio and Ultra High mobile applications. Thorough training in all branches of Radio and Electronics. Modern laboratories and equipment. Old established school. Ample housing facilities. 7 acre campus. Small classes, enrollments limited. Our graduates are in demand. Write for catalog. Approved for Veterans

VALPARAISO TECHNICAL INSTITUTE
Dept. C VALPARAISO, INDIANA

ELECTRICAL TRAINING

Intensive 32 weeks' residence course in fundamentals of industrial electrical engineering, including radio, electronics. Prepares for technician, engineering aides. Approved for veteran training. 57th year. Enter Sept. 5. Catalog.

BLISS ELECTRICAL SCHOOL
7544 TAKOMA AVENUE
WASHINGTON 12, D. C.



The Electronics Course covers 19 technical specialty subjects in Electronic Engineering, including four in Electronic Design.

In One Year of Study, Become an **ELECTRONIC TECHNICIAN**—This certificate is yours after 12 months of study in the Electrical Engineering (Electronics) course.

Prepare Here for a Career in **RADIO TELEVISION**—In 18 months you can become a Technician, trained for receiver and transmitter testing, servicing, sales and production.



Send coupon or letter today for this free, helpful guidance literature (see below).

MILWAUKEE SCHOOL OF ENGINEERING
Dept. RE-450—1020 N. Broadway, Milwaukee, Wis.

Without obligation send 48-page pictorial bulletin, "Your Career"; 110-page 1950 catalog.

I am interested in course.

Name..... Age.....

Address.....

City..... Zone..... State.....

Check if World War II Veteran

TV ELECTROMAGNETIC SERVICING COURSE

Practical Shop and Laboratory Training at Largest Resident TV School in the East!

Also RADIO SERVICE & REPAIR, F-M & TELEVISION Preparation for F. C. C. LICENSE EXAMS

★ Approved for Veterans ★

DELEHANTY SCHOOL OF TELEVISION
105A EAST 13th STREET • NEW YORK 3, N. Y.

AUDIO (SOUND) ENGINEERING HOME STUDY TRAINING

Practical, easy-to-understand lessons, written by competent Audio Engineers and Educators, prepare you for a better job and a good future in the Television, Radio, Motion Picture, and Recording Industries.

Write today for details—Learn while you earn!!

HOLLYWOOD TECHNICAL INSTITUTE
Div. RE
4925 Santa Monica Blvd. Hollywood 27, California

RADIO SCHOOL DIRECTORY

JOBS in TELEVISION

TELEVISION TECHNICIANS NEEDED AT ONCE
QUALIFIED MEN ONLY • GOOD PAY • STEADY WORK • GOOD FUTURE

AMERICAN RADIO INSTITUTE
CAN TRAIN YOU FOR THIS JOB

Syracuse, N. Y.
New York 2010 B'way (66th St.) 131 Shonnard St.
Buffalo, N. Y. Mount Vernon, N. Y.
640 Main St. 174 Gramatan Ave.

Free Employment Service—GI Approved

TELEVISION

Laboratory and theoretical instruction under the guidance of experts, covering all technical phases of Radio, Frequency Modulation and Television. Prepares for opportunities in Broadcasting, Industry or Own Business.

MORNING, AFTERNOON or EVENING SESSIONS. Licensed by N. Y. State. Free Placement Service. APPROVED FOR VETERANS.

ENROLL NOW FOR NEW CLASSES
Apply Daily 9-9; Sat. 9-2
VISIT, WRITE or PHONE

RADIO-TELEVISION INSTITUTE

Pioneers in Television Training Since 1938
480 Lexington Ave., N. Y. 17 (46th St.)
PLaza 9-5660 2 blocks from Grand Central

RADIO COURSES

Preparatory Mathematics, Service, Broadcast, Television, Marine Operating, Aeronautical, Frequency Modulation, Radar.

Classes now forming for the Summer term June 1st Entrance exam, May 22nd.

Veterans. Literature.

COMMERCIAL RADIO INSTITUTE
(Founded 1920)
38 West Biddle Street, Baltimore 1, Md.

CODE SENDING SPEED

Be a "key" man. Learn how to send and receive messages in code by telegraph and radio. Commerce needs thousands of men for jobs. Good pay, adventure, interesting work. Learn at home quickly through famous Candler System. Qualify for Amateur or Commercial License. Write for FREE BOOK.

CANDLER SYSTEM CO.
Dept. 3-D, Box 928, Denver 1, Colo., U.S.A.

Make Your Career RADIO and TV

In no other industry does the future hold brighter financial promise and security than in AM and FM Radio, Television. These fields need and want men trained as announcers, script writers, disc jockeys, and radio technicians. It will pay you to investigate the Don Martin School of Radio Arts, established in 1937. Complete day and night classes . . . the latest equipment . . . and a staff of 30 nationally known instructors. Over 97% of the combination men graduates are placed on jobs immediately through the free placement service. Approved for veterans.

FREE—Write for Free Booklet "Your Future in Radio."

Don Martin School of Radio Arts

1655 No. Cherokee, Hollywood, Calif. HUdson 23281



RADIO and TELEVISION

Thorough Training in All Technical Phases

APPROVED FOR VETERANS
DAYS—EVENINGS WEEKLY RATES

RCA GRADUATES ARE IN DEMAND
For Free Catalog Write Dept. RC-50

RCA INSTITUTES, Inc.
A Service of Radio Corporation of America
350 WEST 4TH STREET NEW YORK 14, N. Y.

TELEVISION

PREPARE FOR A GOOD JOB!

COMMERCIAL OPERATOR (CODE)
RADIO SERVICEMAN

TELEVISION SERVICING
BROADCAST ENGINEER

V.A. Furnishes Books and Tools
SEND FOR FREE LITERATURE

BALTIMORE TECHNICAL INSTITUTE
1425 Eutaw Place, Dept. C, Baltimore 17, Md.

AUDIO ENGINEERING SCHOOL

Practical engineering training in Audio fundamentals. Disc, Film, Magnetic Recording, and Audio frequency measurements. Studio training simulates Broadcast, Motion Picture, Television, and Commercial Recording work. Approved for Veterans

HOLLYWOOD SOUND INSTITUTE, Inc.
1040-E North Kenmore, Hollywood 27, Calif.
Correspondence Courses Available
Specify If Veteran or Non-Veteran

RADIO COURSES

- RADIO OPERATING • CODE
- RADIO SERVICING • ELECTRONICS
- F.M. TELEVISION
- REFRIGERATION SERVICING

Write for Catalog TE and Picture Brochure



TRADE & TECH. SCHOOL 229 W. 66 St., N. Y. 23
Endicott 2-8117

TV
TV
TV
TV

Career Training in a Minimum of Time

RADIO ELECTRONICS TELEVISION ENGINEERING

Graduates of CREI residence school are preferred by industry because of their training and ability. 23 years practical experience. CREI offers an outstanding faculty, modern laboratories, shops and equipment. New students accepted twice monthly and each may advance as rapidly as he is capable. Approved for Veterans' Training. Write for Details and Free Catalog.

Capitol Radio Engineering Institute, Dept. 304B
16th & Park Road, N.W., Washington 10, D. C.

Please send me your residence school catalog and details.

Name Age

Street

City Zone State

If in high school, what term?

I am entitled to train- Send information on
ing under G.I. Bill, Home Study Courses.

MODERN OSCILLOSCOPES AND THEIR USES, by Jacob H. Ruiter, Jr. Published by Murray Hill Books, Inc., New York. 6 x 9½ inches, 326 pages. Price \$6.00.

The author opens the book with a brief discussion of different types of oscillographs and their development and then introduces the cathode-ray oscilloscope through a description of the characteristics of various types of cathode-ray tubes. After presenting a picture of a general-purpose oscilloscope, he breaks it down into three sections—power-supply circuits; amplifiers, attenuators, and positioning circuits; and time-base circuits—for a detailed discussion of oscilloscopic patterns. Line drawings and photographs illustrate many basic patterns which may be obtained under different conditions.

The oscilloscope is then discussed as an industrial device and as a visual aid in teaching. The chapters on servicing AM, FM, and TV receivers and AM transmitters give detailed step-by-step instructions for testing and servicing circuits. The book concludes with a chapter on photographing oscilloscopic patterns. This chapter contains useful data on still and continuous-motion cameras and on different films. A glossary of radio and electronic terms is included.—R.F.S.

THE RADIO AMATEUR'S HANDBOOK, twenty-seventh edition. Edited and published by the American Radio Relay League, West Hartford, Conn. 6½ x 9½ inches, 616 editorial pages plus 120-page catalog section. Price \$2.00.

The standard radio reference work and amateur bible appears in a bright red cover in its 1950 edition. Chief changes are in emphasis. The chapter on high-frequency transmitters, for example, gains 11 pages, while that on emergency communications loses five. The valuable chapter "Vacuum-Tube Data" has been revised to take care of new 1949 tube types.

FUNDAMENTALS OF VACUUM TUBES, by Austin V. Eastman. Published by McGraw-Hill Book Co., New York 6½ x 9 inches, 644 pages. Price \$5.50.

In this third edition new material has been included on pulse modulation and demodulation, R-C oscillators, and cathode-coupled, cathode-follower, grounded-grid and video amplifiers. A new approach has been made to the treatment of resistance-coupled amplifiers, and changes leading to better organization and simpler presentation have been made.

INTRODUCTORY OFFER

• A Residence Course of Practical Radio in your home for only **\$69.50**

• Complete with test equipment and commercial receiver free of extra cost.

• You can earn while you learn!

Act now while offer is still good.

Oklahoma Institute of Electronics
1017-19 North Harvey
Oklahoma City 3, Oklahoma

C.T.I. TRAINED MEN ARE AVAILABLE!

Each month C.T.I. graduates ambitious young men who have completed an intensive course in Radio and Television maintenance and repairing. Their training has been practical. They've learned by working on modern equipment under personal, expert supervision. If you need a trained technician, we invite you to write for an outline of our course, and for a prospectus of the graduates. (No fees, of course.) Address:

Placement Manager, Dept. P108-4

COMMERCIAL TRADES INSTITUTE
1400 GREENLEAF CHICAGO 26

TRAIN FOR ALL TYPES

FCC (RADIO OPERATOR) LICENSES

Complete Raytheon AM and FM broadcast transmitters and studio control equipment. Also TV camera chain unit. 30th anniversary year. Please send for catalog R.

MASS. RADIO SCHOOL

271 Huntington Ave., Boston 15, Mass.
Lic. by Comm. Mass. Dept. Ed.

RADIO ENGINEERING!

Complete Radio Engineering course incl. Telev., U.H.F., and F.M. B.S. Degree Courses also in Civil, Elect., Mech., Chem., and Aero. Eng.; Bus. Adm., Acct. Visit campus, see well equipped labs. Low cost. Prep. courses. Personalized instruction. Grads successful. Founded 1884. Enter June, Sept., Jan., March. Write for Catalog.

TRI-STATE COLLEGE 2440 College Ave. ANGOLA INDIANA

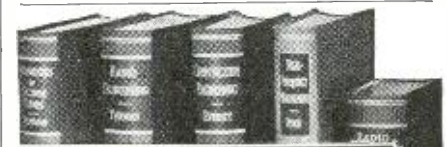

Assembled for your convenience

Facts, standards
practices, data

for the whole field
of radio engineering

Radio Engineering Library

RADIO specialists of the McGraw-Hill publications selected the books for this library as those giving the most complete, dependable coverage of facts needed by engineers whose special fields are grounded on radio fundamentals. They cover circuit phenomena, tube theory, networks, measurements, and other subjects . . . give specialized treatment of all fields of practical design and application.

- ★ Special Low Price
- ★ Bought singly, the five volumes would cost \$30.50. Under this offer you save \$3.00.
- ★ Pay in easy installments

Library includes:

1. Fundamentals of Vacuum Tubes—Eastman
 2. Radio Engineering—Termon
 3. Communication Engineering—Everitt
 4. High-Frequency Measurements—Hund
 5. Radio Engineering Handbook—Henney
- 3559 pages!
2558 illustrations!

FREE 10 Day Trial

McGraw-Hill Book Co., 330 W. 42nd St., N.Y.C. 18
Send me Radio Engineering Library, 5 vols., for 10 days' examination on approval. In 10 days I will send \$2.50, plus few cents postage, and \$5.00 monthly till \$27.50 is paid, or return books postpaid.

Name

Address

City Zone State

Company

Position RC-4-50



- ★Wide-Range
- ★Scratch
- ★Suppressor
- ★Volume Expander

Supreme performance with any variable reluctance pickup.

EXCLUSIVE G.E. PICKUP CIRCUIT

New circuits enable you to attain full benefit from the new G-E Variable Reluctance Magnetic pickup. Employs an exclusive, humless pre-amplifier to produce the most satisfying musical amplifier the world has ever known. If you are a perfectionist, you are the one for whom the ACA-100GE was designed. Send for technical literature.

AMPLIFIER CORP. OF AMERICA

398-10 Broadway New York 13, N. Y.

YOU SAVE TIME & MONEY
With this Assembled
VACUUM TUBE VOLTMETER

At Less Than Kit Prices!

Save plenty! Don't bother building one, here's a *laboratory designed and calibrated* VACUUM TUBE VOLTMETER at less than the cost of the kit.



- Etched panel permanent markings.
- Buy direct from the maker.
- Technically designed and tested.
- Guaranteed by the manufacturer.

Only **\$23.50**

For AM/FM Radio and Television

THESE FEATURES INVITE COMPARISON: Includes a new type stabilized bridge circuit with a 200 microampere 4" alnico magnet meter; 15 megohm input, 3 to 1,500 volt ranges on AC or DC. Ohmmeter ranges to 1,000 megohms. Complete unit is mounted on an aluminum, permanently deep etched panel. Markings won't wear off and set in a bakelite case; 5 5/16" width, 7 7/8" height, 2 1/4" depth. Fully guaranteed—same as RMA!

Big Savings!
HIGH VOLTAGE PROBES... 15,000 volts. Designed for use on the ELLIOTT VACUUM TUBE VOLTMETER. Worth twice as much... Your cost, only **\$3.95**

Write today for FREE literature and more details about other ELLIOTT LABORATORIES precision built instruments offered at great savings.

ORDER TODAY! Send check or Money Order for full amount or enclose 25% with C.O.D. orders. WE PAY postage and C.O.D. fees if you send full amount... save even more!

Elliott Laboratories
140 LIBERTY STREET
NEW YORK 7, N. Y. BARCLAY 7-4239

Your name on our Mailing List &
9LP7 Cathode Ray TUBE \$1.00
Magnetic focus-deflection: 7700 V. anode, War Surplus; JAN; New, guaranteed, wt., 7 lbs.
POLYSTYRENE & LUCITE
cut, machined & engraved to your specs.
GOULD GREEN, 254 Greenwich St., N.Y.C. - 7

7 HARD TO GET ITEMS AT BIG SAVINGS TO YOU

AMAZING BLACK LIGHT



250-watt ultra-violet light source. Makes fluorescent articles glow in the dark. Fits any lamp socket. For experimenting, entertaining, unusual lighting effects. Ship. wt. 2 lbs. ITEM NO. 87 **\$1.95** A SAVING AT

LITTLE GIANT MAGNET

Lightweight 4 oz. ALNICO permanent magnet. 1 3/4" x 1 1/2". Lifts more than 20 TIMES ITS OWN WEIGHT! Ideal for hobbyists, experimenters. Shipping weight 3/4 lbs.



ITEM NO. 159 **\$1.25** BIG VALUE AT

POWERFUL ALL PURPOSE MOTOR

Sturdy shaded pole A.C. induction motor. 15 watts, 3000 rpm. 3"x2"x1 3/4"; 4 mounting studs; 7/8" shaft, 3/16" diameter; 110-120 volts. 50-60 cycles. A.C. only. When geared down, this unit can operate an 18" turntable with a 200 lb. dead weight. Use it for fans, displays, timers and many other practical purposes. Ship. wt. 2 lbs.

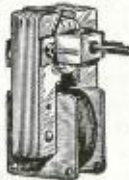

ITEM NO. 147 **\$1.95** UNUSUAL BUY

WATTHOUR METER

Leading makes — completely overhauled, ready for service. 100-110 volts, 60 cycles, 2-wire A.C. Heavy metal case 8 1/2" x 6 1/4" x 5" Easy to install. Shipping weight 14 lbs.



ITEM NO. 33 **\$3.95** NOW ONLY

WESTERN ELECTRIC BREAST MIKE

Lightweight 1 lb. carbon microphone. Aircraft type. Breastplate mounting, adjustable 2-way swivel. Easily fastened straps. For home broadcasts, communications etc. Complete with 6 foot cord, hard rubber plug. Sheradized plate, non-rusting finish. Ship. wt. 2 lbs.



ITEM NO. 152 **95¢** NEW LOW PRICE

TELEPHONE TRANSMITTERS

Genuine transmitters made by Kellogg, Western Electric, Stromberg Carlson. Work on two dry cells. For P.A. systems, intercoms, other practical uses. Shipping weight 1 lb.



ITEM 160 **\$1.95** REAL VALUE

250 POWER TELESCOPE LENS KIT

Make your own high powered 6 ft. telescope! Kit contains 3" diam., .75" focal length, ground and polished objective lens and necessary eye pieces. Magnifies 50x to 250x. Full instructions. Ship. wt. 1 lb. ITEM NO. 123 **\$2.45** YOU SAVE AT

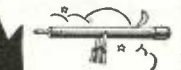

HUDSON SPECIALTIES CO.
40 West Broadway, Dept. RE-4-50
New York 7, N. Y.

I am enclosing full remittance for items circled below. SHIPPING charges included.

OR, my deposit of \$... Ship balance C.O.D. MINIMUM C.O.D. ORDER \$5.00.

C.O.D. ORDERS ACCEPTED ONLY WITH 20% DEPOSIT INCLUDE SHIPPING CHARGES.

Circle Items wanted

87	159	147	33	152	160	123
----	-----	-----	----	-----	-----	-----

Name.....
Address.....
City..... Zone..... State.....

Please Print Clearly

ADVERTISING INDEX

Ace TV Company.....	84
Adson Radio & Electronics Company.....	89
Alliance Manufacturing Company.....	63
Allied Radio Corporation.....	49
Almo Radio Company.....	87
American Electrical Heater Co.....	58
American Phenolic Corporation.....	76
Amplifier Corporation of America.....	72
Approved Electronics.....	92
Ashe Radio Company, Walter.....	77
Astatic Corporation.....	8
Bell Telephone Laboratories, Inc.....	20
Boland & Boyce, Incorporated.....	78
Boyce-Roche Book Company.....	62
Brook Electronics, Incorporated.....	91
Brooks Radio Dist. Corporation.....	67, 87
Buffalo Radio Supply.....	57
Capitol Radio Engineering Institute.....	7
Certified Television Laboratories.....	66
Channel Chief Company.....	75
Cinex, Incorporated.....	75
Cleveland Electronics, Incorporated.....	75
Cleveland Institute of Radio.....	22
Clippard Instrument Laboratories, Inc.....	93
Communications Equipment Company.....	84
Coyne Electrical School.....	83, 84
DeForest's Training, Inc.....	11
DuMont Laboratories, Allen B.....	98
Electro-Technical Industries.....	90
Electronic Associates.....	93
Electronic Instrument Company.....	53
Electronic Measurements Corporation.....	88
Elliott Laboratories.....	96
Fair Radio Sales.....	91
Feiler Engineering Company.....	74, 89
General Electronic Dist. Company.....	50, 51
General Industries Company.....	66
General Test Equipment Company.....	74
Gould-Test.....	96
Greenwich Sales Company.....	88
Greylock Electronic Supply Company.....	74
Harvard Laboratories.....	17
Heath Company.....	12, 13, 14, 15, 16, 17
Hickok Electrical Instrument Company.....	67
House of Television.....	89
Hytron Radio & Electronics Corporation.....	19
Instructograph Company.....	73
Jersey Specialty Company.....	97
Lafayette Radio.....	55
La-Pointe Plascomold Corporation.....	60
Le-Hi Electrical Company.....	74
Leotone Radio Corporation.....	89
Liberty Electronics, Inc.....	75
McConnell's.....	66
McGraw-Hill Book Company, Inc.....	95
Midwest Radio Corporation.....	80
Murray Hill Books, Incorporated.....	86
National Company.....	4
National Radio Institute.....	5
National Schools.....	3
Niagara Radio Supply Corp.....	65
Oak Ridge Mfg. Company.....	64, 83
Odegaard Mfg. Company, John.....	97
Opportunity Adlets.....	97
Ouvejok, George B.....	92
Precision Apparatus Company.....	87
Precision Radiation Instruments, Inc.....	97
Progressive Electronics Company.....	72
Quam-Nichols Company.....	92

RADIO SCHOOL DIRECTORY (Pages 94-95)	
American Radio Inst.	Commercial Radio Inst.
Baltimore Technical Inst.	Commercial Trades Inst.
Bliss Electronic School	Delehanty Institute
Candler System Co.	Hollywood Sound Inst.
Capitol Radio Eng. Inst.	Hollywood Technical Inst.
Martin School of Radio Arts, Don	
Massachusetts Radio School	
Milwaukee School of Engineering	
Oklahoma Inst. of Electronics	
RCA Institutes	
Radio Television Institute	
Tri-State College	
Valparaiso Technical Institute	
YMCA Trade & Technical Schools	

RCA Victor Division Radio, Corporation of America	Inside Front Cover, 6, Back Cover
Radio Apparatus Corporation.....	63
Radio City Products Co., Inc.....	82
Radio Corporation of America.....	61
Radio Dealers Supply Company.....	80
Radio Supply & Engineering.....	69
Radionic Equipment Corporation.....	87
Rose Company.....	97
Sams & Company, Inc., Howard W.....	9
Senco Radio, Incorporated.....	80
Sonic Industries.....	70
Sprague Products Company.....	54
Sprayberry Academy of Radio.....	Inside Back Cover
Standard Transformer Corporation.....	73
Sun Radio & Electronics.....	81
Sutton's Wholesale Electronics, Bill.....	97
Swedgal Radio, Incorporated.....	71
Sylvania Electric Products, Inc.....	21, 79
Tel-A-Ray Enterprises.....	81
Tel-O-Tube Sales Corporation.....	59
Triplet Electrical Instrument Co.....	21
Universal General Corporation.....	73
University Loudspeakers, Inc.....	56
Ward Products Corp. (Div. Gabriel Co.).....	72
Weller Manufacturing Company.....	52
Wholesale Radio Parts Company, Inc.....	85

OPPORTUNITY AD-LETS

Advertisements in this section cost 25¢ a word for each insertion. Name, address and initials must be included at the above rate. Cash should accompany all classified advertisements unless placed by an accredited advertising agency. No advertisement for less than ten words accepted. Ten percent discount for six issues, twenty percent for twelve issues. Objectionable or misleading advertisements not accepted. Advertisements for May, 1950, issue, must reach us not later than March 24, 1950.
Radio-Electronics, 25 W. Broadway, New York 7, N. Y.

SNIPERSCOPE & SNOOPERSCOPIES wanted. Any condition. Needed immediately. Box F1, Radio-Electronics, 25 W. Broadway, New York 7, N. Y.

CLEAR VINYL TUBING. Clear plastic tubing for insulating and protecting wiring (up to 5,000 volts). May also be used for decorative purposes and as fluid hose. Write for complete list of prices and sizes. AMC SUPPLY COMPANY, P. O. Box 1440-S, Fort Worth, Texas.

AMATEUR RADIO LICENSES. COMPLETE THEORY preparation for passing amateur radio examination. Home study courses. American Radio Institute, 101 West 63rd St., New York City. See our ad on Page 34.

"RAPID RADIO REPAIR" now in preparation. Order now \$1.25 Postpaid or COD. Book reveals new, sure-fire technique, repair any set. "Well written . . . wealth of good practical information. . . ." says Engineer Weiss, Hickok Co. John D. Burke, 168-08 90th Ave., Jamaica (NY) NY.

MAGAZINES (BACK DATED)—FOREIGN, DOMESTIC arts, books, booklets, subscriptions, pin-ups, etc. Catalog, 10¢ (refunded). Ciccone's, 65-22 Northern Blvd., Jackson Heights, N. Y.

RECONSTITUTED TIME SWITCHES. 10 day clockwork, 7 jewelled movement, British make, 10 amp 0-250 v. A.C./D.C. Ideal for shop window lighting, radios, neon, heaters. Guaranteed for one year. \$5 each. (Only dollar bills accepted.) Donhoe, Upper Norfolk St., North Shields, Northumberland, England.

SEEBURG RECORD CHANGER PARTS FOR MODELS B, K, L. We ship everywhere. Friend's Wholesale Distributors, 106 North Sixth Street, Philadelphia 6, Pa. Dept. RC.

HERMAN LEWIS GORDON, REGISTERED PATENT Attorney. Patent Investigations and Opinions. Warner Building, Washington, D. C.

WE REPAIR ALL TYPES OF ELECTRICAL INSTRUMENTS, tube checkers and analyzers. Hazleton Instrument Co. (Electric Meter Laboratory), 140 Liberty Street, New York, N. Y. Telephone—BARCLAY 7-4239.

EMERSON TUBES, 40% to 60% off list. All types. Year's guarantee. Free listing. Joseph Kase Electronics, 245 Echo Place, Bronx 57, N. Y.

LANCASTER, ALLWINE & ROMMEL, 436 BOWEN Building, Washington, D. C. Registered Patent Attorneys. Practice before United States Patent Office. Validity and infringement investigations and opinions. Booklet and form "Evidence of Conception" forwarded upon request.

RADIOMEN, SERVICEMEN, BEGINNERS—MAKE more money, easily, quickly. \$250 weekly possible. We show you how. Information free. Merit Products, 218-32L 132nd Avenue, Springfield Gardens 13, New York.

TECHNICIANS !! ENGINEERS !! Interested in a top-paying electronic position? ?? Send post card for information on HOW, WHY, WHERE. MID CONTINENT RESEARCH BUREAU, P. O. Box 121, Wichita, Kansas.

PHONOGRAPH RECORDS 15¢. Catalogue. Paramount TG-313 East Market, Wilkes-Barre, Penna.

Five Element TV Yagi Beams. High Band \$6.75. Low Band \$8.50. Aluminum Tubing. Etc. Willard Itadcliff, Fostoria, Ohio.

All steel TV tower—Shipped direct from the factory at \$8.50 per 10' section. Easy to climb. Can be erected to 70' or more. The Youngstown Steel Towers, 1316 Wilson Avenue, Youngstown 8, Ohio.

"THE STANDARD BOOSTER" best today for fringe areas. \$22.50. Free listing tubes, parts. Will do your buying any item. Joseph Kase Electronics, 245 Echo Place, Bronx 57, N. Y.

★ HERE IS A TERRIFIC VALUE! ★

★ 3 TUBE PHONO AMPLIFIER ★

★ Designed for use with all types of records—2 1/2" Wait output—completely wired with full range tone control. Only \$2.39

★ Lots of three . . . \$2.19

★ Set of Tubes for above . . . \$1.25

★ 50L6 Output Transformer for above35

★ 5" PM Speaker Alnico V1.15

★ 6" PM Speaker Alnico V1.55

★ Hi-Volt Phono Pickup1.79

★ Hi-Volt Phono Cartridge1.69

★ Medium Volt Phono Pickup1.59

★ Medium Volt Cartridge1.49

★ 78 RPM Motor & Turn Table2.49

★ Dual Speed 33 1/2, 78 RPM, M. & T.T. . . .3.89

★ 3 Speed 33 1/2, 45, 78 RPM, M. & T.T. . . .4.95

★ Hi-Fidelity Phono Pickup with turnover Cartridge and 2 Needles for all records4.95

★ TELEVISION SPECIAL ★

★ RCA Type 630 Chassis with Voltage Doubler for 16" operation. Factory wired and aligned for perfect reception. . . . \$159.50

★ Chassis as above, but with Automatic Gain Control, including an additional 6AU6 tube, to eliminate interference. . . . 169.57

★ 16" Glass Picture Tube—1 yr. guarantee. . . . 44.50

★ Write Dept. RE4 for Descriptive Literature. All Prices F.O.B. New York. 25% Deposit required on all orders. Minimum Order \$5.00.

★ THE ROSE COMPANY 98 Park Place ★
★ New York 7, N. Y. (Corner Greenwich St.) ★

THE TECHNIQUE OF RADIO DESIGN (Second Edition) by E. E. Zeppler. Published by John Wiley & Sons. New York. 6 x 8 1/2 inches, 394 pages. Price \$5.00.

This second edition of a standard work (reviewed in RADIO-CRAFT May 1944) has 85 more pages and 23 more diagrams than the first edition. The chapter on receiver noise has been entirely rewritten and the space given to negative feedback greatly expanded. Other revisions appear throughout.

WHO KNOWS—AND WHAT. Published by A. N. Marquis Co., Chicago. 7 3/4 x 10 3/4 inches, 796 pages. Price \$15.70.

This unusual book lists the names and addresses of 16,000 men and women who qualify on 35,000 subjects as experts. Each name is followed either by a short biography or by a symbol indicating that a biography appears in *Who's Who in America*. Another symbol tells whether the person is available for consultation.

WORLD-RADIO HANDBOOK FOR LISTENERS, published and edited by O. Lund Johansen. Distributed in the United States by Ben E. Wilbur, East Orange, N. J. 6 1/2 x 8 1/2 inches, 112 pages. Price \$1.25.

The fourth edition of this complete listing of shortwave broadcast stations of the world, together with long- and mediumwave stations of most countries (the United States is the notable exception), is dated October, 1949. The handbook is now coming out as an annual, with the next edition to be published late in 1950.

The arrangement of earlier editions is followed. Stations are listed according to political divisions, with frequencies, wavelengths, power, main programs and the names and addresses of the companies or administrations responsible for their operation; even the names of the leading personalities are included. A list of long- and medium-wave stations of Europe, North Africa, and the Near East, and a list of the shortwave stations of the world, both arranged by frequencies, is included.

WANTED TO BUY

Large and small quantities of new or used electronic government or manufacturers' surplus tubes and equipment. Highest prices paid. State quantity, condition and best price in first letter.

Box No. F-2 c/o Radio Electronics
25 West Broadway
New York 7, N. Y.

\$10,000 REWARD

Earn the government bonus by locating radium with a **P.R.I. GEIGER COUNTER**

The most sensitive portable Geiger Counter made.

Weight only 2 lbs. Battery lasts a year. Prospecting book included free. Priced from \$49.50 complete.

PRECISION RADIATION INSTRUMENTS, INC.
5478-R Wilshire Blvd. Los Angeles 36, Calif.
Dealer Inquiries Invited

ELECTRONIC DISTRIBUTORS FROM COAST TO COAST

We can now serve you with J.S.C. 300 ohm T.V. twin lead transmission wire, like we have been serving about 50% of television wire requirements in the metropolitan areas during the past year.

Remember — our prices are right, our quality the highest, our deliveries the fastest.

Write for quantity quotations.
Sold to wholesale distributors only.

JERSEY SPECIALTY CO.
Manufacturers of Wire Products
Little Falls, New Jersey
Phone—Little Falls 4-0784-1404-1405

ODEGAARD ORIGINAL NAIL POLYETHYLENE STANDOFF

for Ribbon or Coaxial Cable

Saves more labor, time and money than any other standoff! No drilling—just quick, easy hammer strokes. Easily drives into wood, mortar, iron, aluminum, etc. Excellent mast-coupler. "Step"-locked, permanent installation. Cadmium-plated hardened high-carbon steel nail. Specially punched to-loss distributor.

SERVICEMEN: For free sample and nearest distributor's name, write today to Dept. E.

PARTS DISTRIBUTORS: Choice protected territories still open. For full details, write today to Dept. E.

COPYRIGHT 1949, JOHN ODEGAARD, BROOKLYN, N. Y.

ODEGAARD MFG. CO.
5416 EIGHTH AVE., BROOKLYN 20, N. Y.

SIX TUBE SUPER
Three Gang Condenser

\$33.30 NET
Crowe Panel Kit Included



Panel kit to fit most all makes (Please specify make of car and year model). New up-to-date latest priced Catalog available to dealers.

Bill Sutton's
Wholesale Electronics
5th at Commerce Fort Worth, Tex.

another **DUMONT** first...



BENT-GUN

*Teletrons**

 The new Du Mont Types 12RP4 and 15DP4 (replacing respectively Types 12JP4 and 15AP4) feature the exclusive Du Mont bent-gun. This ion-trap design eliminates ion-spot blemishes while maintaining an undistorted spot for maximum pictorial resolution. Meanwhile, lead-free glass reduces tube weight considerably. Five-pin duodecal base permits using the new half-socket for a significant saving, although old-type full-socket also accommodates these new tubes without modification.

Definitely "Your best buy!" For initial-equipment or replacement purposes — for superlative performance and longest service — insist on Du Mont Teletrons!

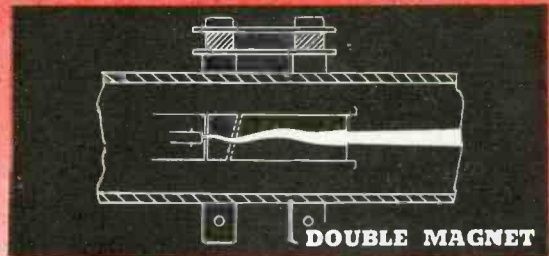
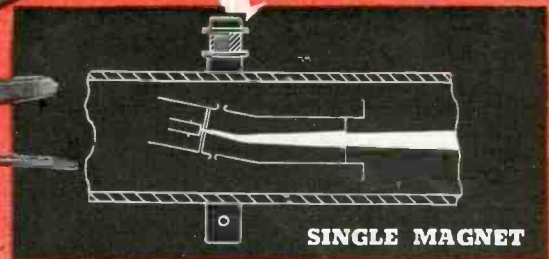

Above: Du Mont bent-gun principle, utilizing single ion-trap magnet. Space saved by eliminating double beam-bending magnet results in shorter neck length. Focused-spot distortion eliminated by use of electrode parts designed to form symmetrical electrostatic fields in G₂ space. Lower-cost magnet.

Below: Conventional straight-gun design. Ion and electron beam is twisted by slanting electrostatic field between second grid and anode, requiring TWO bending magnetic fields. More costly beam-bender. Longer neck. Focused-spot distortion.

Write for latest literature.

© ALLEN B. DU MONT LABORATORIES, INC.

* TRADE MARK

DUMONT FIRST WITH THE FINEST IN **T-V** TUBES
Teletrons

ALLEN B. DU MONT LABORATORIES, INC. • TUBE DIVISION • PASSAIC, NEW JERSEY



HERE IS THE LONG SOUGHT ANSWER IN TELEVISION TRAINING FOR THE MAN ALREADY IN RADIO! TRAIN AT HOME—FULL PROGRAM—4 TO 8 WEEKS!

Low Cost—Monthly Payments. Everything You Need to Learn...

TELEVISION

I Send You NOT JUST an Ordinary TV Kit—But a Complete Training System Including TV Test Equipment

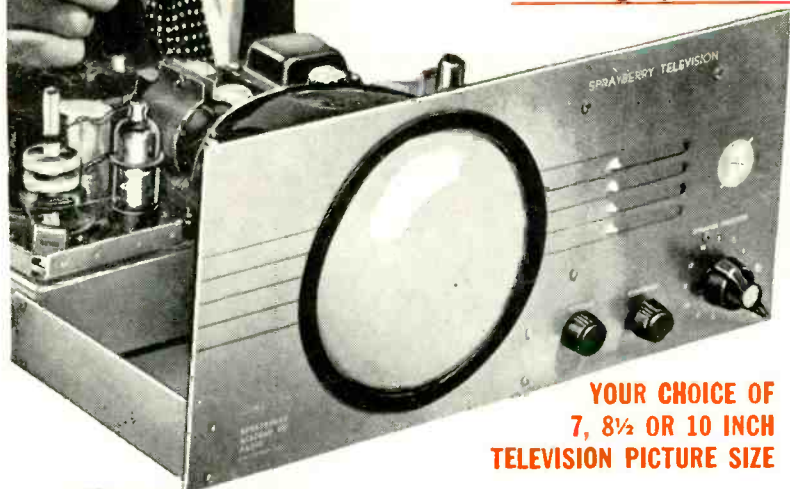

**YOUR CHOICE OF
7, 8½ OR 10 INCH
TELEVISION PICTURE SIZE**

Here is the NEW Combination Sprayberry Television Training System

Out of my laboratory has come an entirely new Television Training...cutting months off the time required in old methods. I give all the knowledge and experience you need in weeks instead of months. I start where your present radio experience ends. The same day you enroll with me, I rush the first of many big Television kits that I will send during your training. From the first hour you are experimenting and testing practical TV circuits...and you keep right on from one fascinating experiment to another. You build the remarkable new Television Receiver-Tester illustrated at the left and useful TV Test Equipment. I give you theory, too, but it's 100% practical stuff that will make money for you in Television.

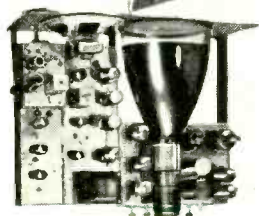

Exclusive THREE-UNIT Construction

You build my Television Receiver-Tester in three separate units—one unit at a time...each complete and self contained within itself. With each unit you perform dozens of important experiments—and each unit may be used in actual Television receiver servicing. In this way my training may save you many dollars by eliminating the need for costly TV Test Equipment. With these three units you can locate most TV Receiver troubles quickly and easily.

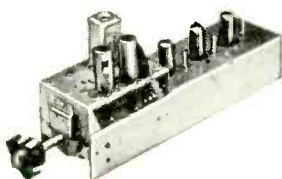

TV Tuner—I.F. Unit

Contains the RF amplified local oscillator, mixer and three stages of broad band IF amplification and the video second detector. The output constitutes the video signal and audio IF signal. For training, it is used to build and test video second detector, and stagger tuned IF amplifier obtaining 4.5 mc band pass. For TV servicing, it becomes a TV calibrator for IF alignment, substitute tuner, IF signal injector and second detector.

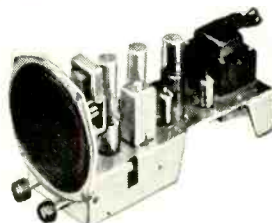

Video-Audio Amplifier Unit

Provides 4.5 mc IF ratio detector, low voltage power supply. For TV, it becomes the audio output, including speaker, video output and low voltage power supply for RF and IF stages. For training, it is used to build and test transformer type power supplies, audio, video, IF amplification and FM detection. For TV servicing, it is an audio signal tracer, IF signal tracer, video signal tracer and low voltage power supply.

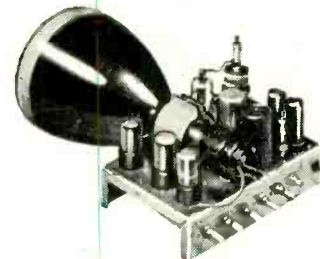

Video Tube "Scope" Unit

Scope unit contains low and high voltage (6000 V.) power supply for independent operation. For television, it becomes the sync, vertical and horizontal sweep circuits and their power supplies. For training, it is used to build and test most TV power supply, deflection, sweep, oscillator, and sync circuits. For TV servicing, it is a video signal tracer and sweep signal analyzer as well as substitute high and low voltage power supplies.

BE READY FOR TOP PAYING TELEVISION JOBS

If you are a radio-serviceman, experimenter, amateur or advanced student... YOUR FUTURE IS IN TELEVISION. Depending upon where you live, Television is either in your town now... or will be there shortly. This is a vast new industry that needs qualified trained men by the thousand to install and service TV sets. There's really big money in Television, but you MUST know what you are doing to "cash-in" on it. I will train you in a few short weeks if you have had previous radio training or experience.

IMPORTANT—FOR MEN JUST STARTING OUT IN RADIO-TELEVISION

If you have no previous experience in Radio work, be sure to mark that fact on the coupon below. I will send you complete information about my Radio-Television training that starts with basic fundamentals and carries you right through my new Radio and Television Training. I will send you my two big Radio-Television books, including an actual lesson selected from my course. I want you to know exactly what this great industry has in store for you. There is no obligation, of course, and NO SALESMAN WILL CALL.

FILL OUT AND MAIL COUPON
Get these Valuable Books **FREE!**

VETERANS—Radio portion of training available under G. I. Bill

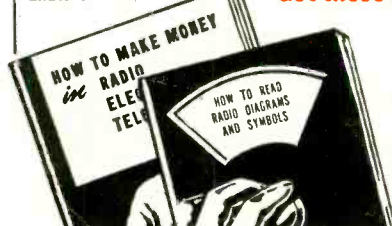

Every Radio Serviceman today realizes his future is in Television. He knows he MUST have training—the right kind of practical training such as I am now offering—to protect his job, his business for the future. This is equally important for the man just starting out. And so I urge you to get the facts I offer you FREE and without obligation. Learn how quickly and easily you can get into Television. Fill out and mail the coupon TODAY.

SPRAYBERRY ACADEMY OF RADIO, 111 N. Canal, Dept. 20H, Chicago 6, Ill.

SPRAYBERRY ACADEMY OF RADIO, Dept. 20-H
111 North Canal St., Chicago 6, Ill.

Please rush to me all information on your Radio-Television Training plan. I understand this does not obligate me and that no salesman will call upon me.

Name..... Age.....

Address.....

City..... State.....

Please Check Below About Your Experience

Are You Experienced? No Experience

THE QUALITY OF RCA TUBES IS UNQUESTIONED



Higher Quality Standards for TV, FM and AM

THE *QUALITY LEVEL* of RCA miniatures has been continually advanced in step with circuit progress. Improved design . . . more rigid control over manufacture and inspection . . . and more exacting tests, including rigid re-test before shipment, are the reasons why RCA miniatures have unusually uniform characteristics, so important to tubes for television receivers in particular, and also for FM and AM receivers. Their dependability in criti-

cal circuits cuts down costly service call-backs.

And now . . . this *extra* quality of RCA miniatures is "packed in so it can't be shaken out." A new type "snug-fit" carton protects tubes against damage by holding them securely in place during transit.

RCA's engineering leadership adds *value beyond price* to the RCA tubes you sell. Your customers know about this advantage too.

Always keep in touch with your RCA Tube Distributor



RADIO CORPORATION of AMERICA
ELECTRON TUBES

HARRISON, N. J.