

RADIO — ELECTRONICS

K

IN THIS ISSUE
See "Electrets"

HUGO GERNSBACK,
Editor

formerly

**RADIO
CRAFT**



NEW ELECTRET
DEVELOPMENTS
SEE RADIO SCIENCE SECTION

APRIL
1949

30¢

U. S. and
CANADA

LATEST IN RADIO — ELECTRONICS — TELEVISION

MONEY BACK GUARANTEE—We believe units offered for sale by mail order should be sold only on a "Money-Back-If-Not-Satisfied" basis. We carefully check the design, calibration and value of all items advertised by us and unhesitatingly offer all merchandise subject to a return for credit or refund. You, the customer, are the sole judge as to value of the item or items you have purchased.

FOR FM-AM TELEVISION

BUILD YOUR OWN SIGNAL TRACER and SAVE!!



(We can supply the Model CA-12 completely wired, ready to operate—\$29.25.)

Increasing production of P.M. and Television Receivers means more complex Receivers. Now more than ever this time-saving method of quickly and easily localizing the exact cause of trouble becomes the "must" method. Since 1939 when we first introduced our CHANNEL ANALYZER we have worked continuously developing and improving the "short-cut" method of Receiver servicing.

The Only Signal Tracer in the Low Price Range Including BOTH METER AND SPEAKER!!

FEATURES: ★ Comparative intensity of the signal is read directly on the meter—quality of the signal is heard in the speaker. ★ Simple to operate—only one connecting cable—no tuning controls. ★ Highly sensitive—uses an improved vacuum-tube voltmeter circuit. ★ Tube and resistor capacity network are built into the detector probe. ★ Built-in high gain amplifier—Alnico V speaker. ★ Completely portable—weighs 8 pounds—measures 5½" x 6½" x 9".

MODEL CA-12 Kit includes ALL PARTS assembled and ready for wiring, circuit diagram and detailed operating data for the completed instrument.

\$21⁹⁵

THE NEW MODEL 670

SUPER METER



SUPER METER. A Combination VOLT - OHM - MILLIAMMETER plus CAPACITY REACTANCE, INDUCTANCE and DECIBEL MEASUREMENTS.

D.C. VOLTS: 0 to 7.5/15/75/150/750/1500/7500. **A.C. VOLTS:** 0 to 15/30/150/300/1500/3000 Volts. **OUTPUT VOLTS:** 0 to 15/30/150/300/1500/3000. **D.C. CURRENT:** 0 to 1.5/15/150 ma. 0 to 1.5 Amps. **RESISTANCE:** 0 to 500/100,000 ohms. 0 to 10 Megohms. **CAPACITY:** .001 to 2 Mfd. .1 to 4 Mfd. (Quality test for electrolytics.) **REACTANCE:** 700 to 27,000 Ohms; 13,000 Ohms to 3 Megohms.

INDUCTANCE: 1.75 to 70 Henries; 35 to 8,000 Henries.

DECIBELS: -10 to +18. +10 to +38. +10 to +58.

The model #70 comes housed in a rugged, crackle-finished steel cabinet complete with test leads and operating instructions. Size 5½" x 7½" x 3".

\$28⁴⁰
NET

THE NEW MODEL 777

20,000 OHMS PER VOLT!! TUBE & SET TESTER

Tube Tester Specifications:

★ Tests all tubes including New Miniatures, etc. Also Pilot Lights.
★ Tests by the well-established emission method for tube quality, directly read on the scale of the meter. ★ New type line voltage.

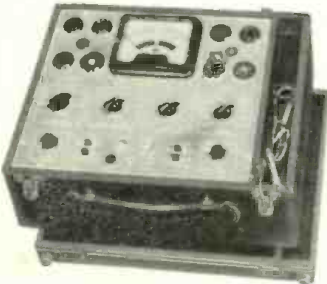

V.O.M. Specifications:

D.C. VOLTS: (at 20,000 Ohms Per Volt), 0 to 7.5/15/75/150/750/1,500 Volts.

A.C. VOLTS: (At 10,000 Ohms Per Volt), 0 to 15/30/150/300/1,500/3,000 Volts.

D.C. CURRENT: 0 to 1.5/15/150 Ma. 0 to 1.5 Amperes.

RESISTANCE: 0 to 5,000/50,000/500,000 Ohms. 0 to 50 Megohms.

Model 777 operates on 90-120 volts 60 cycles A.C. Housed in beautiful hand-rubbed cabinet. Complete with test leads, tubes, charts and detailed operating instructions. Size 13" x 12½" x 6".

\$59⁹⁵
NET

The New Model 770 — An Accurate Pocket-Size

VOLT-OHM MILLIAMMETER



(Sensitivity: 1000 ohms per volt)

Features:

Compact—measures 3¼" x 5¾" x 2¼". Uses latest design 2% accurate 1 Mil. D'Arsonval type meter. Same zero adjustment holds for both resistance ranges. It is not necessary to readjust when switching from one resistance range to another. This is an important time-saving feature never before included in a V.O.M. in this price range. Housed in round-cornered, molded case. Beautiful black etched panel. Depressed letters filled with permanent white, insures long-life even with constant use.

Specifications: 6 A.C. VOLTAGE RANGES:

0-15/30/150/300/1500/3000 volts.

6 D.C. VOLTAGE RANGES: 0-7½/15/75/150/750/1500 volts.

4 D.C. CURRENT RANGES: 0-1½/15/150 Ma. 0-1½ Amps.

2 RESISTANCE RANGES: 0-500 Ohms. 0-1 Megohm.

The Model 770 comes complete with self-contained batteries, test leads and all operating instructions.

\$13⁹⁰
NET

The Model 88 — A COMBINATION

SIGNAL GENERATOR AND SIGNAL TRACER



*Frequency Range: 150 Kilocycles to 50 Megacycles. *The R.F. Signal Frequency is kept completely constant at all output levels. *Modulation is accomplished by Grid-blocking action which is equally effective for alignment of amplitude and frequency modulation as well as for television receivers. *R.F. obtainable separately or modulated by the Audio Frequency.

Signal Tracer Specifications:

*Uses the new Sylvania 1N34 Germanium crystal Diode which combined with a resistance-capacity network provides a frequency range of 300 cycles to 50 Megacycles.

The Model 88 comes complete with all test leads and operating instructions. ONLY

\$28⁸⁵
NET

20% DEPOSIT REQUIRED ON ALL C.O.D. ORDERS

GENERAL ELECTRONIC DISTRIBUTING CO. DEPT. RC-4, 98 PARK PLACE, NEW YORK 7, N. Y.

You Practice COMMUNICATIONS

I Send You Parts To Build This Equipment

As part of my new Communications Course I send you parts to build your own Transmitter. Conduct actual procedure demanded of Broadcast Station Operators, practice many interesting experiments and tests, learn how to put a transmitter on the air.



NEW

You Practice Radio SERVICING

On This Modern Radio You Build With Parts I Send

As part of my Servicing Course, I send you the speaker, tubes, chassis, transformer, loop antenna, EVERYTHING you need to build this modern Radio Receiver that brings in local and distant stations. You use it to conduct many tests and experiments.



BE A RADIO-TELEVISION TECHNICIAN

Learn Servicing or Communications by Practicing in Spare Time with **MANY KITS OF PARTS I Send**

YOU BUILD this Tester as part of my Servicing Course. It soon helps you earn \$5, \$10 and more a week **EXTRA MONEY** fixing neighbors' Radios in spare time while learning.

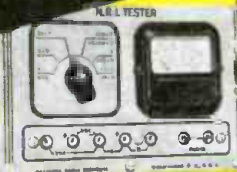

YOU BUILD this Power Pack as part of my new Communications Course. Use it to conduct fascinating experiments with frequency amplifiers and multipliers, buffer stages, etc.



YOU BUILD this Superheterodyne Receiver Circuit and conduct Frequency Modulation experiments and many other tests as part of my Servicing Course.



YOU BUILD this Signal Generator as part of my Servicing Course for more valuable experience. It provides amplitude-modulated signals for many interesting tests and experiments.



VETERANS

GET THIS TRAINING WITHOUT COST UNDER G. I. BILL MAIL COUPON

YOU BUILD this Wavemeter as part of my new Communications Course. Use it with Oscillator you also build that furnishes basic power to transmitter and determines transmitter frequency.



J. E. SMITH, President National Radio Institute

Want a good-pay job in the fast-growing Radio and Television industries or to be boss of your own money-making Radio and Television shop? I've trained hundreds of men with no previous experience to be Radio technicians. I can do the same for you! Or now, for the first time, enroll in my new practical course in Radio—Television Communications—learn to be a Broadcasting and Communications technician. You learn Radio and Television principles from clear, illustrated lessons. You get practical Radio experience with **MANY KITS OF PARTS I SEND** in my train-at-home method. All equipment yours to keep.

MAKE EXTRA MONEY IN SPARE TIME

As part of my Radio Servicing Course, I send **EXTRA MONEY** booklets, starting the day you enroll. Use your know-how to make \$5, \$10 and more a week **EXTRA MONEY** fixing Radios in spare time while training. The next step is your own Radio shop or a good-pay Radio servicing job. Or, if you prefer, get into Government, Police, Aviation or Marine Radio, Broadcasting, Radio Manufacturing or Public Address Work.

BRIGHT FUTURE IN TELEVISION

Think of the present and future opportunities in the fast-growing Television field. New stations are going on the air every month. . . . Television manufacturers are producing over 100,000 sets a month. It's a fast-growing field and the man who knows Television will be in demand.

GET ACTUAL LESSON AND BOOK FREE

Send now for my special **DOUBLE FREE OFFER**. Get actual lesson on Radio Repairing short-cuts absolutely free. Also get 64-page book, "HOW TO BE A SUCCESS IN RADIO—TELEVISION—ELECTRONICS." See how quickly, easily you can start. J. E. SMITH, President, Dept. 9DX, National Radio Institute, Pioneer Home Study Radio School, Washington 9, D. C.

I TRAINED THESE MEN AT HOME



Good Job In Radio Station "Am Chief Engineer of Station WORD, in charge of four men. Owe all I know about Radio to NRI."—**CLYDE J. BURDETTE**, Spartanburg, South Carolina.



Makes Extra Cash In Spare Time "Earned enough spare time cash to pay for my course by time I graduated. NRI training is tops!"—**ALEXANDER KISH**, Carteret, New Jersey.



Operates Own Radio Business "Now have two Radio shops servicing about 200 sets a month. Have largest service establishment in Southeast Missouri."—**ARLEY STUDYVIN**, DeSoto, Mo.

MAIL COUPON! FIND OUT ABOUT THIS TESTED WAY TO BETTER PAY

Good for Both—FREE

MR. J. E. SMITH, President, Dept. 9DX National Radio Institute, Washington 9, D. C.

Mail me **FREE** Sample Lesson and 64-page book about how to win success in Radio and Television—Electronics. (No salesman will call. Please write plainly.)

Name..... Age.....

Address.....

City..... Zone..... State.....

Check if Veteran **APPROVED FOR TRAINING UNDER G. I. BILL**



RADIO — ELECTRONICS

formerly **RADIO-CRAFT**

Incorporating
SHORT WAVE CRAFT* **TELEVISION NEWS***
RADIO & TELEVISION
*Trademark registered U. S. Patent Office

**177,000 COPIES
 OF THIS ISSUE
 DISTRIBUTED**

Hugo Gernsback, Editor-in-Chief
 Fred Shunaman, Managing Editor
 M. Harvey Gernsback, Consulting Editor
 Robert F. Scott, W2PWG, Technical Editor
 R. H. Dorf, W2QMI, Associate Editor
 I. Queen, W2OUX, Editorial Associate
 Angie Pascale, Production Manager
 Elmer Fuller, Shortwave Editor
 Wm. Lyon McLaughlin,
 Tech. Illustration Director
 G. Aliquo, Circulation Manager
 Charles K. Brett,
 National Advertising Director
 John J. Lamson,
 New York Advertising Director
 Alfred Stern, Promotion Manager

Contents _____ **April, 1949**

Editorial (Page 19)
 Television By-Products.....by Hugo Gernsback 19

Radio Science (Pages 20-23)
 Improved Electrets (Cover Feature).....by E. D. Padgett 20

Electronics (Pages 24-30)
 Microwaves, Part I.....by C. W. Palmer 24
 Oscillator Circuits as Used in Industry.....by Ed Bukstein 27
 Diathermy Generator.....by H. L. Bumbough 29

Television (Pages 31-35)
 Cinema Television.....by E. Aisberg 31
 Antennas for Television, Part IV.....by Edward M. Noll and Matt Mandl 32
 Magnetic TV Enlarger.....by Mohammed Ulysses Fips, I.R.E. 34

Broadcasting and Communications (Pages 36-38)
 Telephone Lines in Broadcasting.....by Leigh L. Kimball 36

Audio (Pages 38-42)
 Quality Disc Recorder.....by Richard H. Dorf 38
 Audio Impedance Matching.....by Walther Richter 41
 Useful 10-Watt Amplifier.....by W. D. Hayes, W6MNU 42

Amateur (Pages 43-45)
 Bandswitching Exciter.....by Bob White 43

Servicing (Pages 46-49)
 Fundamentals of Radio Servicing, Part III—What is Induction?....by John T. Frye 46
 Sound Can Make Money for You.....by Guy S. Cornish 48

Theory and Design (Pages 50-51)
 Transmission Lines.....by Robert C. Paine 50

Construction (Pages 52-54)
 A-Battery Eliminator.....by Ryland Hobson 52
 20-Meter Vacation Converter.....by P. F. Egerton, Jr. 54

Test Instruments (Pages 55-56)
 Ohmmeter Reads to 300 Megohms.....by John T. Bailey 55

Foreign News (Pages 68-69)
 European Report.....by Major Ralph W. Hallows 68

FM (Pages 74-84)
 "Back Porch" Booster Brings up FM Signals.....by James C. Drake 74
 FM Station List..... 78

Departments

The Radio Month.....	10	New Patents.....	72
Radio Business.....	16	People.....	85
New Devices.....	58	Technotes.....	87
Radio-Electronic Circuits.....	60	Miscellany.....	89
Question Box.....	66	Communications.....	95
Try This One.....	74	Book Reviews.....	97

ON THE COVER: Miss Mary Jane Padgett checks the charge on an electret. Kodachrome by Avery Slack.

RADIO-ELECTRONICS, April, 1949, Volume XX, No. 7. Published monthly. Publication Office: Erie Ave. E to G Streets, Philadelphia 32, Pa. Entered as second class master September 27, 1938, at the post office at Philadelphia, Pa., under the Act of March 3, 1879. **SUBSCRIPTION RATES:** In U. S. and Canada, in U. S. possessions, Mexico, South and Central American countries, \$3.50; \$6.00 for two years; \$8.00 for three years; single copies 30c. All other foreign countries \$4.50 a year, \$8.00 for two years, \$11.00 for three years. Allow one month for change of address. When ordering a change please furnish an address stencil impression from a recent wrapper. **RADIO-CRAFT PUBLICATIONS, INC.** Hugo Gernsback, Pres.; M. Harvey Gernsback, Vice-Pres.; G. Aliquo, Sec'y. Contents Copyright, 1949, by Radio-Craft Publications, Inc. Text and illustrations must not be reproduced without permission of copyright owners. **EDITORIAL AND ADVERTISING OFFICES**, 25 West Broadway, New York 7, N. Y. Tel. REctor 2-9690. **BRANCH ADVERTISING OFFICES:** Chicago: 308 W. Washington Street. Telephone 11Andolph 6-7363. Detroit: Frank Holstein, Room 402, Lexington Bldg., 2970 West Grand Blvd. Telephone TRinity 5-7026. Los Angeles: Ralph W. Harker, 806 South Hill St. Tel. Tucker 1793. San Francisco: Ralph W. Harker, 582 Market St. Tel. Garfield 1-2481. **FOREIGN AGENTS:** Great Britain: Atlas Publishing and Distributing Co., Ltd., 18 Bride Lane, Fleet St., London E.C.4. Australia: McGill's Agency, 179 Elizabeth Street, Melbourne. France: Brentano's, 37 Avenue de l'Opera, Paris 2e. Holland: Trilectron, Heemsteedsche, Dreef 124 Heemstede. Greece: International Book & News Agency, 17 Amerikis Street, Athens. So. Africa: Central News Agency, Ltd., Cor. Bissik & Commissioner Sts., Johannesburg; 112 Lear Street, Capetown; 389 Smith Street, Durban. Natal: Universal Book Agency, 70 Harrison Street, Johannesburg. Middle East: Sziematzky Middle East Agency, Jaffa Road, Jerusalem. India: Suali Gupta (Distributors) Co., Armita Bazar Patrika Lt., 14 Ananda Chatterjee lane, Calcutta. Broadway News Centre, Post Bag #5557, Dadar, Bombay #14. K. L. Kannappa Mudaliar, 30 General Patters Road, Mount Road, Madras 2. Pakistan: Paradise Book Stall, Opp. Regal Cinema, Preedy St., Karachi 3.

Editorial and Executive Offices:
 25 West Broadway, New York 7, N. Y.



MEMBER AUDIT BUREAU OF CIRCULATION

An Efficient Low-Cost Replacement Speaker



TRU-SONIC Model P-52FR Co-Spiral Speaker

Subdues deficiencies both in set itself and in source material. Built with the same precision limits and same engineering skill found in all Tru-Sonic units. Full 15 watts of power handling capacity. 15" seamless molded curvilinear cone of new design. Two acoustic sections, one designed for reproducing lowest bass, and one section for extended high tones. Reproducing range is 40 to 14,000 cycles! (flat ± 5 db 70-7000 cps). Powerful Alnico 5 Magnet. Greatest electro-acoustic transfer efficiency and widest range of any speaker utilizing 1 voice coil. 90 Degrees of high frequency dispersion. List Price \$80.00 (Normal trade discounts)



TRU-SONIC Model P-52A Coaxial Speaker

Combined in a single assembly are a Low-Frequency unit of the cone type, a High-Frequency unit of the multicellular type and the Dividing-Network. Ideal for AM and FM reception, broadcast station monitoring, and sound-motion-picture reproduction. List Price \$205.00 (Normal trade discounts.)

Write for Circular 252 illustrating and describing the complete Tru-Sonic line of Speaker Systems for Theaters and Homes.

STEPHENS

MFG. CORP.

8538 Warner Drive
 Culver City Calif.

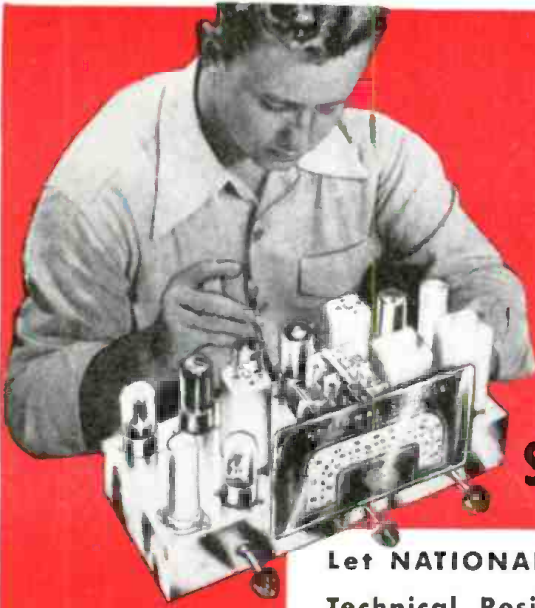

Learn RADIO

TELEVISION, ELECTRONICS

by SHOP METHOD HOME TRAINING

Let NATIONAL SCHOOLS, of Los Angeles, a practical Technical Resident Trade School for almost 50 years, train you for today's unlimited opportunities in Radio

You receive all parts, including tubes, for building this fine, modern Superheterodyne Receiver. This and other valuable standard equipment becomes your property.

these two FREE books will tell you how

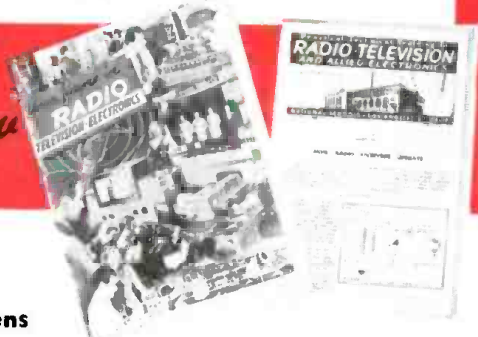

Good Jobs Await the Trained Radio Technician

You are needed in the great, modern Radio, Television and Electronics industry! Trained Radio technicians are in constant and growing demand at excellent pay—in Broadcasting, Communications, Television, Radar, Research Laboratories, Home Radio Service, etc. National Schools Master Shop Method Home Study course, with newly added lessons and equipment, can train you in your spare time, right in your own home, for these exciting opportunities. Our method has been proved by the remarkable success of National Schools-trained men all over the world.

You Learn by Building Equipment with Standard Radio Parts We Send You

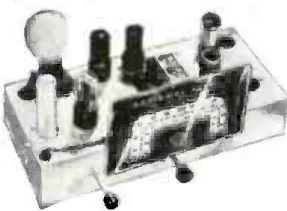

Your National Schools Course includes not only basic theory, but practical training as well—you learn by doing. We send you complete standard equipment of professional quality for building various experimental and test units. You advance step by step until you are able to build the modern superheterodyne receiver shown above, which is yours to keep and enjoy. You perform more than 100 experiments—build many types of circuits, signal generator, low power radio transmitter, audio oscillator, and other units. The Free Books shown above tell you more about it—send for them today!

Lessons and Instruction Material Are Up-to-date, Practical, Interesting

National Schools Master Shop Method Home Training gives you basic and advanced instruction in all phases of Radio, Television and Electronics. Each lesson is made easy to understand by numerous illustrations and diagrams. All instruction material has been developed and tested in our own shops and laboratories, under the supervision of our own engineers and instructors. A free sample lesson is yours upon request—use the coupon below.

You Get This and Other Valuable Information in the Free Sample Lesson:

1. Basic Receiver Circuits and How They are Used.
2. Construction of the Antenna Circuit.
3. How Energy is Picked Up by the Aerial.
4. How Signal Currents are Converted into Sound.
5. How the Tuning Condenser Operates.
6. How the R-F Transformer Handles the Signal, and other data, with diagrams and illustrations.

Both Home Study and Resident Training Offered

APPROVED FOR VETERANS

Check Coupon Below

Now! NEW PROFESSIONAL MULTITESTER INCLUDED:



This versatile testing instrument is portable and complete with test leads. Simple to operate, accurate and dependable. You will be able to quickly locate trouble and adjust the most delicate circuits. You can use the Multitester at home or on service calls. It is designed to measure AC and DC volts, current, resistance and decibels. You will be proud to own and use this valuable professional instrument.

GET THE DETAILS—SEND THE COUPON →

NATIONAL SCHOOLS

LOS ANGELES 37, CALIFORNIA EST. 1903



MAIL OPPORTUNITY COUPON FOR QUICK ACTION

NATIONAL SCHOOL, Dept. 4-RER
4000 S. Figueroa, Los Angeles 37, Calif. Paste on a postcard

Mail me FREE the book "Your Future in Radio" including a sample lesson of your choice. I understand no salesman will call on me.

NAME AGE

ADDRESS

CITY Zone STATE

Check here if Veteran of World War II

T.A.C. DOES IT *First* AGAIN!

"America's greatest
Television Values
per square inch
of picture!"

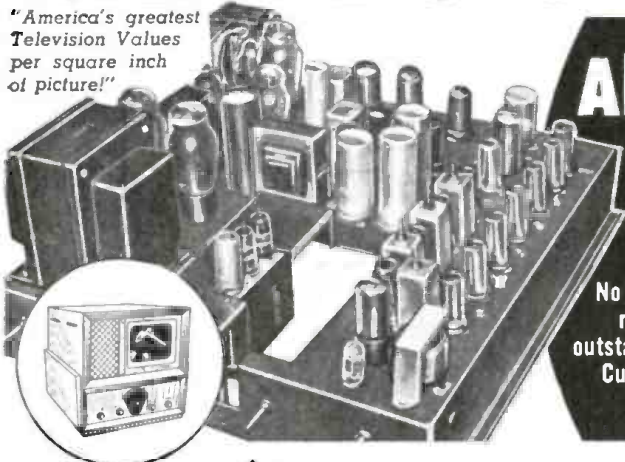

All Major Components Already Mounted on Chassis!

No technical knowledge
required to build this
outstanding, proven T.A.C.
Custom-Built Television
Receiver!

including Pre-wired "VIVIDeo"
I. F. Strip and Pre-wired front end

Now! BUILD THE FINEST PROVEN CUSTOM-BUILT TELEVISION RECEIVER IN MUCH LESS TIME . . . WITH LESS EFFORT . . . FOR LESS MONEY!

EXCLUSIVE T. A. C. "VIVIDeo" FEATURE

Pre-wired, pre-tuned and tubed I.F. sound and video strip (patents pending). An exclusive T.A.C. feature developed by our own research. All in one chassis.

FREE

Complete comprehensive Service Data on the T.A.C. exclusive "VIVIDeo" 13-tube Picture and Sound I.F. Strip (Pat. Pend.). Contains all information needed to thoroughly understand and service this unique high-gain I.F. Strip which features 5½ stages of Cathode-Coupled Grounded-Grid Video I.F. amplification. For high gain, sensitivity, stability, "VIVIDeo" can't be beat! Write for FREE booklet SB-1 or ask your local jobber for it. Booklet SB-1 also included with each T.A.C. Direct-View assembly.

GUARANTEE

All components are of the finest quality and are fully guaranteed under the Standard RMA Guarantee. All TAC Assemblies are guaranteed to operate when assembled according to directions.

MODEL P-520 . . . 520 Sq. In. SCREEN PROJECTION TELEVISION ASSEMBLY

• Bausch & Lomb F; 1.9 Lens • Eastman Kodak Screen • DuMont Inputuner • 37 R.C.A. Tubes • Pre-Wired & Pre-Tuned Picture I.F. & Sound I.F. • Pre-Wired 30 K.V. Tripler Fly Back Power Supply • Automatic Gain Control • Aluminum Coated Top Mirror • Metal Rack • Specially Designed Hood and Picture Frame Supplied • 5TP4 Projection Tube • 12" R.C.A. High Fidelity Speaker • Two Low Voltage Power Supplies.

MODEL P-520
Dealer's net **\$769.50***

MODEL P-520W
Dealer's net **\$895.00***

The above unit completely wired and ready to install.

Front and rear panels optional at additional cost.

Complete Instruction and Service Manual compiled by John F. Rider Laboratories in collaboration with T.A.C. engineers, included with each P-520. This manual also separately available at \$2.50 each, dealer's net. Ask your local jobber for it.

NEW! SUPER-SIMPLIFIED INSTRUCTIONS! AND COMPLETE SERVICE DATA

NEW LOW PRICES

The most explicit, easiest-to-follow, most elaborately detailed instructions in television—that even a layman can follow. ONLY 13 TUBES REMAIN TO BE WIRED! ABSOLUTELY NOTHING TO MOUNT!

T.A.C. STANDARD MODELS

29 RCA tubes, plus RCA or DuMont C. R. Tube. Pre-wired "VIVIDeo" 13-tube Picture and Sound I.F. Strip with 5½ stages of Picture Amplification. Pre-wired All-Channel Front End with Fine Tuning. RCA 5x7 Oval Heavy Duty PM Speaker. Delivered complete, with ALL MAJOR COMPONENTS MOUNTED, PLUS New Comprehensive SUPER-SIMPLIFIED DATA for Wiring and Servicing.

Model M101S—Complete (less C.R. Tube) **\$169.50** Dealer's Net*

Model F101S—Complete with 10" RCA C.R. Tube **203.50** Dealer's Net*

Model F121S—Complete with 12" DuMont C.R. Tube **231.25** Dealer's Net*

Model F151S—Complete with 15" Dumont C.R. Tube **314.50** Dealer's Net*

T.A.C. CHAMPION MODELS

Identical extra-value features as above except Standard Tuner replaced by DuMont Inputuner for Continuous Tuning of ALL FM RADIO AND TV CHANNELS.

Model M101C—Complete (less C.R. Tube) **\$209.50** Dealer's Net*

Model F101C—Complete with 10" RCA C.R. Tube **243.75** Dealer's Net*

Model F121C—Complete with 12" DuMont C.R. Tube **271.40** Dealer's Net*

Model F151C—Complete with 15" DuMont C.R. Tube **357.35** Dealer's Net*

Model F201C—Complete with 20" DuMont C.R. Tube **566.75** Dealer's Net*

ALL T.A.C. 15" and 20" Assemblies contain 30 RCA tubes, plus DuMont C.R. tube, RCA 12" Heavy Duty PM Speaker, and all features mentioned above PLUS Pre-wired 34KV High Voltage Doubler Power Supply.

Model F201C—Complete with 20" DuMont C.R. Tube **566.75** Dealer's Net*

CABINETS AND STANDS IN BLOND AND WALNUT AVAILABLE AT REASONABLE PRICES. WRITE FOR LITERATURE.

TELEVISION ASSEMBLY CO.

Subsidiary of
Snaider Television Corp.

● Write for Catalog on our Complete Line of TV Replacement Components!

* PRICES 5% HIGHER WEST OF THE MISSISSIPPI
Prices subject to change without notice.

540 BUSHWICK AVE.
BROOKLYN 6, N. Y.

Distributed through NATIONAL PARTS DISTRIBUTORS
Write for the source nearest to you

RADIO-ELECTRONICS for

Don't miss the chance of a lifetime!

TELEVISION

Radio - Electronics ..

OFFER YOU A PROFITABLE FUTURE!

Get the Facts About Our

GREATEST OFFER in 17 YEARS

Here's good news . . . big news . . . our BIGGEST NEWS in 17 years. The equipment pictured at the right gives a partial idea of D.T.I.'s remarkable new combination of shop-method, home-training aids.

Now you can use and keep ALL of this equipment — PLUS other major training aids — to prepare you at home for a grand future in the fast-moving field of TELEVISION . . . RADIO . . . ELECTRONICS.

SEND FOR FREE BOOKLET

Mail the coupon today for our big, new 48-page OPPORTUNITY GUIDE BOOK. See how D.T.I.'s amazing, newer, training method helps you get started toward a GOOD JOB or your OWN BUSINESS in one of America's most promising, thrilling fields . . . that includes Television . . . F.M., Train, 2-Way Taxi, Aviation, and Broadcast Radio . . . Industrial Electronics . . . and other fast-developing branches.

In addition to well-illustrated lessons, you receive 16 shipments of Radio-Electronic parts from which you work over 300 instructive projects — including the building of (1) a commercial-type CATHODE RAY OSCILLOSCOPE that helps you get practical Television circuit training, (2) a double-range R-F SIGNAL GENERATOR, (3) a jewel-bearing MULTI-METER and (4) a quality 6-tube SUPERHET RADIO. You keep all of this equipment.

You also use HOME MOVIES

. . . a D. T. I. Exclusive!

D.T.I. alone includes the use of modern, visual training aid . . . MOVIES . . . to help you learn faster, easier at home. You see electrons on the march and other fascinating "hidden action" — a remarkable home training advantage that speeds your progress.



DeFOREST'S TRAINING, INC.

CHICAGO, ILLINOIS

Affiliated with the De Vry Corporation
Builders of Electronic and Movie Equipment



OSCILLOSCOPE

MULTI-METER

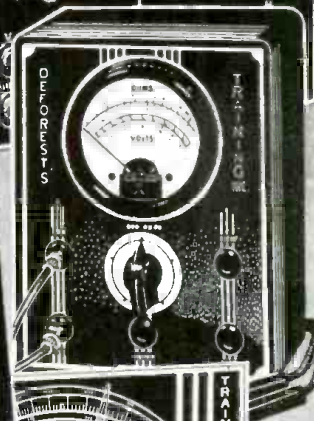

YOU BUILD and KEEP THIS EQUIPMENT
Work over 300 Home Experiments

EMPLOYMENT SERVICE

When you complete your training, our effective Employment Service is available to you without extra cost, to help you get started.

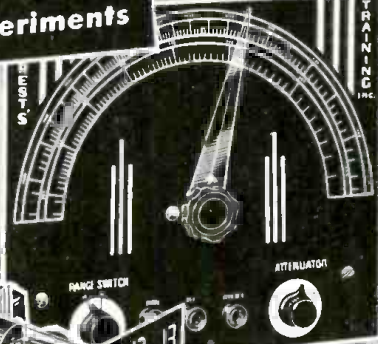

R-F SIGNAL GENERATOR



6-TUBE RECEIVER

You May Choose to Train in Our MODERN CHICAGO LABORATORIES Train quickly, using a wide variety of commercial equipment. D. T. I.'s new labs are among the finest of their kind. Ample instructors . . . every major training advantage. Write for details!

MAIL THIS OPPORTUNITY COUPON NOW!

DeForest's Training, Inc.
2533 N. Ashland Ave., Dept. RC-F4
Chicago 14, Illinois

Send me FREE your 48-page OPPORTUNITY GUIDE BOOK showing how I may make my start in Television — Radio — Electronics.

Name _____ Age _____

Street _____ Apt. _____

City _____ Zone _____ State _____



REG. \$27.50 LIST
12 INCH COAXIAL ONLY \$10.95
 P.M. SPEAKER
 ★ BRAND NEW ★ FACTORY CARTONED ★ BUILT IN MATCHING NETWORK

Designed by one of America's finest speaker builders. Made for FM high fidelity radios, record players and P.A. systems. This speaker is incorporated in radios selling in the \$500.00 bracket. It has an especially designed 12" x 6 1/2" Alnico V Magnet PM for the low range and a coaxially built-in 3" Alnico V tweeter. The high pass filter is concealed under the pot cover. Just hook to your 8 ohm output transformer (will hook in place of any home radio speaker, as most speakers have an 8 ohm voice coil). Only 2 wires to connect will handle 18 watts peak. Frequency response, 50 to 15,000 CPS. This coaxial PM speaker should sell for \$35.00. Why buy an ordinary speaker, when we offer you the speaker of the future, for only \$10.95?

Stock No. CN-12X—Weight 8 lbs. \$10.95. 2 for \$20.95.
DELUXE MODEL 12 INCH COAXIAL P.M. SPEAKER \$12.95
 12" coaxial No. CR-13X. The same basic design as the model CN-12X, described above, but furnished with 6.8 ohm magnet in the 12" woofer. Frequency response, 40 to 15,000 CPS. Has more melow tone than CN-12X. Weight 9 lbs.
 Model CR-13X \$12.95. 2 for \$24.95.

15 INCH REGULAR COAXIAL P.M. SPEAKER \$24.95
 REGULAR \$60.00 LIST

★ CURVED MOLDED CONE ★ 21.5 OZ. MAGNET ★ OUR FINEST SPEAKER

The KING COAX. A 21.5 oz. 15 inch Alnico V PM speaker with a built-in high frequency tweeter. Will respond to from 50 to 12,000 cycles. This is a ruggedly built speaker with a curvilinear one piece molded cone. Built-in high pass filter. Just hook to any 8 ohm output transformer. Built by the maker of our popular 12 inch coax model 4-12X. Weight 22 lbs. This speaker has a retail list of over \$60.00. We offer you our 5-15x15-inch coax for only \$24.95.

"JUKE BOX" 15 INCH P.M. SPEAKER \$9.95
 REGULAR \$35.00 LIST
 HAS NEW MOLDED CONE

A carload purchase, from a number one builder of fine FM speakers, enables us to offer this regular \$35.00 list 15" speaker for only \$9.95. New one piece molded cone, with 8 ohm voice coil, 12 oz. Alnico V magnet, will take 18 watts average audio and 25 watts peak. If you want a speaker to put out 18 low notes, buy this model. This is without a doubt the most speaker for the money that is available today. Include postage for 11 lbs. Stock No. 15-KR. Net price \$9.95.

KINGJUKE 50-WATT 15 INCH P.M. SPEAKER SCOOP PRICE \$16.95
 Model 15-L. The KING of all juke box speakers. Frequency response as low as 30 cycles. Will take 50 watts peak audio and 35 watts average, with ease. The most efficiently designed built today. 5 watts input to this speaker will give twice the air movement of an ordinary speaker. Has 1 1/2" 8 ohm voice coil and molded one piece cone. Designed to retail for \$50.00. Include postage for 18 lbs. Stock No. 15-LB. Net price \$16.95. 2 for \$32.95.

50 WATT 12 INCH P.M. SPEAKER SCOOP PRICE \$14.95
 Model A-50-12". 50 watt super heavy duty permanent magnet speaker. Has 1 1/2" 8 ohm treated voice coil and one piece molded cone. Heavy half inch machined pot, with bolt secured 21 oz. Alnico V magnet. Frame is of heavy construction with metal pot cover. Finished in silver-grey enamel. This speaker is the best value possible today. Efficiency is two to three times that of ordinary speakers. Especially recommended for all public address systems and high quality home audio. Will handle 35 watts with ease and 50 watts peak for short lengths of time. Its retail value is \$50.00. But, by our large purchase, we are able to offer it to you for only \$14.95. Do not confuse this speaker with surplus merchandise. This is the latest production. Model A-50. Weight 15 lbs. Net \$14.95. 2 for \$29.00.

100 MINIATURE CARTONED TUBES \$29.95

MALLORY CONDENSER SALE EVERY CENT. GUARANTEED 1 YEAR

ALUMINUM CAN SCREW MFG. SAVE HALF

Save half on these genuine Mallory Aluminum can upright screw mounting. Fresh stock, one year guarantee.

RS213 8 mfd. 450V. 1"x2 3/4"49c
 RS215 12 mfd. 450V. 1"x2 3/4"34c
 RS223 30 mfd. 450V. 1 1/2"x3 1/2"59c
 RS202 8x8 mfd. 450V. 1 1/2"x3 3/4"59c

MALLORY EVERYDAY REPLACEMENTS

Mallory ST. 2N, 3N, 4S. Cardboard tubes with metal tabs for vertically or under chassis mounting. Fresh stock, one year guarantee.

ST595 8 mfd. 450V. 3/4"x2 1/4"29c
 ST597 15 mfd. 450V. 1"x2 3/4"39c
 ST598 20 mfd. 450V. 1"x2 3/4"44c
 ST599 30 mfd. 450V. 1"x2 3/4"49c
 2N509 20x20 mfd. 250V. 1 1/2"x2 1/2"29c
 2N518 8x8 mfd. 450V. 1"x2 3/4"49c
 2S356 30x30 mfd. 150V. 1 1/2"x2 1/2"44c
 3N533 30x30 mfd. 150V. 20x25V. . . .54c
 3S579 8x8 mfd. 450V. 20x25V. . . .44c
 1 1/2"x2 3/4"54c
 3S584 8x8 mfd. 450V. 1 1/2"x2 3/4"59c
 4S718 8x8 mfd. 450V. 10x10 25V. . . .59c
 1 1/2"x2 3/4"59c

Mallory TCS Aluminum tubes with paper insulating tubes, separate sections with lugs. Buy a good supply of these at over half off. Fresh stock, one year guarantee.

TCS43 20x20 mfd. 150V. 1"x2 3/4"34c
 TCS47 30x30 mfd. 150V. 1"x2 3/4"44c
 TCS48 40x40 mfd. 150V. 1"x2 3/4"49c
 TCS52 20x20 mfd. 250V. 1 1/2"x2 1/2"29c
 TCS55 20x20 mfd. 250V. 1 1/2"x2 1/2"34c
 TCS71 8x8 mfd. 450V. 1"x2 3/4"49c
 TCS74 18x15 mfd. 450V. 1"x2 3/4"59c
 TCS75 20x20 mfd. 450V. 1 1/2"x2 1/2"65c
 Mallory TCD dual with common neg. and 2" lead.

TCD55 20x20 mfd. 250V. 1"x2"34c
 TCD52 10x10 mfd. 250V. 1"x2"29c
 TCD53 20x20 mfd. 250V. 1 1/2"x2 1/2"34c

ORDER 100 ASSORTED OF THE ABOVE MALLORY ELECTROLYTICS AND TAKE 10% DISCOUNT

MALLORY BY-PASSES DON'T PASS UP THESE GENUINE MALLORY BY-PASSES. PRICES UNEQUALLED

600 Volt type TP—Wax filled.
 .004 .006 .008 .02 .04 .06 Ck Each.
 100 for \$6.95.
 Mallory—1600 Volt. Fresh stock. .002 .02 .04 .05, 15c Each, 10 for \$12.95.

250,000 Tubes for fast sale. Tremendous Value. Tubes up to \$3.00 list. 100 Cartoned and branded Hyvac Miniature Tubes for \$29.95. Over a million sold. Guaranteed full replacement. 34c Each in smaller quantities.

1R5	12BA6	12AX7	6AU6	6BF6
174	12BE6	9Y7	6BJ6	6AU7
1U5	35W4	12AU6	6BA6	6AJ5
3A4	50B5	12BF6	6BE6	6E5U
155	35Z5	117Z3	6AT6	
3V4	12AT7	6AQ5	6C4	
3Q4	12AU7	6BM6	6AL5	
354	12BA7	6X4	6AQ5	

Popular GT Tubes, individually cartonned and priced at 95c. \$35.00 per hundred. 39c Each in smaller quantities.

0V5	6X5	6SK7	125F7	125N7
6SN7	6SD7	6SQ7	6F5	12BF7
6CS	5Y3	25L6	6J5	65L7
6P5	6K7	70L7	65J7	35Z5
12A6	5Y3	184	125J7	
658	6K6	12K8	65F5	
1258	65A7	12A6	80	

T.V. SALVAGE \$2.95

Buy this slight unseem. Television Salvage Chassis Scoop. Over 150 Resister molded. Plastic, and ceramic Condensers. No Coils. 17 Tube Octal sockets. 2 F.P. Condensers. Chassis pan. Partially built up. Offered to tear up for the parts. Stock #17FX. Net \$2.95. Weight 14 lbs.

AUTOMATIC CHANGERS \$12.95

VM-800 Automatic Record Changer. Plays 10-12 inch or 12-10 inch record automatically. Base Size 13 1/2"x14. Light weight crystal pickup. A red hot scoop in a changer. Net \$12.95. Two for \$24.95. Model 246. Stewart Warner with Permanent Needle. Size 12x3 Scoop price \$12.95. 2 for \$25.00. Weight 8 lbs. Net \$24.95. Size 12x13 1/2". Net \$29.25.

COMPLETE INTERCOM \$11.95

McGee Intercom. Master and sub-station, housed in small match-size wall nut plastic front, 5 1/2 x 7 x 3 1/2 inches. Sliding front for desk or wall installations. Furnished with 50 feet of interconnecting wire. Sub-station may be used up to 1000 feet from master station. These units are new and factory cartonned. Complete with tubes. Made to retail at \$29.95. A lucky purchase enables us to offer these to you; for only \$11.95. Include postage for 8 lbs. Stock No. MC-25.

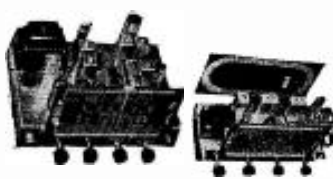

11-TUBE FM/AM MODEL S-56 . . . \$59.50
8-TUBE FM/AM MODEL S-56 . . . \$39.95

Model S-56 Hallcrafters, high fidelity, 11 tube AM-FM Radio receiver chassis for custom installations. Receives standard broadcast 540 to 1700 KC and 88 to 108 MC. Automatic frequency control on FM, holds the receiver in perfect tune. Phone connection on rear chassis. 5-tube range tone control with usse boost. Push-pull 6K6 tubes in audio system. Frequency response essentially flat, from 50 to 14,000 CPS. Wide vision accurately calibrated slide rule dial, with pre-selection on broadcast band. Output transformer matches home radio that we know of today. Better get your order in early. Designed to be used in commercial radios selling in the \$400.00 to \$500.00 class. The regular dealers net on this chassis is \$110.00. However, a lucky purchase enables us to offer these brand new, factory cartonned S-56 Hallcrafters Chassis, complete with tubes and operation instructions, at only \$59.50, less speaker. Speaker matching Transformer 500 OHM to voice coil \$2.50 extra. Weight 25 lbs. Buy your S-56 with a coaxial PM speaker. Check your combination from the prices listed below.

S-56 Hallcrafters AM-FM chassis, with push-pull 6K6 audio system. Output transformer, High fidelity 12" coaxial PM speaker: Model CR-13X. All for only \$71.95.

S-56 Hallcrafters AM-FM chassis, with tube 500 ohm to line matching transformer and our 12", 12 oz. Alnico V PM speaker, equipped with University Lab, high frequency adapter. This combination gives augmented and an extended high frequency response. All for only \$83.50.

Model S-59 Hallcrafters, high fidelity, 8 tube FM-AM radio chassis, for custom installations. Receives broadcast 540 to 1700 kc and FM, 88 to 108 mc. Accurately calibrated slide rule dial. Variable tone control. Frequency response 50 to 14,000 CPS. Output matches 500 ohm line. A terrific value at only \$39.95. Priced complete with tubes, but less speaker. Brand new factory cartonned. Weight 16 lbs. Net \$39.95. Line to voice coil matching transformer \$2.50, extra. Price complete, S-59, line transformer, our CN-12X, 12" coaxial PM speaker; all for the Scoop Price of \$49.95.

BUY COMPLETE FACTORY ENGINEERED KITS AT McGEE

DELUXE 5-TUBE AC-DC KIT OUR LEADER \$9.95

Made from Detroit Components. A full size 5-tube radio kit housed in a 13-inch wood cabinet with full plastic front. Lighted slide rule dial. Incorporates 12AT7, 6X4, 6AV6, 6AR5, 6AL5, 6AU6 antenna, ready punched chassis, etc. This is another one of our line production radio kits. Part 2 is furnished including tubes: 12BA6, 12BE6, 12AT6, 50B5 and 35W4. Diagrams, photos and instructions are included. 55 dynamic speaker. Output transformer broadcast 550 to 1650 kc. Weight 9 lbs. Kit Model TP-6C. Net \$9.95.

Portable Player KH Scoop \$9.95

Deluxe portable electronic record player kit in deluxe control case. Includes all parts and easy to wire diagrams. Comes complete with 8" leatherette portable carrying case self-starting phonograph pickup, 5" PM speaker, 10" VPI transformer to build 70L7 amplifier. Stock No. CK-1. Net price \$9.95. Weight 14 lbs.

12-WATT AMP. KIT, \$10.95

KIT MODEL AC-12. 12 watt amplifier kit. Ideal for high quality record player as well as public address or recording amplifier. Matched component. Ready punched chassis. One control fader for phono to microphone. Gain enough for crystal or dynamic microphone. 100 mil power transformer for 60 cycle operation. Priced complete with tubes: 2-6V6, 6SN7, 6BH7 and rectifier. Diagrams and Photos furnished. Kit Model AC-12. Net \$19.95. 12" Alnico 5 PM speaker \$6.95 extra; crystal microphone and desk stand \$4.95 extra.

The above AC-12 amplifier wired and tested ready to operate. Net \$14.95. Specify Stock No. AC-1125. 12-inch Alnico V PM speaker \$5.95 extra. Crystal mike and desk stand \$4.95.

1948 MODEL—MIKE-BROADCASTER ONLY \$7.95

WIRED AND TESTED

Broadcasts 800 to 1500 KC from either a Phonograph pick-up or a crystal or dynamic mike. Makes any radio receiver a P.A. system. Great quality. Has fader control from mike to record, simulating a regular broadcast station. This is a power model; Standard L-40, L-26, and 35W4 tubes. Priced with tubes and connecting instructions. Works on 110 volts AC—Crystal or dynamic microphone. Complete with DE-5 truly a de-luxe mike-phonograph oscillator. DE-2X Phonograph Oscillator. Wired and tested. Broadcasts from 800 to 1500 KC from either a phonograph pick-up or a crystal or dynamic mike. Powerful circuit has variable gain control. Priced complete with 2 tubes and connecting instructions. Net \$7.95.

CRYSTAL CARTRIDGES

Astatic MLP-1 cartridge used in Webster Chicago and many original equipment changers, with needles. \$4.49.
 Astatic MLP-2 improvement over the MLP-1. Has quiet type Q-T needle. Scoop price, \$4.99.
 Standard L-40, L-26, cartridges, old standby. Complete with rest clip. Each, \$1.79; 10 for \$15.00.
 Astatic L-70, L-75, cartridges or equal. Each, \$1.79; 10 for \$13.00.
 Astatic L-72-A or equal 3 1/2 volt output. Used in the best record players, etc.. \$1.79; 10 for \$13.00.

HALLCRAFTERS

11-TUBE FM-AM CUSTOM REC. CHASSIS \$110.00 VALUE
McGEE'S SALE PRICE \$59.50

S-56 Hallcrafters AM-FM chassis, with tubes, 500 ohm to line matching transformer and 15" Kink Co-AX PM speaker: Model S-15X. This is an ideal combination for the recreation room, having both heavy base and excellent high frequency response. All for the price of only \$81.95.

FM, folded dipole antenna, with 60 feet of 300 ohm line and equipped with 5 foot mast, \$4.49, extra.

Model S-59 Hallcrafters, high fidelity, 8 tube FM-AM radio chassis, for custom installations. Receives broadcast 540 to 1700 kc and FM, 88 to 108 mc. Accurately calibrated slide rule dial. Variable tone control. Frequency response 50 to 14,000 CPS. Output matches 500 ohm line. A terrific value at only \$39.95. Priced complete with tubes, but less speaker. Brand new factory cartonned. Weight 16 lbs. Net \$39.95. Line to voice coil matching transformer \$2.50, extra. Price complete, S-59, line transformer, our CN-12X, 12" coaxial PM speaker; all for the Scoop Price of \$49.95.

4-TUBE T.R.F. KIT BARGAIN SPECIAL \$6.95

4 tube AC-DC TRF radio kit. Ideal for students and beginners. Every part furnished to build this kit, including tubes, diagram and Photos. Has Alnico V PM speaker and tubes. 12AT7, 12AV6, 50B5, 6AR5. Plastic cabinet with alpine dial. Receives broadcast 550 to 1650 KC. This is the easiest type of radio to build. Kit Model TP-4. Weight 6 lbs. Net \$6.95.

8-TUBE RADIO KIT 2-BAND \$16.95

Kit Model AC-4K6. A complete kit of parts, tubes and ready punched chassis (no cabinet). To build a true 8-Tube AC transformer type radio. We furnish every piece as well as printed diagram and photo. Chassis size 14 1/2"x12 1/2". 6-inch lighted slide rule dial. Receives broadcast and foreign short wave, 45 to 18 MC; 3 gain tuning condenser, pre-selection on both bands. 6V6 output. This kit goes together like a manufactured radio. Parts from parts intended for use by Detroit. Priced complete with tubes. Include postage for 16 lbs. Model AC-4K6. Net \$16.95.

Basic Parts for AC-4K6 described above. If you already have the small parts and tubes for receiver construction we offer you the basic parts only, namely the punched chassis, 12AT7, 12AV6, condenser gang, IF coils, Osc. and RF coils, band sweep, diagram and photo. This is without a doubt the best value in the U.S. today. Include postage for 9 lbs. Model DRK-8. Net \$6.95.

Kit ABK-7. A complete kit on same chassis as AC-4K6, but in an 8 Tube AC-DC circuit with push-pull 2515 tubes. Output power spec. same as AC-4K6. Include postage for 14 lbs. Net \$16.95.

THEATRE QUALITY AMPLIFIER KIT \$75.00 Value ONLY \$24.95



Complete 15 watt true-fidelity audio amplifier kit. Response essentially flat from 20 to 17,000 cycles. Inputs for crystal mike and any phono pick up, crystal, magnetic or electric variable reluctance 3 tone controls and fader control. Merit high fidelity wax impregnated output, matches 16, 18, 250 and 500 ohm line. Complete with 7 miniature tubes. (PF 6AQ5 in output.) Diagram, photo and assembly instructions furnished. Kit Model ME 15R net \$24.95. Lab. wired and tested \$34.95. Speakers recommended. Altec 15-inch model 603B. Net \$62.00. Our 15-inch King coaxial regular \$62.50 list net \$24.95. Our 12-inch coaxial Model CR-13X \$12.95.

6-VOLT POWER SUPPLY SCOOP \$2.95

1 1/2 Volt—60 Volt Vibrator Power Supply. Makes 1 1/2 Volt portable radios works on 6 volt storage battery. Has 4 Prono 600 ma 600 mA plug. Worth \$10.00. Sale price \$2.95. Stock No. X-VT. Weight 6 lbs. Seldon—10" Watt Soldering Iron. Net \$2.00. Our 15-inch King coaxial regular \$62.50 list net \$24.95. Our 12-inch coaxial Model CR-13X \$12.95. Sale Price \$1.95.



Increase Your Technical Skill and Your Income with CREI Spare-Time Training at home . . .

IF YOU'RE satisfied with your present job—and so wrapped up in its routine that you don't look beyond today—then CREI can't help you. But if you're an *ambitious* radio technician who realizes that better jobs go to men with technical education, then *CREI has an educational program for you.* Whether your interest and activity are in broadcasting, television, servicing, manufacturing or any other branch of electronics, you can "go all the way" with CREI.

Add CREI technical education to your present radio experience, and you can become worthy of a better job with bigger pay checks. You can't ignore your need for more technical education, because the radio-electronics industry is moving ahead so fast, that more technical knowledge is necessary if you want a better position—and larger pay checks. You need to fortify yourself with additional study if you are to meet the challenge of expanding fields—and the job competition created by wartime advancements.

If you have had professional or amateur radio experience and want to make more money, let us prove to you we have the training you need to qualify for a better radio job. To help us answer intelligently your inquiry—*please state briefly your background of experience, education and present position.*



Capitol Radio Engineering Institute

An Accredited Technical Institute

Dept. 144A 16th and Park Road, N. W., Washington 10, D. C.

Branch Offices: New York (7) 170 Broadway • San Francisco (2) 760 Market St.

APRIL, 1949

Here's what Student Roeschke says of CREI: "This course of study has been very beneficial to me, not only because it has added a lot to my technical knowledge alone, but has enabled me to obtain several increases in income during the past two years."

CREI places at your service its 22 years of background in home study and residence radio-electronic instruction. It is an Accredited Technical Institute that takes you through introductory, basic principles to advanced work, and on to specialized fields of radio-electronics *as your capabilities permit.*

Send for, and read, the new CREI catalog and course outline. It explains the sound up-grading program, the thoroughly proven courses, and what CREI can do for you. It gives you a good idea of how practical and easy-to-understand CREI courses are, and shows you why so many thousands have benefited by CREI enrollment since 1927.

VETERANS! CREI TRAINING AVAILABLE UNDER G. I. BILL

MAIL COUPON FOR FREE BOOKLET

CAPITOL RADIO ENGINEERING INSTITUTE
16th & Park Road, N. W., Dept. 144A, Washington 10, D. C.

Gentlemen: Please send your free booklet, "Your Future in the New World of Electronics," together with full details of your home-study training. I am attaching a brief resume of my experience, education and present position.

Check field of greatest interest:

- PRACTICAL RADIO-ELECTRONICS
- PRACTICAL TELEVISION
- BROADCASTING
- AERONAUTICAL RADIO ENGINEERING
- RECEIVER SERVICING

NAME _____

STREET _____

CITY _____ ZONE _____ STATE _____

I AM ENTITLED TO TRAINING UNDER G. I. BILL.

TRANSVISION

"Flip-Up" TV ANTENNA

... the revolutionary **PRE-ASSEMBLED, PRE-WIRED TV ANTENNA** that gives Superior Performance on ALL CHANNELS —yet **COSTS YOU ONLY 1/2** the price of equivalent antennas!

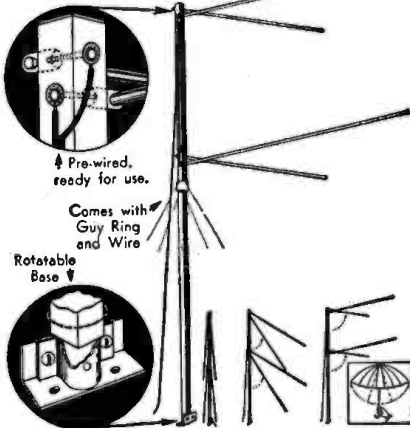

- **PRE-ASSEMBLED**, ready for use. Just "Flip-up" (like an umbrella) and install.
- **PRE-WIRED** —just connect your lead-in to the two terminals.
- **RECEIVES ALL CHANNELS**
- **ALL-DIRECTIONAL**; can be oriented for the weakest station in an area with assurance that all other channels will be brought in equally well.
- **EXTREMELY SENSITIVE.** Unusual high gain on upper channels. Ideal for fringe areas.
- **PRICE: \$6⁹⁵ NET**

Completely assembled with rotatable base, 7-ft. mast, guy ring and guy wire.
Additional 7-ft. masts, to build antenna up to 19 ft., at small extra cost.

ADDITIONAL Superior Features of the "Flip-Up" Antenna:—

- Upper and lower bands completely wired. Eliminates need for two separate antenna installations for the high and low TV bands; therefore, no coupling losses.

RUGGED CONSTRUCTION: Most of the antenna has been designed of non-conducting material which prevents possible grounding and reduction of signal strength. It has unusually high mechanical strength and is extremely rigid when installed.

- Guy ring and guy wires provided for added rigidity.
- Additional 7-ft. extension masts can be furnished to increase height to total of 19 ft.

—and REMEMBER, "Flip-Up" COSTS ABOUT 1/2 the price of equivalent antennas!

All prices fair traded . . . All prices 5% higher west of the Mississippi River.

See your local Transvision Outlet, or for further information write to:

TRANSVISION, INC. DEPT. RC
NEW ROCHELLE, N. Y.

Other Transvision News on Page 61

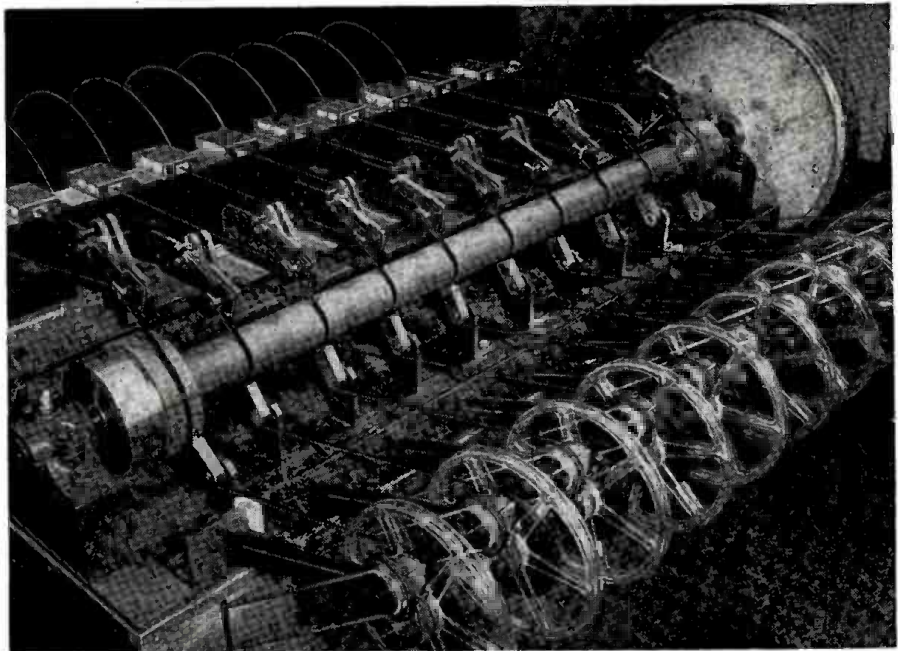

New multiple recorder may make music and entertainment available on tape as it is on discs.

TAPE RECORDINGS are duplicated by a new multiple recorder paralleling the disc-pressing process, developed by The Minnesota Mining and Manufacturing Company, makers of Scotch recording tape. The firm announced last month that the machine would reproduce 48 hours of recorded material on tape in one hour. The master tape is played through a playback head and the impulses are fed to recording heads through which tapes are running to several other reels simultaneously. All tapes are driven by a common capstan to maintain perfect speed accuracy. Either single-track (ordinary) or double-track tapes can be duplicated. The latter (see story on Magnetape Twin-Trax, October 1948 issue, page 42) run in one direction using half the tape width, then in the other using the remaining portion of the tape. Forty-eight of these running at 3 3/4 inches per second can be turned out in an hour, each containing an hour-long program. At 7 1/2 inches per second, 32 can be duplicated in an hour, each with an hour's program material.

ANNUAL AWARD to "the organization or individual who has done the most for the radio service technician during the year" was made to the Philco Corporation by the Federation of Radio Servicemen's Associations of Pennsyl-

vania at a special meeting held for the purpose February 14. The presentation was made at a luncheon held at the William Penn Hotel in Harrisburg, to James M. Skinner, Jr., Philco's vice-president in charge of service and parts, by Leonard Helk, president of the Lackawanna Radio Technicians Association.

The award was made in recognition of the work done by Philco in establishing training courses in television repair and maintenance. The meeting was addressed by Mr. Skinner and by Dave Krantz, chairman of FRSA, and briefly by delegates from neighboring states, editors of the radio press, and representatives of Philco. More than 40 persons, some from points as far distant as New York City and Indianapolis, attended the presentation ceremony.

TOWN MEETING of Radio Technicians, the fifth and last in the current series, will take place on April 11, 12, and 13 in the Ashland Boulevard Auditorium, Chicago, Harry A. Egle, Town Meetings chairman for the Radio Parts Industry Coordinating Committee, announced last month. For the first time, each technician attending will be given a "Certificate of Leadership in Television" suitable for framing and hanging in the shop.



Leonard Helk, left, presents plaque to James M. Skinner, Jr., right, Philco vice-president.

RADIO-ELECTRONICS for

U.H.F. TV experiments will be carried on by WQAN, Scranton, Pa., WCFI, Pawtucket, R. I., and WPTZ, Philadelphia, Pa., if construction permits asked of the FCC last month are granted. The stations propose to operate experimental transmitters to check the propagation characteristics of "upstairs" television.

CLOSE-SPACED TRIODE is the name given to a new u.h.f. tube announced last month by Bell Telephone Laboratories. The name is derived from the extremely small spacing—about one-fifth the diameter of a human hair—between grid and cathode. The small spacing reduces electron transit time, making for better performance at extremely high frequencies. It is only about one-sixth that found in any previous triode. The tube's grid wires,

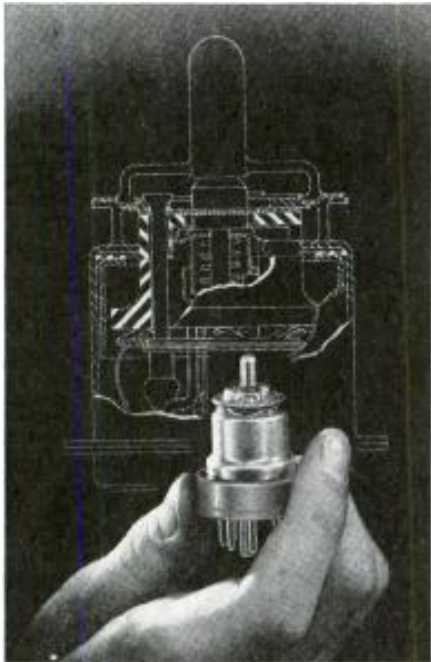

Photo and cutaway drawing of new u.h.f. tube.

.0003 inch in diameter, are spaced .001 inch apart; winding them is one of the most delicate operations ever attempted in vacuum-tube construction.

The tube will be used as an amplifier, modulator, oscillator, and frequency multiplier in microwave relays. It is expected to make the relays capable of handling more frequency channels.

Another new development of Bell Laboratories is the two-stream amplifier. This is a traveling-wave tube with two electron streams instead of one. A stream of slow electrons takes power from a stream of fast electrons, and an impressed wave becomes stronger as it travels down the tube. There are no resonant circuits; the tube is simply a wave transmission path which can amplify over a range of 1,000 mc.



Two-stream amplifier is a modified traveling-wave tube with a bandpass of over 1,000 mc.

NOTICE

Beginning with the May issue the term "serviceman," which we have used for 20 years, will be discontinued. Instead the new and better term

TECHNICIAN

will be used.

The new term is coming into common use throughout the entire radio trade and is in keeping with the growing importance of the service-technician. When radio was young almost anyone with a smattering of radio could service a receiver. Nowadays the increasing complexity of radio receivers—and particularly television receivers—is such that only a qualified technician can do justice to such receivers. This condition will continue in the future.

The Editors

COLORED RECORDS will be offered by RCA Victor, the company announced last month. All the new 45-r.p.m. discs (see page 12, March issue) will be color-coded to indicate the type of music. Ruby red will be used for serious music, midnight blue for semi-classical, black for popular, yellow for children's, green for Western, blue for international, and cerise for folk music.

RADAR played a dual role last month in an accident at sea. The radar indicator aboard the Coast Guard icebreaker *Eastwind* showed that a ship was close by but the master did not believe the indication. The *Eastwind* collided with the *Gulfstream*, a tanker, in a pre-dawn fog, because the radar was ignored. Receiving an SOS from the stricken ship, Captain Frank G. Boyer of the *Suzanne*, 14 miles away, picked it up on his radar, which guided him to the scene.



Raytheon Photo

Capt. Boyer of the *Suzanne* scans radar 'scope.



Radio Servicemen

FREE 1949 CATALOG

ALL MERCHANDISE AVAILABLE ON WARDS MONTHLY PAYMENT PLAN

This Supplement to Wards Electronic Equipment Catalog contains nationally known test instruments for the radio serviceman. Has everything from pocket-size meters to large oscillographs, including new models for servicing FM, AM and television equipment.

Also features high quality Sound Systems at greatly reduced prices, television sets and accessories, amateur gear, and high fidelity radio components.

Mail coupon for your free Catalog.

MONTGOMERY WARD—Chicago, Baltimore, Albany, St. Paul, Denver, Kansas City, Portland, Oakland, Ft. Worth.

Please send free 1949 Supplement to Wards Electronic Equipment Catalog.

Name.....
(Please PRINT plainly)

Address.....

City.....State.....

Heathkit TEST



Heathkit engineer measuring frequency response and distortion of Heathkit Oscilloscope using Hewlett Packard Audio Generator and Distortion Analyzer.

1949 MODEL Heathkit VACUUM TUBE VOLTMETER KIT



Features

- New 200 μ a Meter. 24 Ranges.
- New Accessory M.V. Probe makes Heathkit a kilovoltmeter. (Extra)
- New Accessory RF Probe extends range to 100 megacycles. (Extra)

A new Model V-2 Heathkit VTVM with new 200 microampere meter, four additional ranges — full scale linear ranges on both AC and DC of 0-3 V., 10 V., 30 V., 100 V., 300 V. and 1,000 V. Accessory probe listed elsewhere in ad extends voltage range to 3,000 and 10,000 volts D.C. New model has greater sensitivity, stability and accuracy — still the highest quality features — shatterproof plastic full view meter face — automatic meter protection, push pull electronic voltmeter circuit, linear scales — db. scale — ohmmeter measures 1/10 ohm to 1 billion ohms with internal battery — isolated DC test prod for dynamic measurements — 11 megohm input resistance on DC — AC uses electronic rectification with 6H6 tube. All these features and still the amazing price of only \$24.50.

\$24.50

Comes complete with cabinet — panel — three tubes — new Mallory switches — test prods and leads, 1% ceramic divider resistors and all other parts. Complete instruction manual for assembly and use. Better start your laboratory with this precision instrument. Ship. Wt., 8 lbs.

Heathkit RF SIGNAL GENERATOR KIT

\$19.50

Nothing ELSE TO BUY

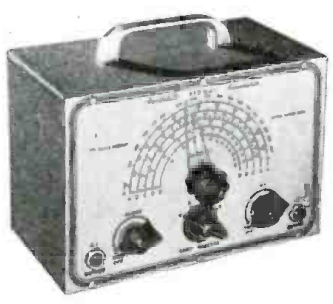

Every shop needs a good signal generator. The Heathkit fulfills every servicing need, fundamentals from 150 Kc. to 30 megacycles with strong harmonics over 100 megacycles covering the new television and FM bands. 110 V. 60 cycle transformer operated power supply. 400 cycle audio available for modulation or audio testing. Uses 6SN7 as RF oscillator and audio amplifier. Complete kit has every part necessary and detailed blueprints and instructions enable the builder to assemble it in a few hours. Large easy to read calibration. Convenient size 9" x 6" x 4 3/4". Shipping Wt., 4 1/2 lbs.

Heathkit 5" OSCILLOSCOPE KIT

Features

- Instant switching to plates or amplifier from front panel.
- Sweep generator supplying variable sweep 15 cycles to 30,000 cycles.
- All controls on front panel.
- Cased electrostatically shielded 110 V. 60 cycle power transformer.
- AC test voltage on front panel.
- External synchronization post on front panel.
- Deflection sensitivity .65 V. per inch full gain.
- Frequency response \pm 20% from 50 cycles to 50 Kc.
- Input impedance 1 Megohm and 50 MMF.

The Heathkit 5" Oscilloscope fulfills every servicing need. The husky cased power transformer supplies 1100 Volts negative and 350 Volts positive. Tubes supplied are two 6SJ7 amplifiers, 884 sweep generator, two 5Y3 rectifiers, and 5BP1 CR tube. Grey crackle aluminum cabinet and beautiful grey and maroon panel. Chassis especially designed for easy assembly.

An oscilloscope provides endless sources of experimentation in radio, electronics, medicine and scientific research. Detailed instructions make assembly fun and instructive. Shipping Wt., 24 lbs. Express only.

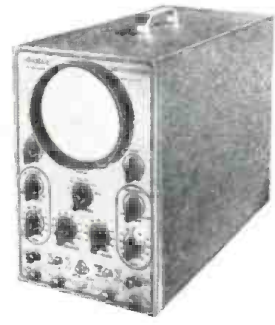

\$39.50

Nothing ELSE TO BUY

New Heathkit SIGNAL TRACER AND UNIVERSAL TEST SPEAKER KIT



\$19.50

Nothing ELSE TO BUY

The popular Heathkit signal tracer has now been combined with a universal test speaker at no increase in price. The same high quality tracer follows signal from antenna to speaker — locates intermittents — defective parts quicker — saves valuable service time — gives greater income per service hour. Works equally well on broadcast — FM or TV receivers. The test speaker has assortment of switching ranges to match push pull or single output impedance. Also tests microphones, pickups — PA systems — comes complete — cabinet — 110 V. 60 cycle power transformer — tubes, test probe, all parts and detailed instructions for assembly and use. Shipping Wt., 8 lbs.

Heathkit ELECTRONIC SWITCH KIT

DOUBLES THE UTILITY OF ANY SCOPE

An electronic switch used with any oscilloscope provides two separately controllable traces on the screen. Each trace is controlled independently and the position of the traces may be varied. The input and output traces of an amplifier may be observed one beside the other or one directly over the other illustrating perfectly any change occurring in the amplifier. Distortion — phase shift and other defects show up instantly, 110 Volt 60 cycle transformer operated. Uses 5 tubes (1 6X5, 2 6SN7's, 2 6SJ7's). Has individual gain controls, positioning control, and coarse and fine sweeping rate controls. The cabinet and panel match all other Heathkits. Every part supplied including detailed instructions for assembly and use. Shipping Wt., 11 lbs.



\$34.50

Heathkit 3-TUBE ALL WAVE RADIO KIT



\$8.75

An ideal way to learn radio. This kit is complete ready to assemble, with tubes and all other parts. Operates from 110 V. AC. Simple, clear detailed instructions make this a good radio training course. Covers regular broadcasts and short wave bands. Plug-in coils. Regenerative circuit. Operates loud speaker. Shipping Wt., 3 lbs.

- HS30 Headphones per set.....\$1.00
- 2 1/2" Permanent Magnet Loudspeaker..... 1.95
- Mahogany Cabinet..... 2.95



The HEATH COMPANY

... BENTON HARBOR 20, MICHIGAN

EQUIPMENT must be good!



Heathkit engineer calibrating Heathkit VTVM using Weston and General Electric laboratory standards.

MATCHED TO THE HIGHEST PRECISION STANDARDS...

Heathkit technician calibrating condensers for Heathkit Condenser Checker using General Radio capacity bridge of 1% accuracy.



New Heathkit TELEVISION ALIGNMENT GENERATOR KIT

Everything you want in a television alignment generator. A wide band sweep generator covering all FM and TV frequencies — a marker indicator — AM modulation for RF alignment — variable calibrated sweep width 0-30 Mc. — mechanical driven inductive sweep. Husky 110 V. 60 cycle power transformer operated — step type output attenuator with 10,000 to 1 range — high output on all ranges — band switching for each range — vernier driven main calibrated dial with over 45 inches of calibrations — vernier driven calibrated indicator marker tuning. Large grey crackle cabinet 16-1/8" x 10-5/8" x 7-3/16". Phase control for single trace adjustment. Uses four high frequency triodes plus 5Y3 rectifier — split stator tuning condensers for greater efficiency and accuracy at high frequencies — this Heathkit is complete and adequate for every alignment need and is supplied with every part — cabinet — calibrated panel — all coils and condensers wound, calibrated and adjusted. Tubes, transformer, test leads — every part with instruction manual for assembly and use. Actually three instruments in one — TV sweep generator — TV AM generator and TV marker indicator. Also covers FM band. Deliveries start early in March. Order early.

\$39.50



Heathkit SINE AND SQUARE WAVE AUDIO GENERATOR KIT



\$34.50
Nothing ELSE TO BUY

Experimenters and servicemen working with a square wave for the first time invariably wonder why it was not introduced before. The characteristics of an amplifier can be determined in seconds compared to several hours of tedious plotting using older methods. Stage by stage, amplifier testing is as easy as signal tracing. The low distortion (less than 1%) and linear output (\pm one db.) make this Heathkit equal or superior to factory built equipment selling for three or four times its price. The circuit is the popular RC tuning circuit using a four rang variable condenser. Three ranges 20-200, 200-2,000, 2,000-20,000 cycles are provided by selector switch. Either sine or square waves instantly available at slide switch. All components are of highest quality, cased 110 V. 60 cycle power transformer, Mallory F.P. filter condensers, 5 tubes, calibrated 2 color panel, grey crackle aluminum cabinet. The detailed instructions make assembly an interesting and instructive few hours. Shipping Wt., 13 lbs.

110 V. A.C. MILITARY RECEIVER POWER SUPPLY KIT

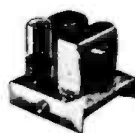

\$5.95

Ideal way to convert military sets. 110 V. 60 cy. transformer operated. Supplies 24 volts for filament — no wiring changes inside radio. Also supplies 250 V. D.C. plate voltage at 50-60 MA. Connections direct to dynamotor input. Complete with all parts and detailed instructions. Ship. Wt., 6 pounds.

110 V. A.C. TRANSMITTER POWER SUPPLY KIT

For BC-645, 223, 522, 274N's, etc. Ideal for powering military transmitters. Supplies 500 to 600 volts at 150 to 200 MA plate, 6.3 C.T. at 4 Amps., 6.3 at 4 Amps., and 12 V. at 4 Amps. Can be combined to supply 3-6, 9-12 or 24 volts at 4 amperes. Kit supplied complete with husky 110 V. 60 cycle power transformer, 5U4 rectifier, oil filled condensers, cased choke, punched chassis, and all other parts, including detailed instructions. Complete — nothing else to buy Shipping Wt., 22 lbs.

\$14.50

Heathkit CONDENSER CHECKER KIT

\$19.50
Nothing ELSE TO BUY



Features

- Bridge type circuit
- Magic eye indicator
- 110 V transformer operated
- All scales on panel
- Power factor scale
- Measures resistance
- Checks paper-mica electrolytics

Checks all types of condensers, paper-mica-electrolytic-ceramic over a range of .00001 MFD to 1000 MFD. All on readable scales that are read direct from the panel. NO CHARTS OR MULTIPLIERS NECESSARY. A condenser checker anyone can read without a college education. A leakage test and polarizing voltage for 20 to 500 volts provided. Measures power factor of electrolytics between 0% and 50%. 110 V. 60 cycle transformer operated complete with rectifier and magic eye tubes, cabinet, calibrated panel, test leads and all other parts. Clear detailed instructions for assembly and use. Why guess at the quality and capacity of a condenser when you can know for less than a twenty dollar bill. Shipping Wt., 7 lbs.



The **HEATH COMPANY**

... BENTON HARBOR 20, MICHIGAN



ELECTRONIC BARGAINS for EXPERIMENTERS and HOBBYISTS

ORDER NOW . . . ALL QUANTITIES LIMITED



PE101C BC645 POWER SUPPLY
NO. 273. Complete power supply for BC 645. Operates from 12 or 24 Volts. Supplies both AC and DC required. Shipping Wgt. 13 lbs. Each **\$3.95**

DM 35 12 VOLT DYNAMOTOR
NO. 274. New input 12 Volt at 18.7 Amperes. Supplies 675V at 275 MA or 1/2 above voltage from 6 volts. Excellent for auto use. Shipping Wgt. 11 lbs. Each **\$7.50**



HOME WORKSHOP GRINDER KIT

NO. 230. Easily assembled 110V AC or DC ball bearing fully enclosed motor from Army surplus dynamotor. Purchaser to make simple changes and shaft extensions, detailed instructions and all parts supplied. Motor approximately 5,000 R.P.M. Ideal for tool-post grinder, flexible shaft tool, model drill press, saw. Shipping Weight 6 lbs. **\$3.95**



COLLINS AUTOTUNE CONTROL HEAD

NO. 278. Brand new controls used on the ART/13, 100 Watt Transmitter. Types 7, 8, 10, and 11 available. Get a spare while available as new cost is over \$22.00 each. Shipping Wgt. 3 lbs. Price any type (mention when ordering). Each **\$4.50**



300 MA SELENIUM RECTIFIERS
NO. 209. Rated 300 MA at 36 Volts, complete with mounting brackets. Shipping 3 FOR \$1.00 Wgt. 1 lb.



1N90 FEED THROUGH INSULATOR

NO. 276. Heavy duty feed through, 2" diameter 4" long, complete with brass hardware and gasket. Shipping Wgt. 2 lbs. 2 FOR **\$1.00**



1N86 STRAIN INSULATOR

NO. 277. Husky army type 1 1/4" diameter, 5 1/4" long. Brown porcelain. Shipping **\$1.00** Wgt. 4 lbs. 4 FOR



G.E. BC 306 ANTENNA TUNING UNIT



NO. 231. Matches any aerial to 150 Watt transmitter, used on BC 375. Brand new. Add postage for 20 lbs. **\$2.95**

G. E. 1,000 VOLT 350 MA DYNAMOTOR



NO. 213. An ideal dynamotor for mobile operation in taxicabs, police cars, sound systems and amateur stations. Supplies above voltage from 12 Volts or 500V. at 350 MA from 6 Volts. Complete with starting relay, and fuses. New. Our Dynamotor A. Shipping Weight 72 lbs. **\$5.95**

POWER TRANSFORMER Specials



NO. 226. Primary 117V. 60 cycle. Secondaries supply 746 V.CT at 220 MA. 6.3V. at 4.5 A., and 5V. at 4A. Will handle 13 tube radio receivers. Supply is limited, order early. Shipping Weight 11 lbs. each. **\$3.95 . . . 3 for \$9.95**

T32 TABLE MICROPHONE

NO. 210. One of the Army's best. Built by Kellogg, ideal for factory call system, public address, amateur use. Brand new in original cartons. Add postage for 5 lbs. **\$2.95**



MINIATURE ELECTRIC MOTOR



NO. 211. Tiny Delco motor only 1" x 1 1/4" x 2" 10,000 RPM. Operates from 6 to 24 V. Excellent for models. Add postage for 1 lb. **\$2.95**

OUTPUT TRANSFORMER

NO. 227. Push pull 6V6's to 6-8 ahm voice coil excellent characteristics. **3 for \$1.95**



RCA SATURABLE REACTOR TRANSFORMER

NO. 246. New RCA No. CKV30531 AC current 750 MA DC current 2 Amperes. Rated 1.75 henries. Shipping wgt. 6 lbs. Each **\$1.00**



12.6V POWER TRANSFORMER



NO. 247. New cased 110 V 60 cy. Power Transformer. Supplies 440V Ct. at 60 MA, 6.3V at 2A. and 12.6V at 1 Amp. Excellent for military sets. Shipping Wgt. 6 lbs. Each. **\$1.95**

RCA INPUT TRANSFORMER

NO. 248. Heavy duty RCA No CKV-30529. Input has primaries 600 to 200 and 25 ohms secondary 250,000 ohms C.T. Shipping Wgt. 2 lbs. Each **\$1.00**



FEDERAL POWER TRANSFORMER



NO. 252. New cased 110V 60 cy. Power Transformer. Supplies 480V CT at 50 MA and 6.3 V at 2.1 Amps. A beautiful transformer. Shipping Wgt. 4 lbs. Each. **\$1.50**

MILITARY POWER TRANSFORMERS

NO. 229. Convert your military receivers without rewiring the filament. "A" type supplies 500 VCT at 50 MA, 5V. at 2A. and 24V. at 1/2 A. "B" type supplies 500 VCT at 50 MA, 5V. at 2A. and 12V. at 1 Amp. State whether A or B type desired. Shipping Weight 4 lbs. **\$2.95**



WALKIE TALKIE TRANSFORMER



NO. 744. Carbon microphone input transformer and output to head-phone transformer, all in one case, excellent for building your own. Shipping Wt. 1 lb. 4 for \$1.00

LOW PASS FILTER UNIT

No. 637. 3000 cycle cutoff consists of 3 inductances and 4 capacitors in network, 500 ohms in and out. Excellent for clipping all frequencies above 3000 cycles. Drawn steel case, shipping Wt. 5 lbs. **\$2.50**



FM PUSH BUTTON TUNER

NO. 224. Brand new ten push button tuning assembly from Army FM receiver. Contains 4 gang 100 MMF silver plated tuning condenser. Add postage for 10 lbs. **\$2.50 EACH**

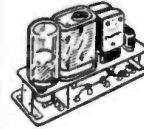

BC 746 TUNING UNIT
NO. 257. Plug in transmitter tuning unit from army Walkie Talkie. Contains antenna and tank coils, tuning condenser, transmitting and receiving crystals. Ideal transmitter foundation. Shipping Wgt. 1 lb. Each **\$1.00**
(Same as above except transmitter crystal in 80 meter amateur band \$2.50 each)

T30 THROAT MICROPHONE

NO. 258. Makes excellent contact microphone for musical instrument or vibration pick-up. Shipping Wgt. 1 lb. \$1.00 each Extension cord with switch for above **\$.50 each**



BC731 CONTROL BOX



with Weston Model 476 AC Voltmeter
NO. 208. Excellent buy in motor control box. Size 8"x10"x5 1/2". Contains Weston 0-150V. AC 3 1/2" voltmeter, motor starting switch, 28 fuses all 30 Amp 110V. and 8 fuse holders. Fuses and holders alone worth the price. Shipping Weight 18 lbs. **\$7.95**

METER SPECIAL

NO. 237. Brand new DeJur Model 312 0-800 M.A. D.C. Square 3" 0-10 M.A. basic meter with built in shunt. Probably the best buy ever offered in a surplus meter. Shipping Weight 1 lb. **\$2.95**



HEARING AID HEADPHONES



NO. 216. The Army's best - eliminate flat ears and outside noise. Complete with transformer for conversion from low to high impedance. With cord and plug complete. Add postage for 1 lb. **\$1.00**

BC 451 CONTROL BOX

NO. 236. Control box for 274N transmitters. Contains proper cv-voice switch, 4 channel switch, power switch, mike jack and telegraph key. Add postage for 2 lbs. **\$1.95**



100 MA FILTER CHOKE



No. 641. Heavy 1.5 henry choke in drawn steel case, 50 ohm resistance, conservatively rated at 100 MA. Shipping Wt. 1 lb. 50c

FILAMENT TRANSFORMER

No. 922. 220V. 60 cy. primary supplies 12.6V. at 3.5 Amps, 15.6V at 1 Amp. Supplies 6.3 at 3.5 Amps and 7.8V. at 1. Amp from 110V. Shipping Wt. 8 lbs. **\$1.50**



PANEL METER



Burlington 0-300 VAC Meter
No. 290. Model 32XA 3 1/2" round AC Voltmeter 0-300 VAC full scale. Scale also calibrated 0-600V. Bakelite case. A beautiful meter in original carton. Shipping Wt. **\$3.95**

DRIVER TRANSFORMER

No. 651. Couples 3000 ohm plate to push pull parallel grids hermetically sealed. Ship. Wt. 1 lb. **\$1.00**



OUTPUT and MODULATION TRANSFORMER



No. 745. Companion transformer to above driver. A push pull output, 3000 ohms to 3.2 ohm voice coil, or to 1250 ohms at 80 MA. A high quality cased unit. Shipping Wt. 2 pounds. **\$1.00**

HOW TO ORDER . . . GIVE PART NUMBER AND DESCRIPTION . . . ADD POSTAGE FOR WEIGHT SHOWN. NO ORDERS UNDER \$2.00 . . . WE WILL SHIP C.O.D.



The HEATH COMPANY

BENTON HARBOR 20, MICHIGAN

RADIO-ELECTRONICS for

IT'S UP TO US!

Yes, that's our favorite expression here at SENCO RADIO. We know that "it's up to us" to provide you with low prices, high quality merchandise, fast service! Why not try us out now and see for yourself?

TUBES!

All Brand New! R. M. A. Guarantees!
Immediate Delivery! In Advance by Catalog!

Type	Each	Each 10	Type	Each	Each 10
OZ4	45	59	6U5/6G5	69	59
1A3	45	39	6U6GT	40	29
1A5GT	59	49	6U7G	35	25
1C5GT	69	59	6V5GT	59	49
1C7G	64	58	6V6GT/G	69	59
1D5G	67	60	6W4GT	49	39
1D7G	69	59	6X5GT/G	71	63
1F7	79	69	6Y6G	53	43
1LC6	49	59	7A5	59	49
1LD5	69	59	7A7	49	44
1LM4	69	59	7E6	49	44
1LN5	69	59	7F7	49	44
1L4	49	45	788	69	59
1P5	59	49	7C5	55	49
1R4	69	59	7G6	49	44
1R5	55	49	7H7	49	44
1S5	58	48	7I7	49	44
1T4	69	55	7Q7	69	59
1T5GT	59	49	7X7 (XXFM)	44	35
1U4	49	39	7Y4	44	35
1V	45	39	12A	79	69
2A7	32	25	12A6	29	25
2E5	89	79	12A8GT	35	28
2X2/879	35	29	12AT7	69	59
3A4	49	39	12AU6	65	55
3B7/1291	59	49	12AV6	49	39
3Q5	55	49	12BA6	50	45
3S4	55	45	12H6	39	34
3V4	79	69	12J7GT	45	39
5U4G	50	40	12K8Y	35	25
5W4GT	39	34	12Q7GT	45	39
5Y3G	42	37	12SA7GT/G	40	32
5Y3GT/G	40	33	12SF5GT	40	32
5Y4G	39	32	12SJ7GT	55	49
5Z3	59	49	12SK7GT/G	45	35
5Z4	59	49	12SL7GT	49	43
6A3	69	59	12SN7GT	49	43
6A4	79	69	12SQ7GT/G	40	32
6A7	53	45	12SR7	35	32
6AB5/6N5	99	89	12Z3	55	49
6AC5	69	59	14A7	65	55
6AC7/1852	79	69	14B6	65	55
6AH6	49	39	14Q7	65	55
6AL7	69	59	19T8	89	79
6AN5	65	55	24A	49	39
6AT6	49	39	25L6GT	55	45
6B4G	89	79	25Z5	49	39
6BA6	49	39	25Z6GT/G	45	39
6BE6	49	38	26	32	25
6BG6G	99	89	27	45	35
6BH6	79	69	32L7GT	52	48
6BJ6	59	49	35L6GT/G	45	39
6C4	29	25	35W4	43	39
6C5GT	40	35	35Z5GT/G	43	39
6D6	49	45	35Z6G	42	37
6F5GT	55	45	35/51	42	37
6F6GT	45	39	36	35	29
6F7/VT70	39	29	39/44	25	19
6G6G	59	49	43	54	47
6H6GT/G	43	36	45	49	39
6J7GT	42	38	45Z5	59	49
6K6GT/G	45	39	47	59	49
6K7G	50	41	47	49	39
6K7GT/G	49	39	50	1.49	99
6K8	69	59	50L6GT	50	45
6L5G	69	59	56	55	45
6N4	49	38	57	45	39
6P5GT	55	49	58	45	39
6SA7GT/G	44	37	75	59	49
6SD7	49	39	76	49	45
6SH7GT	40	32	77	35	27
6SK7GT/G	49	39	78	49	39
6SL7GT	49	47	80	40	38
6SN7GT	49	47	81	1.49	99
6SO7GT/G	44	37	84/6Z4	49	39
6SR7	41	36	85	49	45
6SS7	59	49	99V	35	25
6SW7	55	49	99X	35	25
6TB	89	79	117Z6GT/G	79	69

OIL FILLED CONDENSERS
Standard Brand—Upright Type.
Stand-Off Insulators.

6 Mfd. 600 VDC	69¢
8 Mfd. 600 VDC	79¢
10 Mfd. 600 VDC	89¢
8 Mfd. 1000 VDC	\$1.90

Write for our FREE catalog!
MINIMUM ORDER: \$2.50



WHEN ORDERING—Send 25% deposit for all C.O.D. shipments. Include sufficient postage—excess will be refunded. Orders without postage will be shipped express collect. All prices F.O.B. New York City.

SENCO RADIO INC.
Dept. G, 73 West Broadway
New York 7, N. Y. Tel. BEekman 3-6493

General Electric Tube Division, Schenectady, New York, has developed a new metal television picture tube which offers more viewing area in low-priced TV sets. The tube has a diameter of 8½ inches, but will cost no more to build than a 7-inch tube such as is used now in lower-cost sets; it will give 50% more picture.

Garod Electronics Corp., Brooklyn, in an effort to protect patent rights pending on its new Tele-Zoom television receivers, is utilizing every legal means to prevent unlawful infringement, according to a statement issued by LEONARD ASHBACH, president of the company. Provisions are being made, however, to permit competitive manufacturers to make use of the development.

Radio Manufacturers Association reports that more than 975,000 television receivers were produced during 1948, bringing the postwar total TV set production to at least 1,160,000. An additional 25,000 to 30,000 unassembled TV set kits were reported to have been manufactured last year.

With set manufacturers applying an increasingly large share of their manufacturing facilities to television, particularly during the second half of 1948, production of radio receivers last year declined about 20% under the all-time peak reached by the industry in 1947. Last year's output of radios, however, was the second highest in the industry's history.

Total industry production of radio sets in 1948 was estimated by RMA at more than 16,000,000 of which RMA member companies manufactured 13,265,793. In 1947 the entire industry's production of radio sets exceeded 20,000,000. TV set production by RMA member companies reached a new high of 161,179 in December, only 17,500 sets under the entire output of television receivers in 1947.

RMA member companies reported manufacturing 866,832 TV sets in 1948 as compared with 178,571 in 1947 and 6,476 in 1946. Production by non-member manufacturers brought the total TV set output in 1948 to more than 975,000.

Something more than 200,000,000 radio receiving tubes were sold in 1948 by RMA member companies. Tube sales during last year totalled 204,720,378, an increase of more than 5,000,000 over the 199,533,827 tubes sold in 1947.

Sales of receiving tubes in December also increased considerably over December, 1947, but fell below the November, 1948, sales, RMA said. December sales totalled 19,270,164 compared with 16,511,408 in December, 1947, and 21,118,874 in November, 1948.

A breakdown of RMA member company sales in 1948 showed 146,162,214 tubes sold for new sets; 47,056,521 for replacements; 10,686,769 for export; and 814,874 sold to government agencies. December sales included 14,721,114 tubes sold for new sets; 3,440,437 for replacements; 1,048,760 for export; and 59,853 sold to government agencies.

RCA Engineer Products Department's engineer, RALPH V. LITTLE, JR., outlined recently the progress in the development of television equipment for motion-picture theatres.

In an address before the winter meeting of the American Institute of Electrical Engineers at the Statler Hotel, New York, Mr. Little disclosed, "Two basic systems of large-screen television are being studied by RCA at the present time. One is the direct projection system under which high-brilliance kinescope images are projected by a highly reflective optical system upon special screens; the other an intermediate film system, using standard motion-picture projection technique after television images have been photographed on motion-picture film and suitably processed.

"At the present time," he said, "the problem of the engineer is to develop kinescopes capable of handling greater beam currents and operating at higher potentials in an effort to increase the light output, while at the same time developing smaller, less costly reflective optical systems and directional screens with increased light gain."

Commenting on the performance of the two systems, Mr. Little said, "The capabilities of the projection system are equal to the best studio television equipment, but, of course, any deterioration of the signal between the camera and the projector causes an inferior picture on the screen. Experience has shown that large-screen images produced by both the direct and intermediate systems are entirely acceptable to critical audiences. The equipment and techniques of operation will continue to be improved."

Scott Radio Laboratories of Chicago is demonstrating a new record player capable of playing all three of the current types of records. The machine can be set for three speeds, 78, 33½, and 45 r.p.m.

Garod Electronics Corp. president LEONARD ASHBACH announces the formation of a new company to be known as Garod Electronics, Ltd. of Canada, with a plant located in the Small Arms Building at Long Beach, Ontario, a suburb of Toronto, for the manufacture and distribution in the Dominion of Canada of the complete line of radios and television receivers now manufactured by Garod.

Mr. Ashbach stated that manufacturing facilities for the new organization are now completed and the company is already producing Garod receivers for the Canadian market. Mr. Ashbach further commented, "It may be surprising to the industry that this new company will produce television sets in Canada when it is well known that Canada, at least at the moment, does not have any facilities or television stations. However, our receivers have been engineered to such a sensitivity point that Buffalo and Cleveland can be picked up throughout the Toronto area with such clarity that a substantial market obviously exists in Canada for the reception of U. S. television broadcasts."

Here's what
radio men
say about

SYLVANIA'S DEALER CAMPAIGNS



SCURLOCK'S RADIO SHOP
ELECTRICAL APPLIANCES -- HARDWARE
EVERYTHING PERTAINING TO RADIO
SUMITON, ALABAMA

September 18, 1948

Advertising Department
Sylvania Electric Products Inc.
Emporium, Pa.

Gentlemen:

In 1937 when we started our radio repair business, we used personal postal cards to get our name before our prospective customers. For a beginner, this kind of advertising seemed a little more than we could pay, although it did wonders for our business.

We are happy that the service industry has a great company behind us with national advertising and personal postal cards. During your first co-ordinated advertising campaign we bought 1200 cards and mailed them to our customers according to Sylvania's specifications. The results were so effective that we are going to use the campaign again. We want to see if the campaign is really responsible for the extra business we are enjoying.

The "funny cards", as our customers call them, are even responsible for payment of some of our past due accounts. Our radio sales are up. We are making allowance for old radios which our customers get out for us to repair after receiving our atomic reminder card.

We want to personally thank Sylvania for taking an interest in us and giving us this low cost, yet effective, advertising.

VERY KINDLY YOURS

J. B. Scurlock
J. B. SCURLOCK



PHONE: ARDND
SHOOTERS
DEPENDABLE
MIKE'S
RADIO AND TELEVISION SERVICE
EXPERT SERVICE ON ALL MAKES
10304 N. WEST HIGH
LOS ANGELES, CAL.

November 1, 1948

Advertising Department
Sylvania Electric Products Inc.
Emporium, Pa.

Gentlemen:

I would like this opportunity to tell you how much the Sylvania co-ordinated advertising campaign has helped my business.

Although I have used direct mail postal cards in the past for soliciting new business, the tie-in with national advertising offered in the Sylvania campaign was responsible for an extraordinary return. The response I have had from your campaign has been truly amazing.

As an example, I mailed 1000 postal cards in May at a cost to me of \$10.00. To date this investment has brought a return of \$352.19. During June, July and August I mailed another 1000 cards each month at a total cost of \$30.00. To date the return from this investment has amounted to \$760.46.

You will note that for a total investment of \$40.00 I have, to date, enjoyed an increase in business amounting to \$1,112.65 -- all from new customers. I can safely say that there is still more business to come from these cards in future months.

I mailed another 1000 cards to my prospect list of 12,964 names during October and November. I also expect to mail another 1000 cards during December.

Speaking for myself, I would certainly like to see this campaign become a regular 'shot in the arm' at least twice a year. It will do much to help business in the spring and early fall when business is usually slow.

Many thanks and best wishes.

Very truly yours
MIKE'S RADIO SERVICE

By *Michael Waxman*
Michael Waxman



BEING IN YOUR RADIO TUBES - WE TEST THEM FREE - DEALERS FOR SYLVANIA SEE LISTED LIST

Like these service dealers you
can increase your business

Sylvania's May, June, July and August campaigns are ready for you. Here's what you receive:

- 4 Postal Card Mailings—one for each month.
- 4 Window Displays—one for each month.
- 4 Window Streamers—one for each month.
- 8 Newspaper Ad Mats—two for each month.
- Radio Spot Announcements—several for each month.

Send for full details now! Remember, you pay only the postage on the government postal cards you mail. Sylvania supplies everything else free!

SYLVANIA ELECTRIC

RADIO TUBES; CATHODE RAY TUBES; ELECTRONIC DEVICES; FLUORESCENT LAMPS, FIXTURES, WIRING DEVICES; PHOTOLAMPS; LIGHT BULBS

Sylvania Electric Products Inc.
Advertising Department, R-1704
Emporium, Pa.

Gentlemen: Send full information on your May, June, July and August Service Dealer Campaigns.

Name _____
Company _____
Address _____
City _____ Zone _____
State _____

Which Do You Want?



Better Pay



A Nice Home



A New Car



Greater Security



Happy Vacations and Travel

Get Your FCC Ticket
Jobs worth
\$3,000 to \$7,500
are opening up
right now for
**FCC Licensed
Radiomen.**



I can train you to pass your FCC License Exams in a few short weeks if you've had any practical radio experience—amateur, Army, Navy, radio servicing, or other. My time-proven plan can help you, too, on the road to success.

Let me send you FREE the entire story

Just fill out the coupon and mail it. I will send you, free of charge, a copy of "How to Pass FCC License Exams," plus a sample FCC-type Exam, and the amazing new booklet, "Money Making FCC License Information."

Edw. H. Gullford
Vice President

How to Pass FCC COMMERCIAL RADIO OPERATOR License Exams

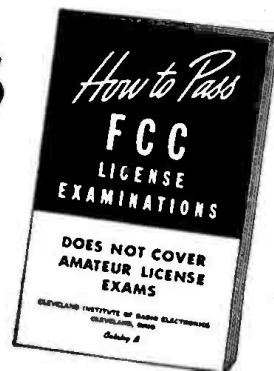

FREE

Tells where to apply for and take FCC examinations, location of examining offices, scope of knowledge required, approved way to prepare for FCC examinations, positive method of checking your knowledge before taking the examinations.

Add Technical Training to Your Practical Experience & Get Your **FCC COMMERCIAL RADIO OPERATOR LICENSE** in a Few Short Weeks...

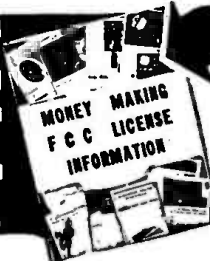

Get This Amazing New Booklet

1. TELLS OF THOUSANDS OF BRAND-NEW, BETTER-PAYING RADIO JOBS NOW OPEN TO FCC LICENSE HOLDERS.
2. TELLS HOW YOU WILL BENEFIT BY HOLDING AN FCC COMMERCIAL LICENSE.
3. TELLS HOW YOU CAN GET YOUR FCC COMMERCIAL RADIO OPERATOR LICENSE IN A FEW SHORT WEEKS—EASILY AND QUICKLY, BY USING CIRE SIMPLIFIED TRAINING AND COACHING AT HOME IN YOUR SPARE TIME.
4. TELLS OF HUNDREDS OF OUR SUCCESSFUL STUDENTS WHO NOW HAVE LICENSES AND NEW, BETTER-PAYING JOBS.
5. TELLS HOW WE PREPARE YOU TO PASS THE NEW FCC COMMERCIAL LICENSE EXAMINATIONS, WHICH NOW INCLUDE FM AND TELEVISION.
6. TELLS HOW WE GUARANTEE TO TRAIN AND COACH YOU UNTIL YOU GET YOUR LICENSE.
7. TELLS HOW WE HELP YOU TO GET A BETTER-PAYING, LICENSED JOB, WITH OUR FREE AND EXCLUSIVE SERVICE, WHICH PREPARES YOUR EMPLOYMENT APPLICATION FOR MAILING TO HUNDREDS OF EMPLOYERS, INCLUDING FM, AM AND TELEVISION BROADCAST STATIONS, RADIO MANUFACTURERS, POLICE RADIO STATIONS, AND RADIO-EQUIPPED TAXI, BUS AND PUBLIC UTILITY COMPANIES.

It's EASY if you use CIRE Simplified Training and Coaching AT HOME in SPARE TIME

Get your license easily and quickly and be ready for the \$3000 to \$7500 jobs that are now open to ticket holders. CIRE training is the only planned course of coaching and training that leads directly to an FCC license.

Your FCC ticket is always recognized in all radio fields as proof of your technical ability



Get All 3 FREE Send Coupon Now!

CIRE Graduates Find FCC License Pays Off

"I now hold ticket Number P-10-3787, and holding the license has helped me to obtain the type of job I've always dreamed of having. Yes, thanks to CIRE, I am now working for CAA as Radio Maintenance Technician, at a far better salary than I've ever had before. I am deeply grateful."
Student No. 3319N12

"I was issued license P-2-11188 on November 4. The next day I was signed on board a tanker as Radio Operator-Purser. Besides radio operating, I handle the payroll's etc., which is all over-time and brings my monthly pay up to between \$400 and \$650."
Student No. 2355N12

CLEVELAND INSTITUTE OF RADIO ELECTRONICS
Desk RC-4 4900 Euclid Bldg., Cleveland 3, Ohio
APPROVED FOR VETERAN TRAINING UNDER THE "G.I. BILL OF RIGHTS"

CLEVELAND INSTITUTE OF RADIO ELECTRONICS

Desk RC-4 4900 Euclid Building, Cleveland 3, Ohio
(Address to Desk No. to avoid delay)

I want to know how I can get my FCC ticket in a few short weeks by training at home in spare time. Send me your amazing new FREE booklet "Money Making FCC License Information," as well as a FREE sample FCC-type exam and FREE booklet, "How to Pass FCC License Examinations" (does not cover exams for amateur license)

Name

Address

City..... Zone..... State.....

Veterans check for enrollment information under G.I. Bill
NO OBLIGATION—NO SALESMEN

RADIO-ELECTRONICS for

TELEVISION BY-PRODUCTS

. . . By-products sometimes constitute the only profit of large corporations . . .

By HUGO GERNSBACK

THE radio industry has consistently missed the boat in certain by-products on which it should have cashed in.

Ever since the earliest days of the art, outsiders who had no connection with the trade cashed in—first on wireless, later on radio, and now on television. For some foolish reason the established radio interests have always thought it beneath their dignity to help popularize radio.

It would seem that others, particularly the toy trade, have reaped a harvest on items that rightfully belong to the radio industry.

During the early twenties when the first radio boom started, hundreds of radio gadgets were sold in toy, novelty, and department stores all over the country. *Only a pitiful few ever originated within the radio industry itself.*

With the present popularity of television—which is sweeping the country—nothing is being done either by the transmitting broadcast interests or the television set manufacturers to reap permanent good will for themselves. Soon the country will again be flooded with hundreds of television gadgets, games, toys, and novelties *without benefit to the industry.*

On this page we show a single example of an exceedingly well-engineered miniature "television set." This is a replica of an RCA televiser and is currently merchandised by the Ralston Breakfast Food interests. It is certain that several million of these little television gadget sets will be sold this year. It is a smart piece of advertising for the RCA people, and is the first instance we have seen in years where some benefit accrues to the radio industry from such an effort.

To get the set, you send 20 cents, plus an Instant Ralston box top, to the cereal company, and you receive your television set, plus a musical ring. The little set, which measures only $\frac{3}{8}$ x $1\frac{3}{8}$ inches, is made of brown plastic, and with it come five $\frac{5}{16}$ -inch circular films which are inserted by way of a brass-back closure plate. The circular film's edge extends a bit beyond the set and can thus be rotated. A strong glass lens is molded into the plastic case, and you look through it against the light to see various scenes.

Never underestimate the influence of our youngsters—they have usually an active say when a television set is bought, nowadays. A good television gadget may influence them strongly.

Soon all television manufacturers will have to compete actively when the present boom has spent itself.

We can imagine all sorts of little gadgets that can be made for a few cents, either to be given away or sold at cost by the manufacturer. All of these gadgets would, of course, be in the shape and form of a brand television receiver, making in this manner a permanent advertisement at an exceedingly low cost.

Such items too are kept for years.

Savings banks for children, jewelry boxes for young girls—dozens of others instantly come to mind. There is a long list of similar articles that can readily be made to be used as ashtrays, stamp boxes, match boxes, ink sets, paper weights, nail boxes, puzzles, etc.

These items can be made in plastic, metal, or a combination of both. They can be produced at low cost.

The television broadcasters likewise can cash in on the vogue of some particular feature that is timely.

To mention only one, a miniature plastic articulated Howdy Doody can be manufactured probably for less than one cent and given to the youngsters or sent to them in exchange for some box top. In this case the sponsor would, of course, foot the bill.

The test pattern which is being broadcast by various stations lends itself particularly well for an ashtray—the pattern being embossed in plastic inside the tray.

All these ideas can be hugely beneficial to the industry. *But, the industry must work fast and it must be up on its toes.*

We recently consulted a number of toy manufacturers. All of them seem to have planned some kind of a television toy. By the middle of this year dozens of such toys will be on the market. *Yet all of them will be sold without the television industry getting any direct benefit.*

There is truly a huge market for television by-products forming at present. *The industry should cash in on it immediately.*





What the electret looks like.

Improved ELECTRETS

By EDWARD PADGETT

New compounds produce electrets with better stability and higher surface charge

INTERESTING opportunities for the electronics researcher lie in the development of improved electrets. An electret is a mixture of certain dielectric materials which has been cooled to solidification in a strong electric field. At room temperature one electret surface has a negative electric charge and the other surface is charged positively. If the electret is covered with a metal-foil "keeper," these electric charges do not decay appreciably with the passage of time.

The first workers to make electrets were Mototaro Eguchi of the Higher Naval College of Tokyo and Andrew Gemant of England and the United States, who repeated Eguchi's experiments some years later. Victor Laughter published the first photographs of electrets in this hemisphere (*RADIO-CRAFT*, May, 1948). Andrew Gemant holds British patents in which electrets are used in experimental electrometers and transformers. The Japanese, however, were the first to find extensive practical uses for the electret. Microphones captured from the Japanese during the war used electrets to furnish polarizing voltages.

Scientists report that Carnauba wax (which comes from a Brazilian palm tree) is an essential ingredient in the preparation of wax electrets. Carnauba wax is a unique mixture of high-melting-point esters. (Esters—as well as water—are formed when organic acids and alcohols react. They are somewhat like salts, but react more slowly than salts.) The best grade of the wax is No. 1 yellow, or No. 1 North Country Carnauba wax. It is hard, brittle, and cracks easily. This cracking may be eliminated by adding suitable extenders such as paraffin wax to the Carnauba.

Experiments performed by the writer at New York University indicate that



The author's sister engaged in removing from the mold a new electret just out of the oven.

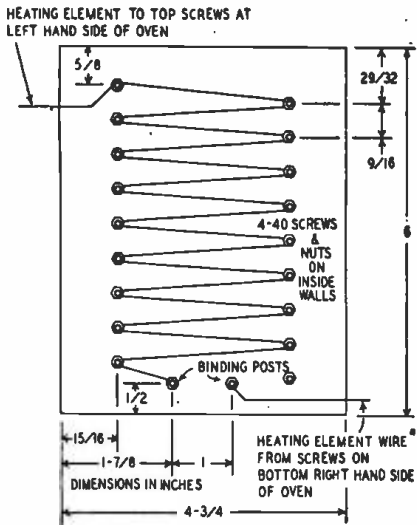
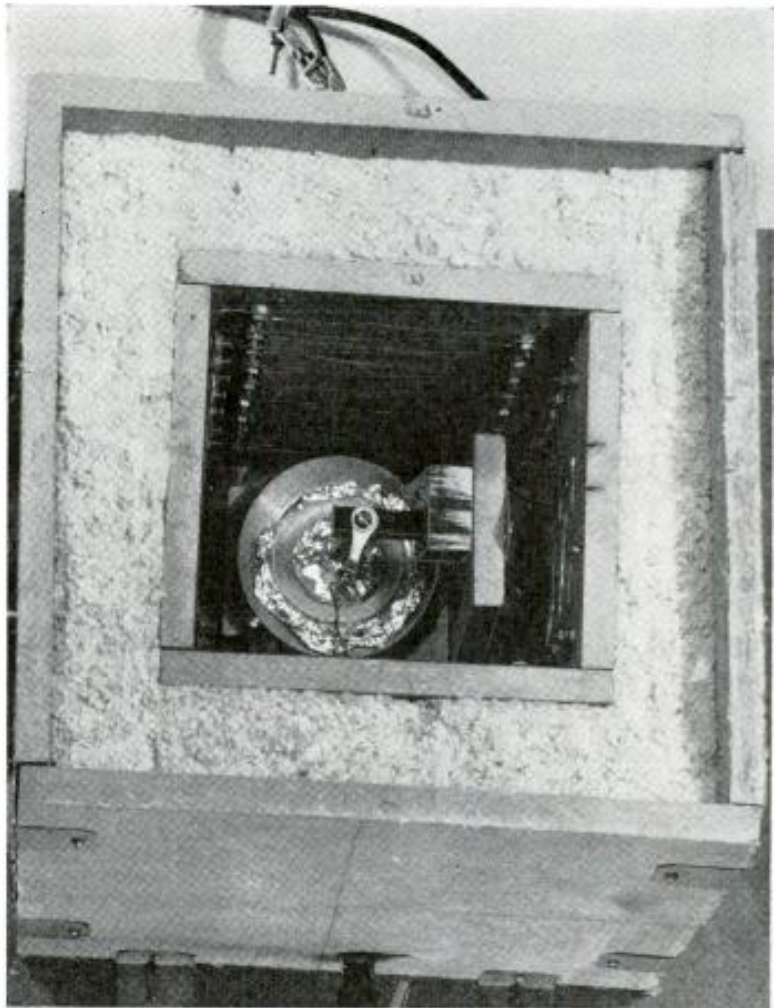

Diagram of heating wires shown in the photo.



Insulation in the author's oven allowed studies of prolonged cooling effects.

electret properties are associated with the polar groups (i.e., -OH, -COOH) that occur in certain substances. Paraffin waxes contain no polar groups and, in themselves, do not form electrets. Carnauba wax contains polar groups and forms electrets.

Early workers made electrets from a mixture of Carnauba wax, rosin, and beeswax. This mixture is not satisfactory for several reasons. For instance, beeswax is relatively soft and so complex, physically and chemically, that it is difficult to study. Rosin is unstable, is subject to decomposition by light, and precipitates out of the wax mixture.

The writer has made electrets of better stability, and with higher surface charge, from equal parts of Carnauba wax and Hercules hydrogenated rosin (Staybelite resin). Hydrogenation of rosin eliminates the difficulties mentioned above. Splendid semiplastic electrets can be made from 45% Carnauba wax, 45% hydrogenated rosin, and 10% ethyl cellulose.

Electret-making apparatus

For preparing satisfactory electrets the following items are necessary: the

dielectrics mentioned; metal foil (.001-inch thick); a high-voltage power supply; a metallic mold (really a parallel-plate disc capacitor) to hold the molten dielectric; and an oven to house the mold. An oven is used because controlled cooling of the dielectric makes better electrets. From 1 to 2 hours is the best cooling time for the mixtures described.

An insulated oven can be made from sheets of 3/8-inch-thick Transite (obtainable from lumber yards or hardware

stores). Transite can be cut with a small, heavy-bladed hacksaw. The Transite slabs are held together with brass 4-40 machine screws and home-made brass brackets (right angles). One of the photographs shows an oven lined with flake asbestos. The lining gave sufficient insulation to study prolonged cooling of the dielectric. The asbestos is not necessary.

A suitable oven for electret making is shown in Fig 1. The inside dimensions

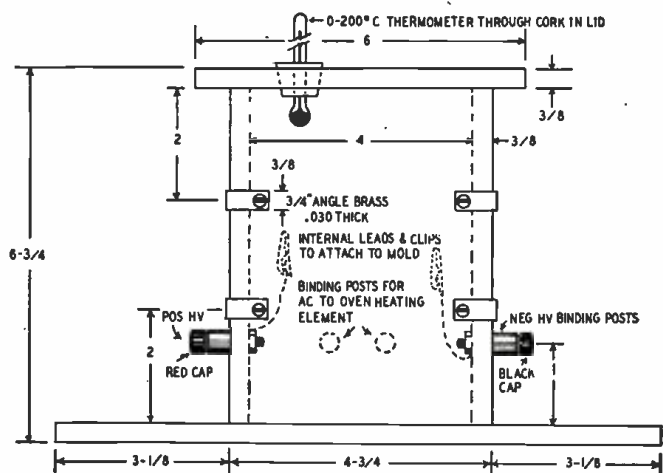
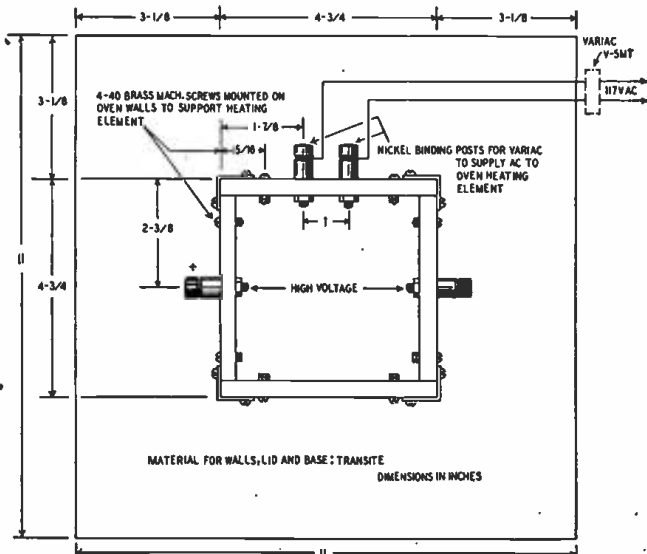

Fig. 1—Top and side views of an oven suitable for making electrets.

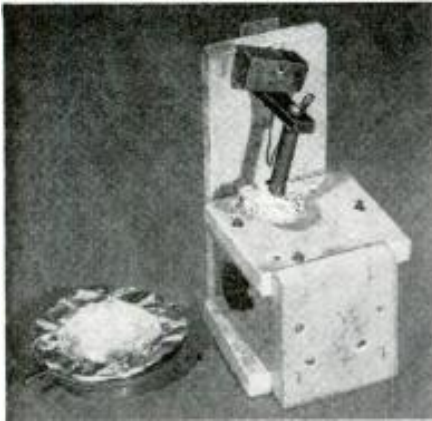

Fig. 2—Transite stand holds the mold, covered with tinfoil. Stand is placed in the oven.

of the oven cavity are 4 x 4 x 6 inches. Two colored binding posts for application of high voltages to the mold are mounted in opposite oven walls. From these posts short lengths of No. 18 hook-up wire terminated with small clips pass into the oven cavity. Connecting the clips to the mold permits application of the high-voltage field to the dielectric inside.

One of the remaining oven walls contains two nickel-plated binding posts for the heating element of No. 28 Nichrome wire (4.25 ohms per foot). The element may contain from 25 to 50 feet of resistance wire, depending on the number of screws in the oven walls. Two rows of staggered holes are drilled in each wall. Machine screws and nuts are inserted, the nuts facing into the cavity. Start at one nickel binding post and wind the Nichrome wire in zig-zag fashion over the screws on the inside cavity. Terminate the wire at the other nickel binding post. Washers prevent cutting the Nichrome wire when tightening the nuts to hold the wire in place. Commercial a.c. is applied to the heating element through a General Radio V5-M-T Variac. Oven temperatures are read from a thermometer (0 to 200 degrees C) mounted in a cork in the oven lid. Simply lift off the lid to remove it from the oven. In the lab thermocouples and a Leeds and Northrup recording potentiometer were used to obtain temperature readings.

The mold which holds the dielectric is a parallel-plate capacitor. The lower electrode is a circular, rimmed brass cup with an inside diameter of 40 mm and an inside depth of 13 mm. Cup walls are 1.6 mm thick. The top electrode is a flat brass disc 25 mm in diameter and 2 mm thick, silver-soldered to a brass rod 1/4 inch in diameter and 1 1/2 inches long. Both electrodes are lined with .001-inch aluminum foil. The rod of the upper electrode is screwed to a bakelite insulator attached to a Transite stand (see Fig. 2). A slit in the back of the stand allows adjustment of the vertical distance between electrodes. The Transite stand is 4 3/4 inches high and 2 3/4 inches wide, and fits nicely into the oven cavity.

Fig. 3 shows the circuit of the high-

voltage power supply used to apply a strong electric field to the dielectric in the mold. Notice the warning not to ground the chassis. The General Radio 200-B Variac permits control of the output from about 500 to 10,000 volts (no load). High-voltage connectors and cable must be used for the output circuit. A 0-200 microammeter in series with ten 1/2-watt resistors totaling 50 megohms is placed across the output terminals. This shows the voltage applied to the dielectric in the mold. A cheap multimeter (0-1 ma) with a 1/16-ampere miniature fuse in the high-voltage leads shows the current that flows through the dielectric.

How to make electrets

The mold, with a 4-mm distance between electrodes, is placed on the Trans-

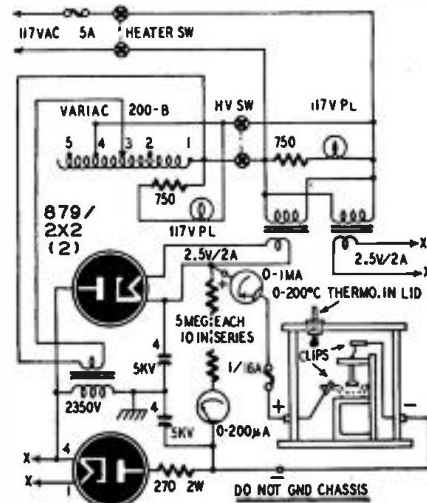
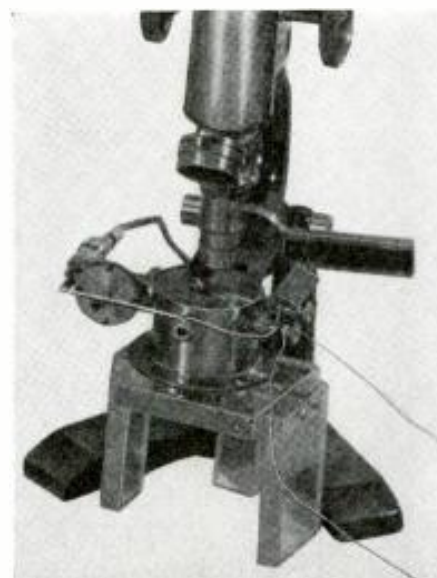

Fig. 3—Power supply furnishes high voltage.

ite stand and inserted in the oven. Clip the high-potential leads inside the oven to the mold elements. The V5-M-T Variac is attached to the heating-element terminals, and the oven is heated to 100 degrees C.



Electrometer is observed through microscope.

Lift the lid off the oven. Pour the Carnuba wax-hydrogenated rosin mixture, previously heated to 110 degrees C in a beaker for one half hour to drive out moisture, into the mold through a small Pyrex funnel. Stop pouring when the molten mass is just deep enough to touch the upper electrode. Replace the oven lid and, when the thermometer again reads 100 degrees C, turn off the heating element.

Disconnect the V5-M-T Variac from its terminals on the oven. Attach the high-voltage cables from the power supply to the colored high-voltage terminals on the oven. When the thermometer falls to 90 degrees C, turn up the 200-B Variac in the power supply until approximately 3,000 volts is applied to the mold. For a 4-mm distance between mold electrodes the field strength will be 7,500 volts per centimeter. Depending on the purity and the nature of the dielectric, the current through the molten mixture will be from about 400 to 1,000 microamperes. This current decreases as the dielectric solidifies, reading approximately zero at room temperature.

At room temperature turn the 200-B Varac to zero and turn off the power supply. Wait at least one minute before disconnecting the high-voltage leads at the power-supply terminals on the panel. Be careful to avoid shocks during this procedure; a shock from charged 4-μf condensers can be fatal.

Next, disconnect the mold from its leads inside the oven and take the stand and mold from the oven. Unscrew the top electrode and remove it from the stand. With the fingers lift the foil containing the electret from the lower electrode. Brush off loose flakes of dielectric. Fold the edges of the foil up over the electret until it is completely covered by foil. The foil acts as a keeper and has the same function as the keeper on a magnet. Completed electrets must be kept wrapped in foil and stored in a closed dessicator or fruit jar which contains about 1/4 ounce of CaCl₂ or other dessicant.

Measuring the surface charge

The surface charges on electrets are measured with an electrometer—an instrument for measuring potential difference or indicating the presence of electricity. The gold-leaf electrometer is one type of electrometer. The Lindemann electrometer, used by this writer,

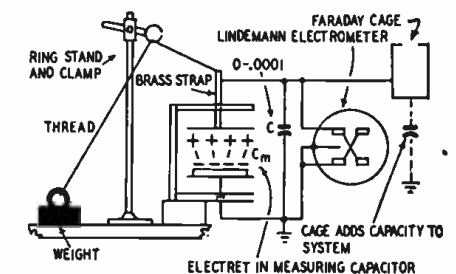

Fig. 4—Schematic of the electrometer setup.

is a metal box which contains four conducting plates. Opposite plates are connected internally to form two pairs of quadrants. A conducting needle, hanging from a fiber inside the box, completes this capacitor-type measuring instrument. Connect the needle to one pair of

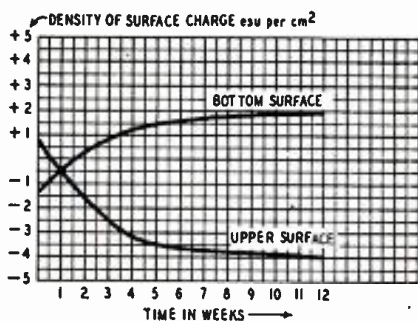

Fig. 5—A graph of surface-charge growth. quadrants (see Fig. 4). A potential difference applied to the quadrants charges the electrometer (regarded as a capacitor) and deflects the electrometer needle. The deflection is proportional to the square of the applied potential difference. Thus batteries of known e.m.f. can be attached to the quadrants (electrometer terminals) to calibrate the electrometer measuring circuit. Graphs of electrometer deflection versus potential difference can be drawn for various values of C. C is a small mica capacitor that can be placed across the electrometer to increase the total capacitance of the measuring system. Consequently, when an electret is placed in the measuring capacitor Cm, the deflection corresponds to a known potential difference on a calibration curve. The deflection is

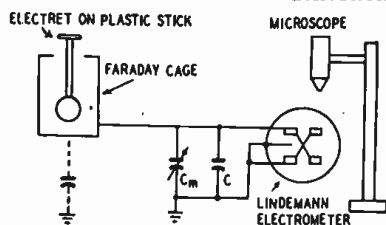

Fig. 6—Setup for finding electret polarity.

observed through a microscope and measured in terms of the units on an arbitrary scale in the microscope eyepiece. A photograph shows a closeup view of the electrometer and the microscope.

The measuring capacitor Cm (Fig. 4) is a modified N-10 Hammerlund capacitor. The capacitor plates are taken off the original insulator and cut down to a radius of 20 mm with a lathe. This makes the area of each plate the same as that of an electret. Then the plates are mounted on a plastic stand 2 inches high. Disregarding the thicknesses of the base and top arm of the plastic mount, the maximum distance between plates will be 1½ inches.

A thin brass strap 3 inches long by ¾ inch wide is soldered to the top plate of Cm. The strap slides up and down through a slit in the top arm of the mount. A silk thread is attached to the free end of the strap. The other end of the thread is tied to a weight (a heavy nut). Looping the thread over a labora-

tory ring stand and moving the weight by hand permits adjustment of the distance between plates of Cm.

A Faraday cage is connected to the high side of the electrometer measuring circuit. The dotted capacitor in the drawing shows that the cage adds capacitance to the circuit. The Faraday cage is a metal cookie can with the lacquer removed. Its use will be apparent in a moment.

The total capacitance of the measuring system, with maximum distance between plates of Cm, is measured by the substitution method. For a 50-µmf value of C the total capacitance was 61 µmf.

The electret's charge

The observed growth of charge on electret surfaces follows the exponen-



Fig. 7—Lifting electret from Faraday cage. The time required for the charges to reach maximum values is from 2 to 4 months. The growth of charge for one of the author's electrets is shown in Fig. 5. This graph

circuit capacitance, and causes an electrometer deflection. The sign of the induced charges is opposite that of the charges on the electret. Then bring a charged rubber or glass rod near the Faraday cage. When the electrometer shows a decreased deflection, it indicates the sign of the net electret charge is the same as that on the charged rod. A charged rubber rod (negative) always causes a decreased electrometer deflection, showing that the net electret charge is negative. This is based on the principle that unlike charges attract.

To find the actual magnitude of charge on an electret surface the measuring capacitor Cm (Fig. 4) is used. Place an electret on the bottom plate of Cm. With the measuring system short-circuited, lower the top plate of Cm until it touches the electret surface. Then remove the short circuit. Raise the top plate of Cm to the top of the plastic mount. Raising Cm causes work to be done and induces a charge on the top plate of Cm. The sign at the induced charge is opposite to that on the electret surface. The work done charges the measuring system capacitance and deflects the electrometer needle. The deflection is noted, and the corresponding potential difference read from a calibration curve.

To obtain the total charge on the electret surface the relation $Q=CV$ is used. The total capacitance C is known. Since $0.9 \times$ capacitance, in microfarads equals centimeters of capacitance, and practical volts (p.d.) divided by 300 equals statvolts, the total charge Q on the surface is obtained in statcoulombs. The density of surface charge is Q/A , which is statcoulombs per square centimeter. A is the electret area. Reversing the electret in Cm, and repeating the procedure gives the density of surface charge for the other electret surface.

For these surface-charge measure-

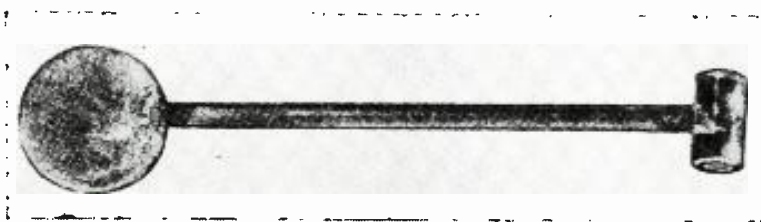

The electret is mounted on a plastic handle so that it need not be touched with the hands.

shows a reversal in the sign of the charge on each surface as time passes. Also, this graph shows that the sign of the net charge of Carnauba wax electrets is negative.

To find the sign of the net charge on an electret the Faraday cage (see Fig. 6 and the cover picture) is used. Insert the electret in the Faraday cage, first short-circuiting the measuring circuit with a small piece of wire in an insulated handle (pigtail in cover photo). Then remove the short-circuit and lift the electret from the cage as shown in Fig. 7. The work done in lifting the electret from the cage induces charges on the sides of the cage, charges the

ments the electrets were mounted as shown in the photographs on plastic handles, to prevent the observer from becoming charged and to make it unnecessary to touch the electret at any time.

Eguchi and Gemant found the relative density of surface charge, under ideal laboratory conditions, to be approximately 6 statcoulombs per square centimeter. To find the magnitude of surface charge for practical purposes this writer used the above method and depending on the type of electret, found that the density of surface charge varied from 0.25 to 4.00 statcoulombs per square centimeter.

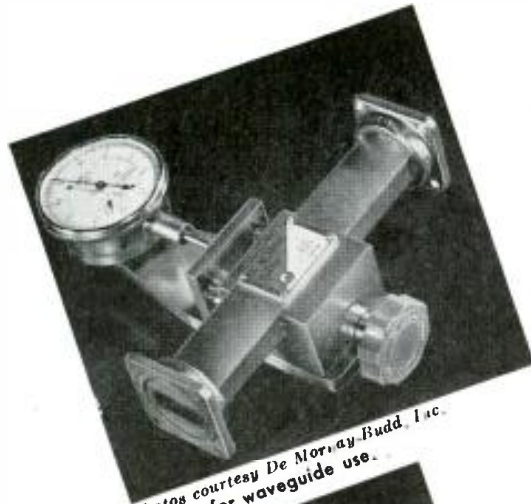

Photos courtesy De Moray-Budd, Inc.
A variable attenuator for waveguide use.



Waveguides may be tuned with this device.

MICROWAVES

PART I— How radio waves can be transmitted inside pieces of pipe

By C. W. PALMER

WAVEGUIDES and waveguide techniques have developed so rapidly as a result of wartime use in radar, point-to-point communication, and other ultra-high-frequency radio systems that the average radioman has not had time to acquaint himself with their principles, understand their advantages in u.h.f. applications, or to learn how to use them. Technical publications have devoted considerable space to waveguide techniques during the past year or two, but usually in language which presupposes some familiarity with the subject and considerable engineering training.

It is important that the practical radioman get a thorough understanding of waveguides and their use. With color television in the offing, and with ham radio (particularly narrow-band FM) looking to higher frequencies in the u.h.f. spectrum, "radio plumbing" (as the guides are affectionately called) will become increasingly common in the next few years.

First of all, what is a waveguide and how does it differ from the parallel-wire and co-axial transmission lines that have become second nature to the ham and the television and FM experimenter? It is a simple hollow tube, usually made of metal, having no central conductor or wire. It is essentially a

means of restricting ultra-high-frequency waves within its walls so that they may be transferred from one place to another.

Waveguides are used mostly for conducting the waves generated by a u.h.f. oscillator to the antenna, for conducting the waves picked up at a receiving antenna to the converter or detector, and for mixing or combining several u.h.f. waves. Waveguides also provide a convenient method for measurement of frequency, power, and similar characteristics in the u.h.f. spectrum.

Waveguides may be rectangular, circular, or oval, though most of the present-day applications use the rectangular guide because it has been found easier to fabricate than the other two shapes.

Losses in waveguides are relatively low since the waves bounce off or are reflected by the inner metallic walls of the guide but otherwise travel much the same as radio waves in free space. The guides may be bent around corners, carrying the waves with them. (The action here is similar to the transmission of light waves through lucite or fused

quartz rods. As a matter of fact waveguides can be made of solid dielectric rods. The waves will follow along just as the light waves do in the lucite rod. The losses are higher than in hollow metallic waveguides, however, which explains why dielectric rods are seldom used.)

Propagation in wave guides

So much for a general explanation of what constitutes a waveguide. To understand how high-frequency radio waves travel in a guide, let's look at Fig. 1. This picture is familiar to most radiomen and is often used to explain dx transmission. A few miles above the earth's surface, there are accumulations or layers of ionized air or gases that act as a reflecting plate or mirror, bouncing the waves back toward the earth's surface, where they are again

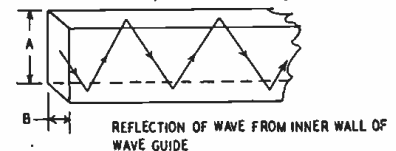

Fig. 2—The waves bounce off the metal walls, reflected by the surface of the earth. Thus the waves are bounced back and forth to appear in receiving antennas thousands of miles away from the transmitter.

In a like manner, the u.h.f. waves bounce back and forth from opposite sides of the waveguide as shown in Fig. 2. The only restriction is that distance A must be greater than a half-wave-

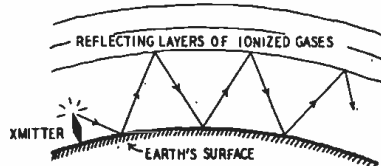

Fig. 1—The oldest and best-known waveguide.

We present here the first article of a series on microwave propagation and waveguide equipment. Since waveguides are the only practical means for propagating and controlling waves across a wide band of frequencies in what is becoming a highly important part of the radio spectrum, the up-to-date radioman must master waveguide technique.

length or the waves bounce back and forth from directly opposite points and do not advance through the guide. The frequency at which A is half a wavelength is known as the cutoff frequency of the guide.

Waveguide action cannot be fully understood in terms of transmission-line theory, though there are some similarities between them. Waveguides must be approached from the viewpoint of radiation of electromagnetic waves instead of that of conduction.

However, since most radiomen are familiar to some extent with transmission lines, they provide a jumping-off point. Let us examine Fig. 3-a. This shows a section of two-wire transmission line with a quarter-wave stub across it. The open ends of a quarter-wave stub present a high impedance across the line and do not short circuit it. As a result, the addition of the stub has very little effect on radio currents flowing in the transmission line. Now if we add an infinite number of quarter-wave stubs, as in Fig. 3-b, we will have a continuous rectangular pipe (3-c) or one type of waveguide. In this guide,

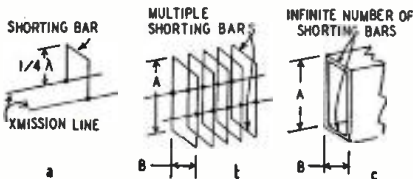

Fig. 3—How a waveguide might have evolved.

dimension A must be at least a half-wavelength but may be larger. (If it were smaller, the waves would be below the cutoff frequency of the waveguide.)

In considering the transmission of r.f. energy in waveguides, a new term, *mode*, has been applied. If we examine a cross section of co-axial transmission line, where there is a central conducting wire surrounded by a metal tube or shield but insulated from it, we find that there are two fields, a magnetic

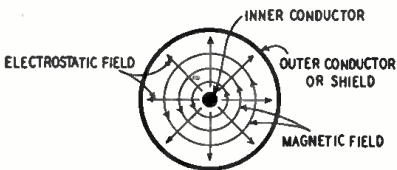

Fig. 4—Energy in co-axial transmission line.

field and an electrostatic field, resulting from the conduction of r.f. current through the transmission line. This is

illustrated in simplified form in Fig. 4.

Similarly, in a waveguide, electrostatic and magnetic fields are built up due to the propagation of r.f. current. These can be seen for one mode or orientation of fields, called the TE₀₁ mode, in a rectangular waveguide in Fig. 5-a. The magnetic lines of force can be likened to whirlpools when looking down on the top of the waveguide. These whirlpools travel down the tube in the direction of propagation. The electrostatic lines of

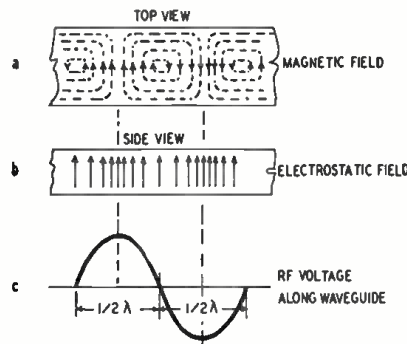

Fig. 5—Energy in a rectangular waveguide.

force are at right angles to the magnetic ones and are shown in the side view of the waveguide in Fig. 5-b. The corresponding instantaneous r.f. potential along the guide is shown at c.

There are numerous modes, identified by the letters TM for transverse magnetic and the letters TE for transverse electrostatic modes, one of the most commonly used one being the TE₀₁.

The subscripts refer to the number of waves which travel down the guide at one time. A TE₀₂ wave, for example, would have two waves traveling down the waveguide side by side, much as if a vertical partition were running down the center. A diagram of the TE₀₂ mode is given in the article *Microwaveguides* in last December's issue. The question of modes will be covered in greater detail in a future article.

The modes are determined or selected by the type and placement of the coupling device from the source of r.f. energy. Usually r.f. power is introduced into or extracted from a waveguide by means of a quarter-wave dipole, probe, or coupling loop. Two of these are shown in Fig. 6. In the case of the TE₀₁ mode the probe is introduced at the center of the A dimension and at a point of maximum electrostatic field. When a loop is used, it must be introduced in the B dimension at a point where the magnetic field is greatest.

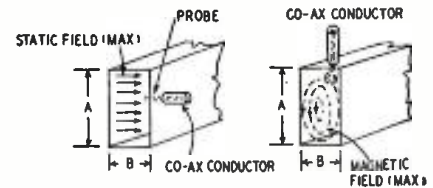

Fig. 6—Getting energy in and out of guides.

Microwave testing equipment is usually arranged so that the coupling device can be shifted by means of a slot cut longitudinally in a length of waveguide. This allows the energy distribution to be examined continuously along the guide. There is a point of maximum energy, reversed in polarity from the previous maximum, at each half-wave point. This provides a convenient means of measuring wavelength or frequency and also *standing-wave ratio*, which will be discussed in detail in a later article.

Waveguide dimensions

A given size waveguide can carry u.h.f. currents of any frequency higher than cutoff, but there is one optimum frequency that is carried best by a given size of guide. For this reason the radio industry has endeavored to standardize on the smallest number of sizes consistent with good performance. In the following list, dimensions are in inches and frequency in megacycles:

A dimension	B dimension	Cutoff freq.	Wall thickness
3	1½	2,080	.080
2	1	3,155	.064
1½	¾	4,305	.064
1¼	⅝	5,265	.064
1	½	6,772	.064
¾	⅜	9,495	.064
½	¼	14,060	.040
1½/32	¾/16	20,935	.031

Above 20,000 mc it has become the practice to use solid coin-silver waveguides or, in some cases, laminated guides, because of the difficulty of manufacturing hollow guides of constant size. The tentative outside dimensions of these are as follows:

A dimension (inches)	B dimension (inches)	Range (mc)
0.42	0.17	18,000-26,000
0.34	0.17	22,000-33,000
0.28	0.14	26,000-40,000
0.224	0.112	33,000-50,000
0.188	0.094	40,000-60,000
0.148	0.074	50,000-75,000
0.122	0.061	60,000-90,000

(Continued on following page)

Because of size and construction limitations, waveguides are not practical for frequencies higher than about 100,000 mc or lower than 3,000 mc. An idea of the relative efficiency of a given size

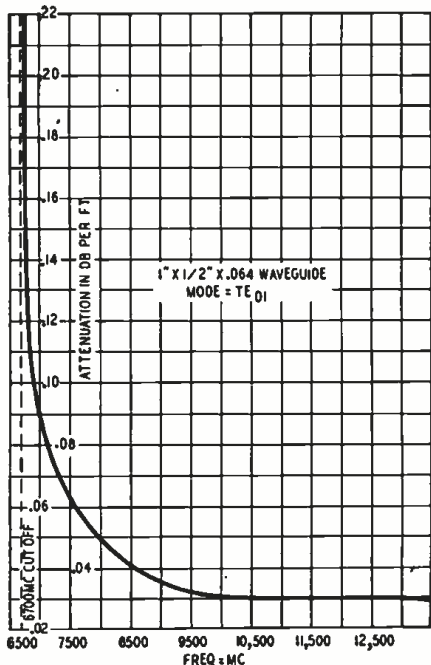

Fig. 7—Attenuation as cutoff is approached.

guide for a wide frequency spectrum can be seen in Fig. 7. Here, attenuation in decibels per foot of a piece of 1 x 1/2-inch waveguide is shown at various frequencies. The low-frequency cutoff at about 6,700 mc is quite evident in the greatly increased loss as this frequency is approached.

Special waveguide devices

Just as at lower frequencies, special devices for introducing inductance, capacitance, and resistance are available for waveguides, though they differ in shape and use from the familiar coils, capacitors, and resistors. For example, fixed or variable resistors in waveguide practice are strips of resistance material introduced longitudinally in the

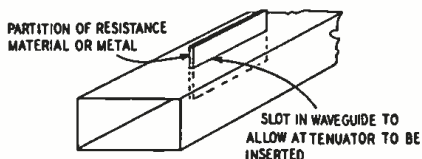

Fig. 8—Variable resistor, waveguide style.

guide as shown in Fig. 8. The further into the waveguide the resistor strip is lowered, the greater the attenuation. By adding a driving mechanism, we have a variable attenuator which can be calibrated.

A section of waveguide can be used as a tuned circuit or as a transformer, displaying both inductance and capacitance or, to be more exact, inductive and capacitive reactance. In Fig. 9 the u.h.f. voltage is introduced at point X. If the C dimensions are a quarter-wave each, reflections will occur and reinforce the voltage at X. (Dimensions C may also be multiples of a quarter-wavelength.)



The standing-wave detector, a device for exploring energy distribution in a waveguide.

By moving the closed ends, the guide can be tuned.

Open-ended or closed sections of waveguide can be used for switching u.h.f. currents from one waveguide path to another, without actually closing off the undesired path mechanically. Fig. 10 shows a small section of waveguide with two paths Y and Z and a short closed section U arranged with a mechanical flap that provides a short circuit at point A. When A is shorted, point X is effectively a solid wall and r.f. current can pass only through path Y. When the short at A is removed, current can pass both Y and Z paths. Many varied switching arrangements have been devised following this general scheme.

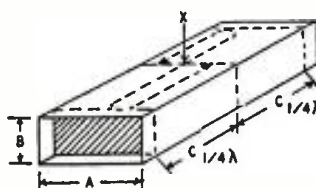

Fig. 9—The waveguide section may be made to act like an inductor or capacitor by making it less or more than a quarter wave long. See RADIO-ELECTRONICS, Dec. 1948, p. 24.

Impedance matching, usually done with transformers on lower frequencies, is accomplished in waveguides with shorting stubs. For instance in matching a waveguide section to a length of co-axial line, the characteristic impedance of the waveguide is higher than that of the co-axial line. The impedances are matched by introducing metal plates called matching stubs. They reduce the opening in the guide and reduce its impedance to match the co-axial line, which is coupled by means of a loop or dipole to the waveguide.

When two lengths of waveguide are coupled together, there is danger of leakage of the u.h.f. current at the junction, with resulting loss in efficiency. By

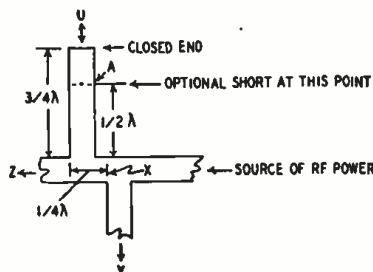

Fig. 10—Right-angle stubs may make a point in the waveguide impassable to radio waves.

cutting a slot approximately a quarter-wavelength deep in the junction plate of one of the pieces of waveguide, an r.f. choke is created at the junction (see Fig. 3-a); it effectively prevents high-frequency leakage. See Fig. 11. A straight junction is always butted against a choke or slotted junction in joining waveguide units.

From the few examples given above it can be seen that you can do anything with waveguides that can be done with the old familiar coils, capacitors, and

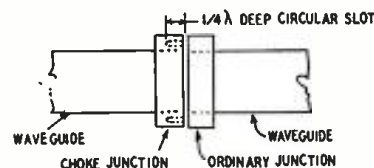
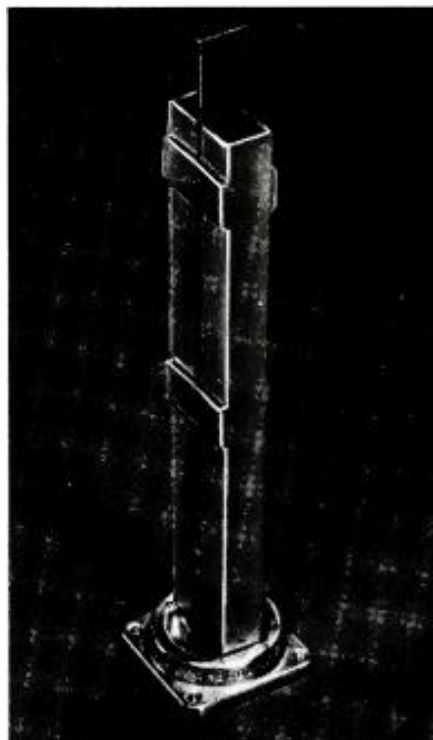

Fig. 11—A quarter-wave stub (slot in this case) is an efficient radio-frequency choke.

transmission lines. The only difference is in the mechanical form of the waveguide circuits. In further articles of this series, the use of waveguides as inductors, capacitors, and attenuators will be described. Setups for measuring frequency, generating power, and measuring standing-wave ratio will be shown, and the discussion of basic waveguide theory will be continued.

(Our next installment will discuss some of the things mentioned above in greater detail, paying special attention to standing waves and the standing-wave ratio, waveguide tuning, and resonant cavities, and will introduce some simple waveguide circuits.)



A terminating section, or piece of waveguide with an attenuating strip which presents to the waves the waveguide's characteristic impedance, terminating the line without causing reflections or setting up standing waves.

Oscillator Circuits as Used in Industry

By ED BUKSTEIN*

In addition to their usual signal-generating function, oscillator circuits are suitable for a wide variety of control applications. For example, starting or stopping oscillation may cause a relay to operate and to control an external circuit. For this purpose the oscillator is a sensitive and reliable control.

Fig. 1 illustrates the operating principle of one type of control oscillator. The circuit is simple, oscillation resulting from the energy fed back from L1 to L2. When the circuit is in oscillation, the plate current of the tube is at minimum and the relay is open. The reason for this is that during oscillation grid current flows and produces a bias voltage across the grid resistor. The negative grid voltage limits the plate current.

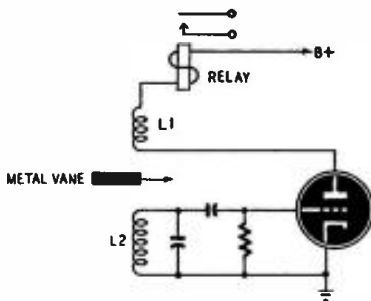

Fig. 1—Vane stops oscillation—relay closes.

If, for any reason, oscillation ceases, no bias voltage is developed, the plate current increases, and relay closes. For instance, if a metal vane is brought into the space between L1 and L2, feedback is reduced to a point where oscillation stops. In short, insertion of the metal vane causes the relay to operate.

One application for this circuit is leveling elevators at floor levels. An oscillator is mounted at each floor, and the metal vane is attached to the bottom of the elevator platform. The electrical connections to the elevator door are made so that the door cannot be opened until the oscillator relay is closed; that is, until the elevator is properly leveled.

A similar arrangement might be used with railroad cars. With the oscillator mounted on the underside of the car

and the metal vane between the tracks, arrival of the car at a given point on the tracks would operate the relay.

Another variation of the same basic principle is the protective meter. Coils L1 and L2 are made compact and are mounted on the face of the meter as shown in Fig. 2. A small aluminum slug is attached to the pointer. As the meter reading increases to a predetermined value, the aluminum slug passes between the coils and the relay closes, preventing a voltage or current from rising above a certain level. The coils may be made movable to permit setting at any desired level.

The oscillator shown in Fig. 1 could also be adapted to assembly-line problems such as detecting metal particles in packaged foods passing on a conveyor belt. Operation of the relay would energize a reject mechanism to remove the objectionable item from the conveyor belt automatically.

In other applications, it may be desirable to have the relay normally closed so that it will open upon the insertion of the metal vane. This may be accomplished by providing some other form of feedback and reversing coil L1 so that its feedback is degenerative. Under these conditions, oscillation is prevented by the degenerative feedback until the metal vane is inserted. The metal vane reduces the degenerative feedback, allows the circuit to oscillate, and causes the relay to open.

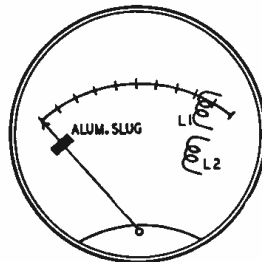

Fig. 2—The vane circuit adapted to a meter.

Another form of control oscillator is the capacitance-operated relay often used as an alarm to indicate the approach of a person or object. Here again the circuit consists of an oscillator containing a relay in its plate circuit (Fig. 3).

If a finger is touched to the grid of

this oscillator, the grid-to-ground capacitance is so altered that oscillation ceases. As in the previous case, when the oscillation stops, no bias is developed and the plate current increases to a value sufficient to close the relay.

To eliminate the necessity of touching a grid, the grid is connected to a large metal plate. Contact with this plate will cause the relay to operate. The circuit may be made sufficiently sensitive so that direct contact with the plate is not necessary, the approach of a person or object being sufficient to trigger the circuit. The metal plate may be a metal door or a large plate fastened to a door; the circuit will indicate the approach of anyone toward the door. In

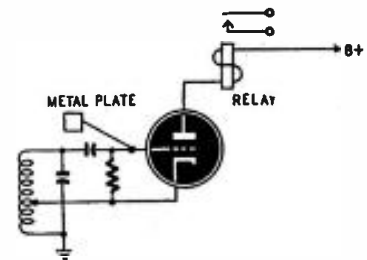

Fig. 3—The simplest capacity-operated relay.

other cases, the doorknob itself or the handle of any cabinet or compartment door may be used as the metal plate. The system may be used to protect a bank vault or safe, in the latter case the safe itself being used as the metal plate.

Another possible use of the circuit is for counting, for instance, the number of automobiles passing over a bridge. The automobile's approach to a metal plate initiates circuit action. The relay is replaced by an electromechanical counter with numbered disks. The same system could be used to count objects passing down an assembly line.

The circuit is also adaptable for the protection of power-machine operators. The metal plate is located so that the operator's hand, if in a dangerous position, will prevent the machine from operating.

One system of remote control involves the use of carrier-current transmission. An impulse of r.f. energy is transmitted over the power lines. Somewhere else in the same building or vicinity a re-

*Northwestern Vocational Institute.

ceiver connected to the same power lines and tuned to the same frequency picks up the signal and operates a relay. This method of remote control is illustrated in Fig. 4. When the transmitter is turned on by a key or push-button, a pulse of r.f. energy is transmitted through the power lines. At the other end of the system, the pulse is picked up by the receiver whose output operates a relay.

Suitable transmitter and receiver circuits are shown in Fig. 5. The transmitter is a conventional oscillator. For convenience and simplicity, no rectifier is used, the oscillator operating directly from the a.c. line. When the switch is closed, the circuit oscillates and feeds r.f. energy into the line.

The receiver also is small and simple. A series-resonant L-C circuit tuned to the frequency of the transmitter picks up the signal from the power lines. The signal voltage developed across C causes ionization in the OA4-G gas tube. The

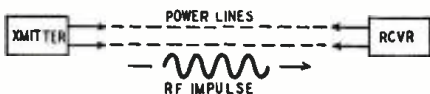

Fig. 4—Power lines carry control impulses.

resultant increase of plate current closes the relay. This system is satisfactory for a wide variety of remote control uses.

Use of the oscillator for measurement is demonstrated by the circuit of Fig. 6. The frequency of the signal is determined by the L and C of the tuned circuit. The capacitor is made up of

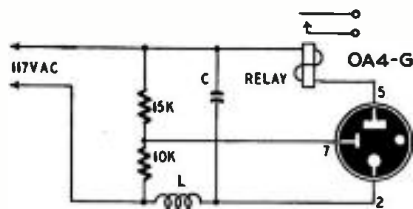
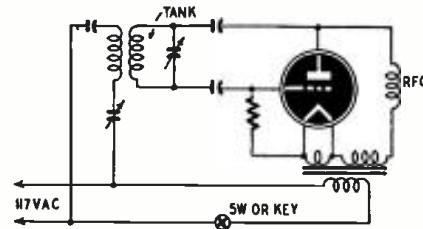

Fig. 5—Typical receiver (above) and transmitter (below) for power-line control circuits.



two plates, one of which is free to move. As the plates become farther separated, the capacitance is decreased and the frequency of oscillation increases. Conversely, as the plates move closer together, the frequency decreases. This oscillator may be used as a highly sensitive electronic micrometer for accurate thickness measurements, the thickness of a material placed between the two plates determining the frequency of oscillation. Thus, oscillator frequency becomes a function of material thickness.

The plates may also be moved by the changing thickness of a belt of manufactured material as it passes between them. Sensitivity may be increased by

passing the material between rollers mechanically coupled to the plates. A mechanical gain resulting from lever action will cause a small movement of the rollers to produce a relatively large movement of the plates.

The same circuit may be used also as a humidity gauge. In this application, the two plates are connected to opposite ends of a stretched fiber. Changes in the air's moisture content cause the fiber to expand or contract and consequently vary the frequency of oscillation.

The oscillator shown in Fig. 6 is often used in conjunction with a fixed oscillator as shown in Fig. 7. The fixed oscillator and the variable one both feed into a mixer circuit to produce an audio beat note. Any variation of plate spacing produces a change in the audio note in the loudspeaker, giving an aural indication.

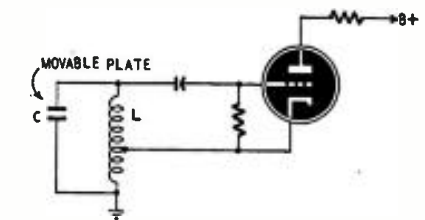

Fig. 6—An oscillator used for measurement.

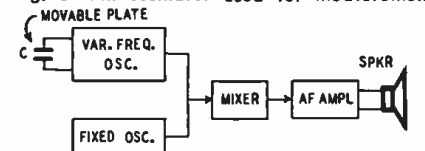

Fig. 7—Measuring circuit with aural output.

FOR SAFER ANTENNA INSTALLATIONS

The rapid increase in the use of television receivers has brought a flood of inquiries as to the relative fire and life hazards of television sets, and as to their proper installation and the installation of their antenna systems.

Since television operates on essentially a line-of-sight basis, proper reception usually necessitates an exterior antenna and as the distance from the television transmitter increases, the antenna must of necessity extend higher in elevation. This increases somewhat the possibility of damage by lightning, and, as the antenna is usually mounted on a pole or tower on the roof, there is a possibility that, unless properly installed and supported, the system may fall in high winds, dropping across power lines or injuring persons or property.

The National Electrical Code, in Article 810, contains provisions covering radio receiving aerials, but these provisions were designed primarily to cover conventional radio installations and do not appear adequate for the special conditions of television. . . Arresters for ordinary radio aerials are not suitable for television, but proper arresters are available. These arresters should be placed on each conductor of a ribbon-type lead-in. If a co-axial cable

is used for lead-in, suitable protection will be provided by grounding the exterior metal sheath.

Where the antenna is mounted on a metal pole or tower, the pole or tower should be properly grounded. Opinions vary as to the size of the grounding conductor, but it should preferably be at least a No. 6 or 8 A.W.G., connected to a suitable ground such as an underground water pipe, and if the building is equipped with a lightning rod system, should be properly bonded to this system.

The type of lead-in commonly used is the polyethylene ribbon type. Although this material burns much like rubber, and falls in flaming drops, its use for this purpose is not considered particularly hazardous. Recent improvements of the polyethylene lead-in, although still flammable, have eliminated the flaming drops. The co-axial cable lead-in is generally considered the best from the fire hazard viewpoint, but is considerably more expensive and has operational disadvantages.

Considerable care should be given to the mechanical stability of the antenna and its support. Where located on the roofs of buildings the antenna and supporting guys should not be so located as to interfere with operations of the

fire department or where liable to cross with electric power lines. Some fears have been expressed as to the possibility of shock hazard on contact with an antenna or lead-in, because of the high voltage used in the receiver, but these fears are groundless if the receiver is properly designed.

It is generally considered that a television receiver has a greater inherent fire hazard than a conventional radio receiver, because of its greater current consumption, a greater number of heat producing components and the higher voltage used. Particular care should be taken that the natural ventilation built into the set is not obstructed or reduced by location or blanketing. Television sets should not be left turned on while unattended.

Television sets of several manufacturers have been listed by Underwriters' Laboratories, Inc., as having been acceptably designed and constructed with respect to the fire and life hazard. Prospective purchasers should assure themselves that the set they contemplate purchasing is listed by the Laboratories.

(The report quoted above was Special Interest Bulletin No. 275 issued by the National Board of Fire Underwriters, New York, N. Y.—Editor)

Diathermy Generator

Any experienced radio constructor can build a serviceable diathermy machine

By H. L. BUMBAUGH



Front-panel photo shows the control markings.

THE diathermy equipment shown on these pages has been in use several years. It has proven powerful enough and free from "bugs." No repairs or adjustments have ever been necessary, mostly due to the fact that all components operate with large safety factors.

The application of high-frequency alternating currents to body tissues has long been considered of great therapeutic value. The equipment, however, is relatively costly. With this fact in mind the author set out to design and build a modern diathermy oscillator and to present information about it in such form that any amateur, serviceman, or other technically qualified person might easily duplicate the device.

A word of caution should be given. All apparatus of this nature comes under the regulations of the Federal Communications Commission and must be constructed and operated strictly in accordance with those regulations. The equipment described here does comply.

Medical men consulted expressed the opinion that a raw a.c. wave places considerably more strain on the body tissues and nerves than the relatively smoother wave from a rectifier with a small amount of filtering and that the rectified waveform gives greater heating effect for any given power output.

Since a rectified output means lengthened tube life, a reduction in interference, and generally better all-around conditions a rectified setup using 866 tubes was decided on.

Considering the nature of the requirements and the probability of operation by technically unskilled persons, it was deemed advisable to provide for at least 200 watts of power.

The oscillator chosen was a push-pull type using 838 tubes. Other tubes of equivalent power rating may, of course, be substituted. The circuit diagram appears on the next page.

The oscillator must operate at one of the frequencies designated for diathermy by the FCC; in our case the 13,560-kc band was chosen. The oscillator should not deviate from this center frequency by more than 6.78 kc, which is a reasonable stability requirement.

As will be seen from Fig. 1, the circuit for the applicator pads consists of

a pickup coil L2 mounted co-axially with the plate coil and a series variable tuning capacitor. With increasing capacitance this capacitor causes the pad circuit to approach but never attain resonance with the plate circuit. This permits loading the oscillator adequately but cannot make it unstable due to reduced excitation resulting from a too heavily loaded plate circuit.

The degree of heat furnished is controlled by the grid-bias setting of the 4-position bias switch and of the pad-circuit variable capacitor.

Many of the parts required for the oscillator will be found in the junk-box. The pads or other applicators will probably have to be purchased from a manufacturer of physical therapy apparatus.

Tubes equivalent in power rating to 838's may also be used if proper grid bias is applied and other operating requirements are met. Gammatron 54's have been used with considerable success, and the initial cost is quite low.

(Continued on following page)



The equipment is mounted on two decks inside the cabinet. R.f. section is on top.

In Fig. 1 it will be noted that two switches are required to put the device in operation. The ON position of these switches is indicated by a red and a green bullseye behind which small night light assemblies have been placed. The TREATMENT switch cannot connect the primary of the power transformer to the line unless the WARM UP switch has connected the filament transformers. This is to prevent application of plate voltage with no filament voltage; the filaments should be heated for a short time before applying high voltage. Operators should be thoroughly instructed in this routine.

To apply the output of the equipment to a patient, plug the machine into a convenient 117-volt a.c. outlet. Insert the banana plugs on the ends of the pad leads into the large jacks on the lower-right-hand corner of the control panel (see photo). Turn on the WARM UP switch which applies filament voltage and turns on the green pilot light. After a couple of minutes—having arranged the pads on the patient as explained later—close the TREATMENT switch which applies power, lights the red pilot light, and begins the treatment.

Coarse adjustment of the treatment intensity is obtained by adjusting the POWER switch in the lower-left-hand corner of the control panel. Fine gradations are obtained by varying the setting of the pad-circuit variable capacitor (the wheel in the lower center section of the control panel). In the majority of cases a maximum meter reading will occur at or near full scale

on the capacitor dial. While the millimeter will not show as great changes in readings with rotation of the variable pad-circuit capacitor as it will between successive points on the POWER switch, a neon bulb held near one of the pads will show a considerable variation in r.f. energy output through the range of the capacitor.

The cabinet for the equipment may either be purchased or made by the constructor. We were unable to find a ready-made cabinet which met our requirements, so we built one, 21 inches high, 18 inches wide, and 15 inches deep out of 3-ply veneer. The sloping panel on which all the controls are mounted was made of tempered Presdwood and after several coats of shellac was finished off with three coats of black enamel, dressed down with steel wool, and a final coat of wax applied. The cabinet proper was given three coats of an orchid gray enamel.

Four large-wheel casters and a metal handle on each side of the cabinet make it easy to move the equipment from place to place.

Figure 2 shows how the pad circuit terminates on the control panel in two large jacks which accommodate large banana plugs on the end of the pad leads.

The high-voltage transformer is an old instrument transformer obtained from the local power company's salvage shop. It furnishes 1,000 volts each side of the center tap. Such transformers are ideally suited for this use as they are very small and yet have adequate power capacity. Any local power company should be able to furnish an obsolete one at a very reasonable price. Of course, any other transformer giving 1,000 volts each side of center and having a power capacity of 200 or 300 watts may be used equally well.

Any value between 4 and 12 henries will do for the filter choke. It should have a current-carrying capacity of about 300 ma.

The line filter chokes shown in the 117-volt supply line are air-wound $1\frac{1}{4}$ inches in diameter to a length of $2\frac{3}{8}$ inches with 14 turns of No. 18 enameled wire. There are two windings, interwound with each other. One winding is shunted with a 100- μ f variable capacitor which can be tuned to give greatest trap effect. Because of the unity coupling between the two windings, the one capacitor serves to tune both windings.

The 838 plate coil L1 is 17 turns of No. 8 enameled wire air-wound $2\frac{1}{2}$ inches in diameter to a length of 4 inches. L2, the pad pickup coil, is 22 turns of No. 10 enameled wound to a diameter of $1\frac{1}{2}$ inches in two sections of 10 turns each, spaced the diameter of the wire, the two sections being spaced 2 inches apart by partially straightening out two of the center turns. L3 is 25 turns of No. 10 enameled, $1\frac{1}{2}$ inches in diameter, air-wound, 3 inches long.

The builder has the option of using either pads or a coil for applying r.f. to the patient. Either form may be obtained from the larger supply houses.

Each pad is a flat grid of small-mesh wire cemented or molded between two layers of rubber, with a stranded conductor soldered to the wire mesh, the conductor being housed in rubber tubing. In use, the pads are placed on each side of the body or the member to be treated.

When the coil is used, it is wound around the member or coiled upon it. Distributed capacitance completes the "patient circuit."

A word of caution is in order here concerning any metal objects in the field of either the pads or the coil. Any piece of metal—no matter what size—will have induced in it currents which may heat the metal to a very high temperature and may cause painful burns or perhaps ruin clothing. Always make sure no metal objects of any kind are in the field of the applicator.

Diathermy can be extremely dangerous. Treatments must be administered only by a qualified physician who is familiar with diathermy techniques.

When construction is finished, the oscillator should be set on the operating frequency of 13,560 kc by means of an r.f. oscillator, a calibrated communications receiver, or other available means. Once set it will require no further attention. As a final precaution a check should be made to see that the operation of the device in no way interferes with any established service, such as radio or television. Should any such interference show up, the usual amateur remedies may be applied.

(Interference from diathermy equipment has troubled many users of radio equipment for a number of years. The FCC, after considerable study, assigned three bands of frequencies for diathermy equipment. These bands were allocated in portions of the radio-frequency spectrum where they are least likely to interfere with broadcast or vital communication services. The center frequencies of the bands are 13,560, 27,120, and 40,680 kilocycles. The frequency tolerances of these bands are 6.78, 162.0, and 20.0 kilocycles respectively. There is no limit to the radiation of the fundamental so long as it is within the prescribed bands. The harmonic radiation shall not exceed 25 μ v per meter at a distance of 1,000 feet.

If such equipment interferes with operation of nearby broadcast or television receivers, wave traps and tuned stubs may effect a cure. If your equipment does interfere with the neighbors radio, it is advisable to have a radio service technician take the necessary remedial steps.—Editor)

MATERIALS FOR DIATHERMY GENERATOR

Resistors: 2—15,000, 2—25,000 ohms, 25 watts.
Capacitors: 6—.002- μ f, 1-kv, mica; 1—1- μ f, 1-kv, oil-filled; 2—50- μ f, split-stator, 1—250- μ f, variable, $\frac{1}{4}$ -inch plate spacing.
Tubes: 2—838, 2—866/866A.
Switches: 2—s.p.s.t. toggle, 1—single-circuit, 4-position rotary.
Transformers and choke: 1—2.5-volt, 10-ampere, 1—10-volt, 7.5-ampere filament transformers; 1—2,000-volt, 300-ma, center-tapped high-voltage transformer; 1—12-henry, 300-ma filter choke.
Miscellaneous: 1—2.5-mh, 300-ma r.f. choke; 1—0-300-ma d.c. meter; sockets for 838's and 866's; 2—117-volt pilot-lamp assemblies, one with green, one with red jewel; 1—5-ampere fuse and holder; 2—diathermy application pads; cabinet; necessary hardware.

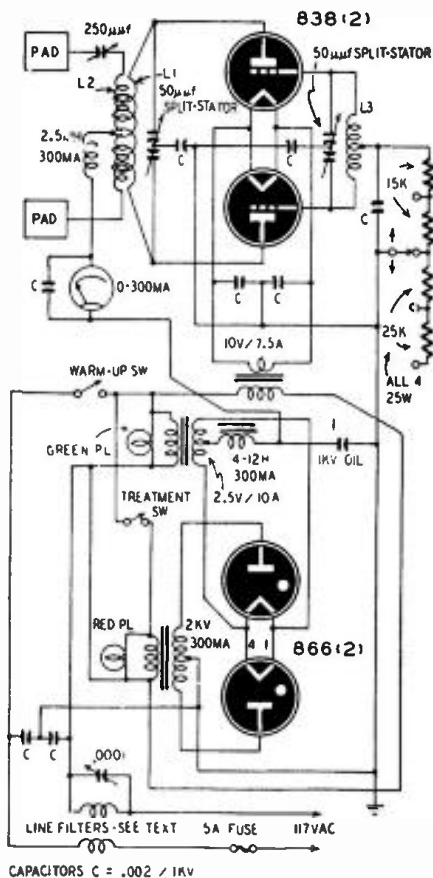

Fig. 1—Schematic of the diathermy generator.

Cinema Television

By E. AISBERG*

IN October, 1948, an international congress on the relations between television and the cinema was held in Paris. The chief subject was television, a new technique which lends itself to discussion more readily than the moving picture art in which practically everything is already standardized. A number of very interesting ideas were brought forth.

Incontrovertibly, television has benefited by numerous ideas gained from the technique of the movies. Especially in the television studio has the new art profited from the experience gained in moving-picture photography. Whether lighting, "panning," mixing, or fading, the technique is that of the cinema studio. The regular special effects of movie-camera technique are more or less successfully reproduced in television. The technicians who transmit images through space draw without shame upon the immense treasure accumulated by the specialists of the transmission of images through film.

Finally—and more immediately and directly—television fills a good part of its programs with the help of moving-picture films. At least this is the case in France where the relations between the cinematographic industry and the official television services are excellent. The producers of films realize (with a more keen intelligence than was expected) that, far from competing with the movie producers, television offers excellent advertising to their films. This is why the antennas of Télévision Française transmit feature films, documentaries, and newsreels every week.

If television benefits from the services offered it by the cinema, it may, in return, pay its debt in a most striking manner. One can foresee what an immense contribution television may make to the motion-picture art. For example, the television camera offers several points of superiority over that of the cinema:

1. Its *sensitivity* is notably greater than that of the most sensitive emulsions. The slow-electron orthicon tube permits taking pictures in twilight and even by the light of a candle—something impossible even with the fastest panchromatic films.

2. In a television camera it is possible, by purely electric controls, to modify, not only the mean brilliance of the images, but also their gamma—that is to say, the degree of contrast. In film, the gamma of a given emulsion handled with a given developer is constant.

3. An *electronic finder*, consisting of a viewing tube, permits viewing the image *at the instant* it is being taken. On the other hand, the optical finders of moving-picture cameras inform the operator only incompletely.

4. By using *several cameras* simultaneously it is possible to take advantage of all the tricks of mixing, the passage by fading from one scene to another, without resorting to the artifices of the cutting room.

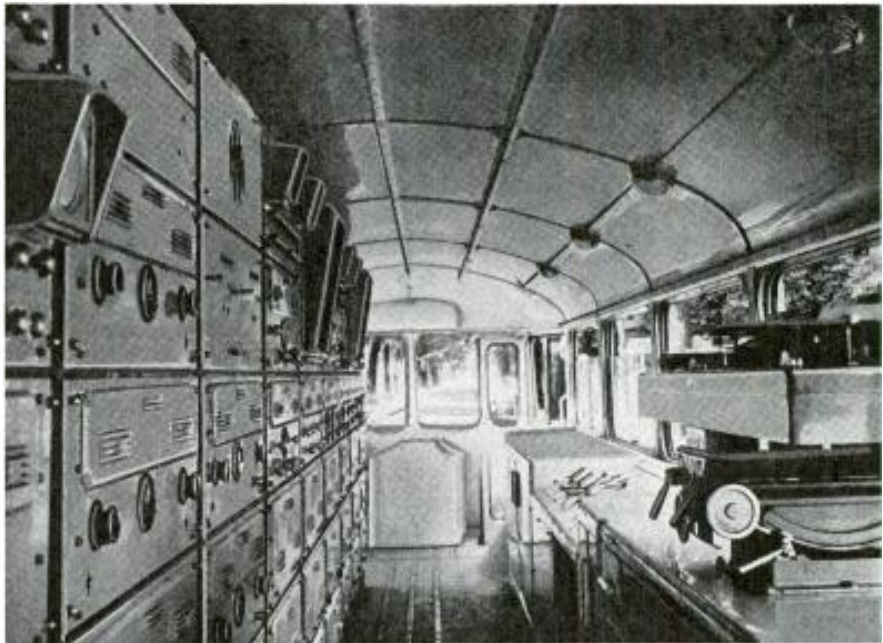

A French television truck equipped for outside news pickup and microwave transmission.

All these qualities of television give rise to the belief that in the future the television camera will be substituted for the standard moving-picture camera now used. The pictures will be taken with one or several television cameras, operating under the best possible conditions. The images when registered will be transmitted on co-axial cables, in the form of video frequencies, to a central reception point where they will be projected upon the screen of a television receiving tube, from which they will be finally registered on film.

The director can control the images on a television screen which will indicate to him exactly how the images are being registered on the film. He can thus make any necessary corrections with the receiver controls, at the same time giving instructions for the changes

in staging required to make corrections unnecessary.

In the case of newsreels, it is again useful to register them with the aid of a television camera and to transmit them by shortwave to a central reception point where they may be filmed. Further, they may be relayed from the reception point to moving-picture theaters equipped for large-screen projection television. In this manner, the event may be viewed by moving-picture spectators at the time it takes place. Simultaneously it can be preserved in celluloid for the thousands of other spectators who will view it with a certain displacement in time. Thus, after having received essential help from the moving-picture art, television may in its turn lend its assistance to the adult techniques of the cinema.

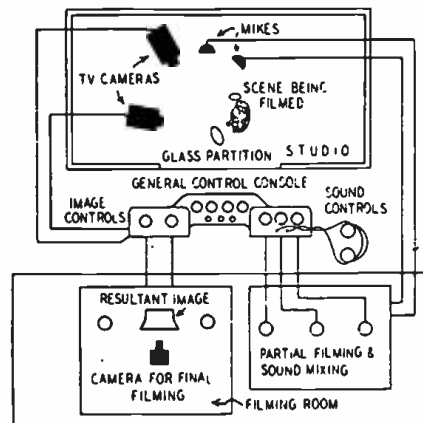

How television may be used in film studios.

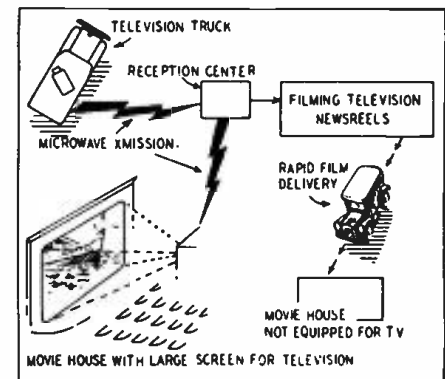

Television and microwaves speed newsreels.

*EDITOR: *Toute La Radio*, Paris, France.

Antennas For Television*

Part IV—Excellent reception may be had from the simple dipole provided it is made and matched to the line correctly

By
EDWARD M. NOLL
and
MATT MANDL†

A SIMPLE antenna properly cut, positioned, oriented, and matched will equal or surpass in performance many of the elaborate arrays now so prevalent. Elaborate antennas do give additional gain and noise rejection, but the antenna type is not the only important factor in reception.

There are many locations in which a very basic antenna with its simplicity, ease of erection, and lower cost will serve. The simple antenna is much easier to support and it can be mounted high and clear—an increase in antenna height being more effective than the addition of an element.

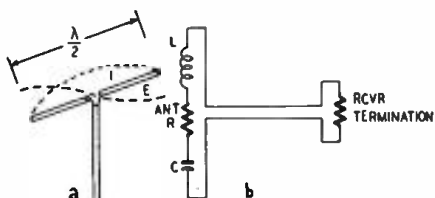

Fig. 1—Actual and equivalent dipole circuits.

For optimum performance from any type of antenna these points must be considered:

1. Correct antenna matching. To obtain maximum transfer of signal, it is vitally important that the transmission line match the receiver input, for it is this point from which reflections might start. Antenna match to transmission line and correct transmission-line length (or addition of lengthening stub) can give considerable improvement to weak stations, regardless of the type of antenna used. Use a low-loss line, remembering that the longer it is, the greater the attenuation. If any mismatch should be present, it will be aggravated by additional length.

2. Antenna positioning and orientation. Ideal performance of any antenna system can be expected only if that antenna is oriented and positioned to obtain peak signal from the weakest stations.

Antenna equivalent circuit

The simple half-wave antenna opened and fed at the center (Fig. 1-a) acts as a series resonant circuit, consisting in effect of an inductor and capacitor plus a resistive component (Fig. 1-b). This is similar to the tuned circuit with which the radio serviceman is familiar. Thus, the antenna has a specific resistance and reactance. It is the resistive component which is matched to the transmission line to convey maximum signal along the line to the receiver input. The net reactance increases as the signal departs from the resonant frequency and introduces mismatch and loss, limiting the bandwidth of the antenna. Because bandwidth is an important consideration in television due to the broad band of frequencies which must be received, the ideal television antenna is one with a rather low Q, that is, a high ratio of resistance to either inductive or capacitive reactance at resonance. This can be obtained by using an antenna with a relatively large surface area or effective surface area (antenna with a number of fanned elements).

A series resonant circuit also has resonant characteristics at harmonic frequencies. For this reason an antenna can also be made sensitive on harmonically related frequencies. For example, an antenna a half-wavelength long and fed at the center at a current maximum can also have sensitivity at the third and higher odd harmonics (Fig. 2). It becomes a three-half-wavelength antenna at the third harmonic, and point of feed is again a current maximum.

Experimental procedure

Extensive tests on both simple and elaborate antennas were undertaken

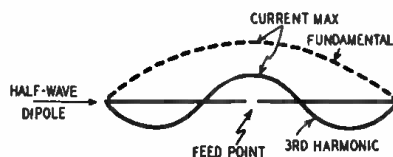

Fig. 2—Reason for third-harmonic reception.

with these considerations in mind. In the tests, the paramount factor was always "How was the picture on the

screen of the television receiver affected? Was the change for a given test so small as to be insignificant, or was it worthy of serious consideration because of its effect on performance?"

In making the checks on different types of antennas, accuracy and uniformity were obtained by positioning each antenna in a space loop of the same station. One hundred feet of 300-ohm transmission line was used between antenna and receiver. Much of the research was made at a test site near Trenton, N. J., using the signals from the three Philadelphia television stations approximately 30 air-line miles from Trenton. Thus the checks were made near the fringe area of the stations, where antenna performance is of great significance. At the same time

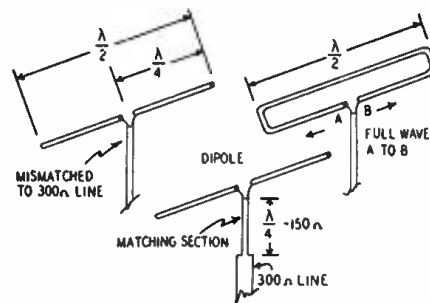

Fig. 3—Two ways of matching to 300-ohm line.

long-range checks were made on the New York stations approximately 60 air-line miles from Trenton. Special checks were also made in many other areas to verify results obtained at the major test site.

In testing antenna performance, a folded dipole was used as a standard antenna because it conveniently matches a 300-ohm line, which in turn matches the 300-ohm input of television receivers.

Simple dipole antenna

A simple dipole (Fig. 3) proved usable at this distance when mismatched to a 300-ohm line. Height of antenna, orientation, and positioning in a space

* From a forthcoming book: "Reference Guide for Television Antennas."

† Television Instructors—Technical Institute, Temple University.

loop were of major importance, proving more effective in bettering antenna system performance than the addition of a reflector or stacking antenna elements. Of course, the erection of a higher-gain antenna at this optimum position resulted in a further improvement, but not so much.



Fig. 4—Hand-held antenna used for testing.

As the diameter of the dipole elements was increased, not only was there a perceptible increase in signal strength, but also an increase in bandwidth. This made the dipole antenna cut for the lower-channel stations quite effective for the high-band stations. A minimum recommended diameter for a dipole element is 1/2 inch.

A dipole antenna mismatched to a 300-ohm line gave inferior performance on all channels compared to a folded dipole. However, with a quarter-wave matching section between the 73-ohm dipole and the 300-ohm line, the signal strength came up to a level not much different from that delivered by the standard folded dipole.

The matching section consists of quarter-wavelength of line attached between antenna and transmission line.

In calculating the necessary impedance Z_m of the line used for the matching section,

$$Z_m = \sqrt{R_a Z_o}$$

where R_a is the antenna's radiation resistance and Z_o is the impedance of the main transmission line. Thus, to match a 73-ohm dipole to a 300-ohm line requires a quarter-wave section of 150-ohm line. Its length should be slightly shorter than a quarter-wave in free space; it is found by multiplying the free-space figure by the velocity constant of the 150-ohm line, usually available from the manufacturer.

The mismatched dipole does have a low Q and therefore a broad bandwidth. However, it was found that that is not always desirable. It is often helpful to be able to improve sensitivity on one or more stations at a sacrifice in bandwidth. For example, in a specific check

a dipole was cut for channel 3 and a quarter-wave matching section was also cut to match this antenna to a 300-ohm line. Reception was appreciably improved on channel 3. The signal was no poorer on channel 6 than with the same dipole mismatched to a 300-ohm line. On channel 10 there was a perceptible improvement compared to the same dipole previously mismatched to a 300-ohm line. Obviously, then, a matching section in conjunction with the dipole will improve performance on a weak station without detracting from the signal of a stronger station.

It is, of course, possible to match a simple dipole to a co-axial line; but as attenuation of co-ax cable line is considerable and it does not match standard receiver inputs, a definitely weaker signal results.

Harmonic relations

A dipole or folded-dipole antenna cut for a specific channel has a certain bandwidth and has appreciable sensitivity at odd harmonics. For example, a folded dipole cut for channel 3 gave satisfactory performance on channel 6. On channel 10 which is approximately the third harmonic of channel 3, sensitivity was excellent, in fact, equal to that which could be obtained from a folded dipole cut for channel 10. Thus it seems sensible and possible in most locations to cut a single antenna for some point

TABLE I

Chan- nel	Channel Limits (mc)	Length (in each half of dipole)	Folded di- pole (full length, in inches before folding)	1/4-wave match- ing section	3rd harmonic channels
2	54-60	48.6	207	40	7
3	60-66	44	181	36	8, 9, 10
4	66-72	40	166	33	11, 12, 13
5	76-82	35	145	29	
6	82-88	32.6	134	27	
7	174-180	15.6	64.7	12.9	
8	180-186	15.1	62.6	12.5	
9	186-192	14.6	60.6	12.1	
10	192-198	14.2	58.7	11.7	
11	198-204	13.8	57	11.4	
12	204-210	13.4	55.3	11.1	
13	210-216	13	53.8	10.8	

in the low band and have that same antenna perform very well on the high-frequency channels.

An antenna cut for any of the high-band channels, however, will give definitely inferior performance on the low-frequency channels. In most localities, therefore, a very simple antenna will suffice for reception of all stations if the antenna is properly cut and positioned for best performance on the weakest station. Performance can be further improved for the weak station by adjusting the length of the transmission line, or by the use of a stub across the antenna input terminals.

Space loop check

A simple folded dipole can be used to locate the space loops of the stations to be received. Most TV antennas and their masts are too cumbersome to carry around a roof. A simple channel 13 folded dipole mounted on a light col-

lapsible mast is the ideal tool for locating the loops for all signals to be received. It is shown in Fig. 4. This antenna, although it certainly cannot give good performance on the low-band stations, does give a positive indication of space loops on all channels. Light in weight and easy to handle, it can be held at a level which approximates the height of the antenna to be installed for the customer.

The antenna is made very simply as can be seen in Fig. 5. It consists of the folded dipole attached directly to the top section of the mast without any insulation. This can be done if the mast is joined to the antenna at the exact center of the unbroken side of the folded dipole since this point is a voltage node or ground point. A small metal standoff is used to hold the antenna away from the mast. The radio-man can build it in a few minutes with no difficulty.

Antenna dimension table

To assist the serviceman in choosing correct antenna dimensions, Table I is very helpful. Antenna lengths given have been corrected for end effects (capacitive loading at the ends of the antenna), and quarter-wavelength matching sections have been shortened in accordance with the velocity constant of the usual 150-ohm ribbon line.

To help in choosing a low-band antenna which will have good pickup on the high-band channels because of harmonic relations, the chart also indicates those high-band channels which have a harmonic relation to a low-band channel. The third harmonic is the only harmonic which is significant because other harmonics fall outside the TV channels.

As an example, a dipole for channel 3, with a 1/2-inch separation at the center where transmission line is attached, would have an over-all length of 88.5 inches. According to the last column, this antenna would also be effective on channels 8, 9, and 10.

In the next article performance comparisons will be given for various antennas with respect to propagation characteristics, including the use of reflectors and directors.



Fig. 5—Close-up shows construction details.

MAGNETIC TV ENLARGER

By MOHAMMED ULYSSES FIBS, I.R.E.*

ONE morning last month, the Editor-in-Chief of RADIO-ELECTRONICS called us into his inner sanctum. We immediately observed that he had several television sets going full blast. Without wasting any words whatsoever he took two Alnico bar magnets each about four inches long and began waving them at the television images of each of the receivers. We noticed that each image was influenced profoundly by the powerful magnets. By manipulating the two magnets the image was either drawn out—or by reversing the polarity of the magnets—the image was compressed. In other words, the picture was enlarged in the one case, reduced in the other. (You can try this pretty experiment yourself by getting a pair of permanent Alnico magnets.)

The Chief then explained to us that the action of the magnetic field merely influenced the electronic beam of the cathode-ray tube, to create this effect.

A number of photographs showing the action were then taken. To the best of my knowledge it is the first time that photographs showing this phenomenon

*Inane Radio Electronics

have been published anywhere.

After the Chief had finished his demonstration he pointed out that here was a new idea of which so far no use had

been made. He urged us earnestly to give the matter serious thought because he was certain that the effect would have practical uses in the future.

* * *

Sensational new invention enlarges image over 250% . . .

The idea which the Chief had demonstrated to us fascinated me irresistibly. I kept thinking and dreaming about it for days. Finally an idea crystallized, and I immediately started to work on it with my usual enthusiasm.

One of television's great troubles—it seemed to me—is that the price of television receivers is out of all proportion. The way we are going, it will take several decades before everyone in America has a television receiver. To solve this price bottleneck would be the most

important contribution to television. We all know, of course, that the most expensive part of the television receiver is the cathode-ray tube. I knew that if every television receiver built had only a minimum—say a 3-inch—cathode-ray tube, and if now the image could be enlarged to any desired size at low cost,

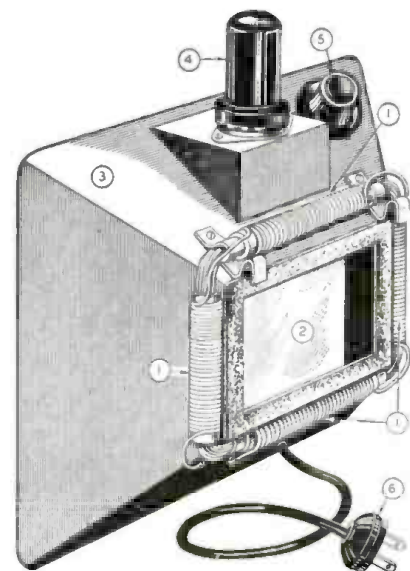

Elements of magnetic enlarger: 1—electromagnetic coils; 2—inside of ground glass coated with fluorescent paint; 3—enlarger case; 4—6X5 rectifier; 5—rheostat; 6—plug.

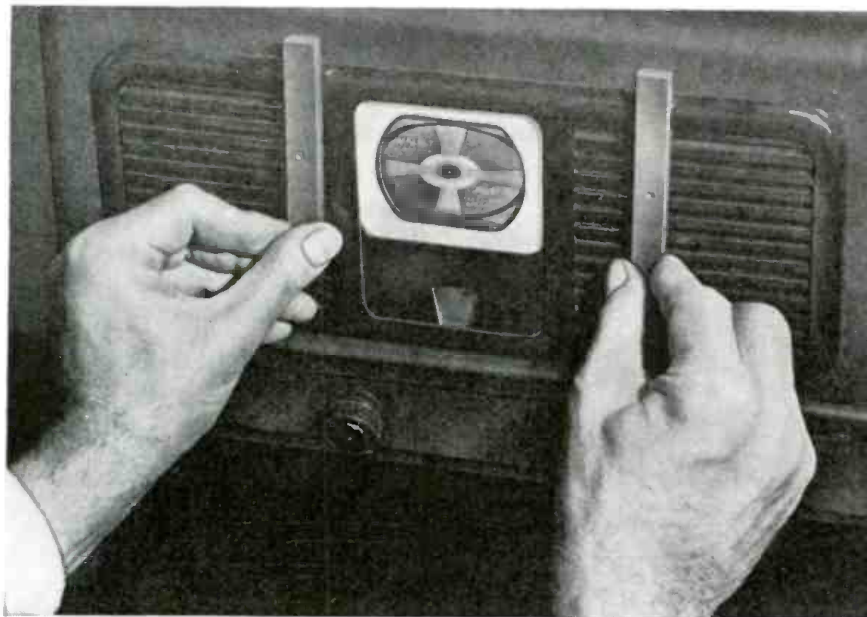

Holding a pair of permanent magnets on both sides of the screen elongates the picture.

television certainly would have arrived in earnest.

I immediately started building an experimental device which I call *The Magnetic TV Enlarger*. It is shown here in several illustrations.

First we require an electromagnetic field built in the form of a rectangular electromagnet with four field coils. These coils are energized from the 117-volt a.c. line. A rectifier tube (or selenium rectifier) is used to obtain the necessary direct current. A rheostat in the circuit regulates the flow of current. The magnetic field should be roughly the size of the cathode-ray tube.

I intended to use my enlarger with the smallest television receiver made: the *Pilot*, which uses a 3-inch tube. I then constructed a box of wood, at the other side of which there was a ground-glass plate. As a fluorescent or phos-

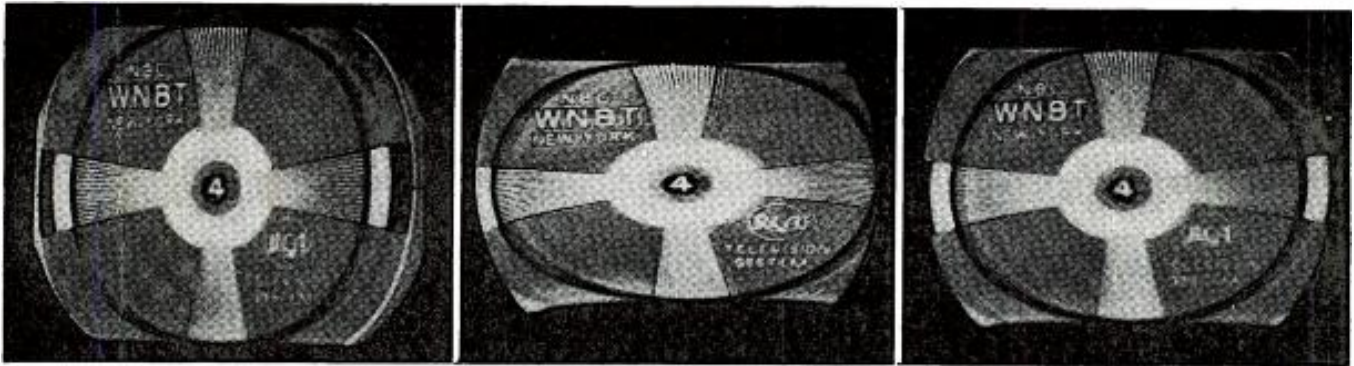

The three photos show what happens when magnets are held in various positions around a TV screen. Any set owner can try this for himself.

phorus coating was necessary for the picture, I coated the mat side of the 8x10-inch glass with fluorescent paint obtained from a luminous paint company.

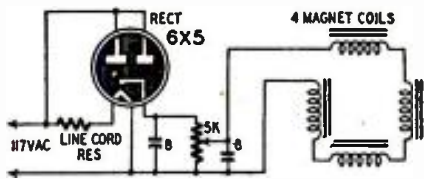

How line current is rectified for the coils.

When we energize the electromagnets, the image is enlarged in proportion to the strength of the magnetic field. The electron beam now strikes the glass, coated with its active film.

Inasmuch as the glass measures 8x10 inches, the image from the 3-inch cathode-ray tube is enlarged nearly 300% on the glass screen.

Theoretically, if the magnetic field is

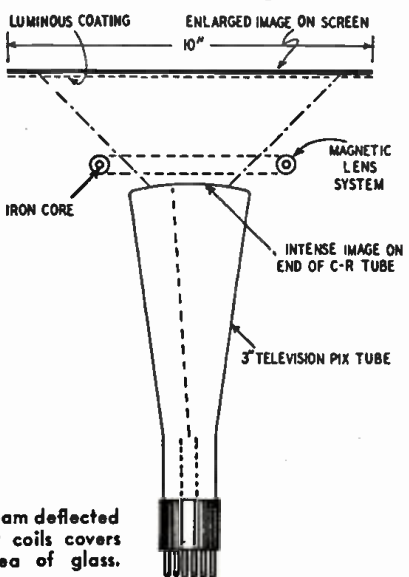

Beam deflected by coils covers area of glass.

correctly proportioned and carefully adjusted as to strength, there should not be any distortion whatsoever. The reason for this is that the enlargement is proportional at all points.

Mark well that there is no aberration as when an image is enlarged by a lens.

With the magnetic enlarger you view the image on a perfectly plane surface and consequently there can be no distortion whatsoever. Most important, with the magnetic enlarger we do not enlarge the image optically; the effect

is completely and 100% electronic.

The thing that pleased me most about my development was that the cost is very small. I built the entire enlarger for less than \$3.00.

We can enlarge a 3-inch cathode-ray-tube picture to a 10-inch image, or 7-inch tube image to a 20-inch picture, etc., at an exceedingly low cost.

Once the television manufacturers have adopted my enlarger, the cost of TV receivers will drop sensationally.

The next morning I went to see the Chief and excitedly told him what I had. He looked the enlarger over with a puzzled mien and then wanted to know if I had tried it out. I said no, not yet, because I did not have a television set at home. So I thought it might be an excellent idea if we tried it out on the Chief's office receiver.

The Boss lit a huge fresh cigar and started to look over my enlarger with a somewhat quizzical look on his face.

"Fips, my boy," said the big Chief, "you certainly have something here. Your busy little brain must have been working overtime. Let's see it work!"

I turned on the set, plugged in my magnetic enlarger, and then adjusted the rheostat to bring it up to the proper field strength. The Chief was sitting nearby puffing away on his big cigar with a curious smile upon his face. The set took a long time to warm up. Once I took off the enlarger to see if there was an image on the 3-inch tube. There was. However, for some reason or other the 10-inch screen did not light up.

Was it possible that there was a break somewhere in the circuit? I carefully went over the connections, all of which seemed O.K. There was something wrong somewhere, which I could not grasp immediately. I was now exuding perspiration all over the place, when out of the vacuum-like silence the scornful voice of the Chief rang out with metallic harshness.

"Well, Fips, you pulled another boner, and I know exactly where it is. Your enlarger should work perfectly except for one minor point: Just how do the electrons from the cathode-ray tube get to your glass plate?"

"With the power which you have—a 3-inch cathode-ray tube—you cannot project an electron beam out in the air so that it will strike your prepared glass plate several inches away. Otherwise, your device is fine. So far no one

has been able to project an electron beam any distance outside a glass cathode-ray tube. Hence, your enlarger in this form cannot operate. So, the next time you build one of your fool contraptions be sure you think it all through carefully before building models."

With that the Chief threw my magnetic enlarger into his waste basket. He then gave me a not too friendly push and slammed the door behind me.

As I sailed into the outer office I collided with the opposite wall on which a large calendar was hanging. As I hit it I was also forcibly struck by the date. It read

April 1

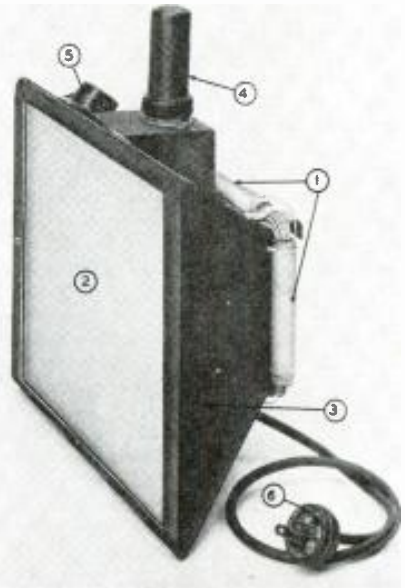

A photo of the finished magnetic TV enlarger.

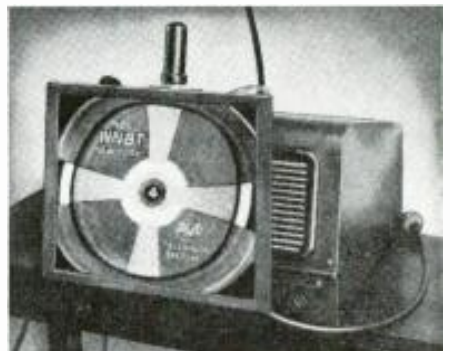

The enlarged 3" picture measures 8 x 10 inches.

Telephone Lines in Broadcasting

Part I—Frequency response measurement and equalization of program lines

By LEIGH L. KIMBALL*

THE telephone line is still the major link between the broadcast studio, the remote pickup point, and the transmitter located outside the city. Relay transmitters and portable recorders despite all their recent developments are still a long way from supplanting the telephone line because of the latter's simplicity, relatively low cost, and ready availability from the various telephone systems throughout the country. Today, telephone lines go to almost every point of interest—networking even small communities in amazing detail—so that it is usually no problem for the telephone companies to supply wire facilities to broadcast stations quickly, efficiently, reliably, and inexpensively, with a minimum amount of bother to the broadcaster. But the problems confronting the broadcast engineer are what to expect from his lines in the way of performance and how to use telephone facilities most efficiently.

Telephone lines have two main uses in broadcasting: program transmission from remote pickup point to studio, from studio to transmitter, and from studio to the long-lines exchange for network operations; and program-coordination communication by means of the program pair itself or by means of a private line (PL) direct to the remote point, intended primarily for telephone communication. Long-distance intercity facilities should not be left out of a list of major uses, but in most cases the only part of such circuits over which the broadcast engineer has any direct control is the local loop to the long-lines exchange. Therefore, this article will concern itself strictly with the relatively short telephone lines referred to as *local loops*.

The most important technical characteristics of a telephone line are frequency response, loss, and noise.

Frequency-response measurement

At audio frequencies telephone lines are mainly capacitive, which, along with copper and insulation losses, reduces their efficiency at higher frequen-

*Chief Engineer, WASH.-FM.

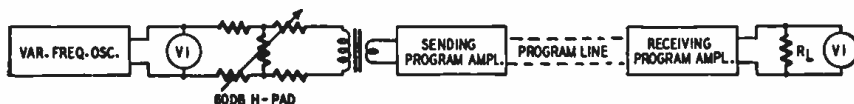
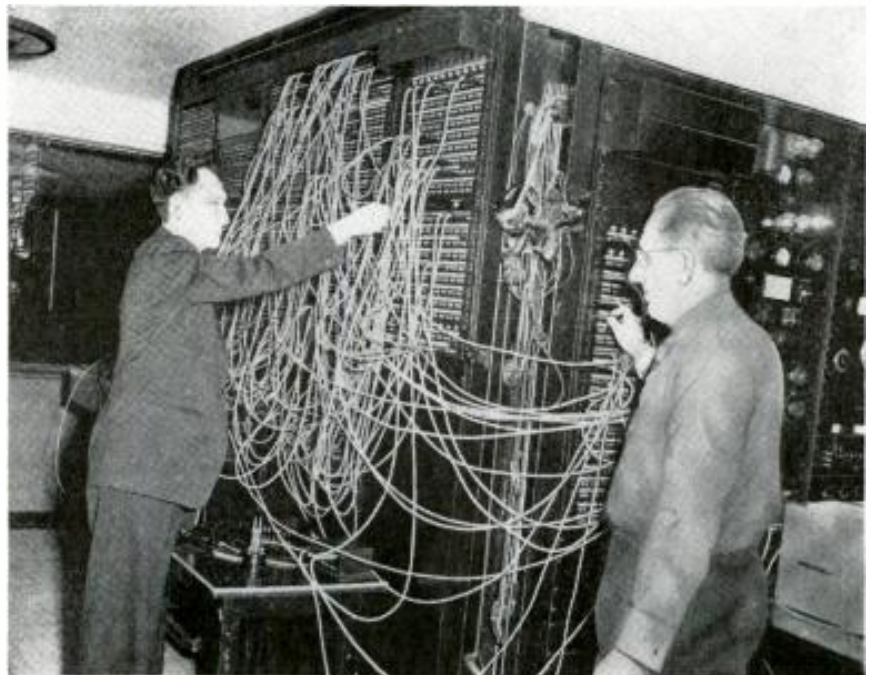

Fig. 1—Setup for measuring frequency response of phone line. VI's are volume indicators.



Courtesy National Broadcasting Co.

Election-night state of NBC's patch board shows importance of telephone lines to broadcasting.

cies. There are several methods of compensating for or equalizing the high-frequency drop; one of these is to add series inductance at intervals along the line. The telephone companies make wide use of this series loading, both in intracity voice circuits and intercity long lines. But that procedure is usually too complicated for radio circuits which may be used for relatively short periods of time. The more common practice is to supply the line without loading and use equalizing equipment at the terminations.

Frequency response of nonloaded lines is determined mainly by line length and the gauge of the wires used. The heavier the gauge, the better the high-frequency response. As line length increases, it becomes more difficult to transmit high frequencies. The response may be calculated in advance; but, since the total line may include several different wire gauges, it is usually much simpler to measure it. The measurement is a problem in itself.

In general, it is best to test a line with the amplifiers that will be used for program purposes. The input level to the sending amplifier should be held constant as frequency is varied. A typical arrangement is shown in Fig. 1. The receiving amplifier may simply be connected to the line and adjusted for a

convenient reading on a standard volume indicator (VI) in its output circuit. A dummy load R_L , equal to the amplifier's output impedance (usually 600 ohms) should be provided, as the VI is a high-impedance device (7,500 ohms for the NAB standard VU meter) and



Fig. 2—Simpler response measurement hookup.

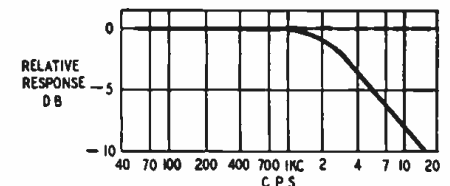

Fig. 3—Correct and incorrect measurements.

will not load the amplifier correctly.

If the arrangement in Fig. 1 is too bulky for portable work, another arrangement requiring only an oscillator (shown in Fig. 2) is equally good if the internal impedance of the sending amplifier is known. In the diagram R_1 is the internal impedance of the sending amplifier normally used at the line input.

This is the arrangement agreed upon by the major networks and the A. T. & T. When only an oscillator is available for line frequency-response measurement, it should be adhered to strictly. Putting the voltmeter or VI (used to see that oscillator output is held con-

stant) directly across the line terminals at the sending end can result in serious errors, since the test generator's effective internal impedance becomes zero rather than simulating that of the amplifier to be used for transmitting programs. An indication of the possible error is shown in Fig. 3 for an actual case on a short loop. The solid curve shows the line to be actually very poor when used with a 600-ohm amplifier, although, when measured incorrectly (dashed line) it looks very good.

The reason for the series resistors is that an audio amplifier is actually a constant-voltage generator with an internal resistance of R_i , as shown in Fig. 4. The constant voltage E can be con-

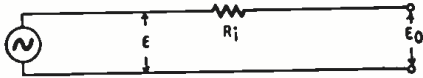

Fig. 4—Audio amplifier output, equivalent.

sidered as the microphone output voltage (amplified by a constant factor) which, of course, is independent of conditions in the output circuit. Therefore, when E is constant, the amplifier output voltage E_o depends only on the internal resistance of the generator, and on the load impedance at any frequency. This is true of an amplifier, and the condition



Fig. 5—Internal impedance measurement rig.

is duplicated, for all practical purposes, by the arrangement in Fig. 2 where R_i is split into two parts for the sake of line balance. The internal voltage of the generator is held constant manually, by adjusting the gain control at each frequency for constant reading on the VI across the output.

Internal impedance

The internal impedance of a commercial broadcast amplifier may or may not be equal to its rated output impedance. For instance, the 600-ohm output of a popular line amplifier was found to have 65 ohms internal impedance due to inverse feedback over the last two stages. This is desirable, as the low internal impedance helps to equalize the line. But if line frequency-response measurements are to be made in accordance with Fig. 2, the true internal impedance

of the program amplifier should be known. Measuring it is simple.

Referring to Fig. 5:

$$E_o = E_i \frac{R}{R + R_i}, \text{ and}$$

$$R_i = \frac{R(E_i - E_o)}{E_o}$$

E_i is measured by the a.c. v.t.v.m. when R is disconnected from the circuit and an audio tone is applied to the input of the amplifier; E_o is the a.c. voltage across the output terminals when R is connected; and R is a resistance comparable to R_i . R must be small enough to give a substantial difference between E_i and E_o , yet large enough not to cause distortion in the output stage of the amplifier. A workable value usually is 600 ohms.

The procedure is valid only if the output impedance of the amplifier is constant and resistive over the audio range. This is usually true of a high-quality broadcast amplifier; but, if there is any doubt, R_i can be measured at several frequencies. If there is appreciable variation in R_i , the line must be equalized and tested in accordance with Fig. 1.

Equalization

Two principal methods of local-loop equalization are commonly employed. They are shown in Fig. 6. Method 1 simply makes use of the transformed input and output impedances of the line amplifiers to provide a heavy (150-ohm) resistive loading to shunt out the effects of line capacitance. This extends the high-frequency response in much the same manner as is sometimes used in audio amplifiers. Method 1 can be used to equalize lines of the following maximum lengths and wire gauges to about 8000 cycles. If 15-kc equalization is desired the lengths should be scaled down.

Wire Gauge	Length (miles)
16	5
19	2.3
22	1.5

The equalizing procedure for method 1 is a simple frequency-response check.

Method 2 makes use of a variable-impedance leg at the receiving end that actually mismatches the line at the low frequencies but has little effect at high frequencies. Correct equalization is obtained when the line loss at high frequencies equals the loss at low fre-

quencies due to reflection from the mismatched termination. This system is used for longer lines than method 1; it will equalize lines up to about 10 miles in length. Method 2 is:

1. Set the parallel resonant circuit (L_o and C_o) to a frequency slightly higher than the maximum desired.
2. With the equalizer in the circuit and R_o at zero resistance, send a tone reference from the test oscillator at the highest frequency desired and note the VI reading at the receiving end.
3. Shift the oscillator to a low frequency (50 or 100 cycles) maintaining the same output level as before, and increase the resistance of R_o until the same VI reading is obtained as before.
4. Make a complete frequency run and take care of any touch-up adjustments necessary to get a flat response over the desired range. The maximum variation can usually be held to ± 1 db.

Various combinations of methods 1 and 2 may be used. One of these, method 3 is recommended for especially long lines where good frequency response with low noise level is important.

Two effects which may cause irregular frequency response cannot be removed by these equalization procedures. The first and most serious is a series loading coil in the line. The telephone company may sometimes overlook one of these inductances which they use to equalize voice circuits and unintentionally leave it in the line. The symptoms are unmistakable—no reasonable amount of equalizing work will extend the frequency range much higher than 4 kc. Fig. 7 is a typical response curve.

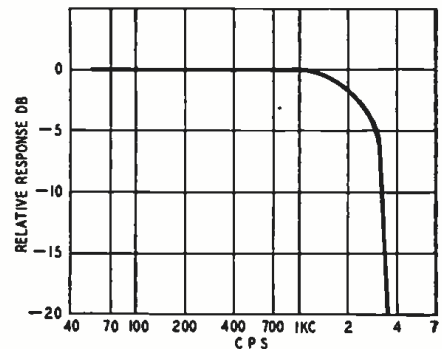

Fig. 7—Effect of loading coils in the line.

The second common cause of irregularity is an impedance discontinuity along the line resulting from the use of different cable gauges in the loop make-up or from branch circuits which are tied on at some point. The principal result is a bumpy response curve. The effects of different cable gauges in the line are usually small. However, the results of branch circuits may be more serious, especially since an unterminated branch is very susceptible to cross-talk interference from adjacent cable pairs.

(The concluding part of this article, which will appear in an early issue, will discuss line loss, noise, correct termination, and maintenance.)

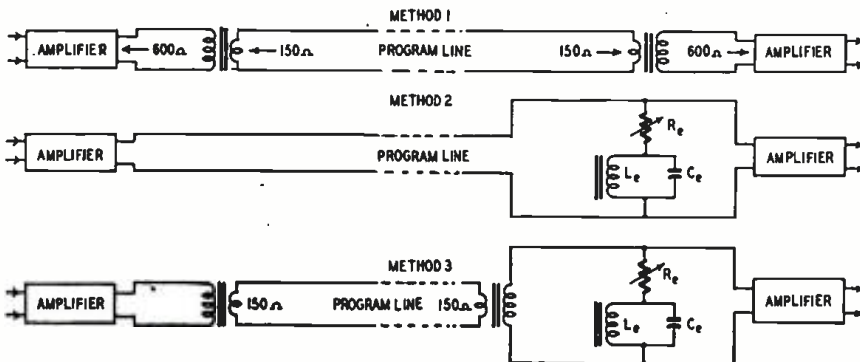
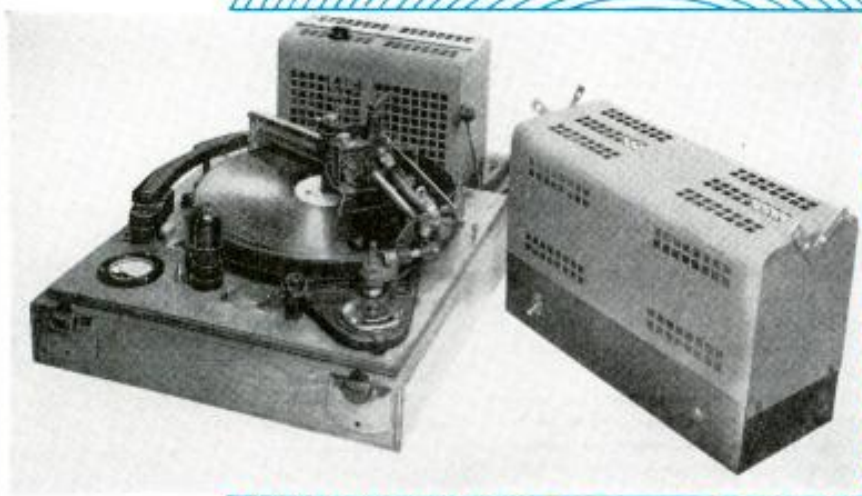

Fig. 6—Several methods of equalizing the frequency response of program telephone lines.

Quality Disc Recorder



By RICHARD H. DORF

Recording components are amplifier and mechanism in case and power supply at the right.

FOR the large number of audio enthusiasts who are not satisfied with ordinary-quality recorders, here is a portable system which is capable of making records comparable in quality to the best commercial jobs. Besides giving the recordist the benefits of high fidelity, the system is compact, versatile enough for PA work, and suitable for record listening at home. The three functions—recording, PA or monitoring, and record playing—are selected by a novel “gearshift” switch on the side of the amplifier.

The amplifier is designed for use with the audio control console described on page 34 of the February issue of *RADIO-ELECTRONICS*. However, any other pre-amplifier could be used, or additional voltage amplifiers could be added to the recording amplifier itself. When used with the console, the entire recording system is portable in two parts: the console is fastened to the power supply with thumbscrews and carried by means of the handle on the console top; and the recorder case, containing amplifier and turntable assembly, is carried by its handle. While the combination is neither as light nor as small as many commercial portable recorders, the results it gives and the versatility it offers are well worth the added size.

Fig. 1 is a schematic diagram of the recording amplifier. The output of the console which feeds it is zero db in 500 ohms, which results in 1.73 volts. Rather than use an expensive (and hum-sensitive) transformer at the input of the recording amplifier, the 6C5 input grid resistor is a 500-ohm potentiometer. This terminates the 500-ohm line from

the console correctly, and the 6C5 gives enough amplification to overcome the loss caused by the lack of the usual step-up (line-to-grid) transformer.

The second 6C5 gives additional voltage amplification. (There is a little more than necessary, as a matter of fact.) The 6N7 is a self-balancing phase inverter, and the output stage is a pair of push-pull 2A3's. (6B4's—with the necessary filament- and bias-voltage changes—might be more available today. The 2A3's were on hand when the unit was built.)

Equalization

Of the two unusual features in the amplifier, the more important for recording purposes is the carefully calculated equalization. As the writer has previously pointed out (*Practical Disc Recording*, Gernsback Library, No. 39), there must be a certain amount of pre-emphasis in the high-frequency range during recording so that signal-to-noise ratio will be high in playback. As a practical matter, too, the record-playing systems owned by most people have a drop in the high range, making pre-emphasis necessary to restore fidelity.

The only standard for pre-emphasis in the recording field is the so-called NAB curve, which results in a boost of 16 db at 10,000 cycles. Most phonograph records have frequency curves somewhere between the NAB standard and a characteristic with slightly less boost. Fig. 2 shows the response of this amplifier with the switch in the recording position. The boost is 2.5 db less than the NAB prescribes at 10,000 cycles, giving a very close approximation to

what is found on most records. As a result, any good playback system adjusted for ordinary records will give top results with records made with this amplifier.

The equalizer circuit used to obtain the curve consists of R1 and C1 in combination with R2. The network, though extremely simple, cannot be arrived at by ear. In building the amplifier, the constructor should not vary the values of the equalizer circuit, no matter what changes he may want to make in other sections of the amplifier.

A crystal cutter, the Brush RC-20, is used because it gives the best results for the least amount of money as far as fidelity is concerned. Because a crystal cutter is a constant-amplitude device, a resistor must be placed in series with it to obtain the modified-constant-velocity characteristic usual in phonograph records.

Fig. 3 is a diagram of the components on the motor board. The amplifier output is fed from the 2A3 plates through 0.5- μ f blocking capacitors (Fig. 1) to the cutter jack. The cutter plug (Fig. 3) is plugged into this jack to carry audio to the cutter. R3 is the necessary series resistor.

The “gear shift”

The second interesting feature of the system is the switching arrangement. The amplifier can be used, not only for recording, but also for listening. A 3-position, 6-circuit rotary switch S1 (Fig. 1) selects any of three functions: in position 1, output is fed to the cutter; in position 2, output is fed through a high-fidelity transformer to the speak-

er; and, in position 3, output is also fed to the speaker, but the input circuit is transferred from the regular line to a crystal pickup mounted on the motor board.

As the under-chassis photograph shows, S1 is mounted lengthwise on the chassis. Long switch supports allow the two wafers to be placed reasonably close to the circuits they control so that accidental feedback is not likely and long leads are unnecessary.

The photograph of the main case shows how the amplifier is mounted so that only the dust cover shows. If the knob controlling S1 were at the end of the chassis, it would be inconvenient to turn. Therefore a metal shaft coupler was attached to the shaft in place of a knob. One of its screws was removed and a long rod, the end of which was threaded, was screwed in its place. This rod (it can be seen at the right of the amplifier) controls the switch very much like an automobile gear-shift lever. Pull it toward you and record; leave it at center and listen to the output of the console; push it to the rear and use the built-in crystal pickup.

Two volume controls R4 and R5 are switched at the amplifier input. R4 is mounted at the left end of the chassis and has no knob. Once set for the proper recording level, it is thereafter left alone. R5 is mounted on the chassis, an extension shaft projecting through the dust cover. The control knob seen atop the amplifier is used to control volume when listening. The crystal pickup has its own volume control, as Fig. 3 shows.

S1-c switches the equalizer. When it is not in the circuit, in position 2, the amplifier output to the speaker is flat within 2 db from 50 to 15,000 cycles. It is switched in when the crystal pickup is used because it has almost exactly the correct high boost to give a good crystal pickup the right correction for standard records.

The power supply (Fig. 4), a standard job with plenty of filtering, is built on a separate chassis 14 x 6 x 2½ inches with a standard amplifier dust cover. Separation of the power supply from both recording amplifier and console (which it also supplies) keeps hum down to the irreducible minimum. Octal tube sockets mounted on the rear apron accommodate plugs and cables to carry power to amplifier and console.

Fig. 3 shows how the components mounted on the recorder motor board are connected. The rectifier and milliammeter provide an additional check on volume being fed to the cutter, although the decibel meter mounted on the console should be used mainly; the milliammeter will give false readings, since it is preceded by high-boost equalization. It is, however, a positive indicator which will show at once any mistakes or faults in switching or connections. If the meter kicks, the cutter is almost certainly receiving audio. R6, an adjustable meter multiplier, is mounted on the motor board underneath the turntable and has no knob. When it is once set, tampering is not likely.

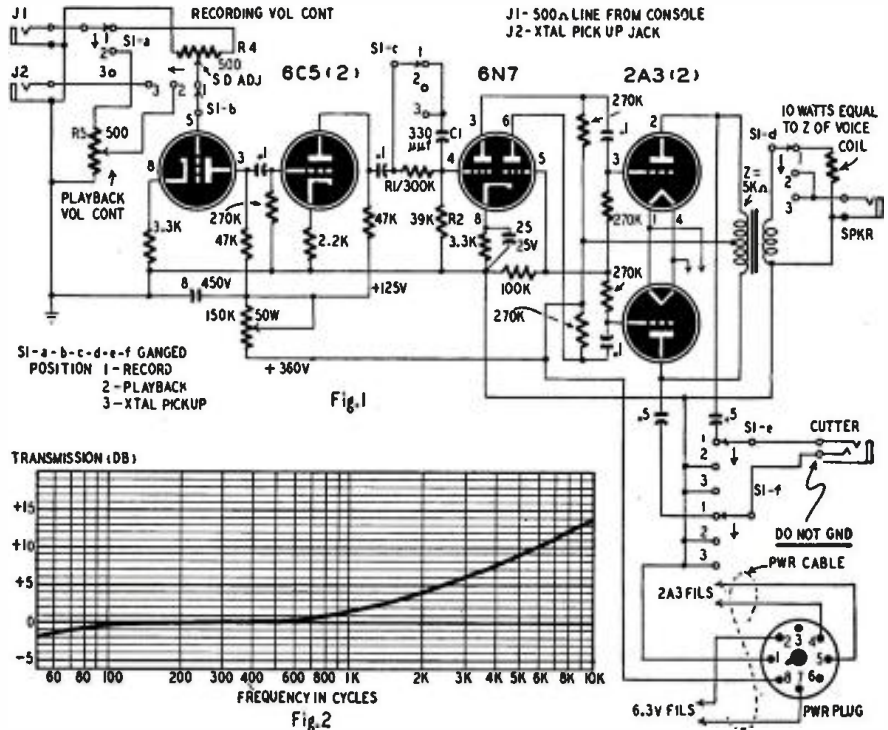

Fig. 1—Complete circuit of the recording amplifier. Fig. 2—Equalized frequency response.

Making the case

The construction of the case is shown in detail in Fig. 5. These dimensions will do for almost any 12-inch recording mechanism. The one shown in the photo is a prewar Rek-O-Cut. An overhead-lathe mechanism almost always gives superior results to a swinging-arm unit, and the case cover is high enough to accommodate most lathes.

The amplifier is set in the rear of the case. Holes are drilled into the amplifier chassis through the 1 x 1 cross-member on the floor of the case. The chassis holes are tapped so that a machine screw can be passed through each hole in the wood to hold the amplifier in place. Similar holes for additional supporting screws are made through the rear of the case into the amplifier. The amplifier chassis is 5 inches deep, and the space allowed is 5¼ inches. Its width is 10 inches, allowing space for plugs on either side.

The 1 x 1 motor-board supports are flush with the top of the sides. The motor board is placed (and fastened with edge screws) on top of these; it is, thus, above the sides of the case. When the

cover is lowered, the edges of the motor board keep the sides of the cover exactly in line.

The photograph shows how the components are mounted on the motor board. Mountings are not given in the

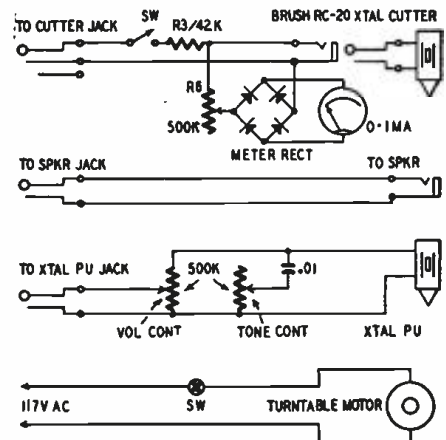

Fig. 3—Components mounted on the motor board.

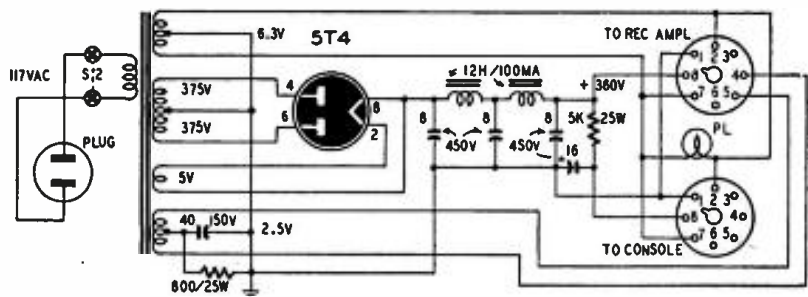

Fig. 4—The power supply. A 25,000-ohm, 25-watt bleeder can be added for better regulation.

drawing because they will depend on the particular recording mechanism used. Two 5-inch speakers were on hand when the recorder was built, so they were placed in the cover. For better results, an external high-quality speaker may be plugged into the speaker jack mounted on the right rear of the motor board.

The cover is fastened to the case with loose-pin hinges, similar to those used on portable typewriters, so that the cover can be removed entirely. Trunk catches (large ones) fasten the front for carrying. A heavy leather handle attached to the front of the cover must be positioned so that the weight will be evenly distributed. After assembly, the

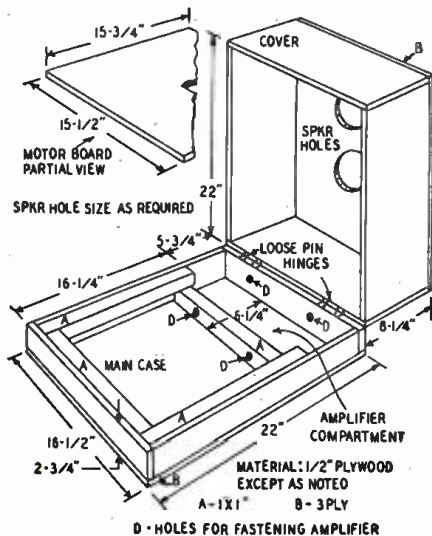

Fig. 5—How to make amplifier-recorder case.

closed case was up-ended and balanced on a sharp-edged support to find the center of balance. The balance point was marked, and the handle placed there.

Keeping in mind the fact that the amplifier and mechanism are heavy and that either can easily be damaged if dropped, be sure to make all wood joints in the case firm and strong. The original job was done by a cabinetmaker, who rabbeted the joints and used the strongest possible glue. Heavier stock would also provide insurance against accidents but might add too much to the weight.

The mechanism and pickup must be fastened down tightly for carrying. The photo reveals the angle brackets and thumbscrews used for the cutter. The method will vary, of course, with different mechanisms, but the only requirement is that nothing must be allowed to move. An ordinary alligator clip screwed to the motor board keeps the pickup in place. Clip brackets in the top of the cover carry stylus containers, and cleats carry cables. A photographer's telescopic tripod is carried, too, as a microphone stand.

There is always a thread-removal problem with disc recorders. It is solved in this unit with an Audiodisc Chip Chaser, which is a felt "brush" fastened to hinged supports. The device is sold just placed next to the turntable. To make the chaser part of the assembly, the base was removed and the vertical support screwed to a small angle bracket fastened to the motor board.

Adjusting the system

There are only two adjustments to be made in the electrical system before

using the recorder. These are setting R4 and R6 for the correct recording level.

Feed a 200-cycle tone through the console and adjust the volume control



The amplifier chassis without its dust cover.

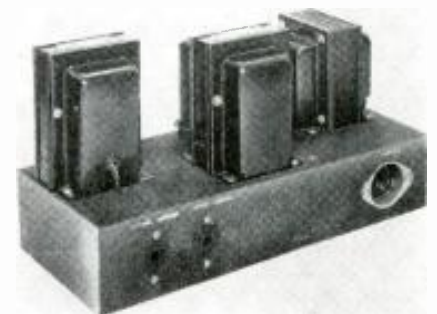

The power supply uses two big, heavy chokes.

on the console so the decibel meter reads zero. Adjust R4 so that a vacuum-tube voltmeter (a good nonelectronic voltmeter could be used) connected directly across the cutter reads between 90 and 100 volts. Never disturb R4 again. Make a mark on the milliammeter on the motor board at about the 0.6-ma point. Then adjust R6 until the meter needle is at the mark. When recording, do not depend on the milliammeter to read correct level, since high frequencies will not register correctly (due to the equalization).

MATERIALS FOR RECORDER

Resistors: 1—2,200, 2—3,300, 1—39,000, 1—42,000, 2—47,000, 1—100,000, 5—270,000, 1—300,000 ohms, 1/2 watt; 1—800, 1—5,000 ohms, 25 watts; 1—150,000 ohms, 50 watts, adjustable; 2—500-, 3—500,000-ohm potentiometers; 1—10-watt resistor equal to impedance of voice coil.

Capacitors: 1—330 μ f, mica; 1—.01, 4—0.1, 2—0.5 μ f, 600 volts, paper; 1—25 μ f, 25 volts, 1—40 μ f, 150 volts, 4—8, 1—16 μ f, 450 volts, electrolytic.

Transformers and chokes: 1—power, 750 volts center-tapped, 100 ma, 6.3 volts, 4 amperes, 5 volts, 3 amperes, 2.5 volts, 8 amperes; 1—output, 5,000-ohm push-pull plates to voice coil, 15 watts, 100-ma primary; 2—12-h, 100-ma filter chokes.

Tubes: 2—6C5, 1—6N7, 2—2A3, 1—5Y4.

Switches: 1—3-position, 6-circuit, rotary, with lang; est available indexing assembly; 2—s.p.s.t. toggle, 1—d.p.s.t. toggle.

Connectors: 5—single-circuit, non-shorting phone jacks; 1—2-circuit phone jack (for PL-68-type plug); 3—single-circuit phone plugs; 1—2-circuit phone plug (PL-68); 2—octal tube sockets; 1—cable-end octal male plug; 1—chassis-mounting, unpolarized, male 117-volt plug.

Recording components: 1—turntable; 1—Brush RC-20 crystal cutter; 1—crystal pickup.

Miscellaneous: 1—meter rectifier; 1—0-1-ma d.c. meter; 1—6-volt pilot-light assembly; 4—octal, 2—4-prong tube sockets; 1—threaded rod and shaft coupler for "gear shift"; wood for case (see Fig. 5); loud-speaker(s); loose-pin hinges; trunk catches; knobs, hardware, etc.

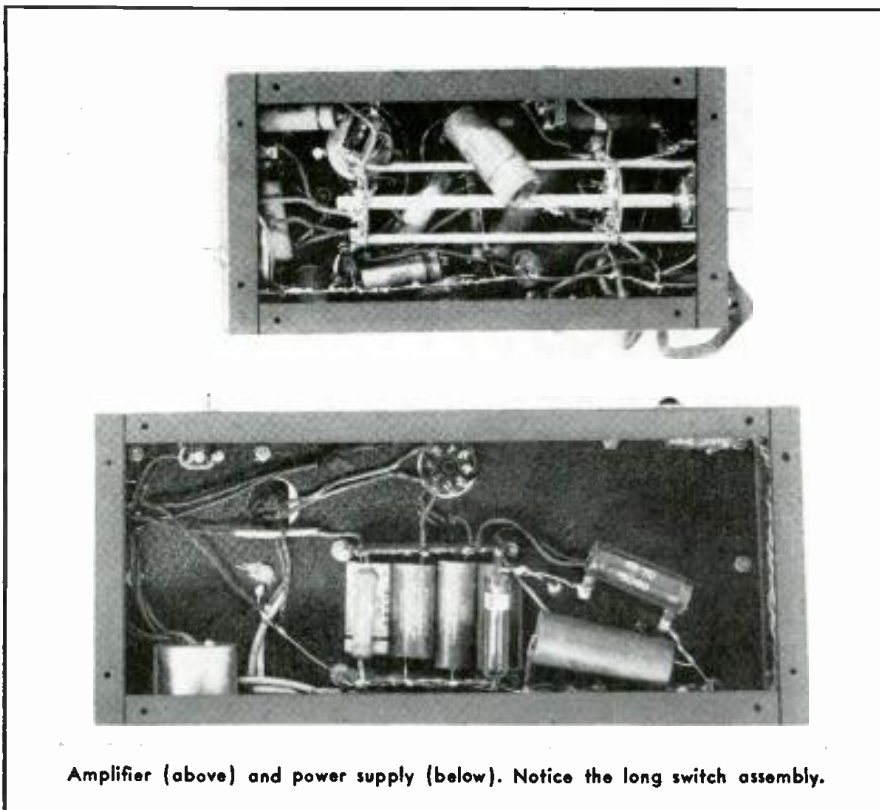

Amplifier (above) and power supply (below). Notice the long switch assembly.

Audio Impedance Matching

Part II—Data on how to match several speakers to an amplifier, each powered as desired and all impedances correctly matched to the output of the amplifier

By WALTHER RICHTER*

IN the first installment (February issue) of this article we showed why amplifier load and internal impedances are important in transferring power to the speaker and in speaker damping. The practical application of the principles presented is best illustrated with the aid of a few examples.

Suppose we are given an amplifier rated at 30 watts, and that the output transformer is provided with 20- and 125-ohm taps. The statement that the amplifier will deliver 30 watts permits us to calculate the maximum voltage and current values of the two taps. Applying one or both of the formulas $P = E^2/R$ and $P = I^2R$, we find that for a single load of 125 ohms, if operated from the corresponding tap, a voltage of 61.2 and a current of 0.49 ampere will result in 30 watts; on the 20-ohm tap, 24.5 volts and 1.22 amperes will result in 30 watts. These, then, are the voltage and current values which must not be exceeded.

Suppose, now, that we want to operate a 500-ohm speaker from the amplifier, and that the speaker is rated at 10 watts. Should we use a matching transformer?

To obtain 10 watts in a resistance of 500 ohms, 70.7 volts are needed; the current will be 0.14 ampere. If we connect the loudspeaker directly to the 125-ohm tap, we cannot quite reach the full 10 watts without exceeding the voltage limit of the amplifier although we will be below the maximum rating as far as current goes.

How will this arrangement be with

regard to damping? Whatever the internal resistance of the amplifier, it will certainly appear smaller to a 500-ohm load than to a 125-ohm load. If it happens to be an amplifier with a triode in the output stage, the internal resistance (as seen at the transformer secondary) can be expected to be around 60 ohms. With a load of 500 ohms looking back at 60 ohms, the damping will be considerably better than with a 125-ohm load; and this connection will therefore actually give better results than the 125-ohm load—provided the amplifier is truly capable of 30 watts output.

Now suppose that, instead of a speaker of 500 ohms, we have one with a resistance of 6 ohms and capable of handling 6 watts of power. (To use a 30-watt amplifier to drive a 6-watt speaker seems ridiculous, but let us assume that the two pieces of equipment were inherited from two different uncles.) To obtain 6 watts in a 6-ohm load requires 6 volts at 1 ampere. The 24.5 volts and 1.22 amperes which can be obtained from the 20-ohm tap are in excess of the current and voltage ratings of the 6-ohm speaker, and we could connect the speaker to this tap.

But how does this circuit arrangement look with regard to damping? Again we do not know the internal resistance of the amplifier; but if it is a triode amplifier, the internal resistance at the 20-ohm tap will look like approximately 10 ohms. To connect a 6-ohm speaker to a generator with an internal resistance of 10 ohms is not a very satisfactory arrangement, since the voice coil, instead of looking back into a resistance equal to approximately

one-half of its own resistance, is looking back into a resistance almost twice its size!

No build-out resistors

By trying to be too smart, we could do even worse! We might reason, for instance, that for an amplifier to operate most efficiently on the 20-ohm tap, the load connected to this tap should be 20 ohms; and since we have only a 6-ohm speaker, we might have the bright idea of placing 14 ohms in series with it to bring the total up to 20. To be sure, this gets our 6 watts to the speaker, but 14 watts of audio power in the 14-ohm resistor are thrown away and do us no good whatsoever. More important, the total resistance in the voice-coil circuit is now equal to the internal resistance of the generator (which was already too high on the 20-ohm tap) plus the 14 ohms of series resistance.

In this case, we should use a matching transformer, which will make the 6-ohm speaker appear as either 20 ohms (if we wish to connect it to the 20-ohm tap) or as 125 ohms (if that is where we wish to connect it). The design and construction of a matching transformer to take care of a relatively small mismatch, such as perhaps 4 to 1, is not very difficult and can usually be accomplished by utilizing the core of an old audio transformer. Such a design will be discussed in a future article. Matching transformers can be purchased for all common impedances.

A multiple speaker problem

Suppose we have an amplifier rated at 30 watts, with an output transformer having 500-, 16-, and 6-ohm taps. We wish to operate a 500-ohm, 10-watt loudspeaker, a 20-ohm, 20-watt speaker, and four 6-ohm, 4-watt speakers. The full power which all the speakers can take is 46 watts, which exceeds the rating of the amplifier. First, therefore, we must decide how the available 30 watts are to be distributed.

One could argue that the wattage allotted to each speaker should simply be $\frac{30}{46}$ of its maximum. This solution is not necessarily the best one. One of the speakers may be considerably more efficient than the others. Or the speakers may be serving different rooms which

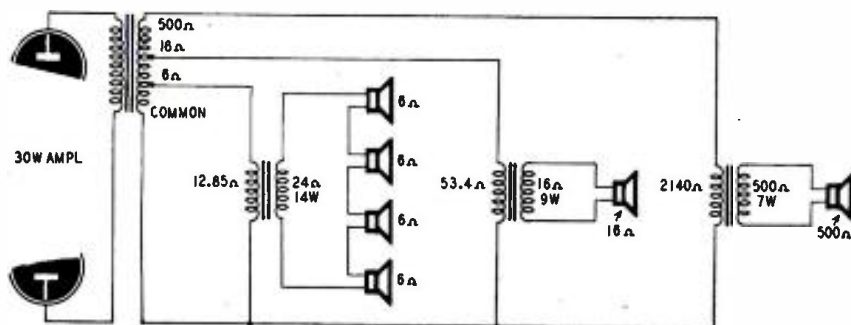

Fig. 1—Simple calculations were used in matching these six loudspeakers to the amplifier.

require different amounts of output.

After the best judgment has been used in distributing available power, it probably will still be necessary to insert attenuators in some of the speaker lines. However, any audio disappearing in an attenuator is a total loss, so it is well worth while to try to make the distribution as close as possible to the required conditions.

Suppose now that with the amplifier wide open delivering 30 watts (See Fig. 1) the 6-ohm speakers are each to receive 3.5 watts; the 20-ohm speaker, 9 watts; and the 500-ohm speaker, 7 watts.

None of the speakers can be connected directly to any of the available transformer taps; the 500-ohm speaker cannot even be connected to the 500-ohm tap, since with this connection alone the amplifier would be fully loaded. If additional loads are to be placed on the other taps, the current taken from the 500-ohm tap must be reduced; which means that the load resistance connected to this tap must be increased.

If a single 500-ohm load were connected to the 500-ohm tap and the amplifier were delivering 30 watts, 122.5 volts would have to be delivered by this tap: $E = \sqrt{PR}$. Since we have decided that only 7 watts is to go to the 500-ohm speaker, a matching transformer must be used between tap and speak-

er. The transformer primary must form a load which will consume 7 watts when 122.5 volts is placed across it. Substituting 122.5 volts and 7 watts in the formula $P = E^2/R$, and solving for R ($R = E^2/P$), gives us a value of 2,140 ohms. This apparent mismatch is in the right direction, since the internal impedance of the amplifier looks smaller to a 2,140-ohm than to a 500-ohm load.

By the same reasoning, we find that to consume 9 watts the 16-ohm speaker must look to the 16-ohm tap like a load of 53.4 ohms. The four 6-ohm speakers together, to consume a total of 14 watts, must look to the 6-ohm tap like a load of 12.85 ohms. The 6-ohm speakers may be connected either in series or in parallel; whatever the resultant combined impedance is, the matching transformer must make it look to the amplifier like 12.85 ohms. Assuming that we choose the series connection, the impedance ratio must be 24 to 12.85.

It is not necessary to have a multitap output transformer. Suppose the transformer has only one output impedance, 500 ohms. The primaries of all three matching transformers, when paralleled across this 500-ohm output, must result in 500 ohms, and each must draw the required power. Since the voltage available at the 500-ohm output is known (122.5) and we have decided on

the power to be drawn by each speaker, we can find the impedance necessary at each matching transformer primary.

Transposing the formula $P = E^2/R$ to solve for R ($R = E^2/P$), substituting 122.5 for E and, successively, 7, 9, and 14 for P , we find that the primary of

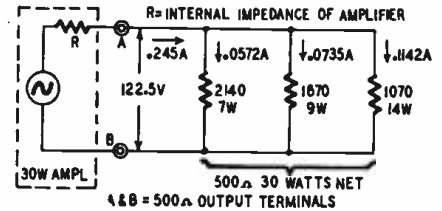

Fig. 2—Matching with 3 output transformers.

the 500-ohm matching transformer must have an impedance of 2,140 ohms; that of the 16-ohm transformer, 1,670 ohms; and the transformer for the four 6-ohm speakers, 1,070 ohms. Fig. 2 shows the resistance, current, and power values. Resistors have been drawn in place of the transformer primaries to accentuate the circuit's similarity to an ordinary resistor network.

It is not usually easy to find matching transformers with the correct values. The next article of this series will demonstrate the simplicity of making transformers to fit the job.

Useful 10-Watt Amplifier

by W. D. HAYES, W6MNU

ONE of the most useful pieces of equipment for the radio builder and experimenter is a simple, medium-powered audio amplifier—free of bugs and flexible with regard to input requirements. Such an amplifier can be used in conjunction with an r.f. tuner to make a complete receiver. It makes an excellent phono amplifier for use with either ordinary records or special sound-effect records for home movie productions. It can act as the principal unit of a small public address system with either phonograph or microphone input.

The amplifier described provides 10 watts output from a pair of push-pull 6V6-GT's, and has sufficient gain to give full output from any high-impedance microphone. Provision is made for two phonograph pickups so that sound effects can be faded in and out in case the amplifier is used with home movies. If two phonos are used, each must have a volume control. Two gain controls are incorporated in the amplifier itself, one in the microphone channel, and one in the phono channel.

The microphone signal is amplified by a 6SJ7-GT pentode, which is resistance-coupled to one half of a 6SN7-GT. The other half of the 6SN7-GT cathode-couples the phono channel into the first

half. This provides a very simple and effective mixing arrangement. Transformer coupling is employed both in the input and output of the push-pull 6V6-GT's, and output impedances of 4, 8 and 16 ohms are available.

The amplifier and its power supply are built on an aluminum chassis 5½ inches wide, 10½ inches long, and 2 inches deep. There is ample room below the chassis for the few parts required. To reduce the possibility of hum, the power transformer is mounted at right angles to the two audio transformers. Across the rear of the chassis from left to right are the microphone jack, the two sets of phono input terminals, the speaker socket, the fuse holder, and the 117-volt line cord.

Across the front are the microphone gain control on the extreme left, followed by the phono gain control, the pilot light, and the on-off switch.

MATERIALS FOR AMPLIFIER

Resistors: 1—470-ohm, 2-watt; 1—1,000-ohm, 1—2,200-ohm, 1-watt; 1—3,300-ohm, 2—33,000-ohm, 3—330,000-ohm, 1—470,000-ohm, 1—1-megohm, ½-watt; 2—500,000-ohm potentiometers.

Capacitors: 1—.03-µf, 3—0.1-µf, 400-volt paper; 2—20-µf, 450-volt, 1—8-µf, 450-volt, 1—50-µf, 25-volt, electrolytic.

Transformers: 1—power, 600-volt, center-tapped, 55-ma, 5-volt, 2-amperes, 6.3-volt, 2.7-amperes; 1—interstage, 1:3 turns ratio; 1—output, 8,000-ohm, push-pull, to voice coil.

Tubes: 1—6SJ7-GT, 1—6SN7-GT, 2—6V6-GT, 1—80.

Miscellaneous: 1—2-ampere fuse and holder assembly; 1—s.p.s.f. toggle switch; 4—octal, 1—4-prong tube sockets; 1—5½ x 10½ x 2-inch chassis; necessary hardware.

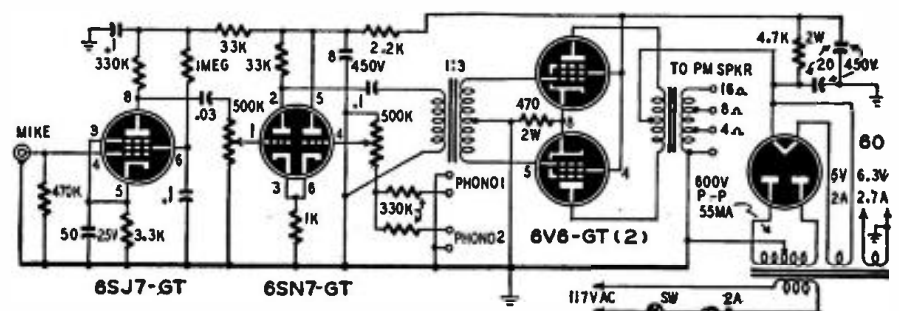

RADIO-ELECTRONICS for

Bandswitching Exciter

By BOB WHITE

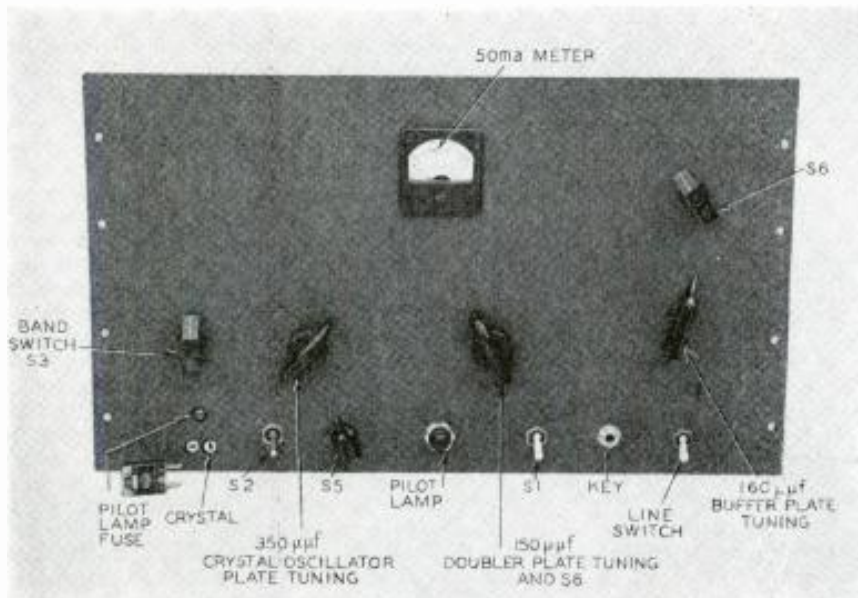

The exciter is fully described in the photographs. Here is the 7 x 13-inch front panel.

A BAND-SWITCHING exciter is a necessity in the amateur station which operates on more than one band. This exciter will operate with a crystal of any frequency from 80 to 10 meters, though only a single set of low-frequency crystals is needed for operation on 80, 40, 20, 15, and 10. It can be used with additional doubler stages for operation on v.h.f. bands which are not integral multiples of the lower amateur frequencies. There is a send-receive relay and a keying system.

The exciter has three stages: a 3.45-30-mc, bandswitching, harmonic-generating crystal oscillator; an 11-33-mc bandswitching doubler; and a 3.45-33-mc bandswitching buffer or doubler. A power supply is included.

The pictures will be of much greater assistance in constructing the exciter than any description that could be written; however, a few suggestions are included on some of the less obvious details.

The chassis is 17 x 13 x 2 inches and the dimensions of the front panel (a standard relay-rack panel can be used) are 11 x 19 inches. The panel should be securely fastened to the chassis, and a shield panel should be erected from front to rear between the 807 plate circuit and the other plate circuits. The parts should be arranged for short, direct leads. All grounds of each stage should be made to a single point on the chassis, and each grounding point should be returned directly to the negative terminal of the power supply.

Because the rotors and frames of the oscillator and first doubler plate-tuning capacitors are connected directly to the positive side of the high-voltage supply, the capacitors must be insulated from the chassis and panel. Stand-off insulators or small insulating boards of suitable plastic are satisfactory. The shafts

must be connected to the tuning controls through insulated couplings. The two variable 25- μf coupling capacitors must also be thoroughly insulated with steatite, lucite, or a similar good high-frequency insulating material.

It is probably best to wire the power supply first. Of particular interest in this section is the relay system. The send-receive switch for the entire transmitter should be connected across terminals A and C to energize the 120-volt relay coil. Terminals B and C should be connected to the coils of the other transmitter relays (final amplifier relay, modulator relay, antenna relay, etc.). Terminals D and E are to be connected to the receiver's standby terminals to silence it automatically during transmission.

One set of contacts on the relay controls the high-voltage supply. When the coil is energized, high voltage is supplied to all stages. The cathodes of the 6L6 doubler and 807 are returned to the negative connection of the power supply through a set of relay contacts and the keying jack.

Switch S1 connects high voltage to all stages with the relay in receive position. Only the oscillator functions, because the cathode contacts of the relay remain open. There are many advantages in having the oscillator operative during the receiving period. The oper-

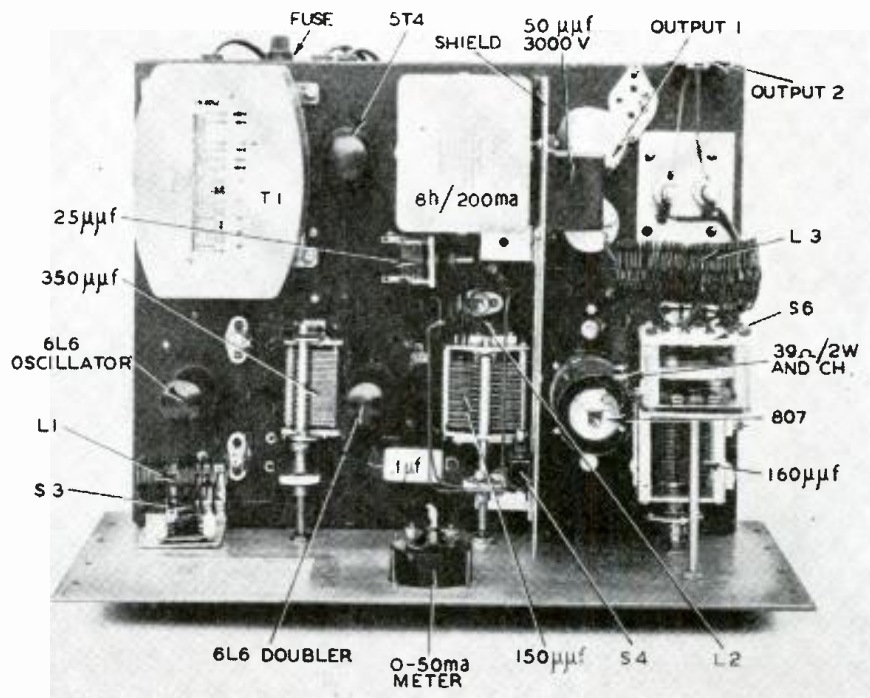

This top view shows positions of all components. Power supply is mounted on same chassis.

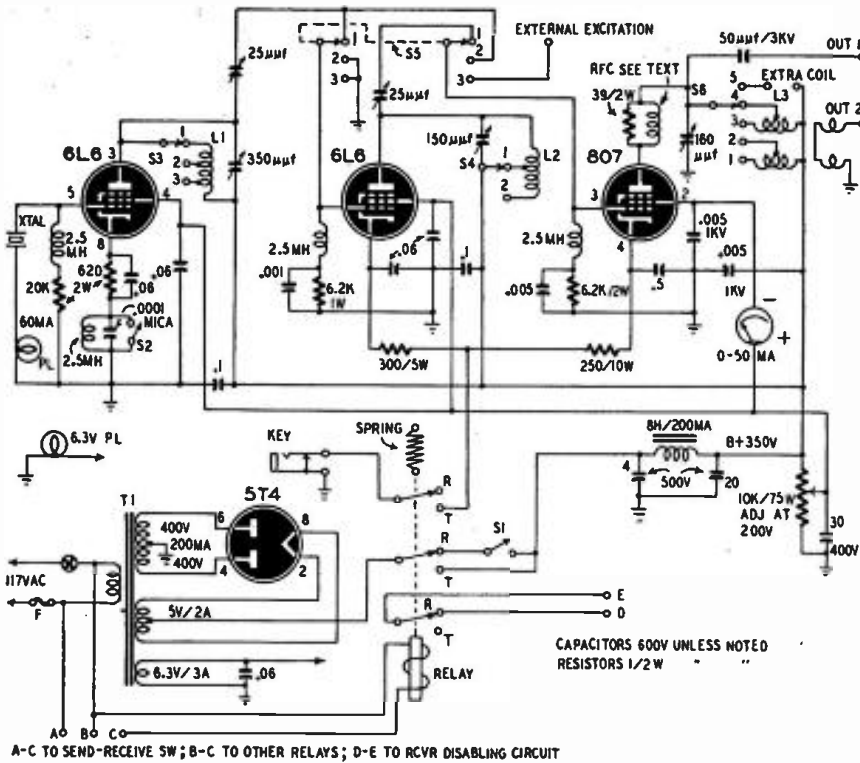

The schematic. Switch S5 permits bypassing the 6L6 doubler or using external excitation.

ator can check his frequency for interference. Because the oscillator frequency can be varied approximately 1 kc by the plate-tuning circuit if the oscillator is operated on the fundamental frequency of the crystal it is possible to adjust the transmitting frequency exactly.

The bleeder resistor with the variable tap cannot be adjusted until all stages are completed. The tap on the resistor should be set for approximately 200 volts.

The 6L6 oscillator may be wired next. The purpose of the toggle switch S2 is to short-circuit the choke and capacitor when the oscillator plate circuit is to be tuned to the same frequency as the crystal. Closing the switch reduces the crystal current to a safe value. The pilot lamp connected in series with the crystal serves as a current indicator and provides some protection.

L1, S3, and the 350-µmf variable capacitor are the oscillator plate-tuning circuit. Position 1 of the switch covers 3.45 to 7.5 mc; position 2, 6.00 to 13.5 mc; and position 3, 13 to 30 mc. L1 was wound with No. 12 enameled wire on a 1 3/8-inch cylindrical form. From tap 1 to tap 2 there are 9 close-wound turns; from tap 2 to tap 3 there are 7 close-wound turns; and from tap 3 to the B-plus end there are 2 1/2 spaced turns.

The coil should be fastened to its switch S with the form still in place. The form can be removed after the end leads have been soldered. The tap connections should be soldered with special care to see that the adjacent turns are not short-circuited. The oscillator should be tested and the coil spacing adjusted for the correct coverage. The turns can then be held rigidly in place by cement-

ing two narrow strips of lucite to the windings.

The 6L6 doubler stage is the third section to be wired. The plate of this stage should never be tuned to the frequency of the grid signal because this may result in parasitic oscillation. The circuit tunes from 11.0 to 19.5 mc with S4 in position 2 and 18.8 to 33.0 mc in position 1.

L2 is constructed with the same wire and form as L1. From the plate end of the coil to tap 1, there are 1 1/2 spaced turns and from tap 1 to tap 2 there are 3 1/2 turns. The length of the wire connecting switch to coil affects tuning.

The two-position switch S4 is a small roller-leaf microswitch. The small non-metallic roller of the switch rests against the outer rotor plate of the tuning capacitor, which can be rotated through 360 degrees. When the capacitor is rotated 180 degrees from minimum to maximum capacitance, the slight pressure exerted on the roller by the rotor plate is sufficient to hold the switch closed in position 1. When the capacitor is turned through the remaining 180 degrees, the rotor plate does not touch the roller and the switch is released to position 2. Two frequency ranges are thus covered and the entire 360 degrees of rotation are utilized.

Switch S5 in position 3 connects the 807 grid to a terminal for external excitation; in position 2 it connects the output of the 6L6 oscillator stage to the 807, bypassing the 6L6 doubler; and in position 1 it connects the output of the oscillator to the doubler and the doubler to the 807. No. 12 or 14 wire is recommended for the wiring of this switch and the other r.f. circuits. The two 25-µmf variable coupling capacitors are adjusted to give adequate excitation on all positions of S5 and at all frequencies. The best position was found to be with the plates about half meshed.

The fourth and last division of the exciter to be wired is the 807 stage. This can be operated as either a straight amplifier or a doubler because of the special precautions taken in its construction. The plate circuit is shielded

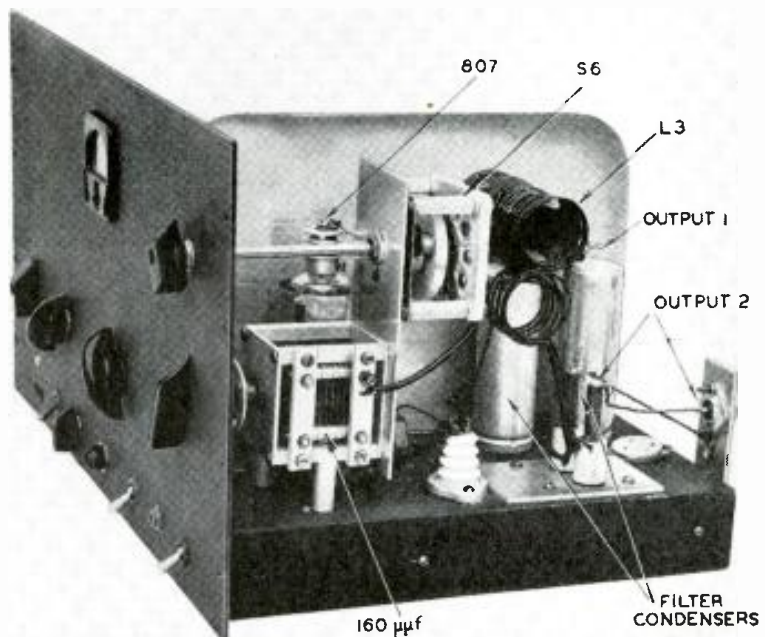

This view of the output end shows construction and layout of the 807 stage excellently.

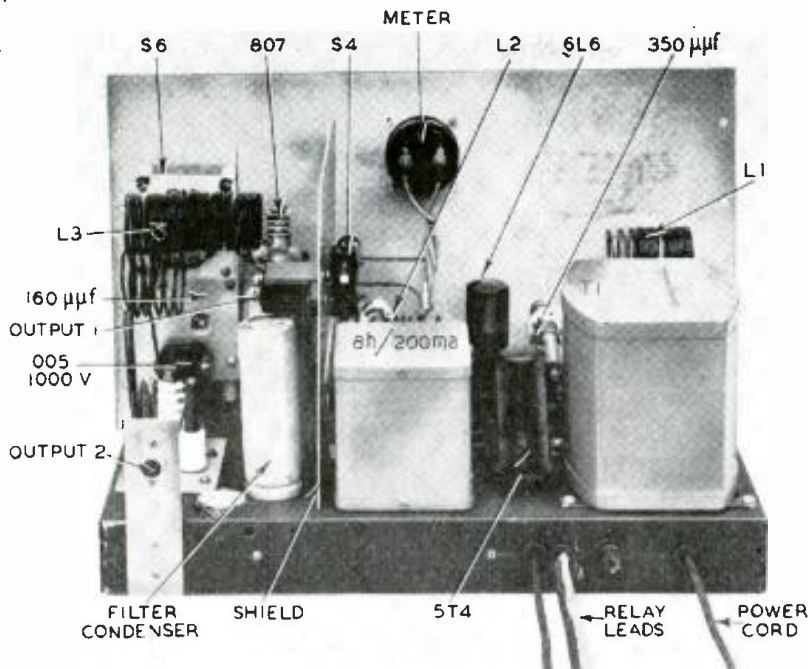

Rear of the chassis. A small shield separates the output stage from the rest of the exciter.

Next, plug in a crystal and turn switch S5 to position 2 so that the oscillator output excites the 807. Set the oscillator bandswitch S3 to the position that includes the fundamental, second-harmonic, or third-harmonic frequency of the crystal. Remember to close switch S2 for operation on the fundamental crystal frequency. Adjust the oscillator tuning capacitor for an increase in the 807 screen current; the oscillator stage is then approximately adjusted.

If the 6L6 doubler is to be used, S5 should next be set to position 1. Bandswitch S4 and the doubler tuning capacitor should be set for twice the output frequency of the oscillator stage. When the doubler plate circuit is tuned to resonance, the meter reading will rise.

The plate circuit of the 807 can then be resonated either to the fundamental or a harmonic by turning switch S6 to the correct position and tuning the capacitor. The screen current will increase still more when the 807 tank is adjusted. As a last step, the setting of all the tuning condensers should be touched up to produce maximum screen current.

MATERIALS FOR EXCITER

- Resistors: 1—6,200 ohms, 1 watt; 1—39, 1—620, 1—6,200, 1—20,000 ohms, 2 watts; 1—300 ohms, 5 watts; 1—250 ohms, 10 watts; 1—10,000 ohms, 75 watts, adjustable.
- Capacitors: 1—100 μf, 1—.001 μf, 2—.005 μf, mica; 1—50 μf, 1—.005 μf, 3,000 volts, mica; 5—.06, 3—0.1, 1—0.5, 1—4 μf, 600 volts, paper; 1—20, 1—30 μf, 450 volts, electrolytic; 2—25, 1—150, 1—160, 1—350 μf, variable.
- Transformers and chokes: 1—power transformer, 800 volts, center-tapped, 6.3 volts, 3 amperes, 5 volts, 2 amperes; 1—8-h, 200-ma filter choke; 4—2.5-mh r.f. chokes.
- Switches: 3—s.p.s.t. toggle; 1—1-circuit, 3-position, 1—1-circuit, 5-position, 1—2-circuit, 3-position rotary; 1—s.p.d.t. micro-switch with insulated roller actuating arm.
- Tubes: 1—5T4, 2—6L6, 1—807.
- Miscellaneous: 1—117-volt a.c. relay, 3-pole, double-throw contacts; 1—0.50-ma meter; 1—closed-circuit phone jack; 1—6.3-volt pilot assembly; 1—17 x 13 x 2-inch chassis; 1—11 x 19-inch rack panel; necessary insulators, binding posts, shield metal, insulated couplings, hardware.

from the oscillator and doubler stages by the shield placed on the chassis (see photos). The 807 is enclosed in a metal can as a further precaution. A 39-ohm, 2-watt carbon resistor with a choke in parallel is also used to suppress parasitic oscillation. The choke consists of 20 turns of No. 26 d.c.c. wire wound around the carbon resistor.

The rotor and frame of the 807 plate tuning capacitor are grounded directly to the chassis. The .005-μf plate bypass capacitor should be mounted as close to the tuning capacitor as practicable so that short, direct leads to the coil and tuning capacitor are possible. Coil L3 consists of two windings; positions 1 and 2 on the bandswitch S6 tune 3.45 to 6.30 and 6.20 to 12.0 mc, respectively. Positions 3 and 4 tune 11.9 to 20.0 and 18.0 to 33.0 mc. Position 5 is for an extra coil of any desired range.

The windings were made in much the same way as the coils previously discussed. The low-frequency coil consists of 11 close-wound turns from the B-plus end to tap 2 and 19½ turns from tap 2 to tap 1. The bottom coil, wound with the same size form and wire, consists of 2 spaced turns from B-plus to tap 4 and 3 spaced turns from tap 4 to tap 3.

Two output systems are shown. The first employs a 50-μmf coupling capacitor connected to the 807 tank circuit. This is suitable for connection directly to the grid circuit of the next transmitter stage, which must be located near the exciter.

The second output system employs a pair of series-connected coupling coils placed at the B-plus ends of the two tuning-coil windings. Each coupling coil is composed of approximately 2 turns of No. 12 enameled wire. They are alike except that they are wound in opposite directions with a continuous length of wire which forms a figure-8 because of the reverse in winding di-

rection. The coupling link for the 11.9-33-mc plate coil must be spaced about ¼ inch from the winding. This output system is suitable for link coupling; co-axial cable between the exciter and the transmitter is recommended.

One 0-50-ma meter in the screen lead of the 807 serves for adjusting the entire exciter. With no excitation applied to the 807 grid, screen current is practically zero. It is increased when excitation is applied, and further increased when the 807 tank is tuned to resonance.

The procedure for tuning is similar for all bands. First, turn the exciter on and energize the send-receive relay.

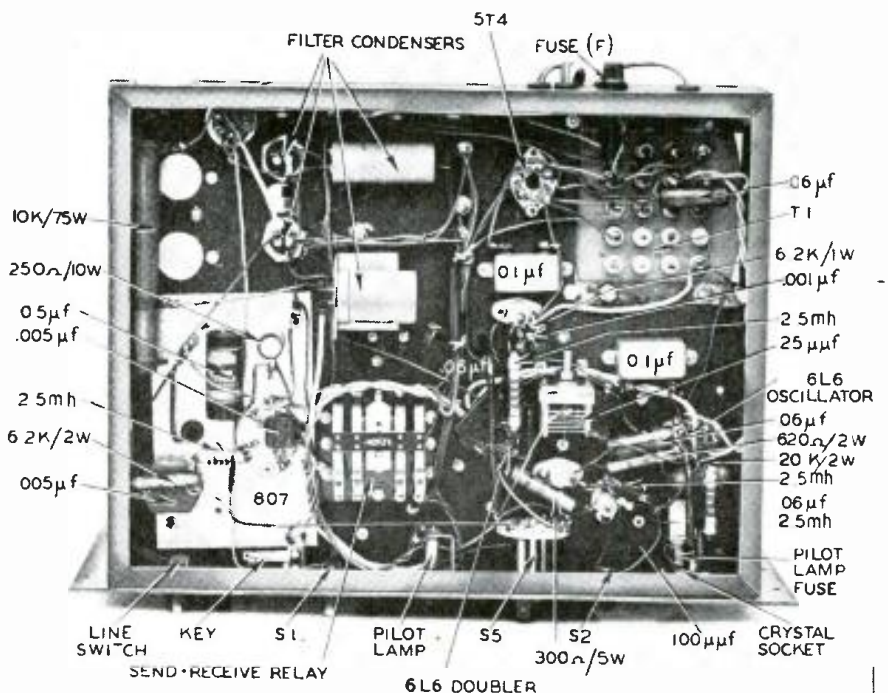

The under-chassis view. Most of the important components are identified in the call-outs.

Fundamentals of Radio Servicing

Part III—What Is Induction?

By JOHN T. FRYE

HAVE you sat in a hotel lobby where all was quiet until a cute blonde got up from where she had been sitting unnoticed behind a potted palm and glided across the floor? If you have, you may have noticed—if you were not too busy watching the blonde—that there was something about the girl *in motion* that seemed to exert a magnetic effect on every masculine head in the lobby.

Well, what this blonde has, our friend the little electron has, too; for as soon as an electron starts to move, it is surrounded by a magnetic field. Let me repeat this, for it is one of the most important facts in radio: *an electron in motion is surrounded by a magnetic field.*

The magnetic field surrounding a single hustling electron is too small to be easily measured with crude instruments, but when a few million of them cavort along through a wire carrying a substantial direct current, it is easy to observe the total magnetic field generated. Fig. 1 shows a vertical wire car-

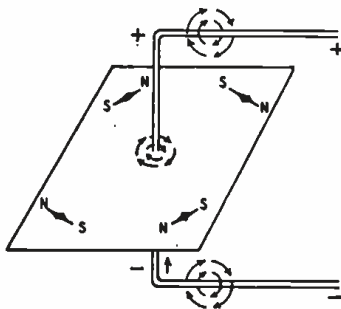

Fig. 1—The field around an electric current.

rying such a current, with four compasses grouped around the wire. Since a magnetic field is the only force that affects a compass needle, and since lines of magnetic force enter the S pole of the compass needle and leave by the N pole, we can see that the magnetic field about the wire consists of circulating concentric lines of force. Reversing the direction of the current causes the needles to reverse their positions, indicating the truth of the left-hand rule for wires:

Grasp the wire with the left hand so that the thumb points in the direction

the current is flowing; then the fingers will be pointing in the direction in which the magnetic lines of force encircle the wire.

(Radiomen used to go along with Ben Franklin's original mistake and pretend the current flows from positive to negative—although we know that just the opposite is true. They, of course had to use the right hand.)

Increasing and decreasing the current while moving the compass needles to different distances from the wire will show that the strength of the magnetic field is related to the amount of current flowing. It is easy to see why. More current means that more electrons are moving, and the total magnetic field about the wire is simply the sum of the magnetic fields of the individual electrons that are passing through the wire.

The inductor

Suppose we wind our length of wire into a coil. What happens to the magnetic field about the wire? Fig. 2, showing two adjacent turns of such a coil with an exaggerated separation between the turns, gives the answer. For one thing, we see that as the magnetic lines of force continue their dog-chasing-his-tail routine about the wire of each loop, all of these lines pass through the center of the loop, and as they do so, they are all traveling in the same direction. This is true for all the turns of the coil: when the lines of force are at the "most inside" point of the coil, they are all traveling in the same direction. A half-turn later, when each circling line of force is at its greatest distance from the center of the coil, it is traveling in exactly the opposite direction; and that means that *all* of the lines of force are doing so. Between turns, though, the lines of force of two side-by-side turns are traveling in opposite directions.

When we reflect that these magnetic lines of force are true *forces* and can be added when they are working together, we come to the following conclusions about a coil of wire carrying a direct current:

1. The circulating lines of force about the wire add together inside and outside the coil to produce new and strong-

er lines of force that issue from one end of the coil, return outside to the opposite end, and then pass through the center of the coil.

2. Between the adjacent turns, the opposite-going lines of force buck each other and so cancel.

3. The new magnetic field is most intense inside the coil where all of the lines of force are crowded together.

4. The coil has a N and a S pole just as does a bar magnet, and reversing the direction of current through the coil causes these poles to exchange places.

5. Since the individual fields of all the turns of wire are added together to produce the field of the coil, it follows that the more turns of wire there are, the stronger will be the magnetic field of the coil. Also, since the strength of the field of each individual turn depends upon the amount of current flowing through it, so does the strength of the field of the coil as a whole depend on the current.

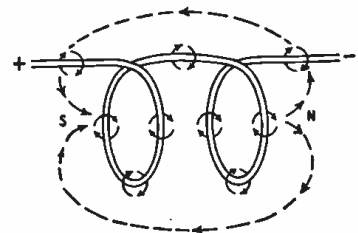

Fig. 2—The fields help or hinder each other.

If a bar of iron is thrust through the center of our coil, the magnetic field is greatly increased. The reason is that a magnetic line of force feels about iron the way a cat feels about catnip. It just loves to wriggle through that soft iron, and it will endure a great deal of crowding to be permitted to do so. In fact, a coil with an iron core will accommodate several hundred times as many lines of force as will the same coil carrying the same current with only air in its center. The more lines of force there are, the stronger is the magnetic field.

Magnetism creates current

One of the nicest things about the study of electricity is that it is such a *vice versa* business: There are so many statements in this subject to which you

can add, "And so is the opposite true." An example is our statement about the moving electron creating a magnetic field. *If a conductor is cut by the lines of force of a magnetic field, an e.m.f. is set up in the conductor which causes electrons to move, or current to flow.*

When we speak of the conductor being "cut by lines of force," we mean that either the conductor or the lines of force must be moving. A wire moved between the poles of a horseshoe magnet, a bar magnet thrust into a coil, or a wire placed so as to intercept the expanding and contracting lines of force that surround another wire through which a current of varying intensity is flowing all fulfill this requirement. Remember, though, that either the field or the conductor has to hold still while the other moves through it—or else one has to be zigging when the other is zagging.

The intensity of the e.m.f. "induced" by this action depends upon how many lines of force are cut in how short a time. This means that a strong magnetic field with many lines of force and a very rapid movement of either those lines of force or the conductor will produce a high voltage.

Self-induction

And now we are ready to meet *self-induction*, which is just about as bull-headed and conservative a quality as you will find anywhere, inside electricity or out! It simply cannot bear a change. Take the case of Fig. 3. Here we have a battery connected across an iron-core coil of many turns. A lamp that barely lights on the battery voltage is across the coil, and a switch and an ammeter are in series with it and the battery.

When we close the switch, the light glows dimly; but the hand of the current-indicating meter rises quite slowly to a maximum reading. Why so slowly? We know that electrons move with the speed of light. Why are the little cusses apparently dragging their feet just because there is a coil in the circuit? Well, when the current started to flow through the coil, a magnetic field started to build up around that coil. As the lines of force of this expanding field cut the turns of the coil, an e.m.f. was induced in those windings that had a polarity opposite to the voltage applied by the battery. This "bucking" voltage was very nearly equal to the battery voltage.

However, as the induced bucking voltage or back-e.m.f. approached the battery voltage, it slowed down the increasing current from the battery. This in turn slowed down the expansion of the magnetic field that was producing the bucking voltage.

As you can see, this gives the battery voltage the whip-hand: if the induced e.m.f. could rise to the value of the battery voltage, it would stop the current flow; and this would spell its own doom. The net result is that the battery steadily wins the tug of war, but it takes time. Eventually the current rises to the maximum amount the battery can push through the resistance

of the coil wire, and then the magnetic field ceases to expand. It just hovers out there in the vicinity of the coil without either increasing or decreasing. Since the lines of force are no longer moving and cutting the turns of the coil, there is no more back-e.m.f.

Now let us quickly open the switch. Instantly the ammeter falls to zero, but a split-second later the lamp flashes very brightly and then goes out. Where did this lamp-flashing voltage—obviously higher than our battery voltage—come from? How could current continue to flow through the lamp *after* the battery had been cut off? Gremlins?

No, the answer lies in what happened to that hovering magnetic field when we opened the switch. Since this cut off the sustaining current, we simply knocked the props from under that field, and it did the only thing it could do: collapsed. As the field contracted, the lines of force whizzed through the coil turns faster than a small boy going through his yard gate at curfew time; and the speed with which these lines of force intercepted the wires accounts for the fact that high e.m.f.—higher than the battery voltage—was set up in the coil.

You remember that the e.m.f. generated by the expanding magnetic field was of such polarity as to resist the voltage of the battery. As might be suspected, the voltage induced by the collapsing field is of opposite polarity and tries to keep the current flowing after the battery has been cut off. After doing all it could to prevent the current from starting to flow in the first place, now the self-inductance does all it can to prevent that current from stopping!

This property of a coil or wire that tends to *prevent any change* in the cur-

rent passing through it—that always tries to preserve the *status quo*—is called *inductance*. The unit of measurement of how much of this property a circuit element has is the *henry*. When a current change of 1 ampere per second in a circuit produces an induced e.m.f. of 1 volt, the circuit is said to have an inductance of 1 henry. If 2 volts are produced, the inductance is 2 henries, etc. Smaller units are the *millihenry* (one thousandth of a henry) and the *microhenry* (one millionth of a henry).

Inductors are often used in radio work, but they are usually called by some other name. For example, we have filter and audio chokes which consist of many turns of wire on iron cores and may have inductances from 1 to 100 henries. R.f. chokes have fewer turns of wire with an air core, and they vary

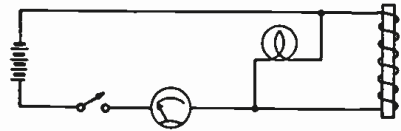
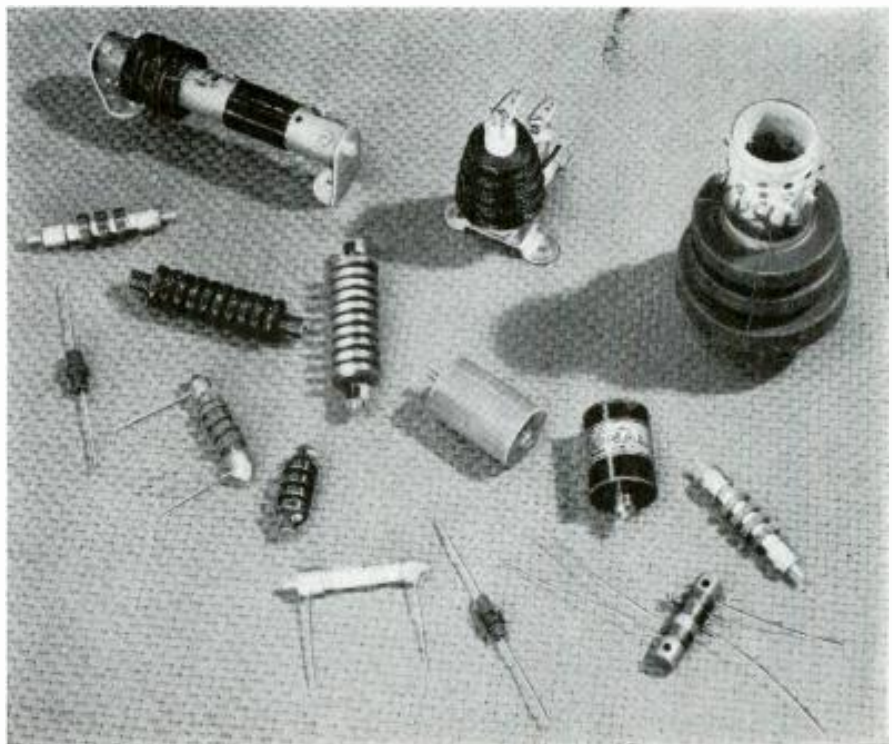

Fig. 3—Setup to demonstrate self-induction.

from a few microhenries to 100 millihenries.

Inductance is chiefly concerned with coils, and anything having to do with coils is of major importance in radio. This business of magnetic induction is the key to understanding what goes on in many of the parts you find in any radio receiver. Do not, therefore, dismiss it as not being of practical value. A knowledge of magnetic induction is as practical in understanding radio as the knowledge of the alphabet is in learning to read.



This group of high-frequency (r.f.) inductors includes both transformers and chokes.

Sound Can Make Money For You

By GUY S. CORNISH

EVERY radio serviceman is interested in making more money. Probably the most obvious way is to get more radios to fix—and to add a few more hours to the present day's 24. But there is at least one other way: that is, specializing in sound work in addition to repairing radios. As a matter of fact, some radiomen have done so well with audio that they have almost completely forsaken receiver repair!

No doubt the most popular piece of sound equipment in use today is the small portable public-address system, consisting of an audio amplifier, one or two speakers, a microphone, and the necessary connecting cables. The circuit in the audio amplifier does not differ greatly from that used in the larger console radios. There may be a stage or two more of amplification to increase the over-all gain, but the radioman, with his knowledge of radio circuits, should have no difficulty in checking the unit.

In addition to public-address, there is the intercommunicating system used in factories, schools, and offices, which is nothing more than a small audio amplifier containing a speaker. The speaker becomes a microphone when the lever is pressed down to talk, and a speaker when the lever is released to listen. The circuit diagram is pasted on the bottom or inside the back of many intercom cabinets to assist the technician in checking. However, it may be well to write the manufacturer for circuit

drawings and file them in a folder for future use. The amplifiers used in sound motion-picture equipment and electric guitars are checked in the same manner as those used in public-address systems.

Some repairmen have added the servicing of hearing aids to their line. These little units are nothing more than miniature audio amplifiers using special tubes. Servicing, as a rule, amounts to nothing more than replacing batteries and tubes, but should circuit trouble develop it can be located by standard checking methods.

Rental of sound equipment

In addition to servicing audio devices, the serviceman often finds a good profit in keeping an amplifier or two on hand to rent out. Without a doubt one of the best sound units for rental is the small portable public-address system; the radioman should build or purchase one for this purpose. It should consist of a 10- or 20-watt amplifier, two speakers, microphone, stand, and the necessary connecting cables. The equipment must be reasonably light, for portability, and all controls should be plainly marked. If the radioman is located in a community where the use of such equipment is not common, he should set it up without charge, as a demonstration. After people have become accustomed to the use of public address, every gathering of a couple of hundred or more will become a potential customer.

The radioman should decide on a fair rental price for each day; where the system is used for several days at a stretch, a sliding scale can be suggested.

The system should be called for and delivered by the people renting it, saving the serviceman's time. Those renting the equipment should be told that they will be held responsible for any damage due to misuse.

To assist the serviceman in getting this business, here are some suggestions: Contact church groups, lodges, clubs, schools, business organizations, and civic associations, and explain to them that you are in a position to furnish public-address equipment for their meetings at a reasonable rental rate for an evening. If booked for several evenings, say once a week or once a month, you can quote a special price. If any are lukewarm to your proposition, offer them a demonstration at no charge.

Another sound unit that is fast becoming popular is the applause meter. This consists of a sound pickup such as a good microphone or a specially housed speaker, a high-gain audio amplifier, and a special decibel meter with a scale of either 100 or 1,000 divisions. This unit can be purchased complete or can be constructed from readily available parts. It is used to register the intensity of the applause given any contestant in local amateur contests and the like.

A complete sound service

The radioman who wishes to realize the greatest possible revenue from the addition of sound to his service business should, in addition to his repair and rentals, arrange to furnish complete sound service. There is a definite difference between rental and service.

In plain rentals, the user simply rents the equipment, sets it up himself, operates it, and when through, returns it to the owner. In sound service, the owner of the equipment calls at the location where the service is to be used, measures for cable lengths, estimates the proper size of equipment for best results, and decides on the type of microphone. After he has made his check on the location, he estimates his service charge and the user signs a contract for a certain date. When this date arrives, the sound man brings his equipment, hooks it up, and operates it during the program. When through, he takes it back to his shop.

The equipment is usually larger and more elaborate than the smaller rental type. Complete sound service is not limited to live speech and music amplification, but includes record music, radio rebroadcasting, and telephone pickup.

One type of record music furnished



Small transmitter on stand sends voices from rostrum to receiver and amplifier in the car.

by a complete sound service is background or dinner music, soft music played while crowds are assembling or while dinner is being served. The volume must be kept low enough not to interfere with conversation, and is usually slow or waltz music. Another type of popular service is playing band records at political rallies, sporting events, fairs, and festivals.

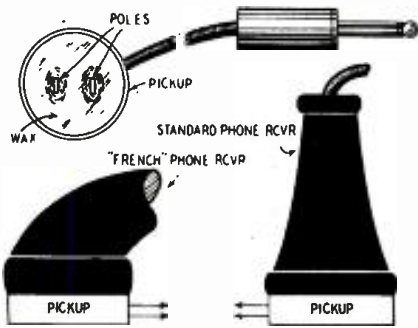

Fig. 1—Headphone makes telephone pickup.

There are times when a large gathering desires to hear a special program from a radio station. The radioman can easily arrange to rebroadcast the program over the public-address system. It can be done by connecting one side of a .03- μ f capacitor to the grid circuit of the output tube of a good a.c. receiver. The other side of the capacitor is connected to the center conductor of a microphone cable and the outer shield of the cable is connected to the radio chassis. The cable should be several feet long and supplied with a phone plug on the other end to fit the phonograph input jack on the amplifier.

A telephone pickup often comes in handy and can be easily made. It is an induction device. No connection must ever be made to any telephone equipment. The pickup is made from a two-pole telephone receiver, or better still, one of the early magnetic loudspeaker units. The diaphragm of the receiver is removed and the space inside the receiver is filled with melted sealing wax (see Fig. 1) to a point level with the pole pieces. This acts as a protection for the coils. The receiver is equipped with a length of microphone cable terminated by a phone plug to fit the phonograph input jack on the amplifier. By placing a telephone receiver on this pickup and rotating it to find the best position, any telephone conversation can be amplified so that a crowd of any size can hear it.

In some of the rural or smaller communities, playing phonograph records through the public-address system provides excellent music for dancing. Even in the larger and more populated sections, dances are sometimes given outdoors at lawn parties and playgrounds, and here the amplified music can be heard better than music from a live band. If good dance records are selected, the dancers will prefer the music to that of the smaller and less experienced orchestras.

Permanent installations

Before setting up an indoor system, make sure the available voltage and current are correct for the equipment. Ordinary PA systems are designed for 110-120 volts a.c. at 60 cycles, and in most locations the current in the building will be correct. However, there are still some buildings with their own generating plant supplying d.c. at 110 volts. The safest thing is to consult the custodian of the building.

The radioman will not have much choice as to where he places the microphone, as the position is established by the location of the stage or platform. The amplifier should not be placed too far from the microphone, and if possible, close to an electric outlet.

If a close-talking microphone is used and the amplifier gain is not advanced too far, the speaker placement is not critical. But where the gain is advanced to increase the amplification, a serious problem may develop. If the sound waves from the speakers strike the microphone directly, feedback will result. Drawings of several small halls are shown in Fig. 2 with properly placed speakers.

Outside installations

Setting up a public-address system to make announcements at picnics, sporting events, and other outdoor gatherings is, as a rule, somewhat simpler than inside installations in small halls. Outdoors there are seldom reflections and feedback. The first thing is to see if the current and voltage are correct for the system used. Be sure you plug in near the main line and not at the end of a string of lights where the voltage drop may be excessive.

The speakers should be hung higher than the heads of the people and 40 or 50 feet from the microphone. If the speakers are not weatherproof, covers made of thin rubber cloth or cellophane should be carried and slipped over the speakers in case of rain.

Be sure that no cables lie on the ground where someone may trip and fall over them. Such accidents sometimes result in expensive lawsuits. Do not permit anyone, especially children, to play with the equipment. It is better to delegate one man to make the announcements, thus assuring better handling of the microphone. If wires are hung overhead, they should never be stretched too tight; if the span is long, a rope should be stretched and the cables hung from the rope. Very little trouble will be experienced in outdoor hookups if ordinary precautions are taken.

Sales make profits, too

The radioman may find that when rentals become too frequent, schools, dance halls, and so on may decide to purchase their own equipment and have it permanently installed. Here the radioman can enter the sales field and work on a commission basis.

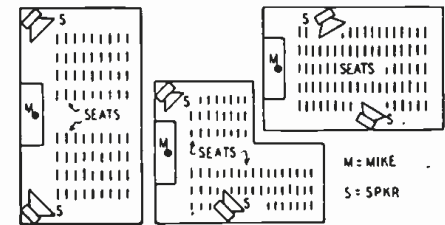
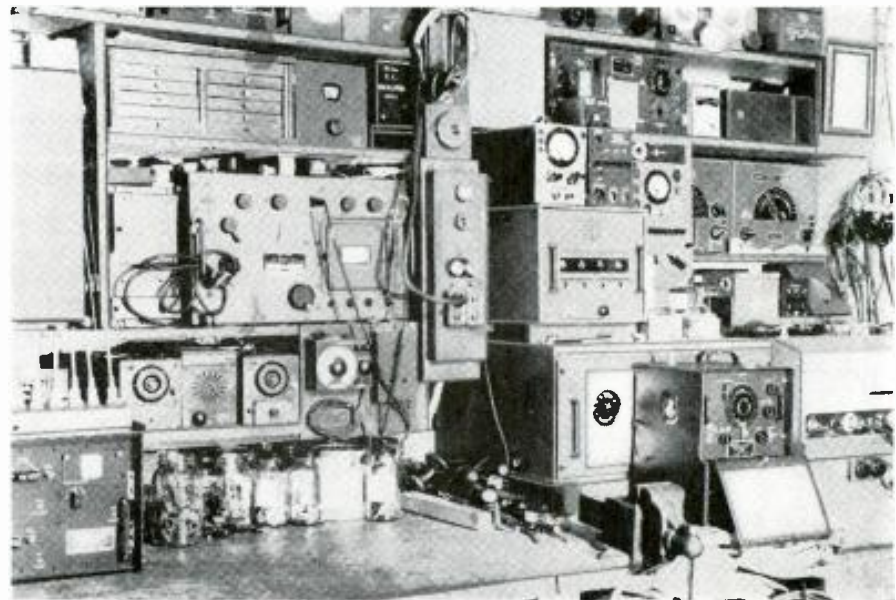

Fig. 2—Placing speakers in vari-shaped halls.

He should contact several distributors of sound equipment, get their prices and sales information, and call on these prospective customers. He should quote prices and cost of installation; and, if he makes a sale, the agreement should be made in writing to avoid any misunderstanding. After the installation the radioman can suggest a maintenance contract, in which he will make regular inspection trips to check tubes, microphone cables, and all connections, and keep the equipment free from corrosion and dust.



The author's workbench holds a large assortment of instruments for servicing sound devices.

Transmission Lines

By ROBERT C. PAINE

BEFORE radio communication went to its present high frequencies we used to think of a transformer as two coils of wire wound together on an air or iron core. But at the higher frequencies used today, a transformer can be just a pair of heavy conductors (a section of transmission line or co-axial cable). This is the *quarter-wave transformer* or *Q-section*, as it is used by hams.

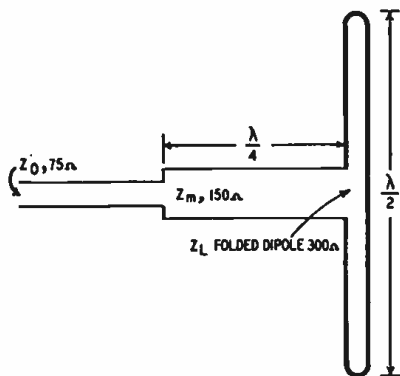

Fig. 1—A quarter-wave matching transformer.

The first two articles in this series (December, 1948, and February, 1949) described several uses of transmission-line sections for impedance matching. The quarter-wave transformer converts the ratio between the impedance connected to one end and its own impedance to the reciprocal of this ratio at the other end of the transformer. Fig. 1 is an example. The characteristic impedance Z_m of the quarter-wave transform-

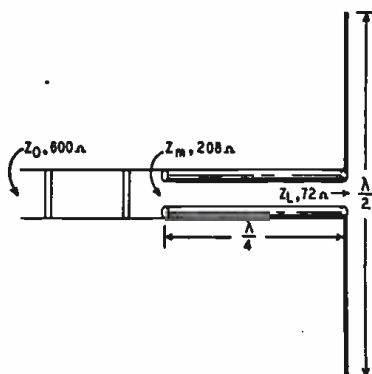

Fig. 2—The Q-section is well known to hams.

er (determined by the diameter and spacing of its wires) is 150 ohms. The impedance of the folded dipole connected to one end of the transformer is 300 ohms. The ratio, therefore, of the antenna to the transformer impedance is 2. Since the reciprocal of 2 is $\frac{1}{2}$, the impedance at the other end of the transformer is one-half Z_m : $150/2$, or 75 ohms. A 75-ohm line can be connected to this 75-ohm impedance, the net effect being to match the 75-ohm line to the 300-ohm antenna. This use of the Q-section is common in FM and TV practice when the receiver input is designed to match a 75-ohm line.

The radioman often has to find the correct impedance of a quarter-wave transformer to match two known impedances. If the input or line impedance is called Z_o , that of the quarter-wave matching transformer Z_m , and the load impedance Z_L , the formula is:

$$Z_m = \sqrt{Z_o Z_L}$$

In other words, simply multiply the input and load impedances together and take the square root (the geometric

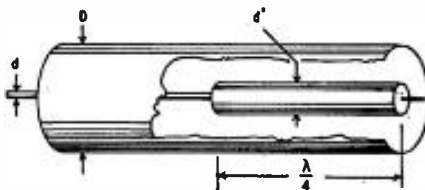

Fig. 3—A co-axial quarter-wave section.

mean of the two values) for the impedance of the matching section.

Since the characteristic impedance of a line is usually nearly pure resistance, the quarter-wave transformer can match it only to a load that is also pure resistance. The impedance of any kind of load as seen at the points in the standing wave (see earlier articles in this series) where the voltage is at a minimum (node) or maximum (antinode or loop) is pure resistance. If the load happens to be reactive and not pure resistance, the transformer should be located at one of these points. At a voltage antinode the resistance equals the standing wave ratio times the characteristic impedance, or $s.w.r. \times Z_o$. At a voltage node the resistance equals $Z_o/s.w.r.$

The quarter-wave section—how its impedance-inverting qualities are used to make it a matching transformer, an insulator, or to balance junctions of unlike lines

The Q-section transformer

As an example of the Q-section used by amateurs, take a half-wave dipole of 72 ohms impedance to be coupled to a 600-ohm line of parallel wires supported on insulating spreaders. The required impedance of the Q-section equals $\sqrt{72 \times 600} = 208$ ohms. Two $\frac{1}{2}$ -inch-diameter tubes spaced $1\frac{1}{2}$ inches between centers would give this impedance, as calculated by the formula for impedance of parallel conductors given in the December installment of this series. This Q-section is shown in Fig. 2. On co-axial lines at ultra-high frequencies the quarter-wave transformer may be in the form of a sleeve over the center conductor. Fig. 3 shows the end of a co-axial line with such a sleeve transformer. The characteristic impedance of the co-axial line depends on the ratio D/d of the inside diameter of the outer sheath to the outside diameter of the center conductor. Then the impedance of the line can be decreased for the last quarter-wavelength by making the inner conductor larger (d') to form a quarter-wave transformer. This sleeve forms a section of lower impedance than the rest of the line.

The quarter-wave transformer is a quarter-wavelength only at a given frequency and functions properly only in a relatively narrow band near this frequency. To pass a wider band the transformer may consist of a series of two or more sections in graduated impedance steps. The more steps used, the

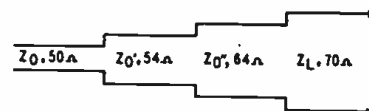

Fig. 4—Sample wide-band matching section.

wider the band transmitted. The author has shown elsewhere¹ how to compute these steps logarithmically. Fig. 4 shows a two-step multiple transformer for connecting a 50-ohm line to a 70-ohm load. This two-section transformer practically eliminates standing waves in the range 70 to 110 mc. ($s.w.r. = 1.03$). If a single-section transformer were substituted the $s.w.r.$ would be 1.13 in this range.

Insulators and bazookas

If the quarter-wave section is short-circuited at one end it shows an infinite impedance at the other end (for an ideal, no-loss line). Actually the input impedance can be made very high, as explained in the second of this series of articles, making it possible to use such a section as a metallic support or "insulator" for an ultra-high-frequency line or antenna².

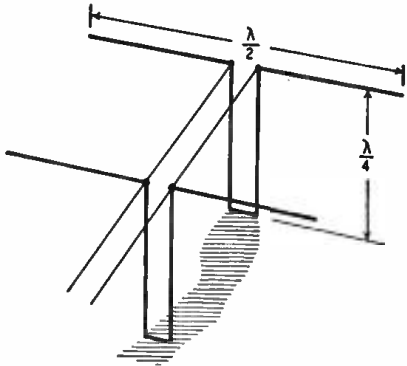

Fig. 5—Showing how to use copper insulators.

Fig. 5 shows two elements of a directional array of dipoles, with connecting transmission line, supported by such metallic insulators. Some radar systems use large arrays of these elements. The same principle is applied to co-axial lines at ultra-high frequencies to support the center conductor, as shown

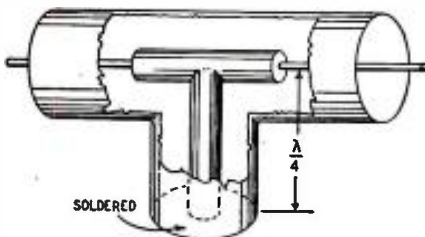

Fig. 6—The quarter-wave insulator in co-ax.

in Fig. 6. The supporting pillar is a quarter-wavelength long, and is soldered or otherwise solidly connected to the outside conductor. If a sleeve is used over the center conductor also, as shown, a broader band of frequencies can be transmitted.

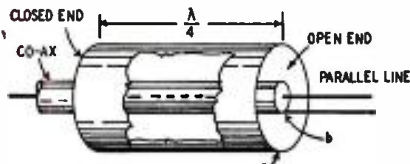

Fig. 7—Bazooka between co-ax and open line.

A section of line a halfwave long shows the same impedance at both ends. Thus if it is shorted at one end, it shows zero impedance at the other end; or if it is open at one end, it shows infinite impedance at the other (for a no-loss line). The quarter-wave metallic insulator at twice the frequency for which it is intended is a half-wave section and shorts the line. This frequency is the second harmonic of the generated frequency, so the quarter-wave section can also serve to suppress the second har-

monic while freely passing the fundamental.

The co-axial type of line is essentially unbalanced to ground. If it is directly connected to the balanced parallel type of line or to a balanced load, unbalanced currents flow along its outer surface, resulting in undesired radiation or pick-up of interference. To avoid this condition, special transformers known as *bazookas* are used.

One type of bazooka is shown in Fig. 7. A sleeve a quarter-wave long is placed over the end of the cable. One end is closed and the other open. The cable passes through the closed end, and the outer sheath is soldered or otherwise secured to the bazooka sleeve. The sheath of the co-axial cable then forms the inner conductor of a co-axial line of which the sleeve is the outer conductor. Since the sleeve is a quarter-wave long and it is shorted to the line sheath at one end, the impedance between points a and b is high. The sleeve is effectively the grounded element; since the end of the actual line sheath is separated from it by high impedance, it is effectively isolated from ground and may be connected to one side of a balanced parallel-wire line.

A different form of bazooka is used

to feed a dipole from a co-axial line. This is shown in Fig. 8. Here the bazooka is reversed and the outer surface of the sleeve itself radiates and becomes the lower half of a dipole of which d (connected to the center conductor) is the upper half. The inverted quarter-wave insulator separates this radiating surface from the outer surface of the co-axial sheath and keeps an unbalanced current from appearing upon it.

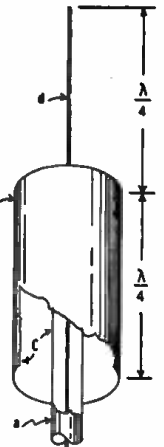

Fig. 8—The bazooka-principle antenna.

It should be pointed out that in all of the above figures dimensions have been purposely distorted to show more clearly the principles described.

References:

1. Robert C. Paine, *Broad Band Quarter-wave Transformers* Radio News (Radio-Electronic Engineering Ed.) pg. 14, July, 1947.
2. Robert C. Paine, *Metallic Insulators for Broad-Band Transmission*, Radio News (Radio-Electronic Engineering Ed.) pg. 9 April, 1947.

30-KV NEGATIVE VOLTMETER

The inverted-tetrode voltmeter, so called because the functions of the grid and plate are reversed, is designed to measure high negative voltages developed by low-current sources. This circuit, described in *The Review of Scientific Instruments*, measures up to 30,000 volts with an input impedance of 10,000,000 megohms. Its operation is based on the fact that current flowing in a positive grid circuit can be controlled by the plate voltage. In this circuit, a large change in plate voltage produces a small change in grid current when the grid voltage is held constant. The voltage to be measured is applied between the plate and ground—with the negative side connected to the plate. The meter in the grid circuit measures changes in grid current and may be calibrated in kilovolts.

The screen grid is grounded to shield the control grid from the plate and thereby lower the transconductance of the tube. R2, R3, R4, and R5 provide a bucking voltage to cancel the grid current that flows through the meter with zero plate voltage. R2 zeros the meter.

Degeneration provided by the cathode resistor RC improves the linearity of the grid-current plate-voltage relationship and further reduces the transconductance. RC is adjusted for full-scale deflection at 30 kv.

The 4-125A is a transmitting-type tetrode with a 125-watt plate dissipation rating. It handles positive plate voltages up to 3,000 volts. HK257's,

813's, 8001's, and similar tubes can be used in adaptations of this circuit. It will be necessary to experiment with the value of the cathode resistor to get the lowest usable grid-current plate-voltage relationship. The bucking voltage must be adjusted to limit the current through the meter.

This v.t.v.m. is useful in measuring the output of voltage multipliers, radio-frequency and kick-back power supplies, and other low-current high-voltage sources of the types commonly used in cathode-ray and velocity-modulated circuits.

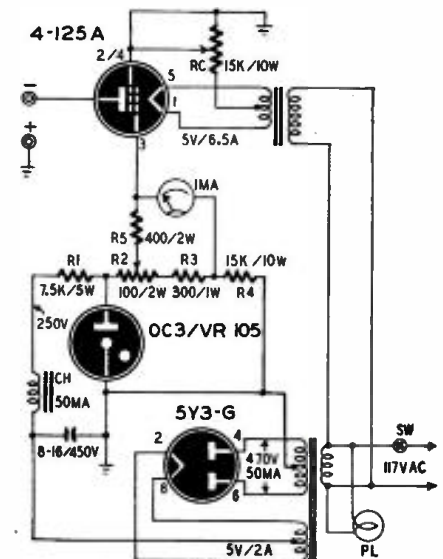

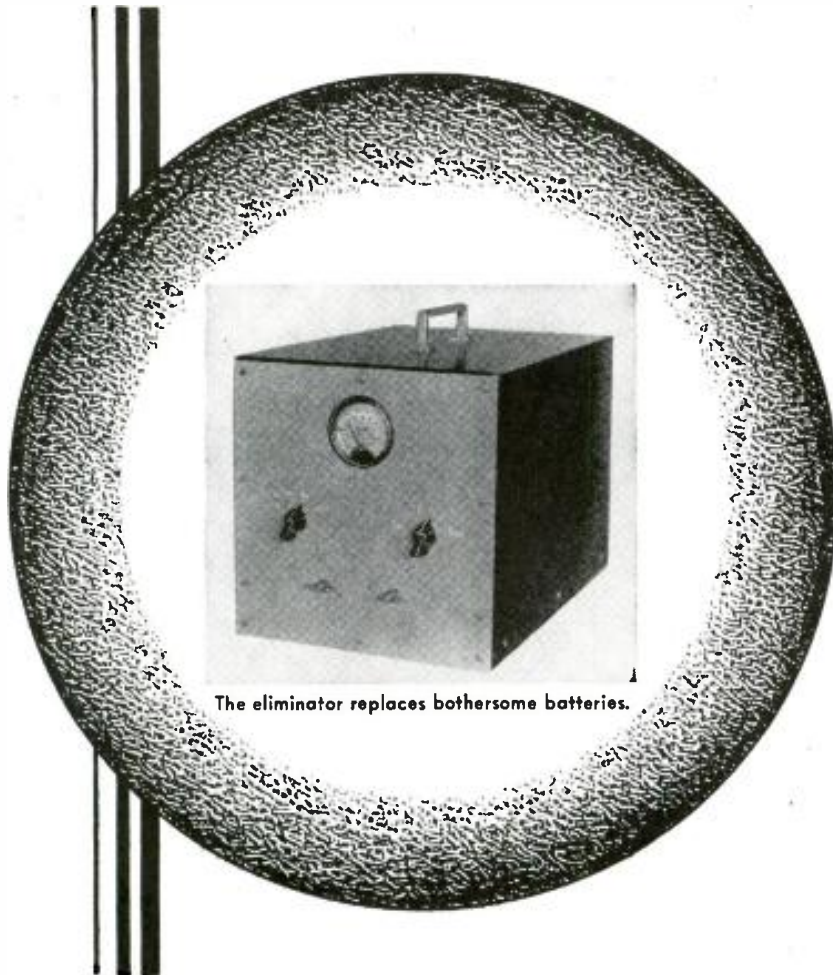

The eliminator replaces bothersome batteries.

A-Battery Eliminator

By RYLAND HOBSON

RADIO servicemen realize the advantages a battery eliminator has over the battery. At their best, storage batteries require a lot of attention, are usually messy, and must be kept charged. The eliminator described in this article can be built for less than the cost of a good storage battery, and because of variable output voltages, has many more applications.

Because most builders prefer to follow their own design in respect to appearance, and because the constructional details can be clearly seen in the photographs, no plans are given for chassis, panel, or cabinet. The information in the schematic diagram will be enough for the experienced builder; nor, with the help of this article, will the less experienced builder have any difficulty in building this highly efficient battery eliminator.

Special attention is given to winding

the power transformer. As is the case wherever a transformer is used, a certain amount of mathematics is involved. The simple formulas used here are sufficiently accurate for all practical purposes.

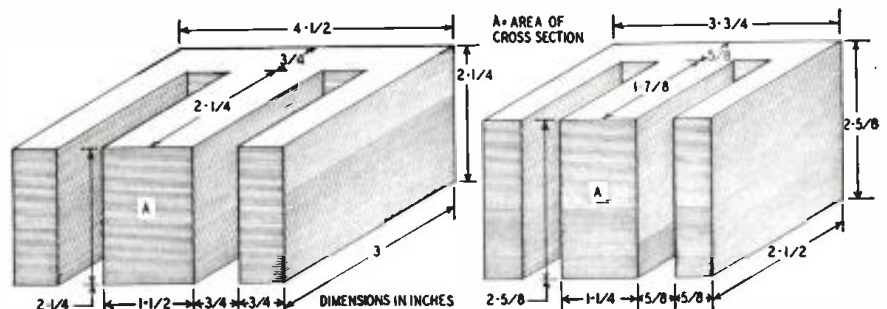

Fig 1—Transformer laminations are interleaved from opposite ends, not stacked up as shown (see any transformer). Choke laminations are all inserted from one end, with a gap between them and the straight end pieces. A piece of fiber inserted in the gap keeps it constant.

The laminations used for the transformer and choke were taken from old burned-out radio power transformers. The area of cross section (A in Fig. 1) is 3.375 square inches for the transformer and 3.28 (3¼ approximately) square inches for the choke. Laminations from two identical transformers were used for the power transformer and were stacked until the calculated area of cross section was obtained. (It is advisable to draw the transformer to full size and check the window space for the winding.)

The first step in designing the transformer was to calculate the power required from the secondary winding. The current for the secondary was set at a little more than was actually needed, and as there is a voltage drop across the dry-disc rectifier and choke, this, too, had to be taken into consideration. The maximum secondary voltage was therefore set at 16 volts and 10 amperes. Wattage was therefore 160.

To determine the primary wattage, the formula, "primary wattage = total secondary wattage / efficiency expressed as a decimal," was used. The efficiency was assumed to be 90%, which, expressed as a decimal, becomes 0.9. When the known values are substituted, the formula becomes "primary wattage = 160/0.9=178 watts."

With the primary and secondary wattage known, the next step was to calculate the turns per volt for the primary winding. As the transformer used is of the shell type (see drawing) and is to be operated from 60-cycle a.c., the formula, "turns per volt = $32/\sqrt{\text{Primary Wattage}}$," was used. (If the transformer is to be of the core type and the unit is to be operated from 60 cycle a.c., the formula, "turns per volt = $42/\sqrt{\text{Primary Wattage}}$," should be used.)

By substituting the known values in the formula, it becomes, "Turns per volt = $32/\sqrt{178} = \frac{32}{13.34} = 2.4$ turns per volt" for the primary. "Turns per volt" means that for each volt impressed across the primary winding, there must be 2.4 turns of wire.

The size of the core in square inches was determined by the formula, "area of cross section = voltage per turn \times 7.5." "Voltage per turn," as used in the formula, is merely equal to 1 divided

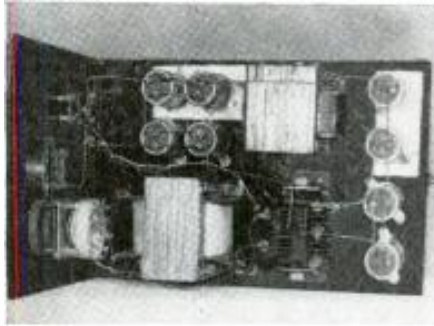

Chassis-top view shows how parts are mounted.

by the "turns per volt." Since the turns per volt, as already calculated, is 2.4, the volts per turn is equal to $1/2.4 = 0.42$ approximately. Due to the core losses, etc., the figure 0.42 can be rounded out to a little more than actually calculated. We made it 0.45 for convenience. Area of cross section is then $0.45 \times 7.5 = 3.375$ square inches.

To determine the wire size needed for the primary winding, the formula, "current \times watts / volts," was used. Since the primary wattage was found to be 178 and is to be connected to a 115-volt (maximum) lighting circuit, the approximate current will be $178/115 = 1.5$ amperes. A conductor cross section of 1,000 circular mils for each ampere of current flowing through the primary winding was chosen. 1,000 circular mils

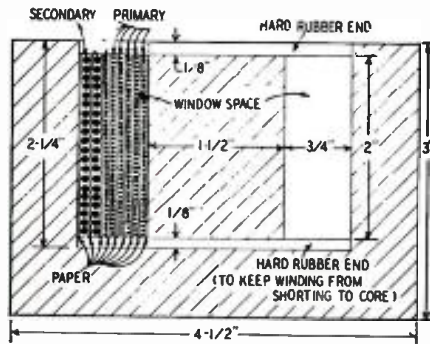

Fig. 2—The transformer core drawn to scale.

per ampere = $1.5 \times 1,000 = 1,500$ circular mils. A wire table showed that No. 18 (A.W.G.) enameled wire has a conductor cross section of about 1,600 circular mils, and it was chosen for the primary winding. The primary has 6 layers of wire, 46 turns per layer or a total of 276 turns—approximately 245 feet of wire (see Fig. 2). Insulating paper .008 inch thick was used between all layers of wire.

As the line voltage in this area is not always 110, the primary was tapped for 100, (low) 110 (medium), and 115 (high) volts. For the 100-volt tap, 240 turns of wire were used ($100 \times 2.4 = 240$); for the 110 volt tap, 24 turns were added to the first tap ($110 \times 2.4 = 264$); and for the last tap (end of winding), 12 turns were added to the second tap ($115 \times 2.4 = 276$). Different positions on the primary switch will vary the d.c. output in small steps. The eliminator has been operated for over an hour with

the primary switch in the LOW position and with a line voltage of 115 volts, without the transformer getting hot.

The number of turns for the secondary winding per volt output was calculated a little high, to allow for resistance drop and possible losses. Thus, we used 2.5 turns per volt. For every turn per volt on the primary, there is 0.1 more on the secondary ($2.5 - 2.4 = 0.1$).

No. 12 enameled wire was used to wind the secondary. At 1,000 circular mils per ampere, No. 12 will carry safely 6 amperes or a little more. (Only 700

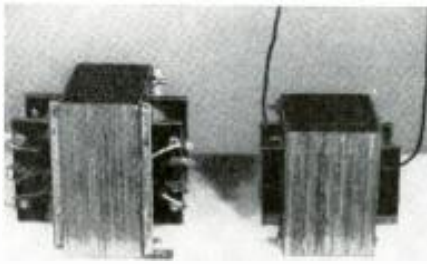

The finished home-made transformer and choke.

circular mils per ampere is used by a number of manufacturers of radio receiver power transformers.) For the first secondary tap, 15 turns of wire were used ($2.5 \times 6 = 15$). For the second tap, 5 turns were added to the first tap ($2.5 \times 8 = 20$). Another 5 turns were added for the third tap ($2.5 \times 10 = 25$); 5 turns were added for the fourth tap ($2.5 \times 12 = 30$), the fifth tap ($2.5 \times 14 = 35$), and the sixth and last tap ($2.5 \times 16 = 40$). The last tap is not used until the rectifier ages and its efficiency decreases. The maximum no-load a.c. voltage should not exceed 14.4 volts for the rectifier specified. The secondary has two layers of wire, a total of 40 turns and approximately 30 feet of wire. If the window space of the transformer and choke will permit, a larger size wire can well be used.

No formulas were used in designing the choke. Various charts, technical books, and so on were consulted, and the choke was wound on a trial basis.

Laminations from two similar transformers were also used in the choke and stacked until the desired area of cross section was obtained. (If the builder will use the same area of cross section as stated here, good results can be expected.) Unlike transformers, the laminations of the choke should not be interleaved, but should be butted. As the choke is to carry mostly d.c., it should have an air gap in its core to prevent magnetic saturation of the core by the heavy d.c. The effective air gap will be that of the sum of individual air gaps. The air gap was kept constant by a piece of insulating paper .008 inch thick, and can be adjusted if need be.

Approximately 33 feet of No. 12 enameled wire was used to wind the choke. The choke has four layers of wire, 16 turns per layer, a total of 64 turns. Insulating paper .008 inch thick was used between each layer of wire.

As shown in Fig. 3, a capacitance-

input filter was used, but a choke input filter gives good results. If a choke input filter is chosen, a capacitor of not less than 4,000 μf should be used.

Eight 1,600- μf , 12-d.c.-working-volt electrolytics were used in a series-parallel circuit so as to give a total of 1,600 μf at 24 working volts each side of the choke.

With the eliminator connected to a pure resistive load drawing 6 amperes at 6 volts, there is no measurable a.c. in the output (measured with a v.t.v.m. on the 3-volt a.c. scale, and with a 'scope turned to full gain, .06 volt root-mean-square per inch). With the above load connected to the output terminals, there is a measured d.c. drop across the choke of $\frac{1}{2}$ volt (measured with a v.t.v.m. on the 3-volt d.c. scale).

As shown in the diagram, an ammeter is used in the output to indicate current drain. The ammeter was chosen instead of a voltmeter because an external ammeter is the most troublesome meter to connect and because most radiomen do not have an ammeter in their volt-ohm-milliammeters. An ammeter will, at times, indicate a defective vibrator, and is capable of standing heavy overloads.

From the secondary winding to the output terminals, the eliminator is wired with No. 12 enameled wire. The line cord is conventional, and is brought up through the chassis, directly under the primary switch.

There are a number of dry-disc rectifiers on the market from which to choose, but this eliminator was built for a Mallory 1S16CB7J. Most dry-disc rectifiers will stand severe intermittent overloads, but should not be overloaded for constant duty.

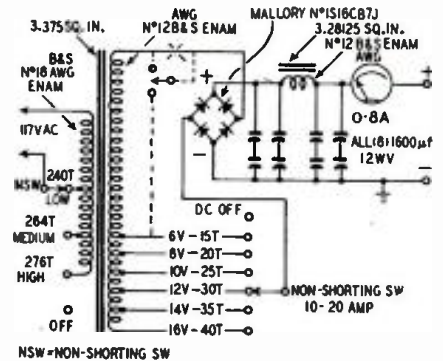

Fig. 3—Complete schematic of the eliminator.

Two automobile radios (6 tubes each) have simultaneously been connected to the eliminator, drawing 10 amperes at $5\frac{1}{2}$ volts, and both radios operated in a normal manner.

The d.c. voltage from the eliminator will vary with load. The secondary switch is calibrated with a load drawing $5\frac{1}{2}$ amperes at 6 volts, starting at the 8-volt position, working backwards, which gives the approximate voltages as shown in Fig. 3.

Whatever type cabinet is chosen for the eliminator, plenty of ventilation should be allowed.

20-Meter Vacation Converter

EACH year, the writer and a friend like to take a week's bachelor holiday. Two years ago, according to custom, we seized some canned goods and a battery portable, and retreated to a cabin in the Northern Woods.

We both like to listen to 20-meter dx over hot coffee in the small hours, and the battery portable just wasn't up to it. So we had an "engineering session" to design a converter with a minimum of batteries and a maximum of performance.

The results obtained with the 20-meter converter we built were so gratifying that we felt it would interest other readers of RADIO-ELECTRONICS.

Two miniature tubes are used. A 1R5 serves as regenerative mixer, while a 1U5 functions as the local oscillator. These tubes work well on a single 45-volt B-battery.

The converter output is at 1500-1600-kc, which, with the controlled regeneration, makes images almost nonexistent.

Most of the credit for successful operation of this circuit goes to the output coil L5 and its padding capacitor C1. This coil determines the output frequency of the converter. C1 is a dual trimmer from an old i.f. transformer; the two sections in parallel total 440 μ f. This combination makes a high-C circuit which keeps the converter stable.

The layout of parts may be seen in the photos. The extra-deep chassis (5x7x3½ inches) serves two purposes. It allows a symmetrical control arrangement on the front panel, and also keeps the batteries in place when the whole outfit is in the cabinet.

Short leads are essential, especially on grids and plates. Do not trust the chassis as a ground. Join ground points with bare hookup wire, treating the chassis as though it were made of a nonconductor.

When wiring is completed, check carefully. Connect batteries, antenna, and the output cable, which should be attached to the aerial and ground posts of any receiver tuning the 1500-1600-kc range.

Rotate the mixer capacitor C2 with the regeneration control full on, and tune the broadcast receiver to find the converter output frequency. The converter output will appear as a series of "plops" or a hissing sound.

Adjust C1 so that the "plops" come in at some clear spot between 1500 and 1600 kc.

All tuning is now done with the converter controls. Back off the regeneration control until the mixer stops oscillating. If this does not occur at half scale, two adjustments are provided. The antenna capacitor may be varied, or

By P. F. EGERTON JR.

the number of turns varied on L2. However, the latter should not be necessary. Best results will probably be obtained with C3 set at maximum.

The regeneration control does not have to be touched for locals. It is, however, very useful when fishing for weak stations or separating signals on crowded bands.

The rest of the controls are used as in any shortwave superhet.

The converter was tried in our cabin, which is surrounded by tall trees. The aerial was 20 feet of wire up in the rafters. A four-tube battery superheterodyne completed the setup. Amateurs on 20 meters in Hawaii, England, and Australia, just to mention a few, were heard at speaker volume.

We don't want to brag—but we have used the outfit at home too, and the batteries are dying of shelf life!

The writer would like to acknowledge the assistance of E. L. Houston, Jr., who was the "associate engineer," and the photography contributed by Don Mowat.

20-METER COIL TABLE

Coil	Turns	Wire (AWG)	Spacing
L1	5	24 enam.	close
L2	4	24 enam.	close
L3	7	18 bare	1 inch
L4	4	24 enam.	close
L5	80	30 enam.	close

L2 wound ¼ inch below L1, with 3-30- μ f trimmer inside form. L3 tapped 2½ turns from ground end. L4 wound ¼ inch below L3. All coils on 1½-inch-diameter plug-in forms except L5, which is wound on ½-inch-diameter polystyrene rod.

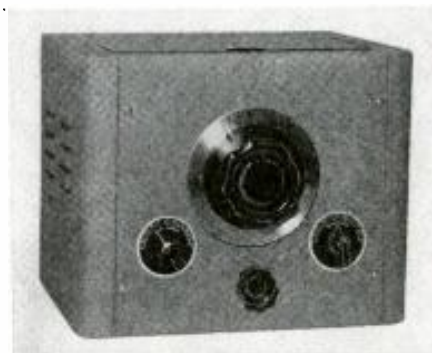

The batteries fit into the converter's case:

MATERIALS FOR CONVERTER

Resistors: 1—47,000, 1—100,000 ohms, ½ watt; 1—10,000-ohm linear potentiometer with switch.
Capacitors: 1—100 μ f, mica; 1—.01 μ f, 200 volts, paper; 2—3-30- μ f mica trimmer; 2—220- μ f trimmers from old i.f. transformer; 1—35, 1—50, 1—100 μ f, air variable.
Tubes: 1—1R5, 1—1U5.
Batteries: 1—1.5-volt A, 1—45-volt B.
Miscellaneous: 2—7-prong miniature tube sockets; 2—1½-inch coil forms (plug-in) and sockets; 1—5 x 7 x 3½-inch chassis and cabinet; necessary knobs, dials, and hardware

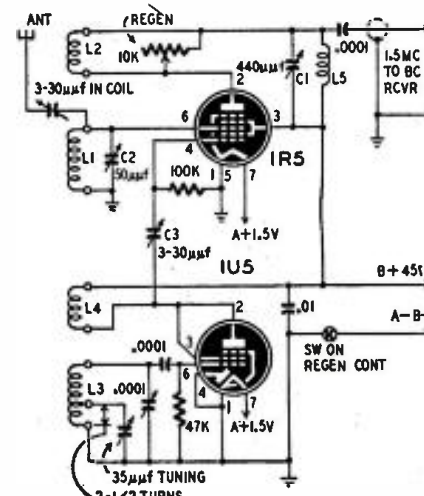

Complete schematic of the converter.

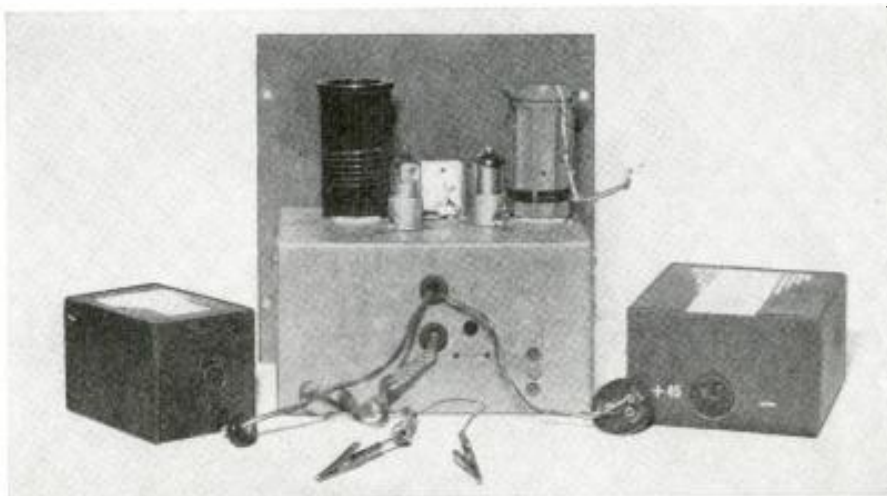

Extra-deep chassis allows symmetrical control placement and keeps the batteries in place.

Ohmmeter Reads To 300 Megohms



The ohmmeter ranges are push-button-selected.

A NEW ohmmeter has been designed to meet all the needs of modern servicing and to avoid the limitations of certain common types. Its advantages are:

1. It is always ready for use at the snap of the switch—no waiting for tubes to heat up.
2. There are no batteries to run down or to compensate for because of reduced voltage due to age.
3. No zero adjusting is required when switching between ranges.
4. Maximum and minimum ranges are adequate for the most exacting servicing requirements.
5. It cannot burn out low-current tube filaments.
6. It is not affected by line-voltage fluctuations.
7. It is simple to use—just select the proper range.

The ordinary basic ohmmeter circuit of Fig. 1 consists of a series ar-

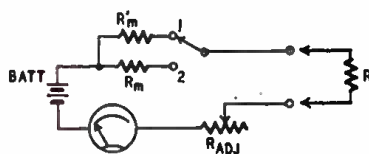

Fig. 1.—This is a standard ohmmeter circuit.

angement of battery, meter, and resistance, with means for switching ranges and adjusting for zero balance. This simple circuit, regardless of range, theoretically reads from zero to infinity, but from the practical standpoint it falls far short of being a perfect solution. The highest value ordinarily marked on the meter scale is 200 times

A novel circuit powered by the 117-volt line makes a wide-range, accurate, easily constructed ohmmeter for the technician

By JOHN T. BAILEY

the mid-scale marking. The mid-scale value is equal to the total resistance of the series circuit with the terminals short-circuited. The total resistance is determined by the battery voltage and by the meter's current rating. For instance, using a 1-ma meter and a 20-volt battery would require a total resistance of 20 divided by .001 or 20,000 ohms. The meter scale would be calibrated from zero at the right to 20,000 ohms at mid-scale with a value of $200 \times 20,000$ or 4 megohms at the left.

This scale is fairly open and easy to read from center to the right and compressed and increasingly hard to read to the left. However, with suitably overlapping ranges, this compressed scale is more serviceable than a linear one.

difficulty in laying out the scale for good readability.

The power supply (Fig. 2) is a full-wave voltage doubler employing a pair of selenium rectifiers fed by a 1-to-1-ratio transformer. The transformer isolates the circuit from the power line so that there will be no danger of a short when probing in an a.c.-d.c. chassis.

The voltage-doubling circuit is required to produce a high enough starting voltage for the OD3/VR150 regulator tube, the constant voltage across which is used to energize the ohmmeter circuits. Note that all heat-generating components of the power supply are mounted above the chassis and cannot cause temperature errors in the measuring-circuit resistors, which are all mounted under the chassis.

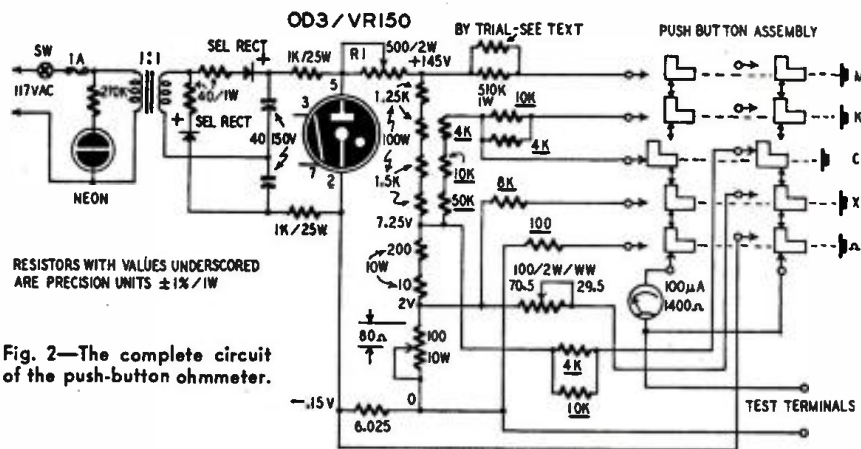

Fig. 2—The complete circuit of the push-button ohmmeter.

It is obvious from this example that the maximum range can be increased by using a higher-voltage battery, a more sensitive meter, or both. Each of these possibilities has its limitations. Larger batteries are expensive and bulky; microammeters are expensive and delicate.

The obvious solution is an a.c. power supply. In the ohmmeter shown in the photos, a 145-volt power source is used with a 100-microampere meter movement. The mid-scale reading is about 1.45 megohms, and a maximum reading of 300 megohms is obtained. Actually, the model shown has a maximum of 200 megohms indicated because of the dif-

Not all OD3/VR150 regulator tubes, even of the same manufacture, strike at the same voltage. Therefore it was decided to use 145 instead of 150 volts to power the ohmmeter. A 500-ohm rheostat R1 is connected between the tube and the ohmmeter circuit to absorb whatever difference exists between 145 volts and the voltage established by the regulator. This rheostat is adjusted from the front panel and, after it is once set, need not be touched unless tubes are changed. (It might be more tamper-proof if placed on the chassis. —Editor)

A bleeder made up of several series resistors is connected across the 145

volts so that lower voltages can be obtained for the lower ranges. This

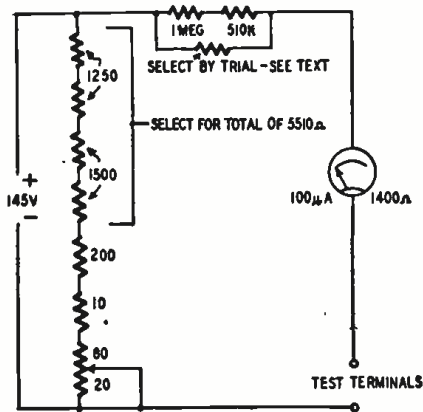

Fig. 3—High range is simple series circuit.

bleeder totals 5,800 ohms; 25 ma flows through it at all times. Except for the high range, it is important that this current be constant, so extra-heavy-wattage, wire-wound resistors are used, four in series, to make up the top 5,510-ohm section, so that the temperature rise will be small and will not change the resistance materially. These four resistors are mounted vertically under the chassis. Two are 1,250 ohms each, and the other two are 1,500 ohms each. Select these resistors carefully so that their total will be as close to 5,510 ohms as possible. The other sections of the bleeder consist of 210, 80, and 6,025

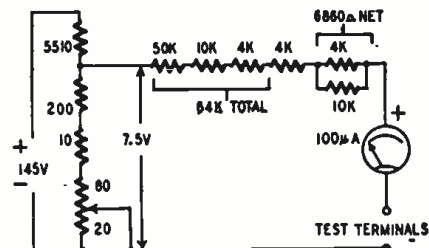

Fig. 4—The K range reads 1/20 of the M range.

ohms, all wire-wound. The latter may be home-made by winding the necessary length of enameled copper wire on a high-value carbon resistor.

The meter circuits

To describe the ohmmeter circuit, it is best to take one range at a time. Starting with the high or M range of 300 megohms, we have a simple series circuit, as shown in Fig. 3, with 145 volts d.c., a 100-microampere meter, and a multiplier. The multiplier value is 145 divided by .0001 or 1.45 megohms. From that value we must subtract the resistance of the meter and the effective internal resistance of the power supply. This is easiest to do by trial. Start with a 1.5-megohm multiplier consisting of 1-megohm and 510,000-ohm resistors in series. Then shunt this combination with a resistor of whatever value gives full-scale deflection with the ohmmeter test terminals shorted. An approximate value will be 4 or 5 megohms. Pay particular attention to getting this circuit exactly right because it later serves as a check on the calibration of the other

ranges by acting as a voltmeter to check the 145-volt setting of the power-supply rheostat.

The second highest range (the K range) has the same calibration curve as the M range but reads 1/20 as much. This ratio provides good overlap. Since the M range reads 1.45 megohms at exact mid-scale, the K range must read 1.45/20 or 72,500 ohms at mid-scale. This is accomplished by another simple series circuit as shown in Fig. 4. The voltage is picked off at the 7.25-volt tap, making a multiplier of 72,500 ohms necessary. Subtracting the meter resistance (1,400 ohms for the meter used in this model) and disregarding the power-supply and bleeder resistances as negligible on this range, we find we need 71,100 ohms. If we break this down into 64,300 plus 6,800, we get a total of 71,100 and can use the 64,300-ohm section in the next range. Values of 64,300 and 6,800 ohms are not generally available in precision, wire-wound meter multipliers, but they can be approximated by combining standard multipliers. The 6,800 ohms (actually 6,860) is made up of a 4,000-ohm resistor in series with a 10,000- and 4,000-ohm shunt combination. The 64,300 value (actually 64,000) results from 50,000, 10,000 and 4,000 ohms in series. The difference between the actual and calculated values is less than 1% and therefore acceptable. Because of the substantial overlap and the difficulty in reading the crowded portion of the scale, this range was marked to only 500,000 ohms.

The third or C range is carried out to 20,000 ohms and reads 3,000 ohms at mid-scale. The circuit is shown in Fig. 5. The 7.5-volt tap and the 64,000-ohm multiplier section of the K range are used, plus a shunt resistor of 2,860 ohms. This shunt resistor is a parallel combination of 10,000 and 4,000 ohms.

The fourth or X range of Fig. 6 uses the same calibration as the C range and is 1/20th of it, reading 1,000 ohms maximum and 150 ohms at mid-scale. The 2-volt tap is used with an 8,000-ohm series resistor and a 70.5-ohm shunt. The 70.5-ohm resistor should be a wire-wound one with an adjustable slide.

The fifth or low range is different from the others and can be seen in Fig. 7. It is typical of low-range scales in that it reads backward. The meter is deflected to full scale with terminals open. The resistance to be measured is connected as a shunt across the meter, causing the meter to back up. The unusual part about this design is that it reads only 6 ohms at mid-scale, and a low reading of .05 ohms is possible. When we consider that the resistance of a pair of test leads is about this much, we realize that this range is more than adequate for low-resistance service in measuring coils, for instance. Another very important feature of this low range is that it is impossible to pass more than 25 ma through the resistance being measured. Most back-up-type, low-range ohmmeters pass considerable current, some as high as 300 ma, and

almost all pass enough to burn out the filaments of a subminiature or hearing-aid tube. With this circuit there is no danger.

Fig. 2 shows that the ohmmeter uses

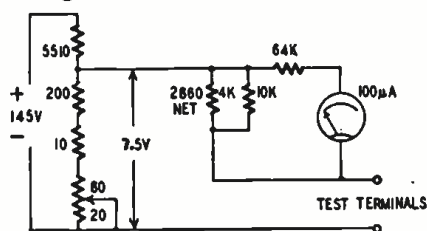

Fig. 5—C range has a 20,000-ohm maximum.

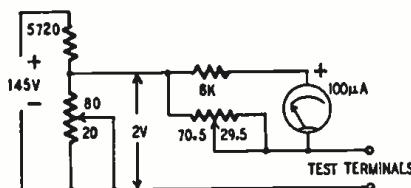

Fig. 6—X range reads 150 ohms at mid-scale.

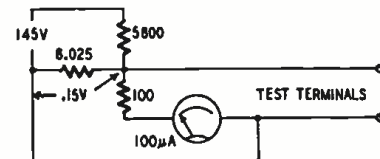

Fig. 7—Low-range scale reads left to right.

a push-button transfer switch for selecting the various ranges. This transfer feature is necessary to prevent damaging the meter if more than one button is held in at the same time. The usual type of push-button assembly used on home receivers, it is readily available. The best-quality switch must be used or else its own leakage resistance will cause error on the high range. A simple two-gang, five-position rotary switch could be substituted.

Calibration of the ohmmeter is relatively simple. The scale divisions are calculated using the formula: scale reading (assuming a 100-division scale) = $100 - (100R / (R + R_m))$. R is the resistance being measured and R_m is the meter-circuit resistance, both values expressed in the same units. For example on the high range, a 500,000-ohm resistor being tested would read $100 - (100 \times 5 / (5 + 1.45)) = 74.36$ divisions on a 100-division scale or almost three-fourths of full scale. Additional points are calculated in the same manner.

When carefully constructed and calibrated, this ohmmeter will prove a valuable piece of test equipment in any service shop or laboratory. In service in the author's laboratory for over a year now, it still retains its original accuracy.

MATERIALS FOR OHMMETER

Resistors: 1—100, 3—4,000, 1—8,000, 3—10,000, 1—50,000 ohms, 1 watt, precision ($\pm 1\%$); 2—40, 1—270,000, 1—510,000 ohms, 1—1 megohm, 1 watt; 1—10, 1—200 ohms, 10 watts; 1—1,000 ohms, 25 watts; 2—1,250, 2—1,500 ohms, 100 watts; 1—500-ohm, 2-watt rheostat; 1—100 ohms, 2 watts, adjustable; 1—100 ohms, 10 watts, adjustable.
Miscellaneous: 2—40- μ f, 150-volt electrolytic capacitors; 1—1-to-1-ratio power transformer; 2—5-plate selenium rectifiers; 1—neon lamp; 1—1-ampere fuse assembly; 1—OD3/VR150 tube; 1—100- μ a meter with internal resistance of 1,400 ohms; 1—2-gang, 5-button, transfer-type push-button assembly; 1—s.p.s.t. toggle switch; case, hardware etc

If You Haven't a Copy—Get ALLIED's Latest Supplement

**ALL THE NEWEST RELEASES!
BIG SAVINGS ON SPECIALS!**

FREE



Typical ALLIED Values!



Knight TV Antenna

High-efficiency indoor type—with length and direction easily adjustable for maximum reception. Covers all TV channels. Compact; fits on TV cabinet or table, or mounts to wall. Ideal where roof antennas can't be installed.
97-354. ONLY..... \$4.09

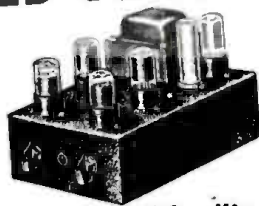

Hi-Fi Amplifier Kit

Superb quality at low cost. 10 watt output; 20-10,000 cps at ± 1.5 db; practically distortionless. Takes 6-8 ohm PM speaker, any crystal pickup. With all parts, tubes, chassis 10x6 1/2 x 3", instructions; less wire and solder.
110-120 v., 50-60 cy AC. \$22.75
83-222. ONLY..... \$22.75



HT-17 Transmitter

Save over \$30 on this Hallicrafters all-band CW job. Ideal for beginners; perfect for Field Day tests, Net tie-in, vacation use, emergency. Covers 80, 40, 20, 15, 10 meter bands. Satin-black cabinet, 12 1/4 x 6 1/4 x 7 1/4". For 105-125 v., 50-60 cy AC. Complete with tubes and all coils; less crystal.
97-580. ONLY..... \$39.50



Knight Wire Recorder

Makes and plays wire-recordings; plays any 10 or 12" 78 rpm disc recording; serves as PA system or as wireless phono oscillator. Easy to operate. Complete in compact simulated leather case; with crystal hand-mike and pickup, all tubes, 2 half-hour spools of wire. For 105-125 v., 60 cy AC.
96-172. ONLY..... \$99.50

Beginners—Get on the Air for Less Than \$100!

Yes—you can get a complete station at ALLIED for less than \$100! Includes HT-17 Transmitter complete with coils for all bands; Hallicrafters S-38 Receiver; a quality handkey; headset; Biiley 40 meter crystal; antenna wire and insulators; ARRL station logbook; Amateur Radio Callbook—everything you need to get on the air—at amazingly low cost!
97-636. Complete Low-Cost Ham Station, f.o.b. Chicago, ONLY .. \$97.50
Terms: \$19.50 down, \$6.89 monthly for 12 months

All Prices F.O.B. Chicago

For your complete buying guide to Everything in Radio, use this new, value-packed Supplement together with ALLIED'S big 180-page Catalog. Here are all the latest developments in Radio, Television and Electronics—plus tremendous savings on popular, top-quality equipment—especially selected values for Servicemen, Engineers, Amateurs, Sound Men, Builders and Experimenters. Make your money-saving selections from the world's largest stocks—ready for immediate shipment. If you haven't a copy of ALLIED'S latest Supplement and complete 180-page Catalog, write for them today!

Get These Leading Buying Guides



Here's the 180-page 1949 Catalog for Everyone in Radio! Packed with everything in Radio: Latest Receivers, Phono Equipment, Television, Sound Systems and components, High-Fidelity equipment, Recorders, Amateur gear, Test Equipment—plus thousands of parts, tubes, supplies, books—everything you need at lowest, money-saving prices. Get your FREE copy now!

And here's the up-to-the-minute Supplement—all the new equipment releases, including latest Television developments, and big price reductions on popular equipment. Send for FREE copy!



ALLIED RADIO CORP.

833 W. Jackson Blvd., Dept. 2-D-8 Chicago 7, Illinois

- Send FREE 1949 ALLIED SUPPLEMENT.
- Send FREE 1949 180-Page ALLIED CATALOG.

Enter order for.....
.....
..... \$..... enclosed
Name.....
Address.....
City..... Zone..... State.....

ALLIED RADIO

Everything in Radio and Electronics

5-INCH OSCILLOSCOPE

Telemark Electronics Corp.,
Brooklyn, N. Y.

Model 450-A 5-inch oscilloscope has vertical and horizontal amplifiers with a bandwidth of 2 cycles to 450 kc, extending to 850 kc at 6 db down. Sensi-



tivity is 0.15 volt per inch of deflection. Frequency-compensated attenuators, a Z-axis input, and calibration test voltage are provided.

PHONOGRAPH ARM

Clarkston Corp.,
Los Angeles, Calif.

The new Triatic arm is suitable for any pickup cartridge not over 3/4 inch wide. The cartridge can be replaced without soldering, and adjustment of needle force from five grams up is possible. The arm is made in two sizes for use with 12-inch records or 16-inch transcriptions.

CRYSTAL PRESSURE GAUGES

Cambridge Thermionic Corp.,
Cambridge, Mass.

Developed during the war, this piezoelectric gauge will measure instantaneous or explosive-type pressures ranging from a few pounds to 30,000 pounds per square inch. The gauge, available for the first time to industrial and laboratory users, contains a piezoelectric

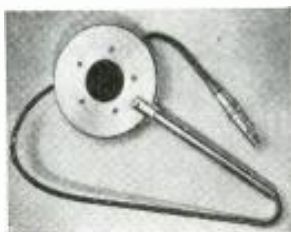

crystal which generates a voltage the instantaneous value of which is proportional to the stress which it undergoes. Because the voltage appears only while the pressure is varying (as in a phonograph pickup), steady stresses cannot be measured. Units of this type were used to measure air and underwater pressures at the Bikini atom-bomb tests. They are commonly employed for measuring large-magnitude shocks transmitted through liquids, gases, and sometimes solids. Typical applications are evaluating the explosive forces in big guns and in the cylinders of internal combustion engines.

HIGH-VOLTAGE 'SCOPE

Allen B. Du Mont Laboratories,
Inc., Clifton, N. J.

Type 248-A oscilloscope may be operated on accelerating potentials as high as 14,000 volts without modification. The built-in supply furnishes 4,000 volts; but, where higher writing speed must be recorded and greater deflection sensitivities are needed, an external supply is used. Inclusion of a 5RP-A cathode-ray tube in the instrument allows use of the higher voltage,

PLUG-IN LINKS

Barker & Williamson, Inc.,
Upper Darby, Pa.

Standard r.f. tank coils may be matched to a wide variety of impedances by using various links. These plug into a special swinging arm, easily attached to the coils. The old arm is removed by tapping out the pin which forms the hinge. Links are available with 1, 3, 6, and 10 turns.

SIGNAL TRACER-TESTER

Test Craft Instrument Co.,
New York, N. Y.

Model TC-75 is a combination test speaker and signal tracer incorporating a single-stage audio amplifier. The tracer probe contains a 1N34 crystal detector. Components are provided in addition, for substitution testing, 7 capacitors and 10 resistors. Various speaker impedances may be selected by a switch to match most output tubes, and various field values are available as well.

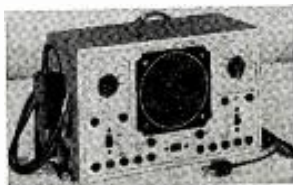
**RADIO NOISE LOCATOR**

Eltron, Inc.,
Jackson, Mich.

This small device locates radio noise in electrical power circuits. Weighing 11 pounds, it has only one operating control. The sensitivity is adjusted for maximum and the loop antenna is probed along the circuit. Noise level is indicated on a meter, and the noise can be heard in headphones.

SMALL CO-AXIAL RELAYS

Advance Electric and Relay Co.,
Los Angeles, Calif.

Two new types of small co-axial relays have been designed for mobile and other low-power transmitters. Though only 2-15/16 inches long overall, the relays maintain a voltage standing-wave ratio of 1.04 at 80 mc and 1.4 at 300 mc. They are built for use with 50-ohm cable. Terminal positions on the relays can be varied for special purposes. They may be had with N-type connectors and d.p.d.t. auxiliary contacts.

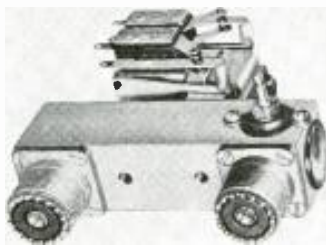
**ALL-TRIODE AMPLIFIER**

Brook Electronics, Inc.,
Elizabeth, N. J.

The 12A series amplifiers are 10-watt versions of the Brooks all-triode, high-quality, 30-watt units. Model 12A3, shown in the photo, has a separate console for remote control. Frequency response is virtually constant from 20 to 20,000 cycles, and distortion is negligible, even at peaks in excess of 10 watts. Inputs are provided for both crystal and magnetic pickups; avail-

able output impedances range from 2 to 500 ohms. Model 12A2 is identical to this type electrically, but controls and amplifier are on one chassis.

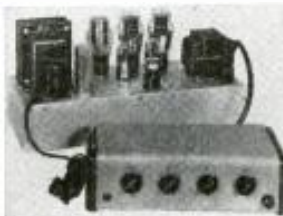
**TV STUDIO MONITOR**

Allen B. Du Mont Laboratories,
Inc., Passaic, N. J.

Type 2116, large-screen picture monitor has a 215-square-inch screen and may be used at any point in the television studio plant. Only brightness and contrast controls are on the front panel. A speaker is provided for high-fidelity audio monitoring where that is desired. The monitor operates from a composite signal on a 75-ohm line with a peak-to-peak voltage level between 0.5 and 2.5 volts. Over-all dimensions are 38 x 22 x 30 inches. Weight is 300 lb.

SOUND PROJECTOR

Jensen Manufacturing Co.,
Chicago, Ill.

The VR-241 ST-789 Hypex projector is intended to be hung from the ceiling to cover a circular area. The unit has a maximum power rating of 25 watts for



speech and music, with a frequency range from 140 to 6,000 cycles and a voice-coil impedance of 16 ohms. The driver has a phenolic diaphragm and employs an Alnico V magnet. It is enclosed but may be removed and replaced if necessary. The projectors are made largely of stainless steel, aluminum, and other corrosion-resistant materials for maximum protection against weather.

CHIP REMOVER

Audio Devices, Inc.,
New York, N. Y.

The Chip-Chaser is a felt strip backed with aluminum and supported by an arm embedded in a heavy cast-iron base. The felt strip, placed on discs being cut, sweeps the thread of cut-out lacquer to the center, keeping it out of the way of the stylus. Two sizes are made, one for turntable diameters up to 12 inches, and another for 16-inch tables. The chaser requires no installation; it is merely set down beside the turntable and the felt is dropped on the record. The device was manufactured for a short time before the war but material shortages delayed the start of renewed production run until recently.

TV MAGNIFYING LENS

RCA Manufacturing Co., Inc.,
Camden, N. J.

Images received on 7- or 10-inch TV receivers can be enlarged to approximate the size of the image on a 15-inch tube with the new RCA oil-filled plastic lens. The manufacturer claims it is lighter in weight and transmits more light than similar lenses of solid glass or plastic.

TV PROJECTION LENS

Spellman Television Co., Inc.,
New York, N. Y.

The new Spellman f/1.9 projection lens is designed to project a TV image from a small size up to 7 x 9 feet. The lens is in a barrel 7 inches long and 4 1/2 inches in diameter. The barrel has a special corrective lens for use with 5TP4 tubes. This lens can be removed when the set has a flat-face C-R tube.

A slotted mounting ring is available for hand focusing adjustments. This ring has four holes for mounting on the plate.

**LIGHTWEIGHT HEADSET**

Telex, Inc.,
Minneapolis, Minn.

The Twinset is a dual-receiver headset said to be wearable with a minimum of discomfort. A ball-and-socket joint connects each receiver acoustically with a small ear-plug, which can be adjusted exactly to suit the wearer's ear. The headband, of Z-Nickel steel encased in Tenite plastic, can be bent or twisted into any shape, to fit the head or for carrying in the pocket. The cable is a single cord rather than the more usual yoke; its end may be plugged into either receiver.

AMPLIFIER CHANGES

Hermon Hosmer Scott, Inc.,
Cambridge, Mass.

Changes in the output transformer and the chassis finish of the 210-A amplifier (which includes the dynamic noise suppressor) result in better performance and appearance. An oversize output transformer provides very low distortion and reduces hum level to 86 db below maximum power output; actual hum level is .05 microwatt. A new anodized aluminum chassis eliminates tarnishing and resists damage from rubbing and chafing.

**SELF-HEATED SOLDERING IRON**

Kemode Manufacturing Co., Inc.,
New York, N. Y.

Requiring no electric current or external heat of any kind, the Quik-Shot soldering iron utilizes a chemical cartridge that heats the iron to working temperature in 5 seconds and maintains an average heat of 800 degrees F for 7 minutes. To charge the iron, the tip is unscrewed and a cartridge inserted. When a spring rod at the end of the handle is pulled back and released, the handle is pulled back and released, the cartridge is ignited and the iron heats.

The cartridge contains magnesium-type powders whose heating action is known as the thermit process. No gas is generated so that the cartridge is non-explosive. The iron is especially applicable to outdoor work—installing antennas, for instance—where a.c. is not available.

RADIO-ELECTRONICS for

DC Amplidyne



\$8.95

Input 27 Volts at 44 amps. 8300 R.P.M., Output 60 Volts at 8.8 amps, or 530 watts. Manufactured by G. E. or Marathon Electric. Shipped Express Charges Collect.

New 2VOLT Battery \$1.25



Brand new, compact, spillproof built-in hydrometer, group several together to get higher voltages. Fully guaranteed. Shipped dry, add 35c to cover postage and handling.

\$14.25



Radio Compass Receiver 433 Complete with tubes. Used but good. Shipped Express charges collect.

TUBE BARGAINS!

Minimum Order \$2.00

* indicates Postpaid
1 indicates 25c postage
2 indicates 35c postage
3 indicates 50c postage

215-A	-----	\$.79c *
211	-----	.69c *
3 CP-1	-----	.95c 1
3 DP-1A	-----	.95c 1
3 FP-7A	-----	1.35 1
3 HP-7	-----	1.45 1
5 FP-7	-----	1.75 2
5 CP-1	-----	1.95 2
5 BP-1	-----	2.45 2
5 HP-1	-----	2.45 2
705 A	-----	1.19 *
7C4	-----	.29c *
7 BP-7	-----	2.65 3
7 CP-1	-----	3.25 3
9 GP-7	----- Express Collect	3.50
10Y	-----	.49c *
1626	-----	.39c *
HY615	-----	.59c *
531	-----	3.95 *

ARC-5 Control Box



Brand new in original cartons. C-30/ARC-5 Push Button Control Box. Only \$1.29 Postpaid.

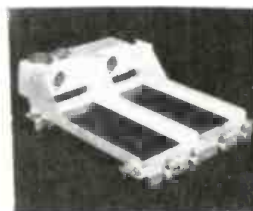

COMMAND SET RACKS

Double Transmitter rack. Brand new in original carton. No. FT-226 only 99c postpaid.

Triple receiver rack. No. FT-220-A. Brand new in original cartons, only \$1.59 postpaid.

Phantom Antenna
85¢



A transmitting antenna, for use on approximately 450 MC. Complete with standard coax connector. A weather-proof unit. (Add 25c to cover handling and postage).

BC-616 Control Box

Originally used with the command set between Modulator BC456A and Control Box BC451A. Contains 3, 24 volt relays and other parts an excellent buy at only \$1.39 postpaid.

IMPORTANT!

All merchandise subject to prior sale, minimum order \$2.00, No C.O.D. orders accepted. Michigan residents must add 3% State sales tax.

TIME DELAY RELAY

24 volt, 200 ohms Resistance, approximately 1/50 of 1 second delay. Brand new type B-9 manufactured by Gaurdian Electric. Part No. 34464. Price, only 99c post paid.



New Rectifiers

Brand new Selenium Rectifier 48 volt AC 1 Amp. .79c postpaid.

Brand New Tube Sockets

Tube Sockets 12 octals (2 different types) 79c postpaid.

Brand New Antennas

AN-131-A Collapsible 10'8" Antenna. \$1.49 co., postpaid

Bargains IN Plugs

- AN - 3102 - 40 - 1P
- AN - 3106 - 20 - 2P
- AN - 3106 - 8S - 1S
- AN - 3108 - 16 - 2P
- AN - 3108 - 28 - 2P
- AN - 3106 - 24 - 5P
- AN - 3106 - 18 - 3P

All Brand New

Your choice any 4 plugs ... \$1.00 Postpaid

N. SILVERSTINE CO.

6532 EAST McNICHOLS ROAD DETROIT 12, MICH

"Seven Acres of Surplus"

DISTORTION METER

Sound enthusiasts frequently go to considerable trouble to run response curves and power output measurements on their pet amplifiers, but they are usually stuck when it comes to measuring the harmonic content in the output signal.

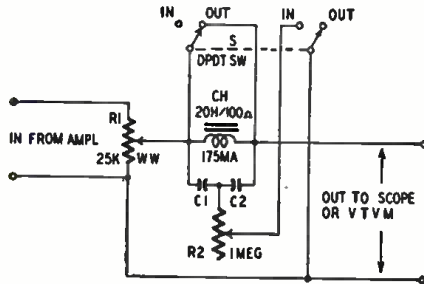

A simple circuit for measuring the total harmonic distortion present in the output of any complete amplifier, or single amplifier stage, was shown in *The C-D Capacitor*. It consists of an input control R1 and a bridged-T filter composed of CH, C1, C2, and R2. CH is a 20-henry filter choke rated at 175 ma with 100 ohms d.c. resistance. It is a Stancor type C-1410 or equivalent. If 400 cycles is your standard test frequency, C1 and C2 are each 0.312 μf . For 1,000-cycle test frequency, each has a value of .05 μf . This filter will remove the fundamental of a distorted test signal while passing the harmonics (distortion), which can then be measured and compared with the total signal voltage to determine the amount of distortion present.

After building the unit shown in the schematic, connect its input terminals to the output of a good sine-wave generator and its output terminals to the vertical amplifier of a scope or to an a.c. v.t.v.m. Set switch S to IN. Set R1 to the maximum voltage position. Adjust the oscillator to the test frequency—400 or 1,000 cycles, depending on the values selected for C1 and C2. Tune the oscillator gently about the test frequency while adjusting R2 for *minimum* deflection of scope or meter. When the null has been found, R2 will not require further adjusting.

To use the instrument, connect the oscillator to the input of the amplifier to be tested and set the amplifier volume control to the desired output. Connect the input of the distortion meter across the voice coil or plate load to the amplifier. Short-circuit the filter by throwing S to OUT. Adjust R1 to give full-scale deflection on the meter or scope, and record the voltage reading as E1. Without touching any controls, throw S to IN and record the new voltage as E2. The total percentage of harmonic distortion is $E2/E1 \times 100$.

NOVEL BIAS SUPPLY

The advantages of fixed bias in receivers, transmitters, and audio amplifiers are well known; but this type of bias is seldom used, probably because most circuits require a separate power supply or a special power transformer

with a bias tap on the high-voltage winding.

A novel bias supply without these disadvantages was described recently in *T.S.F. Pour Tous* (Radio for All), Paris, France. This circuit develops from 10 to 30 volts of bias from a 6H6. Unlike most circuits of this general type, both sides of the supply are isolated from the a.c. line and from the high-voltage supply. The cathodes of the 6H6 are paralleled and connected to the line through 0.1- μf , 1,500-volt capacitors. R1 completes the d.c. path through the plates and cathodes of the tube. Vary this resistor between 50,000 and 100,000 ohms to vary the output voltages between 10 and 30 volts. For lower voltages, use a tapped resistor for R2, and set the taps for the voltage desired.

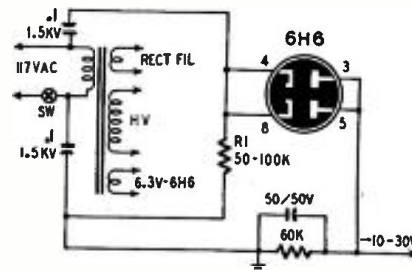

The 6H6 heater may be operated from any 6.3-volt winding on a power transformer. Other duo-diodes such as the 25Z6, 50Y6, and 117Z6-GT can be used in this circuit if supplied with proper heater voltages.

STROBOSCOPIC WATCH TIMER

A number of methods have been developed for regulating the speed of watches and clocks. One of the more common electronic devices for this purpose uses a circuit that produces a flash of light each time the watch ticks. The flashes are compared with a standard frequency.

A device such as this, described recently in the magazine *Electronics*, uses a carbon microphone working into a 6SF5 that is biased to cutoff. The watch is placed on the diaphragm of the microphone. Each time it ticks it produces a positive pulse in the secondary of the transformer. This pulse overcomes the bias on the 6SF5 and permits it to draw current. The voltage on the plate drops, producing a negative pulse on the grid of the strobotron which may be a Sylvania 1D21 or equivalent. The voltage difference between the two grids in the strobotron causes the tube to ionize. The 4- μf capacitor discharges through the

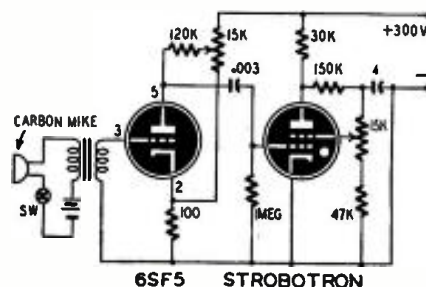

tube, producing a sharp, short-duration pulse of light. When the capacitor is discharged, the voltage on the plate and shield grid drops below normal value, the tube de-ionizes and is ready for the next firing pulse.

The average watch ticks five times—thus producing five pulses of light—each second. When the flashes of light fall on a disc rotating at 300 r.p.m. (5 r.p.s.), a dot or line on the disc will appear to stand still if the watch is keeping good time. If the watch is fast, the disc will appear to rotate backward, or forward if it is slow.

The rate with which a watch is gaining or losing time can be determined by measuring the angle that the spot on the disc covers in a given time interval.

SAFETY FOR AMPLIFIERS

Overload relays are often used to remove high voltage from a grid-leak-biased triode class-C amplifier when excitation fails or plate current rises to an abnormal level. This method has the disadvantage that the relay may operate while the load is being adjusted or during transients that may originate in preceding stages.

This protective circuit, described in *Electronic Engineering* (London), is based on a ratio between the maximum permissible grid and plate currents.

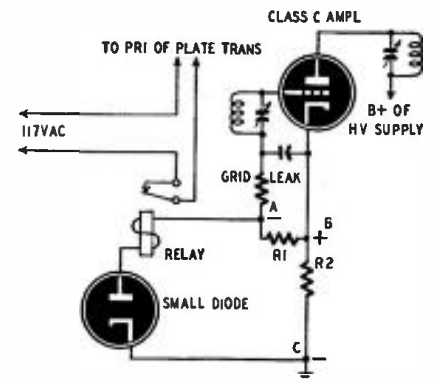

Resistor R1 is inserted between the grid leak and the cathode, and R2 is connected between the cathode and ground. The values of these resistors should be chosen so the ratio $R1/R2$ equals the maximum permissible plate current divided by the maximum grid current. R2 should be low enough so it does not subtract appreciably from the operating plate voltage.

A small diode and relay are connected as shown. Under correct operating conditions, the voltages across R1 and R2 are equal with opposite polarity so the diode will not conduct. If excitation fails, point A becomes less negative, the diode conducts and opens the relay contacts in series with the a.c. line to the high-voltage supply. Excessive plate current caused by overmodulation or an arc in the plate circuit will make B (and the diode plate) more positive so the relay will open.

R1 may be a part of the normal grid leak with point A fixed by a slider. The relay should be a sensitive type operating with low voltage and low current.

TRANSVISION

PRESENTS THE NEW MODEL 12CL TV-FM KIT

Brings the biggest and best in television within the reach of everyone.

- Features 12½" tube with fitted All-Angle Lens, giving over 200 sq. inch picture which is visible from any place in a room.
- Gives ideal long-range reception with **CONTINUOUS TUNING** on ALL CHANNELS. Has De Luxe TV-FM Inputuner.
- COMPLETE with Cabinet, Lens, Roto-Table, Antenna, Lead-in Wire.
- A **BIG PROFIT-MAKER** for service dealers. This kit is TOPS—ideal for homes, clubs, taverns, and other commercial installations.

EASY TO ASSEMBLE . . . NO TECHNICAL KNOWLEDGE REQUIRED

Transvision's simple step-by-step Instruction Sheet makes assembling a TV Kit a pleasure. Each kit comes complete with all-channel double-folded dipole antenna and 60 ft. of lead-in wire. *Nothing else to buy!*



MODEL 12CL TV-FM KIT

\$399⁰⁰
NET

Includes Cabinet, Lens, Table, Antenna

Here's amazing
GIGANTIC VALUE!

OVER

200

SQ. IN. PICTURE

VISIBLE from ALL ANGLES
with FM RADIO

(Has De Luxe TV-FM Inputuner)

(Picture bigger than a tabloid newspaper page)
IMAGE IS EQUAL to that of a 20" tube—even sharper and clearer—visible from all angles.

EQUIVALENT OF \$1000.00 SETS!

Price of the new 12CL electromagnetic kit includes these outstanding features:

- 12½" picture tube with special fitted All-Angle Lens and color kit.
 - Beautiful select-grain cabinet and roto-table.
 - De Luxe Continuous TV-FM Inputuner.
 - New all-channel hi-gain antenna and 60 feet of lead-in wire.
- Nothing else to buy.



"CUSTOM-ART" Television Cabinets Made to Order . . . Radiomen, Dealers—

Here is a beautiful line of exclusive, custom-built cabinets, designed and completely built in our factory, and finished to your customers' specifications . . . at very reasonable prices. Shown here is Transvision's "Modern Comprehensive" which has provision for TV/FM/AM, Record Changer, Album Shelf, Bar, and Concealed Wine Cellar. For further details on the complete line, write for FOLDER No. D-1.

TRANSVISION Complete Line of TELEVISION COMPONENTS

Essential units for building a quality television set . . . Transvision makes available a complete line of high quality parts competitively priced. Included in this line are Filter Chokes, all types of Transformers, Focus Coils, Deflection Yokes Coils—and of course major units such as Picture Tubes, Antennas, Lenses, etc., etc.

WRITE FOR COMPONENTS FOLDER P-1



TRANSVISION ALL-ANGLE LENSES for ALL TV SETS. Give picture sizes up to 150 sq. in. Exclusive patented feature makes image visible from wide angle. Lenses come with adapter for installation on ANY 7" or 10" picture tube, and with color kits. All-Angle Lens for 7" tubes (gives 75 sq. in. picture), Net \$21.95. All-Angle Lens for 10" tubes (gives 150 sq. in. picture), Net \$32.50.

ASSEMBLE Your Own CABINETS

Transvision's "MODULAR" Cabinets come in knock-down, unpainted units, offering an unlimited range of combinations, including even a bar. Finish them off to suit your taste and need.



Corner piece, shown above, has room for TV, Phono, Record Storage, and open Book Case. COMPLETE . . . Net \$84.00 For other units and prices, write for "Modular" Catalog.

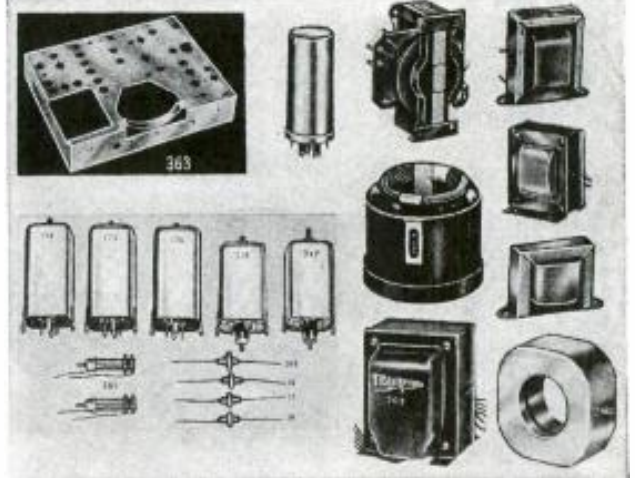

GET into the TELEVISION BUSINESS in a BIG WAY

Radiomen, Servicemen, Dealers . . . Transvision offers you, through your jobber, a 3-point Dealer Plan for making big money in television: (1) Sell TV sets constructed by you from Transvision Kits. (2) Sell exclusive Custom-Built Jobs with beautiful "Custom-Art" Cabinets. (3) Sell "packaged" Transvision TV Products, including Kits, Components, and Accessories. For FULL DETAILS about this amazing plan, WRITE FOR FOLDER No. D-1, or ask your Transvision Outlet.

FREE 162 p. TELEVISION COURSE with purchase of any Transvision TV Kit . . . You don't need this course to assemble a Transvision Kit, because the job is easy enough and our instruction sheet is simple and clear. BUT, if you want a good introduction to television fundamentals as a basis for further study, the Transvision Television Home-Study Course is ideal. Remember, you pay nothing extra for this course. Ask your Transvision Outlet.

All Transvision Prices are fair traded; subject to change without notice. Prices 5% higher west of the Mississippi.

TRANSVISION, INC., Dept. RE, NEW ROCHELLE, N. Y.

For FREE 20-page TV BOOKLET and 8-page CATALOG, SEE YOUR TRANSVISION OUTLET!

NEW YORK, N. Y.
PALLADIUM TELEVISION CORP.
785 Third Ave.
PHILED TELEVISION CO.
142 Liberty St.

BRONX, N. Y.
TRANSVISION OF THE BRONX
248 East 149th St.

BROOKLYN, N. Y.
TRANSVISION OF BROOKLYN
485 Coney Island Ave.

STATEN ISLAND, N. Y.
B. & D. DISTRIBUTING CO.
Staten Island 5

LONG ISLAND, N. Y.
TRANSVISION OF LONG ISLAND
40-14 Greenpoint Ave.
Long Island City, N. Y.

WESTCHESTER, N. Y.
TRANSVISION OF WESTCHESTER
149 Riverdale Ave.
Yonkers, N. Y.

SYRACUSE, N. Y.
TRANSVISION OF SYRACUSE
517 Butternut St.

NEW JERSEY
TRANSVISION OF NEW JERSEY
601 Broad St.
Newark, N. J.

BOSTON, MASS.
TRANSVISION OF NEW ENGLAND
1306 Boylston St.

PHILADELPHIA, PA.
TRANSVISION OF PHILA.
235 N. Broad St.

WASHINGTON, D. C.
STAR RADIO . . . 409 11th St., N.W.

CHICAGO, ILL.
TRANSVISION OF CHICAGO
1002 S. Michigan Ave.

CALIFORNIA
TRANSVISION OF CALIFORNIA
8572 Santa Monica Blvd., Hollywood
3471 California St., San Francisco

GREEN STOCKS COMPLETE LINE EICO INSTRUMENT KITS

HIGH PRECISION VACUUM TUBE VOLTMETER

Model 221K Complete Kit **\$23.95**



THE MOST USEFUL TOOL ON YOUR RADIO BENCH! D.C. and A.C. ranges 0-5, 10, 100, 500, and 1000 volts. Ohmmeter ranges from .2 ohm to 1,000 megohms in steps of R x1, R x10, R x100, R x1000 and R x1 megohm. Db scale from -20 to 55 Db in 5 ranges. D.C. input resistance is 25 megohms. A.C. input impedance is over 1 1/2 megohms. Diode A.C. rectifier for greater accuracy and wider frequency range to 30 Kc. Large, rugged, 4 1/2" meter with all A.C. and D.C. readings on one simple scale. All multiplier resistors matched to 1% accuracy. Complete with 6B6, 6X5, 6SN7 tubes and test prods. All numbers etched into panel; can never rub off. Heavy gauge steel cabinet. Size: 9-7/16" x 6" x 5". Shipping Wt. 10 lbs. **NOTHING ELSE TO BUY!**

Model P-75 germanium crystal probe for visual RF signal tracing, and measurements to over 200 megacycles **\$7.50**

ASSEMBLED VTVM

Model 221—Includes all advantages of above. Completely assembled, hand calibrated and tested and ready to use, at the amazingly low price of..... **\$49.95**

POCKET VOLT-OHM-MILLIAMETER COMPLETE KIT

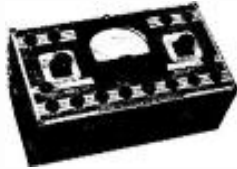

Model 511-K. A "MUST" FOR EVERY SERVICE MAN! The small, handy instrument that every repairman uses a thousand times a day. Large 3" meter, beautiful etched panel. Simple to assemble. A PERFECT KIT FOR BEGINNERS. Ranges, DC -0/5/50/250/500/2500 volts. AC -0/10/100/500/1000 volts. Output -0/10/100/500/1000 volts. DC Ma. -0/1/10. DC Amps. -0/1/10. Ohmmeter -0/500/100,000 ohms/0/1 meg. Db meter -8 to 55 **\$14.95**

ASSEMBLED—READY TO USE

Model 511—Completely wired, tested and assembled at the factory. Rugged, built for heavy duty **\$17.95**

OSCILLOSCOPE KIT

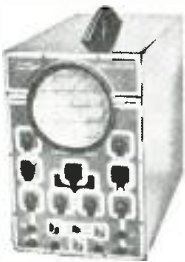

Model 400-K Indispensable for AM, FM, and TELEVISION. Horizontal sweep circuit 15 to 30,000 cycles. All controls on front panel. Linear sweep with N4 gas triode. Graph screen for measuring peak to peak voltage. Frequency response of horizontal and vertical amplifiers from 50 cycles to 50 Kc. Input impedance 1 megohm and 50 mmfd. Etched panel for long life. Tube complement: 2-6SL7, 2-5Y3, 1-884, 1-58P1. Provision for external synchronization, test voltage and intensity modulation. Deflection sensitivity: .50 volts per inch full gain. Detailed instructions and pictorial diagrams included. **NOTHING ELSE TO BUY!** Size: 8 1/2"W x 13"H x 17"D. Shpg wt. 40 lbs **\$39.95**

COMPLETELY FACTORY WIRE OSCILLOSCOPE

Model 400—Same as above but wired, tested and assembled. A sturdy well-designed instrument, ready to use on your work bench. Don't wait, **ORDER NOW!** **\$69.95**

SENSATIONAL PRICE REDUCTION!

Model 113-A MULTI-ANALYST—Completely wired, ready to operate. **NOW FOR THE FIRST TIME..... \$69.95**

A Complete VTVM that follows signal from antenna to speaker! Extremely sensitive wide range AUDIBLE signal tracer. 8 tubes—gain over 90 in probe alone! Limited quantity—order NOW!

20% Deposit required with C. O. D. Orders. All orders F.O.B. New York. All orders must include shipping charges.

THE FAMED HOUSE OF BARGAINS

GREEN RADIO DISTRIBUTORS

Electronic Supplies and Equipment
482 Sutter Avenue, DI 2-4444, Brooklyn 7, N. Y.

RESISTANCE-CAPACITANCE BRIDGE

Originally described in *Radio and Hobbies*, (Australia) this resistance-capacitance bridge can be used to measure resistors between 1 ohm and 50 megohms and capacitance between 1 μ f and 50 μ f with a high degree of accuracy. Values between 50 and 100 microfarads or megohms can be approximated closely. Power factor can be measured with a calibrated control, and leakage is in-

the receiver. This type of circuit is almost invariably used in a high-impedance circuit where it is likely to pick up hum from a.c. circuits and cause feedback because of coupling to the a.f. circuits. These disadvantages can be overcome by using the selective a.f. filter described in *The Short Wave Listener* (London).

This is a medium-impedance device that is inserted between the receiver phone jack and a pair of 2,000-4,000-

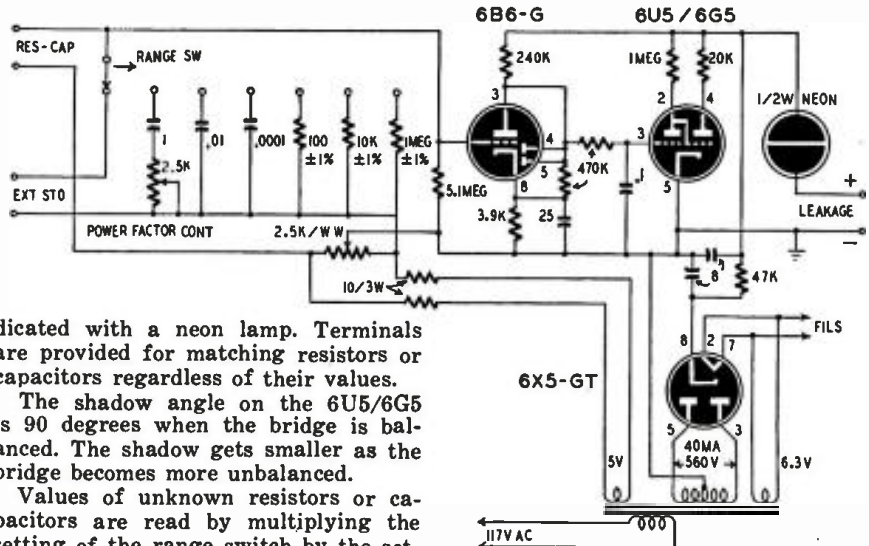

dicated with a neon lamp. Terminals are provided for matching resistors or capacitors regardless of their values.

The shadow angle on the 6U5/6G5 is 90 degrees when the bridge is balanced. The shadow gets smaller as the bridge becomes more unbalanced.

Values of unknown resistors or capacitors are read by multiplying the setting of the range switch by the setting of the ratio dial. This dial is calibrated by connecting known resistors and capacitors across the RES-CAP terminals and balancing the bridge. Determine the ratio between the standard and known values and mark this ratio on the dial.

A 2,500-ohm power-factor control is in series with the 1- μ f standard. This control is calibrated using the formula: power factor equals .03768 x RC; where R is the resistance in series with the standard in microfarads.

The 10-ohm resistors in each leg of the 5-volt winding are to limit the current when two very low resistors are being matched.

The 100- μ f and 0.1- μ f capacitors are silver micas with tolerances of 2.5% or better. The 1- μ f standard is a paper unit with a narrow tolerance. It may be made from two 0.5- μ f paper units whose actual values are over and under the rated value by an equal amount.

The components can be laid out in any convenient form. This unit was built on a small chassis with panel. The six terminals are in a row across the top of the panel, the null indicator is above the range switch on the left side, the neon lamp above the power factor dial on the right, and the ratio dial is in the center.

SELECTIVE A. F. FILTER

Recently a number of articles have appeared on improving receiver selectivity for c.w. reception. Most of the methods entail installing a converter and special low-frequency i.f. amplifier just before the second detector of the receiver. Another method is to insert a selective filter in the a.f. section of

ohm headphones. Using the filter in this circuit makes it unnecessary to alter most receivers.

The circuit, as shown in the figure, is simple. The filter peaks sharply between 1,200 and 1,500 cycles. Signals are down 10 db at 900 and 2,000 cycles, and 20 db down at 700 and 3,000 cycles. The performance of the filter depends largely on the Q of the tuned circuits. Each coil consists of 500 turns of No. 36/47 Litz wire on a 1 1/2-inch length of

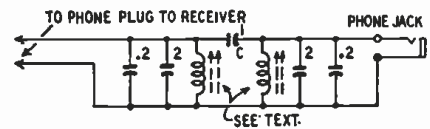

3/4-inch bakelite or fiber tubing, 1 1/2-inch circles of the same material being fitted on the ends of the tube to make a spool or bobbin. Small holes should be drilled in one end to bring out leads. The form should be filled either with thin strips of mu-metal or a powdered-iron slug. Mount the coils where there is minimum coupling between them. The coils are tuned by 2- μ f paper condensers paralleled by 0.2- μ f papers.

The filter introduces a loss of about 20 db, so the volume control on the receiver will have to be turned above normal when the filter is used. When working from impedances other than 2,000 to 4,000 ohms, try different values of C until satisfactory results is obtained.

This circuit will not work too well on receivers with the phone jack in the voice-coil circuit.

To use the filter, tune in a signal and adjust the b.f.o. until the background noise and other signals are sharply attenuated.

RADIOMENS HEADQUARTERS + WORLD WIDE MAIL ORDER SERVICE !!

AMAZING BICYCLE RADIO

The year's hottest sensation. Powerful superhet in beautiful maroon crackle finish case w. built-in 3 foot gleaming chrome telescopic whip antenna. Exactly like a car radio except works off self-contained standard portable radio batteries, easily obtainable anywhere. Theft-proof mounting bracket attached by anyone to a bike or motorcycle in 3 minutes. Readily installed on any vehicle from a wheelchair to a wltch's broom. Radio removable from mounting bracket instantly by means of a special key provided, so that it can be carried anywhere for use as a portable if desired. Weight 5 lbs. Your cost with batteries—\$24.95; without batteries—\$22.50.

1000 Cycle AUDIO FILTERS

Navy PD52010-1 low pass audio filters as mentioned in the "Peaked Audio" article in June CQ, and designated by the above number, are the exact electrical and physical equivalent of commercial audio filter units selling for \$35.00 wholesale. They are infinitely better than the surplus "Radio Range Filters" being sold for reducing QRM, and at 2 KC of resonance for example, a 2 section filter using PD52010-1 is capable of twice the selectivity available thru the use of the Q5-er (the BC453 section of the 27A4 which has provided the amateur's previous highest standard of interference elimination). EXTRA SPECIAL! -NAVY PD52010-1 with diagram. \$5.00

\$12.95 TAKE ALL BIG THREE BARGAINS

HOME WORKSHOP AT BARGAIN PRICE. Accurate and precise 2 speed guaranteed hobby lathe, the essential machine for the home workshop, sturdy enough for light production work or factory standby service. Supplied with 56" of beiling for connecting to any available electric motor or power take-off. Also included in this unbelievable offer are such accessories as a 1/2" drill chuck with specially hardened tool steel jaws, a 4" electric hand held speed grinding wheel, a cotton buffing wheel with a large supply of buffing compound, and a 4" steel wire scratch brush. Your cost \$6.00. Sole export agent. Distributor inquiries invited.

ALUMINUM GEAR BOX 18x8x7 that contains two powerful electric motors and two matched gear trains. 62 gears in all varying in size from 1/2 to 4 inches in diameter. This unit is readily converted to rotate a beam antenna or any other similar use. \$5.00

SENSATIONAL FASCINATING. AMAZING SELSYNS. Brand new selсын made by G. E. Co. Two or more connected together work perfectly on 110 VAC. Any rotation of the shaft of one selсын and all others connected to it will rotate exactly as many degrees in the same direction following one another as if the units were connected together by shafting instead of wires. This is true whether you twist the shaft of the master unit a fraction of a revolution or many revolutions. Useful for indicating the direction of weather vanes, rotating directional antennas, or controlling innumerable operations from a distance. Complete with diagram and instructions. Pair matched pair \$4.95

OUR PE-109 DIRECT CURRENT POWER PLANT

This power plant consists of a gasoline engine that is coupled to a 2000 watt 32 volt DC generator. This unit is ideal for use in locations that are not serviced by commercial power or to run any of the surplus items that require 24-32v-DC for operation. The price of this power plant tested and in good condition is only \$79.95 F.O.B. Buffalo, or we can supply in strictly "as is" condition for \$58.95 F.O.B. New York City. These factors are exactly as received, in heavy steel, including 777 motor, 610 generator, cases, and we are unable to determine the individual units are new, or what their condition is if used, while the \$79.95 are "as is" condition.

that we have brought to Buffalo for testing and repair if necessary. We do not recommend gambling on the "as is" condition, except for quantity purchasers. We can also supply a converter that will supply 110V AC from the above unit or from any 32v DC source for \$12.95.

RT1655 Only \$14.5

11 tube crystal controlled superheterodyne receiver that covers the FM band. The ultra modern circuit uses the latest types of tubes including 777 motor, 610 generator, beautiful chassis and aluminum cabinet. Tubes and diagram included.

COMPRESSED AIR INSTANTLY, ANYWHERE!!

Portable Air Compressor and storage tank. Ruggedly built of best materials using lifeline lubricated ball-bearing on connecting rod and oil impregnated main bearing on shaft. Unusual design forever eliminates valve trouble, the most common fault in air compressors. PATENTED unique air intake system increases efficiency tremendously over other compressors so that air output is much greater than that from larger compressors powered by heavier motors. Will deliver approx. 3500 cu. in. air per min. at maintained pressure of 30 lbs., or will inflate a 90 lb. truck tire in less than 1 min. Complete with 100 lb. gauge, fingertip adjustment allows setting of output pressure at any value, which will automatically be maintained. Works from any 1/4 HP. motor. Useful for spraying paints or lacquers, disinfectants, insecticides, annealing or brazing with natural gas, inflating tires, etc. Price \$14.50 postage prepaid anywhere in U.S. Efficient adjustable syphon type spray gun complete with 12 ft. of 100 lb. tested hose for only \$7.75 with pint container, also prepaid.

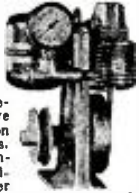

Signal Corp Relay Box RC-616 made by Bell. Contains 6 pole double pole telephone type relays, condensers, resistors, terminals, etc. in a 6 1/2 x 5 1/2 x 2 1/4 beautiful polished aluminum case. \$1.95

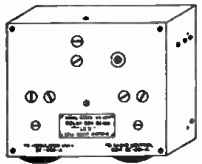

ALL PURPOSE NEON TESTERS. 60 to 550 volt. Indicate all kinds of current, AC, DC or RF, and comes complete with instruction booklet outlining various tests on radio sets, including the location of fading, dead stages, shorts, and making screen-grid and plate circuit tests. 35c ea. Per doz. on attractive display card—\$3.50.

SENSATIONAL VALUE IN AC-DC POCKET TESTER

This analyzer, featuring a sensitive repulsion type meter housed in a bakelite case, represents the culmination of 15 years achievement in the instrument field by a large company specializing in electronic test equipment.

Specifications of the AC-DC Model Volt-Ohmmilliammeter: AC Volts—0-25, 50, 125, 250; DC Volts—0-25, 50, 125, 250; Milliamperes AC—0 to 50; DC Milliamperes—0 to 50; Ohms Full Scale—100,000; Ohms Center Scale—2400; Capacity—.05 to 15 Mfd. Total Price, prepaid anywhere in the USA is \$7.95. Stimler DC Meter, lacking the AC operated ranges of above, \$5.50 prepaid.

SOS EMERGENCY TRANSMITTER SOS

This is the famous Gibson Girl Transmitter that saved so many lives during the war. It is used as a distress call transmitter on boats and airplanes. The Gibson Girl is the simplest transmitter in the world to operate. No instruction or experience necessary. No external power supply required for operation. It is merely necessary to turn the crank on the top of the transmitter and power is generated and the distress signal is automatically sent out on the international distress frequency. Brand New Gibson Girl transmitter complete with tubes.....\$9.95 Antenna Kit for Gibson Girl Transmitter. This kit was designed to improve the effectiveness of the Gibson Girl Transmitter by increasing the range several times. The kit includes 300 feet of special antenna wire, two balloons for raising the antenna in calm weather, two hydrogen generators to inflate the balloons, a special box kite for antenna erection in windy weather, and a searchlight, powered by the crank operated generator in the transmitter. Complete kit.....\$9.95

THE LATEST TELEVISION RECEIVER



The lowest priced TV receiver to retain all the necessary and important technical refinements found in the most expensive sets. Works all TV channels. Has 26-inch screen, automatic picture lock which eliminates need for returning during programs by preventing pictures from drifting. Has automatic sound level control. Minimum number of manual controls make set easiest of any to operate. Beautifully grained genuine mahogany cabinet hand-rubbed to a finish of distinction. Fully covered by Radio Manufacturers Assn. standard guarantee. Free indoor aerial included. Table model—\$149.95 Floor model with oversize speaker—\$189.95 Nothing else to buy except for those who need outdoor aerials because of their great distance from a TV station.

"SO" RADAR SET

"SO" RADAR SET, complete with 9 tubes including picture tube. This Plan—Position Indicator Oscilloscope has a self-contained pack designed to run from the 110 V. power supply on LST or PT boats. It provides a 5" diameter picture adjustable at will to an 80, 40, or 2 mile circle with the boat at the center, showing location of land, other ships, or any obstruction, so that navigation can be carried out in pitch darkness or dense fog with as much safety as in brightest sunlight. Your cost \$39.95.

6.95 TAKES ALL THREE BIG BARGAINS

BANDSWITCHING TUNING TURRET made by Western Electric. Covers 4 bands above 100 MC. All coils wound with #14 silver-plated wire. Complete with tuning condensers and powerful electric driving motor. Diagram included. ONE OF OUR MOST TERRIFIC VALUES—ONLY \$2.95.

AUDIO AMPLIFIER—Brand new. 2 stage triode amplifiers having 2 of the valuable and scarce uncancer type audio transformers that sell for over \$10.00 a piece. Neat aluminum case, fully enclosed (largest dimension 6 inches). Perfect for intercom system, phono amplifier, mike amplifier or signal tracer amplifier for testing radio sets. A sensational bargain at only.....\$3.40 each

DUAL METER—One 50 uA and one 200uA movement in the same case. This meter is ideally suited for use as a combination modulation percentage and carrier shift indicator. If desired the movements may be removed from the case and used separately for voltmeters, ohmmeters, meters, etc. All meters are in perfect operating condition, but a few have cracked glasses. This super value costs only.....\$1.95

RT 1579 With Tubes, Diagram and Parts List Only \$14.95



Consists of a three stage (cascade 6SJ7's and 6FG output stage) high gain, high fidelity amplifier with 60 cycle 110V power supply on the same 13 1/2 x 14 1/2 chassis, which is protected by a substantial steel cover over tubes and parts. Made by Western Electric with typical quality components such as a husky power transformer and oil condensers, this unit is obviously intended to give years of trouble-free service with no more need for repairs than a telephone. Disconnect one wire each, from the special input and output filters, will result in as high a fidelity amplifier as can be obtained.

Selenium rectifiers—Dry disc type 1 1/2" x 1". 1.2 Amp. maximum. Suitable for converting DC relays to AC, for supplying filament source in portable radios, converting DC meters to AC applications. Can also be used in low current chargers—\$.90.

Meter Rectifiers—Can be used for replacement, or in construction of a variety of test equipment—Full Wave—\$1.25. Half Wave—\$.90.

"RT 1711"

RT1711 Brand New 12 Tube, 110 Volt Receiver-Indicator-Oscilloscope complete with all tubes and power supply. Has telescoping hood over scope tube, which is equipped with a detachable calibrated screen. Has control and amplitude controls and two video inputs. A natural for television.....\$39.95

"P.M. SPEAKERS"

Latest type PM Speaker in a fully-enclosed finished metal cabinet. This speaker in a case match communication receivers, and in addition make perfect intercom remote stations. Our price, \$4.50, including output transformer.....\$4.95



World renowned 700 page tenth edition of the Radio Handbook in cloth binding and hard cover at the sensational reduced price, for a limited time only, \$1.49

MICROPHONES—Super Special—Highest quality all chrome bullet shaped CRYSTAL MIKE of top-flight nationally known brand—\$3.95. Also DWYANIC MIKE—95c. RIKI MIKE—80c. PUSH-TO-TALK MIKE—(With switch on handle)—80c. LAPEL MIKE—(Specify whether carbon or magnetic)—93c.

GENERAL ELECTRIC 15-TUBE TRANSMITTER-RECEIVER

TERRIFIC POWER—(20 watts) on any instantly selected, easily pre-adjusted frequency from 435 to 300 MC. Transmitter uses 2 tubes including Western Electric 316 A as final. Receiver uses 10 tubes including 95's as first detector and oscillator, and 3 7H7's as IF's with 4 slug-tuned 40 MC. IF transformers, plus a 7H7, 7E6's and 7T7's in addition unit containing 8 relays designed to operate any sort of external equipment when actuated by a received signal from a similar set elsewhere. Originally designed for 12 Volt operation, power supply is not included, as it is a cinch for any experimenter to connect this unit for 110 AC, using any supply capable of 400 VDC at 135 Ma. The ideal unit for use in mobile or stationary service in the Citizens Radio Telephone Band, where no amateur license is necessary. Instructions and diagrams supplied for running the RT-1248 transmitter on either code or voice in AM or FM transmission or reception, for use as a mobile public address system, on 80 to 100 MC as an FM broadcast receiver, as a Facsimile transmitter or receiver, as an Amateur Television transmitter or receiver for remote control relay hookups for Geiger-Mueller Counter applications. Order our RT-1248 for only \$29.95 or two for \$53.90, if desired with #14 silver-plated wire. Complete with tuning condensers and powerful electric driving motor. Diagram included. ONE OF OUR MOST TERRIFIC VALUES—ONLY \$2.95.

AUDIO AMPLIFIER—Brand new. 2 stage triode amplifiers having 2 of the valuable and scarce uncancer type audio transformers that sell for over \$10.00 a piece. Neat aluminum case, fully enclosed (largest dimension 6 inches). Perfect for intercom system, phono amplifier, mike amplifier or signal tracer amplifier for testing radio sets. A sensational bargain at only.....\$3.40 each

AT LAST YOU CAN AFFORD A LABORATORY STANDARD MICRO-VOLTER

The famous Measurements Corp. Model 78E, 5 Tube Laboratory Standard Signal Generator (that sold new, for \$29.00) is now available at only \$29.95. Such companies as Admiral Corp. and John Meek, Inc. have ordered from us and repeated many times of these 78 generators for use in their labs and production line testing.

Uses 1-9002, 1-7Y4, 1-VR 150-30, 1-7C7, and 1-7C5 tubes. Output continuously variable from 0 to 100,000 Microvolts.

AUTO RADIO DEALERS! ATTENTION!

Nationally advertised brand of 1949 car radio which will fit practically any car and every pocketbook. Six tube superheterodyne with three gang condenser and 6 1/2" speaker, \$32.25 for a sample. Dealer price \$29.97 each, in lots of two or more.

RECORD PLAYER BARGAIN

All you need for a record playing attachment for your radio except the cabinet! Special equipment—Full Wave—\$1.25. Half Wave—\$.90.





ONE of Britain's biggest banks has found a unique use for television. During the wartime bombing raids, the ledgers were removed from large towns and sent to out-of-the-way spots in the country for safety's sake. Since the war, some of the banks continue to keep their books in places some distance from their main buildings. Until now a bank manager wishing to examine a customer's account has either obtained particulars by telephone or had the documents sent to him. The bank in question has found an ultra-modern way out of the difficulty; it has installed TV transmitters at the places where the books are kept and receivers in its managers' offices. Now when a manager wants to know the best or worst about a client who has called to see him, he just picks up the telephone and says, "Show me Mr. Smith's account." At the other end the clerk places the ledger, opened at John Smith's page, in front of the TV camera. The manager then sees all the required information displayed on the screen of his receiver. A special transmission system is, of course, used to prevent others from being able to look in on the televised accounts and know somebody else's business.

No bad idea, I think. It seems likely that in large offices and factories the plant phone and the intercom systems will be supplemented in the near future by plant TV systems. You don't have to do a lot of thinking to see how useful they'd be and what a lot of time they'd save. (See "Office Television Systems" on page 67 of the March issue of RADIO-ELECTRONICS for a description of just such an office-industrial TV unit.—*Editor*)

Radio control increasing

It's a long time now since I described Britain's first radio-controlled fleet of taxicabs at the university town of Cambridge. Since then central control by radio has been extended in all kinds of directions, some of them quite unexpected. One northern county council, for instance, has a fleet of snow plows which are often needed in widely scattered places to deal with wintertime emergencies. All are now fitted with

v.h.f. radio transceivers, and the drivers listen at regular intervals for headquarters calls. At headquarters is a map on which snow-blocked roads are shown as telephoned reports come in, as well as the position of every plow. A sudden shift in the wind may cause drifts to start piling up on the road through some distant valley. One glance at the map shows the location of any plows that are available for the job, and they are sent where they're wanted without loss of time. Another interesting use of radio control is by the authorities of a hospital service in a large country district. Here it is applied to ambulances and its usefulness was strikingly proved within a day or two of its installation. A telephone call came through from a small village—desperate case, ambulance needed at once. The map showed that one ambulance was traveling on a road not far from the village. It was contacted by radio. Within five minutes of the call the case was picked up by the ambulance, which brought it to the hospital in less than a quarter of an hour. (This kind of quick service would be a boon even in a large American city! —*Editor*)

Navigational aids

Within a short time from now, radar navigational aids will be available to ships sailing along any part of Britain's coastline or approaching it from any direction. The whole of the North Sea and a great part of the English Channel are already covered. New radar centers, soon to be in operation, will serve those parts of the coast which are not yet provided for. The system used is the Decca, which has many interesting features. Unlike Loran and Gee it does not use pulses, though, like them, it gives its directions by means of a criss-cross latticework of hyperbolic curves. A Decca center of which there are now two in Britain and one in Denmark, consists of a master station and two slaves. Instead of pulses, these transmit very long radio waves. Position fixing in a ship or plane using the system is done by means of the phase difference at the receiver of the waves from the three transmitters. The presentation to the navigator is delightfully simple, for he has nothing to work out and need not even know what phase or phase difference means. What he sees in

European Report

By Major Ralph W. Hallows

RADIO-ELECTRONICS LONDON CORRESPONDENT

his receiving unit is sets of figures appearing in the square apertures of a dial, just like the figures which are seen in the mileage recording part of an automobile speedometer. Provided that he has a chart marked with the Decca hyperbolic lattice he can fix his position within a few yards at any instant. No matter what the weather may be, he can confidently set a course with the help of the lattice, and can check whether or not the ship is being kept to it, by means of the succession of figures appearing in the apertures of the dial. The Decca system has already given proof of its complete reliability. The coasting ships which bring tens of thousands of tons of coal each week from the mining districts of the North of England to London and other southern areas are all equipped with Decca apparatus. They used to be held up by fog or falling snow; now they make their trip in any kind of weather almost as regularly and as punctually as the trains of a railroad.

The commercial aspect is interesting. The radar centers are installed, operated, and maintained by the Decca Company, which gets its profit by leasing receiving units to ships of all sorts. The terms are quite moderate, and they include the cost, not only of supplying the receivers, but also of maintaining them in first-rate condition and of training members of the ship's staff to make the best possible use of them, an important necessity.

Ferry radar

If you look at a map of Britain, you will notice that many of its most important seaports are actually quite a long way inland. London, Southampton, Liverpool, Glasgow, Leith, Hull, and Grimsby are all on rivers with many miles of wide estuary between them and the sea. These estuaries are mostly unsuitable for bridges high enough to allow ocean-going ships to pass; hence ferries must be used to carry the heavy traffic across the gaps that they make in busy main roads. In the past fogs have caused bad delays in the ferry services, which, of course, cut right across the streams of shipping. More and more of these are now being fitted with radar navigational aids. With these they can follow their courses no matter how thick the weather may be, for the marker

buoys and beacons are always plainly seen on the radar screens. And the radar eye enables them to "see" their way through the shipping moving upstream and down. As the ferries are largely used by automobiles and trucks making long-distance runs, radar is thus beginning indirectly to have a big influence on the speed and safety of road travel in winter and when the weather is foggy.

TV progress

At the time of writing, the number of televisers in use is just on the 100,000 mark—even though we have still only one TV transmitting station. Just 20 months ago the total was 18,000; so the increase has averaged rather over 4,000 a month. It would have been considerably greater if the manufacturers could have produced the televisers fast enough to meet the demand. The chief problem, as I mentioned recently, has been the shortage of cathode-ray tubes. This trouble, I learn, is mainly due to difficulty in obtaining the glass "bottles" which are required—so there's literally a bottleneck in TV production! The 10-inch tube is by far the most popular size amongst viewers. They won't have anything smaller because they find the picture size unsatisfactory with tubes under 10 inches. Many sets with 12-inch and 15-inch tubes are sold, but the drawback here is the big jump in cost. People are also a bit scared of the cost of replacing one of these big tubes when it comes to a natural or an accidental end. C-R tubes are expensive, and it's not funny to be faced with a replacement cost which is equivalent to \$60 to \$80.

Wired TV

There are schemes afoot here to pipe television to many homes from a single receiving center. One of these proposes to give its subscribers a service at video frequency. Their receivers would be of the simplest kind, with no r.f. or i.f. stages. This system is interesting, but its main application is to quite small centers, such as groups of apartment homes under the same roof, for it does not lend itself easily to distribution over any but short distances. Another possible system distributes the programs at i.f. A third distributes the carrier and its sidebands after collection by an antenna high enough to be unaffected by man-made static and preamplification, if this is found necessary. I believe that there is quite a future for TV supplies of one or other of these kinds piped over co-axial cable, particularly if interference-free reception can be guaranteed and if televisers are supplied on hire for a weekly or monthly payment which includes full maintenance. Many concerns here supply broadcast-band sound programs under similar schemes and most of them have proven gold mines for those who run them. I don't see any reason why piped TV should not be just as popular and just as profitable both to the operators and to the public.

APRIL, 1949

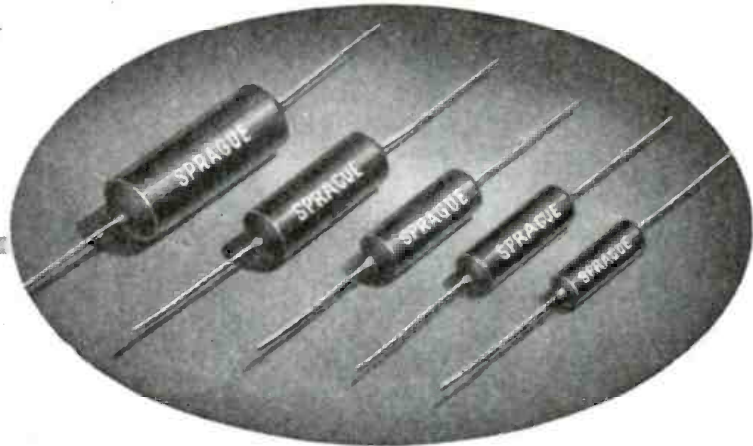

THE LOW-DOWN ON Phenolic Molded Tubulars TYPES **TM** AND **MB**

(600 volts)

(1600 volts)

Sprague's introduction of the first practical phenolic-molded tubular capacitor was probably the most revolutionary capacitor development in radio servicing history. It is to clarify any misunderstandings which may exist regarding this remarkable advancement and explain things fully that the following information is given.

DO THEY COST MORE?

Not as far as you are concerned. Sprague TM and MB Molded Tubulars cost considerably more to manufacture, yet you buy them at the same prices as ordinary wax cardboard tubulars. TM's and MB's are truly premium capacitors at no premium price.

ARE THEY REALLY BETTER?

Most emphatically yes. Sprague Molded Tubulars represent just about as much improvement over conventional wax cardboard types as the new Ford does over the old Model A. They're tested at 95% relative humidity for 250 hours. They operate at temperatures from -40°F. to +185°F. without batting an eye. They're life-tested at 1½ times rated voltage for 250 hours. Their high-temperature thermo-setting phenolic jackets mean that they'll not only outperform conventional wax capacitors under severe conditions of heat, moisture, vibration and rough handling but last much longer and give better performance on ordinary jobs.

WHERE SHOULD I USE THEM?

Use them on any by-pass application where you want capacitors that won't cause trouble later. They're tops for auto and aircraft radio, television and other difficult jobs. And, because they cost you nothing extra, Sprague Molded Tubulars make ideal replacements for any service work where you want to do a really first-class job.

DOES EVERYBODY MAKE THEM?

Not by a jugful! However, because of the remarkable success of Sprague TM's and MB's there will soon be plenty of imitations. This means you'll be wise to ask for them by name and be sure of getting the original practical molded tubulars—thoroughly tested and proved through years of service.

WHO SELLS THEM?

Sprague Molded Tubulars are featured by leading distributors throughout the country. If you don't know the name of the one nearest you, write or wire and we'll advise you promptly.

WHERE CAN I GET COMPLETE INFORMATION?

Bulletin giving complete catalog information on Sprague TM and MB Molded Tubulars can be obtained from your Sprague jobber—or we'll mail one on request.

SPRAGUE PRODUCTS COMPANY, North Adams, Mass.

Jobbing distributing organization for the products of the Sprague Electric Company

CAPACITORS **SPRAGUE** *KOOLOHM
RESISTORS
*T.M. Reg. U.S. Pat. Off.

RECORDER-AMPLIFIER

? Please print a diagram of a 30-watt amplifier for recording and playback. I have a high-fidelity output transformer with a plate-to-plate load impedance of 6,600 ohms for 6L6's, a 30-watt hi-fi speaker with built-in 500-ohm output transformer, and a 4-ohm magnetic cutter.—A.R., Huntington, W. V.

A. Here is a recorder amplifier designed to your specifications. The sound can be monitored with phones and recording level checked with the 6U5 electron-ray indicator. A 5-pole, 4-position switch alters the input and output circuits for the various operations. Separate pickup and turntable are needed when making recordings from a record. Place the major components on the chassis so that the power-supply section is as far as possible from the input circuits. Shield all plate and grid leads up to the input grid of the 6N7 and keep them as short as possible. Use shielded cable and plugs.

MATERIALS FOR RECORDER-AMPLIFIER
Resistors: 2—4.7, 1—3, 2—2.2, 7—1 megohm, 1/2 watt; 3—470,000, 2—330,000, 2—270,000, 2—100,000, 2—56,000, 3—27,000, 1—15,000, 1—1,500, 1—560 ohms, 1/2 watt; 1—50,000, 1—500 ohms, 50 watts; 1—250 ohms, 10 watts; 1—5,600 ohms, 4 watts; 1—12,000, 1—4,700 ohms, 2 watts; 7—500,000-ohm potentiometers.
Capacitors: 1—.0005, 1—.006- μ f, 450-volt mica; 2—.025, 7—.01, 2—.006, 1—.05- μ f, 600-volt paper; 2—.01- μ f, 400-volt paper; 3—10, 1—40- μ f, 450-volt electrolytic; 3—10- μ f, 500-volt electrolytic; 1—50, 1—25- μ f, 25-volt electrolytic.
Transformers: 1—output, high-fidelity, 6,600 ohms plate-to-plate, 30-watts, multi-tap secondary; 1—power, 780 volts center-tapped at 150 ma or more, 5 volts, 3 amperes, 6.3 volts, 5 amperes; 2—chokes, 7 H, 150 ma or more.
Tubes: 2—6L6, 1—6N7, 2—6SK7, 1—6SN7, 1—5U4-G, 1—6U5/6G5.
Miscellaneous: 1—chassis about 10 x 17 x 3 inches, 7—octal, sockets; 1—tuning-indicator assembly; 1—recorder assembly with magnetic cutter and xtal pickup; 2—s.p.s.f. toggle, 5—circuit, 4-position rotary switches; 1—1N34 crystal diode; 3—shielded microphone connectors; assorted hardware.

FAULTY CIRCUIT LOCATOR

? I need a locator for grounded and shorted wires in conduits. The equip-

capacitor of such value that the circuit will resonate at the oscillator frequency.

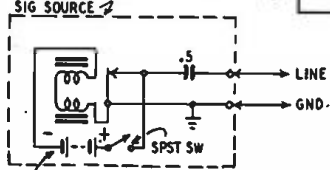
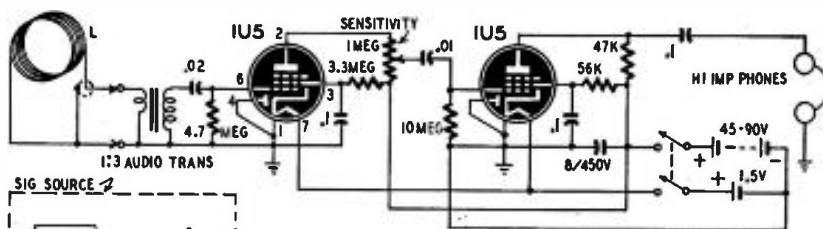

ment must be battery-operated and must be able to locate faulty points without any necessity for opening the conduits.—R. L. A., San Leandro, Calif.

A. A suitable fault locator appears in the diagram. The buzzer signal (a 400- to 1,000-cycle audio oscillator tone can be used, if desired) is fed into the line under test. The pickup coil L is held close to the conduit and moved along it, the coil picking up the signal from the line by induction. When there is a break or a short in the wires at any point reached by the coil, the operator will no longer hear the signal.

The exploring coil is wound with 200 turns of No. 36 s.c.c. wire, taped so that they will not fall apart. Make the winding about 12 inches in diameter, and fasten it to handle made of a light stick.

For greater sensitivity when an oscillator is used, the secondary of the input transformer may be shunted with a

6-VOLT SUPPLY

? I have two magnesium-cupric sulphide bridge rectifiers that will deliver 7.5 volts at 20 amperes into an inductive load from an a.c. input of 19.8 volts. Can I use these to make a supply to deliver 6.6 volts at 30 amperes? If so, what voltage should be supplied by the transformer and how is this computed?—A.P.P., Lima, Ohio.

A. Since each of the rectifier units you have will deliver only 20 amperes, it is necessary that you connect them in parallel as shown in Figs. 1, 2, and 3. When dry rectifiers are connected in parallel, it is recommended that they be operated from separate transformers and their outputs connected in parallel as shown in Fig. 1. With this circuit you can draw up to 40 amperes from the supply. If you do not care to use the two transformers, then use the circuit in Fig. 2 or 3.

Most manufacturers specify that the current rating of the individual rectifiers be reduced to 75% of the maximum rating when used in these circuits.

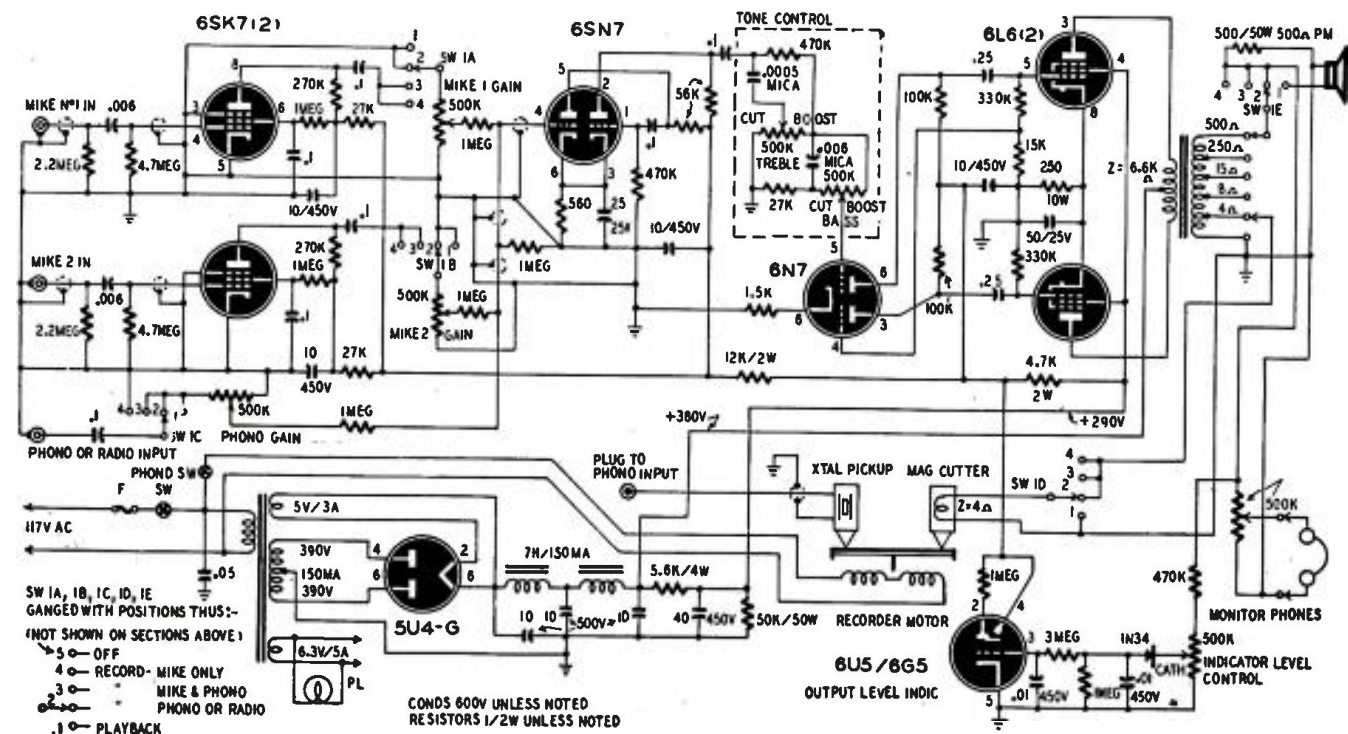

To determine the correct a.c. input voltage for your rectifier units, subtract the difference between the *rated output voltage* and *desired output* from the *rated a.c. input voltage*. The resultant is the a.c. voltage to be applied to develop the desired d.c. output voltage. For example:

$$19.8 - (7.5 - 6.6) = 19.8 - 0.9 = 18.9 \text{ volts a.c.}$$

A transformer delivering 18.9 volts with the current ratings necessary for either circuit will probably have to be made on special order, but you can im-

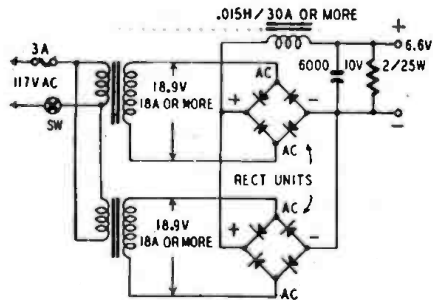

Fig. 1—Paralleled outputs supply 40 amperes.

prove by using a number of high-current 6.3-volt filament transformers in series parallel to deliver the required voltage and current. Three of these transformers with their secondaries in series aiding and primaries in parallel will deliver 18.9 volts. Connect enough of these series strings in parallel to deliver the current you want.

It will be worth while to use a heavy series resistor or an auto-transformer in the a.c. line to control the voltage. You should put an a.c. voltmeter across

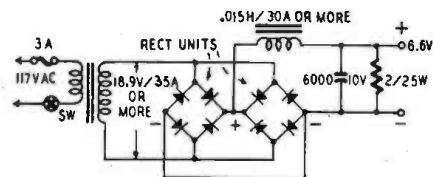

Fig. 2—Rectifier has single input and output.

the input terminals of the rectifier and make sure that the no-load a.c.-input to the rectifier units does not exceed manufacturer's specifications, or damage is likely to result.

If you would like a supply to deliver 6.6 volts to separate 15-ampere loads, then use the circuit in Fig. 3. Each set

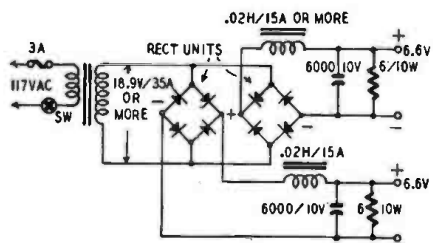

Fig. 3—This circuit has two separate outputs.

of terminals will deliver up to 15 amperes when used alone. Connect them in parallel for 30 amperes maximum output. The outputs can be connected in series to deliver 13.2 volts at a maximum of 15 amperes.

APRIL, 1949



Model 260 in all-bakelite roll top carrying case

There are more
Simpson 260
 high sensitivity
 Volt-Ohm-Milliammeters
 in use today than all others
 combined! Your Parts Jobber
 can tell you why

SIMPSON ELECTRIC COMPANY

5200 S. 218 W. Kinzie St., Chicago 44, Ill. In Canada: Bach-Simpson, Ltd., London, Ont.

RANGES at 20,000 ohms per volt DC, 1000 ohms per volt AC

VOLTS: AC & DC—2.5, 10, 50, 250, 1,000, 5,000

DC CURRENT: 10, 100, 500 MA—10 AMP—100 MICRO AMP

OHMS: 0-2,000 (12 center), 0-200,000 (1200 center), 0-20 MEGOHMS (120,000 ohms center)

DECIBELS: (5 ranges) -10 to +52 DB

ESSE RADIO CO.

SURPLUS RADIO CONVERSION MANUAL

Edited and printed by Techno-Graphic Publications. It contains 115 pages, size is 7" x 10 1/2", printed on good paper stock, covers well bound. A partial list of contents includes complete information on the conversion of the following popular war surplus items: BC-221 Frequency meter, BC342, BC312, BC348, BC946B, SCR274N, SCR522, BC1068A receivers, BC412 cathode ray oscilloscope, BC645 transceiver for citizen's band, SCR274N transmitters, SCR522 transmitter, TBY transceiver, various dynamometers, and a cross-index on tube numbers, frequency allocation chart, electronic surplus index with listing of over 135 items and description or functions or frequencies or tube line-ups etc. of same. Circuit diagrams of original items, and of converted jobs, together in the manual. The text is clear, concise and with values of various component parts abound easy to read and follow.

The price per copy is\$1.25

MINE DETECTOR AN/PRS-1

The detector is designed to detect metals, non-uniformities (rocks, tree-roots) and may be used to detect metal buried in logs, to locate cables, pipes, sewer tile and etc. It is widely used by lumber camps, miners, prospectors, plumbers, treasure hunters and explorers.

A portable device used in the detection of both metallic and non-metallic by aural (ear) and visual (eye) means. These are brand new outfits, complete with instruction book and spare tubes. Shipped in original overseas moisture-proof container.

The set consists of the detector head with antenna and reflector meter, a meter housing and lower section of exploring rod, amplifier assembly, exploring rod extension, bag designated to carry equipment while operating, and wooden case for storing or transporting the complete unit when not in use. This detector is not nearly as sensitive as the SCR-625 Mine detector. However, because of its price and its simplicity, you cannot go wrong on buying one for \$14.95. Shipping weight, 125 lbs. Weight in operation only 22 lbs.

Batteries are not included but we can supply them for \$8.25 per set.

Our Price \$14.95

Shipping Weight 125 lbs.
Weight in Operation Only 22 lbs.

AIRCRAFT RADIO RANGE FILTER FL-8-A

For helpful reduction of QRM on crowded CW bands. When attached to output of any communications receiver:

1—Will pass signal of 1020 CPS, eliminating others.

2—Will pass voice frequencies and eliminate 1020 CPS code signal.

Compact, light weight, with switch. Size 2 3/4" x 2 3/4" x 3 3/4".

Price\$1.25 ea.

JACK BOX BC-1366

Contains 2-pole 5-position switch, rheostat, two phone jacks, etc. In aluminum case 3 1/4" x 4 3/8" x 2 1/4". Complete with headphone set adapter to match high to low impedance. Price\$1.00

Esse's Special Offer

CABLE CONNECTORS AND PLUGS Choice .25—All Brand New

Manufacturer	Type	Price
Amphenol	AN3101-14-10P	25¢ each
Amphenol	AN3101-18-185	25¢ each
Amphenol	AN3101-22-55P	25¢ each
Amphenol	AN3102-22-15P	25¢ each
Amphenol	AN3102-28-10P	25¢ each
Amphenol	AN3102-32-55P	25¢ each
Amphenol	AN3106-18-115	25¢ each
Amphenol	AN3106-18-18P	25¢ each
Amphenol	AN3106-24-65	25¢ each
Amphenol	AN3106-24-7P	25¢ each
Amphenol	AN3106-32-55	25¢ each
Harwood	AN3108-145*	25¢ each
Aero	AN3108-145-25	25¢ each
Cannon	AN3108-145-25	25¢ each
Amphenol	AN3108-145-25	25¢ each
Amphenol	AN3108-18-12P	25¢ each
Amphenol	AN3108-22-55	25¢ each
Cannon	AN3108-22-55	25¢ each
Amphenol	AN3108-24-6P	25¢ each
Amphenol	AN3108-24-165	25¢ each
Cannon	AN3108-24-165	25¢ each
Amphenol	AN3108-32-5P	25¢ each
Amphenol	AN3108-28-10P	25¢ each

BC-375 GE MOPA TRANSMITTER

The most famous of all surplus transmitters. Was used by the Army bombers and ground stations during the War. Frequency range is covered by means of plug-in tuning units as shown below. Each tuning unit has its own oscillator and power amplifier coils and condensers, and antenna tuning circuits all designed to operate at top efficiency within its particular frequency range. Transmitter and accessories are finished in black crackle, and the milliammeter, voltmeter, and RF ometer are mounted on the front panel. Frequency Range: 200 500 Kc. and 1500-12,500 Kc. (Will operate on 10 and 20 meter band with slight modification). Oscillator self-excited, thermo-compensated, and band calibrated. Power Amplifier: neutralized class "C" stage, using 211 tube, and equipped with antenna coupling circuit which matches practically any length antenna. Modulator: Class "B"—uses two 211 tubes. Power Supply: Dynamotor which furnishes 1000 V. at 350 Ma. instructions and diagram for 110 V. AC furnished upon request for

\$1.00

PRICES: As follows—

Transmitter only\$12.50

Tuning units TU-6B, TU-7B, TU-8B, TU-9B,

TU-10B, TU-26B, choice 2.50

Dynamotor PE-73C 4.95

Antenna tuning unit (BC-306A) 4.95

ATTENTION! PROSPECTORS, MINERS, OIL COMPANIES, PLUMBERS, etc. Below is the finest metal detecting mine detector ever constructed . . .

SCR-625 MINE DETECTOR

Brand New

Metallic Objects Only

Used by the Army to detect buried metallic mines. Its private use suggests the location of underground or underwater pipes, cables and ore bearing rock, the location of metallic fragments in scrap materials, logs, etc., and the screening of personnel in plants for carrying of metallic objects.

The unit consists of a balanced inductance bridge, a two-tube amp. and a 1,000 cycle oscillator. The presence of metal disturbs the bridge balance, resulting in a volume change of the 1,000 cycle tone. The tubes used are low-battery drain types such as 1G6 and 1N5. The circuit may be modified for control of warning signals, stopping of machinery, etc., when metal is detected. Operates from two flashlight batteries and 103 V. "B." However, a power supply operating from 110 V. may be used. Comes complete with spare tubes, spare resonator and instruction manual—in wooden chest 8 1/4" x 28 1/4" x 16". Weight in operation is 15 lbs. New, complete in original overseas packing container. Originally sold by War Assets for \$166.00.

The U. S. Forestry Service has recommended procedure for using the SCR-625 Mine Detector to find concealed metal in tree logs and other timber products.

Price\$59.50

Batteries\$4.00 extra

INDIANAPOLIS INDIANA

TELRAD 18-A FREQUENCY STANDARD

Checks signals in the range of 100 Kc. to 45 Mc. with a high degree of accuracy. Self-contained power supply is 110, 130, 150, 220, and 250 V. 25-60 cycle AC. Complete with tubes, dual crystal, and instruction book. Brand new.

Price\$24.95

MARKER-BEACON RECEIVER

Can be adapted to radio controlled devices. Was used by pilots to flash a signal lamp on aircraft instrument panel when in range of a beacon transmitter. Responds to modulated signals over a variable range of 62 to 80 Mc. Tube plates and filaments operate directly from 24 V. DC. Can be adapted for radio control of experimental apparatus, opening garage doors, etc. Circuit diagram and parts list included on either model shown below:

BC-357—contains 12C8 and 12SQ7 tubes and sensitive relay (size 5 3/4" x 5 1/4" x 3 1/4").

Price\$1.95

BC-1033—contains 6SH7, 6SL7 and 12SN7 tubes, sensitive relay (size 5 3/4" x 5 1/4" x 3 1/4").

Price\$2.25

R-89/ARN 5A GLIDE PATH RECEIVER

Formerly used for blind landing but adaptable to many other uses such as receiver for new police or citizen's band. Band of operation 326-335 mc. on any of three predetermined crystal controlled frequencies. Contains eleven tubes, 6 relays and other valuable parts. For 24 V. DC operation. Size 13 3/4" x 5 1/4" x 6 3/8".

Price, complete\$9.00

BC-645 ULTRA HI-FREQUENCY TRANSMITTER-RECEIVER

You read about it recently in QST! Originally operated in the frequency band from 450 to 500 Mc. Can be converted to 420 Mc. amateur band. Consists of complete transmitter and modulator system, and receiver. Complete, brand new, with 15 tubes.

\$11.95

OXYGEN TANKS 500-LB. PRESSURE

Aviators oxygen breathing bottles. Non-shatterable. Ideal to use for air tank on air horns, paint sprayers, pneumatic tools. Excellent condition.

\$3.50

ESSE RADIO CO.

Esse's Special Offer

**INDIANAPOLIS
INDIANA**

LS-3 LOUDSPEAKER

6" PM type, housed in heavy metal case. For use on BC-348 Receiver. Self-contained output transformer to match 4000 ohm impedance. Used but guaranteed satisfactory.
Price **\$4.95**

BC-221 FREQUENCY METER

Covers 125-20,000 Kc. Battery or 110 V. AC or vibra-pack operated. A beautiful instrument. The finest we have ever had. **\$69.50**

SN-7C/APQ-13

Sensational offer for television engineers. Contains 19 Mc. IF strip containing 5—WE 717A tubes, other HF strips containing 2—6AK5's, 3—6SL7-GT's, 1—WE717A, 4—6SN7GT's, 2—6N7's, 2—6L6's, 1—6H6, 3—6AC-7's, 2—6AG7's, 1—6V6, a total of 26 tubes. Other parts such as DPDT relay, 7 pots, 12 Amphenol 831R chassis connectors and numerous condensers, toggle switches, RF chokes, variable condensers and transformers. Wgt. approx. 25 lbs. Size 20" L. x 11 1/2" W. x 7 3/4" H. **\$14.50**

PP-51/APQ-9

RECTIFIER POWER UNIT

400 cycle 115 V. Contains 4—5R4GY tubes, 2—4 Mfd. 1000 V. DC condensers, 2—1 Mfd. 1500 V. DC condensers, 400-2600 cycle transformer, power resistors, etc. Wgt. 38 lbs. Size 21" L. x 5 1/8" W. x 7 3/4" H. **\$4.95**

CP-11/APS-15

Contains following tubes: 13-6SN7-GT's, 3-6SA7-GT's, 1-5Y3-GT. 1: 24 V. motor and blower (blower will operate on 110 V. 60 cy.). 4-one megohm precision wire-wound resistors, 80-86 Kc. crystal, numerous other transformers, condensers, etc. Shipping weight approximately 25 lbs.

Price **\$6.50**

WILLARD LEAD ACID CELLS, \$2.00

(Brand new) 6 V. (dry-charged) **\$2.00**
6 V. in metal carrying case (dry-charged) **3.00**
(Add electrolyte specific gravity 1.265—any drugstore.)

T39/APQ-9 RADAR XMITTER

Contains many excellent parts for the VHF experimenter such as a cavity oscillator using 2-RCA 8012 tubes rated at full output to 500 Mc. Tubes are forced air cooled by 24 V. DC motor, which is easily converted for 110 V. AC operation. Other valuable parts such as a pair of 807's, 2-6AC7, 1-931 and 1-6AG7 tubes; ceramic switch, potentiometers, gears, revolution counter, etc. **\$9.75**



CLOSED VIEW

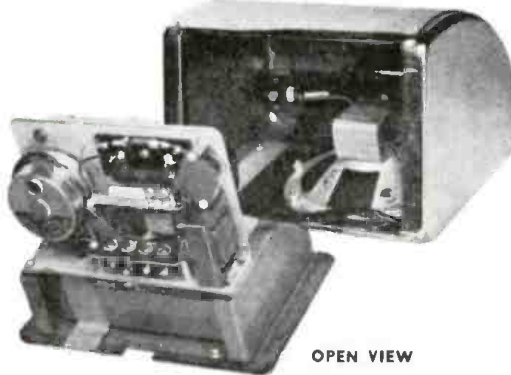

OPEN VIEW

REMOTE CONTROLLED COIN INSERT AND SPEAKER BOX

- Made by Personal Music Corp. Newark, N. J.
- Model F
- 24 Volt operated, fused
- Weight 6 1/2 lbs.
- Size 4 3/4" x 7 1/2" x 5 1/2" high
- Sloping front
- PM Speaker 5" size
- Has 2 Pilot Lights for illumination
- Finished in chrome metal and grill with red plastic
- Accepts 1 to 6 nickels
- Each 5¢ coin gives about two phono records of music
- Should be mounted on a flat base
- Has Haydon Mfg. Co. timer
- Has provision for locks (lock furnished)
- Easily removable coin box, size 6" x 3 1/2" x 1 1/2"
- Requires 4 wires from power unit
- A beautiful piece of equipment that could be built to house coin operated radio.
- Worth several times our asking price.
- Price brand new **\$4.00**

**A TREMENDOUS BARGAIN
Quartz Crystals without Holders**

Get an assortment of these and grind to your own frequencies or use them as they are. .5X.6" B-cut lapped on faces and wired on edges (Ready to use). We will give you an assortment of these from approximately 13 thousandths of an inch to 24 thousandths of an inch whereby you can grind to frequencies desired.

These crystals are now ground to the approximate following frequencies:

3500	4300	5600	6300	7306
3700	4600	5800	6700	7400
3900	4900	6000	6800	7500
4100	5300	6200	6900	7800
				7900

Formula for converting thicknesses of B-cut crystals to frequency is as follows: $F = 98.4/T$ where F is frequency in kilocycles and T is thickness in inches. AN ASSORTMENT OF 20 DIFFERENT THICKNESSES. **\$1.50**

**SCR 274N COMMAND SET
OR
BC-348 POWER SUPPLY**

To convert the BC-348 receiver for 110 V. AC operation. Constructed especially for the Esse Radio Company by a leading transformer company.

These power supplies have gained great popularity due to quality, price and simplicity in conversion. Filament supply 24V. Rectifier tube used: 6x5 (not included).

Price **\$5.95 ea.**

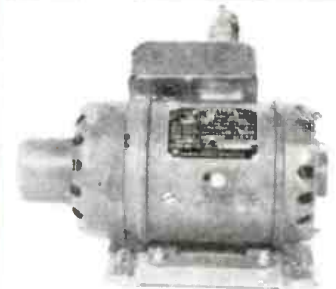

MG-149F INVERTER

Input 24 V. DC 36 amps. Output 115 V. 400 cy. AC, 500 V. A. Output at 90% P.F. **\$5.95**



**ATTENTION AIRLINES!
BC-348 COMMUNICATIONS RECEIVER**

6 bands, 200-500 Kc. and 1.5-18 Mc. 2 stages RF, 3 stages IF, BFO, crystal filter, manual or AVC. Complete with tubes and 24 V. dynamotor. These receivers have been thoroughly checked in our work-shop and found in excellent condition. **\$149.50**

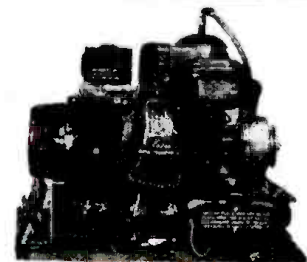

(HRU) DC POWER SUPPLY

24-28 V. at 70 amp. 2000 watts gasoline engine generator with electric starter. Power supply which can be used to operate 24-28 V. equipment, start airplane engines, charge batteries, as a welding machine, lighting system, or for amateur radio station. 21 1/2" x 17 1/2" x 24 5/8". Wgt., 115 lbs. **\$55.00**

**PILOT'S CONTROL BOX
TYPE CRV-23254**

Used with CRV-46151 Receiver for remote control of volume, selection of any one of six frequency bands, has off/on switch or selection of C.W. and M.C.W. and M.V.C. or A.V.C. Black crackle finish. Size, 2"x2 1/2"x5" high. Brand new.

Price.....\$1.50 ea.

**RECEIVER TUNING HEAD
CRV-23253**

Used with CRV-46151 Receiver for vernier tuning. Has beveled dial with hairline cursor. Bands are 200-560, 560-1600, 1600-4450, 4450-9050 Kcs. Each band spread over about 280 degrees of dial edge. Has provision for flexible tuning shaft or can be adapted for direct drive on any tuning shaft. Black crackle finish. Size, 5"x3"x2" overall. Brand new.

Price.....\$1.50 ea.

**ANTENNA KIT
2A-264-126**

Consists of 1 canvas bag containing 20 ceramic insulators each 3" long, 1 covered wire 5' long, 1 covered wire 10' long, 1 covered wire 35' long, 2 covered wires 25' long each, 5 covered wires 20' long each (all wires included for 1/8" thimbles and 6" connecting leads at each end), wire 150' long, (all this is stranded copper wire, covered with weather-proofed insulations). Useful to any ham, serviceman or experimenter. Brand new overseas boxes. \$4.50

**BL-SELENIUM
RECTIFIER**

110 V. AC input; 110 V. DC output, .75 amp. rating.

\$1.25

TURBO AMPLIFIERS

Used for parts or small phono-amplifier, shipped complete with the following tubes: 2-7C5's, 1-7Y4, 1-7F7. Our greatest bargain. See July 1947 "Radio Craft" for conversion data. Each. \$1.25

HONE and WHETSTONE
HUNTER'S and FISHERMAN'S SPECIAL! ALSO
FOR HOME WORKSHOP and MACHINE SHOP

Fine quality, high-grade knife, fish-hook, tool and hand-axe sharpener and polisher. U.S. Government surplus. Light weight (weight less than 1 ounce). Size, 1/2 inch wide x 4 inches long. One-half of instrument is finest possible whetstone and other half is cork rust remover and polisher. Any trapper, hunter, fisherman, hobbyist or machinist cannot afford to pass up this bargain. Brand New



ORDER NOW
15c
each
\$1.00
per dozen

BATTERIES Battery BA-41, delivers 4 1/2, 60, 25 1/2, Volts. Used with BC-620 Transceiver, for bias supply, or portable equipment. Size 2"x2 1/4"x3 1/2". Outdated but tests okay. Unused. **25c**

Battery BA-32, 144, 4 1/2, and 3 Volts positive and 1 3/2 Volts negative. Used with BC-222 Walkie-Talkie Transceiver. Size 5"x8"x7". Husky and has long life. Outdated but tests okay. Unused. **3 for \$9.95**

ALUMINUM BOX with lid. Size about, 3"x3"x2 1/2" with pointed end at top. Ideal for meter case, switch and fuse box, control box, for holding loose parts. Brand new. **30c**

PHILLIPS SCREWDRIVER 6 3/4" overall length. Blade 3" long. Insulated non-slip handle 7/8" diameter. Brand new. **15c**

PORTABLE TRANSMITTER Navy Department Model M1-2462 (made by RCA). Sound powered microphone transmitter with push-to-talk switch. Metal formed chest-plate with adjustable strap far support about operator's neck. Pivot adjustment for placing of microphone. Has 7-wire color-coded rubber covered heavy duty cable, 20 ft. long. Units will work up to several thousands of feet apart, no batteries or external supply needed. Several units may be connected together on same circuit. Indispensable for television antenna installation, electrical wiring work, plumbing contractors and other point to point work. Transmitter only. Receiver not included. Brand new. **Ea. \$7.50**

GLASS TELEPHONE-POLE INSULATORS Hemingway size 680. Fits 3/4" wooden crossarm pin. Overall height 5", diameter 4". Will hold two single steel wires, or two pair of stranded wire cables. Brand new. **Ea. 40c**

MAGNESYN INDICATOR

To be used for beam antenna. Practically same as I-81-A Selsyn indicator. 15-25 V. 60 cycle AC. 3" size. Excellent condition. **\$1.25 ea. Plug for connection..... .50**

FIELD TELEPHONE WIRE

3-conductor, stranded, insulated and weather-proofed. Ideal for intercommunication systems, telephones, Selsyn indicators. Use it inside or out of doors. 525 foot roll. Brand new. Price.....\$4.25 ea.

ARGON BULBS

2-watt, 110 V., Edison base. Ideal for R.F. indication, night light. Brand new. Box of ten. Price per box.....\$1.75

**WESTINGHOUSE
RECTIGON BATTERY
CHARGER BULB**

Style 289416, 6 ampere rating. For replacement in most chargers or for building power supply to use on D.C. operated equipment. Brand new. Price.....\$1.90 ea.

CO-AXIAL CABLE

For high frequency low-loss trouble-free weather proof, durable service. Fully shielded, cut to length. Brand new. RG8/U-52 ohm. Price — 100 ft. for.....\$4.95

**AMPHENOL LOW-LOSS
UHF CONNECTOR**

For RG type cable. Rugged construction, heavily silver plated, provides easy assembly and positive connection. Type 83-IAP Angle Plug Adapter polystyrene insert, pin and socket—very special—**\$15.00 per hundred** Type 83-IR Receptacle, chassis type, low-loss Mica filled insert, very special **\$25.00 per hundred**

LIP MICROPHONE

Lip microphone, made by Western Electric, Navy type CW-51071, with instruction sheet, brand new **75c each**

TYPE 813 TUBES

Type 813 tubes (New) ... **\$4.25 ea.**
Type 813 tube sockets (New) **.50 ea.**



DYNAMOTOR DM-35-D

Western Electric Model No. 5DY83A87. Manufactured by G.E. for Signal Corps, U.S. Army. Input 12.5 volts DC at 18.7 amps. Output 625 volts DC at .225 amps. Diameter 3 1/2", length 7 1/2", mounting rack 8 1/2" long. Ideal power supply for mobile installations. Brand new in original boxes. **\$6.95**

**A-5 AUTOMATIC PILOT
SERVO M1**



Made by Delco-Remy. Has 1/2 horsepower shunt type DC motor, 27.5 V. 11 amps input, speed 6000 rpm. Has hydraulic lift — (Intended use—Hydraulic lift actuates Ailerons on airplane). Overall length 16", width 12", height 11". Net weight 29 lbs. Shipping weight 35 lbs. Hardware for cable drum included. Brand new in original packing boxes. **\$9.95**

Radio Co
130 W. New York St.
Indianapolis 4, Ind.

Unless Otherwise Stated, All of This Equipment Is Sold As Used
CASH REQUIRED
WITH ALL ORDERS
Orders Shipped F.O.B. Collect

SELECTIVITY IMPROVEMENT

Many of the old-style t.r.f. midsets are not very selective where there are strong local stations.

I wanted to hear a station on 590 kc, and there was a strong station nearby on 610 kc. The drawing shows the modification I made.

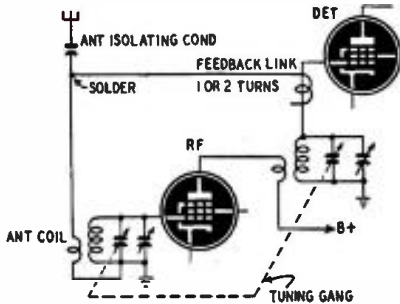

The end of a piece of insulated wire connected to the top of the antenna coil was wound around the grid lead of the next stage (the detector in my receiver), making the set regenerate. The number of turns—that is, the coupling—must be adjusted so that the set is always just below the oscillation point all over the dial when the volume control is turned up. The entire receiver was realigned.

The improvement in selectivity was ample, and sensitivity was increased.

WILLIAM JOYCE,
Derry, N. H.

SMALL CAPACITORS

When small capacitors are needed for experimental purposes, use radio tubes. The tube handbook supplies data concerning the interelectrode capacitance of each tube.

Use very short connecting leads to avoid adding extra capacitance. Other elements of the tube, of course, should not be connected to anything, nor can sockets be used.

For v.h.f. and u.h.f. work, acorn and miniature tubes are best because they have smaller residual inductances.

HAROLD PALLATZ,
Brooklyn, N. Y.

TWO-BAND ANTENNA

The 20-meter half-wave dipole shown in a is a very good standard transmitting antenna. However, it is useless as a dipole on 40 meters. It can be used on 40 meters, however, by converting it into a Marconi, as shown at b. Tie the ends of the transmission line together and connect them to one end of the link. Ground the other end.

VADI GENNIS,
Cleveland, Ohio

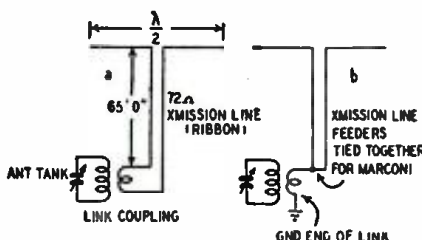

USES FOR MASKING TAPE

A roll of masking tape is very handy in the service shop. Here are some possible uses:

When replacing a speaker cone, it may be difficult to clean out the air gap. Insert a piece of tape and move it around until all the dirt has stuck to the gummed side.

When moving record players and changers, fasten the pickup arm down with a strip of tape.

Use the tape to fasten repair bills and job cards to receivers. The tape will stick but the adhesive will not mar the cabinet.

Cables can be "laced" with masking tape and small parts can be fastened together with it. Where voltages are not high, it will serve as insulation.

When restringing a dial cord, use pieces of tape to keep the string from slipping off the pulleys until the job is done.

ALAN MCFARLANE,
Aberdeen, S. D.

REMOVING CONTROL KNOBS

When a control knob is hard to remove from its shaft, don't pry it off with a screwdriver, as this is likely to ruin the cabinet and break the edge of the knob. Wind a piece of heavy cord or thin rope once around the shaft in back of the knob, then pull the ends of the cord outward. The knob will come off without damage.

D. SRINIVASA RAO,
Madras, India

SHORTED TUNING CAPACITORS

One way to locate and remove shorts from a tuning capacitor is to disconnect all leads from the "high" side of the capacitor and insert it in the circuit

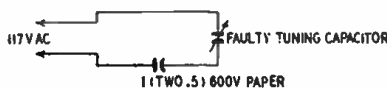

shown. If filings are shorting the plates, sparks will be seen when the shaft is rotated. The shorts can often be removed by continuing to rotate the capacitor until no more sparks are seen.

JOHN W. TURNER,
Newark, N. J.

SURPLUS MICROPHONES

Surplus T-17 microphones will reproduce speech more clearly if additional small holes are drilled in the cap covering the diaphragm. Be sure to remove the cover before drilling it to avoid damaging the diaphragm. Further improvement can be made by carefully removing the cloth protective cover from the diaphragm and removing the capacitor connected across the mike on the rear. Talk across the face of the mike rather than right into it.

L. E. KLINGBERG,
Inglewood, Calif.

TRACING PAPER CHECKS CIRCUIT

When building an electronic device from a circuit diagram, lay a sheet of thin tracing paper over the diagram. As each part and wire is connected, trace the corresponding portion of the diagram with a pencil. When the last wire has been soldered in place, the completed tracing will tell the builder so. When this or a similar method is not used, it is very easy to forget some connection.

HOWARD A. MILLER, W2WLZ,
Rochester, N. Y.

TINNING AN IRON

When you buy a new iron (or clean an old one), remove the tip, heat it with a blowtorch to the temperature required for melting silver solder, and flow silver solder all over the tip, practically plating it. When the tip is cool, put it back in the iron. It should never require tinning, fluxing, or filing, since temperatures ordinarily needed for soldering will not melt the silver solder.

VADI GENNIS,
Cleveland, Ohio

V.H.F. TUNING WAND

The old tuning wand used on broadcast receivers is no longer particularly useful because of the iron cores in many r.f. coils. A modified type of wand, however, is very handy for testing v.h.f. circuits. This one is intended for the 2-meter amateur band.

Use a phenolic or polystyrene rod 7 inches long and at least 1/4 inch in diameter. Drill 1/8-inch-diameter holes in each end, each hole being 1/2 inch deep. Into one hole, force a 1/2-inch length of 1/8-inch-diameter powdered-iron core salvaged from an old i.f. or r.f. coil; into the other hole place a brass slug of the same size.

When you have built a v.h.f. tuned circuit which seems unable to hit resonance, try inserting each end of the wand into the coil. If inserting the iron end resonates the tank, more inductance is needed because the iron adds inductance. If the brass end does the trick,



less inductance is needed because the brass lowers the inductance of the coil. If neither end improves matters, either the circuit is at resonance or it is very far off.

DAVID GNESSIN,
Columbus, Ohio

KEEPING SOLDER OFF CHASSIS

To prevent solder from sticking to a chassis while making a joint on a tube-socket lug, rub the chassis with the end of a small candle. Any solder that falls will not stick to the waxed metal.

GEORGE WECHSLER,
Brooklyn, N. Y.

ORTHICON CONTROL

Patent No. 2,451,640

Robert R. Thalner, Princeton, N.J.

(assigned to Radio Corp. of America)

In an orthicon television camera tube, the image is focused on a light-sensitive cathode which emits electrons. These are accelerated and focused on a mosaic capable of secondary emission. Positive charges remain where electrons leave the mosaic. The beam from an electron gun scans the mosaic, neutralizing positive charges where they exist. The electrons not absorbed in this way are returned to a signal plate. This is the video output which corresponds to the televised image.

It is preferable to maintain a high modulation percentage of the electron beam. A dark optical image can be accommodated by a weak electron beam, but a strong beam is needed when the

highlights are brilliant. Since highlights may vary from one moment to the next, the beam control should be automatic.

In this new method, the video output is amplified in two stages. The output of the first appears across the load consisting of R and C in series. The video signal is like the one illustrated at B. The positive portion is the blanking pulse (originally applied to the orthicon screen), and the negative peak varies with the brilliance of the televised image.

The latter passes through the left-hand diode of E and appears across condenser A and the control grid of tube D. The blanking pulse passes through the right-hand diode and does not affect the control circuit.

To illustrate how the circuit operates, assume that the image highlights become more brilliant at some instant. Then highly positive charges appear at the corresponding points

EXPANSION DETECTOR

Patent No. 2,451,908

Marietta Blau, New York City
(assigned to Canadian Radium and Uranium Corp., New York City)

This apparatus is sensitive enough to detect a change of only 2 microns (millionths of an

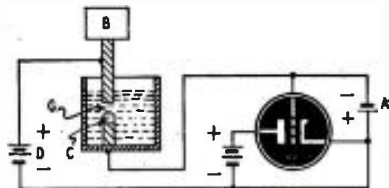

inch). The change may be due to displacement or expansion of a body caused, for example, by variation in temperature, pressure, or magnetostriction. The body whose expansion is to be measured may be made of any material—a conductor or a non-conductor—and it may be of any shape—a cylindrical rod, a spiral or helical coil, etc.

Two rods about 3/16-inch in diameter are immersed in a liquid which can be ionized. Xylol, benzine, or pure water may be used. The upper rod is clamped to the body B under measurement, leaving a gap G between the rods. This gap changes in length with expansion or contraction of B.

A radioactive cell C on the lower rod ionizes the liquid over a short distance. Normally the gap is adjusted so that it is just too large for the ionization to reach the upper rod. If B expands, the gap is slightly reduced and ionization current begins to flow through battery D. The positive potential of D partly overcomes the effect of the negative battery A, and the ionization current increases further. This current indicates the length of the gap, and consequently the expansion of B.

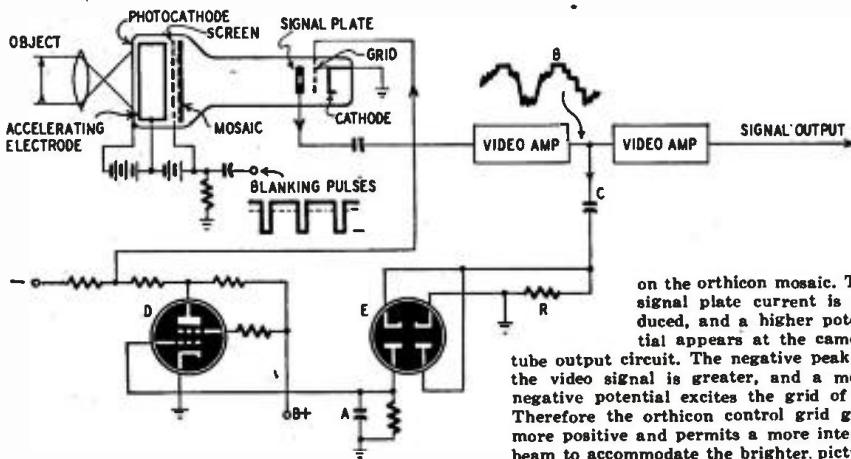

on the orthicon mosaic. The signal plate current is reduced, and a higher potential appears at the camera tube output circuit. The negative peak of the video signal is greater, and a more negative potential excites the grid of D. Therefore the orthicon control grid goes more positive and permits a more intense beam to accommodate the brighter picture which must be transmitted.

For GREATER Earnings... LEARN RADIO-ELECTRONICS



This fast-growing science of RADIO, TELEVISION, RADAR and ELECTRONICS, offers tremendous opportunities, and in no industry is RADIO-ELECTRONICS more important than in aviation. A skilled technician who *knows* the modern application of electronic devices, as used in the aircraft industry, is always in demand . . . not only in aviation, but in many other industries. Many large organizations call on Spartan regularly for graduates. Often, students are hired months before graduation.

Don't confuse the RADIO-ELECTRONICS course offered by SPARTAN with other courses, offered anywhere! As a graduate from this famous school you will know the application to industrial control devices; to the search for petroleum; and the important uses of radar, television and other electronic equipment.

SPARTAN offers two complete and thorough courses. You will work on the most modern and complete equipment. You will build equipment. You may join the SPARTAN "Ham" Club. Either course prepares you for Federal Communication Commission license tests—first class radio telephone, second class radio telegraph, or class "B" radio amateur.

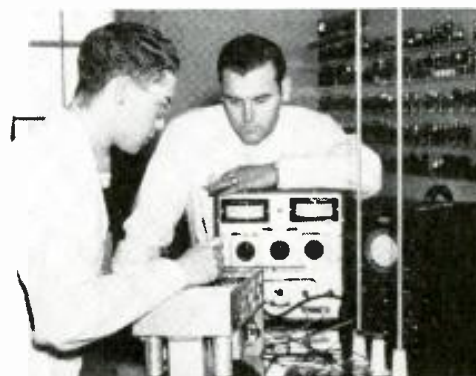

SPARTAN'S 21 years of teaching civilian and army personnel is your assurance of receiving the best possible training in the least possible time. *You'll not need MORE than Spartan training—you cannot afford to take LESS.*

BIG CATALOG—Free

NAME _____ AGE _____

ADDRESS _____

CITY _____ STATE _____

Dept. RE-49

G. I. APPROVED—Write TODAY for Complete Information

SPARTAN
SCHOOL OF RADIO AND ELECTRONICS

SCHOOL OF AERONAUTICS
MAXWELL W. BAUFORD, DIRECTOR

COLLEGE OF ENGINEERING
ADDRESS DEPT. RE 49

TULSA, OKLAHOMA

RADIO-ELECTRONICS for

SIGNAL BUOY

Patent No. 2,448,713
Clarence W. Hansell,
Port Jefferson, N.Y.

(assigned to Radio Corp. of America)

In this adaptation of the walkie-talkie idea a tiny transmitter, operated at very high frequencies, is self-contained with antenna and batteries in a water-tight buoy. Dropped into the water, its microphone enables distant listeners to hear the approach of submarines or ships. An automatic switch turns on the transmitter when water pressure acts on the diaphragm, pressing it inward and making contact.

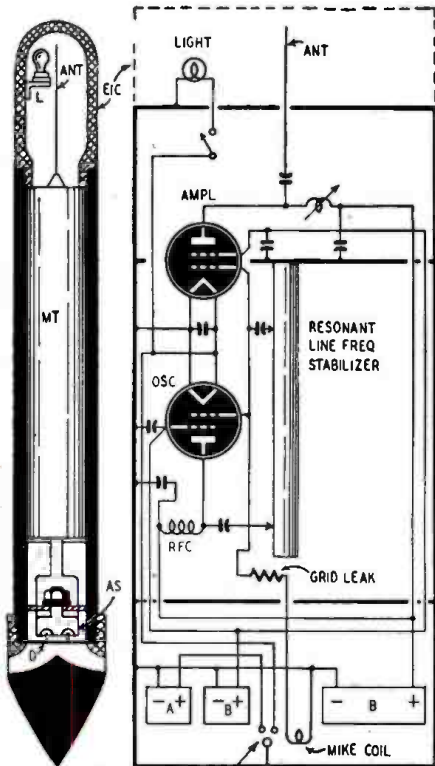

CROSS SECTION PRESSURE OPERATED SW DIAPHRAGM
L- OPTIONAL LIGHT; EIC- ELECTRICALLY INSULATING CAP;
MT- MOD. TRANSMITTER; AS- AUTO. SW. & MIKE UNIT; D- DIAPHRAGM

MICROWAVE TUBE

Patent No. 2,449,975

Harold O. Bishop and Donald Kirk, Jr.
United States Navy

At very high frequencies, most radio tubes are limited by transit-time problems. Above 200 mc the period of a cycle is so short that it compares with the time needed for an electron to move through the tube. This new tube is effective at frequencies as high as 1,000 mc because transit time is not a factor.

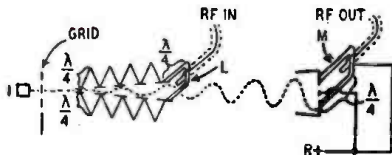

Electrons from a source (1) pass through a grid and between deflecting plates. At each side of the tube the plates are connected by quarter-wave stubs so adjacent elements are out of phase. The last plates on each side are fed from a transmission line L which is coupled to a coaxial cable.

At the far end of the tube, electrons are collected by plates connected to the line M. A coupling loop transfers r.f. energy to the coaxial cable.

When a microwave voltage is fed to the input line, the electron beam is deflected. Since adjacent and opposite plates have opposite polarity at any instant, the beam becomes wavy. The more plates built into the tube, the greater the deflection. At the receiving end electrons are

**“PERFECT”
Two PRODUCTS!**

1 TV BOOSTER

CHECK THESE FEATURES

- HIGH STABLE GAIN . . . LOW INHERENT NOISE
 - FACTORY TESTED FOR "FACT" *
 - SPECIALLY DESIGNED INPUT CIRCUIT FOR HIGH SIGNAL TO NOISE RATIO AND GAIN
 - UNIFORM GAIN WITH 5 TO 6 MC. BANDWIDTH ON ALL CHANNELS
 - GROUND BRAIDS TO AVOID REGENERATION
 - ALL COMPONENTS FULLY FACTORY TESTED AND GUARANTEED
 - MAHOGANY OR WALNUT CABINETS - FURNITURE TYPE FINISH
- *Fringe area condition test. Only definite procedure for assuring perfect performance with a TV Booster.

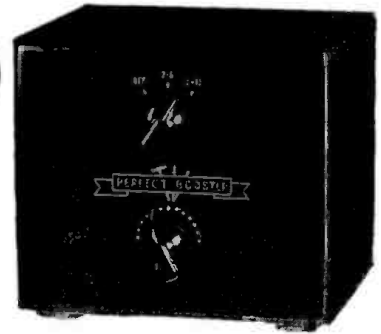

List \$28.50

Slightly Higher West of the Rockies

2 FM TUNER

CHECK THESE FEATURES

- ADAPTABLE TO ANY BROADCAST OR TELEVISION RECEIVER
- 5 TUBES PLUS SELENIUM RECTIFIER AND HEAVY DUTY POWER TRANSFORMER
- UNUSUALLY SENSITIVE STATIC FREE FM CIRCUIT
- TEMPERATURE COMPENSATED OSCILLATOR TO MINIMIZE DRIFT
- BUILT IN ANTENNA CIRCUIT FOR LOCAL RECEPTION

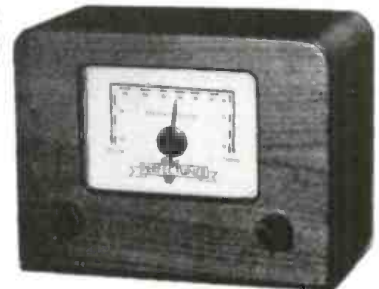

List \$29.95

Slightly Higher West of the Rockies

Write for information on spectacularly priced 12 1/2" TV receiver

Write for descriptive literature and name of local representative. Or send order direct.

PERFECT PRODUCTS CO.
82-27 217th STREET
QUEENS VILLAGE, N. Y.

SOLE NATIONAL SALES REPRESENTATIVE
L. S. KRULL SALES ASSOCIATES
49 PAYSON AVENUE NEW YORK 34, N. Y.

collected at the upper and lower plates alternately. Therefore current flows in M at the same frequency as the input, but the output is amplified. If the input and output are connected together, the tube can be made to function as an oscillator.

DIRECTION-FINDER ANTENNA

Patent No. 2,448,017

Henry G. Busignies, Forest Hills,
and Nathan Marchand, New York, N.Y.
(assigned to Federal Tel. and Radio Corp.)

Two separate antenna systems are usually needed for radio direction finding because radio signals may be polarized vertically or horizontally, sometimes both at the same time. If an antenna is rotated for a null on one component, the other may still be received.

This inventor uses two dipoles mounted at a 45-degree angle and positioned in front of a sheet-metal or wire-screen reflector. The whole antenna may be rotated about its vertical axis to scan the

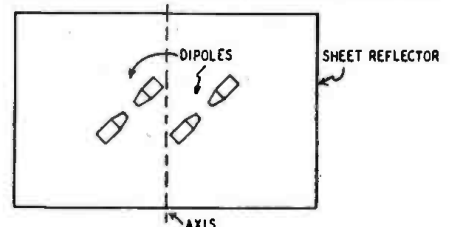

entire azimuth. Each dipole is effective on both vertically and horizontally polarized signals. Therefore, it may be rotated for a null without regard to the polarization of the wave being received.



THE VIDEO HAND BOOK

800 pages—hundreds of illustrations covering everything in television!
14 sections, bound in handsome DuPont Fabrikoid\$5.00

This is the newest book on television—for anyone working at or interested in television—order now to reserve your copy.



THE RADIO DATA BOOK

1148 pages—hundreds of illustrations, tables and charts—covering everything in radio!
The complete radio book, bound in handsome DuPont Fabrikoid. \$5.00

This famous book—combined with the VIDEO HANDBOOK will form a technical library that cannot be equalled—order your copy today!



RADIO MAINTENANCE MAGAZINE

The outstanding service—Technicians' Trade Journal. Each monthly issue a valuable reference work as well as interesting, informative reading.

One year (12 issues).....\$3.00
Two years (24 issues).....\$5.00

Handsome green and gold binders are also available to preserve your copies of RADIO MAINTENANCE\$2.00 ea.

BOLAND E. BOYCE, INC.
MONTCLAIR, N. J.

RC-49

- Send me the VIDEO HANDBOOK. Enclosed is \$5.00.
- Send me the RADIO DATA BOOK. Enclosed is \$5.00.
- Send me One Year of RADIO MAINTENANCE. Enclosed is \$3.00.
- Send me Two Years of RADIO MAINTENANCE. Enclosed is \$5.00.
- Send me _____ binders for RADIO MAINTENANCE at \$2.00 each. Enclosed is _____

NAME _____
OCCUPATION _____
ADDRESS _____
CITY _____ ZONE _____
STATE _____

"MULTI-TESTER" MODEL 30



Model 30 (Illustrated)\$15.95 net
Model 30P (Portable) 19.45 net
Model 30K (Complete KIT and Instructions) 13.95 net

SIGNAL GENERATOR MODEL 300



Supplies 456 Kc, 465 Kc, 600 Kc, and 1500 Kc.
Model 300 (Illustrated)\$16.95 net
Write for FREE CATALOG. SEE your local distributor.
If not available, WRITE to

BRADSHAW INSTRUMENT CO.
42 Flatbush Ave., Dept. RC, Brooklyn 17, N.Y.

"Back-Porch" Booster Brings Up FM Signals

By **JAMES C. DRAKE***

MANY owners of the popular Pilotuner or other small FM tuners may live, like myself, outside a metropolitan area—away from strong FM broadcast stations. My tuner is capable of fine audio reproduction but lacks sufficient sensitivity to bring in fairly distant stations with little noise.

Tuning was extremely difficult, and seldom could a station be heard with less noise than on the AM band. Various antennas were tried, but even with the best antenna there was noise.

The next (and successful) attempt was to provide more gain in the tuner. Adding the i.f. amplifier diagrammed in Fig. 1 provided these desirable results:

1. Increased the audio output voltage as much as one triode audio amplifier stage.
2. Increased the gain so much that many new stations were added to the receiver log. The *measured* gain of the stage is 12.
3. The tuner requires only a simple antenna for good results.
4. Made it possible to receive many FM stations without noise regardless of atmospheric conditions—day or night.

The improvement in reception makes it well worth while to build and install the additional "back-porch" i.f. amplifier. The cost is less than \$5 for all new parts, and most experimenters and radiomen will have several of the components on hand.

This "back-porch" or outboard style of mounting requires only two small bolt holes in the tuner chassis and disturbs only one wire of the original r.f. circuit. Alignment requires only an AM signal generator tuned to 10.7 mc.

Construction

The first step is to make a small sub-

*Valparaiso Technical Institute, Indiana.

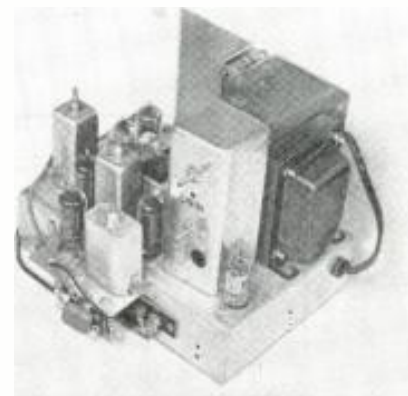

Fig. 2—The booster attaches to center rear.

chassis from a piece of aluminum about 2 x 3 inches. This is bent into an L shape by folding it along its length to make a chassis 1½ x 3 inches with a ½-inch mounting flange (see Figs. 2 and 3). The one shown was cut from an aluminum recording disk. Drill two small mounting holes in the vertical flange as shown in Figs. 3 and 4. When drilling these holes, keep in mind that the small mounting bolts must come through the tuner chassis at a clear spot which will not interfere with its wiring.

Next, cut the holes for mounting the tube socket and the 10.7-mc i.f. transformer. It is important that they be mounted as shown in Fig. 2. Notice that the tube on the outboard amplifier is mounted so that it is immediately behind the last i.f. transformer of the tuner. Notice also that the i.f. can is behind the last 6BA6 i.f. amplifier of the tuner. They are placed thus to minimize the length of the input and output leads of the auxiliary amplifier.

When mounting the tube socket and i.f. can, pay attention to orientation. In Fig. 3 notice that pin 1 on the socket is nearest the mounting flange to keep the input wire short. The output of the i.f. transformer is likewise nearest the

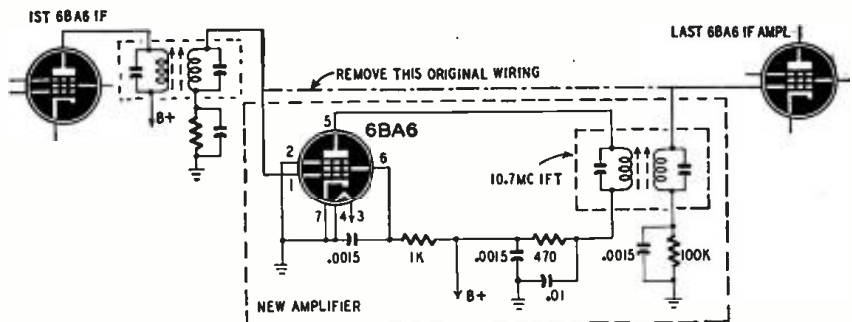

Fig. 1—The booster is an additional i.f. stage inserted between the two present ones.

flange. Be sure that the grounds for the cathode, filament, and all bypass capacitors are made to one common point on the chassis. This is particularly important in preventing oscillation. See how this has been done in Fig. 3. In this picture, the only leads not yet in place are the B-plus, filament, input, and output.

To have a place to connect the input and output leads of the amplifier to the tuner, I pulled out terminals 3 and 5 from the strip on the rear apron of the tuner. The wire from terminal 2 was removed inasmuch as a folded dipole and twin-lead transmission line were

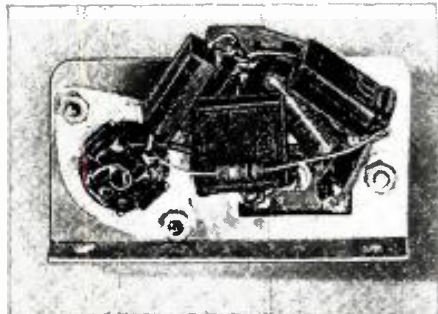

Fig. 3—Booster underchassis, partly wired.

to be used. Terminal 3 was then grounded, making terminals 1 and 2 the antenna transmission-line connections. The phono input wire which was formerly on terminal 5 was soldered to terminal 4. Of course the original ground on terminal 4 had to be removed. The only loss here was the built-in antenna. Variations in this arrangement are possible.

The chassis can now be mounted on the tuner's rear apron. Be sure it makes good electrical contact—poor contact can be a source of trouble. The filament wire is run through the opening in the chassis next to the terminal strip (under terminal 2) to pin 4 of the first 6BA6 i.f. amplifier socket. The black B-plus lead shown in Fig. 5 enters the tuner chassis through a hole already punched in the rear and is connected to the main B-plus lead on the mounting lug at the left.

The input and output leads are then



Fig. 4—Top view, showing holes in flange.

United Cuts Prices!!!

- METERS—G. E. Type AO-22. 3/4" round bakelite case. 0-150 V.A.C. Shipping weight approximately—2 Lbs. Brand new—\$3.50; Ammeter, G.E. 2" round bakelite case. 0-50 Amps. 50 Mv. (less shunt) 5 Amps. full scale. Shipping weight approximately—1 Lb. New—\$1.95; Voltmeter, Sun 3" round bakelite case. 0-500 V.D.C. at 1000 Ohms per volt. Shipping weight approximately—1 1/2 Lbs. New—\$2.75; Weston Model #307. Output—0-10. 2" round bakelite case. 2.2 Ma. movement. Mounted in O.D. wood case. 3/4" x 4 1/4" x 4 1/4". Shipping weight approximately 2 1/2 Lbs. New—\$2.39.
- METER ACCESSORIES—Ammeter shunt. Weston Type D-41207. 100 Amps. D.C. 50 Mv. Mounted on bakelite base. Shipping weight approximately 1 Lb. Brand new—\$2.95; Current Transformer, Weston Type 380. Ratio 75:1. 50—133 cycles. With mounting bracket. Shipping weight approximately—1 Lb. New—\$2.75.
- KITS—Ceramic Insulators, assorted popular types. Shipping weight approximately 3 Lbs. 15 for 59c; Bathub Condensers, single and multiple units, assorted values and types. Shipping weight approximately 2 1/2 Lbs. 15 for 69c; Carbon Resistors, assorted values, mostly insulated. Shipping weight approximately 1 Lb. 100 for \$1.95; Mica or Ceramicon Condensers, silver and mica types, assorted capacitance and voltages. 100 for \$2.95; Filter condensers, all new and usable, 10 for 89c; Hardware kit, consists of 3 Lbs. of standard nuts, bolts, washers, etc. Only \$1.29; Tube sockets, all types and sizes. New. 20 for 95c; Coil forms, Ceramic, phenolic, bakelite, etc. in various types and sizes. New. 15 for 39c; Relays, choice assorted of A.C. and D.C. Standard and special units in excellent condition. Shipping weight approximately—2 Lbs. 6 for \$1.75; Potentiometers, 5000, 10 100 K, 150 K and 500 K. Ideal for multi-range voltmeter. All 5 for \$1.19.
- COILS—12 Mc. Transmitting. Isolaunit form wound with No. 12 tinned wire—31c; 4 Mc. Transmitting. With coupling coil inter-wound on phenolic form—29c; 12 Mc. I.F. for SCR-522. (#292) Slug-tuned and shielded. New—59c; 915 Kc. Output I.F. for SCR-348. Slug-tuned and shielded. New—49c; 455 Kc. Crystal filter I.F. (Halicrafters) Slug-tuned and shielded. New—59c; 465 Kc. B.F. Osc. coil with air trimmer pitch control. Slug-tuned. Shielded. New—59c; 1415 Kc. B.F. Osc. coil as used in SCR-274-N series receivers. Air-tuned and shielded. New—19c; 20 Mc. I.F. Slug-tuned and shielded. New—49c; 30 Mc. I.F. Wound on Polybrene form. Air-tuned and shielded. New—49c; 20-28 Mc. Osc. Ceramic or Micalex form. Slug-tuned and temperature compensated. For B.C. 603 Receiver. Shielded. New—59c.
- VARIABLE TUNING CONDENSERS—2 Gang—Osc. section: Minimum 23 Mmf. Maximum 200 Mmf. Antenna section: Minimum 45 Mmf. Maximum 450 Mmf. With trimmers. 3/4" x 1 1/2" x 2 1/2". Shipping weight approximately—1 Lb. Either type—49c; 3 Gang T.R.F. or Super. All sections: Minimum 18 Mmf. Maximum 450 Mmf. Clockwise. 3/4" to 1 vernier. 2 1/2" dial drum mounted on 3/4" hub. Ceramic insulation. Size: 1 1/2" x 1 1/2" x 1 1/2". Shipping weight approximately—2 Lbs. 49c; 3 Gang T.R.F. or Super. All sections: Minimum 16 Mmf. Maximum 370 Mmf. Counter-clockwise. 3/4" to 1 loaded gear vernier. Direct and vernier shafts. 1/4" Dia. x 3/4" long. Trimmers on two sections. Size: 1 1/2" x 2 1/2" x 4 3/4". Shipping weight approximately—2 Lbs. New—75c.
- CONTROL BOXES—C-30/ARC-5 with 7 push buttons. Brand new. Shipping weight approximately 2 Lbs. \$1.19; C-30A/ARC-5 with 4 position switch. Shipping weight approximately—2 Lbs. New—79c; RE-1/ARR-1 Antenna Switching. 12 or 24 V.D.C. rotary relay. Size: 4" x 4" x 2". Shipping weight approximately—1 Lb. New—49c; Microphone Amplifier #295. Used with SCR-522. Permits using carbon microphone in place of dynamic. Excellent condition. Shipping weight approximately 1 1/2 Lbs.—79c.
- ALUMINUM PANELS—All 19" wide with standard relay notching. Unfinished natural aluminum. 16 gauge (.051) 10 1/4" high, hard—69c; 10 gauge (.102) 10 1/4" high, half hard—\$1.19; 10 gauge (.102) half hard. 12 1/2" high—39c.
- ROTATING ASSEMBLY—For small installations. RL-42 motor and gear box. 24 V.D.C. reversible. Approximately 2 1/2 R.P.M. New—\$3.29. Robbins—49c.
- TRANSFORMERS—Single button carbon mike to single grid. Lux terminals. Upright mounting. Shielded. New—49c; Double button carbon mike to single grid. With leads. Shielded. 59c; 6-12-24 Volt filament transformer—Shielded in heavy metal case. All terminals on bottom. Primary: 115 or 230 V. Size: 3" x 3 1/4" x 4". Shipping weight approximately—5 Lbs. New—\$2.19; Smoothing choke—29 Ht. at 25 Ma. (Used in BC-610 speech amplifier) Black wrinkle case with lug terminals. Brand new. Only—75c.
- SWITCHES—Micro-switch—normally closed. 10 Amps. 125 V. Pin operated. Shipping weight approximately—6 Oz. New—45c; Motor switch—3 P.D.T. 3 buttons labeled "Manual—Off—Automatic". Locks in both operating positions. Ideal for shop equipment operation. Shipping weight approximately—9 Oz. New—39c; Anti-Capacity Lever Switch—(Mossman) Heavy duty contacts. Center position: 3 poles closed. 1st position: 4th pole closed. (Momentary) 2nd position: all poles open. Phosphor bronze leaves. Spring loaded lever. Positive action. Size: 1 1/4" x 1 1/2" x 6". Shipping weight approximately 1 Lb. New—98c; Thermoswitches. Fenwal cartridge type S39. Size: 3/4" Dia. x 4" long. Normally closed. Rated at 115 V. 10 Amps. 230 V. 5 Amps. A.C. Adjustable from -100° to +400° F. at 90° per turn. Normally set at 275°. 2 shielded asbestos covered leads. New—95c; Type S15—Same as S39 except 3 1/2" long, rated at 5 Amps. 115 V.A.C. and leads not shielded. Originally boxed—79c.
- RECORDING HEADS—(Shure) Magnetic. 4 Ohms at 400 cycles. With cord and stylus screw. Slightly scratched. Good condition. Shipping weight approximately—1 Lb. Only—79c.
- MINIATURE SOCKET AND SHIELD ASSEMBLY—9 pin. Black phenolic socket. New. Each—25c; 4 for 95c.
- MICROPHONE CAPSULES—W.E. Type F-1. Used, but in excellent condition. Shipping weight approximately 1/4 Lb.—75c.
- Quantities are limited—order now! Prices subject to change without notice. Minimum order—\$2.00; 25% deposit required. Balance C.O.D. All orders shipped F.O.B. Chicago. All foreign shipments, minimum order—\$50.00.
- TUNING UNITS—BC-746. The basic unit for a low power crystal transmitter. With two crystals, two coils and one tuning condenser—150 Mmf. A.P.C. Shipping weight—1 Lb. 79c; With one 80 meter crystal—95c; With two 80 meter crystals—\$1.29; BC-191 and BC-375 Tuning Units—TU-25, 200-500 Kc.—\$1.49; TU-10, 10 Mc.—1.2 Mc.—\$1.79 (Shipping weight—17 Lbs.) (Less cases); Push Button Tuning Assembly for BC-728—4 push buttons select preset frequencies from 2 to 6 Mc. 12 coils permanently tuned for R.F., mixer and Osc. Completely wired and aligned. Shipping weight approximately—4 Lbs. Brand new—\$1.95.
- CABLES AND CORDS—Patch cords—Red fabric covered cable contains 2 rubber covered tinsel conductors. Complete with 2-PL-47 plugs on ends. 21" L. and 34" L. Shipping weight approximately—2 Lbs. Either type, new—3 for \$1.00; Extension for HS-30—CD-605. 6 1/2" long with transformer and PL-55 plug. New—45c; SCR-522 "Power Plug and Cable"—Housed in Aluminum Box. 3 1/2" long 12 conductors. Shipping weight approximately—2 Lbs. New—\$1.00.
- VOLUME CONTROLS AND POTENTIOMETERS—Volume Control Assembly—500,000 Ohms. S.P.N.T. UL switch. 1 1/2" Dia. Brass shaft. 2 1/4" Irg. slotted and knurled end. 2 leads. one .1 Mi. at 400 V. and one .005 Mi. 400 V. condensers attached. Shipping weight approximately—6 Oz. New—50c; Rheostats—Ohmite baked enamel wirewound. Air-cooled and shielded. Aircraft type. 90 Ohms at 1.35 Amps. Shipping weight approximately—2 Lbs. New—49c; Toroidal Potentiometers—Precision unit completely enclosed in heavy aluminum casing. 300 Ohms wirewound. W. E. G. Now—\$1.15; Potentiometers—5000 Ohm—I.R.C. type D11-114 Silent Stripl. In original cartons, with hardware and universal shaft. Shipping weight approximately—6 Oz. Only—45c; 1 Megohm—Midget C.T.S. Short slotted shaft. Shielded. Shipping weight approximately—6 Oz.—25c; 10,900 Ohm—Midget C.T.S. 5/16" shaft. Shielded. Shipping weight approximately—6 Oz.—25c; Dual Wirewound—10,000 Ohms each section. Separate screwdriver adjustments. 2 Watt. Shipping weight—6 Oz. New—65c; Dual H.D. Ohmite—1200 Ohms at .35 Amps. and 3 Ohms at 4.7 Amps. Baked enamel elements. Complete with knob and panel plate. Shipping weight approximately—2 Lbs. New—85c; Dual Wirewound—100,000 or 70,000 Ohms 2 Watt. Bakelite case. 1 1/2" Dia. 7/8" Deep. Long shaft. Shipping weight approximately—3 Oz. New—65c; 4 Gang Wire-wound—(Claroostat) Heavy duty bakelite construction with metal supports. 6000, 2500, 3000 and 30,000 Ohms. Size: 1 1/2" x 2 1/2" x 1 1/2". Shaft. In original cartons. Shipping weight—1 Lb. 75c.
- FILTER CONDENSERS—W.E. 25 + 25 Mf. at 400 V.D.C. Octal socket mounting. Hermetically sealed. New—65c; Mallory FJ. 50 Mf. at 150 V.D.C. New. 3 for \$1.00; Mallory FJ. 40 + 15 Mf. at 300 V.D.C. and 20 Mf. at 25 V.D.C. New—55c; Filter Strip Assembly—Bakelite strip contains 2-8 Mf. 450 V. PRS. type condensers. 1-6000 Ohm. 4 Watt resistor and few ceramic. New units. 3 for \$1.00.
- JOHNSON UX SOCKET—Heavy duty. Ceramic base. Ideal for type 866 tubes. Shipping weight approximately—1 Lb. New—37c; 5 Prong Isolaunit Sockets—National XC-5. Shipping weight—6 Oz. New. 2 for 25c; Telephone Jacks—To fit PL-68 plug. Panel mounting type. 10 for 95c.
- ALUMINUM BX—Covered with fine woven aluminum braid. 3/4" at 6c per Ft.; 1/2" at 8c per Ft.; 1" at 10c per Ft.; 1 1/2" at 12c per Ft. (I.D.) Minimum Order—10 Ft.
- "ELK'S ANTLERS" AS-27/ARN-5 ANTENNA—Now being used on commercial aircraft. Carefully packed. Shipping weight approximately—10 Lbs. New—\$2.75.
- NEON BULBS—G.E. Type NE-48 3/4 W. Auto hayonet base. 10 for \$1.75.
- PL-68 PLUGS—3 contact microphone type. 10 for 95c.
- PLAN-D-VERNIER DIAL—(Cross). Instrument type. Dia. 5 to 1 ratio. Calibration 0-200 in 360 degrees. Smooth planetary. Shipping weight approximately—3 Lbs. New—\$1.85.
- THROAT MIKES—T-30 (Shure). New in cartons—50c.
- CIRCUIT BREAKERS—G.E. Type AF-1 230 V.A.C. 35 Amps. Single circuit. Overall size: 3" x 4 1/4" x 6". Shipping weight—4 1/2 Lbs. New—\$1.85; Square D Type M. 120-240 V.A.C. 20 Amps. 2 poles. Overall size: 2" x 3" x 4 1/4". Shipping weight—2 Lbs.—New—\$1.75.
- FABRIC LOOM—Weather-proof. Ideal for sleeving on T.V. and FM Antennas. Lead-ins thru skylights and around. I.D. 3/4", 1/2" and 5/8". (Specify size) 50 feet, any size—\$1.45.
- SPECIALS—ELECTRONICS PARTS PACKAGE. An assortment of parts and assemblies which are always useful to any electronics man. The items may be new or removed from new equipment. A REAL PARTS BUY!!! Shipping weight approximately—10 Lb. \$1.29; MAGNIFIER REFLECTOR—8" Dia. Parabolic. (Lancaster Lens) Metallic coated silver surface. Useful in photographic work. (Glass) Shipping weight approximately 1 1/2 Lbs. New—\$1.95; PG-117 C. VIBROPACKS—6-12-14 V.D.C. Good weight condition. Less tubes and vibrators. Shipping weight approximately 20 Lbs.—\$1.95; 6 1/2" CORDS—2 conductor coded leads with lugs on both ends. Enclosed in flexible rubber jacket. New. 3 for 25c; 15 for \$1.00; REMOTE CONTROL CABLES—For MN-29, 433. ARR, etc. 20' long. New—\$2.39; HEARING AID SUBMINIATURES—Fridoles. 1.2V. Filament. 67 V. plate. New—39c; TOGGLE SWITCHES—Assortment of five different types. New—\$1.00.

★ SAVE MONEY!!! A penny post-card brings you United's new catalog of money-saving values. Write today!

UNITED SURPLUS MATERIALS

314 S. HALSTED ST.

CHICAGO 6, ILL.

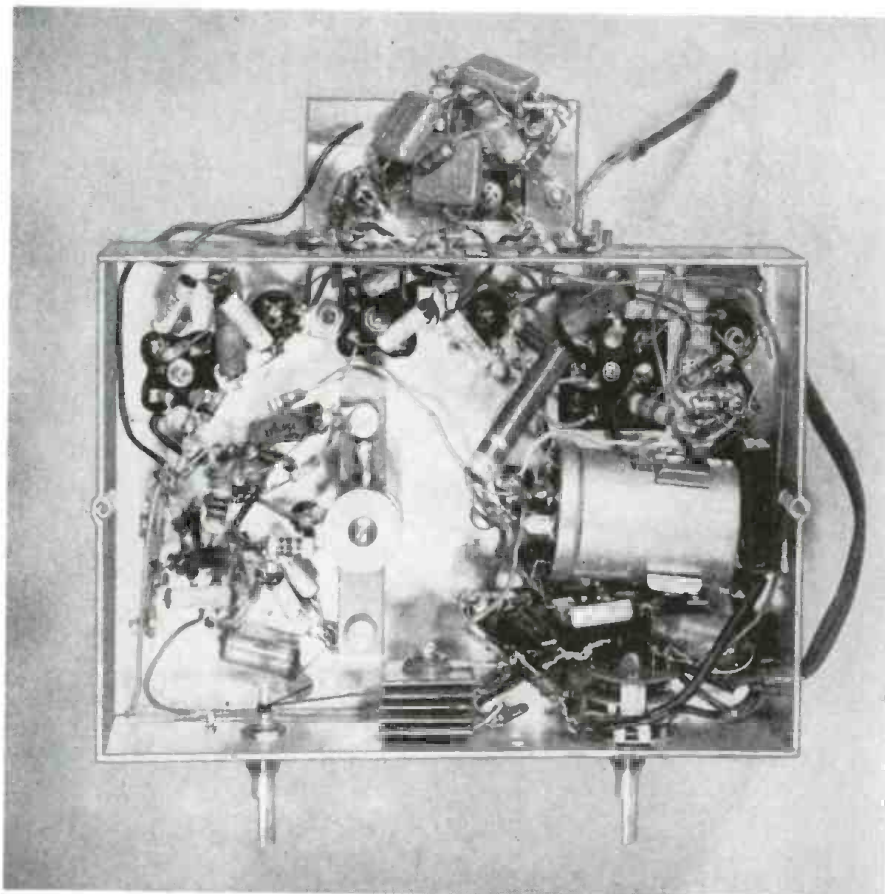

Fig. 5—Underchassis view shows where the connecting wires are led through main chassis.

connected. These leads should be made as short as possible and kept close to the chassis.

Alignment

Since a new stage has been added to the i.f. system of the tuner, it as well as the others needs realignment. Two methods are given because not everyone has all the equipment necessary for the usual alignment procedure. An ordinary AM signal generator can be used provided it has a fair amount of output on 10.7 mc. It would be a good idea to calibrate or note the error of the generator at 10 mc by tuning in WWV and zero-beating the generator with the station. Then the generator will probably be accurate enough for alignment at 10.7. mc.

Connect the signal generator through a .05- μ f capacitor to the signal grid (pin 7) of the 6BE6 and ground. If a v.t.v.m. or 20,000-ohms-per-volt d.c. meter is available connect it between pin 1 of the 6AL5 and ground. If no meter is available, connect the output of the tuner to an audio amplifier. Set the dial of the tuner to 88 mc and allow at least a 30-minute warm-up period.

Begin alignment by tuning the primary (the upper adjustment) of the ratio-detector transformer for maximum reading on the meter or for maximum audio volume. Amplitude modulation must be used in the signal generator for this latter method, but need

FREE

**IF YOU WANT TO LEARN TO
FIX ANY RADIO THIS NEW
SIMPLIFIED WAY**

**HOW TO
GET THE MOST FROM
YOUR RADIO "KNOW-HOW"**

Here is your opportunity to learn all about an amazing new simplified way of fixing any radio. There's nothing complex to learn, no calculating is required. Can be used by beginners or experts. It's as simple as ABC—and quick, too. You can use it on easy or "tough" jobs.

In simple, direct language, this informative 28-page illustrated manual, "The Inside Story" explains why old-fashioned methods actually hamper your servicing ability. It explains why experts have agreed that you can't blame yourself when you're stumped on those extra-tough jobs . . . obsolete servicing methods are preventing you from using your real ability.

So why not find out for yourself how you, too, can take advantage of the remarkable new STETHOSCOPE SERVICING METHOD. You owe it to yourself to get this FREE manual at once. It's chock-full of useful and helpful information, too. Page after page of valuable hints and kinks from the experience of top radio engineers.

**MAIL COUPON OR
PENNY POST CARD
FOR YOUR FREE COPY TODAY**

FEILER ENGINEERING CO., Dept. 4RC9
945 George St., Chicago 14, Illinois

Please RUSH my FREE copy of
"The Inside Story."

Name.....
Address.....
City.....Zone.....State.....

NOW

ESTIMATE REPAIRS ON THE SPOT!

- accurate
(Same as large generators)
- pocket size
- economical

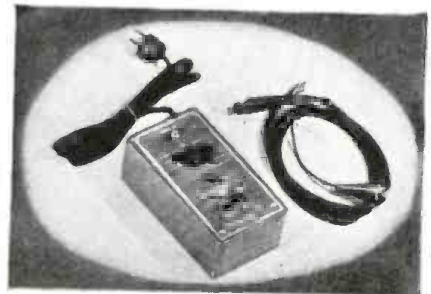

A.M. Signal
Generator Model #710
F.M. Signal
Generator Model #720A

Here are TWO great units that will pay for themselves in 30 days. Helps locate faults quickly and accurately—estimate a repair job or do a complete alignment right on the spot.

Safe for A.C. or D.C. operation. Instrument cases and chassis are completely isolated from power supply. No chance of shock, short circuit, or burnout. Both units complete with individual trimmers for recalibration. Size: 3"x6"x2 $\frac{3}{4}$ ". Weight: 1 $\frac{1}{2}$ lbs.

<p>MODEL #710 Fixed frequencies of 1500-550-456-465 K.C. Complete with tubes, etc.</p> <p style="text-align: center;">\$17.95</p>	<p>MODEL #720 Calibration accurate within 1% for fixed frequencies of 9.1, 10.7, 88 & 108 mc. Complete with tubes, etc.</p> <p style="text-align: center;">\$19.95</p>
---	--

WRITE FOR CATALOGUE R O

RADIO CITY PRODUCTS CO., INC.

152 WEST 25th ST NEW YORK 1, N. Y.

not be used with the meter method. Proceed toward the front, tuning each stage in the same manner.

To complete the i.f. alignment, connect (temporarily) two 100,000-ohm resistors between pin 1 of the 6AL5 and ground. Connect the meter from the junction of the two resistors to the detector side of the audio-output coupling capacitor. Adjust the secondary of the ratio detector transformer (the lower adjustment) for zero meter reading. The meter should register reversed polarity when the slug is rotated through zero output. If not using a meter, adjust the slug for *minimum* sound output. This completes the i.f. alignment.

To touch up the r.f. portion of the tuner, the most practical method is to use FM broadcast stations as signal sources. Tune in on the lowest-frequency FM station that can be received and whose frequency (preferably about 90 mc) is known. If it is not received at the proper dial setting, set the dial to the frequency at which it should appear and adjust the low-frequency oscillator padder (P8 underneath) until the station is received. Then adjust the low-frequency mixer padder (P8 on rear gang) for maximum audio volume or greatest d.c. reference voltage (pin 1 of 6AL5 to ground).

Now tune in the highest-frequency station heard on the band, preferably about 108 mc. If it is not received at the proper dial setting, set the dial to the frequency at which the station should appear and adjust the high-frequency oscillator trimmer (center gang) to bring in the station. Then finish by adjusting the antenna trimmer.

MATERIALS FOR I.F. AMPLIFIER

Resistors: 1—470, 1—1,000, 1—100,000 ohms, 1/2 watt.
Capacitors: 3—.0015, 1—.01- μ f, 400 volts, paper.
Miscellaneous: 1—6BA6; 1—10.7-mc i.f. transformer; 1—octal tube socket; 1—piece of aluminum for chassis (see text); necessary hardware.

CANADIAN GROUP MEETS

The Associated Radio Technicians of British Columbia met in convention last October 5th at Stanley Park. Garth Pither of RCA Victor explained the Magic Monitor, a device used in phonographs to reduce record surface noise. Jack Gray of Canadian General Electric described the 30-station, 250-mobile-unit FM system used by the Ontario Provincial Police. Service and operation of motion-picture projectors was discussed by Wilfred Wheatcroft.

Nick Foster, Superintendent of Technical Schools in Seattle, Wash., talked about the servicing of television receivers. When, some time after the convention, Seattle's KRSC went on the air, Ed Mullins, a member of the ARTBC, was the first person in Vancouver to receive the broadcasts. He had built a receiver many months before. Reception reports were fair, but Mullins predicted that Vancouver residents would not have acceptable television until a station was erected in the Vancouver area. The CBC is presently considering plans to introduce TV to Canada (RADIO-ELECTRONICS, February 1949, page 13).

Announcing



The Cathode-Ray Oscilloscope
BY GEORGE ZWICK

Gernsback Library
No. 40

VITAL FOR TV SERVICING

A new and highly important book! Gives a complete understanding of working principles behind oscilloscope operation, and how to use the instrument effectively. Clearly written with a single purpose—to help you use and understand the oscilloscope. No man servicing television receivers can afford to be without this knowledge. Invaluable for anyone who uses the oscilloscope.

ALL ANGLES COVERED

Chapter 1—Direct Current and Alternating Current. Visual observation and measurement of varying voltages and currents on the cathode-ray tube. Chapter 2—How beam from electron "gun" projects image of current and voltage variations onto fluorescent screen, and how beam is deflected by electrostatic and electromagnetic means. Chapter 3—How signal deflects electron beam vertically in c-r tube and sweep voltage deflects beam horizontally. Role of the saw-tooth oscillator—the gas discharge tube—the multivibrator—synchronization—locking. Chapter 4—The cathode-ray tube—accelerating and focusing power supplies—the sweep generator—the horizontal and vertical amplifiers—controls on oscilloscope—how to operate a "scope. Chapter 5—Aligning TV i.f. channels—TV front-end alignment—Alignment of i.f. amplifiers in AM and FM sets. Use of signal generators—i.f. alignment of a.c.-d.c. receivers—bandpass alignment—aligning the discriminator—the ratio detector—r.f. alignment of AM and FM receivers. Chapter 6—Audio output measurement—voltage gain—power output—audio response curve plotting—peak a.c. measurements. Checking saw-tooth amplifiers—magnetic deflection circuits—synchronizing pulses. Ham transmitter measurements—over and under-modulation. Locating hum—incorrect adjustment of vibrator power supplies. Phase shift in audio amplifiers.

112 PAGES 103 ILLUSTRATIONS

Only 75c

See your jobber today or send for **THE CATHODE-RAY OSCILLOSCOPE** along with other titles in the **GERNSBACK LIBRARY**.



MAIL THIS COUPON NOW

RADCRAFT PUBLICATIONS, Dept. 49
25 West Broadway, New York 7, N. Y.

Send me the books checked, postpaid.

NO. 40 CATHODE-RAY OSCILLOSCOPE 75c

I enclose \$.....

Your Name (Print clearly)

Address

Jobber's Name

Address

- 10 OTHER BOOKS**
- No. 29—Handy Kinks and Short Cuts. 50c
 - No. 30—Unusual patented Circuits. 50c
 - No. 31—Radio Questions and Answers. 50c
 - No. 32—Advanced Service Technicians. 50c
 - No. 33—A Amplifier Builder's Guide. 50c
 - No. 34—Radio-Electronic Circuits. 50c
 - No. 35—Amateur Radio Builder's Guide. 50c
 - No. 36—Radio Test Instruments. 50c
 - No. 37—Elementary Radio Servicing. 50c
 - No. 38—How to Build Radio Receivers. 50c

Regulate Your Line Voltage to fit Your Needs

- On 117 V. line, variable from 95 to 145 Volts. If line drops to 90, variable from 75 to 115 Volts.
- Output adjustable in 1½ volt steps.
- Metered out-put Voltage.
- 140 Watts, max., 50-60 cycle.

Here is a Voltage regulating *isolation transformer* that will make your bench test voltage exactly what you want... Only \$15.00... Capacity 140 Watts max. Every service engineer needs it for more accurate work and time saving short cuts.



Vari-volt Junior...\$15.00 DEALER NET

PARTIAL LIST OF USES

- Radio and Television receiver testing at under or over voltage.
- Speed up or retard heating of light soldering irons.
- Excellent control for primary of high voltage breakdown transformers.

- Controlled voltage for meter calibration.
- To isolate "hass" and live ground from AC-DC Equipment.
- For Schools and educational laboratories.
- Adjusting line voltage to photo lamps for uniform exposure, and many other uses.

OTHER NEW HALLDORSON TRANSFORMERS

- P-2067—Power—117 volts to 240-0-240 @ 60 M.A.—6.3 @ 2.75A.
- P1596B—Isolation—115V. to 115V.—150 Watts.
- P-2040—Stepdown—230V. to 115V.—1000 Watts.

- T-4303—Step up—117V. to 140V.—12 Watts (plate voltage booster for AC-DC sets)
- N-91—Vibrator—6V. to 250V. @ 50 M. A. (CAN-3.04" x 2.4" x 2.2")
- S-210—Plate Trans.—1150-500-0-500-1150 @ 150 M. A.

TELEVISION UNITS

- L-211—Power—365-0-365 @ 250 M. A. D.C.—5V. @ 3A.—5V. @ 2A.—6.3V. @ 6A.—6.3V. @ .8A.
- D4-611—Horizontal Blocking Oscillator (Replacement for RCA type No. 208T1).

- D4-612—Vertical Blocking Oscillator (Replacement for RCA type No. 208T2).
- J-96—Vertical Output Trans. (Replacement for RCA type No. 204T2).
- C4-216—Choke—2 hy @ 200 M.A.—D.C. Resistance Approx. 60 Ohms.

For more information see your Radio Parts Distributor or write **THE HALLDORSON CO., 4500 Ravenswood Avenue, Chicago 40, Ill.**

FM STATION LIST

STATION	LOCATION	FREQUENCY
KAGH-FM	Pasadena, Calif.	98.3
KAKC-FM	Tulsa, Okla.	95.5
KALB-FM	Alexandria, La.	96.9
KALW	San Francisco, Calif.	91.7
KARM-FM	Fresno, Calif.	101.9
KBEE	Madesto, Calif.	103.3
KBIX-FM	Muskogee, Okla.	98.5
KBMT	San Bernardino, Calif.	99.9
KBOA	Kennett, Mo.	98.9
KBON-FM	Omaha, Nebr.	98.7
KBTM-FM	Jonesboro, Ark.	101.9
KBTR	Minneapolis, Minn.	98.5
KBUR-FM	Burlington, Iowa	92.9
KCBC-FM	Des Moines, Iowa	94.1
KCFM	Kansas City, Mo.	94.9
KCKN-FM	Kansas City, Kans.	106.7
KCLI	Los Angeles, Calif.	105.1
KCMC-FM	Texarkana, Tex.	98.1
KCRA-FM	Sacramento, Calif.	96.1
KCRC-FM	Enid, Okla.	102.7
KCRK	Cedar Rapids, Iowa	96.9
KCRW	Santa Monica, Calif.	89.9
KCVN	Stockton, Calif.	91.3
KDFC	San Francisco, Calif.	102.1
KDKA-FM	Pittsburgh, Pa.	92.9
KDNT-FM	Denton, Tex.	106.1
KDON-FM	Monterey, Calif.	94.5
KDTH-FM	Dubuque, Iowa	100.5
KDYL-FM	Salt Lake City, Utah	98.7
KECA-FM	Los Angeles, Calif.	95.5
KENO-FM	Las Vegas, Nev.	103.9
KERN-FM	Bakersfield, Calif.	94.1
KEX-FM	Portland, Ore.	92.3
KFAB-FM	Lincoln, Nebr.	97.9
KFAC-FM	Los Angeles, Calif.	104.3
KFAM-FM	St. Cloud, Minn.	104.7
KFBK-FM	Sacramento, Calif.	96.9
KFDA-FM	Amarillo, Tex.	100.3
KFEL-FM	Denver, Colo.	97.3
KFEQ-FM	St. Joseph, Mo.	92.3
KFH-FM	Wichita, Kans.	100.3
KFI-FM	Los Angeles, Calif.	105.9
KFMB-FM	San Diego, Calif.	101.5
KFMV	Los Angeles, Calif.	94.7
KFMX	Council Bluffs, Iowa	96.1
KFMY	Fort Dodge, Iowa	102.7
KFOR-FM	Lincoln, Nebr.	102.9
KFPW-FM	Fort Smith, Ark.	94.9
KFSA-FM	Fort Smith, Ark.	107.7
KFSD-FM	San Diego, Calif.	94.1
KFUO-FM	Cloyton, Mo.	104.1
KFVS-FM	Cape Girardeau, Mo.	95.7
KFXD-FM	Nampa, Idaho	101.9
KFXM-FM	San Bernardino, Calif.	95.1
KFYO-FM	Lubbock, Tex.	99.5
KGAR-FM	Garden City, Kans.	99.3
KGBS-FM	Harlingen, Tex.	94.7
KGDM-FM	Stockton, Calif.	92.9
KGKB-FM	Tyler, Tex.	101.5
KGLO-FM	Mason City, Iowa	101.1
KGNC-FM	Amarillo, Tex.	104.3
KGOFM	San Francisco, Calif.	106.1
KGPO	Grants Pass, Ore.	96.9
KGW-FM	Portland, Ore.	100.3
KHJ-FM	Los Angeles, Calif.	101.1
KIDO-FM	Boise, Idaho	106.1
KIMV	Hutchinson, Kans.	105.7
KING-FM	Seattle, Wash.	94.9
KIRO-FM	Seattle, Wash.	100.7
KISS	San Antonio, Tex.	99.5
KIXL-FM	Dallas, Tex.	104.5
KJBS-FM	San Francisco, Calif.	98.9
KKLA	Los Angeles, Calif.	97.1
KLCN-FM	Blytheville, Ark.	96.1
KLTI	Longview, Tex.	105.9
KLX-FM	Oakland, Calif.	101.3
KLZ-FM	Denver, Colo.	94.1
KMAR	Bakersfield, Calif.	92.5
KMBC-FM	Kansas City, Mo.	100.5
KMFM	Manroe, La.	104.1
KMGFM	Los Angeles, Calif.	98.7
KMH8	Belton, Tex.	97.1
KMPC-FM	Los Angeles, Calif.	100.3
KMUS-FM	Muskogee, Okla.	101.5
KMYC-FM	Marysville, Calif.	99.9
KNBC-FM	San Francisco, Calif.	99.7
KNEX-FM	McPherson, Kans.	103.3
KNX-FM	Hollywood, Calif.	93.1
KOA-FM	Denver, Colo.	95.7
KOAD	Omaha, Nebr.	92.9
KOCS-FM	Ontario, Calif.	93.5
KOCY-FM	Oklahoma City, Okla.	94.7
KOIN-FM	Portland, Ore.	101.1
KOKX-FM	Keokuk, Iowa	102.7
KOMA-FM	Oklahoma City, Okla.	105.9
KOMO-FM	Seattle, Wash.	98.9
KONO-FM	San Antonio, Tex.	92.9
KOPP-FM	Ogden, Utah	103.9
KOPY	Houston, Tex.	97.9
KOWN	Conway, Ark.	97.7
KOZY	Kansas City, Mo.	98.1
KPFM	Portland, Ore.	97.1
KPOJ-FM	Portland, Ore.	98.7
KPOR	Riverside, Calif.	97.5
KPRA	Portland, Ore.	95.5
KPRC-FM	Houston, Tex.	102.9
KQV-FM	Pittsburgh, Pa.	98.1
KQW-FM	San Francisco, Calif.	103.7
KRBA-FM	Lufkin, Tex.	95.5
KRBC-FM	Abilene, Tex.	96.9
KRCC	Richmond, Calif.	104.5

Halldorson Vacuum Sealed Transformers

HOW TO GET THE MOST
from only
BASIC TEST EQUIPMENT

Service by **Signal Substitution**

The Simple, Modern, Dynamic Speed approach to receiver alignment and adjustment problems, FM-AM-TV.

- Nothing complex to learn
- No extra equipment to purchase
- Universal — non-obsolete
- Employs only Basic Test Equipment



S-S-S tells HOW — in simple, direct language.
New 9th edition now off the press.
100 pages of valuable information.

Available from all leading radio parts and equipment distributors or directly from factory at only 40c per copy.

PRECISION APPARATUS COMPANY, Inc. • 92-27 Horace Harding Blvd., Elmhurst 4, N. Y.

STATION	LOCATION	FREQUENCY
KRE-FM	Berkeley, Calif.	102.9
KRED	Eureka, Calif.	96.3
KRFM	Fresno, Calif.	93.7
KRIC-FM	Beaumont, Tex.	99.5
KRJM	Santa Maria, Calif.	103.1
KRKD-FM	Los Angeles, Calif.	96.3
KRLD-FM	Dallas, Tex.	92.5
KRNT-FM	Des Moines, Iowa	104.5
KROC-FM	Rochester, Minn.	94.7
KRON-FM	San Francisco, Calif.	96.5
KROS-FM	Clinton, Iowa	96.1
KRPO	San Jose, Calif.	92.3
KRSC-FM	Seattle, Wash.	98.1
KRYM	Eugene, Ore.	90.1
KSBR	San Bruno, Calif.	100.5
KSBS	Kansas City, Kans.	105.9
KSCJ-FM	Sioux City, Iowa	94.9
KSD-FM	St. Louis, Mo.	96.1
KSDO	San Diego, Calif.	96.5
KSEI-FM	Pocatello, Idaho	96.5
KSEO-FM	Durant, Okla.	107.3
KSFH	San Francisco, Calif.	94.9
KSJO-FM	San Jose, Calif.	95.3
KSL-FM	Salt Lake City, Utah	100.3
KSO-FM	Des Moines, Iowa	97.3
KSPI-FM	Stillwater, Okla.	93.9
KSTP-FM	St. Paul, Minn.	102.1
KSUI	Iowa City, Iowa	91.7
KTEM-FM	Temple, Tex.	107.5
KTFI-FM	Twin Falls, Idaho	99.7
KTNT	Tacoma, Wash.	97.3
KTOK-FM	Oklahoma City, Okla.	104.3
KTRB-FM	Madesto, Calif.	104.1
KTRH-FM	Houston, Tex.	101.1
KTRN-FM	Wichita Falls, Tex.	97.3
KTTS-FM	Springfield, Mo.	94.7
KTUL-FM	Tulsa, Okla.	97.1
KUGN-FM	Eugene, Ore.	99.1
KUOA-FM	Siloam Springs, Ark.	105.7
KURV-FM	Edinburg, Tex.	104.9
KUSC	Los Angeles, Calif.	91.5
KVCI	Chico, Calif.	101.1
KVEC-FM	San Luis Obispo, Calif.	99.9
KVME	Merced, Calif.	97.5
KVNI-FM	Fargo, N. D.	92.3
KVOB-FM	Alexandria, La.	99.7
KVOE-FM	Santa Ana, Calif.	96.7
KVRE	Redding, Calif.	103.9
KVSO-FM	Ardmore, Okla.	93.7
KVWC-FM	Vernon, Tex.	98.7
KWBR-FM	San Francisco, Calif.	97.3
KWBW-FM	Hutchinson, Kans.	93.1
KWFM	San Diego, Calif.	104.7
KWGD	St. Louis, Mo.	90.5
KWGS	Tulsa, Okla.	101.7
KWLF-FM	Albany, Ore.	99.9
KWFT-FM	Wichita Falls, Tex.	99.1
KWK-FM	St. Louis, Mo.	94.5
KWKH-FM	Shreveport, La.	103.9
KWLK-FM	Langview, Wash.	97.5
KWNO-FM	Winona, Minn.	94.5
KWOC-FM	Poplar Bluff, Mo.	98.5
KWOS-FM	Jefferson City, Mo.	99.7
KWPC-FM	Muscatine, Iowa	95.5
KWRN	Reno, Nev.	105.7
KXEL-FM	Waterloo, Iowa	101.1
KXLW-FM	Clayton, Mo.	107.9
KXOA-FM	Sacramento, Calif.	93.7
KXOK-FM	St. Louis, Mo.	101.5
KYFM	San Antonio, Tex.	96.5
KXYZ-FM	Houston, Tex.	103.5
KYSM-FM	Mankato, Minn.	92.5
KYW-FM	Philadelphia, Pa.	94.7
WAAT-FM	Newark, N. J.	102.1
WABB	Mobile, Ala.	90.1
WABE	Atlanta, Ga.	99.5
WABF	New York, N. Y.	100.9
WABX	Harrisburg, Pa.	88.1
WACE-FM	Chicopee, Mass.	104.3
WAER	Syracuse, N. Y.	99.5
WAFB-FM	Baton Rouge, La.	103.3
WAFM	Birmingham, Ala.	98.5
WAGA-FM	Atlanta, Ga.	93.1
WAGE-FM	Syracuse, N. Y.	107.1
WAIR-FM	Winston-Salem, N. C.	99.3
WAJL	Flint, Mich.	97.3
WAJR-FM	Margantown, W. Va.	96.1
WAKR-FM	Akron, Ohio	97.5
WAMS-FM	Wilmington, Del.	92.5
WAND-FM	Canton, Ohio	94.7
WAPO-FM	Chattanooga, Tenn.	105.3
WARD-FM	Johnstown, Pa.	105.5
WARL-FM	Arlington, Va.	105.7
WARM-FM	Scranton, Pa.	97.1
WASH	Washington, D. C.	101.3
WATG	Ashland, Ohio	97.5
WATL-FM	Atlanta, Ga.	95.3
WAUX-FM	Waukesha, Wis.	95.1
WAYZ-FM	New Haven, Conn.	107.7
WAYS-FM	Charlotte, N. C.	100.7
WBAB-FM	Atlantic City, N. J.	101.1
WBBB-FM	Burlington, N. C.	97.3
WBBM-FM	Chicago, Ill.	97.1
WBBO-FM	Forest City, N. C.	101.1
WBCA	Schenectady, N. Y.	96.1
WBCM-FM	Bay City, Mich.	107.7
WBGN	Highmarket, N. Y.	94.3
WBEC-FM	Pittsfield, Mass.	104.5
WBEN-FM	Buffalo, N. Y.	97.7
WBET-FM	Brackton, Mass.	91.5
WBEZ	Chicago, Ill.	95.5
WBGE-FM	Atlanta, Ga.	91.1
WBGO	Newark, N. J.	100.7
WBIB	New Haven, Conn.	96.3
WBK	Chicago, Ill.	107.1
WBKA-FM	Brackton, Mass.	107.1

IT'S NOT HARD TO FIGURE...



Why so many servicemen are using Quam Adjust-A-Cone Speakers for all their replacement needs!

Here are a couple of good reasons.

Only Quam Adjust-A-Cone Speakers have the adjustable voice coil that permits accurate centering after assembly and before it leaves the factory. This means that rubbing voice coils, a common complaint when permanently glued in position before assembly, are virtually un-

heard of in a Quam Adjust-A-Cone.

The U-Shaped Coil Pot, exclusive with Quam, offers a continuous path for the magnetic lines of force, and results in a stronger magnetic field. This means higher efficiency and better performance.



Take a tip from successful servicemen—replace with Quam.

MAIL COUPON FOR FREE CATALOG

QUAM-NICHOLS CO.
521 E. 33rd Place
Chicago 16, Illinois
Please send QUAM Catalog

Name

Address

City..... State.....

OPPORTUNITY AD-LETS

Advertisements in this section cost 25c a word for each insertion. Name, address and initials must be included at the above rate. Cash should accompany all classified advertisements unless placed by an accredited advertising agency. No advertisement for less than ten words accepted. Ten percent discount on six issues, twenty percent for twelve issues. Objectionable or misleading advertisements not accepted. Advertisements for May, 1949, issue, must reach us not later than March 24, 1949. Radio-Electronics, 25 W. Broadway, New York 7, N. Y.

12B8 & 25B8 TUBES, ADAPTER UNIT USING 2 miniature tubes (6AT6 & 6BA6 for 12B8, and 12AT6 & 12BA6 for 25B8). Takes less space than original tube—nothing else to buy—just plug in & it works. Money-back guarantee. 12B8 or 25B8 unit complete: \$2.49 each, 10 units for \$22.50. Send 25% deposit, balance C.O.D. Write for free parts catalog. COMMERCIAL RADIO, 36 Brattle St., Boston, Mass.

LANCASTER, ALLWINE & ROMMEL, 436 BOWEN Building, Washington 5, D.C. Registered Patent Attorneys. Practices before United States Patent Office. Validity and infringement investigations and Opinions. Booklets and form "Evidence of Conception" forwarded upon request.

TELEVISION, RADIO, TUBES, PARTS. SEND FOR free bargain list. Hailmark, 392A Communipaw Ave., Jersey City, New Jersey.

SELECTED GROUP OF MEN, GRADUATES OF WELL-known trade school, desire employment in Radio Field. Will travel anywhere. Qualified in radio servicing, installation, test instruments, circuit operation, etc. Contact Placement Dept., Eastern Technical School, 388 Purchase Street, New Bedford, Mass.

WE REPAIR ALL TYPES OF ELECTRICAL INSTRUMENTS, tube checkers and analyzers. Hazleton Instrument Co. (Electric Meter Laboratory), 140 Liberty Street, New York N. Y. Telephone—BARELAY 7-4239.

BARGAINS: NEW AND RECONDITIONED HALLICRAFTERS, National, Collins, Hammarlund, Melsner, RME, other receivers, tuners, television receivers, transmitters, etc. Wholesale prices. Terms. Shipped on trial. Liberal trade-in allowance. Write: Henry Radio, Butler, Missouri and 11240 West Olympic, Los Angeles, California.

AMATEUR RADIO LICENSES. COMPLETE THEORY preparation for passing amateur radio examinations. Home study and resident courses. American Radio Institute, 101 West 63rd St., New York City. See our ad on Page 94.

MAGAZINES (BACK DATES)—FOREIGN, DOMESTIC. arts, books, booklets, subscriptions, pin-ups, etc. Catalog, 10c (refunded). Clicerone's, 863 First Ave., New York 17, N. Y.

BARGAIN HUNTING? RADIO SERVICEMEN WRITE. Sensational catalog. Henshaw Radio Supply, 3819 Troost, Kansas City 3, Missouri.

MAKE RADIO PARTS AT HOME. BLUEPRINTS \$1.00. Tell you where to sell. Clifford Orr, 711 Washington, Ludington, Mich.

20-TUBE HI-FI FM-AM SW-PHONO COMBINATION cheap. Forcier, 293 Jefferson, Salem, Mass.

CRYSTAL SET—TELEPHONE COMBINATION DIAGRAM and instructions 25c. Includes attractive offer, literature, year's membership in "XTAL-X CRYSTAL SET CLUB." Box 608, Torrance, Calif.

Sell, or trade for Television Kit, recorder or what-have-you—#78A A.B. Dick mimeo and postal card mimeo machines and colored inks. Herbert Hash, 418 E. 53 St., Brooklyn 3, N. Y.

"ALL ABOUT HEADPHONES." ONLY 24 PAGE COMPLETE repair, operation Handbook. All types. Experts praise it. Including 10c Experimenter's "Radiobuilder." unusual Catalog—total 25c. Laboratories, 578-B, San Carlos, California.

TELEPHONE DIALS. USED. NATIONALLY KNOWN make. Standard speed, 10 pulses per second. Re-built \$2.25. Re-adjusted \$1.25, postpaid. Kissel Electric Products, 431-C, Sherman, Gallon, Ohio.

ENTHUSIASTS! BRITAIN'S FOREMOST RADIO monthly—PRACTICAL WIRELESS—keeps you up-to-date with latest radio news and events. Covers entire British and European radio-television developments. Authoritative constructional data; television and electronic features, discussion columns, etc. Leading experts contribute regularly. For annual subscription mailed direct to your address from London send only \$2.00 to George Newnes, Ltd., (PW.36) 342 Madison Avenue, New York 17.

WANTED: Salesmen to sell Nationally Advertised Brand Radio Tubes to Dealers and Servicemen at liberal discounts. Good Commissions Paid. c/o Radio-Electronics, P. O. Box RE-32, 25 W. Broadway, New York 7, N. Y.

RECORD CHANGER PARTS for leading makes of changers. We ship everywhere. Mail orders invited! FRIEND'S Wholesale Distributors, 106 North Sixth Street, Philadelphia 6, Pa.

TELEVISION—BRIGHT AND CLEAR. ADJUST PRESENT aerial. Build low-cost Precision Antennae. Instructions, charts, diagrams, dimensions, plans. FREE—Television Stations, kilowatts, tower heights. C. F. Proppson Co., Lumberton, N. J.

PHONOGRAPH RECORDS CHEAP. CATALOGUE. Paramount, HJ-313 East Market, Wilkes-Barre, Penna.

"Schematic Diagrams Necessary for Radiotelephone License." Helpful in studying for commercial or amateur license. Send \$1.00. Pramgrim, P.O. Box 1094, Akron 9, Ohio.

FOR SALE—Signal Tracer with Probe, Battery operated. Guaranteed like new condition. Cost \$29.95. Yours for \$18.50. Also several EDWARDS FM Tuners list \$48.50. Yours for \$22.50 each. George Terpay, 7005 Wells Parkway, College Heights Estates, Maryland.

WANTED—Modern Electrics and Popular Electricity 1909. J. Landa, 157 Leverett, Boston 14, Mass.

27 YEARS EXPERIENCE RADIO REPAIRING. SIMPLIFIED system. No calculations. No formulas. Total \$2.00 postpaid or COD. Ross Radio, 14615 Grandriver, Detroit 27, Michigan.

LARGEST SURPLUS STOCK in the COUNTRY at the LOWEST PRICES!

DYNAMOTORS & INVERTERS

- BD-77 —Dynamotor Unit 14v in. 100v. 350 ma out with relay fuse box and filters. FOB Chicago only..... \$5.75
- PE-101-C—Dynamotor unit: 12 or 24v in. outputs 800v. 20ma. 400v. 135ma. 8v. 1.1A 2.75
- PE-55 —Dynamotor unit: 12v in. 16 amp. 500v out. 200 ma. FOB Chicago only 3.75
- PE-206 —Inverter unit, rotary converted. 28v in. 80v at 500VA. 800 cy out. FOB Chicago only 3.95
- DM-32A —Each 95¢. Three for 2.00
- DM-53 —Dynamotor, used with the BC-733. 24v in. 240v. 60ma out. New..... 2.95

SURPRISE PACKAGE

20 pounds assorted radio parts. A \$25.00 value for only..... **\$1.95**

OUTPUT TRANSFORMER

H1-F1. Used in Scott-made Navy receiver. Fully potted. Pri. 5000 ohms. output secondary 600 ohms CT. Interse feedback sec. 60 ohms CT. ONLY..... **\$1.49**

PE-117 UNIVERSAL POWER SUPPLY
6 or 12v input; out. 145v and 90v. less vibrator. voltage regulator and rectifier tube. Ideal mobile power supply unit; excellent condition. FOB Chicago only. Each **\$2.95**

BC-709 INTERPHONE AMPLIFIER

Ideal for aircraft, booster for telephones, etc. FOB Chicago only **\$3.49**

VHF TRANSCEIVER

Ideal substitute for SCR-522. freq. range 140-144 mc. crystal controlled. 10 watts. The receiver section has two individual HF sections, feeding a common 3 stage 10mc IF amplifier. Both HF sections may be operated simultaneously, or either one individually. The receiver unit has 13 tubes. The transmitter is of straight forward design. Transmitter unit has 7 tubes, one #832 as final modulated by a pair of 6L6 and push-pull. Complete unit in case with tubes, crystals and diagram less dynamotor..... **\$14.95**

EXCELLENT CONDITION
New Phantom Antenna for above unit; 3 lamps in parallel with sockets, complete for **95c.**

SMASH VALUES IN COMMAND EQUIPMENT

- BC-452—EXC. \$12.95
- BC-454—EXC. \$3.95—NEW 4.95
- BC-455—EXC. 7.95
- BC-456—NEW 2.85
- BC-457—NEW 6.85
- BC-458—NEW 7.95
- BC-459—EXC. 9.95
- BC-696—EXC. 14.95

CONDENSER

2 MFD. 4000V. Pyranol \$2.95 ea.
4 for \$10.00

GEARED TUNING DIAL

5 band, vernier. BRAND NEW. Frequency Range:— 3.2-4; 8.4-8; 12.8-16; 19.2-24; 25.6-32. Ideal for many applications. An exceptional buy..... **\$1.39**

APS-13 UHF ANTENNA

Suitable for 400 mc citizen band, ideal for UHF experimenters. With director and reflector elements mounted. BRAND NEW. 2 for..... **\$1.49**

BC-659 TRANSMITTER-RECEIVER UNIT

FM transmitter-receiver, crystal controlled, two channels, freq. range 27-38.9 mc. 13 tubes. **\$16.95**

BC-620 TRANSMITTER-RECEIVER UNIT

FM transmitter-receiver, crystal controlled, two channels, freq. range 20-27.9 mc. 13 tubes, dual meter for testing filament and plate circuits. Used, good..... **\$9.95**

Mobile Installation Kit for BC-659 or BC-620 consists of TS-13; MP-18; 4 section whip antenna, **\$12.95** insulators, 2 maintenance manuals: NEW.

FREE!

Our new 8 page catalogue featuring many excellent surplus values. Write for your copy today! It's FREE!

All shipments FOB Chicago or Los Angeles unless specified. 20% Deposit required on all orders. Minimum order accepted—\$5.00. California and Illinois residents, please add regular sales tax to your remittance.

ARROW SALES, INC., Dept. R
MAIN OFFICE:
1712-14 S. Michigan Ave., Chicago 5, Illinois
NORTH SIDE BRANCH:
1802 N. Humboldt Blvd., Chicago.
WEST COAST BRANCH:
1240 S. Alvarado, Los Angeles, Calif.

STATION	LOCATION	FREQUENCY
WBKY	Lexington, Ky.	91.3
WBML-FM	Macan, Ga.	100.7
WBMS-FM	Boston, Mass.	104.1
WBNS	Beloit, Wis.	107.3
WBNU	Aurora, Ill.	103.9
WBNY-FM	Buffalo, N. Y.	92.9
WBOC	Salisbury, Md.	97.5
WBOE	Cleveland, Ohio	90.3
WBON	Bowling Green, Ky.	101.1
WBOW-FM	Terre Haute, Ind.	101.1
WBOX	Louisville, Ky.	100.7
WBRC-FM	Birmingham, Ala.	102.5
WBRE-FM	Wilkes-Barre, Pa.	98.5
WBRL	Baton Rouge, La.	98.1
WBTF-FM	Charlotte, N. C.	99.9
WBUI	Danville, Va.	97.9
WBUS-FM	Bradbury His., Md.	96.7
WBZ-FM	Canton, Ill.	100.9
WBZA-FM	Boston, Mass.	92.9
WCAC	Springfield, Mass.	97.1
WCAE-FM	Anderson, S. C.	101.1
WCAO-FM	Pittsburgh, Pa.	96.1
WCAP-FM	Baltimore, Md.	102.7
WCAR-FM	Asbury Park, N. J.	107.1
WCAU-FM	Pantiac, Mich.	99.5
WCBC-FM	Philadelphia, Pa.	98.1
WCBS-FM	Anderson, Ind.	106.3
WCBT-FM	New York, N. Y.	101.1
WCCE-FM	Raanoke Rapids, N. C.	98.5
WCED-FM	Rocky Mount, N. C.	100.7
WCDF-FM	DuBois, Pa.	102.1
WCFC	Beckley, W. Va.	101.3
WCFL-FM	Chicago, Ill.	104.3
WCFM	Washington, D. C.	99.5
WCFR	Fall River, Mass.	93.5
WCHA-FM	Chambersburg, Pa.	95.9
WCIL-FM	Carbondale, Ill.	100.7
WCJC-FM	Clarksville, Tenn.	106.7
WCLO-FM	Janesville, Wis.	99.9
WCMT-FM	Newark, Ohio	100.3
WCMI-FM	Ashland, Ky.	93.7
WCMW-FM	Canton, Ohio	94.9
WCNB-FM	Connersville, Ind.	100.3
WCNT-FM	Centralia, Ill.	96.5
WCOA-FM	Pensacola, Fla.	98.9
WCOD	Richmond, Va.	98.1
WCQH-FM	Newnan, Ga.	92.3
WCOL-FM	Columbus, Ohio	92.3
WCQN-FM	Atlanta, Ga.	98.5
WCOP-FM	Boston, Mass.	100.7
WCOU-FM	Lewiston, Maine	93.9
WCOV-FM	Montgomery, Ala.	94.5
WCRC-FM	Greenwood, S. C.	95.7
WCSC-FM	Charleston, S. C.	96.9
WCST	Columbus, Ind.	93.7
WCST-FM	New Brunswick, N. J.	98.3
WCCT	Cincinnati, Ohio	101.9
WCCTW	New Castle, Ind.	103.1
WCUM	Cumberland, Md.	102.9
WCVS-FM	Springfield, Ill.	102.9
WDAA-FM	Tampa, Fla.	105.7
WDAK-FM	Columbus, Ga.	107.9
WDBJ-FM	Raanoke, Va.	94.9
WDBQ	Dubuque, Iowa	103.3
WDFT-FM	Detroit, Mich.	101.9
WDHN	New Brunswick, N. J.	93.5
WDLB-FM	Marshfield, Wis.	103.9
WDNC-FM	Durham, N. C.	105.1
WDOS-FM	Oneonta, N. Y.	99.1
WDRS-FM	Hartford, Conn.	93.7
WDSD-FM	New Orleans, La.	105.3
WDTR	Detroit, Mich.	90.9
WDWS-FM	Champaign, Ill.	97.5
WDXY	Spartanburg, S. C.	100.5
WEAU-FM	Eau Claire, Wis.	94.1
WEAW	Evanston, Ill.	105.1
WEBC-FM	Duluth, Minn.	92.3
WEBQ-FM	Harrisburg, Ill.	99.9
WEBR-FM	Buffalo, N. Y.	96.9
WEED-FM	Rocky Mount, N. C.	92.1
WEFI-FM	Boston, Mass.	103.3
WEU-FM	Reading, Pa.	92.9
WEEX	Easton, Pa.	98.3
WEFM	Chicago, Ill.	99.5
WEHS	Chicago, Ill.	97.9
WEIM-FM	Fitchburg, Mass.	104.7
WELD	Columbus, Ohio	97.1
WELI-FM	New Haven, Conn.	107.9
WELL-FM	Battle Creek, Mich.	102.1
WEMP-FM	Milwaukee, Wis.	94.1
WENE-FM	Endicott, N. Y.	101.7
WENR-FM	Chicago, Ill.	94.7
WENY-FM	Elmira, N. Y.	106.9
WEOL-FM	Elyria, Ohio	107.3
WEPM-FM	Martinsburg, W. Va.	94.3
WERC-FM	Erie, Pa.	99.9
WERE-FM	Cleveland, Ohio	98.5
WESB-FM	Bradford, Pa.	97.5
WESC-FM	Greenville, S. C.	92.5
WEST-FM	Bethlehem, Pa.	107.9
WETR	Troy, N. Y.	91.3
WEW-FM	St. Louis, Mo.	95.1
WEWS-FM	Cleveland, Ohio	102.1
WEXL-FM	Royal Oak, Mich.	104.3
WFAA-FM	Dallas, Tex.	97.9
WFAH	Alliance, Ohio	101.7
WFAW	Lafayette, Ind.	95.1
WFAS-FM	White Plains, N. Y.	103.9
WFB-FM	Greenville, S. C.	93.7
WFBG-FM	Altoona, Pa.	103.7
WFBL-FM	Syracuse, N. Y.	93.1
WFR-FM	Baltimore, Md.	101.9
WFHA	New Britain, Conn.	103.7
WFHR-FM	Wisconsin Rapids, Wis.	103.3

HARD-TO-GET PARTS

POWERFUL ALL-PURPOSE INDUCTION MOTOR

IDEAL FOR EXPERIMENTERS—101 USES



Sturdily constructed to precision standards, this self-starting shaded pole A.C. induction motor is powerful enough for a number of uses. Some of these are: Automatic Timing Devices, Current Interrupters, Electric Fans, Electric Chimes, Window Displays, Photocell Control Devices, Electric Vibrators, Small Grinders, Buffers and Polishers, Miniature Pumps, Mechanical Models, Sirens, and other applications.

Consumes about 15 watts of power and has a speed of 3,000 r.p.m. When geared down, this sturdy unit will constantly operate in 18 inch turntable loaded with 200 lbs. dead weight—THAT'S POWER!

Dimensions 3" high by 2" wide by 1 3/4" deep; has 4 convenient mounting studs; stator by 3/16" diameter, and runs in self-aligning oil retaining bearings. Designed for 110-20 volts, 50-60 cycles, A.C. only. Shp. Wt. 2 lbs.

ITEM NO. 147 YOUR PRICE..... **\$1.95**

ULTRA MAGNET

LIFTS MORE THAN 20 TIMES ITS OWN WEIGHT

LITTLE GIANT MAGNET

Lifts 5 lbs. easily. Weighs 4 oz. Made of ALNICO new high-magneto steel. Complete with keeper. Weighs most powerful magnet ever made. The experimenter and hobbyist will find hundreds of excellent uses for this high quality permanent magnet. Measures 1 3/4" x 1 1/2". Shp. Wt. 5 1/2 lbs.

ITEM NO. 159 YOUR PRICE..... **\$1.25**



GENUINE MICROPHONE TRANSMITTERS

Regular telephone transmitters taken from a large telephone supply company's overstock. Work perfectly on 2 dry cells. Can be used on P.A. systems, call systems, inter-communications sets, short-line telephone circuits, house-to-house or farm-to-farm phone lines, also to talk through your own radio or as concealed dictaphone pick-up. Useful replacements on battery-operated rural telephone lines.

THESE ARE GENUINE TRANSMITTERS, MADE BY KELLOGG, WESTERN ELECTRIC AND CARLSON, excellent in appearance and operation. A remarkable value and one seldom offered in these items. No. 160. Shp. Wt. 1 lb.

ITEM NO. 160 YOUR PRICE..... **\$1.95**

WATTHOUR METER

Completely overhauled and ready for immediate service. Designed for regular 110-volt, 60 cycle, 2-wire A.C. circuit. Simple to install; 2 wires from the line and 2 wires to the load. Sturdily constructed in heavy metal case, 8 1/2" high, 6 1/4" wide, 5 1/2" deep. Westinghouse, G. E. Fort Wayne, General or other available make. Shp. Wt. 14 lbs.

ITEM NO. 33 YOUR PRICE.... **\$5.95**

AMAZING BLACK LIGHT!

Powerful 250-Watt Ultra-Violet Source

The best and most practical source of ultra-violet light for general experimental and entertainment use. Makes all fluorescent substances brilliantly luminescent. No transformers of any kind needed. Fits any standard lamp socket. Brings out beautiful opalescent hues in various types of materials. Sweil for amateur parties, plays, etc.; to obtain unique lighting effects. Bulb only. Shp. Wt. 2 lbs.

ITEM NO. 57 YOUR PRICE..... **\$1.95**

WESTERN ELECTRIC BREAST MIKE

This is a fine light-weight aircraft carbon microphone. It weighs only 1 lb.

Mike comes with breastplate mounting and has 2-way leveling adjustment so that it can be adjusted to any desired position. There are 2 woven straps: one goes around neck, the other around chest. Straps can be snapped on and off quickly by an ingenious arrangement.

This excellent mike can be adapted for home broadcasting or private communication systems. By dismounting breastplate, it can be used as desk mike.

Comes complete with 6-foot cord and hard rubber plug. Finished in sherrardized plate, non-rustable. Shipping weight, 2 lbs.

ITEM NO. 152 YOUR PRICE..... **\$1.45**

HUDSON SPECIALTIES CO.

40 West Broadway, Dept. RE-4-49, New York 7, N. Y.

I have circled below the numbers of the items I'm ordering. My full remittance of \$..... (in-circles shipping charges) is enclosed (NO C.O.D. ORDERS UNLESS ACCOMPANIED WITH A DEPOSIT.) OR my deposit of \$..... is enclosed (20% required). Ship order C.O.D. for balance. NO C.O.D. ORDERS FOR LESS THAN \$5.00. BE SURE TO INCLUDE SHIPPING CHARGES. Circle item No. wanted:

147 159 160 57 152 33
Name.....
Address.....
City..... State.....
Please Print Clearly

You Can't Match these MID-AMERICA Values!

ELECTRIC MOTOR SCOOP!



115-volt 60 cycles
Get this motor and make the handiest tool on your workbench! Attach a flexible shaft and you're all set for grinding, sanding and buffing operations. Great for model-makers. 1/20 b.p. motor turns at 2900 R.P.M.—does the job in half the time! 1/2" shaft, 3/4" long, 3 3/4" x 2 3/4" x 3 3/4" high; weighs only 3 1/2 lbs. May be used for many motor applications.

\$3.95

METAL UTILITY CABINET

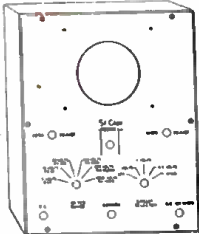

Sturdy steel cabinet, complete with handsome front panel for construction of vacuum tube voltmeter. May be used for other test equipment, amplifiers, xmitters, etc. 8" wide, 10" high, 7" deep. Black crackle finish

\$1.98

3-Inch Scope Shield

Designed for either front or rear mounting. 9" overall. Black, corrosion-proof metal. Improves tube operation and protects from damage. MA-2075.

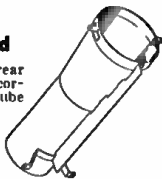

69c each

Iron Core FM and AM IF TRANSFORMERS

Highly efficient for new construction and replacement. III-(4) adjustable iron cores provide high selectivity and gain. Only 2 1/2" x 1 1/2" square; spade lug mounting. MA-2239 10.7 MC IF Transformer 49c ea. MA-2639 155 KC IF Transformer 35c ea.

INTERCOM TRANSFORMER SET

One transformer to match voice coil to grid, another for 50L6 and similar output tubes. Both of these fine units PLUS a momentary DPDT spring return push-button switch for less than value of one transformer alone! These are small, strap-mounting transformers.

ONLY 98c FOR ALL THREE UNITS!

BRAND NEW METERS

Delux Model 310 meter for all-around ham and test applications. 10 ma. DC basic movement, 3 3/4" diameter flange, 2 1/2" body, 1 3/4" deep. Stock up on these while they last. MA-2036

\$1.95 each



GRILLE CLOTH

Never before at our low price! Highest quality, golden-tone grille cloth, styled to harmonize with all cabinet designs. Generous 50" width.

\$1.79 per yard

VARIABLE CONDENSERS

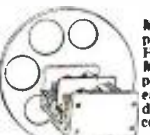

MA-996: 425 and 150 mmf sections complete with mica compression trimmers. Has 4" cable drum. 49c
MA-940: 8P ECIALI 3-band, 365 mmf per section with band-spread rotor for each section. Shafts have 2 1/4" cable drums. Ideal for communication receivers 79c

MA-88-25: 25 mmf butterfly for high frequency applications. Rotor floats on ball bearings. Ceramic insulation. Measures 1 1/2" square x 1 1/2" deep. 32c
MA-8850: 50 mmf, same as above 32c

ORDER FROM THIS AD!

Send 25% deposit with order. Pay balance plus postage on delivery. Get your name on Mid-America's select mailing list and get first crack at latest, greatest values in radio parts, electronic equipment, tubes, etc. Send orders to Desk RC-49. Minimum order \$2.50.

MID-AMERICA CO. Inc.

STORE WAREHOUSE
2412 S. Michigan Ave. 2307 S. Archer Ave.
Chicago 19, Ill. Chicago 16, Ill.

STATION	LOCATION	FREQUENCY
WFIL-FM	Philadelphia, Pa.	102.1
WFIL-FM	Findlay, Ohio	100.5
WFIS	Freeport, Ill.	102.5
WFLA-FM	Tampa, Fla.	93.3
WFLN	Philadelphia, Pa.	95.7
WFLY	Troy, N. Y.	92.3
WFMF	Chicago, Ill.	100.3
WFMI	Portsmouth, N. H.	107.3
WFMJ-FM	Youngstown, Ohio	105.1
WFML	Washington, Ind.	106.5
WFMR	New Bedford, Mass.	98.1
WFMU	Crawfordsville, Ind.	102.9
WFMV	Greensboro, N. C.	97.3
WFMZ	Allentown, Pa.	107.7
WFNC-FM	Fayetteville, N. C.	98.1
WFNF	Wethersfield, N. Y.	107.7
WFNS-FM	Burlington, N. C.	93.9
WFOB	Fostoria, Ohio	105.5
WFOV	Madison, Wis.	104.9
WFGP-FM	Atlantic City, N. Y.	98.5
WFRO	Fremont, Ohio	99.3
WFRS	Grand Rapids, Mich.	92.5
WFTW-FM	Ft. Wayne, Ind.	103.7
WFUV	New York, N. Y.	90.7
WGAA-FM	Cedartown, Ga.	96.1
WGAL-FM	Lancaster, Pa.	101.3
WGAN-FM	Portland, Me.	101.9
WHAS-FM	Louisville, Ky.	99.7
WGAY-FM	Silver Spring, Md.	102.3
WGBA-FM	Columbus, Ga.	95.1
WGBG-FM	Greensboro, N. C.	100.3
WGBI-FM	Scranton, Pa.	101.3
WGBR-FM	Goldsboro, N. C.	93.3
WGBS-FM	Miami, Fla.	96.3
WGCH	Greenwich, Conn.	95.9
WGCM-FM	Gulfport, Miss.	101.5
WGFM	Schenectady, N. Y.	99.5
WGH-FM	Newport News, Va.	96.5
WGHF	New York, N. Y.	101.9
WGNB	Chicago, Ill.	98.7
WGNC-FM	Gastonia, N. C.	101.9
WGNR	New Rochelle, N. Y.	93.5
WHOP-FM	Hopkinsville, Ky.	98.7
WGOR	Ft. Lauderdale, Fla.	106.5
WGOV-FM	Valdosta, Ga.	92.5
WGPA-FM	Bethlehem, Pa.	95.1
WGST-FM	Atlanta, Ga.	94.1
WGTM-FM	Wilson, N. C.	106.7
WGTR	Worcester, Mass.	99.1
WGUY-FM	Bangor, Me.	93.1
WGYN	New York, N. Y.	97.9
WHA-FM	Madison, Wis.	88.7
WHAD	Delafield, Wis.	90.7
WHAI-FM	Greenfield, Mass.	98.3
WHAT-FM	Philadelphia, Pa.	105.3
WHAV-FM	Haverhill, Mass.	92.5
WHB-FM	Kansas City, Mo.	102.1
WHRC-FM	Canton, Ohio	94.1
WHBF-FM	Rock Island, Ill.	98.9
WHRL-FM	Sheboygan, Wis.	100.3
WHBS-FM	Huntsville, Ala.	95.1
WHCU-FM	Ithaca, N. Y.	97.3
WHDH-FM	Boston, Mass.	94.5
WHEC-FM	Rochester, N. Y.	96.5
WHFB-FM	Benton Harbor, Mich	99.9
WHFM	Rochester, N. Y.	98.9
WHHM-FM	Memphis, Tenn.	106.9
WHIO-FM	Dayton, Ohio	99.1
WHIP	Silver Spring, Md.	103.9
WHIS-FM	Bluefield, W. Va.	104.5
WHK-FM	Cleveland, Ohio	100.7
WHKC-FM	Columbus, Ohio	98.7
WHKW	Chilton, Wis.	89.3
WHKY-FM	Hickory, N. C.	102.9
WHLD-FM	Niagara Falls, N. Y.	98.5
WHLI-FM	Hempstead, N. Y.	98.3
WHMA-FM	Anniston, Ala.	100.5
WHNC-FM	Henderson, N. C.	92.5
WHO-FM	Des Moines, Iowa	100.3
WHOO-FM	Orlando, Fla.	96.5
WHPP-FM	Harrisburg, Pa.	97.3
WHPE-FM	High Point, N. C.	95.5
WHTN-FM	Huntington, W. Va.	100.5
WHVA	Poughkeepsie, N. Y.	104.7
WHYN-FM	Holyoke, Mass.	93.1
WIBA-FM	Madison, Wis.	101.5
WIBG-FM	Philadelphia, Pa.	94.1
WIBM-FM	Jackson, Mich.	92.3
WIBW-FM	Topeka, Kans.	102.5
WIBX-FM	Utica, N. Y.	96.9
WIFY-FM	Evansville, Ind.	104.1
WIL-FM	St. Louis, Mo.	97.3
WILA	Woodstock, Ill.	92.1
WILK-FM	Wilkes-Barre, Pa.	107.3
WIMA-FM	Lima, Ohio	102.1
WINX-FM	Washington, D. C.	96.3
WIOD-FM	Miami, Fla.	97.3
WIP-FM	Philadelphia, Pa.	93.3
WIS-FM	Columbia, S. C.	94.5
WISC-FM	Madison, Wis.	98.9
WISE-FM	Asheville, N. C.	102.5
WISN-FM	Milwaukee, Wis.	102.9
WISR-FM	Butler, Pa.	97.7
WIST	Charlotte, N. C.	104.7
WITB-FM	Baltimore, Md.	104.3
WIUC	Urbana, Ill.	91.7
WIZZ	Wilkes-Barre, Pa.	103.3
WJAC-FM	Johnstown, Pa.	95.5
WJAR-FM	Providence, R. I.	95.5
WJAS-FM	Pittsburgh, Pa.	99.7
WJAX-FM	Jacksonville, Fla.	95.1
WJBC-FM	Bloomington, Ill.	101.5
WJBK-FM	Detroit, Mich.	93.1
WJBY-FM	Gadsden, Ala.	103.7
WJDX-FM	Jackson, Miss.	102.9

ONLY \$99.50 IS THE COST!



for the SENSATIONAL-NEW-IMPROVED

10 INCH

TELEVISION KIT

Complete with new built-in pretuned and aligned 13 Channel tuner, all parts and easy step-by-step instructions and schematics.

\$99.50 less tubes

Kit, complete with all tubes \$149.50
Specially designed cabinet for kit 25.00

An amazing value! Even a beginner can assemble one of these fine, new improved television kits. Uses the new 13 channel tuner, prewired and factory aligned for the entire television spectrum. High quality parts and excellent circuit assure perfect performance. Circuit designed by outstanding T.V. engineers. Contains IF stage, oscillator and mixer. Uses new I.F. coils providing maximum gain and picture definition. Sound reception is high quality FM for years of listening pleasure.

Same quality and features for 7" KIT complete, less tubes \$59.50

Complete, with tubes 99.50

Specially designed cabinet for 7" kit 21.00

This kit can be used with Sylvania 10 HP4 10" picture tube without modifications.
7" and 10" KITS AVAILABLE FOR IMMEDIATE DELIVERY FROM STOCK!

The New Model TC-75 TEST CRAFT A COMBINATION TEST SPEAKER AND SIGNAL TRACER



- plus speaker substitution
- plus resistor tester
- plus condenser tester
- plus resistor substitutor
- plus condenser substitutor
- plus output indicator
- plus substitute 100 V. D.C. power supply
- plus field substitutor
- plus voice coil substitution
- plus signal tracer
- plus an experimental one stage audio amplifier
- plus universal output transformer

Complete including signal tracer probe and full instructions.
A must for every radio serviceman and engineer.

NET \$29.50

IMMEDIATE DELIVERY FROM STOCK

The New Model TC-50 TEST CRAFT TUBE AND SET TESTER

A complete laboratory, one purpose test instrument, this versatile combination tube and set tester will accurately test all up-to-date designed tubes. The multi-meter section affords many necessary measurements for everyday's service work.

The New Model TC-50 Tube and Set Tester combines seven instruments, D.C.V., A.C.V., D.C.M.A., Ohms, Output Meter, Decline Meter and Tube Tester. Full scale accuracy to 2%. English Reading GOOD and BAD scale for testing tubes. Obsolescence reduced to absolute minimum. Simple and quick reading charts for tube testing. Multimeter section affords most popular everyday's measurements. Complete with test leads, tube charts and all detailed, operating instructions.

Size 8" x 10 1/2" x 5" **NET \$39.50**

IMMEDIATE DELIVERY FROM STOCK

All orders filled same day received

Metropolitan ELECTRONIC & INSTRUMENT CO.
Dept. RC-4 42 WARREN ST. N. Y. 7, N. Y.

NEW!
Different!
Down-to-earth!

Cash in on



SERVICING PROFITS!

Now ready for delivery!

PRACTICAL TELEVISION SERVICING

By J. R. Johnson and J. H. Newitt
375 pages, 6 x 9, over 230 illustrations

Price only \$4

At last, you can get a book that really gives you the low-down on television servicing—one that tells step by step what to do and also guides you specifically on precautions to take and the mistakes to be avoided. PRACTICAL TELEVISION SERVICING is all the name implies—a complete, down-to-earth working manual for those who want to understand television servicing fully, get straightened out on the vast amount of MISinformation that is creeping into the television picture, and really be able to do television servicing.

Shows Exactly How to do the Work!

This isn't a book of theory, mathematics and general discussions. The authors—one a radio editor, the other a well-known engineer—actually owned and operated a television service shop to get the specific, how-to-do-it information they now pass along to you in easily understood form. In addition to a clear explanation of how television components, construction and operation differ from radio, they show exactly how to perform all specific operations in troubleshooting, diagnosing and remedying television receiver troubles. You don't bother with needless theory. You are actually shown how to do the work!

MAKES TELEVISION REPAIRS EASY TO UNDERSTAND

Here are the subjects covered:

- | | |
|--|---|
| 1. Fundamentals is Here | 10. Test Equipment and Alignment |
| 2. Fundamentals of the Television System | 11. Wiring and Repair Techniques |
| 3. The Radio-frequency, Intermediate-frequency and Detector Sections | 12. Common Troubles in Television Receivers |
| 4. Video Amplifiers | 13. Troubleshooting |
| 5. Cathode Ray Tubes | 14. Servicing Hints and Case Histories |
| 6. Synchronizing and Sweep Circuits | 15. Color Television |
| 7. Power Supplies | A. Intermediate Frequencies of Standard Receivers |
| 8. Antennas and Wave Propagation | B. Receiver Layout Diagrams |
| 9. Television Receiver Installation | C. Glossary |

FACTUAL SERVICING DATA ON

- How to test for an intermittent peaking coil or transformer
- How to get a signal over a mountain
- What to do when the linearity of the picture is poor
- How to guy a mast properly
- Checking video response with a square wave
- When to use mica capacitors in place of other types

... and scores of other practical problems

10 DAYS TRIAL

SEND NO MONEY JUST MAIL COUPON

Dept. RE-49, Murray Hill Books, Inc.
232 Madison Ave., New York 16, N. Y.

Send me Johnson & Newitt's PRACTICAL TELEVISION SERVICING for 10 days' examination on approval. In 10 days I will send \$4, plus a few cents postage, or return book postpaid. Postage paid on cash orders; same return privilege. (Books sent on approval in U.S. only. Price outside U.S. \$4.50 postpaid.)

Name

Address

City, Zone, State

Occupation

STATION	LOCATION	FREQUENCY
WJEJ-FM	Hagerstown, Md.	104.7
WJEM	Springfield, Ohio	103.9
WJHL-FM	Johnson City, Tenn.	100.7
WJHP-FM	Jacksonville, Fla.	96.9
WJIZ	Hammond, Ind.	92.3
WJJW	Wyandotte, Mich.	103.1
WJLB-FM	Detroit, Mich.	97.9
WJLD-FM	Birmingham, Ala.	104.7
WJLK	Asbury Park, N. J.	94.3
WJLS-FM	Beckley, W. Va.	99.5
WJMC-FM	Rice Lake, Wis.	96.3
WJNO-FM	West Palm Beach, Fla.	98.7
WJPF-FM	Herrin, Ill.	98.5
WJPG-FM	Green Bay, Wis.	101.1
WJPR-FM	Greenville, Miss.	101.9
WJR-FM	Detroit, Mich.	96.3
WJSW-FM	Altoona, Pa.	96.5
WJTN-FM	Jamestown, N. Y.	93.3
WJW-FM	Cleveland, Ohio	104.1
WJZ-FM	New York, N. Y.	95.5
WKAP-FM	Allentown, Pa.	106.3
WKAR-FM	East Lansing, Mich.	90.5
WKAT-FM	Miami Beach, Fla.	93.1
WKBH-FM	LaCrosse, Wis.	93.1
WKBN-FM	Youngstown, Ohio	98.9
WKBZ-FM	Manchester, N. H.	100.1
WKBW-FM	Manchester, N. H.	106.5
WKID-FM	Urbana, Ill.	103.3
WKIL	Kankakee, Ill.	100.7
WKJF	Pittsburgh, Pa.	93.7
WKJG-FM	Fr. Wayne, Ind.	106.1
WKMO-FM	Kokomo, Ind.	99.9
WKNP	Corning, N. Y.	106.1
WKOK-FM	Sunbury, Pa.	94.1
WKPB	Knoxville, Tenn.	93.3
WKPT-FM	Kingsport, Tenn.	98.5
WKRG-FM	Mobile, Ala.	99.9
WKRS	Waukegan, Ill.	106.7
WKRT-FM	Corland, N. Y.	99.9
WKST-FM	New Castle, Pa.	101.1
WKWK-FM	Wheeling, W. Va.	97.3
WKY-FM	Oklahoma City, Okla.	98.9
WKYC	Paducah, Ky.	93.3
WLAB	Lebanon, Pa.	104.1
WLAD-FM	Danbury, Conn.	98.3
WLAG-FM	LaGrange, Ga.	104.1
WLAL	Lakewood, Ohio	104.9
WLAN-FM	Lancaster, Pa.	96.9
WLAW-FM	Grand Rapids, Mich.	96.9
WLAW-FM	Lawrence, Mass.	93.7
WLBR	Lebanon, Pa.	100.1
WLCS-FM	Baton Rouge, La.	101.1
WLDM	Detroit, Mich.	95.5
WLDS-FM	Jacksonville, Ill.	100.5
WLEE-FM	Richmond, Va.	102.9
WLET-FM	Toccoa, Ga.	106.1
WLEU-FM	Erie, Pa.	97.9
WLEY	Elmwood Park, Ill.	107.1
WLIN	Merrill, Wis.	100.7
WLIV	Providence, R. I.	107.7
WLLH-FM	Lowell, Mass.	99.5
WLOG-FM	Logan, W. Va.	103.3
WLOK-FM	Lima, Ohio	103.3
WLOS-FM	Asheville, N. C.	104.3
WLOW-FM	Norfolk, Va.	98.9
WLPM-FM	Suffolk, Va.	107.7
WLRD	Miami Beach, Fla.	93.9
WLSU	Baton Rouge, La.	91.7
WLTN	Lewistown, Pa.	97.9
WLVA-FM	Lynchburg, Va.	97.5
WLWA	Cincinnati, Ohio	101.1
WLYN-FM	Lynn, Mass.	105.5
WMA-FM	Washington, D. C.	107.3
WMAQ-FM	Chicago, Ill.	101.1
WMAZ-FM	Baltimore, Md.	97.9
WMAZ-FM	Springfield, Mass.	94.7
WMAZ-FM	Macon, Ga.	99.1
WMBD-FM	Peoria, Ill.	92.5
WMBH-FM	Joplin, Mo.	96.1
WMBI-FM	Chicago, Ill.	95.5
WMBR-FM	Jacksonville, Fla.	96.1
WMBT	Uniontown, Pa.	105.7
WMB5-FM	New York, N. Y.	92.3
WMCB-FM	Memphis, Tenn.	99.7
WMCFC	Baltimore, Md.	94.7
WMCPC	North Adams, Mass.	97.5
WMFM	High Point, N. C.	99.5
WMFR-FM	McKeesport, Pa.	104.9
WMGK-FM	New York, N. Y.	100.3
WMGM-FM	Meadville, Pa.	100.3
WMGW-FM	Montgomery, Ala.	107.5
WMGY-FM	St. Paul, Minn.	99.5
WMIN-FM	Charlotte, N. C.	106.9
WMIT	Mt. Vernon, Ill.	94.1
WMIX-FM	Evansville, Ind.	94.5
WMLL	Mt. Clemens, Mich.	106.3
WMLN	Meriden, Conn.	95.7
WMMW-FM	Mobile, Ala.	97.5
WMOB-FM	Hamilton, Ohio	103.5
WMOH-FM	Pittsburgh, Pa.	94.5
WMOT	Meridian, Miss.	98.5
WMOX-FM	Greenville, S. C.	94.9
WMRC-FM	Marion, Ind.	106.9
WMRI	Massena, N. Y.	105.3
WMUN	Muncie, Ind.	104.1
WMUR-FM	Manchester, N. H.	95.7
WMUS-FM	Muskegon, Mich.	100.5
WMV-FM	Boston, Mass.	98.5
WMV-FM	Norman, Okla.	90.9
WMV-FM	Warren, Pa.	92.1
WMV-FM	Neenah, Wis.	98.5
WMV-FM	Raleigh, N. C.	96.1
WMV-FM	Annapolis, Md.	99.1
WMV-FM	New York, N. Y.	97.1
WMV-FM	Binghamton, N. Y.	100.5

The Dollar Corner
ALL ITEMS \$1 Postpaid
Get your dollar's worth and much more at this dollar radio bargain counter!

RCA 954 Acorn Tubes..... 3 for \$1.00
METER RECTIFIERS, full wave, 10v—30ma..... 3 for \$1.00
MALLORY 550 C, 6Volt sync. Vibrators..... \$1.00
COAX FITTINGS M359, UG-21/U, UG-27/U, UG-100/U..... 3 for \$1.00
BC 348, Q, M, P—1st, 2nd, 1F's..... 3 for \$1.00
ARC-5 BFO COILS, 85kc, 1415kc, 2830kc..... 3 for \$1.00
CERAMICONS, ostd. sizes..... 8 for \$1.00

BARGAIN RADIO, Dept. DB-2
249 N. Juanita, Los Angeles 4, California

GREYLOCK
A DEPENDABLE NAME IN
RADIO TUBES
GT, Glass, and Miniature Types
All Tubes in Individual Cartons

1R5	3Q4	12SA7GT
1R5	3V4	12SK7GT
114	6AT6	12SQ7GT
114	6BA6	(and many others)
384	6BE6	

39¢ each

SPECIAL OFFER! All 99¢ tubes may be purchased in lots of 100 assorted, at \$35 per 100.

Specials: 2E24 .. 89¢ 6B6G .. 89¢

TERMS: Net C.O.D., F.O.B. N.Y.C. Minimum order \$5.00.
Write for Bargain Catalog C-4.

Greylock Electronics Supply Co.
30 Church Street New York 7, N. Y.

SURPRISE PACKAGE
Contains over \$2.50 worth of radio parts such as Superhet Var-cond, Elect Cond, Volume Ch, Trans, Coils, Micacs, Resistors, Hdw, etc—\$1. lbs.

ALL PARTS LISTED IN OUR CATALOG
Please enclose postage

RADIO MAIL ORDERS
75 Barclay St., Dept. RE
N. Y. 7, N. Y.

TELEVISION SCREEN VIEWING FILTERS
Make your own filters for only a few cents each. Different colors, all very easy and inexpensive to make. Send 35¢ for complete instructions.

ELECTRONIC DEVICES CO.
P.O. Box 1016, Morgantown, W. Va.

TELEVISION RECEIVER—\$1.00
Complete instructions for building your own television receiver. 16 pages—11"x17" of pictures, pictorial diagrams, clarified schematics. 17"x22" complete schematic diagram & chassis layout. Also booklet of alignment instructions, voltage & resistance tables and troubleshooting hints.—All for \$1.00.

CERTIFIED TELEVISION LABORATORIES
Dept. C, 5567-13th Ave., Brooklyn 19, N. Y.

FREE
Send name and address for our free catalogue, chock-full of standard brand radio and TV sets, parts and equipment at rock bottom bargain prices.

COMMERCIAL RADIO, DEPT. C
36 Brattle St. Boston 8, Mass.

WANTED—RADIO MECHANICS
At least 2 yrs' mechanics experience on aircraft radio equipment
2nd class F.C.C. Radio-Telegraph Lic. nec.
Amateur Radio License desirable
Apply 9-4 Mon. thru Fri., or write

PERSONNEL DEPARTMENT
PAN AMERICAN WORLD AIRWAYS
LaGuardia Field Long Island, N. Y.
or phone HAVemeyer 4-8400, ext. 503 (N. Y.)

WNDB-FM	Daytona Beach, Fla.	94.5
WNDR-FM	Syracuse, N. Y.	102.5
WNEX-FM	Macon, Ga.	76.9
WNHC-FM	New Haven, Conn.	99.1
WNIG	Uniontown, Pa.	106.5
WNJR-FM	Newark, N. J.	102.7
WNLC-FM	New London, Conn.	99.5
WNNT	Paterson, N. J.	103.5
WNOW-FM	York, Pa.	105.7
WNVC-FM	New York, N. Y.	93.3
WNVE	Brooklyn, N. Y.	91.5
WOAI-FM	San Antonio, Tex.	102.5
WOAK	Oak Park, Ill.	98.3
WOAP-FM	Owosso, Mich.	103.1
WOAY-FM	Oak Hill, W. Va.	94.1
WOC-FM	Davenport, Iowa	103.7
WOCB-FM	West Yarmouth, Mass.	94.3
WOHS-FM	Shelby, N. C.	96.1
WOKZ-FM	Alton, Ill.	99.9
WOLF-FM	Washington, D. C.	98.7
WOMI-FM	Owensboro, Ky.	92.5
WOPI-FM	Bristol, Tenn.	96.9
WOPT	Oswego, N. Y.	104.7
WOR-FM	New York, N. Y.	98.7
WOSH-FM	Oshkosh, Wis.	92.9
WOTW-FM	Nashua, N. H.	106.3
WOWO-FM	Ft. Wayne, Ind.	96.1
WPAD-FM	Paducah, Ky.	96.9
WPAG-FM	Ann Harbor, Mich.	98.7
WPAM-FM	Pottsville, Pa.	95.5
WPAR-FM	Parkersburg, W. Va.	106.5
WPAY-FM	Portsmouth, Ohio	104.1
WPDX-FM	Clarksburg, W. Va.	95.1
WPEN-FM	Philadelphia, Pa.	102.9
WPIC-FM	Sharon, Pa.	102.9
WPIT-FM	Pittsburgh, Pa.	101.5
WPJB	Providence, R. I.	105.1
WPLH-FM	Huntington, W. Va.	102.5
WPMDFM	Frederick, Md.	101.5
WPOE	Elizabeth, N. J.	95.7
WPPA-FM	Pottsville, Pa.	101.9
WPRO-FM	Providence, R. I.	92.3
WPTL	Providence, R. I.	91.5
WQAM-FM	Miami, Fla.	94.9
WQAN	Scranton, Pa.	92.3
WQDI	Quincy, Ill.	105.1
WQQW-FM	Washington, D. C.	103.5
WQXR-FM	New York, N. Y.	96.3
WRAC-FM	Williamsport, Pa.	100.3
WRAL-FM	Raleigh, N. C.	101.5
WRBL-FM	Columbus, Ga.	93.3
WRC-FM	Washington, D. C.	93.9
WRCM	New Orleans, La.	97.1
WREN-FM	Topeka, Kansas	94.1
WREY	Reidsville, N. C.	102.1
WRFL	Winchester, Va.	92.5

CONVERT DIRECT VIEW TV TO PROJECTION TELEVISION

30 KV RF POWER SUPPLY

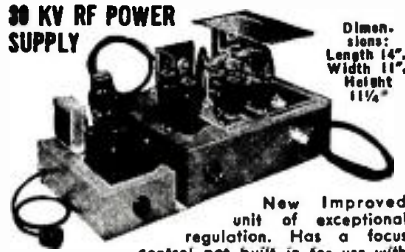

Dimensions: Length 14", Width 11", Height 1 1/4"

New Improved unit of exceptional regulation. Has a focus control pot built in for use with STP4 Tube. Voltage variable from 27 to 30 KV. Supply utilizes 6 tubes.
Net price, including DC Power Supply...\$99.50



SPELLMAN F1.9 PROJECTION TV LENS

Dimensions: Length 7", Diameter 4 1/4" F1.9 EF.5 in. (127.0 mm.) This lens incorporates in barrel a corrective lens for use with a STP4 projection tube. It is easily removable for use with flat type tubes. Lens can be utilized to project picture sizes from several inches to 7 x 9 feet. Complete with mounting ring. Machined slotted Mounting Ring available for hand focusing adjustment. Has 4 holes for easy mounting on plate.
Only \$90 \$8.00 extra.

STP4 Tube. Voltage variable from 27 to 30 KV. Supply utilizes 6 tubes.
Net price, including DC Power Supply...\$99.50



STP4 PROJECTION KINESCOPE TUBE

Features a metal backed white fluorescent screen having high brightness and contrast. Net Price...\$67.50
Conversion diagram supplied with parts. Please specify type of TV set.
Include 25% Deposit with order. Balance C.O.D.

SPELLMAN TELEVISION CO., Inc.
Dept. 8, 130 West 24 Street, New York 11

RUSH YOUR ORDERS IN!

- TELEVISION TUBE, #6C4..... .19
- ONE POUND ROSIN SOLDER..... .59
- ANTENNA HANK, 15 ft. on spool... .09
- LINE CORD, 6 ft. with plug..... .12
- TOGGLE SWITCH, SPST..... .15
- TOGGLE SWITCH, DPST..... .25
- RESISTANCE CORD, 150 ohms..... .29
- RESISTANCE CORD, 180 ohms..... .39
- A.C.-D.C. CHOKE, 50 ma 10 hy..... .29
- OUTPUT TRANSFORMER (2-25L6).. .36
- VOL. CONTROLS, w/s 50K & 1/2 meg. .39
- VOL. CONTROLS, w/s 1 & 2 meg.... .39
- RADIO CHASSIS, with 8 sockets.... .39
- VAR. CONDENSER, 420/420/420..... .95
- G.I. TWO SPEED MOTOR..... 4.95
- L.P.—CRYSTAL PICK-UP..... 3.75
- WEBSTER XTAL CARTRIDGE..... 1.45

ASSORTMENTS 100 OF EACH

- 100—CONDENSERS, .001 to .02.... 3.95
- 100—RESISTORS, 1/2 watt..... 1.50
- 100—SOCKETS, octol, loctol, min.... 4.95
- 100—PILOT LIGHTS, #44, 47, 49, 51 4.95
- 100—KNOBS, screw and push on.... 4.95

TUBE CARTONS

- 100—SMALL PEANUT, 1"x1"x2 1/8".... .75
- 100—LARGE PEANUT, 1"x1"x2 3/4".... .85
- 100—GT TYPE, 1 1/4"x1 1/4"x3 3/8"..... .95
- 100—SMALL G, 1 1/2"x1 1/2"x4 1/2"..... 1.25
- 100—LARGE G, 2"x2"x5"..... 1.45

BROOKS RADIO DIST. CORP.
80 VESEY ST., DEPT. A, NEW YORK 7, N. Y.

DYNAMOTORS

Type	Input Volts	Output Volts	Amps	Radio Set	Prices*
PE 86	28	1.25	.250	RC 36	\$3.95
DM 416	14	6.2	.330	KU 19	15.95N
DY-2/ARR-2	28	1.1	.250	ARC-5	4.75N
DM 36	28	1.4	.220	SCR 508	8.75N
DM 35AZ	14	2.8	.220	BC 733	7.00N
PE 73CM	28	10	1000	BC 375	N
DM 21	14	3.3	.235	BC 312	3.45N
DM 21CX	28	1.6	.235	BC 312	3.45N
DM 25	12	2.3	.250	BC 367	2.491N
DM 28R	28	1.25	.275	BC 348	8.95N
DM 35A	28	7	540	BC 458	5.50N
DM 42	14	46	515	SCR 506	6.501N
			1030		

PE 101C	13/26	12.6	400	.135	SCR 515	5.25N
			800	.020		
BD AR 93	28	6.3	800	.020		4.95N
23550	27	1.75	288	.075	APN-1	3.50N
35X045B	28	1.2	250	.060		3.50N
ZA .0515	12/24	4/2	500	.050		3.95N
ZA .0516	12/24	8/4	12/275	3/110		5.50N
B-19 pack	12	8.4	275	.110	Mark II	9.95N
			500	.050		
D-104	12		225	.100		14.95N
			440	.200		
DA-3A*	28	10	300	.060	SCR 522	8.95
			150	.010		
			14.5	.060		
±5053	28	1.4	250	.060	APN-1	3.05N
PA-7A	28	5	1100	.400	TA-2J	25.00N
OW 21AAX	13	12.6	400	.135		17.50N
	26	6.3	800	.020		
			9	1.12		
BD 77KM	14	40	1000	.350	BC 191	N
						14.00LN
PE 94	28	10	300	.260	SCR	15.00N
			150	.010		
			14.5	.5		

N—New. LN—Like New. *Lens Filter Box & Relays
Replacement dynamotors for PE 73, lens filter box...\$12.00
HAND GENERATORS
GN 35: 350 v, 60 ma; 8v, 2.5 A. New, with hand cranks...\$12.50
GN 45: 500 v, 100 ma; 6v, 3 amps. Slight use. ex. con. with cranks...\$12.50

INVERTERS
PE 218-E: Input: 25-28 vdc, 92 amp. Output: 115 v, 350-500 cy, 1500 volt-amps. Dim: 17" x 6 1/2" x 10". New, export packed...\$49.95
PE 218-H: Same as above, except size: 16 1/2" x 5 3/4" x 10". New...\$49.95
PE 218-W: Used, good cond. \$25.00
PE 206: Input: 28 vdc, 38 amps. Output: 80 v, 800 cy, 500 volt-amps. Dim: 13" x 5 3/4" x 10 1/2". New...\$12.50
GE 5021N3A: Input: 28 vdc, 35 amp. Output: 115 v, 400 cy, 485 volt-amps. Dim: 9" x 4 1/4" diameter. New...\$49.95

TRANSTATS

11.5 KVA: Input 0-115 v, 50-60 cycle. Maximum output: 115 v, 100 amp. All units are new. Guaranteed.
\$99.50 each
2 KVA: 90-130 v input, 50-60 cycles, output 115 volts.
2 KVA Type RH Amertran...\$29.95 each

NBFM-465 KC DISCRIM XFMRs. FOSTER-SEELEY WITH CIRCUIT DIAGRAM. \$2.50 EA.

AUDIO TRANSFORMERS ARC-3 AUDIO COMPONENTS
T-101, #55548 T-104, #55547
T-102, #55545 T-105, #55554
T-103, #55546 T-206, #55320

Price, each
MOD XFMR: PP 807's to PR 807's CL "C".....\$1.65
DRIVER ZEMR: 666 Driver to PP 811 Grids.....\$1.45
UNIVERSAL OUTPUT: Amertran Silcon. PRI: 20,000/16,000/500/4000 ohms. Sec: 500/15/7.5/3.85 ohms. 30db contin. Flat to 17,000 CY.....\$4.75

POWER CHOKES

Swing. Choke: 4.5	.116 hy, 15 amp.	\$ 4.50
.8 hy; 2 to	.01 hy, 2.5 amp.	1.50
1 amp.	.35 hy, 35 amp.	7.50
.03 hy 2 amp.	Dual 2.5 hy, 130 ma.	1.25
8.5 hy, 125 ma.	.1 hy, 12 amp.	.46
25 hy, 65 ma.	ohms	16.00
6 hy, 150 ma.	Dual .5 hy, 380 ma.	.95
Dual 7 hy, 75 ma. 11	5 hy, 40 ma, 312 ohms	.65
hy, 60 ma.	2 hy, 200 ma.	.75
Dual 2 hy, 100 ma.	Dual 120 hy, 17 ma	2.45

CERAMIC CONDENSERS \$7.50 per 100

3 mmf ±5%	60 mmf ±3%
5 mmf ±5%	67 mmf ±20%
4 mmf ±5 mmf	115 mmf ±2%
8.5 mmf ±5 mmf	120 mmf ±5%
11 mmf ±5%	240 mmf ±3%
15 mmf ±5%	1000 mmf ±5%

*Silver-Mica Button Capacitors (Eric, Contralob) \$9.50 per 100
185 mmf ±2.5 mmf
175 mmf ±2.5 mmf
500 mmf ±10%

H. F. ANTENNAE

AN-130, Short Flex.....\$1.75
AT-5, ARR-1, with Low-Loss Base, 12 1/2" L, Approx. 235 MC.....\$1.50
ANTENNA, AN-100-A, for RC 103.....\$3.00
ANTENNA, AN-104-A, for SCR 522.....\$1.75
6-SECTION CERAMIC CAPACITOR, 10,000 mmf (Collins ART-13).....\$4.99 ea.
BC 306-A ANTENNA LOADING UNIT for BC 375 \$2.75 ea.
POWER SWITCH, 4 pos, 60 amps, 600 vac. Arrow Mark.....\$4.25
ROTARY SPARK GAP, 24 vdc, motor, 4 spark gap electrodes, p/ Xmr BC 1081-TG.....\$9.50
PERF. CODE TAPE, paper 11/16" dia, 8" diam. rolls 1.00
CABLE ASSEMBLY, 45 pr. 102" L. Telephone type WF #D16603B.....\$20.00 per length
SONAR SOUND DETECTOR, Underwater detector with microphone units encased in rubber sheath. Model JR.....\$12.50
MNS2W Azimuth control box for aircraft radio compass.....\$1.25
TRANSFORMERS for Collins ART13 Transmitters. GE #7472063. GE #7472063.

BAND PASS FILTER

#7047B. Sharp band pass peaked at 700 cps. Band-width: 650 cycles at 20 db. Impedance from peak. High-to-high impedance. Can be plugged into phone output of receiver for good results. Cuts out QRM New, with circuit diagram.....\$2.25



COAX CONNECTORS

B315P...\$.35 UG 21/U.....\$.85 UG255/U.....\$1.25
B31AP...\$.35 UG 86/U.....\$.75 UG146/U.....\$1.00
B31MP...\$.15 UG 254/U.....\$.75 UG87/U.....1.25
Noredell male to type "N" male adapter.....\$1.25
D-168368 Baby "N" male to type "N"......85
Adapter Cable Assy, Type "N" Male to Type "N" Female.....2.25
Adapter Cable Assy, Sperry Male to Type "N" Male.....2.25
Connector, #49576 for BC 18/U.....1.80

COAX CABLE

RG 9/U, 52 ohms.....\$.22/ft.
RG 17/U, 52 ohm imp.....\$.50/ft.
RG 18/U, 52 ohm imp, armored.....\$.51/ft.
RG 23/U, 50 ohm imp, twin coax, 125 ohm imp, armored.....\$.50/ft.
starting voltage 17 KV......50/ft.
RG 35/U, 70 ohm imp, armored......50/ft.
RG 37/U, 95 ohm imp, twin coax......35/ft.

CROSS POINTER INDICATOR

ID 24-ARN-9 Dual 0-200 microamp. movement in 3" case. Each movement brought out to 6-term receptacle at rear. Originally used in ILS equipment. New \$5.50
ZA Type.....\$10.00



131-C Liberty St. New York 7, N.Y.
All merchandise guaranteed. Mail orders promptly filled. All prices, F.O.B. New York City. Send Money Order or Check. Only shipping charges sent C.O.D.
COMMUNICATIONS EQUIPMENT CO.
MANUFACTURERS QUANTITIES AVAILABLE
PHONE DIGBY 9-4124

NOW! BUILD 15 RADIOS \$14.75
COMPLETE KIT ONLY.

Absolutely No Knowledge of Radio Necessary. You Need No Additional Parts. The PROGRESSIVE RADIO KIT is the Only Complete Kit. Operates on 110-120 Volts AC/DC

Contains everything you need. Instruction book, metal chassis, tubes, condensers, resistors and all other necessary radio parts. The 36-page instruction book written by expert radio instructors and engineers teaches you to build radios in a professional manner. The circuits are designed to provide excellent performance. Altogether, fifteen circuits are constructed, including 11 receivers, 1 audio amplifier and 3 transmitters.

SPECIAL OFFER
Electrical and Radio Tester sent absolutely FREE with each Progressive Radio Kit. Plus FREE Membership in the Progressive Radio Club. Entitles you to free expert advice and consultation service with licensed radio technicians. ORDER YOUR KIT NOW!

BUILD KITS!! SAVE!! LEARN!!

VACUUM TUBE VOLTMETER KIT \$23.95
A professional piece of test equipment you need for FM and TV. FREE: Book on Advanced Servicing Techniques.

5" OSCILLOSCOPE KIT \$39.95
An absolute "must" for today's radioman. FREE: Book on Cathode Ray Oscilloscopes.

VOLT-OHM-MILLIAMMETER KIT \$14.95
Simple to construct. Impedance not accurate. \$14.95
FREE: Book on Elementary Radio Servicing.

SIGNAL TRACER KIT \$21.95
An invaluable aid in trouble-shooting. FREE: Book on Radio Test Instruments.

HIGH FIDELITY HUMLESS AMPLIFIER KIT \$16.00
Attractive aluminum chassis; complete with five tubes and two selenium rectifiers. FREE: Book on Amplifiers.

ECONOMY AMPLIFIER KIT \$5.95
Simple to build; complete with five tubes. FREE: Book on Amplifiers.

7" TELEVISION KIT \$59.50
Complete tube kit. 39.50
FREE: Television Servicing Notes.

10" TELEVISION KIT \$99.50
Complete tube kit. 57.30
FREE: Television Servicing Notes.

10" TELEVISION SUB-ASSEMBLY KIT \$229.50
Sub assembly complete with tubes. FREE: Television Servicing Notes.

12" TELEVISION SUB-ASSEMBLY KIT \$259.50
Sub assembly factory-wired; complete with tubes. FREE: Television Servicing Notes.

15" TELEVISION SUB-ASSEMBLY KIT \$349.50
Sub assembly factory-wired; complete with tubes. FREE: Television Servicing Notes.

5 TUBE AC-DC SUPERHET KIT \$14.25
Complete with tubes and cabinet. FREE: Book on Building Receivers.

6 TUBE AC-DC 2-BAND SUPERHET KIT \$17.45
Complete with tubes and cabinet. FREE: Book on Amateur Radio Building.

7 TUBE AC-DC FM RECEIVER KIT \$29.95
Complete with tubes and cabinet. FREE: Television and FM Servicing Notes.

4 TUBE SUPERHET PORTABLE KIT \$12.95
Complete with tubes and cabinet; less batteries. FREE: Book on Unusual Radio Circuits.

LP RECORD PLAYER KIT \$20.95
Complete with motor, pick-up, permanent needle, amplifier, tubes, speaker, cabinet. FREE: Book on Radio Questions and Answers.

AUTOMATIC
Car Radio Model M-90 (U. S. Patent Mating) \$27.97
Car Radio Model M-92-C (Built-in Battery Charger) 34.97
Bike Radio (anti-theft feature) 17.47
Tom Thumb "Buddy" Portable (3-way plus battery charger) 27.97
7" Table Model Television Receiver 149.65

RMS
All-Channel Video Booster (excellent for fringe areas) \$22.75
All-Channel Television and FM Antenna (2 folded dipoles, 2 reflectors) 15.00

EICO \$9.95
5" Oscilloscope 69.95
Multimeter 17.95

RADIO CRAFTSMAN
FM/AM Tuner Model RC 8 \$110.00
Amplifier Model RC 2 39.00

ESPEY
FM/AM Chassis Model TB1 (11 tube receiver) \$64.00
FM/AM Chassis Model S11 (14 tube receiver) 98.00

VM
Long Playing Dual Speed Record Changer Model 400 \$33.90

FEILER
Pocket Stethoscope Model TS 5 \$28.95
Cathode Ray Stethoscope Model TB7 (less phones and probe) 89.95
Stethoscope Probe (complete with 8C4 tube) 8.25

H.H. SCOTT
Dynamic Noise Suppressor Type 110 A \$49.50

FERRIT
FM-TV Sweep Generator (20 MC sweep width) \$164.95

ALL MERCHANDISE SHIPPED FOB NEW YORK
Deduct 2% if full payment accompanies order. 25% deposit required on C.O.D. orders.
Write for further information concerning the above merchandise. Send for our Free catalog.

PROGRESSIVE ELECTRONICS CO.
Dept. RE-24 497 Union Avenue
Brooklyn 11, New York

STATION	LOCATION	FREQUENCY
WRGA-FM	Rome, Ga.	106.5
WRGK	LaGrange, Ill.	103.1
WRHI-FM	Rock Hill, S. C.	97.5
WRJN-FM	Racine, Wis.	100.7
WRLD-FM	Lawett, Ala.	102.9
WRNL-FM	Richmond, Va.	102.1
WRNY-FM	Rochester, N. Y.	97.9
WROL-FM	Knoxville, Tenn.	97.3
WROV-FM	Roanoke, Va.	103.7
WROW-FM	Albany, N. Y.	93.9
WRSW	Warsaw, Ind.	107.3
WRUF-FM	Gainesville, Fla.	104.1
WRUN-FM	Utica, N. Y.	105.7
WRVB	Richmond, Va.	94.5
WRVC	Norfolk, Va.	102.5
WRWR-FM	Albany, N. Y.	95.1
WRXW	Louisville, Ky.	98.5
WRZE	York, Pa.	102.7
WSAI	Cincinnati, Ohio	98.1
WSAM-FM	Saginaw, Mich.	99.9
WSAN-FM	Allentown, Pa.	99.7
WSAP-FM	Portsmouth, Va.	103.7
WSAR-FM	Fall River, Wis.	95.5
WSAU-FM	Warsaw, Wis.	100.3
WSAV-FM	Savannah, Ga.	104.5
WSB-FM	Atlanta, Ga.	103.3
WSBA-FM	York, Pa.	101.3
WSBF	South Bend, Ind.	101.9
WSEL-FM	Springfield, Mass.	103.3
WSFA-FM	Montgomery, Ala.	93.7
WSGN-FM	Birmingham, Ala.	90.3
WSHS	Floral Park, N. Y.	105.7
WSIC-FM	Statesville, N. C.	97.5
WSIX-FM	Nashville, Tenn.	104.1
WSJS-FM	Winston-Salem, N. C.	106.1
WSLB-FM	Ogdensburg, N. Y.	99.1
WSLS-FM	Roanoke, Va.	103.3
WSM-FM	Nashville, Tenn.	102.7
WSMB-FM	New Orleans, La.	98.9
WSNI-FM	Bridgeton, N. J.	103.5
WSOC-FM	Charlotte, N. C.	99.5
WSON-FM	Henderson, Ky.	89.5
WSOU	South Orange, N. J.	102.1
WSOY-FM	Decatur, Ill.	98.9
WSPA-FM	Spartanburg, S. C.	101.5
WSPD-FM	Toledo, Ohio	97.9
WSPR-FM	Springfield, Mass.	101.3
WSRK	Shelbyville, Ind.	95.3
WSRS-FM	Cleveland Hts., Ohio	96.7
WSTC-FM	Stamford, Conn.	106.5
WSTP-FM	Salisbury, N. C.	103.5
WSTV-FM	Steuenville, Ohio	100.7
WSVA-FM	Harrisonburg, Va.	101.9
WSYO	Sylacauga, Ala.	94.5
WSYR-FM	Syracuse, N. Y.	99.5
WTAD-FM	Quincy, Ill.	96.1
WTAG-FM	Warcester, Mass.	103.9
WTAL-FM	Tallahassee, Fla.	105.7
WTAM-FM	Cleveland, Ohio	102.5
WTAQ-FM	Green Bay, Wis.	97.3
WTAR-FM	Norfolk, Va.	103.7
WTAX-FM	Springfield, Ill.	106.9
WTBO-FM	Cumberland, Md.	97.1
WTGN-FM	Minneapolis, Minn.	91.3
WTDS	Toledo, Ohio	98.3
WTFM	Tiffin, Ohio	99.9
WTHI-FM	Terre Haute, Ind.	106.1
WTHT-FM	Hartford, Conn.	96.5
WTIC-FM	Hartford, Conn.	100.7
WTJS-FM	Jackson, Tenn.	95.1
WTMA-FM	Charleston, S. C.	93.3
WTMJ-FM	Milwaukee, Wis.	97.5
WTOA	Trenton, N. J.	97.3
WTOC-FM	Savannah, Ga.	95.7
WTPS-FM	New Orleans, La.	100.7
WTRC-FM	Elkhart, Ind.	100.5
WTRF-FM	Bellaire, Ohio	102.7
WTRI	Tray, N. Y.	99.9
WTRT	Toledo, Ohio	102.5
WTSP-FM	St. Petersburg, Fla.	106.1
WTSV-FM	Clairemont, N. H.	99.1
WTTM-FM	Port Huron, Mich.	91.7
WUOM	Ann Harbor, Mich.	99.3
WUSJ	Lockport, N. Y.	101.9
WVBT	South Bristol, N. Y.	105.1
WVCN	De Ruyter, N. Y.	101.9
WVCV	Cherry Valley, N. Y.	95.1
WVFC	Ithaca, N. Y.	96.1
WVJS-FM	Owensboro, Ky.	94.7
WVKO	Columbus, Ohio	98.1
WVUN	Chattanooga, Tenn.	94.9
WVWF	Greenfield, Wis.	97.1
WVDC-FM	Washington, D. C.	105.3
WVJ-FM	Hornell, N. Y.	97.5
WVHG-FM	New Orleans, La.	100.3
WVNI	Wabash, Ind.	97.5
WVNY-FM	Watertown, N. Y.	100.5
WVOD-FM	Lynchburg, Va.	107.9
WVWL-FM	Buffalo, N. Y.	104.1
WVWP-FM	Miami, Fla.	101.5
WVPG-FM	Palm Beach, Fla.	97.9
WVST	Wooster, Ohio	104.5
WVYA-FM	Wheeling, W. Va.	98.7
WXHR	Cambridge, Mass.	96.9
WXLW-FM	Indianapolis, Ind.	94.7
WXNJ	Plainfield, N. J.	103.9
WXRT	Chicago, Ill.	101.9
WXYZ-FM	Detroit, Mich.	101.1
WXEA	Alpine, N. J.	93.1

Low FACTORY-TO-YOU Prices

New! MIDWEST TELEVISION

with **BIG 75 Square Inch SCREEN**

Offering **12 1/2" PICTURE TUBE**
12 TELEVISION CHANNELS
PICTURE-HOLD CONTROL

Other Models Include **SYMPHONY GRAND**
AM-FM RADIO-TELEVISION-PHONOGRAPH with NEW DUAL-SPEED RECORD PLAYER

also complete CHASSIS for Custom Installation — and Adopter Chassis and Console for use with 1947, 1948, 1949 Midwest Radio Models.

EASY TERMS

30 DAYS TRIAL

SEND THIS COUPON FOR FREE TELEVISION AND RADIO LITERATURE

MIDWEST RADIO & TELEVISION CORP.
Dept. 388, 909 Broadway, Cincinnati 2, Ohio

Name _____
Address _____
City _____

WE ARE LOOKING FOR TUBES!

WHAT HAVE YOU GOT?

Interested in small or large quantities of all types of Transmitting, Industrial, and Receiving Tubes. Send offerings to:

T. L. BLACK, WHOLESALE TUBE DIV.
NIAGARA RADIO SUPPLY CORP.
160 Greenwich St., New York 6, N. Y.

>> TUBES <<

FACTORY SEALED CARTONS
YOUR ASSORTMENT 25 FOR \$9.25
50 FOR \$18.00 100 FOR \$35.00

1R5	3S4	12SA7GT	35W4
1S5	3V4	12SK7GT	35Z5GT
1T4	12AT6	12BQ7GT	30B5
1U4	12BA6	12B7GT	50L6GT
3Q4	12BE6	Each	35B5 117Z3

ASSORTED BULK PACKED—25 for \$8.75
50 FOR \$17.00 100 FOR \$33.00

The following tubes at 49c each

6AG5	6AL5	6F8G	6T8
6AK5	6AU6	6SN7GT	12AU7
			19T6

MANY OTHER TUBE TYPES AVAILABLE. SEND FOR FREE TUBE LIST.
Complete stock of replacement parts available for the RCA 630TS TV Receiver.
Send for our parts bargain list.

HALLMARK ELECTRONIC CORPORATION
594 Communipaw Ave.
Jersey City 4, New Jersey BERGEN 4-6365

Parts of the old 160-meter band are again open to the amateur. Regulations which vary according to the geographical location permit operation on various bands between 1800 and 2000 kc, with powers between 50 and 500 watts.

Walter Albert Buck has been elected operating vice-president of the RCA Victor Division, *Radio Corporation of America*, it was announced by John G. Wilson, executive vice-president of the division.



Mr. Buck, a retired rear-admiral of the U. S. Navy, has served since March 15, 1948, as president of Radiomarine Corporation of America, a service of RCA. In retiring from the Navy last March,

Mr. Buck ended a distinguished Navy career of thirty years, the last two of which he served as Paymaster-General and Chief of the Bureau of Supplies and Accounts. For his wartime services, he was awarded the Legion of Merit.

Terry P. Cunningham has been appointed as director of advertising and sales promotion for *Sylvania Electric Products, Inc.*, it was announced by R. H. Bishop, vice-president in charge of sales. Mr. Cunningham will direct advertising and sales promotion for the lighting-fixture, lamp, radio-tube, and electronics divisions and the Wabash Corporation.



He was formerly advertising manager of the radio-tube, electronics, and international division and has been associated with Sylvania Electric and subsidiaries since 1942 as an advertising executive and sales manager of Colonial Radio Corporation, a Sylvania subsidiary.

Louis G. Pacent, Jr., has been advanced to the post of vice-president in charge of manufacturing of *Radio Speakers, Inc.* of Chicago, it was announced by Dorman D. Israel, president. The firm is a subsidiary of Emerson Radio and Phonograph Corp., New York.

Sidney L. Chertok has been appointed to the application engineering staff of *Sprague Electric Company*, North Adams, Mass., Julian K. Sprague, vice-president, announced. Mr. Chertok will also serve as sales promotion manager of the *Sprague Products Company*, jobbers' distributing organization for Sprague capacitors, resistors and other products, it was announced by Harry Kalker, Sprague Products president.

Well known in the electronic and radio industry, Mr. Chertok was formerly sales promotion manager of Solar Manufacturing Corp., North Bergen, New Jersey, and its distributing subsidiary, Solar Capacitor Sales Corp.

Frank D. Peltier has been appointed director of engineering, appliance division of the engineering department, *Philco Corporation*, Philadelphia, it was announced by David B. Smith, vice-

LET THIS "AUTOMATIC TEACHER" show you exactly how to repair over 4800 RADIO MODELS without expensive test equipment!

GHIRARDI SAVES YOU TIME —HELPS YOU MAKE MONEY

Ghirardi's RADIO TROUBLESHOOTER'S HANDBOOK is the ideal manual to show you exactly how to repair radios at home in spare time—quickly and without a lot of previous experience or costly test equipment. It contains MORE THAN 4 POUNDS OF FACTUAL, time-saving, money-making repair data for repairing all models and makes of radios better, faster and more profitably than you may have thought possible!

NOT A "STUDY" BOOK

RADIO TROUBLESHOOTER'S HANDBOOK can easily pay for itself the first time you use it. You don't have to study it. Simply look up the make, model, and trouble symptom of the Radio you want to repair and go to work. No lost time! Clear instructions tell exactly what the trouble is likely to be—EXACTLY how to fix it. Actually, this big 744-page manual-size HANDBOOK brings you factual, specific repair data for the common troubles that occur in over 4800 popular models of Home and Auto radio receivers and Automatic record changers of 202 manufacturers! In addition, there are hundreds of pages of helpful repair charts, tube charts, data on tuning alignment, transformer troubles, tubes and parts substitution, etc., etc.—all for only \$5 (\$5.50 foreign). Read it for 10 days... at our risk! Use coupon.

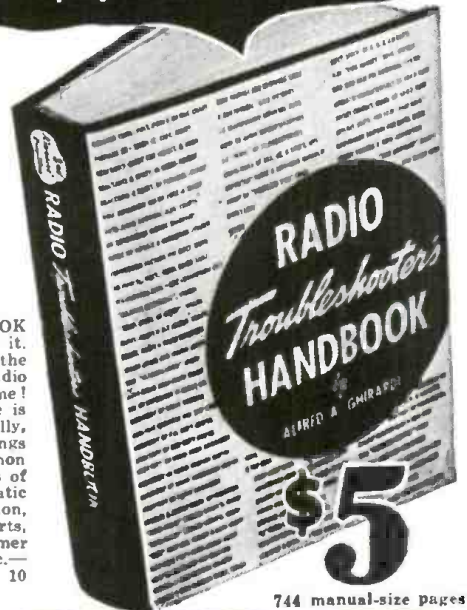

Get a Complete RADIO-ELECTRONIC SERVICE EDUCATION AT HOME—WITHOUT AN INSTRUCTOR

COMPLETE DATA ON TEST INSTRUMENTS —TROUBLESHOOTING—REPAIR



1300 pages. 706 illus. 723 review questions

A. A. Ghirardi's big 1300-page MODERN RADIO SERVICING is the finest, most complete instruction book on Radio-Electronic service work for either the novice or the professional Radio-Electronic serviceman—bar none! Read from the beginning, it is a COMPLETE COURSE IN SERVICING by scientific methods. Used for reference, it is an invaluable means of brushing up on any servicing problem. Gives complete information on all essential service instru-

ment types; how they work (with wiring diagrams), when and why to use them; how to build your own; preliminary trouble checks; circuit and parts analysis; parts repair, replacement, substitution; obscure radio troubles; aligning and neutralizing; interference reduction — and hundreds of other subjects including How to Start and Operate a Successful Radio Electronic Service Business. 723 self-testing review questions help you check your progress EVERY STEP OF THE WAY. Only \$5 complete \$5.50 foreign).

10 DAYS' FREE EXAMINATION

Technical Division, MURRAY HILL BOOKS, INC. Dept. RC-49, 232 Madison Ave., New York 16, N. Y.

Send me the books checked below for 10 days examination on approval. In 10 days I will pay for the books plus a few cents postage, or return them postpaid. (Postage paid on cash orders; same return privilege. Books sent on approval in U. S. only.)

- MODERN RADIO SERVICING \$5 (\$5.50 foreign)
- RADIO TROUBLESHOOTER'S HANDBOOK \$5 (\$5.50 foreign)
- Special MONEY-SAVING COMBINATION Both big books for only \$9.50 (\$10.50 foreign)

Name.....
 Address.....
 City & Dist. No..... State.....
 (Please print or write plainly)

You Can't Go Wrong on a Ghirardi Radio Book



MONEY-SAVING OFFER!

Get BOTH big books — Radio's most famous Service Library — over 2030 pages — at a bargain combination price. See coupon.

TUBES! NATIONALLY ADVERTISED BRANDS TUBES!

RCA — Kenrad — Sylvania — Tung-Sol — National Union — Raytheon — Philco — Hytron
All new tubes, 100% guaranteed, individually boxed.

TYPE	PRICE	TYPE	PRICE	TYPE	PRICE	TYPE	PRICE	TYPE	PRICE
0A4G	\$0.96	3A7	\$0.72	6K7G	\$0.60	6Y6G	\$0.85	12AH7GT	\$1.15
01A	.60	3B7/1291	.85	6Y7G	.95	6Z5G	1.15	12AT6	.60
02A	.80	3D6/1299	.96	6L5G	.96	6Z7G	1.40	12BA6	.65
1A3	.80	3Q4	.80	6L6	1.26	6ZY5G	.80	12BE6	.65
1A4P	1.40	3Q5GT	.85	6L6GA	1.15	7A4	.72	12C8	1.15
1A5GT	.65	3R4	.72	6L7	1.15	7A5	.72	12H6	.65
1A8	1.15	3R4GY	1.15	6N7	.85	7A6	.72	12J5GT	.54
1A7GT	.72	5T4	1.40	6P5GT	.80	7A7	.72	12J6GT	.72
1B4P	1.40	5U4G	.54	6Q7	.72	7A8	.72	12K8	.60
1B5/258	1.15	5V4G	.54	6R7	.96	7B4	.72	12Q7GT	.65
1C5GT	.80	5W4	.96	6R7GT	.85	7B5	.72	12SA7GT	.65
1C8	1.15	5X4G	.65	6S7	.96	7B6	.72	12SB7	.65
1C7	1.15	5Y3GT	.45	6SA7GT	.80	7B7	.72	12SC7	.65
1D5GP	1.40	5Y4G	.85	6SB7	.85	7B8	.72	12SF7	.72
1D7G	1.15	5Z3	.85	6SB7-Y	.85	7C3	.72	12SG7	.72
1D8GP	1.40	5Z4	.96	6S7GT	1.15	7C6	.72	12SM7	.80
1E3GP	1.40	6A1	.96	6S07GT	1.15	7C7	.72	12S17	.80
1E4GT	1.40	6A1/LA	1.15	6SF5	.72	7E9	.72	12SK7GT	.60
1F3	.96	6A5	.96	6SF7	.72	7E7	.80	12SL7GT	.65
1F5G	.96	6A7	.72	6SG7	.72	7F7	.80	12SN7GT	.60
1Q4	.96	6AN7	.72	6SH7	.80	7F8	.96	12SQ7GT	.60
1Q6GT	.96	6AN7	1.15	6SJ7	.80	7G7	.96	12SR7	.80
1H4G	.80	6AD7	.96	6SK7GT	.80	7H7	.80	12Z3	.98
1H5GT	.80	6AD7G	1.15	6S7GT	.85	7I7	.80	12Z5(6Z5)	1.15
1H6GT	1.15	6AF6G	.96	6N7GT	.80	7L7	.80	14A4	.96
1J6	.96	6A5S	1.25	6G7	.80	7N7	.80	14A7	.80
1L4	.72	6AG7	1.15	6SR7	.85	7Q7	.95	14B6	.80
1LA4	.96	6AK5	1.25	6SR7	.85	7V7	.96	14C7	.80
1LA8	.96	6AL3	1.25	6S7	.96	7W7	.96	14F7	.80
1LB4	.96	6AL7	.96	6SV7	1.15	7X7	.96	14H7	.80
1LC5	.96	6AQ7	.80	6T7GT	1.15	(XXFM)	.96	14J7	.96
1LD5	.96	6AT8	.54	6U5	.72	7Y4	.72	14N7	.96
1LE3	.96	6B4G	.96	6U8	.65	7Z4	.72	14Q7	.80
1LE8	.96	6B7	1.15	6U7	.85	10	1.40	14R7	.80
1LH4	.96	6B3G	1.15	6V6	1.15	12A	.65	14W7	.96
1LN5	.96	6C4	.60	6V6GT	.72	12A5	1.15	19	1.15
1NSGT	.72	6C5	.60	6V7G	.96	12A6	1.15	25L6GT	.60
1P5GT	.80	6C6	.72	6W7G	.96	12A7	1.15	25Z8GT	.65
1Q3GT	.96	6C8G	1.15	6X5GT	.54	12A8	.72	27	.65
1R4	.96	6D6	.60					31D7	1.15
1R5	.72	6E5	.80					31E7	.96
1R4	.85	6E5	.80					32	1.15
1S5	.85	6F6GT	.80					32L7GT	1.15
1T4	.72	6F7	.72					33	1.15
1T5GT	.96	6F8G	1.15					34	1.15
1V	.80	6G6G	.96					35	.72
2A3	1.15	6H6GT	.60					35A5	.72
2A4G	1.15	6H5GT	.54					35B5	.72
2A5	.80	6J5GT	.54					35L6GT	.66
2A6	.96	6I8	1.25						
2B7	.96	6J7	.72						
2X2	1.15	6K6GT	.54						

TERMS: 25% with Order
—Balance C. O. D.—F. O. B.
Chicago. Prices Subject
to Change Without Notice.
Minimum Order \$2.00.

FRANKLIN-ELLIS CO. 1313 West Randolph Street
Dept. RE-4 Chicago 7, Illinois

A CHALLENGE — Order a model 247. Disregard the unbelievably low price and compare it on the basis of appearance, quality and performance with any other Tube Tester (ANY MAKE, ANY PRICE). If you are not completely satisfied with the model 247 after a 15 day trial, return it to us for full refund—no explanation necessary. The model 247 is not surplus nor is it a hushed over pre-war model. It is newly designed and incorporates new advances in Tube Tester design. Read the description below and order one today!

THE NEW MODEL 247



TUBE TESTER

Checks octals, loctals, bantam jr. peanuts, television miniatures, magic eye, hearing aids, thyratrons, the new type H.F. miniatures, etc.

Features:

- * A newly designed element selector switch reduces the possibility of obsolescence to an absolute minimum.
- * When checking Diode, Triode and Pentode sections of multi-purpose tubes, sections can be tested individually. A special isolating circuit allows each section to be tested as if it were in a separate envelope.
- * The Model 247 provides a super sensitive method of checking for shorts and leakages up to 5 Megohms between any and all of the terminals.
- * One of the most important improvements, we believe, is the fact that the 4 position fast-action snap switches are all numbered in with the standard R.M.A. numbering system. Thus, if the element terminating in pin No. 7 of a tube is under test, button No. 7 is used for that test.

Model 247 comes complete with new speed-read chart. Comes housed in handsome, hand-rubbed oak cabinet sloped for bench use. A slip-on portable hinged cover is included for outside use. Size: 10 3/4" x 8 3/4" x 5 3/4".

20% Deposit Required on All C.O.D. Orders

MOSS ELECTRONIC DISTRIBUTING CO. DEPT. RC-4, 229 FULTON ST. NEW YORK 7, N. Y.

ONLY \$29.90 NET

president in charge of research and engineering. Peltier, an authority in the field of refrigeration engineering with many years of experience, has been with Philco since 1939 and has been responsible for development of the company's refrigerators, home freezers, and air conditioners. During the war, he made a notable contribution to ordnance engineering.

Louis Silver, vice-president and sales manager of *Garod Electronics Corporation*, Brooklyn, New York, has been appointed executive vice-president and general manager, according to an announcement from Leonard Ashbach, president. Mr. Ashbach also announced the appointment of Paul Graf as assistant vice-president in charge of production and Robert Leykum as plant superintendent. Messrs. Graf and Leykum have been associated with Garod nearly ten years. Maurice Raphael, assistant to the president of Garod, was elevated to the post of vice-president. Mr. Raphael, one of radio's pioneers, has been associated with the industry over 30 years.



Joseph B. Elliott was appointed vice-president in charge of all RCA Victor consumer products and L. W. Teegarden as vice-president in charge of all RCA technical products. The announcement was made by J. G. Wilson, executive vice-president of the Radio Corporation of America, in charge of the RCA Victor Division.

At the same time, Mr. Wilson announced the promotions of Henry G. Baker to general manager of the Home Instrument Department and Richard T. Orth to general manager of the Tube Department.

Mr. Elliott, who for the past four years served as vice-president in charge of the RCA Victor Home Instrument Department, will in his new capacity direct the over-all activities of all consumer products, including radios, Victrola radio-phonographs, television receivers and phonograph records. Formerly vice-president in charge of the RCA Tube Department, Mr. Teegarden will direct the company's activities in the electronic equipment and apparatus field as well as in tubes, parts and batteries. Included in this field are broadcast and communications equipment, sound products, aviation and theatre motion-picture equipment, and scientific instruments.

General sales manager of the Home Instrument Department since 1945, Mr. Baker will be in charge of design, engineering, and manufacturing of radios, television receivers and Victrola radio-phonographs, in addition to sales, advertising, and promotional activities which had previously been his responsibility. Mr. Orth will assume similar enlarged responsibilities in the Tube Department of which he has been merchandise manager since 1947.

... MEISSNER 24-TV

Some receivers were shipped without a width control. The necessary coil for adding this control may be added by simply drilling a hole and making the connections indicated in the drawing.

To minimize the effects of ignition noise, insert a 100-ohm, 1/2-watt, bias resistor bypassed with a 250- μ f capacitor between the cathode of the 6AC7 first video amplifier and ground. Return the suppressor to chassis, not to cathode.

CONNECT WITH CONT. COIL LEADS TO THESE 2 TERMINALS ON THE HORIZ. OUTPUT TRANS.

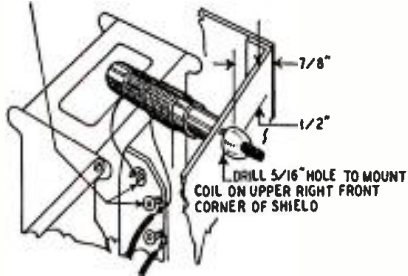

Models with serial numbers higher than 1398 have a provision for keeping d.c. out of the deflection yoke. This change can be made on previous sets by inserting a series 0.5- μ f, 400-volt blocking capacitor instead of the 22-ohm resistor now in the circuit.

Dealers may obtain all parts necessary for these modifications from the manufacturer without charge.

... HALLICRAFTERS T-54

The front end of the picture tube is supported by a rubber bushing on the panel of this set. Place a soft pad under the tube before removing the front panel. This prevents the tube from dropping and possibly breaking against the chassis.

G. J. MACHEAK
San Pedro, Calif.

... KNIGHT G9511

Volume and tone changed intermittently. Signal tracing indicated faulty a.v.c. action, which was finally traced to a 75 which was bad, even though it tested good on a standard tester.

JOHN C. CHEPLA,
Springfield, Ill.

... WESTINGHOUSE WR-305

This set burned up its output transformer and later its power transformer. The 6F6 output tube was passing too much plate current because a bad tone-control contact broke connections between the 6F6 grid and the bias supply, as shown in diagram a. After replacing the tone control, the bias-supply con-

BIAS POINT CHANGED

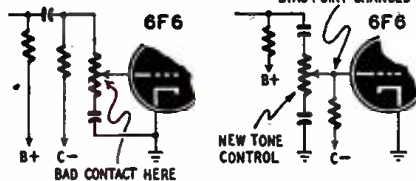

ORIGINAL CIRCUIT a.

REVISED CIRCUIT b.

Bias is made independent of the tone control.

APRIL, 1949

THERE'S A CINAUDAGRAPH SPEAKER

FOR EVERY PURPOSE!



83 DIFFERENT MODELS in the World's Most Complete Line!

Do you have your FREE copy of the new CINAUDAGRAPH CATALOG? Write to Dept. 153A, Cinaudagraph Speakers, 1401 Fairfax Trafficway, Kansas City, Kansas.

From two-inch units for portable radios . . . to fifteen-inch models for commercial phonographs and public address systems . . . there's a CINAUDAGRAPH SPEAKER tailored for each job.

Whether you need a standard speaker, or a specialized unit for a particular application, CINAUDAGRAPH meets your exacting requirements with precision engineered equipment. When you buy speakers, always specify CINAUDAGRAPH . . . and be sure you're getting the best!



DIVISION OF AIREON MFG. CORP.
SALES OFFICE and FACTORY 1401 FAIRFAX TRAFFICWAY KANSAS CITY, KANSAS
CANADIAN OFFICE: Charles W. Poulton, Queen at Bay St., Toronto, Ont.
EXPORT OFFICE: 13 E. 40th St., New York, N. Y. Cable ARLAB

NEW TELEVISION ANTENNA ROTATOR

Ideal reversible motor for rotating all types of antennas at the top. Weighs only 4 1/2 lbs. Size: 7 1/2" L. less shaft. Gear box and Mix. 4 1/2" x 3 1/2". Motor size: 3/4" L. x 2 1/4" D. Shaft size: 3/8" x 1 1/2" threaded. Operates from 24 V. DC. 2 amps. 4.5 RPM or 36 V. AC. Torque: 70 lbs. per inch. Price: \$8.95

TRANSFORMER—For above Rotator—110 Volt 60 cycle. Primary: 36 V.A.C. Sec. Price: \$2.95

WHIP ANTENNA FOR MOBILE AND STATIONARY USE

MP-48 Mast Base Mounting with heavy vertical coil spring. Insulated at top to receive Mast Section MS-53. Mast Base only \$2.95

MAST SECTIONS: For above MP-48, tubular steel, corner coated. Painted—In 3 foot sections. Bottom section MS-53 can be used to make any length. MS-52-51-50-49 for taper. Screw-In type. Any Section—Price .50 each

TRANSFORMERS—110 Volt 60 Cycle Primaries

Sec. 24 Volt 2 amp.	\$2.25
Sec. 14-14 or 28 Volt 7 1/2 or 15 amp.	4.95
Sec. 12 Volt 1 amp.	1.50
Sec. 24 Volt 1 amp.	1.95
Sec. 24 Volt .5 amp.	1.50

MOTOR CONTROL RHEOSTAT

Heavy-duty, wire wound control for regulating speed of AC or DC motors, toy trains, etc. 150 watt, 8.28 ohms, 5 amps. Price \$1.75

INTERPHONE AMPLIFIER BC-347

Army Aircraft Type. Uses 6FS Tube. Completely enclosed. Size: 2 1/2" x 3" x 6" Less Tube. Price—each 79c Or—Three (3) for \$2.00

TRANSTAT VOLTAGE REGULATOR

For 60 cycle AC voltage regulation. 103 V—126 V at 2.7 amps. Price: NEW \$9.95

DYNAMOTORS

INPUT:	OUTPUT:	STOCK NO.:	PRICE:
9 V. DC	405 V. 95 MA	DM 635 X	\$3.95
12 V. DC	220 V. 100 MA	D 402	3.95
12 V. DC	440 V. 200 MA	D 401	7.95
28 V. DC	F/ SCR 522	PE 94	7.95
12/24 V. DC	F/ No. 18 MARK II	P/S #3	9.50
13/26 V. DC	F/ BC-845	PE 101	2.95
12/24 V. DC	500 V. 50 MA	USA/0151	1.95
28 V. DC	F/ Comm. Receivers	DM 32	1.95
14 V. DC	230 V. 100 MA	DM 20	3.95
12/24 V. DC	440 V. 200 MA and 220 V. 100 MA	D 104	9.95
28 V. DC	400 Cycle Inverter	MC-148F (Reconditioned)	12.95

RECTIFIER UNIT

110 Volt 60 cycle input; output 12 V. DC 10 amps. Can be used to charge batteries or operate DC equipment. Electronic Lab. mfg. Price—NEW \$29.95

Address Dept. RE • All Prices Are F.O.B., Lima, Ohio • 25% Deposit on C.O.D. Orders

FAIR RADIO SALES

132 SOUTH MAIN ST. LIMA, OHIO

EVERY SERVICEMAN
CAN afford
SUPERIOR
TEST EQUIPMENT



THE NEW MODEL 770—
An Accurate Pocket-Size
VOLT-OHM MILLIAMMETER
(SENSITIVITY: 1000 OHMS PER VOLT)

Features:

- Compact—measures 3 1/4" x 5 1/2" x 2 1/4"
- Uses latest design 2% accurate 1 Mil. D'Arsonval type meter.
- Same zero adjustment holds for both resistance ranges. It is not necessary to readjust when switching from one resistance range to another. This is an important time-saving feature never before included in a V.O.M. in this price range.
- Housed in round-cornered, molded case.
- Beautiful black etched panel. Depressed letters filled with permanent white. Insures long-life even with constant use.

Specifications: 6 A.C. VOLTAGE RANGES: 0-15/30/150/300/1500/3000 volts.
6 D.C. VOLTAGE RANGES: 0-7 1/2/15/75/150/750/1500 volts.
4 D.C. CURRENT RANGES: 0-1 1/2/15/150/Ma. 0-1 1/2 Amps.
2 RESISTANCE RANGES: 0-500 ohms. 0-1 Megohm.

The Model 770 comes complete with self-contained batteries, test leads and all operating instructions

\$13.90
NET

We manufacture a complete line of radio test equipment.
Write Dept. RC-4 for FREE catalog today!

MFD. BY



SUPERIOR INSTRUMENTS CO.

227 Fulton St., New York 7, N. Y.

at your regular jobber

Some Prefer a Portable

Others Prefer a Standard

But ALL Prefer
TWIN-TRAX*

"The Tape Recorder
the Engineers are Buying"

When it comes to high fidelity sound equipment, it's the specifications that count with engineers. And that's why they're buying Twin-Trax—the popular-priced tape recorder with professional specifications. Extended frequency response, wide dynamic range, low hum level, easy operation, trouble-free performance! And two tracks means twice the playing time on standard tape reels, with tape costs cut in half—a saving you don't have to be an engineer to appreciate.

Write today for technical literature and professional factory discounts.

AMPLIFIER CORP. OF AMERICA

398-10 Broadway New York 13, N. Y.



YOU'LL SAVE
MANY DOLLARS
WITH THIS
BIG 180 PAGE
FREE
CATALOG

**TELEVISION, ELECTRONIC PARTS,
HIGH FIDELITY RADIO, HAM GEAR,
PUBLIC ADDRESS EQUIPMENT,
PARTS AND WORKSHOP TOOLS**

A penny postcard will bring you the 1949 Lafayette-Concord catalog. It's a bargain guide that means big savings to you. There are pages and pages of the finest equipment at amazing low prices. Use it to order everything you need, and pocket the difference. Helps you save both time and money. You'll like shopping from this mammoth book of bargains.

Write for your copy today. It's free!

LAFAYETTE-CONCORD

World's largest
radio supply
organization

LAFAYETTE-CONCORD, Dept. JD-9
100 Sixth Avenue, New York 13
901 West Jackson Blvd., Chicago 7
265 Peachtree Street, Atlanta 3

Please rush free catalog No. 89

Name.....
Address.....
City.....Zone.....State.....

RUSH THIS COUPON FOR FREE CATALOG

nection was made directly to the grid, as in diagram *b*, so that a future break in the tone-control circuit would not affect bias.

JOHN T. BAILEY,
Short Hills, N. J.

... PHILCO AUTO SETS

A frequent cause of low volume is a coating of grease and dirt on the 10-megohm resistor connected from the grid of the first audio stage to ground.

Do not draw the mounting nuts on the car's dash too tight when replacing the set; the material used on the control head is weak and will break after a period of vibration on the road.

E. E. BALDWIN,
Grand Island, Neb.

... SILVERTONE R1161

When the set hums loudly and all filter capacitors are good, check the ballast resistor R17 (manufacturer's part number) for shorts to the chassis. If it is shorted, replace or reinsulate it.

HURLEY D. ROBINSON,
Pullman, W. Va.

... DELCO R119

When the set lacks volume, check the .02- μ f capacitor between 6C5 plate and grid (manufacturer's part No. 88189). Leakage causes the trouble. There may or may not be distortion.

HURLEY D. ROBINSON,
Pullman, W. Va.

Radio Thirty-Five Years Ago
In Gernsback Publications

HUGO GERNSBACK
Founder

Modern Electricity.....	1908
Electrical Experimenter.....	1913
Radio News.....	1919
Science & Invention.....	1920
Radio-Craft.....	1929
Short-Wave Craft.....	1930
Wireless Association of America.....	1930

Some of the larger libraries in the country still have copies of ELECTRICAL EXPERIMENTER on file for interested readers.

**IN APRIL 1915 ELECTRICAL
EXPERIMENTER**

- 100,000-Cycle Alternators, by Frank C. Perkins
- Unique Method of Recording the Voice
- A Handy Radio Circuit, by Paul F. Shney
- Commercial Radio Transmitting Condensers
- A Novel Aerial for Radio Experiments, by Philip E. Edelman
- The Mignon Radio Coupler
- D. L. & W. Railroad Wireless
- Hammond Radio Boat Goes 56 Miles
- The D.C. Arc for Wireless Telegraphy and Telephony, by G. G. Blake
- Tikker for Undamped Waves, by James L. Green
- How to Construct a Radiation Indicator, by Chas. Rosenthal
- A Clever Mineral Detector, by Irving Byrnes
- Audion Amplifier Transformer

RADIO-ELECTRONICS for

TUBES! TUBES! TUBES!

NATIONALLY ADVERTISED BRANDS

BRAND NEW! BRAND NEW!

TYPE	PRICE	TYPE	PRICE	TYPE	PRICE
OZ4	\$.55	GAT6	\$.69	12J5	\$.49
1A7GT	\$.69	6AV6	\$.69	12KBY	\$.89
1B3GT	1.49	6BA6	\$.69	12SA7	\$.55
1D5GT	1.29	6BG6	1.89	12S17	\$.55
1D7G	1.19	6C4	\$.29	12SK7	\$.49
1HS6T	\$.69	6D6	\$.49	12SQ7	\$.49
1LC6	\$.99	6F8GT	\$.49	14A7	\$.55
1LDS	\$.99	6GG6	\$.95	14B6	\$.55
1LNS	\$.69	6H6	\$.49	14Q7	\$.55
1NSGT	\$.69	6J5GT	\$.49	25L5	\$.59
1RS	\$.69	6J6	\$.89	25Z5	\$.49
1S4	\$.69	6L6GA	1.09	25Z6	\$.49
1S5	\$.59	6S47GT	\$.45	30	\$.39
1S6	\$.59	6S07GT	\$.45	34	\$.39
3Q4	\$.59	6SK7GT	\$.45	35A3	\$.55
3Q5GT	\$.59	6SL7GT	\$.79	35L6	\$.55
3S4	\$.89	6SN7GT	\$.69	35WA	\$.45
5T4	\$.89	6SQ7GT	\$.45	35Y4	\$.49
5U4	\$.59	6SH7	\$.39	35Z3	\$.69
5V4	\$.89	6S7	\$.59	35Z5	\$.49
5X4	\$.49	6S77	\$.79	39/44	\$.39
5Y3GT	\$.39	6US/6GS	\$.69	50A5	\$.55
6A4	\$.89	6V6	\$.69	50B5	\$.55
6A7	\$.69	6X5	\$.69	50L6	\$.55
6AC7	\$.79	6Y6G	\$.79	57	\$.39
6AD7G	\$.89	7A8	\$.79	76	\$.39
6AR5	\$.89	12A6	\$.29	80	\$.42
6AK6	\$.89	12AT6	\$.49	11Z26	\$.69
6AL5	\$.79	12BA6	\$.59		
6AQ5	\$.79	12BE6	\$.59		

WRITE FOR COMPLETE NEW CATALOG
MINIMUM ORDER \$3.00

ALL PRICES F.O.B. N.Y.C.
ON COD ORDER 25% DEPOSIT

THE ROSE COMPANY

98 Park Place, Dept. E, New York 7, N. Y.

TELE- OR RADIOVISION?

In his editorial "Radiovision" in the July 1948 issue, your editor pointed out that the present state of the art permits transmission of video signals either by wire or through the air. It was advocated that the word *radiovision* be adopted and applied to video signals transmitted through space just as radio-telephone differentiates between wired and wireless transmissions.

Copies of the editorial were forwarded to some of the leading figures in the radio and television industry—both here and abroad—and they were asked to express their opinions in the matter. It was interesting to note that almost everyone who replied stated that they felt that *radiovision* is definitely more specific than *television* as a term for defining video transmission through space. Extracts from some typical letters are shown here:

... Of course *radiovision* is the only logical term. I hope you will be able to persuade both technical and non-technical minded people to accept your proposal.

*Ejner U. Christiansen,
Danske Radio Industri*

... Your suggested adaptation of *radiovision* instead of *television* is certainly to be recommended at least for radiated video. The prefix "tele" means afar and has been associated with communication by wires. ... The great difficulty lies in effecting the change after so many years of *television*.

*Benjamin F. Meissner,
Meissner Inventions, Inc.*

... *Radiovision* is a better and more expressive word than *television*. Persuade the industry to confine *television* to wire transmission and use *radiovision* for present broadcasting and you will have made a useful contribution toward clarifying the scientific vocabulary.

*G. Parr, Managing Editor,
Electronic Engineering (England)*

... *Television* should be applied solely to transmission of sight over wires, while *radiovision* should be confined to the transmission of sight via the medium of the ether.

*Pierre Boucheron,
Radio WGL (Fort Wayne, Ind.)*

... Personally, I think you have a very good point, and I would like to see it adopted before it is too late.

*G. B. Rowe,
John F. Rider Publisher, Inc.*

... Personally I am all for changing the name in view of the probability of wired vision.

*James Turner, Editor
Scottish Radio Trade Digest*

... We are happy to tell you that we share your views in this respect and

**GOVERNMENT SURPLUS!
WORLD'S LOWEST PRICE**

PHOTO FLASH EQUIPMENT



COMES COMPLETE WITH
4 EDGERTON FLASH TUBES & REFLECTORS

EASY TO CONVERT INTO A 2-WAY PHOTO FLASH UNIT OPERATES ON 110V. AC & 12V. BATTERY

Brand new at a fraction of original cost. Contains finest component parts available. All necessary parts and complete instructions included. After conversion, works on 110V AC or 12V battery by a flick of a switch.

WRITE FOR MORE DETAILED INFORMATION. IMMEDIATE DELIVERY COMPLETE

\$68.

CINEX, INC., 165 W. 46th St., N. Y. 19, N. Y., Dept. RE-4

500 FORMULAS TO SUCCESS

Many million dollar firms started with a single formula, for which they paid a big price. Here you have 500—no less—tried and tested formulas, recipes and processes for making things ... all at the ridiculously low price of 25¢.

Here is your opportunity to start a business with but a few dollars' capital and with undreamed of profits in prospect. You can also use these formulas in your own home to cut household expenses to the bone. Or you can put them to use in your workshop to cut costs as much as 100%.

Quit paying out many dollars in profits to manufacturers, wholesalers, and dealers, when you can make the same thing yourself for a few cents. It's so easy when you follow our simple instructions.

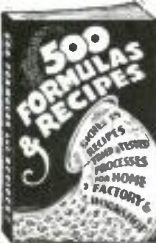

66 PAGES, 47,000 WORDS IN TEXT
Send for "500 FORMULAS AND RECIPES" today. Enclose 25¢, that's all you won't be asked for another cent now or later. Sold on a money-back guarantee.

NATIONAL PLANS COMPANY
1966R Broadway, New York 23, N. Y.

NOTICE TO TRUCK JOBBERS

We can supply you with complete stocks of all types of Nationally Advertised Brand Tubes, individually boxed, at 10% to 20% below distributor's cost.

Write—Wire—Phone For Details
REX PRODUCTS COMPANY, Dept. C-3
1313 W. Randolph St., Chicago 7, Illinois
Phone: SEaley 3-3030

TV LENS FILTERS
SAVE \$\$\$—REDUCE GLARE & EYE STRAIN—IMPROVE PICTURE QUALITY!!
Heavy acetate, blue tinted, EASILY ATTACHED IN A FEW SECONDS!! ... A "must" for complete TV enjoyment.

For 7" tubes	\$.75	For 15" tubes	\$1.89
For 10" tubes	.89	For 20" tubes	3.39
For 12" tubes	1.39		

HAND SIGNAL LAMP—Precision-built 5 colored lens turret (R—Red, Green, Blue, White, Clear). Adj. trigger switch & V-sight. Operates on 2 flash cells. Black wrinkle finish. With 2 bulbs. Shpg. wt. 5 lbs. **WHILE THEY LAST.**

GENERATOR VOLTAGE REGULATOR (GE)—Navy type GBD-1-A-18. Contains valuable 24 stepped contact 24V. adjustable; asstd. resistors, plugs & sockets, shock mounts, etc. Shpg. wt. 4 lbs. **A STEAL AT \$1.49**

HEARING AID AMPLIFIER ASSEMBLY
(Sonotone vacuum tube type). **MAKE A REAL VEST POCKET RADIO or AMPLIFIER** adding only small tuner & speaker or phone. Ready-wired miniature components include: 2 controls, output trans., choke, switch, resistors, condensers, etc. Overall ONLY: 2"x1/2"x5"—Weights 3 1/2 ozs. Less tubes & case. Complete with Diagrams for 2 or 3 tube set—**NOW ONLY \$2.49**



PORTABLE AC-DC AMPLIFIER
Here's a fine quality professional unit—**AMAZINGLY LOW PRICED!** Wide freq. response for use with **MUSICAL INSTRUMENTS, SPEECH or PHONO INPUT, FM TUNERS, etc.** FEATURES: 8" PM speaker, 2 inputs, vol. & tone controls, 110V. AC or DC. Beautiful Blue or Brown simulated leather case. 16 1/2"x13"x5 1/2". Complete with tubes. **1895**
Shpg. wt. 11 lbs.
ONCE IN A LIFETIME BUY!!!

JUMBO RADIO PARTS ASSORTMENT—MORE FOR YOUR MONEY!! DON'T MISS this GIANT kit of new & dismantled Radio & Electronic parts—17 FULL POUNDS OF COILS, TRANSFORMERS, WIRE, HARDWARE, SPEAKER ACCESSORIES, RESISTORS, CONDENSERS, CONTROL, ETC., ETC. ALL (17 lbs.) for ONLY **2.95**

Min. order \$2.00. 20% Deposit Req. on all C.O.D.'s. Please add sufficient postage—excess refunded.

LEDIONE RADIO CO.
67 Dry Street, New York 7, N. Y.

SERVICEMAN'S SUPER-MART



It's a serviceman's paradise, when he steps into our store. We have lost the use of the word "no" when these boys walk in or write for parts. "Yes" is the word to all their requests because we try to satisfy every serviceman. And don't forget, our prices are subject to regular dealer discounts. How about getting on our mailing list? Write Dept. E4.

ADSON RADIO & ELECTRONICS CO.
221 Fulton Street New York 7, N. Y.

TELEVISION IS HERE!!

Our new catalog lists hundreds of new television items; sets, parts and accessories at unbelievably low prices. Write today—its free!

Television Transformer.
Pri. 115 Volts 60 Cycles. Sec. 2500 Volts @ 2 ma.; 6.3 Volts @ .6A.; 2.5 Volts @ 1.75A
PRICE \$3.85

MODEL NFRD—RADIO NOISE FILTER

If it doesn't work, send it back!!

We absolutely guarantee that our Model NFRD will eliminate all line noises when properly connected to radios, television sets, short wave sets, motors, electric shavers, refrigerators, vibrators, oil burners, transmitters, and all other sources of interference. This unit will carry up to 12 amperes or 1½ KW of power and may be used right at the source of interference or at the radio.

Small size only 3"x1½"x7½". Very low price only EACH **\$1.95**

EASILY ASSEMBLED RADIO KITS

5 Tube AC-DC superhet kit furnished in a brown plastic cabinet of artistic design, cabinet size (9"x5"x6")

Variable condenser tuned; with 2 double tuned I. F.'s.

Tubes used: 1 - 12SA7, 1 - 12SQ7, 1 - 12SK7
1 - 35Z5 and 1 - 50L6

PRICE \$11.95 including 5 standard tubes

3 WAY PORTABLE KIT

- For operation on 110 volt AC or DC and battery
- Superheterodyne circuit
- Full vision dial
- High gain loop
- Two-Tone brown leatherette cabinet, size 7x12½x6½"
- Tubes used: 1R5, 35A, 18S, 2 - 1T4, plus rectifier.

PRICE \$13.75 Not including tubes
Extra for kit tubes \$3.75

A SCIENTIFICALLY DESIGNED PHONO SCRATCH FILTER

Resonated at approximately 4500 cycles effectively reducing objectionable needle scratch without altering the brilliancy of reproduction.

Contains a HI-Q SERIES resonated circuit. Tested by means of an audio oscillator and an oscilloscope to give 22 db. attenuation with very low signal loss.

EASY TO ATTACH
Just two wires to clip on. Compact
Price **\$1.98**

THREE TUBE PHONO AMPLIFIER

An assembled unit ready for installation using tone and volume control and six feet of rubber cord

(Not including Tubes) **\$2.95**
With Complete Set of Tubes **\$3.95**

PHONO OSCILLATOR

Wireless phono oscillator transmits recording for crystal pick-ups or voices from carbon mike through radio without wires. Can also be used as an intercom by using P.M. speaker as mike. Price

(excluding tubes) **\$2.95**
With Complete Set of Tubes **\$3.95**

DUAL SPEED RECORD CHANGERS

VM Model 801A. Economically priced, will play the new 33 1/3 and the standard 78RPM records automatically. Features a single tone arm with dual reversible cartridge. Price **\$26.65**

VM Model 400C. A high fidelity low cost two speed record player. Will play either type of record by a quick flip of the finger. 78RPM records can be played intermittent—10" and 12" sizes—only one tone arm used with reversible needles. Price **\$33.90**

VM Model 402. Deluxe Model has all the features of Model 400C above plus a quick quiet changing cycle—less than 4 seconds between records, automatic cut off and quick gentle handling of records. Beautifully finished. Price **\$36.00**

SPECIAL! SPECIAL!

Mammoth assortment of radio and electronic parts, not less than TEN POUNDS of new transformers, chokes, condensers, resistors, switches, coils, wire, hardware, etc. A super-buy for experimenters, servicemen, and amateurs for only **\$1.25**

Satisfaction guaranteed on all merchandise.

All prices F.O.B. New York City

WRITE FOR FREE CATALOG T-4

RADIO DEALERS SUPPLY CO.

154 Greenwich St. New York 6, N. Y.

glad to report that a number of personalities consulted do the same.

Karl Pinsker, Editor
Radio-Service (Switzerland)

. . . In our opinion, *radiovision* in place of *television* is more appropriate. . . . No doubt the new term will sound a bit strange to people used to *television*, but all will soon get used to it.

D. D. Lakhanpal, Editor
Radio Times of India

. . . *Radiotelevision* seems to me much more logical, but it has the big disadvantage of including four syllables. For this reason, I think *radiovision* would be even better. I think too, that if any change is to be made, it should be made now.

John Moyle, Editor
Radio & Hobbies (Australia)

. . . I think it a very good idea to use *radiovision* instead of *television* for video transmissions through space. Surely it is of great value if *television* can be reserved for video transmission by wire.

John Schroder, Editor
Popular Radio (Stockholm)

. . . It seems to me that we could profitably follow your line of thought and adopt *radiovision* as applying to transmission by radio, and perhaps, leaving *television* for transmission by wire.

E. T. Flewelling

. . . *Radiovision* is more truly descriptive word for radiation of visual information in all directions, as against *television* which should mean video information aimed in one direction, as over a wire.

Hamilton Hoge, President
United States Television Mfg. Corp.

. . . As to my opinion with regard to adopting *radiovision* instead of *tele-*

vision for transmission by radio, I entirely agree with you that the matter is urgent.

D. Capolino, Editor
Radio Schemi (Italy)

. . . It is my belief that your suggestion comes too late. While the number of television stations and receivers is relatively small, *television* is literally a household word.

James Hillier,
RCA Laboratories Division

. . . It would seem that *television* (for vision) is appropriate whether used for transmission by wire or radio. *Radiovision* is confined to the latter only, and today radio transmission is almost always associated with co-axial cable or wire transmission.

R. L. Triplett,
The Triplett Electrical Instrument Co.

. . . For many years, Commander MacDonald advocated the use of *radionics* instead of electronics, yet all groups still prefer to use the latter expression. . . . Once a word is imbedded in the public's mind, it stays there. *Radiovision*, I think, will never replace *television*.

J. R. Poppele,
Vice President, WOR

. . . Your suggestion referring to the present *television* as *radiovision* will probably never be adopted. Words never come into popular usage unless the muscular effort and expenditure of energy required to pronounce the new word is less than that required to enunciate the older form. The pitch of the human voice is determined by the tension of the vocal cords, and the contour of the frequency spectrum is determined by the four major resonances of the mouth, throat, and nose. A large muscular effort is required to change the resonant points of these resonances. *Television* requires



Suggested by Louis Joliet, Haverhill, Mass.

Nol Nol Junior, you've got too much contrast!

RADIO-ELECTRONICS for

TUBES 30¢

IN BULK LOTS OF 100 EACH

Individually boxed, assorted, 34c each
THOUSANDS OF SATISFIED BUYERS!

Made by leading manufacturer—RMA Guaranteed.
Money back if not completely satisfied.

1R5	384	6C8G	6SF5GT	6X5GT	12S17GT
1B5	6AT6	6K5GT	6S7GT	12AT6	128K7GT
1T4	6BA6	6SK9GT	6K6GT	12BA6	35W4
1U3	6BE6	6SA7GT	6S8GT	12BE6	50B5
3Q4	6B8G	6SD7GT	6V6GT	12SA7GT	11Z3

6SN7GT, 12SN7GT—48c ea.

RCA • GE • SYLVANIA • RALTHEON
NATIONAL UNION • TUNGSO
KEN-RAD • HYTRON

Individually boxed Standard RMA Guarantee
5Y3GT—45c; 6F8GT—55c; 6SN7GT—90c; 12S17GT
—70c; 25L6GT—70c; 25Z5—60c; 25Z6GT—80c;
35L6GT—65c; 35Z5GT—49c; 50L6GT—65c

Above ten types show manufacturer's brands. Shipment will be made of makes available when order is received.
... Specify Price When Ordering ...



FORTHEUHFBUGS

Here's the best bet yet in UHF gear! A portable test oscillator designed for the Navy. Gold-plated cavity resonator provides freq. range of 234 to 258 mc. Includes 2-955's. Ready to go. Plenty of room in the battery compartment to house a small modulator and power supply... Oit... RIP out the parts and you have a dandy 1/16" aluminum cabinet (no holes) with handle. Dzus fasteners.

9 1/2" x 6 1/2" x 6 1/2" \$3.95

RADIONIC EQUIPMENT COMPANY

Tribune Theater Entrance
170H Nassau Street New York 7, N. Y.
WOrth 2-0421
Open daily 9-6 • Saturday 9-5

FREE: MAIL TODAY ↓

RADIONIC EQUIPMENT COMPANY Dept. 104
170H Nassau St., New York 7, N. Y.

Please rush free copy of latest bulletin of radio and television bargains in parts, tubes, sets and accessories.

Name

Address

City..... State.....

HEADSET H-16U SPECIAL



8000 ohm Dual. Headset H-16U—most sensitive phones built—noiseproof—may be used as a sound powered intercom—Also used with simple Xial to make a complete radio receiver—light, durable, efficient, molded, soft neoprene earcups, shaped to snugly and comfortably envelope the entire ear. Everyone BRAND order or check today.
Special per Pair \$1.89
Plus 25c each for postage

ATTENTION Amateurs-Experimenters-Inventors

Cut your cost on radio supplies and equipment in half. Clip coupon today. Hundreds of "hard to get" war surplus items along with the best in standard brand equipment—all at great savings to you. Let us know your particular requirements. IMMEDIATE DELIVERY.

PLEASE PUT MY NAME ON YOUR MAILING LIST FOR SPECIAL BULLETINS.

NAME

ADDRESS

CITY..... STATE.....

NIAGARA RADIO SUPPLY CORP.
160 Greenwich St., New York City 6, N. Y.

a minimum of muscular activity during its pronunciation. *Radiovision*, while substantially the same length, nevertheless involves a rapid tuning of these resonances.

L. A. de Rosa,
Federal Telecommunication Laboratories, Inc.

WITH THE ASSOCIATIONS

The Pennsylvania Federation of Radio Servicemens Associations elected new officers at its January meeting, held in Harrisburg. Dave Krantz of Philadelphia was elected chairman, Robert Reidy of the Lehigh Valley association, vice-chairman, and John Rader of the Reading group, secretary and treasurer for 1949. Arrangements were made for the annual award of a plaque to the individual or organization who had done the most for the radio technician and the radio servicing industry during the past year.

The Associated Radio Technicians of British Columbia are issuing their *Bulletin* in a bright new format. Beginning with the December, 1948, issue, it is a little magazine, 7 x 8 inches, folded and stapled. Paper and type are good and easy to read. The December issue had twelve pages, and the January issue, eight.

The Mid-State (Harrisburg, Pa.) association reports two unexpected results from the recent Preventive Maintenance Month. First one is that the campaign increased the number of radios in operation in the district by at least 25%. Large numbers of people brought in radios which had been lying around since "shortage of parts" made it impossible to repair them in wartime. Second unexpected result is that people in the Harrisburg district were awakened to the existence of the Association by the Maintenance Month advertising to an extent that would have been impossible with any mere publicity campaign. Set owners now know about the Mid-State Association and look for member shops when their radios are in need of repair.

The Monterey Peninsula (California) Radio-Electronics Trade group reports a successful lecture meeting, attended by technicians who came from as far as San Jose, 74 miles away. Plans are being made to erect a cooperative television antenna to learn the possibilities of television reception from San Francisco.

The Radio Electronic Technicians Association (RETA) of Orangeville, Ontario, counts members in five neighboring towns. Meetings are being held monthly at one of these towns, 50% of all meetings being held at the Orangeville headquarters.

The Associated Radio Technicians of Alberta are working out their own classification system. Technicians will probably be rated in five groups: no certificate rating, beginners, radio technicians, radio service engineers, and radio service managers, reports L. V. Devitte, secretary of the Calgary branch of the Association.

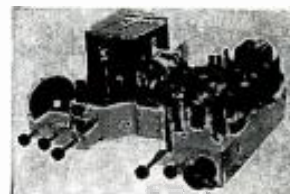

630 Type TELEVISION CHASSIS

IN KIT FORM OF ASSEMBLED

— PRICES ON REQUEST —

PARTS FOR SAME SOLD SEPARATELY

PUNCHED CHASSIS	5.45
No. KRK2W—R.C.A. TUNER.....	39.50
GENERAL ELECTRIC TUNER.....	28.95
POWER TRANSFORMER, 295 ma, 115 V.....	14.95
VIDEO and I.F. KIT, w/peaking coils.	11.97
FOCUS COIL	4.70
DEFLECTION YOKE.....	5.45
WIDTH CONTROL.....	.47
HORIZONTAL CONTROL54
YOKE MOUNTING HOOD.....	.97
FILAMENT CHOKE15

SPECIAL TRANSFORMERS

VERTICAL OUTPUT.....	3.15
VERTICAL BLOCKING.....	1.80
HORIZONTAL OUTPUT.....	5.45
HORIZONTAL BLOCKING.....	2.25

GUARANTEED C.R. TUBES

10—INCH, 10BP4.....	34.50
12 1/2—INCH, 12TP4.....	51.95
15—INCH, 15CRT.....	79.50
TWIN LEAD-IN, 300 ohms 100 ft....	1.95
TWIN LEAD-IN, 300 ohms, 500 ft....	7.95
CO-AX CABLE, RG59U, 100 ft.....	5.25
CO-AX CABLE, RG59U, 500 ft.....	24.75

BROOKS RADIO DIST. CORP.
80 VESEY ST., DEPT. A, NEW YORK 7, N. Y.

AUTO RADIO RECEPTION Intensified

with the **SIGNAL**

A featherweight unit that gives greatly increased signal pickup when attached to any type whip car aerial. Attached instantly—adjustable for any angle—will not wind-whip—highly decorative—not-rusting, allows use of rod in telescoped position or extended—greater volume—greater distance.

The Signal Soc is the most unusual auto radio item to appear on the market in the past ten years.

Available in Red, Blue, Green, or natural anodized aluminum finish.
List price \$2.00
Your Cost \$1.20



Specify colors wanted Check with order. Postpaid in U.S.A. (Jobber inquiries invited.)

WORLD IN COLOR PRODUCTIONS
108 W. Church St. Elmira, N. Y.

SERVICEMEN'S RADIO PARTS KITS

100 Asst. Insul. Res. \$1.45	20 Asst. Knobs .5
10 Asst. By-Pass .45	1 Lb. Asst. Radio Hdw. .25
20 Asst. Trimmers .59	15 Asst. Sockets .59
25 Asst. Mic. .89	10 Asst. Elect. cond. 2.69
10 Asst. Vol. Controls .89	20 Asst. Term. Strip .69
1 Lb. Asst. cut wire .69	20 9" length Spag. .15

Buy All Above Kits for \$9.75. Enclose Postage.
DONGNE FM-AM 13-TUBE TUNER. Complete ready to operate..... \$39.95
88-108 Mc-550-1600 Kc.
REMIT IN FULL FOR FAST DELIVERY
RADIO MAIL ORDERS
75 Barclay St. Dept. RE N. Y. 7, N. Y.

STILL THE LEADER!

The famous ACA-100 Amplifier — a self-balancing, drift-correcting, direct-coupled amplifier — the most satisfying musical amplifier ever designed. Based on early Loffin-White circuits, perfected by A. C. Shaney in 1936, and now brought to a standard of quality far above that of any corresponding amplifier. Exclusive features include:

- Push-Pull Triode Expander.
- Non frequency-discriminating noise suppressor.
- Push-pull hi and lo freq. variable equalizers.

If you are satisfied with nothing less than the best, write today for free technical literature.

Special models for all magnetic cartridges.



AMPLIFIER CORP. OF AMERICA
398-10 Broadway New York 13, N. Y.



Assembled for your convenience

Facts, standards practices, data

for the whole field of radio engineering

Radio Engineering Library

RADIO specialists of the McGraw-Hill publications selected the books for this library as those giving the most complete, dependable coverage of facts needed by engineers whose special fields are grounded on radio fundamentals. They cover circuit phenomena, tube theory, networks, measurements, and other subjects . . . give specialized treatment of all fields of practical design and application.

★ Special Low Price
Bought singly, the five volumes would cost \$30. Under this offer you save \$2.50.

★ Pay in easy installments

★ **FREE 10 DAY TRIAL!**

- Library includes:**
1. **FUNDAMENTALS OF VACUUM TUBES**—Eastman
 2. **RADIO ENGINEERING**—Terman
 3. **COMMUNICATION ENGINEERING**—Everitt
 4. **HIGH-FREQUENCY MEASUREMENTS**—Hund
 5. **RADIO ENGINEERING HANDBOOK**—Henney
- 3559 pages!
2558 illustrations!

McGraw-Hill Book Co., 330 W. 42d St., N.Y.C. 18

Send me Radio Engineering Library, 5 vols., for 10 days' examination on approval. In 10 days I will send \$2.50, plus a few cents postage, and \$5.00 monthly until \$27.50 is paid, or return books postpaid.

Name.....

Address.....

City.....Zone.....State.....

Company.....

Position.....RC-4-49

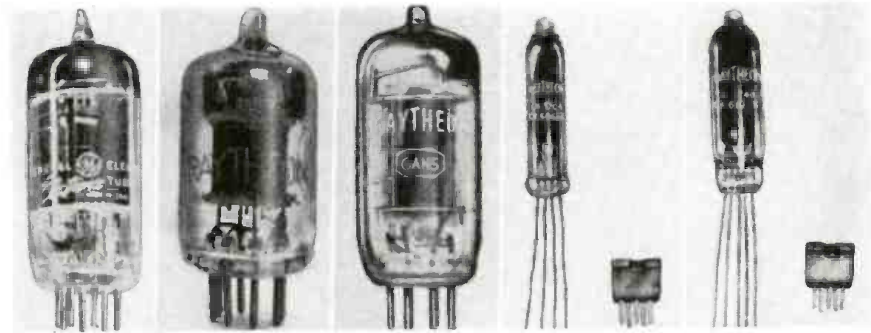

From left to right: GL-5610, CK-5654, 6AN5, CK5704/CK606BX and CK5744/CK619CX.

NEW MINIATURE AND SUBMINIATURE TUBES

Five new miniature and subminiature tubes have made their appearance recently.

General Electric announces the GL-5610, a 7-pin miniature designed for industrial jobs, such as operating a relay in a control circuit. Maximum rated plate voltage is 300 and plate dissipation is 3 watts. For typical operation, heater voltage is 6.3, plate current 17 ma, and plate resistance 3,500 ohms. The tube's seated height is 1 1/8 inches.

Raytheon has announced four tubes. The CK5654 is a rugged version of the 6AK5. The heater will withstand at least 5,000 on-and-off cycles at 7.5 volts. Other improvements suit the tube es-

pecially for aircraft and other services where dependability and long life are important.

Raytheon's 6AN5 is a miniature pentode usable in many cases as a replacement for the 6AG7. Normal plate current is 35 ma, transconductance 8,000 ohms. It is also useful at very high frequencies and as a switching tube for computers.

The CK5704/CK606BX is a subminiature diode with characteristics similar to half of a 6AL5. The resonant frequency of the tube is over 1200 mc.

Another Raytheon subminiature, the CK5744/CK619CX, is a high-mu triode for general-purpose use.

CUSTOMERS SELL THEMSELVES SOUND

With the emphasis placed by manufacturers in the last few years on high fidelity in sound reproduction, the buyer of tuners, amplifiers, record players, and speakers is confronted with a problem in selecting the components he likes best. Recognizing that the best way to decide is to compare them directly, two large radio suppliers have set up unusual electrical comparison circuits in their sound salesrooms.

Sun Radio and Electronics Company of New York has allocated a large room to audio equipment. At one end, all the popular high-fidelity speakers are arranged in three tiers; at the side is a large group of FM and AM tuners and record players. A large push-button board allows the customer to select any combination of components and to change the combination as often as he



Switching panel on wall combines any of the pieces of equipment in Sun's sound sales room.

RADIO-ELECTRONICS for

telrex INC.
CONICAL ANTENNAS
RUTHERFORD AVENUE ON ROUTE 35
ASBURY PARK, N. J. PHONE: ASBURY PARK 1 0119
BOX 879R, ASBURY PARK, N. J.

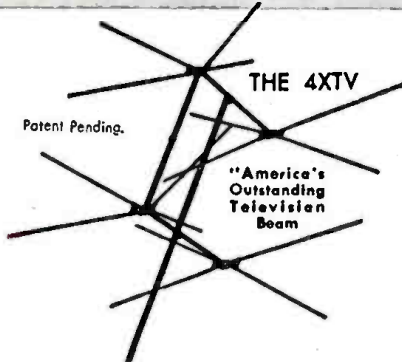

- Hi-Gain Stacked Conical "V" Beam
 - Channels 2 to 13 Plus FM
 - Low Inception Angle
 - Extremely High Signal to Noise Ratio
 - 150 Ohm Non-varying Impedance
 - Use 72, 150 or 300 Ohm Transmission Lines
 - Universal Mounting Clamps
- SEE YOUR DISTRIBUTOR**

\$1,000 A MONTH

JUST ONE of the many plans in this book brought in over \$1,000 a month steadily from radio service alone. **How To Make More Money in Radio Service** is so full of money-making plans it will amaze you. EVEN BEGINNERS using the easier plans made WAY OVER \$100 a week working from home. Why work for wages? Become your own boss and make more money. This book is making money for radiomen everywhere: U.S.A., Canada, Puerto Rico, Mexico, So. America, Hawaii, Philippines, other countries. Letters of thanks come in continually.

—Book very helpful—following advice in the book earned high as \$100 a week radio repairing in my apartment.
C. C. Seidler,
Brooklyn, N. Y.

In business 17 years. Book contains many things which took me many years to learn the hard way. Book worth many times its small cost.
P. V. Fustner,
Elmwood, Illinois

25 years' experience packed in 83-page book by Gale. Among MANY other things shows you where the money is and how to get it FAST: How to test sets without taking them out of cabinets and give estimates RAPIDLY; How much to charge; How much work to do on sets; How to start spare and build to full time; How to connect with big-money concerns; How to get plenty of customers QUICKLY.

HOW TO BUILD A MONEY-MAKING RADIO MAIL ORDER BUSINESS—another hit by Gale, 88 pages. Two easy-to-follow plans. Real opportunity to get in BIG-PAYING business. Start spare or full time. How to start with other dealers' money and stock; How to work with customers' money; How to obtain sales items easily; How to handle your incoming cash, checks, money orders; How to make repeat sales; The secret of the chain and MANY other things. Millions \$\$\$ going in the mails. Get your share. The world is your market. You may reach it from attic, cellar, or apartment. There is MAGIC in your mail box. Learn to use it and start streams of cash, checks, and money orders toward you from North, East, South, and West.

Price each book ONLY \$3 postpaid. C.O.D.'s in U.S.A. only, at \$3 plus few cents postal fee. Books shipped same day. You have NOTHING TO LOSE. Examine book 5 days. If not positively satisfied, return it and we refund purchase price immediately. More information on books FREE.

MERIT PRODUCTS, DEPT. RE.
216-32 132 Avenue Springfield Gardens 13, N. Y.

wishes. Best of all, since the mere push of a button changes source, amplifier, or speaker instantly, he has the rare opportunity of comparing the sound quality of two speakers, for instance, without the usual time lag required for plugging in. The "sound memory" is notoriously tricky, and this time lag usually makes a comparison between two good-quality sounds unreliable. With instantaneous switching, however, any difference in sound is unmistakably apparent.



William Rivkin of the New York store demonstrates Lafayette-Concord's switching system.

Sun encourages the customer to operate the buttons himself so that he can change combinations as often as necessary to convince himself of the rightness of his choice. Twenty-six hundred component combinations are possible, and the customer literally "sells himself."

Lafayette-Concord Radio has made a somewhat similar system available in its New York, Newark, Boston, Chicago, and Atlanta stores. Here ten record players, 45 amplifiers, and 21 speakers are interconnected with rotary switches. The salesman can select any combination of units at the customer's request.

The instantaneous selection system appears to benefit both customer—who can quickly satisfy his own desires—and the salesman—whose sales talk is largely unnecessary. It may well be adaptable to the requirements of other dealers.

THE ORIGIN OF "VIDEO"

Video was first used to designate television back in 1932, Dr. Orestes H. Caldwell revealed recently. Dr. Caldwell, former Federal Radio Commission chairman and now publisher of *Tele-Tech*, recalled that it was at an RMA subcommittee meeting in New York, when committee members appointed to propose TV standards were asked to find a name for the frequencies which produce pictures. After an hour of cogitation, each member came up with a list and "video" was finally chosen. The word is believed to have come from John V. L. Hogan's list.

**TELEVISION
SERVICING at a
PRICE YOU CAN PAY**

**R. S. E. 3 inch
TELEVISION SCOPE**

Features:

- WIDE BAND VER-TICAL RESPONSE
- FLAT TO 750kc
- DOWN 3db
- AT 1mc
- VOLTAGE GAIN OF 20 AT 5mc

AR-3

The R.S.E., AR-3 Scope has been built by Armstrong to our rigid specifications. It's a complete unit that embodies standard horizontal amplifier and sweep circuits with normal sensitivity.

The case is 8" high x 5" wide x 14" long, attractively finished in "hammered" opalescent blue enamel. Operates on standard 110 volts—60 cycles—40 watts. Tubes, 38P1—6AC7—6SJ7—6X5—5Y3—884. Instructions included. Complete specifications upon request. Satisfaction or your money back.

PRICE \$49.95
F. O. B. DETROIT

**PUSHBACK
WIRE**

BELOW MILL PRICES!

2,000,000 feet—tinned copper—all 1st. class, double cotton serve, waxed finish. Available 1,000 foot rolls.

22 gauge (6 colors) \$3.98 roll
20 gauge (6 colors) 4.98 roll
18 gauge (brown only) 6.49 roll

MIDGET I. F. TRANSFORMERS

Original List \$2.10
NOW 36c EACH

At discounts up to 86%

400-500 Kc range
1 1/4" square, 3" high
hi-gain iron core.
INPUT—A826
OUTPUT—A827

Matched Pair	Specify Type	Egg Crate of 100
69c	Dozen	\$29.00
	\$3.95	

ORDER INSTRUCTIONS

Minimum order—\$2.00. 25% deposit with order required for all C.O.D. shipments. Be sure to include sufficient postage—excess will be refunded. Orders received without postage will be shipped express collect. All prices F.O.B. Detroit.

RADIO SUPPLY & ENGINEERING CO., Inc.
85 SELDEN AVE. DETROIT 7, MICH.

RADIO SCHOOL DIRECTORY

SPECIALIZE • SPECIALIZE



You can become a Radio and Television Technician now!

A million new jobs — almost 4,000 a week — will be created in the television industry during the next five years according to estimates of industry leaders. Actually, during 1948, television grew faster than any other industry in the history of America.

Here is a real opportunity for you. Trained television technicians are in demand. By starting now, you can get in on the ground floor — grow as television grows.

To help supply this needed manpower, the Milwaukee School of Engineering has expanded its radio and television courses. Now you can get complete practical, technical training in the MSOE laboratories. *This is not just a serviceman's course.* It prepares you for a career in all of the technical phases of television and radio.

This special course Prepares you for any of the following careers:

- | | | |
|-------------------------------|---|--|
| Television Serviceman | Supervisor in Radio and Television Assembly | Police, Taxi-Cab and Railroad Transmitter Operator |
| Radio Serviceman | Radio and Television Tester | Police, Taxi-Cab and Railroad Receiver Serviceman |
| Radio and Television Retailer | Broadcast Radio-Operator | |

OTHER COURSES AVAILABLE		
SERVICE	TECHNICIAN	PROFESSIONAL
6 to 12 Months	1 to 2 Years	3 Years
• Electricity	• Electrotechnics	• Electrical Engineering
• Welding	• Radio and Television	Bachelor of Science
• Refrigeration	• Electronics	Degree
• Heating	• Refrigeration, Heating and Air Conditioning	Major in Electronics or Power

MILWAUKEE SCHOOL of ENGINEERING

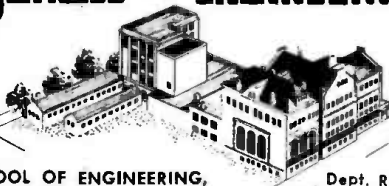

A Technical Institute Founded 1903
by Oscar Werwith

MILWAUKEE SCHOOL OF ENGINEERING,
N. Broadway and E. State

Dept. RE-449
Milwaukee, Wis.

Without obligation send me free booklet "Career Building" and more details on course in Radio and Television or _____ course.

Name _____ Age _____

Address _____

City _____ State _____

LEARN RADIO!

PREPARE FOR A GOOD JOB!
COMMERCIAL OPERATOR (CODE)
RADIO SERVICEMAN
TELEVISION SERVICING
BROADCAST ENGINEER
Veterans get \$130.00 Equipment
SEND FOR FREE LITERATURE
BALTIMORE TECHNICAL INSTITUTE
1425 Eutaw Place, Dept. C, Baltimore 17, Md.



RADIO ENGINEERING

FM—Television—Broadcast

Police Radio, Marine Radio, Radio Servicing, Aviation Radio and Ultra High mobile applications. Thorough training in all branches of Radio and Electronics. Modern laboratories and equipment. Old established school. Ample housing facilities. 7 acre campus. Small classes, enrollments limited. Our graduates are in demand. Write for catalog.

Approved for Veterans
VALPARAISO TECHNICAL INSTITUTE
Dept. C VALPARAISO, INDIANA

RCA RADIO and TELEVISION
Thorough Training in All Technical Phases
APPROVED FOR VETERANS
DAYS—EVENINGS WEEKLY RATES
RCA GRADUATES ARE IN DEMAND
For Free Catalog Write Dept. RC-49
RCA INSTITUTES, Inc.
A Service of Radio Corporation of America
350 WEST 4TH STREET NEW YORK 14, N. Y.



JOB IN TELEVISION

YOUNG MEN 16 TO 60
There is a Job Opening for Every Qualified Trained Television Technician
WE CAN TRAIN YOU
Free Employment Service
Visit Our Modern Laboratories and Class Rooms
APPROVED UNDER G.I. BILL OF RIGHTS
AMERICAN RADIO INSTITUTE
New York Buffalo, N. Y. Syracuse, N. Y.
101 W. 63 St. 640 Main St. 131 Shonnard St.
"Teaching Radio Since 1935"

TELEVISION NEW, INTERESTING TECHNICAL CAREER

As Television gains momentum, rapidly, constantly, it offers to properly-trained technicians careers with a future in Industry, Broadcasting or own Business.
Train at an Institute that pioneered in TELEVISION TRAINING since 1938. Morning, Afternoon or Evening Sessions in laboratory and theoretical instruction, under guidance of experts, covering all phases of Radio, Frequency Modulation, Television, Licensed by N. Y. State. Free Placement Service. Approved for Veterans.
ENROLL NOW FOR NEW CLASSES
Visit, Write or Phone
RADIO-TELEVISION INSTITUTE
480 Lexington Ave., N. Y. 17 (46th St.)
Plaza 3-4585 2 blocks from Grand Central



RADIO COURSES

Preparatory, Service, Broadcast, Television, Marine Operating, Aeronautical, Frequency Modulation, Radar.
Classes now forming for the summer term June 1st
Entrance exam. May 16
Veterans. Literature.
COMMERCIAL RADIO INSTITUTE
(Founded 1920)
38 West Biddle Street, Baltimore 1, Md.

CODE SENDING SPEED

Be a "key" man. Learn how to send and receive messages in code by telegraph and radio. Commerce needs thousands of men for jobs. Good pay, adventure, interesting work. Learn at home quickly through famous Candler System. Qualify for Amateur or Commercial License. Write for FREE BOOK.
CANDLER SYSTEM CO.
Dept. 3-D, Box 928, Denver 1, Colo., U.S.A.

LIKED SERVICING STORY

Dear Editor:

The article "Using Your Ohmmeter," in the January issue, is well worth reading by the average plant electrician who services electronic equipment such as automatic welders and photo-electric relays. I also like the articles on photo-electric relays which have been printed in RADIO-ELECTRONICS. I had trouble with some and the articles were a great help.

EARL MYERS,
Brantford, Ont.

ONE LIMITER NOT ENOUGH

Dear Editor:

I had the same trouble with automobile ignition interference on the FM band as Mr. Zarattaro ("Communications," August, 1948). I was using an "old-band" receiver with a single limiter and a discriminator.

I modernized the set by adding a tuner with a ratio detector. With the same antenna and lead-in, there was no more ignition noise.

My conclusion is that a single limiter is no use. If you can't afford a tuner with dual limiters, use a ratio detector.

ALAN M. PALMER,
Brooklyn, N. Y.

VARIETY OF ARTICLES

Dear Editor:

RADIO-ELECTRONICS has improved greatly both in quality and in contents. The editors can be proud of the great variety of subjects so well covered and illustrated.

AUDIO ENGINEERING SCHOOL

A practical Audio Engineering course in Sound Fundamentals; FILM and MAGNETIC Recording; Transmission Measurements; Monitoring and Mixing. Laboratories contain Transmission Sets, Oscillators; Harmonic Analyzer, Distortion Sets, Intermodulation Analyzer, and other equipment. Recording Studio simulating Broadcast, Motion Picture and Commercial Sound Recording. H. M. Tremaine, Pres.-Director. Approved for Veterans and Foreign Vets.

HOLLYWOOD SOUND INSTITUTE, Inc.
1040-E North Kenmore Hollywood 27, Calif.

RADIO COURSES

- RADIO OPERATING
- RADIO SERVICING
- F.M. TELEVISION
- CODE
- ELECTRONICS

• REFRIGERATION SERVICING

Write for Catalog and Pictures Brochure

Y.M.C.A. TRADE & TECHNICAL SCHOOLS
229 W. 68 St. (West of B'way) New York City

CORRESPONDENCE COURSES IN RADIO and ELECTRICAL ENGINEERING

ELECTRICAL ENGINEERING Get good grasp of wide electrical field. Prepare yourself at Low Cost, for secure future. Modern course. So simplified anyone can understand quickly.

RADIO ENGINEERING Extra fine course in radio, public address, photo-electric work. Trains you to be super-service man, real vacuum-tube technician. Servicemen needed badly. Diploma on completion. Many graduates earning big pay.

FREE Electronic Kit given to students enrolling by June 1. WRITE for free school catalog, student magazines, course details of deferred Payment plan, etc. Lincoln Engineering School, Box 931-RE-4, Lincoln 2, Neb.

ELECTRICAL TRAINING

Intensive 32 weeks' residence course in fundamentals of industrial electrical engineering, including radio, electronics. Prepares for technician, engineering aides. Approved for veteran training. 56th year. Enter April 4, Sept. 6. Catalog.

BLISS ELECTRICAL SCHOOL
7544 TAKOMA AVENUE
WASHINGTON 12, D. C.

The variety of articles you print should make every issue interesting if it is read—not just glanced through. Many times I find small items more interesting than many feature articles, yet they could be passed over unread when glancing quickly through the magazine.

JOHN KWIETINSKAS
Duquesne, Pa.

NO TV FOR CANADA

Dear Editor:

I know the U. S. serviceman needs all those articles on television, but it will be a long time before they are any use to us in Canada.

I find J. R. Langham's articles very informative.

D. DODD,
Winnipeg, Canada

REPORTS TELEVISION DX

Dear Editor:

I thought you might be interested in my television dx. I was in sort of a "hole" so I put up a 40-foot tower and a Taco 495 antenna. I get New Haven most of the time; that is about 100 miles away. Channel 4 in both New York and Boston comes in so I can't watch one unless the other is off the air. Some nights WFIL-TV in Philadelphia interferes with more local reception on channel 6. I am using a Hallicrafters T-54 and two boosters.

DONALD E. SMITH,
Northfield, Mass.

CORRECTIONS

There should be a ground connection at the junction of the 250-ohm and 470,000-ohm resistors in the output stage of the TG-10 conversion diagram on page 78 of the February 1949 issue.

We thank Mr. Theodore C. Smith, of Rome, New York, for calling our attention to this omission.

The value of R10 was omitted from the parts list of the Phono Amplifier on page 78 of the January 1949 issue. This resistor is a 1,000-ohm 5-watt unit.

Our thanks to Mr. Walter Johnston, of Atlanta, Ga., for this correction.



F.B. Suggested by Isadore Waber, Philadelphia, Pa.
"Y' know, sometimes I feel like these darned things are coming out of my ears."

RADIO TUBES

All Brand New

MONEY BACK GUARANTEE!

THIS LIST COMPRISES
OVER 8500 TUBES

6C4, Kenrad .19

1B5,	Sylvania	.29
1C6,	General Elec.	.29
1H6,	Sylvania	.29
1G4,	R.C.A.	.29
1LA6,	Sylvania	.69
1LC6,	Sylvania	.69
1LD5,	Sylvania	.39
1LE3,	Sylvania	.79
1LH4,	Sylvania	.69
5T4,	R.C.A.	.69
5V4,	Sylvania	.85
5X4,	Cunningham	.69
6E5,	General Elec.	.69
6G6,	Philco	.59
6F5,	Stand. Brand	.59
6H6,	Kenrad	.37
6K7,	R.C.A.	.49
6SQ7,	General Elec.	.39
7A6,	Sylvania	.59
7B6,	Sylvania	.59
7C7,	Sylvania	.59
7F7,	Sylvania	.59
7F8,	Philco	.59
12SR7,	Kenrad	.29
12SJ7,	R.C.A.	.49
12Z3,	Cunningham	.69
14A7,	Sylvania	.49
14B6,	Sylvania	.49
14Q7,	Sylvania	.49
14R7,	Sylvania	.49
35L6,	Hytron	.55
35W4,	Sylvania	.39
35Z5,	Kenrad	.39
50A5,	Sylvania	.79
50B5,	Sylvania	.55
50L6,	Kenrad	.55
117L7,	Tungsol	.88
117N7,	Philco	.88
117Z3,	Tungsol	.69
117Z6,	Sylvania	.88
OZ4,	Stand. Brand	.59
26,	Cunningham	.36
30,	Cunningham	.19
34,	R.C.A.	.29
56,	Hytron	.29
75,	Stand. Brand	.69
76,	Philco	.39
77,	Nat. Union	.39
80,	Stand. Brand	.39

Substitutes of other standard brands will be made if listed tubes are out of stock

TELEVISION TUBES

Guaranteed Brands

10"	—10BP4\$34.50
12½"	—12TP4 51.95
15"	—15CRT 79.50

BROOKS RADIO DIST. CORP.
80 Vesey St., Dept. A, New York 7, N. Y.

AT LAST! A LOW COST POWER UNIT for Service Work

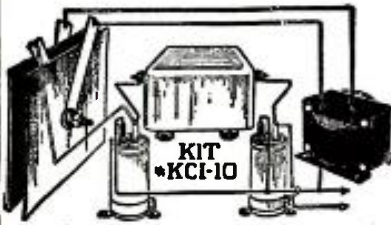

"A" Eliminator Kit #KC I-10
Including pictorial and schematic diagrams **\$1950**

These kits fulfill the long-standing need of every serviceman and technician. They are designed to operate from a 115 V.A.C. 50/60 cycle source, and deliver 6 V.D.C.'s well-filtered from three to eight amperes, with a peak rating of ten amperes. The A.C. ripple percentage is held to remarkably low values.

This unit charges a standard auto battery in one day!!

- Do away with bulky batteries!
- Do away with corroding fumes!
- Simplify your service operation!

Order this fine kit for your bench today!!

No C.O.D.'s, please. Orders received without sufficient allowance for postage will be shipped via Railway Express collect.

Shipping wt., 12 lbs.

OPAD-GREEN COMPANY

71 Warren St. New York 7, N. Y.
Phone: BEekman 3-7385-6

LEARN

Electricity OR Radio-Television IN THE GREAT SHOPS OF COYNE



TRAIN QUICKLY!
OLDEST, BEST EQUIPPED SCHOOL OF ITS KIND in U.S.
2 Opportunity Fields

Come to the Great Shops of COYNE in Chicago during our 50th Anniversary Year! Get quick, practical training in RADIO-TELEVISION or ELECTRICITY. G. I. Approved. Finance plan for non-veterans. Mail Coupon Today for complete details.

NOT "HOME-STUDY" COURSES!
You learn on real, full-size equipment, not by mail. Finest staff of trained instructors to help you get ready quickly for a better job, a fine future.

FREE BOOKS Clip coupon for big illustrated Coyne book on either ELECTRICITY or RADIO-TELEVISION. Both books sent FREE if you wish. No obligation; no salesman will call. Act NOW!

B. W. COOKE, Pres.
COYNE Electrical & Radio School, Dept. 49-51H
500 S. Paulina Street, Chicago 12, Illinois

Send FREE BOOK and full details on:

ELECTRICITY RADIO-TELEVISION

NAME.....

ADDRESS.....

CITY..... STATE.....

CLARKSTAN PHONO NEEDLE GAUGE



Essential for Micro Groove & standard equipment. Accurate to one gram—has both gram and ounce scales for proper weight adjustment of all types tone arms. Net price \$1.50.

SEE YOUR JOSSER TODAY.
CLARKSTAN CORP. 11927 West Pico Blvd. Los Angeles 34, Calif.

ADVERTISING INDEX

APRIL 1949

Adson Radio & Electronics Company.....	89
Allied Radio Corporation.....	57
Amplifier Corporation of America.....	88, 92, 97
Arrow Sales, Inc.....	80
Bargain Radio.....	82
Bell Telephone Laboratories, Inc.....	Back Cover
Boland & Boyce, Inc.....	74
Bradshaw Instruments Company.....	74
Brooks Radio Distributing Company.....	83, 91, 95
Buffalo Radio Supply.....	63
Capitol Radio Engineering Institute.....	9, Inside Back Cover
Certified Television Laboratories.....	82
Cinacograph Speakers.....	87
Cinex, Inc.....	89
Clarkstan Corporation.....	96
Cleveland Institute of Radio.....	18
Columbia Electronics.....	97
Commercial Radio.....	82
Communications Equipment Company.....	83
Coyne Electrical School.....	96, 97
DeForest's Training, Inc.....	7
Esse Radio Company.....	68, 69, 70
Fair Radio Sales.....	87
Feiler Engineering Company.....	76
Franklin-Elis Co.....	86
General Electronic Distributing Company.....	Inside Front Cover
Green Radio Distributors.....	62
Graylock Electronic Supply Company.....	82
Haildorson Company, Inc.....	78
Hallmark Electronic Corporation.....	84
Heath Company.....	12, 13, 14, 15
Hudson Specialties.....	80
Instructograph Company.....	96
Lafayette-Cancard.....	88
Leatone Radio Corporation.....	89
McGee Radio Company.....	8
McGraw-Hill Book Company, Inc.....	92
Merit Products.....	93
Metropolitan Electronic and Instrument Co.....	81
Mid-America Company.....	81
Midwest Co.....	84
Miles Reproducer.....	96
Montgomery Ward.....	11
Moss Electronic Distributing Company.....	86
Murray Hill Books, Inc.....	82, 85
National Plans Company.....	89
National Radio Institute.....	3
National Schools.....	5
Niagara Radio Supply Company.....	84, 91
Opad-Green Company.....	96
Opportunity Adlets.....	79
Pan American World Airways.....	82
Perfect Products.....	73
Precision Apparatus Company.....	78
Progressive Electronics Company.....	84
Quam Nichols Company.....	79

RADIO SCHOOL DIRECTORY

(Pages 94-95)

American Radio Institute
Baltimore Technical Institute
Bliss Electrical School
Candler System Company
Commercial Radio Institute
Hollywood Sound Institute, Inc.
Lincoln Engineering School
Milwaukee School of Engineering
RCA Institutes
Radio Television Institute
Valparaiso Technical Institute
YMCA Trade & Technical Schools

Radcraft Publications, Inc.....	77
Radio City Products Company, Inc.....	76
Radio Dealers Supply Company.....	90
Radio Distributing Co.....	96
Radio Mail Orders.....	82, 91, 96
Radionic Equipment Company.....	91
Radio Publications.....	96
Radio Supply & Engineering Company.....	93
Rex Products.....	89
The Rose Company.....	89
Senco Radio, Inc.....	16
N. Silverstine Co.....	59
Simpson Electric Company.....	67
Spartan School of Aeronautics.....	72
Spellman Television Company.....	83
Sprague Products Company.....	65
Stephens Manufacturing Corporation.....	4
Superior Instruments.....	88
Sylvania Electric Products.....	17
Television Assembly Company.....	6
Telrex, Inc.....	93
Transvision.....	10, 41
United Surplus Materials.....	75
The Videocraft Company.....	82
Wells Sales, Inc.....	98
World in Color Productions.....	91

\$139 PHONO AMPLIFIER

2 Tube AC-DC
3 at \$1.25 2 tubes—50L6—35Z5 \$1
PHONO OSC—2 TUBE \$2.75
Uses 35Z5, 128A7, 2 tubes \$1.20
PHONO AMPLIFIER
3 Tube AC-DC **\$1.69**
3 at \$1.49
Volume and Tone Controls.
Uses 12SQ7, 35Z5, 50L6.
Set of 3 Tubes.....\$1.35
Output Trans......32
5" Alnico Speaker.....1.10
8" PM Speaker.....1.45
ALLIANCE PHONO MOTORS
PICKUP \$1.79—HIGH OUTPUT PICKUP.....1.99
ALL ABOVE WIRED & TESTED
\$1 Deposit on all orders. Free Catalog RE
RADIO MAIL ORDERS
75 Barclay St., New York 7, N. Y.

Get Started in Radio



10 "HOW-TO-DO-IT" BOOKS
Get a solid foundation in radio by means of these 10 timely text books. Each clearly written, profusely illustrated, contains over 15,000 words. You'll be amazed at the wealth of information packed into these handy books. Excellent for reference—ideal for technical library. Your money back if not satisfied.

5 BOOKS for 50c
10 BOOKS for \$1.00
Sent to You Postpaid

- | | |
|--|-------------------------------------|
| No. 1—How to Make Four Doerte Short Wave Sets | No. 6—How to Make Fun With Radio |
| No. 2—How to Make the Most Popular All-Wave 1 and 2 Tube Receivers | No. 7—How to Read Radio Diagrams |
| No. 3—Alternating Current for Beginners | No. 8—Radio for Beginners |
| No. 4—All About Aerials | No. 9—Simple Electrical Experiments |
| No. 5—Beginners' Radio Dictionary (Leading Terms) | No. 10—Television |

Remit by check or money order—re-Plaster letter if you send cash or stamps.

RADIO PUBLICATIONS

25A West B'way. New York (7)

"TELEMIKE" FOR PHONE TALKS

A new midget inductor unit for picking up the conversations on both ends of the line for transmission to any type disc, wire, film or cylinder electric recorder. Designed to operate also with a standard good quality radio receiver, phonograph or microphone amplifier for group loud speaker listening. This unit fits over the outside of the carpiece of the standard telephone or may be concealed inside the telephone base (cradle type) or inside of ringer box. Requires no electrical connection to the telephone or its wires. Complete with 5 feet of cable.
Type "P" 1 1/2"x2 1/2"x1/2" thick
picks up conversation a few inches away from telephone

\$15.00

\$20.00

80% cash with order, balance C. O. D.

Send orders to Dept. RB.

MILES REPRODUCER CO., INC.
812 Broadway New York 3, N. Y.

EASY TO LEARN CODE

It is easy to learn or increase speed with an Instructograph Code Teacher. Affords the quickest and most practical method yet developed. For beginners or advanced students. Available tapes from beginner's alphabet to typical messages on all subjects. Speed range 5 to 40 WPM. Always ready—no QRM.



ENDORSED BY THOUSANDS!

The Instructograph Code Teacher literally takes the place of an operator-instructor and enables anyone to learn and master code without further assistance—thousands of successful operators have "acquired the code" with the Instructograph System. Write today for convenient rental and purchase plans.

INSTRUCTOGRAPH COMPANY

4701 Sheridan Rd., Dept. RC, Chicago 40, Ill.

COUPON-OF-THE-MONTH

- | | |
|---|--------------|
| TUBES—STD. BRAND 5Y3 GT..... | 3 for \$0.99 |
| TUBES—STD. BRAND 12SQ7 or 12AT6..... | 2 for .99 |
| VOL. CONTROLS—STD. BR. .5 Meg. W. SW..... | 3 for .99 |
| CONDENSERS—40-40 Mfd. 150V..... | 2 for .99 |
| CONDENSERS—20-20 Mfd. 150V..... | 3 for .99 |
| LOOP ANTENNA—HI GAIN (5"x8")..... | 3 for .99 |
| I.F. COILS 455 KC (1 1/2"x2 1/4")..... | 3 for .99 |
| OSC. COILS 455 KC (for 12SA7)..... | 4 for .99 |
| BY PASS COND. .001—18 Ass'd..... | .99 |
| SIGNAL COND KIT—100 Rt. Ass'd. & 8 Springs..... | .99 |
| GRILLE CLOTH—6 Ass'd. 6"x6" & 10 Knobs..... | .99 |
| COMBINATION KIT—All Above Items—Only..... | 10.00 |

WITH THIS COUPON—ORDER AT ONCE
Write for Monthly Coupons and Bulletin
RADIO DISTRIBUTING CO. PASADENA 18, CAL.

RADIO-ELECTRONICS for

1949 BBC YEAR BOOK, published by the British Broadcasting Corporation, London. 5 x 7½ inches. 152 pages. Price 3 shillings sixpence.

Like the previous editions of this yearly report, the 1949 BBC Year Book is a compilation of articles by British Broadcasting's performers, officials, and engineers. Of interest to the shortwave listener, it does an excellent job of telling how the BBC operates and what it has accomplished during the year. The large number of illustrations of familiar broadcasters give the BBC listener a chance to see the people whose voices he hears from afar.—*R.H.D.*

THE ADVERTISING AND BUSINESS SIDE OF RADIO, by Ned Midgley. Published by Prentice-Hall, Inc., New York. 5¼ x 8¼, 363 pages. Price \$5.35.

While intended primarily for those interested in selling radio time (and buying it) and in the financial end of broadcasting, the volume will be of interest to the technical and program staffs of the larger radio stations, who usually look upon the business operations of the station as an unfathomable mystery.

The text explains in adult language the why and wherefore of rate fixing, discount figures, contract provisions, network procedures, spot sales, and the like. The various sales adjuncts are covered fully—audience research, promotion, campaign planning. A valuable feature is the inclusion of specific data—financial and historical—on the major networks and their affiliates. Sections on FM and TV bring the information right up to date.—*R.H.D.*

ELECTRONIC MUSICAL INSTRUMENTS, by S. K. Lewer. Published by *Electronic Engineering*, London, England. 5½ x 8½ inches, 101 pages. Price 3 shillings sixpence.

A welcome addition to the pitifully small supply of literature on electronic music, this little book describes and classifies electronic musical instruments, then devotes a chapter each to oscillating-tube circuits, and electrostatic, electromagnetic, and photoelectric tone generators. Another chapter deals with amplifiers and control circuits. These latter are important in electronic musical instruments. A volume control which would be satisfactory on a radio, for example, would wear out in a short time under the constant use to which it would be subjected in an electronic musical instrument.

Some interesting material on the acoustics of music is found in an introductory chapter, and a bibliographical selection is furnished in an appendix.

MICROWAVES and RADAR ELECTRONICS, by Ernest C. Pollard and Julian M. Sturtevant. Published by John Wiley & Sons, Inc., New York. 5¼ x 8¼ inches, 426 pages. Price \$5.00.

The authors have so prepared this book that it is easily read and understood by almost anyone with a background of elementary college physics and mathematics and a working knowledge of electron-tube theory.

The first chapter, Electromagnetic Fields and Microwaves, introduces the reader to the background material required for understanding microwaves. If the reader lacks a college background in physics and mathematics, he is likely to have trouble with this chapter. The

remaining chapters, Coaxial Lines, Waveguides and Cavities, The Production of Microwaves, Microwave Technique, Pulse Circuits, Cathode-Ray Tube Indicators, Tuned Amplifiers, Amplification of Very Weak Signals, Servomechanisms and Computers, Miscellaneous Circuits, Radar and its Accessories, Microwave Communications, and Microwaves in Physical Research are definitely college-level text book material but can be understood by anyone with a slightly more than average knowledge of radio and electronic fundamentals.

Three appendices cover The Fourier Integral, Curl and Stokes' Theorem, and Units. The latter describes the units of measurement used by the authors in discussing electric and magnetic fields.—*R.F.S.*

THEORY AND APPLICATION OF RADIO-FREQUENCY HEATING, by George H. Brown, Cyril N. Hoyer, and Rudolph A. Bierwirth. Published by D. Van Nostrand Company, Inc., New York. 9¼ x 6 inches, 370 pages. Price \$6.50.

This is a mathematical treatment of radio-frequency heating theory and practice based on the findings of the authors, research engineers in the RCA Laboratories. It contains a wealth of information on the design of radio-frequency heating equipment and heating techniques.

Although highly mathematical, the material is supplemented by charts and diagrams that offer graphical proof of the mathematical derivations.

The 24 chapters are illustrated with photographs of experimental and commercial equipment used for radio-frequency heating. Some of the more interesting chapters cover such topics as soldering, brazing, baking paints, welding, pasteurization of foods and drugs, and efficiency of heating equipment.—*R.F.S.*

BIG MONEY IN RADIO & TELEVISION

New 5-Volume Set

FREE for 7 days trial

APPLIED PRACTICAL RADIO

Be the radio expert of your locality—The one they come to with the toughest service jobs.

This new 5 volume set gives you solid working knowledge of Radio and Television. Covers everything from basic principles to newest in FM, Television, Testing Instruments, etc. Clear, practical. Tells you how to construct, install, service. Gives you short-cut trouble shooting methods. More than 1500 pages, 1000 illustrations, charts, diagrams.

FREE TRIAL OFFER Examine these great, pay-raising books for 7 days at our expense. Just fill in and mail coupon below. That's Coyne's FREE Trial Offer!

FREE! 150 RADIO & TELEVISION DIAGRAM BOOK!

If you act at once, we will include with APPLIED RADIO our big practical book "150 Radio and Television Diagrams Explained" as a FREE Gift. If you don't want the set, send it back at our expense within 7 days. If you keep the set, send either \$15 cash, or \$3 in 7 days and \$3 a month until \$16.75 is paid. Either way, the Diagrams book is yours to keep! Send coupon today. If it's not an order—just a request to see the Set and get the Diagrams book Free. Act now!

GOOD FOR FREE TRIAL and FREE BOOK!

Educational Book Publishing Division
COYNE ELECTRICAL & RADIO SCHOOL, 500 S. Paulina St.
 Dept. 49-T1, Chicago 12, Ill.
 Rush APPLIED PRACTICAL RADIO, postpaid, for 7 days FREE Examination per your offer. Also include FREE Book of 150 Radio Diagrams Explained.
 Name Age
 Address
 Town Zone State

COLUMBIA

Gem of the Surplus!

TCS RECEIVER—3-BAND

1.5 Mcs to 12Mcs. Designed by the top commercial communication equipment manufacturer—Collins. A proven, rugged performer. Standard on every Navy ship afloat. Good used condition. Ea. **\$34.95**

ASB RECEIVER

Complete with lighthouse tubes in R.F. sections. Ideal for citizens' bands. Used but good condition. Ea. **\$17.95**
 NOTE: Brand new sets also are available.

GO-9 HIGH FREQUENCY TRANSMITTER

Frequency range 300 to 600 Kc—3,000 to 18,100 Kc. No plug-in coils needed. Manual band switching system. Power output: 125 watts. Has very stable E.C.O. Ready as is to go on the air—no changes necessary. It's hot on 20, 40 and 80 meter bands. Extra! We'll supply a technical manual with first 25 sets sold! External power supply necessary. Used, excellent condition. Rock-bottom low price: **\$67.95**

LORAN SCOPE

6A/APN-4—a terrific piece of lab equipment! With 110V supply it can be used for many tests. Contains 27 tubes such as 6SN7GT, 6H6GT, 6SL7GT and a raft of others, plus 100 Kc crystal, 22 pots, switches, condensers, transformers, etc. In aluminum case approx. 9"x12"x18". Used but in very excellent condition. Schematic supplied FREE. Each **\$27.50**

TUBES! TUBES!

12DP7—brand new!
 Each **\$13.95**

APN-1 ALTIMETER—420 MC FM TRANSCEIVER

With tubes, dynamotor. Used, but in good condition. **\$4.95**

\$64.00 QUESTION: Have YOU received our NEW, hot-off-the-press catalogue? THEN SEND FOR IT!!!

All prices F.O.B. Los Angeles. 25% deposit with order. Balance C.O.D.

COLUMBIA ELECTRONICS

Department R-C
 522-524 S. San Pedro Street
 Los Angeles 13, California

Booklets by A. C. Shaney

Written by a foremost Audio design engineer—
Yours almost as a gift!

- Elements of Magnetic Tape Recording and 999 Applications **25¢**
- Direct-Coupled FM-AM Amplifier Manual **25¢**
- 20 Steps to Perfect Amplification **3¢ in postage**

Thousands Sold!
 Famous Twin-Trax Instruction Book! Practically a course in tape recording. 30 diagrams, illustrations.
\$250 (Price may be applied against future purchase of chassis.)

AMPLIFIER CORP. OF AMERICA
 398-10 Broadway New York 13, N. Y.



TUBES

• TRANSMITTING
• RECEIVING
• INDUSTRIAL
• SPECIAL PURPOSE

Guaranteed by WELLS

Brand new, standard make tubes by the thousands are ready for immediate delivery at the lowest prices in our history. Check this list for exceptional values in magnetrons, cathode ray tubes, voltage regulators, transmitting tubes and also neon, pilot and flashlight bulbs. Be sure to order enough for future needs directly from this ad or through your local parts jobber.

Type	Price	Type	Price	Type	Price	Type	Price
O1A	\$0.50	RK-34	\$0.45	RK-715B	\$7.95	874	\$2.15
0Z4	1.05	36	.55	717A	.90	884	1.50
1B22	5.55	37	0.55	721A	3.95	954	.55
1R4/1294	.65	38	.55	724B	4.25	955	.55
1R5	1.12	39/44	.34	725A	19.95	956	.55
1S5	1.12	41	.55	726A	19.95	957	.55
1T4	1.12	45 Spec. VT-52	.55	801	.60	1005	.45
2C26	.55	46	.85	801A	.80	1148	.40
2C26A	.70	49	.75	803	7.75	1201	.95
2C44	1.25	EF50/VT-250	.65	804	10.45	1616	1.25
2J22	14.85	RK60/1641	.65	805	5.75	1619	.55
2J31	14.85	72	1.10	807	1.20	1624	1.25
2J32	14.85	CEQ-72	1.55	810	7.95	1625	.45
2J38	18.95	76	.55	811	2.35	1626	.45
2J48	16.55	77	.55	813	7.85	1629	.45
2X2/879	.75	VR-78	.68	814	3.75	1636	4.75
3A5	1.10	80	.41	815	2.85	2050	.78
3B22	3.95	83	.85	826	.49	2051	.95
3B25	1.15	83V	.95	829	3.25	7193	.35
3BP1	3.75	VR-90	.70	829B	3.95	8011	2.55
3C24/24G	.49	VT-90/8011	2.55	830B	3.75	8012	4.35
3D6/1299	1.25	VR-92	.65	832A	3.50	8020	3.25
3E29/8298	3.95	100R	3.45	837	1.25	9001	.70
3FP7	2.95	FG-105	10.95	838	3.25	9002	.65
3HP7	2.95	VR-105	.90	841	.55	9003	.55
3Q5	.95	VT-127 English	.35	843	.55	9004	.55
REL-5	19.95	VT-127A Triode	2.55	851	39.50	9006	.55
5AP1	3.75	VR-150	.70	WL-860	2.55		
5EP1	2.85	VT-158	9.85	861	34.50		
5EP4	3.95	211	.65	864	.55		
5CP1	3.85	215A	1.95	865	2.55		
5GP1	6.55	218	4.45	866A	1.40		
5J23	14.85	249C	2.95	869B	28.95		
5J29	14.85	282B	4.35	872A	2.45		
6AC7	.95	304TH	6.55				
6B7	.99	304TL	.90				
6C6	.75	316A/VT-191	.75				
6C8G	1.05	350B	2.55				
6C21	19.95	371B	2.55				
6D6	.60	388A	6.45				
6F8G	1.05	417A	19.85				
6H6	.52	GL434A	4.95				
6J5	.52	446A	1.55				
6L7	.90	446B	1.55				
6SG7	.95	GL471A	2.95				
6SL7	.65	WL-530	24.95				
6SN7GT	.85	WL-531	19.95				
7A7	.70	532A	3.55				
7C4/1203	.45	GL-559	3.75				
10/VT-25	.52	KU-610	7.45				
12A6	.35	Hy-615	1.25				
12C8	.35	WL-681	19.95				
125G7	.68	700B	9.95				
12X825, 2 amp. Tungar	2.95	700C	9.95				
FG-17	2.95	700D	9.95				
RK20A	4.95	702A	2.95				
REL-21	3.65	704A	1.95				
23D4 Ballast	.35	705A	2.65				
28D7	.45	707A	19.50				
30/VT-67 {For	.95	707B	23.25				
33/VT-33 {Walkie Talkies	.95	710A	2.15				
34	.35	714AY	9.95				

NEON BULBS FOR RADIO USE

NE-2	\$0.06
NE-15	.06
NE-48	.24
NE-16	.24
NE-51	.06

PILOT AND FLASHLIGHT BULBS

Stock No.	Mazda No.	Volts	Watts	Bulb	Base	Price Each
64	350-40	6-8	E3 CP	G-6	DC Bay	\$0.07
1820	350-50	28	.1 Amp	T-3 1/2	Min. Bay	.12
57	350-31	12-16	1.5 CP	G-4 1/2	Min. Bay	.08
Spec.	350-42	12	6 Watts	S-6	Cand. Scr.	.13
1446	350-20	12	.2 Amps	G-3 1/2	Min. Scr.	.07
49	350-14	2	.06	T-3 1/4	Min. Bay	.06
356	350-15	120	3 Watts	S-6	Can. Bay	.11
PR-10	348-22	6	.5 Amps	B-3 1/2	Min. Flang	.05
1477	350-18	24	.17 Amp	T-3	Min. Scr.	.16
323	350-55	3 (Aircraft)		T-1 1/2	953	.22
350-19	350-19	120	500 W	T-20	Med. Pf.	1.45
44 (Ruby)	LB-103	6-8	.25 Amp	T-3 1/2	Min. Bay	.04
1195	LB-102	12-16	50 CP	RP-11	DC Bay	.14
313	LB-104	28	.17 Amp	T-3 1/2	Min. Bay	.11
12	350-24	12	.09 Amp	T-2	Tel Base	.18
24-A2 W E	LB-107	24	.75 Amp	T-2	Tel Base	.18
S-14 ARGON	LB-109	105	2 1/2 Watt	Med.	Screw	.22
TELEPHONE TYPE NEON	350-63			T-2		.17
6-8	350-41	943	100 CP	G-1 1/2	S. S. Pref.	.65
18	350-43	11A/T4C	.11 Amp	T-4	Cand. Scr.	.14

Manufacturers: We carry thousands of electronic parts in stock. Send us your requests for quotations.

Distributors: Our standard jobber arrangement applies. Order directly from this ad.



320 N. LA SALLE ST. DEPT. Y, CHICAGO 10, ILL.



Change Your Uncertainty to PROFIT with CREI's New Home Study Course in

Television and FM Servicing

TELEVISION'S growth has been so rapid that it has exceeded the forecasts of even the experts. And it has exceeded the abilities of a lot of radio servicemen, because they aren't properly qualified to work with TV and FM.

If you want to make your future secure in the expanding servicing field, CREI can show you the way this new, *practical* Servicing Course. *It helps you earn more money faster because it assumes you already know radio fundamentals.* Yet you do not have to be an engineer to reap the benefits. The course is not over the heads of those with limited experience—if they have natural ability and a real desire to get ahead. It teaches what you need to know to install and repair TV and FM sets. It gives you sound instruction in basic radio math, lenses and mirrors, modern test equipment, inductive coupling and condensers at ultra-high frequencies; practical applications of resonant circuits; TV tubes; FM receiver alignment; TV anten-

nas; picture synchronization; TV trouble-shooting—and much more, all of a practical nature that you can put to work immediately.

Chairman Wayne Coy of the FCC estimates there will be 400 TV stations on the air within two years—and 1,000 in eight or nine years. David Sarnoff, chairman of the board of RCA, predicts about 18 million TV sets will be in use by the end of 1953. FM figures are equally impressive, with about 4,000,000 more radios with FM forecast in 1949. There can be no doubt about the importance of, and the need for, experienced TV-FM servicemen. Are you going to be qualified for the increased earnings that lie ahead?

VETERANS! THIS COURSE IS G.I. APPROVED.

MAIL TODAY!

RADIO SERVICE DIVISION OF
CAPITOL RADIO
ENGINEERING INSTITUTE
An Accredited Technical Institute

Dept. 154A, 16th & Park Road, N. W., Washington 10, D. C.
 Branch Offices: N. Y. 7, 170 Broadway; San Francisco 2, 760 Market St.

CAPITOL RADIO ENGINEERING INSTITUTE
 16th & Park Road, N. W., Dept. 154A, Washington 10, D. C.

Gentlemen:

Send me complete details of the new home study course and the booklet that explains the CREI self-improvement program and courses. I am attaching a brief resume of my experience, education and present position.

NAME _____

STREET _____

CITY _____ ZONE _____ STATE _____

I AM ENTITLED TO TRAINING UNDER G. I. BILL.

Vibration Control



Columbian Humming Birds, one of the famous drawings from nature by John James Audubon.

Wing vibration, nimbly controlled, keeps the humming bird in flight, enables it to feed without alighting.

Electric vibration is the essence of telephone transmission. Voice, music, pictures, teletype—no matter what type of signal—the story is told by the frequency and strength of not one, but many vibrations.

Learning how to control electric vibrations to pin-point accuracy has been one of the basic jobs of Bell Laboratories scientists in their development of the “carrier” art which enables the sending of many more conversations over existing

wires. Among their inventions have been oscillators, modulators, filters, coaxials, wave-guides, and radio lenses.

Constantly Bell Laboratories scientists discover new and better ways to control and adapt electric vibrations by wire or radio to the needs of the telephone user. Their pioneer work in this field is one important reason behind today’s clear, dependable and economical telephone service.

BELL TELEPHONE LABORATORIES



Exploring and inventing, devising and perfecting, for continued improvements and economies in telephone service.