

**RADIO
NEWS**

RADIO-ELECTRONIC

Engineering

DEPARTMENT

**AUGUST
1944**

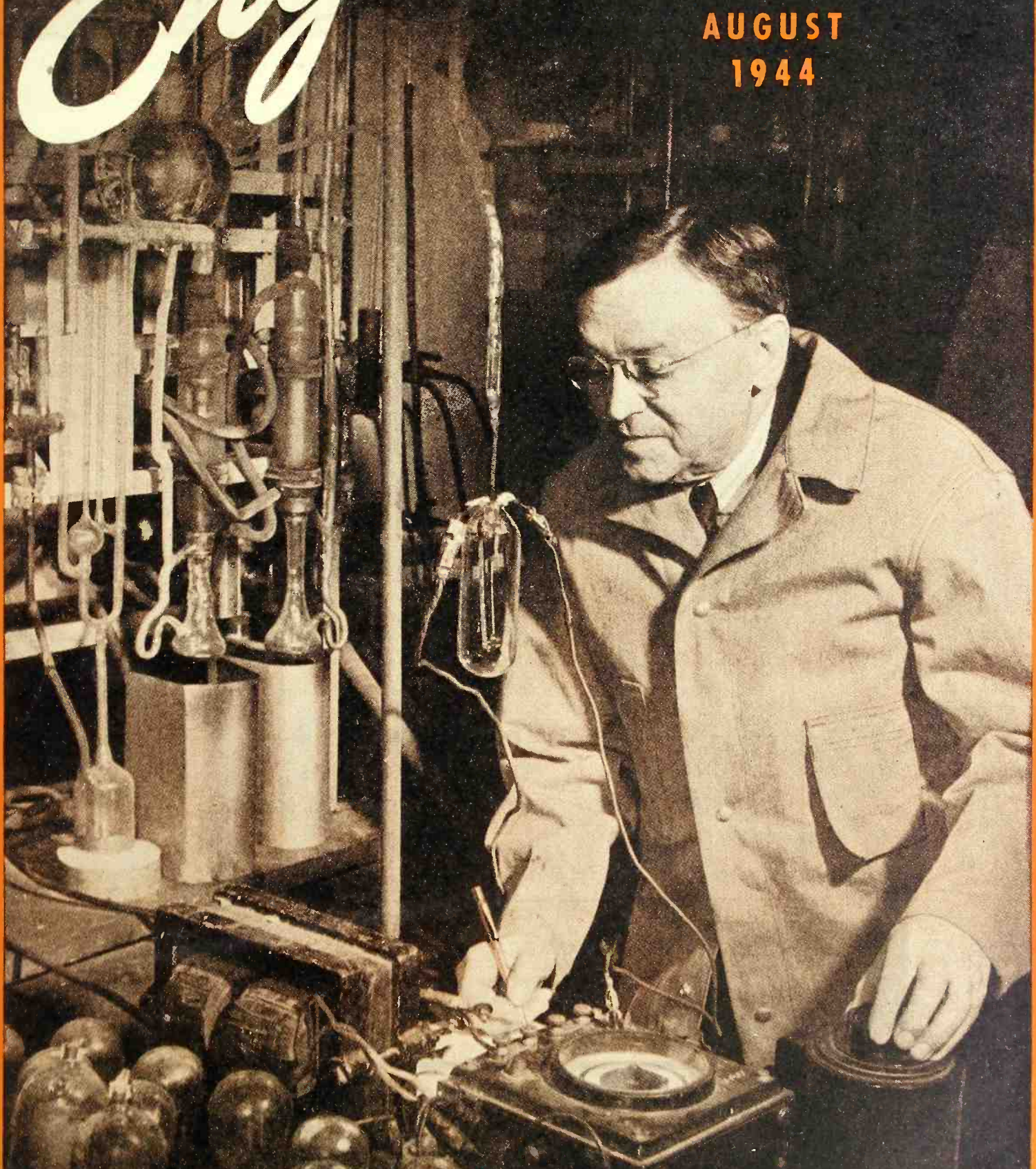

**TELEVISION ★ RADAR ★ ELECTRONICS ★ RESEARCH
COMMUNICATIONS ★ MAINTENANCE**

**RADIO
NEWS**

RADIO-ELECTRONIC

Engineering

DEPARTMENT

"Reg. U. S. Pat. Off." (pending)

ELECTRONICS • COMMUNICATIONS • TELEVISION • RESEARCH • MAINTENANCE

AUGUST, 1944

ELECTRONIC CONTROLS IN INDUSTRY	B. R. Cannon	3
The rapid advance in the use of electronics in industry.		
DENSITOMETRY	Albert A. Shurkus	7
The use of electronics in the measurement of optical density.		
S-T TELEVISION LINK ANTENNA	B. P. Brown	12
Design of a suitable studio-transmitter television link antenna.		
THE ENGINEER'S FUTURE OBLIGATION AND OPPORTUNITY	Haraden Pratt	15
Engineers face a grave responsibility in the future.		
FREQUENCY MEASURING EQUIPMENT	John D. Goodell	16
Instruments for the accurate determination of frequency.		
DESIGN OF R.F. INDUCTANCES	R. G. Middleton	20
Optimum coil construction for frequencies from 4 to 100 megacycles.		

DEPARTMENTS

PERSONALS	26	NEWSBRIEFS	36
INDUSTRIAL REVIEW	28	TECHNICAL BOOKS	41
NEW PRODUCTS	32	PATENTS	42
TELEVISION	44		

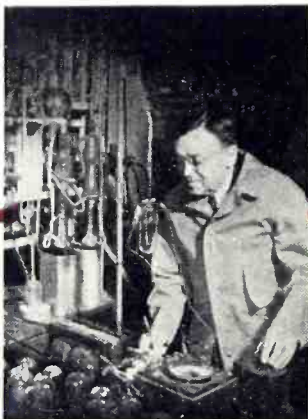

RADIO-ELECTRONIC ENGINEERING is published each month as a special edition in a limited number of copies of RADIO NEWS, by the Ziff-Davis Publishing Company, 540 N. Michigan Avenue, Chicago 11, Ill.

VOLUME 3 NUMBER 2 Copyright, 1944, Ziff-Davis Publishing Company

COVER PHOTO—BY WESTINGHOUSE

Dr. Harvey C. Rentschler, director of research at the Westinghouse Lamp Division, is shown conducting some experiments on the behavior of electrons on an oxide surface in order to improve the life of radio tubes.



ELECTRONIC CONTROLS IN INDUSTRY

By **B. R. CANNON**

Process Engineer, Hughes Aircraft Co.

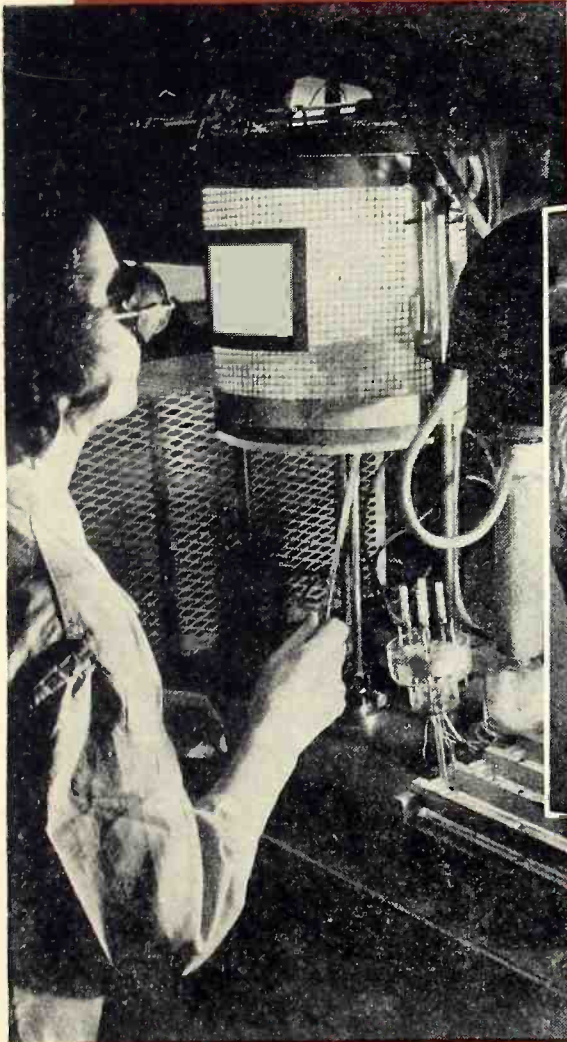

Arc welding grid collar to grid support in atmosphere of hydrogen-UHF transmitter tube.

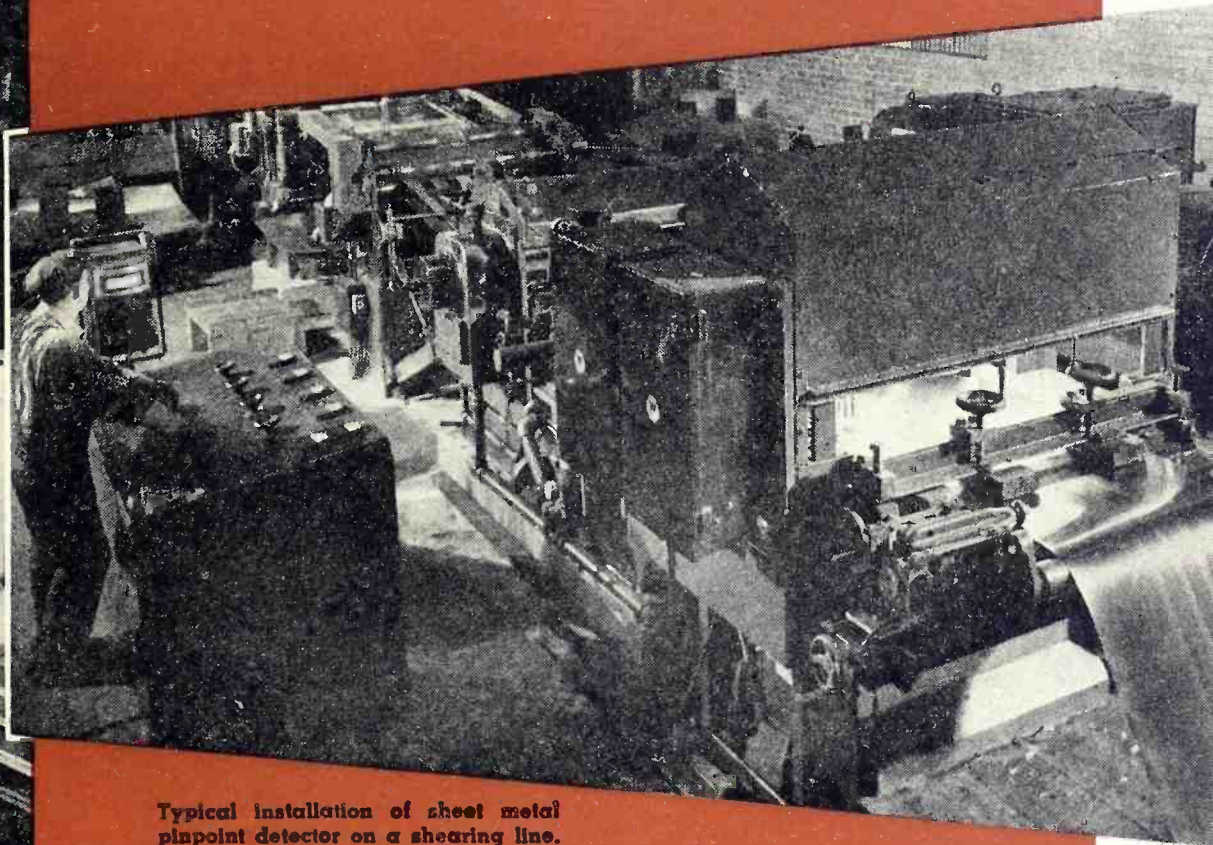

Typical installation of sheet metal pinpoint detector on a shearing line.

A few of the many different types of industrial electronic controls and their application in industry are discussed.

ELECTRONICS is fast assuming a position of major importance in our war expanded industries. Now, more than ever before, the application of electronics has brought relief to the harassed manufacturer who must maintain difficult work schedules with a minimum of skilled labor. Even before World War II our foremost industrial engineers had recognized the merits of electronic controls, but development had been slow, equipment expensive. Today, with speed the keynote, the products of this modern science have forged ahead.

Not all of the electronic equipment now in use is new to industry; much of it is merely the result of improved design. Typical of this is the thyatron variable-speed motor drive control. This drive is comprised of an anode transformer, a rectifier and control unit, a push button station, and a direct current motor drive. A photo-

graph of a typical thyatron control of this kind is shown on page 4.

The rectifier of the ignitron electronic tube converts alternating current to direct current at the motor. The control unit utilizes two or more potentiometers which govern a full range of preadjustable speeds for both directions of travel. The operation of this motor-drive is based upon the principle of armature and field voltage variation governed by electronic devices. Thus if the armature voltage is increased to basic motor speed and the field is then decreased, the speed of the motor increases. Higher speed is attained by increasing the armature voltage to double the basic speed value. Speed adjustment is established by the potentiometer which, acting through the electronic control circuit, causes the thyatron tubes supplying the armature voltage to increase or decrease their output.

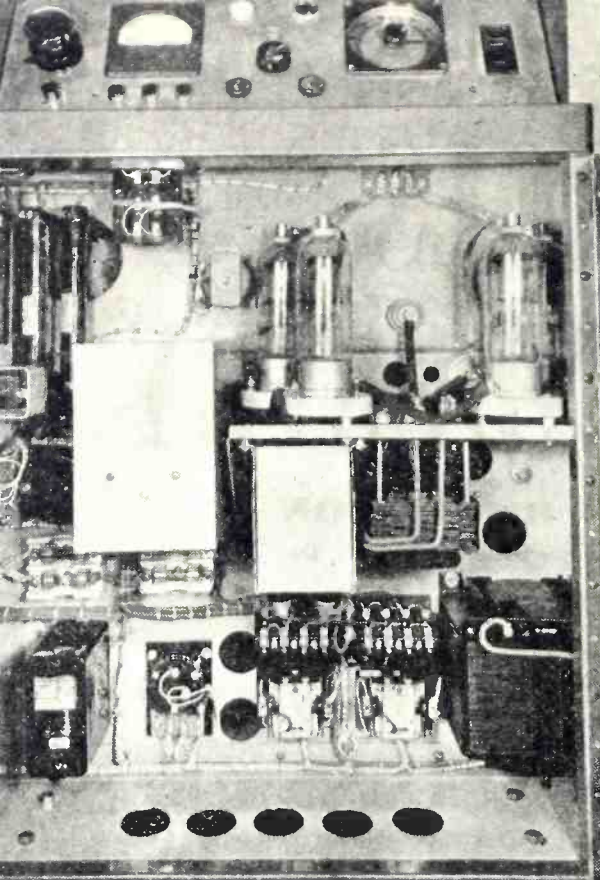

Rectifier section of plastics preheater using radio frequency as source of heat.

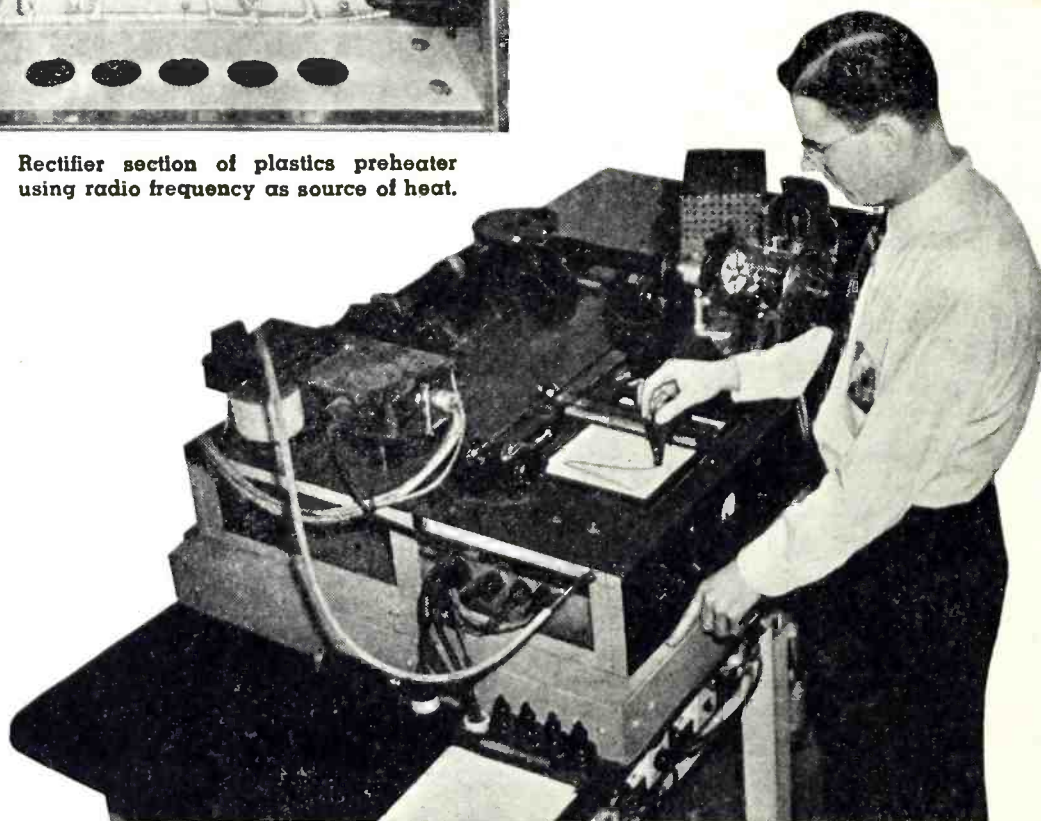

The RCA electronic recording photoelectric spectrophotometer.

Adjustable speed motor drive on capacitor winding machine.

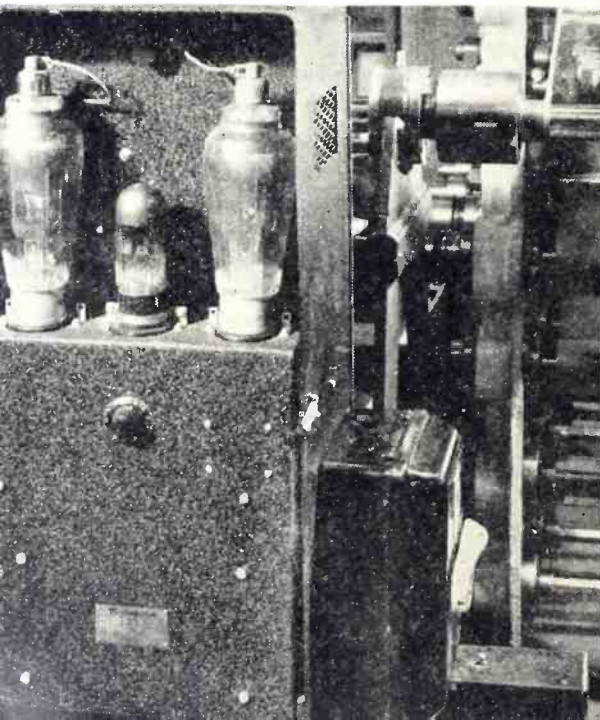

Mere motor-drive speed control as described is not a novelty in the electronic field. It was only through the addition of numerous new features and refinements that a more widespread use of its versatile and advantageous functions was made possible. Some of these newly acquired features include conversion of alternating current to direct current at the machine, wider speed range control, single dial operation, pre-set accuracy, shockless acceleration, full torque at low speeds, constant speed at varying loads, fast reversal of the motor at all speeds, and swift braking action.

The dynamic braking action is of particular interest. This action is achieved by means of a circuit modification which initiates automatic appli-

too large a section of metal or not enough. The resultant weld will be weak. Thus, this type of welding requires a precise control within an extremely narrow range of current and time in order to produce quality results. Electronic equipment in the form of a completely synchronous ignitron welding timer has provided a suitable means for overcoming many of these welding difficulties. This control system usually includes a circuit control to open and close the circuit to the primary of the welding transformer, a timing control to time the sequence of electrode operations, and a heat control arrangement for adjusting the welding current to the correct value. The latest d.c. precision timer is equipped with a d.c. power source to operate the solenoid valve. A half cycle protective relay is also used with the ignitron timing system at some plants. This relay provides an automatic shut-off of the machine in event of failure of one of the ignitron or power tubes. This is a distinct advantage where continuous high grade welding is mandatory and where failure of the ignitron or power tubes might result in reaction of the welded parts.

Operation of this timer follows a definite sequence pattern. A foot switch closes the circuit from the synchronous timer to the grid circuit of the thyatron tubes. The timing potential applies a positive potential to the grids of these tubes. No current is passed until all of the thyatron tubes in this series are conducting. When current is passed, the ignitron power tubes are energized. A new impulse is received by the thyatron tubes for each succeeding half cycle of the "on" period during which power is desired. No impulses are delivered during the "off" period. Heat control is obtained by adjusting the point on each half cycle at which breakdown of the ignitron occurs. A general layout of the circuit is shown in Fig. 3.

A timing accuracy within one cycle, or a sixtieth of a second, is possible with this method of control. Precise electronic timing at the point of application of additional pressure to the welding electrodes has resulted in a reduction of energy used while producing a better grade of weld.

The resistance welding of high carbon steels has reached a new state of perfection due to the application of electronic methods. Formerly, the welding of a steel with higher than a .030 of one per cent carbon content resulted in brittle welds subject to cracking. With electronic controls to time the welding period the successful joining of steels with as high as .060 of one per cent carbon is possible.

cation of full field once power is removed from the armature. The removal of power from the armature is the result of stop-button pressure which opens the line contactor.

Used in combination, these useful features of the variable-speed motor drive control have found successful application to such machinery as turret and tool room lathes, milling machines, grinders, drill presses, winch drivers, balancing machines, boring mills, shell lathes, pump drives, and scores of other war vital machines.

In resistance welding a similar use of electronic controls has been made. Many of the metals normally resistance welded, such as aluminum and magnesium, have a sharp fusion point. During the spot welding operation inaccuracy of timing may either melt

Machine arc welding is utilizing thyatron electronic control to maintain automatically the proper arc length regardless of curvatures in the material being welded.

The adoption of photoelectric devices has resulted in a drastic reduction in manhours, with the subsequent speeding of accurate production. The highly sensitive gas-filled phototube is finding new uses while its predecessor, the stable high-vacuum tube, is likewise being widely used.

The detection of material defects, such as small holes, is a prime factor in the production of quality controlled sheet metal. It was with this in mind that electronic engineers designed the pin hole detector. The simplified detector is composed of a light source, a phototube housing, and a control unit. The light source emanates from a number of exciter lamps wired in parallel and set to produce a high degree of illumination across the entire width of the metal strip under examination.

Each phototube is mounted in the containing box with its individual lens set for focus of the light to the tube. The entire phototube housing, in compact form, is mounted under the sheet metal strip in such a manner as to provide a close proximity ($\frac{1}{2}$ " or less) between the sheet and the top of the shutter guide. The control unit contains a thyatron panel, a static type voltage regulator, and a lamp failure relay. The amplifier is housed in a separate cabinet.

Operation of the detector begins when the light, shining through a hole in the metal, creates an impulse which in turn is magnified by the amplifier. The amplified impulse goes to the thy-

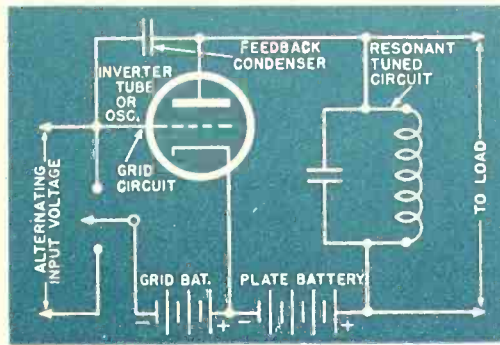

Fig. 1. Oscillator or inverter circuit for induction and dielectric heating control.

atron panel and is impressed upon a thyatron tube which functions as a locking relay and gives an indication of the hole. Automatic reset is accomplished by a thyatron time delay relay.

This apparatus may also be used to control the cut of wrappers or box materials. The cutting procedure is performed by registering a color spot on the material to be cut at the point where the shearing is to take place. The photoelectric response to the color spot when impressed upon the electronic tube sets the cutting machine in motion.

The valuable effect of photoelectric research has also been employed in the refinement of the high precision instruments used to control the basic material element present in the color products of paints, dyes, inks, and textiles.

One of these instruments, namely the recording spectrophotometer, has found rather extensive use in control laboratories throughout the country. This instrument is, in the main, made up of a monochromator, a photoelectric photometer, and a recording de-

vice. Layout details are given in Fig. 6. Light from the monochromator, a double prism type, passes through two Rochon and one Wollaston prisms. The monochromator is equipped with bilateral slits automatically adjusted for a wavelength band of 10 millimicrons within the wavelength range of 400 to 700 millimicrons. Thus, a high degree of spectral purity under laboratory conditions is assured.

The photometer combines the polarization method of photometry with a photoelectric balancing scheme so as to eliminate the possible harmful factors resulting from light source characteristics and non-linear phototube and amplifier sensitivity.

Two cams form part of the standard equipment. A regular 100% cam is employed to translate the Rochon prism angle to per cent transmission or reflectance. A five-times cam is also included to expand the readings below 20% to five times their normal value.

Angular position of the Rochon prism with respect to the Wollaston prism determines the ratio of the energy distribution as reflected by the sample and the standard of that product. When the light reflected from the sample and the standard is not the same, an alternating current is generated in the phototube circuit. The phase of this alternating component with respect to the voltage applied to the synchronous motor determines which of the reflected beams is more intense. This amplified alternating component is then used to control, by means of the thyatron stage, the direction of rotation of the balance motor. The

Fig. 2. Schematic diagram of power supply for inductor heater coil used in tin plating.

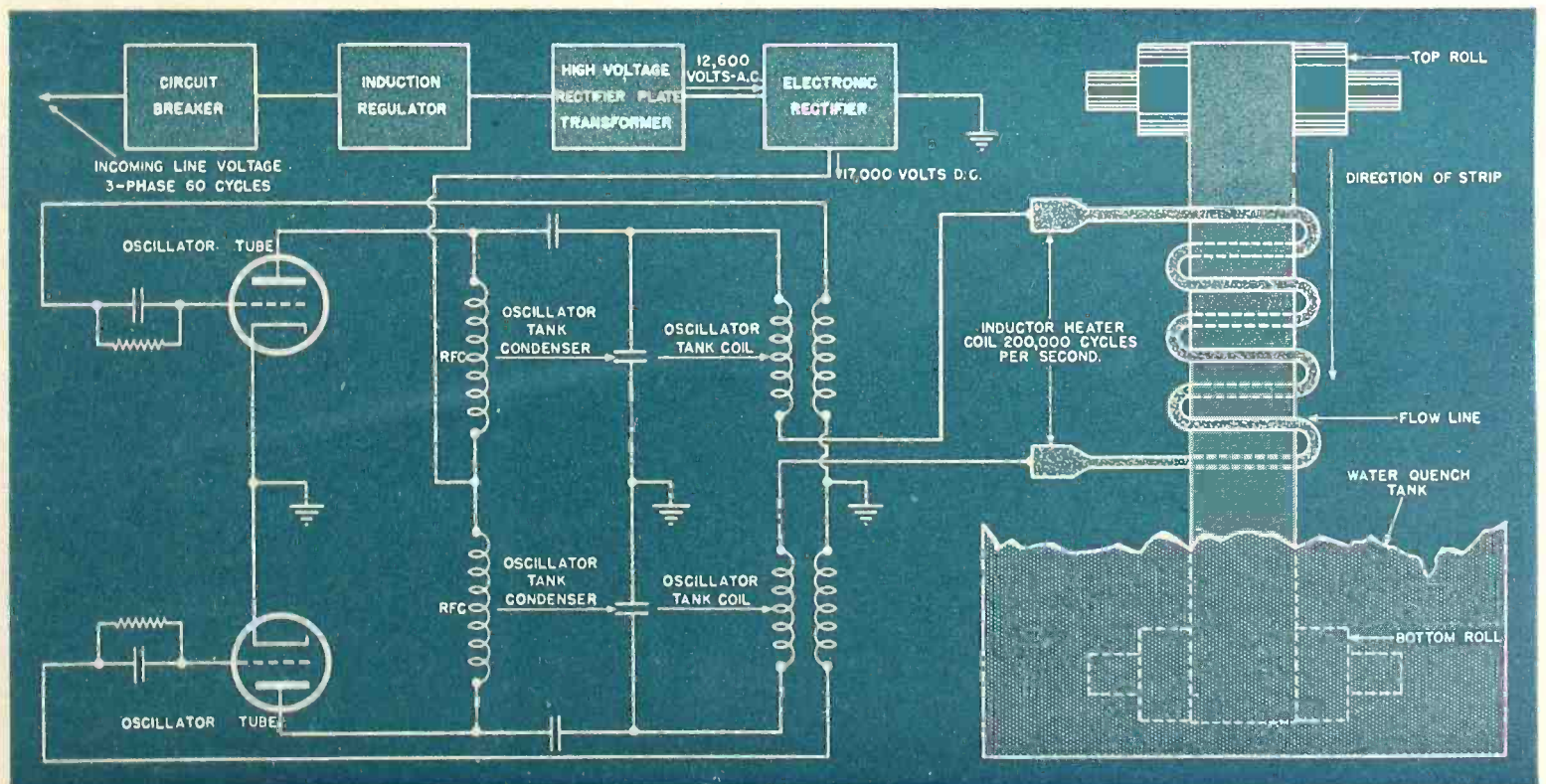

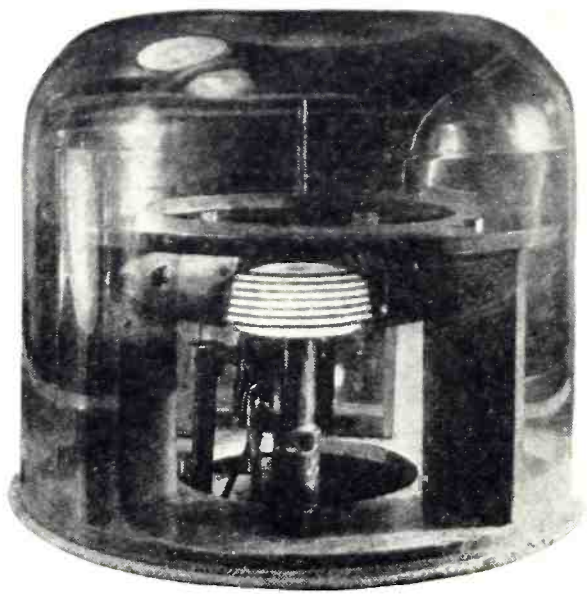

Carbiding a rock bit drill by means of induction heating.

Rochon prism is automatically readjusted by the motor to obtain a redistribution of energy in the sample and the standard beams, thus removing the alternating component in the phototube current. The angular position of the Rochon prism is therefore a measure of the reflectance of the sample in terms of the standard. This instrument is proving its worth to the camouflage experts who must match colors closely to prevent the detection of variation by means of infra-red cameras. The spectrophotometer is adapted to the measurement of comparative infra-red radiations of almost a million different color shades with unbelievable exactness. Further use of a variation of this instrument is in the large scale application of the spectrometer to mass analysis of gases and synthetic rubber products. A considerable saving of time is effected by its use. An analysis which once took several days now is completed in a few minutes.

Many of the heat-treaters in the pre-war era depended upon mechanically controlled pyrometers for holding heat values within desired ranges. This

class of controls is mainly of the intermittent contact type which must take into consideration the time for mechanical operations to take place.

The demands of Army and Navy Heat-Treat Specifications proved too stringent for the slow acting mechanical heat controls. Once again electronics was called upon to supply an answer to the problem. Convincing evidence that the solution was an excellent one is found in the fact that at this date heat treating controls constitute a major portion of the enormous amount of electronic equipment being produced. A system of electronic heat control that has found popularity in a great number of heat treating plants incorporates a dual-unit control enclosed in a single compact case. Part of the two divisions of the system includes an accurately calibrated high resistance thermo-electric pyrometer of the multi-voltmeter type. A recording temperature indicator is actuated by a thermocouple located in the heat treat furnace.

The second division of the system is the control unit. This includes an arrangement of a vacuum tube with a heavy duty relay whose contacts regulate the fuel input to the heating unit. This tube in combination with the associated apparatus forms an r.f. oscillator circuit. The r.f. current from this oscillator is allowed to flow through a pair of minute coils wound of silk covered wire. The coils are mounted on a lever whose pointer may be set on the temperature scale. A tiny tab of aluminum is cemented on the temperature indicator so that a movement of the pointer will cause the tab to enter between the coils, changing their inductance. The change influences the frequency of the oscillator, causing the withdrawal of the vacuum tube of more or less current from the line. The current change in the tube is then used to operate a re-

lay which in turn controls the fuel supply to the furnace. It was a combination of heat and photoelectric controls which gave the steel industry the now famous Bessemer Flame Control. This device makes it possible to determine the "end point" of the steel, that is, the moment when the blowing of the steel should cease. If a miscalculation caused too lengthy blowing, the steel would revert to iron oxide. Too little blowing often produces uneven distribution of the elements and surface defects.

The high frequency heating method

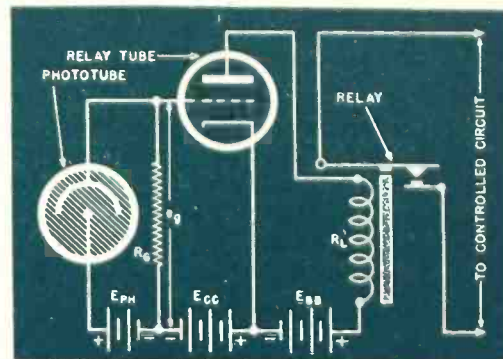

Fig. 4. Electronic relay controlled by means of a photoelectric cell.

has been of equal good service when applied to the tin-plating industry. With the swift decline of the supply of this metal, tin platers were forced to resort to extremely thin plate thicknesses in the finishing of steel cans. Unevenly deposited tin and a resultant high porosity of the plated surface was often a result of this thin plating. Various methods of combating the poor plating results were attempted. Most of these lengthened the plating operation, thereby slowing production. With the application of high frequency oscillation, improvement was swift. The electroplated part was passed through a coil energized by a high frequency of approximately 200 kc. The tin plate melted and flowed into a smooth, non-porous coat with controllable thicknesses as little as .030 of an inch. Plating time was better than 1200 feet per minute for 30 inch sheets.

There are in the textile industry many adaptations of electronic controls. One of these, dye control, has already been mentioned in discussion of the spectrophotometer.

A second control, the electronic weft straightener, has found only limited use, although its future possibilities are great. The straightener is an instrument of the photoelectric class. It operates and controls the weft-thread straightness necessary to quality fabrics. To the human operator this was a tedious, nerve wracking job. Speed was restricted by the limitations of human movement and vision. The phototube scans the individual threads at

(Continued on page 30)

Fig. 3. Schematic diagram of ignitron welding control circuit.

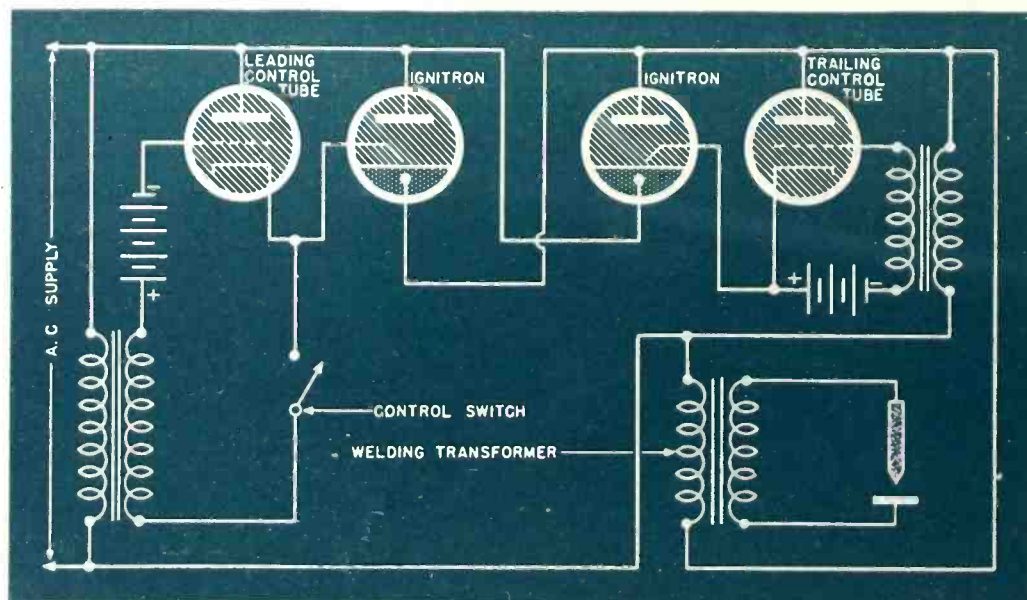

DENSITOMETRY

By **ALBERT A. SHURKUS**

Engr., Bausch and Lomb Optical Co.

A discussion of various methods and equipment for measuring optical density.

THE photographic camera is in all probability the most widely used technological device, with the possible exception of the radio receiver. The photographic process is possible only because photochemical methods have been developed through the course of years whereby the real image formed by a lens, consisting of areas of differential light intensities, can be recorded as areas of differential darkening—or opacity—upon a *negative* transparency. The reader is, without a doubt, familiar with the use of the term *negative* in this connection. This *negative* transparency will exhibit the greatest amount of blackening where the light in the image is the most intense and can be, in turn, converted into a *positive* print by further photochemical reactions.

It was in about the year 1880 that Ferdinand Hurter and Vero C. Driffield began their fundamental investigations into the laws of exposure and development of photographic materials. In the course of their researches they were called upon to define a unit for measuring the amount of blackening of the developed photographic image. They selected the optical density for this purpose. Density has been defined as

$$D = \log \frac{1}{T} \dots \dots \dots (1)$$

where T, the transmission, is the ratio of the light transmitted by the developed image to the light incident upon it.

From the psychological standpoint, this definition of density is a happy one, for the eye, like the ear, responds logarithmically to stimuli. It is well known, of course, that the decibel, also a logarithmic unit, is a better index of the effect of the sound output of an audio amplifier upon the ear than is a corresponding change in power output.

The use of the density unit is of further advantage when two or more transparencies are superimposed, in that the resultant density is but the simple arithmetic sum of the component densities, whereas the resultant transmission is the product of the transmission components.

In Table 1, the density equivalents

for different transmissions are shown. The relationships shown in this table hold true by the definition given. The actual density of a given sample, however, is not a fixed value but is dependent to a great extent upon the method of measurement, as will be explained.

It is a well known fact that a photo-

graphic emulsion is composed of discrete grains of silver bromide such as are shown in the photomicrograph of Fig. 2. Following an exposure to light, these grains are developable, that is, they can be converted into metallic silver through the action of certain chemicals. Indeed, it has been found



Fig. 1. AnSCO-Sweet Densitometer being used to measure the optical density of a film from which an enlargement is to be prepared.

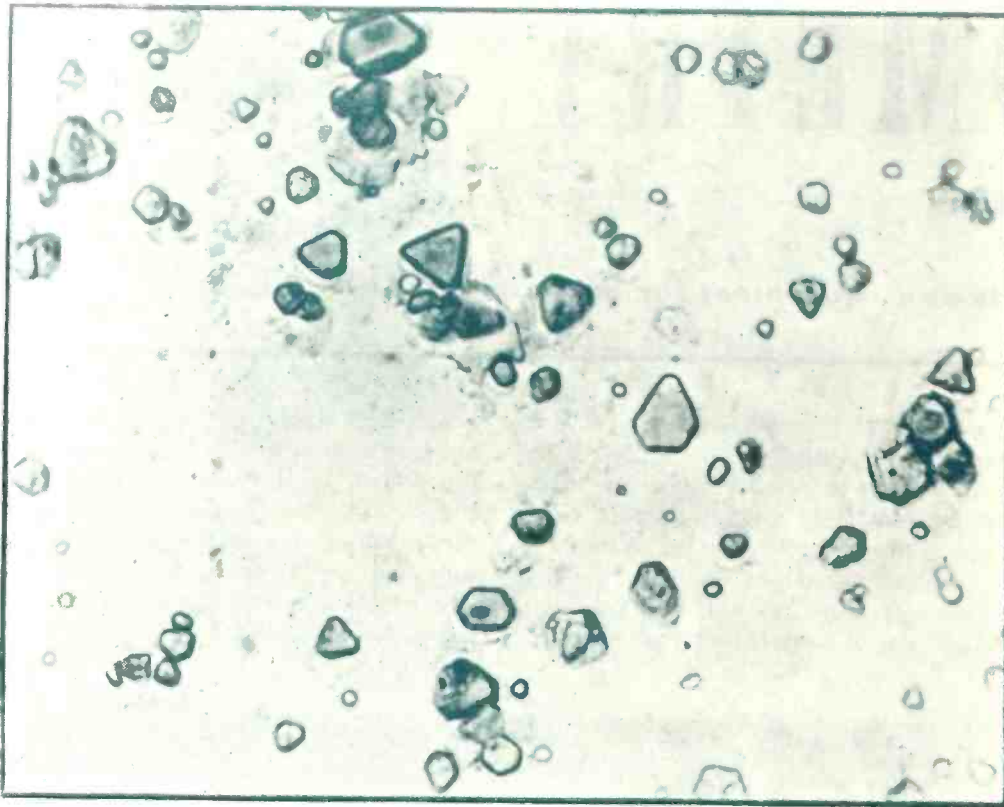

Fig. 2. Photomicrograph of dispersed silver bromide grains at 3000 X magnification.

that silver bromide is self-developable in that it darkens upon excessive exposure to light, bromine gas being liberated and metallic silver in the colloidal state being left behind. This decomposition will occur in gelatin-free silver bromide as well as in the grains of a photographic emulsion. It is of interest to note that the developability of silver bromide can be produced by agencies other than light, for example, by pressure, heat, and certain chemicals just as the developability of a grain can be destroyed by the action of strong oxidizing agents like chromic acid, free halogens, and ozone.

Since the photographic negative

does consist of such small, discrete particles, and since the density of such a negative is directly proportional to the preponderance and size of these particles, the light transmitted by it consists of two components. One is the light transmitted directly without change in direction, the other is that scattered diffusely in all directions. Hence, when the density of a photographic negative is to be determined, the method of this determination is of great importance.

If a film specimen is illuminated by collimated light and is examined in a manner that excludes all diffuse light, as shown in Fig. 7, it is said that *spec-*

ular density is measured. When the photoelectric element receives all of the emergent light, as shown in Figs. 8 and 9, *diffuse* density is measured. Theoretically, of course, the only way in which true diffuse densities can be determined is through the use of an integrating sphere, as shown in Fig. 10. In practice, however, it has been found that strict conformity to theoretically ideal systems is unnecessary, except for instruments of the primary standard type for, after a given densitometer has been initially calibrated as to either diffuse or specular density, it will continue to give correct readings on heterogeneous samples.

Because the density of a photographic negative is due to small silver particles, it should be evident that the scattering power increases with an increased deposit of silver, that is with increased density, the resultant effect being to render specular densities higher than diffuse densities. This difference increases with the absolute density. The ratio, however, of specular to diffuse density is approximately constant over a considerable density range. This ratio is called Callier's coefficient and is ordinarily about 1.3 which means that specular densities are about 30 per cent higher than diffuse densities. If the sample were a non-scattering absorber, like a neutral density optical glass filter, it would not matter what optical method of measurement had been used for no diffusion would exist.

The spectral quality of the light used in making densitometric measurements is also of importance. A bluish tinted negative, for example, would possess a higher density to red light than to blue. Likewise, the color sensitivity of the photoelectric element is a factor to be considered, for should the response characteristic of the photoelectric element be radically different than that of the printing paper or other medium, poor results would be obtained. The correct solution of this problem of color correction would be the use of a phototube, filter and light source combination approximating closely the spectral sensitivity of the source-printing medium combination. In the various branches of photography, however, nearly every conceivable type of optical system and color sensitivity occurs, making the design of a truly universal densitometer chimerical.

Thus far, this discussion has been limited to transmission density. The general concepts already discussed, however, apply as well to reflecting surfaces, such as photographic paper prints. Reflectance has been defined as the ratio of the light reflected by a surface to that incident upon it. Since

Fig. 3. Electrical circuit of the Ansco-Sweet Densitometer shown in Fig. 1.

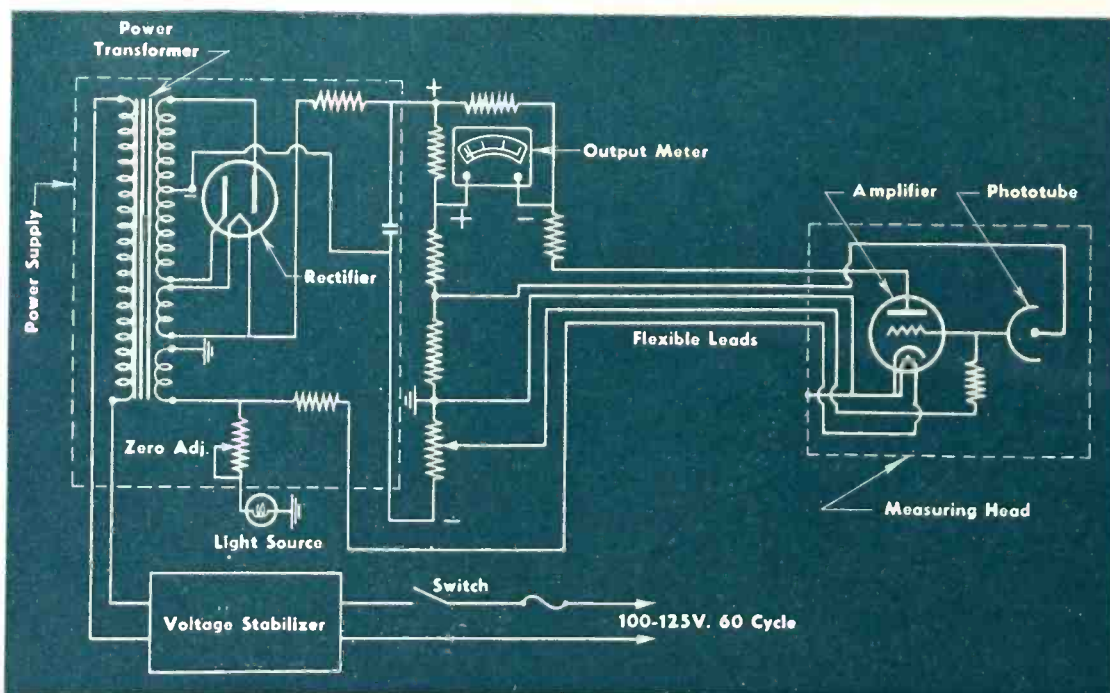

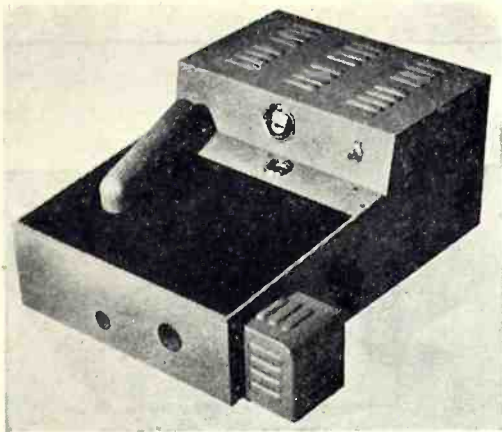

Fig. 4. The National Photocolor Densitometer.

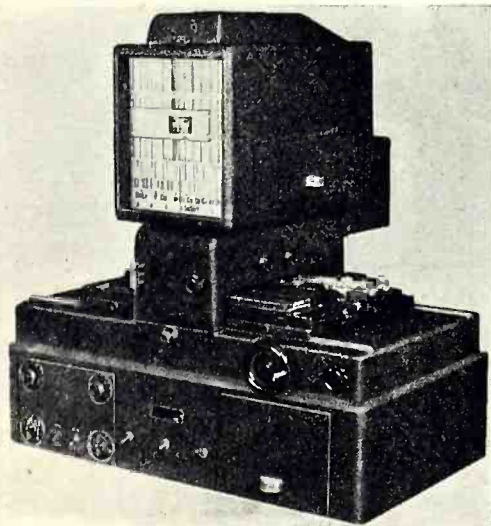

Fig. 5. ARL and Dieterl Spectrum Comparator and Densitometer.

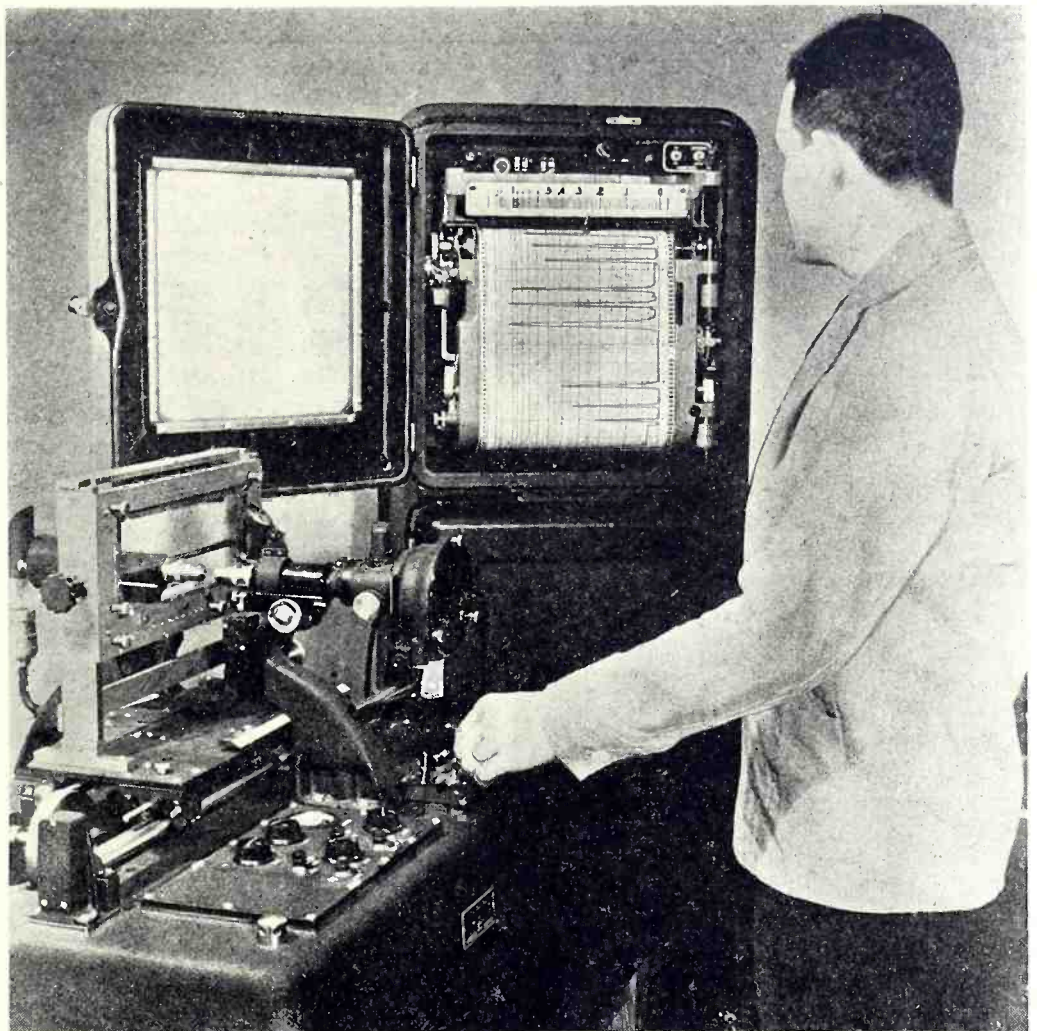

Fig. 6. The Knorr-Albers Recording Microphotometer for automatically recording the densities of spectrum lines in spectrographs.

this reflection can be either specular or diffuse, or a combination thereof, the reflection density can be either specular or diffuse, being in this case

$$D = \log \frac{1}{R} \dots \dots \dots (2)$$

where R is the reflectance. However, in reflection density measurements a new factor must be considered. This is the surface gloss.

At best, any definition of gloss must be an arbitrary one for no value can be assigned without specifying the angles of illumination and observation. It has become customary in photographic laboratories to illuminate paper samples at an angle of 45°. According to a widely accepted definition, if B_n is the brightness of the surface when viewed normally, and B_s is the brightness when viewed specularly, as shown in Fig. 11, the gloss is

$$G = \frac{B_s - B_n}{B_n} \dots \dots \dots (3)$$

On the basis of this definition, magnesium carbonate (chalk) has a gloss of 0.1, matte papers about 0.5, and glossy papers may have a gloss as high as 25. It is evident, then, that the maximum density of a glossy paper is higher than that of a matte paper since the measurement of reflection density includes all of the light re-

flected from the paper's surface. Since the maximum density of glossy paper is so much higher, it is capable of rendering a wider range of tone values than matte papers.

Such are the aspects of densitometry. Add to these considerations the fact that, as a rule, the photographic densitometer must be capable of measurement in the range of 0.0 to 3.0 with an accuracy of 0.01, or a light intensity range of 1000 to 1, and it becomes readily apparent that the design of photoelectric densitometers places stringent demands upon electronic components.

Visual Densitometers

For many years densitometric measurements were made using visual methods akin to those of visual photometry, the accuracy of which are dependent upon the ability of the eye to estimate and to match the relative brightnesses of two closely adjacent fields. Such a field, called a photometric field, may possess any of a number of forms (Fig. 17) as determined by the construction of the photometer head. To attain high precision it is necessary that the dividing line between two adjacent parts of the field be as fine as possible.

The fundamental method of determining the intensity of an unknown

light source by comparison with a source of known intensity has been to move a photometer head along the line joining these two sources until the two halves of the photometric field appear to possess the same brightness. This method is illustrated in Fig. 12. The photometer head shown, however, is not one with which high accuracy might be obtained since a relatively broad black dividing line separates the two halves of the field. A much better photometer head for this service is one devised by Lummer and Brodhun shown in Fig. 13. If the photometer head is properly constructed, the inverse square law of illumination applies. This law states that the intensity of a light source varies inversely as the square of the distance from it, provided that the source is so small in its dimensions compared with the distance from it that it may be considered a point source. From the practical aspect the accuracy of photometric measurements is such that this condition prevails when the dimensions of the source are less than one-twentieth the distance from it. Thus, the intensity of the unknown source can be computed in terms of the standard source from a simple measurement of the distances from the two light sources, represented by d_1 and d_2 , which are related to the intensity by the equation:

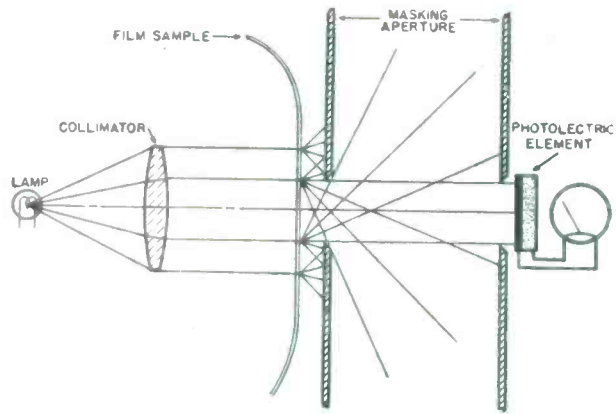

Fig. 7. One method of measuring specular density. Diffuse rays are blocked by the second diaphragm.

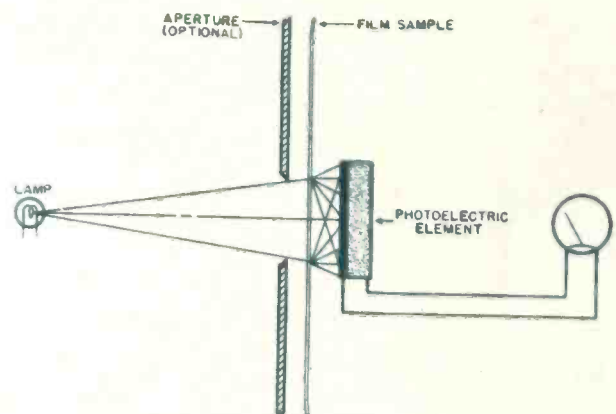

Fig. 8. A method of measuring diffuse density. Both direct and diffuse rays strike the photocell.

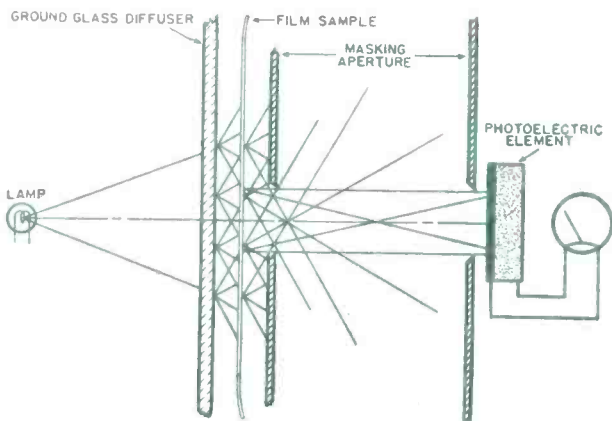

Fig. 9. A method of measuring diffuse density. Incident light is diffused before striking film.

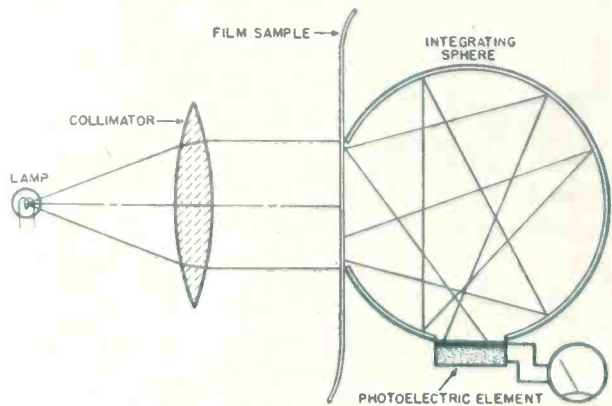

Fig. 10. A method of measuring diffuse density in which an integrating sphere is used.

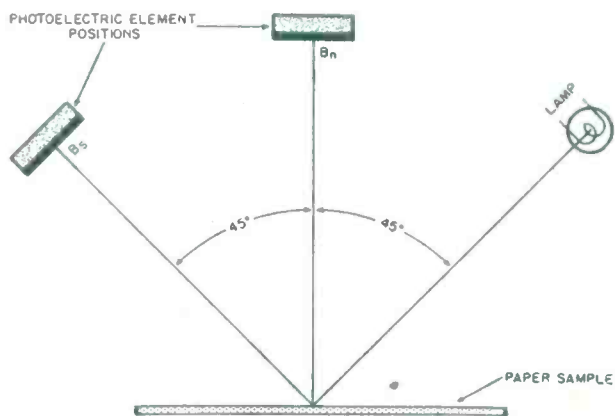

Fig. 11. Standard method for measuring the gloss of photographic papers.

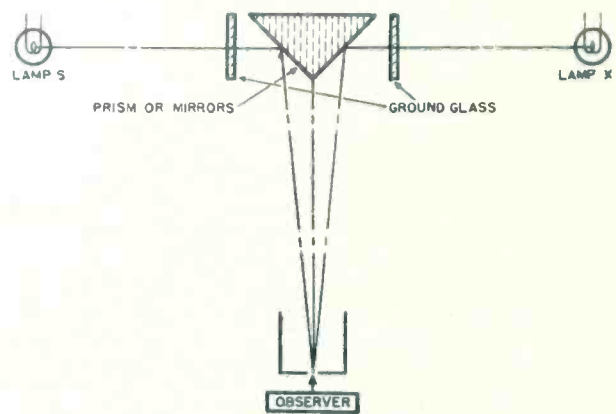

Fig. 12. A simple form of photometer for measuring the relative intensity of two light sources.

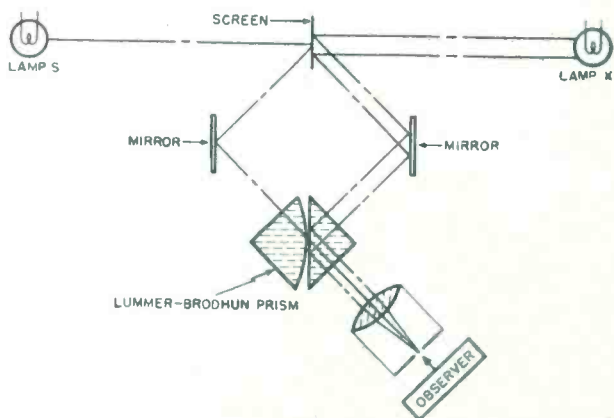

Fig. 13. The Lummer-Brodhun photometer for the accurate comparison of light intensities.

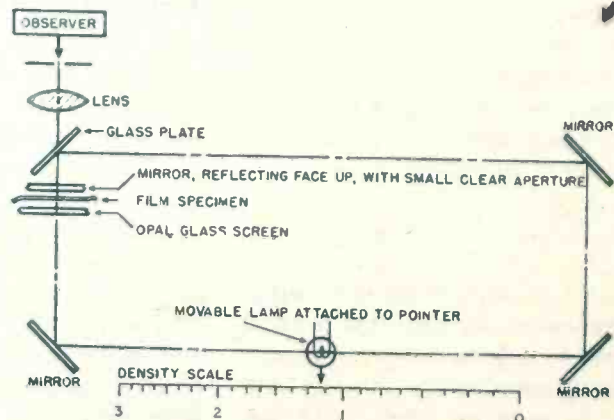

Fig. 14. Marshall densitometer. Note the similarity to the simple photometer (Fig. 12).

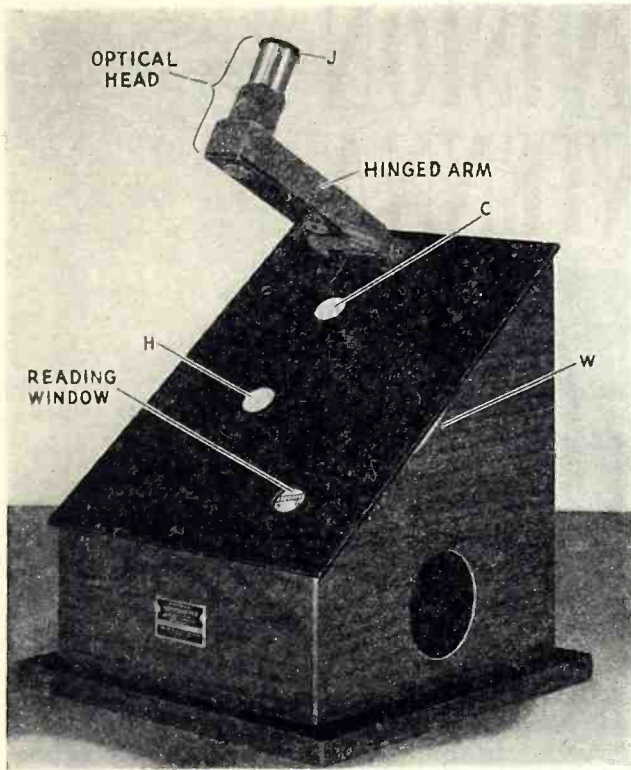

Fig. 15. Eastman Transmission Densitometer showing instrument with hinged arm raised.

$$\frac{I_1}{(d_1)^2} = \frac{I_2}{(d_2)^2} \dots \dots \dots (4)$$

Like all subjective measurements, however, the accuracy of the photometric match depends upon the comfort and physiological condition of the observer. At best, an experienced observer can attain an accuracy of 0.2% in the mean of a large number of settings.

A modification of this photometric procedure has been applied to the measurement of density, an example of which is the Marshall Densitometer. Referring to the diagram shown in Fig. 14, it may be seen that the light source, S, is movable in either direction along the optic axis. With zero density in the measuring beam, this light source can be so positioned that the optical path lengths of both beams are such that both halves of the photometric field are of equal brightness. With any other density, the optical path length of the comparison beam must be increased, thus diminishing the light in its part of the photometric field, in order that a photometric match might be obtained. A scale measuring the horizontal movement of the lamp can be calibrated in terms of density.

The Eastman Transmission Densitometer, Fig. 15 designed by J. G. Capstaff and R. A. Purdy, operates upon a different principle. With this instrument, the density being measured is compared visually with a calibrated circular photographic density strip possessing a continuous density gradient up to a density of 3.0 in about 315° of its circumference. The optical system of this instrument is shown dia-

grammatically in Fig. 18. In operation, one beam of light from the lamp A is reflected by mirrors B and D and diffused by the opal glass screen C and the ground glass E so that a light beam of uniform intensity reaches the clear glass plate, F, acting as a mirror inclined at 45° to the optic axis. At G is located a silvered mirror, reflecting surface up, with a clear portion about 1/2 mm. in diameter in its center.

The second beam of light reaches the clear area in the mirror G from below, having passed through the calibrated strip, W, and the density under measurement which is located over the opal glass diffusing screen, H. When the comparison field at G is viewed through the magnifier eyepiece, J, it will be seen that the first beam provides a comparison

field of fixed brightness, while the second beam appears as a dot in its center of this comparison field. This dot may be made to match the comparison field in brightness by suitable rotation of the calibrated strip.

To bring the photometric field into balance when there is zero density over the opal glass, H, the highest density of the calibrated strip is necessary. With an unknown density in the sample position, and the photometric field in balance, it can be seen that the highest density of the calibrated strip minus the density of the strip at the point of balance is equal to the measured density, and it is this value that appears upon the scale as the density reading.

A third type of visual densitometer is an adaptation of the Martens polarization photometer. In an instrument of this type the two halves of the comparison field are polarized at right angles to each other. Variation of the intensity in the two halves is made by rotation of an analyzer prism, which rotation is read upon a divided circle. Since the extinction of light by a pair of polarizers, such as are employed in this instrument, is governed by exact physical laws, the Martens photometer may be calibrated directly without reference to any standard. This in itself is a decided advantage. Furthermore, the calibration of such a photometer will not vary with age. Because of its precision and reliability it has often been used as a primary standard for densitometric measurements.

Photoelectric Densitometers

Since the accuracy of visual instruments is dependent upon fatigue, over-

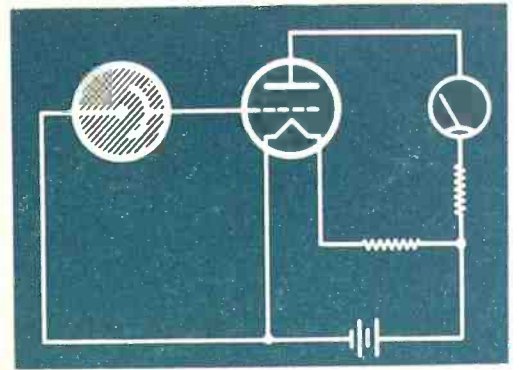

Fig. 16. Phototube and amplifier circuit having a logarithmic response.

all physiological condition, experience, and other personal factors on the part of the observer, many attempts have been made to apply photoelectric elements to densitometry. Some of these photoelectric densitometers have employed barrier-layer photocells, others photoemissive phototubes. Both types depend upon the fact that when light falls upon certain photoactive materials, an electron flow results that is proportional to the intensity of the illumination.

These photoelectric instruments may be grouped into two broad classifications, one, those that measure directly the light passed by a sample, and two, those that compare the intensity of the transmitted beam with one of known intensity.

The simplest type of direct reading photoelectric densitometer is exemplified (Continued on page 38)

Fig. 17. Forms of common photometric fields.

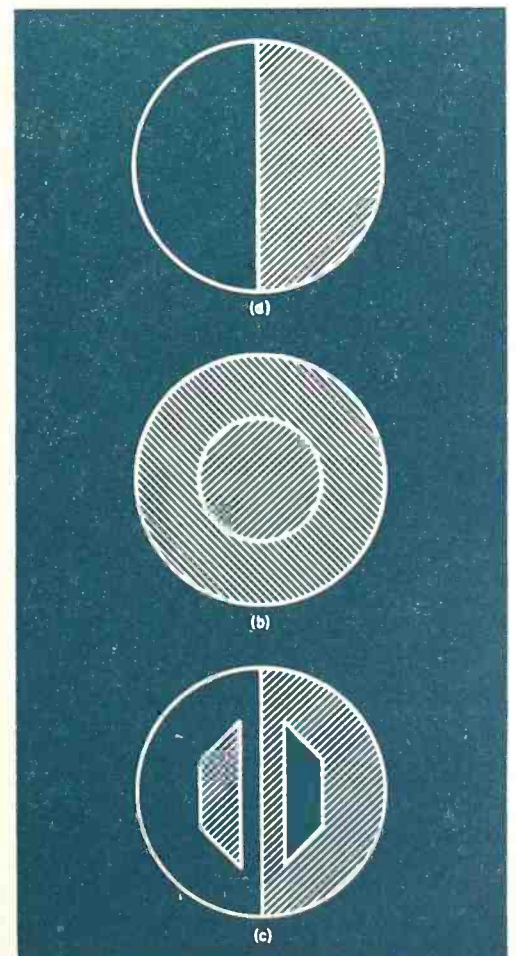

S-T TELEVISION LINK ANTENNA

By **B. P. BROWN**

Electronics Dept., General Electric Co.

Problems encountered in the design of a studio-transmitter television link antenna.

BEFORE considering the actual constructional and electrical details of the S-T Television link antenna system described here, perhaps it is desirable to first review the electrical requirements necessary for satisfactory operation of a link antenna system which would be suitable for operation with a present-day high definition television system. The basic requirements for most effective and most satisfactory operation of such an antenna are essentially four in number, the first three being general requirements necessary for satisfactory operation of any antenna system used for high definition television transmission, and the fourth being necessary primarily because the antenna system is to be used for S-T link service.

Considering the three general television antenna system requirements: first, the antenna system should be horizontally polarized, a condition based upon observation and measurements regarding noise level and the possibility of multipath receiving conditions. Second, the antenna must have a radiation characteristic such that the field strength at a given receiving location remains substantially constant for equal antenna power inputs at every frequency in the operating frequency channel. In other words, the antenna radiation pattern must remain substantially unchanged at all frequencies in the operating band. Then, the third of the general television antenna requirements, which, in general, is the one that receives the largest amount of attention in development and design, states that the impedance at the driving point of the antenna system be substantially constant and purely resistive at every point in the operating channel of frequencies. In addition, the antenna driving point impedance must be equal in magnitude to the characteristic impedance of the transmission line which energizes the antenna. The fourth requirement, imposed because the antenna system is to operate as a link system, requires the horizontal characteristic radiation pattern to be of the nature of a unidirectional

beam so as to concentrate the radiation in the direction of the main transmitter location. This, of course, is for the purpose of utilizing the power fed into the link antenna most effectively by reducing its radiation in directions not toward the receiver at the main transmitter. In addition, the beam characteristic reduces the possibility of interference with other nearby stations which may operate on the same relay channel.

In general, the third mentioned requirement stating that the impedance at the driving point of the antenna be substantially constant and purely resistive, and, also, be matched into the characteristic impedance of its feeding transmission line, is the most difficult of the above-mentioned conditions to obtain in practice; and the development of antenna and transmission line circuits which will accomplish this desired effect has received a large amount of attention from antenna engineers. That the attention given to details in this problem is justified is readily recognizable if one has ever seen a television picture transmitted through a system whose antenna did not meet this requirement. A lack of the necessary band-width in the impedance characteristic of the antenna may be sufficient to attenuate the high frequency components of the transmitted pulses to the extent of seriously limiting the horizontal definition in the picture. Then, too, a material lack of the proper antenna-to-transmission line impedance match may very well produce reflections of such magnitude on the transmission line as to result in a visible displaced image or "ghost" on the received picture. The amount of displacement of the ghost image from the real picture image will depend primarily on the length of transmission line used between the transmitter and antenna, the displacement of the ghost on the screen being directly proportional to the time taken for the radio frequency waves on the line to traverse twice the total length of transmission line.

With reference to the impedance uni-

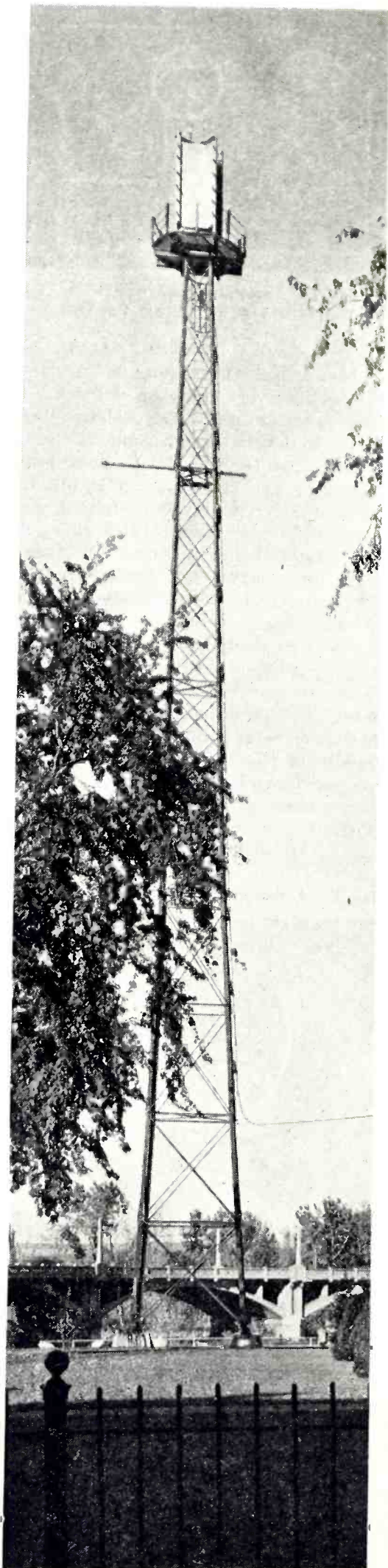

S-T television link antenna at G.E. station, WRGB, Schenectady, N. Y.

Fig. 1. Calculated horizontal radiation pattern of the antenna system shown in Fig. 3.

formity and match into the feeding transmission line, it is often quite inconvenient and impractical to produce an antenna system whose impedance would remain exactly constant and purely resistive over a wide band of frequencies, and, at the same time, would match perfectly into the feeding transmission line. In view of this, there are allowable tolerances which may be given to the antenna impedance across the frequency band and also to the degree of impedance mismatch which may be tolerated without materially affecting the definition of the system. Since both the antenna impedance characteristic and match into the transmission line are directly responsible for the behavior of the waves on the transmission line, an overall view of the antenna characteristics may be seen from the appearance of the transmission line waves. To be more specific, any sort of impedance variation or mismatch seen by the transmission line feeding the antenna will present itself in the form of a wave traveling back along the transmission line in the direction of the transmitter. This backward traveling wave will add itself vectorially to the forward traveling waves and produce an overall effect of standing waves on the transmission line. The amplitude of standing waves will then be a direct function of the backward traveling waves. For purposes of convenience, the amplitude of the backward traveling waves is usually expressed in terms of its fractional part of the forward traveling waves, and, when expressed in this form, is called "the reflection coefficient." In other words, this reflection coefficient (which is a voltage ratio) is the ratio of the amplitude of the reflected waves to the amplitude of the incident waves on the transmission line. It is the value of the reflection coefficient that is usually employed as a figure of merit for operating characteristics of a television antenna system, and it is here that the tolerances of the system are usually specified. Experience with existing systems has shown that a maximum allowable reflection coefficient of the order of 0.05 is tolerable for suitable operation of a television system.

In order to achieve the above mentioned desirable characteristics in the antenna system under consideration, that is, a unidirectional beam radiation pattern and a substantially constant,

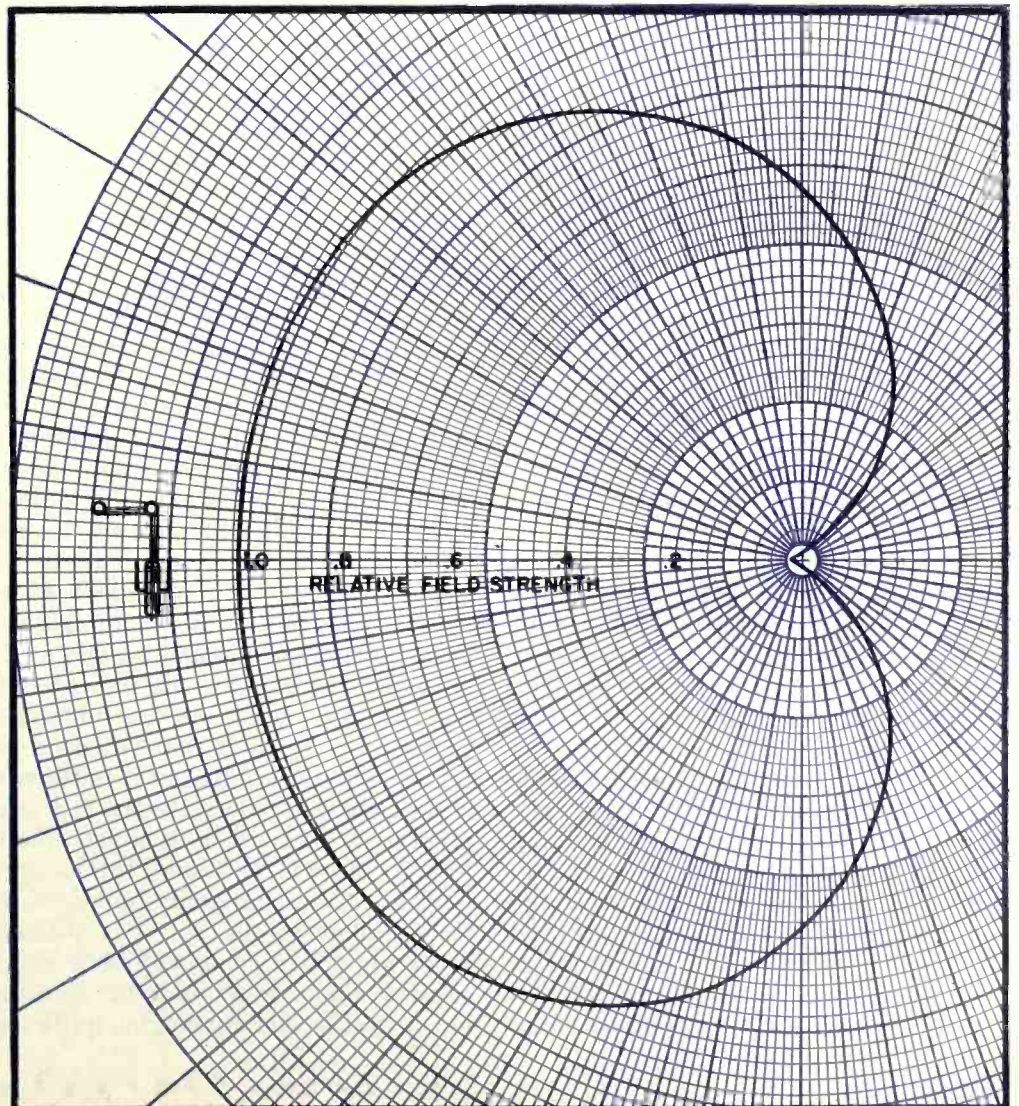
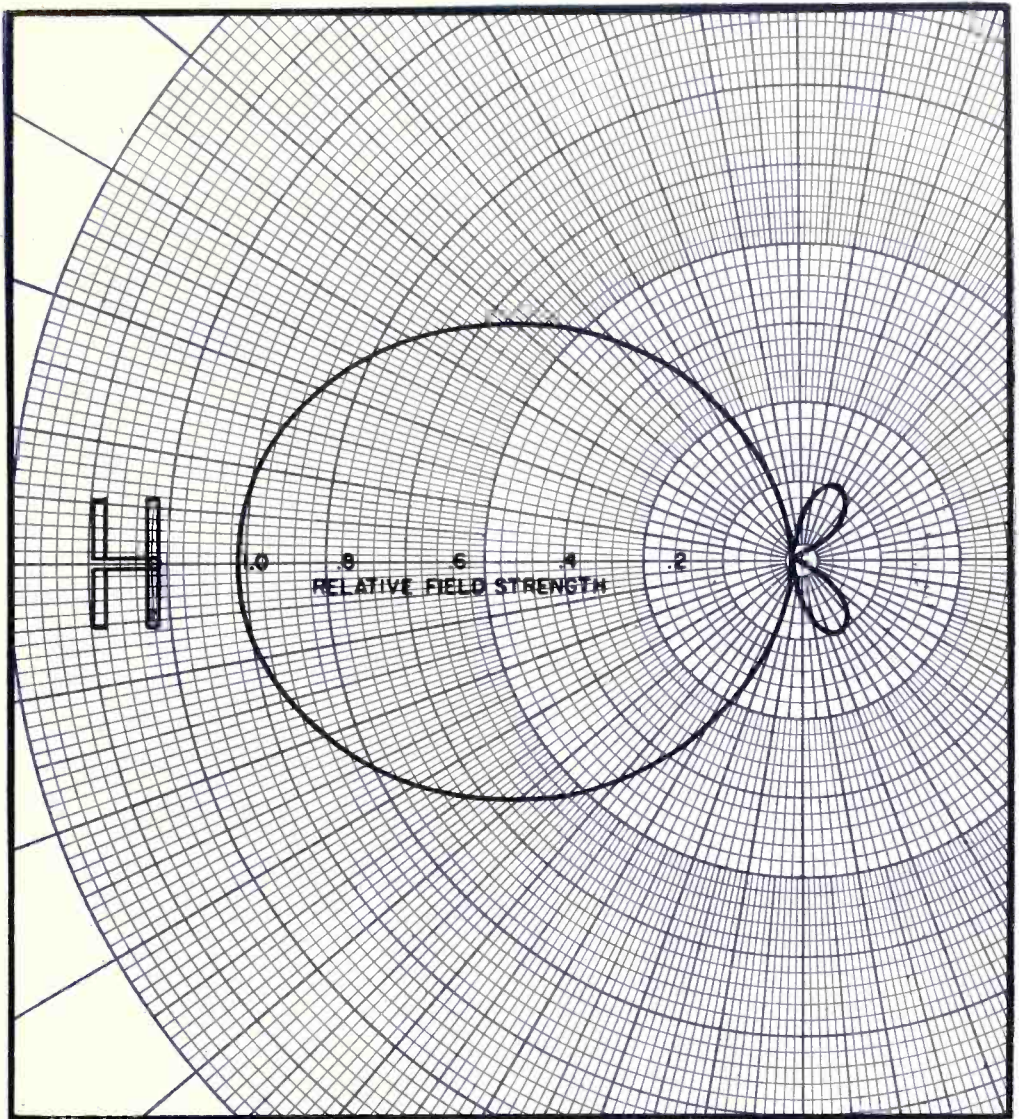

Fig. 2. Calculated vertical radiation pattern of the antenna system shown in Fig. 3.

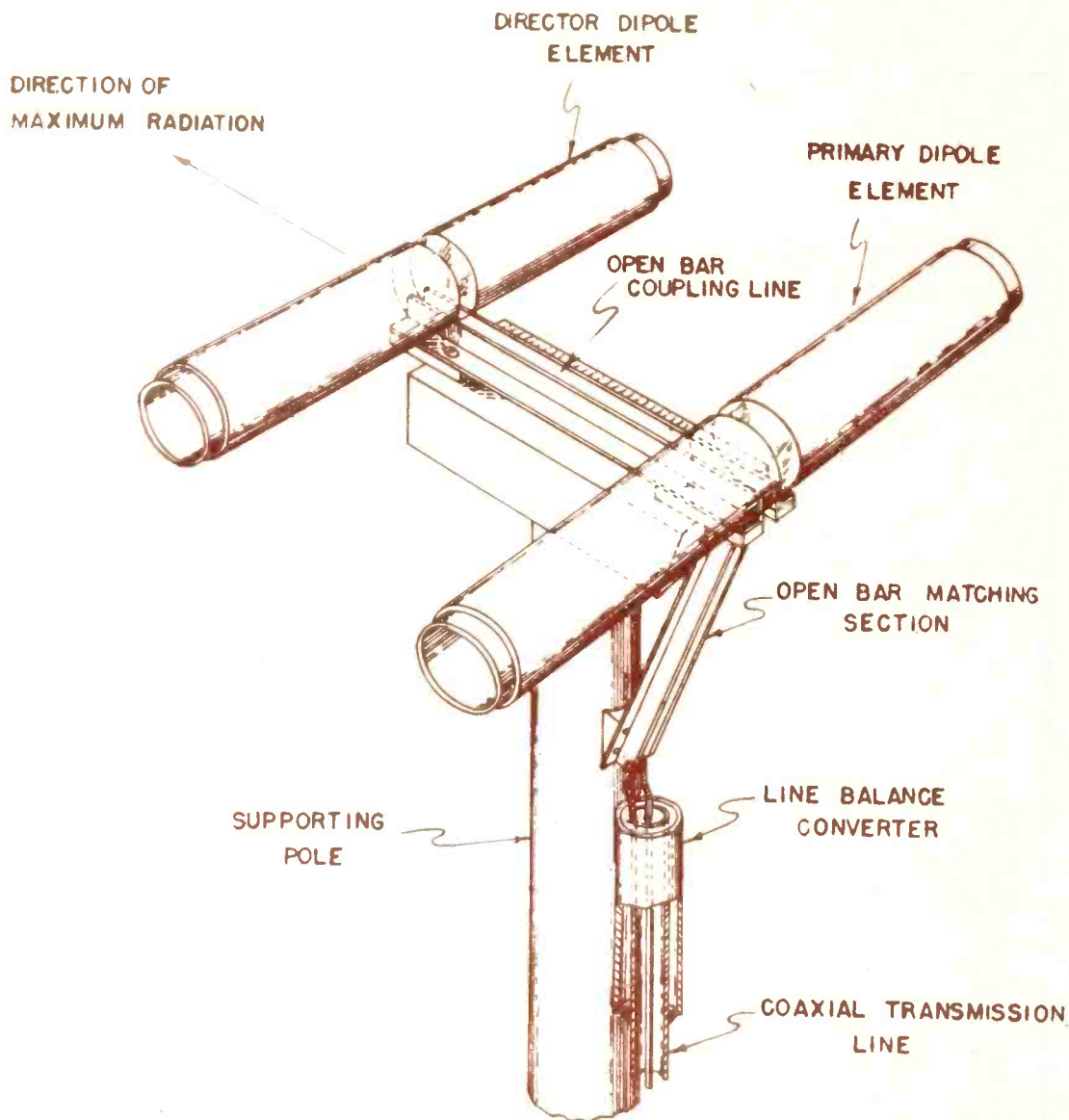

Fig. 3. Schematic view of basic array unit of television link antenna.

purely resistive, matched impedance characteristic across a 6 megacycle television band (as evidenced by a maximum reflection coefficient of the order of 0.05), a basic array unit is employed which is illustrated in Fig. 1. The energized antenna elements shown in Fig. 1 are essentially two dipole antennas, placed mutually parallel to each other with their spacing between centers being one quarter wave length at the mean operating frequency for which operation is desired. The dipoles are energized at their centers in order to provide a low value of working impedance and zero reactance at the mean operating frequency. An open bar transmission line whose characteristic impedance is essentially equal to the half wave resonant impedance of one of the dipoles is used to connect the two dipole centers together. The length of this open bar coupling line is made one quarter wavelength at the midband operating frequency. Energy for the system is supplied through the quarter wavelength open bar matching section shown, and this, in turn, receives its excitation by being connected to the coaxial transmission line and line balance converter combination. The quarter wave matching section has a characteristic impedance equal

in magnitude to the geometric mean between the impedance at the feed point of the first dipole and the characteristic impedance of the coaxial transmission line. The line balance converter is employed at the termination of the coaxial transmission line for the purpose of preventing r.f. currents from flowing down the outside of the outer conductor of the coaxial transmission line, thus forcing a balance of currents flowing into the open bar matching section. Use of a line balance converter is almost imperative in all cases where a transition from an unbalanced coaxial line to a balanced open wire transmission line is employed.

The direction of maximum field intensity from this array lies along a line perpendicular to the dipoles and in the plane of the dipoles, as indicated in Fig. 3. The shape of the horizontal radiation pattern is that which is obtained when the horizontal pattern of a horizontal dipole antenna is multiplied by a cardioid, as is illustrated in Fig. 2. As will be noted, the antenna patterns from this array appear to be very similar to the patterns obtained from an array composed of a single excited dipole and parasitic director, hence, the second dipole may quite log-

ically be called driven director element.

From the standpoint of impedance, each dipole will present a varying impedance characteristic as the frequency of the impressed signals to them is varied. However, in the system described here, the fact that each dipole alone presents a varying impedance characteristic with frequency is of little consequence if the variation is not too great, and too, providing the impedance variation of each dipole is the same. The individual dipole impedances correct themselves to give the proper wide-band operation when connected together by means of the quarter wavelength coupling line. Briefly this coupling line is an impedance inverting device which inverts the impedance of the director dipole element before it is combined with the impedance of the primary dipole element. The end result of the impedance combination at the feedpoint of the primary dipole element is that the net impedance becomes substantially constant and purely resistive over the entire television operating band.

In order to obtain a better understanding of the operation of the system, perhaps it is desirable to inspect the action of the individual dipoles more thoroughly. If it were possible to arrange two dipole antennas relatively close together without materially affecting the free-space impedance of either dipole, this system would probably be composed of two dipoles of equal length, each being one-half wave length long at the midband operating frequency. However, due to mutual impedance effects, the lengths of the dipoles are necessarily made unequal. In particular, the mutual impedance effects cause one dipole to possess an increased resistance component while the other dipole possesses a decreased resistance component of approximately the same amount. Also, one element contains a positive mutual reactance and the other a negative mutual reactance. More directly speaking, the 90 degree lagging phase of the director dipole causes the mutual impedance effects to increase the resistance component of the primary dipole element, at the same time causing the reactance of the element to become more negative. In order to compensate for this effect and to bring the resonant frequency of the primary dipole element back to the center of the operating band of frequencies, the length of the primary dipole element must be increased.

On the other hand, the 90 degree leading phase of the primary dipole element (as referred to the phase of the director dipole element) produces mutual impedance effects which result

(Continued on page 47)

The Engineer's Future

Obligation and Opportunity

By **HARADEN PRATT**

A brief statement of the problems confronting the engineer in the postwar period and the need for strong action.

WAR generates opportunities for great advancement in the basic sciences but, to a large extent, application of the knowledge gained to create new means and develop new methods must take place over several years of the succeeding peaceful era. Upon emergence from a war, these new instrumentalities, be they discoveries or developments, are only partially understood and such applications as have been made of them have been for the more obvious things that would help the war effort.

When the normal peacetime developments of a period of years are suddenly forced into a span of as many months, the proceeds have not become digested by the body politic, as they would have been had they come in the more normal way. Therefore, even the technical and engineering world has much to learn, for during this intensive time each man has been absorbed in his own task, and in addition, the usual channels for the dissemination of information have, perforce, become greatly curtailed.

It is the engineer, more than the scientific man, who has to deal with this postwar problem of which he is fully conscious but as yet only partially informed. The job to be done is not to search for more new things, but to become acquainted with the just-acquired reservoir of knowledge and to make useful applications as rapidly as possible. Here, the engineer faces many serious obstacles.

The first of these is the desire of the public generally to see the proceeds of new methods. In its impatience it will become annoyed when these methods do not appear rapidly. This enthusiasm of expectation will tend, in some ways, to slow down business in many respects. For example, Mr. Citizen will decide not to build a house now because new and cheaper materials, methods and designs are right around the corner, whereas, as a matter of fact, they are much further away around many corners than he



Haraden Pratt, vice-president and chief engineer of Mackay Radio and Telegraph.

realizes. This feeling of frustration will develop as time goes on and become reflected in the attitude of business men, bankers and legislators.

A second situation arises out of the great postwar need for many constructive enterprises. Building and the manufacturing of consumers' goods, the supplies of which have become depleted, will forge ahead. All such activities must obviously be encouraged. But the cry from the people will be for new things, and the business man will be forced to act not only to meet this demand, but to meet his own problem of reducing his costs through use of new materials and methods. His operations will also be characterized by his need to outdo his competitors.

A third condition will arise out of the efforts of the promoter. Seeking to develop a new business or lured by the attraction of quick and perhaps temporary profits, many enterprises will spring up that may result in ill advised activities and the commercialization of as yet unproven or untried ideas.

Against all this speed and turmoil the informed engineer must pit his resources. One of his principal responsibilities must be that of educating the people. Not only education in the field of technical matter, but education in

matters of how technical evolution progresses and how the welding of new things with the older processes and situations can best be done. Some of the problems are going to be of profound magnitude and will bring with them important changes in the methods of civilized living. An example is the advent of world-wide mass air transportation. Never, heretofore, has the world been confronted with a radical change of an important instrumentality in such a short time. The railroad, the telephone, the automobile and almost everything else we now have, grew up much more slowly.

It will not best serve interests of making the most adequate progress in this forthcoming postwar era, to relegate the engineer to dealing only in circumscribed fields of influence closely associated with specific projects and their related problems of production, construction and detailed application. The vision and understanding of the technically trained man, begotten from his experience of moulding together the tangible and the intangible is needed to complete the thinking of those who legislate and those who pioneer in commercial ventures. The engineer himself must take the lead in orienting his thinking into the channels which will create the opportunities that will spell more success for him and which will contribute to a smoother progress in these forthcoming days. He must get away from the idea of waiting for somebody else to state a problem, and waiting still longer until the problem is tangible enough for his slide rule and handbooks. If he should look to acquiring an expanded role by forcing himself into the councils of others he can expect to be of less service than if he is sought out by those others.

In this direction lies the effort the engineer must make to enable him to attain a satisfactory orientation to meet the obligation he owes to the generation just ahead.

FREQUENCY MEASURING EQUIPMENT

By **JOHN D. GOODELL**

Consulting Engr., St. Paul

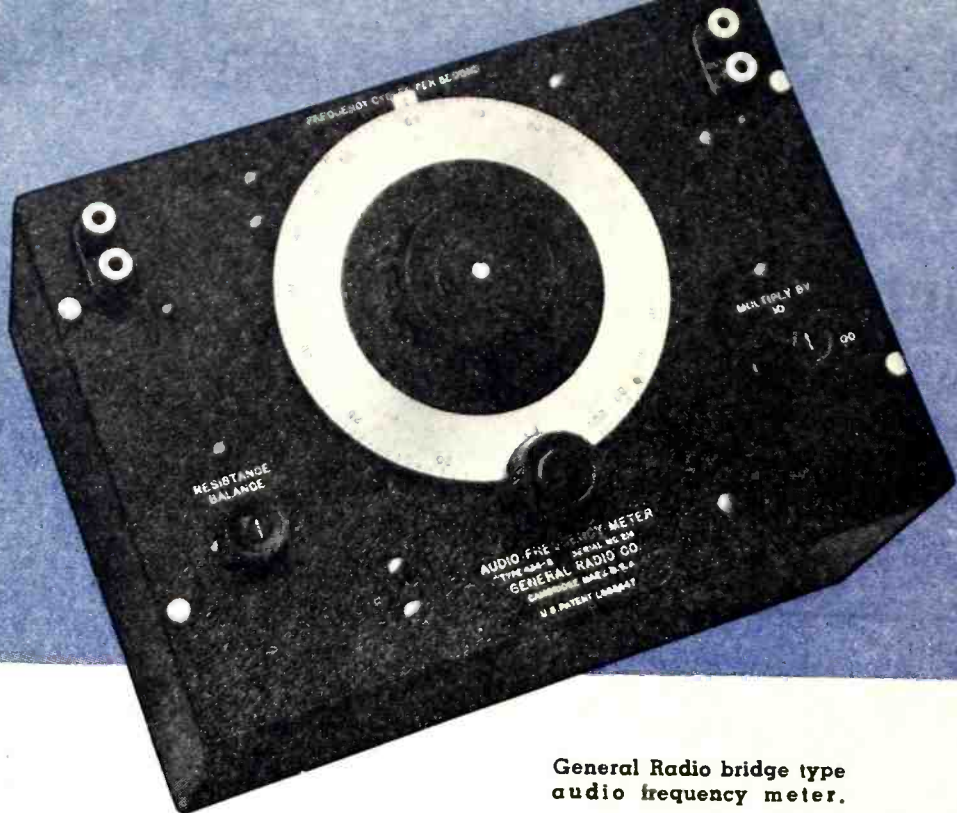

General Radio bridge type audio frequency meter.

Equipment and methods for the accurate determination of frequency.

AS recently as a decade ago, precise frequency measuring equipment was relatively scarce. Today the increasing investigation of electronic applications where frequency determination of great accuracy is vital, has enormously increased the availability of such apparatus. Radio and telephone communications require increasingly rigid frequency standards; a high percentage of our clocks, phonograph motors, electronic musical instruments and other devices depend on the supply of frequency controlled alternating current for proper operation. Single side-band suppressed carrier developments demand absolute frequency stability, hence equally absolute measurements. Finally, the perfection of electrical primary standards of frequency has reached sufficient precision to use them for determining the accuracy of astronomical clocks and for discovering irregularities in the basic reference for all previous frequency measure-

ments—the rotational period of the earth. Some of these methods were discussed in a preceding article.¹

Frequency is often determined by comparison with a standard reference, and heterodyne methods are used to produce a frequency equal to the difference between the two. Alternatively, a cathode ray oscilloscope may be used so that a stationary pattern represents a simple fractional difference between the compared frequencies.

In using the oscilloscope to compare frequencies, the two frequencies are connected respectively to the X and Y plates at equal input levels. Stationary Lissajous figures represent relationships corresponding to simple fractions as indicated in Fig. 6. When the ratio is not a simple fraction, the figure will rotate. The ratio is determined by X_n/Y_n where X_n is the number of times the figure is tangential to the X axis and Y_n tangential to the Y axis. Obviously this will not apply

if the phase differences are 0° or 180° , because the advance and return traces will coincide.

As the frequency ratios increase, the patterns become too complex for visual inspection. An alternate method is to apply the lower frequency through a resistance-capacitance phase splitting circuit as shown in Fig. 10(A). R and C are adjusted for equal potentials, producing a circular trace. The higher frequency is then connected in series with the accelerating voltage on the anode of the cathode ray tube, as shown in Fig. 10(B). The size of the circular trace is inversely proportional to the magnitude of the accelerating voltage. Consequently the radius of the circular pattern will increase and decrease cyclically with the alternations of the voltage applied in series with the direct voltage normally acting on the anode. This produces gear-shaped figures for simple integral relationships with the number of "teeth" indicating the ratio. For ratios such as 2:3, 2:5, 2:7 and 3:4, the patterns become more intricate and appear as shown in Fig. 4(A).

It is also possible to modulate the beam, Fig. 4(B), so as to vary the intensity of the spot, which produces an interrupted pattern, Fig. 4(C), with the number of spots indicating the ratio. If the sources are stable, ratios up to 50:1 may be accurately determined. If the figures rotate, the ratios are not precisely fractional, and the relative "sense" of the frequencies determines the direction of motion.

Stroboscopic methods are used extensively for frequency determination. Perhaps the commonest application is in connection with recording and phonograph motors. A disc is designed so that, when rotated on the turntable, the alternate black and white mark-

Fig. 1. General Radio absorption type ultra-high frequency wave meter (55 to 400 mc.).

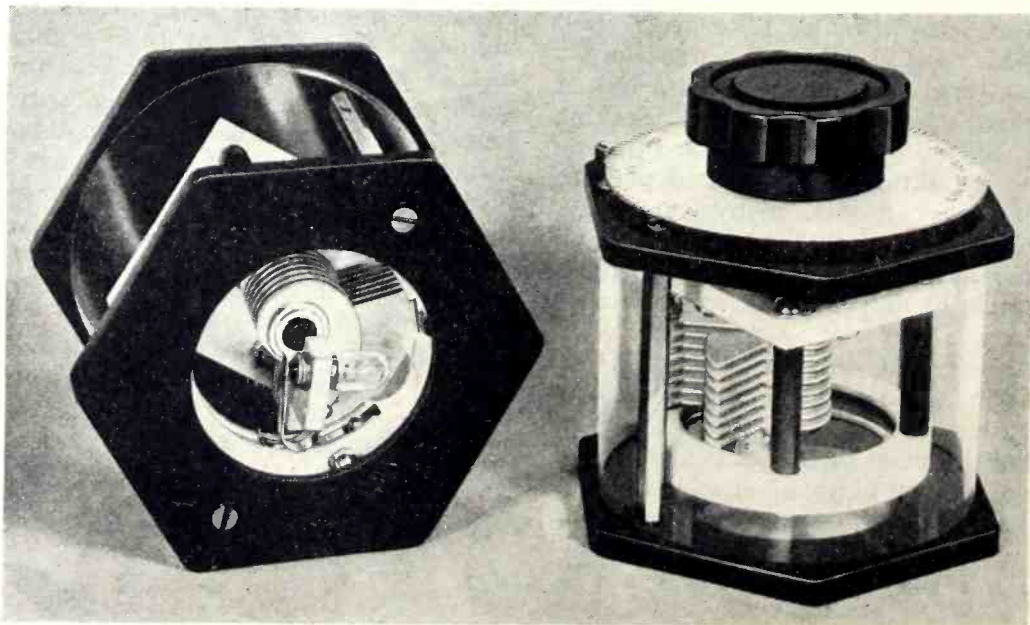

ings will appear stationary under 60 cycle illumination (usually from a neon lamp) if the motor is turning constantly at the proper speed. Such discs are often made with concentric rings of markings for various frequencies. In principle the markings are spaced so that each black sector moves to the position previously occupied by the adjacent black sector in precise time synchronization with the successive flashes of light. It must be borne in mind that the stationary effect will also be produced when the disc is moving at a multiple of the basic speed. If the rotation is an exact submultiple ($1/n$) of the basic speed, the stationary effect will occur, but the number of black segments will appear as n times the actual number. Obviously the effect is reversible, and the frequency of the light source may be calibrated in terms of a motor of known speed. Discs are commercially available covering audio and commercial frequencies, and are usually patterned for use on a 1-kc synchronous motor.

An excellent and interesting application of stroboscopic effects is used by a manufacturer of vibrating reed frequency meters. The usual audio frequency oscillator is not sufficiently stable to provide a standard comparative source for calibrating purposes within the limits (usually around one-fourth of one percent) set for vibrating reeds. Fifteen electronic tuning fork oscillators, Fig. 7, are operated constantly at a central point. Battery cable circuits conduct the output to the various production line, inspection, and other operators. The voltage is converted from comparatively high impedance into adequate power to operate a reed frequency meter. The reed closest to resonance with the selected tuning fork vibrates at the standard frequency. The local audio oscillator is connected to drive a stroboscopic light source illuminating the vibrating reed. Calibration of the audio oscillator is conveniently accomplished by adjustment until the stroboscopic light "stops" the motion of the reed.

Stroboscopes operating on the flashing lamp principles are used extensively to determine the frequency of rotating or reciprocating objects. A gas-filled lamp is caused to produce short, brilliant flashes controlled by an electronic switch or synchronous motor-driven contactor. Commercial devices provide flashing speeds up to 14,000 per minute for visual investigations. The flashing speed is adjusted from a direct reading dial on which frequency can be read when the flashes correspond to the motion of the object under investigation. Below 600 rpm the persistence of vision is not ade-

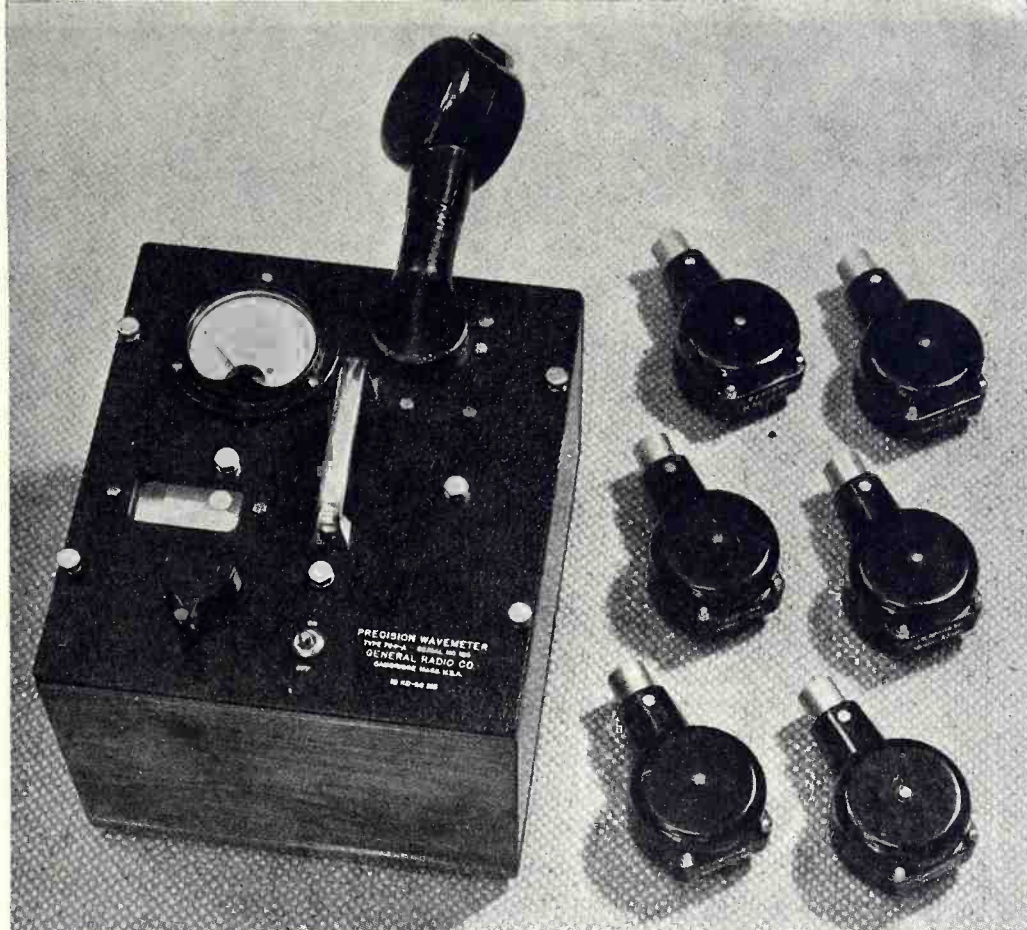

Fig. 2. General Radio precision wavemeter with plug-in coils for various frequency ranges.

quate to retain successive images and flicker effects result. Multiple images may be used with some success below 600 rpm. By using multiples of the basic flashing speeds, frequencies as high as 100,000 rpm may be determined. Accuracy is obtainable within $\pm 1\%$ when the instrument is standardized in terms of a frequency-controlled power line. Flash duration is approximately five to ten microseconds. For tachometer measurements this method is often particularly desirable because no physical contact is required, hence no power is absorbed.

When any electrical, mechanical or electro-mechanical system is activated by energy at a frequency corresponding to one of its natural periods, it will

oscillate at greater amplitude, for the same quantity of drive, than at any other frequency. Such resonance effects are used in many methods of frequency measurement.

Mechanical devices based on this principle include the sonometer, in which vibrating strings are electro-mechanically driven, and vibrating reed frequency meters. The latter are used in many different applications, such as the tuning of automobile horns, determination of harmonic ringing frequencies for telephone services, on motor generators, as tachometers, for control panel indications in industrial plants, and in the manufacture of radio and electronic equipment. Recent developments and new uses for vibrating reed meters have brought about methods of extending the frequency ranges and types available in commercial instruments. Some of these applications are restricted for security purposes during the war. In connection with electrophysiological measurements, experiments are currently being conducted with these meters calibrated to frequencies as low as one cycle per second. For example, in brain wave work it has been noted that a direct correlation may be obtained between the frequency of the Alpha rhythm and the degree of consciousness in a patient under anesthesia. The advantages of a direct reading meter for such purposes during operative procedures is obvious. One advantage of vibrating reeds in electroencephalography is the fact that a frequency spectrum is continuously observable. In other words, if several

Fig. 3. General Radio Strobotac.



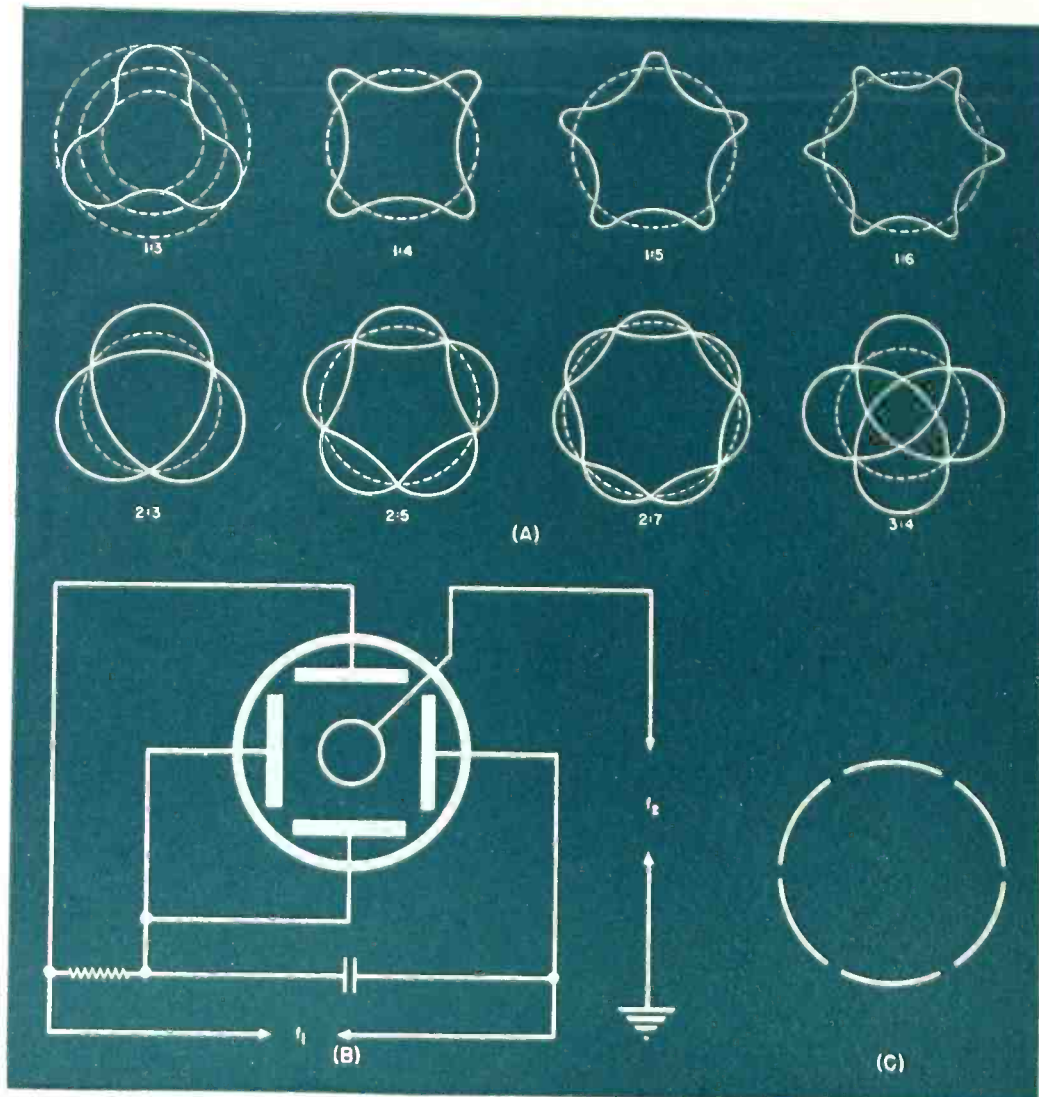

Fig. 4. (A) "Gear wheel" oscilloscope patterns obtained from circuit of Fig. 10. (B) Oscilloscope connections for "spot wheel" patterns. (C) "Spot wheel" pattern for $f_2/f_1 = 6$.

Fig. 5. (A) Lecher wire system for measuring high frequencies. (B) Bridge for comparing unknown to standard frequency. (C) A typical resonance bridge. (D) Wien capacitance bridge.

frequencies are present, each will be indicated by the amplitude of a separate reed.

Electrical circuits operating on resonance principles for frequency determination have been termed wavemeters, and most such instruments are of the absorption type, designed for use at radio frequencies. Several simple circuits are shown in Fig. 9. An accuracy of 0.05% is obtainable over a frequency range from about five to 300,000 kilocycles per second. This method is based on the fact that such circuits absorb maximum energy from a loosely coupled test circuit when the capacitance and inductance are so adjusted that

$$f = \frac{1}{2\pi \sqrt{LC}} \dots (1)$$

and maximum current flow and voltage will appear across the variable condenser. It is clear that the resonant frequency is

$$f' = f \sqrt{\left(1 - \frac{R_L^2 C}{4L}\right)} = f \sqrt{\left(1 - \frac{1}{4Q^2}\right)} \dots (2)$$

cycles per second, where $R = 0$ and

$$Q = \frac{2\pi f L}{R_L} \dots (3)$$

Hence a high value for Q permits calibration directly from a knowledge of L and C . For precise work, however, calibration should be accomplished in terms of a standard frequency. The value of Q then has importance only with respect to the sharpness of resonance settings.

A thermo-electric meter of low heater resistance is often used as a resonance indicator; rectifier type meters of one milliamper or less are connected to a pickup coil closely coupled to the absorption circuit inductance. Increased accuracy may be obtained through the use of a vacuum tube voltmeter connected to the input of the frequency meter. For rough approximations a neon glow lamp gives adequate evidence of resonance.

Fig. 9(B) and (C) shows two methods of avoiding detector damping effects, as well as reducing the shifts in calibration caused by detector replacements. In one case the coupling to the diode detector is accomplished by a loosely coupled coil consisting of a single turn. In the other a capacity potential divider isolates the vacuum tube voltmeter from the resonant circuit.

The accuracy obtained may be considerably increased by tuning for equal deflection on each side of resonance and computing the final value as the mean between the readings. Increased sensitivity is thus achieved by depend-

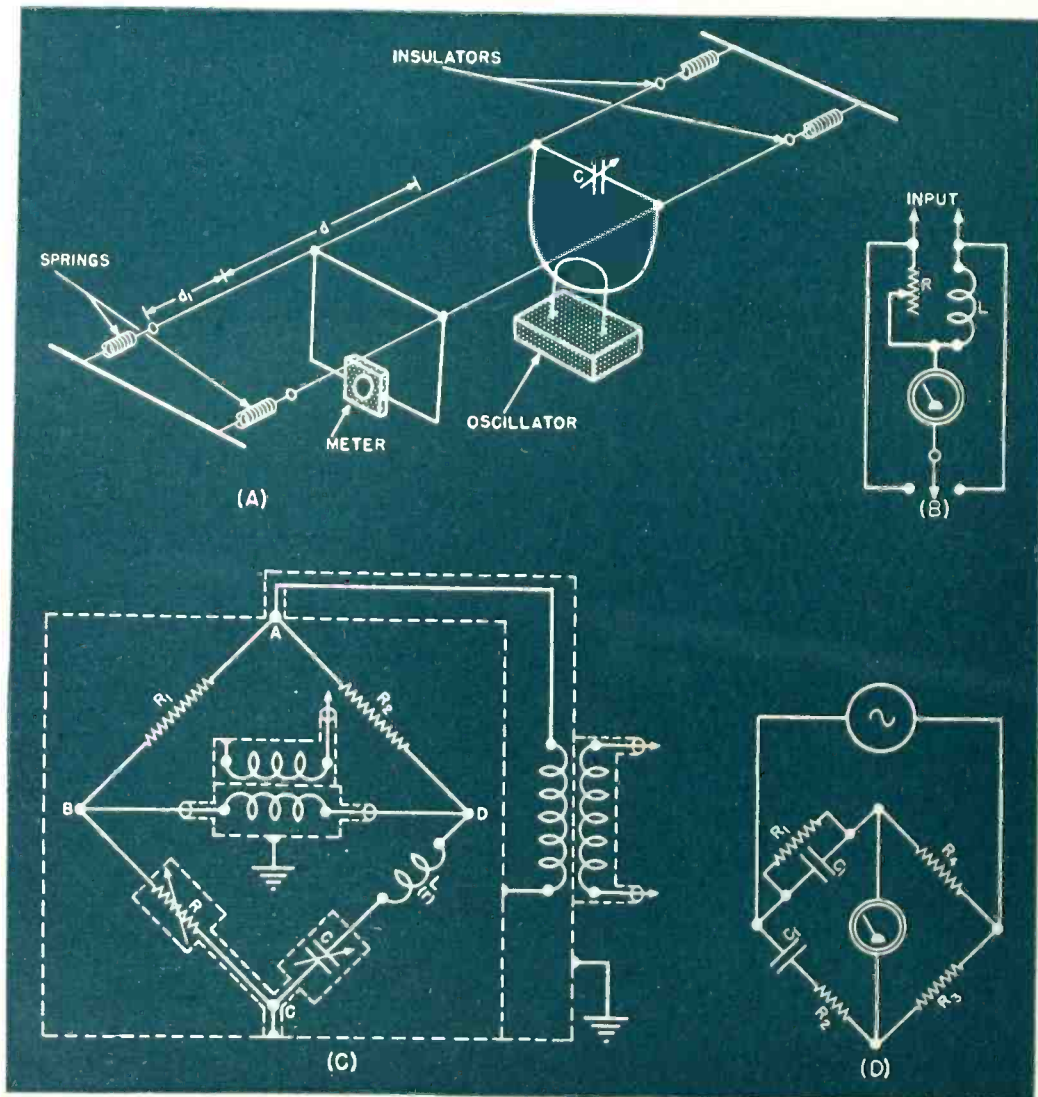

ing on the steep sides of the curve instead of the flat top corresponding to resonance. A small capacitance may be used to accomplish this adjustment automatically, in which case the variable condenser is tuned to a point where switching the small capacitor produces no deflection change.

Commercial instruments with these advantages are available and may be obtained with facilities for plugging in a variety of induction coils. (Fig. 2).

When an alternating voltage is applied across a piezo-electric quartz crystal, the amplitude of forced vibration of the crystal is greatly increased where the frequency is within one or two parts in 10^4 of a natural physical period. Among the many circuits which may be used to detect resonance in a crystal, the one shown in Fig. 8 is selected for illustration. The crystal is connected between the detector grid and cathode and radio frequency energy applied to the input. If the input power is constant, the anode current will change noticeably only when the applied frequency approaches series or parallel resonance with the crystal. At series resonance, the anode current falls abruptly, and at parallel resonance the opposite effect occurs. Also, if a parallel tuned circuit is used with the crystal connected across it, the resonance curve obtained will show a sharp dip at the natural period of the crystal. These effects are of value in checking the calibration of wave-meters and oscillators.

An interesting luminous resonator using a quartz rod depends upon converse effects. The rod is mounted in such a manner that one end rests freely on one electrode, and the other end is separated from the second electrode by an air gap of approximately 0.5 mm., with the entire assembly fixed in a glass envelope evacuated to an air pressure of about 10 mm. of mercury. A coupling coil is connected to the electrodes and is brought into the influence of the r.f. power under investigation. When the energizing frequency approaches the natural longitudinal period of the quartz rod, a glow which is brightest at the midpoint of the rod becomes visible. Observations of the maximum glow indication may be used to determine frequency with greater accuracy than one part in 10^4 . Harmonics of the natural quartz period will exhibit the same phenomenon, but these overtones generally vary from mathematical values by amounts up to -1%.

Some reference should be made in this section to the use of a resonant bridge for determining radio frequencies in the lower ranges, Fig. 5(C). The capacitance in CD is varied until that arm is in resonance (the inductance

may also be made variable). Then R is adjusted until the drop across CB is equal to the resistance loss in CD, and BD gives a zero reading. This can only be accomplished with a sine wave input and any harmonics present will still appear across BD when the bridge is balanced for the fundamental input frequency. The circuit may be used in this manner to ascertain the total magnitude of harmonic content in a complex wave form. Used in connection with a detector amplifier, the bridge may be designed to measure frequencies below 100 kilocycles with great accuracy. Careful shielding, as indicated, is essential.

There are many methods of using bridge circuits for frequency measurements, both in the audio and radio spectrums. A simple and effective comparison method is shown in Fig 5(B). The capacitance effect of the coil, L, must be small. The decade box resistance, R, is adjusted to give the same deflection on the vacuum tube voltmeter for connection to the inductance and resistance sides of the bridge when the standard frequency is connected. The same procedure is followed with the unknown frequency. Then, where r represents the resistance of L, the unknown frequency may be computed from the formula

$$f_x = f_s \sqrt{\frac{R_x^2 - r_x^2}{R_s^2 - r_s^2}} \dots \dots \dots (4)$$

The effective resistance of L being small relative to the decade box resistances,

$$f_x = \frac{R_x}{R_s} f_s \dots \dots \dots (5)$$

It is not necessary to calibrate the

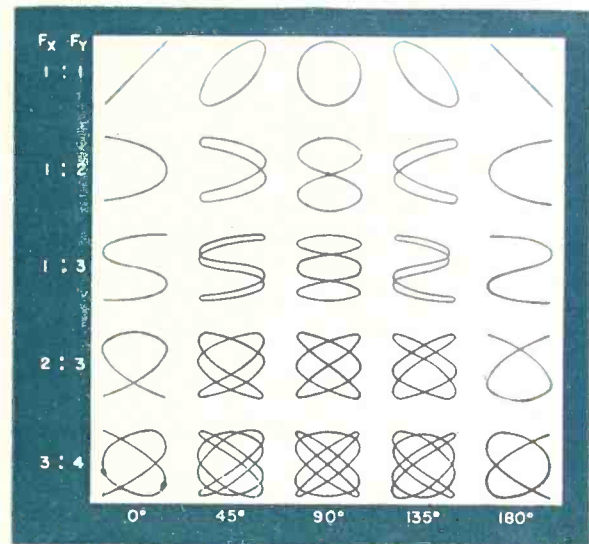

Fig. 6. Fractional Lissajous figures resulting from various frequency ratios.

vacuum tube voltmeter since it is indicative only of relative balance conditions between the arms. This method is limited to relatively pure frequency inputs.

Of all the bridge circuits used in frequency determination, the Wien bridge is the most generally practical, Fig. 5(D). This bridge is balanced when

$$C_1 = \frac{R_3}{R_4} \left(\frac{C_2}{1 + \omega^2 C_2^2 R_2^2} \right) \dots \dots \dots (6)$$

and

$$R_1 = \frac{R_4}{R_3} \left(\frac{1 + \omega^2 C_2^2 R_2^2}{\omega^2 C_2^2 R_2^2} \right) \dots \dots \dots (7)$$

so that

$$\omega^2 C_1 C_2 R_1 R_2 = 1 \dots \dots \dots (8)$$

$$f = \frac{1}{2\pi \sqrt{C_1 C_2 R_1 R_2}} \dots \dots \dots (9)$$

since $\omega = 2\pi f$, and $f = 1/2\pi RC$, if $R_1 = R_2$ and $C_1 = C_2$.

This becomes an excellent direct reading frequency meter when de-
(Continued on page 45)

Fig. 7. J-B-T Instruments electronic tuning fork oscillator circuit.⁶

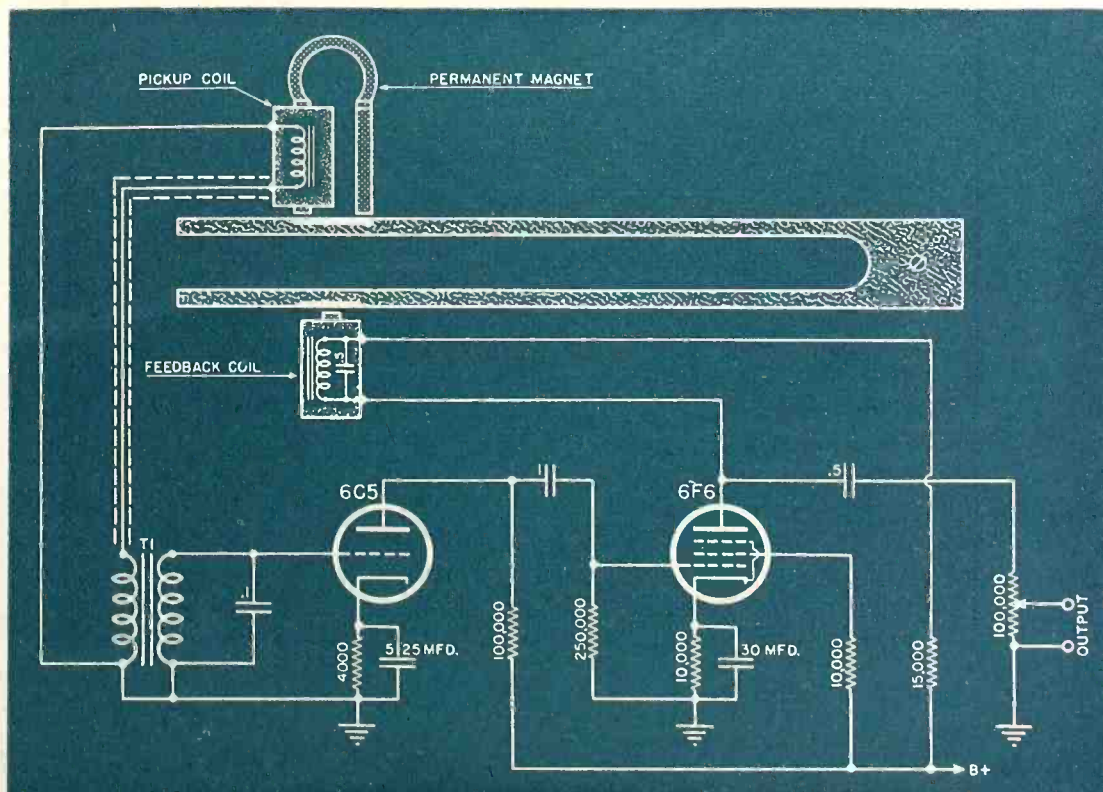

Design of R.F. Inductances

By **R. G. MIDDLETON**

Asst. Project Engr., Templetone Radio Co.

A procedure for the optimum design of small single-layer solenoids for frequencies between 4 and 100 megacycles.

RECEIVER performance is a function of the merit (or Q) of tuned circuit inductances. For efficient performance, design calculations at high frequencies must not be carried out on a rule-of-thumb basis. During the past seven years sufficient data has been established by various investigators to place receiver coil design upon a solid engineering foundation.

A tuned circuit is represented to a first degree of approximation by the equivalent circuit shown in Fig. 2. For the small coils considered in this paper, C_0 is very small, less than 5 micromicrofarads, and it may be combined with the capacitance of the tuning capacitor, C, with which the coil is associated, since R_0 is always small. The effective resistance of the inductance is usually considerably larger than the effective resistance of the capacitor, but, at high frequencies, the capacitor resistance may also be of importance.

Recent work³ indicates that for single-layer solenoids, C_0 is seriously re-

duced by skin effect and proximity effect. Results question the validity of the classic Palermo formula in the UHF region when large wire sizes are used. (See Fig. 13.) When worked above its natural frequency, it has likewise been established that a coil may behave as a transmission line⁴ with

AUTHOR'S NOTE: This article is based upon a paper entitled "The Design of Inductances for Frequencies Between 4 and 25 Megacycles" by Dale Pollack.¹

non-uniformly distributed constants.

Metallurgical improvement of powdered core materials has resulted in improved performance up to 100 mc, as well as a simplification of tuning mechanisms⁵. Careful design results in a definitely higher Q, even at UHF. Core function is becoming identified with shielding action in certain cases, and manufacturers in general are drawing upon experience of the plastics industry.

Iron cores are primarily used in r.f.

coils to obtain increased inductance⁶. Coincident with inductance increase are core losses due to hysteresis and eddy currents.

The numerical value of the inductance, L, is determined by circuit considerations, and, consequently, is fixed by specification. This article is concerned with the value of effective resistance, R, of the inductance, and with the design of coils to have a minimum effective resistance. The merit factor of a coil is usually expressed in terms of Q, or $\omega L/R$, where R is the effective resistance. The Q of a capacitor is $1/\omega CR$, and as the losses of common air capacitors are low, it has become customary to charge the capacitor loss against the coil for most purposes. The importance of high-Q circuits in modern receiver design is well known.

The increased ratio of a.c. to d.c. resistance of coils at high frequencies is the result of:⁷

- 1) Skin effect in the wires, that is, the non-uniform current distribution over the cross-section of the wire, caused by the internal flux of the wire itself.
- 2) Proximity effect, that is, the non-uniform current distribution over the cross-section of the wire, caused by flux from neighboring turns of wire.
- 3) Dielectric losses, caused by hysteresis in the dielectric between turns of wire, insulation or oxidation on wire surface, or dielectric bodies in the coil field.
- 4) Eddy current losses in metallic bodies in coil field; core materials are critically situated.
- 5) Electromagnetic radiation losses.

As a consequence of these losses, the effective resistance of a coil may be many times its d.c. resistance. The magnitude of these losses is determined by the construction of the coil, the factors which must be considered in designing a coil being:¹

- 1) Coil dimensions: length and diameter.
- 2) Wire: material, insulation, size, plating.
- 3) Coil form; material, insulation, size.
- 4) Location of coil with respect to

Fig. 1. Core-to-coil capacitance effects. Coil length, 1½ in., core length, 2¼ in., initial coil Q_0 , 75, winding pitch, 0.00855 in., core diameter, ⅜ in.

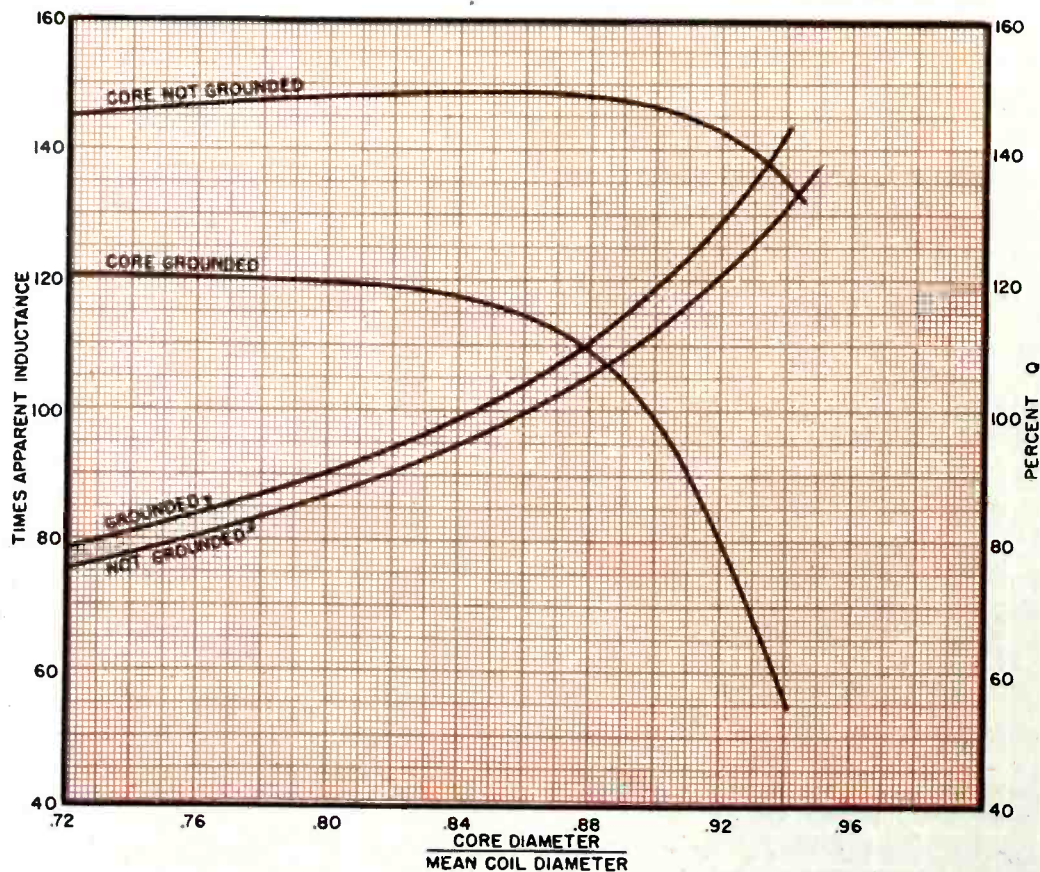

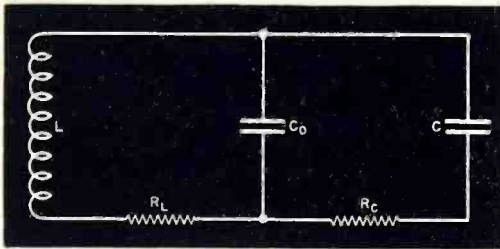

Fig. 2. Approximate equivalent circuit of a coil and tuning condenser combination.

metallic and dielectric bodies.

- 5) Core: material, size, location, subdivision.

The design problem is to proportion these factors so that the effective resistance of the coil will be a minimum.

Butterworth⁸ is the classical investigator of coil resistance at high frequencies; his solutions, while complicated, place no restriction upon frequency. His calculations have been somewhat simplified⁹ and an extension of the conclusions applied to short solenoids above 4 mc by Pollack.¹

Hund and DeGroot¹⁰ made measurements up to 5 mc. Hall¹¹ describes tests up to 6 mc, and Morecroft¹² presents data up to 4 mc. Barden and Grimes¹⁴ describe measurements at 15 mc.

Pollack's Experimental Work

Two sets of coils were tested, with inductances of approximately 1.1 and 3.6 microhenries. One design parameter was varied at a time within a large group of coils. Tests were made for various coil form materials with several depths of winding grooves.

At frequencies below the natural frequency of the coil, it is found that the Q of an inductance is proportional to the square root of frequency. Butterworth's equations were found to agree empirically by better than 10%.

Fig. 5 illustrates variation in Q with wire size, the optimum wire diameter d_0 being:

$$d_0 = \frac{b}{\sqrt{2N}} \quad (1)$$

where b is the length of winding in centimeters and N the total number of turns on the coil. Table 1 compares theoretical with empirical diameters. The experimental coils were wound on bakelite forms.

Length-to-Diameter Ratio

Fig. 6 shows the effect of changes in ratio of coil length to diameter, for a certain group of coils in which the coil diameter, wire size, inductance, and frequency were held constant. A similar set of curves with the coil length held constant is given in Fig. 7.

It may be concluded that the optimum length-to-diameter ratio is between 0.5 and 0.3, with a reasonably wide tolerance permissible.

Variation in Q with coil dimensions using optimum wire size is of consid-

erable importance¹ and is plotted in Fig. 8 and 9. It is noted that, for a constant diameter of coil, Q increases with coil length, but the increase is less rapid as large values of b/D are attained. (D is the coil diameter in centimeters and Q' is proportional to Q .) Practical limitations specify optimum ratios.

This limitation is frequently the size of the coil shield, which, in turn, is limited in size by the space available in the apparatus. The influence of the shield is complex, at certain spacings actually reducing the resistance¹⁵ by electrostatic redistribution of coil currents, but not as much as it reduces the inductance. It has been shown¹⁶ that if the coil diameter is less than half the shield diameter, and the ends of the coil are separated by at least a coil diameter from the ends of the shield, the Q of the tuned circuit is reduced by only 5 to 8%. This restriction may be used to determine the size of coil enclosed in a shield.

Calculation of Number of Turns

For a given inductance at high frequencies,

$$N \text{ (no. of turns)} = \sqrt{\frac{L(102S + 45)}{D}} \quad (2)$$

where L is the inductance in microhenries and $S = b/D$, will give results accurate to 5%.

Losses resulting from dielectrics in the coil field, in the frequency range from 6 to 20 mc., are recorded in Figs. 3, 12, 14, and 15. A bakelite form with a shallow groove for the wire, and enameled wire, may be used with little reduction in Q . The groove should not be any deeper than is necessary to give the requisite coil rigidity. Use of special coil forms and special materials does not appear to be justified.¹

Powdered Metallic Cores

The Q of a coil is controlled not only by the loss in the core but also by the permeability of the core material.¹⁷ Further, as the particle size is decreased, the gain (lower losses) from further reduction in particle size tends to become proportionately less and less, while at the same time the net effective permeability tends to drop at an increasing rate. This results in the crossing of these two lines at some point, after which further reduction in size becomes negative in its effect upon coil Q .

The data in Figs. 19, 20, and 21 have been taken with the following coils:¹⁷

Frequency range	Type of Winding	Length	Mean Diameter
5-12 mc	Solenoid	0.406"	0.535"
10-22 mc	Solenoid	0.437"	0.550"
15-50 mc	Solenoid	0.500"	0.543"

The various cores are compared upon a common Q in air of 100 by the method of Foster and Newlon⁶ and the con-

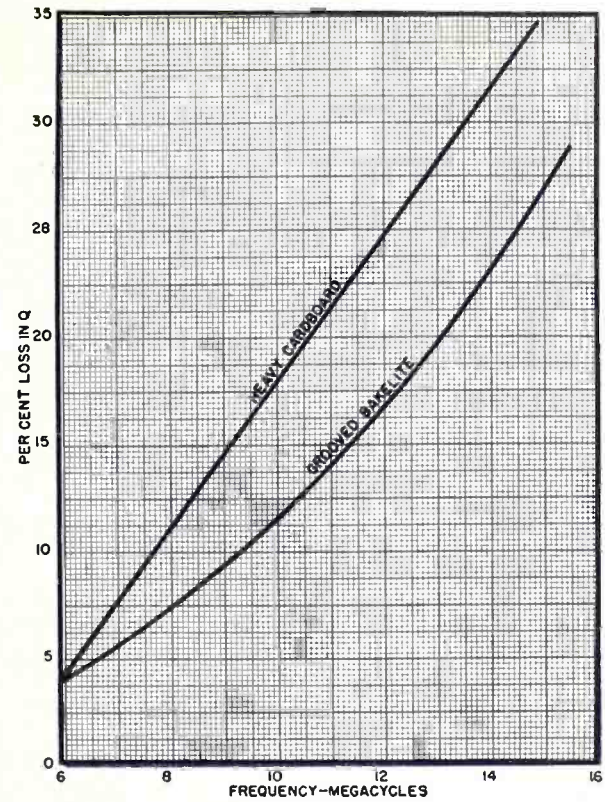

Fig. 3. Percent loss in Q with cardboard and bakelite forms. $L = 3.6 \mu\text{h.}$, $D = 5 \text{ cm.}$, $b = 1.5 \text{ cm.}$, wire size, number 32 B. and S.

tribution of the particular core to coil Q is at once apparent.

It has been pointed out⁶ that data such as presented herewith is only valuable for comparative purposes when used with windings of similar geometric design. Coils used for measurement purposes were solenoids of lengths approximately equal to core length. The Q meter was chosen for these measurements.

The core materials considered were compounded of powdered ferrous particles held together in a hard metallic mass by a suitable resinous binder.¹⁷ While representing what may be regarded as standard practice, still high-

Fig. 4. Experimental test coil.

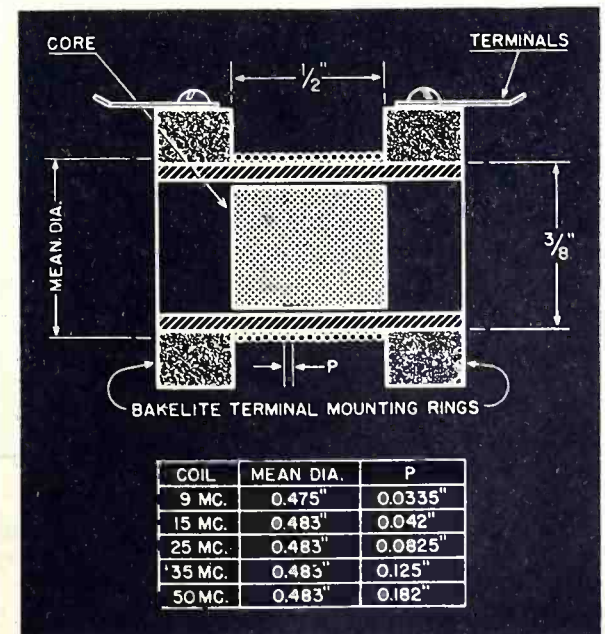

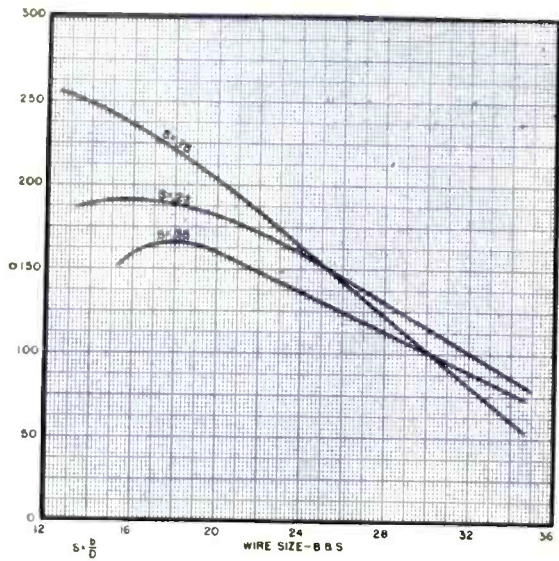

Fig. 5. Variation in Q with wire size. $L = 1.1$ microhenrys, $f = 20$ megacycles, D (coil dia.) = 2.5 cm.

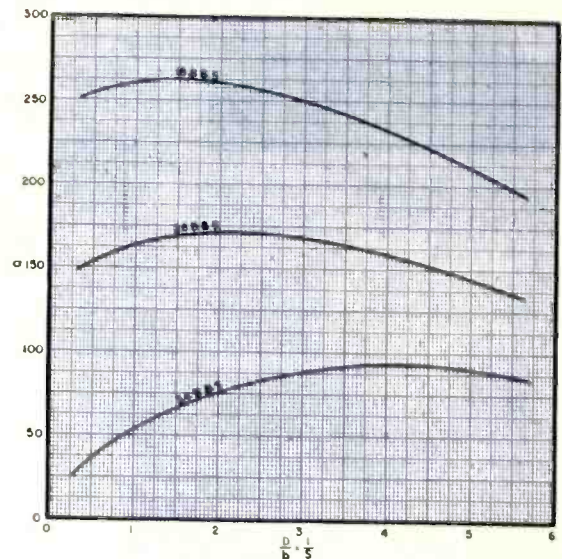

Fig. 6. Variation in Q with coil length: dia. ratio, D const. (2.5 cm.), $L = 1.1$ microhenrys, $f = 17$ mc.

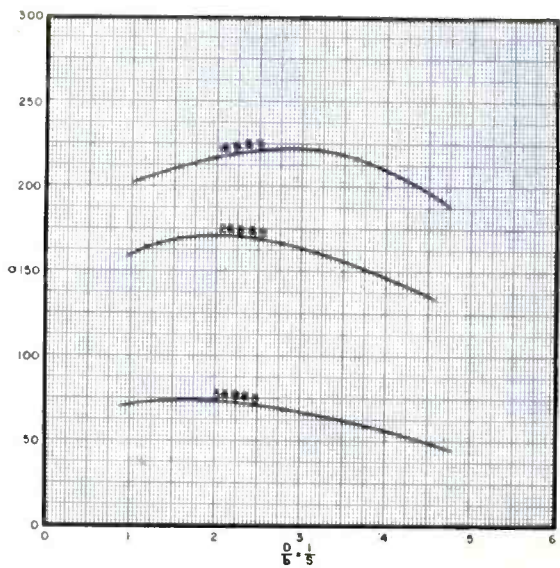

Fig. 7. Variation in Q with coil length: dia. ratio, b const. (1.5 cm.), $L = 3.6$ microhenrys, $f = 13$ mc.

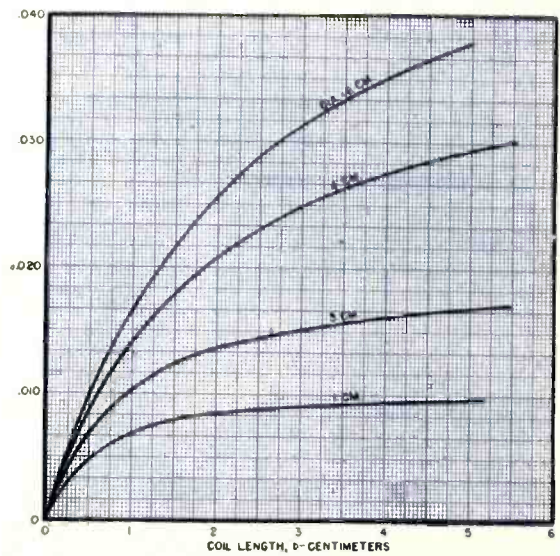

Fig. 8. Variation in Q with length and dia. of coil, wire size kept at optimum. (Q' proportional to Q .)

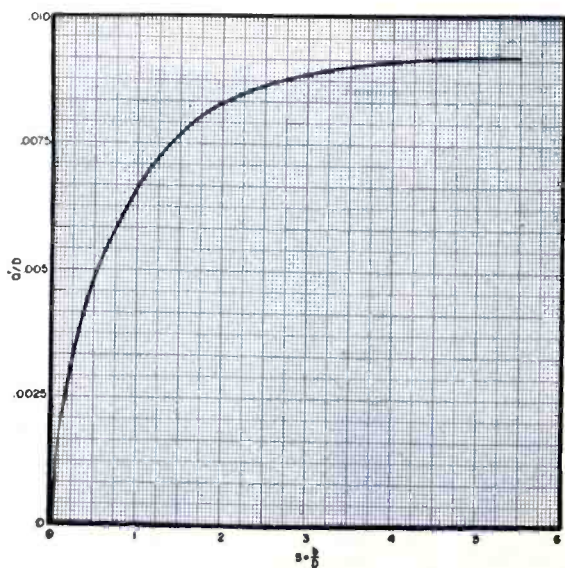

Fig. 9. Variation in Q with length: dia. ratio, D optimum and constant. (Q' proportional to Q .)

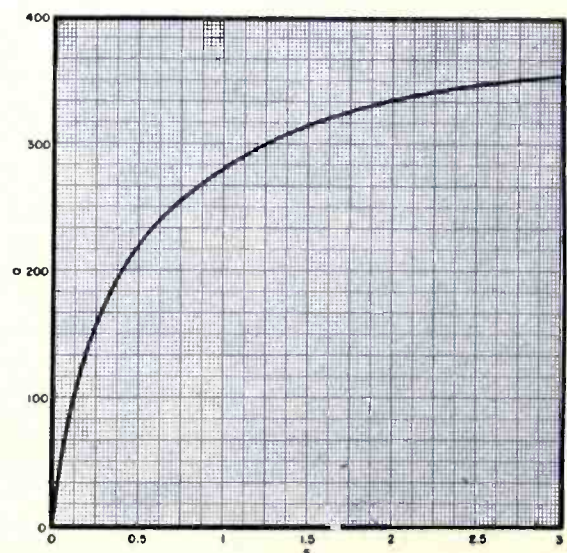

Fig. 10. Variation in Q with length: dia. ratio, wire size optimum. These are theoretical curves.

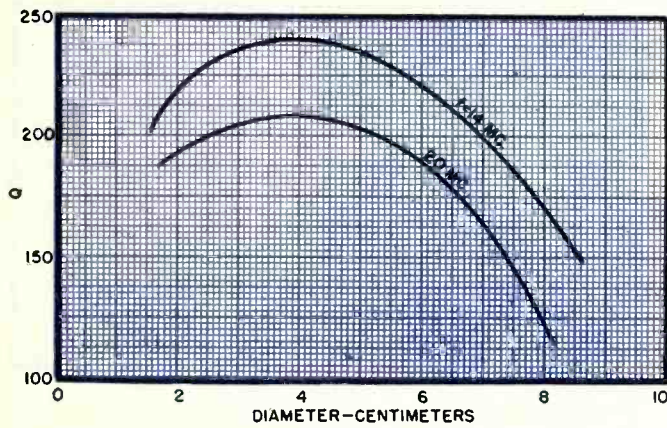

Fig. 11. Variation in Q with coil diameter, with length: dia. ratio and wire size constant. $b/D = 2.8$, $L = 1.1$. μh . $d = 0.081$ cm.

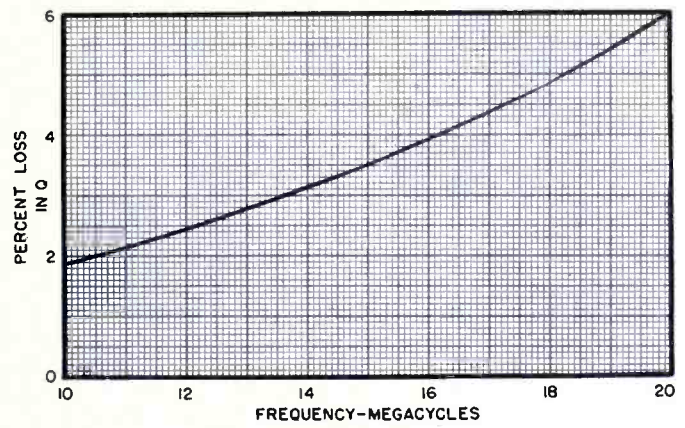

Fig. 12. Percent loss in Q resulting from enamel wire insulation. $L = 1.1$ μh , $D = 2.5$ cm., $b = 3.4$ cm., wire size #18 B. and S.

er Q 's may be attained by close attention to coil and core dimensions and core material.

Annealed copper may be utilized for small inductance variations with some sacrifice of Q ,⁶ as shown in Figs. 4 and 16. The curves for coil Q with various core formulas illustrate that the designer must take into account the frequency band over which he desires to operate as well as geometric considerations. Even a crude core such as annealed copper is better suited to application at 50 mc that at 10 mc.

The effect of coil diameter⁶ upon inductance increase obtained by an iron core, and the associated change in coil Q , is shown in Fig. 17. These characteristics, obtained by varying the coil diameter while holding all other parameters constant, are of importance in pointing out the direction of optimum coil design. These characteristics are concave upwards with the slope constantly decreasing as the coil diameter decreases. This means that increasingly larger amounts of inductance change are obtained with increasingly smaller amounts of Q change, and that, therefore, the most efficient coil design is obtained with the largest ratio of core diameter to coil diameter. The limitation on such increase of efficiency may be the rise of core-to-coil capacitance effects as very thin coil walls are

approached. These effects become of first-order importance in long coils with very thin walls. Figs. 1 and 18 illustrate the capacitance effects between the core and the coil that may be encountered on long thin-walled coils. The apparent change of inductance and the per cent of initial Q in air with the core in the coil is shown in Fig. 1 as a function of core-diameter-to-coil-diameter ratio. The quasi-distributed-capacitance effect of the core is considerably greater with the core grounded than with the core floating, as is evidenced by the increased apparent inductance change when the core is grounded. The increased coil-to-core capacitance causes a very large drop in coil Q due to the high dielectric losses in the coil form.

Fig. 18 shows the apparent inductance increase and the Q change caused by the core plotted as the function of the coil-length-to-coil-diameter ratio. The rising apparent-inductance-change characteristic shows the effect of increased coil-to-core capacitance as the length of the coil and core is increased. The same deleterious effect upon Q may be noticed as was noted in Fig. 1 when the core is grounded.

Effect of Coil Shields

The effect of a shield on the inductance of a coil at radio frequencies is

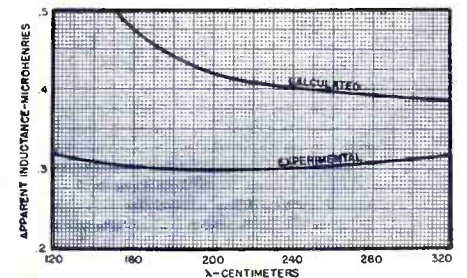

Fig. 13. Apparent inductance vs. λ for coil wound with 22 B. and S. gauge wire.

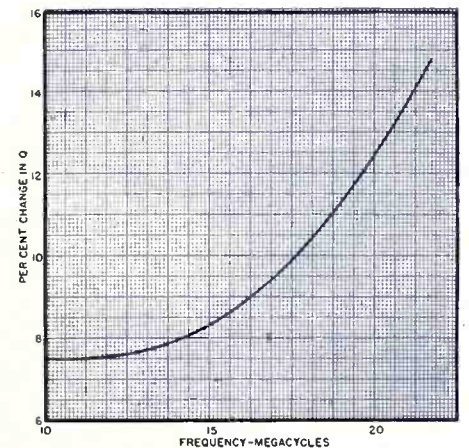

Fig. 14. Percent loss in Q resulting from a 0.04 cm. bakelite form. $L = 1.1$ μh ., $D = 2.5$ cm., $b = 1.9$ cm., wire size #14 B. and S.

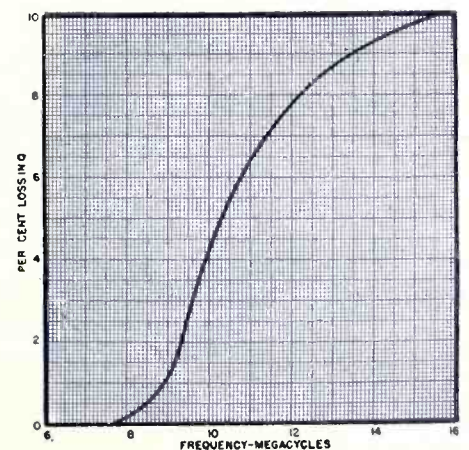

Fig. 15. Percent loss in Q resulting from grooved bakelite form. $L = 3.6$ μh ., $D = 2.5$ cm., $b = 1.5$ cm., wire size, #18 B. and S.

Table 1

Coil Description			Optimum Wire Diameter (Centimeters)		Percentage Difference From Experimental Figure
Inductance (Microhenries)	Diameter (Centimeters)	Length (Centimeters)	From Equation	From Experiment	
3.6	2.5	1.55	0.090	0.102	12
3.6	3.8	1.45	0.108	0.115	6
3.6	2.5	1.55	0.090	0.115	22
1.1	2.5	0.89	0.105	0.100	5
1.1	2.5	0.56	0.079	0.093	15
1.0	1.3	0.69	0.055	0.064*	13
1.0	3.8	0.79	0.142	0.134*	6

* From data in Barden and Grimes's paper.¹⁴

Personals



D. C. COLLINS has been advanced from the post of eastern manager to that of manager of Western Electric's Electrical Research Products Division. The division which was formerly known as ERPI was made a part of the Western Electric organization in 1941. The equipment developed by this division is now being devoted entirely to the armed forces but many postwar improvements born of new engineering techniques are expected.



ERNEST A. DAHL, who joined the Rock Island Railroad as Electronics Engineer on April first of this year has just completed the first of a series of projects involving the use of two-way radio in the operation and control of moving trains. The engineering details of this project were outlined by Mr. Dahl in the July issue of *Radio-Electronic Engineering*. Other projects include end-to-end communication and radio controlled safety devices.



DR. O. S. DUFFENDACK has resigned his position at the University of Michigan to accept the post of director of the new research laboratory of the North American Philips Company of Irvington, New York. He brings to his new position a wide engineering experience which will enable him to ably supervise the many research projects being carried on by this company in engineering and manufacturing vitally needed war materials.



C. O. ELLIS' position as Superintendent of Communications for the Rock Island Railroad has been expanded to include a newer form of railroad communications, namely, two-way radio. On June 5th he carried on the first conversation over the system with Mr. Farrington, the executive officer of the line, at the dedication ceremonies held in the Blue Island, Illinois, freight yards. The equipment is now in regular daily use.



WILLIAM MONTGOMERY who has been serving as production coordinator for the expanded war program of the John Meck Industries at Plymouth, Indiana, has just been named executive engineer for contact with governmental agencies according to an announcement by John Meck, head of the company. Mr. Montgomery has been associated with the company for over three years in various capacities including that of general sales manager.



EARL R. SAYRE has been appointed Application Engineer for the P. R. Mallory and Company's line of electrical, electronic and metallurgical products. Mr. Sayre was formerly associated with the Arrow-Hart and Hegeman Electric Company before joining the staff at Mallory. The company manufactures a complete line of precision parts for various electronic applications hence, the scope of Mr. Sayre's new position is wide and varied.

Design of Inductances

(Continued from page 24)

(4) Wire size: Calculate from equation (1).

(5) Core: Where any but the smallest inductance changes are desired, use ferrous or magnetic alloy powdered cores. The core formula is determined by the frequency range to be covered. The core diameter may be somewhat less than the inside coil diameter, and is not unduly critical.

(6) Graphical Calculations: For rapid calculation of coil parameters from 1 to 30 microhenries, Everett's chart is most convenient. This chart makes the boundary assumption that the coil length is always one-half the coil diameter.

This article has discussed the design of single layer coils for frequencies up to 100 megacycles. For higher frequencies, and for multi-layer or scramble-wound coils, other factors must be taken into consideration, and the points discussed in this article do not necessarily apply.

BIBLIOGRAPHY

- (1) *The Design of Inductances for Frequencies Between 4 and 25 Megacycles*, Dale Pollack. *Electrical Engineering*, Sept., 1937.
- (2) *Distributed Capacity of Single-Layer Coils*, A. J. Palermo. *I.R.E. Proceedings*, July, 1934.
- (3) *The Measurement of Coil Reactance in the 100-Megacycle Region*, F. Hamburger, Jr., and C. F. Miller. *I.R.E. Proceedings*, Oct., 1940.
- (4) *A Study of R-F Choke Coils*, R. Lee. *Electronics*, April, 1934.
- (5) *Radio Uses of Powdered Iron Cores*. *Electronics*, February, 1942.
- (6) *Measurement of Iron Cores at Radio Frequencies*, D. E. Foster and A. E. Newlon. *I.R.E. Proceedings*, May, 1941.
- (7) *High Frequency Resistance*, P. K. Turner. *Wireless Eng.*, March, 1926.
- (8) *On Eddy Current Losses in Cylindrical Conductors and Short Coils*, S. Butterworth. *Philosophical Transactions*, vol. A-222, 1921, p. 57. *Note on the A-C Resistance of Solenoidal Coils*, S. Butterworth. *Proceedings of the Royal Society*, vol. A-107, 1925, p. 693.
- (9) *Effective Resistance of Inductance Coils at Radio Frequency*, S. Butterworth. *Wireless Engineering*, in 4 parts: I—April, 1926; II—May, 1926; III—July, 1926; IV—August, 1926. This paper was summarized by B. B. Austin, *Wireless Engineering*, January, 1934. Nomographs are found in R. T. Beatty's *Radio Data Charts* (second edition), Illiffe and Sons, London.
- (10) *Radio Frequency Resistance and Inductance of Coils Used in Broadcast Reception*, A. Hund and C. J. DeGroot. *Bur. Stand. Tech. Paper*, vol. 19, 1925, p. 651.
- (11) *Resistance of Conductors and Windings of Single-Layer Coils*, E. L. Hall. *Bur. Stand. Tech. Paper*, v. 21, 1926, p. 109.
- (12) *Principles of Radio Communication*, J. H. Morecroft. Third Edition, J. Wiley & Sons.
- (13) *Measurements of Coil Losses at High Frequency*, H. Schwarz. *Hoch. u. Elekt.*, vol. 46, August, 1935, p. 50.
- (14) *Coil Design for High Frequency Receivers*, W. S. Barden and D. Grimes. *Electronics*, vol. 7, June, 1934.
- (15) *Formulas for the Skin Effect*, H. A. Wheeler. *I.R.E. Proceedings*, Sept., 1942.
- (16) *Die Rueckwirkung Metallischer Spulenkapseln auf Verluste, Induktivitaet, u. Aussenfeld einer Spule*, H. Kaden, *E.N.T.*, vol. 10, July, 1933, p. 277. *The Effect of Screening Cans on the Effective Inductance and Resistance of Coils*, G. W. O. Howe, *Wireless Engineering*, vol. 11, March, 1934, p. 115.
- (17) *Engineering Bulletin* (a publication), Henry L. Crowley & Co. October, 1941.
- (18) *The Effective Inductance and Resistance of Screened Coils*, A. G. Bogle. *Journal Institute of Electrical Engineers*, Sept., 1940.
- (19) *Short Wave Inductance Chart*, Frederick Everett. *Electronics*, March, 1940.

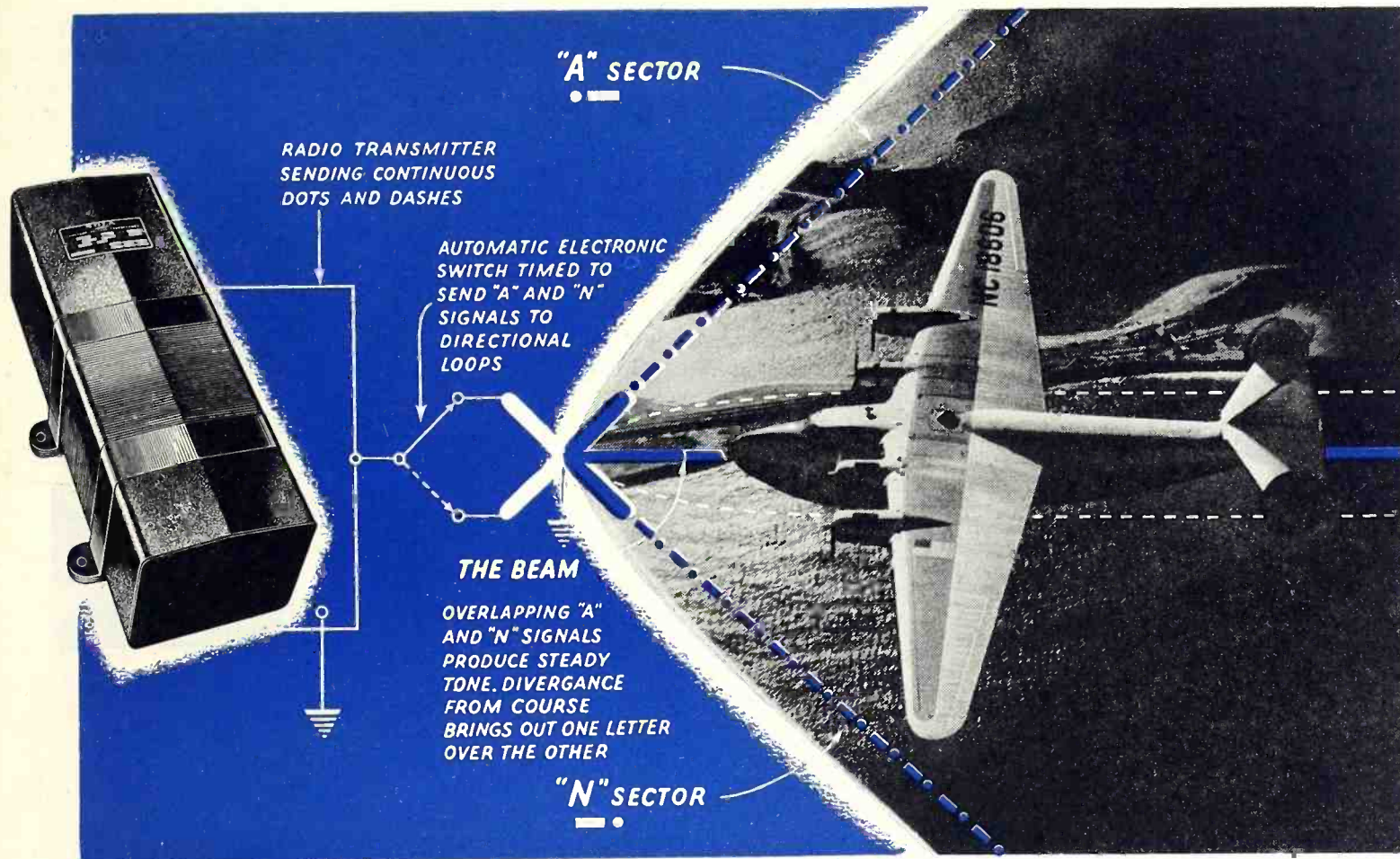

COMMERCIAL AIRLINES keep the beam "on the beam" with built-in **CONSTANT VOLTAGE.**

Miles above familiar landmarks, with vision obliterated by fog, sleet or storm clouds, the steady, fused tone of the "dot dash—dash dot" in the head phones is like a soothing symphony to the ears of the airplane pilot. A fading, disrupted signal spells danger.

Thus you will find SOLA Constant Voltage Transformers powering the directional beams of most commercial air lines, and the instrument landing equipment of the C. A. A. Without this constancy of operating voltage, a steady projection of radio beams is impossible.

Radio range stations must necessarily be in constant operation and fully automatic. In most instances

they are located at great distances from the airports. Anything short of instantaneous adjustment of the voltage fluctuations would be unacceptable to these instruments, too sensitive to tolerate variations exceeding $\pm 1\%$.

SOLA Constant Voltage Transformers were selected for this important assignment because of their dependable automatic operation. They have no tubes or net-works to get out of order—they require no manual supervision—they are self-protecting against short circuit—they instantly reduce voltage fluctuations as great as 30% to safe operating limits.

In designing any device dependent on precise input voltage, the de-

sign engineer's responsibility does not end with specifying the operating voltage on the label.

It is the designer's responsibility to the user to assure the availability of rated voltage at all times, by building automatic voltage control into the unit—or to instruct the user as to how constant voltage might be obtained for those devices not so equipped.

SOLA Constant Voltage Transformers are available in standard units with capacities ranging from 10VA to 15KVA. As a built-in part of electrically operated instruments or devices, special units can be custom built to exact product design specifications.

Constant Voltage Transformers

SOLA

To Manufacturers:

Built-in voltage control guarantees the voltage called for on your label. Consult our engineers on details of design specifications.

Ask for Bulletin / 74

Transformers for: Constant Voltage • Cold Cathode Lighting • Mercury Lamps • Series Lighting • Fluorescent Lighting • X-Ray Equipment • Luminous Tube Signs
Oil Burner Ignition • Radio • Power • Controls • Signal Systems • Door Bells and Chimes • etc. SOLA ELECTRIC CO., 2525 Clybourn Ave., Chicago 14, Ill.

Industrial Review



Plytube Antenna Masts

IN the interest of conserving critical material, a new radio antenna mast made of plywood has been developed by the Plymold Corporation to meet Army and Navy specifications.

Plytube is a plywood tubing fabricated from thin veneers and thermo-setting synthetic resins. Weight for weight, this plywood tubing compares very favorably with steel tubing used in similar applications, with the added advantage that this material will float.

Plytube can be fabricated from practically any species of veneer, with

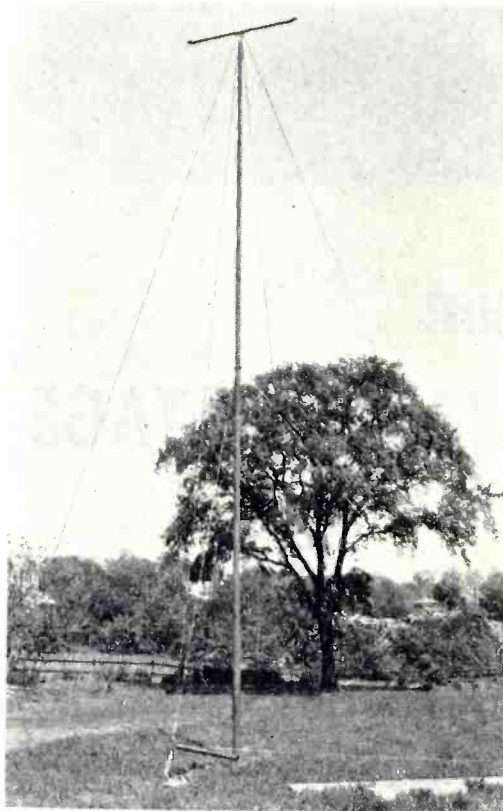

each species imparting slightly different properties to the finished product. At the present time, only non-critical veneers are used. The urea formaldehyde glue is used as the bonding agent for this tubing. Phenol, although more critical, may be used with similar results.

Veneers are built up in such a manner that stress or strain in any direction acts upon the total columnar grain fibres of the veneer layers. To meet radial crushing strength and hydrostatic internal pressure requirements, a special construction has been developed. For torsion, columnar compression and flexural and tensile strengths, other methods of construction are employed. All of these constructions can be combined.

Because of its plastic bonding agent, Plytube is rendered waterproof, flame-proof, splinter-proof and rot-proof. This material possesses low electrical conductivity and is dimensionally stable under extreme temperatures which makes it suitable for use in sub-zero weather. By means of a special coating, this material may carry chemicals, as well as being used for gasoline and oil containers and conduit.

The telescopic antenna mast is but one of the interesting applications of this product. The various sections of Plytube may be threaded on the job and fitted together to form the necessary lengths of tubing.

Because Plytube uses a minimum of critical materials and is extremely light in weight, many applications of this material have been made in aircraft construction and the fabrication of material which must be transported by air. Railings of ships which are above the water line have been made of this material with the resultant decrease in tonnage and increase in carrying space.

Plytube is available at the present time with inside diameters from $\frac{1}{2}$ " to 18" and wall thicknesses from .05" to .50", in any reasonable length.

Although the entire field of plywood tubing is comparatively new, great strides have been made in developing a uniform and practical product. Army field tests of this product have been carried on for over a year.

The mast illustrated is a 50 foot mast which collapses into a package 6 inches in diameter by 10 feet 10 inches long. This mast, together with fittings and spare parts along with the erection equipment weighs less than 200 pounds. Two men may erect this mast in 30 minutes.

From the brief outline of the characteristics of this material given, various possible applications of this plywood tubing can be visualized.

* * *

Filament Manufacture

INCREDIBLY fine filaments, sixty of which would make the thickness of a human hair, are being drawn at the Westinghouse research laboratories by means of a cross-bow which is a modern application of a medieval weapon.

These filaments, which are $\frac{1}{30,000}$ of an inch in diameter, are used to measure or calibrate the magnifying

power of the electron microscope. The cross-bow is made from tough, flexible steel and is mounted on a wooden stock. This instrument shoots an arrow that draws the quartz filament.



In order to make such a very delicate thread it is necessary for the quartz to spin out at a high rate of speed while it is still in a hot, fluid state and before it has a chance to cool and harden.

Unbroken pieces up to 20 feet in length are often obtained, but more often the filaments are dispersed in smaller sections through the route the arrow takes. These filaments are extremely flexible and can be wound around the finger like a thread.

* * *

Lead Coating Method

A NEW hot dip lead alloy coating technique, combined with new alloy and flux developments has made it possible to utilize a low tin content alloy coating to render metal products corrosion resistant.

Ease of handling the new materials, their wide adaptability, plus the satisfactory appearance of the finished product now makes it possible to use this lead alloy for gasoline tanks, oil containers, air conditioning ducts, convection and heater coils, radio housings and small radio parts.

The National Lead Company is now marketing a low tin content alloy suitable to all hot dip processes now in use. These alloys show excellent wetting properties, uniform coating characteristics, low melting points, good fluidity, minimum dross and in general, excellent working properties. The coating becomes harder with age increasing from 12 to 20 Brinell (500 kg) after two or three days at room temperatures. This results in better abrasion resistance and greater ability on the part of the coating to withstand the mechanical injury ordinarily encountered in handling the coated products.

(Continued on page 34)

~~LENOXITE~~

METALIZED STEATITE



OUTSTANDING
BECAUSE IT
PROVIDES

- 1 STEATITE INSULATION YET HERMETIC SEAL
- 2 QUICK, AND EASY PRODUCTION SOLDERING
- 3 UNUSUAL STRENGTH OF SOLDER BOND
- 4 SIMPLIFIED DESIGN THRU ELIMINATION OF GASKETS, WASHERS, SHIELDS, CEMENT
- 5 LOWER COSTS!

~~LENOXITE~~

STEATITE BONDED WITH SILVER · TIN · COPPER · NICKEL · CHROMIUM · PLATINUM

SPECIFY

LENOXITE PRECISION STEATITE

LENOXITE DIVISION

LENOX INC. TRENTON 5, NEW JERSEY

NEW PRODUCTS

COCKPIT LAMP

A shielded lamp for night flying pilots has been developed by *Electronics Laboratories, Inc.*

This unit, known as the X-244 employs an ultra-violet lens, control switches and rheostats to permit the operator to control the amount of light diffused. Covering the lens is a shut-

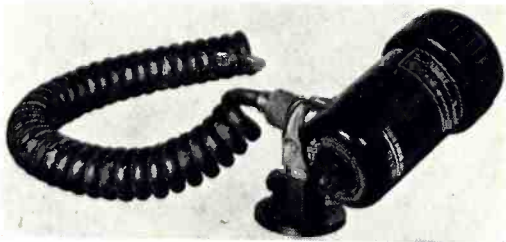

ter which, when closed, shuts off the light. Immediately back of the lens is an iris which permits focussing of the light to a spot or a flood.

Another feature of this lamp is the retractable, rubber-jacketed electrical cord supplied by Cordage, Inc., an affiliate of Kellogg Switchboard and Supply Co. of Chicago. This cord can be stretched to approximately seven times its contracted length to provide flexibility of application.

While this product is being reserved exclusively for the Armed Forces, many postwar applications of this principle are expected to be developed.

EXTRUDED TUBINGS

A newly developed vinyl tubing, with the same electrical properties as conventional tubings, but with improved heat endurance characteristics, resistance to oil embrittlement and resistance to gasoline-benzol is now being produced commercially by the National Varnished Products Corporation.

This new tubing, which is designated as the Natvar 400 series is available on the same priority basis as other vinyl tubings.

Wires insulated with Natvar 400 may be soldered without special care or technique and without flow or opening of the tube near the point of soldering. This product is resistant to tear and has a tensile strength in excess of 3000 pounds per square inch, with elongation from 170% to 410% depending on the type of tubing. Flexibility is assured at temperatures as low as -80 degrees F.

This tubing is chemically inert and is suitable for oil lines, sheathing and other protective coverings in applications where adverse oil, solvent or acid conditions are severe and where protection from chemicals or vibration is required over a wide temperature range.

Specifications of the Natvar 400 series tubings are available from *The National Varnished Products Corporation* of Woodbridge, New Jersey.

H-F HEAT TREATING

High frequency induction heating is being used on the production line at the Industrial Electronics Division of Federal Telephone and Radio Corporation in what is believed to be the first application of this type of heating for rapid, quantity production.

The unit used for this application of heat is Megatherm, a new product developed by the company. The application is to finished bearing pins, which are case hardened to a depth of .025" as they are fed automatically through a glass tube and water quenched as they leave the heating coil at the rate of 75 bearing pins per minute.

The heating unit employs a 5 megacycle energy, the surface of each part treated is heated above its critical temperature in less than one second. Due to the high speed with which the heat is applied to the surface, there is insufficient time for the heat to penetrate into the core and only a thin sur-



face layer experiences a change in physical state. The central portion of

the parts retain all of their original toughness and strength.

Megatherm has a simple push button control and requires no tuning or other technical adjustment. The cost of operation depends on the size of the unit, in the case of the 25 kw. unit the cost runs to approximately 50 cents an hour. The unit is compact and requires a floor space four feet square.

Information about this high frequency heating unit may be obtained by writing direct to *Federal Telephone and Radio Corporation*, Newark, New Jersey.

MONOCHROMATIC LIGHT

A monochromatic light unit, for use with DoAll Optical Flats, has been announced by the Continental Machines.

This unit provides accurate measurements of flatness, height and parallelism. The instrument uses one-wave



length helium light rays which are yellow in color and thus more easily distinguishable. The light is high in intensity which concentrates the light on a smaller area and gives greater illumination for distinguishing the light wave unit known as the "fringe" or interference band. The rays from this light, when observed through DoAll Optical Flats produce interference bands of 11.6 micro-inches.

The maximum height of the lamp-to-table is 12", while the minimum is 8½". The projection head tilts, 90 degrees up and 21 degrees down and rotates 360 degrees. The unit operates on 110 volt, 60 cycle, single-phase current and weighs twelve pounds.

Information regarding possible applications may be secured by writing direct to *Continental Machines, Inc.*, Dept. RE-8, 1301 Washington Avenue, South, Minneapolis 4, Minnesota.

RECTIFIER TUBES

The CE-200 and CE-201 mercury vapor rectifier tubes are being offered by the Continental Electric Company, to fill the need for a 2 ampere, full wave rectifier which is suitable for applications up to about 250 volts d.c.

These tubes have been recently redesigned for improved performance.

Improved and Simplified

A-N Quick Disconnect Plugs and Receptacles
for Use in Aircraft • Ordnance • Signal Corps • Radios • Instruments

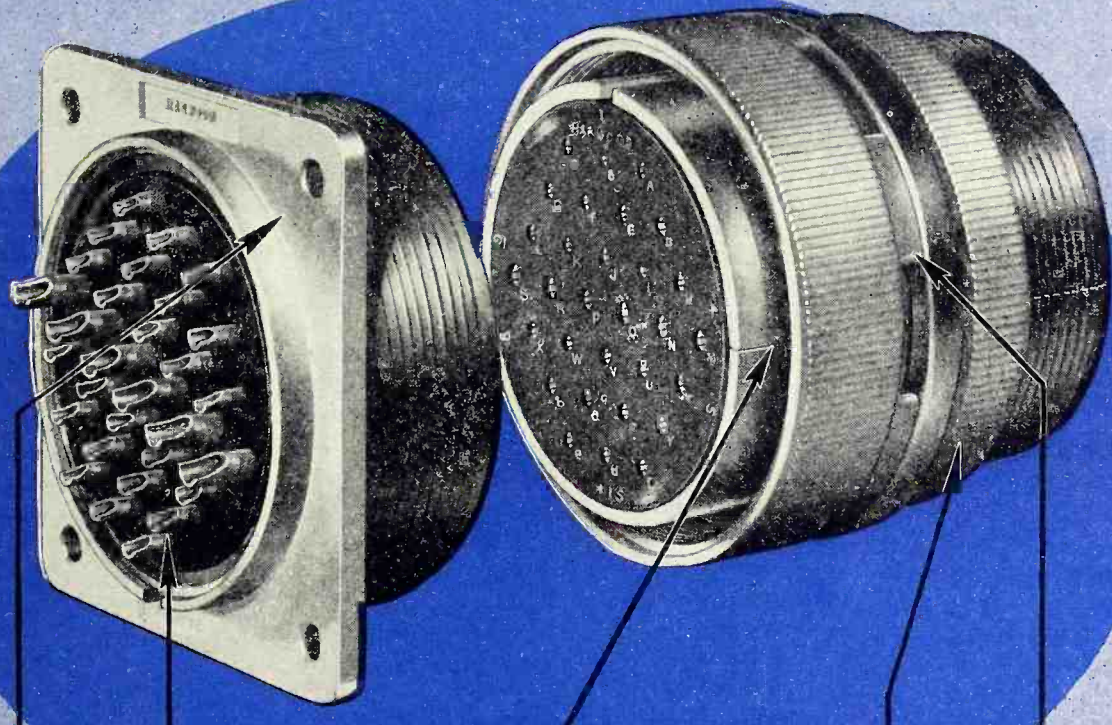

Finish: *New, conductive, and corrosion-resistant.*

Contacts: *Made of a new silver-clad material affording greater conductivity, and positioned for easier and faster fabrication.*

Split Shell: *Designed to facilitate assembly, inspection, and maintenance, with all the advantages of solid construction.*

Assembly Ring: *Provides positive locking of split shell and eliminates hazards from vibration.*

Coupling Ring: *Multiple positions for safety wiring.*

Harwood Connectors, constructed in accordance with Army and Navy Specifications Nos. AN-9534a and AN-W-C-591, have been consistently improved and simplified through progressive engineering, constant retooling, use of better materials, and rigid quality control.

Expanded production facilities make Harwood Con-

nectors available in large quantities with assurance that your delivery requirements will be met on schedule. A complete line of AN 3100, AN 3102, AN 3106, and AN 3108 plugs and receptacles are available in sizes ranging from 10S to 48.

Harwood Connectors are used by practically all of the principal aircraft, instrument, and radio concerns.

THE HARWOOD CO.

Division of Los Angeles Corporation

ELECTRICAL CABLE CONNECTORS

540 North La Brea Avenue • Los Angeles 36, California

Webster 7184

They have low average arc drop which gives assurance of minimum internal heating, maximum life and efficiency.



Both tubes have identical electrical characteristics, the difference between them is in the base. CE-200 has a standard 4-pin base and the CE-201 has a special long-pin industrial base, thus making it directly interchangeable with other tubes having the same characteristics.

Technical data on both types of tubes are covered by Bulletin No. 111 which will be furnished on request from *Continental Electric Company*, Dept. RE-8, Geneva, Illinois.

SOLDERLESS TERMINALS

A new contribution of electrical engineering to the war effort is the development by Aircraft-Marine Products, Inc. of solderless instrument terminals which are virtually impervious to corrosion over long periods of time.

These terminals have been subjected to rigorous tests of various types. These tests indicated no increase in resistance of these terminals. Many factors were utilized in the development of these terminals, namely, correct base metals, appropriate methods of heat treatment, accurate structural design and proper plating.

An ingenious crimping tool, resembling a pair of pliers is included with this unit. Strands of wire and the connector are crimped into a homogeneous mass that assures good electrical connection. So simple is this operation that unskilled workers may use this tool without danger of defective connections.

Further details of this product along with application data may be obtained by writing direct to *Aircraft-Marine Products, Inc.*, Harrisburg, Pa.

MICROFILM RECORDS

A simple, yet safe way of preserving vital records for an indefinite period has been developed by Microcopy Corporation.

The Microcopy Translite Hi-Reduction process is the application of microfilming to engineering drawings as well as any other valuable record, document, drawing, or map kept in industrial manufacturing plant files. High-fidelity reproduction of engineering drawings, either in pencil or on trans-

(Continued on page 43)

Industrial Review

(Continued from page 28)

The actual coating operation, after the requisite cleaning, pickling and fluxing, consists of immersion of the article in the molten metal, with sufficient agitation to assist in the freeing of adhering flux. The coated articles may be cooled in air, after dipping or they may be quenched in oil, which latter technique results in more even and finer grained coatings.

Stroboscope

THE announcement by the *Universal Microphone Company* that they will again distribute the "Stroboscope" will be of interest to radio and recording studios as well as individual owners of phonographs and recorder combinations.

This device, which is printed on heavy stock, may be used to determine the exact turntable speed for high quality reproduction of phonograph records and transcriptions, thus enabling reproduction with true pitch and tempo.

The stroboscope is designed to work at 33½ or 78 rpm under a light of 25, 50 or 60 cycles.

Copies of the stroboscope are available through dealers who are making the distribution free of charge to their customers. No copies will be forwarded from the company.

B & O Installs Radio

A MOBILE transmitter and receiver unit over which two-way conversation can be carried on between railroad trainmasters and train crews will play an important part in



the radio tests in train operations about to be conducted jointly by the Baltimore and Ohio Railroad and the Radio Division of the Bendix Aviation Corporation.

The mobile unit is the size of a

household floor model receiving set and is to be mounted on an engine so that the crews may be in constant touch with the train and yardmasters to receive orders for the movement of cars. The F.C.C. has granted temporary permits for the installation of the transmitting sets to be used in the test.

Waterproofed Radio

A NEW waterproof cover has been developed for use with the Galvin "Handie-Talkie" in order that the set



may be in operating condition in spite of exposure to salt-spray, windblown sand or even submersion.

Two way communication can be maintained by means of the Handie-Talkie without removing the protective cover. This equipment landed on beachheads or carried ashore by troops may be subjected to various adverse conditions, but the cover gives complete protection without interfering in any way with either transmission or reception.

Press Wireless War News

THE first radio communications group sponsored by the press is already in operation on the invasion beachhead to transmit radio press dispatches, telephotos, radio pictures and facsimile messages.

These facilities are available to 450 war correspondents representing over 115 organizations who have been accredited to report the present war from the European front and to other authorized agencies.

The equipment is capable of sending and receiving all varieties of radio traffic including broadcast transmission to the broadcasting networks of the United States. In addition to a semi-permanent station, a truck with transmitting and receiving sets and a unit for generating electric power to operate them, has been fitted to follow the troops and flash special bulletins and other news direct from the front.

The Press Wireless "invasion unit" is under the direction of Stanley F. Grammer, the company's Western European manager. The personnel consists of radio engineers, operators, technicians and other radio men.



a New and Superior **DIAL LIGHT SOCKET**

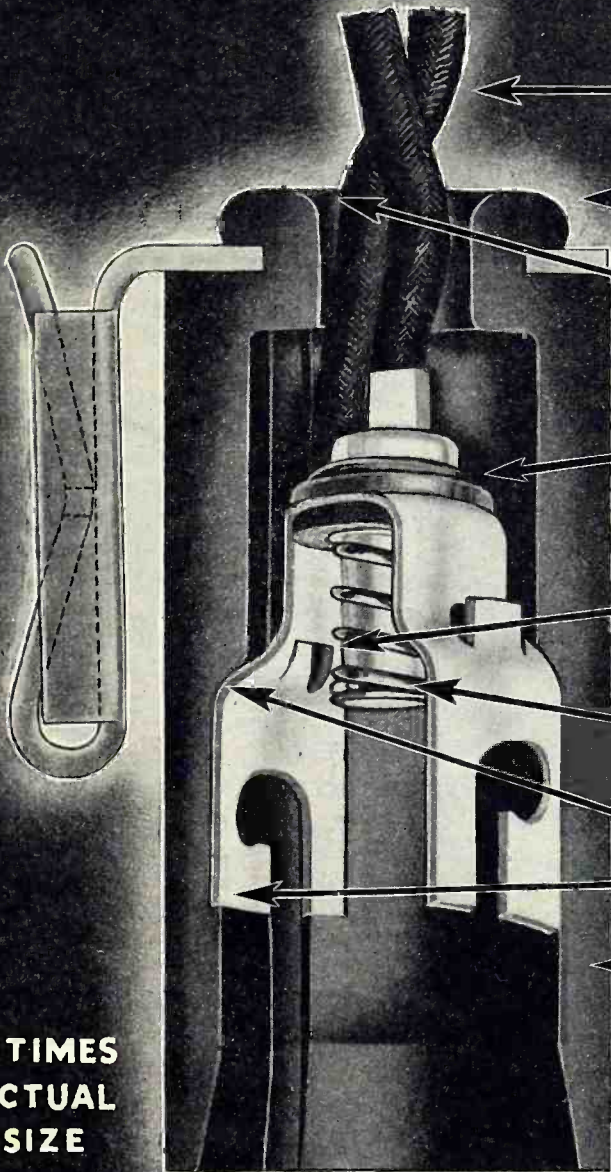

**4 TIMES
ACTUAL
SIZE**

Tensile strength of leads and connections far in excess of requirements.

Tough, plastic shell molded around bracket providing a secure bond with mechanical strength far beyond any normal requirement.

Rounded edge will not cut or fray wire insulation.

Voltage Breakdown between contacts—1200 Volts. Voltage Breakdown to ground—5000 Volts.

Lug on contact fits in groove in shell so that contact cannot be turned or twisted when inserting lamp.

Center contact mounted so that it cannot protrude from shell and short on chassis when lamp is removed.

Plastic shell is recessed for contacts, which cannot be pushed or pulled out of position.

Stronger, tougher, heavy walled plastic shell.

A variety of different mounting bracket styles available, suitable for practically any mounting.

For Your Present and Post-War Production

**40TH ANNIVERSARY
1904-1944**

This year Lenz celebrates its 40th year of service to the communications industry.

Lenz Dial Light Sockets have always been known for their superior mechanical qualities and electrical characteristics.

Now these sockets are still further improved, with even greater mechanical strength. A stronger, tougher plastic shell is attached to the bracket with a new type of construction that provides a virtually unbreakable bond between shell and bracket. Its excellent electrical characteristics are maintained.

Consider these Lenz Dial Sockets for your present and post war production. Write for sample today.

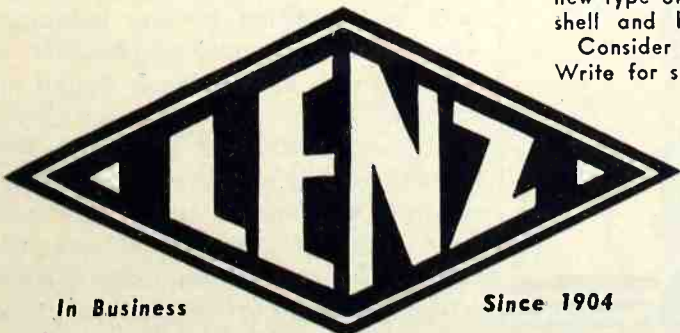

In Business

Since 1904

**LENZ ELECTRIC
MANUFACTURING CO.**

1751 N. WESTERN AVE.

CHICAGO 47, ILLINOIS

ELECTRIC CORDS, WIRES AND CABLES

ENGINEERING DEPARTMENT

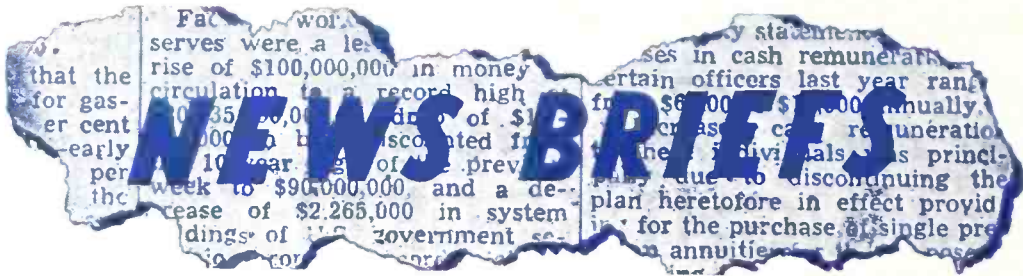

NEW ELECTRONICS CO.

Electronic Engineering Company, a new concern specializing in the manufacture of difficult types of electronic equipment such as intricate and complex transformers, chokes and wave filters, has opened a factory and main office at 735 West Ohio Street, Chicago 10, Illinois, and a branch office at 5200 West Chicago Avenue in the same city.

The new firm will also offer a consulting service for the testing and checking of proposed electronic equipment and for writers of technical papers.

The planning and production manager is E. J. Rehfeldt who has had ten years' experience with Thordarson Electrical Mfg. Co. as manager of the export sales, advertising and sales promotion manager.

Harry Holubow, the chief engineer, comes to Electronic Engineering after seven years' experience as design and

research engineer at Thordarson. Mr. Holubow holds degrees in electrical engineering from Lewis Institute and Armour Institute.

COSGROVE HEADS RMA

At the conclusion of the organization's Third War Production Confer-



ence, the Radio Manufacturers' Association elected Raymond C. Cosgrove, vice-president and general manager of

the manufacturing division, Crosley Corporation, as president of the association.

Mr. Cosgrove succeeds Paul V. Galvin, president of the Galvin Mfg. Company of Chicago who has served as head of the RMA for the past three years.

RCA'S ROSTRON DIES

John B. Rostron, vice-president and traffic manager of R. C. A. Communications, Inc., a subsidiary of Radio Corporation of America, died June 12th at the age of 67 at his home in Hewlett, Long Island.

Mr. Rostron who was an employee of RCA for twenty-four years was born in Manchester, England. He came to the United States in 1899.

He was assistant traffic manager of the company when the first radio photographs were transmitted to London in 1926. He was appointed traffic manager in 1929 and was elected vice-president and traffic manager on December 6, 1940. He was a lieutenant commander in the United States Naval Reserve.

CHANGES NAME

The Raytheon Production Corporation has issued an announcement advising of a change in the corporate name as of June 1, of this year.

Henceforth, the company will be known as the Raytheon Manufacturing Company, Radio Receiving Tube Division. The address of the factory at 55 Chapel Street, Newton, Massachusetts, as well as the addresses of branch warehouses and sales offices will remain the same.

EXPORT LABELS

Special export labels, which have been approved by the OWI for application to non-lend lease exports, are now available according to the Meyer-cord Company of Chicago.

These labels, which must be furnished by the company using them, may be designed to include the company trademark or slogan. The seal can be used in any shape or size and may be furnished in any language. The OWI will supply translations in any language and the basic design for the seal.

Although the use of the seal is voluntary, in view of increasing country-of-origin identification competition from other foreign competitors, the OWI anticipates an enthusiastic cooperation from exporting manufacturers in the United States.

The Meyer-cord Company, one of the decalcomania manufacturers who are

A NEW FEATURE OF GREAT IMPORTANCE ADDED TO OUR "OLD TIMER"

Now . . . Chatterless operation is added to the known sensitivity of our "Old Timer" (200 Series) . . . The new feature consists of an energy absorbing material sealed within a contact carrying cage. The compound used is not affected by age, oil, or moisture.

New Feature . . . eliminates "bounce" and "chatter"

No Bounce! No Chatter!
 . . . in the new Kurman 200S Flat Keying Relay

KEYING FEATURES:

1. No bounce. No chatter.
2. Input 50 Milliwatts.
3. Will key up to 150 words per minute, or 60 impulses per second.
4. Armature is mica insulated; is suitable for keying a 50 Megacycle R.F. signal.
5. Contacts will carry up to 2 Amps.

Oscilloscopic wave form looks like this

NOT like this

Send also for complete information on the new line of KURMAN vibration-proof RELAYS.

KURMAN ELECTRIC CO.

35-18 37th STREET • LONG ISLAND CITY 1, N. Y.

The Trend is to . . .

CERAMIC-METAL SUB ASSEMBLIES

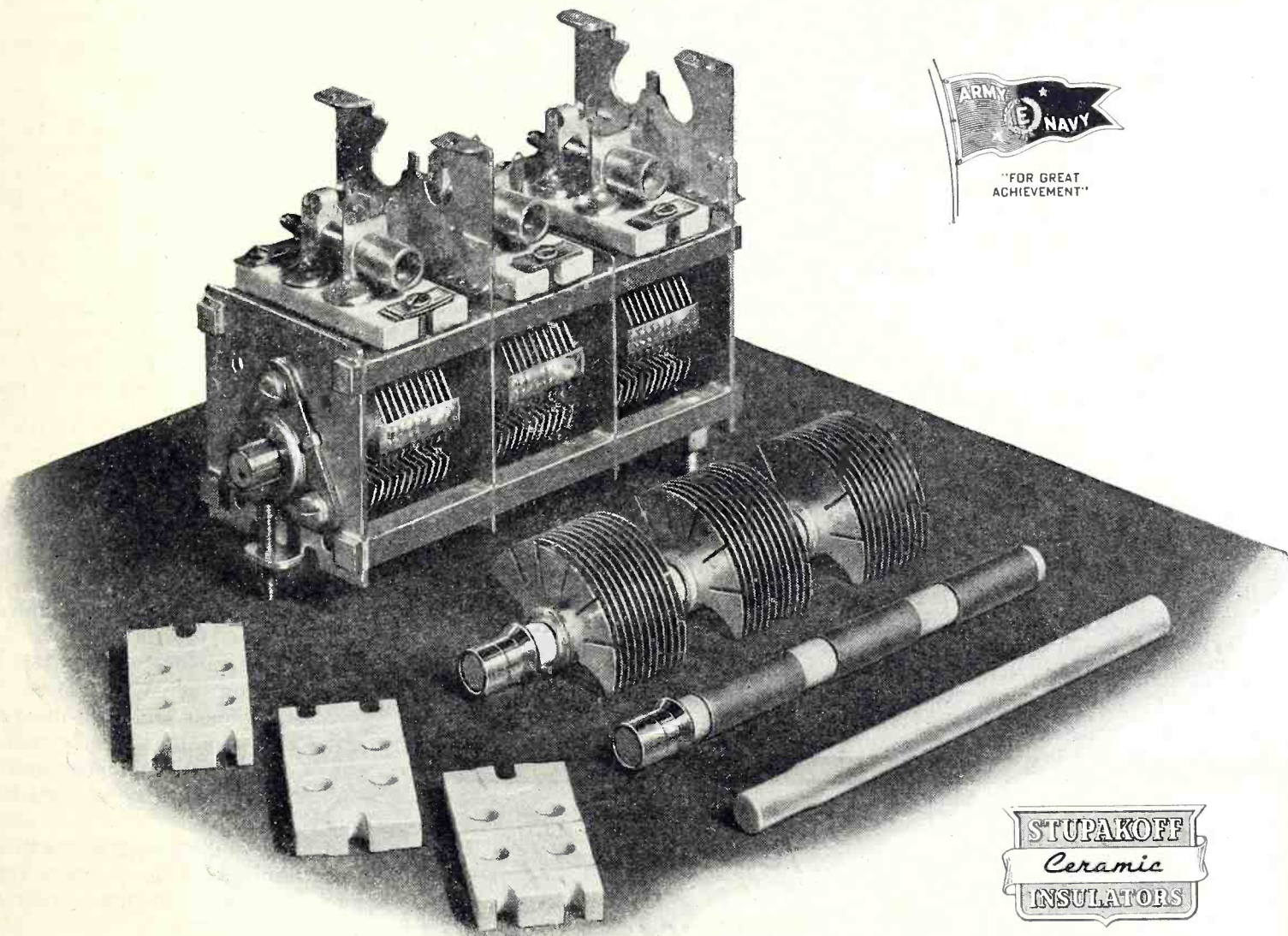

Condenser Courtesy of
General Instrument Corporation

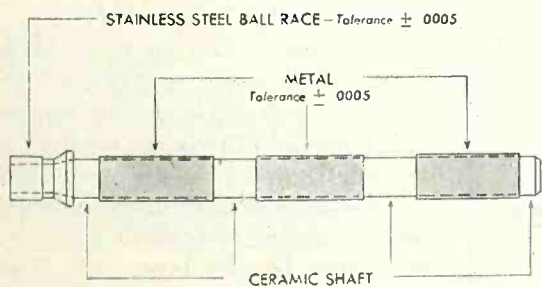

ILLUSTRATED is a "precision condenser" equipped with Stupakoff insulators and metallized ceramic sub-assembly.

This metallized ceramic rotor shaft is only one of many extremely accurate sub-assemblies produced by Stupakoff.

Correctly engineered, laboratory perfected and converted to large scale production, such parts offer optimum electrical and mechanical characteristics.

Use our experience to solve your special problems. Write, wire or phone—our engineering and production facilities are ready to serve you promptly.

BUY MORE THAN BEFORE IN THE FIFTH WAR LOAN

SINCE 1897

STUPAKOFF

Products for the World of Electronics

STUPAKOFF CERAMIC AND MANUFACTURING CO., LATROBE, PA.

supplying this seal, are located in Chicago, Illinois.

Full information regarding the export seal program may be obtained by writing to the *Special Promotion Division, Office of War Information*, 250 West 57th Street, New York 19, New York.

HIRES WORKERS

One way of tapping the still great labor supply of unemployed women has been devised by the Standard Transformer Corporation, with more than satisfactory results.

Believing that women are not fully aware of the possibilities of factory work, Jerry Kahn, president of the company, took his factory to the worker. An assembly line was set up in a store near the company plant where housewives and potential factory workers could watch assembly line operations.

Complete work benches were installed and manned by typical employees working on Signal Corps radios, Walkie Talkies and other types of field communications equipment. Both male and female operators of all ages were distributed throughout the line to impress upon the "window shopper" that anyone could do war

work and that it was easy and pleasant.

Posters describing the advantages and benefits accruing from employment at Stancor were displayed. Members of the personnel department were on hand to give out application blanks and "sell" the worker on the idea of war employment.

SAFETY AWARD

A special wartime award in recognition of its outstanding safety record was presented to the RCA Victor's Camden, New Jersey, plant by the National Safety Council.

The award which is symbolized by a large "S" flag was accepted from Mr. W. Burke Smith of the Council by Mr. Oliver C. Boileau, safety director of the Camden plant which produces communications equipment for the armed forces.

In spite of a large increase in personnel and production, the plant achieved a reduction in frequency of accidents of 10% and severity of accidents by 70% over the preceding year.

This is the tenth safety award won by the Camden plant within a two-year period. Other awards include the Liberty Bell award and eight depart-

mental citations from the New Jersey Department of Labor.

ASA WAR STANDARD

A new standard of graphical symbols for electrical and electronic equipment has just been completed by the American War Standards committee of the ASA.

The need for such a coordinated system of indicating electrical circuits and equipment in engineering drawings is obvious and has long been recognized. The answer to this need has been given in this new standard entitled "Coordination of Electrical Graphical Symbols."

Copies of this new standard are available from the *American Standards Association*, 29 West 39th Street, New York 18, New York, for a charge of ten cents.

FAST DELIVERY

In an effort to expedite the handling of critical war orders, the John Meck Industries of Plymouth, Indiana, has purchased a Monocoupe airplane for the delivery of material.

The ship, powered by a 125 HP Kinner engine, is a full-sized, although small, fast and sure means of air travel. The plane is piloted by some of the Meck employees and occasionally by one of the several local women pilots.

The plane is fully equipped with radio and blind-flying instruments and is hangared a short distance from the plant in Plymouth.



"Technically Correct..."

is more than just a phrase, when applied to tube making. Being "technically correct" regarding engineering construction, and the choice of quality materials is a fetish with Cetron engineers!

CETRON

Rectifiers... Phototubes Electronic Tubes

are precision built for longer life and dependable service.

2 EXAMPLES of Cetron Quality:

- CE-222 . . . Full wave rectifier tube for installations where high efficiency and long life are important requirements.
- CE-306 . . . Grid control rectifier (Thyratron) especially suited for industrial applications such as handling primary currents of small resistance welders . . . motor control, etc.

CONTINENTAL ELECTRIC COMPANY

CHICAGO OFFICE 903 MERCHANDISE MART GENEVA, ILL. NEW YORK OFFICE 265 W. 14th ST.

WRITE FOR CATALOG.

Densitometry

(Continued from page 11)

fied by the Weston Printex Meter, Model 877, shown in Fig. 18. The essential components of this instrument consist of a light source with a concentrated filament to give essentially a point source of light, a condensing lens, and an aperture placed before a selenium-iron barrier-layer cell. The output of this photocell is measured by a sensitive microammeter whose scale is calibrated in density. It is evident that were a meter with linear response employed, this density scale would be compressed at the high end. For this reason, specially designed pole pieces are used in the meter to make the scale more nearly linear in density. In this way the indicating meter is similar to that used in decibel meters, that is, the scale is somewhat similar to a logarithmic scale.

There can be no question that these instruments are the essence of simplic-

ity. Their chief disadvantage, instability caused by line voltage fluctuations resulting in variations in light source intensity, can be overcome through use of a voltage regulator or battery.

TABLE 1

Transmission	Percentage Transmission	Density
1.00	100	0.00
0.90	90	0.045
0.80	80	0.10
0.70	70	0.16
0.60	60	0.22
0.50	50	0.30
0.40	40	0.40
0.30	30	0.52
0.20	20	0.70
0.10	10	1.00
0.01	1.0	2.00
0.001	0.1	3.00
0.0001	0.01	4.00
0.00001	0.001	5.00

It is possible too, to make a simple direct reading densitometer, that is, one in which the scale is linear with respect to density, through use of a phototube utilizing the cathode-grid (internal) resistance of a triode as a load in the manner shown in Fig. 16. In this circuit, the phototube current which is, to a very close approximation, a linear function of the incident illumination, is passed by the grid of the amplifier tube. But the grid potential of a triode has been demonstrated as being a logarithmic function of grid current. The plate current, on the other hand, is, within limits, a linear function of grid voltage, hence

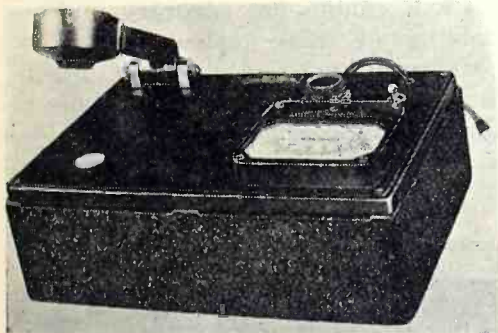

Fig. 18. Weston Printex Meter, model 877.

the plate current results in being a logarithmic function of the phototube current. In this way, too, the plate current is linearly proportional to the density. In a commercial form of this circuit, Fig. 3, the batteries have been replaced by an a.c. operated power supply. If all of the voltages involved are well regulated, including the lamp voltage, good accuracy can be obtained. The instrument shown in Fig. 1, the AnSCO Sweet Densitometer, employs this circuit. It will be noted that



QUICK DELIVERY can be made on this extremely low loss transmission line. Especially suited for RF transmission at high or ultra-high frequencies, it has wide application (1) as a connector between transmitter and antenna, (2) for interconnecting RF circuits in transmitter and television apparatus, (3) for transmitting standard frequencies from generator to test positions, and (4) for phase sampling purposes.

Andrew type 83 is a $\frac{3}{8}$ " diameter, air-insulated, coaxial transmission line. The outer conductor material is soft-temper copper tubing, easily bent to shape by hand and strong enough to withstand crushing. Spacers providing adequate mechanical support are made of best available steatite and contribute negligibly to power loss.

Accessory equipment for Coaxial Transmission Line, illustrated:

Type 853 Junction Box: Right angle box required where very sharp right angle turn is necessary.

Type 825 Junction Box: Three way T box for joining three lines at right angles.

Type 1601R Terminal: Gas tight end terminal with exclusive Andrew glass to metal seal. Incorporates small, relief needle valve for discharging gas.

Type 810 Connector: Cast bronze outer connector with copper sleeve for inner conductor.

Andrew Company manufactures all sizes in coaxial transmission lines and all necessary accessories.

Write for Descriptive Catalog



Type 853

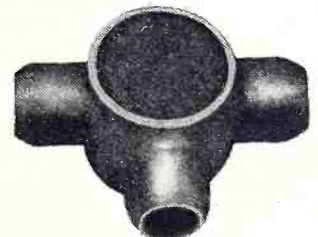

Type 825



Type 1601R



Type 810



Andrew Type 83 ($\frac{3}{8}$ " diameter) coaxial transmission line is manufactured in 100 foot lengths and may be purchased in coils of this length or in factory spliced coils of any length up to $\frac{1}{2}$ mile.

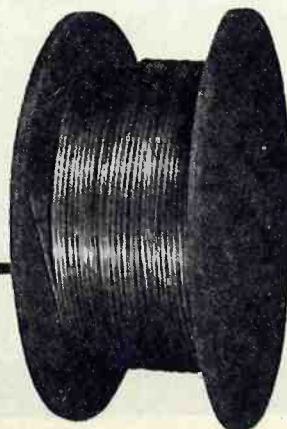

ANDREW CO.

ANDREW

363 EAST 75th STREET
CHICAGO 19, ILLINOIS

a voltage regulator has been employed.

These photoelectric densitometers already described are surpassed insofar as stability of response is concerned by the balanced circuit types. It can be shown that the simple Wheatstone bridge is independent of supply voltage fluctuations when balanced. Elaboration of such a bridge yields a circuit, one form of which is shown in Fig. 19. It will be seen that the galvanometer of the usual bridge has been replaced by an amplifier and cathode-ray tube indicator. Light from the lamp is divided by means of mirrors and made to fall upon two photo-

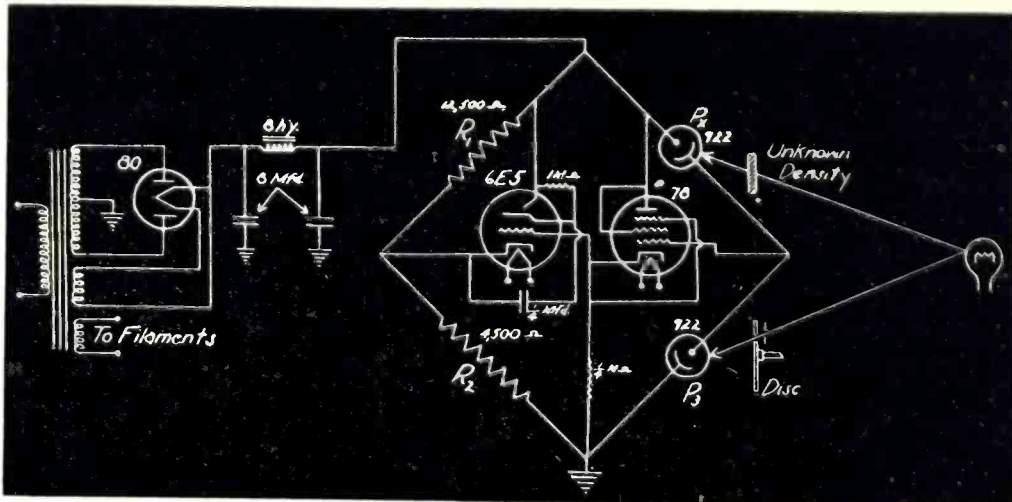

Fig. 19. Diagram of the bridge circuit used in the National Photocolor densitometer.

tubes as indicated. The density sample is placed before one phototube while an aperture calibrated in terms of density is placed before the other. This aperture is adjusted until the same amount of light falls upon each phototube. This state of balance is indicated by the "magic-eye" tube. The National Photocolor Densitometer employing these optical and electrical principles is shown in its latest form in Fig. 5.

Densitometers are not restricted in their use to the measurement of photographic densities. They have been used in the measurement of the density of transparent films, filters, gases, and liquids. They are being constantly used to detect and measure smoke. In this latter form they may be called smoke alarms.

Quantitative spectrographic analysis methods, which are proving especially useful in the determination of metallic elements in low concentrations with a speed and accuracy surpassing by far that obtainable with chemical analysis methods, employ a highly specialized version of the densitometer. For this work, a spectrogram of the substance being analyzed is made and placed upon the stage of the densitometer. Spectrum line densities

are then measured. If all conditions are suitably controlled, a comparison of the densities of chosen lines will indicate the concentration present of the substance under analysis. Shown in Fig. 4 is the ARL & Dietert Comparator and Densitometer for use in spectrographic analysis. The light passing the spectral line enters a slit and then falls upon a phototube, the output of which is amplified by a bridge circuit amplifier. The current output of this amplifier is then measured by a galvanometer of short period.

Another form of spectrum densitometer is the Knorr-Albers Recording Microphotometer manufactured by the Leeds and Northrup Company shown in Fig. 6. This instrument uses a Speedomax Recorder in place of a galvanometer and automatically records the spectrum line densities. This continuous record assures also that the peak density will be determined, as is required for this precise work.

Continued developments in electronics will enable the accuracy and reliability of these instruments to be constantly improved. As a result, industry and research will contribute to the greatly expanded use of these devices.

Fig. 20. Optical system of the Eastman transmission densitometer shown in Fig. 15.

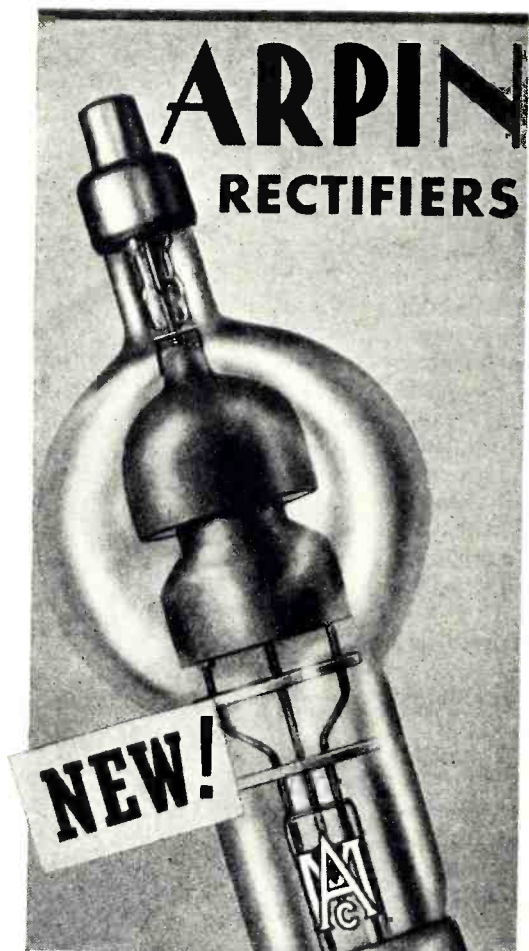
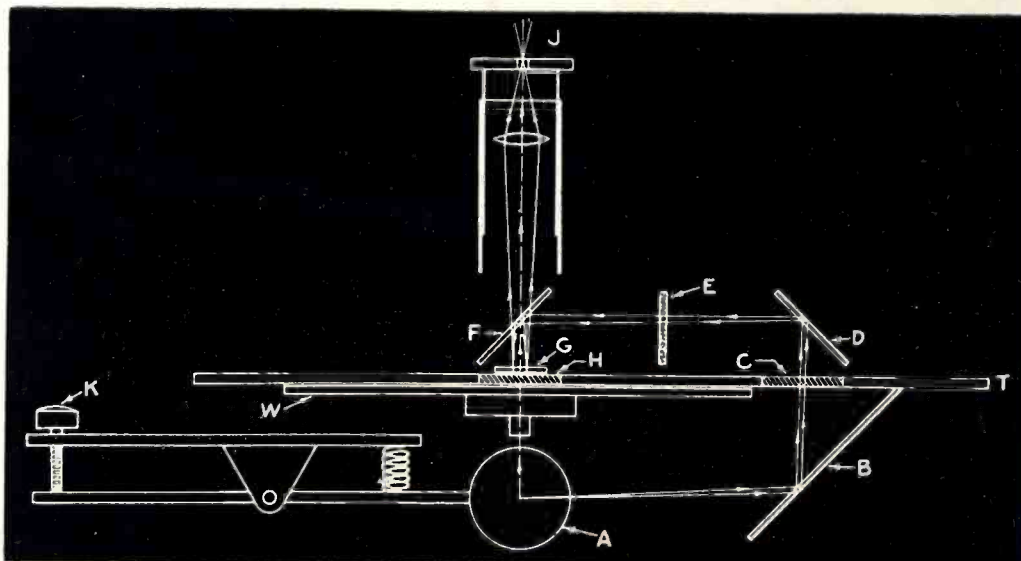

869-B
FOR HIGH
VOLTAGE
HALF WAVE
MERCURY
VAPOR

MAX. PEAK $I_p = 10$ AMPS.
MAX. AVE. $I_p = 2\frac{1}{2}$ AMPS.
MAX. PEAK $E_b = 20,000$ V.
FIL. 5 V., 22 AMPS.

Send for Characteristics Folder



REPAIR SERVICE . . .
WATER-COOLED TUBES
We repair all types of water-cooled
tubes. FULLY GUARANTEED.

ARPIN MANUFACTURING CO.
420 Alden St., Orange, N. J.

TECHNICAL BOOKS

"FIELDS AND WAVES IN MODERN RADIO," by Simon Ramo and John R. Whinnery. Published by *John R. Wiley and Sons*, New York. 495 pages. Price \$5.00.

This is the eleventh book in the General Electric Series for advanced engineers written by outstanding men of the company's organization.

This text presents certain aspects of the electromagnetic theory and their application in radio engineering. Heretofore, information of this type was available only by consulting many books where the subject was covered in an incomplete manner. Since this book is used in training student engineers, all of the material included is practical material which may be utilized in specific design calculations.

The problems covered include those of high-frequency circuits, skin effects, shielding problems, wave transmission and reflection problems, transmission lines and wave guides, cavity resonators, antennas and other radiating systems as well as the correlation of fields and waves with circuits so that they may be viewed as part of the whole.

One of the valuable features of the text is an appendix which includes the nomenclature of the book. This table helps to clarify the text material and contributes to an easier understanding of the subject matter.

"ENGLISH FOR ENGINEERS," by Harbarger, Whitmer and Price. Published by *McGraw-Hill Book Company*, New York. 218 pages. Price \$1.75.

The day of the inarticulate engineer is passing rapidly and in his place is the well-trained engineer who has ideas and can express them in writing or on the public platform.

The need for an adequate means of expression is further emphasized by the fact that the engineer is now expected to contribute to leading technical journals as an integral part of his job. To assist the engineer, this text has been written. In this book the problem of writing clearly is simplified by a few basic rules of sentence structure and grammar. The engineering report, which in the past has been as incomprehensible to the uninitiated as *Variety*, can be made clear, concise and understandable by adhering to certain basic rules for its composition.

The book should be part of the library of every engineer.

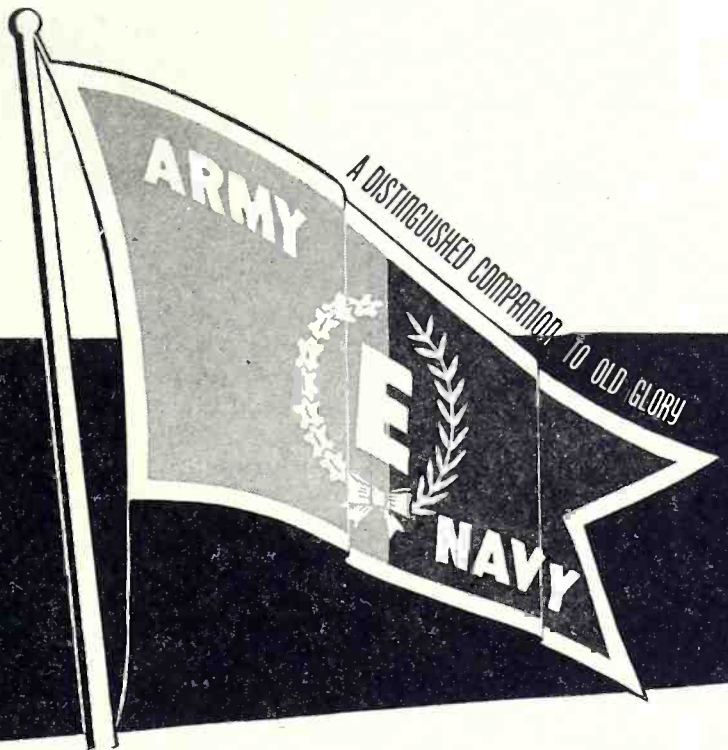

For EXCEPTIONAL PERFORMANCE

INSULINE has been awarded the Army-Navy "E" for exceptional performance in the production of Radio-Electronic Products.

With resolution, and naturally with pride, we accept this honor. The "E" pennant flying beside "Old Glory", is a ringing challenge.

It is a battle cry, saying: "Back up our fighting men . . . Give them the material strength with which to implement their fighting hearts!"

We are resolved that this call shall be answered with stepped-up production . . . with new records of exceptional performance worthy of the trust placed in us by the Armed Forces.

☆☆☆☆☆

Looking Ahead! Though engaged in vital war work, Insuline is looking ahead. We are gearing our organization for the post-war requirements of the Radio-Electronics Industry.

Write for the 48-page Catalogue of ICA Products, and brochure on the ICA organization and facilities.



INSULINE
CORPORATION OF AMERICA
INSULINE BUILDING • LONG ISLAND CITY, N.Y.

finch facsimile

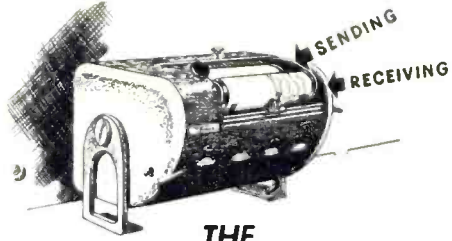

THE "INSTANT COURIER"

(Transmits pictured messages by radio or wire.)

★
For the present, Finch manufacturing facilities are being devoted to special radio apparatus for . . .

- U. S. SIGNAL CORPS
- U. S. NAVY
- U. S. ORDNANCE DEPT.
- F. C. C.
- F. B. I.
- U. S. TREASURY DEPT.
- and WAR MANUFACTURERS

FINCH
TELECOMMUNICATIONS, Inc.
PASSAIC, N. J.

UHF-RF-AC-DC VACUUM TUBE VOLTMETERS



- ★ As laboratory standard or for production testing.
- ★ Both AC and DC input impedances high.
- ★ RF "Probe" for convenience and efficiency at high radio frequencies—over 100 megacycles.
- ★ Complete with power supply.
- ★ Accurate and stable on all voltage ranges.

BULLETIN ON REQUEST
ALFRED W. BARBER
LABORATORIES
34-08 Francis Lewis Blvd. Flushing, N. Y.

PATENTS

PRODUCING ELECTRIC IMPULSES

An apparatus for the treatment of nerves and muscles by means of electric impulses, comprising means for producing a succession of electric impulses, a device for generating a rhythmically pulsating current, means controlled by said pulsating current to

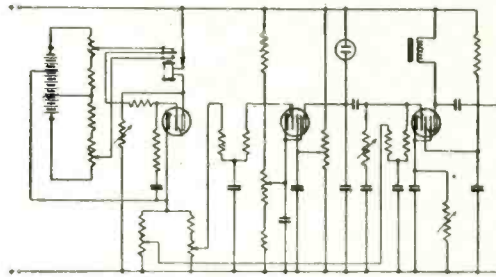

vary the time intervals between said individual impulses, and independently adjustable means also controlled by said pulsating current to vary the amplitude of said pulses. Preben Morland Gentofte, and Jorgen Adolph Smith, vested in Alien Property Custodian. Filed September 3, 1941, issued June 6, 1944, No. 2,350,797.

GAS TUBE RELAY CIRCUITS

A high impedance, pure resistance potential divider is connected across the line in parallel with a cold cathode, low pressure gaseous discharge tube.

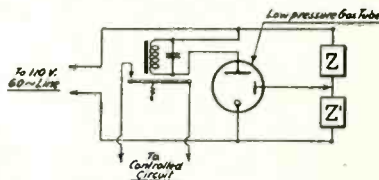

A relay is placed in the plate circuit of the tube, and the tap on the potential divider connected to the starter anode. Harmon B. Deal, assigned to Radio Corporation of America. Filed March 13, 1942, issued May 30, 1944, No. 2,349,849.

ELECTRON EMISSION DEVICE

An electron discharge device wherein a high voltage is impressed between the electrodes during the period of operation. An arc gap is provided between the high-voltage terminals, the spacing being such that spark-over would occur at the applied voltage. Means are provided for energizing the device for a period of time so short that ionization of air with attendant spark-over at the arc-gap does not oc-

cur regardless of the high instantaneous potential difference at the arc-gap. Charles M. Slack and Louis F. Ehrke,

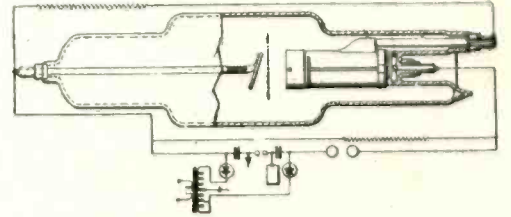

assigned to Westinghouse Electric and Manufacturing Company. Filed July 22, 1942, issued May 23, 1944, No. 2,349,468.

DIVERSITY RECEIVING SYSTEM

The method of operating a diversity receiving system which includes collecting signal energy at two spaced points, combining the energies col-

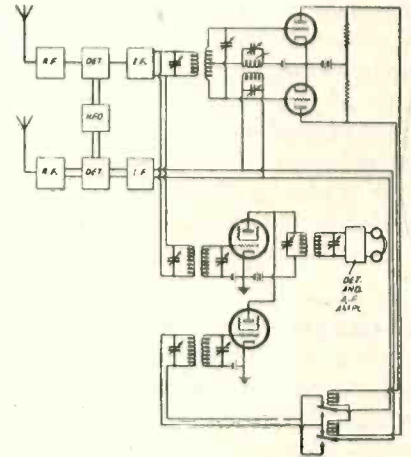

lected, producing a single voltage responsive to relative variations in phase of the two collected energies and utilizing said voltage to produced fixed changes of 180 degrees in the phase relation of the combined energies. Murray G. Crosby, assigned to Radio Corporation of America. Filed December 31, 1941, issued May 23, 1944, No. 2,349,407.

CATHODE RAY TUBE

The electrons strike an intermediate screen and cause it to emit secondary electrons from the back. These secondary electrons are then focused on the fluorescent screen to produce an image of the oscillogram. Karl Kohl, vested in the Alien Property Custodian. Filed Nov. 26, 1940, issued June 6, 1944, No. 2,350,774.

New Products

(Continued from page 34)

parent paper is possible by this process.

Since reproduction is photographic, copies can be made of the original film in any desired sizes for distribution to branches, service depots and other points serviced by the plant.

Since reduction photographs of all records are on a continuous roll, the master files become tamper-proof, extraction-proof and substitution-proof. A 90 to 98 percent reduction in filing space is possible by means of Microcopy.

For reading individual drawings from the film, a viewer is supplied in

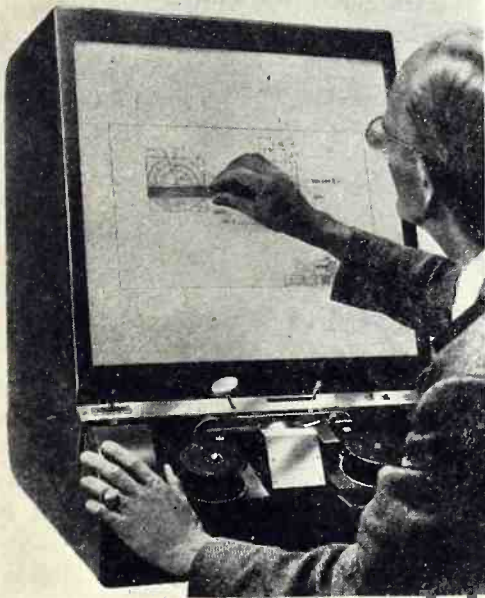

various models. This viewer, operated on a motion picture film projector principle, is operated from a control panel. Enlargements are made on a screen of the entire drawings or record, as well as, any portion of the record, as desired.

Information in greater detail will be furnished to those who request it from *Microcopy Corporation*, 2800 West Olive Avenue, Burbank, California.

SOUND REPRODUCER

A new duo-directional baffle reproducer which can be used in conjunction with the company's music and voice paging systems, has been announced by *Executone, Inc.*

An 8" permanent magnetic speaker having a 6 ohm voice coil is enclosed in the acoustically designed baffle of this Model HI-8. An opening front and back provides duo-directional transmission. This unit is designed for use in any size area where up to medium noise conditions exist and wide angle of voice and sound is desired.

Additional data about these units is available from *Executone, Inc.*, 415 Lexington Avenue, New York, New York.

WILEY BOOKS in COMMUNICATIONS — ELECTRONICS



Post-war plans in your field are being made now. Now is the time, then, to step up your knowledge. Be ready for new duties. Look over the important titles listed below. Make your selection and order from the coupon today.

FIELDS AND WAVES IN MODERN RADIO

By Simon Ramo and John R. Whinnery

503 Pages

\$5.00

Authoritative data on high-frequency circuits, skin effect, shielding problems, problems of wave transmission and reflection, transmission lines and wave guides, cavity resonators, and antennas and other radiating systems—with a rigorous account of the technique of applying field and wave theory to the solution of modern radio problems.

HOW TO PASS RADIO LICENSE EXAMINATIONS—Second Edition

By CHARLES E. DREW

320 Pages

\$3.00

Newly revised and brought up to date, this well-known book, in question-and-answer form, offers much helpful material to amateur radio operators, radiotelephone and telegraph operators, whether interested in broadcasting, marine, aeronautical, or any other field of radio transmission and reception.

RADIO RECEIVER DESIGN—Part 1

By K. R. STURLEY

435 Pages

\$4.50

Communications engineers will want to own this book, which covers radio frequency amplification and detection. A detailed study, stage by stage, beginning with the aerial and going as far as the detector.

TIME BASES—(Scanning Generators)

By O. S. PUCKLE

204 Pages

\$2.75

Covers the subject from both the design and the development points of view; assembles more time bases circuits than have heretofore been available in one volume.

PRINCIPLES OF RADIO—Fourth Edition

By KEITH HENNEY

549 Pages

\$3.50

A complete and authoritative presentation of radio, in its fundamentals as well as its recent developments. Partial list of contents includes: Ohm's Law; Inductance; Capacitance; Circuits; Coils; the Vacuum Tube; Amplifiers; Rectifiers; Oscillators; Television; etc. Profusely illustrated.

COMMUNICATION CIRCUITS

—Second Edition

By L. A. WARE and H. R. REED

330 Pages

\$3.50

An expansion of an eminently successful book to include new material on physical aspects of wave guide transmission, impedance matching, solution of circuits, and the theory of rectangular and cylindrical wave guides.

HYPER AND ULTRA-HIGH FREQUENCY ENGINEERING

By ROBERT I. SARBACHER and

WILLIAM A. EDSON

644 Pages

\$5.50

A practical treatment of an important new branch of communications engineering, requiring no special advanced knowledge. Of value to the beginner, as well as those having some familiarity with the subject.

GUIDE TO CATHODE RAY PATTERNS

By MERWYN BLY

30 Pages

\$1.50

Important for technicians and laboratory workers. This book summarizes briefly by means of sketches and captions the cathode-ray pattern types encountered in the usual course of laboratory and test bench work.

FUNDAMENTAL RADIO EXPERIMENTS

By ROBERT C. HIGGY

96 Pages

\$1.50

Thirty-two basic experiments in electricity, electronics and radio, with a full explanation of the principles involved as well as laboratory procedure.

BASIC ELECTRICITY FOR COMMUNICATIONS

By WILLIAM H. TIMBIE

603 Pages

\$3.50

A simple, clear presentation of the fundamentals of electricity and their application in the problems of communications and radio. The first twelve chapters illustrate the principles by simple application to communications appliances. The remainder of the book covers the appliances and their operation.

SHORT-WAVE WIRELESS

—Fourth Edition

By A. W. LADNER and C. R. STONER

573 Pages

\$6.00

The latest facts and theory (as far as they may be released now) on the many leading American, English and European developments taking place in short-wave and ultra-short-wave work.

ON APPROVAL COUPON

JOHN WILEY & SONS, INC.

440 Fourth Avenue, New York 16, N. Y.

Please send me on ten days' approval the books I have checked in this advertisement (or I am attaching to this coupon a separate list of the books desired). At the end of that time, if I decide to keep the books, I will remit indicated price plus postage; otherwise I will return the books postpaid.

NAME

ADDRESS

CITY AND STATE

EMPLOYED BY

REE-8-44

Television

CBS Poll on Video

THE Columbia Broadcasting Company has just completed a survey of 106 independent stations on television with the following reported results. To the question regarding the improved television reception due to new engineering improvements justifying the concerted efforts of manufacturers, broadcasters and the government 98% replied in the affirmative and 2% indicated that they did not know. All stations replying indicated that color television was up to 250% more effective than black and white.

Of the stations replying, 83% did not believe that the present black and white television as received in actual broadcast was sufficiently good to induce widespread consumer purchases of receiving sets at \$200 and up. Fifty-three percent of the stations' replies indicated that the present black and white could be viewed up to an hour without eyestrain while 97% indicated that this condition was not true for a two-hour period.

From this survey, the Columbia Broadcasting System have concluded that the need for better pictures will have to be met before widespread acceptance of this medium is possible.

* * *

RKO Television

THE Radio-Keith-Orpheum Corporation through its president, Mr. N. Peter Rathvon, has announced the formation of a subsidiary television company to be known as the RKO Television Corporation, with executive offices in the RKO Building, 1270 Sixth Avenue, New York.

In making the announcement, Mr. Rathvon pointed out that although many persons consider television to be exclusively within the radio field, the motion picture industry cannot afford to ignore the possibilities of this entertainment medium.

Some of the motion picture techniques may be adapted to television programming and Mr. Rathvon feels that a producing company is best qualified to develop this technique in the television field. It is the plan of the new company to produce films for telecasting purposes as an entirely separate and distinct industry.

Officers of the new corporation in-

clude, in addition to Mr. Rathvon who will act as chairman of the board, Mr. Frederic Ullman, Jr., of Pathe News, vice-president, Mr. Ralph B. Austrian, executive vice-president and Mr. Malcolm Kingsberg, treasurer of RKO, vice-president.

* * *

Television Standards

THE General Electric Company has announced their stand on the present television standards controversy in a statement released by Mr. Paul L. Chamberlain, manager of sales of GE's Transmitter Division.

According to Mr. Chamberlain, "Post-war television need not be handicapped by 'freezing' the present standards nor need it be delayed by the search for the theoretical ultimate in equipment."

"If the Radio Technical Planning Board will adopt the same step-by-step method that many business concerns are now using in their post-war planning," said Mr. Chamberlain, "broadcasters and the public will have the finest television that the industry can provide when conditions again make it possible to manufacture television receivers and transmitters."

"In April, 1944, the General Electric Company announced a plan by which prospective television broadcasters could obtain a post-war priority on television transmitting equipment. This plan did not refer to any equipment specification or standards because of our intention to take full advantage of all possible war-time developments. Numerous reservations for post-war delivery of television transmitters have been received since the announcement of this plan, thus assuring the wide availability of television program service after the war."

* * *

"Sound on Video"

A FORMAL demonstration of a new method of telecasting "Sound on Video" will be held by the inventor, James E. Robinson, on September 5, 1944, in Buffalo, New York, in conjunction with the Institute of Radio Engineers.

Details of this system will be given in an article by Mr. Robinson in an early issue of *Radio-Electronic Engineering*.

Reservations to attend this demonstration must be made with Mr. Robinson no later than August 15, to assure acceptance. Letters making reservation should be addressed to 143 Bidwell Parkway, Office 1, Buffalo 9, New York.

* * *

Philco Dedicates Link

A NEW YORK to Philadelphia television relay transmitter link, connecting the two cities for video broadcasts has been put into operation by the Philco Corporation. This new link, installed near Princeton, New Jersey, replaces previous experimental installations and marks the beginning of the first regularly scheduled relay system capable of providing commercial service in the United States.

This relay was developed by the Philco engineers who point out that similar links can be constructed at a cost of about \$15,000. When located approximately 50 miles apart, these links may form the basis for a nationwide television system in the postwar period.

* * *

RTPB Television Panel

IN A special announcement, Dr. W. R. G. Baker, chairman of the RTPB, advises that the board has not made any formal recommendations with respect to the location of television in the frequency spectrum because the work of Panel 6 on Television has not been completed.

Dr. Baker stated that when the television panel and its six committees have completed their work, the board will issue a statement, but that any statements issued prior to the completion of the work would be premature.

* * *

Bell System Video

IN A recent issue of the Bell Telephone Magazine, the plans of the Bell System for television were discussed by Keith S. McHugh and George L. Best in an article entitled "The Bell System's Interest in Program Television."

Network transmission facilities are pointed out as one of the greatest needs of television to make programs available to other than local audiences, thus increasing the scope and value of the telecast.

A tentative program of coaxial cable routes have been set up by AT&T calling for construction covering a period from 1945 to 1950.

* * *

Television Supervisor

YOUNG AND RUBICAM, one of the oldest New York advertising agencies has appointed a television supervisor to handle accounts assigned for

telecasting. William E. Forbes, for seven years associated with the Columbia Broadcasting System, has received the appointment.

Mr. Forbes entered radio with the Don Lee Broadcasting System on the West Coast. Subsequently, he served as assistant to Donald W. Thornburgh, vice-president of CBS in Hollywood; general manager of WCCO in Minneapolis-St. Paul; and finally as executive assistant to W. S. Paley, president of the Columbia Broadcasting System.

* * *

Galvin on Television

PAUL V. GALVIN, the retiring head of the Radio Manufacturers' Association, feels that television will be perfected under the prod of wartime necessity and will be translated into post-war benefits for the public.

Mr. Galvin feels that some day the television industry will be as large as the present radio industry. He further states that those in the radio industry will become the natural leaders in the production of television sets.

Frequency

(Continued from page 19)

signed so that $C_1 = C_2$, $R_3 = 2R_4$, and $R_2 = R_1$. The values of R_4 , C_1 , R_3 , and C_2 are fixed, and arrangements made to adjust R_1 and R_2 simultaneously in equal quantities. These steps for R_1 and R_2 are considered in such conductance values as 100, 50, 33.5, 25, 20 . . . 11.1 and 10 ohms, since balance conditions are represented by $\omega = 1/R_1 C_2$. Filter circuits are necessary to eliminate harmonics. Headphones or a vacuum tube voltmeter may be

Fig. 8. A simple piezo-electric quartz resonator and typical response curve.

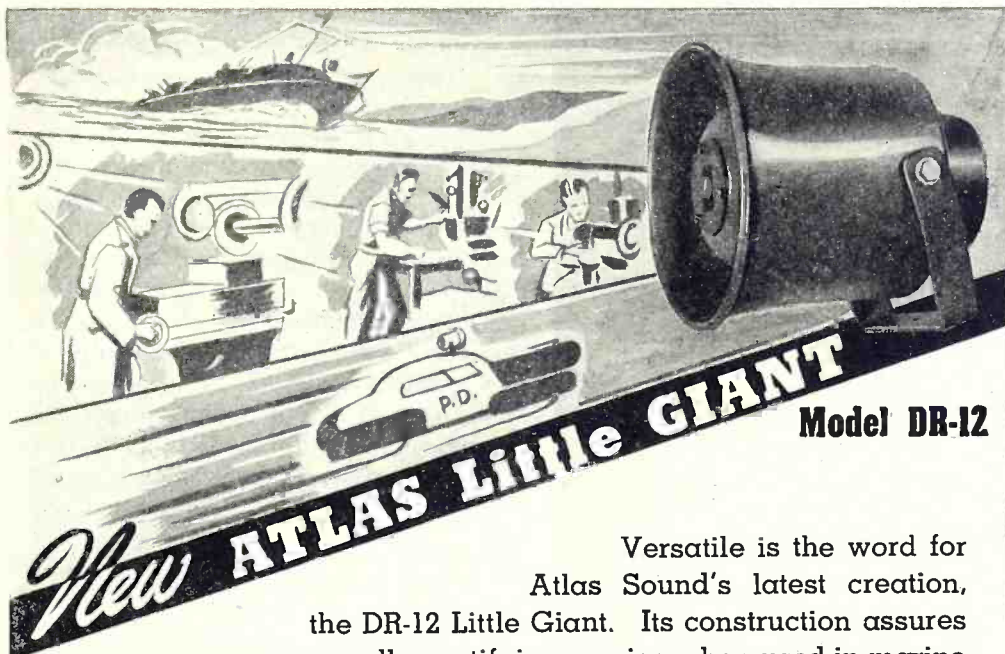
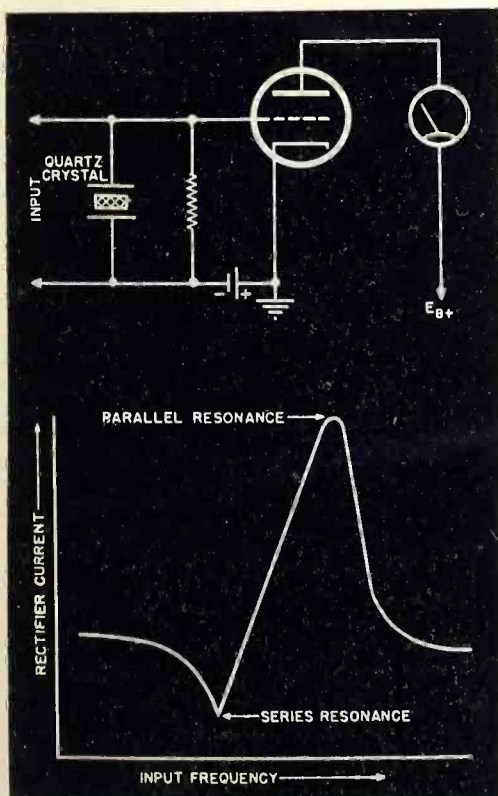

Versatile is the word for Atlas Sound's latest creation, the DR-12 Little Giant. Its construction assures equally gratifying service when used in marine application, factory, police and other communications . . . a design that has proven itself more than equal to War's rigorous demands.

Bell diameter 7"—over-all length 7½"
WRITE FOR DETAILED DESCRIPTION

ATLAS SOUND

CORPORATION

1445 39th Street

Brooklyn, N. Y.

ENGINEERS: Here's the **BIG POINT** about **AMPERITE REGULATORS**



Features:

1. Amperites cut battery voltage fluctuation from approximately 50% to 2%.
 2. Hermetically sealed — not affected by altitude, ambient temperature, humidity.
 3. Compact . . . light . . . and inexpensive.
- Used by U.S. Army, Navy, and Air Corps.

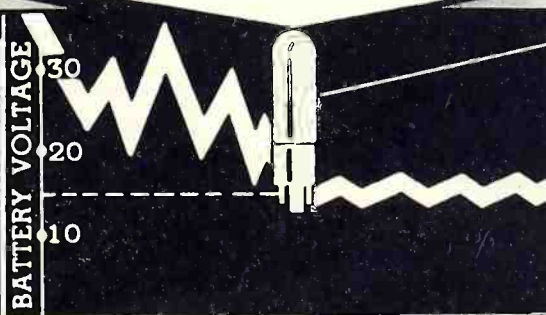

VOLTAGE OF 24V BATTERY & CHARGER VARIES APPROX. **50%** WITH **AMPERITE** VOLTAGE VARIES ONLY **2%**

DELAY RELAYS: For delays from 1 to 100 seconds. Hermetically sealed. Unaffected by altitude. . . . Send for catalogue sheet.

NEW! 4-page folder will help you solve Current and Voltage Problems; contains much valuable data in practical form—Write for your copy now.

AMPERITE CO., 561 Broadway, New York (12), N. Y.

In Canada: Atlas Radio Corp., Ltd., 560 King St., W. Toronto

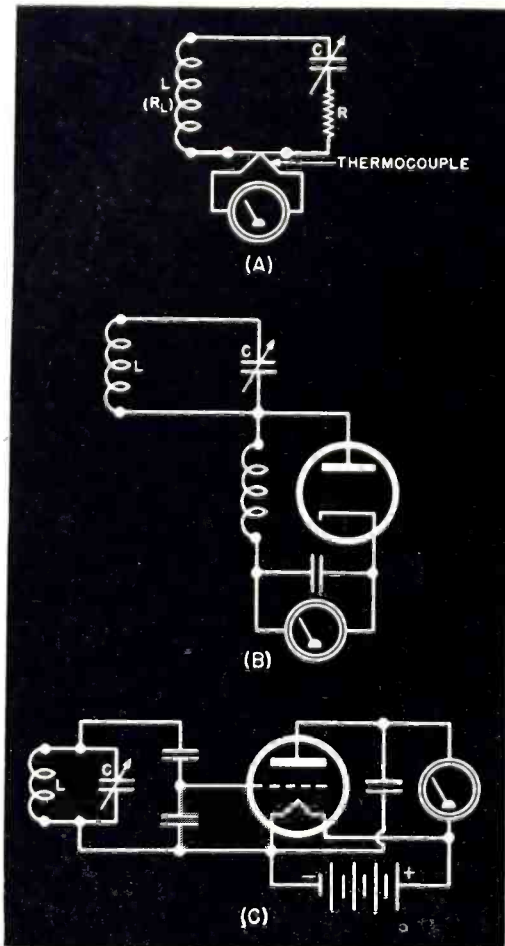

Fig. 9. Absorption wavemeter circuits showing two methods, (B) and (C), of avoiding detector damping effects.

used for null detection. Accuracy is obtainable within plus or minus 0.5% for frequencies up to about 20,000 cycles per second. A commercial form of this bridge is shown on page 16. The greatest advantage of Wien bridge circuits is in the exclusive use of capacitance and resistance elements, eliminating the possibility of magnetic pickup. In the instrument shown, the resistance elements are tapered so that the scale is logarithmic. The frequencies from 20 to 20,000 cycles per second are covered in three ranges by means of a selector switch. For determining the frequency of oscillators used as power sources in audio frequency measurements, and for measuring difference frequencies in radio ranges, as well as other laboratory uses this is a flexible and useful instrument.

The Lecher-Wire system of frequency determination is of particular interest at this time because of the increasing use of the higher frequency spectrum for which this method is especially suitable. Fig. 5(A) shows the basic arrangement and is referred to for purposes of outlining the principle and procedure. The bridge across the wires is of sliding design and consists of a thermo-electric meter with full scale deflection of approximately 100 milliamperes, and five ohms heater resistance. A heavy copper wire shunts the meter in order to reduce the effective resistance of the parallel combination to a negligible value with respect to wave reflections.

The bridge is moved along the parallel wires and the distance measured between two maximum current readings. This notation corresponds to half a wave length. The condenser, C, is connected across the lines near the input section in order to avoid excessive length, and this capacitance is adjusted so that the initial maximum current indication also occurs close to the input end.

In order to compensate for the difference between the wave length λ_0 in free space and measurements on the wires, the term Δ is used for correction in the following equations:

$$\lambda_0 = 2d(1 + \Delta) \dots \dots \dots (10)$$

$$f = \frac{1.499 \times 10^8}{d(1 + \Delta)} \dots \dots \dots (11)$$

$$\Delta = \frac{\sqrt{r_0}}{8 \log_e B \sqrt{\left\{ \omega \left[1 - \left(\frac{s}{a} \right)^2 \right] \right\}}} \dots \dots (12)$$

where a is the distance between conductors, s is the diameter of the parallel wires and

$$B = \frac{1 + \sqrt{\left[1 - \left(\frac{s}{a} \right)^2 \right]}}{\frac{s}{a}} \dots \dots \dots (13)$$

Generally the distance a is very large compared to the diameter s , and $B \approx 2a/s$. The d.c. resistance per centimeter length of the double line is represented by r_0 in terms of abohms (10^9 abohms = 1 ohm) and $\omega/2\pi$ is the frequency in cycles per second. The correction is usually of an order of magnitude below 0.5%.

It is important that d , be small as compared to the $\frac{1}{4}$ wave length distribution or any odd multiple thereof, in order to avoid free-end effects from the parallel lines. If this relationship is not considered, interaction between the tuned open end branch and the tuned branch from the meter to the input side may occur through a coupling effect of the meter bridge, and double hump phenomena will result. For practical reasons this apparatus

Fig. 10. Resistance-capacitance phase splitter and connections for "gear wheel" patterns.

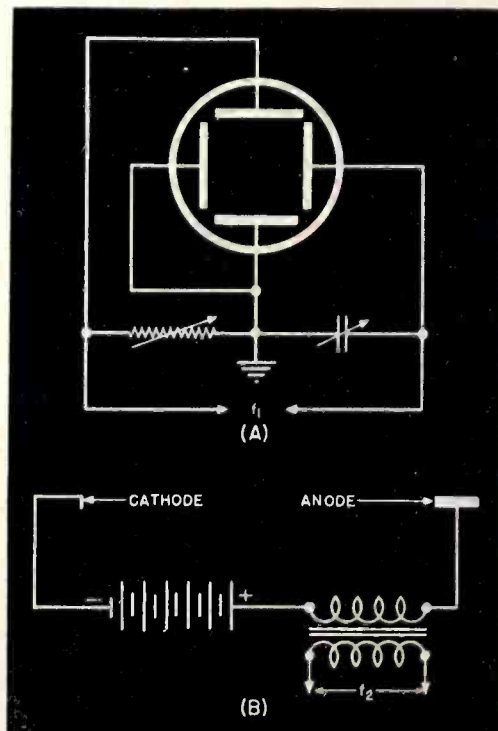

U. S. A. Signal Corps
Communication
 EQUIPMENT and COMPONENTS
 PROMPT DELIVERY

Complete units
 or any component
 parts now available on:

CD-318-A	JK-26	PL-54	PL-68	BC-347-C
CD-307-A	JK-48	PL-55	"A" Plug	PE-86
CD-874	PL-47	PL-58	BC-366	JB-47
	SW-141		TD-3	

TRAVLER KARENOLA
 RADIO AND TELEVISION CORPORATION
 1030 W. VAN BUREN ST., CHICAGO 7, ILL.

PRECISION RADIO AND COMMUNICATION EQUIPMENT

PHOTO CREDITS

- 3 (left) . . . North American Philips
 3 (right) Westinghouse
 4 (top) R.C.A.
 4 (bottom) Westinghouse
 6 Westinghouse
 9 (lower left) . . Leeds & Northrup
 11 (upper right) . . Eastman Kodak

is limited to measurements below 20 meters.

As extended frequency ranges come into more general use, new methods and new applications of old methods of frequency determination will be developed. The opportunities for ingenuity and original research work in this field after the war are indicated by present trends as worthy of specialization on the part of forward-looking engineers.

REFERENCES

1. Goodell, John D., "Frequency Determination," *Radio-Electronic Engineering*, July, 1944.
2. Takagishi, Eijiro, "On a Double Hump Phenomenon of Current through a Bridge across Parallel Lines," *Proc. I. R. E.*, Vol. 18, p. 513, March 1930.
3. Dunmore and Engel, "A Method of Measuring Very Short Radio Wave Lengths and Their Use in Frequency Standardization," *Proc. I. R. E.*, Vol. 21, p. 29, January 1923.
4. Hund, "Correction Factor for the Parallel Wire System in Absolute Frequency Standardization," *Proc. I. R. E.*, Vol. 12, p. 817, December 1924.
5. Hazen and Kenyon, "Primary Radio Standard by Use of Cathode Ray Oscilloscope," U. S. Bureau of Standards Scientific Paper 489.
6. Andersen, Donald E., "Tuning Fork Standards for Meter Calibration," *Electrical World*, January 8, 1944.
7. Terman, "Measurements in Radio Engineering," McGraw-Hill, 1935.
8. Brown, "Radio Frequency Electrical Measurements," McGraw-Hill, 1938.
9. Hund, "High Frequency Measurements," McGraw-Hill, 1933.
10. "Frequency Measurement in the British Post," *Post Office Electrical Engineers Journal*, Vol. 24, p. 155, 1931.
11. Catalogue "K", General Radio Company.

S-T Antenna

(Continued from page 14)

in a decreased resistance component and increased inductive reactance component in the impedance characteristic of the director dipole element. Contrary to the situation on the primary element, compensation for this effect is made by reducing the length of the director dipole element.

When the proper lengthening and shortening of the dipole elements has been effected, thereby placing each dipole in resonance at the midband frequency of operation, the resistance and reactance variations of both elements with frequency will compensate through the impedance inverting properties of the quarter wavelength coupling line. Thus, the impedance presented to the quarter wavelength matching section assumes the characteristics of a relatively constant resistance and substantially zero reactance across the operating television band.

An antenna system composed of four vertical bays of these basic units has been in use as a television relay link antenna for some years at WRGB, the television station of the General Electric Company. This particular antenna operates on an assigned relay channel of 166-172 megacycles for the purpose of relaying video signals from the WRGB television studio in Schenectady, N. Y., to the location of the main transmitter in the Helderberg Mountains, an airline distance of some 12 miles.

Future television requirements may dictate the use of an even wider video band but the antenna here described represents a satisfactory solution to the engineering problems encountered in the present six megacycle television band.

BATHTUB CONDENSERS



. . . . ready for you!

Need help on your requirements? We can furnish bathtub condensers to a limited number of additional manufacturers of radio and electronic units. Delivery of reasonable quantities made in five-six weeks. Samples will be furnished upon request.

H. R. S. PRODUCTS

5707 West Lake Street
 Chicago, Illinois

Wanted ENGINEERS

- Radio
- Chemical
- Electrical
- Electronic
- Mechanical
- Metallurgical
- Factory Planning
- Materials Handling
- Manufacturing Planning

Work in connection with the manufacture of a wide variety of new and advanced types of communications equipment and special electronic products.

Apply (or write), giving full qualifications, to:

C. R. L.
 EMPLOYMENT DEPARTMENT

Western Electric Co.

100 CENTRAL AV., KEARNY, N. J.

Applicants must comply with WMC regulations

INDEX OF ADVERTISERS

COMPANY	AGENCY	PAGE NO.
Amperite Company	H. J. Gold Co., Advertising	45
Andrew, Victor J. Co.	Burton Browne, Advertising	39
Arpln Mfg. Co.	Gallard Advertising Agency	40
Atlas Sound Corporation	Hart Lehman, Advertising	45
Barber, Alfred W., Labs.	Harold Marshall Adv. Co.	42
Bentley, Harris, Mfg. Co.	John Falkner Arndt & Company, Inc.	48
Continental Electric Co.	Duane Wanamaker Adv.	38
Finch Telecommunications, Inc.	Wortman, Barton and Gould	42
Guthman, Edwin I., & Co.	Sidney S. Lovitt, Advertising	25
Harwood Co.	John H. Riordan Co.	33
H.R.S. Products		47
Insuline Corp. of America	H. J. Gold Co., Advertising	41
Kurman Electric Co.	H. J. Gold Co., Advertising	36
Lenox, Inc., Lenoxite Division		29
Lenz Electric Mfg. Co.	Triangle Advertising Agency	35
Radio Receptor Co.	Shappe-Wilkes Inc.	31
Sola Electric Co.	Hardy Advertising	27
Stupakoff Ceramic & Manufacturing Co.	W. S. Hill Company Advertising	37
Trav-Ler Karenola Radio Co.	Jones Frankel Co., Advertising	46
Western Electric	Deutsch & Shea Advertising Agency	47
Wiley, John, & Sons, Inc.	S. Duane Lyon, Inc.	43

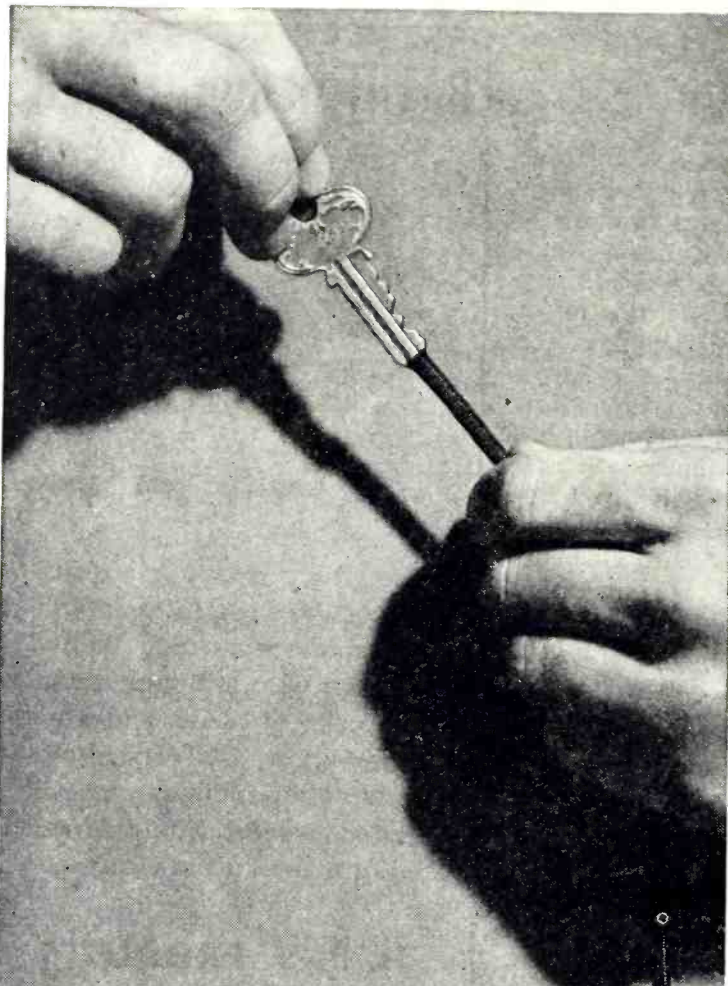

KEY TEST

Opens Up New Sleeving Advantages

PROVE TO YOURSELF THE NON-FRAYING, FLEXIBLE QUALITIES OF BH EXTRA FLEX FIBERGLAS SLEEVING

MAKE THIS simple test right at your desk and you'll see that here at last is a truly non-fraying, flexible sleeving. Just take a length of BH *Extra Flexible* Fibreglas Sleeving and jam an ordinary key into one end. Turn it around and push it up and down in the sleeving. Notice how the sleeving spreads but doesn't fray. Now do the same with a similar size piece of your present saturated sleeving. It breaks and frays. Further abuse unravels it. But BH Sleeving stands up under rough handling and severe service alike.

BH EXTRA FLEXIBLE FIBERGLAS SLEEVING
NON-FRAYING • FLEXIBLE • HEAT-RESISTANT • NON-INFLAMMABLE • WATER-RESISTANT • VERMIN-PROOF
NON-DETERIORATING • HIGH DIELECTRIC AND YARN STRENGTH • NON-CRYSTALLIZING at LOW TEMPERATURES

BH Sleeving is woven from choicest continuous-filament Fibreglas yarns and treated by an exclusive BH process that gives it stamina and pliability. Natural properties of Fibreglas as an insulator are virtually unequalled. So why be content with any less efficient sleeving? You'll want to try the BH test yourself. BH Sleeving is available in all sizes from No. 20 to $\frac{5}{8}$ ", inclusive. Write for samples of specific sizes *today* and be convinced. Bentley, Harris Manufacturing Co., Dept. R, Conshohocken, Pa.

THE RESULTS MAGNIFIED

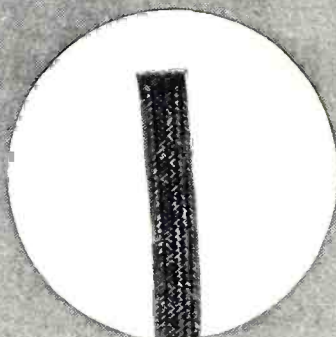

◀ The BH Way

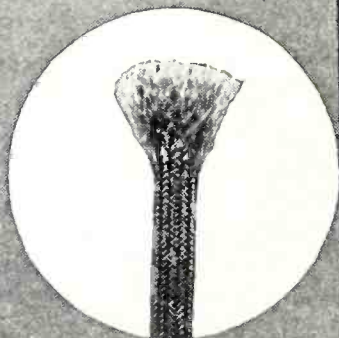

The Ordinary Way ▶



NON-BURNING IMPREGNATED MAGNETO TUBING • NON-BURNING FLEXIBLE VARNISHED TUBING • SATURATED AND NON-SATURATED SLEEVING

BENTLEY, HARRIS MANUFACTURING CO.
Conshohocken, Penna.