

INCLUDING
*Communication
Engineering*
and
*TV & RADIO
ENGINEERING*

RADIO-ELECTRONIC *Engineering*

Reg. U.S. Pat. Off.

JANUARY, 1955

POLE MOUNT MICROWAVE STATION

7

DIGESTS OF NEC PAPERS

10

Automatic Production of
Wafer Coil Inductive Components
Microwave Components for
Double Ridge Wave Guide
Strip Line Excitation Methods
Factors Affecting Tube Life
in Present-Day Military Applications
Wide-Range SWR Indicator
Coating Thickness Measurements
Using Pulsed Eddy Currents
Power Gain of a
Dielectric Amplifier

THE "UNI-LEVEL" AMPLIFIER

15

DIODE AMPLIFIER

18

BROADCAST APPLICATION
OF TAPE RECORDING

20

DEPARTMENTS

COMMUNICATION REVIEW . . .	22
NEW PRODUCTS	24
NEWS BRIEFS	26
NEW LITERATURE	28
NEW TUBES	30
PERSONALS	32
TV-AM-FM PRODUCTION	34
TECHNICAL BOOKS	35
CALENDAR	39

Centrally located master oscillator at the plant of
Lenkurt Electric Co., Inc., San Carlos, Calif., pro-
vides four accurately controlled standard frequencies.

TELEVISION • ELECTRONICS • COMMUNICATIONS • AUDIO • MICROWAVES • RADAR • RESEARCH

LARGEST PRODUCERS IN THIS FIELD FOR TWO DECADES...

HIGH Q INDUCTORS FOR EVERY APPLICATION

FROM STOCK... ITEMS BELOW AND 650 OTHERS IN OUR CATALOGUE B.



MQ Series Compact Hermetic Toroid Inductors

The MQ permalloy dust toroids combine the highest Q in their class with minimum size. Stability is excellent under varying voltage, temperature, frequency and vibration conditions. High permeability case plus uniform winding affords shielding of approximately 80 db.

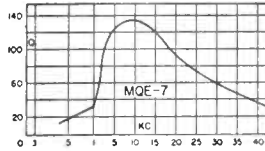

MQE
15 stock values from 7 Mhy. to 2.8 Hy.

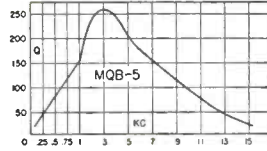

MQB
12 stock values from 10 Mhy. to 25 Hy.

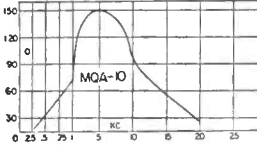

MQA
19 stock values from 7 Mhy. to 22 Hy.



MQ case structure.

	Length	Width	Height
MQE	1/2	1-1/16	1-7/32
MQA	11/16	1-9/32	1-23/32
MQB	1-5/16	2-9/16	2-13/16

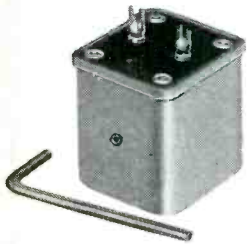

VIC case structure
Length 1-1/4 Width 1-11/32 Height 1-7/16

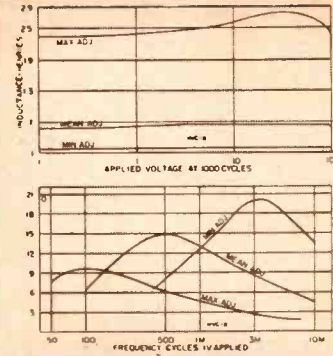

Type	Mean Hys.	Type	Mean Hys.
VIC-1	.0085	VIC-12	1.3
VIC-2	.013	VIC-13	2.2
VIC-3	.021	VIC-14	3.4
VIC-4	.034	VIC-15	5.4
VIC-5	.053	VIC-16	8.5
VIC-6	.084	VIC-17	13.
VIC-7	.13	VIC-18	21.
VIC-8	.21	VIC-19	33.
VIC-9	.34	VIC-20	52.
VIC-10	.54	VIC-21	83.
VIC-11	.85	VIC-22	130.

VIC Variable Inductors

The VIC Inductors have represented an ideal solution to the problem of tuned audio circuits. A set screw in the side of the case permits adjustment of the inductance from +85% to -45% of the mean value. Setting is positive.

Curves shown indicate effective Q and L with varying frequency and applied AC voltage.



MQE-1	2.5/10 Hys.
MQE-2	5/20 Hys.
MQE-3	50/200 Hys.
MQE-4	100/400 Hys.

MQL case
1-13/16 dia. X 2-1/2" H.

MQL Low Frequency High Q Coils

The MQL series of high Q coils employ special laminated Hipermalloy cores to provide very high Q at low frequencies with exceptional stability for changes of voltage, frequency, and temperature. Two identical windings permit series, parallel, or transformer type connections.

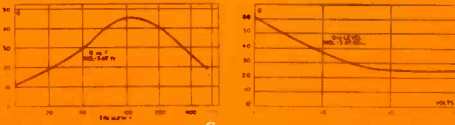

DI Inductance Decades

These decades set new standards of Q, stability, frequency range and convenience. Inductance values laboratory adjusted to better than 1%. Units housed in a compact die cast case with sloping panel ideal for laboratory use.

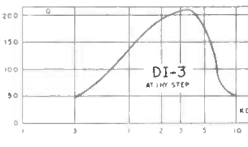

DI-1 Ten 10 Mhy. steps.
DI-2 Ten 100 Mhy. steps.
DI-3 Ten 1 Hy. steps.
DI-4 Ten 10 Hy. steps.



DI DECADE
Length 4 1/2"
Width 4 3/8"
Height 2 3/8"

HVC Hermetic Variable Inductors

A step forward from our long established VIC series. Hermetically sealed to MIL-T-27... extremely compact... wider inductance range... higher Q... lower and higher frequencies... superior voltage and temperature stability.

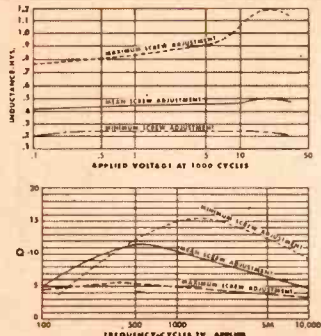

Type No.	Min. Hys.	Mean Hys.	Max. Hys.
HVC-1	.002	.006	.02
HVC-2	.005	.015	.05
HVC-3	.011	.040	.11
HVC-4	.03	.1	.3
HVC-5	.07	.25	.7
HVC-6	.2	.6	2
HVC-7	.5	1.5	5
HVC-8	1.1	4.0	11
HVC-9	3.0	10	30
HVC-10	7.0	25	70
HVC-11	20	60	200
HVC-12	50	150	500



HVC case structure.
Width 25/32 Length 1-1/8 Height 1-7/32

SPECIAL UNITS TO YOUR NEEDS

Send your specifications for prices.

UNITED TRANSFORMER CO.

150 Varick Street, New York 13, N. Y. EXPORT DIVISION: 13 E. 40th St., New York 16, N. Y. CABLES: "ARLAB"



50 Watt VHF FIXED STATION



The new Pye 50 watt V.H.F. FIXED STATION is of an advanced design employing the latest techniques. It is ideal for use in normal fixed and mobile schemes where high powered transmitters are required and may also be used for point-to-point radio-telephone links.

A further application is in the aeronautical band where the 50 watt transmitter, together with the standard Pye fixed receiver, provides one of the most efficient ground-to-air control stations at present available in the world.



Pye (New Zealand), Ltd.,
Auckland C.I., New Zealand.
Pye Radio & Television (Pty.) Ltd.,
Johannesburg,
South Africa.

Pye Canada, Ltd.,
Ajax, Canada.
Pye Limited,
Plaza de Necaxa 7,
Mexico 5.

Pye-Electronic Pty, Ltd.,
Melbourne, Australia.
Pye Limited,
Tucuman 829,
Buenos Aires.

Pye Ireland, Ltd.,
Dublin, Eire.
Pye Limited,
5th Ave. Building,
200 5th Ave., New York.

PYE LIMITED

CAMBRIDGE

ENGLAND

For more information, circle No. 2 on Reader Service Card

RADIO-ELECTRONIC ENGINEERING is published monthly by Ziff-Davis Publishing Company, William B. Ziff, Chairman of the Board (1946-1953) at 84 E. Lake St., Chicago 1, Ill. Entered as second-class matter March 29, 1954 at the post office, Chicago, Ill. SUBSCRIPTIONS: Subscribers to Radio-Electronic Engineering automatically receive Radio & Television News. RATES: one year U.S. and possessions, and Canada \$6.00; Pan-American Union countries \$8.50; all other foreign countries \$7.00; SUBSCRIPTION SERVICE: All communications concerning subscriptions should be addressed to Circulation Dept., 64 E. Lake St., Chicago 1, Ill. Subscribers should allow at least four weeks for change of address.

To the Engineer who is Very Particular



RCA expansion opens the kind of permanent opportunities you'll find most desirable

A whole new program of expansion at RCA—in Research, Systems, Design, Development and Manufacturing—opens a broad variety of permanent positions with all the features that appeal to the alert, creative engineer. These are opportunities with a future . . . available *today* for the man who wants to move ahead professionally with the world leader in electronics. They include work in fields of phenomenal growth. At the RCA engineering laboratories *listed in the chart on the right*, you'll find the kind of living and working conditions attractive to the professional man and his family.

Engineers and scientists find every important factor that stimulates creative

effort . . . including a quality and quantity of laboratory facilities unsurpassed in the electronics industry . . . and everyday association with men recognized at the top of their profession.

RCA's benefits add up to an impressive list of "extras." Among them: tuition for advanced study at recognized universities . . . a complete program of company-paid insurance for you and your family . . . a modern retirement program . . . relocation assistance available.

Your individual accomplishments and progress are recognized and rewarded through carefully planned advancement programs. Financially as well as professionally, you move ahead at RCA!

For more information, circle No. 3 on Reader Service Card

about His Future . . .

What can RCA offer you?

Check the chart below for your career opportunity in

COLOR TELEVISION
AVIATION ELECTRONICS
ELECTRON TUBES
MISSILE GUIDANCE

FIELDS OF ENGINEERING ACTIVITY	TYPE OF DEGREE AND YEARS OF EXPERIENCE PREFERRED											
	Electrical Engineers			Mechanical Engineers			Physical Science			Chemistry Ceramics Glass Technology Metallurgy		
	1-2	2-3	4+	1-2	2-3	4+	1-2	2-3	4+	1-2	2-3	4+
RESEARCH • SYSTEMS • DESIGN • DEVELOPMENT												
COLOR TV TUBES —Electron Optics—Instrumental Analysis—Solid States (Phosphors, High Temperature Phenomena, Photo Sensitive Materials and Glass to Metal Sealing)	L	L	L	L	L	L	L	L		L	L	L
RECEIVING TUBES —Circuitry—Life Test and Rating—Tube Testing—Thermionic Emission	H	H	H		H	H		H			H	H
SEMI-CONDUCTORS —Transistors—Circuitry—Advanced Development	H	H	H	H		H	H	H	H		H	H
MICROWAVE TUBES —Tube Development and Manufacture (Traveling Wave—Backward Wave)		H	H	H			H	H			H	H
GAS, POWER AND PHOTO TUBES —Photo Sensitive Devices—Glass to Metal Sealing	L	L	L	L	L		L	L		L	L	
AVIATION ELECTRONICS —Radar—Computers—Servo Mechanisms—Shock and Vibration—Circuitry—Remote Control—Heat Transfer—Sub-Miniaturization—Automatic Flight—Design for Automation—Transistorization			M			M			M			
			C			C			C			
RADAR —Circuitry—Antenna Design—Servo Systems—Gear Trains—Intricate Mechanisms—Fire Control			M			M			M			
			C			C			C			
COMPUTERS (ANALOG AND DIGITAL) —Systems—Advanced Development—Circuitry—Assembly Design—Mechanisms			M			M			M			
			C			C			C			
COMMUNICATIONS —Microwave—Aviation—Specialized Military Systems			M			M			M			
			C			C			C			
MISSILE GUIDANCE —Systems Planning and Design—Radar—Fire Control—Shock Problems—Servo Mechanisms			M			M			M			
COMPONENTS —Transformers—Coils—TV Deflection Yokes (Color or Monochrome)—Resistors		C	C		C	C		C	C			
MANUFACTURING	L			L	L		L	L		L	L	
Tri-Color Tubes—Microwave Tubes	H			H								
MACHINE DESIGN		L	L		L	L						
Mechanical and Electrical—Automatic or Semi-Automatic Machines				H	H		H	H				

Location Code

- C—Camden, N. J.—in greater Philadelphia near many suburban communities.
- H—Harrison, N. J.—just 18 minutes from downtown New York.
- L—Lancaster, Pa.—in beautiful Lancaster County, about an hour's drive west of Philadelphia.
- M—Morristown, N. J.—quiet, attractive suburban community close to Philadelphia.

Please send resume of education and experience, with location preferred, to:

Mr. John R. Weld,
 Employment Manager, Dept. C-4A
 Radio Corporation of America
 30 Rockefeller Plaza
 New York 20, N. Y.



RADIO CORPORATION OF AMERICA

IT'S **CHICAGO** FOR
High Fidelity

**BROADCAST
MILITARY
MINIATURE
COMMERCIAL
HOME**



Where fine audio quality is essential, for private, commercial or military equipment, you can depend on CHICAGO high fidelity transformers for distortionless sound reproduction.

CHICAGO

**ULTRA-LINEAR
HIGH FIDELITY**

**Output Transformer
BO-13**

This "super-range" transformer, specifically designed for ultra-linear Williamson amplifier circuits, is typical of the many high fidelity transformers available from CHICAGO.

Amplifier frequency response, with the BO-13, is flat from 20 to 60,000 cycles at 20 watts output. At a 1 watt listening level, the BO-13 is flat from less than 10 cycles to beyond 200,000 cycles.

Intermodulation distortion, measured at 60 and 7000 cycles, 4:1 ratio, is less than 3% at 21 watts. Total harmonic distortion is below 0.1%, measured at 1000 cycles, up to 21 watts.

The BO-13 is housed in a compact, seamless steel case measuring $3\frac{3}{16}$ " x $3\frac{11}{16}$ " x $4\frac{11}{16}$ " high. CHICAGO's famous "sealed-in-steel" construction provides maximum shielding and full humidity protection.

CHICAGO Bulletin 33 lists performance curves and other useful information on the BO-13. Write for your FREE copy, or get it from your CHICAGO distributor.



**CHICAGO CATALOG
CT-554,**
listing complete electrical and physical specifications on over 500 CHICAGO transformers. Available from your CHICAGO distributor or from Chicago Standard Transformer Corporation.

EXPORT SALES:
Roburn Agencies, Inc.
431 Greenwich Street
New York 13, N. Y.

CHICAGO STANDARD TRANSFORMER CORP.

3501 ADDISON STREET • CHICAGO 18, ILLINOIS

For more information, circle No. 4 on Reader Service Card

**RADIO-ELECTRONIC
Engineering**

INCLUDING
*TV & RADIO & Communication
ENGINEERING & Engineering*

Edited by H. S. RENNE
and the Radio & Television News Staff

VOLUME 24 NUMBER 1
JANUARY, 1955

Editor and Asst. Publisher
OLIVER READ, D. Sc.

Managing Editor
WM. A. STOCKLIN, B. S.

Technical Editor
H. S. RENNE, M. S.

Assistant Editor
M. C. MAGNA

Art Editor
FRANK SAYLES

Draftsmen
**ALBERT A. GANS
JOSEPH A. GOLANEK**

Advertising Director
L. L. OSTEN

Advertising Manager
TED SUITO

Western Adv. Manager
JOHN E. PAYNE

ZIFF-DAVIS PUBLISHING COMPANY

WILLIAM B. ZIFF (1898-1953) FOUNDER
Editorial and Executive Offices
366 Madison Ave., New York 17, N. Y.

President
B. G. DAVIS

Vice-Presidents
**H. J. MORGANROTH
M. H. FROELICH**

Secretary-Treasurer
G. E. CARNEY

Circulation Manager
M. MICHAELSON

BRANCH OFFICES

CHICAGO (1): 64 E. Lake St.
LOS ANGELES (14): 900 Wilshire Blvd.

RADIO-ELECTRONIC ENGINEERING is published each month as a separate publication and is available by subscription only when purchased with a subscription to RADIO & TELEVISION NEWS.

(Average Paid Circulation Over 28,000)

Copyright 1954 by Ziff-Davis Publishing Company
(All Rights Reserved)

POLE MOUNT MICROWAVE STATION

By **PAUL A. GREENMEYER**

Editor, *Communication News**

This inexpensive "packaged" microwave system for the 960-mc. band can provide voice and control circuits.

FOR a considerable time, there has existed a recognized need for an extremely simple, inexpensive microwave radio communication station particularly suitable for short distances and for applications that would not justify a high capacity, more expensive system. Recently, a "packaged" 960-mc. station with provisions for voice channels was devised to fill this need. It can serve either for leg (side) circuits in a large system, or for a small but complete short-haul system. In this station, both radio and multiplex equipment are accommodated in a single, small, weatherproof cabinet. Since it can be installed on a pole or mast, it has neither real estate nor expensive tower requirements; and it will serve either as a permanent or a temporary installation. This "package" can be used for both voice and control circuits; it can be used for more than one hop; it can be integrated into other systems; and, finally, a station complete with transmission line and antennas can be provided at unusually low cost.

Fields of Application

The simplified "pole mount" station is designed to operate in the 940-960 mc. range which includes frequency assignments for the following services: (1) International Control, (2) Stations on Land in the Maritime Service, (3) Aeronautical Services, (4) Public Safety Radio Service, (5) Industrial Radio Service, and (6) Land Transportation Radio Service. Since it can also be set up for operating frequencies as low as 890 mc., the equipment will serve to handle the following bands: (1) 890-940 mc. (broadcast; fixed, ISM), (2) 940-952 mc. (FM broadcast STL), (3) 952-960 mc. (operational-fixed). A conversion kit is available for handling the 890-940 mc. range.

One of the primary functions to be served by the simplified station is that of a v.h.f. control link. In many two-way v.h.f. radio systems, it is desirable to install the transmitter on an eleva-

tion some distance from the control point in order to obtain greater coverage. Ordinarily, wire lines link the transmitter with control. Frequently, however, it will be found that a one-hop microwave installation will prove more satisfactory as well as more economical. This arrangement has been found highly satisfactory for public safety applications such as police, fire, forestry, wildlife; and also for the petroleum, utility and other industrial and land transportation services. Such installations can be set up on a simplex or duplex basis as required.

Petroleum Industry

While the petroleum industry has made more prolific use of microwave than any other industry—investing some 15 million dollars within the past few years, practically all the systems installed have been of the type requiring buildings, roads, real estate and other fairly costly capital investments. Heretofore, no consideration has been given to employing a packaged station, with provisions for voice channels, that could be placed on the wall of a building, on an existing structure, or on a pole. However, a definite need exists for such equipment, which would serve in two major situations.

First, it frequently happens that after a microwave system has been operating for some time it appears desirable to extend the service to some other points off the main line. Since these remote points usually do not require the full facilities of the main microwave circuit, a channel or two is usually sufficient. In such cases, the packaged stations could be utilized to provide the side circuits.

Second, off-shore drilling operations miles away from regular communication facilities usually have need for a communication link with the mainland. Since they are generally not more than 20 miles off shore, a single-hop microwave circuit will provide adequate facilities. In addition, they do not have either the need for a 24-channel system or the room for bulky buildings to house



Dipoles with parabolic reflectors provide the best antennas. Opposite polarization is used for transmitting and receiving.

A typical RCA "pole mount" installation.



*Engineering Products Division, Radio Corporation of America

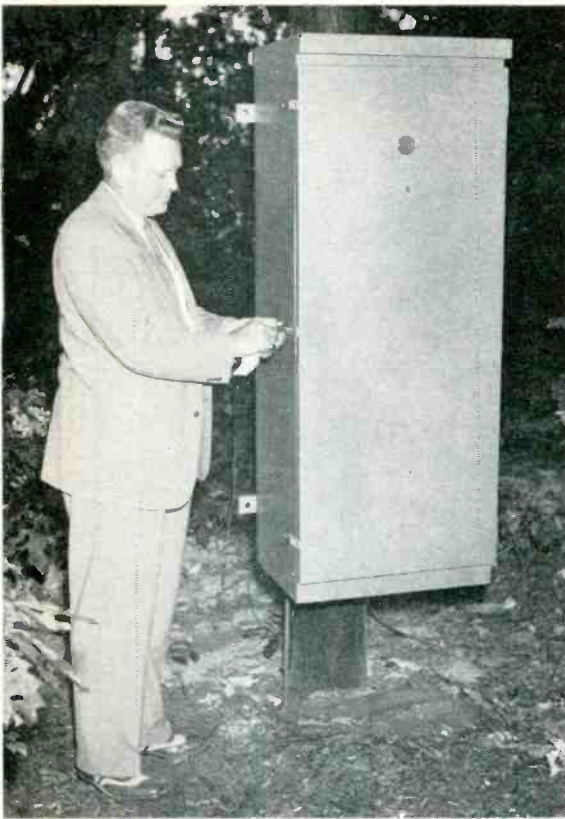

Close-up of 960-mc. pole mount station.

large systems. A simplified two-channel system would usually provide adequate voice communication, and could be expanded for additional voice and control circuits up to five channels, if required. The packaged station could be employed here also.

Electric Utilities

Although microwave promises to fill the demand for the load control, remote metering, and many other problems facing these vital suppliers, progress in acquiring microwave systems has been somewhat slow. Several major utilities have finally achieved almost

spectacular success with microwave solutions to their communications problems, but most of the utilities have been taking a rather conservative attitude. In a recent survey, they have indicated a desire to experiment first with small low-cost circuits before plunging into all-out programs for extensive system-wide microwave installations.

Experiences of several utilities have demonstrated the soundness of the conservative approach. The *Arizona Public Service Company*, for example, started in 1949 with standard 960-mc. equipment for a 12- and a 16-mile hop for telemetering and supervisory control. Experience proved so satisfactory that additions of 960- and 2000-mc. equipment covering a distance of 210 miles, with v.h.f. control and voice, were completed in 1953. Seven stations, covering a distance of 150 miles, were completed in 1954. More additions, covering 175 miles from Yuma to Phoenix, are now in the construction stage.

In this case, the microwave system is a constantly growing one, comprising a smooth series of expansions that keep pace with company progress, spreading out the capital outlay, and avoiding any problems of major dislocations. Any confusion caused by acquainting operations and maintenance personnel with a new means of communications is reduced to a minimum. Changes are more readily and easily accepted when taken in small doses. The communication links are more easily integrated into system operation by building upon experience already gained.

Arizona's two original hops in 1949 represented an investment of some \$15,000 (approximately \$10,000 less than a carrier system would have cost) and each additional installation has likewise occasioned but a modest outlay. Successful results following each installation have demonstrated the wisdom of the chosen method. Hence, it may

be said that the conservative approach is not necessarily a slow or a hesitant approach; rather it is the more astute approach.

General Industrial Uses

In general, the simplified station offers industry the same advantages as standard microwave equipment. Chief of these are lower cost and greater reliability as compared to pole lines. The number of voice channels, however, is limited to a total of six while the length of the hop is limited to approximately 30 miles. Greater distances can be covered by using a repeater, i.e., employing two packaged stations, back-to-back.

The facilities afforded are the same as those of standard microwave systems: voice channels, facsimile, v.h.f. and supervisory control, telemetering and teletype. The equipment can be used either as the beginning of an original microwave system or for addition to an existing system. Two packaged stations would be required to form a complete one-hop circuit, which is the smallest and simplest system with which one could begin.

Station Design

This packaged microwave station does not incorporate a new, untried design but consists of an adaptation of standard RCA 960-mc. u.h.f. radio equipment that has been in service since 1949. The basic equipment is installed in a 15" x 23" x 61" weatherproof housing suitable for wall or pole mounting, with hinged standard 19" rack frame. Satisfactory operation is possible throughout a wide temperature range. For above normal ambient temperature conditions, a thermostatically controlled fan is available which draws air in through a filter at the bottom of the cabinet.

The cabinet has a full-length door which can be padlocked, and is provided with a strip rubber seal. Hinged for

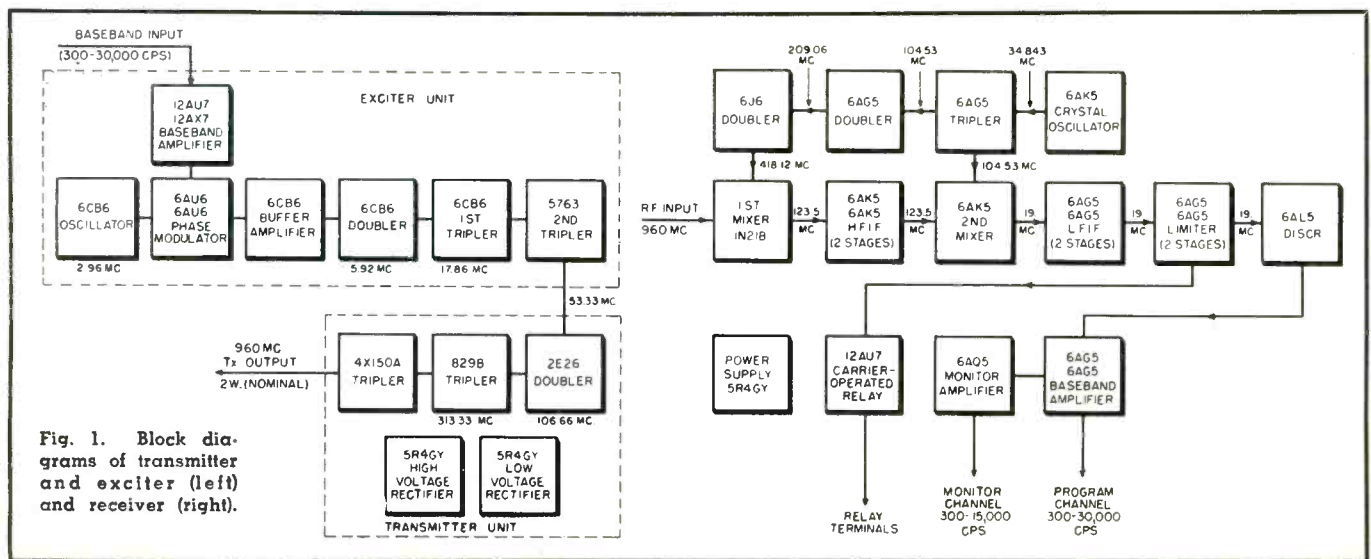

Fig. 1. Block diagrams of transmitter and exciter (left) and receiver (right).

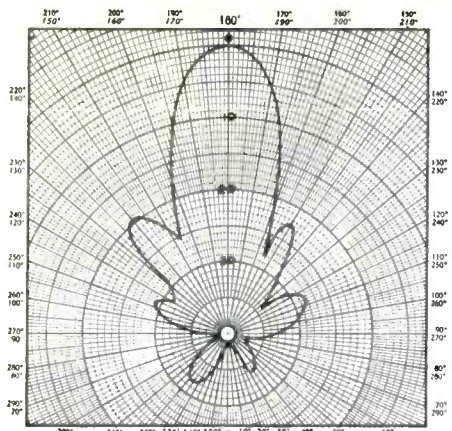

Fig. 2. E-plane pattern for 6' antenna.

pullout, the rack provides access to the rear as well as the front during service and maintenance operations. The radio equipment can be interconnected with RCA 960-, 2000-, or 2500-mc. systems.

Two parabolic reflectors and two 100' coils of transmission line (longer lengths are available) with required fittings constitute the antenna system. When the cabinet and antenna system are installed on a mounting structure (pole, building or tower), it is only necessary to connect the 110-volt a.c. supply and communication lines to place the station in operation.

The antennas ordinarily recommended for use with this equipment are dipoles with parabolic reflectors having diameters of 2, 4, 6 or 10 feet, depending upon the nature and length of the path covered by each link. In Table 1, the power gain relative to an isotropic source and the 3-db beamwidth is tabulated for each of these antenna sizes. The pattern data for a 6' antenna is illustrated in Figs. 2 and 3. Ordinarily, the receiving antenna will be of the same size and type as the transmitting antenna.

In order to provide maximum flexibility and ease of installation, yet retain satisfactory operating characteristics and not offset the minimum base cost, it was decided to employ "Styroflex" 1/2" transmission line. This aluminum sheathed coax eliminates elbows and other fittings, can be cleated to a pole or building, and is fairly flexible. Since it can be rolled and is supplied complete with fittings attached, the installation proceeds rapidly. It is desirable to order the line completely made up in the lengths required even though the standard package includes two 100' lengths.

Since the package station is designed to be a minimum cost proposition, it was deemed unreasonable to double its cost by adding provision for emergency power. The entire philosophy of the approach would be offset by the expense of real estate, shelter, and additional

equipment that would be required for emergency power. A supplemental power supply can, of course, be made available should a special case require it; however, the reliability of this equipment and of propagation in this band as experienced over the years indicates that the original assumption is justified.

By using single-sideband frequency-division multiplexing, the equipment can handle up to six voice channels (300-3000 cycles) over one hop. (For a greater number of hops, fewer channels should be used if the same voice channel quality is to be maintained.) This is the type of channeling equipment in general use, and which is used by the telephone industry with reliable operation and minimum maintenance. Also, it is in line with the policy of employing conventional circuits and tubes.

A specially designed multiplex unit is available to provide two voice channels, with signaling, in the same cabinet housing the radio equipment. This unit provides a total of two channels and will supply signaling for the basic channel and power for the derived channel. Any additional channels that may be required can be accommodated in an identical weatherproof cabinet.

Circuit Details

The transmitter has been designed for use with an exciter and receiver to provide a fixed, point-to-point radio link for transmission of one or more channels of communication simultaneously. The combination of a transmitter and receiver is designated MM-9. Channels may consist of voice and/or tone signals for remote control or telemetering. The equipment is designed to permit operation of several such links in tandem to form a microwave relay system. For such operation, the transmitters and receivers can be operated on an unattended basis.

Exciter and Transmitter

The MM-9 employs phase modulation of a direct crystal-controlled carrier frequency. In addition to permitting the use of direct crystal control, phase modulation has the highly desirable characteristic for multichannel service that for a single link, or a series of

Table 1. Antenna power gain and beamwidth for several parabolic reflectors.

Paraboloid (ft.)	Gain* (db)	Beamwidth (3 db) (deg.)	
		E	H
2	13.2	42.0	30.0
4	18.0	20.0	19.0
6	22.0	15.2	11.3
10	26.5	8.0	6.0

*Relative to an isotropic source

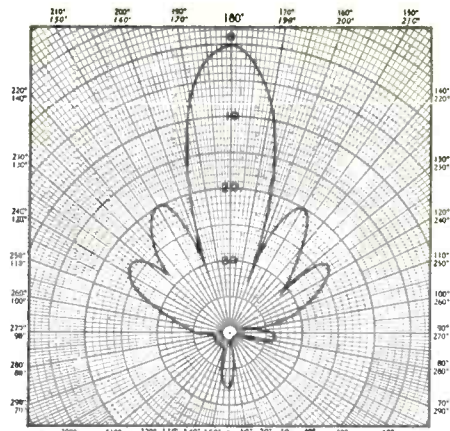

Fig. 3. H-plane pattern for 6' antenna.

links, the signal-to-noise ratio is constant for any increment of the modulating frequency band.

A single meter in combination with switches and multipliers serves to measure all necessary currents and voltages for normal tuning and operation, including the grid current, plate current, plate voltage and relative r.f. power output of the final stage.

Transmitter and exciter are separate (Continued on page 36)

Interior view of packaged station. Blank panels are for multiplexing equipment.

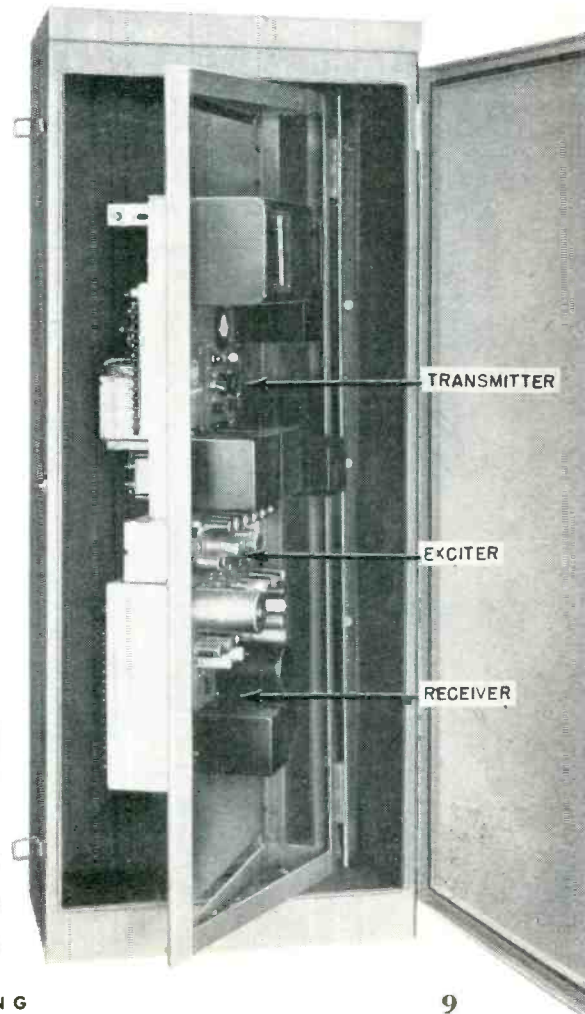

DIGESTS OF NEC PAPERS

Technical data abstracted from several of the papers which were presented at the 1954 National Electronics Conference.

"AUTOMATIC PRODUCTION OF WAFER COIL INDUCTIVE COMPONENTS" by Albert Zack and Theodore Wroblewski, Sylvania Electric Products Inc.

TO FIND a method of producing inductive components automatically, a complete study of product design

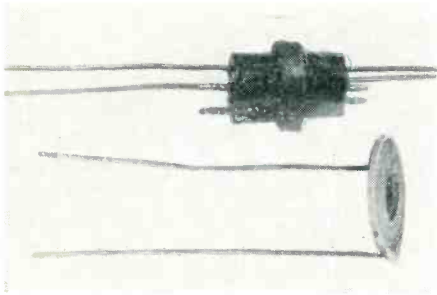

Fig. 1. Conventional peaking coil (top) and equivalent wafer construction (bottom).

and method of manufacture was made and a different concept of design and production evolved. This concept resulted in the development of a wafer coil technique whereby sheets of conductor and insulation material can be wound together into a roll, and the roll sliced into cross-sectional wafers which may then be stacked to form an inductive element. Two machines have

been built to prove the practicability of this technique—a winding machine which can wind a roll sufficiently large so that several hundred coils can be cut from it, and a semiautomatic cutting machine which will cut unattended a complete roll into any required width. Work on the development was done under Contract No. AF33(616)-486 directed by the Wright Air Development Center of the United States Air Force.

Terminals are placed at the start and finish of the winding for the entire roll. Widths of the slices are determined by the current-carrying capacity required of the winding. In the case of very fine spacing between turns, several methods can be used to "unshort" any possible burrs which might occur in the cutting process. The wafer coils are then stacked in a manner dictated by the required design, forming either a single or multiple coil. As many wafers are used as are needed to provide the proper number of turns. The first and last wafers are connected to terminal cards which have strong lead wires attached to provide an outside connection to the completed coil. Assembled primary and secondary coils are then placed on a core, and the unit is ready for final processing.

Inasmuch as very thin foils are available and it is possible to sectionalize these wafers down to the order of .010" in width, coils with very fine conductors can be made which would be quite difficult to match using conventional fine wire. Spacing between turns is possible down to .0002".

In most iron core inductors, the wafer coil construction can be made interchangeable both electrically and physically with conventional wound transformers. Figure 3 shows the same type of pulse transformer constructed with both techniques; the wafer coil unit is smaller although both units are electrically equivalent. In the case of peaking coils, there is a radical difference physically. Figure 1 shows electrically equivalent peaking coils of a different physical construction.

Adequate experience has been gained in the building of various samples to be able to determine all the steps needed for automatic assembly of the wafers. These steps can be identified as follows: (1) winding of laminated foil or rolled sheet stock, (2) cutting or slicing of wound laminated rolls, (3) assembly of wafers to tape, (4) assembly of wafers into coils, and (5) assembly of core and coil. To give a perspective of such an automatic setup, the essentials were combined and a sketch made (Fig. 2) to illustrate the whole process.

The basic stock roll of aluminum or copper foil (A) is fed through a stage (B) where a coating is applied. The coating is done on one side only, terminal tabs attached, and the foil moved to a special arbor so that the terminal tab can be shaped and fastened securely. Winding is started automatically and stops at the proper point. The wound roll is then ejected into a magazine which may be moved through a curing or drying stage (C), if necessary, before reaching the cutting stage

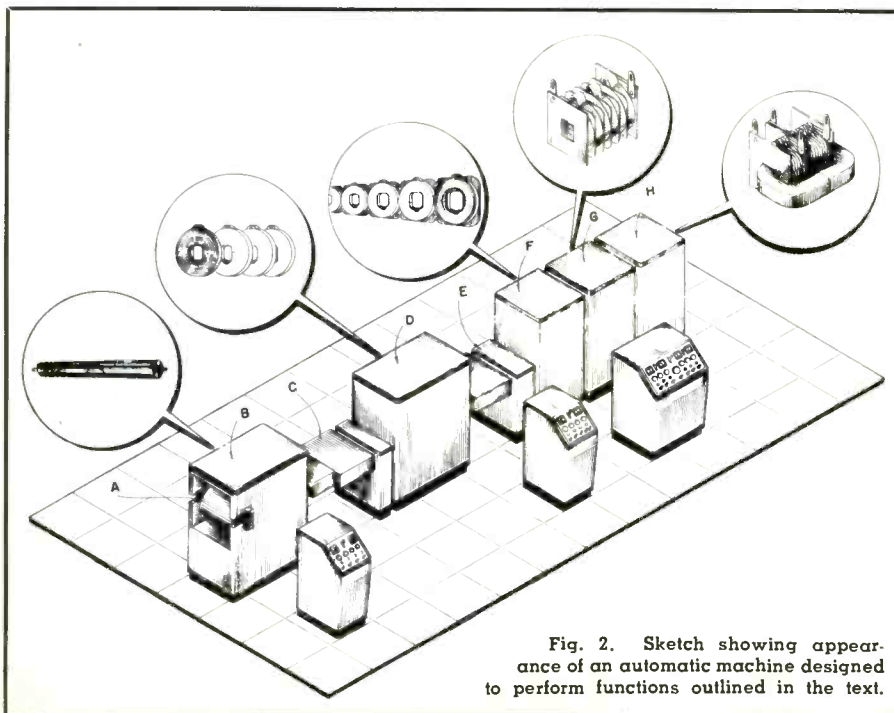

Fig. 2. Sketch showing appearance of an automatic machine designed to perform functions outlined in the text.

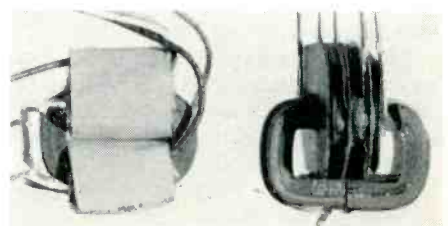

Fig. 3. Common pulse transformer (left) and equivalent wafer construction (right).

at (D). After slicing, the resultant wafers are dropped into receiving ducts which move each wafer along to (E), where any necessary cleaning for shorted coils is carried out. In addition, prior to mounting, an insulation is sprayed on both sides of each wafer and dried. The coated wafers are then moved to point (F) where each wafer is positioned automatically and a plunger moves it into a center position. At this point, electrodes punch and weld the inside terminal to the tape terminal. At stage (G), an indexing device such as an IBM card unit determines the total number of wafers to be accepted for final assembly. After dip-soldering, the wafers are placed directly on cores (H).

"MICROWAVE COMPONENTS FOR DOUBLE RIDGE WAVE GUIDE" by K. Tomiyasu and L. Swern, *Sperry Gyroscope Company*.

RIDGE wave guide has three principal advantages over rectangular wave guide in microwave applications. First, for a given outside dimension, the cutoff frequency of the dominant mode may be considerably reduced due to the capacitive loading effect

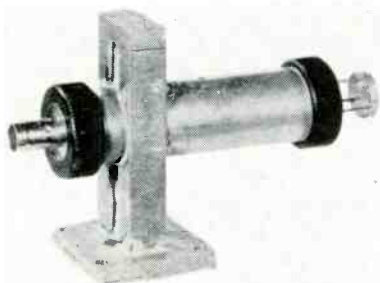

Fig. 1. Ridge wave guide crystal detector.

of the ridge. Second, because the wave guide is smaller for a given frequency band, there is a large saving of weight and space. Third, because of the nature of the ridge cross section, the bandwidth over which dominant mode operation can exist is considerably greater than for rectangular wave guide. However, ridge wave guide has a lower power-handling capacity, greater attenuation and more critical tolerance requirements.

In Fig. 3, there is a cross section of the ridge wave guide used in developing microwave components at *Sperry*. The external dimensions correspond to those of standard X-band rectangular wave guide. The dominant mode cutoff frequency was calculated to be 4355 mc. and the cutoff frequency of the next higher mode was determined to be 13,800 mc., so that the dominant mode

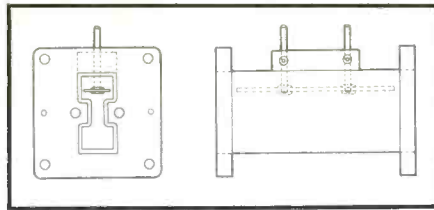

Fig. 2. Ridge wave guide attenuator.

bandwidth extends from 4355 to 13,800 mc. Extrapolated attenuation data leads to the expectation of an attenuation range of 8 to 14 db per 100' over the dominant mode bandwidth.

One component which has been developed is a transition from double ridge guide to $1\frac{1}{2} \times \frac{3}{4}$ " rectangular wave guide. This transition, shown in Fig. 5, was machined from two brass blocks which were soldered together. The ridge, which tapers to zero height at the rectangular wave guide end, is of constant width throughout the entire length of the transition. It is essential to match the radius of the ridge shoulder to that in the drawn wave guide. The transition is approximately $9\frac{5}{8}$ " long and has a maximum VSWR of 1.05 over a 10% bandwidth in the C-band region.

Shown in Fig. 4A is a transition to Type "N" coaxial line. The center conductor of the coaxial line extends through the wave guide and becomes the center conductor of the short-circuited coaxial stub. Two tuning parameters are available—the positions of the wave guide and coaxial shorts. However, it is necessary to add another parameter, a capacitive matching screw, to obtain better performance. Average VSWR is about 1.15 over the 10% bandwidth.

Figures 2 and 4B illustrate a ridge

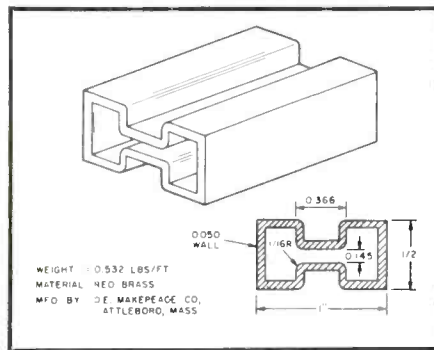

Fig. 3. Double ridge wave guide design.

guide attenuator. Variable and fixed attenuators ranging from 6 to 70 db of attenuation were developed. These attenuators are of the parallel-vane type with the vane parallel to the narrow wall of the wave guide, and the vane position always restricted to the side of the ridge. The lossy vane is a thin piece of metallized glass. Measured at-

tenuation was found to vary only slightly over the 10% band, and the average VSWR is 1.15—with a maximum of 1.2.

A crystal detector, shown in Fig. 1, contains a 1N23B crystal and has a BNC connector for the video output. There is a fixed wave guide short and an adjustable coaxial stub. Spring loading is provided to assure good crystal contact, and a capacitive iris is included for broadband matching. Made



Fig. 4. (A) Ridge wave guide to Type "N" coaxial line transition. (B) Ridge wave guide attenuator, also shown in Fig. 2.

from 0.032"-thick brass stock, the iris is soldered onto the ridge guide flange. The detector was tested with 20 crystals. With 16 of these crystals, the VSWR obtained for a crystal rectified current of 0.6 ma. was equal to or less than 1.5 over the band.

Design of a slotted line for ridge wave guide posed some problems because of the concentrated field in the ridge gap region. The narrowest practical slot width was found to be 0.040", and an additional brass block was soldered to the top of the guide for rigidity.

Still another development is a hybrid junction—a side-wall type of directional coupler. The coupling region consists of an open wall containing five equally spaced inductive posts. The length of the open wall region and the diameter of the inductive posts were determined by the theory given in the article on the Transvar directional coupler in the July, 1953, issue of the Proceedings of the IRE. Average VSWR is 1.4 and the average directivity or isolation between input arms is about 18 db. This hybrid junction may be combined with two crystal detectors to form a balanced mixer.

The *Sperry* development program was supported by the Applied Physics Laboratory of Johns Hopkins University.

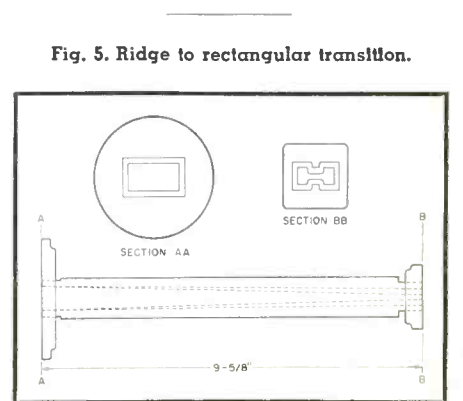

Fig. 5. Ridge to rectangular transition.

"STRIP LINE EXCITATION METHODS"
by Franklin S. Coale, *Sperry Gyro-
scope Company.*

STRIP transmission lines are becoming increasingly important in microwave systems, especially in the low power portions of such systems. Since these microwave circuits usually contain wave guides and coaxial lines, the design of good transitions from wave guides and coaxial lines to strip lines has received a lot of attention. Several such transitions for three types of strip line will be discussed here: Type A—single ground plane with a dielectric-supported strip conductor; Type B—double ground plane, or sandwich, with the strip conductor supported by dielectric spacers; and Type

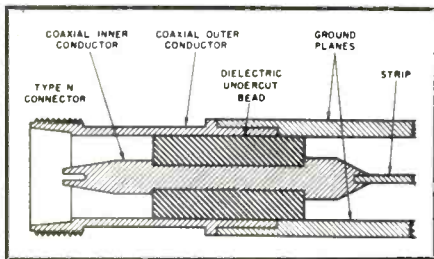

Fig. 1. Butt transition from coax to double-ground-plane strip line.

C—single ground plane with the strip conductor supported from above by a dielectric channel.

A simple butt or end-on transition for Type B line is shown in Fig. 1. Discontinuity between the center conductor of the coaxial line and the strip conductor is matched by an undercut dielectric bead. A fine adjustment of the matching can be made by varying the distance between the discontinuity and the bead. Transitions of this type have been found to have a VSWR of less than 1.15 and an insertion loss of less than 0.4 db over a 17% band in the 6000-mc. region. At higher frequencies, the dielectric losses raise the insertion loss appreciably.

Shown in Fig. 2 is an end-on transition from coaxial line to Type A strip line. Here, the center conductor of the coaxial line is tapered gradually for about three wavelengths until it has the

Fig. 2. Tapered transition from coax to single-ground-plane strip line.

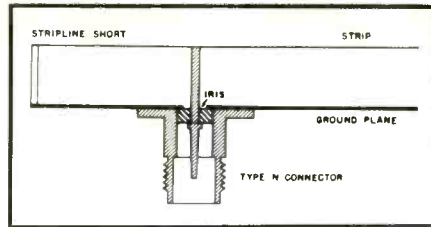
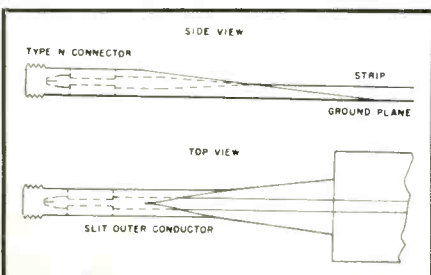

Fig. 3. Perpendicular transition from coax to single-ground-plane strip line.

same rectangular cross section as the strip conductor. Also, the outer conductor is slit and gradually deformed to the dimensions of the ground plane of the strip line. This type of transition is fairly broadband in the higher frequency ranges, but as the length of the taper approaches one wavelength, the mismatch and radiation losses increase.

It is also possible to devise perpendicular transitions for coaxial line to strip line. This kind of transition is only suited to the single-ground-plane strip lines, Types A and C, because of its geometry, as can be seen in Fig. 3. The junction between the inner conductor and the strip conductor is matched by an iris in the ground plane. A VSWR of less than 1.15 over three

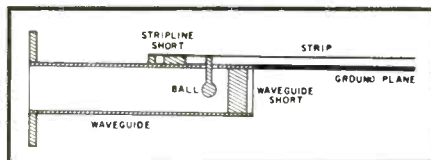

Fig. 4. Ball-probe transition from waveguide to single-ground-plane strip line.

octaves has been achieved for this transition.

The ball-probe transition from waveguide to coaxial line is the most broadband, so it is natural to consider its use for waveguide to strip line transitions. The ball probe is inherently a low power device, but as strip line is also limited to low power applications, no important characteristics are sacrificed. In such a transition, shown in Fig. 4, the following parameters are important: (1) position of the short in the waveguide, (2) diameter and height of the ball, (3) diameter of the rod, (4) size of the iris in the conductor which forms both the ground plane of the strip line and one wall of the waveguide, (5) position of the short in the strip line. This particular unit was designed for use in the X band with Type C strip line.

Figure 5 illustrates another transition from waveguide to strip line in which an intermediate section of ridged waveguide is used. The widths of the ridge and the strip conductor were made equal and the ridge-to-waveguide wall spacing was made equal to

the spacing of the strip above the ground plane. It was found that by placing a plate across the end of the waveguide (leaving enough space at the bottom for the strip) the VSWR was improved and radiation losses were reduced.

In summary, the butt transition from coaxial line to strip line is good over a medium bandwidth, has low losses,

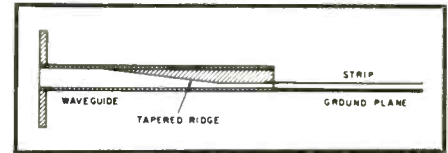

Fig. 5. Ridge transition from waveguide to single-ground-plane strip line.

and can be used in any frequency range below the X band. The tapered transition from coaxial line to strip line has better bandwidth, but losses limit its high frequency use and size limits its low frequency applications. Both of these transitions can be used for all three types of strip line. The perpendicular transition from coaxial line to strip line is the most broadband of all, but it cannot be used for the Type B— or sandwich—line. Transitions from waveguide to strip line are naturally limited to the bandwidth of the waveguide; they are appreciably more difficult to design and more expensive to manufacture. The ridge transition has a lower insertion loss than the ball-probe transition, but the bandwidth of the ball-probe device is greater.

"FACTORS AFFECTING TUBE LIFE IN PRESENT-DAY MILITARY APPLICATIONS" by Joseph R. Garafola, *Aeronautical Radio, Inc.*

ELECTRON tubes removed from military equipment and collected by the Military Contract Department of *Aeronautical Radio, Inc., (ARINC)*, for analysis are grouped into three broad categories: (1) tubes with catastrophic-type defects, (2) tubes with gradual-deterioration type defects, and (3) tubes in which no defect can be found. Special tests conducted by *ARINC* in the field have shown that many of the tubes in the gradual-deterioration and no-defect categories have been removed long before their useful life was at an end.

Catastrophic defects are the kind that will ordinarily produce the sudden-death type of tube failure. They include broken glass, mechanical defects, filament defects, and permanent and intermittent shorts and opens. Limited data indicate, however, that in the returns from some military bases as many as 30% of the tubes assigned to the catastrophic group because of shorts

actually have no defect other than interelectrode leakage, which may be considered a gradual-deterioration defect. Gradual-deterioration type defects are predominantly concerned with the decay of transconductance, the loss of emission due to the development of cathode interface, and the development of leakage paths between elements. These defects reveal themselves by the gradual degradation of equipment performance to an unsatisfactory level. Tubes in the "no-defect" group are in many cases closely related to those in the gradual-deterioration category, the difference being that the characteristics of the no-defect tubes have not degraded past the lower acceptance test limit. Many of them have been removed as a precautionary measure.

The problem of catastrophic failures was recognized early in the military tube development programs, and steps were taken to correct the condition through improved tube design. It was not until considerably later that the importance of the gradual-deterioration type of defects was recognized, but much work is now being done at the design and manufacturing levels to alleviate this problem as well. Much can also be done to increase the utilization of useful tube life in existing military equipment. To accomplish this increase of tube utilization is a maintenance problem involving the development of a maintenance system which will allow each tube to remain in its socket until its characteristics degrade to the point where performance is marginal, and yet will assure its removal before actual equipment failure.

Using equipment performance as the basis of acceptance or rejection of tubes, such a system must have a safety-factor feature which will allow it to make a reasonably accurate prediction as to whether or not the equipment will continue to give satisfactory operation for a specified period of time. Systems which will accomplish these objectives have been devised and are widely used in industry, notably in the field of electronic computers. They are based on marginal testing of the equipment involved. By "marginal testing" is meant the method of testing for satisfactory operation of a piece of equipment or circuit in which the various parameters of the circuit are varied about a normal operating point by some means such as raising or lowering the supply voltage.

A typical example of the marginal testing technique is the procedure in which the equipment operation is checked at reduced filament voltage. As the filament voltage is decreased, the cathode emission for each tube is decreased with a resultant decrease of

transconductance. As the deterioration proceeds, a point will eventually be reached where satisfactory operation at the reduced voltage is not achieved. This is an indication that if the equipment is put back into service in its existing condition a failure is likely to occur before the next scheduled testing period of the maintenance program.

Marginal test systems are designed primarily to minimize the effect of the gradual-deterioration type of defects on tube removal rates; they cannot be expected to contribute directly to the reduction of catastrophic failures. However, by reducing tube testing and handling to a minimum, a well-designed marginal-testing maintenance system should make a substantial indirect contribution to the reduction of catastrophic failures. It has been estimated that, with improved tubes as they can be built today, it should be possible to obtain a tube removal rate of one-tenth of 1% per thousand hours for the first thousand hours. The development and application of marginal testing systems are justified by the quality of improved tubes now being built, and point the way to the attainment of this ideal.

"WIDE-RANGE SWR INDICATOR" by George O. Thogersen, *Airborne Instruments Laboratory, Inc.*

IN MANY high-frequency circuits, rapid measurement may be far more important than precise measurement. This is especially true during early stages of development on such devices as antennas, filters, matching sections, and attenuators; the immediate qualitative effect of adjustments on standing-wave ratio over a range of frequencies must be known. An automatic standing-wave-ratio indicator developed for laboratory and production use from 400 to 1350 mc. facilitates the adjustment of equipment under such circumstances.

Motor-driven swept oscillators deliver a test signal to the equipment whose SWR is to be measured. A compact reflectometer, which may be located as far as 100 feet from the rest of the SWR indicator, compares the reflection from the load under test to the reflection from a reference load having unity SWR. A ratio-measuring unit converts the signal from the reflectometer into a signal directly proportional to the SWR of the unknown load. This signal is then applied to an oscilloscope for continuous display over a frequency range of either 400-900 mc. or 900-1350 mc. SWR can be read directly from an overlay scale or production limits can be marked on the face of the oscilloscope.

Figure 1 shows a schematic diagram of the reflectometer, whose configura-

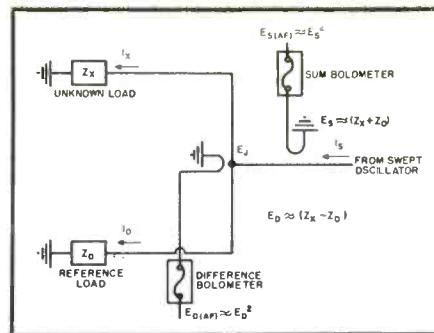
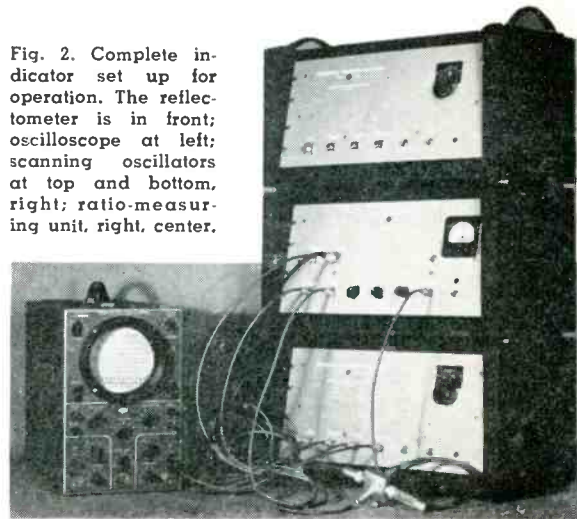

Fig. 1. Schematic diagram showing basic operating principles of reflectometer.

tion is that of a coaxial "tee," with a characteristic impedance of 50 ohms. R.F. power from each swept oscillator is fed into the stem and the input current divides at the cross, some flowing to the 50-ohm reference load and some to the unknown load. The input is, therefore, the sum of these two parts. A coupling loop on the stem of the "tee" samples the sum of the two cross-arm currents, while a loop coupled to the intersection of the stem and the cross samples the difference of the two cross-arm currents. When both sides of the cross are terminated in matching loads, the current in the stem splits equally in each side of the cross. When one load is not matched to its arm, the current in the stem divides in a ratio dependent on the relative mismatch of that load. A sample of the relative difference between the two parts into which the current divides is a measure of the degree of mismatch of the unknown load.

A reference load SWR of about 1.04 or less over the full frequency range of the instrument is satisfactory. Responses of the two pickup loops in the reflectometer are not uniform throughout the frequency range but must be identical. The loops are physically very small and are shielded to prevent capacitive coupling. Despite the small size of the loops, they are resonant in the

Fig. 2. Complete indicator set up for operation. The reflectometer is in front; oscilloscope at left; scanning oscillators at top and bottom, right; ratio-measuring unit, right, center.



operating frequency range of the instrument. The resonance curves of both loops are matched by tuning screws placed at their outputs. Each loop terminates in one of two bolometers contained within the reflectometer housing. Bolometers are used for detectors because they provide uniform and stable characteristics and are not easily disturbed by jarring or overload current below their burn-out level. Because of their square-law characteristics, each bolometer output voltage varies as the square of the loop voltage. This effect, though not essential, is useful because it results in less crowding of the high end of the SWR calibration.

The output of the difference bolometer is displayed as a function of frequency on the oscilloscope with the screen calibrated directly in SWR. Simple voltage divider circuits permit any reasonable full deflection SWR value desired. Necessary constancy of power applied to the reflectometer is achieved by controlling the modulation level of the oscillators.

"COATING THICKNESS MEASUREMENTS USING PULSED EDDY CURRENTS" by Donald L. Waidelich, *University of Missouri*. (Work was done while author was at *Argonne National Laboratory*).

ONE METHOD of measuring the thickness of a metal coated or clad upon a base metal is to use an intense localized electromagnetic field (pro-

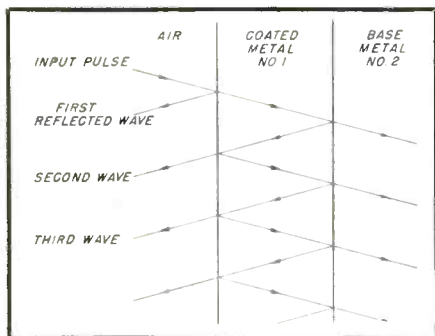

Fig. 1. Reflections from coated metal.

duced by a pulsed eddy current) which is applied to the surface of the clad metal—and to record echoes from the metallic layers. These echoes appear when the electrical properties of clad metal experience a sudden discontinuity such as that caused by a metal-to-metal interface. A small single-layer probe coil with its axis perpendicular to the surface of the metal is used to set up the electromagnetic field and to receive the echoes. This allows the investigation of a small area and facilitates point-by-point depth measurements.

Reflection from the clad metal is composed of a series of waves, as

shown in Fig. 1. The second reflected wave contains information about the depth of the clad metal, and is the one used for thickness measurements. The more electrical difference there is between the clad and the base metals, the larger is the metal-to-metal reflection

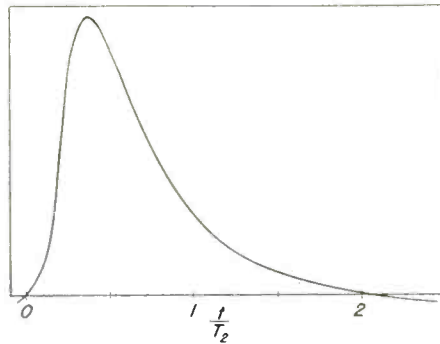

Fig. 2. Output pulse for a step input magnetic field. T_2 is basic constant.

factor. Reflection time, T_2 , is the basic constant for determining the depth of the clad metal. Shown in Fig. 2 is the output pulse for a step input magnetic field which has a large positive peak followed by a very small negative peak. Its most useful characteristic was found to be the crossing point between the positive and negative pulses. This crossing point depends directly on T_2 which in turn depends upon depth. It can be seen from Fig. 2 that if the input pulse is rectangular it should have a length of about $T = 2T_2$ for best sensitivity.

Figure 3 is a simplified schematic diagram of a thyatron pulser and bridge circuit. A standard probe is used in one arm of the bridge, and a test probe in the other, the two probes being as nearly identical as possible. The rate generator of an oscilloscope is used to trigger the thyatron which sends identical pulses through the standard and the test probes. Responses of these probes are balanced against each other, and the difference voltage

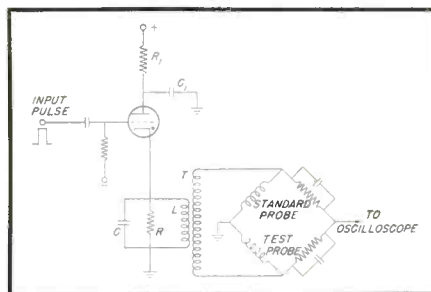

Fig. 3. Simplified schematic diagram of thyatron pulser and bridge circuit.

is amplified and reproduced by the oscilloscope. Proper interpretation of the oscilloscope trace will yield the depth of the coating thickness.

Duration and shape of the pulses are primarily determined by the shunt circuit composed of the capacitor C , the resistor R , and the primary inductance L along with capacitor C_1 . The shape of the pulses is further modified by the action of the transformer and the bridge circuit containing the probes. Auxiliary variable resistors and capacitors are inserted in the bridge circuit to make the balance as nearly perfect as possible. The secondary winding of the transformer is isolated and shielded sufficiently from the primary winding so that both ends of the secondary are nearly symmetrical with respect to ground potential.

A simplified cross section through the axis of one type of cylindrical probe is shown in Fig. 4. The cross-hatched material is one of the ferromagnetic ceramic materials, and the single layer coil is wound on the axial rod. This rod has two separate parts mounted within an insulating tube with an air gap between the two parts. The left-hand part of the axial rod is movable so that a better balance is obtainable between the standard and the test probes, which are about $\frac{1}{2}$ " in diameter. If sufficient sensitivity were available, the outer shell of the probe could be dispensed with and only the inner axial rod used, thus materially reducing the effective area of the probe.

The standard sample of metal is placed on the standard probe and the sample to be measured is put on the test probe. Various balancing adjustments, such as those of the bridge and that on the test probe, are then made so that the pulse output is as nearly zero as is possible. Then a slight unbalance is added by changing the test probe adjustment a small amount. The crossing point of the resulting pulse is singled out and the time axis about this point is expanded a great deal. As the thickness of the cladding of the sample changes, the position of the crossing point on the zero axis also changes, and thus the position of the crossing point may be calibrated in terms of thickness of cladding.

One of the early difficulties with this method was that the crossing point would change position with test probe spacing, i.e., the distance between the probe and the metal plate. It was found experimentally that the slope of the

(Continued on page 36)

Fig. 4. Cross section of typical probe.

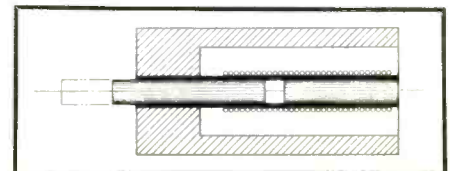

THE "UNI-LEVEL" AMPLIFIER

By

ARCHIE A. MCGEE

Audio Design Engineer
General Electric Company

THERE has long been a need for some type of automatic gain control device which could literally give the audio engineer a third hand. In many small AM-FM operations, the duties of the engineer include performing the functions of a disc jockey, spot announcer, switchboard operator, and transmitter engineer, in addition to maintaining proper program level. Since the advent of a new FCC ruling, it is not even required that a licensed engineer be on duty at the transmitter at all times.

The amplifier to be described here is useful in all audio and video operations where the countless duties to be performed make it extremely desirable for the audio portion of the program to be as nearly automatic as possible. This is particularly true in one-man audio-video operations. Present interest in such a device has been made evident by the great variety of audio level control circuits which have been described in various trade publications. In most cases, these articles have described amplifiers which have been altered to provide automatic gain control features.

The whole concept of automatic level control amplifiers is not new. Amplifiers of this type have been available, in the past, in one form or another. However, these units were bulky in size, critical in operation and required rack mounting. In general, they were not ideally suited to use with the average studio audio system.

Function of Amplifier

In developing the *General Electric* Type BA-9-A "uni-level" amplifier (Fig. 1), it was the deliberate function of the design to achieve automatic control of the audio level variations. One of the basic requirements of this unit was that it be compact and readily adaptable to replacing the program amplifier in practically every type of studio audio system. It is a companion piece to the present line of "plug-in" amplifiers and studio console recently described.

Every operating engineer is familiar with the average level changes encountered when switching between turntables, studios or projectors with sound-on-film. The prime function of this amplifier is to control these level

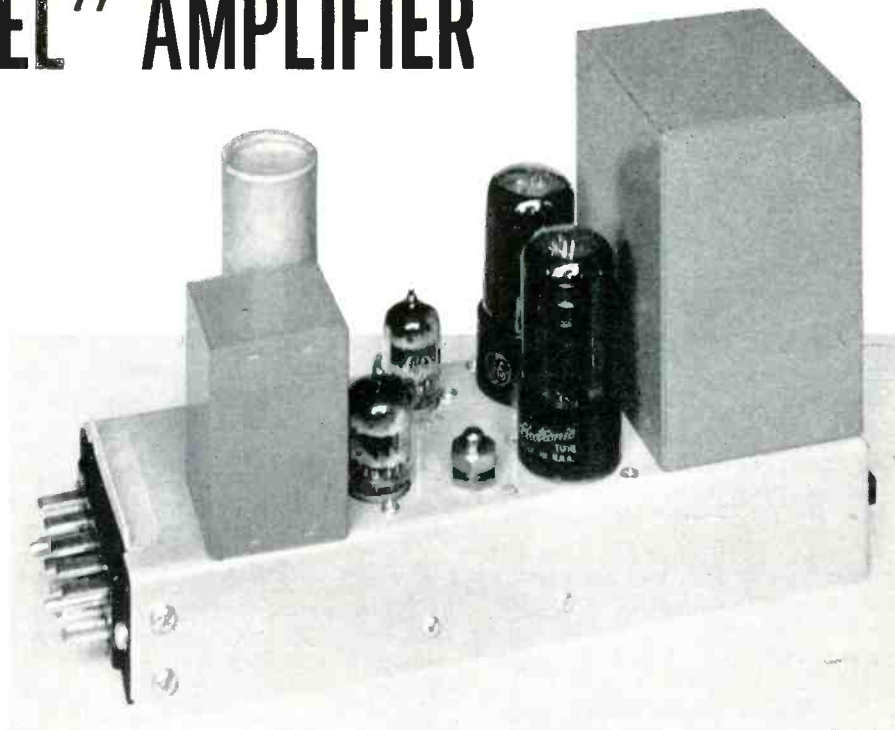

Fig. 1. Over-all view of Type BA-9-A "uni-level" plug-in amplifier.

Design details of a compact, plug-in amplifier for the automatic control of audio level variations.

changes and to do so with no degradation of program quality apparent to the ear.

The working range of control of the Type BA-9-A is extremely wide. Changes of 30 db in input signal level above the threshold point—the point where signals are no longer linearly amplified but have gain reduction applied—can be controlled. A special threshold control (shown in Fig. 1) can select a continuously variable compression ratio from 1.6:1 to 5:1 (as shown in Fig. 2). The optimum point of operation is with a 3:1 compression ratio and it is this type of operation that will be discussed here.

Operating Features

In the "uni-level" amplifier, as in

conventional limiting amplifiers, signals below the threshold point are linearly amplified, while those above the threshold are amplified less and less as the amplitude increases. For better understanding of the operation of the circuit, a block diagram is given in Fig. 6 and a complete schematic in Fig. 7. Electrically, the unit consists of a recently developed Type GL-6386 tube which is used as a push-pull triode in a variable gain input stage to supply a signal to an output stage utilizing two 6V6GT power tubes. The signal for the bias generator rectifier is supplied from the plates of the output stage. The bias generator uses a full-wave 6AL5 rectifier whose output supplies a bias voltage back to the control grids of the GL-6386 tube. A switch is provided on the front of the chassis (Fig. 3) so that average control of program material or peak compression of program material may be obtained.

Frequency response is flat within ± 1 db from 50 cps to 15,000 cps under any condition and up to gain reduction of 30 db. Insertion gain is 54 db, with an equivalent input noise of -109 dbm or less. When the threshold control is set for an output level of $+20$ dbm (1 mw. in 600 ohms), the total harmonic distortion under any degree of gain reduction up to 30 db is $1\frac{1}{2}\%$ or less from 100 to 15,000 cps, and 2% or

Fig. 2. Effect of various settings of threshold control.

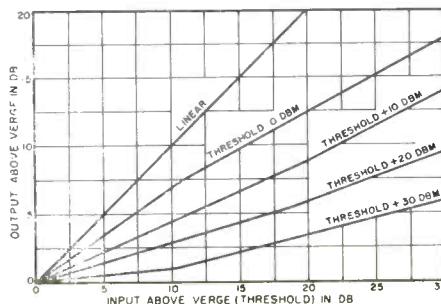

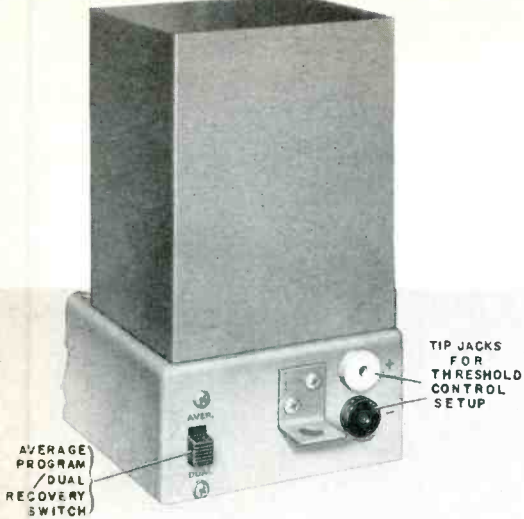

Fig. 3. Front view of the amplifier showing "average-dual" switch and tip jacks for the threshold control setup.

less from 50 to 100 cps. The amplifier is designed to be operated from 30/150/-250/600-ohm source impedance and to feed loads of 150 or 600 ohms balanced or unbalanced.

The complete unit is 3 1/2" wide, 10 3/4" long, and 5 3/4" high. All electrical connections are made through a 2400 Series Jones plug designed for low leakage between pins and from pins to shell, and with low contact resistance. Mounted on the front of the chassis are a pair of tip jacks which are used to connect a d.c. voltmeter to adjust the threshold control voltage applied in the bias generator circuit.

The slide switch on the front of the chassis is marked "aver/dual" and allows selection of two different types of operation. In the "aver" position, the attack time of the amplifier is slowed down to 62 milliseconds. Thus, for program material whose level is higher than the threshold point for less than 62 milliseconds, the audio level will not be substantially reduced. When the program level exceeds the threshold of gain reduction for longer than 62 milliseconds, the gain is no longer a linear function. The compression ratio that has been selected with the variable threshold control will determine how little the output will rise with signals exceeding the threshold setting. Such operation allows the amplifier to function over a change in the average signal level, thereby retaining the dynamic range of the program material.

Recovery time is also a function of the switch position. When the switch is in the "aver" position, recovery time will be 5.25 seconds for 63% recovery to normal level after the signal falls below the gain reduction point. When the switch is in the "dual" position, the attack time is shortened to 11 milliseconds, and so any signal whose level exceeds the threshold point for more than 11 milliseconds will be reduced. As compared with a conventional peak

limiting amplifier, the Type BA-9-A is, in reality, a relatively slow-acting device and therefore is not recommended as a transmitter limiting amplifier. In the "dual" position, the recovery time is an automatic function of program material. For relatively short periods of gain reduction, the recovery time is .9 seconds for 63% recovery. For sustained periods of gain reduction, i.e., 10 seconds or longer, the recovery time is 14 seconds for 63% recovery.

Ability to select the type of operation to fit individual applications is a highly desirable feature. If the recovery times do not suit some particular application, they can be altered by changing the values of two resistors. Smaller values of resistance will make faster recovery times possible, of course, and larger values will increase recovery time.

GL-6386 Characteristics

The exceptional performance characteristics of the "uni-level" amplifier are without question due to the new and unusual tube—GL-6386—which is a variable- μ dual triode. Elimination of a balancing control in the variable gain stage was one of the first advantages gained. This elimination was possible because the maximum unbalance which can occur between sections of the GL-6386 is 2.5 ma. In all other high-quality limiting amplifier designs using tubes such as the 6BA6 in the variable gain stage, balancing controls are a necessity due to the wide variations in tube currents between tubes. With 6BA6 tubes, the variation can be as much as 9 ma. Since the "uni-level" amplifier features relatively slow attack times, the thump component is negligible. More accurate balance of the tube currents in the gain-controlled stage is not required.

Another important feature of the GL-6386 is the extremely wide range of control, with a minimum of distur-

tion, which is attainable with this tube. Measurements indicate that as much as -100 volts can be applied to the control grid with distortion remaining at 5% or less. Such measurements include increasing the signal to the variable gain stage by 40 db and inserting an artificial bias at the center tap of the input transformer secondary sufficient to maintain the output level at the original value.

The GL-6386 is the first variable- μ dual triode to be marketed and as such is more economical in circuit components and consumption of d.c. power than previously available variable- μ tubes. When a variable- μ pentode is used, it is often necessary to specify fixed screen voltage operation to improve automatic gain control characteristics and extend the cutoff region. Such operation might require a stiff bleeder, resulting in an uneconomical waste of d.c. power. Another choice might be to use a VR tube which requires more space and results in increased cost.

In addition to the above features, considerable space savings is realized by being able to include in one tube all the tube elements required for push-pull operation.

Metering Circuit

It is felt that an automatic level control amplifier will eventually be as indispensable as a vu meter in every studio. With that thought in mind, a metering circuit was developed which could use any standard vu meter as an indicator of gain reduction. A scale in the form of a decal may be applied to the present vu meter scale without reducing its usefulness. The gain reduction scale is calibrated to read in db the amount which the input signal level rises above the threshold point. As calibrated, the scale is accurate only for a compression ratio of 3:1. When it is desired to use the "uni-level" amplifier with some other compression ratio, a correction chart supplied with the unit should be employed. A vu meter circuit can be used to show either gain reduction or vu by the simple addition of a lever key or switch with two form C contacts (as shown in Fig. 4).

The gain reduction meter does not indicate actual gain reduction but the amount by which the input signal is above the threshold point. Thus, with the recommended compression ratio of 3:1, output will rise 1 db for each 3-db rise in input signal level above threshold point. It is believed that a gain reduction (g.r.) meter can be used more effectively than a vu meter to ride gain when this amplifier is employed.

Most audio program levels are set to peak at a certain point on the vu meter scale. If the same level is supplied to the Type BA-9-A and is just

Fig. 4. Metering circuit for measuring amount of gain reduction being employed.

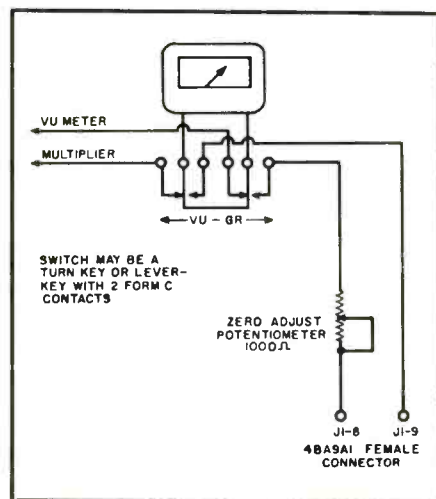

sufficient to cause gain reduction to be indicated on the g.r. meter, it will be obvious that—when using the recommended compression ratio of 3:1—for each 3 db of gain reduction shown on the g.r. meter the output will have risen 1 db.

Applications

The “uni-level” amplifier can be used as a combination compressor-expander amplifier in conjunction with any transmitter limiting amplifier. It can be set for control of average level changes by putting the “aver/dual” switch in the “aver” position. The signal input should be sufficient to cause about 15 db of gain reduction to be shown on the g.r. meter when it is operating at what would be considered normal signal level. It is now possible to have an increase of 15 db in the input signal level with a resultant increase in output signal level of only 5 db when a compression ratio of 3:1 is used. When the input signal level decreases from the normal signal level as much as 15 db, the output signal level will decrease by only 5 db. A typical compressor-expander arrangement is shown in Fig. 5C.

Use of the “uni-level” amplifier in any application will result in an increase in the average signal level supplied to a transmitter. This increase is evidenced by the fact that the signal supplied to the amplifier can be much greater with no instantaneous overloading of any circuit components between the input and the transmitter limiting amplifier. This means higher effective radiated signal, greater coverage with no change in the transmitter, and no added cost except the price of a Type BA-9-A.

It is also possible to have this unit perform as an automatic fader control. Assume that there are two sources of signal, one being a turntable and the other a microphone channel (Fig. 5C). The amplifier can be operated with the switch in either position for average or peak control of program material. Actual switch position would be determined by individual application and would only make a difference in how fast the turntable in the following example would return to its original level.

The turntable should be set up so that it causes only 2 to 3 db of gain reduction to be read on the g.r. meter. The level of the microphone channel should be set so that its level at the mixer bus is 20-db higher than the turntable at the same point. Now the automatic fader action is set so that it is only necessary to speak into the microphone when the turntable is in use, and the turntable signal will immediately (depending upon the attack time used) fade down and be separated from the

microphone channel signal by 20 db. When the announcement in the microphone channel has been completed, the turntable signal will again rise to its previous level. While the microphone channel is in use and the turntable signal is suppressed by 20 db, the output signal level is up less than 7 db. This 7-db rise may be taken care of by the transmitter limiting amplifier.

Type BA-9-A can be used for unattended remote operation in the same manner as previously described for compressor-expander use. Once the initial setups are made, it would only be necessary to make level checks occasionally. Whether the amplifier is located at the remote or at the studio would be determined by the individual application. In order to make one unit serve many remotes, it would probably be located at the studio. Figure 5B shows a typical studio setup for use on an unattended remote, and Fig. 5A shows the amplifier at the remote.

Applications of the “uni-level” amplifier are many and it would be impossible to cover all cases here. Suffice it to say that the small size and easy adaptability of the unit should make it a valuable addition to any audio system.

REFERENCE:

1. Zwyer, B. E., “Design of Studio Audio Systems,” *RADIO-ELECTRONIC ENGINEERING*, Vol. 23, No. 2, p. 7, August, 1954.

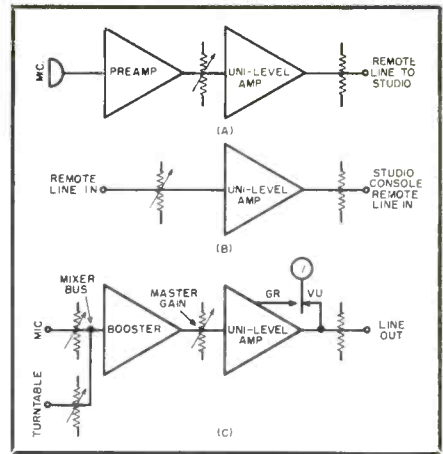

Fig. 5. (A) Typical application of Type BA-9-A at remotes. (B) Application at studio for unattended remotes. (C) How amplifier may be used in most consoles.

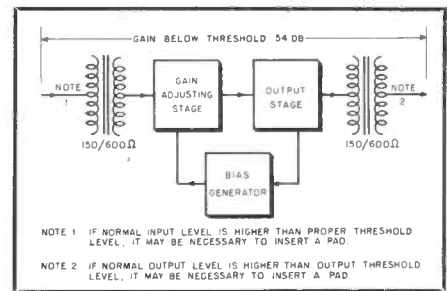
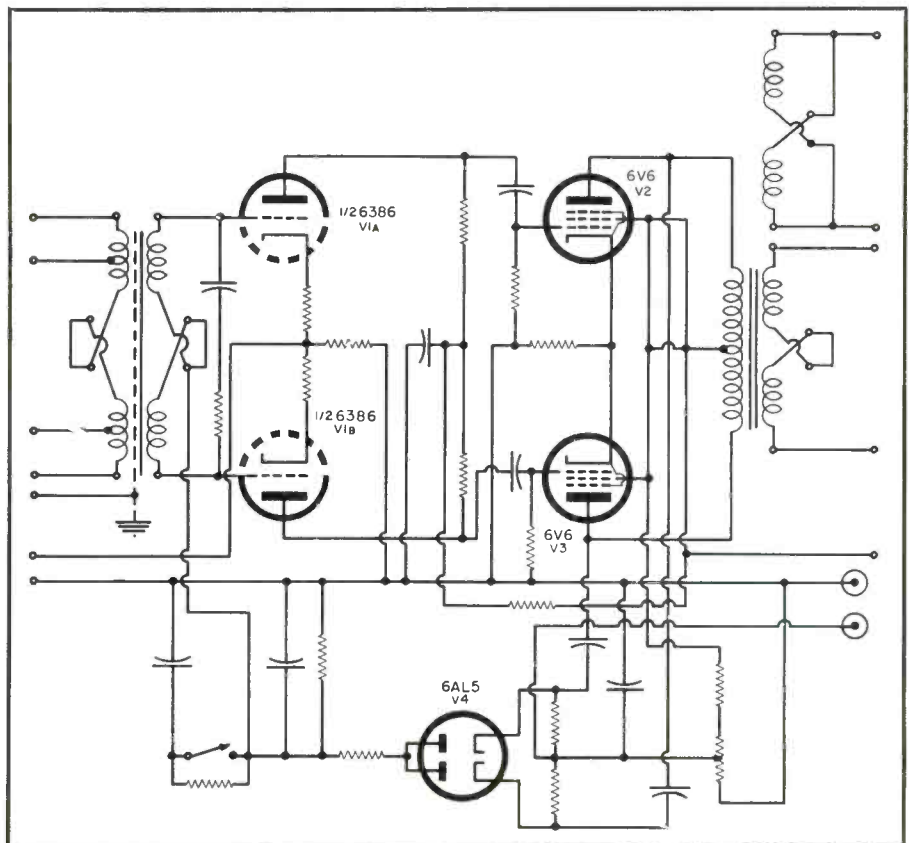

Fig. 6. Block diagram of “uni-level” amplifier. Note that pads may be necessary to adjust input and output levels.

Fig. 7. Over-all schematic diagram of the Type BA-9-A “uni-level” amplifier.



DIODE AMPLIFIER

Fig. 1. Basic amplifier circuit.

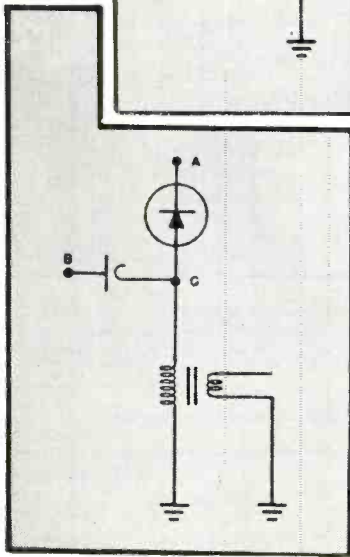
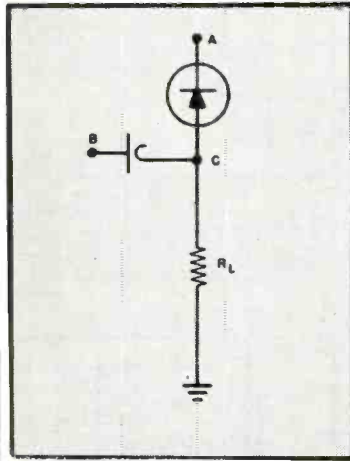

Fig. 2. Current gain is provided by the use of a transformer for R_L .

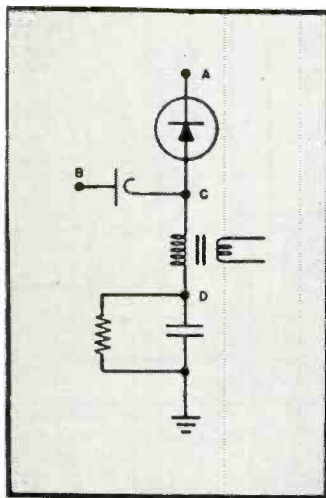
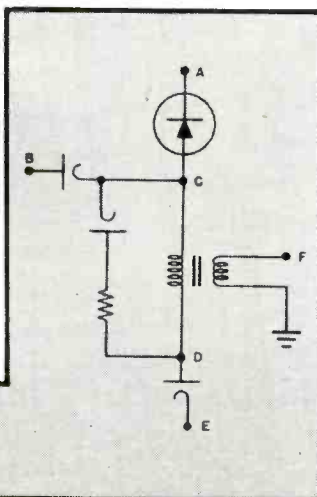

Fig. 3. The addition of a capacitor and a resistor aids in transformer primary recovery between pulses.

Fig. 4. Improvement of Fig. 3 which permits the transformer to recover on a pulse-to-pulse basis.



By **A. W. HOLT**

National Bureau of Standards

Reverse transient phenomena of semiconductor diodes can be utilized to produce power gains up to 10 per stage.

RESearch ON semiconducting diodes has led to the development of a new class of amplifier that utilizes the reverse transient phenomena of these two-element rectifying devices. Using no vacuum tubes and achieving power gains up to 10 per stage, the diode amplifier promises important application in the future design of high-speed electronic digital computers. For example, it may be used as a pulse-repeater stage, in varied types of flip-flop circuits, or as a wide-band, flat-response amplifier. Because suitable diodes are now in regular production, commercial applications are practical at the present time. Future improvements may make the principle useful for amplification at microwave frequencies.

The basic requirement of the diode amplifier is that it be supplied with power from an r.f. source whose frequency is the same or higher than the modulating signal frequency, thus putting it in the same category with magnetic and dielectric amplifiers.

Amplifier Action

A semiconductor diode of the germa-

nium or silicon type has two static conditions: (1) a forward conducting state, characterized by high conductivity, and (2) a reverse conducting state, characterized by low conductivity. The forward state is achieved by applying a biasing voltage so that the anode is more positive than the cathode, while the reverse state is achieved by applying voltage of opposite polarity. The forward voltage acts to create a steady supply of "carriers" of current within the semiconducting material, thus maintaining a condition of high conductivity. Carriers are not created during the reverse static state. If the voltage applied to the diode is switched quickly from forward to reverse voltage, a transient phenomenon occurs in which a large reverse current flows for an appreciable time after switching takes place, and decays until the static reverse state is reached. The transient current occurs because the carriers which were present due to the forward voltage remain available to be swept out by the application of the reverse voltage. However, the carriers do not remain indefinitely during a period of delay between cessa-

Fig. 5. Waveforms at various points in the circuit of Fig. 4. Clock A is shown as a square wave although a half-wave rectified sine wave can be used.

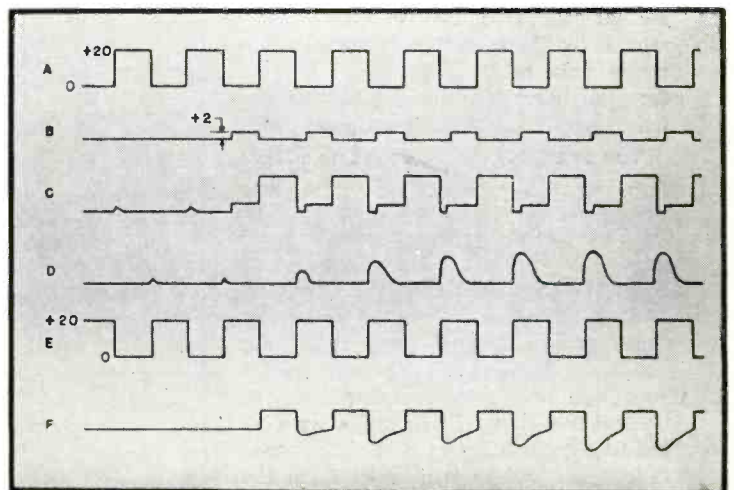

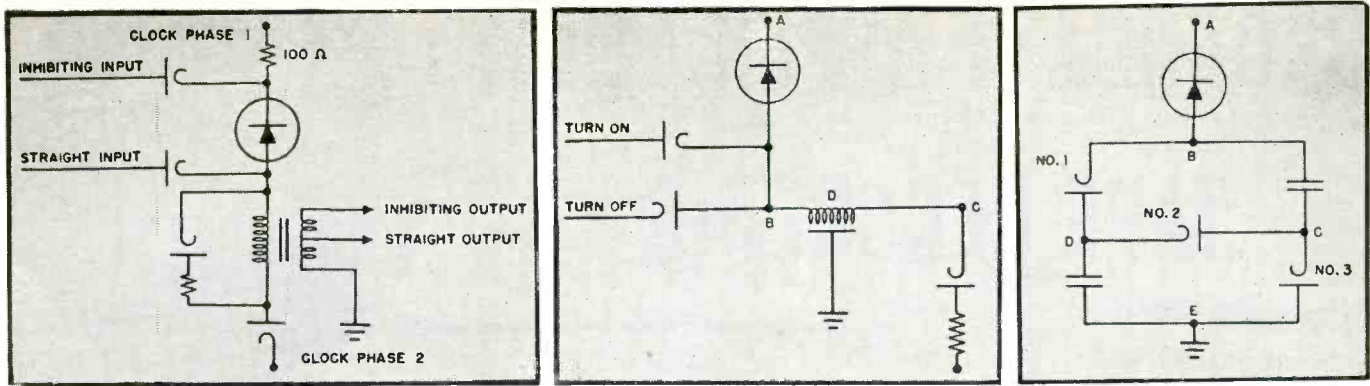

Fig. 6. Left, computer pulse repeater stage; additional logical "or" gates may be added as desired. Center, flip-flop circuit which stores energy between clock pulses in the delay line (D). Right, current-doubler flip-flop circuit.

tion of forward voltage and application of reverse voltage; instead, their number decreases with time during this period.

Although amplification in the diode is not a continuous phenomenon, the action may be likened to the way in which amplification is obtained in a transistor. In a transistor, the emitter can be regarded as a diode existing in the forward conducting state and the collector as a diode in the reverse state. If any of the carriers created by the forward biased diode are transported to the vicinity of the reverse biased diode, a larger current than the static current will flow in the latter diode.

Voltage on the emitter of a transistor produces current which creates carriers. These carriers change the current in the collector, which in turn changes the voltage across the collector. In the case of a junction transistor used in the common base circuit, the collector current is almost equal to the emitter current, so that power gain is effectively determined by the ratio between the forward and the reverse resistances. Thus, power gain is obtained by a transfer of current from one circuit of low impedance to another circuit of high impedance.

The diode amplifier obtains its power gain in a similar manner, except that one electrode serves as both emitter and collector, but at different times. During one-half of the cycle, the anode is more positive than the cathode, and the anode acts as the emitter of the junction transistor; during the other half-cycle, the anode acts as a collector. When it is an emitter, it injects carriers into the germanium with only a small applied forward voltage, i.e., at a low impedance level. When it is a collector, the anode withdraws these same carriers, but only by applying a much higher voltage—at a higher impedance level.

Resistance-Diode Coupling

The simplest form of diode amplifier employs a resistance-diode-coupled cir-

cuit. In Fig. 1, the waveform applied to point A comes from a 1-mc. power source. This frequency was chosen for experimental purposes because its 1- μ sec. period is approximately equal to the decay time of the carriers in the diodes which have been most extensively used. The r.f. supply, or "clock," not only acts as the power source but also as the switch which controls the two separate phases of the amplification cycle: the intake of signal power into the amplifier diode (injection of carriers) and the output of amplified power (decay of carriers). As an analogy, the operation of the diode amplifier may be likened to that of a gasoline engine, where fuel is injected during one part of the cycle and fired at a later part of the cycle.

When there is no input at point B, there is no output because of the high impedance of the amplifier diode. A small voltage spike does appear in the output due to the small capacitance of the diode. This spike, however, can be decreased by paralleling the load resistor with a capacitor for capacitance division. When point B is raised to +2 volts while the clock is at zero volts, carriers are injected into the diode by current in the direction B-C-A. The diode then presents for a short time a very low impedance to the reverse voltage that the clock applies. Since this impedance is low compared to the load resistor, most of the clock voltage appears across the resistor.

Power gains of about 10 (average output power/average input power) have been measured using a 20-volt clock. The only limitation on the amplitude of the clock voltage is that it must not exceed the reverse breakdown voltage. The requirement on the clock supply is rather severe; during the time that the clock is at zero volts, its impedance should be very low, so that as much as possible of the available input signal power will be across the diode and not divided between the diode and the clock source. In practical applications, the clock voltage may be dis-

tributed as a full sine wave and then half-wave rectified near the point of use.

Transformer-Diode Coupling

Some circuit element which transforms voltage gain to current gain is essential to most of the circuits using the diode amplifier, because there is no average current gain in the diodes that have been used so far in the experiments performed at the Bureau. The transformer-diode-coupled circuit shown in Fig. 2 achieves current gain through a step-down transformer. Its operation is similar to that of the resistance-diode-coupled amplifier. The circuit in this form is suitable for the amplification of low-duty-cycle pulses but will not operate at high duty cycles because the stored energy in the magnetic circuit will not permit the transformer primary to "recover" or "fly back." A solution to this difficulty can be obtained through the addition of a capacitor and resistor between the transformer primary and ground, as shown in Fig. 3. This circuit has the disadvantage that the flyback requirements of the inductance are satisfied only on a many-pulse basis and not on a pulse-to-pulse basis. The many-pulse average can also cause trouble in turning off the stage at the end of a train of pulses.

If the end of the transformer primary (point E, Fig. 4) were to be driven by a clock voltage 180° out of phase with
(Continued on page 32)

Fig. 7. Waveforms of the current-doubler flip-flop of Fig. 6, right.

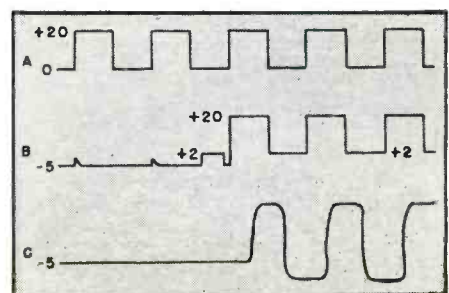

BROADCAST APPLICATION OF TAPE RECORDING

By **HERBERT MICHELS**

Chief Engineer, Station WHCU

Tape playback of spot announcements and station breaks is expedited by a remote control system.

GENERAL use of tape recording in broadcast stations has been found to be of substantial aid not only in "sharpening" studio operating efficiencies, but also—if properly employed—in presenting a much smoother programming setup to the listening audience. For this reason, tape machines are now common fixtures in nearly all radio and television stations.

One of the most successful broadcasting applications of tape will be found at the network affiliate station. Here, the tape playback of station breaks and spot announcements between network programs has proven a bonanza for the local station. By this method, an announcer can assemble the entire day's between-network breaks in less than one hour, leaving the remaining part of the working day for the preparation of local programming. No longer need an announcer be maintained on duty throughout the entire broadcast day—or on weekends. Also, higher grade announcers may be employed, since a broadcasting station properly set up for tape recording and playback requires far fewer programming workers.

This increasing use of tape, however, places a heavy responsibility on the technical staff. When taped announcements are employed, the control room engineer has the complete responsibility for seeing that the correct "spot" gets on the air—at the correct time—and

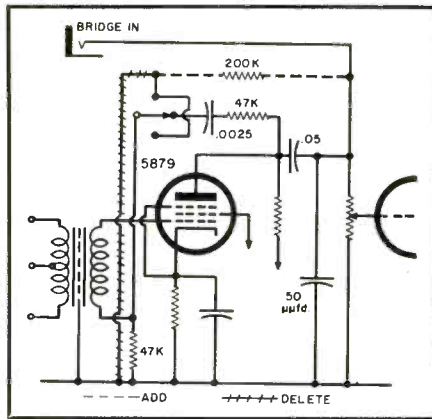

Fig. 2. Revised input and output circuits of the Magnecorder.

at the proper level. For this reason, the tape recording and playback setup to be described was established at WHCU.

The specific aim was to devise a system whereby spot announcements (or between-record announcements) could be placed on and off the air conveniently. In addition, since errors can be rather "embarrassing" when tape is employed, a method of preventing the airing of miscued spots was also required. Needless to say, levels have to be preset; fade-ins or blasting cannot be tolerated in a commercial broadcast station.

Transmission Level Control

A Magnecord PT6-AH tape recorder and PT6-J amplifier are used at WHCU. While the combination is basically satisfactory, a few minor modifications were required to permit its use for the specific application. In broadcasting work, levels are adjusted with variable T and H pads on the control console, so that the level control on the Magnecorder was neither needed nor desired. It was therefore preset and locked to provide "zero" level on playback, as indicated on the recording meter. The 600-ohm PT6-J amplifier output was then padded down 28 db to provide correct fade-in

Fig. 1. Circuits for providing correct input and output levels.

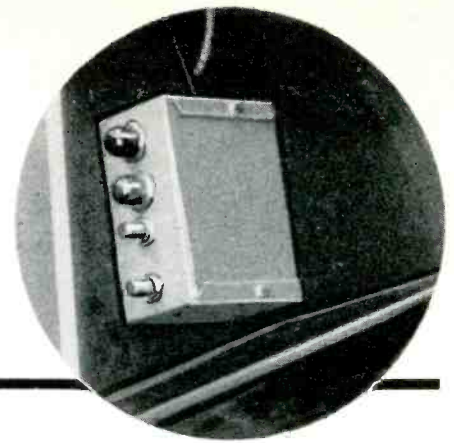
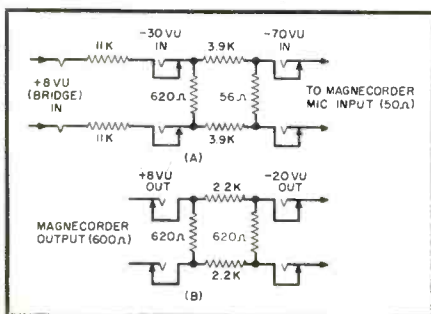

Fig. 3. Remote control unit is mounted on control console.

level with the console fader set at exactly midposition. In this way, correct playback levels are always assured.

It was found that after presetting the Magnecorder "gain" control for correct playback level the control setting was not suitable for recording, since a poor signal-to-noise ratio resulted from the higher playback level setting. This problem was solved by simply reducing the first stage gain in the PT6-J, while recording, to a value which resulted in a satisfactory signal-to-noise ratio. Negative feedback was employed to reduce the gain. The feedback is connected through the "record-playback" switch, and so is only employed when the amplifier is used for recording. After this circuit modification was made, as shown in Fig. 2, the "gain" setting on the Magnecorder did not need to be changed for switching between record and playback functions.

Audio input is connected through the patch panel at +8 vu level, padded approximately 70 db by a bridging-to-50 ohm fixed resistance pad, then fed into the balanced microphone input connector on the PT6-J. Therefore, since the bus system is at a fixed +8 vu level at all times, correct recording levels are always assured.

The preceding circuit modification and fixed pad installation proved to be an excellent solution to the transmission level problem. However, still remaining was the problem of establishing a convenient method of operation (starting and stopping on cue) and error prevention.

Operating Convenience

At WHCU, convenience of operation is quite important, since the studio control room contains a rather large and elaborate three-studio mixing system, an output bus switching system, turntables, and four tape recorders all under the control of only one operator. To locate all tape machines within easy reach of the one control room operator

(Continued on page 33)

And Now...

RCA Announces the FIRST Low-Cost

Packaged Microwave

with Voice Channels

PROVED throughout the nation and the world, RCA 960 megacycle Microwave is now available in a low-cost "package" unit, MM-9, as a complete station.

Important savings include:

- Minimum real estate requirements
- No tower construction
- Easy economical installation
- Minimum maintenance
- Unattended reliable operation

When mounted on inexpensive supports, such as wooden poles, up to 100 feet high, or on existing structures, which can be spaced 20 or more miles apart, the MM-9 Microwave "package" units provide an ideal low-cost solution to many point-

to-point communications problems.

RCA Microwave uses highly directional radio signals which are beamed from one relay station to the next by "dish" antennas. It can be interconnected with existing telephone lines and switchboards and virtually eliminates the weather hazards of carrier and wire lines. RCA Microwave employs readily available tubes and familiar circuits which are easy to service. The RCA Service Company provides nationwide installation and service facilities, if desired.

For complete information on the new MM-9 Packaged Microwave Stations, send coupon, below.

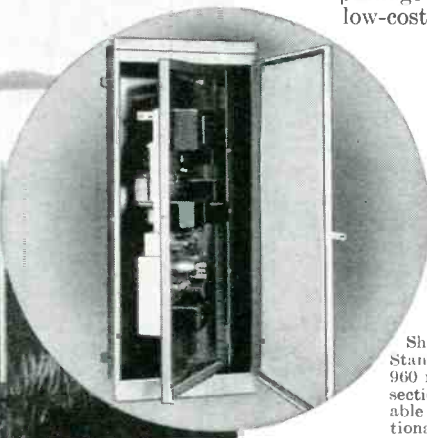

Typical Uses of MM-9 Packaged Microwave:

1. Telephone Circuits
2. Supervisory Control
3. Remote VHF Control
4. Facsimile
5. Teletype

FOR

Gas Utilities
Electric Utilities
Pipelines
State Agencies
Municipal Systems
Police Departments
Transportation Systems

Showing hinged rack construction, with all components easily accessible for servicing. Standard "package" equipment includes weather-proof cabinet, 2 parabolic reflectors, 960 megacycle transmitter unit, exciter unit, 960 megacycle receiver. Also 2 100-ft. sections of semi-flexible transmission lines with all required fittings. Space is available for multiplex equipment to provide two voice channels with signaling. Additional multiplex equipment can be mounted in a similar cabinet.



RADIO CORPORATION
of AMERICA
COMMUNICATIONS EQUIPMENT
CAMDEN, N. J.

Radio Corporation of America, Camden, N. J.

Dept. M-157, Building 15-1

In Canada, RCA VICTOR Company Limited, Montreal

Please send me your new booklet, "RCA Low-Cost Packaged Microwave Stations."

NAME _____ TITLE _____

COMPANY _____

ADDRESS _____

CITY _____ ZONE _____ STATE _____

Have an RCA representative get in touch with me.

For more information, circle No. 5 on Reader Service Card

RADIO-ELECTRONIC ENGINEERING

COMMUNICATION REVIEW

RADIOTELEPHONE-TELEGRAPH UNIT

The Mackay Type MRU-14 is a new shipboard radio unit that combines in a single cabinet a 250-watt radiotelephone and radiotelegraph transmitter, a communication receiver, and all requisite control facilities, including an independent intercommunication circuit between the unit and a remote control station. It employs a high frequency transmitter capable of providing 19 telephone and 9 radiotelegraph crystal-controlled output channels. Each of these channels may be preset to any frequency between 2 and 24 mc.

Developed by the Marine Division of Mackay Radio and Telegraph Company, Inc., a subsidiary of American Cable & Radio Corporation, 67 Broad St., New York 4, N. Y. the new console was designed as a companion piece to the medium frequency radiotelegraph unit MRU-10; together, they constitute a compact, highly versatile radiotelegraph-radio-telephone station for use in both coastal and high seas communications.

Circle No. 51 on Reader Service Card

NOISY AREA "PACKAGE"

Operating flexibility and extra power to overcome high audible noise levels are two characteristics of a low-cost "packaged" two-way radio system recently placed in production by Motorola for use in repair trucks or other vehicles. It provides a means of directing a work crew's activities as well as communicating with headquarters and other

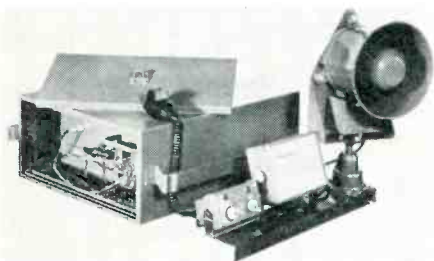

vehicles, and is especially recommended for use in noisy industrial areas.

Consisting of receiver, transmitter, and power supply with an audio booster amplifier, the system fits into a standard 15" housing, takes up a minimum of space, and is easily installed. With an audio output of 10 watts and an r.f. output of 25 watts, it operates interchangeably from either a 6- or 12-volt battery installation. More information

can be obtained from Motorola Communications and Electronics, Inc., Technical Information Center, 4501 W. Augusta Blvd., Chicago 51, Ill.

Circle No. 52 on Reader Service Card

MOBILE TRANSMITTER-RECEIVER

Designed to work from either a 6- or 12-volt battery, interchangeably, the new G-E 25-watt mobile combination transmitter-receiver operates in the 152-174 mc. band. Conversion from either 6- to 12-volt or 12- to 6-volt operation may be accomplished in the field by simply rotating two connector plugs

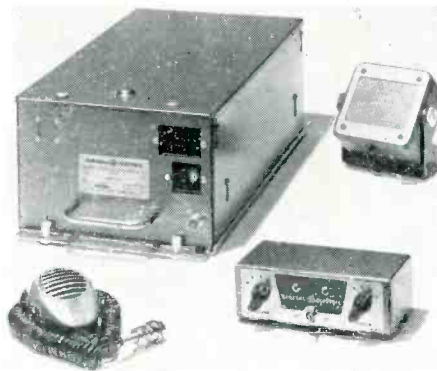

and changing the two pilot lights and fuse values on the control head.

Announced by the General Electric Company, Electronics Park, Syracuse, N. Y., this two-way radio unit is easily convertible to split channel operation. It is expected to be most useful for fleet operators such as police and fire departments, taxicabs, power utilities and industrial concerns. Compact in size, the transmitter-receiver may be mounted on the dashboard by the simple addition of direct controls on the unit itself.

Circle No. 53 on Reader Service Card

V.H.F. RADIO NETWORK

In New Zealand, the Civil Aviation Administration has partially completed a comprehensive network of v.h.f. radio stations which enable pilots of aircraft "en route" to talk direct to air traffic control centers. The first v.h.f. station was established 3500' up on the eastern side of Mount Egmont, and now a second station operating on the same frequencies has been set up on the top of 1500'-high Colonial Knob.

Pye Limited of Cambridge, England, and Ericsson Telephones Limited, of Beeston, Nottingham, are supplying all

the radio and telephone carrier equipment used for linking the air-ground stations with the control centers. The system consists of Pye FM v.h.f. multi-

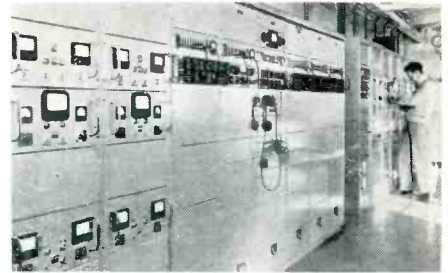

channel radio equipment in conjunction with Ericsson six-channel carrier telephone equipment.

Circle No. 54 on Reader Service Card

TRAIN RADIO FOR GREAT NORTHERN

Equipment for the expansion of the two-way radio communications system of Great Northern Railway freight trains operating on the 1800-mile "main line" between Minneapolis and Seattle has been ordered from the Bendix Radio Division of Bendix Aviation Corporation, Baltimore, Md. Ninety-five transmitter-receiver units to serve 52 diesel locomotives and 23 cabooses plus two work trains, two automobiles used by supervisors, and 10 wayside or base stations will be added to the present system of 36 base stations, 30 diesels and 25 cabooses which has been in operation for about a year.

All of the new radio equipment for Great Northern locomotives will use 64-volt, direct-conversion radio communications units powered from diesel starter batteries. It is claimed that communications equipment operating on this power instead of customary 117-volt a.c. can save up to \$600 per locomotive.

Circle No. 55 on Reader Service Card

WAYSTATION SUBSET

Use of an Automatic Electric waystation subset permits more telephones to be bridged on waystation train dispatching lines and extends the practical range of the lines to greater distances, according to the manufacturer. Circular 1810, available from Automatic Electric Sales Corporation, 1033 W. Van Buren St., Chicago 7, Ill., explains how these advantages are obtained by means of balanced impedance between transmitting and receiving as well as minimized bridging loss.

Circle No. 56 on Reader Service Card

TWINPLEX SYSTEM

A new Twinplex communication system makes possible a two-channel radio circuit whereby two nonsynchronous or
(Continued on page 34)

WHERE POWER
IS VITAL

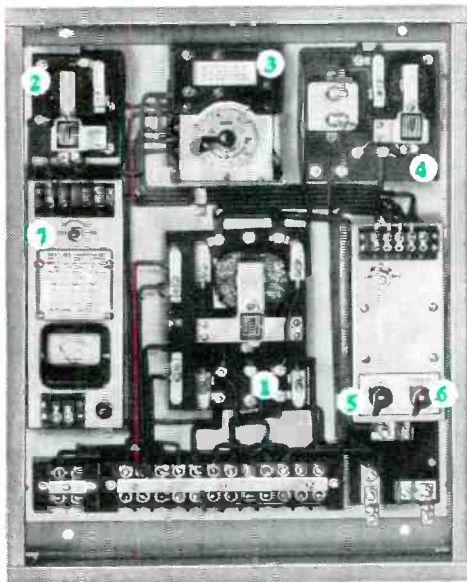

This ASCO[®]
Automatic Transfer Switch Panel
does 24-hour guard duty

ASCO Automatic Transfer Switches
provide continuous adequate-voltage power . . .

- Trigger stand-by system to start emergency generator.
- Transfer connected load when rated voltage and frequency are attained.

To assure continuous power an ASCO Automatic Transfer Switch (1), stands ready to transfer the load to an emergency source within 2 to 5 cycles when normal power fails. Once the normal source is in proper operating condition, the load is automatically restored.

To assure adequate-voltage power, the voltage sensitive Close Differential Relay (2), operating with the Transfer Switch, provides transfer on a 5% differential in power supply voltage (less, if required).

For further information on ASCO Emergency Generator Controls, see our booklet, "When Normal Power Fails", with essential engineering data. Write today for your free copy.



Automatic Switch Co.

385-R Lakeside Avenue, Orange, N. J. • ORange 2-5300

For more information, circle No. 6 on Reader Service Card
RADIO-ELECTRONIC ENGINEERING

Other Features:

Timer (3)—Provides 3-5 second delay on engine starting; 0-13 minute adjustable delay on restoration to normal; 2 minute delay on stopping engine.

Lockout Relay (4)—Prevents transfer until electric plant rated voltage and frequency are attained.

Test Switch (5)—Simulates normal failure.

Stand-by Switch (6)—Disconnects engine start circuit and permits independent operation of emergency generator set.

Trickle Charger (7)—(With ammeter and 5 ampere fuse). Keeps emergency electric plant starting batteries charged.

This complete panel may be installed with your new emergency power supply, or may be wired into an existing installation. ASCO Transfer Switches are available up to 1,000 Amperes, 750 Volts, A-C or D-C, with modifications as required.

ASCO also designs and manufactures a complete line of Electro-magnetic Controls including Solenoid Valves, Remote Control Switches, Contactors, Relays, and Complete Control Panels.

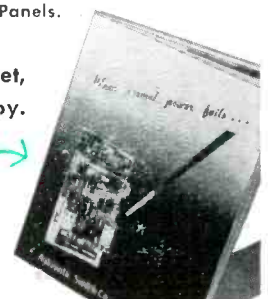

NEW PRODUCTS

MINIATURE BRIDGE BALANCE

Well suited for use in aircraft and guided missile flight instrumentation, the Model BP-18A 18-channel bridge

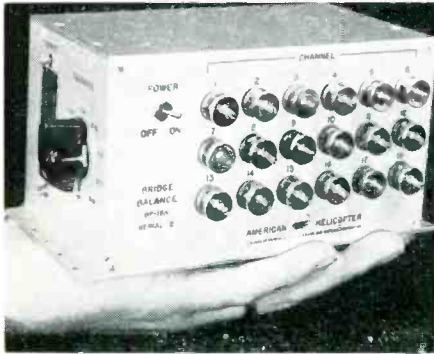

balance has provisions for controlling the electrical balance, sensitivity and calibration of resistance bridge sensing devices such as strain gages, accelerometers and pressure pickups. It has been introduced by *American Helicopter*, division of *Fairchild Engine and Airplane Corporation*, 1800 Rosecrans Ave., Manhattan Beach, Calif.

Said to be the smallest and lightest unit of its kind, Model BP-18A weighs only 2.4 pounds and its over-all dimensions are $7\frac{1}{8}$ " x $3\frac{1}{2}$ " x $3\frac{1}{2}$ ". Components are of high precision and rugged construction to provide the same degree of accuracy and ruggedness of much larger laboratory models. Ten-turn potentiometers with shaft locks are employed for circuit balancing.

Circle No. 57 on Reader Service Card

SLIDE SCREW TUNER

The slide screw tuner announced by *Transline Associates*, 57 State St., Newark 4, N. J., operates over the entire X-band frequency range. Carefully de-

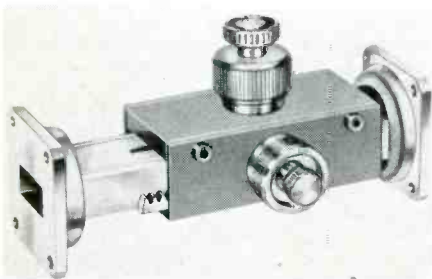

signed "choke" sections are incorporated in the unit which insure that any radiation or contact losses are negligi-

ble. VSWR values of 20 can be corrected to 1.02 or less and small reflections completely cancelled.

This unit consists of a slotted wave guide and a precision carriage to which an adjustable probe is attached. The longitudinal position of the probe is controlled through a rack and pinion drive, and the depth of insertion is varied by means of a knurled screw.

Circle No. 58 on Reader Service Card

"VERNISTAT"

For use in servo systems and analog computers, the "Vernistat" is a new type of precision variable-ratio transformer being manufactured by the *Vernistat Division, Perkin-Elmer Corporation*, Norwalk, Conn. It combines low output impedance with the resolution

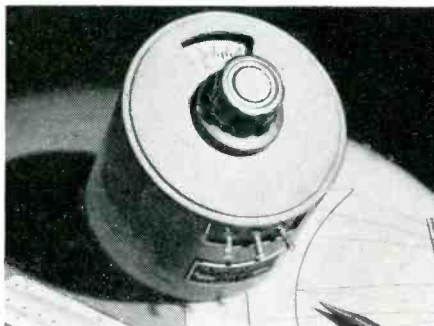

and linearity ordinarily associated only with high impedance multiturn potentiometers.

The "Vernistat" consists of a tapped autotransformer that provides the basic division of voltage into several discrete levels, which are selected and further subdivided by a continuous one-turn interpolating potentiometer. Moving through ten turns, the potentiometer interpolates between 30 transformer taps which may be adjusted to approximate a curve of any nature.

Circle No. 59 on Reader Service Card

CRYSTAL SWEEP CALIBRATOR

Developed for oscilloscope time base calibration, the *Loral Model 238-1A* crystal sweep calibrator is applicable to sweep time calibration and frequency measurement, and may also be used as a marker generator or as a counter and computer calibrator. This compact, self-contained unit produces narrow pulses spaced at intervals of 1, 10, 100, 1000 and 10,000 μ sec. Pulse spacing is ac-

curate to $\pm 0.01\%$ and is controlled by two precision crystals.

Output pulse widths of 0.1 or 1 μ sec. are provided by the Model 238-1A, re-



cently announced by *Loral Electronics Corporation*, 794 East 140th St., New York 54, N. Y. Pulse outputs are positive and are preset by internal adjustments for each range to a level of 3.0 volts; output impedance is 93 ohms. Accurate output frequencies of 1 mc., 100, 10 and 1 kc., and 100 cps are furnished at the various pulse-spacing settings.

Circle No. 60 on Reader Service Card

TEFLON PRODUCTS

Erie-Chemelec Teflon products now include: stand-off and feed-thru insulators, 7- and 9-pin miniature tube sockets, crystal sockets, 15- and 18-pin connectors, and five sizes of spaghetti in three colors. A complete catalog and price sheet on these products is available from the Distributor Sales Division, *Erie Resistor Corporation*, Erie, Pa.

The physical properties of Teflon, *du Pont's* tetrafluoroethylene resin, make it a high-performance insulating material. It has a loss factor of less than 0.0005 and a dielectric constant of only 2.0—throughout the frequency range from 60 cycles to 30,000 mc. It is service-

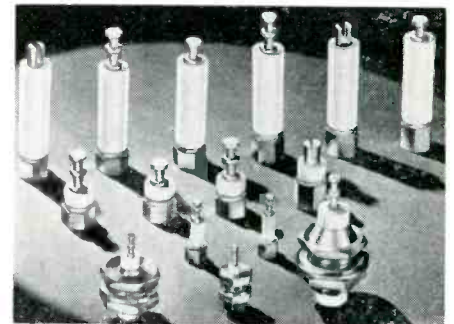

able at any temperature from -110° to 500° F for long periods with negligible change in dielectric strength, power factor or other critical characteristics.

Circle No. 61 on Reader Service Card

NOISE FIGURE TEST SET

A noise figure test set has been announced by *Linear Equipment Lab-*

oratories, Inc., Brightwater Place, Massapequa, L. I., N. Y., which permits uniform, consistent measurements of noise factor and observation of tuner r.f. selectivity. Model HF-20 comprises a wide-band amplifier, built-in 3-db attenuation network, detector and output indicator, and electronically regulated



power is provided for both amplifier and most tuners. Introduction of attenuation does not affect selectivity.

Circle No. 62 on Reader Service Card

BOLOMETER MOUNT

Sierra Electronic Corporation, 1050 Brittan Ave., San Carlos 2, Calif., is offering a new bolometer mount for measuring relative r.f. power, particularly on low duty cycle r.f. pulses. It is designed for operation with pulse modulated waves where the usefulness of crystal detectors is often limited.

Model 157 may be used on pulse modulated or unmodulated waves in a direct-reading d.c. bridge setup, or with an audio transformer and voltmeter on modulated waves. In either circuit, maximum sensitivity is obtained when the mount is operated with approximately 7-ma. bias, resulting in a maximum power input capability of 20 mw.

Circle No. 63 on Reader Service Card

R.F. COAXIAL SWITCH

Exact requirements of modern microwave components and accessories are met by the new miniature r.f. coaxial switch announced by Transco Products, Inc. This rugged, compact, lightweight unit was specifically designed for use



under severe environmental conditions where space, weight and mounting savings are factors.

Characteristics include: frequency range—0 to 8000 mc.; VSWR—1.3 maximum with type "N" connectors; inser-

tion loss—0.2 db maximum; crosstalk—50 db minimum; life duration—500,000 operations minimum. Complete technical data is available on request from Transco Products, Inc., 12210 Nebraska Ave., Los Angeles 25, Calif.

Circle No. 64 on Reader Service Card

TOROIDAL COIL WINDER

Manufacturers of computing machines, pulse transformers, amplifiers and other electronic equipment using small toroidal coils should be interested in the midget toroidal coil winder—a recent development of Electro Devices Co., Somerville, Mass. Replacing slow, expensive hand-writing of extremely small rings or cores with fine wire, it winds 30 to 40 gage wire into coils having as small as 1/8" inside diameters.

Compact and simple to operate, the midget winder can be mounted on a



bench or pedestal. It handles a wide variety of different type wires and can produce coils comprising various combinations of wire. Speeds up to 600 turns per minute are attainable, depending on type and size of coil.

Circle No. 65 on Reader Service Card

CATHODE-RAY OSCILLOGRAPH

The Du Mont Type 327 is a cathode-ray oscillograph capable of precise measurements of time and amplitude within the frequency range of d.c. to 5 mc. Announced by the Instrument Division of Allen B. Du Mont Laboratories, Inc., it was designed to fill the gap between low-cost low-frequency oscillographs and high-priced wide-band laboratory equipment.

Complete technical information may be obtained from the Technical Sales Dept., Allen B. Du Mont Laboratories, Inc., Clifton, N. J.

Circle No. 66 on Reader Service Card

COUNTERPOISE RELAY

Unique design and microprecision construction have resulted in a counterpoise relay with dependable performance, immunity to vibration and shock, and long service life. Announced by the Diaphlex Division of Cook Electric Company, 2700 N. Southport Ave., Chicago 14, Ill., the relay incorporates the prin-

ciple of the fulcrum and the lever, thus offering a new relay concept.

When two balanced weights act in the same direction and at equal and

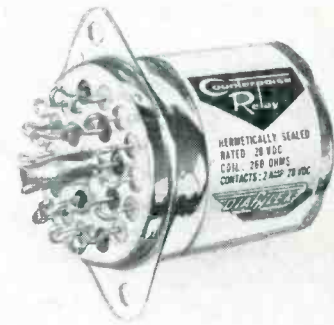

opposite distances from the fulcrum, no motion can take place. This is the case when the relay is subjected to either shock or vibration. However, when the coil is energized and de-energized, a force couple is produced giving the lever a smooth, rocking motion which is transmitted to the relay contacts. Therefore, the entire relay mechanism is responsive to electrical energy only.

Circle No. 67 on Reader Service Card

WIDE-BAND ELECTRONIC SWITCH

Providing d.c. to 15-mc. dual trace oscilloscope presentations, the Model ES-180 may be used with almost any conventional oscilloscope. Announced by Teletronics Laboratory, Inc., Westbury, N. Y., this wide-band electronic switch has a movable horizontal index which makes rapid and accurate amplitude and time measurements, without parallax error. Signals are displayed

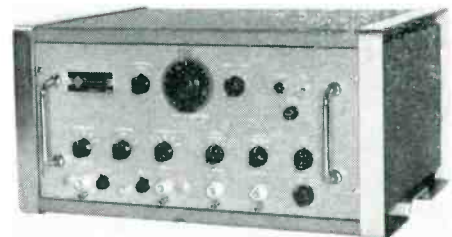

on alternate sweeps, switched at sweep-end, at rates up to 100 kc.

Typical applications for which a simultaneous viewing and comparison of two inputs may be made include: overshoot, rise time and duration measurements; accurate shape, time and amplitude comparisons; simultaneous display of related waveforms; and simultaneous display of nonsynchronous signals.

Circle No. 68 on Reader Service Card

MICROWAVE TRANSMISSION LINE

Ruggedized versions of "Uniline" unidirectional microwave transmission line are being offered by the Cascade Re-
(Continued on page 38)

NEWS BRIEFS

JOHN SCOTT AWARD

Marvin Camras, inventor of modern magnetic recording and senior physicist at Armour Research Foundation of Illinois Institute of Technology, Chicago, Ill., is slated to receive the John Scott award for scientific achievement. The 138-year-old award—consisting of \$1000 in cash, a copper medal, and a scroll—will be presented by the City of Philadelphia, trustee.

Mr. Camras is being given the award for his discoveries and subsequent im-

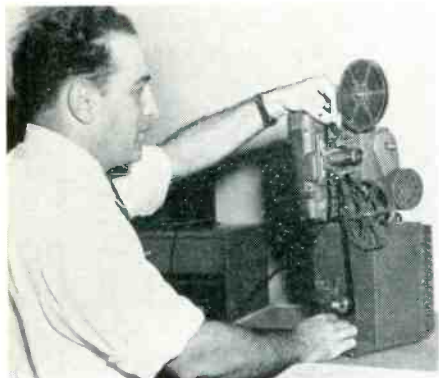

provements in magnetic recording that helped skyrocket this field into an eighty million dollar annual industry. His inventions are currently used in radio broadcasting, motion pictures, memory units for high speed electronic computers, instrumentation, guided missiles, and a host of others. In the photograph, Mr. Camras is shown adjusting the film in a projector adapted for magnetic sound.

Circle No. 69 on Reader Service Card

INDUSTRIAL ELECTRONICS EXPANSION

Electronic mechanization of clerical work in offices will be the greatest growth area of electronics in the coming ten years, according to William J. Morlock, general manager of the Commercial Equipment Department of *General Electric Company*, Syracuse, N. Y. Sales of electronic equipment, exclusive of military equipment, are expected to increase to a five billion dollar yearly market.

Commercial electronics will expand from its present 8% share of the business to 25% during the same period, Mr. Morlock predicted, with industrial electronic equipment accounting for

over half of the commercial sales; marketing research indicates that this field will expand 700% while the older fields of electronics will expand only 50%.

Circle No. 70 on Reader Service Card

MRIA COMMITTEE ACTIONS

At the second annual meeting of the Magnetic Recording Industries Association in October, four subcommittees were set up by the Standards and Engineering Committee to study standardization problems and recommend procedures to be adopted. Other MRIA committees made plans to conduct panel meetings for the education of groups throughout the country who are interested in magnetic recording, to compile statistical information about sales of tape and machines for the members, and to study applicable freight rates for various components.

Circle No. 71 on Reader Service Card

COMPONENT REMOVAL METHOD

To aid in the servicing of its "PLAcir" chassis radios, *Motorola Inc.*, 4545 W. Augusta Blvd., Chicago 51, Ill., has developed a controlled-temperature heating pot. The individual wiring leads and wiring for this chassis are produced as a single unit via a patented plating process on a phenolic base. Through the use of the pot, it is possible to remove every component on the chassis without lifting any of the wiring pattern.

Removal of defective components is best accomplished by simultaneous heat-

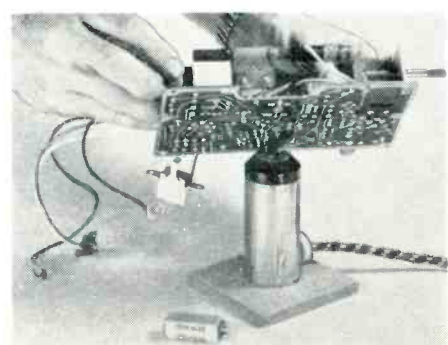

ing of all the terminals of the component. When the terminals are dipped into the soldering pot, the component part will become unsoldered with a gentle lift. The main feature of the pot is its compactness, which allows

simultaneous heating over such a limited area.

Circle No. 72 on Reader Service Card

GUIDED MISSILE STAFF

Additions to the staff of the Guided Missile Division of *The Ramo-Woolbridge Corporation*, 8820 Bellanca Ave., Los Angeles, Calif., include Dr. Herbert C. Corben (left) and Dr. Wendell A.



Horning (center) as physicists, and Dr. Millard V. Barton (right) as engineer.

Dr. Corben has served on the staff of Carnegie Institute of Technology as professor of physics, and as visiting professor in Italy on the Fulbright Commission. The scientific experience of Dr. Horning was gained with the *General Electric Company* at Hanford, Wash., where he spent six years as theoretical physicist in neutron physics and reactor theory. Dr. Barton has been chairman and professor of the Engineering Mechanics Department and research engineer, Defense Research Laboratory, University of Texas.

Circle No. 73 on Reader Service Card

CONTROL RESEARCH CENTER

A \$1,000,000 research center has been created by *Robertshaw-Fulton Controls Company* at Irwin, Pa., to develop new control devices for home appliances and industry. Its 31,000 square feet contain the latest laboratory equipment and special devices for simulating the varied conditions required for research and testing projects in the controls field. With a staff which will include engineers, physicists, chemists, technicians, and draftsmen, the *Robertshaw Research Center* will serve as research and development headquarters for the company's seven manufacturing divisions.

Circle No. 74 on Reader Service Card

GENERAL RADIO BRANCH OFFICE

To provide better service to customers in the District of Columbia and adjacent territory, *General Radio Company* has opened a branch engineering and sales office at 8055 Thirteenth St., Silver Spring, Maryland. Through this office, technical and commercial information on *G-R* products can be furnished promptly and aid given in the selection of equipment to meet specific measurement problems. William R. Saylor, formerly of the sales engineer-

ing staff at Cambridge, Mass., is the manager of the new office.

Circle No. 75 on Reader Service Card

"PIG-TAILORING"

Bruno-New York Industries Corporation, 460 West 34th St., New York 1, N. Y., has developed a technique and associated equipment with which to simplify and improve the process of assembling resistors, capacitors, diodes and other axial lead components as well as sleeved or bare wire jumpers. Simultaneously reducing labor cost and increasing quality, the production technique is called "Pig-Tailoring" and is practical for both short- and long-run production.

To accomplish lead-tailoring or otherwise prepare axial component pigtails

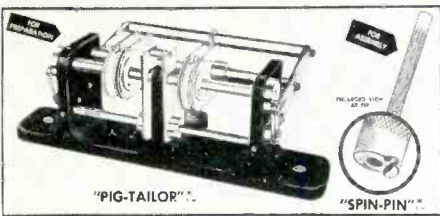

for assembly, a small foot-operated machine is being manufactured under the trade name "Pig-Tailor." It is capable of simultaneously and accurately measuring, cutting and bending both axial leads of any component at the average rate of 750 units per hour. Assembly, the second step in the process, utilizes another device called a "Spin-Pin" for fast and uniform spinning of tailored component leads around turret-type terminals.

Circle No. 76 on Reader Service Card

SRI PROJECT OFFICE IN HAWAII

Stanford Research Institute has established a project office with resident staff in Honolulu, Hawaii, as the result of a formal invitation from both the Territorial Legislature and the Hawaiian Chamber of Commerce. One interest of the new office will be to assemble information about Hawaii to be incorporated in the Western Resources Handbook, a public service activity of the Institute. The initial operating staff will be headed by William E. Hosken, economist and manager of company development research.

Circle No. 77 on Reader Service Card

TECHNICAL INFORMATION HEAD

H. C. McDaniel has been appointed manager of technical information for the Westinghouse Electric Corporation, 401 Liberty Ave., Pittsburgh 30, Pa. Formerly manager of technical public-
(Continued on page 35)

Only Precision OFFERS YOU HIGHEST QUALITY, LOW COST PAPER TUBING

in
any shape
every size
any length
plus
any ID
every OD
any quantity

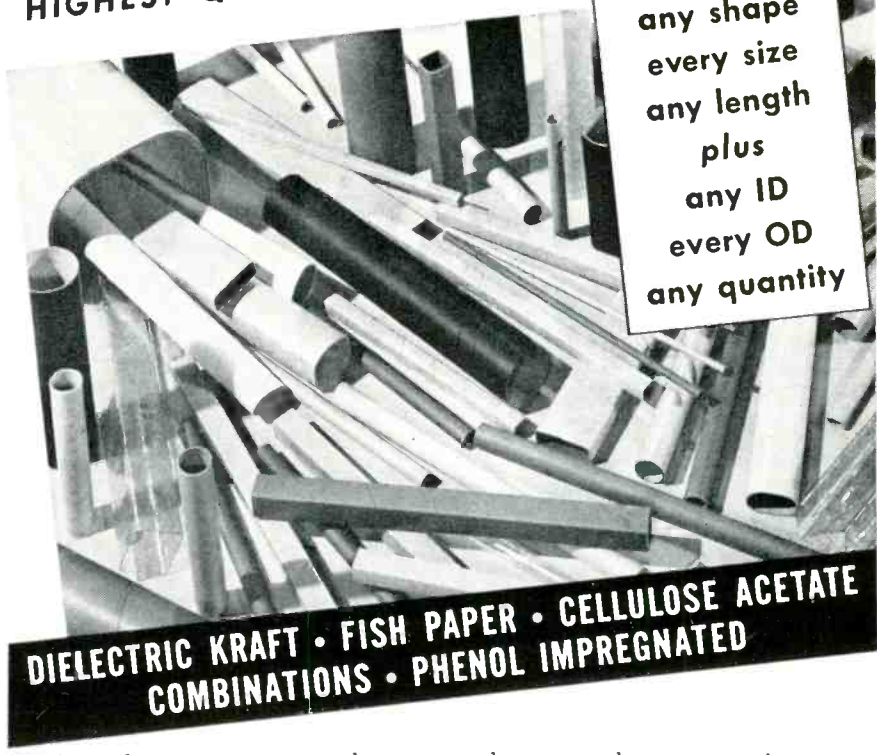

**DIELECTRIC KRAFT • FISH PAPER • CELLULOSE ACETATE
COMBINATIONS • PHENOL IMPREGNATED**

Round, square, rectangular, triangular, any shape, any size — Precision Paper Tube Co. can provide *all* your paper tubing needs. Your specifications are met to the most exacting tolerances. Precision Paper Tubes are sturdy, crush resistant, have high tensile strength and excellent dimensional stability.

Send in your specifications for samples. Request Arbor List of over 2000 sizes.

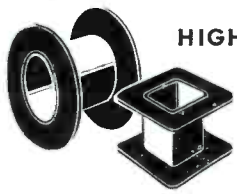

HIGH DIELECTRIC BOBBINS FOR BETTER COILS

Precision-made on specially designed equipment, using the finest materials, to provide maximum tensile strength, light weight, more winding space and other essential electrical and mechanical characteristics.

Furnished in any size or shape. Supplied plain or fitted with leads, slots or holes. Flanges cut to specification, plain or embossed. Tube ends swaged to lock flanges.

Send Specifications for samples. Ask for illustrated folder.

Sales Representatives in:

- | | |
|---|---|
| New England:
Framingham, Massachusetts, Framingham 7091 | Missouri, Southern Illinois, Iowa:
St. Louis, Missouri, Sterling 2318 |
| Metropolitan New York, New Jersey:
Jersey City, New Jersey, Journal Square 4-3574 | Maryland:
Baltimore, Maryland, Plaza 2-3211 |
| Upstate New York:
Syracuse, New York, Syracuse 76-8056 | Philadelphia, Camden:
Philadelphia, Pa., Chestnut Hill 8-0282 |
| Northern Ohio, Western Pennsylvania:
Cleveland, Ohio, Atlantic 1-1060 | California:
Pasadena, California, Sycamore 8-3919 |
| Indiana, Southern Ohio:
Logansport, Indiana, Logansport 2555 | Canada:
Montreal, Quebec, Canada, Walnut 2715 |



PRECISION PAPER TUBE CO.

2063 W. CHARLESTON ST. CHICAGO 47, ILL.

Plant No. 2: 79 Chapel St., Hartford, Conn.

For more information, circle No. 7 on Reader Service Card

NEW LITERATURE

"SPEAKING OF ENGINEERING"

"Speaking of Engineering" is the title of a 16-page, two-color brochure issued by the *Vitro Engineering Division of Vitro Corporation of America*, 120 Wall St., New York 5, N. Y. It discusses facilities for the design and engineering of processing and manufacturing plants for government and industry. An illustrated chart depicts the course of an average architect-engineer or architect-engineer-management project at *Vitro*.

Circle No. 78 on Reader Service Card

DIRECTORY OF LABORATORIES

The National Academy of Sciences—National Research Council is now compiling the tenth edition of "Industrial Research Laboratories of the United States," a directory of American industries and businesses which maintain scientific research and development facilities. Publication is scheduled for mid-1955.

Industrial laboratories that wish to be included in the directory can obtain

a questionnaire from James F. Mauk, Staff Associate, National Academy of Sciences—National Research Council, 2101 Constitution Avenue, N. W., Washington 25, D. C.

Circle No. 79 on Reader Service Card

PLANNED COMMUNICATIONS

Planned plant communications systems are discussed in a booklet entitled "The Nerve System of Controlled Manufacturing is Communications" which has been released by *TelAutograph Corp.*, 16 West 61st St., New York 23, N. Y. Six basic manufacturing problems are graphically illustrated and analyzed in this new 16-page, eight-color booklet. Proved solutions for the dissemination of information are included with an explanation of the use of *TelAutograph* "Telescriber" systems.

Circle No. 80 on Reader Service Card

VOLTAGE STABILIZERS

Raytheon voltage stabilizers—their performance characteristics, and their importance to industry—are covered in

a new 16-page catalog. Factual in content, Catalog 4-260 discusses applications for the voltage stabilizers and shows why they are of value to manufacturers using or producing electronic and electrical equipment.

Copies of Catalog 4-260 are available from the *Raytheon Manufacturing Company*, Department 6120-PR, Waltham 54, Mass.

Circle No. 81 on Reader Service Card

DYNAMIC TUBE COMPARATOR

A six-page, two-color pamphlet has been released by the Electronics Division of *American Machine & Foundry Company*, 1085 Commonwealth Ave., Boston 15, Mass., on its new dynamic tube comparator. Unretouched oscilloscope photographs are featured, as well as keyed and simplified block diagrams of the comparator. Specifications are included.

Circle No. 82 on Reader Service Card

DEFENSE ELECTRONICS

Complete facilities for defense electronics are detailed in a three-color, 32-page report just published by the Electronic Division of the *Otis Elevator Company*. Entitled "Electronics for Defense," it describes the extensive experience and resources for research, development, design and manufacture of electronic equipment which the com-

"UDEC II" DIGITAL ELECTRONIC COMPUTER

HIGH SPEED solution of a wide range of scientific, industrial and management problems is possible with the giant UDEC II (Unitized Digital Electronic Computer), which was recently constructed in a record-breaking time of three months through the use of the "building block" principle. It is the central computing element of a computation center operated by the Electronic Instruments Division of *Burroughs Corporation*, at 1209 Vine St., Philadelphia, Pa.

The 648 individual pulse chassis that comprise UDEC II are stacked in 31 vertical channels in a C-shaped steel rack, 7' high and 60' long. In the center

Workmen are placing building-block units in the 31 vertical channels of UDEC II.

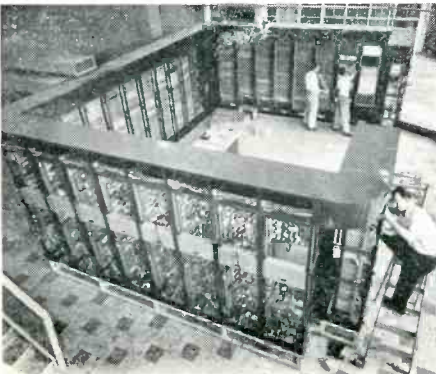

of the C formed by the machine are the various input and output mechanisms that feed information in and out of the computer, and the desk-size control console from which the entire computer is operated. UDEC II contains more than 3000 vacuum tubes, and more than 7000 germanium crystal diodes, as well as batteries of tiny magnetic cores. Close to 4000 cables interconnect the basic units.

Input equipment includes two teletype readers, each with a maximum input rate of six characters a second; and both a *Ferranti* and a *Burroughs* photoreader, operating at an input rate of 100 characters a second. At the output end, UDEC II can feed answers to one or more of the following five output devices—two teletype page printers and two teletype tape perforators, each with maximum output rates of six characters a second, and a *Burroughs* thermal printer which can deliver up to 30 characters a second.

The memory device is an 8½"-diameter magnetic drum which rotates at a speed of 3600 revolutions per minute. Maximum capacity of this internal storage unit is 5300 ten-digit words. Information and instructions are read in serial fashion into the memory where they are stored along magnetic paths (tracks) which circle the drum. Words are read into or out of a particular address or position on the drum by means of a number of reading heads spaced outside the drum around its periphery.

UDEC II uses a system of single address in which two instructions are contained in one ten-digit word. Average access time to information on the drum is 8.5 milliseconds.

Operation of UDEC II is fully automatic. The control section contains four separate flip-flop registers: (1) a program counter which controls the sequencing of instructions, (2) an address register which designates the location of the word involved, (3) a command register which specifies the operation to be performed, and (4) a Z counter. The latter unit has a two-fold function: it can determine and control the number of times the same operation will be performed on a series of numbers, and can also effect temporary modification of the address portion of an instruction.

As the basic arithmetic unit of the computer is a flip-flop adder, all arithmetic operations involve addition; subtraction is negative addition, multiplication is repeated addition, and division is repeated negative addition. UDEC II adds numbers in series-parallel fashion. Binary digits, or bits, representing each decimal digit within the machine are added in parallel; decimal digits themselves are added serially. The arithmetic unit of UDEC II can add or subtract two nine-digit decimal numbers in one one-hundred-twentieth of a second, multiply or divide the same two numbers in one twentieth of a second.

Circle No. 83 on Reader Service Card

pany offers to the Armed Services and industry.

Copies of this report may be obtained on letterhead request from the Electronic Division, *Otis Elevator Company*, 35 Ryerson St., Brooklyn 5, N. Y.

Circle No. 84 on Reader Service Card

DELAY LINES

General Catalog 54, offered by *Richard D. Brew and Company, Inc.*, Airport Rd., Concord, N. H., includes illustrations, descriptions, and technical data for lumped constant, distributed constant, and ultrasonic delay lines. Design, engineering, and manufacturing facilities are also discussed in this 12-page, two-color brochure.

Circle No. 85 on Reader Service Card

TRANSISTOR REPORTS

Two reports on transistor research listed in recent issues of the Bibliography of Technical Reports have been made available by the Office of Technical Services of the U. S. Department of Commerce. Both may be obtained from the Library of Congress, Publication Board Project, Washington 25, D. C.

"Transistor Circuitry for I.F. and Audio Amplifiers" covers research done by *Zenith Radio Corporation* for the Army Signal Corps in an effort to

hasten the replacement of bulky vacuum tubes in radio receivers by practical, low-cost transistors. (Code No. PB 114233—microfilm, \$2.75; photocopy, \$6.50.)

"Transistor Circuit Components," a survey of miniature electronic components for use in transistor circuits made by Wright Air Development Center, discusses components already available as well as those under development. (Code No. PB 114778—microfilm, \$2.25; photocopy, \$4.00.)

Circle No. 86 on Reader Service Card

COMMUNICATIONS RECEIVER

Collins Radio Company, Cedar Rapids, Iowa, has published an eight-page bulletin on its 51X-1 v.h.f. communications receiver. Outstanding features of this high performance airborne receiver are presented, specifications and dimensional drawings given, and associated equipment described and illustrated.

Circle No. 87 on Reader Service Card

BLAW-KNOX ACTIVITIES

Diversified manufacturing activities of the *Blaw-Knox Company* are presented in a recently published 48-page informational brochure. Entitled "This is *Blaw-Knox*," it contains illustrated material on all major departmental operations in the company's 11 divi-

sions: *Blaw-Knox Equipment, Buflorvak, Chemical Plants, Foote Construction, Lewis Machinery, National Alloy, Power Piping and Sprinkler Rolls, and Union Steel Castings.*

Copies of "This is *Blaw-Knox*" are available from *Blaw-Knox Company*, Farmers Bank Building, Pittsburgh 30, Pa.

Circle No. 88 on Reader Service Card

MEASURING INSTRUMENTS

Brief technical descriptions of 18 *Federal* measuring and testing instruments are given in a new general catalog. A two-color, eight-page presentation, it is available on request from *Rudolph Feldt, Manager, Instrument Division, Federal Telephone and Radio Company*, 100 Kingsland Rd., Clifton, N. J.

Circle No. 89 on Reader Service Card

COMPUTATION FORMULAS

National Bureau of Standards Circular 544, entitled "Formulas for Computing Capacitance and Inductance," by *Chester Snow*, contains 69 pages and 37 figures, and is available from the Government Printing Office, Washington 25, D. C., for 40 cents a copy.

Explicit formulas are given for the computation of (1) capacitance between conductors having a great va-

(Continued on page 38)

Broadband RF Power Meters

THE CHOICE OF ALL ARMED SERVICES
FOR MICROWAVE POWER MEASUREMENTS

POWER: PULSE and CW— $5\mu\text{W}$ to 5W average
FREQUENCY: 20MC — 10,000MC
ACCURACY: 5% Absolute at all ranges,
frequencies, temperatures

- **INDICATIONS:** Direct Reading
- **CALIBRATION:** Compensates for All Variables
- **R-F COMPONENTS:** 3, 6, 10 and 20db Attenuators, Bolometer Mount and Elements, R-F Cable
- **BOLOMETER:** Broadband, High Overload Capacity
- **PLUMBING:** $\frac{3}{8}$ " and $\frac{7}{8}$ " 50-ohm Coaxial
- **POWER SOURCE:** 115VAC $\pm 15\%$, 50-1000 cps
- **CONSTRUCTION:** Rugged, meets all JAN, MIL requirements

TYPICAL APPLICATIONS

Microwave Links . . . Television . . . Communications . . .
Radar . . . Telemetry . . . Signal Generators . . .
Laboratory Standards.

Write for descriptive literature to Department RE-1

Bruno - New York Industries Corporation

DESIGNERS AND MANUFACTURERS OF ELECTRONIC EQUIPMENT

460 WEST 34th STREET

NEW YORK 1, N. Y.

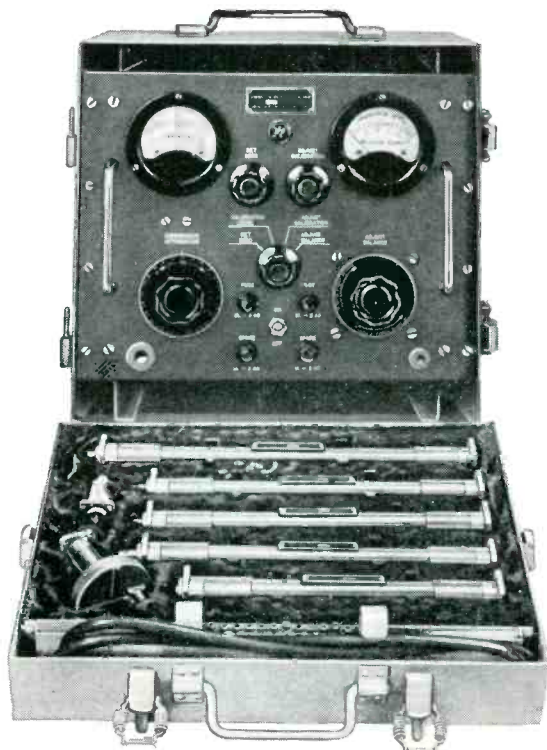

For more information, circle No. 8 on Reader Service Card

NEW TUBES

GOLD JUNCTION DIODE

A subminiature germanium diode employing a miniature gold junction has been announced by the Semiconductor Division of the *Hughes Aircraft Com-*

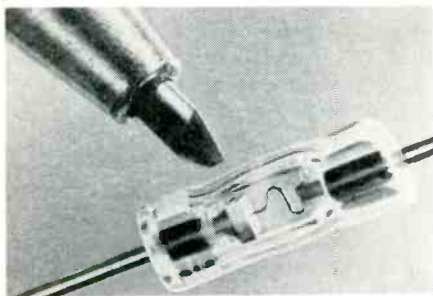

pany, Florence Ave. at Teale St., Culver City, Calif. Described as a true junction device, it has exceptionally stable mechanical and electrical characteristics.

The *Hughes* gold junction diode is manufactured with a fusion-sealed, one-piece glass body, impervious to external contaminating agents. Actual size of the diode body is 0.265" long by 0.130" wide, maximum. Its high forward conductance and high back resistance properties make it particularly suitable in such applications as magnetic am-

plifier circuits, clamps, d.c. restorers, and logical gates.

Circle No. 90 on Reader Service Card

CATHODE-RAY RADAR TUBE

Development of a 5" cathode-ray tube for radar applications has been announced by the Tube Department of the *General Electric Company*, Schenectady 5, N. Y. Type GL-5FP14-A utilizes a high-resolution electron gun which provides an exceptionally narrow trace on the screen. When used in aircraft PPI equipment, it is expected to allow earlier resolution of closely grouped ground targets.

Type GL-5FP14-A has a maximum line width limit specification of .25 mm. In the older GL-5FP14 type, with which it is electrically and mechanically interchangeable, the maximum line width limit specification was .50 mm. under similar operating conditions. This decrease in line width, or spot size, means that target identification will be aided considerably.

Circle No. 91 on Reader Service Card

21" COLOR TV TUBE

The first 21" rectangular color TV shadow mask picture tube to be man-

ufactured by *Allen B. Du Mont Laboratories, Inc.*, 760 Bloomfield Ave., Clifton, N. J., has been presented to Dr. Allen B. Du Mont, president, by F. P. Rice, Tube Division manager, and Kenneth Hoagland, chief engineer. Having a picture area of approximately 225 square inches and of metal cone construction, the tube will take its place in the *Du Mont* museum alongside other "firsts" in television.

Du Mont techniques for the manufacture of rectangular color TV tubes of the shadow mask type are now being applied to 21" and 22" rectangular glass envelopes in order to provide the largest size color TV picture yet developed. Quantity deliveries of large picture area rectangular tubes are expected to be made in 1955.

Circle No. 92 on Reader Service Card

WESTINGHOUSE TRANSISTORS

Types 2N54, 2N55, and 2N56 *Westinghouse* germanium *p-n-p* junction transistors are designed for low-power, low-frequency amplifier applications. Each is capable of dissipating 200 mw.

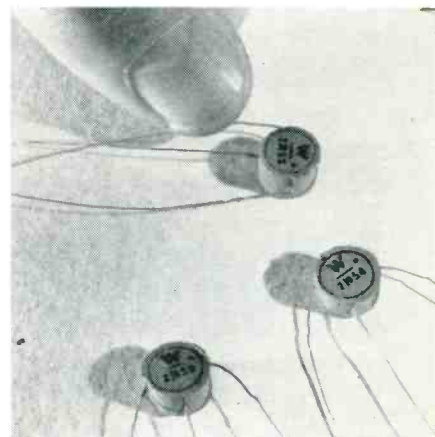

at 25° C, and each is provided with leads for wired-in installation.

Average current gain of the three transistors is: 2N54—0.97; 2N55—0.95; and 2N56—0.92. The average cutoff at the 6-mw. power level is 500 kc. Further information may be obtained from the Electronic Tube Division of *Westinghouse Electric Corporation*, Dept. T-291, Box 284, Elmira, N. Y.

Circle No. 93 on Reader Service Card

AMPEREX TRANSISTORS

Ampere Electronic Corporation has announced the availability of four *p-n-p* junction transistors—Types 0C70, 0C71, 080C and 081C. Complete specifications and data on all four units may be obtained from the Engineering Department of *Ampere Electronic Corporation*, 230 Duffy Ave., Hicksville, L. I., N. Y.

Both the 0C70 and 0C71 transistors have average noise figures of only 10 db and are particularly suited to hear-

TRANSISTORIZED CALCULATOR

AN experimental "all-transistor" calculator with a computing unit about one-half the size and requiring only 5% as much power as a comparable vacuum tube unit has been built by *International Business Machines Corporation* at Poughkeepsie, N. Y. More than 2000 transistors are used in the machine, a number of which are of a design devel-

oped by the company's own engineers to meet the operating characteristics required in computer circuits. This experimental engineering model is believed to be the first fully operative transistorized computer complete with automatic input and output.

The new machine is comparable in capacity to *IBM's* Type 604 electronic calculator which uses 1250 vacuum tubes. In addition to sharply reducing size, the transistors effect a 95% reduction in the power requirements of the electronic unit, eliminating the need for a bulky power supply and forced air cooling of components. Because transistors have a much longer life than vacuum tubes, *IBM* expects that the necessary maintenance of machines employing them will be significantly reduced from that of vacuum tube machines of today.

Printed wiring, replacing much of the wiring normally comprising a computer's nervous system, was incorporated into the design of the experimental calculator to simplify production and maintenance and greatly reduce space requirements. The model contains 595 printed wiring panels, each about two-thirds the size of an *IBM* card, on which the transistors are mounted.

Circle No. 118 on Reader Service Card

Experimental all-transistor computing unit is shown uncovered at the right with high-speed punching unit at left.



ing aids and other portable circuits. The 0C70 has a grounded emitter current gain of 20 to 40, while the 0C71 has a gain of 30 to 75. These units are de-

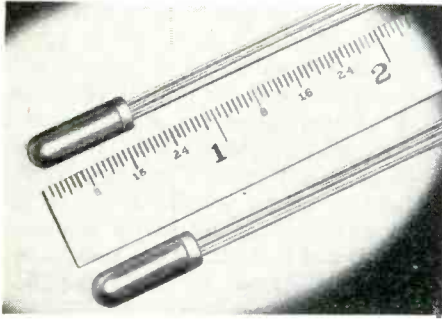

signed for mass production and are "all-glass" with true fusion seals.

The 080C and 081C are metal-cased transistors having the standard JETEC base and dimensions. The metal casing allows a higher collector voltage and a dissipation of 50 mw. at 45° C. Otherwise, the electrical characteristics are the same as for the 0C70 and 0C71.

Circle No. 94 on Reader Service Card

GERMANIUM JUNCTION DIODES

High forward conductances of up to 300 ma. at 1 volt are provided by new Raytheon germanium junction diodes, as well as high reverse resistances, exceptional electrical and mechanical stability, and freedom from hysteresis, drift, flutter, etc. The CK741 and CK747, with very low forward impedance and high ratios of reverse-to-forward resistance, are useful for computer and similar applications, while the CK745

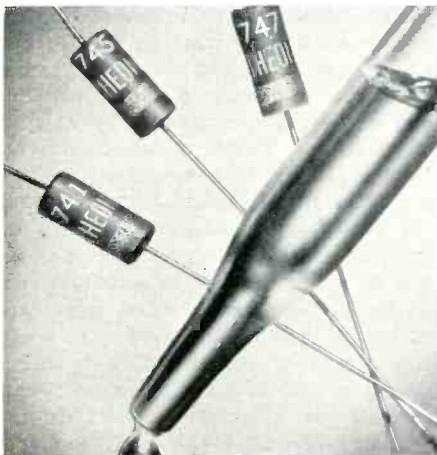

is rated for a peak inverse voltage of 125 volts.

Further technical details may be obtained from Technical Information Service, Raytheon Manufacturing Company, 55 Chapel St., Newton, Mass.

Circle No. 95 on Reader Service Card

RCA "SERIES-STRING" TV TUBES

Twenty new types of "series-string" receiving tubes have been made available
(Continued on page 39)

NOW...

A SUPER LINE OF ACCESSORIES THAT SURPASS ACCEPTED STANDARDS—for STUDIO, MOBILE and MICRO-RELAY EQUIPMENT

Famous BALANCED TV Head supporting a TV camera. Both are mounted on one of our all-metal tripods, which in turn is mounted on a Ceco Spider Dolly. Here is a "team" outstanding for versatility and maneuverability in studio or on location.



New Model C BALANCED TV Head provides correct center of gravity in a FLASH—without groping.

No matter what focal length lens is used on the turret, the camera may be balanced by the positioning handle without loosening the camera tie-down screw. Something every cameraman has always desired.

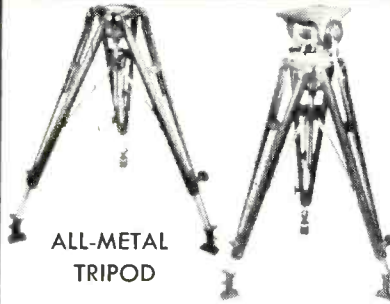
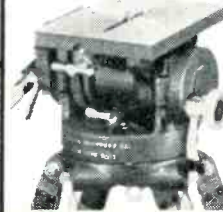

ALL-METAL TRIPOD

Has fixed shoe, also fixed spurs. Rubber pads prevent slipping. These may be flipped out of position, leaving the spur exposed. One lock knob for setting up and breaking down tripod legs, which operate in unison.

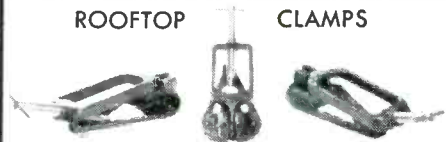

ROOFTOP

CLAMPS

Secures tripod of camera or beam reflector to car top. Made of bronze and brass, with ball-type, yoke-swivel construction. A lot depends on roof clamps—that's why these are made with EXTRA care.



Similar to BALANCED TV head, this new Professional Junior Spring head is ideal for Vidicon cameras weighing up to 25 lbs. Spring head tilt assures camera will return to neutral position when lever is in unlocked position... a wonderful safety factor.



MINI-PRO
New lightweight all-metal MINI-PRO Tripod fulfills a tremendous need—especially for Vidicon cameras weighing up to 8 lbs. Low height measures 33" and maximum height 57". Reversible spur and rubber cushions. Maximum leg spread 35°.

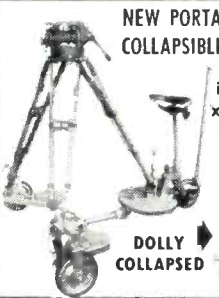

NEW PORTABLE 3-WHEEL COLLAPSIBLE DOLLY

Dolly folds to fit into carrying case—18"x12"x36". Weighs only 60 lbs. Has wheel in rear for steering, which may be locked for straight dollying.

DOLLY COLLAPSED



FRANK C. ZUCKER
CAMERA EQUIPMENT

DEPT. R-1-13 1600 BROADWAY • NEW YORK CITY

For more information, circle No. 9 on Reader Service Card



MONITORADIO for a thoroughly coordinated 2-way communication system.

Now every member of every department can have radio communication for as little as \$49.95

Write today for further information.

MONITORADIO RADIO APPARATUS CORPORATION
55 North Jersey St., Indianapolis, Ind. Phone: ATlantic 1624

For more information, circle No. 10 on Reader Service Card

got enough EARS?

BE ON THE CONSTANT ALERT

All Departments Can Now Listen to Every Vital Message

- Nation's most complete line of monitor receivers.
- Crystal controlled or tunable for any VHF FM communication system.
- Mobile or stationary receivers.
- Prices to meet any budget.
- Certified for civil defense use.

Personals



DR. K. C. BLACK, as head of the communications engineering department of *Raytheon Manufacturing Company*, Waltham, Mass., will be responsible for design and development of new communications products. He has recently been associated with *Polytechnic Research and Development Company*. An outstanding authority in electronics, Dr. Black's work on proximity fuses, radar, and electronic counter measures during World War II was widely recognized.



DR. JAMES HILLIER, pioneer in the development and use of the electron microscope, has joined the research and engineering staff of *Radio Corporation of America* at Princeton, N. J., as an administrative engineer. Former director of the research department of *Melpar, Inc.*, Dr. Hillier was with the *RCA Laboratories* from 1940 to 1953, first as a research physicist and later as supervisor of fundamental electron microscope research.



EDWARD L. NELSON, who has been technical director of the Signal Corps Engineering Laboratories at Fort Monmouth, N. J., since 1951, has now been appointed scientific chief of research and development for the Army Signal Corps. Prior to his service as technical director, Mr. Nelson was associated with *Bell Telephone Laboratories* for many years in various capacities. He is the holder of ten patents on improvements in radio and telephone apparatus.



JAMES W. NELSON, JR., has been appointed to the staff of the new *G-E Microwave Laboratory* in Palo Alto, Calif., as manager for advanced tube development. With the *General Electric Company* since 1946, his most recent position was that of joint project leader on color TV receiver development. Prior to joining *G-E*, Mr. Nelson was a research associate at the NDRC Radiation Laboratories at University of California and Massachusetts Institute of Technology.



HUGH PRUSS, a leading authority in the field of modern telemetering, is now affiliated with *Audio Products Corporation*, Los Angeles, Calif., as head of telemetering research and development. He was previously technical operations director and chief engineer of the Telemetering Division of *Raymond Rosen Engineering Products, Inc.* Mr. Pruss spent 12 years with *Convair*, and has been interested in aviation electronics since 1941.



ALBERT S. TAKACS has joined the Engineering Department of *Vitramon, Incorporated*, capacitor manufacturer of Bridgeport, Conn. Under the supervision of Mr. Leo Geary, his special assignment will be to uncover new applications for *Vitramon's* porcelain capacitors in addition to continuing product improvement. Mr. Takacs was formerly development engineer of industrial process control instruments for *Manning, Maxwell & Moore, Inc.*

Diode Amplifier

(Continued from page 19)

the power supply clock, the flyback requirements would be satisfied on a pulse-to-pulse basis because the point D would be allowed to fly back or not as necessary. During the time the clock pulse is on and when point A is up, point E is at ground and conventional current flows through the path A-C-D-E. After the power clock pulse is off, point E is driven positive by the other clock phase, disconnecting the diode between D and E. At this same time, point B may be charging the diode amplifier for the next power clock pulse. The series diode and resistor between C and D provide critical damping of the flyback.

Other Circuits

Further development of the diode-amplifier concept leads to the design of a complete "pulse repeater stage" for application in electronic digital computers. The circuit at left in Fig. 6 satisfies the essential requirements for a computer stage. It is a combination of the transformer-diode-coupled amplifier (Fig. 4) and an inhibiting gate. Extra logical "or" gates may be added as desired. Delay lines may be used but can be avoided in most cases, since the carriers in the amplifier diode store information. It may be necessary, however, to use some delay lines to time the inhibiting pulses accurately.

The diode amplifier may be used as the basis for a variety of "dynamic" flip-flop circuits—oscillators which can remain stable either in an oscillating or a nonoscillating state. In Fig. 6 (center) is a circuit which stores energy between clock pulses in a delay line. The oscillating state is started by raising point B to +2 volts to inject carriers. On the clock pulse immediately following, point B is raised to +20 volts, and the pulse travels down the delay line. At point C, it "sees" an open circuit, and so is returned in the same polarity at the proper time to inject more carriers into the amplifier diode. The delay line serves as an impedance-matching device as well as a delay line, as it can provide the necessary current. In injecting carriers into the amplifier diode, however, the delay line "sees" a very low impedance, and so some energy is returned down the line for a third travel, negative this time. At point C, the negative pulse is matched and absorbed; if it were not absorbed, it would travel back down the line a fourth time and prevent the next carrier injection.

Another flip-flop circuit (Fig. 6, right), is a current-doubler type. Essentially, it charges two capacitors in series and then discharges them in parallel. If point B is pulled positive, diodes

No. 1 and No. 3 are cut off and current flows through the path B-C-D-E, thus charging the two capacitors in parallel. When point B becomes negative, diode No. 2 is cut off, and current flows through the paths E-D-B and E-C-B, thus discharging the capacitors in parallel. When used with the germanium diode amplifier, this circuit makes a flip-flop whose applied frequency can be varied over a very wide range. Many other flip-flop circuits have been developed, some of which are even simpler and less expensive than those described here.

Silicon junction diodes have a much faster transient recovery than germanium junction diodes, and therefore can be used in faster circuits. In experiments carried out at the Bureau to study the usefulness of the silicon diode as a diode amplifier, a current-doubler type of flip-flop operated satisfactorily with a clock frequency of 25 mc.; the circuit exhibited start-stop times of about 100 millimicroseconds. It should be possible to achieve much higher frequencies by using diodes with even shorter decay times.

Broadcast Application

(Continued from page 20)

was an impossible task; therefore, a remote control system was established for a tape machine located some distance from the operating position. This remotely controlled machine, rack-mounted at a convenient height, is used as a spot and station-break recorder and playback unit.

Incorporated in this remote control system for the tape machine is a unique "lock-out" feature which almost completely eliminates errors in tape cueing. Basically, the control unit functions to allow the playback of only one spot—after that, indicator lights inform the operator that the next spot has not been cued, and lock-out circuits prevent the recorder from being operated again

Fig. 4. Remote control system circuitry.

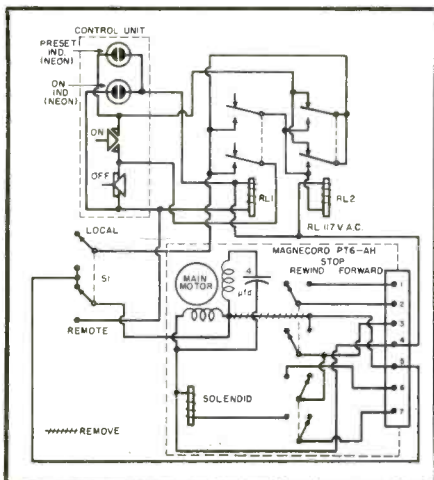

until the operator goes to the tape machine and recues the next spot. When the "start" button on the remote unit is depressed, the machine will play the next spot; a "preset" lamp informs the operator that the machine is "ready."

The control unit, containing two indicator lamps and two push buttons, is mounted on the control console, as shown in Fig. 3. An "auto-manual" toggle-type switch is mounted above the *Magnecorder* on the rack; in the "manual" position, it allows the *Magnecorder* to be operated in normal fashion (as though no remote system were connected). After the engineer checks and cues his tape to the first spot announcement, he throws the "auto-manual" switch to "auto" position and the function switch on the *Magnecorder* to "forward." The machine is then preset and ready for the first spot.

After the first spot is "aired," the "off" push button is depressed, which stops the machine. However, the "preset" lamp is no longer lit and the machine will not start again if the "on" push button is depressed. Only after the engineer has recued the tape at the station-break machine rack may the machine again be started from the remote (console) position.

Advantages of System

To summarize, the advantages are:

1. The control room engineer may operate the station-break machine from the normal operating position.
 2. After operation, the machine is locked-out until the next spot has been cued.
 3. A preset lamp informs the operator that the machine has been cued and is ready for the next operation.
- In addition, the circuit has been designed so that failure of any relay or relay contact in the remote system will not start the machine prematurely nor prevent its normal operation from the rack position.

It should be noted that when the *Magnecorder* is in remote preset position its idler wheel is engaged against the capstan while the capstan is not rotating. However, this does not seem to cause any "flat spots" on the idler; in a recent test made after four months of daily operation no damage to the idler wheel was observed.

The circuitry of the remote control system is displayed in Fig. 4. Two 117-volt a.c. relays are employed; RL_1 provides power to the drive motor in the *Magnecorder* while RL_2 provides a lock-out when energized, thereby permitting only one "on-off" operation of RL_1 . To operate RL_1 again, RL_2 must be de-energized by removal of power to the remote system; either the "auto-manual" switch or the *Magnecorder* "rewind-off-forward" switch can be utilized for this purpose.

Choice of Stations COAST to COAST



MODEL 655

Slim-Trim
DYNAMIC
for TV and BC



Versatile,
Rugged—
for Stand,
Hand or
Boom Use

PROVED ON TOUGHEST JOBS Response 40 to 20,000 cps

Achieves more extended efficient high-frequency response than in any microphone commercially available. Output level —55 db. Affords high signal-to-thermal-noise ratio. Acoustically treated grille minimizes effect of wind and breath blasts. Omnidirectional. Easily concealed in studio props. Has superior *Acoustalloy* diaphragm. Impedance 250 ohms; easily changed to 50 ohms. Cannon UA-3 connector. TV gray finish. 18 ft. cable.

Model 655. List Price \$200

MODEL 654

Similar to the "655". Response 50 to 16,000 cps. Output —55 db. Recessed selector gives 50 or 250 ohms impedance. Swivel stud Cannon XL-3 connector. 18 ft. cable. List \$95.

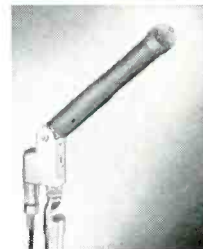

Available from Authorized E-V Distributors. Normal trade discount applies. Write for Catalog No. 119.

NO FINER CHOICE THAN

Electro-Voice

ELECTRO-VOICE, INC. • BUCHANAN, MICH.

Circle No. 11 on Reader Service Card

Communication Review

(Continued from page 22)

synchronous telegraph transmissions modulate a single radio carrier wave—by causing the carrier to assume one of four specific frequencies with 400-cps separations. It is being manufactured by *Northern Radio Co., Inc.*, 147 W. 22nd St., New York 11, N. Y.

Transmitting equipment consists of a Twinplex combiner Type 177 Model 1



and an r.f. frequency shift keyer such as *Northern Radio* Type 105 Model 4. The combiner converts the four possible conditions of two telegraph signals respectively into one of four voltages related in a 0-1-2-3 manner; its output voltage frequency-modulates the keyer.

Receiving equipment consists of a Twinplex converter Type 178 Model 1 (shown in the photograph) and a single or diversity receiver such as *Northern Radio* Type 110 dual diversity receiving system. The converter demodulates and separates the four audio tones from the

radio receiver(s) into two channels, each carrying the originally transmitted intelligence.

Circle No. 96 on Reader Service Card

AIRBORNE TRANSCEIVER

Admiral Corporation, 3800 Cortland St., Chicago 47, Ill., is producing a radio receiver-transmitter for use in U. S. bombers and fighter planes that can be tuned to 1750 v.h.f. and u.h.f. frequencies. The first of its kind, this airborne all-channel transceiver operates between 225 and 400 mc. on the u.h.f. band, and can be set for automatic tuning to any 20 of the v.h.f. and u.h.f. channels. An entirely different set of 20 channels can be selected each day.

Containing 56 tubes and upwards of 3000 component parts, the AN/ARC-27 is being installed in such Air Force planes as *Boeing's* B-47 and B-52 bombers and *North American's* new F-100 Super Sabrejet. All Navy aircraft will also carry this radio equipment.

Circle No. 97 on Reader Service Card

FRONT-MOUNT ANTENNAS

Two new and improved front-mount antennas are being produced by *The Antenna Specialists Company* which are said to provide easier installation, greater efficiency and longer life than similar units on the market. Information on both models may be obtained from Mr. M. Friedberg, President, *The Antenna Specialists Company*, 12435 Euclid Ave., Cleveland, Ohio.

The ASP-80 is a "disguised" antenna for detectives, cab spotters, and similar users who wish to conceal the fact that they have two-way communications; it duplicates the appearance of an ordinary automotive telescopic antenna, except that the joints are permanently connected to withstand transmitting currents. The other antenna, designated as ASP-85, has a tapered whip rod, and is intended for taxis and service vehicles utilizing a front-mount or rear-deck antenna.

Circle No. 98 on Reader Service Card

MOBILE BASE STATIONS

Base stations designed for the 25-54 mc. and 450-470 mc. bands have been announced by the Mobile Communications Department of *Allen B. Du Mont Laboratories, Inc.*, 760 Bloomfield Ave., Clifton, N. J. They are intended for use with two of *Du Mont's* mobile receiver-transmitter systems introduced during 1954, as well as with other makes of mobile radio equipment.

Type MCA-151-A is for operation in the 25-54 mc. band, while Type MCA-450-A and 451-A (modifications of the

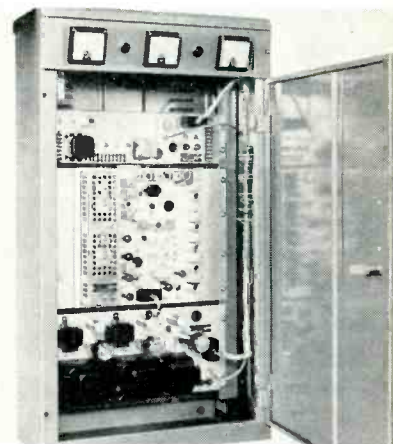

same base station, as shown in the photograph) are for operation in the 450-470 mc. range—MCA-450-A covers the 450-460 mc. commercial band and MCA-451-A covers the 460-462 mc. and 468-470 mc. class A citizens bands. Both stations incorporate transmitter, receiver, termination panel, and power supply in a single metal desk-mounting cabinet with front and rear doors for complete accessibility.

Circle No. 99 on Reader Service Card

REMOTE CONTROL DISPLAY

At the 36th annual convention of the American Gas Association in Atlantic City, N. J., a complete, functioning system of electronic equipment for controlling a distant, virtually unattended gas turbine pumping station was demonstrated by the *General Electric Company*, Syracuse, N. Y. Controls and equipment controlled were located in two separated rooms outside the convention auditorium. The audience could

TV-AM-FM SET PRODUCTION

Information based on latest reports from RETMA.

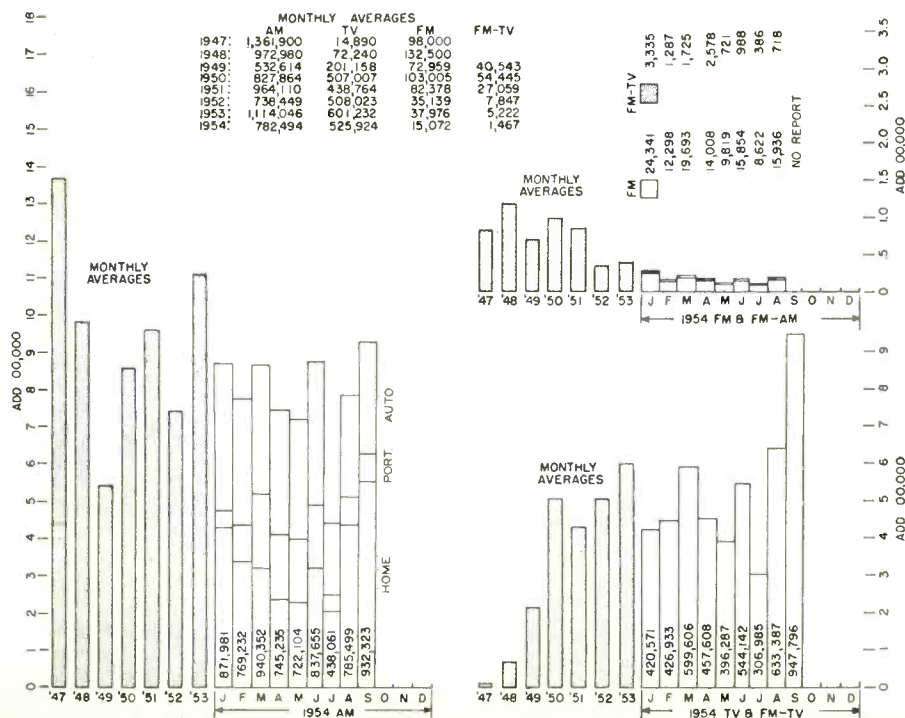

see what was happening through the medium of closed circuit TV.

The two rooms served as dispatch station and remote gas turbine pumping station, connected only by microwave radio. With this communications and control link, the dispatcher not only received and sent teletype, telephone, and radio messages between the two "stations," but also started, adjusted the speed and precisely controlled the "gas turbine driven compressor." Effects of his actions were reported via the microwave radio and telemetering equipment and indicated on meters.

Circle No. 100 on Reader Service Card

GLOSSARY OF COMMUNICATIONS

What is believed to be the first formal glossary of words and definitions peculiar to the field of microwave and mobile radio communications is now available. The 39-page booklet utilizes sketches, diagrams and charts, as well as text, to define esoteric terms which describe the theory, nature and operation of radio communications equipment. Entitled "Microwave and Mobile Communications Terms," it may be obtained on request from Dept. P-368, Engineering Products Division, Radio Corporation of America, Camden, N. J.

Circle No. 101 on Reader Service Card

LIFEBOAT RADIO EQUIPMENT

Lifeboat radio equipment will be supplied to troop transports of the Military Sea Transportation Service, U. S. Navy, by the Marine Division of *MacKay Radio and Telegraph Company*, a subsidiary of *American Cable & Radio Corporation*, 67 Broad St., New York 4, N. Y. An order for 100 Type 402-A units was recently placed by the Bureau of Ships, Washington, D. C., to provide for communication between lifeboats and shore or shipboard stations.

Type 402-A, developed specifically for passenger vessels, consists of a compact, rugged radiotelegraph transmitter-receiver which can be operated by untrained personnel. A built-in automatic distress signal keyer permits the transmission of sequences of the Inter-

national Auto Alarm Signal and SOS signals on 500 kc., followed on 8364 kc. by more distress signals and by a long dash for use by radio direction finders.

Circle No. 102 on Reader Service Card

TELEPHONE SYSTEM IN BREWERY

How the *Jacob Ruppert Brewery* makes use of an internal telephone system in controlling quality and integrating complex stages of brewery operation is told and pictured in an eight-page case history issued by the manufacturer of P-A-X business telephones. Copies of the booklet are available from *Automatic Electric Sales Corporation*, 1033 W. Van Buren St., Chicago 7, Ill.

Circle No. 103 on Reader Service Card

News Briefs

(Continued from page 27)

ity, Mr. McDaniel will now supervise both the technical publicity operations and the "Westinghouse Engineer" magazine. He replaces C. A. Scarlott, who has resigned to accept the position of manager of technical information services at the Stanford Research Institute, Palo Alto, Calif.

Circle No. 104 on Reader Service Card

BERKELEY SERVICES

The *Berkeley division of Beckman Instruments, Inc.*, 2200 Wright Ave., Richmond, Calif., has announced the formation of an integrated engineering group to provide a complete engineering service for the design, construction and installation of industrial recording and control systems.

Manufacturer of the EASE analog computer, the *Berkeley division* has also announced the availability of a national network of analog computing and simulation facilities. Independent organizations located in Richmond and Los Angeles, Calif., Baton Rouge, La., Birmingham, Ala., Roseland, N. J., and Arlington, Mass., are fully equipped with EASE computers and linked in a network to provide full interchange of experience and operational techniques.

Circle No. 105 on Reader Service Card

COLOR KINESCOPE DEPARTMENT

Establishment of a special Color Kinescope Operations Department has been announced by the Tube Division of *Radio Corporation of America*, Harrison, N. J. The new department, which will have its headquarters at the *RCA* plant in Lancaster, Pa., will be devoted exclusively to the engineering and manufacturing of color television picture tubes. Harry R. Seelen, associated with *RCA* tube engineering and manufacturing for nearly 25 years, has been appointed manager.

Circle No. 106 on Reader Service Card

TECHNICAL BOOKS

"TELEVISION—The Electronics of Image Transmission in Color and Monochrome" by V. K. Zworykin and G. A. Morton, *RCA Laboratories*. Second Edition. Published by *John Wiley & Sons, Inc.*, 440 Fourth Ave., New York 16, N. Y. 1037 pages. \$17.50.

During the 14 years following the first edition of this book, television grew from a restricted experimental field to a nation-wide major industry. Although most of the fundamental principles were outlined in the first edition, profound engineering advances have made necessary the revision of every chapter and the complete rewriting of many.

The organization of material in this second edition follows closely that of the first. New sections deal with semiconductors, photoconductors, and recent developments in photoemitters and phosphors. There is a discussion of the pickup tube problem and the camera tubes, such as the image orthicon and Vidicon, which have been developed as a solution to this problem. Color television is treated both from the standpoint of the fundamental principles involved and its practical aspects, and the specialized features of industrial TV are presented.

"TABLE OF SINE AND COSINE INTEGRALS FOR ARGUMENTS FROM 10 TO 100," National Bureau of Standards Applied Mathematics Series 32. 187 pages. \$2.25. (Order from the Government Printing Office, Washington 25, D.C.)

In pure mathematics, the sine and cosine integrals have long played an important part in the theory of numbers and in the calculus of probabilities. Lately, however, they have assumed a growing practical importance. Apart from their application to almost every branch of theoretical physics, they are now encountered in engineering problems of fundamental character, so that complete tables of numerical values have become indispensable.

This volume is a reissue of the table prepared by the Mathematical Tables Project of the Federal Works Agency, Works Project Administration for the City of New York, under the sponsorship of the National Bureau of Standards, published in 1942 and known as Mathematical Table 13. The book contains numerical values of $Si(x)$ and $Ci(x)$, $x = 10(.01)$ 100, 10D. In addition, there are auxiliary tables of multiples of $\pi/2$, $\frac{1}{2}p(1-p)$, $p(1-p^2)/6$ and $q(1-q^2)/6$, where $p + q = 1$, to facilitate interpolation.

Professional Card

FRANK H. McINTOSH

Consulting Radio Engineer

1216 Wyatt Bldg., Washington 5, D. C.

MEtropolitan 8-4477

Member AFCCE

Circle No. 12 on Reader Service Card

NEC Digests

(Continued from page 14)

oscilloscope trace varied with this probe spacing also. If the distance between the probe and the plate were varied until the slope of the trace had some fixed value, then the probe spacing would always be the same and the crossing point would be a measurement of the clad thickness.

"POWER GAIN OF A DIELECTRIC AMPLIFIER" by Stanley Zisk, Naval Ordnance Laboratory.

A DIELECTRIC amplifier is defined as "a device which, in order to obtain amplification or control, uses nonlinear capacitors either alone or in combination with other circuit elements." The dielectric amplifier circuits which have previously been devised employ an r.f. power source in the range from 1 to 5 mc. and have a bandwidth exclusive of coupling networks extending from d.c. to about 10 kc. Input to the amplifier usually is directly across one or two nonlinear capacitors of 400 to 1000 μfd . capacity, which therefore presents a high impedance at audio frequencies. The dissipation factor of these capacitors as measured on a bridge is as high as 8%, indicating that the power loss in the input circuit is not negligible. Although several analyses have been made of dielectric amplifier operation, no one to the author's knowledge has heretofore measured the input power, which is an important factor in most dielectric amplifier design problems. Accordingly, a project was undertaken to determine the actual power gain of a dielectric amplifier.

It was first necessary to consider the principles of dielectric amplifier operation. Presently available nonlinear capacitors are made with a ceramic dielectric containing a large percentage of barium titanate, other compounds being added to modify the electrical and physical characteristics of pure titanate. Such capacitors exhibit a nonlinear and usually multivalued relationship between charge and applied voltage, similar to the hysteresis loop of a ferromagnetic material. In the

analysis of networks containing nonlinear capacitors, the term "capacity" is ambiguous. When voltages of different frequencies are applied to such a capacitor, the capacities presented to the various voltage sources are not likely to be the same. "Incremental capacity" is a more revealing quantity than "capacity." When a d.c. voltage is applied in series with a small a.c. voltage and the resulting a.c. current is measured, the incremental impedance of the capacitor is found to vary as a function of the d.c. voltage.

Unlike ferromagnetic core materials, the hysteresis loss of a nonlinear capacitor is relatively low; consequently, the latter can be incorporated in a resonant circuit without excessive heating. Thus, an a.c. signal can be used to vary the resonant frequency of a tuned circuit, producing a much greater impedance change per unit input voltage than can be obtained with the capacitor alone (Fig. 1). This so-called "resonant" amplifier circuit holds the greatest possibility for practical application, since voltage and power gains greater than unity can be obtained with the resonant amplifier as opposed to the nonresonant type which produces positive power gains but voltage gains of the order of 0.3.

For measuring the input power to an experimental dielectric amplifier, a circuit similar to a nonresonant dielectric amplifier was constructed. Temperature of a *Radiation, Inc.* Type R2-226 500- μfd . capacitor was kept constant as were the a.f. voltage and the frequency of the a.f. and r.f. sources. In this way, the incremental capacitance and small-signal loss of the capacitor could be measured under conditions similar to dielectric amplifier operation.

An analysis of the amplifier revealed that for maximum output power the load resistance should be three times the r.f. resistance of the coil plus nonlinear capacitors. Under these conditions, the total Q equals 0.75 times the unloaded Q of the resonant circuit. In the experimental unit, the equivalent resistance of the tuned circuit was 4000 ohms at 2.5 mc., requiring a load resistance of 12,000 ohms and giving a Q of 27 unloaded and 21 loaded.

The r.f. source which was used provided 12 ma. of r.f. current, giving 36 volts across the two capacitors in series at the maximum-sensitivity point. If the unloaded Q had been higher or lower than 27, the resulting difference in the r.f. voltage would have required a respectively lower or higher value of load resistance than the calculated optimum to obtain the best gain. The calculated voltage gain of the amplifier was 1.3, and the measured gain 1.1. For an input of 1 volt, the output power

would be 10^{-4} watt and the input power 5×10^{-8} watt, a power gain of 2000.

It was noted in the course of the work that the results of a given series of measurements could not be repeated at a later time, because the characteristics of a nonlinear capacitor are a function of the history of voltages applied. Repeatability was obtained after a suitable routine of measurements was established.

Pole Mount Station

(Continued from page 9)

units located on separate panels. The transmitter panel includes a power supply that also serves the exciter. The receiver panel has its own independent power supply so that the transmitter and receiver can operate independently. Thus, the equipment can be used as a one-way (simplex) as well as a two-way (duplex) system. A one-way link is usually sufficient for remote control of v.h.f. transmitters, or pickup of a slave v.h.f. receiver.

The exciter unit supplies one-half watt of r.f. driving power to the transmitter. It consists of a crystal oscillator, a phase modulator, a two-stage push-pull and a buffer amplifier. A frequency doubler and two triplers multiply the crystal frequency by 18 to produce an exciter output frequency of approximately 52 mc. This frequency is again multiplied by 18 in the transmitter.

A Pierce oscillator controlled by a low temperature coefficient crystal is electronically coupled to the phase modulator circuit. No crystal heater is required. Frequency stability is $\pm .005\%$ over a temperature range of -30°C to $+50^\circ\text{C}$. A vernier capacitor connected between control grid and ground permits a slight adjustment of crystal frequency.

Coupling to the grids of the phase modulator tubes is accomplished by means of tuned circuits, so designed that the r.f. voltages at the two grids are 90° out of phase. Modulation is accomplished by applying 180° out-of-phase components of an audio amplifier output to the r.f. ground ends of the tuned inductances, thus varying the gain of the tubes at an audio rate.

Three multiplier stages are included in the transmitter. Tuned circuits for each multiplier stage have been designed with limited tuning range to preclude incorrect adjustments. The output circuit consists of a half-wave coaxial resonator in the plate circuit of the final tripler, giving an output of 2 watts at any desired frequency in the 890-960 mc. range. The output coupling loop is designed to match a 52-ohm coaxial line.

An r.f. monitor circuit, consisting of a small loop, crystal diode and bypass

Fig. 1. "Resonant" dielectric amplifier circuit provides gain greater than unity.

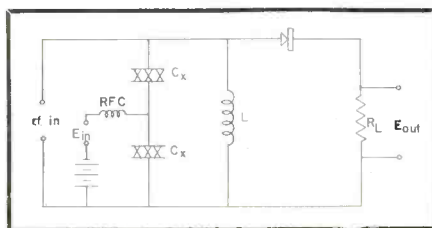

capacitor, is located on the back of the transmitter. By this means, the panel meter may be used to indicate resonance in the final cavity as well as relative transmitter power output. Connections for an external monitoring meter are also provided. This output, approximately 100 microamperes, may be used to operate an alarm for indicating transmitter failure.

The self-contained transmitter-exciter power supply is composed of two units. A low voltage unit supplies plate (300 volts at 120 ma.) and heater power for the exciter and the first multiplier stage of the transmitter. A high voltage unit supplies plate power (750 volts at 250 ma.) for the last two stages of the transmitter. Both units are protected by "slo-blo" fuses, and operate from a 105/115/125 volt, 60-cycle supply with a total load of about 450 watts.

Receiver Unit

The receiver is a double superheterodyne type, designed for FM reception. It includes an r.f. coaxial cavity type preselector, capacity-tuned over the 890-960 mc. band. The tuning control can be turned by a crank mounted on the front panel. When the receiver is mounted in a rack with the transmitter unit, various voltages and currents can be read on the panel meter incorporated in the transmitter unit.

The receiver unit includes a program amplifier that produces high-fidelity low-level output suitable for feeding into multiplex equipment. A monitoring amplifier is also included to provide a higher output level suitable for energizing a loudspeaker.

Mounted on the receiver panel is a carrier-operated relay that can be used either for control purposes or for continuous monitoring of the radio circuit. Voltage developed by the receiver carrier causes the relay to operate. The relay contacts, rated at a maximum of 150 watts, 115 volts a.c., may be used to control an alarm, external indicator, etc.

Panel controls of the receiver are as follows: relay control, external meter, switch, audio gain, power "on-off," r.f. preselector, and all coil and transformer tuning. (High-frequency i.f. stages are adjusted only if operating frequency is changed. Low-frequency i.f. stages are prealigned at factory.) Power required is about 100 watts at 105/115/125 volts, 60 cycles.

Frequency-Division Multiplexing

Transmission of more than one channel simultaneously will ordinarily be accomplished employing the method of single-sideband frequency-division multiplex widely used in carrier telephone and telegraph practice. This is carried out by modulating or heterodyning voice

frequencies to successively higher positions in the frequency spectrum.

Under normal conditions, the transmitter and receiver operating as a system will provide suitable signal-to-noise ratios when each channel is modulated approximately 4 radians, although this may be increased or decreased somewhat (provided the 150-kc. limit is observed) depending on the particular conditions of channel load and frequency.

Since each installation will differ in the number and type of communication channels, it is only possible to give a typical example (see Table 3) to indicate how the total permissible frequency deviation is divided between channels.

This example assumes that each of the four channels is occupied with a single frequency tone developing the highest modulating frequency for that channel. The total frequency deviation will, under such conditions, reach the total shown on an instantaneous basis when all deviations add in the same direction. For voice transmission, these conditions are rarely encountered due to the frequency distribution and the syllabic character of speech signals.

It is apparent that with fewer than four channels the modulation index per channel can be increased over that shown. Frequency-division multiplex equipment normally incorporates peak limiting circuits that are effective in preventing overmodulation.

Conclusion

While not a radically new design in the usual sense of the word, this adaptation of conventional equipment, which provides a reliable means of communication for short distances at minimum cost, essentially represents a calculated attack upon the recurring problem faced by any new and promising tool such as microwave. Since it is of relatively recent origin, microwave is sometimes used unwisely and without due recognition of what it can and cannot do. By providing a means to employ this versatile medium in a modest and inexpensive way, especially for those unacquainted with its characteristics, it is believed that the best interests of all concerned will be served.

It should be remembered that microwave itself is not untried but has

Transmitter Specifications	
Power output	2 watts
Operating frequency range	890-960 mc.
Crystal frequency	2.747-2.962 ms.
Crystal circuit frequency adjustment	± .01%
Crystal multiplication	324 times
Frequency stability	± 0.006%
Spurious emission	at least 40 db down
Peak phase modulation capability	± 30 radians or ± 150 kc.—whichever is smaller
Distortion	less than 0.5% (measured at 6 db below peak modulation level with 5-kc. tone)
Baseband* characteristic (measured through receiver)	± 2 db, 300 to 30,000 cycles (referred to level at 5000 cycles)
R.F. output impedance	52 ohms

Receiver Specifications	
Operating frequency range	890-960 mc.
Bandwidth (approximate)	0.5 mc.
I.F. frequencies (two)	115.8-123.5 mc. and 19 mc.
Equivalent noise input (ENI)	4.6 μv.
Spurious response—not less than 40 db down	
Carrier-operated relay sensitivity	1.6 x ENI
Frequency stability	better than ± .01%
Monitor amplifier output	0.5 watt max.
Baseband channel output**	+15 dbm into 600- or 150-ohm load
Baseband channel audio response characteristics (referred to level at 5000 cycles):	
Characteristic A	flat ± 1 db from 300 cycles to 30 kc.
Characteristic B	1060-μsec. deemphasis
Characteristic C	75-μsec. deemphasis
Quieting	within 3 db of theoretical limit for high carrier-to-noise ratios

*Baseband refers to a band of frequencies containing all frequency components of a multiplex signal.
 **Using audio deemphasis characteristic A, this output can be obtained for carrier frequency deviations of ± 50 kc. or more. Baseband channel distortion is less than 1.0% from 300 cycles to 15 kc. with frequency deviation of ± 150 kc.

Table 2. System specifications.

proved itself in many operating installations and in several frequency bands. Standard 960-mc. equipment has, for example, served a California electric utility company in mountain-top locations, often snowbound, for periods as long as 11 months, operating continuously and without maintenance. Moreover, this particular adaptation—the MM-9—is designed to fit into standard systems as a simplified leg circuit, or can be used as a 2- to 6-channel short-distance system. It can be interconnected with other radio and wire-line circuits to provide a completely integrated system.

Thus, the microwave equipment commercially available for communications applications becomes increasingly diversified, so that types for the various specific and diverse uses are designed to serve each such use most efficiently.

Table 3. How frequency deviation may be divided between channels.

Channel No.	Frequency Range (kc.)	Highest Frequency (kc.)	Modulation Index	Carrier Deviation (kc.)
1	0.3 - 3	3	3.95	11.85
2	5 - 7.7	7.7	3.95	30.41
3	9 - 11.7	11.7	3.95	46.21
4	13 - 15.7	15.7	3.95	62.01
Total Peak Frequency Deviation				150.48

New Literature

(Continued from page 29)

riety of geometrical configurations, (2) inductance, both self- and mutual, of circuits of various shapes, and (3) electrodynamic forces acting between coils when carrying current.

Circle No. 107 on Reader Service Card

PRINTED CIRCUIT FABRICATION

The printed circuit design and fabrication facilities of *Sanders Associates, Inc.*, 137 Canal St., Nashua, N. H., are discussed in a two-color folder called "New Concepts in Printed Circuits." Circuit boards and components are fabricated under the direction of engineers who use them daily for development work.

Circle No. 108 on Reader Service Card

MICROWAVE SYSTEM EQUIPMENT

In an attractive 52-page three-color folder, the Engineering Products Division of *Radio Corporation of America*, Camden 2, N. J., has presented the equipment for a typical microwave communications system. "Microwave Radio Relay Communications Equipment"

shows how standard *RCA* radio equipment and accessories work together to provide a high-quality and high-capacity microwave system.

Circle No. 109 on Reader Service Card

OHMART CELLS

Instruments marketed by the *Ohmart Corporation*, 2236 Bogen St., Cincinnati 14, Ohio, are presented in a catalog entitled "Ohmart Cells in Industry." Based on the utilization of "atomic batteries" (Ohmart cells) for the direct conversion of radioactive energy into electrical energy, these instruments include: specific gravity meters, level gages, radioactive source holders, and compensating units.

Circle No. 110 on Reader Service Card

ANTENNAS

Various *Kreco* antennas are described and illustrated in a four-page folder issued by *Herb Kreckman*, 124 Greenwood Drive, Massapequa, N. Y. Included are ground plane, coaxial, u.h.f. broad-band, duo-ground plane, stacked coaxial, and co-plane types.

Circle No. 111 on Reader Service Card

New Products

(Continued from page 25)

search Corporation in five models: R96-104 (9.6 to 10.4 kmc.); R88-96 (8.8 to 9.6 kmc.); R69-74 (6.9 to 7.4 kmc.); R64-69 (6.4 to 6.9 kmc.); and R59-64 (5.9 to 6.4 kmc.).

Now applicable where severe shock and vibration are prevalent and substantially reduced in size, these units are well suited for use in aircraft and missiles, and for mobile and fixed microwave communication equipment. Having an operating temperature range of -55 to $+180^{\circ}$ F, they also make effective load isolators in conjunction with klystrons operating in thermally stabilized enclosures.

Technical information is available on request from *Cascade Research Corporation*, 53 Victory Lane, Los Gatos, Calif.

Circle No. 112 on Reader Service Card

OFF-SET FEED ANTENNA

Broadband electrical characteristics are a feature of the new antenna for microwave relay communications announced by *Prodelin Inc.*, 307 Bergen Ave., Kearny, N. J. Called the "off-set feed antenna," it is available in two

DYSEAC—AN NBS ELECTRONIC COMPUTER

A HIGH-SPEED digital computer designed to serve as the experimental nucleus for a complex data-processing network has been completed by the National Bureau of Standards. The flexibility with which this machine—DYSEAC—controls and responds to a variety of external devices, which may include one or more full-scale computers of similar design, should enable scientists to explore diverse new areas of interest.

The DYSEAC development program was undertaken in 1952 by the staff of the Bureau's Electronic Computers Laboratory under the sponsorship of the Department of Defense. At that time,

the objective of the program was to produce a general-purpose high-speed digital computer that could serve as both a versatile tool for solving a variety of system-simulation programs and as a proving ground for evaluating certain novel logical design features and component packaging techniques. Subsequently, the sponsorship was assumed by the Signal Corps, to whom DYSEAC has been delivered.

Electronic circuit techniques used are similar to those utilized in SEAC. In DYSEAC, the circuitry has been reduced to standardized packages. Only two types of etched circuit plug-in packages are required as basic building blocks. Thus,

it has been possible to use modular construction throughout the computer and to simplify design practice, construction, and maintenance.

DYSEAC is similar to SEAC in several other respects. For example, it operates at a basic repetition rate of 1 mc., uses a serial mode of data representation, and employs a serial acoustic memory. However, its operating capabilities have been extended considerably beyond those of SEAC by the incorporation of several special logical design features. These features enable the computer to communicate in an extremely flexible manner with a large group of external devices performing many diverse functions. Among the devices which may be attached to the computer are those that store, tabulate, file, convert, display, and sense information, or those which actuate mechanisms such as servo equipment in response to signals sent out by the computer as a result of information being processed within it. Even other full-scale computers employing the same digital language may be attached to this machine.

The engineering features of DYSEAC are directly related to its intended use as a data-processing center that can be located at various operating sites without particular difficulty. Equipment is distributed between two 40' trailer vans. The major portion of the equipment—three computer racks, the memory cabinet, and the control console with input-output facilities—is installed in the computer van, while the second van houses regulated d.c. power supplies and provides a general-purpose area for special equipment, storage, and work space. Each van has its own air-conditioning equipment.

Control console of computer. Operator may use teletypewriter for inserting instructions.



types which make possible operation over the entire 1700-2450 and 2450-2700 mc. bands with a VSWR of 1.02 for television use.

Weighing less than 16 pounds, the new antenna is adaptable to a variety

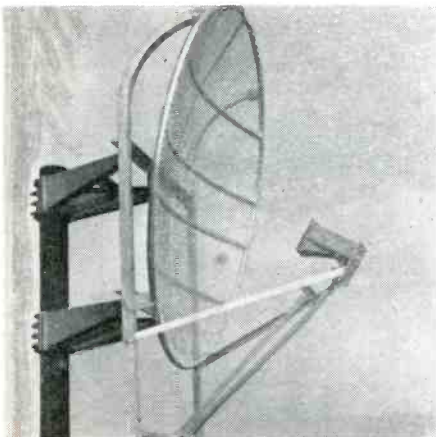

of supporting structures and transmission line input connectors. Low side lobe radiation permits two antennas to be operated back-to-back with greatly reduced crosstalk interference.

Circle No. 113 on Reader Service Card

STANDARD MISMATCH

For determining the absolute accuracy of microwave VSWR equipment, the Electronics & X-Ray Division of the *F-R Machine Works, Inc.*, has announced a new standard mismatch. Designed for greater accuracy and frequency stability, the *FXR* Type X510 is precision milled from an aluminum bar, anodized for protection. It has an absolute accuracy of better than 1% and is available in several values and sizes.

The termination of the *FXR* Type X510 is movable over greater than one-half guide wavelength to allow compensation for its small residual mismatch. This termination is fabricated of a dissipative material supported in a chromium-plated bearing and controlled by a chromium-plated shaft to insure smooth uniform motion within the standard body.

Complete details on the Type X510 are given in a catalog which may be obtained on request from the Electronics

& X-Ray Division of the *F-R Machine Works, Inc.*, 26-12 Borough Place, Woodside 77, N. Y.

Circle No. 114 on Reader Service Card

DIFFERENTIAL AMPLIFIER

Static, transient, or higher frequency oscillatory physical phenomena can be studied and accurately measured using the new Model 400 differential transformer amplifier in conjunction with available differential transformer transducers. The unit contains a carrier oscillator, demodulator, and all circuits necessary to provide an output suitable for display or photographing on a cathode-ray oscilloscope.

Features of the Model 400, announced by *Daytronic Corporation*, 216 S. Main St., Dayton 2, Ohio, include stable calibration, over-all linearity exceeding 1%, and flat frequency response from 0 to 1000 cps within 1/2 db. Transducer core displacements as small as .0001" can be accurately measured. Low impedance output for galvanometer oscillographs is optionally available.

Circle No. 115 on Reader Service Card

BROADCAST MONITOR TUNER

Noise-free reception of even the weakest stations is possible with the Type 310 FM broadcast monitor tuner announced by *Hermon Hosmer Scott, Inc.* The wide-band circuit design includes full 150-kc. i.f. passband and 2-mc. wide limiters and detector, high r.f. selectivity, high converter linearity, and two stages of limiting. Having 2- μ v. sensitivity, the unit provides exceptionally good rejection of ignition noise, cross modulation, adjacent and cochannel interference.

Distortion due to overloading on high signal strengths is prevented with automatic gain control. Tuning is simplified and made noncritical and drift-free by the wide-band design and temperature-compensated oscillator circuit. A new single-sweep tuning mechanism allows the entire FM band to be swept through with a flick of the finger, and the fine tuning control and signal meter permit precision tuning of weak stations even when interference is great.

A free bulletin on the Type 310 is available from *Hermon Hosmer Scott, Inc.*, 385 Putman Ave., Cambridge, Mass.

Circle No. 116 on Reader Service Card

PHOTO CREDITS

- 7, 8, 9.... Radio Corp. of America
- 10.... Sylvania Elec. Products Inc.
- 11.... Sperry Gyroscope Co.
- 13. Airborne Instruments Lab., Inc.
- 15, 16.... General Electric Co.

New Tubes

(Continued from page 31)

able to television set manufacturers by the Tube Division of *Radio Corporation of America*, Harrison, N. J. Engineered for economical receiver operation, they employ 600-ma. heaters designed to operate in a single, series-connected electrical circuit.

The *RCA* tubes are used in series directly across the power line supply and eliminate need of a heater transformer. Except for items involved in the changes of heater design, the "series-string" tubes correspond electrically and mechanically to prototypes widely used in home television receivers.

Listed below with their prototypes, these tubes include: 2AF4-A (prototype 6AF4); 3AL5 (6AL5); 3AU6 (6AU6); 3AV6 (6AV6); 3BY6 (6BY6); 3CF6 (6CF6); 4BQ7-A (6BQ7-A); 4BZ7 (6BZ7); 5AQ5 (6AQ5); 5AS8 (6AS8); 5X8 (6X8); 6AU7 (12AU7); 6S4-A (6S4); 6SN7-GTB (6SN7-GT); 12AX4-GTA (12AX4-GT); 12BH7-A (12BH7); 12BQ6-GTB (6BQ6-GT); 12BY7-A (12BY7); 12W6-GT (6W6-GT); and 25CD6-GA (25CD6-G).

Circle No. 117 on Reader Service Card

CALENDAR of Coming Events

JANUARY 8—Symposium on Design Principles of Transistor Circuits, sponsored by N. Y. Section, IRE, Engineering Societies Auditorium, New York, N. Y.

JANUARY 17-19—Fourth Biennial Conference on High Frequency Measurements, NBS, Washington, D.C.

JANUARY 20-21—RETMA Symposium on Printed Wiring and Circuitry, University of Pennsylvania, Philadelphia, Pa.

JANUARY 26—Symposium on Electronics in Aviation, sponsored by IRE, IAS, ION, RTCA, Hotel Astor, New York, N. Y.

JAN. 31-FEB 4—AIEE Winter General Meeting, Hotel Statler, New York, N. Y.

FEBRUARY 10-12—Seventh Annual Conference and Electronics Show, Southwestern Region, IRE, Dallas, Texas.

FEBRUARY 10-13—Third Annual Audio Fair—Los Angeles and Audio Engineering Society Technical Sessions, Alexandria Hotel, Los Angeles, Calif.

FEBRUARY 17-18—National Conference on Transistor Circuits, IRE, AIEE, and U. of Pennsylvania, University of Pennsylvania Auditorium, Philadelphia, Pa.

MARCH 1-3—Western Joint Computer Conference and Exposition, Hotel Statler, Los Angeles, Calif.

MARCH 21-24—Radio Engineering Show and IRE National Convention, Kingsbridge Armory and Waldorf-Astoria Hotel, New York, N. Y.

APRIL 12-15—Symposium on Modern Network Synthesis, Engineering Societies Building, New York, N. Y.

INDEX TO ADVERTISERS

NAME	PAGE
Automatic Switch Co.	23
Bruno-New York Industries Corporation	29
Camera Equipment Co.	31
Chicago Standard Transformer Corp.	6
Electro-Voice	33
Freed Transformer Co., Inc.	Fourth Cover
McIntosh, Frank H.	35
Precision Paper Tube Co.	27
Pye Limited	3
Monitoradio Radio Apparatus Corp.	31
Radio Corporation of America	4, 5, 21
United Transformer Co.	Second Cover

FREED

Instruments & Transformers

Famous
For

QUALITY • DEPENDABILITY • ACCURACY



No. 1030
Low Frequency
"Q" Indicator

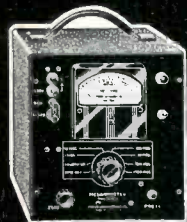

No. 1020B
Megohmmeter

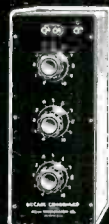

Decade
Inductors



No. 1040
Vacuum Tube Voltmeter



No. 1210
Null Detector &
Vacuum Tube Voltmeter

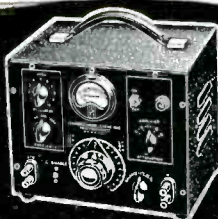

No. 1010
Comparison Bridge

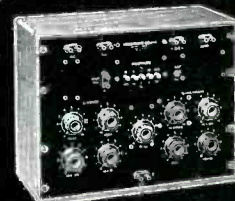

No. 1110A
Incremental Inductance
Bridge

FREED MILITARY PULSE TRANSFORMERS IN STOCK FOR IMMEDIATE DELIVERY

HERMETICALLY SEALED PULSE TRANSFORMERS for use in blocking oscillators, low level interstage coupling, and modulator outputs. Made in accordance with MIL-T-27 specifications. These pulse transformers are designed for maximum power, efficiency and optimum pulse performance. Balanced coil structures permit series or parallel connection of windings for turn ratios other than unity. Pulse characteristics, voltages and impedance levels will depend upon interconnections made.



DM-12



DM-18



DM-8



DM-01

CATALOG NUMBER	APPLICATION	PULSE VOLTAGE KILOVOLTS	PULSE DURATION MICRO-SECONDS	DUTY RATIO	TEST VOLTAGE KV., RMS	CHARACTERISTIC IMPEDANCE OHMS	CASE SIZE
MPT-1	Blocking oscillator or interstage coupling	0.25/0.25/0.25	0.2-1.0	.004	0.7	250	DM-12
MPT-2	Blocking oscillator or interstage coupling	0.25/0.25	0.2-1.0	.004	0.7	250	DM-12
MPT-3	Blocking oscillator or interstage coupling	0.5/0.5/0.5	0.2-1.5	.002	1.0	250	DM-18
MPT-4	Blocking oscillator or interstage coupling	0.5/0.5	0.2-1.5	.002	1.0	250	DM-18
MPT-5	Blocking oscillator or interstage coupling	0.5/0.5/0.5	0.5-2.0	.002	1.0	500	DM-12
MPT-6	Blocking oscillator or interstage coupling	0.5/0.5/0.5	0.5-2.0	.002	1.0	500	DM-12
MPT-7	Blocking oscillator, interstage coupling or low power output	0.7/0.7/0.7	0.5-1.5	.002	1.5	200	DM-18
MPT-8	Blocking oscillator, interstage coupling or low power output	0.7/0.7	0.5-1.5	.002	1.5	200	DM-18
MPT-9	Blocking oscillator, interstage coupling or low power output	1.0/1.0/1.0	0.7-3.5	.002	2.0	200	DM-18
MPT-10	Blocking oscillator, interstage coupling or low power output	1.0/1.0	0.7-3.5	.002	2.0	200	DM-18
MPT-11	Blocking oscillator, interstage coupling or low power output	1.0/1.0/1.0	1.0-5.0	.002	2.0	500	DM-01
MPT-12	Blocking oscillator, interstage coupling or low power output	0.15/0.15 0.3/0.3	0.2-1.0	.004	0.7	700	DM-8

SEND FOR COMPLETE CATALOG OF
FREED INSTRUMENTS AND TRANSFORMERS

FREED TRANSFORMER CO., INC.

1719 WEIRFIELD ST. (RIDGEWOOD) BROOKLYN 27, N.Y.