

INCLUDING  
*Communication  
Engineering*  
and  
*TV & RADIO  
ENGINEERING*

# RADIO-ELECTRONIC *Engineering*

Reg. U. S. Pat. Off.

**NOVEMBER, 1954**

COMMUNICATIONS  
FOR MISSILE TESTING  
7

ELECTRONIC THICKNESS GAGES  
10

THE PHANTASTRON  
12

MULTIPLEXING MICROWAVE  
COMMUNICATIONS CIRCUITS  
15

INDUCTIVE COORDINATION  
18

TEMPERATURE-COMPENSATED  
STRAIN GAGES  
20

## DEPARTMENTS

|                             |    |
|-----------------------------|----|
| COMMUNICATION REVIEW . . .  | 22 |
| NEW PRODUCTS . . . . .      | 24 |
| PERSONALS . . . . .         | 26 |
| TECHNICAL BOOKS . . . . .   | 27 |
| NEW LITERATURE . . . . .    | 28 |
| TV-AM-FM PRODUCTION . . . . | 28 |
| NEWS BRIEFS . . . . .       | 32 |
| CALENDAR . . . . .          | 33 |
| NEW TUBES . . . . .         | 34 |

Electronic controls are used in conjunction with a chromatographic column to effect separation of chemical compounds at the National Institutes of Health.

TELEVISION • ELECTRONICS • COMMUNICATIONS • AUDIO • MICROWAVES • RADAR • RESEARCH



OUR MILLIONTH FILTER SHIPPED THIS YEAR...

# FILTERS

## FOR EVERY APPLICATION



### TELEMETERING FILTERS

UTC manufactures a wide variety of band pass filters for multi-channel telemetering. Illustrated are a group of filters supplied for 400 cycle to 40 KC service. Miniaturized units have been made for many applications. For example a group of 4 cubic inch units which provide 50 channels between 4 KC and 100 KC.

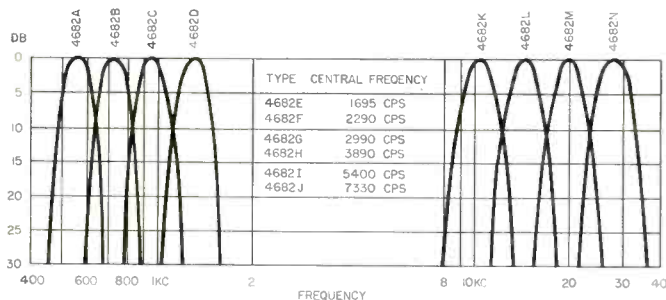

Dimensions:  
(4682A) 1½ x 2 x 4"



Dimensions:  
(3834) 1¼ x 1¼ x 2-3/16"  
(2000, 1) 1¼ x 1¼ x 1½"

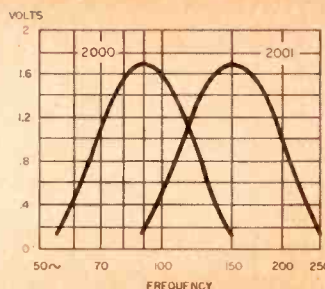
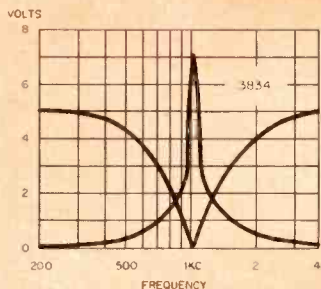

### AIRCRAFT FILTERS

UTC has produced the bulk of filters used in aircraft equipment for over a decade. The curve at the left is that of a miniaturized (100 cycles) range filter providing high attenuation between voice and range frequencies.

Curves at the right are that of our miniaturized 90 and 150 cycle filters for glide path systems.

### CARRIER FILTERS

A wide variety of carrier filters are available for specific applications. This type of tone channel filter can be supplied in a varied range of band widths and attenuations. The curves shown are typical units.

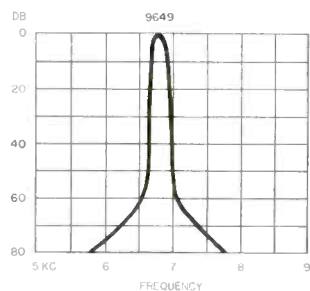
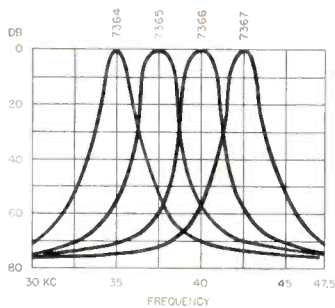

Dimensions:  
(7364 series) 1½ x 1½ x 2¼"  
(9649) 1½ x 2 x 4"

### DISCRIMINATORS

These high Q discriminators provide exceptional amplification and linearity. Typical characteristics available are illustrated by the low and higher frequency curves shown.

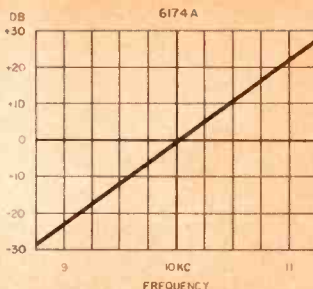
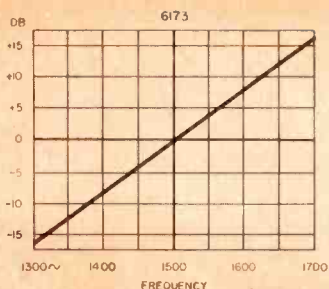

Dimensions:  
(6173) 1-1/16 x 1¾ x 3"  
(6174A) 1 x 1¼ x 2¼"

For full data on stock UTC transformers, reactors, filters, and high Q coils, write for Catalog A.

**UNITED TRANSFORMER CO.**

150 Varick Street, New York 13, N. Y. EXPORT DIVISION: 13 E. 40th St., New York 16, N. Y. CABLES: "ARLAB"

**"hides"**  
*behind*  
**a...**

**hand**



*...the new* **BK-6A**  
**RCA** *dynamic*  
*miniature microphone*

Here's a miniature mike that does a man-size job... This RCA Dynamic Microphone is small enough to conceal in a man's hand or under his necktie. Ladies can hide it behind a corsage. Or, you can put it behind a table decoration. In any setting, it's an amazing help in keeping the informal atmosphere so many television shows, interviews and public occasions require.

However you use it, you can be sure of correct speech quality. Low-pitched chest sounds, sibilants and high-pitched sounds are all reproduced in proper balance.

Just three inches long, weighing only 5½ ounces and neutral in color, this RCA Miniature is as inconspicuous as modern microphone design can make it. A small and very flexible cable allows free, easy movement by anyone using it. And in spite of its unusual compactness, the BK-6A is a high quality microphone and has very durable construction.

This RCA Miniature Dynamic Microphone can increase *your* staging and production flexibility in many ways. For information on *all* of its advantages... contact your RCA Broadcast Sales Representative, or write Dept. K-157, RCA Engineering Products Division. In Canada, write RCA Victor Ltd., Montreal.



**RADIO CORPORATION of AMERICA**  
ENGINEERING PRODUCTS DIVISION      CAMDEN, N.J.



**...tie**



**...corsage**



# For Economical Control of Remote Operations . . . THE "MULTI-GATE" SYSTEM



Remote Station  
Equipment

**Provides Complete  
Control & Supervision  
Over a Single Circuit**

- Used over Wire, Radio,  
Microwave or Carrier
- One or More Remote  
Points
- Complete Report-Back  
Facilities
- Fail-Safe Operation
- Automatic Memory  
and Programming

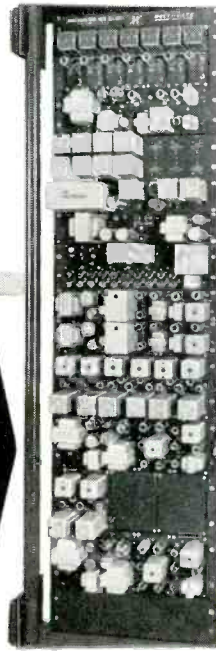

Control Station  
Equipment

Hammarlund Remote Supervisory Control equipment is particularly well-adapted to operations of petroleum refineries, pipelines, railroads, public utilities, and other organizations that have widespread physical facilities. This equipment fulfills their requirement for central coordinated control because it makes possible the operation of distant functions immediately and positively from one or more master stations.

Two basic factors, carefully pre-determined for the equipment, were flexibility and versatility. Because it is designed on building-block principles—using standard sections in individually unique combinations—great flexibility has been achieved. For all practical purposes, a customer gets a custom installation at a standard inflexible system cost. Its versatility makes it adaptable to any application in any industry or organization. Only a single circuit is required for control and supervisory report-back. The number of remote functions that may be handled by a "Multi-Gate" system is virtually unlimited.

**For Detailed Information Write For Bulletin M11.**

## HAMMARLUND

**THE HAMMARLUND MANUFACTURING CO., INC.**  
**MAIN PLANT & OFFICES: 460 W. 34th St., N. Y. 1, N. Y.**  
**Mid-West Sales Office: 605 N. Michigan, Chicago 11, Ill. • Export Sales Office: 13 E. 40th St., N. Y.**

*For more information, circle No. 3 on Reader Service Card*

RADIO-ELECTRONIC ENGINEERING is published monthly by Ziff-Davis Publishing Company, William B. Ziff, Chairman of the Board (1946-1953) at 64 E. Lake St., Chicago 1, Ill. Entered as second-class matter March 29, 1954 at the post office, Chicago, Ill. SUBSCRIPTIONS: Subscribers to Radio-Electronic Engineering automatically receive Radio & Television News. RATES: one year U. S. and possessions, and Canada \$6.00; Pan-American Union countries \$8.50; all other foreign countries \$7.00. SUBSCRIPTION SERVICE: All communications concerning subscriptions should be addressed to Circulation Dept., 64 E. Lake St., Chicago 1, Ill. Subscribers should allow at least four weeks for change of address.

**RADIO-ELECTRONIC**  
*Engineering*

INCLUDING

*TV & RADIO & Communication*  
**ENGINEERING Engineering**

Edited by H. S. RENNE  
and the Radio & Television News Staff

VOLUME 23 NUMBER 5  
NOVEMBER, 1954

Editor and Asst. Publisher  
OLIVER READ, D. Sc., WIETI

Managing Editor  
WM. A. STOCKLIN, B. S.

Technical Editor  
H. S. RENNE, M. S.

Assistant Editor  
M. C. MAGNA

Art Editor  
FRANK SAYLES

Draftsmen  
ALBERT A. GANS  
JOSEPH A. GOLANEK

Advertising Manager  
L. I. OSTEN

Midwest Adv. Manager  
JOHN A. RONAN, JR.

Western Adv. Manager  
JOHN E. PAYNE

### ZIFF-DAVIS PUBLISHING COMPANY

WILLIAM B. ZIFF (1898-1953) FOUNDER  
Editorial and Executive Offices  
366 Madison Ave., New York 17, N. Y.

President  
B. G. DAVIS

Vice-Presidents  
H. J. MORGANROTH  
M. H. FROELICH

Secretary-Treasurer  
G. E. CARNEY

Circulation Manager  
M. MICHAELSON

#### BRANCH OFFICES

CHICAGO (1): 64 E. Lake St.  
LOS ANGELES (14): 900 Wilshire Blvd.

RADIO-ELECTRONIC ENGINEERING is published each month as a separate publication and is available by subscription only when purchased with a subscription to RADIO & TELEVISION NEWS.

(Average Paid Circulation Over 28,000)

Copyright 1954 by Ziff-Davis Publishing Company  
(All Rights Reserved)

6/12?

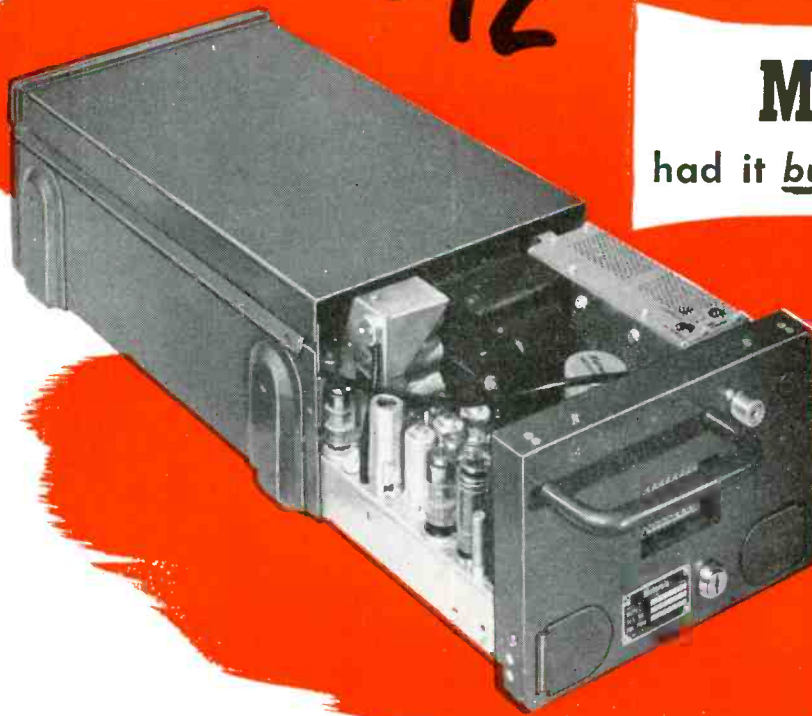

**Motorola**  
had it built-in a year ago

*A growing number of automobile manufacturers are changing from 6 to 12 volt electrical systems. Motorola 2-way radio now gives you built-in protection against expensive obsolescence should any part of your fleet be affected by this trend.*

**WHAT IT IS**—It's truly universal 6/12V equipment—2-way radio that can be interchanged in mixed 6 and 12-volt fleets without modification of power supplies, jumpers, plugs, connectors, cables or switches. When re-installing in a 12-volt car, no cable replacement is required. It is so foolproof that you can safely make changeovers in the dark without worry of burning out tubes or damaging a power supply.

**FEATURES**—The *all-vibrator* power supply attains over 70% power conversion efficiency with a resultant power drain reduction of up to 40%—for more power per unit size per ampere drain than any other sets on the market—all this, plus the superior performance of Motorola's famous Sensicon with guaranteed permanent selectivity and seven other exclusive features.

**ACCEPTANCE**—Again anticipating the trends, Motorola offers freedom from obsolescence, and superior performance at lower cost. You can easily see and hear the difference—greater signal strength, more audio power, longer battery and generator life, lower maintenance costs. You get all this in Motorola's truly universal 6/12-volt mobile units—available in the following classes:

- 25-54 mc., 25-30 and 50-60 watts R.F. output
- 144-174 mc., 10 and 25 watts R.F. output
- 450-470 mc., 18-20 watt R.F. output

Here is a partial list of Motorola customers who have 6/12 volt interchangeable mobile units—

|                       |                              |                         |
|-----------------------|------------------------------|-------------------------|
| Michigan State Police | Community Public Service Co. | Florida State Police    |
| Ohio State Police     | County of Orange, Calif.     | Iowa State Police       |
| Boston Edison Co.     | El Paso National Gas Co.     | State of South Carolina |



**Motorola Communications & Electronics, Inc.**  
A SUBSIDIARY OF MOTOROLA, INC.  
4501 W. Augusta, Chicago 51, Ill. • Rogers Majestic Electronics, Ltd., Toronto, Canada

For more information, circle No. 4 on Reader Service Card

RADIO-ELECTRONIC ENGINEERING

a complete NEW line!

# RADIART SEAL·VENT Communication Vibrators

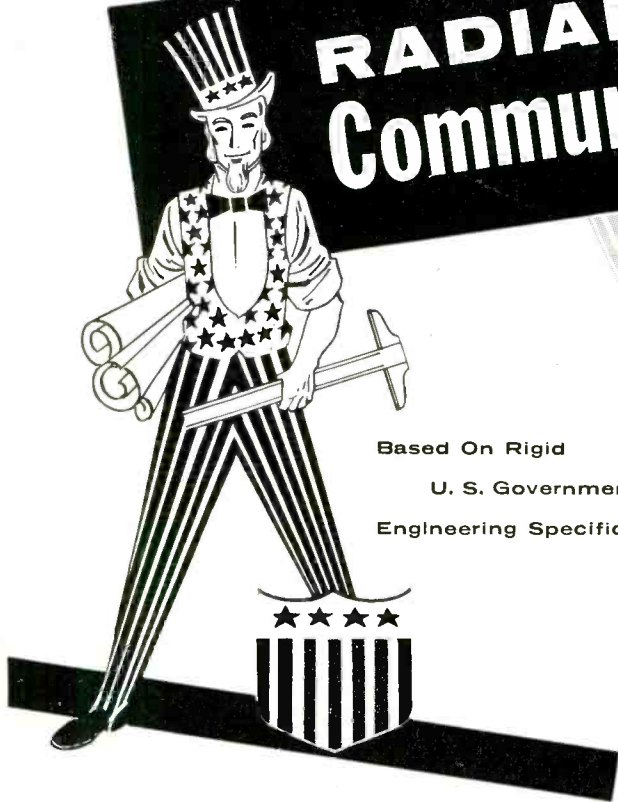

Based On Rigid  
U. S. Government  
Engineering Specifications

NOW... RADIART makes available to you FOR YOUR OWN NEEDS a complete replacement group of COMMUNICATION VIBRATORS that are engineered and designed on U. S. Signal Corps specifications. Don't settle for anything less than the best - and THESE ARE THE BEST!

These Six Types Offer Complete Replacement for ORIGINAL Communication Equipment:

| Old No. | New No.     |
|---------|-------------|
| 5515    | <b>5715</b> |
| 5518    | <b>5718</b> |
| ★       | <b>5721</b> |
| 5605    | <b>5805</b> |
| 5620    | <b>5820</b> |
| 5621    | <b>5821</b> |



THE **RADIART** CORPORATION  
CLEVELAND 13, OHIO

TV ANTENNAS • AUTO AERIALS • VIBRATORS • ROTORS • POWER SUPPLIES

For more information, circle No. 5 on Reader Service Card

RADIO-ELECTRONIC ENGINEERING



# COMMUNICATIONS *for* MISSILE TESTING

Fig. 1. Left rack: tape recorder control, interphone amplifier, and master control. Right rack: monitor, PA mixer, recorder mixer, and an interphone monitor mixer.

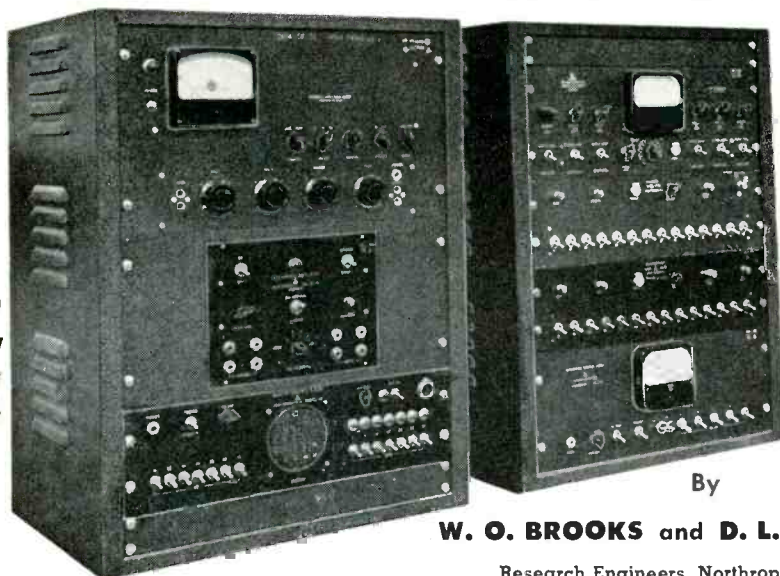

By

**W. O. BROOKS and D. L. STEPHENSON**

Research Engineers, Northrop Aircraft, Inc.

ONE OF THE largest missile test ranges in the United States is based at the Air Force Missile Test Center, Patrick Air Force Base, Cocoa, Florida. Cape Canaveral, some 20 miles northeast of PAFB, is the launching site for the range, which extends approximately 1000 miles southeast across the Bahama Islands. Observation and instrumentation sites are located throughout this island chain at intervals of approximately 200 miles. (See Fig. 2.) Communications between the various island bases and the launch site are maintained by h.f. radio link, while communications between aircraft and nearby land bases utilize v.h.f. Long-range communications between ground and air also utilize h.f. The transmitters and receivers are supplied and operated by AFMTC personnel. In order to facilitate use of the radio communications on this range by *Northrop Aircraft, Inc.*, remote control equipment has been designed which is capable of operating over underground telephone cables at distances of several miles from the transmitter and receiver buildings.

An elaborate and extremely reliable intercommunication system for the various *Northrop* test facilities on Cape Canaveral is imperative during the stages of final assembly and testing of the missiles. For the safety of test crews alone, reliable communications must be maintained during all phases of operation. Launch crews must be alerted at the proper time, and flight test, telemetering, radio control, and

radar tracking crews must be kept abreast of the launching progress so that they may coordinate their programs. Since these various crews are located at several points separated by several miles, an interphone system has also been designed to operate over leased commercial telephone lines. (See Fig. 6 for block diagram.)

## Interphone Facilities

Conditions vary considerably from area to area in which the interphone system is used, and the requirements are quite different from the standard type of office intercom system.

## Requirements

1. At the launching pads, the system must be capable of sufficient power output into close-fitting earphones to override the noise of a jet engine during the preflight engine run-up; while in the blockhouse, the same "black box" should be capable of a controlled level output into a small directional speaker, with a maximum output of .5-watt audio.
2. The system should be capable of two-way conversation over a single balanced telephone pair without a "press-to-talk" switch being involved. The "live" mike must not pick up much background noise.
3. Output of the "send" amplifier must be at standard telephone line level (+ 4 dbm, 1.228 volts, at 600 ohms). Some means should also be provided for adjusting and monitoring this level at each area.

*Radio communications and intercom facilities at Patrick Air Force Base.*

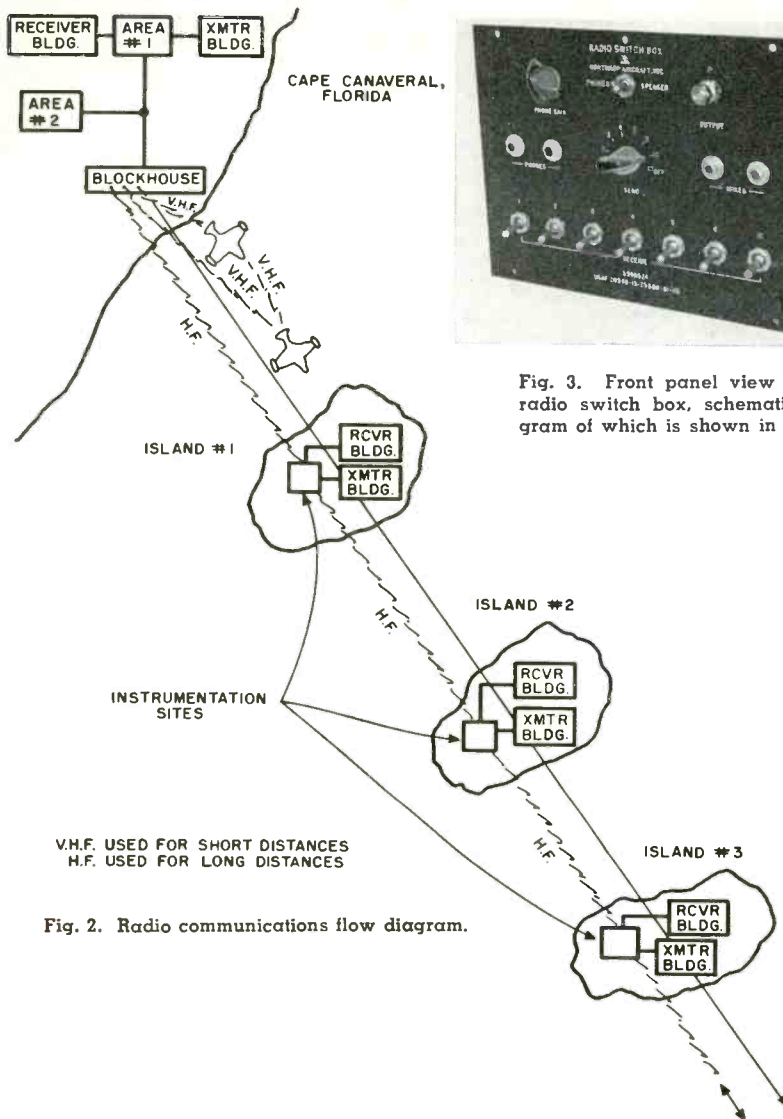
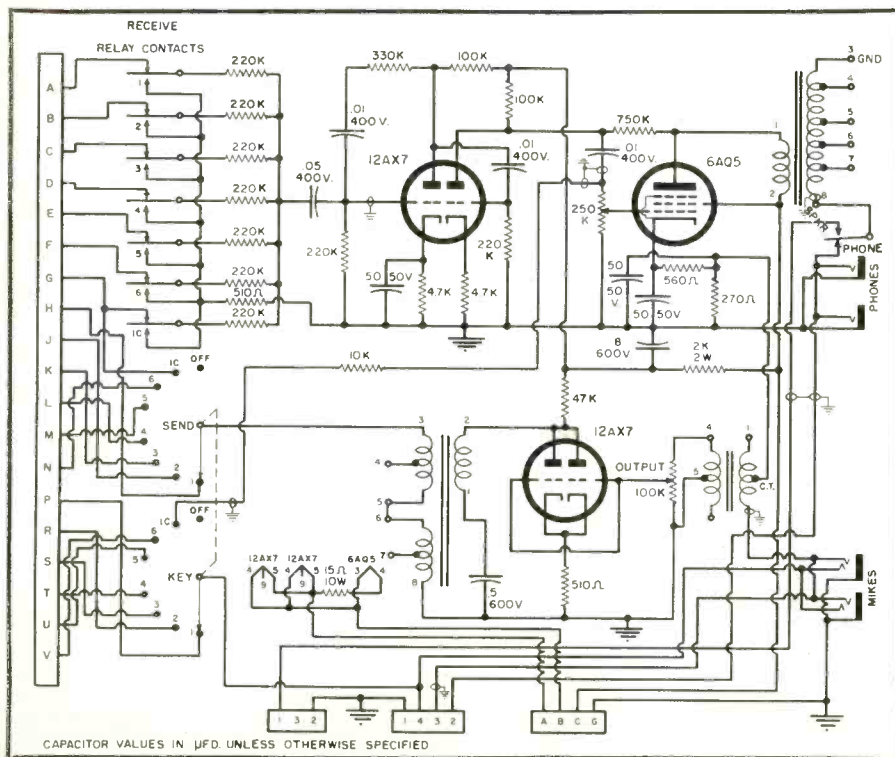

Fig. 2. Radio communications flow diagram.



Fig. 3. Front panel view of the radio switch box, schematic diagram of which is shown in Fig. 4.

Fig. 4. Schematic diagram of radio switch box.



CAPACITOR VALUES IN  $\mu$ F. UNLESS OTHERWISE SPECIFIED

4. Prelaunch and launch phases of the operation need simultaneous separate communications among several groups of specialists between the various areas of the base; therefore, the interphone system should have five independent lines so that an operator can choose, by means of a selector switch, any one of five lines. For added safety, as well as for calling purposes, any operator should be able to contact all other persons using any other portion of the system.
5. The equipment at each remote position within each area should be capable of handling four mikes and phones plus a plug in back for an extension jack box permitting the use of four more mikes and phones where necessary in an adjoining position.
6. Units at the pads must be portable, so that five groups of four men each can operate on the ground around the missile (the equivalent of five black boxes), while through the use of an extension jack panel another five groups of four men can work around the top on an aerostand.
7. Independent of the switch on the front panel of each unit for selecting any one of five lines, a patch panel is needed in the blockhouse to permit prepatching to any one of the separate areas.
8. In order to prevent serious changes in audio level, it is necessary to hold the outgoing level within 6 db of the preset level regardless of whether one or all boxes are on the same line simultaneously.
9. Frequency response of the entire system should be reasonably flat over the voice range of frequencies between 200 and 4000 cycles.
10. Straightforward engineering with no trick circuits and as few tubes as possible should be used for maximum reliability. Also, mikes and earphones must be as rugged as possible.
11. For economic reasons, all of the interphone units should be the same regardless of the particular areas in which they may be operated.

### System Design

The first item to be considered is the single-channel interphone amplifier, referred to in Fig. 6 as IPA. In this setup, a 6C4 type tube serves as the "send" amplifier, and a 6AQ5 type as the "receive" amplifier. Through the use of back-to-back transformers, these stages are coupled into the balanced line. A screw adjust potentiometer is used in the "send" amplifier for a semipermanent setting to +4 dbm line level, while a knob adjust potentiometer



in the "receive" amplifier adjusts the "receive" level to a comfortable listening level for phones or external speaker. The 6AQ5 type tube was chosen for its power capabilities as well as its ability to furnish mike current from its cathode with negligible fluctuation of bias with modulation. Since the power output requirements are only 1/2 watt, the tube is biased down to the point of low drain on the power supply. The power supply consists of a type 6X4 tube with a single-section RC filter.

By means of a two-deck five-position rotary selector switch, the 600-ohm output (and input) of each unit is switched to any one of the five balanced lines. A 12-pole single-throw a.c. relay energized by a spring return toggle switch provides a means of paralleling the five lines for the "all-stations" function.

Carbon microphones, type T-17 hand mikes, and T-27 chest mikes are used in all of the less noisy areas, with type T-33 throat mikes serving at the pads and other points of extreme noise. Such an arrangement allows the use of "live" mikes with no "press-to-talk" switches. For cases where external speakers are required, bullet-type Jensen speakers with internal 600-ohm transformers are installed. All other locations are equipped with low-impedance army-type HS-33 headsets.

As will be noticed in the block diagram of Fig. 6, several single-channel interphone amplifiers are located within the same area. To comply with the requirement for a maximum of 6-db drop in audio level when all boxes are paralleled on one line simultaneously, the outputs of the five lines from each group of amplifiers go to a set of line match-

ing transformers which comprises a "matching unit." The side of the transformers connected to the group of boxes is matched for the worst condition, nine boxes in parallel, i.e., approximately 60 ohms, while the other side matches the 600-ohm line.

Monitoring is accomplished by means of an interphone monitor mixer. This unit has a standard vu meter on the front panel equipped with a rotary selector switch for monitoring by meter or phones any one of the five lines. Also, any combination of the five lines may be mixed into two separate outputs. These outputs represent the only connection between the interphone and the radio communication system and run to the public address and recorder mixers in the radio communication system so that information from each system can be piped over the public address lines or to the tape recorder.

To aid in production, operation, and maintenance of the portable unit at each pad, five of the single-channel units are combined into one large unit with a common power supply. The five-channel interphone amplifier (shown in Fig. 7) is rack-mounted in a weatherproof box large enough to contain the necessary matching unit, and the entire box is shock-mounted onto a cart that can

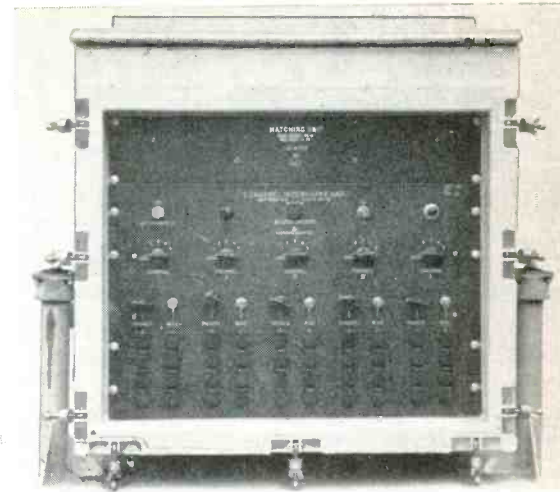

Fig. 7: Five-channel interphone amplifier and matching unit.

be removed from a pad at firing time.

At each pad, there is a need for communications facilities for men working in and around the missile in places where it would be inconvenient, if not impossible, to locate an interphone amplifier, and for these people dual extension cords for headset and carbon mike are provided. The extension cords are made in 25' lengths, and several

(Continued on page 36)

Fig. 5. Block diagram of the radio communications system.

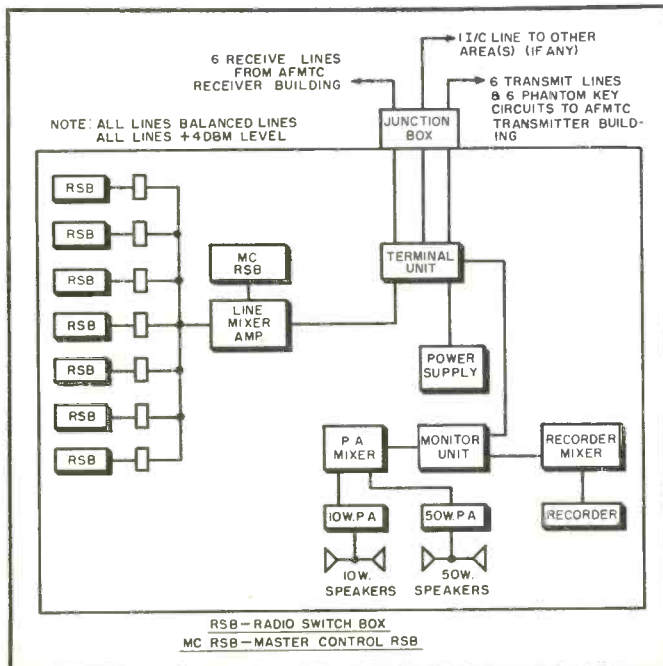
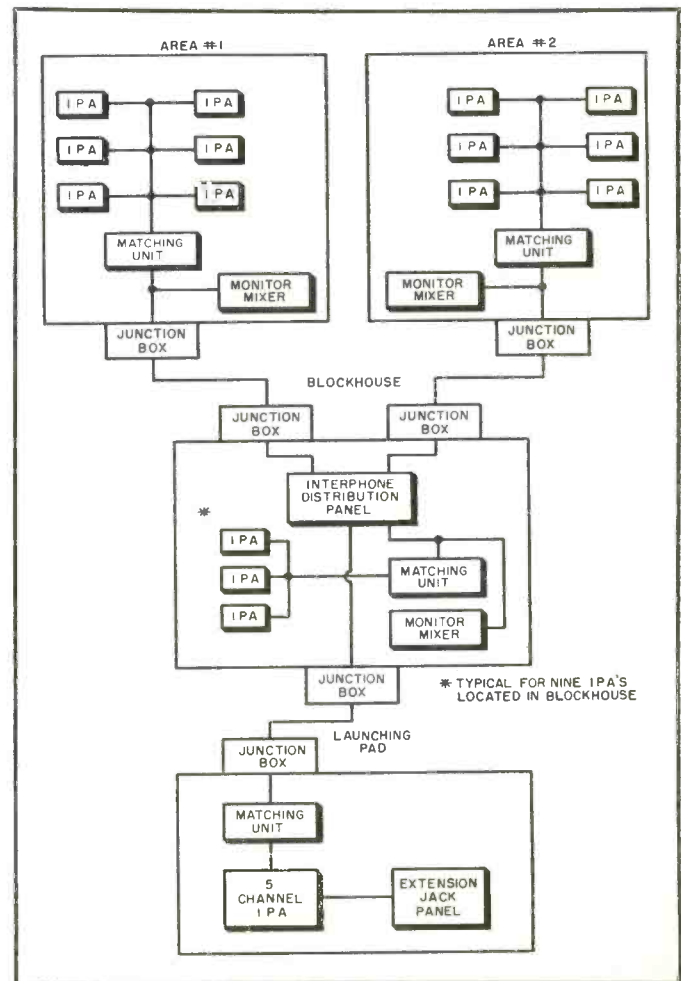

Fig. 6. Block diagram of interphone system in use at the Air Force Missile Test Center.



# ELECTRONIC THICKNESS GAGES

Three types of gages have been developed at NBS for thickness determinations.

**M**ANY of the metal products manufactured in this country are clad or coated with another, usually more expensive, metal to obtain special surface properties such as corrosion resistance, wear resistance, or improved appearance. For process control and inspection of the finished product, rapid, reliable procedures for measuring the thickness of the metallic coatings are required. While a great number of methods, based on almost every property of metals, have been developed for this purpose, few of these are nondestructive and direct-reading. Magnetic gages, such as the NBS-developed Magne-gage, are used most widely, but they are limited to combinations in which at least one of the metals is ferromagnetic. Although beta-ray and x-ray thickness gages are capable of fairly general application, their high cost makes them suitable only for large plants having considerable volume of production; use of the beta-ray gage is also limited to large objects. The demand for a nondestructive test method of measurement utilizing a portable economic instrument has led to the development of three types of gages by the National Bureau of Standards, each designed for a specific application.

## The Dermatron

The Dermatron (Fig. 1) was developed by Abner Brenner and Jean García-Rivera with the assistance of B. Wagoner, Jr., and R. L. Hill, all of NBS, under a program of basic instrumentation sponsored at the Bureau by the Department of Defense and the Atomic Energy Commission; financial support for the project was also provided by the Bureau of Engraving and

Printing, U. S. Treasury Department.

This gage makes use of the "skin effect," by which an eddy current induced in a metallic surface can be limited to a thin surface layer by employing a high frequency current as the inducing agent. The depth of penetration of the induced current is inversely proportional to the square root of the frequency of the inducing current and directly proportional to the resistivity of the metal. Thus, for a given frequency, the magnitude of the eddy current induced in a surface layer will depend upon the conductivity of the layer, other factors being constant. If the coating and the basis metal have different conductivities, the effective conductivity of the composite surface layer, and hence the magnitude of the induced eddy current, will depend to a large extent upon the thickness of the coating.

With the Dermatron, the magnitude of the induced eddy current is measured indirectly through the effect of its magnetic field, which opposes that of the inducing current. The opposition of the two magnetic fields lowers the impedance of the high frequency coil, thus permitting more current to pass through it. A meter connected in series with the coil indicates the current changes.

Fig. 2. Dermatron circuit: S—oscillator; VD—voltage divider; R—germanium rectifiers; TP—test probe; C—mica capacitor; VR—potentiometer, helipot type, 0-100 ohms; M—d.c. microammeter.

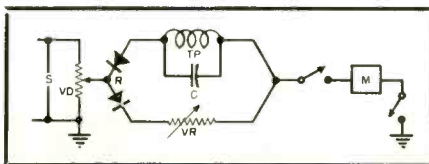

Fig. 1. The Dermatron is useful for measuring thickness of plated coatings on silverware.

In practice, no calculations are necessary, as calibration curves made from specimens of known thicknesses are used. Each pair of metals requires an individual calibration curve having two limits: one limit is the reading of the meter when the probe coil is brought near the bare basis metal, and the other is the reading with the probe adjacent to a layer of the coating that is thick enough to yield the maximum effect on the current.

Power is supplied by a commercial oscillator with a 6-watt output, and the amount of current through the circuit is controlled by means of a voltage divider placed across the oscillator. Between the voltage divider and a d.c. microammeter is a parallel circuit containing in one branch a variable resistance and in the other branch the probe coil with its capacitor (see Fig. 2). Each branch contains a germanium diode in opposite phase with the other. Thus, during one-half of the cycle the current passes through the test probe and the meter, and during the other half of the cycle the current passes through the variable resistance and the meter—but in the opposite direction. The d.c. meter registers the difference between these two currents.

Initially, the meter is made to read zero when the probe is placed on a reference surface of the bare basis metal. This is done by balancing the variable resistance against the test probe and its capacitor. The test probe is then placed on the metallic surface to be tested, and the resulting change of impedance is indicated by the meter reading.

A technique known as the "peak method" has been found to give most accurate measurements because it di-





Fig. 3. Wave guide plating indicator uses conductance to determine the thickness of internal plating.

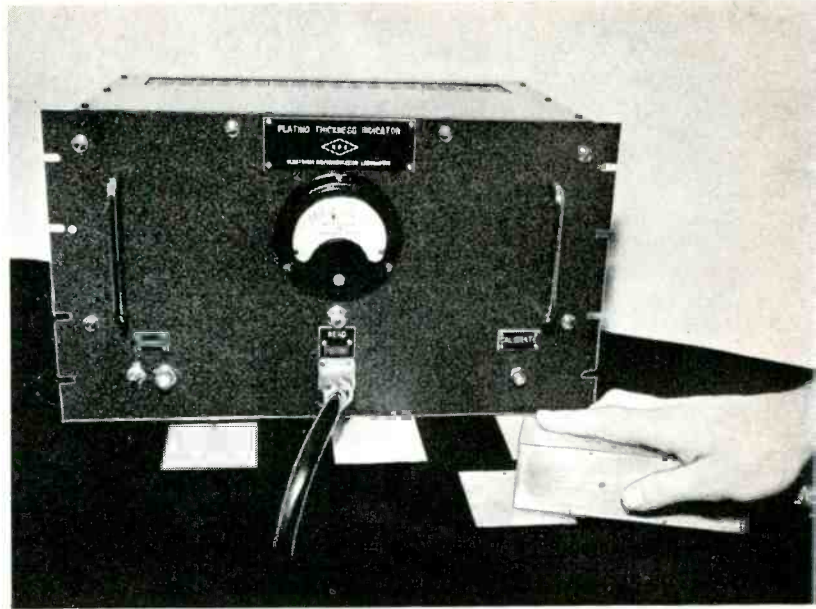

Fig. 4. Phase-angle thickness gage is insensitive to any variations in the probe-to-sample spacing.

minishes errors due to dust or dirt on the sample, the geometry of the object, and the inclination of the probe. In this procedure, the probe is first brought near the surface of a bare piece of basis metal and then slowly raised. The needle of the meter will move in one direction until a peak value is reached; it will then reverse its direction. When the instrument is adjusted so that the peak for the basis metal occurs at the zero reading, the probe is placed on the sample to be tested and slowly raised until the peak reading for the sample is obtained. This method has been adopted for all measurements except those made on coatings of nonconductors on metals or of poorly conducting metals on highly conducting metals. These coatings require direct contact between the probe and the surface of the specimen at the time of the reading.

Range of thickness which can be measured by the Dermatron depends upon the frequency used. A given frequency may be used only for thicknesses through which a significant amount of current penetrates. High frequencies are most suitable for accurate measurement of thin coatings because the penetration of the current is shallower. At a frequency of 2 mc., most coatings up to 1.5 mils in thickness can be measured accurately. A frequency of 100 kc. permits coatings up to 6 mils to be measured, but measurements of thin deposits are not as accurate at this frequency.

#### Phase-Angle Thickness Gage

A phase-angle thickness gage (Fig. 4) was developed by W. A. Yates and J. L. Queen of NBS for the Navy Bu-

reau of Ships. The probe of this instrument consists of a mutual inductance transducer which is held in proximity to the sample but does not necessarily touch it. Also located on the probe head is a buckout transformer, shielded from the influence of the sample. These two elements are electrically connected and excited with r.f. current in opposition, producing output voltages whose phase difference is responsive to the conductance of the sample. A phasemeter, specifically designed for use with the probe, is calibrated for the desired frequency ranges. For direct reading of thickness, the phasemeter output is indicated on a meter calibrated in mils of silver

which has been applied to a basis of 0.037" stainless steel. In use, the instrument is adjusted first for null phase difference when the probe is held away from the influence of the sample. Thereafter, thickness readings are obtained by bringing the probe in proximity to the specimen—usually within 0.125". The readings obtained are not affected by probe-to-sample spacings of less than 0.125".

Choice of operating conditions for a plating thickness gage is strongly influenced by the circumstances under which it is to be used, since the plating and basis metal both contribute to

*(Continued on page 30)*

Fig. 5. Schematic diagram of the wave guide plating indicator.

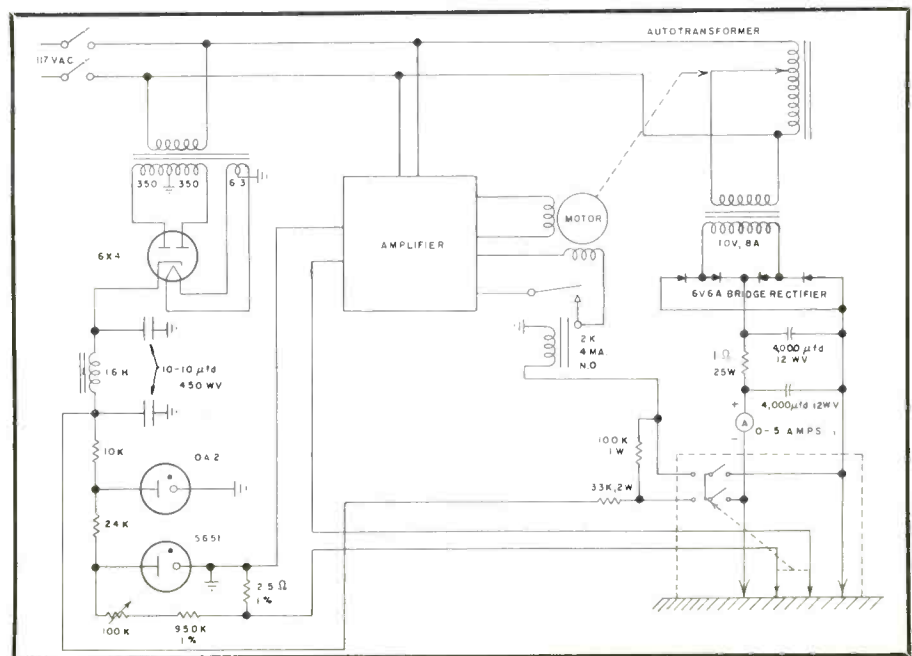

# THE PHANTASTRON

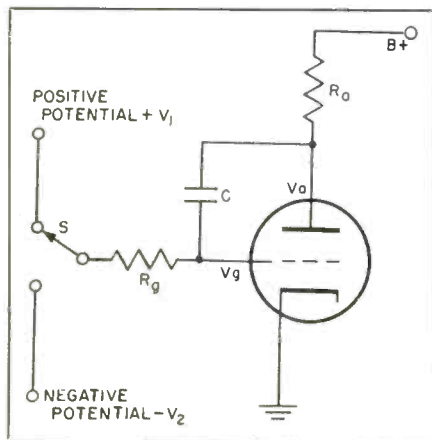
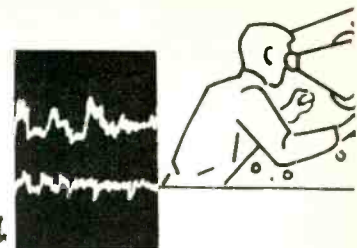

Fig. 1. A simple Miller circuit.

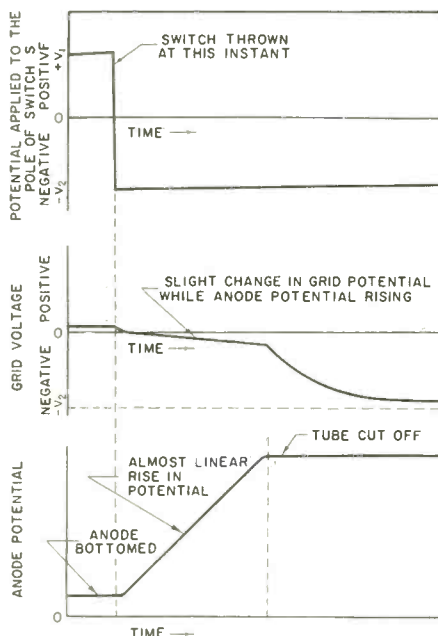
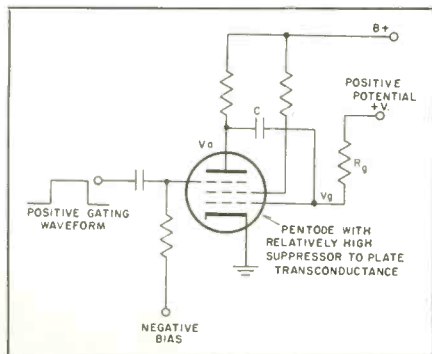

Fig. 2. Grid and anode waveforms obtainable with a Miller circuit.

Fig. 3. The gated Miller circuit.



A circuit for producing, by triggering, a square wave of controllable yet very stable duration.

**D**URING the years from 1942 to 1946, the Telecommunication Research Establishment of the British Ministry of Aircraft Production was located in the Malvern Boys College in the little town of Great Malvern in Worcestershire. The college property consisted of a cluster of separate buildings situated on a hillside looking eastward over the Vale of Evesham, and in the basement rooms of one of these buildings was located the laboratory of two of England's leading electronic circuit engineers, Dr. F. C. Williams and N. F. Moody. Out of their laboratory came many ingenious and useful circuits, and though many of these have been described in highly technical English journals, they are relatively unknown in this country. By means of this article, the author hopes to acquaint the American electronics engineer with one of the most important of the Williams-Moody circuits. This is the "phantastron," a device for the production—by triggering—of a square wave of controllable yet very stable duration which has found considerable use in radar and other pulse circuitry.

## Miller Circuit

To understand the phantastron circuit, it is first desirable to study the so-called Miller circuit. This circuit is illustrated in its simplest form in Fig. 1, and is seen to consist merely of a triode with a grid leak  $R_g$ , a capacitor  $C$  connected between grid and anode, and an anode resistor  $R_a$ . With the pole of the switch  $S$  in the grid circuit connected to the positive potential, the tube is heavily conducting and its anode is "bottomed" or at a minimum potential. Grid current is drawn through the grid leak  $R_g$  and the grid is slightly positive with respect to the cathode.

Now assume that the switch is snapped into the other position connecting the pole to a negative potential  $-V_2$ . The current through the grid leak  $R_g$  reverses its polarity, and electrons flow from the source of negative potential  $-V_2$  to the plate of the capacitor  $C$  attached to the grid of the tube. However, the grid potential of the tube must remain within the operating range of the grid (within a few volts) because of

the feedback afforded by the capacitor  $C$ . If the grid should go negative too rapidly, the feedback would tend to swing the anode potential positive. Since the anode is capacitively coupled to the grid, a positive swing on the anode would cause a positive swing in grid potential counteracting the original tendency for the grid to go negative.

The net result of connecting the pole of the switch  $S$  to the negative potential  $-V_2$  is to cause the tube to be gradually biased off and the anode potential to rise in a substantially linear manner. The rate of rise in potential at the anode of the tube up to a point close to cutoff may be calculated as follows:

The current through the grid leak is given by  $(V_g + V_2)/R_g$ , and if  $V_2$  is expressed in volts and  $R_g$  in megohms, the grid leak current is given in microamperes. Knowing the rate of flow of current into the capacitor, and knowing the capacity, the rate of increase in potential  $d(V_a - V_g)/dt$  across it can be determined. This rate of rise of potential in volts per microsecond is given by the ratio of the current to the capacity, where the current is in microamperes and the capacity is in micro-microfarads. Expressed mathematically, it becomes:

$$\frac{d(V_a - V_g)}{dt} = \frac{(V_g + V_2)}{R_g} \times \frac{1}{C} \quad (1)$$

If the grid voltage is assumed to remain close to zero on cathode potential, the rate of rise of the anode voltage may be expressed as:

$$\frac{dV_a}{dt} = \frac{V_2}{R_g C} \quad (2)$$

A useful guide for mentally calculating rates of change of potential is to remember that a flow of one microampere into one micromicrofarad produces a rate of change in voltage of one volt per microsecond.

Once the triode has ceased to conduct and the anode remains at its maximum potential, the grid potential begins to go negative until it is at the same potential as  $-V_2$ .

The changes in potential at the anode and grid of the tube are illustrated by Fig. 2. The change in grid potential





during the rise time of the anode potential causes a slight nonlinearity. However, this is improved considerably by the use of high gain pentodes with sharp cutoff characteristics.

### Gated Miller Circuit

The next step in the development of the phantastron is embodied in the gated Miller circuit, shown diagrammatically in Fig. 3. With the arrangement as shown, a positive square wave or gating pulse applied to the suppressor grid produces a linear run-down of the anode potential.

Such a circuit requires a tube with a relatively high suppressor-to-plate transconductance. A very suitable tube for this purpose is the 6AS6, a miniature seven-pin type, although pentagrid converters like the 6SA7 can also be utilized provided that the third grid is employed as a suppressor. (The British tube that is used for essentially all phantastron circuits is the VR116.)

Examination of Fig. 3 shows that during quiescence the suppressor is biased negatively, thus preventing any anode conduction. The control grid (at approximately ground potential) is connected to a positive potential ( $V$ ) via the grid leak ( $R_g$ ), and hence the screen receives most of the cathode current. Upon the application of a positive gating pulse of sufficient amplitude, the suppressor becomes positive with respect to cathode and allows the anode to conduct. The anode potential falls rapidly for three or four volts and then proceeds to fall in a uniform manner until "bottoming" occurs as a result of the action of the capacitor between anode and grid. The rate of fall of the anode potential is approximately:

$$\frac{dV_a}{dt} = \frac{V - V_0}{R_g C} \quad (3)$$

where  $V_0$  remains close to zero during the run-down time of the anode voltage. This is illustrated by Fig. 4, which shows the waveforms occurring at the various electrodes.

If the gating waveform is of longer duration than the anode run-down time, then the anode remains "bottomed" for the remainder of the gating pulse, although the grid potential climbs back to ground potential. It will be noted that the screen potential also falls when "bottoming" occurs due to the rise in grid voltage and screen current.

At the termination of the gating pulse, the anode voltage rises exponentially to the potential of the B+ supply,

and in so doing may produce a slight positive surge on the grid and a negative surge on the screen voltage due to a slight increase in cathode current. If the gating pulse terminates before "bottoming" occurs, then the electrodes immediately begin to recover their quiescent potentials. Hence, to produce a complete run-down of the anode potential, the gating pulse should have a duration at least as long as the anode run-down time. In the phantastron, however, only a short-duration trigger pulse is required to initiate a complete operation of the circuit.

### The Phantastron Circuit

The phantastron circuit is similar in design to the gated Miller circuit except that during the run-down time the suppressor grid is automatically held at a higher potential than the cathode potential. Thus, the circuit requires only a triggering action for its operation.

A typical circuit designed to give a square-wave voltage waveform on its screen of approximately 100- $\mu$ sec. duration is shown in Fig. 5. It will be noted that during quiescence the grid voltage is clamped at about 40 volts positive with respect to ground by means of the diode. Since the cathode, control grid and screen section of the tube act as a cathode follower, the cathode potential is close to 40 volts; and with a cathode resistor of 3900 ohms, the cathode current is close to 10 milliamperes. This current is collected by the screen which has a resistor in its circuit of the order of 8200 ohms. If the B+ voltage is 175 volts, the screen potential is close to 93 volts or about 53 volts with respect to cathode. The 20,000-ohm suppressor leak is connected to a potential of +20 volts, and therefore the suppressor is biased 20 volts below cathode potential. This bias prevents conduction by the anode which is at a potential close to 175 volts (the B+ potential).

Suppose that a positive pulse of, say, 30 volts amplitude is applied to the suppressor. Anode conduction begins immediately and the anode potential falls rapidly almost 40 volts, as shown in Fig. 6. The grid then falls to a voltage close to a ground potential, the screen current almost disappears, and the anode is free to conduct. However, the current drawn by the tube is limited by the high value resistor in its anode (500,000 ohms). Moreover, it cannot reach a state of maximum conduction immediately due to the presence of

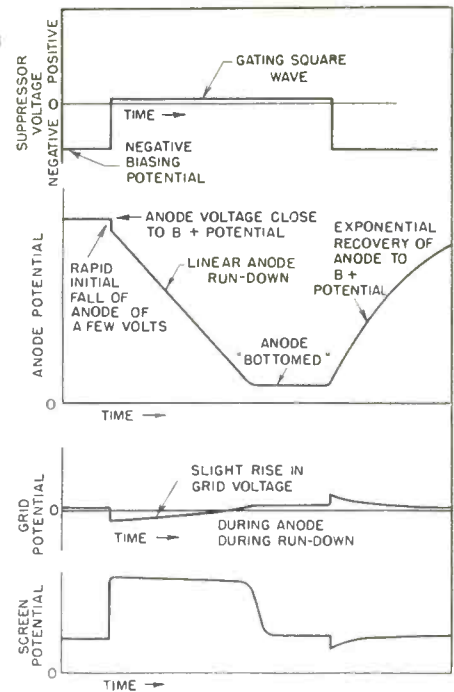

Fig. 4. Typical waveforms which can be obtained with gated Miller circuit.

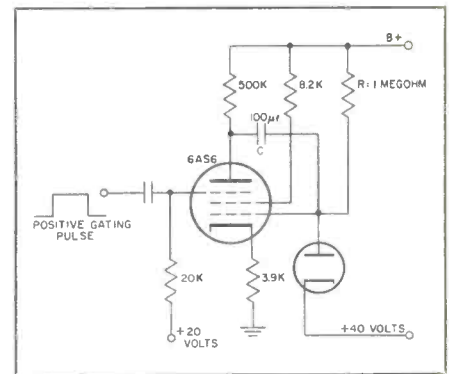
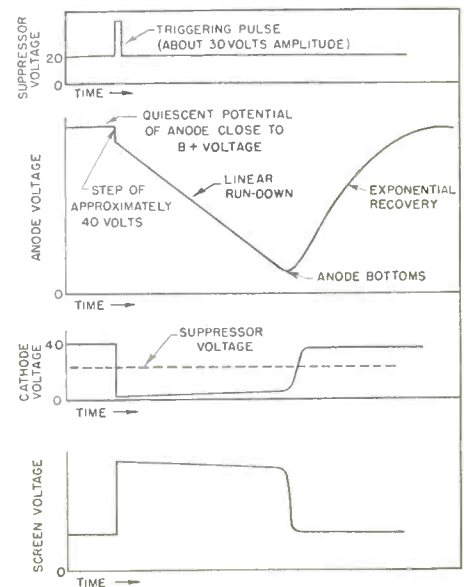

Fig. 5. A typical phantastron circuit.

Fig. 6. Waveforms obtainable at the various tube terminals of the typical phantastron circuit shown in Fig. 5.



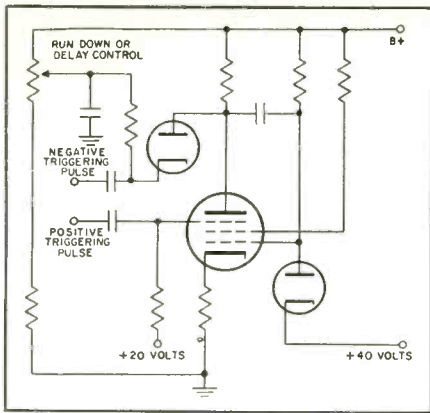

Fig. 7. Method of varying the run-down time of a phantastron by varying anode potential of triggered tube.

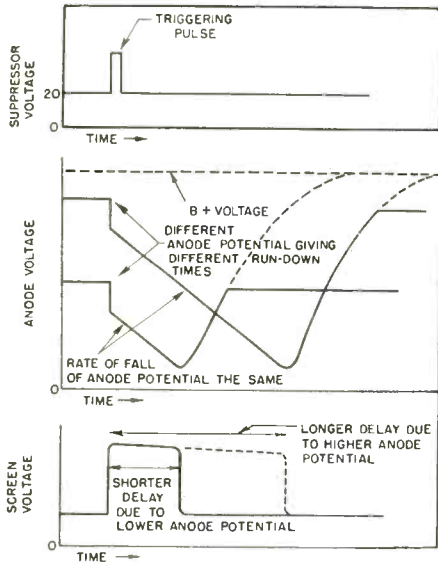
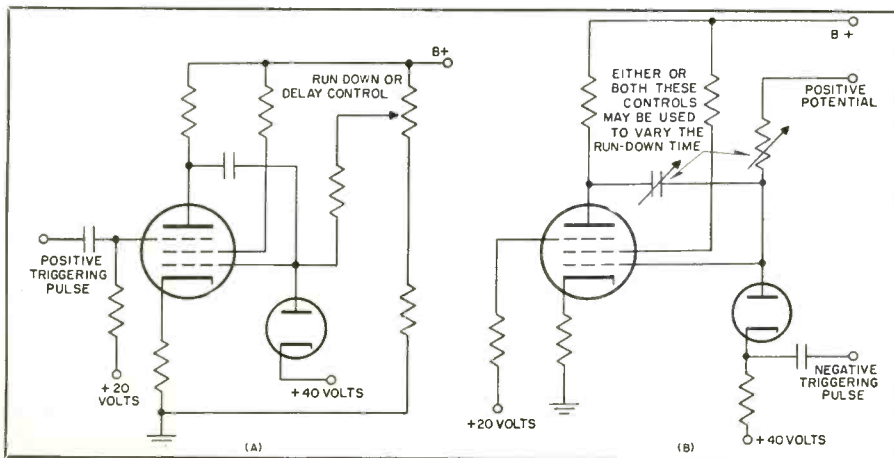

Fig. 8. Waveforms obtainable when anode potential of Fig. 7 is varied.

the capacitor between anode and grid. As a consequence, the potential of the anode falls linearly with respect to time at a rate inversely proportional to the product of the capacitor  $C$  and the resistance  $R$ .

Fig. 9. Varying the run-down time of a phantastron by varying (A) the potential applied to the grid leak, and (B) the grid leak and feedback capacitor.



When "bottoming" of the anode occurs, the grid potential ceases to be influenced by the falling anode voltage and begins to rise. As it does so, the cathode current increases in unison with it. A stage is soon reached where the cathode potential rises above the suppressor voltage; and when this occurs, the anode potential tends to rise, pulling the grid and cathode potential even higher. Thus, a flyback action occurs and the tube returns to its quiescent level.

If the reader is sufficiently interested to build the circuit shown in Fig. 5, he should experiment with various values of grid leak, anode-grid capacity and anode resistance. Increasing either of the first two variables produces an increase in the duration of the positive screen square wave. Increasing the anode resistance, however, has little effect on cathode waveform, although it does increase the recovery time of the anode circuit.

Of the various waveforms produced by the phantastron, the screen waveform is the most commonly used. It is a positive-going square wave of 50 to 150 volts amplitude in most cases and is developed across an impedance of the order of 10,000 ohms. The cathode waveform is of the opposite polarity and is only of the order of 40 volts. However, it is of sufficient amplitude to find considerable use in pulse circuitry.

#### Varying Run-down Time

The phantastron is extremely useful due to the fact that its run-down time may be made directly proportional to a controlling potential. To accomplish this proportionality, the anode potential of the tube during its quiescent state may be controlled by means of a diode and potentiometer arrangement as shown in Fig. 7. (The same figure shows how positive or negative pulses may be used for triggering.) By controlling the anode potential, the potential through which the anode can fall is varied. How-

ever, the rate of fall in voltage remains the same, and so the time of fall or duration of the run-down is varied, as illustrated in Fig. 8. In radar ranging circuits, the controlling potential—instead of being a potentiometer—is frequently the anode potential of another tube.

Run-down time of the circuit may also be controlled by adjustment of the potential applied to the grid leak, as illustrated in Fig. 9A. However, in this case, the run-down time is almost inversely proportional to the applied voltage. Because of this nonlinear operation, variation of the voltage applied to the grid is seldom used as a method of control.

Where a manually operated control is desired, the value of either the grid leak or the grid-anode capacitor may be changed. In the former case, a variable resistor is used for the leak, and in the latter, a variable capacitor. Increasing the value of either increases the run-down time, and both methods provide essentially linear controls. Fig. 9B illustrates a circuit using both methods of control.

#### Methods of Triggering

The simplest method of triggering the circuit involves the application of positive pulses to the suppressor with an amplitude sufficient to overcome the suppressor bias (the potential difference existing between suppressor grid and cathode). This type of triggering is illustrated in Fig. 5. It is desirable to use a relatively low value of grid leak (such as 10,000 to 50,000 ohms) since large values tend to permit the tube to produce parasitic oscillations.

If only negative pulses are available for triggering the phantastron, they, too, may be used at the anode or at the control or first grid. When applied to the grid, they may be fed to the cathode of the catching or voltage-limiting diode there, as illustrated in Fig. 9B, in which case a cathode resistance is necessary if the 40-volt source of potential has a low impedance to the pulse. Similarly, as an alternative method of triggering, a negative pulse may be applied to the cathode of the diode in the anode circuit as illustrated by Fig. 7. In all cases, however, the duration of the triggering pulse should be short compared with the minimum run-down time of the phantastron.

#### Stability

One of the characteristics of the phantastron that has made it so popular in radar circuitry is its constancy of run-down time with respect to fluctuations in the B+ supply. This constancy is evident only when the potentials applied to the anode and the grid leak are derived from the B+ supply and can

(Continued on page 32)



# MULTIPLEXING MICROWAVE COMMUNICATIONS CIRCUITS

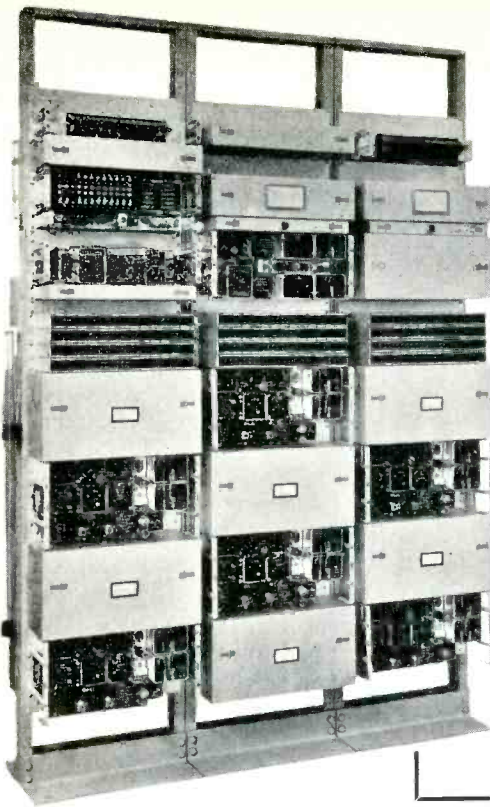

Fig. 1. Lenkurt 24-channel Type 33C frequency-division multiplex system.

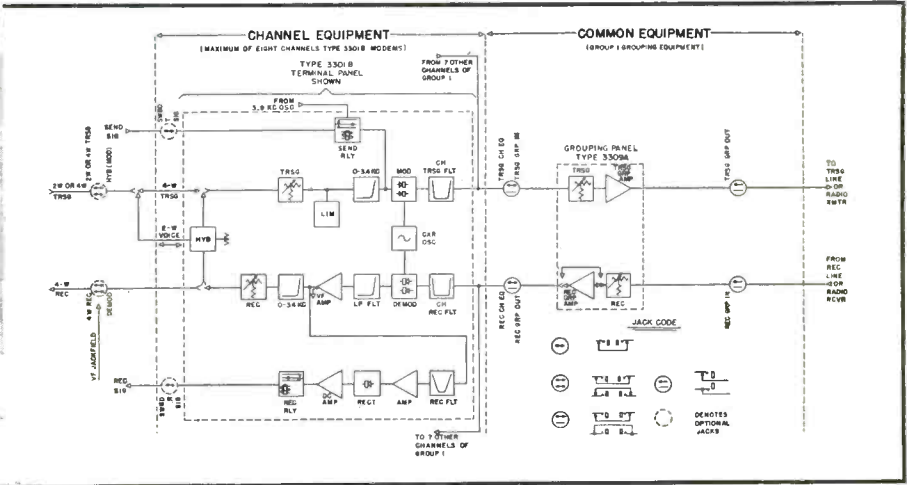

Fig. 2. Block diagram of an eight-channel group assembly which is a part of the Type 33C equipment shown in Fig. 1.

By **ALDEN P. BOWSER**

Lenkurt Electric Sales Co.

*Either frequency- or time-division multiplexing can be used for multiple transmission of intelligence.*

ATTEMPTS to multiplex communications circuits followed close on the heels of the development of successful single-channel systems. Multiplexing was a natural line of investigation to pursue because of the increasing demand for communications services brought about by the complexities of modern living and the unprecedented requirements for relaying multichannel interrelated intelligence.

In approaching the problem of multiplexing, two essential parameters are considered—frequency and time. Scientists and engineers have developed a vast number of systems by which available frequency spectrum and time can be allocated so as to make possible the multiple transmission of intelligence. These many systems, however, fall simply into two general types—frequency-division multiplex and time-division multiplex. In the former, a portion of the bandwidth is used all of the time by each channel; in the latter, all of the bandwidth is used by each channel for a portion of the time.

In frequency-division multiplex, the channels may be considered as separate low-frequency radio transmitters operating on adjacent channels. The entire r.f. band made up of these channels is then used to modulate a wide-band radio transmitter or applied directly to wire line or cable transmission facilities.

In time-division multiplex, each channel is successively connected to the transmission medium by a commutation

device which, through the use of a synchronizing signal, is precisely duplicated at the remote terminal.

### Typical System

A typical arrangement of frequency-division multiplex equipment is shown in Fig. 1. This system will provide up to 24 toll quality voice channels using single-sideband suppressed-carrier methods. Each of these channels may, if desired, be subdivided into 18 or more telegraph or telemetering channels. An out-of-band signaling channel is integral with each voice channel.

The channels are allocated into three eight-channel groups. Group one is obtained by single-step modulation to space channels at 5-kc. intervals between 10 and 50 kc. Groups two and three are obtained by group modulation of the basic eight-channel group. Fig. 2 shows a block diagram of a group assembly. Voice-frequency drop circuits are connected to the channel equipment through any necessary hybrid or pad arrangements. A low-pass filter removes voice-frequency components at frequencies higher than the desired

channel bandwidth. Desired frequencies are then applied to a balanced modulator. Modulation products are transmitted through a channel-transmitting filter which passes only the desired sideband. The output of this channel is combined with the outputs of seven other similar channels whose carrier frequencies and, hence, output bands are different and so arranged as to be placed at 5-kc. intervals from 10 to 50 kc.

Signals received from the radio receiver are fed through a pad and receiving group amplifier into a series of channel receiving filters which separate the combined intelligence into individual channels. From these filters, the sideband energy is combined in demodulators with carrier signals which are common to both modulator and demodulator for a given channel. The demodulated frequencies are applied to a low-pass filter, where the lower sideband is selected. This sideband is then amplified and connected to the receiving drop.

If more than eight channels are required, a multigroup system can be

Fig. 3. Frequency-division multiplex equipment provides multichannel service with three outlying islands at USNAMTC, Point Mugu, Calif.

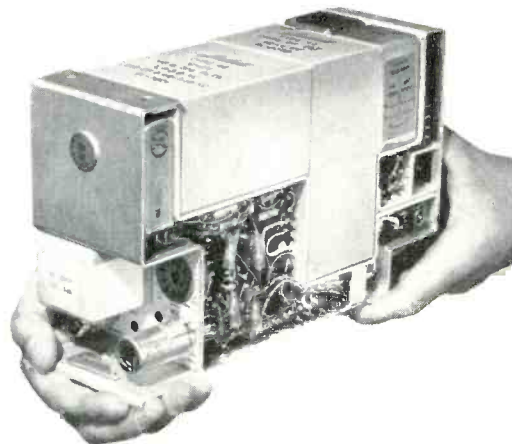
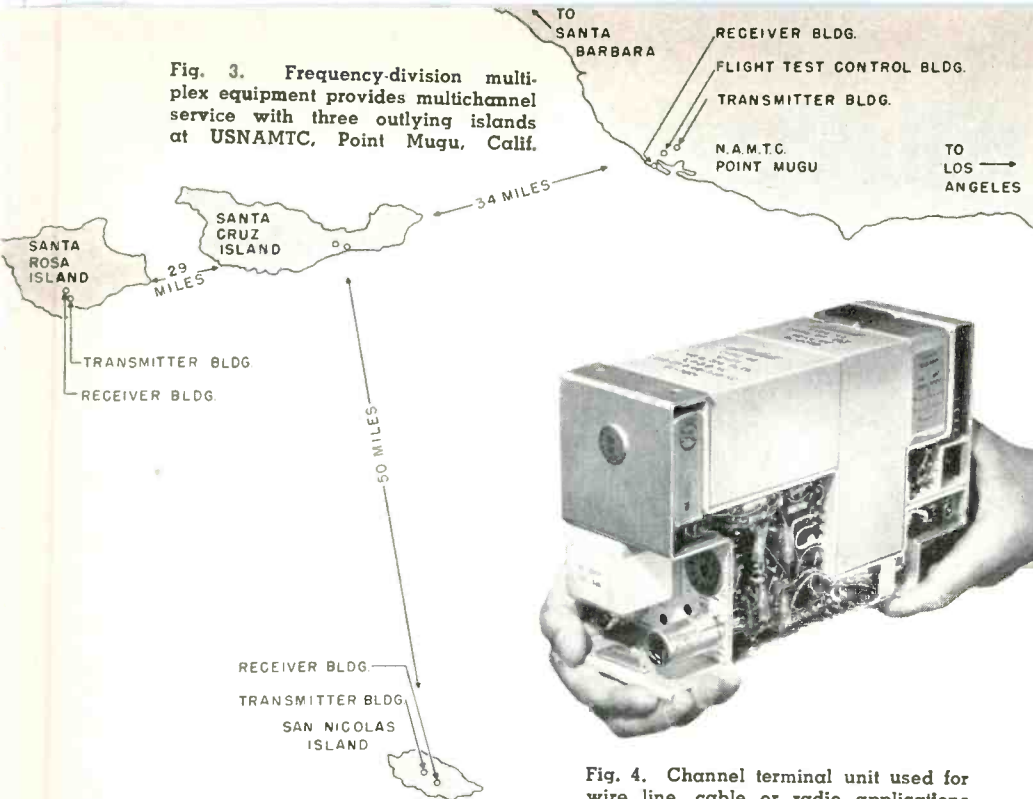

Fig. 4. Channel terminal unit used for wire line, cable or radio applications.

tics of the higher frequencies may be unsuitable for the type of service required. At frequencies of 900 mc. or below, where the degradation of service as a result of atmospheric conditions, precipitation, fog, etc., is much less pronounced than in *L*, *S* and *X* bands, the spectrum space is at a premium. For this service, frequency-division multiplex using single-sideband carrier channels is a "natural." The required bandwidth is essentially only that of the channel voice frequencies required for transmission multiplied by the number of channels required. This is substantially less by a factor of six or eight than the bandwidth required of the simplest time-division system.

Frequency-division multiplexing is inherently suited to the initial installation of partial systems which may later be expanded as required with minimum cost and minimum disruption to service. It is readily possible to add individual channels or groups of channels to most systems by merely adding the equipment required for the new channels in parallel with existing apparatus. The result is simply an extension of the upper frequency limit by the required amount. Furthermore, the expansion capability of an FDM system is not purchased by any compromise with performance, complexity or cost.

In planning a multiplexed microwave communication system, selection of the operating frequency is one of the most important considerations. Although higher frequencies make possible the use of highly directional arrays such as horns, lenses, and wide aperture reflectors, the depth of fading is usually a direct function of the frequency and tends to limit the length of a link which can be satisfactorily operated. Normally, fading will be found more severe on links which are operated over water routes or along a coast line.

used. In a typical application, three identical eight-channel groups are employed, two of which are subjected to a further modulation process in which the combined sideband energy of the eight channels is modulated against a high frequency oscillator to produce a translation in frequency of the entire band to a new location.

For different requirements, different models of equipment have been developed involving one modulation process for a simple system to as many as five for a complicated and extensive system. Each modulation process, however, is simple; the equipment to produce the required effect is conventional, easily understood and easily maintained; and the life and stability of components and circuits are excellent.

Many types of time-division multi-

plex systems exist. Their common characteristic is that each type involves successive switching between channels of the system to sample the intelligence which is to be transmitted. This sample is used to vary some characteristic of the pulse train. The more common types of pulse time-division multiplex systems are pulse amplitude modulation, pulse length modulation, pulse position modulation and pulse code modulation.

#### Engineering Factors

Often of great importance in selection of a system for a particular need is the question of available bandwidth. At some of the higher frequency assignments, bandwidth is adequate at the present time for any reasonable number of channels. However, as is often the case, the propagation characteris-

Fig. 5. Modulation plan for Type 45BX 48-channel system for radio applications.

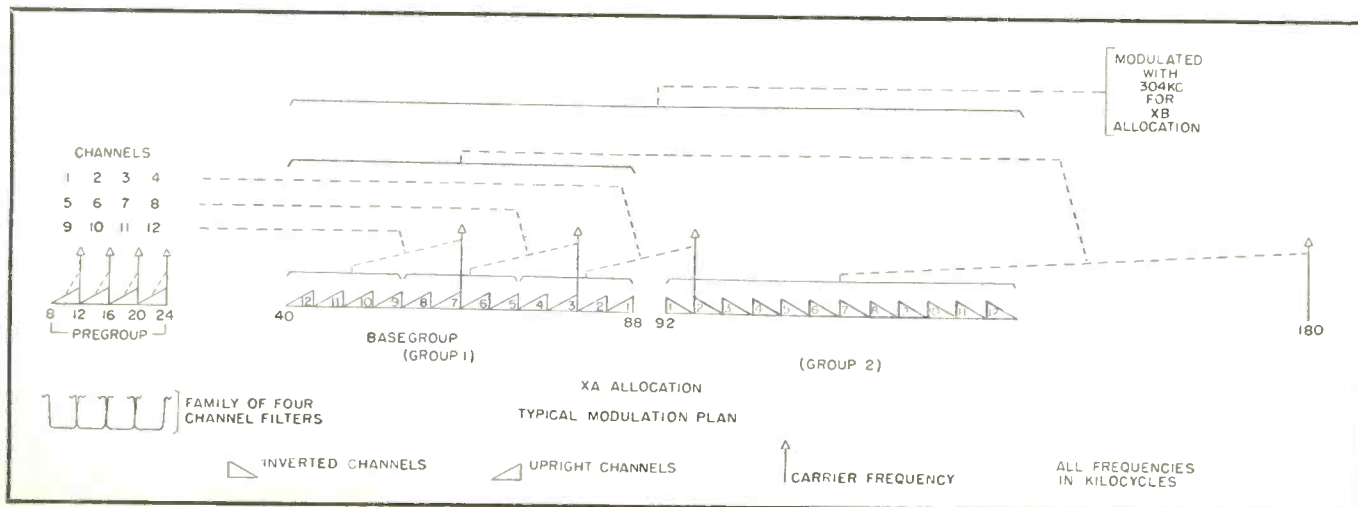





# INDUCTIVE COORDINATION

By **NICHOLAS ALCHUK**

*Simple power line filters can reduce interference on wire line voice circuits due to the proximity of the two lines.*

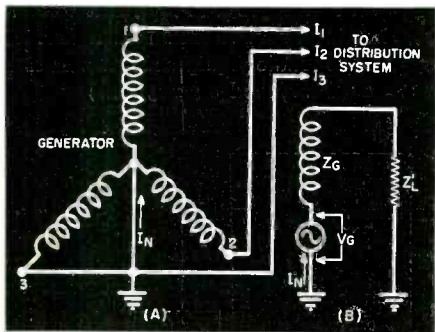

Fig. 1. (A) Schematic diagram of a grounded neutral generator connected to a distribution system. (B) Equivalent circuit of the same generator.

Fig. 2. Method for connecting a wave trap in the generator neutral lead.

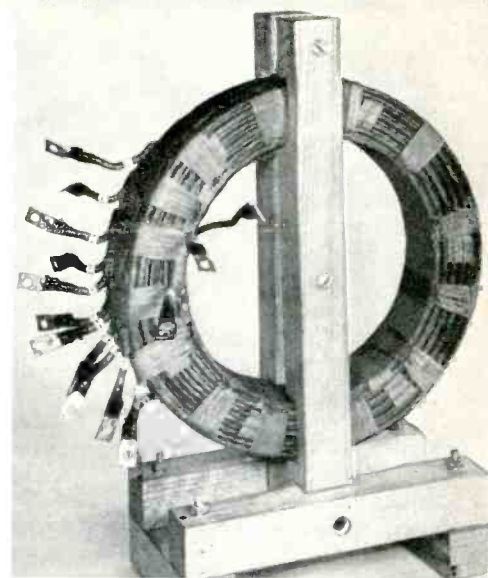
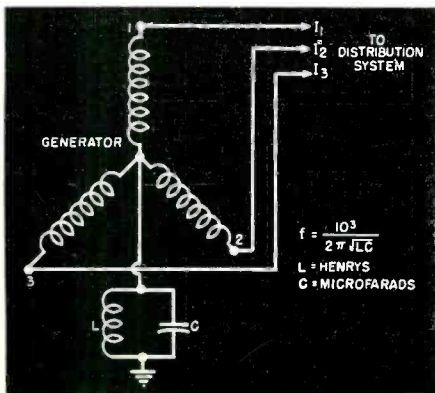

Fig. 3. Typical replacement coil.

**A**LTHOUGH recent advances in v.h.f. and u.h.f. have occupied the attention of many electronic engineers, problems of a highly complex nature are being solved by communication engineers in the extensive and expanding field of low frequency communications. One problem in particular which frequently confronts the communication engineer is that of inductive coordination. Inductive interference of sufficient amplitude appearing on communication channels will prevent the economic use of a low frequency system.

Communication wire systems are used widely by electric and telephone utilities for voice, telemetering and other functions too numerous to mention. In many instances, the communication and power circuits share the same right-of-way, or wire circuits are directly attached to the power line poles. The resultant induced voltage or noise on the communication channel manifests itself in several ways, and requires a joint inductive coordination program between the two principals involved in an effort to reduce the undesirable interference. Although more familiar to the power engineer, the terminology encountered in inductive coordination has also become part of the communication engineer's vocabulary.

Inductive interference problems may be divided into two types: (1) noise-frequency problems related to the harmonics of the power system, and (2) low-frequency problems associated with the fundamental frequency of the power system. The present discussion will deal with noise-frequency problems only. It may be mentioned, however, that low-frequency induction effects are normally associated with ground-return fundamental-frequency, or with third harmonic currents. Problems of this nature may be encountered but

can be controlled somewhat by the design of the power lines and the generating equipment.

## Noise-Frequency Interference

Noise-frequency interference occurs as a result of the induced voltage from harmonics in the power circuits. Two principal factors in the power system control its influence: (1) the waveshape of the power currents and voltages, and (2) the phase balance of the power lines and equipment to ground.

It is impossible to generate and transmit a pure 60-cycle sine wave owing to the generation of harmonics in the generators, transformers and utilization equipment. Harmonics of the power system fall into two broad classes: (1) triple components, and (2) nontriple components. Nontriple components on a three-phase system, such as the 7th harmonic (420 cycles) and the 11th harmonic (660 cycles) etc., are 120° apart and identical with the fundamental voltage; these components appear on the power lines as balanced quantities. Because of the unbalance of lines and equipment, they also appear as residual interfering quantities. Conversely, triple harmonics such as the 3rd (180 cycles) and the 15th (900 cycles) are in phase and appear on the lines normally as residual quantities. There is no difference in the action of triple and nontriple harmonics on a single-phase system. In any specific case, it is important to determine whether the components are balanced or residual, since their control may be entirely different.

Generating and transformer equipment are reasonably balanced both at the fundamental and harmonic frequencies. With certain types of connections, however, triple harmonics may be impressed on the lines. Unbalance is





Fig. 4. Two-frequency wave trap.

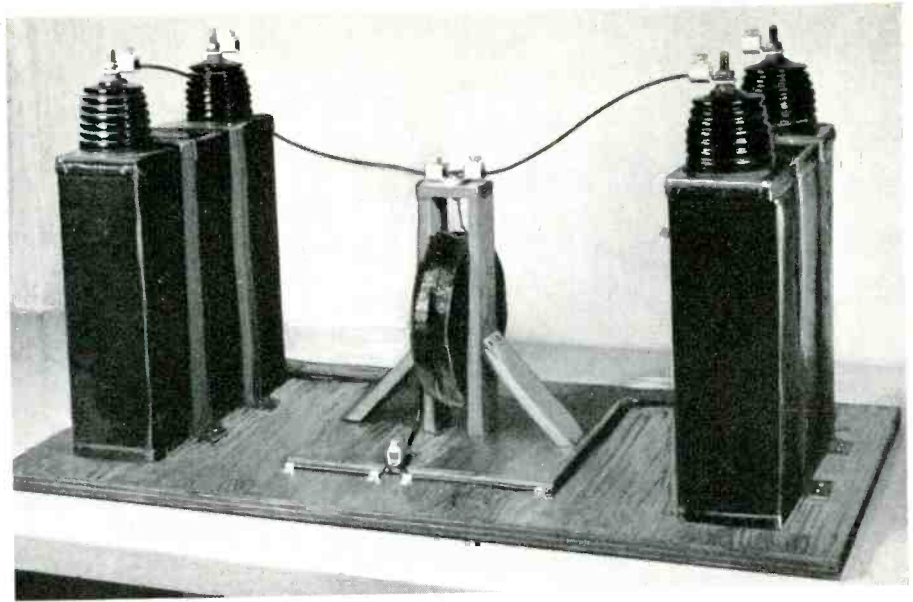

Fig. 5. Wave trap for operation at a single frequency only.

negligible at 60 cycles, but it increases in importance as the frequency is raised. Power and communication lines can be reasonably balanced at the lower harmonic frequencies by means of transpositions.

The effect of harmonic voltages depends on the frequency response of the communication system. Because the coupling between power and communication facilities is proportional to frequency, the influence of a given harmonic quantity is proportional to the frequency response of the communication system multiplied by a factor proportional to its frequency. Using this information, the telephone interference factor (TIF) for current or voltage may be derived. The numerical value of TIF is important in inductive coordination, and is frequently encountered.

#### Testing Equipment

A wide variety of test equipment is available to detect and measure the interference factor in communication circuits. Among the more important instruments are:

1. Harmonic analyzers
2. Noise-measuring sets
3. TIF meters

Harmonic analyzers permit the measurement in volts and amperes of individual harmonic quantities in the power and communication circuits. A noise-measuring set is a vacuum-tube instrument with weighting networks which measures by means of an oscilloscope or indicating meter the equivalent noise on different types of circuits; this instrument also readily measures the audio noise in a telephone carrier or radio channel. TIF meters contain weighting networks which weight the individual harmonic components in accordance with predetermined curves

and give direct measurements of current or voltage TIF.

#### Reducing Interference

Isolation of the generator neutral will eliminate residual currents. Satisfactory reductions can also be obtained in some instances by using reactors or a combination of reactors and capacitors connected in the neutral-to-ground lead of the generator.

Before attempting to apply remedial measures, an analysis of the power circuit harmonic components must be made. As in electronic engineering, the equivalent circuit is extensively used. Figure 1B illustrates such a circuit with respect to residuals of a generator connected directly to a transmission system.

In Fig. 1B,  $V_G$  represents any single frequency component of voltage which would exist between the neutral of the generator and ground under load conditions with the neutral-to-ground connection open.  $I_N$  is the corresponding component of the total neutral current resulting from  $V_G$  being impressed on the impedances  $Z_G$  and  $Z_L'$  (the impedances of the three generator phases in parallel and the impedance to ground of the transmission or distribution system, respectively). This equivalent single-phase circuit is useful in determining the effect of selective traps in the neutral of the generator.

Letting  $Z_L = Z_G + Z_L'$ , the effectiveness of any impedance inserted in the generator neutral would be:

$$\alpha = \frac{Z_L}{Z_L + Z_N} \dots \dots \dots (1)$$

$Z_N$  being the inserted impedance, and  $\alpha$  the attenuation factor (db).

From a knowledge of the total impedance to ground,  $Z_L$  and  $Z_N$ , it is possible to predict the effectiveness of any

trap inserted in the neutral connection.

#### Neutral Reactors

In instances where a number of harmonic residual currents are to be suppressed, particularly those of higher frequencies, satisfactory results may be obtained by inserting a reactor in the generator neutral-to-ground connection.

If consistent with satisfactory system operation, the reactor is chosen to give the required harmonic reduction at the lowest frequency suppressed; reductions at the higher frequencies will then be as great or greater than that on which the design is based. The 60-cycle reactance which will give the desired attenuation at a particular frequency can be readily calculated from the following equation:

$$X_R = \frac{Z_{Ln} (1 \pm \alpha)}{n} \dots \dots \dots (2)$$

where  $\alpha$  represents the attenuation ratio,  $n$  is the harmonic at the frequency at which attenuation is desired, and  $Z_{Ln}$  represents the system impedance to ground at the  $n$ th harmonic. The sign + or - depends upon the phase angle of  $Z_{Ln}$ .

#### Single Unit Wave Traps

Considerable attenuation of residual current at a particular single frequency may be obtained by inserting a wave trap in the generator neutral-to-ground connection. Figure 2 illustrates its position in the circuit, while Figs. 3, 4, and 5 show typical wave trap construction.

Representing the ratio of coil reactance ( $X_R$ ) to the sum of the effective resistance of the reactor plus the equivalent resistance of the capacitor by  $Q$ , the impedance  $Z_T$  of the wave trap at resonance is:

(Continued on page 35)

# TEMPERATURE-COMPENSATED STRAIN GAGES

*New gages permit strain measurements to be made at high temperatures without elaborate compensating circuits.*

BY ALVIN B. KAUFMAN

Northrop Aircraft, Inc.

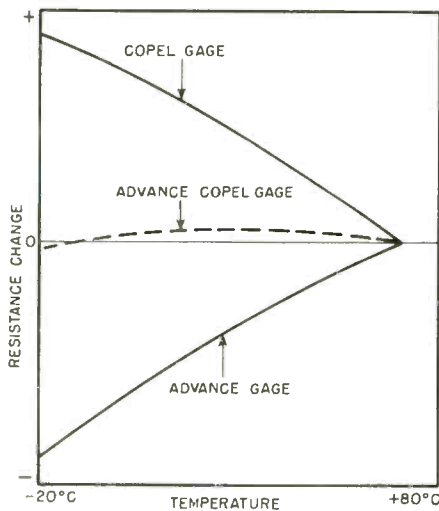

Fig. 1. Temperature-resistance curves for three types of gages cemented on dural. Note superiority of advance copel.

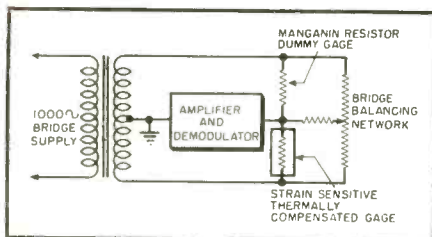

Fig. 2. Partial schematic of typical temperature-compensated strain gage application utilizing a dummy gage.

THE AVAILABILITY of temperature-compensated strain gages now makes practical the measurement of absolute strain or stress in applications where such measurement was formerly very difficult. Special fabrication procedures and materials have been developed to correct for changes in gage resistance due to temperature changes, and the coefficient of thermal expansion of the gages can be made to match either steel or aluminum.

Basically, strain gages are used electrically in some form of a Wheatstone bridge. With this type of circuit configuration, the signal produced by the gage changing resistance may be differentiated from the bridge exciting voltage. The configurations and problems incidental to the use of strain gages in a Wheatstone bridge circuit have been covered quite adequately<sup>1</sup>. However, a resume of bridge considerations might be desirable, and the effect of the new *Baldwin-Lima-Hamilton* temperature-compensated gages upon prevailing circuitry used by the industry will be discussed briefly.

Functionally, a strain gage bridge may have from one to four active legs. Where either two or four gages are employed, any resistance change due to either thermal-resistance effect or to a difference in the coefficient of expansion between the gage wire and the material it is mounted on will be cancelled out, as both gages (or bridge legs) will vary equally in resistance.

In many instances, it is possible to have only one active strain gage installed on the structure to be tested. It is the practice nominally in these instances to mount a dummy gage on a sheet of the same material, near the active gage. This supplies the other leg needed for "half-bridge" configurations and at the same time effectively gives temperature compensation<sup>1</sup>, assuming that the dummy plate and the structure attain the same temperature. Of course, where absolute magnitude of strain measurement is not required, an ordinary resistor may be used in that leg as a dummy.

There are many one-gage installations, however, where it is desirable to measure absolute strain magnitude<sup>2</sup> but impossible to stabilize the bridge circuit thermally by use of a dummy strain gage. The *Baldwin* temperature-compensated gages were designed specifically for installations of this nature. Each gage consists of two wires in series, one having a positive and one a negative coefficient of fictitious strain with temperature change, and each is used in the correct proportion so that there is little over-all resistance change for wide ambient temperature variations. They are made from specially selected cupro-nickel wire and are similar to the "A" type strain gage.

In the case of dural and mild steel, no single-wire material has been found having a thermal expansion coefficient plus a temperature coefficient of resistance, the resultant of which is equal to the strain introduced by the thermal expansion of the metal mounting surface, and yet possessing a high strain sensitivity. For this reason, it is necessary to use two wires having temperature characteristics similar to dural or steel, one with a slightly positive and one with a slightly negative coefficient as compared with these materials. Typical of wires meeting this requirement are advance and copel wire. Copel has a coefficient of expansion slightly greater than dural while advance wire has a coefficient which is slightly less, causing a compressive and tension strain respectively if gages of each type are mounted on a piece of aluminum or steel and the temperature rises (see Fig. 1). Perhaps because of bonding cements, or the differences between metals, the rates of expansion are not uniform or linear with regard to rising increments of temperature. For this reason, it is not possible to make a perfectly compensated gage.

The *Baldwin* temperature-compensated gages are made primarily for use on two materials only—annealed mild steel and 24S-T6 duraluminum.

*(Continued on page 36)*

Fig. 3. Apparent strain vs. temperature for a gage which has been compensated for best fit from  $-50^{\circ}$  to  $+250^{\circ}$  F. Dotted lines show normal spread.

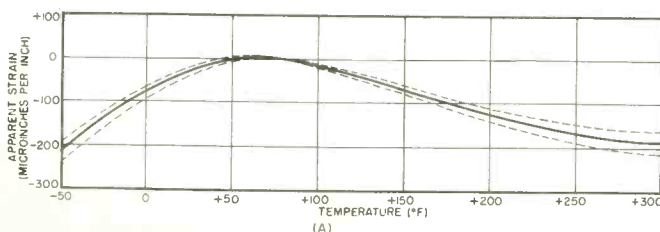
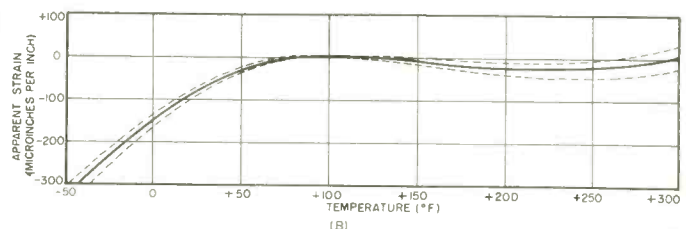

Fig. 4. Curve similar to that of Fig. 3 except that gage has been compensated for best fit from  $+50^{\circ}$  to  $+250^{\circ}$  F. Dotted lines show normal spread.





# RCA NEEDS ENGINEERS

## who won't be held back!

RCA, world leader in electronics, has career opportunities for qualified **ELECTRICAL** and **MECHANICAL ENGINEERS** . . . **PHYSICISTS** . . . **METALLURGISTS** . . . **PHYSICAL CHEMISTS** . . . **CERAMISTS** . . . and **GLASS TECHNOLOGISTS** for long range work in military or commercial fields.

**— SYSTEMS — ANALYSIS — DEVELOPMENT  
— DESIGN — APPLICATION ENGINEERING**

*in the following fields:*

**AVIATION ELECTRONICS (FIRE CONTROL, PRECISION NAVIGATION, COMMUNICATIONS)**— Radar—Analog Computers—Digital Computers—Servo-Mechanisms—Shock & Vibration—Circuitry—Heat Transfer—Remote Controls—Sub-Minaturization—Automatic Flight—Transistorization—Automation

**RADAR**—Circuitry—Antenna Design—Servo Systems—Information Display Systems—Gear Trains—Stable Elements—Intricate Mechanisms

**COMPUTERS**—Digital and Analog—Systems Planning—Storage Technique—Circuitry—Servo-Mechanisms—Assembly Design—High Speed Intricate Mechanisms

**COMMUNICATIONS**—Microwave—Aviation—Mobile—Specialized Military Systems

**MISSILE GUIDANCE**—Systems Planning and Design—Radar and Fire Control—Servo-Mechanisms—Vibration and Shock Problems—Telemetry

**COMPONENT PARTS (COLOR & MONOCHROMETV)**—HV Transformers—Coils—Deflection Yokes

**SEMI-CONDUCTORS**—Transistors—Diodes

**ELECTRON TUBE DEVELOPMENT**—Receiving—Transmitting—Cathode-Ray—Phototubes and Magnetrons—Power Tubes—Camera Tubes

**ELECTRONIC EQUIPMENT FIELD ENGINEERS**—Specialists for domestic and overseas assignment on military electronic Communications, Navigational Aids, and Guided Missiles.

At RCA you'll work in an atmosphere conducive to creative work—laboratory facilities unsurpassed in the electronics industry . . . constant association with leading scientists and engineers.

Positions now open in Systems, Analysis, Development, Design and Application Engineering. Your choice of long range work in commercial or military fields.

Delightful suburban living easily available. Modern retirement program . . . liberal tuition refund plan for advanced study at recognized universities . . . modern company paid benefits for you and your family.

Individual accomplishments readily recognized. Ample opportunities for increased income and professional advancement.

Join the team at RCA and grow with the world leader in electronics.

*Personal interviews arranged in your city.*

Please send complete resume of your education, experience, and specialized field preference to:

**MR. JOHN R. WELD**  
Employment Manager

Dept. 304K  
Radio Corporation of America  
30 Rockefeller Plaza, New York 20, N.Y.



Tmks. ®

**RADIO CORPORATION of AMERICA**

*For more information, circle No. 6 on Reader Service Card*

**RADIO-ELECTRONIC ENGINEERING**

# COMMUNICATION REVIEW

## HARVESTING BY RADIO

Two-way radio has been used in Quarryville, Pa., for the past two years by *Gibbs Foods*, a food processor, in the harvesting and canning of such delicate crops as peas and beans. *Gibbs Foods* moves its employees with split-second timing from field to field over a 30-mile area in order to harvest the crop from each field as it reaches maturity—a matter of only a few hours.

In the photograph, C. Clifton Anderson, head of the *Gibbs* field department, uses the base station unit to give field-shifting orders to supervisors and field hands during the pea harvest. Radio

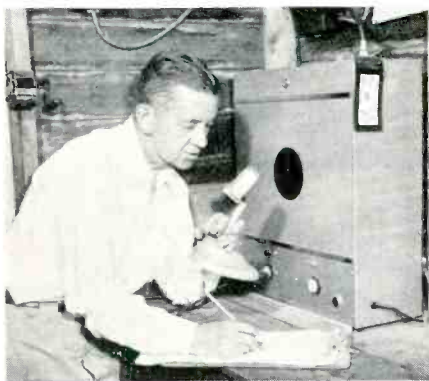

contact is maintained from this base station with four mobile units—two in automobiles and two in trucks—in a constant effort to beat the clock. The radio system was developed by the *Bendix Radio Division of Bendix Aviation Corporation*, Baltimore, Md.

Circle No. 51 on Reader Service Card

## CLIMBING MOUNT EVEREST

All radio equipment used in the conquest of Mount Everest last year was designed and produced by *Pye Limited*, Cambridge, England. The ten dry battery-operated v.h.f. "Walkiephones" taken by the expedition were considerably modified for communication between parties up and down the mountain. Each set was made small enough to be mounted on the chest, without impeding the climber, and the batteries were carried in a special waistcoat under the climber's clothes.

Arranged for single-frequency simplex, the sets were fixed-tuned at 72 mc., with crystal control for both transmitters and receivers. The press-to-talk switch was the only manual control; the climbers never needed to take off

their gloves to use radio. Sir John Hunt, leader of the expedition, stated that the radio communication facilities made a significant contribution to its final success.

Circle No. 52 on Reader Service Card

## CIVIL DEFENSE SYSTEM

In the event of an emergency, Cuyahoga County, in Cleveland, Ohio, will have a complete Civil Defense two-way radio communication system to tie together all elements of the county civil defense forces. Included in the communications "package," to be supplied by the *General Electric Company*, Syracuse, N. Y., will be base station, mobile, and portable two-way radio equipment for the Cuyahoga County Civil Defense Control Center, six zone control stations, and five alternate zone control stations, plus five triangular self-supporting towers for the necessary antennas. Shipment is expected to be made late this year, with installation of the system completed early next year.

Circle No. 53 on Reader Service Card

## COMMUNICATIONS RECEIVER

A continuously calibrated bandspread and novel sectionalized construction are features of the Pro-310 communications receiver. The precision differential tuning system makes it possible to read the exact frequency to which the receiver is set anywhere from 550 kc. to 35.5 mc. Its rotary turret construction for selecting any one of the six bands permits separate removal of individual circuit sections.

Introduced by the *Hammarlund Manufacturing Company, Inc.*, 460 West



34th St., New York 1, N. Y., the set uses double conversion from 2.2 to 35.5 mc. for high image rejection. High stability is achieved through the crystal-controlled second-conversion oscillator, and improved front-end selectivity is

obtained with the single-tube triple-tuned r.f. section.

Circle No. 54 on Reader Service Card

## MOBILE RADIO "PACKAGE"

Maximum transmitter output with a minimum battery drain is possible with the FLEETCOM 6/12-volt mobile two-way radio "package" announced by *Communications Company, Inc.*, Coral Gables, Florida. Rated output for the

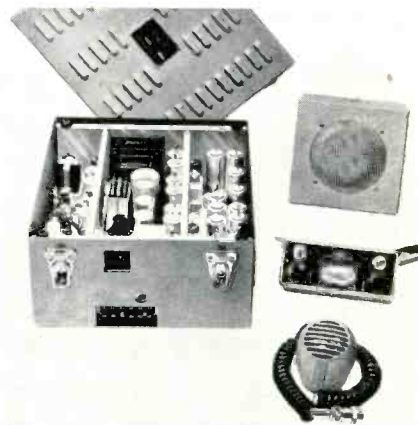

25-50 mc. band is 25 watts, and for the 144-174 mc. band 15 watts. Standby battery drain is 8 amperes at 6 volts or 4 amperes at 12 volts, while transmitting drain is 20 amperes at 6 volts or 10 amperes at 12 volts.

The *COMCO* Model 400 is a rugged universal self-contained unit designed especially for police (Public Safety), Industrial Radio Services and Land Transportation Radio Services, and consists of a crystal-controlled receiver, transmitter and vibrator power supply. Not shown in the photograph are the antenna and other accessories.

Circle No. 55 on Reader Service Card

## "PACKAGED" MICROWAVE STATION

The first commercial "packaged" microwave radio station—a compact, weatherproofed metal cabinet containing equipment for line-of-sight one-hop point-to-point communication—has been announced by the *RCA Engineering Products Division*. It comes complete with mesh-type parabolic receiving and transmitting antennas, styroflex transmission line, and fittings.

Housed within the cabinet is *RCA* 960-mc. microwave radio equipment—a receiver, transmitter and an exciter. The transmitter has a power output of two watts and an output impedance of 52 ohms. Both the transmitter and receiver have an operating frequency range of 890 to 960 mc.

A detailed brochure is available from Communications Marketing Department, Engineering Products Division, *Radio Corporation of America*, Camden, N. J.

Circle No. 56 on Reader Service Card





# WALKIEPHONE

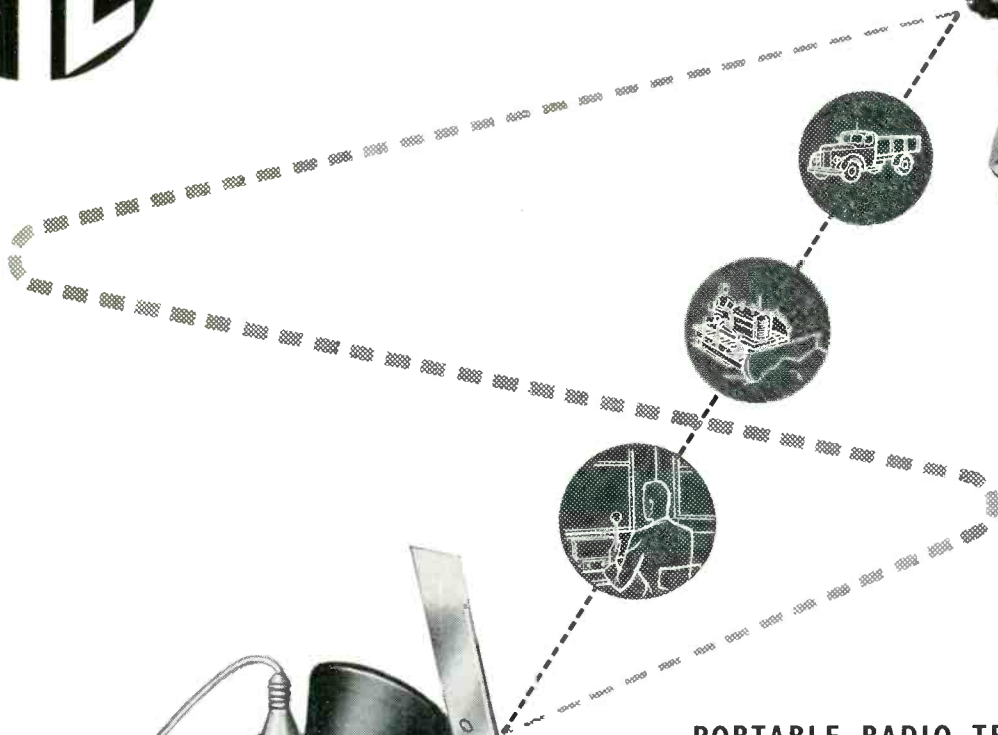

## PORTABLE RADIO-TELEPHONE FOR CIVIL ENGINEERING COMMUNICATIONS

For purposes of routine inspection and maintenance the Pye V.H.F. Walkiephone makes a valuable but inexpensive addition to any V.H.F. scheme. Unimpeded by this light-weight equipment one man becomes a constant source of information and, when required, a centre of control. In places both unexpected and inaccessible the Pye "Walkiephone" ensures the smooth control of emergency operations. Robust, reliable, and economical in use, the complete equipment weighs only 10½ lbs. with batteries.



## Telecommunications



Pye (New Zealand), Ltd.,  
Auckland C.I., New Zealand.  
Pye Radio & Television (Pty.) Ltd.,  
Johannesburg,  
South Africa.

Pye Canada, Ltd.,  
Ajax, Canada.  
Pye Limited,  
Plaza de Necaxa 7,  
Mexico 5.

Pye-Electronic Pty, Ltd.,  
Melbourne, Australia.  
Pye Limited,  
Tucuman 829,  
Buenos Aires.

Pye Ireland, Ltd.,  
Dublin, Eire.  
Pye Limited,  
5th Ave. Building,  
200 5th Ave., New York.

**PYE LIMITED**

**CAMBRIDGE**

**ENGLAND**

*For more information, circle No. 7 on Reader Service Card*

# NEW PRODUCTS

## WAVEMETER

Amerac, Incorporated, 116 Topsfield Rd., Wenham, Mass., has announced the Model 230 C-band wavemeter, a coaxial-type instrument covering the frequency



range from 3500 to 6500 mc. Power-handling capability by the absorption method is from .5 mw. to 1 watt maximum, while power-handling by the transmission method is from 1 mw. to 25 watts (peak power).

Features of the Model 230 include: (1) a precision-ground lead screw for accuracy of measurement, (2) cavity body made from a solid block, precision-machined to close tolerances, for mechanical stability, (3) the use of Invar in the line displacement portion for high frequency stability and (4) tri-plate of all r.f. surfaces.

Circle No. 57 on Reader Service Card

## GRID-DIP OSCILLATOR

For applications in the u.h.f. band, Measurements Corporation, Boonton, N. J., a subsidiary of Thomas A. Edison, Inc., is producing a grid-dip oscillator which covers the 430-940 mc.



range. Called the Model 59-u.h.f. megacycle meter, this instrument incorporates a unique oscillator with a split-

stator tuning capacitor, arranged so that a fixed coupling point is at the center of the oscillator inductance.

Coupling sensitivity is excellent and grid current variation is minimal over the entire band. The oscillator output is either c.w. or 120-cycle modulated. Linear calibration is provided with a calibration point every 10 mc., and accuracy is better than 2%.

Circle No. 58 on Reader Service Card

## RECORDING OSCILLOGRAPH

Continuous time-synchronized records of up to 16 separate phenomena are provided by the Miller CR-I cathode-ray



recording oscillograph at frequencies as great as 50,000 cps. All channels are recorded simultaneously on 8"-wide photographic paper at chart speeds of 3" to 400" per second. By means of the integral, single-sweep circuits, the instrument's eight dual-gun cathode-ray tubes may also be photographed directly to provide an accurate simultaneous record of 16 phenomena at frequencies as high as 250,000 cps.

Recently announced by William Miller Instruments, Inc., 325 North Halstead Ave., Pasadena 8, Calif., the CR-I contains its own power supplies, pre-amplifiers and deflection amplifiers and recorder in a single cabinet. Individual controls on all channels make the system very flexible and adaptable to a wide range of signals.

Circle No. 59 on Reader Service Card

## DECADE RESISTANCE UNIT

Production of a plug-in decade resistance unit for use in analog comput-

ing equipment, circuit development, and specialized work in electrical engineering laboratories has been announced by Telex, Inc. Trade-named GEDA, and designed by the Goodyear Aircraft Corporation and Telex, it was miniaturized

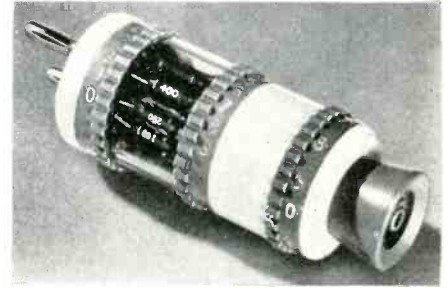

in the Telex laboratories through the use of printed circuitry.

Units are available in four stock types with maximum resistance values of 1 and 10 megohms and 1 and 10 kilohms, but can be built to other specifications if desired. Set resistance value of 1% tolerance is shown on three dials, with the top dial controlling a potentiometer which permits the unit to be set to within 0.1% of any range value by means of a suitable resistance bridge.

Additional information may be obtained from Department KP, Telex, Inc., E-A Division, Telex Park, St. Paul, Minnesota.

Circle No. 60 on Reader Service Card

## FREQUENCY METER

Replacing the TS-175 frequency meter, the new TS-175A/U announced by Colortone Electronics, Inc., 238 William St., New York 38, N. Y., contains a heterodyne oscillator and a crystal-controlled calibrator. It measures the frequency of an r.f. signal within the



range of 85 to 1000 mc., and enables transmitters, receivers and test equipment operating in this range to be calibrated by the zero-beat method.

Utilizing miniature ruggedized tubes and components, the TS-175A/U is designed for power supply or battery operation. After a warm-up period of 15

(Continued on page 33)



**WHERE POWER  
IS VITAL**

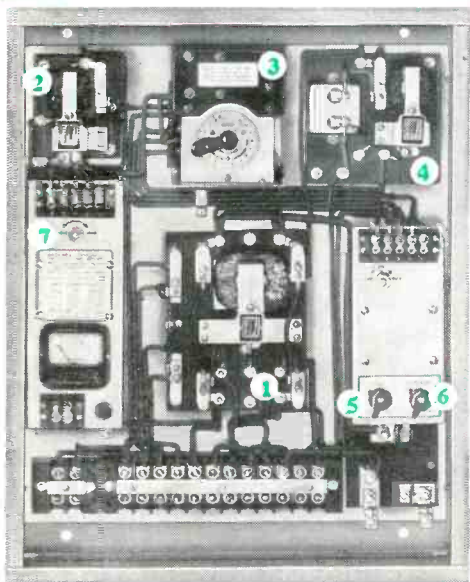

**This ASCO<sup>®</sup>  
Automatic Transfer Switch Panel  
does 24-hour guard duty**

**ASCO Automatic Transfer Switches  
provide continuous adequate-voltage power . . .**

- Trigger stand-by system to start emergency generator.
- Transfer connected load when rated voltage and frequency are attained.

To assure continuous power an ASCO Automatic Transfer Switch (1), stands ready to transfer the load to an emergency source within 2 to 5 cycles when normal power fails. Once the normal source is in proper operating condition, the load is automatically restored.

To assure adequate-voltage power, the voltage sensitive Close Differential Relay (2), operating with the Transfer Switch, provides transfer on a 5% differential in power supply voltage (less, if required).

*For further information* on ASCO Emergency Generator Controls, see our booklet, "When Normal Power Fails", with essential engineering data. Write today for your free copy.



**Automatic Switch Co.**

385-R Lakeside Avenue, Orange, N. J. • ORange 2-5300

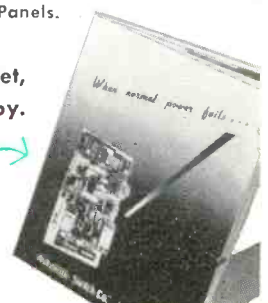

**Other Features:**

**Timer (3)**—Provides 3-5 second delay on engine starting; 0-13 minute adjustable delay on restoration to normal; 2 minute delay on stopping engine.

**Lockout Relay (4)**—Prevents transfer until electric plant rated voltage and frequency are attained.

**Test Switch (5)**—Simulates normal failure.

**Stand-by Switch (6)**—Disconnects engine start circuit and permits independent operation of emergency generator set.

**Trickle Charger (7)**—(With ammeter and 5 ampere fuse). Keeps emergency electric plant starting batteries charged.

This complete panel may be installed with your new emergency power supply, or may be wired into an existing installation. ASCO Transfer Switches are available up to 1,000 Amperes, 750 Volts, A-C or D-C, with modifications as required.

ASCO also designs and manufactures a complete line of Electro-magnetic Controls including Solenoid Valves, Remote Control Switches, Contactors, Relays, and Complete Control Panels.

*For more information, circle No. 8 on Reader Service Card*

RADIO-ELECTRONIC ENGINEERING



used on  
**TV and BC**



## LAVALIER Model 646 Dynamic

Remarkably small, versatile microphone—for chest, desk or hand use. Frees hands of announcer or performer for demonstration or dramatic effects. Recessed screw in grille for adjustment of high frequency response to suit the application. No additional closely associated auxiliary equipment required.

Peak-free response  
60 to 10,000 cps.  
Output —57 db.  
Omnidirectional.  
Acoustically treated  
grille minimizes wind  
and breath blasts. E-V  
Acoustalloy diaphragm.  
Available in 50, 150  
or 250 ohms.  
Non-reflecting gray  
finish. Size: 1 1/8" diam.  
6 1/4" long. Net wt.  
6 1/2 oz. 30 ft. cable.  
Supplied with neck  
cord and support clips.  
Model 646. List, \$140.  
Model 416 Desk Stand. List \$5.



Normal Trade  
Discount Applies

Available from E-V Authorized Distributors  
Write for Bulletin No. 201

# Electro-Voice®

ELECTRO VOICE, INC. • BUCHANAN, MICH.  
Circle No. 9 on Reader Service Card

# Personals



**HARRY T. BELLAMY**, on leave of absence from his position as ceramist with *Lindberg Engineering Company*, Chicago, Ill., has been appointed refractory technologist to the North Western Railway of Pakistan's new refractory manufacturing plant in Malakwal. He will assist in an Armour Research Foundation project to advise in the building and operation of the plant under the Foreign Operations Administration's foreign aid program.



**JEROME CORWIN** will head the new Design and Development Section on electromechanical devices, servomechanisms and computers of the Special Products Division, *I-T-E Circuit Breaker Company*, Philadelphia, Pa. Best known as the designer of the first antenna structure to make contact with the moon, Mr. Corwin was previously chief of the Mechanical Engineering Section of the U. S. Army Signal Corps Laboratories at Fort Monmouth, N. J.



**DR. LOUIS G. DUNN** has joined *The Ramo-Wooldridge Corporation*, Los Angeles, Calif., as associate director of the new Guided Missile Research Division. Prior to his resignation as director of the Jet Propulsion Laboratory of the California Institute of Technology, which position he has held since 1947, Dr. Dunn was in charge of the recently completed program for the first ballistic surface-to-surface guided missile developed in this country.



**WILLIAM H. HENRICH** has been named assistant to the general manager in charge of production and sales at *Condenser Products Company*, division of *New Haven Clock and Watch Company*, New Haven, Conn. Holder of patents on electronically controlled high-speed printing mechanisms and voltage regulators, Mr. Henrich served as chief development engineer for *Sorensen & Company, Inc.*, and prior to that as an electronics engineer for *Remington Rand, Inc.*



**DR. ERNST H. KRAUSE** resigned his post as associate director of research at the Naval Research Laboratory in Washington, D. C., to become director of the new research laboratories at the Missile Systems Division of *Lockheed Aircraft Corporation*, Van Nuys, Calif. Dr. Krause has long been closely associated with missile and nuclear weapon development work at the N.R.L., the Los Alamos Scientific Laboratory, and the Atomic Energy Commission.



**H. R. OLDFIELD, JR.**, with the Electronics Division of the *General Electric Company* since 1945, has now been appointed manager of the new *G-E* microwave tube development laboratory being established in Palo Alto, Calif. Mr. Oldfield is a former manager of the *G-E* Advanced Electronics Center at Cornell University, and until his current appointment was manager of plans and product applications in the *G-E* Laboratories Department.



# TECHNICAL BOOKS

**"MILLIMICROSECOND PULSE TECHNIQUES"** by I. A. D. Lewis and F. H. Wells, Atomic Energy Research Establishment, Harwell, England. Published by *McGraw-Hill Book Co., Inc.*, 330 West 42nd St., New York 36, N. Y. 310 pages. \$7.50.

Published jointly with the *Pergamon Press* of London, this new addition to the *Pergamon Series of Monographs on Electronics and Waves* covers the theory and design of electronic circuits and devices by pulse methods for operation in the millimicrosecond range—which lies between the microsecond region and the microwave region. Of main concern is the development of devices of large bandwidth, extending down to comparatively low frequencies.

Theoretical principles and practical techniques are interwoven in the text, which includes the most up-to-date material heretofore available only in widely scattered periodicals. The bulk of the work is devoted to a consideration of basic circuit elements and pieces of equipment of universal application. Details of specific applications, mostly in the field of nuclear physics instrumentation, fill the last two chapters.

**"ELECTRICAL BREAKDOWN OF GASES"** by J. M. Meek and J. D. Craggs. Published by *Oxford University Press*, 114 Fifth Ave., New York 11, N. Y. 507 pages. \$10.50.

While this book has been written primarily for physicists and electrical engineers engaged in fundamental investigations of the nature of electrical breakdown in gases, it should also be of value to those concerned with the development and application of gas-filled electron tubes or with the many other technical problems associated with gaseous discharges. One of the *International Series of Monographs on Physics*, its purpose is to summarize present knowledge about the mechanisms of growth of electrical discharges in gases and the transitions between different forms of discharges.

Among the topics covered are: fundamental processes in electrical discharges; breakdown at low gas pressures; corona discharges; the lightning discharge; theory of the spark mechanism; breakdown voltage characteristics; irradiation and time lags; high-frequency breakdown of gases; the spark channel; electrode effects; and glow-to-arc transitions. Comprehensive lists of references are included.

Circle No. 10 on Reader Service Card

You Replace with  
the Best when  
you Buy

# RCA



More RCA-2E26 tubes are used in mobile transmitters than any other transmitting tube type.

WHEN YOU REPLACE TUBES in your communications equipment, you want the best tubes you can obtain. That's why it pays to insist on RCA Tubes.

RCA's engineering leadership, production experience, and rigid standards of quality control assure you of tube *Performance Security* in the operation of your mobile communications equipment. As evidence of this, more RCA tubes have been performance-proved under field operating conditions than any other make.

Call your local RCA Tube Distributor for efficient service and fast delivery.



**RADIO CORPORATION of AMERICA**  
**ELECTRON TUBES HARRISON, N. J.**

# NEW LITERATURE

## CHROMACODER SYSTEM

What the Chromacoder is, how it functions, and what its advantages are over other types of live color TV broadcasting systems are explained in a four-page illustrated brochure published by the *General Electric Company*. Details are given on the use of the Chromacoder with color-modified monochrome cameras to obtain an NTSC color signal.

Copies of the brochure are available free on request from the *General Electric Company*, Broadcast Equipment, Electronics Park, Syracuse, N. Y.

Circle No. 61 on Reader Service Card

## TUBE CHARACTERISTIC SHEETS

Large-size (8½" x 11"), precision-drawn vacuum tube sheets are offered by *Vacuum Tube Research*, 4624 West Rosalie St., St. Louis 15, Mo., in the form of a 48-page tablet or in single sheet quantities. The tablet, entitled "Vacuum Tube Characteristics and Design Sheets," includes curves for 48 tube types, plus a nine-page explanation of the use of the characteristic curves, and may be obtained for 85 cents a copy. Single sheets are priced from 2.5 cents per sheet for a quantity

of 50-199 sheets of a given tube type up to 1.2 cents per sheet for quantities of 5000 and over.

Circle No. 62 on Reader Service Card

## POTENTIOMETERS

At the 1954 Electronic Components Symposium in Washington, D. C., Mr. Lawrence B. Krauss, Project Engineer of the *Fairchild Camera and Instrument Corporation*, Potentiometer Division, presented a paper on metallic film potentiometers which is now available for distribution to interested engineers. Copies of the paper, entitled "General Design and Performance Characteristics of Film Type Potentiometers," may be obtained from Barry J. Hawkins, *Fairchild Camera and Instrument Corporation*, Potentiometer Division, 225 Park Ave., Hicksville, N. Y.

Circle No. 63 on Reader Service Card

## STANDARD CRYSTALS

Catalog 354 is a 12-page illustrated brochure recently issued by the *Standard Crystal Company* which features its complete line from subminiature, hermetically sealed, plated units to crystal ovens. An unusual military chart, de-

signed for the customer's guidance in selecting proper crystal types for particular requirements, is incorporated in this catalog, copies of which are available from *Standard Crystal Company*, 1714 Locust St., Kansas City, Mo.

Circle No. 64 on Reader Service Card

## BOBBINLESS RESISTORS

*Monson Manufacturing Corporation*, 6059 W. Belmont Ave., Chicago 34, Ill., has issued a catalog page picturing and describing its new line of low-cost, small-size bobbinless noninductive precision wire-type resistors. Complete data are given on tolerances, sealing of ceramic tubes, resistance wire and terminals; a table lists typical sizes and resistance ranges.

Circle No. 65 on Reader Service Card

## WIRES AND CABLES

A 44-page catalog on electronic wires, cables and components has just been released by *Birnbach Radio Co., Inc.*, 145 Hudson St., New York 13, N. Y. It lists every type of wire and cable now in use for microphone, intercom, broadcast and other electronic uses, with detailed technical information on each type. The section on plugs, jacks and connectors contains schematic diagrams and full descriptions for every item.

Circle No. 66 on Reader Service Card

## "INSTRUMENTATION"

Many industrial developments are reported in Vol. 7, No. 4, of "Instrumentation," technical publication of the Industrial Division, *Minneapolis-Honeywell Regulator Co.*, Wayne and Windrim Avenues, Philadelphia 44, Pa. Featured articles cover round-the-clock processing of gamma globulin and the design of a weighing device so sensitive it can measure and record the difference in weight between a broad and a narrow pencil line.

Circle No. 67 on Reader Service Card

## ELECTRICAL INDICATING INSTRUMENTS

Design features of the *DeJUR* line of ASA electrical indicating instruments have been presented in a four-page technical brochure together with schematic diagrams and outline dimensions. The instruments are manufactured in round, square and rectangular models, and are adaptable to most panel uses.

Copies of this brochure may be obtained from the Electronic Sales Division, *DeJUR-AMSCO Corporation*, 45-01 Northern Blvd., Long Island City 1, N. Y.

Circle No. 68 on Reader Service Card

## REPEAT CYCLE TIMERS

Complete information on a new line of miniature hermetically sealed repeat cycle timers is contained in a two-page

## TV-AM-FM SET PRODUCTION

Information based on latest reports from RETMA.

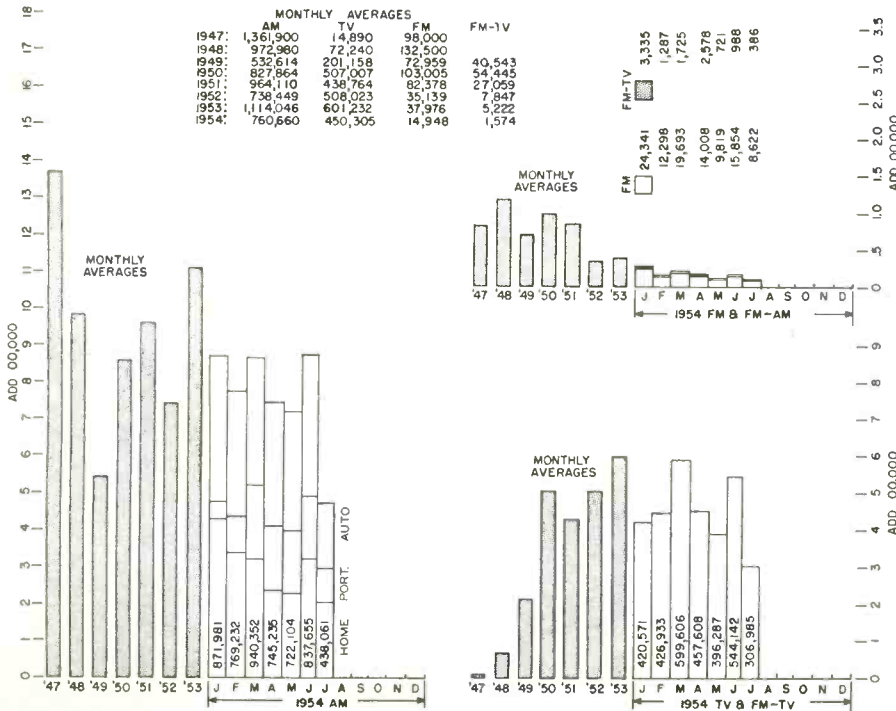



# New circuit development obsoletes conventional UHF 2-Way Radio design

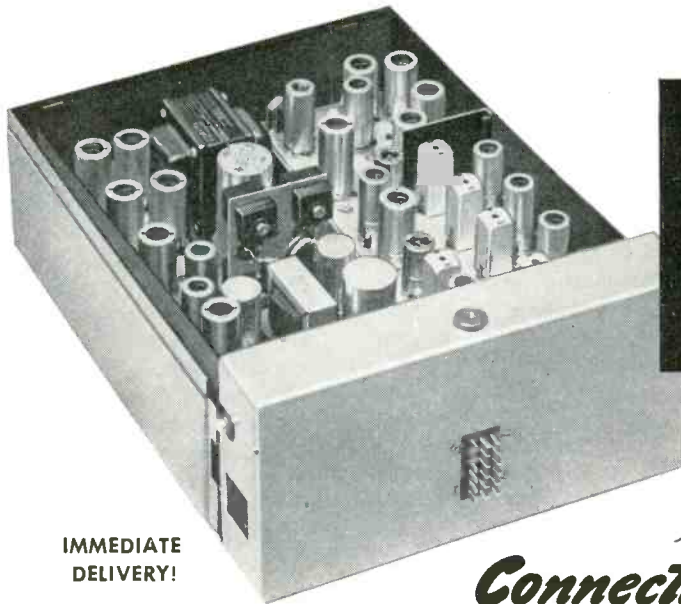

IMMEDIATE DELIVERY!

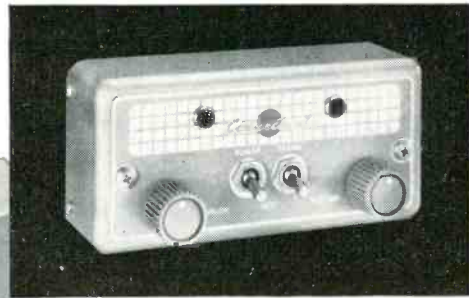

## Connecticut **FLEETWAY** FIRST FM 2-WAY RADIO

UNIQUE CONN-TENNA DESIGN BEAMS STRONG HORIZONTAL SIGNAL

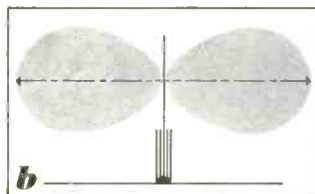
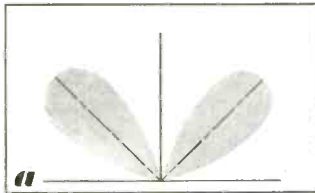

More evidence of FLEETWAY's radical design is found in its new Conn-tenna. Sketch A shows how conventional monopole antenna dissipates much of its signal at 45° upward angle. Sketch B shows how multipole Conn-tenna concentrates radiation along a horizontal plane, transmitting a stronger signal with lower power requirement.

**HIGHER OVERTONE** • The patented Lister circuit uses a starting frequency of 75 Mc instead of the usual 6 Mc. Low 6-time frequency multiplication required to reach 450 Mc contrasts with 24-times or more in other types of equipment.

**GREATER STABILITY** • Direct circuitry and fewer components permit better control of signal output, greatly minimize drift and spurious radiation. Result is greater stability requiring minimum maintenance, producing clearest signal ever attained in mobile radio.

**'FM' CLARITY MINUS NOISE** • True frequency modulation — for the first time in mobile radio — produces noise-free, natural tone quality, and eliminates distortion so common in conventional equipment. *This is true FM, not commonly used phase modulation (PM).*

**LOWER OPERATING COST** • Simplified FLEETWAY circuitry requires fewer tubes and parts — uses standard, lower cost crystals and tubes, needs less servicing.

**NEW 450-470 Mc BAND OPENS 2-WAY RADIO TO EVERY CITIZEN AND COMPANY** • Even if you have not been able to obtain a license for 2-way radio for yourself or your business, the chances are you can now get an immediate assignment in the recently opened 450-460 commercial fleet band or in the 460-470 citizens' band. These new bands offer easy licensing requirements for anyone who does not qualify in one of the older channels. You can now enjoy the advantages of FLEETWAY mobile radio for business or private use.

See your local FLEETWAY dealer or write for "Technical Comparison" booklet containing parts and performance comparison of leading mobile radio equipment.

## Connecticut

CONNECTICUT TELEPHONE & ELECTRIC CORP. 106 BRITANNIA ST. MERIDEN, CONN.

For more information, circle No. 11 on Reader Service Card

**OPPORTUNITY  
AT RCA  
... FOR  
BROADCAST  
FIELD  
ENGINEERS**

RCA needs trained broadcast engineers who can direct and participate in the installation and service of television broadcast equipment. Here's an *excellent* opportunity for training and experience with color TV transmitters.

**Can you qualify?** You need: 2-3 years' experience in broadcast equipment, including work on TV transmitter installation. You should have: EE degree or good technical schooling, 1st Class Radio-Telephone License.

**ENJOY RCA ADVANTAGES:**

- Top Salaries
- Many Liberal Company-Paid Benefits
- Relocation Assistance

*For personal interview, please send a complete resume of your education and experience to:*

**Employment Manager, Dept. Y-621  
RCA Service Company, Inc., Camden 2, N. J.**



**RCA SERVICE COMPANY, INC.  
CAMDEN 2, N. J.**

*For more information, circle No. 12 on Reader Service Card*

**UHF Standard Signal Generator**

**with Low Hum Level**

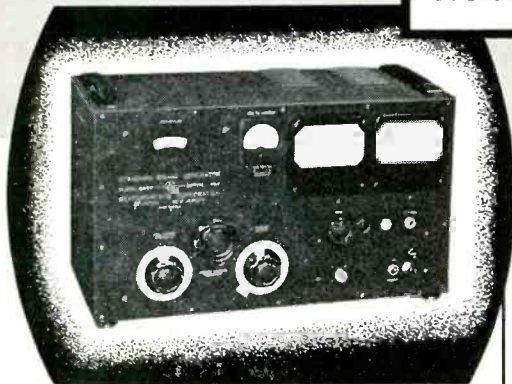

**MODEL 84-TV**

**FEATURES:**

- DC operation of oscillator tube filament.
- Wide continuous frequency coverage.
- Frequency calibration accurate to  $\pm 0.5\%$ .
- Output dial calibrated in microvolts.
- Negligible stray field and leakage.
- Special design mutual inductance type attenuator.
- Low harmonic content.
- Low residual hum modulation.

**USES:**

The versatility of this instrument makes it adaptable to many applications within its frequency range; for driving slotted lines and other impedance measuring devices; for measuring the characteristics of UHF filters, traps, antennas, matching networks and other devices.

**SPECIFICATIONS:**

- Frequency Range: 300 to 1000 Mc.
- Frequency accuracy  $\pm 0.5\%$ .
- Output: 0.1 uv to 1.0 v across a 50-ohm load.
- Modulation: 0 to 30% from an internal 1000-cycle oscillator. External modulation from 50 to 20,000 cys. Residual hum modulation less than 0.5%.
- Power Supply: 105 to 125 volts, 60 cycles, 120 watts.
- Leakage: Negligible.

*Laboratory Standards*



**MEASUREMENTS  
CORPORATION  
BOONTON · NEW JERSEY**

bulletin released by *The A. W. Haydon Company*. Cycling time, timing accuracy, detail characteristics and determination of timing tolerances are all covered in Bulletin A.W.H. RC200, available from *The A. W. Haydon Company*, 230 North Elm St., Waterbury, Conn.

Circle No. 69 on Reader Service Card

**Thickness Gages**

*(Continued from page 11)*

changes in the phase angle. For a thin plating of low resistivity on a basis metal of high resistivity, the problem is one of measuring the plating thickness alone. As the resistivities approach the same value (i.e., thinner basis and thicker plating), it becomes difficult to differentiate between the plating and the basis metal. However, this condition is not reached in the application for which the instrument is intended, since the resistivities of silver and stainless steel differ greatly. If the thickness of the basis material varies, the frequency of the exciter may be increased until the transducer field does not entirely penetrate the thinnest portion of the base. If the basis thickness is constant, however, a higher sensitivity may be obtained by lowering the operating frequency to a point where the calculated skin depth of the material is greater than its thickness.

**Wave Guide Plating Indicator**

While designed specifically for measuring from the outside the quantity of silver plating on the inside of an L-band wave guide, the wave guide plating quantity indicator developed by M. Davidson and N. Rahal of NBS under the sponsorship of the Navy Bureau of Ships is also useful for a wide variety of plating or thickness measurements. Its calibration is unaffected by the magnetic properties of the material under test.

This gage actually measures the conductance of the silver deposited on the steel wall. Variations in the density and in the thickness of the silver cause a much greater change in the total conductance than similar variations in the steel. Since the probe measures over an area of only a few square inches at a time, it is possible to compare any local portion of the wave guide wall with any other portion.

Although the conductance measuring technique has been used before to make thickness measurements of homogeneous plates, it is used here to determine the thickness of one material of high conductivity plated on another material of low conductivity. The Bureau's procedure overcomes the limitations of pre-

Circle No. 13 on Reader Service Card



vious methods of measuring stainless steel wave guides by relying on a d.c. measurement of the conductance of the wave guide walls and the plated coating. The local conductance is measured by passing a known amount of direct current through a portion of the wave guide wall, utilizing a pair of electrodes or probes. By measuring the potential between two other points in the neighborhood of the current probes, the conductance can be determined, provided that (1) the current flow is laminar throughout the material and (2) the linear dimensions of the material are several times greater than the probe spacing. Laminar—or two-dimensional—flow is achieved by making the current probe spacing much greater than the thickness of the wave guide wall.

The plating indicator consists of two units (see Fig. 3): one is the hand-held probe which is applied to the wave guide, and the other is a chassis which contains the detecting and measuring circuitry, the power supplies, and a calibrated indicating meter. To supply current and to measure potential, the probe housing contains two pairs of electrodes or probes. The two current probes provide a source and sink of current, and the two potential probes detect the potential between two points in the neighborhood of the current probes. Pointed brass rods spaced about 2" apart, the current probes are slightly blunted to keep the contact resistance low, since they may pass up to five amperes. The potential probes are hard steel needles; they are spring-loaded and project slightly beyond the current probes to insure good contact.

The circuit (Fig. 5) is designed so that a constant voltage is maintained across the potential probes by varying the current through the current probes. Current required to maintain the constant potential is directly proportional to the conductance of the material, and hence will vary directly with changes in the quantity of plating. By using the simple servo techniques of self-balancing, the indicator is made to read directly and is automatized to such an extent that the indicating meter and a power switch are the only components on the front panel; there are no operating adjustments.

When the probe is lifted from the wave guide, a switch in the probe housing shunts the current flow and at the same time disconnects the servo motor. Thus, the ammeter reading is maintained whenever the probe is removed; and as the meter needle does not need to start from the zero mark for each reading, a rapid succession of readings can be made.



Circle No. 14 on Reader Service Card



Where fine audio quality is essential, for private, commercial or military equipment, you can depend on CHICAGO high fidelity transformers for distortionless sound reproduction.

# CHICAGO

## ULTRA-LINEAR HIGH FIDELITY

Output Transformer  
BO-13

This "super-range" transformer, specifically designed for ultra-linear Williamson amplifier circuits, is typical of the many high fidelity transformers available from CHICAGO.

Amplifier frequency response, with the BO-13, is flat from 20 to 60,000 cycles at 20 watts output. At a 1 watt listening level, the BO-13 is flat from less than 10 cycles to beyond 200,000 cycles.

Intermodulation distortion, measured at 60 and 7000 cycles, 4:1 ratio, is less than 3% at 21 watts. Total harmonic distortion is below 0.1%, measured at 1000 cycles, up to 21 watts.

The BO-13 is housed in a compact, seamless steel case measuring 3<sup>5</sup>/<sub>16</sub>" x 3<sup>11</sup>/<sub>16</sub>" x 4<sup>11</sup>/<sub>16</sub>" high. CHICAGO's famous "sealed-in-steel" construction provides maximum shielding and full humidity protection.

CHICAGO Bulletin 33 lists performance curves and other useful information on the BO-13. Write for your FREE copy, or get it from your CHICAGO distributor.



CHICAGO CATALOG CT-554, listing complete electrical and physical specifications on over 500 CHICAGO transformers. Available from your CHICAGO distributor or from Chicago Standard Transformer Corporation.

### CHICAGO STANDARD TRANSFORMER CORP.

3501 ADDISON STREET • CHICAGO 18, ILLINOIS

EXPORT SALES:  
Roburn Agencies, Inc.  
431 Greenwich Street  
New York 13, N. Y.

# NEWS BRIEFS

## "BOOSTER" SYSTEM TESTS

Successful field tests have been made with an experimental u.h.f. TV "booster" system by the *Radio Corporation of America*, Camden, N. J., in cooperation with Station WJTV, Channel 25, Jackson, Miss., which indicate the possibility of extending u.h.f. TV service into areas now "blacked out" because of geographic conditions. A detailed engineering report of the operation has been filed with the FCC.

Under a temporary grant from the FCC, these tests were conducted in the Vicksburg, Miss., area with the "booster" equipment located some 37 miles from the WJTV main transmitter. Results showed that the station received an effective increase in its power of 200 times due to the booster system, which produced a 23-db improvement in field intensity in at least 50% of the total receiving areas.

Circle No. 70 on Reader Service Card

## PHOTOCONDUCTIVE CELLS

Slips of glass coated with lead sulfide that can give 10,000 times as much sensitivity to certain infrared rays as previously available laboratory instruments have been introduced by the *Eastman Kodak Company*, Rochester 4, N. Y. Shown in the photograph is a piece of glass three-quarters of an inch long which contains 20 photoconductive cells; the tiny black specks under the

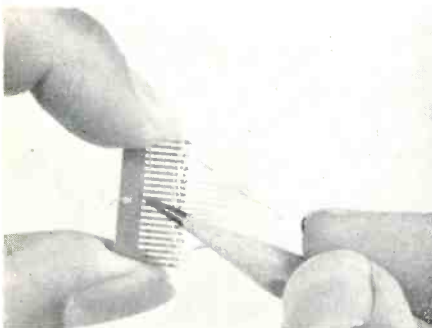

pencil point are the cells themselves—known as Ektron detectors.

Due to the extreme infrared sensitivity of these cells, coupled with their simplicity and adaptability to manufacture in any size or shape, they are expected to have important applications in the design of sensitive machinery and in detection of warm objects at a

distance. They are also highly sensitive to all colors of visible light and on into the ultraviolet.

Circle No. 71 on Reader Service Card

## ELECTRONIC STAMPINGS

High production methods have made it possible to effect cost savings on quantity runs of small stampings for radio, television and electronic use. Over 1000 different parts are now

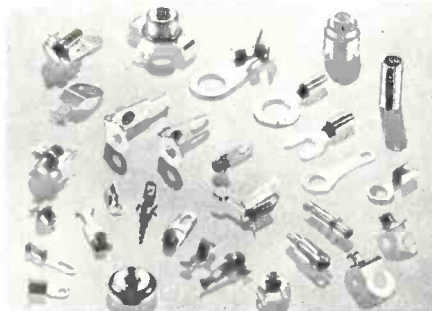

available as standard items from the *Malco Tool and Mfg. Co.*, Chicago, Ill., including such items as solder lugs, terminals, contacts and corona rings.

These parts are supplied to specification within minute tolerances, with precision tooling assuring uniformity and high quality. Base metals include brass, copper, beryllium copper, phosphor bronze and steel. Further information may be obtained from *Malco Tool and Mfg. Co.*, Dept. REN, 4025 W. Lake St., Chicago 24, Ill.

Circle No. 72 on Reader Service Card

## IMPROVING TV COVERAGE

A special committee of the Radio-Electronics - Television Manufacturers Association has filed an interim report with the Federal Communications Commission suggesting that consideration be given to the authorization of two types of television transmitting stations which would tend to improve TV coverage yet be consistent with the economics of obtaining such coverage—"satellite stations" and "special services television stations."

This report was filed by the RETMA Committee on Satellite and Special Services Television Broadcast Stations, formed last March as a special committee of the Broadcast Equipment Section, RETMA Technical Products Division. More detailed suggestions and

technical data will be submitted later which may serve to formulate the basis of FCC rule-making proceedings necessary for commercial operation.

## The Phantastron

(Continued from page 14)

fluctuate in the same manner as the B+ line.

If the B+ supply voltage increases by say,  $x\%$ , then the quiescent anode voltage also changes by the same percentage. If the current flowing out of the capacitor during the run-down time were to remain fixed, then the duration of the run-down would be increased by about  $x\%$ . However, the current flowing out of the capacitor would also have changed by this same percentage, and hence the rate of run-down would be  $x\%$  greater. In short, an increase of  $x\%$  in the B+ supply causes an increase of  $x\%$  in the potential through which the anode must fall, but since the rate of run-down is increased  $x\%$ , the period of the run-down remains essentially constant.

## Conclusion

In the design of phantastron circuits, care should be exercised in the layout of the high impedance grid circuit. Current should flow to and from the grid only through the grid leak and not via leakage in the anode-grid capacitor or leakage on a components board. If the grid leak is to be soldered to lugs on a terminal board, the pins adjacent to the grid end of the resistor should not carry high potentials. Under adverse conditions, leakage resistance between adjacent pins on a terminal board has been found to be of the same order as the grid resistance.

Since it is the usual practice to use a double diode in the circuit (one diode being used for the grid circuit and the other for the anode circuit), it is also desirable to insure that no heater-cathode breakdown occurs. To prevent such breakdown in radar circuits, a separate filament transformer is used to supply power to the heaters of the double diodes, and the center tap of the heater winding of the transformer has been fixed at a potential midway between ground and the B+ supply.

The phantastron, only slightly more complex than a conventional flip-flop, offers superior performance with regard to triggering, stability and control. Its development during World War II helped establish Allied supremacy in the field of radar, and it is unfortunate that this circuit is not more familiar to the engineers of today. Circuits of even greater stability and timing accuracy such as the "sanatron," "sanaphant" and the "sanatrig" have since been evolved from the phantastron.



## New Products

(Continued from page 24)

minutes, the frequency drift is within .0025%. Calibration accuracy after the warm-up period is within .005% at normal temperature, 20°C (68°F). An antenna cable, two adapters and a probe are normally stored in the lower front compartment.

Circle No. 73 on Reader Service Card

## COUNTER CHRONOGRAPH

Housed in two dripproof heavy-gauge reinforced aluminum cabinets, the Model 471 counter chronograph contains a temperature-compensated crystal-controlled 8-mc. oscillator that produces timing pulses exactly one-eighth of a microsecond apart. These pulses are gated into a high-speed electronic counter during an unknown interval. Upon completion of a measurement, neon lamps give direct indication of the exact number of microseconds and eighths of microseconds in the interval.

Announced by *Potter Instrument Company, Inc.*, 115 Cutter Mill Rd., Great Neck, N. Y., Model 471 was designed for use in the field testing of radar and sonar equipment. Special highly stable counting circuits assure complete reliability of counts. When used with a high-speed recorder or printer, this split-second timer recycles for another measurement as soon as one reading is recorded.

Circle No. 74 on Reader Service Card

## CALENDAR of Coming Events

**OCTOBER 26-28**—Second National Conference on Tube Techniques, Western Union Auditorium, New York, N. Y.

**NOVEMBER 4-5**—East Coast Conference on Airborne and Navigational Electronics, Sheraton-Belvedere Hotel, Baltimore, Md.

**NOVEMBER 8-10**—Microwave Symposium, Engineering Societies Auditorium, New York, N. Y.

**NOVEMBER 10-11**—IRE-AIEE Conference on Electronic Instrumentation and Nucleonics in Medicine, Morrison Hotel, Chicago, Ill.

**NOVEMBER 18-19**—Sixth Annual Electronics Conference, sponsored by the Kansas City Section, IRE, Hotel President, Kansas City, Mo.

**NOVEMBER 18-19**—Symposium on Fluctuation Phenomena in Microwave Sources, Western Union Auditorium, New York, N. Y.

**NOVEMBER 20-21**—First U. S. Automation Show, Waldorf-Astoria Hotel, New York, N. Y.

**DECEMBER 8-10**—Fourth Annual Eastern Joint Computer Conference and Exhibition, Bellevue-Stratford Hotel, Philadelphia, Pa.

Circle No. 15 on Reader Service Card

# WIDE-RANGE FREQUENCY METER 85-1000 MEGACYCLES

## TS-175A/U

Government Approved

Calibration Accuracy:  
.005%

Stability:  
.0025%

Resettability:  
.0025%



**IMMEDIATE  
DELIVERY**

## A VERSATILE PRECISION MEASURING INSTRUMENT

Recommended Applications:

- Precise Measurements of Frequencies
- Production Testing
- Alignment of Transmitters and Receivers
- Laboratory Testing
- Portable Field Testing
- A Secondary Frequency Standard
- Signal Generator Calibration
- U.H.F. and V.H.F. Television Alignment

**Calibration:** Each instrument is individually calibrated, without interpolation, at 50 Kilocycle intervals throughout its range.

**Frequency Range:** The unit covers the calibrated range of 85 to 1000 megacycles. The fundamental of the precision variable frequency oscillator is 85 to 200 megacycles.

**Sensitivity:** The Frequency meter can detect a radio frequency signal of 20 microvolts with an audio power output up to 50 milliwatts depending on the frequency.

**Internal Modulation:** When desired, amplitude modulation of 1000 cycles in frequency can be employed. The modulation percentage is approximately 30%.

**Radio Frequency Output:** The output voltage from a 50 ohm source, varies from 300 to 100,000 microvolts, within the range of 85 to 1000 megacycles.

**Secondary Frequency Standard:** A 5000 Kc. oscillator incorporating a CR-18/U crystal can be used as a secondary frequency standard with harmonics of 5 megacycles up to 200 megacycles.

Territories for representation available.

We offer a complete automatic recalibration service on all frequency meters.

**COLORTONE**  
ELECTRONICS, Incorporated  
238 William Street, New York, N. Y. • COrtlandt 7-5160  
Executive Offices: 400 Duffy Ave., Hicksville, Long Island

**THOUSANDS OF QUALITY TUBES**  
IN SMALL AND LARGE QUANTITIES

DIRECT SOURCE FOR:  
★ SPECIAL PURPOSE  
★ TRANSMITTING  
★ TV, RADIO & OTHER TYPES

We Stock for Prompt Shipment one of the Most Complete inventories of SPECIAL-PURPOSE, TV, & RADIO TUBES. We offer fully guaranteed, Standard Brands at the Lowest Prices, consistent with Highest Quality.

**CERTIFIED LABORATORY CHECKING FACILITIES**

Geared to intelligently and efficiently handle export orders. Packing . . . forwarding . . . correspondence dispatched quickly and with assurance.

We stock and manufacture Selenium Rectifiers and Transformers to your Electrical and Mechanical specs . . . Fast Delivery!

**TYPICAL VALUES**

**SUBMINIATURE TYPES**

|         | EACH   |                 | EACH |
|---------|--------|-----------------|------|
| 5633    | \$6.90 | CK-5703WA       | 4.50 |
| 5634    | 6.90   | CK-5704         | 2.20 |
| 5635    | 6.90   | CK-5744         | 1.25 |
| 5636    | 6.90   | CK-5744WA       | 4.50 |
| 5637    | 3.50   | CK-5784         | 3.25 |
| 5638    | 7.90   | 5829            | 1.75 |
| 5639    | 7.90   | 5829WA          | 5.80 |
| 5641    | 3.50   | 5840            | 6.90 |
| 5642    | .95    | 5896            | 6.90 |
| 5643    | 6.00   | 5899            | 6.90 |
| 5646    | 6.90   | 6021            | 5.95 |
| 5647    | 3.75   | 6D4             | 2.50 |
| CK-5676 | 1.15   | 6K4             | 2.75 |
| CK-5702 | 2.20   | AND MANY OTHERS |      |
| CK-5703 | 1.25   | IN STOCK        |      |

**POPULAR, NEW RUGGEDIZED TYPES . . .**

|             | Jan and Commercial |             |      |
|-------------|--------------------|-------------|------|
| 2D21        | \$ 1.00            | 5763        | .95  |
| 6J4 (RCA)   | 4.50               | 5814        | 1.75 |
| 6AK5-W      | 1.70               | 5879        | 1.00 |
| 5654/6AK5-W | 1.85               | 6073        | 1.75 |
| 6AS6        | 1.75               | 6080        | 3.25 |
| 5656        | 14.75              | 6080 WA     | 5.50 |
| 5670        | 2.75               | 6082        | 3.35 |
| 5725/6AS6W  | 2.45               | 6096        | 1.90 |
| 5726/6AL5-W | 1.15               | and others. |      |
| 5751        | 1.75               |             |      |

WRITE FOR FULL LIST

**WE WILL BUY**

"Turn Your Excess Tubes Into Cash!—  
For Quick Action and a Fair Deal,  
Write, Wire or Call."

AUTHORIZED DISTRIBUTORS FOR:  
WESTINGHOUSE      LEWIS-KAUFMAN  
EIMAC CBS-HYTRON      CETRON PENTALABS

**BARRY ELECTRONICS CORP.**

R-136 LIBERTY ST., NEW YORK 6, U.S.A.  
Cable BARRYLECT, N. Y.

Circle No. 16 on Reader Service Card

# NEW TUBES

**TWIN BEAM POWER TUBE**

A small, sturdy, twin beam power tube, the RCA-6524 is intended for use as a push-pull r.f. power amplifier or



as a frequency tripler in fixed and mobile equipment operating in the u.h.f. range between 450 and 470 mc. At lower frequencies in the u.h.f. range, it can be operated with higher plate voltage and plate input to give increased power output. Announced by the Tube Division of Radio Corporation of America, Harrison, N. J., this tube may also be employed as an a.f. power amplifier and modulator.

Circle No. 75 on Reader Service Card

**XENON THYRATRON**

The 6478 xenon thyatron introduced by Taylor Tubes, Inc., 2312 Wabansia Ave., Chicago 47, Ill., meets the exacting electrical and mechanical requirements for reliable airborne operation at high altitudes. Its small size and flexible anode lead make this tube suitable for applications where space is limited, and hard glass construction makes it useful in high shock installations.

Maximum de-ionization time of 80  $\mu$ sec. is a feature of the 6478 thyatron. It has a maximum operating voltage of 1500 volts, a.c., a continuous anode current of 1.5 amperes, continuously recurring peak anode current of 7 amperes, and a filament current of 7 amperes



at 2.5 volts. Ambient temperature limits are  $-75^{\circ}$  C to  $+85^{\circ}$  C.

Circle No. 76 on Reader Service Card

**GERMANIUM MICROWAVE CRYSTAL**

Gahagan, Inc., has announced the development of the first successful germanium microwave crystal, designated GX-10. Extensive tests at government and industrial laboratories have proven the GX-10 to be superior to the present 1N21B and 1N21C silicon-type crystals for noise, burnout and ruggedness.

For additional information, write to John G. Hambor, Gahagan, Inc., 11 West Fourth St., Bethlehem, Pa.

Circle No. 77 on Reader Service Card

**AMPEREX TUBES**

Three new tubes have been announced by Amperex Electronic Corporation: two high-quality amplifier pentodes for high-fidelity audio sound systems and a ruggedized version of the standard type 2D21 thyatron.

Known as Types 6CA7 and EL84, the two pentodes offer a means of developing higher power and lower distortion than competitive types. Type 6CA7 (shown in the photograph) has a 25-watt plate dissipation, and Type EL84 has a 12-watt plate dissipation; they are designed to deliver high power without drawing control grid current.

The AX5727 thyatron is for relay and servo control applications where reliability of operation and mechanical ruggedness are important. An inert gas-filled tube with negative control characteristics, it has a high control ratio which is stable over a wide tem-



**SPLICES MAGNETIC TAPE**

Neatly - Quickly - Easily

Kit includes plastic splicer which adheres to recorder or worktable, generous supply of pre-cut tape splicing tabs, handy blade, instructions and plastic case. Only \$1.50 postpaid. If your dealer can't supply you, order from . . .

**COUSINO, INC.**

2321 Madison Ave.

Toledo 2, Ohio

Circle No. 17 on Reader Service Card



perature range, and features low grid-anode capacitance and low grid current.

Complete data may be obtained from the Engineering Department of *Ampere Electronic Corporation*, 230 Duffy Ave., Hicksville, L. I., N. Y.

Circle No. 78 on Reader Service Card

### Inductive Coordination

(Continued from page 19)

$$Z_T = X_R Q \quad (3)$$

and the attenuation factor is:

$$\alpha = \frac{Z_{L_n}}{X_R Q} \quad (4)$$

In practice, ratios of reactance to  $Q$  of at least 20 can be obtained. The effectiveness of a wave trap will not be appreciably affected by system frequency variation when  $Q$  values of approximately 25 are obtained. Under these conditions, the 60-cycle impedance of a reactor when tuned to the  $n$ th harmonic may be determined by the following relation:

$$X = \frac{Z_{L_n}}{nQ} \text{ ohms} \quad (5)$$

The value of the tuning capacity may be determined from the inductance of the reactor at the tuned frequency:

$$C = \frac{10^6}{(377n)^2 L_n} \text{ } \mu\text{fd.} \quad (6)$$

$L_n$  being in henrys.

#### Inductively Coupled Wave Traps

When a suitable reactor is already available, its sections may be employed in wave traps tuned to different frequencies. This may be done satisfactorily in instances where the coefficient of coupling between the reactor sections does not exceed a certain critical value, as shown by the relation:

$$K_c = \frac{F_L^2 - 1}{F_B^2 + 1} \quad (7)$$

The ratio of the frequencies at which the traps are to be tuned is larger to smaller.

The coefficient of coupling between any two sections of the reactor may be determined by bridge measurements of the inductance of each section alone ( $L_1$  and  $L_2$ ), and the total inductance obtained with two sections connected in series aiding. From these values, the coefficient may be calculated as follows:

$$K = \frac{L_T - (L_1 + L_2)}{2\sqrt{L_1 L_2}} \quad (8)$$

#### Conclusion:

In the preceding discussion, no attempt has been made to present all phases of inductive studies. It will be realized, however, that the solutions to the interference problems are based on fundamental principles of communication engineering.

Circle No. 18 on Reader Service Card

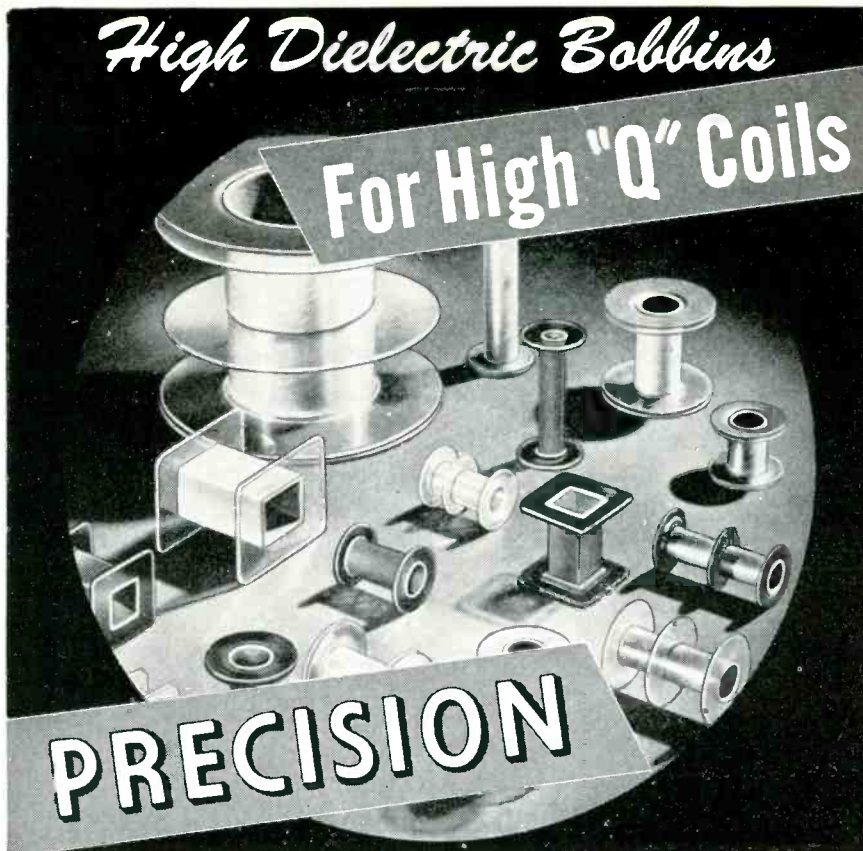

**MADE TO YOUR EXACT SPECIFICATIONS  
IN ANY SIZE • SHAPE • QUANTITY**

Precision coil bobbins are fabricated from high dielectric materials and quality controlled to the most minute tolerances . . . Yet, because they are made on special high production equipment, they're available to you for prompt delivery at low unit cost.

Cores are spirally wound dielectric kraft, fish paper, acetate, phenol impregnated or combinations. Flanges are cut to any specification for all types of mountings.

Request illustrated bulletin. Send specifications for samples.

#### High Strength Low Cost Paper Tubes

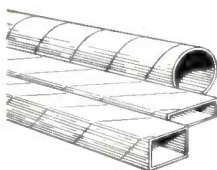

Accurately fabricated in any size, shape, ID or OD. Spirally wound from select dielectric materials. Crush resistant, with excellent dimensional stability. Subject to rigid control and inspection for tolerance and uniformity.

Ask for samples and Arbor List of over 2000 sizes.

#### Sales Representatives in:

- |   |   |
|---|---|
| <b>New England:</b><br>Framingham, Massachusetts, Framingham 7091                           | <b>Missouri, Southern Illinois, Iowa:</b><br>St. Louis, Missouri, Sterling 2318 |
| <b>Metropolitan New York, New Jersey:</b><br>Jersey City, New Jersey, Journal Square 4-3574 | <b>Maryland:</b><br>Baltimore, Maryland, Plaza 2-3211                           |
| <b>Upstate New York:</b><br>Syracuse, New York, Syracuse 76-8056                            | <b>Philadelphia, Camden:</b><br>Philadelphia, Pa., Chestnut Hill 8-0282         |
| <b>Northern Ohio, Western Pennsylvania:</b><br>Cleveland, Ohio, Atlantic 1-1060             | <b>California:</b><br>Pasadena, California, Sycamore 8-3919                     |
| <b>Indiana, Southern Ohio:</b><br>Logansport, Indiana, Logansport 2555                      | <b>Canada:</b><br>Montreal, Quebec, Canada, Walnut 2715                         |



**PRECISION PAPER TUBE CO.**

2063 W. CHARLESTON ST.

CHICAGO 47, ILL.

Plant No. 2: 79 Chapel St., Hartford, Conn.

## Strain Gages

(Continued from page 20)

Their use on other materials may result in less effective temperature compensation because of the variation in thermal expansion coefficients to be found among materials of the same general alloy class. A difference in temperature coefficient of expansion, for example, of  $+1 \times 10^{-6}/^{\circ}\text{F}$  from that of the specified metals is equivalent to 1 microinch / inch /  $^{\circ}\text{F}$  counterclockwise rotation of the curves shown in Figs. 3 and 4.

Use of single gages for the measurement of strain or stress involves possible circuitry changes to prevent system-induced errors. The active leg of the bridge includes not only the new temperature-compensated gage resistance, but its wire lead resistance also, making the circuit susceptible to error from temperature-resistance changes in the lead wires unless precautions are taken. The simplest method for compensating for such an error is to use lead wires of low electrical resistance or a low-coefficient wire such as constantan or manganin. However, if copper wire is used, a size of wire too large for convenience may be necessary, or the "dead" resistance of a low-coefficient wire such as constantan may be too high for practical use.

To avoid these limitations, the so-called "three-wire system" common in resistance thermometry may be used, as illustrated in Fig. 5. Here, lead wires "d" and "e" are equal and subject to the same temperatures throughout their length. Lead wire "f" may differ from "d" and "e" in resistance and need not be subject to the same temperatures although it is usually run along with the other two wires. With the circuit modified, as indicated, each lead wire is effectively placed on adjacent sides of the bridge and resistance variation in the leads does not affect bridge balance or introduce an "error" signal.

The temperature-compensated gages may be obtained in 120- to 350-ohm values with a gage factor of 2, as out-

Fig. 5. Three-wire system for avoiding errors due to lead wire temperatures.

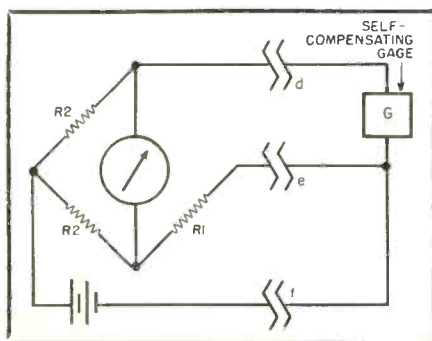

lined in Bulletin 174 which is available from Baldwin-Lima-Hamilton Corp., Philadelphia 42, Pa. They are manufactured in single-element, dual-element, and rosette types.

### REFERENCES:

1. Kaufman, Alvin B., "Stress and Strain Determination," RADIO-ELECTRONIC ENGINEERING, Vol. 15, No. 5, p. 11A, November, 1950.
2. Kaufman, Alvin B., "Oscillographic Strain Gage Recording," RADIO-ELECTRONIC ENGINEERING, Vol. 15, No. 3, p. 15A, September, 1950.

## Missile Testing

(Continued from page 9)

can be used in series if necessary.

Communications facilities are also needed atop the portable aerostand at each launching pad. This requirement is satisfied in a similar manner, except that all five channels are brought out to an extension jack panel where the interested personnel can plug into the desired channel. Thus, there are three independent means of portability: (1) the five-channel interphone cart itself can be pushed to any desired location within reach of its self-contained 50' cable, (2) the aerostand may be pushed to any desired location within reach of its self-contained 75' cable, and (3) each man may move about either the cart or the aerostand, using one or several 25' extension cords.

A feature of the interphone system which provides even greater flexibility is the interphone distribution panel, located in the blockhouse, which enables the six separate areas served by this system to be patched into one another in any desired fashion. For example, one line from any given location, say one of the launching pads, can be patched to one or more of the other locations, and therefore it is possible to have one line reserved for each location if desired.

### Radio Communications

As almost all postlaunch activities involve aircraft and distant down-range instrumentation sites, arrangements were made for the use of six r.f. channels—four v.h.f. and two h.f. The two h.f. channels serve double duty for ground-to-ground and ground-to-air long-range communications, while the four v.h.f. channels are exclusively for ground-to-air and air-to-air communications. Means must thus be provided for remotely switching the six available radio channels plus an additional liaison intercommunications channel to those areas and persons requiring radio communication. Figure 5 illustrates a typical area installation.

#### Requirements

1. At each of the several different areas, the equipment should be capable of switching the six "trans-

mit," six key, and six "receive" lines at the operator's option. General channel switching requirements (all positions except master control) are: (1) the selection of any one "transmit" channel and its associated key line, or intercom line, (2) selection of any combination of the six "receive" lines plus intercom, (3) a choice of external speaker or headphones, and (4) the use of carbon microphones. Master control requirements include: (1) the selection of any combination of the six "transmit" channels with the associated key line plus intercom and a public address line, (2) selection of any combination of the six "receive" lines plus intercom, (3) a choice of internal speaker or headphones, and (4) the use of dynamic microphones.

2. All indoor areas must have a low-power public address system for paging, and all launching pads a high-power public address system for paging and safety warnings. Some form of selective mixing of all low-power and all high-power systems is also necessary.
3. The equipment must be capable of handling selective mixing of any or all of the six "transmit" lines, six "receive" lines, intercom lines, and public address lines, and information from the five interphone lines already mixed in the interphone monitor mixer of the interphone system; and provision must be made for four hours of continuous recording of the above information.
4. Visual and audio monitoring as desired should be available on any of the six "transmit," six "receive," intercom and PA lines, and for adjusting all incoming and outgoing lines to  $+4$  dbm.
5. Line-matching requirements include provision for maintaining constant modulation efficiency by keeping "transmit" line level constant regardless of the number of radio switch boxes paralleled on the same "transmit" line, for transforming from unbalanced switching lines to balanced telephone lines, and for permitting phantom keying over the balanced telephone lines.
6. Arrangements for muting the "receive" lines when transmitting must be included in order to prevent feedback.
7. Frequency response of the system should be as flat as reasonably possible over the range of voice frequencies, 200 to 4000 cycles.
8. Hum specifications should be set at  $-60$  dbm.
9. Crosstalk specifications should be set at 60 db below the "transmit" level of  $+4$  dbm.



# TAKE ADVANTAGE OF THE



# READER SERVICE

Here are the advertisers in this issue of RADIO-ELECTRONIC ENGINEERING. To get more information quickly on their products (listed below), use the convenient post-free inquiry card . . . card also provides for obtaining more information on items mentioned in the various departments.

| <i>AD. NO.</i> | <i>ADVERTISER</i>                          | <i>PRODUCTS</i>                   |
|----------------|--|-----------------------------------|
| (2nd Cover) 1  | UNITED TRANSFORMER CO. . . . .             | Filters                           |
| (Page 3) 2     | RADIO CORPORATION OF AMERICA . . . . .     | Miniature Dynamic Microphones     |
| 3              | HAMMARLUND MANUFACTURING CO., INC. . . . . | Remote Control Systems            |
| 4              | MOTOROLA COMMUNICATIONS & ELECTRONICS      | 6/12-Volt Two-Way Radio           |
| 5              | RADIART CORPORATION . . . . .              | Communication Vibrators           |
| 6              | RADIO CORPORATION OF AMERICA . . . . .     | Employment Opportunities          |
| 7              | PYE LIMITED . . . . .                      | Portable Radio-Telephones         |
| 8              | AUTOMATIC SWITCH CO. . . . .               | Automatic Transfer Switches       |
| 9              | ELECTRO-VOICE . . . . .                    | Dynamic Microphones               |
| 10             | RADIO CORPORATION OF AMERICA . . . . .     | Electron Tubes                    |
| 11             | CONNECTICUT TELEPHONE & ELECTRIC CORP.     | FM Two-Way Radio                  |
| 12             | RCA SERVICE COMPANY, INC. . . . .          | Broadcast Engineers Wanted        |
| 13             | MEASUREMENTS CORPORATION . . . . .         | U.H.F. Standard Signal Generators |
| 14             | CHICAGO STANDARD TRANSFORMER CORP. . . . . | High Fidelity Transformers        |
| 15             | COLORTONE ELECTRONICS, INC. . . . .        | Frequency Meters                  |
| 16             | BARRY ELECTRONICS CORP. . . . .            | Special-Purpose, TV & Radio Tubes |
| 17             | COUSINO, INC. . . . .                      | Magnetic Tape Splicing Kits       |
| 18             | PRECISION PAPER TUBE CO. . . . .           | Coil Bobbins                      |
| 19             | CAMERA EQUIPMENT CO. . . . .               | Camera Accessories                |
| 20             | MONITORADIO RADIO APPARATUS CORP. . . . .  | Monitor Receivers                 |
| 21             | ADAIR ENGINEERING CO., GEORGE P. . . . .   | Consulting Engineering            |
| 22             | GABRIEL COMPANY . . . . .                  | High Frequency Antennas           |
| 23             | KLIPSCH & ASSOCIATES . . . . .             | Acoustic Development & Consulting |
| 24             | McINTOSH, FRANK H. . . . .                 | Consulting Radio Engineering      |
| 25             | MEASUREMENTS CORPORATION . . . . .         | Research & Mfg. Engineering       |
| 26             | ZOPHAR MILLS, INC. . . . .                 | Waxes & Compounds                 |
| 27             | GENERAL PRECISION LABORATORY, INC. . . . . | Miniature Camera Tubes            |

DETACH AND SEND FOR ADVERTISED PRODUCT & DEPARTMENT INFORMATION

REE 114

Name \_\_\_\_\_

Title \_\_\_\_\_

Company \_\_\_\_\_

Company Address \_\_\_\_\_

**FOR MORE INFORMATION ON ADVERTISED PRODUCTS, PLEASE CIRCLE NOS.**

- 1 2 3 4 5 6 7 8 9 10 11 12 13 14 15 16 17 18 19  
 20 21 22 23 24 25 26 27 28 29 30 31 32 33 34  
 35 36 37 38 39 40 41 42 43 44 45 46 47 48 49 50

**FOR MORE INFORMATION ON DEPARTMENT ITEMS, PLEASE CIRCLE NOS.**

- 51 52 53 54 55 56 57 58 59 60 61 62 63 64 65 66  
 67 68 69 70 71 72 73 74 75 76 77 78 79 80 81 82 83  
 84 85 86 87 88 89 90 91 92 93 94 95 96 97 98 99 100

THIS CARD MUST BE USED BEFORE JANUARY 1, 1955

# **RADIO-ELECTRONIC** *Engineering*

## READER SERVICE

RADIO-ELECTRONIC ENGINEERING has always kept its readers up-to-date and well informed on important engineering phases of research, development and application. The RADIO-ELECTRONIC ENGINEERING Reader Service is designed to provide you with even greater benefits. By taking advantage of this service, you will be able to obtain more detailed information on specific products and department features quickly and easily.

DETACH AND SEND FOR ADVERTISED PRODUCT & DEPARTMENT INFORMATION



**BUSINESS REPLY CARD**  
No postage stamp necessary if mailed in the United States

FIRST CLASS  
PERMIT No. 37110  
(Sec. 34.9 P.L.&R.)  
NEW YORK, N. Y.

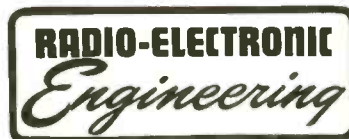

366 MADISON AVENUE  
NEW YORK 17, NEW YORK

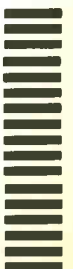



10. All equipment must operate from commercial 60-cycle power lines.

### System Design

The first major unit for channel switching at each remote location with in each area is the "radio switch box." (See Fig. 3.) Referring to the schematic (Fig. 4), the "send" portion employs a type 12AX7 tube transformer coupled to the 600-ohm lines via a rotary selector switch for the selection of the channel desired. The "receive" part of the unit uses an electronic mixer so that any combination of the six "receive" lines and intercom can be heard simultaneously. Toggle switches in each "receive" line permit the selection of the required lines to be mixed. Since the audio level of all the lines is +4 dbm, it is not necessary to employ a low-level plate-type mixer which would call for six half-tubes for just this purpose alone. Instead, a "Summer" type of mixer normally seen in computer circuitry is used. This permits excellent mixing, with a crosstalk figure of -60 dbm, and only requires one-half of a 12AX7. A type 6AQ5 output power tube gives .5 watts into an external bullet-type speaker or headphones.

Located at the master control operator's position is the master control radio switch box. Since a dynamic microphone is necessary, a preamplifier is an additional feature of this unit. As the requirements state that any combination of the "transmit" and "receive" lines, intercom, and public address may be employed simultaneously, toggle switches are utilized throughout both the "send" and "receive" lines instead of rotary selector switches. Any or all of the six key lines may be required at the same time, and since there is only one microphone press-to-talk switch available, six relays are incorporated for keying and muting.

A "terminal unit" fulfills the requirements for receiver line muting, keying, and transforming balanced to unbalanced lines. Line transformers perform the function of transforming balanced to unbalanced lines. Six sensitive relays are incorporated in this unit to key the distant transmitters by phantom key lines. One set of contacts on the keying relays mutes the respective "receive" line by shunting a 22-ohm resistor across the incoming 600-ohm lines.

To prevent the combined output of the various units from changing as their outputs are paralleled, a form of electronic mixing is used for the six "send" lines. The line mixer amplifier takes the individual outputs from as many as ten remote units with six "send" lines each, electronically mixes

Circle No. 20 on Reader Service Card

# NOW...

## A SUPER LINE OF ACCESSORIES THAT SURPASS ACCEPTED STANDARDS—for STUDIO, MOBILE and MICRO-RELAY EQUIPMENT

Famous **BALANCED TV Head** supporting a TV camera. Both are mounted on one of our all-metal tripods, which in turn is mounted on a **Ceco Spider Dolly**. Here is a "team" outstanding for versatility and maneuverability in studio or on location.



New Model C **BALANCED TV Head** provides correct center of gravity in a **FLASH**—without groping.

No matter what focal length lens is used on the turret, the camera may be balanced by the positioning handle without loosening the camera tie-down screw. Something every cameraman has always desired.

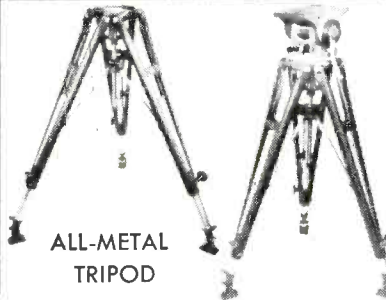
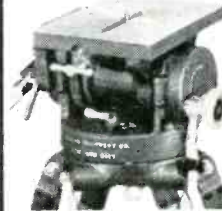

**ALL-METAL TRIPOD**

Has fixed shoe, also fixed spurs. Rubber pads prevent slipping. These may be flipped out of position, leaving the spur exposed. One lock knob for setting up and breaking down tripod legs, which operate in unison.

**ROOFTOP**

**CLAMPS**

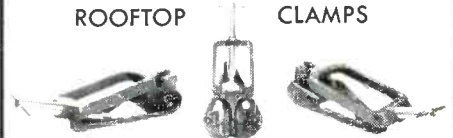

Secures tripod of camera or beam reflector to car top. Made of bronze and brass, with ball-type, yoke-swivel construction. A lot depends on roof clamps—that's why these are made with **EXTRA** care.



Similar to **BALANCED TV head**, this new **Professional Junior Spring head** is ideal for **Vidicon** cameras weighing up to 25 lbs. Spring head tilt assures camera will return to neutral position when lever is in unlocked position... a wonderful safety factor.

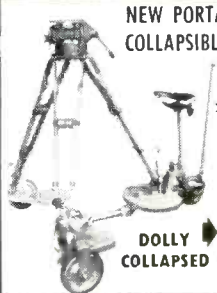

**NEW PORTABLE 3-WHEEL COLLAPSIBLE DOLLY**

Dolly folds to fit into carrying case—18"x12"x36". Weighs only 60 lbs. Has wheel in rear for steering, which may be locked for straight dollying.



**MINI-PRO**  
New lightweight all-metal **MINI-PRO Tripod** fulfills a tremendous need—especially for **Vidicon** cameras weighing up to 8 lbs. Low height measures 33" and maximum height 57". Reversible spur and rubber cushions. Maximum leg spread 35".

FRANK C. ZUCKER  
**CAMERA EQUIPMENT**

DEPT. P-11-13 1600 BROADWAY • NEW YORK CITY

For more information, circle No. 19 on Reader Service Card



**MONITORADIO** for a thoroughly coordinated 2-way communication system.

Now every member of every department can have radio communication for as little as \$49.95

Write today for further information.

got enough **EARS?**

**BE ON THE CONSTANT ALERT**

All Departments Can Now Listen to Every Vital Message

- Nation's most complete line of monitor receivers.
- Crystal controlled or tunable for any VHF FM communication system.
- Mobile or stationary receivers.
- Prices to meet any budget.
- Certified for civil defense use.

**MONITORADIO RADIO APPARATUS CORPORATION**

55 North Jersey St., Indianapolis, Ind. Phone: Atlantic 1624

## Professional Directory

### GEORGE P. ADAIR Engineering Co.

**Consulting Engineers**  
Radio, Television, Communications,  
Electronics  
1610 Eye St., N.W. EXecutive 3-1230  
Washington 6, D. C.

Circle No. 21 on Reader Service Card

### GABRIEL ELECTRONICS DIVISION



Formerly Workshop Assoc. Div.  
THE GABRIEL COMPANY

**Specialists in  
High-Frequency  
Antennas**

Endicott St. Norwood, Mass.  
Norwood 7-3300

Circle No. 22 on Reader Service Card

**Paul W. Klipsch**  
Professional Engineer  
Acoustic development  
and consulting

**Klipsch and Associates**  
building the authentic  
KLIPSCHORN  
world's finest sound reproducer

Hope, Arkansas Tel. Hope PRespect 7-3395

Circle No. 23 on Reader Service Card

### FRANK H. McINTOSH

**Consulting Radio Engineer**

1216 Wyatt Bldg., Washington 5, D. C.  
MEtropolitan 8-4477  
Member AFCCE

Circle No. 24 on Reader Service Card

### MEASUREMENTS CORPORATION



*Research &  
Manufacturing  
Engineers*

Harry W. Houck John M. Van Beuren M. A. Honnell  
Specialists in the Design and  
Development of Electronic Test Instruments  
BOONTON, N. J.

Circle No. 25 on Reader Service Card

Take advantage of the  
**READER SERVICE CARD**  
—a fast, convenient way  
to get further information!

the outputs, and feeds the six outgoing lines via cathode followers with no more than a 1-db variation in output regardless of whether one or ten units are paralleled.

In order to establish and monitor the incoming and outgoing lines to the required +4 dbm level for the telephone lines, the monitor unit contains a standard vu meter which is switched across the desired line by means of a selector switch. It also contains a monitor jack for headphones where audio monitoring is desired.

For indoor public address requirements, a Masco commercial 10-watt amplifier, Model MH-110, drives two *Racon* Model RE-12 10-watt speakers. For outdoor PA coverage to the pads, a Masco 50-watt unit, Model MA-50n, drives two *Racon* heavy-duty paging speakers rated at 25 watts each. These directional speakers are mounted atop the blockhouse with the speakers facing the pads.

A PA mixer gives selective mixing of the six "receive," six "send," I/C, I/P, and PA lines into the PA system. This unit is mounted in one of the small racks used by the master control operator for his specified operation.

Continuous four-hour recording of the communication proceedings is made by a *Stancil-Hoffman* tape recorder, modified to operate at 3 3/4" per second. The tape transport mechanism and power supply are mounted in the large communications racks, while the recorder amplifier unit is necessarily located at the master control position. This means that the recording signal, the playback signal, and the bias signal of approximately 80 kc. must operate over the 20 feet of cable separating these two positions.

A recorder mixer mixes the six "receive," six "send," intercom, interphone and PA lines into the recorder at the will of the master control operator. This unit is also mounted in one of the small racks at the master control position.

Since the radio communications gear is grouped in the same general areas, power is supplied via a common power supply. The primary advantage of the central power supply is the economy resulting from excellent filtering and regulation. Means for decoupling of

the individual units where required is installed at the units themselves. It is the belief of the designers that this central power supply represents the major contributing factor in achieving the hum level of 60 db below 0 dbm for the over-all system.

The use of 600-ohm shielded leads helps reduce electrostatic and circulating 60-cycle types of hum to -60 dbm, and shields out external noise generated by radar and computers. This shielding aids in reducing crosstalk between the lines to the required -60 dbm.

Figures 1 and 3 show portions of the radio communications system equipment. It should be noted that there is a seventh "I/C" position for the selector switch on the radio switch boxes. This is a separate intercom position, not part of the interphone system. The purpose of this seventh channel is to provide land-line communications between the various persons using the radio communications system, since they may not all have ready access to the interphone system.

#### Results:

The two systems described above were tested in the field after installation, and excellent results were secured. In the radio communications system, crosstalk between the "transmit" lines, between the "receive" lines, and between the "transmit" and the "receive" lines was a maximum of 60 db below the +4 dbm outgoing level.

Over-all frequency response of the "receive" function from incoming line to audio output (resistive load for measurements) was  $\pm 2$  db from 200 to

#### CORRECTION NOTICE

An item on page 23 of the August issue referred to the first radio-equipped mobile ticket office in the world. We have been advised that *Trans World Airlines, Inc.* has had a radio-equipped mobile ticket office in operation since June, 1953.

#### PHOTO CREDITS

|                   |                            |
|-------------------|----------------------------|
| PAGE              | CREDIT                     |
| 7, 8, 9 . . . . . | Northrop Aircraft, Inc.    |
| 10, 11 . . . . .  | Nat. Bureau of Standards   |
| 15, 16 . . . . .  | Lenkurt Electric Co., Inc. |

#### INDEX OF ADVERTISERS

| NAME                                      | PAGE         | NAME  | PAGE         |
|---|--------------|---|--------------|
| Adair Engineering Co., George P.          | 38           | Klipsch & Associates                        | 38           |
| Automatic Switch Co.                      | 25           | McIntosh, Frank H.                          | 38           |
| Barry Electronics Corp.                   | 34           | Measurements Corporation                    | 30, 38       |
| Camera Equipment Co.                      | 37           | Monitoradio Radio Apparatus Corp.           | 37           |
| Chicago Standard Transformer Corp.        | 31           | Motorola Communications & Electronics, Inc. | 5            |
| Colortone Electronics, Inc.               | 33           | Precision Paper Tube Co.                    | 35           |
| Connecticut Telephone & Electric Corp.    | 29           | Pye Limited                                 | 23           |
| Cosino, Inc.                              | 34           | Radiart Corporation, The                    | 6            |
| Electro-Voice                             | 26           | Radio Corporation of America                | 3, 21, 27    |
| Gabriel Company, The                      | 38           | RCA Service Company, Inc.                   | 30           |
| General Precision Laboratory Incorporated | Fourth Cover | United Transformer Co.                      | Second Cover |
| Hammarlund Manufacturing Co., Inc.        | 4            | Zophar Mills, Inc.                          | 39           |



5000 cycles. Over-all frequency response of the "transmit" function from microphone input to outgoing lines was  $\pm 2$  db from 200 to 6000 cycles; the "transmit" function was designed for slightly better frequency response in order to allow for line losses.

Test results of the interphone system were equally good. Crosstalk between the interphone and radio communication systems was a maximum of  $-80$  db from  $+4$  dbm. The "receive" and "transmit" frequency responses were both  $\pm 3$  db from 300 to 4000 cycles.

Both systems provide clear, crisp voice communications to all points required, and after being tested in the field for one year have proven satisfactory to all concerned.

## Multiplexing

(Continued from page 17)

at too high a level can result in overloading by loud talkers with resulting interchannel cross modulation. Conversely, too low a level will reduce the fade margin on the radio link. Some of the elements which must be considered in setting levels in a radio system are the number of channels, the use factor on these channels, type of signaling and signaling levels, the presence of volume compressors or companders, and the level of intentionally transmitted carrier.

In a radio system, the channel signal-to-noise ratio is limited by thermal noise (hiss) and/or distortion products from other channels (babble). Since gain of the receiver is controlled by the received signal level through the use of a regulator, insufficient signal level to the receiver will result in receiver gains being automatically increased to a point which may bring thermal noise into prominence. An increase in signal level imparted at the transmitter modulator will correct this situation unless radio channel overloading results, as evidenced by excessive cross modulation or babble. The proper operating level, except in cases where the radio link is operating under decidedly marginal conditions, is an important but not unduly critical adjustment.

The separation of the carrier equipment and the radio apparatus may be substantial, and extensions of this type are readily accomplished with frequency-division systems. It is necessary to recognize, however, that the characteristics of the interconnecting lines may become important, depending on the frequencies used and the facility used for interconnecting the radio and carrier equipment. For long lines, it may be necessary to match impedances and equalize for the effect of slope.

Among the primary advantages of multiplexed microwave is its ability to serve relatively inaccessible areas at moderate cost, while providing substantial circuit capacity. Further, its flexibility provides infinite possibilities for rearrangement, expansion and relocation under the impetus of changing requirements, thus preserving its usefulness beyond the life of the particular project for which it was originally procured.

An example of an application of multiplexed microwave communications to a military problem is illustrated in Fig. 3. The United States Naval Air Missile Test Center at Point Mugu, California, was faced with a requirement for greatly enlarging the communications system interconnecting the mainland with the islands of Santa Cruz, Santa Rosa and San Nicolas. Frequency-division multiplexed radio was selected to provide the necessary facilities. The new installation provides 23 voice channels, each with its own signaling facility, and five additional independent telegraph channels for teleprinter use. Each of the channels is on a full party-line basis so that each circuit can be used at the mainland or at any of the three islands and received simultaneously at the other three points. In order to meet the requirements for party-line service, the installation was arranged with Santa Cruz as a hub for the other three stations. Information originating at Santa Cruz Island is relayed to the other three stations simultaneously while information originating at any of the other stations is received at Santa Cruz Island and simultaneously relayed to the remaining two stations.

Design of this system is based on the use, at the hub location, of a four-way, four-wire resistance bridge to which are connected all of the radio receivers and transmitters at that station. The bridge provides

four pairs of terminals to which the radio carrier inputs and outputs are connected. The resistance configuration is such that low loss is obtained between each input and three of the outputs, while a high loss is provided between the same input and one of the outputs. Thus, signals received from one station are passed through the resistance bridge to the transmitters sending to the other three stations, but are effectively blocked from the transmitter sending signals back to the originating station. Variations of this operating principle may be applied to systems having different requirements for number of channels, number of terminals, and types of operation.

## Conclusion

Within the past 15 years, multiplexed microwave communications has obtained stature as a highly successful communication medium. The attention which is being devoted to it by the *Lenkurt Electric Company* and other manufacturers in the field, and the acceptance which it is receiving by the users, both commercial and government, indicate that the future will bring about a vast increase in the use of multiplexing.

# ZOPHAR WAXES COMPOUNDS

Zophar waxes, resins and compounds to impregnate, dip, seal, embed, or pot, electronic and electrical equipment or components of all types; radio, television, etc.

Cold flows from 100°F. to 285°F.

Special waxes non-cracking at  $-76^{\circ}\text{F}$ .

Compounds meeting Government specifications, plain or fungus resistant.

Let us help you with your engineering problems.



**ZOPHAR MILLS, INC.**  
112-130 26th Street,  
Brooklyn 32, N. Y.

For more information, circle No. 26 on Reader Service Card

**SMALL EYE FOR A BIG JOB...**

the  
**GPL PYE**  
"STATICON"

the miniature camera tube  
for new advances in  
industrial TV



TYPE GP-6198

The Staticon (Type GP-6198) is a photoconductive tube, operating on the low velocity scanning principle. It is only 6½ inches long and 1 inch in diameter, yet has a resolution of 600 lines or better.

The sensitivity of the Staticon provides a clear sharp picture at  $f/2.0$  with only 50 foot-lamberts in the scene.

Developed and refined specifically for high

definition in small size, the Staticon permits major advances in compact, light-weight TV cameras for many uses. Initial cost and operating costs are lower.

Complete specifications of this tube are available from any General Precision Laboratory office. The tube will be offered to distributors throughout the U.S., as well as in complete camera chains by GPL PYE.



### THE MODERN INDUSTRIAL CAMERA

This GPL PYE camera uses the new Staticon! It's high-definition TV for industry and science. All main elements in one case; uses standard TV receivers or monitors for viewing at any distance.

Staticon camera has simple controls, uses AC power, needs only normal lighting.

Full technical details, and demonstration at your site, from any GPL office.

#### DISTRIBUTOR INQUIRIES WELCOMED

Full details on "STATICON" distribution are available from all GPL offices . . .

**General Precision Laboratory**

INCORPORATED

PLEASANTVILLE NEW YORK

REGIONAL OFFICES: CHICAGO • ATLANTA • DALLAS • GLENDALE, CALIFORNIA



For more information, circle No. 27 on Reader Service Card