

RADIO-ELECTRONIC

Engineering

**RADIO &
TELEVISION
NEWS**

Reg. U. S. Pat. Off.

TELEVISION • RADAR • ELECTRONICS • RESEARCH • COMMUNICATIONS • MICROWAVES

OCTOBER, 1951

RC FILTER CIRCUITS

3

NUCLEAR PULSE AMPLIFIERS

7

GATE AND DELAY GENERATOR

10

THE SERIES AMPLIFIER

12

AN INTRODUCTION TO COMPUTER
CONCEPTS

14

MAGNETIC ATTENUATOR

18

PER-CENT RIPPLE NOMOGRAPHS

32

DEPARTMENTS

NEW PRODUCTS20

NEWS BRIEFS22

PERSONALS26

PATENT REVIEW28

TECHNICAL BOOKS29

CALENDAR30



Copyright, 1951, by Ziff-Davis Publishing Co.

RADIO-ELECTRONIC ENGINEERING is published each month as a special section in a limited number of copies of RADIO & TELEVISION NEWS, by the Ziff-Davis Publishing Company, 185 N. Wabash Avenue, Chicago 1, Illinois.

The inspection of cathode-ray bulbs for glass strain after seal-in of the electron gun is performed in Rdytheon Mfg. Co.'s Cathode-Ray Tube Division in Newton, Massachusetts, by placing the part to be inspected between the polarized light source and the eyepieces.



PREMIUM PERFORMANCE SUBMINIATURES . . .

SYLVANIA OFFERS A COMPLETE LINE FOR GOVERNMENT CONTRACTORS

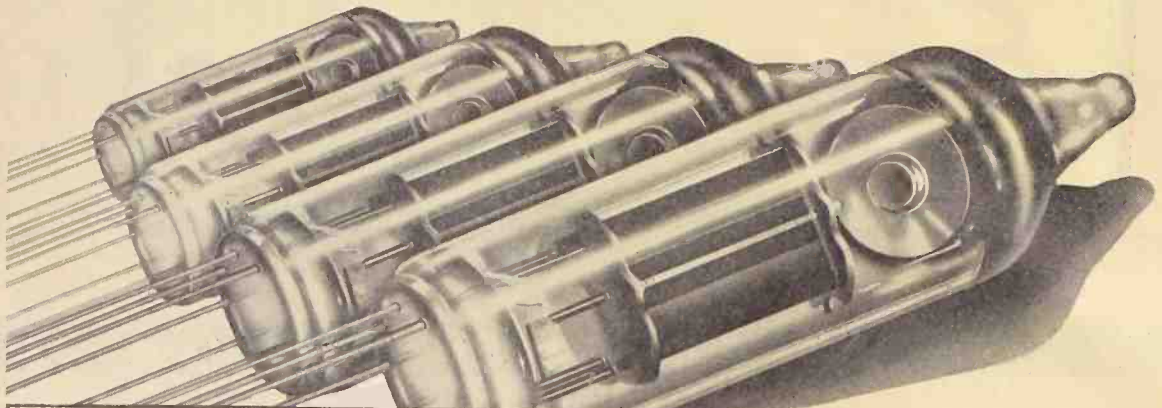

SYLVANIA PREMIUM PERFORMANCE SUBMINIATURE TUBES								
*Armed Services Preferred Types								
Type	Description	Ef (Volts)	If (ma)	Eb (Volts)	Ec2 (Volts)	Em (μmhos)	Po (Watts)	
PENTODES								
5636	Pentode Mixer	6.3	150	100	100	1250 (gc)		
*5639	Video Pentode	6.3	450	150	100	9000	1.0 (R _L = 9000Ω)	
*5840 (5901)	Sharp Cut-off UHF Pentode	6.3	150	100	100	5000		
*5899 (5900)	Semi-remote Cut-off UHF Pentode	6.3	150	100	100	4500		
*5902	Audio Beam Power Pentode	6.3	450	110	110	4200	1.0 (R _L = 3000Ω)	
*5905	Sharp Cut-off UHF Pentode	26.5	45	26.5	26.5	2850		
*5906	Sharp Cut-off UHF Pentode	26.5	45	100	100	5000		
*5907	Remote Cut-off UHF Pentode	26.5	45	26.5	26.5	3000		
*5908	Pentode Mixer	26.5	45	26.5	26.5	1000 (gc)		
*5916	Pentode Mixer	26.5	45	100	100	1280 (gc)		
TRIODES								
*5718 (5897)	Medium Mu UHF Triode	6.3	150	100		5800	0.9 (500 Mc Osc)	
*5719 (5898)	High Mu Triode	6.3	150	100		1700	70	
5977	Medium Mu Triode	6.3	150	100		4500	16	
5987	Low Mu Power Triode	6.3	450	100		1850	4.1	
*5904	Medium Mu UHF Triode	26.5	45	26.5		4700	0.06 (400 Mc Osc)	
6021	Medium Mu Double Triode	6.3	300	100		4800	35	
6111	Medium Mu Double Triode	6.3	300	100		4750	20	
6112	High Mu Double Triode	6.3	300	100		1850	70	
DIODES								
*5641	Single Diode	6.3	450	930 peak inverse plate volts 50 ma dc output				
*5647	Single Diode (T1)	6.3	150	460 peak inverse plate volts 10 ma dc output				
*5896	Double Diode	6.3	300	460 peak inverse plate volts 10 ma dc output per plate				
*5903	Double Diode	26.5	75	460 peak inverse plate volts 10 ma dc output per plate				
6110	Double Diode	6.3	150	460 peak inverse plate volts 4.4 ma dc output per plate				
GAS TUBES								
5643	Tetrode Thyatron	6.3	150	Average Anode Current = 22 ma Peak Anode Current = 100 ma				
*5644	Voltage Regulator	—	—	Operating Voltage = 95 volts Operating Current = 5-25 ma				

Long life... fatigue tested...
High "g" vibration tested...
Impact resistant... stabilized
by burn-in period.

Twenty-five different types of Premium Performance Subminiature Tubes are now offered by Sylvania.

All are cathode types and are suitable for use in military communications equipment operating up to 400 mc. Engineered to function under severe conditions of vibration, shock, and high temperatures, they are excellent for rugged duty in guided missiles as well as in military signal equipment, fire control, etc.

Manufactured with either long or short leads in circular arrangement. At present available only on DO or CMP rated orders. For complete data concerning characteristics and applications, mail the coupon now!



SYLVANIA



RADIO TUBES; TELEVISION PICTURE TUBES; ELECTRONIC PRODUCTS; ELECTRONIC TEST EQUIPMENT; FLUORESCENT TUBES, FIXTURES; SIGN TUBING, WIRING DEVICES; LIGHT BULBS; PHOTOLAMPS; TELEVISION SETS

Sylvania Electric Products Inc.
Dept. R-1310, Emporium, Pa.

Please send me illustrated folder describing the complete line of Sylvania Subminiature Premium Performance Tubes.

Name _____
Company _____
Street _____
City _____ Zone _____ State _____

Band-pass filters in the 15 to 160 cps range may be designed by the use of RC networks with feedback amplifiers.

By
DAVID FIDELMAN

RC FILTER CIRCUITS

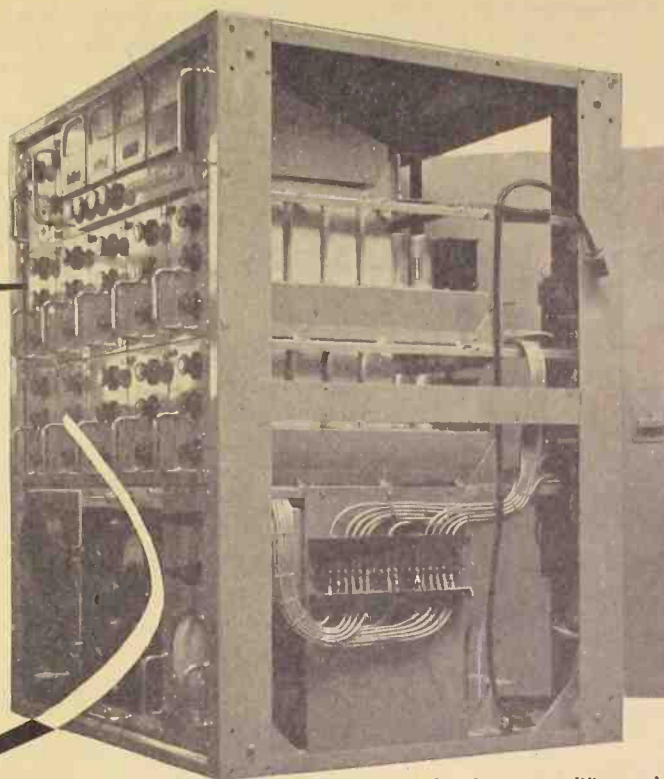

A complete band-pass amplifier rack, showing the internal construction.

THE USE OF ELECTRICAL FILTER networks has become extremely important in electronic engineering. Such networks have important applications in all phases of electronics, since they can be designed to give almost any type of frequency cutoff and discrimination characteristics. The extensive theory of electronic wave filters and techniques which has been developed for use in their design apply to the design of filters in all frequency ranges from low audio to microwave frequencies.

However, circuit elements have different characteristics at different frequencies, therefore the basic filter design equations must be applied differently in the different frequency ranges. In the middle audio frequencies and the low radio frequencies, the circuit elements commonly used in networks are the standard types of condensers and iron-core inductors. At microwave frequencies, the components take the form of microwave plumbing, which is reasonably familiar to most electronic engineers. But at the low audio frequencies, there is considerable difficulty in the design of networks because of the practical difficulties which arise in the design of suitable circuit components.

The equations and formulas for the design of filter networks assume that the

components used are dissipationless and that there are no incidental resistances in the circuit, except for the terminating resistances. In constructing such filters, it is therefore essential to use high-quality coils and condensers with the least practical amount of dissipation, so that the performance of the completed network will be reasonably close to the theoretical design requirements. The effects of dissipation are: (a) to cause an insertion loss in the pass band, (b) to decrease the sharpness of cutoff, and (c) to cause the peaks of theoretically infinite attenuation to be finite. As the dissipation increases, these effects become more pronounced. At audio frequencies, the effects of dissipation are most closely associated with inductances, and very few problems arise from the use of standard commercial condensers at frequencies up to the higher radio frequencies. Good results can be attained at audio frequencies above about 100 cycles with the use of good quality toroidal inductances wound on high-permeability molybdenum-permalloy powder cores. Inductors of this type can be made which have a Q of 50 in the neighborhood of 300 to 500 cps, and can have a Q as high as 200 at about 3000 cps.

However, at frequencies below 100 cps their Q may be as low as 10 or less, and it is extremely difficult and expensive to construct filters using such inductances for low frequencies. Another factor which adds to the difficulty of

designing conventional filters for low frequencies is that the capacities required at these frequencies become too large and bulky to be practical.

In many sound and vibration problems it is necessary to construct and use filter networks at these low audio frequencies, and in such applications it is therefore necessary to use other electronic principles and techniques to attain the same results as with conventional filter networks at the higher frequencies. The method which is used to achieve these results is by the use of RC networks with feedback amplifiers to form a non-passive type of filter. An example of the application of such methods is in the Sound Analyzing and Measuring System shown in the photographs which accompany this article. In this system (designed and built by the Fairchild Recording Equipment Corp. for the U. S. Navy Bureau of Ships), the audio spectrum is divided into sharply defined overlapping octave bands from a low frequency limit of 15 cps to an upper frequency of 160 cps. Because of the low frequency at which this equipment must operate it illustrates the application of the principles to be described in this article.

The meaning of these techniques may be better understood with a brief review of the more conventional filter circuits and their principles of operation. The frequency-selective attenuation characteristics of filter networks may be classified into four categories:

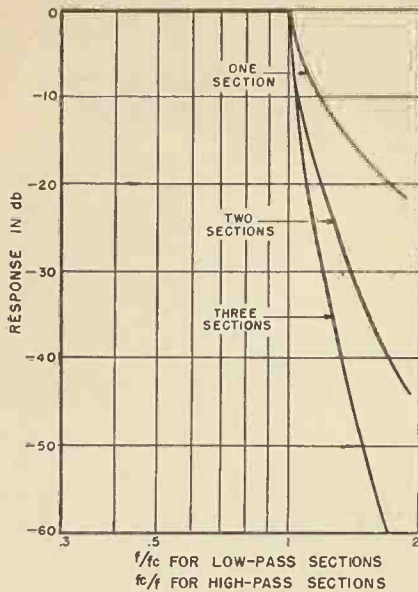

Fig. 1. Ideal frequency response of one, two, and three constant-k filter sections.

(1) *low-pass filters*, which pass all frequencies up to some finite cutoff frequency and attenuate all higher frequencies;

(2) *high-pass filters*, which transmit all frequencies above the cutoff frequency and attenuate all lower frequencies;

(3) *band-pass filters*, which transmit a definite band of frequencies and attenuate all frequencies outside this band;

(4) *band elimination filters*, which attenuate a definite band of frequencies and transmit all frequencies outside this band.

Band-pass filters in general can be composed either of band-pass sections, or by suitable combinations of high-pass and low-pass filters. Band-elimination filters are seldom used in practice, and will not be considered further.

Most conventional filters have a ladder configuration consisting of symmetrical *T* or π sections connected in tandem in sufficient numbers and types to secure the desired attenuation characteristic. The simplest basic filter sections are the constant-*k* filters. Accurate curves showing the typical fre-

Fig. 3. Measured amplitude and phase response of typical parallel-*T* null networks.

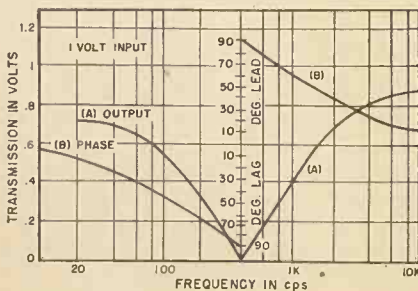

quency response which can be obtained from this type of filter can be seen from the curves given in Fig. 1, which show the attenuation characteristics obtained from one section, two sections and three sections.

Other types of frequency response can be obtained by use of *m*-derived filter sections, which permit better impedance matching to resistive terminations and which can have extremely high attenuations at particular frequencies in the stop-band. However, the constant-*k* filter is essentially the limiting case of the *m*-derived filter in which $m = 1$, and for the purposes of this brief review the properties of conventional filters are sufficiently well illustrated by the constant-*k* filter. Further properties of such filters, and of the *m*-derived sections, may be found in numerous books and articles on the subject of filter theory.

From frequencies of about 100 to 200 cycles and up, practical filters of this type can be constructed which are capable of giving extremely good results, closely approximating almost any frequency response characteristic which can be designed from network theory. Below about 100 cycles, the low *Q* of even the best iron-core inductances and

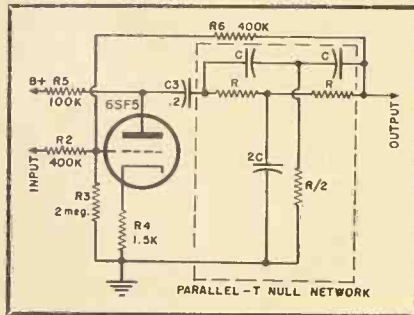

Fig. 2. Parallel-*T* network and its use in a feedback amplifier stage.

the high values of capacity make it very difficult and quite impractical to use these conventional filters in applications where sharp cutoffs and high attenuation slopes are required. At these low frequencies, *RC* networks must be used in order to attain these desired characteristics.

Because of the basic dissipative characteristics of resistance-capacity filter sections, any system to achieve the required high attenuation slopes and sharp cutoff characteristics must make use of feedback techniques. This can be done in different ways, and several techniques have been developed.

The major problem in the use of *RC* networks is that they do not give a sharp cutoff. An isolated *RC* section will give an eventual attenuation of 6 db per octave, but it begins to have appreciable attenuation several octaves before this slope is reached. Thus a

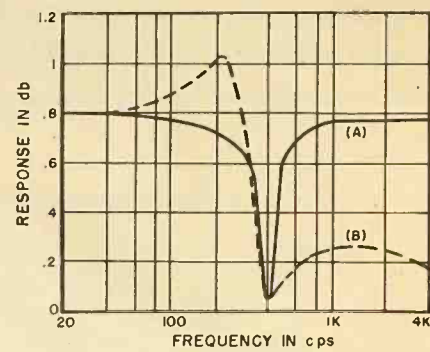
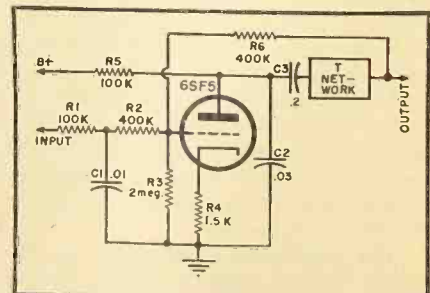

Fig. 4. (A) Response of stage shown in Fig. 2. (B) Response when condenser C_2 is shunted from plate to ground (Fig. 5).

filter made up of several such sections will have an attenuation curve whose slope is gradually increasing over a good many octaves, and such a simple system will not give the required flatness in the pass band nor sharpness at cutoff. The use of a parallel-*T* null network in a feedback circuit makes available a method of sharpening the attenuation characteristic obtained from *RC* sections.

One type of circuit which places the parallel-*T* null network at the output of a conventional triode amplifier stage, then applies feedback from the output of the null network back to the input of the amplifier, is shown in Fig. 2. The frequency characteristic of the null network by itself is shown in Fig. 3, which gives both the amplitude and phase characteristics. When this network is used in the amplifier circuit with feedback, the sharpness is considerably increased as shown in the response curve A of Fig. 4. The addition of R_1 , C_1 and C_2 to this circuit as shown in Fig. 5 results in the low pass characteristic of Fig. 7. The effect of these elements may be seen better from the curve B of Fig. 4, which shows the response when only C_2 is added to the circuit, increasing the response below the null frequency and decreasing the response above the null frequency. The addition of the R_1 , C_1 section, as shown in Fig. 5, causes a gradual roll-off at the higher frequencies, thus lowering the peak below the null and increasing the attenuation at high frequencies to give the resulting

Fig. 5. The addition of R_1 , C_1 , and C_2 to Fig. 2 to give a low-pass circuit.



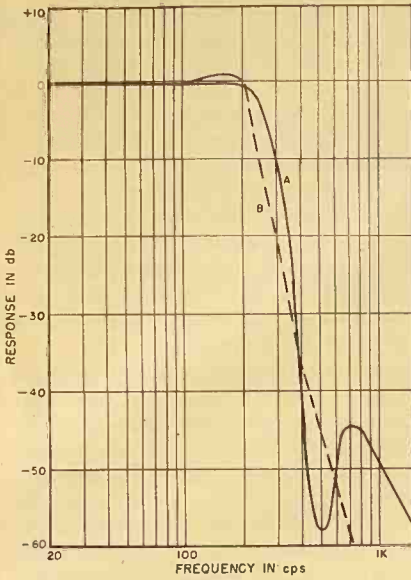

Fig. 6. Comparison of response of LC and RC filters. (A) Two sections of RC circuit of Fig. 5 with cutoff at 200 cps. (B) Two LC sections of constant- k filter with cutoff at 2000 cps.

low-pass characteristics of Fig. 7. A high-pass characteristic is obtained in a similar manner by adding a resistor to ground at the input to the parallel- T network, and reversing the positions of R_i and C_i in the input section.

When two such sections are used, a sharper cutoff is obtained, and the curve which results from using two of the low-pass sections of Fig. 5 is shown in the curve A of Fig. 6. This curve has a high initial slope and a frequency of high attenuation, and has an appearance somewhat similar to that of an m -derived filter. The dashed curve B is the response of a conventional two-section constant- k filter with a cut-off frequency of 2000 cps, superimposed on the frequency scale of the RC filter for comparison. It can be seen that although the RC circuit has a higher initial slope, the over-all attenuation at frequencies well past cutoff is less than that of the constant- k filter. Unfortunately, this particular type of circuit is not capable of giving a curve which has these characteristics of the constant- k filter.

An RC filter system which can give the constant- k type of characteristic is one which uses a sufficient number of isolated RC sections to give the required slope at frequencies far beyond cutoff, in conjunction with a feedback null network to give a resonant circuit which lifts or equalizes the slowly drooping portions of the RC response curve and holds it flat until the attenuation has reached the desired value. The basic operation of this system is illustrated roughly in the curves of Fig. 8, which show typical curves for a system assum-

ing eight RC sections to give an eventual attenuation of 48 db per octave. Curve A shows the frequency response of the eight RC sections alone, with the gradual roll-off starting at about two octaves above the cutoff frequency, and gradually increasing over about three octaves to reach the eventual 48 db/octave slope at about an octave below the cutoff frequency. Curve B shows the frequency response of the feedback resonant circuit alone, in which the use of the parallel- T network in the feedback circuit gives a resonance curve of the type shown. Combining the two response curves gives the desired low-pass curve, which is flat to the cutoff frequency, then drops sharply with a 48 db/octave slope below the cutoff frequency, with a slight rounding at cutoff. When the RC circuits are high-pass sections, with series resistance and shunt capacity to ground, a sharp cutoff high-pass filter characteristic is obtained. A band-pass filter can be obtained just by combining a high-pass and a low-pass section with appropriate cutoff points.

The simplest basic circuit for obtaining these frequency curves is shown in the schematic of Fig. 9. This basic circuit consists of a single-stage amplifier with a parallel- T null network in the feedback loop in such a manner that a resonant frequency response characteristic is obtained, followed by a succession of the proper number of RC sections. This simple circuit satisfies all the conditions which are necessary for the production of the desired response curve. However, it has certain drawbacks which may be undesirable in some applications. These are mainly concerned with stability over possible variations in operating conditions, since the response curve of the feedback null network can change with aging or changing of the tube, or with changes in voltages, with resulting changes in the over-all frequency response characteristic. To avoid this effect, over-all negative feedback must be used in the resonant circuits.

The final circuit which was designed

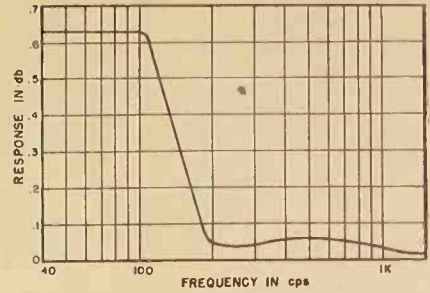

Fig. 7. Low-pass response characteristics of Fig. 5 with 1 volt input.

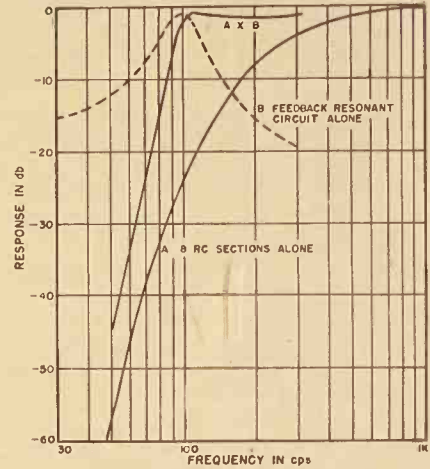

Fig. 8. Frequency response curves for synthesis of sharp cutoff RC filter.

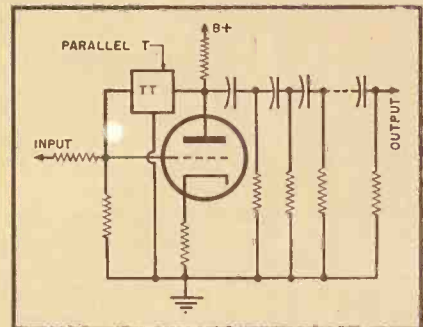
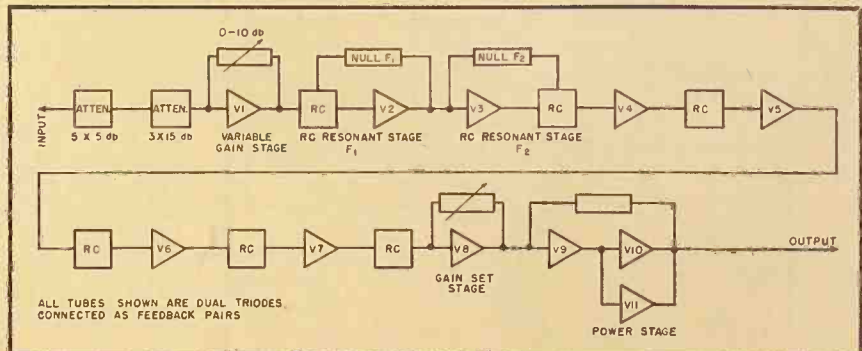

Fig. 9. Simple circuit which will give the response characteristics of Fig. 8.

to use the RC sections with feedback null networks to give a stable band-pass response curve is shown in Fig. 10. This

Fig. 10. Block diagram of combined high-pass and low-pass RC filters to give a band-pass filter characteristic.



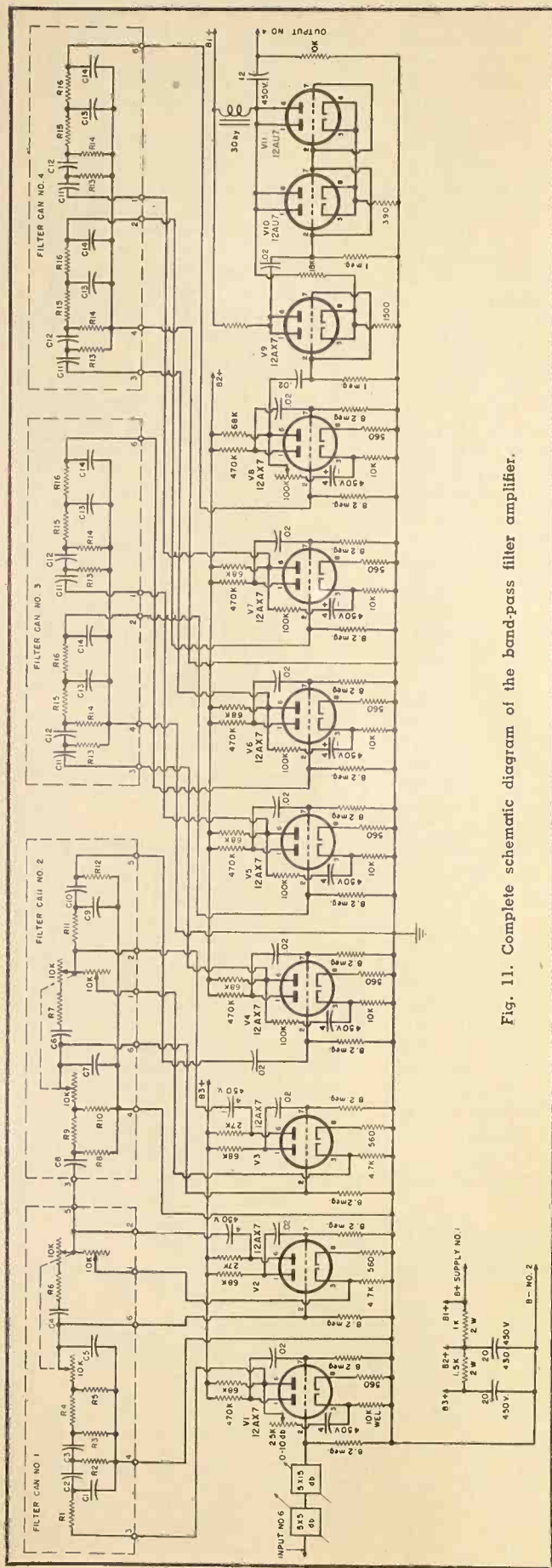

Fig. 11. Complete schematic diagram of the band-pass filter amplifier.

system is the one used to give the octave band-pass characteristic required for the Sound Analyzing and Measuring System mentioned earlier, which gives sharp cutoff characteristics at frequencies as low as 15 cps. A photograph of a complete band-pass filter of this type is shown in Fig. 13. The design and construction of the filters is such that the same amplifier chassis is used for all frequency bands, with the RC filter components mounted in four plug-in cans, so that the frequency characteristic is determined by the particular set of filter cans which is plugged into the amplifier. Each band-pass filter is mounted on a separate plug-in chassis, and ten such filters mount in one relay-rack cabinet together with other associated equipment to form a complete measurement range covering one frequency decade.

The complete schematic circuit diagram of a band-pass filter amplifier is shown in Fig. 11. Basically, the filter consists of a high-pass and low-pass unit—each of which is made up of eight isolated RC sections, two non-isolated (iterative) sections, and a feedback parallel-T network. For simplicity of circuit and economy of components, the high-pass and the low-pass circuits are combined, as can be seen from the circuit schematic. In order to achieve the optimum sharpness of cutoffs in RC circuits it is necessary to insure adequate isolation of the individual sections so that a succeeding section does not load the previous ones. This isolation is obtained by incorporating the sections in groups of two or four, with isolation between the groups obtained by the use of vacuum tubes, introduced as feedback pairs whose gain is adjusted to be approximately equal to the insertion loss of the RC group preceding it. This allows the use of a distributed filter with a net gain of approximately unity, and with nearly equal overload probabilities throughout. Because of distributed capacities, small cumulative variations in gain, and cumulative tolerance errors, it is not easily practicable to pre-adjust these units to their exact tolerances. Therefore controls allowing 2% or 3% adjustment of peak frequency are incorporated with the T networks. The feedback loop gain determines the Q of the resonant peak, and this Q is adjustable to correct the droop of the RC sections up to the point of cutoff.

The resonant circuit characteristic depends upon the fact that the null network provides a large amount of negative feedback for all frequencies except those near its null. Since the parallel-T network provides no feedback at its null frequency, this would result in a feedback amplifier at all frequencies except those of greatest interest, unless an additional feedback path is provided at these frequencies. This is done by feeding back through a variable resistor from the second plate to the first cathode of the feedback pair. Since the null network is fed back to the first grid, the two feedback paths are completely independent. Adjustment of the amount of auxiliary feedback controls the gain, and therefore the Q of the resonant circuit. The frequency of resonance is controlled by adjusting the resistances in the null network by means of the double-ganged potentiometer. The frequency and the Q adjustments are completely independent and do not react on each other in any way. The over-all stability with this circuit arrangement is such that with an effective Q of the order of 5, there is about 0.1 db change at resonance for a supply voltage change of 35%.

The frequency characteristics of the RC filter circuit may be compared with the results obtained from the more conventional filter networks, by referring to the schematic wiring diagram of Fig. 12. This circuit shows the type of filter used to give the band-pass characteristic in the highest frequency range. These filters are LC units which make use of a tandem arrangement of high-pass and low-pass filters in a circuit designed so that it can be used with the same amplifiers that are used for the lower frequencies.

(Continued on page 24)

NUCLEAR PULSE AMPLIFIERS

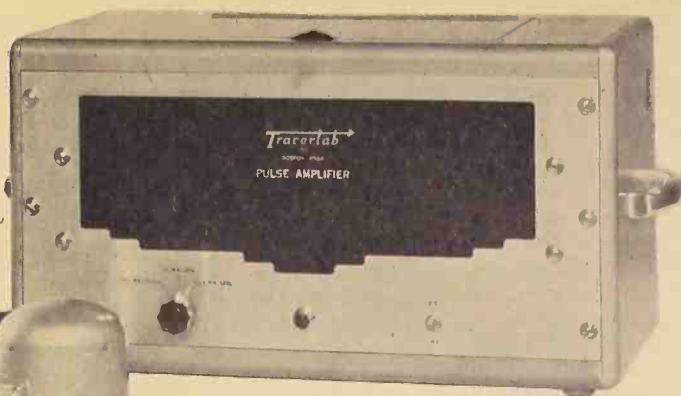

The Tracerlab model SC-15 pulse amplifier.

By
EDWIN N. KAUFMAN

Background information on such problems as rise time, resolution, and counting rate.

THIS ARTICLE is a brief summary of the theory and operation of pulse amplifiers as used with proportional ionization chambers to detect and count various nuclear particles. It is not an attempt to cover the complete engineering aspects of this field, but rather an article to acquaint those engineers unfamiliar to this field with basic background information. An adequate discussion of the majority of design problems concerned with pulse amplifiers can be found in standard texts.

Ionization chambers have various detecting characteristics depending upon the operating voltage, gas, and pressure. These characteristics are used to obtain different operating regions which are named (1) proportional, (2) limited proportional, and (3) Geiger. The proportional ionization chamber provides ionization currents in relationship to the energy of the particle. Thus, viewed on an oscilloscope, alpha particles would show much higher ionization currents than those caused by beta particles. This allows selective detection and counting of either the alpha or beta particles.

As the voltage is raised on an ionization chamber it passes through the limited proportional region into the Geiger region of operation. In the Geiger region of operation a particle of any type will cause an ionization current to flow through the tube which is independent of the particle energy or type.

A particle detector also used with pulse amplifiers is the scintillation counter. The scintillation counter consists of a photomultiplier tube and a material which emits light when struck by a nuclear particle. Many materials have been used from vycor glass, naphthalene, and polystyrene for gamma

detection to zinc sulfide phosphors and other materials for alpha detection. The emitted light from the best detecting materials has a very short rise and decay time, thus the scintillation counter is capable of usually fast counting rates.

Today most ionization chambers use gas amplification, consisting of argon or methane or other various gases or combinations as the ionizing gas. The high gradient electrical field required for the proportional region is accomplished by using a small diameter collector wire (1 to 3 mil) and by operating voltages up to about 5000. Operating voltages vary widely due to the gas used and the geometry of the chamber. Three ionization chambers that come to mind operate respectively at 900, 2100, and 3300 volts for alpha counting.

Almost all proportional ionization chambers have plateaus. That is, as the chamber voltage is increased from very low to high voltages, the counting rate will rise rapidly, then over a plateau of several hundred volts the counting rate will remain essentially the same; depending upon the instrument, between a 1% to 20% increase; then the counting rate will rise sharply as the voltage is increased. Even though the detecting ionization chamber is operated on this plateau, for consistent results, the operating voltage should be from a regulated power supply.

Proportional ionization chambers and pulse amplifier scaling units are coming into great use in counting rooms, replacing the familiar Geiger tube. Geiger tubes have dead times of 90 to 400 microseconds when they are unable to detect particles. This means that coincidence curves must be run on all Geiger tubes used in exacting nuclear experiments. A Geiger tube and associated circuit with a 300 microsecond

dead time has a loss of 0.5% per thousand counts; therefore, at a counting rate of 10,000 counts per minute the registered count would be low by 500 counts per minute.

Obviously much time is wasted both in running coincidence checks and in applying a correction to all the data accumulated. In the use of particle detection by either proportional chambers or scintillation systems, the short dead time of the entire system precludes the necessity of coincidence curves, even when the system is used at ten times normal Geiger detecting rates. Another advantage to proportional counting over Geiger counting is that the detector has an indefinite life.

Pulse amplifiers are necessary in counting individual alpha or beta particles and in some instances gamma-produced electrons. The particles detected by an ionization chamber, if amplified faithfully, would tend to overload an amplifier because of the long (*RC*) waveform caused by the input circuit of the amplifier. To avoid this difficulty it is customary to choose a poor low frequency response for the amplifier. This causes the output signal to drop to zero quickly following the rapid steep rise of each pulse. The signal thus becomes a series of peaked narrow pulses. It is desirable to have square wave pulses so that a discriminator can easily determine the pulse height, but in practice the common solution to this problem is to include a single short time constant coupling in the amplifier to obtain a narrow *RC* pulse. The output of the pulse amplifier is fed into an amplitude discriminator. Often this is simply a modified Schmitt circuit capable of supplying a fixed output pulse suitable for driving a scaler or counting rate meter. The voltage stability of existing discriminators is on the order of plus or minus 0.1 volts; therefore, most discriminators are operated in the range of 10 to 100 volts.

In the design of a pulse amplifier all the amplifier time constants should be made long except for one stage,

which should have the short time constant. This raises the question of where to place the short time constant. From one standpoint the coupling should be placed at a point where there is no danger of preceding stages overloading from the pile-up of pulses. From another standpoint, it should be placed as far along in the amplifier as possible, since it acts as a filter for hum, microphonics, and low frequency noise components originating in early stages.

Generally the short time constant coupling is placed at the input to the main pulse amplifier which has been preceded by one to four tubes of preamplification. This type of pulse shaping has certain disadvantages so that some amplifiers are being built with delay line pulse shaping to provide a square wave pulse. Complexities, however, have limited this method.

A discussion of pulse amplifiers would not be complete without a mention of regulated power supplies. The power supply used with a pulse amplifier is fully as important as the amplifier itself. The use of gaseous voltage regulator tubes has no place in a pulse amplifier power supply except as a reference source.

This can be a sad fact unknown for weeks while experimentation goes on. A vacuum tube regulator system must be used, one with a high degree of stability and gain and low impedance. If this is not used, amplifier oscillation and pulsing will occur even though heroic steps are taken to decouple the amplifier stages.

Noise is the big problem of pulse amplifiers. Pulse amplifiers whose low frequency response has been reduced

for the purpose of shaping pulses from an electrical detector are naturally less sensitive to hum and microphonic pickup. These amplifiers often use a common a.c. heater supply for all stages. The main cause of spurious counting is power line transients that have high frequency components. To minimize these transients one of the following remedies may be used: an electrostatic shield on the filament transformer; an isolation transformer for the entire unit; or running the instrument from an instrument a.c. line where no electrical machinery is connected at all. A prime example of the cause of this type of transient is the office calculating machine.

Noise is also picked up electromagnetically. This is a serious type of noise as it is very difficult to eliminate. One main cause is the multiplicity of grounds often used. It is often difficult or impossible to use a minimum of grounds. In general, the best advice that can be offered is to choose an electrically quiet room or building while carrying out experiments.

Signal-to-noise ratio can often be increased considerably by using a triode preamplifier input tube instead of a pentode tube such as has been used in the past years.

The above-mentioned causes are the usual noise sources; however, few texts mention power supply pulse noise created by insulation leakage from the ionization chamber high voltage supply. This is often the main cause of spurious counting. This can be easily seen. The power supply feeds the bottom of the chamber collector resistor. The signal caused by alpha or beta pickup pro-

duces a voltage drop across this resistor, which in turn is fed into the grid of the preamplifier input tube. Generally, at low voltages (1000 or under) no leakage trouble occurs.

In many cases ionization chamber voltages range upward to 5000 volts. A few electrons leaking to ground from either the top or bottom of this input resistor in a spurious fashion will introduce a signal into the amplifier exactly as if the ionization chamber had collected electrons due to ionization. The same effect occurs when the high voltage lead intermittently breaks down to ground, invisible to any high voltage meter due to the low current drain of a few electrons.

The same effect of spurious counting will happen if corona occurs, almost anywhere, in the high voltage power supply. Sometimes this corona is hard to detect as it is so slight. Naturally all precautions should be taken, such as large rounded surfaces where high voltages are concerned.

Generally the high voltage leads and input resistor to the ionization chamber are supported on stand-off or feed-through insulators.

Only the ceramic insulators, such as Steatite, under-rated by a factor of three to eight, are satisfactory for this use. Bakelite and other stand-offs have severe leakage at high voltages. Some designers have a low-capacity condenser mounted directly at the ionization chamber, at the bottom of the input resistor to eliminate pulses originating in the high voltage lead and power supply, but this is certainly not a cure-all. Lucite and polystyrene are poor stand-off materials as they generate pulses from mechanical strains. This has been covered in various papers. Polystyrene can be used but it is difficult to work with and maintain the clean surface that is so necessary. All in all, the two best stand-offs, feed-through, or supports are either ceramic material or glass beads such as are used in hermetically-sealed transformers. In some instances it is possible to clip down the high voltage lead, usually an RG cable, so that it can act as the stand-off itself. The fewer stand-offs the less trouble will be encountered.

Cable connectors can also cause spurious pulses. Several companies make special pulse-type connectors. In general these connectors are not necessary except in areas of high humidity or where voltages over 3000 are expected to be used.

The preamplifier input resistor can be of a standard type even though high voltage is impressed across it as the actual voltage drop across the resistor is very small.

The input high voltage coupling condenser is very critical. The best con-

Fig. 1. Typical pulse amplifier gain and discriminator settings for photoneutron counting. Chamber voltage, 600 v. Operating gain 1-50.

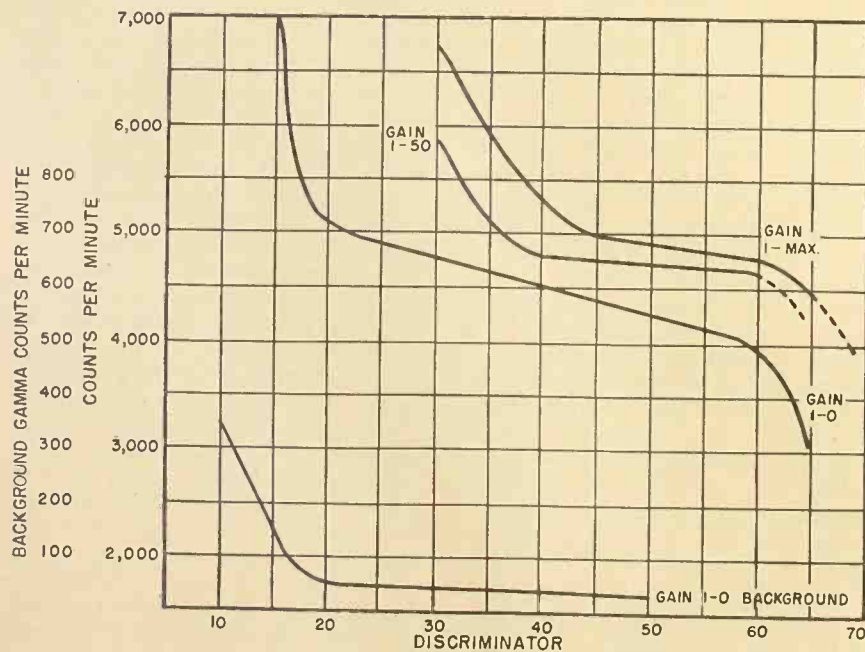

condensers found so far for this use is the *Cenralab 850 series*. These condensers are entirely satisfactory where the humidity is 60% or under. Power supply and pulse decoupling condensers are also extremely critical. The most satisfactory condensers from an internal and external leakage and pulse generation consideration are Glassmikes.

The "Bible" for pulse suppression is an article by F. M. Glass in the April 1949 *Review of Scientific Instruments*.

The gain of a pulse amplifier as used in detecting particles is usually on the order of 10^6 although gains of 10^5 have been used and even 100 times smaller when gas amplification is used in the electrical detector. It is usual to have the maximum amplifier gain large enough to make the random noise output of less than 10 volts as the discriminators in use are not used below 10 volts. Almost all pulse amplifiers have coarse and fine gain controls. The coarse gain control is a step attenuator consisting of a simple resistor network. The fine gain control is a potentiometer. The output pulses from a pulse amplifier are usually chosen to have a positive polarity so that a low impedance cathode follower output stage is stable. The output of the cathode follower goes through a cable to a discriminator stage mounted in a scaler. A better version, and in my opinion, much superior, has the discriminator stage mounted on the pulse amplifier chassis. This permits the pulse amplifier and discriminator to be used with almost any scaler.

The amount of gain stability of a pulse amplifier becomes very important when the electrical detector does not possess a good plateau. Thus, for best results, an amplifier should have quite a little feedback.

The high frequency response of a pulse amplifier is usually expressed in terms of amplifier rise time. Rise times range between 0.05 and 10 microseconds, depending upon the experiment. This range of rise times corresponds to a range of upper half-power frequencies from mc. to 300 kc. If the pulse amplifiers driving a scaler with a ten microsecond resolution, then having a rise time much shorter than 10 microseconds would be useless. As one may easily calculate, the counting rate at even ten microseconds is quite high, but scaler units are being designed with much higher resolution time for use with short-lived radio isotopes which have high particle rates over a period of seconds to minutes.

In operating a pulse amplifier and ionization chamber the chamber voltage and the amplifier gain and discriminator must be adjusted to give a minimum unwanted background, as well as to locate a plateau with the best slope.

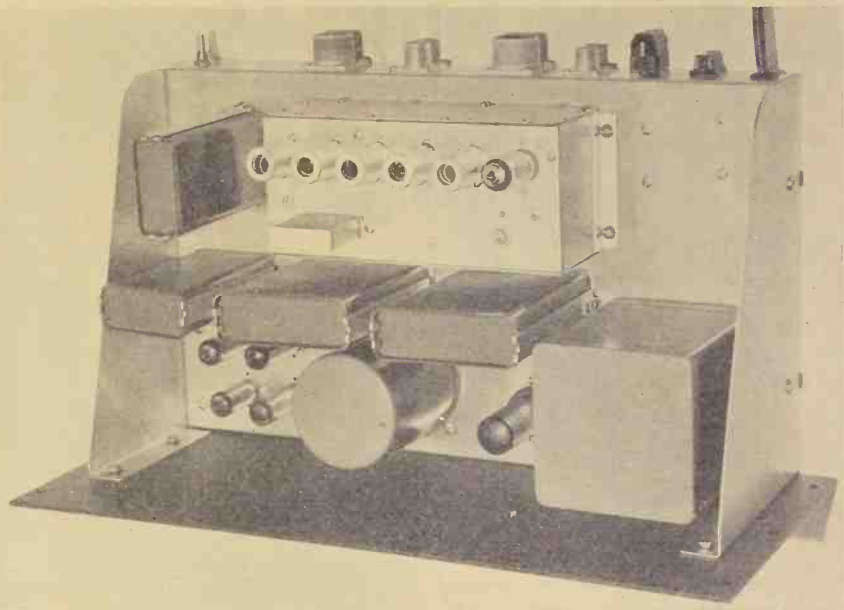

Top view of the Tracerlab pulse amplifier, showing placement of parts.

This generally is done by setting a fixed chamber voltage and setting the amplifier gain to a fixed value. The discriminator is then varied between 10 and 100 volts and the counts per minute recorded at the various discriminator settings. The procedure is repeated, maintaining the fixed gain, raising the chamber voltage to a new fixed voltage, and varying the discriminator and again recording the counts per minute at the various settings. Finally, the gain is increased and another set of curves obtained. This requires a good deal of time and a large number of curves to be drawn. Fortunately, the operating voltage of many chambers is known so that the procedure is simplified; the chamber voltage is fixed, and curves run with various amplifier gains and discriminator settings. If a serious background exists, such as unwanted gamma, these curves will indicate the settings to stay under for a minimum background count. Following these tests a radioactive sample is inserted in the detecting chamber and all the above repeated. An examination of the curves obtained will obviously give the best operating position.

The detection of neutrons imposes special problems. Slow neutrons are, as a rule, detected by boron lined or boron gas filled ionization chambers. The neutron upon striking the boron produces an alpha particle which ionizes the gas present in the ionization chamber. Fast neutrons are slowed up by a moderator such as polyethylene and then detected.

In some instances "fission chambers" are used to detect slow neutrons; although the output pulse is extremely strong, the counting or detecting efficiency is very low. The fission chamber

does have the advantage that it will not detect gamma and therefore has no gamma background which must be discriminated against.

A fission chamber consists of a piece of enriched uranium or other fissionable material and a fine collector wire. A neutron striking the uranium causes fission to take place. The fission products are then detected. As can be seen, a "fission chamber" can be used to detect neutrons only.

The curves included with this article are typical examples of a pulse amplifier system, used with a boron lined ionization chamber, to detect neutrons. The neutrons in this case were produced by subjecting beryllium blocks to gamma rays. The photographs of the pulse amplifier show typical construction methods and electrical parts layout.

Fig. 2 Typical curve of pulse amplifier and discriminator settings to lower background gamma count when counting neutrons with boron lined ionization chamber. Photoneutrons are produced by radium gamma rays on beryllium.

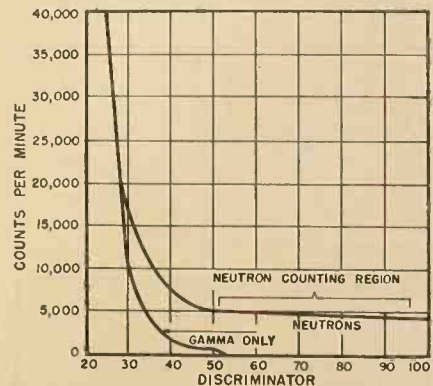

GATE And DELAY GENERATOR

Fig. 1. Top-front view of the MIT duplex gate and delay generator.

By
ROBERT R. RATHBONE

Servomechanisms Laboratory
Massachusetts Institute of Technology

This unit provides a rectangular gate variable from 0.5 to 2500 microsec., and a 0.1 microsecond pulse.

IN GENERAL, the gate and delay generator is used to "open" and "close" gate tubes at specified times and to trigger flip-flops at the end of a given delay. It provides a rectangular pulse, or gate, and a delayed 0.1 microsecond, half-sine-wave pulse. The length of the gate is continuously variable from 0.5 to 2500 microseconds; the 0.1 microsecond pulse is coincident with the end of the gate. The two outputs may be used simultaneously or separately.

Since many test setups require more than one gate-and-delay building block, two identical, independent generators were constructed side by side on a single

chassis. (This feature not only saves installation time and rack and storage space, but also is extremely convenient when one section is used to feed the second.) Fig. 1 shows the two sections separated by a shield. All controls and jacks required for normal operation are on the front panel; the vacuum tubes and power cable plug into the rear. Over-all rack space required: 6 x 19 inches; depth with plug-in components mounted: 10 inches.

A power supply has not been built into the unit since all the new M.I.T. test blocks operate from central laboratory supplies. The power requirements for operation of both sections at the same time under no signal and 4 kc. signal conditions are:

Voltages	Currents	
	No Signal	4 kc. Signal
+250 v.d.c.	115 ma.	110 ma.
+150 v.d.c.	220 ma.	195 ma.
-150 v.d.c.	8.5 ma.	8.5 ma.
6.3 v.a.c.	7.55 amp.	7.55 amp.

The resolution time of the gate generator varies with the "coarse delay" setting. For the 10 μ sec. setting, the resolution time is 1 μ sec.; for the 50 μ sec., 2 μ sec.; for the 450 μ sec., 10 μ sec.; and for the 2500 μ sec. setting, 70 μ sec. These resolution times are minimum for reliable operation.

A 0.1 microsecond positive pulse is fed into either input jack J_1 or J_2 (Fig. 5). The input line may be either ter-

minated or not, by switching R_1 , the 93 ohm terminating resistor, in or out by means of S_1 . The pulse is then capacitor-coupled to the grid of the trigger tube, V_1 . This tube is normally biased beyond cut-off, and is made to conduct by the pulse. Plate current then flows through R_0 , the plate load resistor of V_{2A} , which is the normally-off section of the single-shot multivibrator. The negative-voltage pulse which results is coupled through either C_6 , C_7 , C_8 , or C_9 , depending on the position of the "coarse delay" switch, to the grid of V_{2B} , which is the normally-on section of the single-shot multivibrator. This triode amplifies the negative pulse and the resulting positive pulse is fed back to the grid of V_{2A} , triggering the multivibrator to its other state. The pertinent voltage waveforms may be seen in Fig. 3, a through d.

Fig. 3c shows the voltage at the grid of V_{2B} , the normally-on section. The waveform shows how the coupling capacitor loses its charge during the delay interval, until the grid comes into the conducting region and the circuit triggers back to its stable state. The length of the delay interval depends on the rate at which this capacitor (C_6 , C_7 , C_8 , or C_9) loses its charge; that

Fig. 2. Clamping circuits and waveforms for gate outputs. (A) Clamping to positive portion of gate. (B) Clamping to base line of the clipped gate.

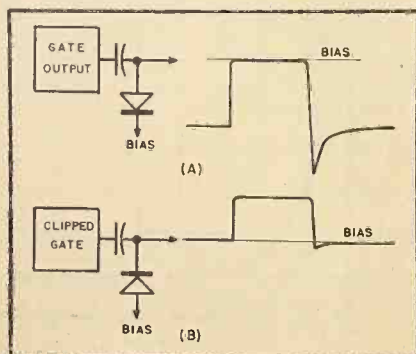

Editor's Note: The test equipment units sponsored by the Office of Naval Research and developed during the past three years by the M.I.T. Servomechanisms Laboratory were designed as building blocks to test pulsed circuits and simulate the control, arithmetic, and storage functions of an electronic digital computer. Two of the blocks, the Variable-Frequency Clock-Pulse Generator and the Pulse Mixer, have been described in previous issues of RADIO-ELECTRONIC ENGINEERING. A third and extremely useful block, the Gate and Delay Generator, is described in this article.

Credit for the original design of the Clock and the Gate and Delay Generator goes to Harry Kenosian, now with the Burroughs Adding Machine Co. Chester A. Rowland, now with Engineering Research Associates, designed the Pulse Mixer.

is, the delay interval depends on the time constant of the grid circuit. The "coarse delay" switch selects different coupling capacitors to give coarse control over the delay range, while the "fine delay" potentiometer R_{13} , gives fine control over the time constant, and hence the delay.

When the circuit triggers back to its stable state, the grid of V_{2B} goes slightly positive as the coupling capacitor is recharged through the grid-to-cathode diode action of V_{2B} . While the grid of V_{2B} is positive, the tube conducts more heavily, causing the negative overshoot seen in the plate waveform of Fig. 3d.

Any fluctuations in the positive supply voltage would cause equivalent changes in the initial charge on the coupling capacitor, which in turn would cause variations in the delay interval. Fluctuations in both the positive and negative supply voltages would change the quiescent bias on V_{2A} , and could make the circuit either difficult to trigger or dangerously close to free running. These same fluctuations could vary the amount of grid current drawn by V_{2A} during the delay interval, and therefore vary the plate swing of V_{2A} and hence the delay interval proportionately. For all of the above reasons, voltage-regulator tubes were used to isolate the circuit from supply fluctuations. V_6 drops the +250 volt supply down to +150, and V_7 drops the -150 volt supply to -105 volts.

Cathode Follower

The positive gate that appears at the plate of V_{2B} (see Fig. 3d) is capacitor-coupled to the grid of the cathode follower, V_3 . The cathode follower drives the "gate output" jack J_3 (Fig.

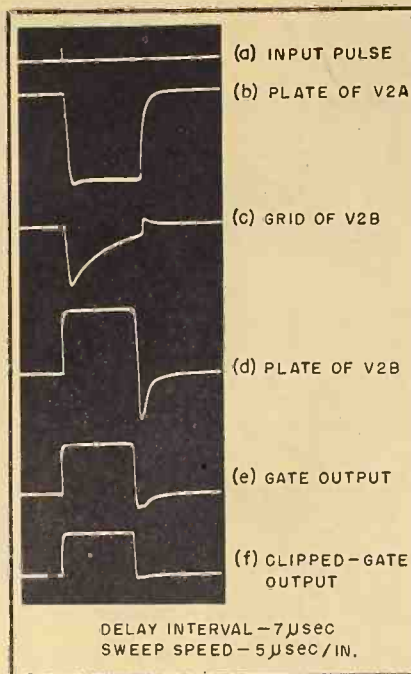

Fig. 3. Pulse shapes of gate generator.

3e). Since the gate is a.c. coupled to the cathode follower, the d.c. level of the base line will depend on the duty factor. It was intended that this gate would be a.c. coupled to some exterior circuit, so that this change in d.c. level was not considered objectionable, and the gate works very well if the new d.c. level in the exterior circuit is established by clamping to the positive portion of the waveform, as shown in Fig. 2A. If it is desired to clamp to the negative portion, or to the base line, then the overshoot at the end of the gate becomes very objectionable. For this reason, the "clipped gate" output was provided. R_{23} and germanium diode

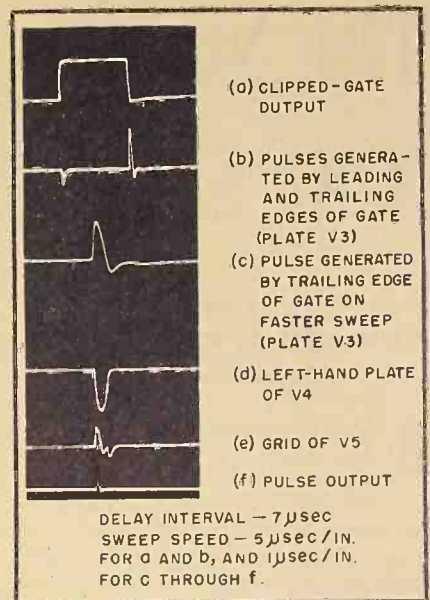

Fig. 4. Pulses of delayed-pulse generator.

CR_1 clip the overshoot, and provide a base line with no overshoot, suitable for clamping (see Fig. 2B). The "clipper control," R_{23} , varies the amount of clipping. Since the gate is a.c. coupled to the grid of the cathode follower, the d.c. level of the base line varies with the duty factor, making a "clipper control" necessary. The clipped gate may be seen in Fig. 3f.

The cathode follower has an $R-L-C$ peaker in its plate, the waveform of which may be seen in Fig. 4b. (The clipped gate is shown in Fig. 4a to give a time reference.) Diode CR_1 damps out any negative ringing of the peaker when the follower conducts at the beginning of the delay interval. At the end of the delay interval, the peaker

(Continued on page 24)

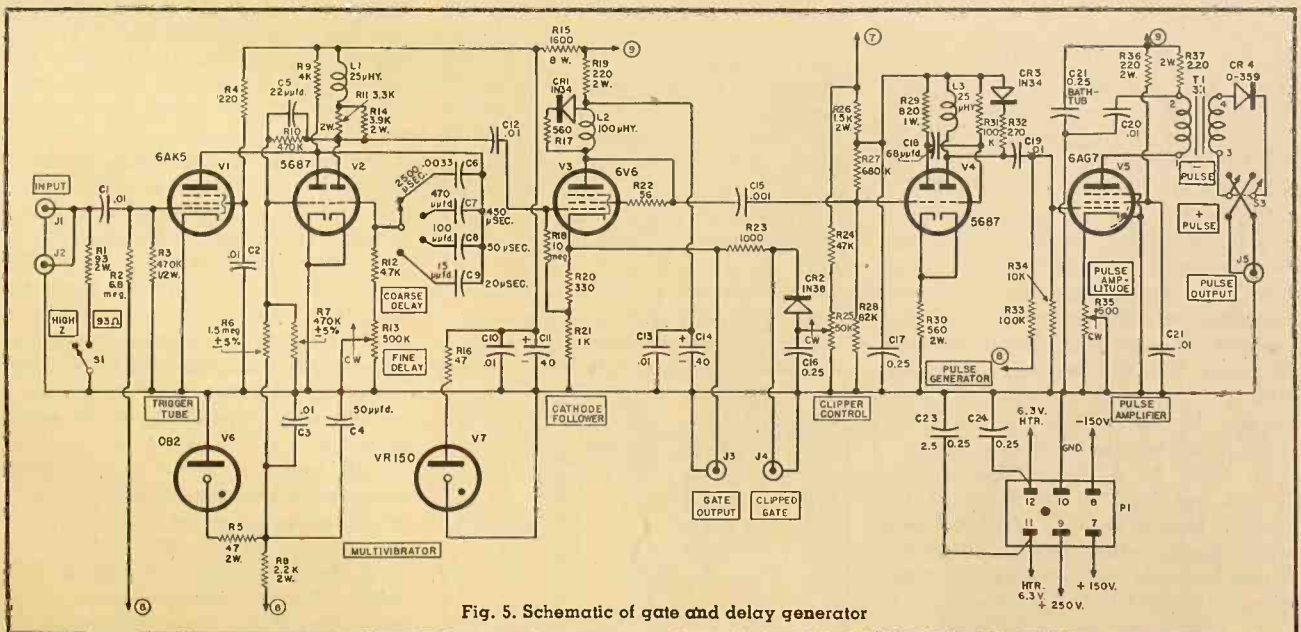

Fig. 5. Schematic of gate and delay generator

The Series AMPLIFIER

By
EDWARD L. CROSBY, JR.

Bendix Radio Division

IMAGINE a television i.f. strip of four stages just barely larger than a penny box of matches!—or a radar receiver, less local oscillator and plumbing, which may be held in the palm of your hand!—or a communications receiver i.f. and detector assembly which will operate reliably at the temperature of boiling water and which will withstand shock acceleration of 100 G's! These and other interesting developments are possible with a new amplifier technique developed at the Research and Development Laboratories of *Bendix Radio Division*. The secret of this technique does not depend on printed circuits or other component subminiaturization. Rather, in the circuit design, most of the components have been left out.

Let us briefly consider the history of this new approach. For the past several years, a great deal of engineering effort has been expended in the field of subminiaturization, the art of making electronic equipment as small as possible. This trend began in earnest when subminiature tubes of the heater-cathode type became available for a.c. service. It progressed to the point where conventional components had been reduced in size until they were expensive, fragile and very difficult to assemble. At this point, progress ceased, until high-K ceramic dielectrics, ceramic tinning techniques, and printed circuit methods were developed. These new tools gave subminiature circuit development a push, and again great strides were made in equipment size reduction. Difficulties appeared however, such as the instability and inaccuracy of printed resistors, necessity of special (and expensive) assembly methods, difficulty of repair, and the fundamental impossibility of printing inductors of large values. It was at this stage that the series amplifier technique was born.

In order to approach the problem from a completely fresh viewpoint, the *Bendix* people chose a type of unit which badly needed reliable subminiaturization, the high-frequency, high-gain, wide-band i.f. amplifier.

To follow the reasoning used, con-

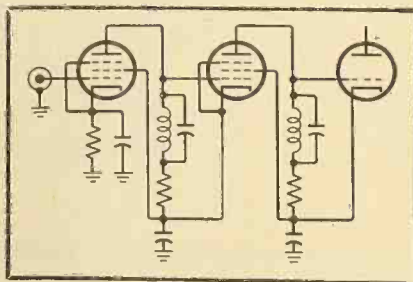

Fig. 1. A four stage i.f. amplifier which was built using the series technique.

A new circuit technique which eliminates many components and assists in miniaturization programs.

sider the conventional circuit of this unit as shown in Fig. 3. This diagram shows a perfectly conventional four-stage i.f. amplifier suitable for wide-band application. The *RC* circuits in the plate and screen supply bus are necessary for decoupling. In an amplifier of considerably less gain than the illustrated example, it might be possible to eliminate some of these components, but for the case shown, the gain will be of the order of 80 to 100 db for bandwidths around 3 megacycles, and the thorough decoupling is absolutely necessary. The space required by these components has prevented the construction of this type of amplifier in a physical size compatible with the space requirements of subminiature tubes. That is, the decoupling elements require enough extra space so that the tubes are actually smaller than necessary.

Fig. 2. Circuit showing unbypassed bias resistor in series with plate load.



In order to remove the decoupling chain, the B+ bus must also be eliminated. How could the tubes be supplied with plate voltage? Why not put the tubes in series? A few quickly sketched diagrams made the idea seem reasonable, and an amplifier was constructed having the same characteristics as the conventional unit of Fig. 3 but the schematic of Fig. 4. It was clear that with the plate of the first stage operating at the same voltage as the grid of the second, no coupling capacitor was required, and with the idea proven by experiment, an entirely new amplifier concept took shape. One amplifier built with the series technique is shown in Fig. 1.

To digress for a moment, it should be pointed out that this amplifier, which has been called the "Series Amplifier," is not by any means a rediscovery of the well known Loftin-White circuit. For one thing, the plate voltages are *not* stabilized. As a matter of fact, it would be a rare occurrence if any two tubes in the string had the same plate-to-cathode voltage. Herein is one of the points of superiority of the series amplifier.

It is well known that the transconductance will be very nearly the same among tubes of a given type if they are operated at the same cathode current. During the last war great difficulty was experienced in designing and testing high gain radar i.f. strips be-

cause of the widely different values of transconductance obtained from production tubes used in the amplifiers. The trouble arose from the fact that with the prescribed applied plate voltage, each tube would take a different value of current, and hence operate at a different transconductance from the others. As a result, frequently an amplifier would show low gain with a certain set of tubes, but would oscillate violently if a "hot" set of tubes was plugged in. Careful tube selection was therefore mandatory. In the series amplifier, the series current is fixed. Each tube operates at the same current, and the transconductances of all tubes are very nearly the same.

The series amplifier technique in i.f. design does not involve any new tuned circuit knowledge. One can use stagger-tuning or synchronous tuning. The coils may be high Q , capacitor tuned units for narrow-band communication use, or they can be relatively low Q , resistance loaded coils for wide-band pulse or TV use.

As the reader may suspect, this circuit technique is not limited to i.f. amplifiers. Low-frequency amplifiers have been built for servo applications. The circuit is easily adaptable to Class C service for frequency multiplier chains. R.f. amplifiers using series distributed parameters, such as coaxial lines with lighthouse tubes, can use this technique. The Wallman cascode low-noise amplifier is particularly suitable for this circuit.

Two big disadvantages of the series amplifier should also be pointed out. The first can be avoided; it is the heater-cathode voltage problem. Most tubes are rated for less than 200 volts maximum between heater and cathode. With the heaters connected in parallel and the tubes connected in series, this rating may be exceeded in the last stages. Thus the number of stages must be restricted.

The second problem, of interest only in i.f. amplifiers, is the difficulty of applying a.v.c. It would seem simple to apply conventional a.v.c. bias voltage to the first grid. Actually this method, although it is the simplest, is the worst. As the tube approaches cut-off, its d.c. plate resistance increases. Since it is passing the same current as any other tube, it now drops more voltage than any other tube between plate and cathode, and the last tube in the string is likely to limit because of inadequate plate voltage. The last tube would therefore be the best to control, but this is very difficult to do since the a.v.c. voltage is required to be negative with respect to the cathode potential. This might possibly be arranged if we knew the cathode voltage, which we don't,

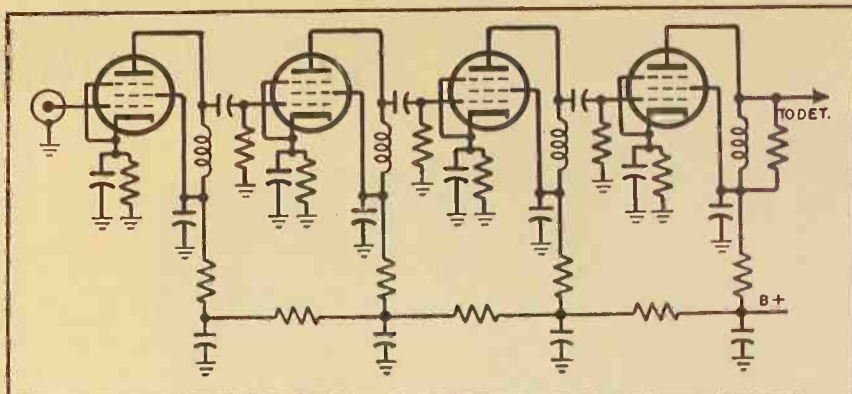

Fig. 3. Schematic diagram of a conventional broad-band amplifier.

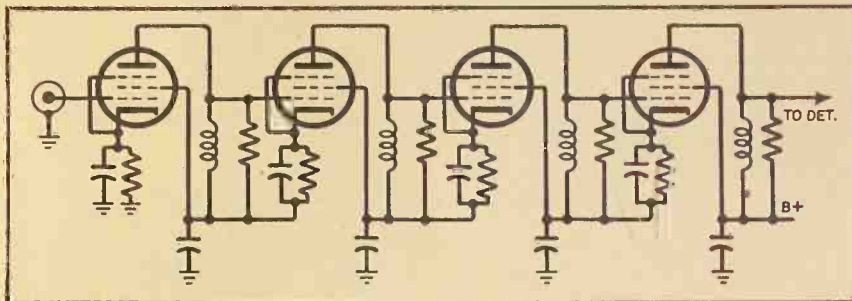

Fig. 4. Prototype series amplifier for broad-band i.f. application.

if it would remain fixed, which it won't.

A better method, but one which still leaves room for improvement, is to use a tube of the same type as those in the amplifier, external to the strip, and connected in series with the B+ input, the a.v.c. voltage being applied to its grid. The extent to which this scheme will control the gain of the amplifier is also restricted by limiting in the last stage. In an amplifier with 90 db gain, a 60 db control range is possible.

In considering the practical design of series amplifier circuits, a few general rules must be laid down. The tuned circuit, whatever its type, must have low d.c. resistance in order to avoid high grid bias on the driven stage. All tubes employed in a series string must be of the same type, or else have similar cathode current requirements for the desired transconductance. Last, applied plate voltage must be such as to operate

the tubes at a cathode current at which the proper transconductance is obtained. Using these rules we may proceed with specific examples.

The wide-band i.f. amplifier is a good place to start. This type of series amplifier, as shown in Fig. 4, is conventional except for the series connection. The bypass capacitors should be generous in value as in any such amplifier. For 30 megacycles, .003 μ f. ceramics are suggested. For 60 megacycle use, .001 μ f. ceramics are adequate, but in either case, keep the leads short. The coils can be any of the usual small slug-tuned types commercially available. Do not use lumped capacitance across the coils, if you want the maximum gain-bandwidth product. Lumped capacitance will narrow the bandwidth without increasing gain. Increasing the resistance will, of course, also narrow the

(Continued on page 30)

Fig. 5. Complete schematic diagram for the 60 megacycle series-loaded zero-bias broad-band series amplifier.

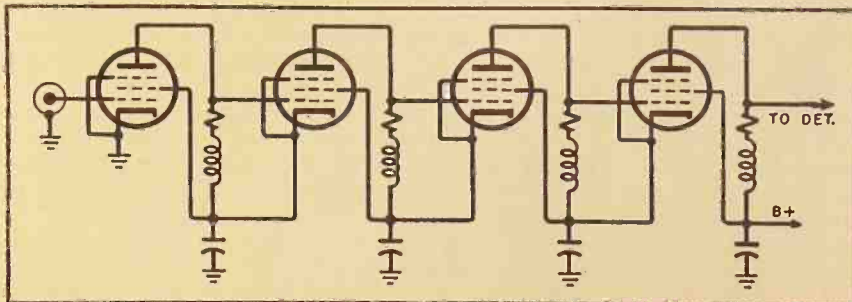

An Introduction To COMPUTER CONCEPTS

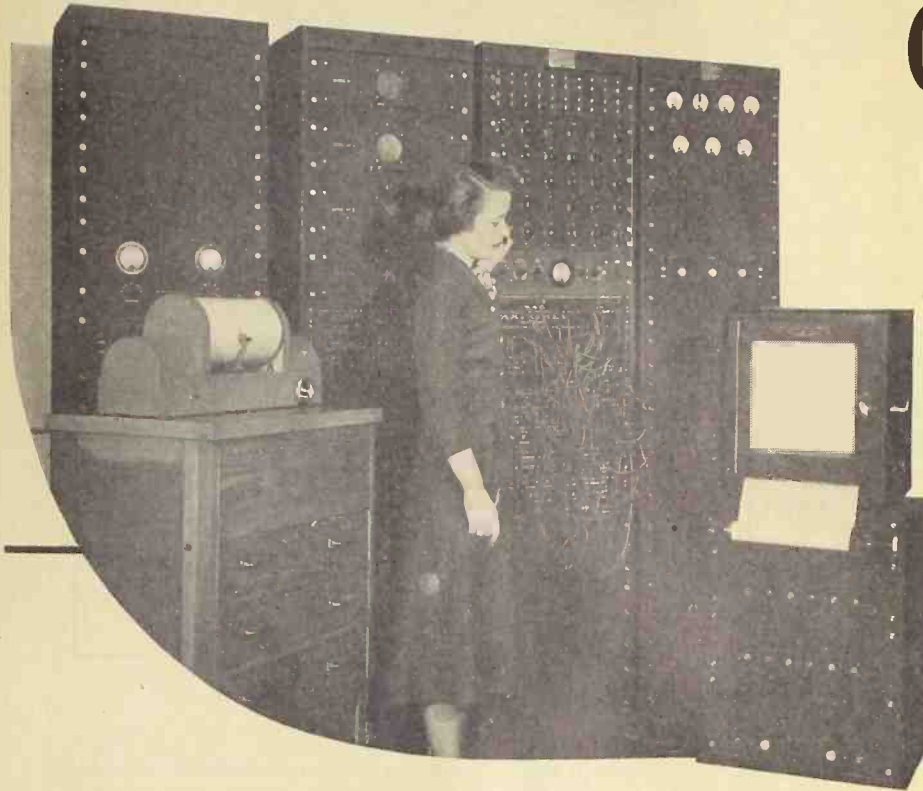

By

JOHN D. GOODELL

The Minnesota Electronics Corp.

A problem being run on the older model REAC. Two cabinets at left are servo and power supply, two at right are computer and power supply.

Part 3 compares computing mechanisms to the human brain, and discusses digital and analog computers.

IT HAS BEEN said that "probability is the very guide of life," and it is certainly true that every man continually makes decisions based on his estimate of various probabilities. Such decisions are: the guiding factor in engineering invention and design; the basis of reasoning for the technician, the means by which executives guide the course of corporations; for statesmen, the progress of government; and for each man, the manner of his life. Most decisions made hourly by everyone do not warrant the precise computation of probabilities. Many decisions are also made every day on the basis of probability estimates on which depend the future of families, cities, nations and society. Such decisions do deserve every effort to insure precise computation.

Many decisions in the latter category involve factors too complex to be accurately estimated in the mind. In such instances individuals may resort to the supplemental memory storage and parallel display methods afforded by pencil and paper. But even the best mind, ultimately limited by complexity, is affected by emotional factors and no human reasoning structure will always produce

an answer conforming to the highest degree of probability confirmation.

It is a common concept that the only fundamental capability of computing machines is that they can add, and their only important value is high speed. Most machines designed to date are intended for repetitively programmed mathematical operations, and for them this concept is valid. It is true in somewhat the same sense that all information may be reduced to a symbolization consisting of combinations of one and zero. But there is at least one other important basic operation that may be built into a machine. It can be given the ability to make guesses.

Guesses may be made on a sheer random basis, in accordance with preset patterns, on the basis of experience (which implies the ability to learn), etc. If the number of possible answers to a problem is limited to a finite set, a system that examines all the answers at random or in a repetitive pattern may be satisfactory. Speed is improved when successive approximations are made in accordance with a convergent series. When convergence is not possible and answers must be considered as

an infinite set, then no machine (and no human being) can ever consider all possible answers. The only hope of consistently good solutions is to weight the guessing process with experience. If the available experience were limited to association with one individual this process would be relatively unsatisfactory, but the shared experience of mankind (which may be shared with a machine) constitutes a considerable quantity of information. Although the memory storage banks of the human mind are incredibly large in capacity with respect to physical size, they do have limitations that need not be applied to machines. The rapidity and accuracy with which the human mental storage banks may be scanned is distinctly limited by comparison with machines.

There has been an avalanche of intuitive guesses regarding the limitations of machine operations by comparison with the operations of the human mind. Any concept that indicates the possibility of complete duplication has been rejected as naive by most really competent mathematicians and logicians. Most rejections are based on the belief that machine operation must be programmed repetitively and most objections may be eliminated by a system that includes the processes of guessing on the basis of experience combined with methods of making randomized jumps.

The human mind is a continuously operating mechanism, and although it functions rather slowly, a lifetime permits the random consideration of a considerable number of hypotheses. Ac-

tually the notion of creative thinking is linked with such random operations and with the ability to recognize a good guess when it comes along. The creation of machines capable of duplicating or improving on the functions of the human mind does not necessarily imply the arrival of any kind of millenium, neither does it imply any necessary disaster. It will not eliminate emotional conflicts or resolve the problems of human relations. It may accelerate the process that is currently conceived to be "progress" and it may minimize errors in judgment that lead to painful mistakes.

It is important to recognize that no degree of confirmation of a probability implies certain prediction. The best guess is the one that has the highest degree of confirmation at the time it is made and this is not affected in any way by the ultimate answer. Uncertainty is not eliminated by making the best possible guess.

The human mind is an extremely flexible general purpose instrument, capable of performing an endless variety of computations. This is one of its most remarkable characteristics and at the same time one of its most limiting features. It is almost axiomatic that general purpose flexibility involves compromises, and one of the great advantages of machines is the fact that they may be designed for specialized applications.

In applications where it is necessary to resolve a large number of variables with maximum speed, continuously self-adjusting mechanical linkages of the analog variety are indicated. In most applications the digital type of computer has certain advantages. One of these is the fact that the error is a definite and predictable quantity that will be constant for all similarly constructed machines. With mechanical linkages the error is a function of the precision with which the parts are made and linked together. There are no two alike. With the digital machine the error will remain the same for the life of the machine while with the analog mechanical variety it will accumulate with wear and usage. Maintenance of digital computers requires only moderate technical skill, while the maintenance of mechanical analog machines involves the services of very highly trained personnel.

Continuously self-adjusting linkages, of course, are not the only form of analog device and many problems may best be solved by manipulating information in terms of electrically analogous signals. Such systems are usually capable of greater speed than digital machines; in general they do not change with time and use as greatly as mechanical linkages, and they undoubt-

edly have an important and permanent place in future machine developments. Many designs will probably use combinations of analog and digital presentations, particularly when convenient and rapid translating systems have been fully developed.

Any device, contemplated for wide use in digital computers, that is not capable of handling information at pulse repetition rates of a megacycle or higher is considered seriously limited. This means that the advantage of essentially instantaneous tracking now held by analog devices may become of little consequence in the not too distant future.

Neglecting input and output structures, a digital computer consists of computing elements, memory storage banks, and internal program control systems. One of the important decisions in the design of such machines is the compromise that must be made between the number of computing elements, the dimensions of the storage banks, and internal program control complexity. Most operations are performed repetitively and it is not efficient to include duplicate circuits for the same operation. In order to avoid this the information is fed into temporary storage and re-cycled through a single computing section in accordance with the instructions supplied by the program control circuitry. Speed becomes more seriously limited by the characteristics of the control circuits and the storage and access time of the memory banks than the computing elements. In most medium and large scale computers the memory elements are the largest sections of the machine both from the standpoint of physical dimensions and number of components.

The importance of program control systems emphasizes the need for compact coding of instructions. While it is



Sine-cosine computer potentiometer manufactured by Electronic Assoc., Inc. for use in computers.

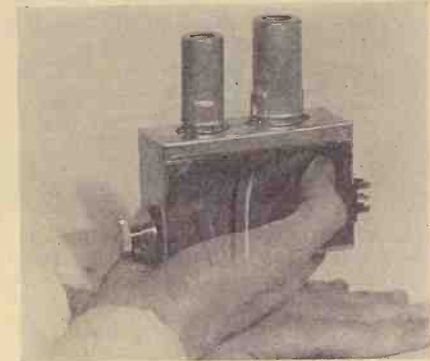

The amplifier portion of the IDA computer made by Computer Corp. of America. Actual computations are performed by twenty identical amplifiers, each of which may be connected as summer, integrator, sign-changer, etc.

true that a machine is best designed for a specialized application, it is almost always necessary to provide for a variety of program procedures within this specialization.

Even in the simplest digital computer the number of elements is very large indeed and reliability of components used in these machines is considerably more important than in most

The master generator portion of a computer made by Laboratory for Electronics, Inc.

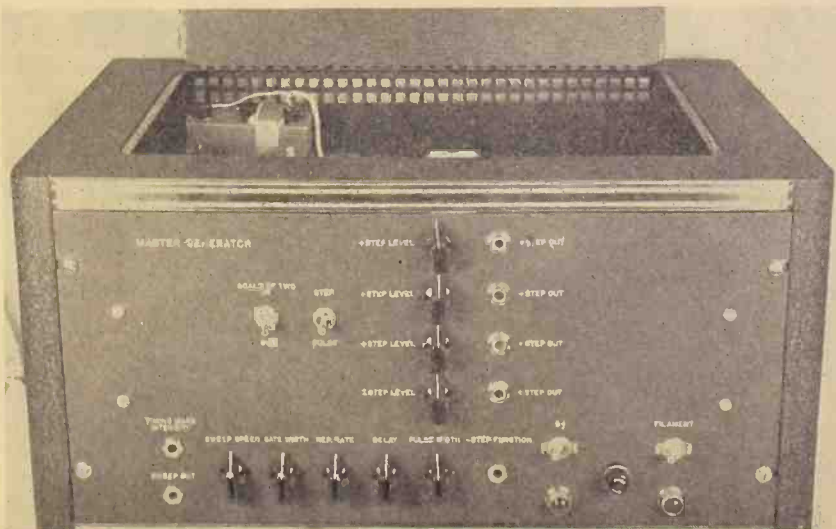



The MADDIDA, made by Northrop Aircraft, Inc. This production model was designed and built for the experimental towing tank of Stevens Institute of Technology. It can be operated by one person, and gives its answer in columns of figures or as plotted curves.

types of equipment. The character of the tasks assigned to them is often of such importance that break-down or error may result in serious consequences. As a result of this and also considerations of simplification and miniaturization there is a continual effort to find components that may be used instead of electron tubes. At the present time various types of storage elements have almost completely replaced tubes for purposes of memory. Included are magnetic drums, magnetic tapes, magnetic cores, mercury delay

lines and many others, some of which have not yet been publicized. Magnetic amplifiers and other systems of amplification are rapidly increasing in importance. Gates, oscillators, counters and practically every circuit element in a computing machine may be designed without the use of tubes. This does not necessarily mean that tubes will be completely eliminated, but it could happen and perhaps it will. If so, it will undoubtedly mean that these new elements will also replace tubes increasingly in other applications.

The UNIVAC, manufactured by Remington Rand, in operation.



The impetus for finding components to replace tubes is not entirely a matter of reliability. Properly designed and used tubes may be applied in such a manner that their reliability is very high indeed. But they consume power and generate heat. When several thousand elements are involved both of these factors take on greater importance. Finally, it is probably true that tubes do not lend themselves as well to ultimate miniaturization as many elements that may be used to replace them.

The amount of engineering and inventive effort that is being expended in the design of computing elements and basic techniques is sufficiently large to insure continuous change for a considerable period of time. There are many possible methods of storage that have not been fully investigated. Matrix methods of solution have been applied in only a very limited way. Input and output structures are still very clumsy and inadequate. Even existing techniques have only been applied to a very limited field.

In recent years mathematicians with the necessary imagination and engineering knowledge to function in connection with computing machine design have been greatly in demand. The development of machines to make decisions and perform other functions similar to those now performed by the human mind will bring about a need for logicians capable of applying their knowledge of reasoning processes. By comparison with the number of well trained mathematicians the number of competent logicians is very limited and knowledge on this subject has not been widely disseminated. There are two journals published in this country but there is not available anywhere in the world a thoroughly adequate introductory text to the subject of symbolic logic and the foundations of mathematics. There is hardly a university or college of any kind in this country in which a course in any kind of logic is a required portion of the curriculum. There are very few institutions in which competent instruction in the developments of the last two centuries is available. This condition will almost certainly change as a result of the need for a better understanding of the subject as applied to the design of computing machinery.

This is the last semi-philosophical article in this series predicting the ultimate importance of computing machinery and indicating the trend toward applications beyond the mere high speed addition in which most contemporary designs are specialized. Future articles will be related to specific design techniques and the development of special components and circuitry.

(To be continued)

NO PLACE FOR AN

almost perfect

PARACHUTE

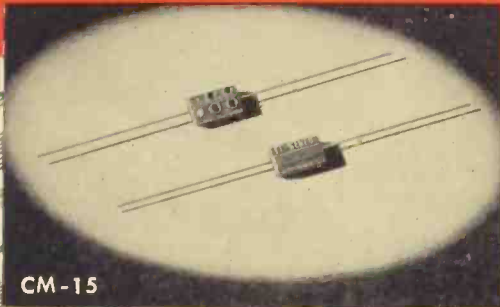

CM-15

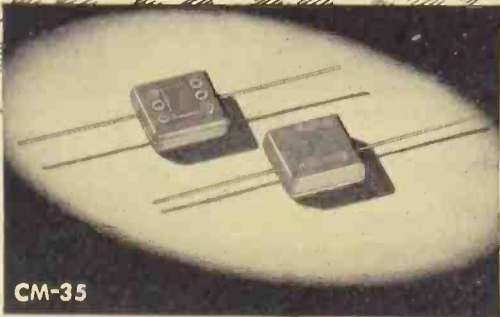

CM-35

In military operations, complete success depends upon the unfailing performance of all parts of the war machine. Small as they are—hidden in the vitals of countless complicated devices—El-Menco Capacitors have won the highest praise for their absolute reliability.

For higher capacity values, which require extreme temperature and time stabilization, there are no substitutes for...

— EL-MENCO SILVERED MICA CAPACITORS —

El-Menco Capacitors are made in all capacities and voltages in accordance with military specifications.

From the smallest to the largest, each El Menco Capacitor is paramount in the performance field.

Jobbers, Retailers, Distributors—For information communicate direct with Arco Electronics, Inc., 103 Lafayette St., New York, N. Y.

Write on your business letterhead for catalog and samples.

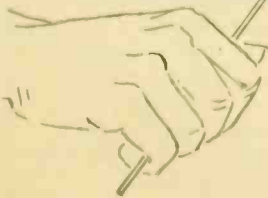

MOLDED MICA

El-Menco CAPACITORS

MICA TRIMMER

Radio and Television Manufacturers, Domestic and Foreign, Communicate Direct With Factory—

THE ELECTRO MOTIVE MFG. CO., INC.

WILLIMANTIC, CONNECTICUT

MAGNETIC ATTENUATOR

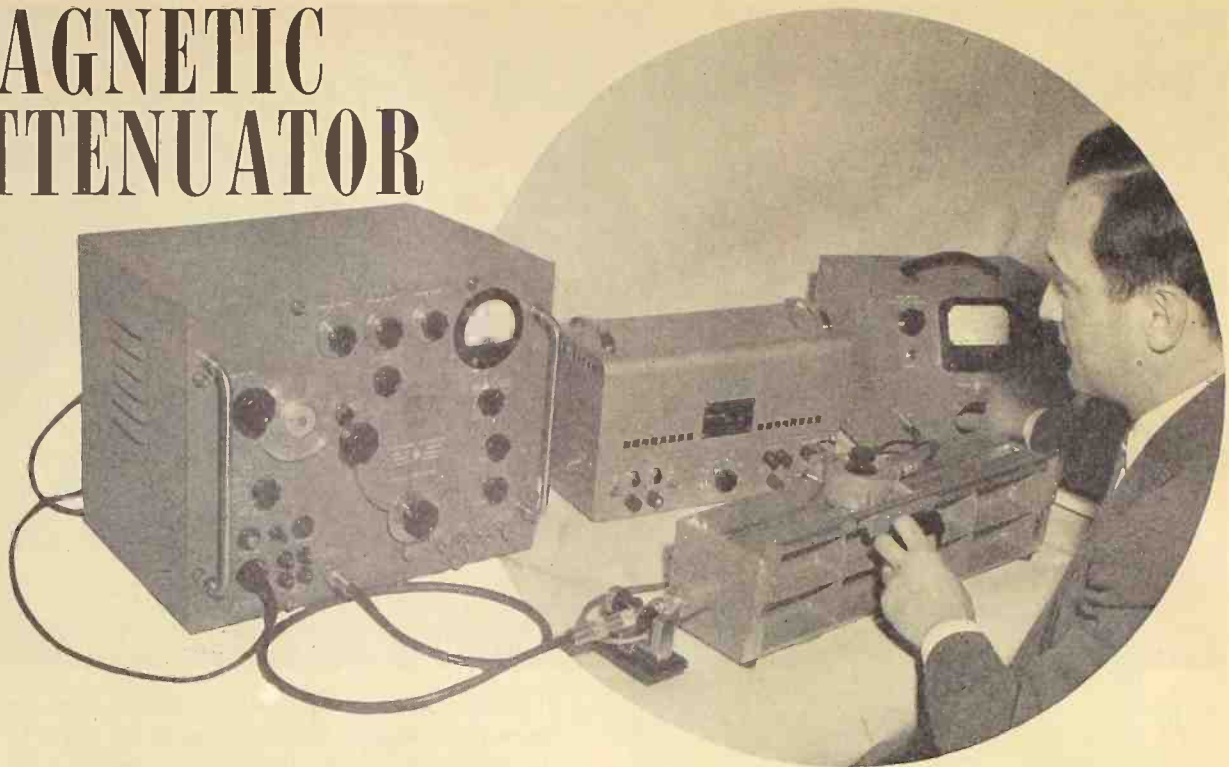

A dissipative ferromagnetic material is used which changes its loss properties in a magnetic field.

The NBS magnetic attenuator inserted in a coaxial line and placed between the poles of an electromagnet.

AN INEXPENSIVE TYPE of microwave attenuator for coaxial transmission lines recently developed by Frank Reggia of the National Bureau of Standards utilizes a magnetic field to obtain instantaneous changes in attenuation. The new device, an outgrowth of NBS research in power measuring techniques at microwave frequencies, is known as a magnetic attenuator. Its operation depends on the interaction between the electromagnetic field within a transmission line, which contains microwave energy-dissipating material, and an external magnetic field applied perpendicularly to the axis of the line. As a result of this interaction, the loss characteristics of the dissipative material are substantially altered. The NBS Magnetic Attenuator requires no movable components, mechanical controls, or slotted sections in coaxial transmission line and may be operated manually or automatically from a proximate or remote position.

Attenuators used at microwave frequencies have multiple purposes such as adjusting power levels, isolating monitoring equipment, or padding an oscillator from variations in the load. However, their use has generally been complicated by control inaccuracies and mechanical inflexibility.

In conventional microwave attenua-

tors, the energy is usually dissipated in an element made of resistive film on glass or bakelite, powdered carbon, or polyiron materials having characteristics that vary with length, composition, and the operating frequency. The dissipative element must often be carefully machined to close tolerances and is usually very fragile. Additional difficulties arise when variable attenuation is required in a transmission line circuit. Complex mechanisms which are necessary to insure a high degree of precision and fineness of control, usually result in bulky, hard-to-handle controls at substantially increased costs.

In designing the NBS Magnetic Attenuator, efforts were made to avoid many of the disadvantages encountered in conventional attenuators. The unit is simple in construction: it is composed only of a slug of some highly permeable and resistive ferromagnetic material placed within the field of an electromagnet. The significant feature of the device is the change in the loss properties of the dissipative material when it is subjected to a magnetic field. Because the magnetic field is produced by an electromagnet, its magnitude can be changed simply and precisely by varying the current in the field coils. Consequently, the permeability and loss characteristics of the dissipative material are controlled, and a variable attenuator re-

sults. In addition, the control characteristics are linear over a substantial range. An NBS investigation of materials such as polyiron and ferrites (with electrical resistivities from 10^2 to 10^7 ohms/cm.) indicated that the loss characteristics not only depend upon the composition and length of the material but increase with increasing frequency.

The size of an NBS Magnetic Attenuator for $\frac{3}{8}$ inch coaxial transmission lines is only $4 \times 4 \times 2$ inches. The dissipative material, a cylinder of polytron, is about $\frac{1}{2}$ inch long and $\frac{3}{8}$ inch in diameter. A recessed conductor hole for the center conductor is drilled into the cylinder, ceramic insulators are placed at the extremities, the whole assembly is encased in a metal sheath, and connector pins are fastened to the ends of the center conductor. Standard type N coaxial connectors are used.

The electromagnet requires a d.c. power source of 0 to 250 volts with a maximum of 30 milliamperes current to produce a magnetic field of 1500 gauss in the air gap. Small changes in the magnetic field are obtained by controlling the field current with a multi-turn *Helipot* potentiometer.

An experimental model of the NBS Magnetic Attenuator which uses polyiron as the dissipative element was operated at frequencies from 1000 to 3000 mc. Variations in the losses of the polyiron were produced which were large

(Continued on page 29)

A ONCE-IN-A-LIFETIME SURPLUS SALE OF BRAND NEW DELCO DUAL BLOWERS!!

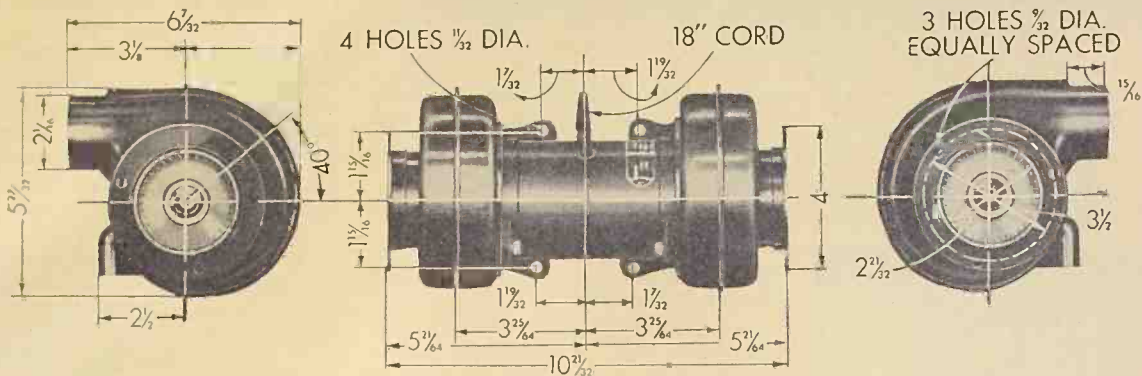

- AC Shaded Pole Motor!
- 2750 FPM Velocity!
- 2800 RPM Operation!
- Dual Multi-Blade Fans!
- Dual Outlet Blowers!
- Quiet, Continuous Duty!

IDEAL FOR:
 Darkrooms, Kitchens, Cooling Transmitter Tubes, Home Use, Humidifiers, Furnace Draft Boosters, Hair Dryers, Marine and Commercial Ventilation, etc.

A lucky special-purchase by Boston's famous RADIO SHACK, enables you to SAVE over half on these BRAND NEW (in original shipping carton) dual blowers made by the Delco division of GENERAL MOTORS! They have a multitude of uses wherever air is circulated in heating, cooling and ventilating services — with innumerable commercial, household and marine applications. Blowers are finished in durable, satin-black lacquer, have universal type mounting brackets (see sketch), and an 18" rubber cord with plug. Snail-type blower housings on each end of the double-shaft Delco Appliance motor employ multi-blade fans for quietness and maximum air volume. Motor will operate continuously with no attention except for lubrication. Convenient size for limited mounting spaces!

MOTOR SPECIFICATIONS:

Die cast alloy case and housings. Stator: 2 field coils, machine wound enamel wire, taped, dipped and baked in insulating varnish for complete protection. Starting Coil: single-turn copper hairpin. Rotor: squirrel-cage type, skewed for quietness. High-grade silicon steel laminations. High-grade precision-ground steel armature shaft. Self-aligning bronze bearings. Universal-type mounting brackets. Lubrication: felt washers in large oil reservoir with sealed oil holes. Operates on 115 volt 60 cycle AC.

BLOWER SPECIFICATIONS:

Pressed steel housings, welded two piece, snail type. Two multi-blade squirrel-cage type fans.

CHARACTERISTICS:

2800 RPM operating speed. Rotation clockwise from right-hand end. 62 watts input 2750 feet per minute velocity. Air delivery 120 cu. ft. per min. free volume. 1/2" water static-pressure. Weight 11 lbs.

THE BLOWER BUY OF A LIFETIME AT ONLY....

\$14.85

BLOWERS AVAILABLE IN QUANTITIES SUFFICIENT FOR PRODUCTION USE

SENSATIONAL! CLOSE-OUT SALE OF SWITCH-TIMERS

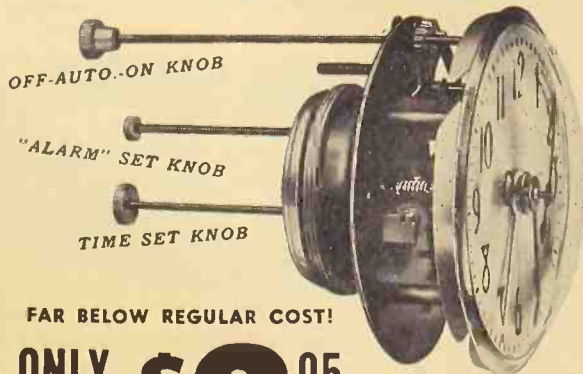

FAR BELOW REGULAR COST!

ONLY **\$3⁹⁵**

- 6 FOR \$22.50
- 12 FOR \$42.60
- 24 FOR \$81.60

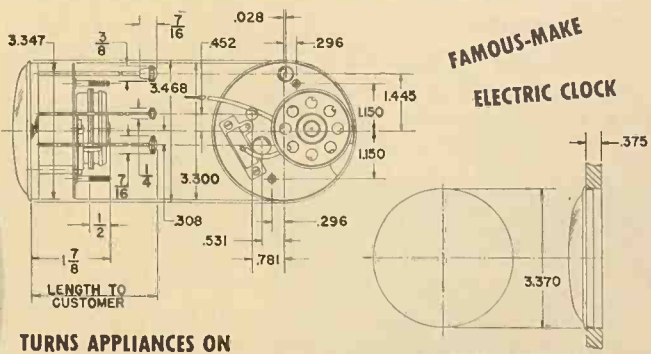

URNS APPLIANCES ON AT PRESET TIME UP TO 12 HOURS

Brand new, individually boxed, guaranteed! One of America's most famous manufacturers! Scores of industrial and lab uses. Instructions furnished. Switch rated 15A 115V. AC operation. Order by mail today, and save \$\$\$.

RADIO SHACK CORPORATION
 167 Washington St., Boston 8, Mass.

NEW PRODUCTS

GENERATOR & CALIBRATOR

Model PC-100 *Teletronics* pulse generator and calibrator is the first of a new line of electronic test equipment developed by *Teletronics Laboratory*,



Inc., 352 Maple Avenue, Westbury, L. I., New York. This instrument was designed to fill a need as an accessory for general use with triggered oscilloscopes and as a source of pulses for triggering other equipment. It produces two rectangular pulses of short duration whose amplitudes and polarities can be independently controlled. The repetition frequency and the time interval between pulses are also adjustable. Accurate marker pulses and square-waves are generated for making both time and amplitude measurements. The unit can be synchronized from an external source or it may be operated self-synchronous, in which case a pulse for synchronizing other equipment is generated.

BRANDING MACHINE

A new method is now in use for marking the identification on conductors of various electrical systems. The old method of using metal and fibre tags



for identification created numerous difficulties involving excessive time, labor, material and awkward operations. The new marking machine is a typewriter-like device with a standard keyboard. Vinylite tubing is clamped into position

in the machine and the identifying letters or numbers are typed on to the tubing. This unit heat-brands the marking below the surface of the tubing, making it both indelible and permanent. A special heating device maintains the correct temperature necessary to deposit durable leaf carbon into the brand.

A unique feature of this device is changeable type. Tubing from $\frac{1}{8}$ " to $\frac{1}{2}$ " diameter can be branded with maximum size type it will take. The type is instantly changeable and is available in special symbols and foreign languages. For further information on this unit write *Ralph C. Coxhead Corporation*, 720 Frelinghuysen Avenue, Newark 5, N. J.

EARPHONES

Audio-Master Corp., 341 Madison Ave., New York 17, N. Y. has developed



an attachment known as the "Earphone Aggregate Unit." With the implementation of this attachment it is now possible to use as many as ten headsets for individual listening. This unit can be used in conjunction with any record or transcription player which has a detachable loudspeaker or a special jack for earphone use. A master volume control and 10 foot extension cord completes the unit.

SELF-INSULATED TERMINALS

Complete technical information on a new line of self-insulated Sta-Kon terminals is contained in Data Sheet S4, issued by *The Thomas & Betts Co., Inc.*, 28A Butler Street, Elizabeth 1, N. J.

These terminals are particularly suitable for use in cramped quarters to prevent the danger of short circuits between adjacent terminals on closely mounted studs. Typical applications include electronic equipment, instru-

ments, industrial control apparatus, aircraft wiring and railway and marine service.

FLIP-FLOP

The *Computer Research Corporation*, Torrance, California has developed a replacement for the vacuum tube in certain medium speed counting, amplifying, and control applications. This component, the CRC Ferro-Resonant Flip-Flop, is a bistable state device which is equivalent to a single vacuum tube Eccles Jordan trigger circuit. It resembles, somewhat, a saturable reactor and operates at frequencies up to

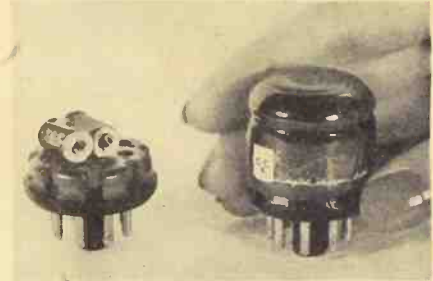

20 kc., has no filament to burn out and occupies about one-tenth the space of a comparable vacuum tube.

The unit is being produced in octal base plug-in form, though it can be miniaturized or provided with solder-in leads. Design of the device is very flexible and can be adapted to ring, gated or carry-type counting, highly sensitive magnetic amplifying switching, storing, delaying, pulse shaping, telemetering, sonar, radar, and similar fields.

FIELD INTENSITY METER

Model NF-105, a high quality, sturdily built noise and field intensity meter covering the frequency range from 20 to 400 mc. has been announced by *Empire Devices, Inc.*, 38-25 Bell Blvd., Bayside, N. Y. In the design of the instrument, particular attention was paid to high accuracy and reliability of measurements, as well as to ease of



operation. The frequency range is covered by means of two plug-in heads housing the r.f. and i.f. circuits.

Two calibrating standards are used: a spot frequency sine wave generator and a broad-band impulse generator.

The standard equipment includes a dipole antenna, a tripod, magnetic and electric field probes, a 50 ohm line probe and injection blocks. Optional equipment available consists of a broadband antenna set, an inverter for d.c. operation, a 500 ohm line probe and a remote indicator.

AMPLIFIER

Designed for making low-level measurements from transducers of stress, strain, displacement, pressure, temperature, velocity, acceleration, and other parameters, the new *Sierra Laboratory* carrier amplifier is intended for engineering, physical, medical, and other dynamic investigations.

High-gain characteristics are combined with low noise. Operating stability is achieved under adverse conditions of local electrical disturbance, as well as temperature and humidity variations. The equipment is housed in units which can be mounted in standard 19 inch racks or bench-stacked as

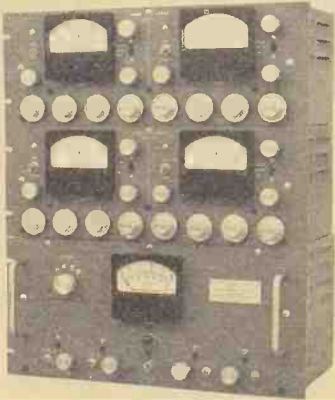

illustrated. To facilitate stress measurements a special network provides readings from 120 ohm strain gages with calibration directly in terms of steel stress. Static zero drift of oscillograph traces is compensated through an automatic zero-control circuit which permits unattended operation of the equipment.

For further information write to *Electronic Engineering Associates, Ltd.*, 1042 Brittan Ave., San Carlos, Calif.

BELLOWS

The *Clifford Manufacturing Company* of Waltham, Massachusetts is offering bellows especially suited for electronic high vacuum work. Available in monel, stainless steel, and other metals having very low gas transmission and emission properties, the bellows are assembled to fittings for individual requirements through a new molecular bonding process, resistance welding, and heli-arc welding, and are highly
(Continued on page 26)

*** MAGNECORDER**
Sound Performance



(Photo by A. Alberts, 1950)

.. from "Studio A" .. to TIMBUKTU! *



The famed traveler, Art Alberts, recently used Magnecord Tape Recorders in his search for African tribal music — never before recorded. His Magneorders underwent 140 degrees temperature, relative humidity ranging from 8 to 99, and 5,000 miles of grueling, jouncing desert and jungle trails. Operating perfectly all the way, Magneorders brought home faithfully accurate reproductions from the court of the Mossi Emperor, south of Timbuktu.

Whether in Timbuktu or in Studio A at KRSC, Seattle, Wash., Magneorders handle delayed programs and "on location" recordings with constant dependability. Easy portability, precision and fidelity make Magne-corder the first choice of radio engineers everywhere.

MORE FEATURES

PT7 accommodates 10 1/2" reels and offers 3 heads, positive timing and pushbutton control. PT7 shown in console is available for portable or rack mount.

GREATER FLEXIBILITY

In rack or console, or in its really portable cases, the Magne-corder will suit every purpose. PT6 is available with 3 speeds (3 3/4", 7 1/2", 15") if preferred.

HIGHER FIDELITY

Lifelike tone quality, low distortion, meet N.A.B. standards — and at a moderate price. PT63 shown in rack mount offers 3 heads to erase, record and play back to monitor from the tape while recording.



WRITE FOR NEW CATALOG
Magne-cord, INC.

360 North Michigan Avenue
Chicago 1, Illinois, Dept. RE-10

Send me latest catalog of Magne-cord equipment.

Name.....
Address.....
City..... Zone..... State.....



NEWS BRIEFS

SPINDLE HARDENER

Spindles for textile machines are selectively surface hardened in *Westinghouse's* twin-unit r.f. induction-heat-

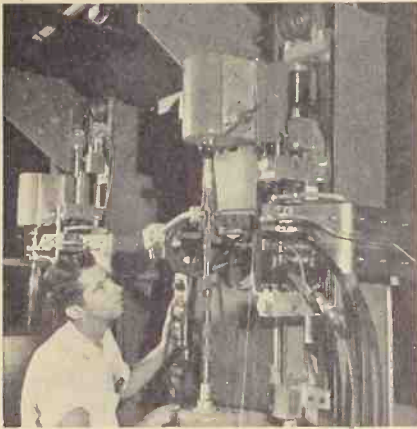

ing machine. As shown in the illustration, while the operator loads or unloads one unit, the other is passing the heating coil along the other, heating only the intended areas.

Further information may be obtained by writing to *Westinghouse Electric Corp.*, 306 Fourth Avenue, Pittsburgh 30, Pa.

MICROWAVE RELAY SYSTEMS

A 1000 mile multi-channel microwave relay system has been installed by *Motorola, Inc.*, 4545 W. Augusta Blvd., Chicago 51, Ill., and is in operation for the *Mid-Valley Pipeline Co.* of St. Louis.

The network includes 36 repeater stations spaced 14 to 37 miles apart. The single antenna for both transmis-



sion and reception, and the 45 degree flat passive reflectors at the top of the towers of *Mid-Valley's* microwave com-

munications system were first used by *Motorola* in practical systems. Starting at Longview, Texas terminal, the line runs east to near Haynesville, Louisiana to Mayersville, Mississippi, up northeast to Abbeville, Mississippi; Denver, Tennessee; Clarkson, Kentucky; to near Cincinnati, Ohio; and to Lima, Ohio as it follows the pipeline.

The illustration shows one of the typical repeater stations along the 1000 mile system. The *Motorola* microwave relay radio equipment is mounted on the ground beneath reflector towers.

TESTING

Special facilities have been installed at *Menlo Research Laboratories* for accurate rating of ultraviolet emission from generators used in the company's Fluoretor brand fluorescence detector-comparators. The special test panel, illustrated, contains a duplicate of the



power supply incorporated in the portable Fluoretor. Complete generator units are plugged into the test position on top of the panel and checked for normal 350 volt, 28 milliamperes, 60 cycle a.c. output. Other indicating instruments show line input characteristics for standardization.

While the generator unit is in this position, its u-v output is directed against a special fluorescent screen whose visible-light output is picked up by a photronic cell and read from another meter. This reading is then converted to microwatts per square centimeter, and each tube is rated accordingly.

Complete literature on the Fluoretor is available on request from *Menlo Research Laboratories*, Drawer 600, Menlo Park, Calif. Inquirers should

specify major field of application since literature is specialized.

ANTENNA RESEARCH

The Research Division of New York University College of Engineering, 181 Street and University Avenue, New York 53, N. Y. is conducting a research project subcontracted by *Camburn, Inc.*, which seeks to develop an antenna assembly that covers the frequency range of 100 kilocycles to 4000 megacycles.

The illustration shows Lester Saporita, research assistant of NYU Col-



lege tuning a whip antenna. The cone shaped device is a broad-band omnidirectional receiving antenna, the lower one having a range of 12 megacycles to 600 megacycles, the upper one from 600 to 4000 megacycles. The whip, using receiver design, covers a band from 100 kilocycles to 12 megacycles.

Base Directorate Electronic Research and Development, Rome Air Development Center, sponsored the prime contract with *Camburn, Inc.*, who in turn subcontracted with NYU College of Engineering for this work.

50th ANNIVERSARY

Sylvania Electric Products Inc., 1740 Broadway, New York 19, N. Y. is observing the 50th anniversary of its founding in 1901 when Frank A. Poor, now vice chairman of the board of directors, purchased for \$3,500 a half-interest in a small business in Middle-



ton, Mass., that refilled burned-out light bulbs. The company started with 15 employees and now has 22,000 people on its staff.

In 1951 *Sylvania* is spending nearly \$10,000,000 for new plants and equipment, and another \$4,000,000 is being

spent on replacement of existing machinery and equipment, which represents an all-time high for the company's investment in plant and machinery in any one year.

The mother plants of *Sylvania* are shown in the illustration. The frame structure (left) is the birthplace of the company at Middleton, Mass. The brick building (right) was occupied by the Pennsylvania branch soon after its founding.

NEW PERSONNEL

Dr. Richard M. Goldrick became research manager of the Fibron Plastics Department of the *Irvington Varnish and Insulator Company*. He was formerly a research chemist with the *Du Pont Polychemicals Department* in Wilmington, Delaware.

W. Moody Wilson joined the department as a research chemist. He had been previously engaged in the development of plastics in conjunction with medical applications for the past four years.

HARBOR RADAR

A successful test of harbor radar was announced by the *Raytheon Manufacturing Company*, Waltham 54, Mas-



sachusetts. Unlike other harbor radar installations which merely use land based ship radar equipment, the Raytheon Harbor Radar System is a completely new approach to the problem, using equipment designed specifically for the purpose. Tests conducted in Boston Harbor on Deer Island were made under actual conditions encountered in a busy harbor. Vessels were moved in and out of the harbor under conditions simulating zero-zero visibility. Orders were given to the vessel's pilot by means of two-way radio telephone equipment.

The antenna, the world's largest, is 41 feet wide and weighs approximately 10,000 pounds, which is more than three times larger than any shipboard type radar antenna and produces a beam

ANY SIZE

Spiral Wound PAPER TUBES

from .450" to 25" I.P.
from 1/2" to 30" Long

SQUARE
RECTANGULAR
TRIANGULAR
HALF-ROUND
ROUND

It pays to check your requirements with PARAMOUNT... because you benefit from PARAMOUNT'S coil-proved design and construction—vast range of stock arbors—wide experience in engineering special tubes! Hi-Dielectric. Hi-Strength. Kraft, Fish Paper, Red Rope, or any combination wound on automatic machines. Tolerances $\pm .002$ ".

ALSO: *Shellac-Bound* Kraft paper tubing. Heated shellac forms an adhesive bond between the laminations. Absolutely moisture resistant.

Paramount PAPER TUBE CORP.

613 Lafayette St., Fort Wayne, Ind.

Mfrs. of Paper Tubing for the Electrical Industry

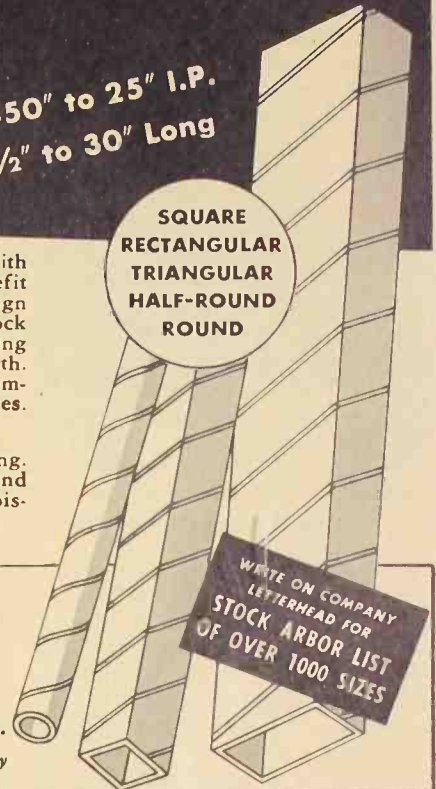

ZOPHAR

--- WAXES
--- COMPOUNDS

Anti-Corona high heat-resistant compounds for Fly Back Transformers.

Waxes and compounds from 100° F to 285° F Melting Points for electrical, radio, television, and electronic components of all types.

Pioneers in fungus-resistant waxes.

Our efficient and experienced laboratory staff is at your service.



ZOPHAR MILLS, INC.
112-130 26th Street,
Brooklyn 32, N. Y.

Measurements Corporation

MODEL 59 MEGACYCLE METER

The only grid-dip meter

covering the wide range of 2.2 Mc. to 400 Mc.



FREQUENCY CALIBRATION: $\pm 2\%$

For determining the resonant frequency of tuned circuits, antennas, transmission lines, bypass condensers, chokes, etc. For measuring inductance and capacitance. May also be used as an auxiliary signal generator; for signal tracing and many other applications.

Complete data on request.

MEASUREMENTS CORPORATION

BOONTON



NEW JERSEY

width of only 42 minutes with a power gain of approximately 10,000. The indicator used on this system employs 16 inch tubes, thus by offsetting and eliminating unwanted objects the presentation is the same as would be seen on a 32 inch tube.

The Harbor Radar System also employs the Raymark Beacon System for identification of specified vessels and also employs specially designed lubberlines for obtaining bearings between two vessels and for obtaining fixes when using the special offset indicators.

NEW PUBLISHERS ASSOCIATION

A new national industry organization, the *Technical Publishers Association*, 30 Vesey Street, New York 7, N. Y., recently came into being when some 28 owners and operators of technical publishing concerns adopted a constitution and elected a board of directors and officers at a meeting held in New York City.

Among the objectives of the new association are: (a) to engage in research and to analyze the practice of technical publishing to improve its standards and techniques; (b) to foster training and education of persons preparing to enter the technical publishing profession and to cooperate with educational institutions; (c) to promote recognition of the profession as an essential service to industry and government; (d) to conduct research and consider "intra-professional problems"; (e) to cooperate with industry and government in developing standardization and simplifications to enable members to offer more economical, expeditious and intelligent services; and (f) to assist in developing fair bidding and purchasing practices and sound employment policies.

FALL MEETING

The 1951 Radio Fall Meeting will be held in the King Edward Hotel, Toronto, Ontario, Canada from October 29th through 31st, according to an announcement by Virgil M. Graham, chairman of the meeting and director of technical relations for *Sylvania Electric Products, Inc.* Graham said that there would be no advance registration for the meeting but that those who attend should make hotel reservations early.

Tentative program for the three day sessions will include general sessions Monday morning, October 29 including an address by Ivan S. Coggeshall, president of the Institute of Radio Engineers; Monday afternoon sessions will be devoted to the reliability of tubes and circuits, sponsored by the IRE Professional Group on Quality Control.

(Continued on page 30)

Gate and Delay

(Continued from page 11)

rings positive, but is damped out when it tries to ring negative. Thus the diode CR_1 insures only one positive pulse, and that at the end of the delay interval. This pulse is also shown in Fig. 4c, on a faster sweep.

Because the gate is a.c. coupled to the cathode follower, the amount of current flowing through the peaker during the delay interval varies with the duty factor. The pulse therefore also varies with the duty factor, but is always large enough to trigger the pulse generator in the following stage.

The pulse generator, V_4 , is a single-shot multivibrator that is triggered by the pulse generated in the plate circuit of the cathode follower at the end of the delay interval. The right-hand half of this tube is normally on, and it holds the left-hand half off by means of the common cathode coupling. The pulse from the plate of the cathode follower triggers this circuit, causing the left-hand half to conduct and a negative-voltage pulse to appear at the left-hand plate. This waveform, seen in Fig. 4d, is capacitor-coupled to the right-hand grid of V_4 . The grid-circuit time constant is quite short, so that the circuit recovers very quickly. When the right-hand half of V_4 is cut off, the peaker in its plate rings positive, the negative overshoots being damped out by conduction of CR_3 . When the circuit returns to its normal state, a second negative pulse appears as current is again built up in the inductance.

The waveform shown in Fig. 4e is capacitor-coupled to the grid of the output buffer, V_5 . This buffer is normally biased off, and it therefore amplifies only the positive portion of the pulse. The resulting output pulse at V_5 is at a 93 ohm impedance level, and may be seen in Fig. 4f, driving 93 ohms. Its length is approximately 0.1 microsecond, and its amplitude may be varied from 0 to 40 volts. Polarity is reversible by use of switch S_3 .

Suggested Improvements in the Circuit

Several improvements are suggested by the authors as possible changes in circuit design if many of the present uses for the unit continue. For example, the gate output is generally fed to one of the control grids of a gate tube, whose cathode is usually grounded. It would therefore be very convenient to have the gate d.c. coupled to the output jacks, and to have the two d.c. levels involved, in the order of -20 and +5 volts. This feature could be accomplished by driving the grid of the cathode follower by the divider that already

drives the grid of V_{2A} . Grid-to-cathode conduction of V_{2A} limits the positive swing of this point during the delay interval, and would nicely establish the level of the top of the gate. The level of the base line could be controlled by choosing the proper negative voltage to which to return the cathode resistor of the cathode follower. If this voltage is chosen so that the tube is cut off between delays, no overshoot would be observed at the output.

The pulse generator could be simplified if the above modifications were used, since the shape of the pulse fed to it from the plate of the cathode follower would be independent of duty factor, but the need for a generator would not be eliminated. The reason is that the current through the cathode follower does not collapse rapidly enough at the end of the delay interval to generate a satisfactory pulse in a peaker designed for 0.1 μ sec.

In general, the unit has performed very satisfactorily. The major difficulty in previous models, which was caused by variations in the power source, has been taken care of by the inclusion of voltage-regulator tubes. The changes suggested above are minor, but come from long and varied use of equipment in the laboratory.

RC Filters

(Continued from page 6)

Each of these filters consists of two sets of two high-pass and two low-pass constant- k sections, as shown in Fig. 12. These filter circuits are quite conventional in design, and are designed to match terminal impedances of the order of 10,000 ohms. In the interests of uniformity, these LC filters are used with the same amplifiers and are mounted in the same plug-in cans as are used in the RC sections. Since the insertion loss of the LC sections is different from that of the RC units, the LC plug-in units contain appropriate loss networks and certain sections of the T circuits are bridged out inside the cans. By the use of this arrangement, identical amplifiers are used at all frequencies, and the filter units from any one amplifier can be plugged into any other without adjustment or change.

The frequency response curves at-

Fig. 12. LC filter used to give band-pass frequency characteristic for highest frequency range. Two such filters are used for each channel.

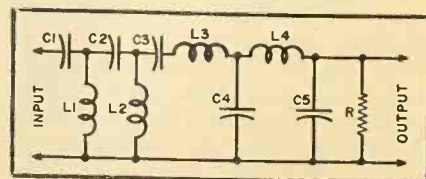

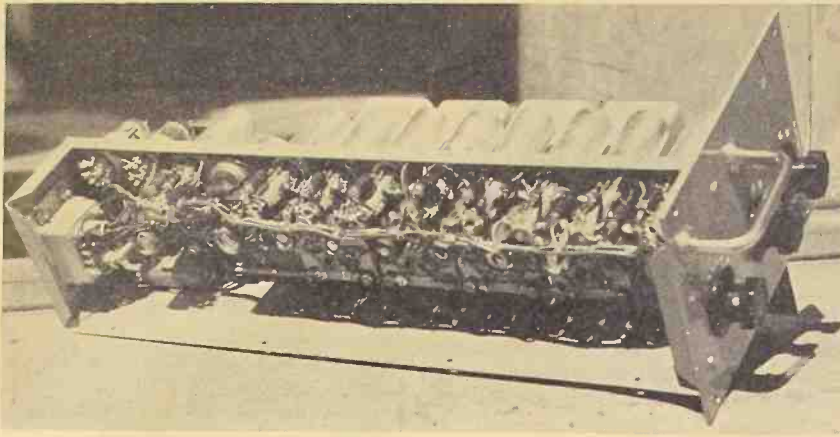

Fig. 13. The wiring and internal construction of a complete band-pass unit whose schematic is shown in Fig. 11.

tained by the use of the filter circuits which have been described are shown in Fig. 14. A set of sample response curves is shown, to illustrate the band-pass characteristics at the extremes and at the center of the frequency range covered by the equipment. These curves show the response of the *RC* networks for the 15-30 cycle, the 400-800 cycle, and the 8000-15,000 cycle bands, and the *LC* network for the 80-160 kilocycle band. They show that the band-pass response curves are approximately the same at all frequencies within the range of the instrument, and that the same type of frequency response is obtained from the *RC* filter circuits as from the *LC* filters.

The actual construction and physical layout of the filters can be seen from the photograph in Fig. 13, by comparing it with the block diagram of Fig. 10 and the circuit schematic of Fig. 11. The basic amplifier chassis contains all

the feedback-pair gain stages, and is so arranged that all the frequency-response components are mounted in the four plug-in cans. Thus, the same basic amplifier unit is used for all of the band-pass filters, with the frequency response determined by the particular set of filter cans which is plugged into the amplifier.

The method of obtaining the filter responses from *RC* circuits described in this article is not essentially new in principle, but it is believed that the circuits which are used in this system represent a distinct advance in the utilization of such networks. By extending the principles of conventional filter theory to the design of *RC* filters, they make it possible to obtain sharp-cutoff filter characteristics at very low frequencies at which it has previously been impractical to obtain the maximum benefits of such networks.



Fig. 14. Typical band-pass frequency response curves to illustrate the band-pass characteristics at extremes and at center for frequency range.

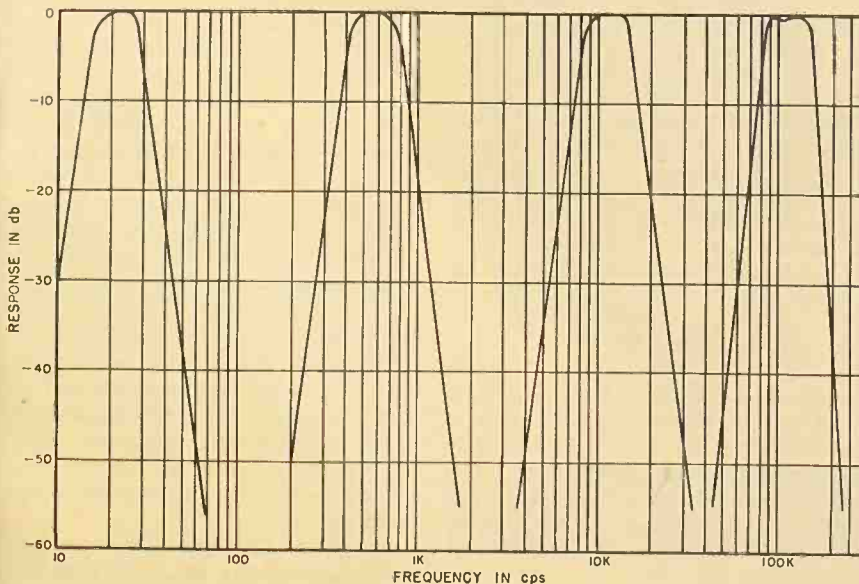

"USE THE BEST FOR TEST"

The **AUDIO OSCILLATOR** that stresses quality in design, construction and performance.



Laboratory
Type TE200K

COMPARE THESE FEATURES:

1. All capacitors are hermetically sealed in oil or mica—no electrolytic capacitors are used.
2. Stable operation assured under varying line voltage conditions through use of electronically regulated power supply.
3. Thermal drift minimized through use of "temperature design" and low temperature coefficient resistors, thereby eliminating constant zero setting.
4. Mounts in standard relay rack or table cabinet.

SPECIFICATIONS:

Frequency Coverage: 20 cycles to 200,000 cycles in four ranges.

Frequency Dial: 6" diameter, direct reading, with planetary drive.

Output Voltage: 0 to 10 volts continuously variable.

Calibration Accuracy: $\pm 2\%$ of dial setting indication.

Average Distortion: 1%

Hum Level: Minus 50 DB or better.

Standard Load: 1000 ohms resistive.

Frequency Response: ± 1 DB from 20 to 200,000 cycles.

Drift: $\pm 2\%$ or better.

Power Supply: 115 volts 50/60 cycles, 60 watts.

For further details write to:

EL-TRONICS

INCORPORATED

2647 N. Howard St.

PHILADELPHIA 33, PENNA.

Personals



WILLIAM AVILA has been elected vice-president and plant manager of *Bardwell & McAlister, Incorporated*. Mr. Avila has engineering degrees from Princeton University, Southern California, the Massachusetts Institute of Technology, and California University at Berkeley. He served as a radar officer during the last war, and upon release from service, became production engineer for the Atomic Energy Commission.



OTTO C. BIXLER has been appointed director of engineering of *Magnecord, Inc.* Mr. Bixler was formerly associated with *Airesearch Manufacturing Co.* as electrical development engineer on aircraft and guided missile applications of special electronic equipment. He received his electrical engineering degree from the University of Southern California, and is a member of Eta Kappa Nu, Tau Beta Pi, AIEE, and SMPTE.



DR. IVAN A. GETTING has been elected vice-president of Engineering & Research at *Raytheon Mfg. Co.* An outstanding authority on radar, Dr. Getting held the post of chief scientist of the U. S. Air Force, and in recognition of his work during the war received the President's Medal of Merit. He is a Fellow of the American Physical Society, senior member of the IRE, and a Fellow of the American Academy of Arts & Science.



LEON HILLMAN has recently been appointed head of the engineering department of *Production Research Corporation*, located at Thornwood, New York, where his duties will be to officiate as director of engineering. Mr. Hillman had formerly been affiliated with the research division of the New York University. *Production Research Corporation* specializes in the research, development, and production of electronic equipment for the Armed Forces.



DR. RICHARD F. HUMPHREYS has been named chairman of the physics department at Armour Research Foundation of Illinois Institute of Technology. In his new position, Dr. Humphreys will head research activities in acoustics and vibrations, high pressure, nucleonics, light and optics, physics of solids, etc. He is a member of Sigma Xi, American Physical Society, and the American Association for the Advancement of Science.



RALPH B. LADD has been named chief of the electronics division of the Office of Aviation Defense Requirements of Civil Aeronautics Administration. Mr. Ladd joined CAA in 1933, and had been chief of the Chicago Electronic Section until transferred to Washington last year. His prime duties now will be responsibility for all Federal Airways requirements programs and Airborne Electronics & Electrical requirements for Civil Aviation.

New Products

(Continued from page 21)

effective for devices requiring adjustment in a vacuum, enabling the operator to "reach into the vacuum" to make adjustments without affecting the vacuum seal in any way. As a hermetic seal, the bellows permits 360 degree rotation while maintaining 100% metallic seal.

A few of the numerous applications for these bellows are for magnetron tubes, in order to insure the vacuum tight chambers even after high temperature bakeout at 900° F for several hours under condition of practically zero air pressure internally and atmospheric pressure externally, and for expansion chambers in mercury filled waveguides, as well as for switch mechanisms and other electronic applications.

SWITCH

General Control Company, Boston 34, Massachusetts, announces a small, standard, telephone-type switch, type

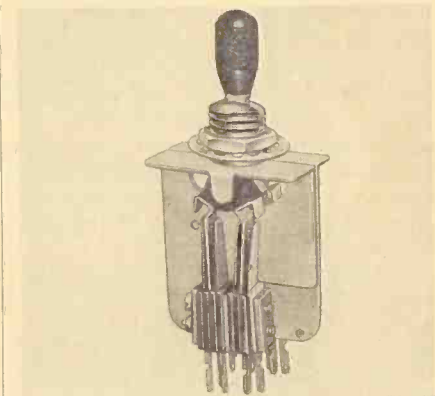

MCT. Maximum depth of this unit in back of panel is 2½ inches; width is ¼ inch, thus providing compactness for multiple mounting on crowded control panels, and is available in two mounting styles: single ½ inch threaded bushing, or 3-48 tapped holes to fit all universal mounting requirements.

A feature of MCT switch is the shielding between pairs of contact assemblies, for contact isolation where necessary. Contacts are either fine silver or silver palladium alloy, and carry ratings of 1 ampere, 115 volts a.c., non-inductive load.

RESISTORS

Miniature hermetically sealed resistors with solder lug terminals and designed to meet the requirements of JAN-R-93, characteristic A, style RB11, have been announced by the *Shallcross Manufacturing Co.*, Collingdale, Pennsylvania.

Known as *Shallcross Akra-ohm* type 1180, the resistors are 19/32 inch long

by 1/2 inch diameter and are rated 0.25 watt at 250 volts. Resistance values up to 0.1, 0.3 or 0.4 megohms may be ob-

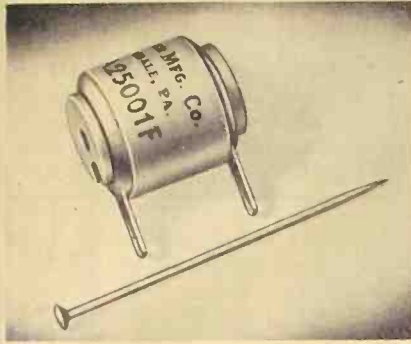

tained depending on the alloy wire used for the non-inductive winding. The units are hermetically sealed in Steatite by a process which provides positive immunity against the effects of humidity, fungus and salt water immersion.

ATTENUATOR

Polarad Electronics Corporation, 100 Metropolitan Avenue, Brooklyn 11, N. Y., announces a new external broad-

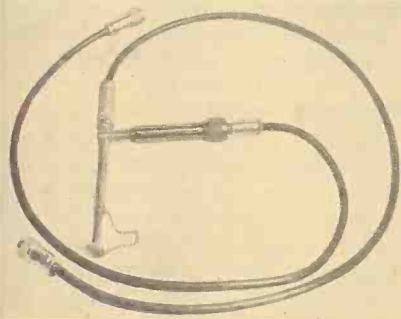

band microwave attenuator, Model SIJ. This unit operates on the principle of a waveguide beyond cut-off and provides a range of attenuation in excess of 140 db. The attenuator is designed to cover the frequency range from 4 to 12 kmc., and has a 50 ohm impedance.

BALL BEARING

The New Hampshire Ball Bearings, Inc., Peterborough, N. H., announces



a new spring-retainer Micro ball bearing. Formerly obtainable in larger sizes only, this new bearing measures

3/32" bore x 1/8" OD x 3/4" wide, in tolerances ABEC 5 and higher. Characteristics include low and uniform values of starting or breakaway torque, a high percentage falling in the range .0006 inch-ounce under a standardized 75 gram thrust load. Individual stainless steel coil springs serve as separators. Rings and balls are standard in high-carbon chrome steel.

SOUND LEVEL METER

Type 410-B sound level meter is used for accurately measuring noise, sound, and vibration, which often have harmful effects on human nerves, efficiency, and hearing. This very rugged, com-



pact, and accurate instrument is made possible by use of subminiature tubes and components, together with patent-pending miniaturization techniques, and

meets all specifications of the American Standards Association.

This unit features greater low-frequency range, from 34 to 140 db above the standard ASA reference level of 0.0002 dynes per square centimeter. Hearing-aid batteries are used, having an operating life of about 50 hours. The unit is available with carrying case, extension cables and vibration measuring equipment. For a bulletin and further information write *Hermon Hosmer Scott, Inc.*, 385 Putnam Avenue, Cambridge 39, Mass.

WELDING ROD

Chemalloy Associates at Gillespie Airport, Santee, California announces a new type of welding and soldering material which particularly simplifies the art of aluminum welding and welding of pewter or potmetals. The Chemalloy welding rod is derived by mixing together molten metals from less critical scrap or virgin zinc, copper, aluminum, lead, tin and slag plus an admixture of wet chemical masses.

To use as welding rod or solder, the aluminum is heated to its softening point, and the chemalloy metal is rubbed on, no flux being necessary.

now... LABORATORY CONTROL ASSURES

PRECISION COIL BOBBINS

With Better Insulation, Moisture-Resistance and Heat-Dissipation

Strict Laboratory Control of materials enables Precision to offer you bobbins that are 15 to 20% stronger, yet light in weight — that have greater insulation, moisture-resistance and heat-dissipation, too. Increased coil winding space is another vital feature of Precision Coil Bobbins.

Flanges furnished with leads, slots, holes or plain—all types supplied flat, recessed or embossed to fit any mounting. Tube ends swaged to lock flanges. Any size, any shape available — round, square, rectangular — in dielectric Kraft, Fish Paper, Cellulose Acetate or combinations.

Send Specifications for Sample and Ask for New Mandrel List of 1000 Sizes.



PRECISION PAPER TUBE CO.

2063 W. Charleston St.
Chicago 47, Ill.

Plant No. Two, 79 Chapel St., Hartford, Conn.

Also Mfrs. of PRECISION PAPER TUBES

PATENT REVIEW

Printed copies of these or any other patents may be obtained from the U. S. Patent Office for 25c each. Address the Commissioner of Patents, Washington 25, D. C.

ELECTRIC PICKUP FOR VIBRATIONS

This invention describes a system for converting mechanical vibrations into electrical impulses by the aid of a

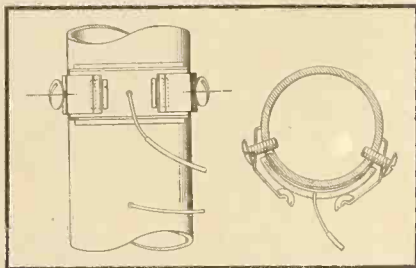

capacitance which varies in accordance with the vibrations. It is particularly useful in picking up vibrations from a vibrant bar or chime.

The device consists essentially of a semicircular metal strip placed on the bar or chime, and insulated from it by means of a suitable dielectric material. It is held in place by clamps. The bar or chime then forms one plate of the condenser and the metal strip of other plate. Vibrations in the bar are converted to variations in capacity, which in turn may be converted into electrical variations by suitable circuitry.

Patent No. 2,553,927 was issued May 22, 1951 in the name of L. A. Maas.

HIGH-FREQUENCY GENERATOR

The object of this invention is to provide an improved device for generating high frequency oscillations by velocity modulating a beam of electrons by means of a relatively low frequency.

A conventional cathode-ray tube gun

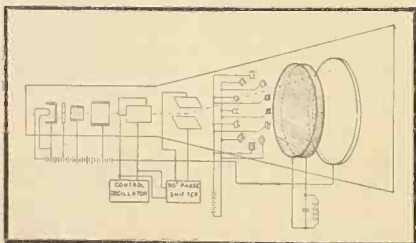

and electrostatic deflection system is used. Following the deflection system is a group of grid segments placed in a circle, each successive segment being

charged with a potential of opposite polarity. The electron beam is caused to rotate so that it passes through the various grids in succession; thus the beam is alternately accelerated and retarded. This will result in bunching. Energy extracting grids intercept these bunches, and a resonant circuit is provided which will oscillate when the bunching frequency is correct.

Patent No. 2,554,117 was issued May 22, 1951 in the name of Angelo Montani.

SECONDARY EMISSION AMPLIFIER

Many proposals have been made for constructing an amplifying vacuum tube utilizing secondary emission. The present invention is a development along these lines and certain advantages over previous designs are claimed.

Electrons emitted from a cathode are formed into a beam by suitable elec-

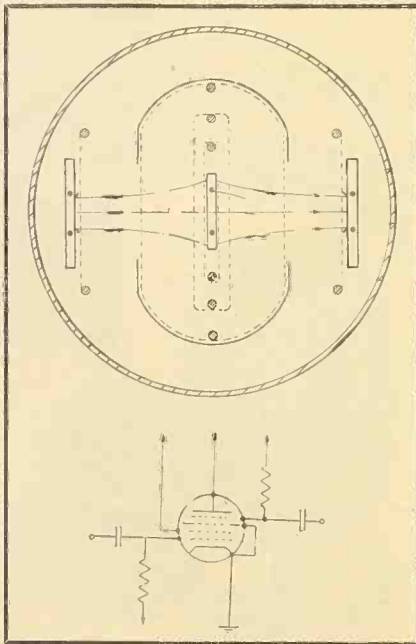

trodes, and pass through a control grid, accelerating grid and suppressor. The beam then passes through a special collector grid and strikes a surface capable of emitting more secondary electrons than there are electrons in the primary beam. These secondary electrons are collected by the collector grid, on which now appears an amplified signal.

An improved method for activating the secondary electron emitting surfaces is provided for, which eliminates

contamination sometimes acquired during the activation process.

Patent No. 2,553,997 was issued May 22, 1951 in the name of Albert Atherton.

DYNAMIC COMPRESSOR AMPLIFIER

The compressor described in this invention consists of an L pad attenuator made up of the two sections of a dual triode. During compression, the series tube gain increases, and the impedance

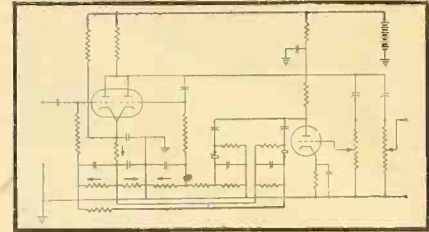

of the shunt tube decreases, thus reducing the amplitude of the signal. At very low signal levels, the series tube amplifies normally.

Two separate rectifier systems are connected in the output of a control amplifier stage. The output control voltage of one system increases and the other decreases when the input signal increases. These control voltages are connected to the grids of a dual triode.

Patent No. 2,553,673 was issued May 22, 1951 in the name of E. S. Purington.

PROTECTIVE SYSTEM

This is a protective system for cutting off the spot on a cathode-ray TV tube in case of failure of the horizontal or vertical sweep. It is desirable where the high voltage is obtained from some source other than the horizontal sweep, such as projection tubes where voltages as high as 80 kv. may be used.

In the present invention, a portion of the voltage driving the horizontal sweep is rectified and filtered. This d.c. voltage biases a thyatron so that it will not conduct. If the horizontal oscillator should fail, no bias will appear on the thyatron, and it will conduct, developing a voltage across its load resistor. This voltage is impressed on

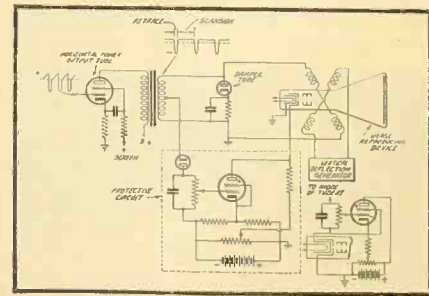

the control grid of the cathode-ray tube, cutting off the electron beam and preventing damage to the screen.

Patent No. 2,536,712 was issued January 2, 1951 in the name of William A. Bently.

TECHNICAL BOOKS

"FUNDAMENTALS OF ATOMIC PHYSICS" by Saul Dushman. Published by McGraw-Hill Book Company, Inc., 330 West 42nd St., New York 18, N. Y. 294 pages. \$5.50.

Designed to be as simple as possible in treatment, this book gives engineers and other technical men a practical knowledge of the atomic and nuclear fundamentals they will be encountering more and more in their work. The volume includes a thorough treatment of the Kinetic theory of gases, the charge and mass of the electron, electronics, photoelectric effects, x-rays, the Bohr theory of the origin of spectral lines, electron configurations in atoms—with a coverage of matter waves, isotopes, and other important factors.

Only elementary calculus is used, and as much emphasis as possible is placed on experimentally observed phenomena. A brief chapter deals with the history of physics, and another summarizes elementary mathematical techniques necessary in order to present this theory in a logical manner, without bringing in more complicated and abstruse considerations. Special features include the most recent advances in the investigation of nuclear phenomena, the development of atomic energy and the production of high-voltage particle accelerators.

"ELEMENTS OF TELEVISION SYSTEMS" by George H. Anner. Published by Prentice-Hall, Inc., 70 Fifth Avenue, New York, N. Y. 804 pages. \$10.35.

This book is divided into three parts; the first dealing with a study of closed systems, those that rely upon cable connections between sending and receiving apparatus, thus the basic problems of any TV system can be studied independently of the problems associated with broadcasting the signal by radio.

In the second part of the book the point of view is expanded to include the complications introduced by using a radio link in place of inter-connecting cables. And the last part is concerned with methods of super-imposing color-perception on a system which is inherently color blind.

Since details of a new art change rapidly, an attempt is made to concentrate on the basic principles involved. The new technique of dot interlace, which promises to become very important in the future, is covered in the appendix.

Magnetic Attenuator

(Continued from page 18)

enough to reduce the attenuation 60 per-cent, change the power by a ratio greater than 60:1, with a voltage standing wave ratio always less than 1.5.

More recently, a study was made at NBS of an attenuator that employs a slug of Ferramic B $\frac{1}{2}$ inch long and $\frac{3}{8}$ inch in diameter as the dissipative medium. The dependence of the losses in the material on frequency was remarkably demonstrated by this experiment. At 2200 mc. the attenuation was reduced from 17 db to less than $\frac{1}{2}$ db, and less than 45 milliamperes of current was required to maintain the magnetic field. At a frequency of 2600 mc., changes in attenuation greater than 20 db were obtained with the same electromagnet currents. To avoid saturation in the iron core of the small, low current electromagnet, a larger unit was used to obtain greater changes in attenuation. At several frequencies, attenuation changes in excess of 95 per-cent have been obtained without difficulty.

While operating at a frequency of 3200 mc., a striking example of ferromagnetic resonance was exhibited. As the electromagnet current was increased, the attenuation decreased from its initial value of 24 db to about 18 db, then peaked to about 25 db, and finally decreased to approximately 1 db. The peak occurred at a current of approximately 0.6 amperes. When operating at 3700 mc., a similar phenomenon occurred. The initial attenuation of 26 db was reduced to about 16 db before peaking to 37 db; finally it dropped to about 1 db as the current continued to increase.

Many applications of this magnetic phenomenon are immediately evident. An audio source can be used to vary the electromagnet current which produces a changing field in the attenuator and consequently amplitude modulates the r.f. signal. The resultant modulation envelope includes the predominant second and higher harmonic frequencies of the audio frequency field. However, these harmonics can be readily eliminated by employing a d.c. bias about which the a.c. field oscillates. The use of the NBS Magnetic Attenuator in this fashion permits amplitude modulation of uhf and microwave oscillator outputs without the frequency modulation effects which occur when the oscillator is modulated directly.

The NBS Magnetic Attenuator is equally adaptable as an output stabilizer for microwave oscillators. The unit can be part of a degenerative feedback circuit in which the magnitude of the field produced by the electromagnet

It's Dependability!



TYPE BH6A
RANGE: 1.4 - 75.0 mc
Supplied per Mil
type CR-18; CR-19;
CR-23; CR-27; CR-
28; CR-32; CR-33;
CR-35; CR-36 when
specified.

Dependability is a composite virtue that Bliley builds into all crystals. From raw quartz to finished crystal, exacting inspection assures dependable performance. That's why Bliley methods and techniques are a "natural" for military as well as civilian applications.

★ TYPE MC9
RANGE:
1.0 - 10.0 mc

Supplied per Mil
type CR-5; CR-6;
CR-8; CR-10 when
specified.

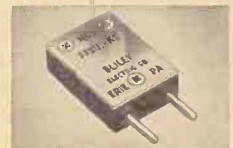

★ TYPE SR5A
RANGE:
2.0 - 15.0 mc

Supplied per Mil
type CR-1A when
specified.



★ TYPE AR23W
RANGE: 0.080 -
0.19999 mc

Supplied per Mil
type CR-15; CR-16;
CR-29; CR-30 when
specified.



★ TYPE BH7A
RANGE:
15.0 - 50.0 mc

Supplied per Mil
type CR-24 when
specified.



Bliley CRYSTALS

BLILEY ELECTRIC COMPANY
UNION STATION BUILDING
ERIE, PA.

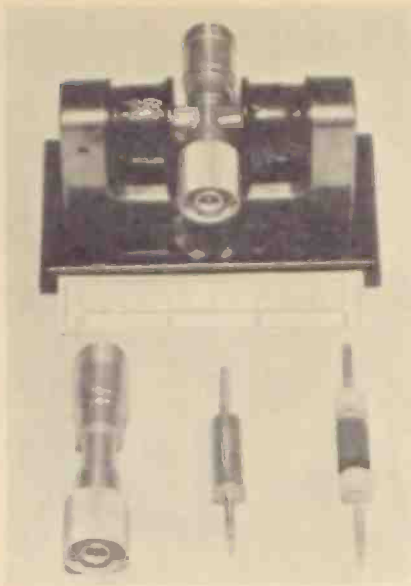

The magnetic attenuator (top) separated into its essential components (bottom).

is controlled by a small amount of r.f. power taken from the coaxial transmission line. Another magnetic unit may also be utilized in such a feedback network. The rectified control voltage coupled from the transmission line may be applied to a magnetic amplifier which controls the electromagnet field directly.

Current NBS investigations are being directed toward finding better and more efficient dissipative materials. Among the latest group of materials under study are magnetic ferrites, which yield greater attenuation changes for a given electromagnet current than does polyiron. These ferrites should thus make possible the use of smaller currents to produce the same changes of attenuation.

CALENDAR of Coming Events

OCT. 8-10 — Fall Meeting of U.S.A. National Committee of URSI and IRE Professional Group on Antennas and Propagation, Ithaca, N.Y.

OCT. 22-24 — 7th Annual National Electronics Conference, Edgewater Beach Hotel, Chicago.

OCT. 22-26 — Fall General Meeting, AIEE, Cleveland, Ohio.

OCT. 23-25 — Forty-second meeting of the Acoustical Society of America, Sherman Hotel, Chicago, Ill.

OCT. 25 — Twentieth anniversary of the American Institute of Physics, Sherman Hotel, Chicago, Ill.

OCT. 29-31 — Radio Fall Meeting, King Edward Hotel, Toronto, Ont., Canada.

NOV. 1-3 — Audio Fair, Hotel New Yorker, New York City.

DEC. 10-12 — Joint IRE-AIEE Computer Conference, Benjamin Franklin Hotel, Philadelphia, Pa.

The Series Amplifier

(Continued from page 13)

bandwidth and, at the same time, increase the gain.

One trick which has been used with great success in making compact amplifiers is to calculate the value of load resistor required, convert it to the equivalent series resistance needed, and then wind the coil with insulated resistance wire of the proper gauge to give the right number of "turns" and "ohms" simultaneously. The relation between equivalent parallel and series resistance for loading i.f. coils is:

$$R_{series} = R_{parallel} / (1 + Q)^2$$

Another trick which may be used, provided the stage bandwidth required is 5 megacycles or more, and the signals to be handled are small (1 volt or less), is to operate the tubes at zero bias. This is an excellent way to save space, since it eliminates a resistor and capacitor in each stage, but remember the bandwidth and signal requirements, and be sure to measure the series plate current and keep it within the rated limit. The use of zero bias will require B+ voltage of only about 50 volts per stage. A schematic of the zero bias circuit is shown in Fig. 5.

It is, of course, possible to operate the series amplifier string on an inverted power supply. In this circuit, B+ is grounded, as is the last stage plate return; and the first cathode is bypassed to ground and fed with high B-. This is a convenient way to have the detector operate at d.c. ground potential.

The above remarks apply, in general, to front ends of tuners. It might be well to point out that the Wallman or cascode low noise circuit is especially suited to the series amplifier circuit. Several adaptations of the series-type Wallman circuit have been built and perform satisfactorily. Their simplicity is unexcelled.

Low frequency amplifiers are another classification in which the series amplifier can be applied. Very high-gain, compact, audio voltage amplifiers can be built with this technique. The coupling impedance is an audio choke. It should have the same characteristics as the audio choke in conventional amplifiers, namely, maximum inductance at rated d.c. current for good low-frequency response, and minimum self-capacitance for a high resonant frequency and good high frequency response.

When using the series amplifier method for a Class C frequency multiplier string, high bias voltage must be obtained either by using a large cathode bias resistor or by using RC coupling in the grid circuit. The latter method does away with one of the chief

advantages of the series amplifier, simplicity; but the convenience of a low-current, high-voltage B+ requirement remains.

Narrow-band i.f. amplifiers, suitable for communications receivers, can also be connected as series amplifiers. Narrow bandwidth tuned circuits are of prime importance in this application. It must be admitted that transformer coupling is superior in this respect, and if need be, transformers can be used. In any case, shunt capacitance tuning with no resistive loading, and high coil Q should be used. If the shunt capacity is relatively large, the bypass on the cathode resistor can be omitted without any undesirable increase of bandwidth, although degeneration will produce somewhat smaller gain. To avoid degeneration, the bias resistor may be placed in series with the tank circuit. This circuit is shown in Fig. 4.

Many more adaptations of the series amplifier will suggest themselves to the reader. Actually a number of interesting applications have been omitted because of limited space. It is hoped, however, that the information presented here will furnish material for experimentation and study by interested engineers and technicians. Here then, is the series amplifier. What will it do for you?

News Briefs

(Continued from page 24)

Tuesday will include a symposium on color television moderated by D. B. Smith, vice chairman of the National Television Systems Committee. Wednesday morning sessions will be sponsored by the IRE Professional Group on Audio and Wednesday afternoon will be devoted to television.

MEN AND MACHINES

An article entitled "Electronics and Human Beings," in the August issue of Harper's magazine, urges that machines replace men wherever possible in order to eliminate waste of technology. The authors, E. W. Leaver and J. J. Brown, point out that the time is at hand for the electronic management not only of industrial production but of business and governmental communication, of financial movement, and of commercial distribution. The article states, "Widespread use of automata (machines, not men) may bring an era of peace and creative human development, with the amelioration of national and individual neuroses. Men should not be used for routine operations and the automaticity of machines should be encouraged."

Per-Cent Ripple

(Continued from page 32)

In recent years engineering has employed the nomograph, or alignment chart, as a means of simplifying the solution of mathematical equations. The nomographs presented are charts of per-cent ripple for a single-phase, full-wave rectifier with an inductor input which operates at a frequency of sixty cycles per second. These nomographs encompass a single-section filter and a two-section filter having identical component sections, and enable one to find quickly the per-cent ripple for a particular LC section without resorting to the solution of an algebraic equation. This is accomplished by placing a straightedge between the selected values of L and C on the outer scales and reading from the intersecting point on the center scale the value of per-cent ripple.

Typical examples given below illustrate the use of the nomographs and the agreement of results with calculated values.

The ripple equation of a single-section, inductor-input filter operating at a frequency of 60 cycles per second is:

$$\text{Per-cent Ripple} = \frac{83 \times 10^{-6}}{LC} \quad (1)$$

As an example, assume $L = 2$ henrys, $C = 10$ microfarads.

By placing a straightedge between these values of L and C on the diagram the per-cent ripple is read from the center scale as about 4.2%, which approximates within reasonable limits the value of 4.15% calculated from Eq. (1).

The equation of per-cent ripple for a two-section, inductor-input filter of a single-phase, full-wave rectifier operating at a frequency of 60 cycles per second is:

$$\text{Per-cent Ripple} = \frac{146 \times 10^{-12}}{(LC)^2} \quad (2)$$

Using the values of L and C as given in the previous example, the calculated value of per-cent ripple is 0.366%, which is in close agreement with the graphic solution of about 0.37%.

It is of interest to note that the component scales of both nomographs are characteristically logarithmic. This is true since L and C appear in the two previously stated equations of per-cent ripple as mutual multipliers, symbolizing the familiar LC product. Because the equations of per-cent ripple contain no algebraic sums or differences, the respective scales of the inductance, L and the capacitance C are exact multiples of the per-cent ripple scale. For the single-section filter, the scale divisions of either L or C are exact multiples of exactly twice the absolute magnitude of the scale divisions of per-cent ripple. The validity of this statement may be proved in a mathematical sense by referring to Eq. (1). This is an equation in which the factors L and C are first degree variables. However, since the variables form an algebraic product, the equation itself is second degree. Similarly, for a two-section filter the respective scales of inductance L , and capacitance C , are exactly four times the absolute magnitude of the scale divisions of per-cent ripple. Equation (2) indicates that the expression is, respectively, second degree in L and C . Again, these variables form an algebraic product and therefore, the equation is fourth degree. Thus the degree of the algebraic equation is related to the absolute scale divisions of the nomograph. Summarizing, for a single-section filter, it may be stated that one logarithmic cycle on the L or C scale is equivalent to two logarithmic cycles on the per-cent ripple scale; for a two-section filter, one logarithmic cycle on the L or C scale is equivalent to four logarithmic cycles on the per-cent ripple scale.

The constant appearing in the ripple equations depends on the frequency of operation. With regard to either nomograph the constant term of the ripple equation is a determining factor in establishing the physical position of the per-cent ripple scale with respect to the scales of inductance and capacitance. It may be stated that the constant of the equation is a shift factor in determining the relative position of the per-cent ripple scale.

Concerning the rectifier circuit in general, it may be observed from the nomographs that a single-section filter reduces the per-cent ripple approximately one-tenth as much as when a two-section filter is employed. The inductance scale of the single-section filter has a maximum value of 100 henrys. Although this is not a practical value, it serves to illustrate the fact that a single-section does not give a high degree of filtering unless very high values of L and C are used.

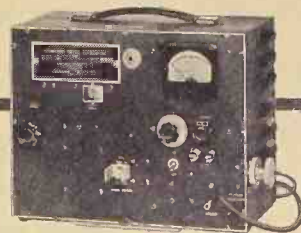

Measurements Corporation
MODEL 78

STANDARD SIGNAL GENERATORS

FREQUENCY RANGE: Choice of two bands; frequency ratio of each band 1.8 to 1 within range of 10 Mc. to 250 Mc. Special single band instruments also available up to 420 Mc.

OUTPUT VOLTAGE: Continuously variable from 1 to 100,000 microvolts.

MODULATION: AM, fixed at 30%.

POWER SUPPLY: 117 v., 50/60 cycles.

MEASUREMENTS CORPORATION

BOONTON



NEW JERSEY



Our 29th Year
QUALITY - PRICE
DEPENDABILITY

VOLTAGE CONTROL PROBLEMS

POWERSTAT VARIABLE TRANSFORMERS are autotransformers of toroidal core design with a movable brush tap which rotates to deliver a continuously adjustable output voltage from a-c power lines. They are available as manually operated or motor-driven models. POWERSTATS feature: excellent regulation, conservative ratings, standard mounting, smooth control and high efficiency. They are offered in 115, 230 and 460 volts; single and three phase; 50/60 and 400/800 cycle types in capacities of 405 VA 60 100 KVA.

5-WAY BINDING POSTS 5 methods of connection. Complete insulation, 30 amp. current capacity, 1000 v. working voltage. Captive head for convenience. Red or black color. 5 connections: 1. Permanent clamping. 2. Spade Lug. 3. Plug-in for Banana Plug. 4. Looping and Clamping. 5. Clip-Lead.



TYPE 116



TYPE 20



5-WAY BINDING POST



TYPE 1156

WRITE FOR FLYER

Type	amps.	List Price
20	3.0	\$ 12.50
116	7.5	23.00
116U	7.5	18.00
1126	15.0	46.00
1156	45.0	118.00
1256	28.0	118.00
Binding Posts		
DF30RC (Block)		.40
DF30RC (Red)		.40

If not rated 25% with order, balance C. O. D. All prices F. O. B. our warehouse New York. No order under \$2.00. We ship to any part of the globe.

LEEDS RADIO CO.

75 Vesey Street
Cortlandt 7-2612

Dept. RN 9
New York City 7

PHOTO CREDITS

Page	Credit
3, 25	Fairchild Recording Equip. Corp.
7, 9	Tracerlab, Inc.
10	Mass. Inst. of Technology
14, 16 (bottom)	Remington Rand
15 (top)	Electronic Associates, Inc.
15 (ctr.)	Computer Corp. of America
15 (bottom)	Laboratory for Electronics, Inc.
16 (top)	Northrop Aircraft, Inc.
18	Nat'l. Bureau of Standards

PER-CENT RIPPLE NOMOGRAPHS

By **CHARLES F. HALM**, Fournier Institute of Technology

The per-cent ripple for single and double section choke input filters can be determined from these nomographs.

(Continued on page 31)

