

FEBRUARY, 1951

**RADIO &
TELEVISION
NEWS**

RADIO-ELECTRONIC

Engineering



TELEVISION

RADAR

ELECTRONICS

RESEARCH

COMMUNICATIONS

MAINTENANCE

RADIO-ELECTRONIC

Engineering

Trade Mark Registered U.S. Patent Office No. 432907

ELECTRONICS • COMMUNICATIONS • TELEVISION • RESEARCH • AUDIO

FEBRUARY, 1951

TELEVISION RELAY LINK.....	M. Silver, L. Staschover and H. French	3A
ELECTRONIC MICROMANOMETER.....		7A
HIGH DEFINITION MONOCHROME TV.....	R. B. Dome	8A
PULSED WAVEFORM FOR BRIDGE MEASUREMENTS	J. C. Monroe and A. B. Kaufman	10A
MICROWAVE SYSTEMS DESIGN.....	J. Racker	12A
IMPEDANCE CIRCLE DIAGRAMS.....	Harold E. Bryan	15A
IMPROVED RAMBERG ACCELEROMETER.....		24A
CONSTANT K TYPE HIGH-PASS FILTER DESIGN.....	Seizo Yamasita	32A

DEPARTMENTS

PERSONALS.....	20A	NEW PRODUCTS.....	26A
NEWS BRIEFS.....	22A	NEW TUBES.....	28A
TECHNICAL BOOKS.....	30A		



RADIO-ELECTRONIC ENGINEERING is published each month as a special edition in a limited number of copies of RADIO & TELEVISION NEWS, by the Ziff-Davis Publishing Company, 185 N. Wabash Avenue, Chicago 1, Illinois.

VOLUME 16, NUMBER 2, Copyright, 1951, Ziff-Davis Publishing Company

COVER PHOTO—By Acme

Preparing for an experiment in the sound-proof room at the Aero-Medical Laboratory, Dr. H. O. Parrack gives the go-ahead signal to Dr. H. E. von Gierke (left). Sleeping guinea pigs are used for this work at Wright Patterson Air Force Base in an exclusive study to determine the effects of noise on hearing.



TELEVISION RELAY LINK

By M. SILVER, L. STASCHOVER
and H. FRENCH

Federal Telecommunication Labs., Inc., Nutley, N. J.

Design and operational data on both transmitter and receiver for 2000 mc. equipment for television relay links.

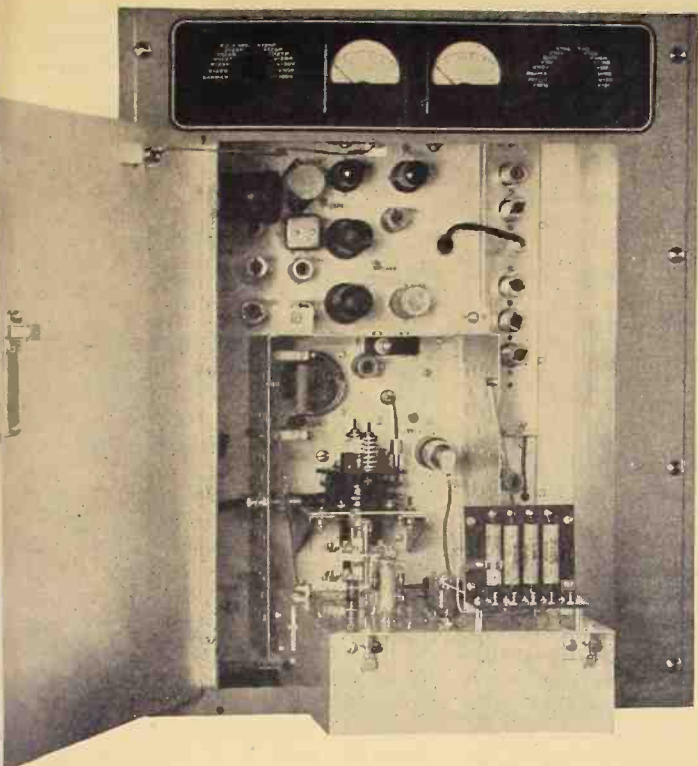

Fig. 1. Close-up view of the TV link transmitter with the front deck down.

EARLY in 1948 the *Federal Telecommunication Laboratories* undertook the design and development of a television radio relay link system. The relay system is intended for high quality, wide-band point-to-point transmission and is designed for a multiplicity of applications, including studio-to-transmitter and portable pick-up service, and multiple repeater operation.

In order to design a link which could be used for the services mentioned, several rigid specifications not necessarily included in the R.M.A. specifications were established. For one thing it was decided that the over-all system transient response for a single link would be .08 microsecond rise time and 5% overshoot. This performance is measured with a test input pulse of .05 microsecond rise time and 2% overshoot. The link signal-to-noise ratio was established as 50 db. below video level and the link transfer characteristic set at 10% black to white compression. Further, since it is intended to use the link in repeater service, and unattended operation is envisaged, the transmitter is crystal stabilized to an accuracy of $\pm .01\%$ and the receiver local oscillator similarly crystal controlled within $\pm .01\%$.

The system operates in the 2000 mc. television pickup band. Frequency modulation is employed with a deviation of 7.5 mc. peak to peak. Amplification is

accomplished at both intermediate and video frequencies. The transmitter and receiver systems are identical whether used as a repeater relay or a terminal relay. This means that at each relay point the video is completely demodulated before application to the next transmitter. A typical transmitter-receiver unit is shown in the block diagram of Fig. 2.

The video input to the transmitter is applied to a 5-stage video amplifier whose output modulates the repeller of a power klystron. The klystron used is a *Sperry SRL-7C* which has a power output of approximately 10 watts. The output of the klystron passes to the antenna feed system through a two-stub tuner employed to obtain a better match between the antenna system and klystron. At the center point of this tuner a probe is inserted to secure a small amount of power for operation of other circuits in the transmitter. This probe is lightly coupled to introduce a minimum of mismatch. Three circuits are fed from this probe. The first is an invar cavity calibrated for use as a frequency meter. The second is a cavity-type discriminator whose output is amplified by a two-stage video amplifier furnishing 2 v. peak-to-peak for standard video monitoring equipment. The third probe drives the center-frequency control system. The reference frequency for the center-frequency control system is generated by a crystal

oscillator whose output is multiplied to approximately 2000 mc. and then mixed with the third probe output to produce a 30 mc. beat frequency. The crystal multiplier is keyed on during the horizontal sync pulse periods by keying pulses available from the clamp system. This keyed 30 mc. signal is amplified and fed to a balanced discriminator. If the i.f. frequency is exactly 30 mc., the output of the discriminator will be zero. If it differs from 30 mc., the output is a pulse whose phase and amplitude are proportional to the difference frequency. This pulse is used to drive a differential relay which operates a motor. The motor is connected to the bellows of the klystron so that the frequency corresponding to the top of the sync pulse of the klystron is mechanically referenced to the r.f. frequency.

Control of the sync pulse frequency is employed to conserve modulation bandwidth. Since the average frequency of the composite signal will vary in accordance with modulation, control based on the average would use approximately twice the bandwidth.

If an electronic system of control were used, the mode characteristics of the klystron would cause distortion to the modulating signal. Since the klystron is frequency modulated to almost full modulating capability, adjustment of the controlled frequency along the characteristic would introduce amplitude nonlinearity in much the same manner as would occur when bias is changed in an audio amplifier. Pulling

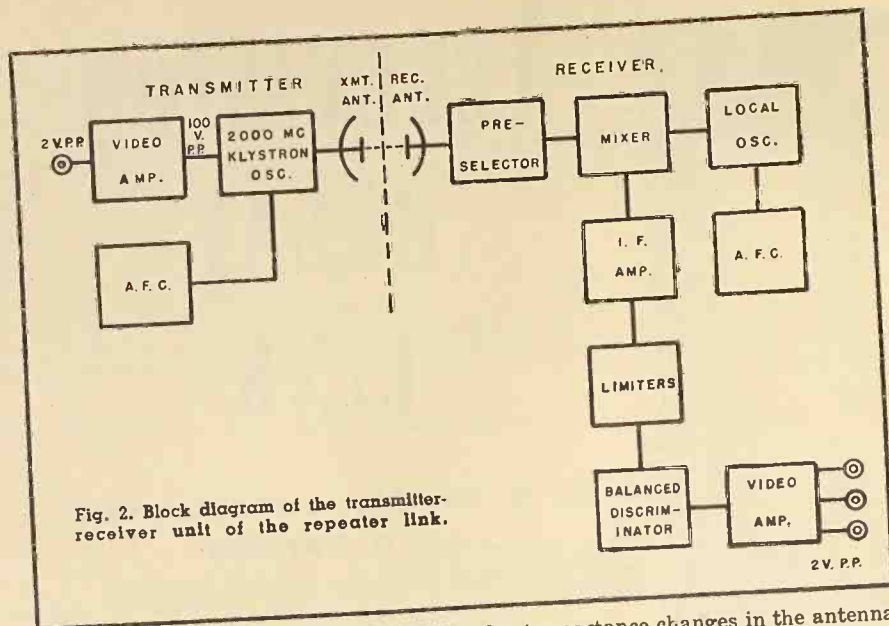

Fig. 2. Block diagram of the transmitter-receiver unit of the repeater link.

nal for the center frequency control system and a synchronizing adjustment for the test circuits, clamping of three of the video amplifier stages.

Before describing the video system, perhaps a brief discussion of the clamps is in order. In the video amplifier, clamps are used to restore the d.c. component throughout the amplifier and to reduce the peak-to-peak signal excursion which results from the asymmetrical nature of the composite television signal.

Consider a television signal changing from white to black and then back to white which is applied to an RC circuit such as an interstage coupling capacitor and grid resistor of the following amplifier stage. The d.c. level of such a varying signal will also change with the content or level change. Since such an RC coupling circuit will not transmit d.c., the resultant signal output appearing across the resistor must in the steady state adjust to zero d.c. component. It follows therefore that the output voltage will be characterized by transient excursions of level at each change in input signal from white to black and back to white, decaying to zero d.c. output at a rate determined by the RC time constant.

These transient excursions can increase the net peak-to-peak signal voltage by 75% or more. This forces the requirement of greater signal handling capacities upon video amplifier stages, and, in an FM system, much larger bandwidths in the r.f. and i.f. stages.

This undesirable response may be avoided by reinserting the d.c. component of the signal at the several amplifier inputs. A d.c. inserter circuit which may perform this function is shown idealized in Fig. 3. The grid resistor in the RC coupling network is replaced by a switch which can be closed during synchronizing pulse period T_1 and open during the remainder of the line period T_2 .

Consider the action of such a circuit on the term $e_{s, sync}$ (e_s) representing a composite video signal, the synchronizing peak levels of which have been altered by time constants in preceding video stages. When the d.c. inserter switch is closed during the sync period, the capacitor is charged or discharged instantaneously to the peak value of the sync voltage. This voltage is maintained during the remainder of the line period T_1 when the switch is opened. When the next sync pulse appears the process is repeated. The video output voltage e_{out} is the algebraic sum of e_s and capacitor voltage e_c . It is apparent that the action of the d.c. inserter upon the distorted input signal is to effect alignment of the synchronizing peak levels. When this is accomplished, the output signal will have had its d.c. com-

due to reactance changes in the antenna system would be similarly reduced by the retuning of the klystron cavity. Three test circuits are provided in the transmitter. The first is a sync pulse and a sawtooth to substitute the normal television signal used to adjust the linearity of the system. This permits complete alignment of the television link without the necessity of providing the external television video signal. The second test circuit is a sine wave sweep of the transmitter for the full 20 mc. capability of the klystron. This can be used to observe misalignment of the antenna systems in the transmitter and receiver or to inspect the i.f. characteristic of the receiver. The third circuit permits the transmitter to be unmodulated and provides a continuous wave which can be useful for orientation of antenna parabolas or propagation measurements. The clamp system provides, in addition to a sync keying sig-

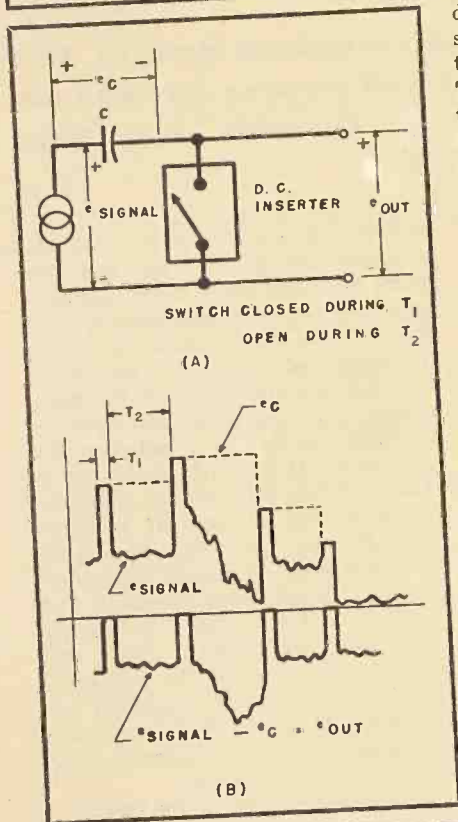
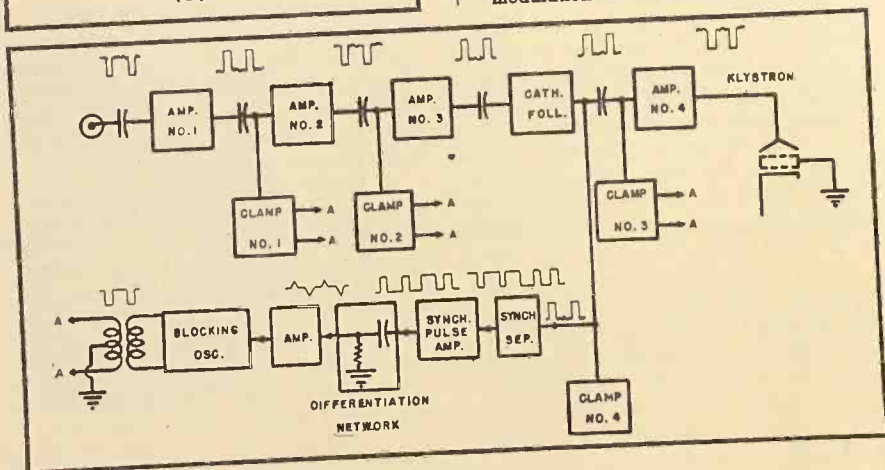

Fig. 3. Block diagram and waveforms showing the action of the d.c. inserter.

Fig. 4. Block diagram and waveforms showing the action of video modulation and clamping system.



ponent restored. A fast acting d.c. inserter which can respond in the above manner to rapid sync level variations obviates the necessity for special low frequency compensation, since the sync pulses repeating at a 15 kc. rate act as amplitude reference markers for low frequency signal variations.

One of the basic requirements of a d.c. inserter is that the time constants for charge as well as discharge of the capacitor C be equal. A practical circuit which will restore the d.c. component of a video signal is the ordinary d.c. restorer consisting of a parallel arrangement of a diode and a high resistance connected in the coupling circuit in place of the ideal switch in Fig. 3. This circuit, however, fails to meet the basic requirement mentioned above. Obviously the charge and discharge time constants are greatly different. The discharge rate through the diode is small while the charge rate through the resistance must be maintained comparatively large to avoid horizontal picture shading, or lowering of vertical sync pulses with respect to the level of the horizontal sync pulses. Another undesirable action of the d.c. restorer is a result of its response to large impulse noise signals. The d.c. restorer will readily charge up the coupling capacitor to noise peaks, but recovery or discharge action will be slow. This results in the undesirable effect in the picture of streaking of several horizontal lines.

A much superior type of circuit in this respect is found in the so called "driven clamp." In this circuit, the charge and discharge time constants can be kept equal and small. Its response to noise impulses therefore cause only a single black line or dot to appear in the picture. The clamp is essentially an electronic switch which is triggered on, or closed, by driving pulses derived from or coinciding in time sequence with the video signal synchronizing pulses.

The clamp system in this equipment, shown in Fig. 4, derives its drive from a blocking oscillator which is synchronized in repetition rate with the horizontal sync pulses of the video signal. The balanced output of the oscillator supplies 1 microsecond driving pulses of required level for operating the several clamps. Three of the five video stages in the modulator are grid clamped. The input stage, operating at low signal levels, and the cathode follower stage, with its inherently low distortion, require no clamping. The sync pulses required for control of the blocking oscillator are taken from the cathode follower output through a pentode sync stripper, which is biased so as to amplify only the sync pulses

above blanking level. The pentode stripper input is clamped to maintain the absolute level of sync pulse peaks constant.

The blocking oscillator action is such that it will respond to sync pulses of frequency no greater than horizontal line rate and will not be triggered by noise pulses occurring between horizontal sync pulses or to vertical period equalizing pulses.

The sync pulse waveform includes horizontal sync pulses as well as vertical equalizing and serrated pulses which occur at a 60-cycle rate. This results in 60-cycle current components which may cause undesirable hum modulation. Such an effect is minimized by differentiating the sync pulses before they are fed to the blocking oscillator for synchronization.

The plate of the modulator is shown direct coupled to the reflector element of the klystron oscillator. As explained previously, for reasons of bandwidth conservation, it is necessary to transmit the d.c. as well as a.c. component of the video signal between stages. It is not practical to employ a clamp coupling between the modulator output and the klystron for several reasons. First, the video level at the plate of the modulator or the repeller of the klystron is of such an amplitude as to require excessive drive for a clamp. Secondly, the repeller electrode current, which varies in magnitude from tube to tube, will seriously impair the action of a clamp circuit much in the same manner as grid current in a video amplifier stage. Finally, the d.c. potential levels at the modulator plate and the klystron repeller element make difficult a practical coupling circuit for clamps.

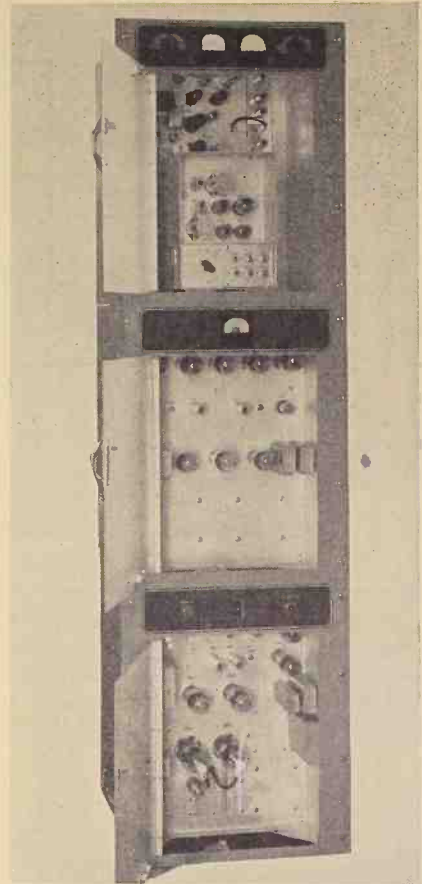

Fig. 5. The transmitter assembled in a standard relay rack.

Fig. 6. The d.c. coupling scheme.

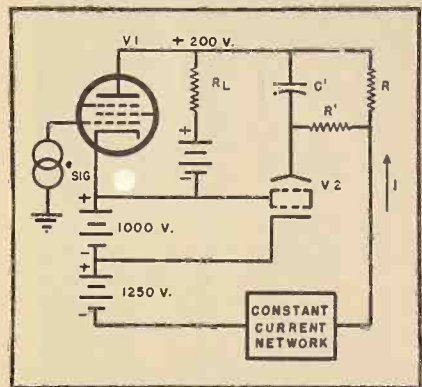
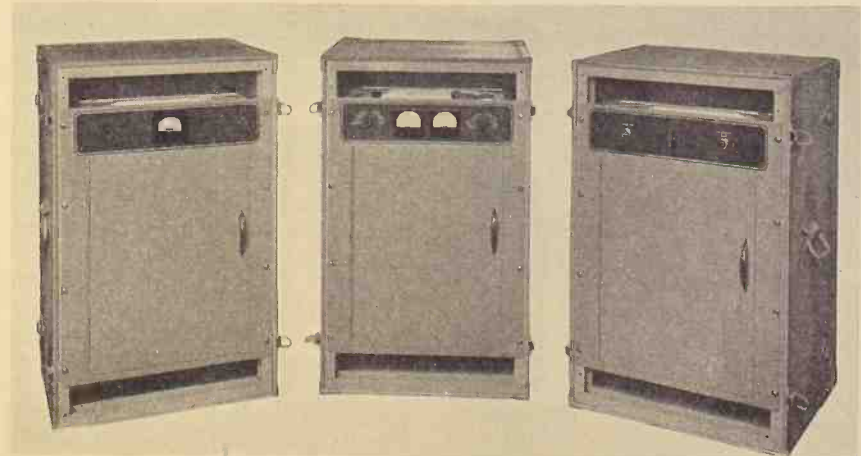

Fig. 7. The transmitter mounted in its three carrying cases.



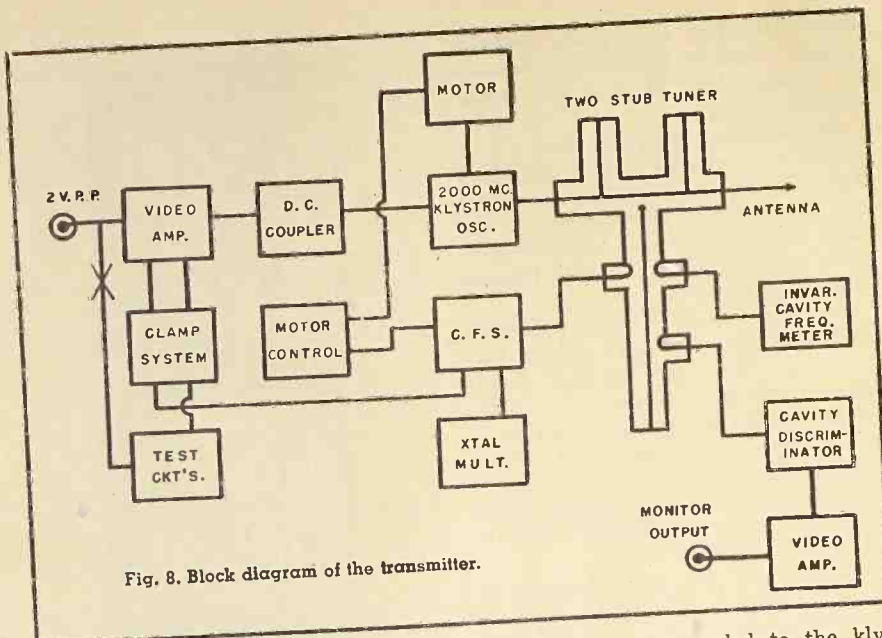
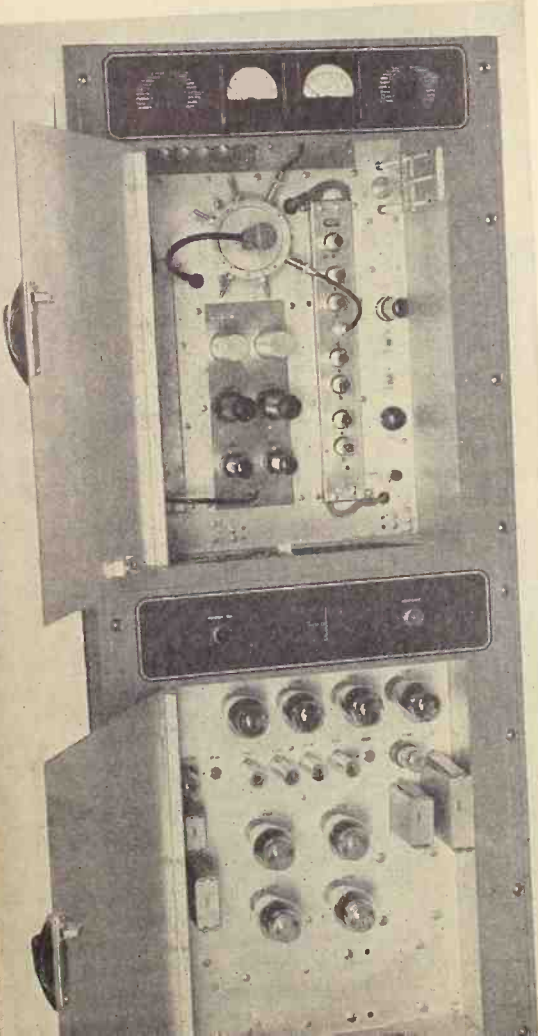

Fig. 8. Block diagram of the transmitter.

The arrangement shown in Fig. 6 offered a satisfactory solution. The klystron is operated with its anode or shell at ground potential and its cathode at 1000 volts. The plate of the

Fig. 9. Rack mounted view of the complete receiver.



modulator is d.c. coupled to the klystron repeller through the load resistance of a current regulator. The current regulator supplies a constant current through R of such a magnitude that the IR drop from the +200 v. modulator plate level provides the proper nominal d.c. potential for the klystron repeller. For d.c. and low frequencies, the current I remains constant regardless of video voltage variations at the modulator plate. This effectively repeats faithfully these signal voltages at the klystron repeller. High frequency video signal components are coupled directly through capacitor C' and resistor R' . Resistor R' also serves to isolate shunting capacity effects of the current regulator circuit. The radiated television signal therefore retains the d.c. component conserving the bandwidth requirement of the receiver.

The receiver employs a simple single superheterodyne system. The antenna feeds through the two-stub tuner to a two-cavity preselector. The cavity preselector includes a crystal mixer using a 1N23B. The local oscillator is a 2K28 receiving type klystron with automatic frequency control. The control system for this klystron is very much simpler than the transmitter system. A crystal oscillator is multiplied in frequency to approximately 2000 mc. and mixed with a portion of the local oscillator signal. The resultant output is 30 mc. beat frequency and is amplified and discriminated in a conventional discriminator circuit. The d.c. output of the discriminator is used to control the repeller voltage on the klystron, thus adjusting the frequency. A limit circuit is provided so that the repeller voltage exists only between two fixed limits, insuring operation on the proper mode. This is an important feature if the equipment is to be unattended. The mixer output

feeds a 120 mc. i.f. system. A low-noise triode input circuit is used which is followed by three triple stagger sections. The i.f. amplifier feeds two stages of grid limiters which in turn drive a balanced discriminator. The i.f. amplifier has a total gain of 90 db. The video amplifier which follows the discriminator is a feedback amplifier having very low distortion and good transient response with approximately 10 mc. bandwidth. The internal impedance of the output circuit is approximately 2 ohms and connections are made to separate output jacks through 75 ohm resistors. Each of the three outputs, therefore, not only operates into 75 ohms but has an effective source impedance of 75 ohms. This, of course, is particularly desirable in avoiding line reflections and in feeding equalizing networks in coax installations. The common two ohm impedance results in negligible interaction within the three outputs. The three outputs are useful since the link in a repeater relay application should be able to provide, in addition to signal for the next relay transmitter, local drop off for a television station, and an independent monitoring source.

The antenna system is designed so that long lengths of cables permitting semi-permanent installations of parabolas are possible. No equipment is mounted at the parabola which means that no active circuits have to be installed or adjusted at the parabola when the equipment is in use. Special air dielectric lines of lengths up to about 700 ft. have been used with excellent standing-wave ratios. This means that if pickup were required at a ball park, where repeat programs throughout a season were anticipated, the antenna and the line could be permanently connected and the equipment which then could be ground mounted could be attached for the specific pickup.

For fixed operation, the transmitter is housed in a standard relay rack. Fig. 5 shows the transmitter assembled in the relay rack. The top chassis contains the complete r.f. circuits, the second chassis the low voltage power supplies which consist of a 250 v. and 150 v. regulated supply, and the bottom chassis the high voltage beam supply and repeller supply for the klystron. The door on the high voltage supply is interlocked. Complete metering facilities are provided so that each tube circuit of the transmitter is monitored by means of a switch so that a fault can be quickly isolated. In addition, the various monitoring facilities incorporated, such as the frequency monitor and power monitor indications, are registered on the meters.

Fig. 2 is a closeup of the transmitter with the front deck down. When this

(Continued on page 27A)

An electronic pressure gauge has been developed

by NBS which will measure pressure in

the range of 1 to 100 microns.

ELECTRONIC MICROMANOMETER

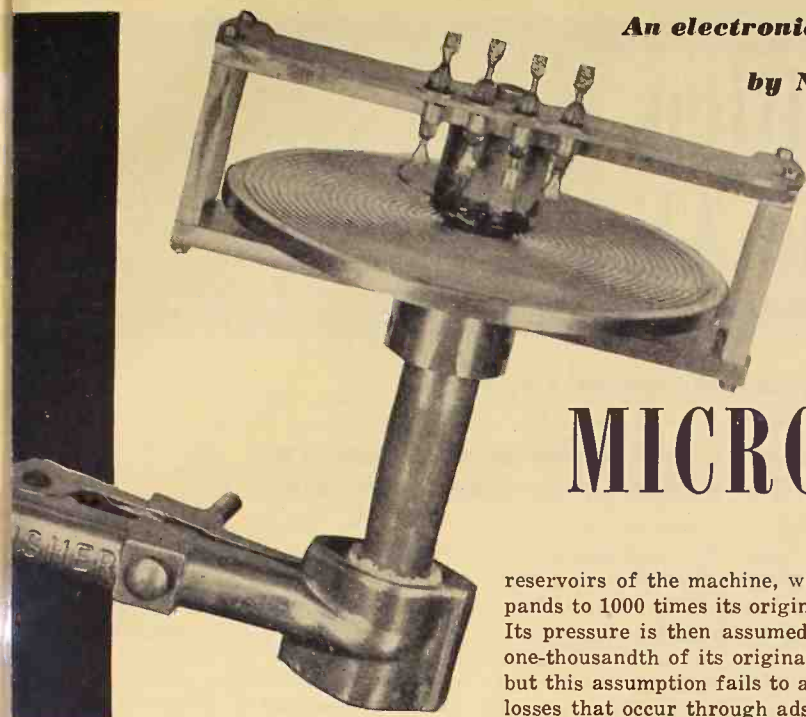

The pressure cell is composed of a very thin corrugated diaphragm sealed to a slightly dished brass disk.

A DIAPHRAGM-TYPE micromanometer, utilizing an electronic pickup, has been developed recently at the National Bureau of Standards to measure differential pressures in the micron region. Constructed for use with a mass spectrometer, the micromanometer gives rapid, direct readings of pressure on a microammeter scale that can be calibrated directly in units of pressure. It is relatively insensitive to temperature changes, will operate in any position, and permits measurements that are totally independent of the type of gas or vapor being measured.

The need for such an instrument arises from the inevitability of error in the usual method of measuring gases for use in a mass spectrometer. A small sample is measured in an ordinary U-tube manometer and passed into the

reservoirs of the machine, where it expands to 1000 times its original volume. Its pressure is then assumed to be one one-thousandth of its original pressure, but this assumption fails to account for losses that occur through adsorption of the vapor by stop-cock grease and the walls of the system, and deviation from perfect gas laws.

It is desirable, therefore, to measure the pressure of the sample in the reservoirs after the losses have occurred. Manometers for the range from one thousandth of a millimeter to one tenth of a millimeter of mercury are usually liquid-level devices, such as McLeod gauges, or depend on thermal effects, such as Pirani or thermocouple gauges. McLeod gauges are accurate, but the presence of mercury or oil vapor introduces difficulties into vacuum work; besides, these instruments are bulky and inconvenient to use. Pirani and thermocouple gauges, while avoiding these difficulties, are inaccurate and unless special care is exercised, give only a rough indication of the vacuum.

The instrument developed at the Bureau consists of a pressure cell and an electronic micrometer, enclosed in a glass dome which can be evacuated or filled to any desired reference pressure. The pressure cell, the heart of the instrument, is composed of a very thin corrugated diaphragm sealed at the periphery to a slightly dished brass disk. This cell is connected to the gas sample so that change in pressure of the gas causes movement of the flexible diaphragm. Movement of the diaphragm in response to pressure variations is measured by a mutual-inductance micrometer placed over, but not in contact with, the diaphragm. Mechanical coupling errors are thus eliminated.

The micrometer was previously developed at the Bureau in connection with the design of indicating devices to measure clearances in journal bearings

(NBS Technical News Bulletin 31, 37, (April 1947). In principle, it makes use of the variation in mutual inductance between two concentric air-core coils which results when the distance of the coils from a nonmagnetic metal surface changes. When the metal is brought immediately adjacent to the end of the form supporting the coils, the mutual inductance is reduced to a minimum by what is effectively a "shielding" action of the metal. As the metal is moved away from the coils, the mutual inductance increases as a linear function of the separation.

In the micromanometer, the metal "shield" is the diaphragm of the pressure cell itself. Radio-frequency current is fed into a primary coil and induces a voltage in a secondary coil, mounted just above the diaphragm. The form supporting the coils is mounted rigidly with respect to the fixed portion (the brass disk) of the cell. Mutual inductance between coils is therefore a function of diaphragm expansion and hence is indicative of gas pressure.

This mutual inductance is compared
(Continued on page 31A)

The electronic pickup is a mutual-inductance electronic micrometer.

Cut-away diagram of pressure cell.

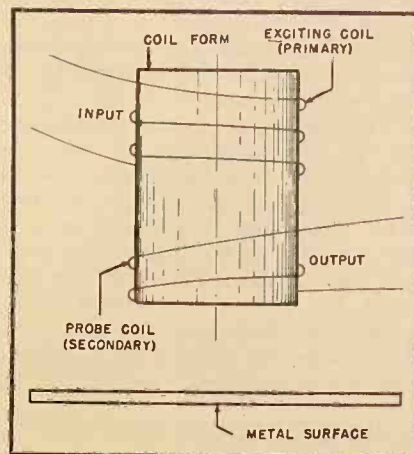
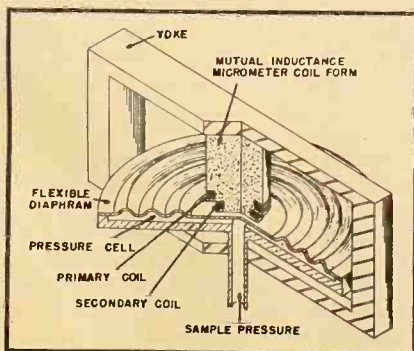

High Definition Monochrome TV

By R. B. DOME, Electrical Consultant

Receiver Division, General Electric Co.

Basic details of a system for increasing monochrome TV definition as much as 50% without increasing bandwidth.

A SIGNIFICANT increase in the definition of a monochrome TV picture may be attained by means of a new system of transmission known as *alternating highs*. This system will provide as much as 50% increase in horizontal resolution without any increase in the transmitted bandwidth.

The fundamentally new feature of this system is the unique treatment of small detail in the picture as compared to the larger areas and larger detail of the picture. Observations have been made which show that the eye is not as susceptible to flicker in small areas as it is to flicker in large areas. Based on this premise, a normal video band may be divided into two approximately equal portions. The low frequency portion is transmitted in regular 60-cycle sequence as in present-day monochrome transmissions. The upper section of the video band may be utilized on *odd* fields for the transmission of picture detail normally transmitted by present transmitters on both odd and even fields. The super-high video band of frequencies, extending beyond the band now capable of being transmitted, is transposed in frequency to fit into the upper section of the band which can be radiated and is transmitted on *even* fields. Thus, if the present band were divided in half, the detail could be extended by a factor of 50%, so that instead of 350 line detail, an effective horizontal resolution of 525 lines could be obtained.

The system can be made compatible by the simple expedient of using the principle of frequency-interlace when transmitting the super-high information. The system is inherently compatible for 75% of the information without such treatment, because the odd fields are exactly like present monochrome odd fields, and the even fields are like present monochrome even fields for the entire lower section of the

frequency band. The only problem remaining is to make the super-high information transmission have a minimum effect on present-day receivers. Since repetitive television information transmitted on alternate fields will largely integrate out because of the persistence of vision, providing the frequencies making up such a signal lie at odd harmonics of half the line frequency, it is proposed to transmit the super-high information in that manner, *i.e.*, by frequency interlace.

The advantages of this system are that (1) sampling is not utilized so that no precision gating is required as in dot interlace, (2) the texture of the picture is not marred by a fine dot structure.

The problem of developing such a system is to provide suitable circuitry for accomplishing the following end results:

- (1) Odd fields to transmit coarse and fine detail as in present monochrome transmissions.
- (2) Even fields to transmit coarse and super-fine detail, with the super-fine detail transposed in frequency to fit into the space normally occupied by the fine detail.

(3) Provision for a re-transposing carrier wave for the superhighs.

(4) Suitable circuitry at the receiver for restoring the picture signal to its full bandwidth.

The Transmitter

The first three items listed above are essentially transmitter problems. At the outset it must be assumed that a suitable camera signal is available; that is, the camera must provide video frequency signals extending appreciably higher than 4 mc., preferably up to 5.5 mc. The block diagram of Fig. 3 shows one method of generating the required signal. The camera produces video frequency signals covering the range from 0 to 5.3 mc. The output of the camera is passed through three wave filters which divide the frequency into three sections, namely,

- (a) 0-1.6 mc.
- (b) 1.0-3.8 mc.
- (c) 3.44-5.3 mc.

The low frequency portion is amplified by a continuously operating amplifier as shown. The middle range, carrying the fine detail, is amplified by a second amplifier and the output of this amplifier is connected in parallel with the low frequency amplifier. This amplifier is keyed on in alternate fields, *i.e.*, it is made conductive for example on all odd fields. The upper range of frequencies, carrying the super-fine detail, is fed to a suitable mixer-transposer to which is also fed a continuous wave of 6.890625 mc., the 875th multiple of half the line frequency of 15,750 c.p.s. The mixer-transposer combines these waves, giving rise to sum and difference frequencies. The difference frequencies are selected by a filter which passes the frequency band of 1.6-3.44 mc. It will be observed that 1.6 mc. comes from 5.3 mc., while 3.44 mc. comes from 3.44 mc. so that an inversion as well as a transposition of the super-highs has taken place. At the output of this filter, a

Fig. 1. Block diagram of a high definition monochrome TV receiver.

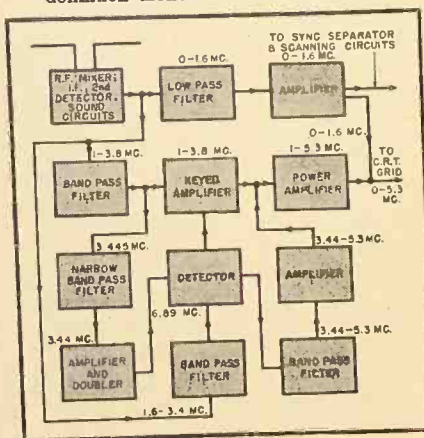

*This article is based on a report presented to the FCC on Sept. 1, 1950.

continuous wave of 3.4453125 mc. is added for use by the receiver in retransposition. The 1.6-3.44 mc. band is amplified by a third amplifier and combined by addition with the 0-1.6 mc. and the 1-3.8 mc. bands. The 1.6-3.44 mc. amplifier is keyed on in alternate fields. The combined signal is combined in a blanking and sync mixer to form a composite television signal which may be fed to the modulator of a conventional television picture transmitter.

The pulse generator chain of the transmitter includes a master oscillator at 6.890625 mc. This is used in the super-high transposer. This frequency is next divided by two to obtain 3.445-3125 mc. for use by the receiver retransposer. This divider is followed by a frequency divider having a ratio of 875 to 1. The factors of 875 are: $5 \times 5 \times 5 \times 7$. The resultant frequency is 3975.5 c.p.s., which is one quarter of the line frequency of 15,750 c.p.s. This divider is followed by an 8 to 1 multiplier which gives 31.5 mc. This is twice the line frequency and is suitable for feeding into and controlling a standard picture transmitter pulse generator. 60 c.p.s. pulses from the pulse generator are fed to a 30 c.p.s. square wave generator which is used to key the two high frequency video amplifiers already described. The transition in keying should take place during the normal vertical blanking period so that the transition is made while the picture tube is cut-off or is black. In this way no transition keying streaks will be seen by the observer.

Gradual cut-off characteristics are purposely provided for the filters so that ringing transients will be held at a minimum.

The choice of 6.890625 mc. for the master oscillator was made so that the high and super-high frequencies would be interleaved or interlaced to best advantage in the interest of achieving maximum compatibility as already explained. For example, the 300th harmonic of 15,750 c.p.s. is 4,725,000 c.p.s. and is consequently a super-high frequency. This becomes transposed to $6,890,625 - 4,725,000 = 2,165,625$ c.p.s., which is $137\frac{1}{2}$ times 15,750, or which therefore lies half-way between the 137th and 138th harmonic of the line scanning frequency. Such a frequency will be self-cancelling on alternate fields insofar as its presence in the picture is observable to the eye.

The Receiver

The receiver is quite conventional except for the video frequency amplifier. This amplifier may be constructed in a number of ways, one of which is shown

in Fig. 1. The output from the second detector is fed to three separate filters. The first is a low pass filter passing the frequencies 0-1.6 mc. common to both odd and even fields. The output of this filter is amplified by the conventional video frequency amplifier and the output of the amplifier is fed to the picture tube gun.

A second filter connected to the second detector passes the band of frequencies from 1.0 to 3.8 mc. These are amplified by a keyed amplifier and then by a second high frequency power amplifier before being combined with the low frequencies to feed the picture tube gun.

A side circuit, connected at the output of the 1.0-3.8 mc. filter, is tuned to the retransposing frequency of 3.445 mc. and this wave is amplified and then doubled in frequency to 6.890625 mc. where it feeds a modulator or detector. The d.c. component of the detector wave is fed to the keyed amplifier so that when 3.445 is present, the keyed amplifier is keyed off.

A third filter connected to the second detector passes the band of frequencies from 1.6 to 3.4 mc. and the output of this filter is fed into the 6.89 mc. detector. The output of this detector will contain a difference band of 3.44 to 5.3 mc.; this band is passed by a band pass filter which excludes the 1.6 to 3.4 mc. band as well as the 6.89 carrier frequency and any traces of 3.445 mc. which may have passed the preceding filters. The output of the 3.44 to 5.3 mc. filter is amplified by a video amplifier and the output of the amplifier is connected in parallel with the output of the 1-3.8 mc. keyed amplifier.

The number of additional tube functions required for this receiver above those required for a conventional monochrome receiver are such that they may be obtained with 4 envelopes, namely:

- Keyed amplifier 6AS6
- Amplifier-doubler 12AX7

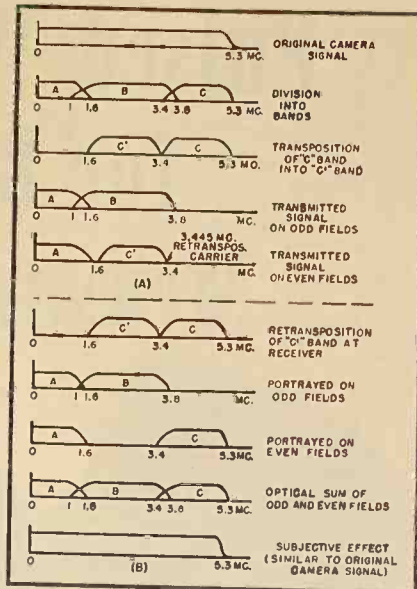

Fig. 2. Summary of steps in transmission and reception of high definition monochrome TV system. (A) transmitter portion and (B) receiver portion of the system.

- High frequency power amplifier 12AU7
- Detector and super-high amplifier 6SF7

The filter response characteristics would be substantially the same as those for the transmitter except transmission bands may be made slightly wider if desired.

Small sections of delay lines may be added as required in order to produce a uniform time delay for all components of the picture.

Fig. 2 depicts the steps in the transmission and reception of this high definition monochrome television system.

Neglecting the effects of blanking, a conventional receiver with a video bandwidth of 3.6 mc. will have a limiting horizontal resolution of 457 lines. The system described, having an effective

(Continued on page 27A)

Fig. 3. Block diagram showing essential functions of the transmitter.

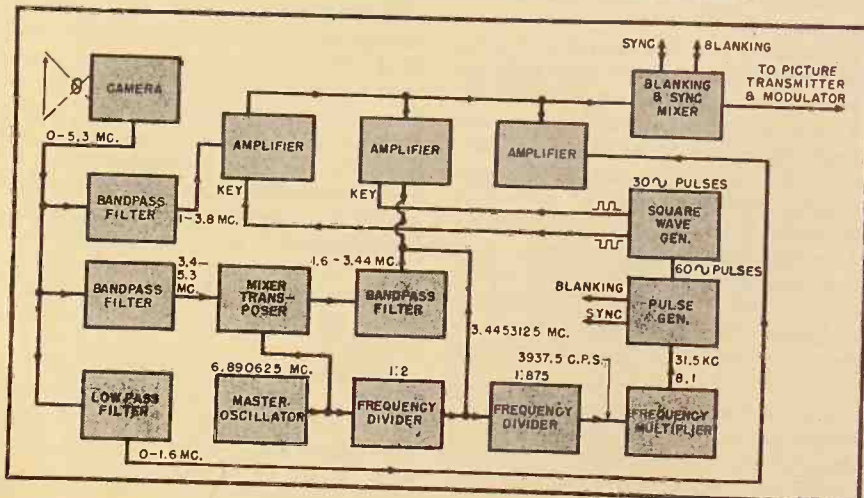

Pulsed Waveform for Bridge Measurements

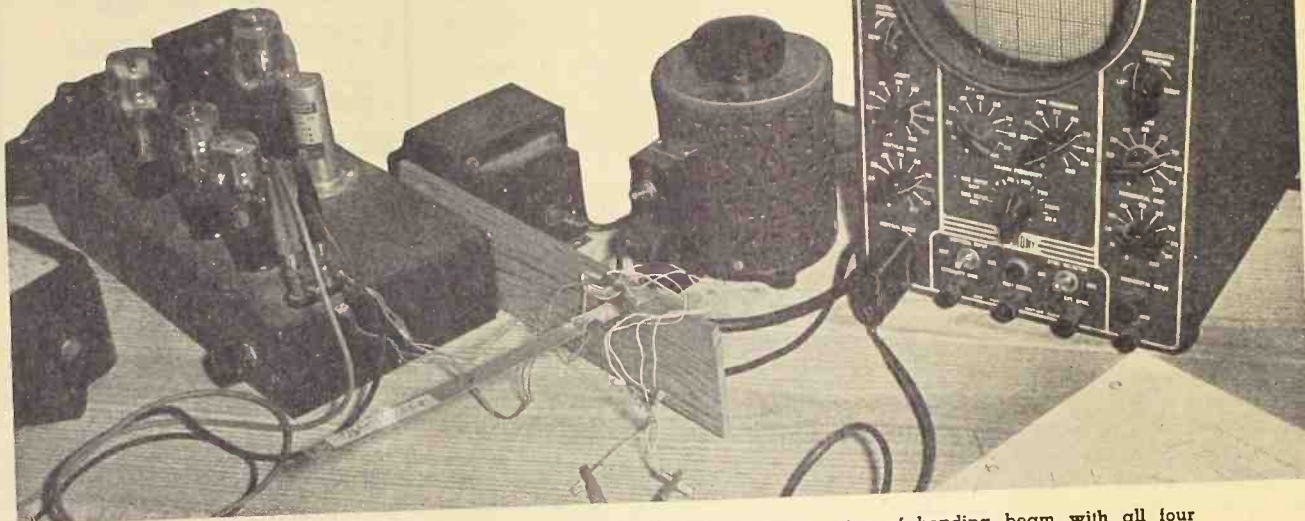

Fig. 1. Experimental test setup of bending beam with all four gauges installed in a full bridge circuit. Pulse supply is at left.

By **J. C. MONROE**
and **A. B. KAUFMAN**

Higher outputs can be obtained from strain gauge bridge circuits with the use of pulsed waveforms.

THE application of a pulsed voltage power supply to a Wheatstone bridge will increase its signal output because of higher permissible input voltage.

Methods of increasing signal output of bridge circuits have been sought for use in telemetering (guided missiles), strain gauge, and industrial equipment applications. Weight saving alone is not the only advantage, but the possible simplification of test equipment and reduction of cost.

Difficulties may be expected with some resistive elements because of high instantaneous temperatures as compared to average temperatures where pulse length cannot be of short enough duration. For a resistive circuit, any type of pulse (or short train of pulses) is satisfactory as long as instantaneous temperatures are not too great. It is also necessary, in some cases, to use peak-to-peak, wideband measuring equipment. The pulse supply itself may present technical or economic difficulties.

The pulse supply need not necessarily supply wave pulses, although that would be optimum. An inexpensive pulse generator can be contrived by using a

simple capacitor discharge system. Experimental work indicates that a rectified 60 cycle pulse, even if only one in every thousand were used, would not give usable increases in signal output because of high instantaneous temperatures.

A pulse waveform includes a rather wide frequency range. An amplifier associated with peak-to-peak measuring equipment which measures a pulsed voltage must therefore have a wide pass band. The measuring equipment must have a high degree of stability. Therefore, these requirements indicate more complex and expensive equipment is necessary than is normally used with a bridge *unless* the signal output is sufficiently increased to require negligible amplification. A particularly important case is that in which the output of the bridge is made sufficiently large to directly modulate a telemetering transmitter.

One of the major possibilities of such a system is to increase the signal output of a strain gauge bridge, and consequently, preliminary research has been carried on in this field.

The signal output from an electrical resistance wire strain gauge is a function of the strain applied to the gauge and of the voltage of the bridge power supply. A limitation of the voltage that can be applied to a strain gauge circuit is the amount of power that can be dissipated from the gauge without too great a temperature rise. The temperature rise must be kept low to minimize problems of temperature resistance changes and to eliminate burning out the gauges. The average temperature rise of the gauge will be a function of the power input and will not be affected by the type of waveform applied. Thus the application of ten volts direct current will give the same average temperature rise as ten volts root mean square of sine waveform. If a peak-to-peak measuring instrument can be used on the output, the sine waveform will give an increase in output voltage of two times the square root of two (*i.e.*, 2.82) when compared with that of a direct current waveform.

The major difficulty with this system lies in the thermal characteristics of the resistive element to be measured. The

heat capacity of the resistive element and the thermal resistance of the insulating material between the resistive element and air or metallic mounting surface will regulate its instantaneous temperature for a given pulse input. The instantaneous temperature regulates the maximum pulse input level.

The use of a pulsed supply with strain gauges can cause instantaneous temperatures which are appreciably higher than the temperatures reached by gauges which have the same average power applied with direct current voltage. A heat balance on a single gauge was made to determine the effect of a pulsed voltage supply. The gauge was installed on a metallic part which was assumed to be at a constant temperature. It was found that the maximum instantaneous temperature of the gauge for a 1/100 second pulse was 0.493 times that of a gauge with the same voltage applied constantly. Assumption was made that sufficient time is allowed between pulses for ΔT to return essentially to zero (which places the gauge again at ambient). Since the temperature varies as the square of the voltage input, the voltage could be increased by the factor $(1/0.493)^2 = 1.4$ without raising the temperature above that occurring with direct current voltage. If pulses of 1/10,000 second length were used, the increase in voltage over a direct current voltage that would cause no increase in instantaneous temperature would be 12. A pulse length of one microsecond would allow an increase of voltage of 112 times the direct current value. These values indicate that either extremely short pulse lengths must be used or greater temperatures must be allowed in the strain gauges. These values were determined mathematically and apply only to a particular strain gauge configuration and its thermal characteristics, but should be typical for gauges mounted on metallic parts. The pulse rate, again, was assumed to be such that sufficient time was allowed between pulses for ΔT of the gauge (or the gauge wire) to return to zero.

It is possible that higher temperatures can be allowed, provided sufficient care is taken in keeping the temperatures the same in opposite legs of the bridge. Of extreme importance will be the installation of the gauges. For example, if an air bubble is allowed under one of the gauges, the thermal resistance between the portion of the gauge above the bubble and the mounting surface will cause the temperature of the gauge to become much higher in this area. Experimentally it was noted that one gauge burned out where a loop of wire at the end of the gauge was slightly raised from the surface causing a higher thermal resistance at that point.

Experimental tests with strain gauges showed significant but unstable improvement in signal output, due to a deficiency in the pulse generator.

Theoretical analysis indicates that change in gauge resistance due to high instantaneous temperatures overcame the small differential change of resistance caused by strain. Normally three methods are used with electrical resistance wire strain gauges to achieve freedom from output variation caused by temperature-induced resistance changes. Resistance wire is used which has a low temperature coefficient. Compensating or "dummy" channels are placed in the opposite legs of the Wheatstone Bridge, so that a change induced in one leg will be compensated by having the same change occur in an opposite leg. Voltage applied to the bridge is kept low so that the temperature of the wire will not be greatly increased by I^2R losses.

The experimental tests were not limited by problems of insulation breakdown between the strain gauge structure. The maximum voltage which can be placed across the gauge before an insulation breakdown occurs would seem to be quite high. Assuming that one side of the gauge is at ground potential, the insulation strength of the paper between the opposite side of the gauge and ground is probably the critical factor. As this paper is impregnated with an acetate base cement, it will probably stand at least 500 and possibly 1000 volts. It is believed, as indicated previously, that factors other than insulation strength will limit the maximum pulse voltage which can be applied to the strain gauges.

The experimental setup consisted of a bridge circuit using four Model SR4, Type A-11 strain gauges. Two of the gauges were installed on the opposite sides of an aluminum bending beam.

(Continued on page 20A)

Fig. 4. Experimental pulse supply and output waveform obtained.

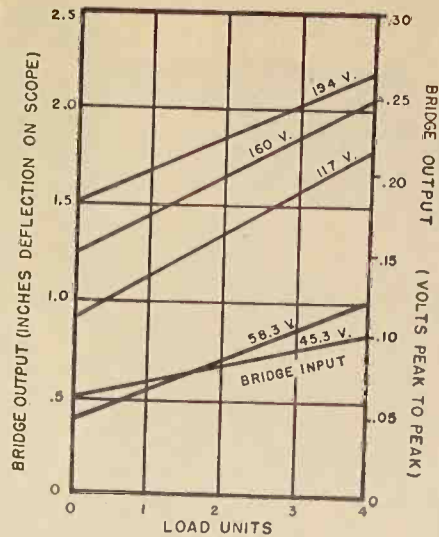
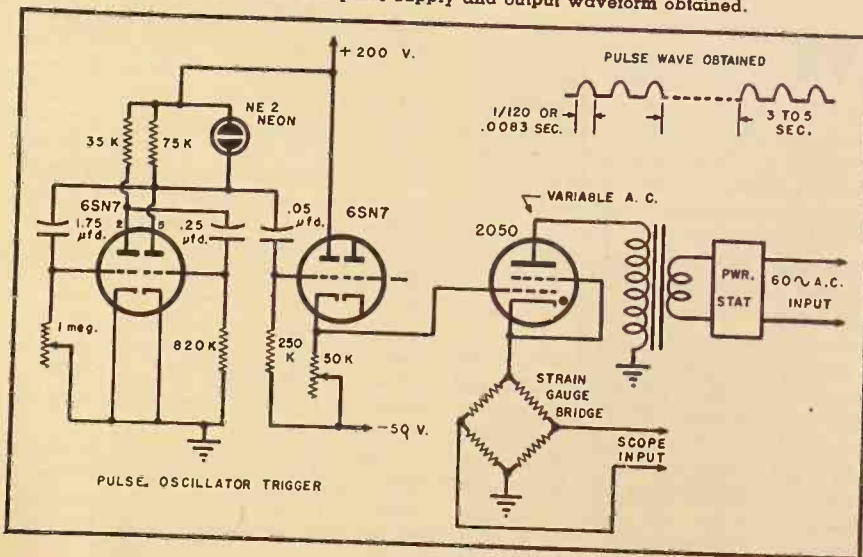

Fig. 2. Bridge output vs. load units for several values of input voltage.

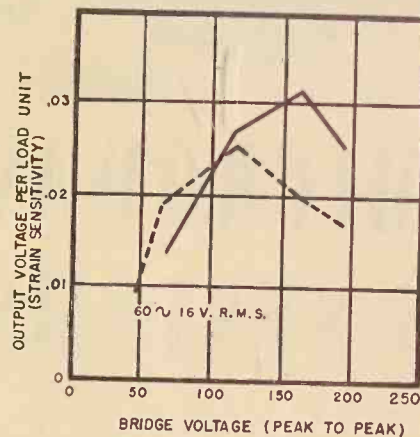
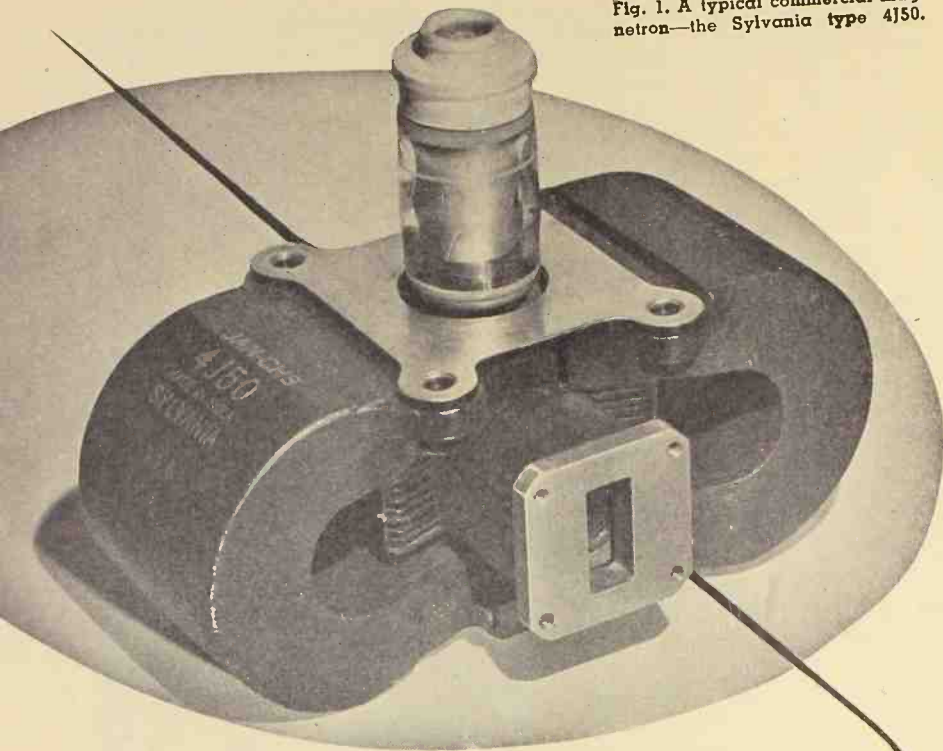

Fig. 3. Output voltage per load unit vs. bridge voltage. All points except first are peak to peak voltages of three half-wave 60-cycle pulses spaced 3.5 sec. for dotted line and 4.8 sec. for solid line.

★

Fig. 1. A typical commercial magnetron—the Sylvania type 4J50.



TV) service: 940 to 960 mc.; 1850 to 2200 mc.; 2500 to 2700 mc.; 3700 to 4200 mc.; 5925 to 6245 mc.; and 6575 to 7125 mc. There are advantages and disadvantages to the use of any of these frequency bands and the one chosen will depend upon the application of the link, features to be emphasized, tube and components readily available, and individual judgment of the engineer.

From an economic viewpoint, the increased cost of power generation as the frequency is increased is offset by the greater antenna power gains that can be obtained (using same elements) so that there is not a great variance in the cost per watt of effective radiated power. However, there is a maximum limit to the antenna power gain that can economically be tolerated. Increased antenna gain means a higher degree of directivity.¹ If the radiated power is confined to a very narrow beam, any slight sway of the supporting towers will cause a "miss" of the receiving antenna. A tower that would be sufficiently rigid to avoid "misses" would also be bulky and expensive. Practical considerations therefore limit antenna gains to the point where beamwidth is greater than 2 degrees. From the viewpoint of minimizing diffraction effects,² it is desirable to have even wider beamwidths.

The availability and size of components must also be considered. A number of lighthouse triodes, klystrons, and magnetrons (such as the one shown in Fig. 1) are being manufactured. The price and production of these tubes should be ascertained when determining the frequency band to be chosen. As the frequency increases, the size of components decreases. This is an advantage in some respects, up to a point where they become too small to be handled conveniently and their adjustments become too critical. Finally, the previous experience of the company must be reviewed, for some of the developmental work may have been effected on other projects. A number of commercial links on the market today are modifications of similar links which were engineered for the armed forces.

Carrier Power Requirements

Once the frequency band is chosen, the next important parameter to determine is the carrier power output required from the transmitter. For the first general calculation it is reasonable to assume that a receiver with a noise factor of about 15 db. can be designed. The carrier power output must be sufficient to provide the minimum signal power input at the receiver that will result in the desired signal-to-noise ratio. This power would therefore be:

$$P_t = P_{rn} X A \dots \dots \dots (1)$$

MICROWAVE SYSTEMS DESIGN

By J. RACKER

Co-author, "Pulse Techniques" (Prentice-Hall, Inc.)

Factors to be considered in choosing frequency band, no. of channels, type of modulation, etc.

MICROWAVE SYSTEMS fall into two classifications, namely, systems developed for government service where virtually all characteristics are rigidly specified, and commercial links which, other than meeting Federal Communications Commission regulations, afford the engineer a wide choice of such parameters as frequency band, number of channels, method of modulation, and so on. In this article we will consider the more general case.

In designing a commercial link, the usual compromise between quality and cost must be made. It is worth remembering, in arriving at this compromise, that microwave equipment frequently competes with wire lines. Hence a major design objective has been to produce equipment that provides more reliable,

higher quality service than equivalent wire lines, and at a lower cost. Thus far, installation of a number of communication links has proven that this objective can be achieved and this fact represents the major selling point for the future large scale use of microwave equipment. An important item in the cost column is the everyday operating expenses of the link. In this connection, great emphasis should be placed on the design of a link that can be simply operated, maintained, and serviced. Complex circuitry requiring highly skilled personnel will undoubtedly raise the day-by-day costs and discourage potential users.

The FCC has allocated the following frequency bands for commercial radio link communication and studio-to-transmitter broadcast (both FM and

where P_t is the carrier power output at the transmitter; P_{rn} is the minimum power input required at the receiver where n hops are involved; X is the transmission line and antenna system power losses; and A represents losses incurred due to path attenuation and fading margin.

To clarify the use of Eqt. (1) a typical problem will be worked out. Assume that the following link characteristics are desired:

- Signal-to-noise ratio (power) 40 db.
- Bandwidth 0.2 mc.
- Number of hops 10
- Transmission line losses 7 db.
- Receiver antenna reradiation 3 db.
- Path attenuation 70 db.
- Fading margin 20 db.
- Receiver noise factor 25 (14 db.)

It has been shown in a previous article³ that the noise at the input of a receiver is equal to:

$$N_o = KTB = 0.4 \times 10^{-14} \text{ watts/mc.}$$

at usual ambient temperatures (2) where K is Boltzmann's constant, T the absolute temperature of the antenna, and B the bandwidth in megacycles.

The noise developed in the receiver itself is determined from the noise factor, F . From the definition of noise factor, the noise introduced by the receiver and antenna can be replaced by an effective input noise power N_i which is equal to:

$$N_i = N_o F \quad (3)$$

In this case, N_i is equal to:

$$N_i = 0.2(0.4 \times 10^{-14})25 = 2 \times 10^{-14} \quad (4)$$

The signal power, P_{ri} , required to provide a 40 db. signal-to-noise ratio (over a single hop) is therefore:

$$40 = 10 \log_{10} \frac{P_{ri}}{2 \times 10^{-14}};$$

$$P_{ri} = 2 \times 10^{-10} \quad (5)$$

For n hops this power must be multiplied by $10 \log_{10} n$, or P_{rn} is:

$$P_{rn} = 10 \log_{10} n P_{ri} = 2 \times 10^{-9} \text{ watts} \quad (6)$$

The signal sent out at the transmitter is attenuated a total of 100 db. (path attenuation 70 db., fading 20 db., transmission line losses 7 db., and receiver antenna reradiation 3 db.) before it reaches the receiver input. The transmitter carrier power necessary to deliver the minimum P_{rn} is therefore:

$$100 = 10 \log_{10} \frac{P_t}{2 \times 10^{-9}};$$

$$P_t = 20 \text{ watts} \quad (7)$$

Method of Modulation

A number of transmission systems, such as those utilizing pulse time, pulse code, or frequency modulation, provide for an improvement in signal-to-noise ratio between carrier conditions and the final output signal. For example, the

carrier signal-to-noise ratio may be 40 db. and the demodulated signal-to-noise ratio (S/N) 55 db. This is usually accomplished at the cost of an increase in bandwidth. The over-all improvement effected, expressed in decibels, reduces the required carrier signal-to-noise ratio by a like amount of decibels. Consequently the minimum receiver input signal, P_{rn} , can also be decreased.

The foregoing is best illustrated by working out a typical example. If pulse time modulation were used in the previous problem, a signal-to-noise improvement of 15 db. can be obtained with a bandwidth of 8 mc. and a duty cycle of 10 per-cent. For this case N_i becomes:

$$N_i = 8(0.4 \times 10^{-14}) 25 = 0.8 \times 10^{-12} \quad (8)$$

Due to the improvement in S/N of 15 db. obtained by this type of modulation, the carrier signal-to-noise ratio required is only 25 db. and the minimum P_{ri} in this case is:

$$P_{ri} = 0.8 \times 10^{-10} \quad (9)$$

and P_{rn} becomes:

$$P_{rn} = (10 \log n) (0.8 \times 10^{-10}) = 8 \times 10^{-10} \quad (10)$$

The carrier power, P_t , required to provide this power at the receiver is:

$$P_t = 8 \times 10^{-9} \approx 25 \text{ watts} \quad (11)$$

However, since the pulse is only "on" 10 per-cent of the time (10 per-cent duty cycle) the average power required to produce 25 watts peak pulse power is:

$$P_{t, av.} = \frac{25}{10} = 2.5 \text{ watts} \quad (12)$$

Thus it is seen that the method of modulation selected can have a definite bearing upon the carrier power required. Furthermore, the modulation method will affect the distortion, number of channels, circuit simplicity and other important characteristics. There-

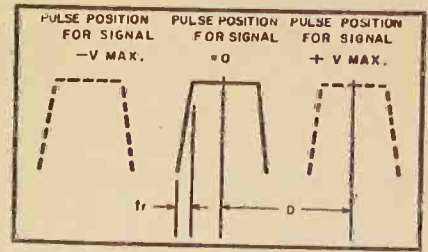

Fig. 2. Time intervals for pulse time modulation S/N calculations.

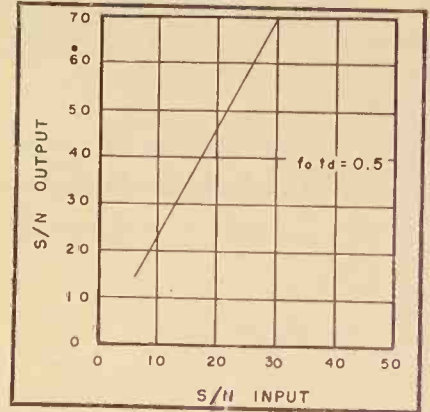
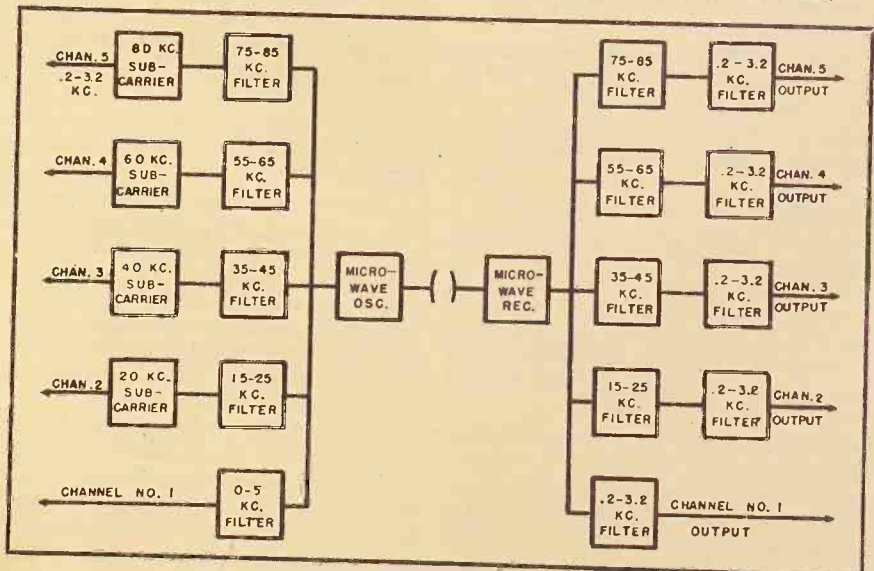

Fig. 3. S/N output vs. S/N input for a PCM system with $f_o t_d = 0.5$.

fore, a review of some of the more widely used modulation methods, together with a general analysis of their characteristics, is presented in this article.

The method of modulation is closely associated with the number of channels to be multiplexed. All microwave links designed to date include provisions for multi-channel operation with the exception of television links. Two methods of multiplexing have been utilized, i.e., frequency division and time division. In frequency division, each audio channel is associated with a sub-carrier

Fig. 4. Frequency division system using double sideband modulation of sub-carrier.



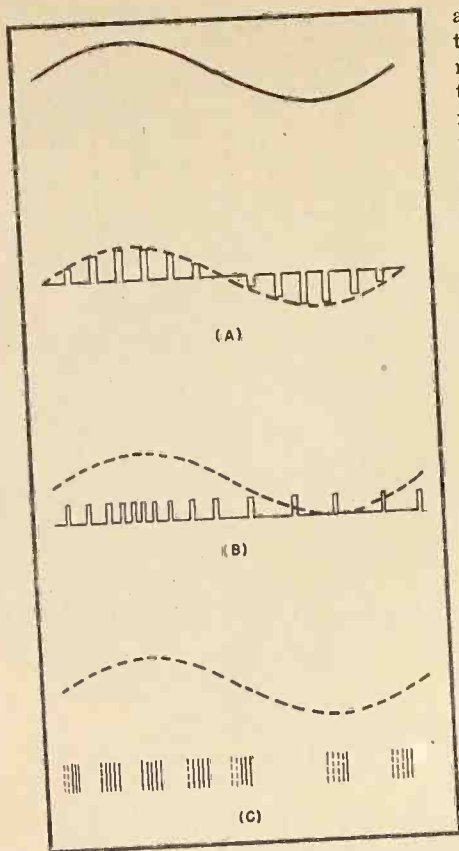

Fig. 5. Three methods of pulse modulation: (A) PAM, (B) PTM, and (C) PCM.

frequency. For example, a four channel frequency division system may have sub-carrier frequencies of 10, 20, 30,

and 40 kc. Each audio circuit modulates the sub-carrier identified with its channel. The modulated sub-carriers are then combined and used to modulate the microwave carrier. At the receiver these channels are then separated by frequency selection and the sub-carrier filtered out, restoring the original audio signal. See Fig. 3.

Three systems have been used for modulating the sub-carrier, namely a) single sideband amplitude modulation; b) double sideband amplitude modulation; and c) frequency modulation. Single sideband modulation is the one in general use for long distances over wire and cable because it is most economical in bandwidth. In this system a gross bandwidth of 4 kc. per channel has been standardized, increasing the band required for good telephone quality by a factor of 1.25 to provide suitable spectrum guards. Economy of bandwidth obtained in this manner is offset by the need for special circuits for filtering out the carrier and unwanted sideband. In applications where simplicity is of prime interest and bandwidth secondary, double sideband modulation can be used. However, since single sideband carrier equipment is utilized commercially to a great extent over wire lines, this method is usually employed in radio links (though the reduction in bandwidth is not too significant at microwave frequencies) to permit integration with existing wire line networks.

Frequency modulation of the sub-carrier is now finding increased application, particularly in carrier telegraphy, because of the improvement in signal-to-noise ratio obtained. The microwave carrier is almost always frequency modulated (in frequency division system), again because of the S/N improvement. This improvement is given by the following equation:

$$(S/N)_f = (S/N)_a \sqrt{3M} \quad (\text{for random noise r.m.s.}) \quad (13)$$

where $(S/N)_f$ is the signal to noise ratio of FM; $(S/N)_a$ is signal to noise ratio of AM; M is the modulation index which is equal to the maximum frequency deviation divided by the maximum audio frequency. For example, if the frequency deviation is 75 kc. and the maximum audio frequency is 15 kc., M is equal to 5.

All frequency division methods have one common disadvantage, that is, the transmission system must be linear to avoid cross-talk. A linear transmission system is one in which the relationship between the output and input variations of the significant signal parameter is linear. In AM the significant parameter is the carrier amplitude; in FM it is the frequency or phase of the carrier.

Time Division Multiplexing

In time division multiplexing, samples of each channel are transmitted in time sequence. That is, the instantaneous amplitude of the first channel signal is recorded and transmitted. Then the instantaneous amplitude of the second channel signal is recorded and transmitted, and so on for each channel. When all channels are sampled, the process is repeated. The sampling frequency should be at least twice that of the highest audio frequency to assure proper separation of audio and sampling frequencies. In this case, since only one channel is being transmitted at one time, cross-talk due to non-linearities in the transmission system are minimized.

Pulse modulation is particularly suitable for time division multiplexing since one of its inherent characteristics is that only one increment of the signal is transmitted at any one instant. Many methods of pulse modulation are available including PAM, in which the pulse amplitude is variable; PTM wherein the time between pulses is proportional to the modulation; and PCM where a coded type of modulation is used. The latter two methods are constant amplitude systems and limiters and other noise reducing devices may be employed effectively to take advantage of this characteristic. Pulse modulation plus constant amplitude is especially important.

(Continued on page 29A)

Table I. Summary of the characteristics of various multiplex systems.

Type of Multiplexing	Type of carrier modulation	Effect of repeaters	S/N and use of bandwidth	Remarks
Frequency Division	AM	Accumulation of noise Accumulation of distortion	Minimum Bandwidth Could be used for TV	Used in long line telephony with single sideband modulation
	FM	Accumulation of noise Phase error can be corrected	Increase of bandwidth reduces sideband clipping and may provide S/N improvement	Used in carrier telegraphy
	FM with sub-carrier	Accumulation of noise	Increase of bandwidth reduces intermodulation but increases noise	
Time Division	PAM-AM	Accumulation of noise Accumulation of distortion	Bandwidth increase reduces inter-modulation Poor S/N ratio	Simplest method adaptable to TV
	PAM-FM	Accumulation of noise Distortion corrected by phase correctors	Increase of bandwidth reduces sideband clipping and may provide S/N improvement	PAM method most suitable for microwaves. Adaptable to TV
	PTM	Accumulation of noise	S/N improvement	Employs simple RC circuits for channel separation
	PCM	No accumulation of distortion or noise	Very large S/N improvement possible	Particularly suitable for very long distance communication

By

HAROLD E. BRYAN

IMPEDANCE

CIRCLE DIAGRAMS

IMPEDANCE circle diagrams or charts can and have saved many hours of tedious calculation in work dealing with transmission lines. Even with radio frequency lines, where the complications are reduced by virtue of the fact that we can usually neglect the effects of series resistance and shunt conductance, calculation of each condition involved in a problem is laborious and time consuming. The usual result is that such problems are often either ignored in the hope that they will solve themselves, or else they are solved by trial and error methods involving the application of much time and sometimes the loss of temper and the results of which are sometimes questionable.

Confucius or somebody once said that a picture is worth ten thousand words. Nothing could be truer in the case of transmission lines. It is difficult, when confronted with an equation full of hyperbolic or trigonometric functions, to visualize what happens when something changes. When the same information is presented in the form of a graph or diagram, the situation is somewhat different. A glance tells just what goes on, and a second glance will tell what the specific values of the various elements involved are, or what to do to obtain a desired result.

Even though their usefulness is often recognized, the fact remains that impedance diagrams have generally not received the attention they should. This is because the man with the problem, be he amateur or engineer, is frequently "scared off" by the frightening aspect of the diagrams. He needn't be. They are complicated in appearance, it is true, but their construction and use are really quite simple. And when once made up, they can be used over and over, reproduced photographically or by other suitable means, and generally be made very useful.

Rectangular Chart

The simplest form of impedance circle diagram to understand and construct is plotted on rectangular coordinates, with the resistance on the horizontal axis and the reactance vertical. Suppose a transmission line of characteristic impedance Z_0 is terminated in an impedance Z_r . When the input impedance is calculated and plotted as above for various lengths of line, the points lie on a circle which is traveled in the clockwise direction as the line is lengthened. When the line is one-half wavelength long the input impedance equals

the load impedance. From this circle the input impedance of a line of any length with the given characteristic impedance and termination may be readily obtained.

The maximum and minimum values of the input impedance are $Z_0(p)$ and Z_0/p , where p is the voltage standing wave ratio (VSWR), and these impedances are resistive. Therefore the circle's center lies on the horizontal (resistive) axis and the circle surrounds the point Z_0 . The center of the circle is at the point

$$\frac{Z_0(p) + Z_0/p}{2}$$

and the radius is

$$\frac{Z_0(p) - Z_0/p}{2}$$

In order to make the chart useful for calculations involving lines of any characteristic impedance, the impedances used in it must be "normalized." That is, instead of plotting impedance directly, we plot impedance divided by Z_0 , making all chart impedances relative to Z_0 . In order to convert a chart impedance to ohms, it must be multiplied by Z_0 . The scale of line lengths is in electrical degrees and measured from a point of maximum impedance for convenience. The maximum and minimum impedances when normalized are of course p and $1/p$.

A whole family of such circles is drawn, as illustrated in Fig. 1A, each for a different value of p . These are called constant- p circles. Circles for values of p not plotted can be obtained by interpolation.

In a similar manner, a family of constant- ϕ circles is drawn for various values of ϕ , the electrical length of the line. The centers all lie on the vertical axis at points determined by:

$$\frac{\tan \phi - \cot \phi}{2}$$

and the radii are

$$\frac{\tan \phi + \cot \phi}{2}$$

The number of circles drawn is arbitrary, but enough should be used to allow for reasonable accuracy in interpolation.

The point (1,0) may be considered the constant- p circle for $p = 1$. This is because in order for $p = 1$ the line must be terminated in its characteristic impedance, and the input impedance of any length of line is then Z_0 . The vertical axis is the circle for an infinite VSWR. Clockwise rotation on this circle is an upward movement on the axis. This shows that the input impedance of a line of infinite VSWR is always purely reactive, except at the quarter-wave points.

The method of construction is illustrated in Fig. 1B. It is not as tough a job as it appears, for several reasons. In the first place, it isn't necessary to figure out the value for the radius of the constant- p circles, since the value of p determines where the circle hits the resistance axis.

For the constant- ϕ circles, however, both the centers and radii have to be determined. Again, this is not as bad as it might be, because a little study shows that the centers and radii for several circles are all the same, and so therefore are the circles. For example, the 10° line takes the same radius and center as the 100° line; and the 80° and 170° lines have the same radius as the 10° and 100° lines, with the center located the same except on the other side of zero. The only difference between the 10° and 100° lines is that they change from one to the other

when they cross the resistance axis. So there are fewer lines to draw than we thought at first. The whole works can be figured out and drawn in a surprisingly short time. The diagram is best prepared to include values of VSWR no greater than necessary, in order to increase the accuracy of measurement.

The Smith Chart

Another very commonly used form of impedance circle diagram is known as the Smith Chart.¹ This chart is no more difficult to construct than the previous one, although it takes a somewhat different form. Instead of using rectangular coordinates to locate the values of resistance and reactance, circles of constant R/Z_0 and X/Z_0 are drawn. Circles of constant p are not drawn, since they are concentric, with their centers at the point $R/Z_0 = 1$. As can be seen from Fig. 4, this chart includes all values of p from zero to infinity, a considerable advantage in some cases, although some portions of the chart are difficult to read. The electrical distance around the chart is marked in wavelengths, and all

divisions are equal. This makes determining the length of the line easier, since a given length of line is the same anywhere on the chart.

The Smith Chart is used in the same manner as the previous one. It is entered at the point Z_r/Z_0 (the load point), rotated around the chart in a clockwise direction for the length of line, and the value of Z_r/Z_0 read at that point. One complete revolution represents 180° or one-half wavelength. For convenience, an arm pivoted at the center and marked in terms of VSWR will facilitate transfer of the impedance from one point to another on the line.

The circles of constant R/Z_0 have their centers at $1/(1 + R/Z_0)$ on the R/Z_0 axis, with radii equal to the same figure. The constant reactance circles' centers are at $1/(X/Z_0)$ and $-1/(X/Z_0)$ on an axis at right angles to and at the infinity end of the R/Z_0 axis. Their radii are equal to $1/(X/Z_0)$. Rectangular coordinates are used in the construction only of the Smith Chart—not in its use—and the centers of the R/Z_0 circles are measured from the vertical X/Z_0 axis, not from the center.

The construction of the chart is shown in Fig. 2.

Although there are a number of other types of impedance diagrams, these two are by far the most commonly used. Neither appears to have any real advantage over the other. The fact that all possible values are contained within the unit circle of the Smith Chart is an advantage, although expanded charts will be needed for some problems regardless of the diagram used.

The real test of the chart to be desired lies with the user himself. One man may prefer one and another the other type, both having good reasons for the choice. Taken all in all, the Smith Chart is probably the most popular of the two, primarily because it does include all values and because a given length of line is the same anywhere on it.

In some cases it is a lot easier to use admittance than impedance, and in other problems it must be used, as in impedance matching with stubs. The circle diagrams can be used with admittance just as easily as impedance. All the chart impedances become chart admit-

Fig. 1. (A) A simple form of impedance circle diagram plotted on rectangular coordinates. The horizontal axis represents resistance and the vertical axis reactance. (B) The steps involved in the construction of the chart shown in (A).

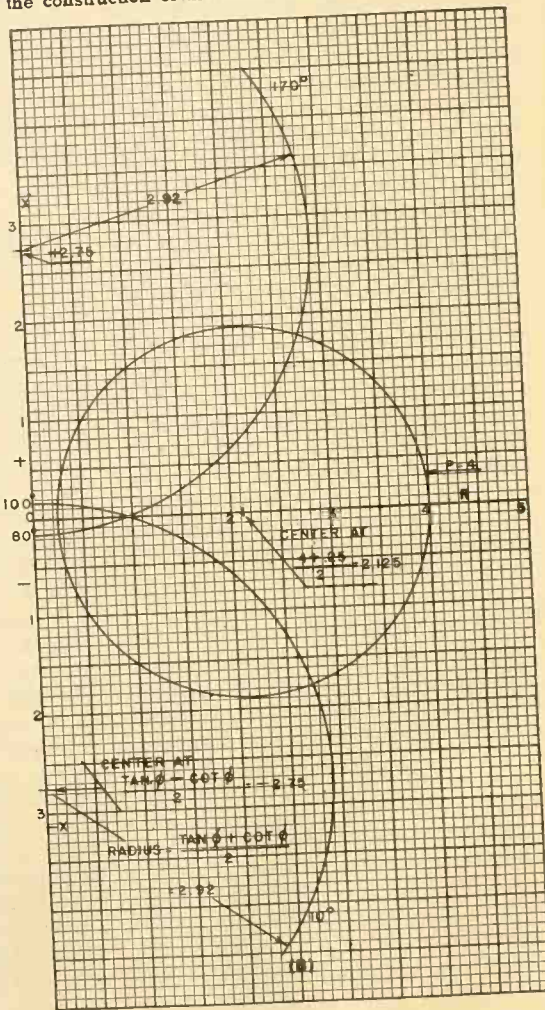
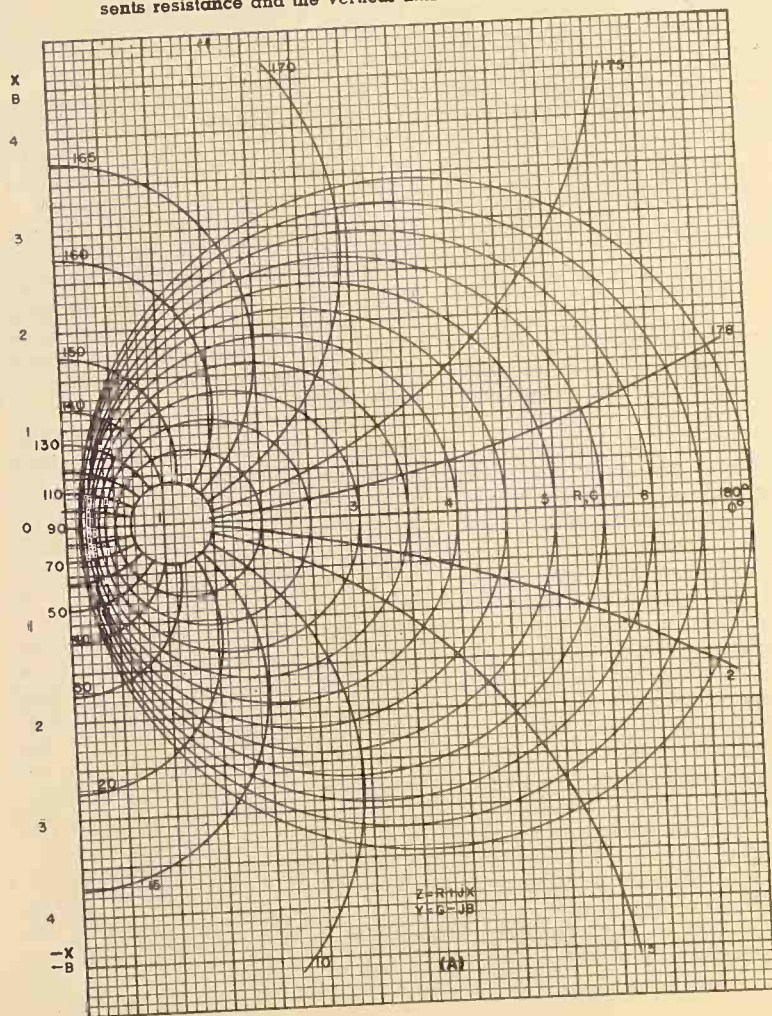

tances, and the constant- ρ circles give the distance along the line from a maximum admittance, instead of maximum impedance. This is a point of *minimum voltage*, instead of *maximum voltage* as with impedance.

When admittance is used, the chart coordinates are G and B , the conductance and susceptance, respectively. Points which represented positive (inductive) reactance before now represent positive (capacitive) susceptance, and vice versa. Motion on the chart is still clockwise going away from the load.

If the impedance is known it is a simple matter to obtain the admittance by a 90° rotation from the impedance point. In the Smith Chart, this is half way around, but in the rectangular coordinate diagram it varies with the position on the diagram. Remember that it is 90° of *electrical* rotation.

Impedance matching may be accomplished by means of series impedance, shunt impedance, or a combination of both. The most common type of series matching element is the quarter-wave transformer. The circle diagram may be used to find the position of the transformer in the line. In the quarter-wave section, $Z'_0 = \sqrt{Z_0 Z_L}$, where Z'_0 is the characteristic impedance of the matching section, and Z_0 and Z_L are its terminating impedances. If Z_0 is the sending end impedance, it must equal Z'_0 if there is to be a match. Thus $Z'_0 = \sqrt{Z_0 Z_L}$.

In high frequency lines, Z_0 and Z'_0 are resistive, so to satisfy the equation, Z_0 must be resistive. This does not mean that the load on the end of the line is necessarily resistive, but that the matching section is inserted so that its load end is at a point of voltage maximum or minimum. This point can be located by rotating clockwise from the load until the resistance axis is reached. The electrical distance traveled to reach this point is the length of line between the load and the matching section. The value of Z_0 thus found is used with Z_L to calculate Z'_0 . There are two points for Z_0 and either may be used. It is better to pick the one nearest the load, unless this is impossible for mechanical reasons.

The use of stubs for impedance matching is also common. Since the input impedance of the stub is purely reactive, it is not generally possible to match impedances by placing it directly at the load (or generator, as the case may be). The stub must be placed at a point on the line where the conductance due to reflection from the load matches the characteristic conductance of the line. Two such points are found in each half wavelength, with the one nearest the load preferred. If a stub less than one-quarter wavelength long is used, and if Y_r/Y_0 is less than one, a

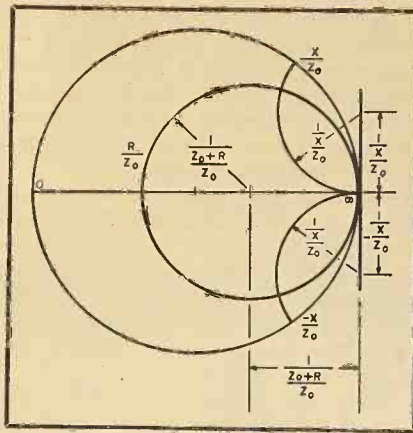

Fig. 2. General method of construction of a Smith chart such as the one shown in Fig. 4 page 18A. Instead of using rectangular coordinates to locate values of resistance and reactance, circles of constant R/Z_0 and X/Z_0 are drawn.

shorted stub may be placed closer to the load than an open one. If the shorted stub length is more than 90° , it may be replaced with an open one one-quarter wavelength shorter.

The point at which the conductances are matched is found by traveling around the chart (clockwise, remember) from the load admittance to a point where the line conductance is 1 on the chart. At that point $G_0 = G_0$, where G_0 is the conductance of the line looking toward the load. The stub's susceptance is equal but opposite in sign to that of the line at this point, since we must establish resonance to cancel the reactance. When the type of stub is decided on, its length is found using this susceptance and the chart.

Remember that when the problem involves parallel impedances, it is essential that admittances be used. The diagrams give series impedance, so with admittance they give parallel values. (Admittances in parallel add like impedances in series.)

As proof of the pudding let's try an example. Both charts are used so that the reader may see how each appears with a given problem.

Example

Use a stub to match the load on a line in which the VSWR is 4 with a voltage minimum located 0.3 wavelength (108°) from the load. This is actually two separate problems: (a) finding the value of the load and (b) finding the position, length, and type of matching stub.

(1) Rectangular coordinate chart. See Fig. 3.

Since the $VSWR = 4$ and the position at a voltage minimum is known, enter the chart at $1/4$ (voltage minimum) and rotate counter-clockwise (toward the load) 108° to find Z_r/Z_0 . Since we are

traveling around the diagram in a reverse direction, we can't just go around to the 108° line. Going half way around the chart (on the resistance axis only) covers 90° , leaving 18° to go; and 18 from 180 leaves 162, so the 162° line is where we stop for 108° travel. This gives us the value of $Z_r/Z_0 = 1.65 + j1.85$.

To find the dimensions of the stub, we must use admittance. Since the value of the load is known, simply rotate 90° around the chart (from 162° to 72°), where we find the load admittance Y_r/Y_0 . Now rotate clockwise (away from the load now) to the point where $G = 1$, which in this case is on the 153° line. This latter distance traveled is the distance of the stub from the load, i.e., $153^\circ - 72^\circ = 81^\circ$. The line admittance at this point is $Y_0/Y_0 = 1 + j1.5$. The stub susceptance must be $-j1.5$, since it must cancel that of the line. This is an inductive stub, so a shorted one should be used. Since the load admittance of a shorted stub is infinite, enter the chart at infinity on the vertical axis (this is a little off the paper, where the positive and negative halves of the axis meet) and go up (clockwise) to -1.5 . This is found at 33.5° , which is the electrical length of the stub. Another point will be found farther from the load, where a capacitive stub will match the line. This point may be used if desirable.

(2) Smith Chart. See Fig. 4.

Enter as before at $1/4 = 0.25$ and rotate counter-clockwise 0.3 wavelength to find $Z_r/Z_0 = 1.65 + j1.85$. To convert to load admittance rotate half way around the chart ($1/4$ wavelength) to $Y_r/Y_0 = 0.275 - j0.29$. From this point go clockwise to the $G/Y_0 = 1$ circle. This distance traveled is the distance from the load to the stub, 0.226 wavelength, and the line admittance is $Y_0/Y_0 = 1 + j1.5$. These figures agree with those found on

Fig. 3. This figure indicates how the example mentioned in the text may be solved by means of the rectangular coordinate chart. Refer to Fig. 1A for a typical rectangular coordinate chart.

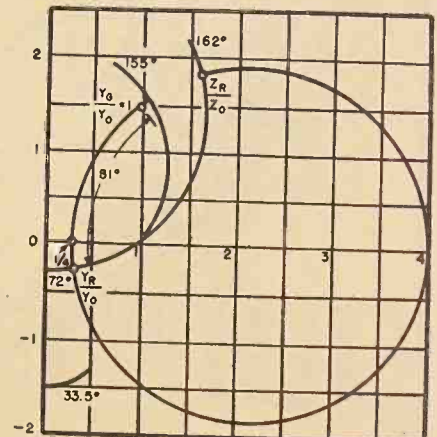

the other chart. To find the length of the shorted stub, enter at $Y_r/Y_0 = \infty$ and rotate clockwise to $B/Y_0 = -1.5$, a distance of $0.343 - 0.25 = 0.093$ wavelength. We have to subtract to find this figure, because 0.25 on the wavelength scale is at the infinity point instead of zero.

The stub length found in these problems assumes that the stub has the same characteristic impedance as the main line.

Impedance diagrams can be used in other types of problems, and although they will in reality be extensions of the uses already mentioned, they are not always obvious.

In high frequency receiver and transmitter design, it is often necessary to determine the length of line which will resonate with a given capacitance or inductance. Knowing the reactance and the impedance of the line, it is easy to find its length from the diagram.

Similarly, the charts can be used in the measurement of unknown reactance at high frequencies by determining the length of line needed to resonate with the unknown. From the length of the line and its characteristic impedance the unknown reactance can readily be found.

Other applications will undoubtedly present themselves to the user as he be-

comes more experienced in the use of the chart.

REFERENCES

1. Smith, P. H., "Transmission Line Calculator"—*Electronics*, Jan. 1939; and "An Improved Transmission Line Calculator"—*Electronics*, Jan. 1944.
2. "Microwave Transmission Circuits," Radiation Laboratory Series, Volume 9. McGraw-Hill Book Co.
3. King, Mimno and Wing, "Transmission Lines, Antennas and Wave Guides," McGraw-Hill Book Co.
4. Slater, J. C., "Microwave Transmission," McGraw-Hill Book Co.
5. Staff, MIT Radar School, "Principles of Radar," Technology Press.
6. Dees, Bowen C., "Graphical Methods of Solving Transmission Line Problems," *RADIO-ELECTRONIC ENGINEERING*, Aug. and Sept., 1945.



Fig. 4. The complete Smith Chart. The solution for the example mentioned in the text is indicated by heavy lines. This chart may be used to solve a great many of the problems encountered in dealing with transmission lines.

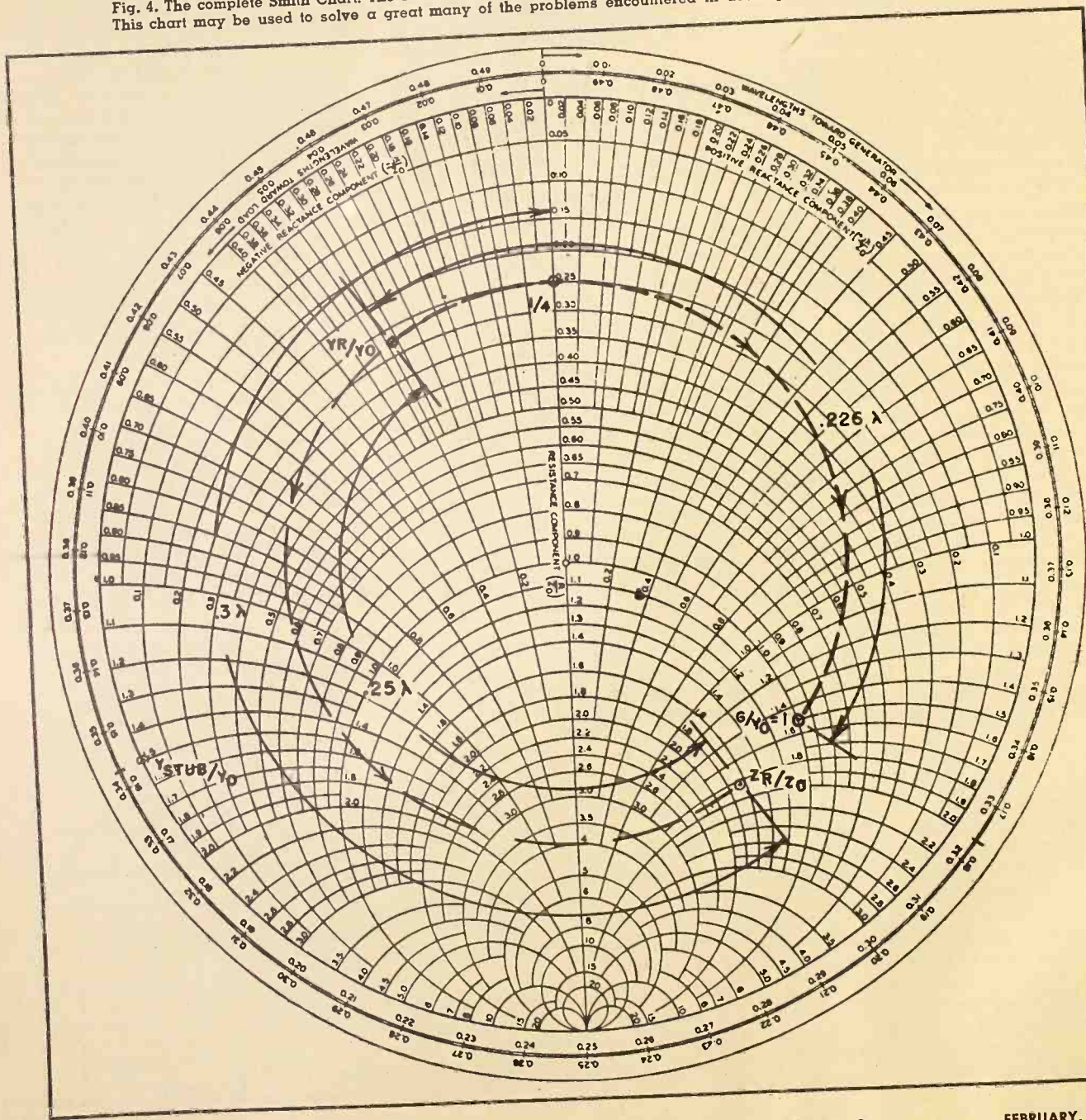

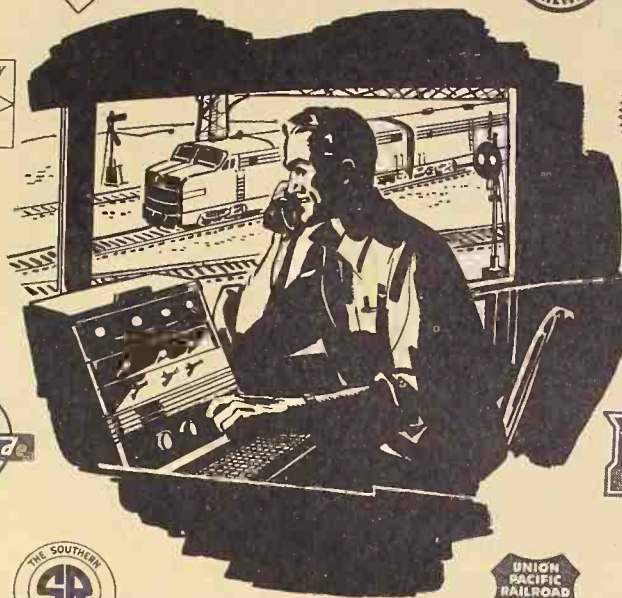

THESE LIFE LINES OF AMERICA . . .

use long life dependable Sylvania Tubes

Progressive railroads everywhere are now using Sylvania radio tubes for multiple communications systems.

In engine-caboose-signal-tower networks, where clear tone and unfailing dependability are of utmost importance, Sylvania tubes are winning increased acceptance. These tubes are designed, built and tested to take more than their share of vibration and rough treatment.

Also, their clarity and freedom from internal noises make them ideal for critical transportation applications . . . in trains, buses, police cars, taxi cabs.

The Sylvania quality tube line is a complete

line. Made in miniature and standard sizes. Also low-drain battery tubes for efficient, compact portable sets.

Get new listings

Call your distributor for new listings and full information. If he cannot serve all your needs immediately, please be patient. Remember, the tube situation is still tight and your distributor is doing his best to deal fairly with all his customers. For further information address: Sylvania Electric Products Inc., Dept. R-1302, Emporium, Pa. *Sylvania representatives are located in all foreign countries. Names on request.*

SYLVANIA ELECTRIC

RADIO TUBES; TELEVISION PICTURE TUBES; ELECTRONIC PRODUCTS; ELECTRONIC TEST EQUIPMENT; FLUORESCENT TUBES, FIXTURES, SIGN TUBING, WIRING DEVICES; LIGHT BULBS; PHOTOLAMPS; TELEVISION SETS

Personals



M. A. ACHESON, formerly chief engineer of the Radio Tube Division, *Sylvania Electric Products Inc.*, has joined the staff of E. Finley Carter, vice president in charge of engineering at New York. Mr. Acheson joined *Sylvania* in 1934 and during World War II directed development of proximity fuze tubes for the Navy Bureau of Ordnance. He is a Fellow in the IRE and holds approximately 30 patents on various circuits and tubes.



THOMAS H. BRIGGS has joined the Research Division of *Burroughs Adding Machine Company* as Research Engineer in the Special Devices Department. Mr. Briggs was formerly a member of the staff of the *Westinghouse Lamp Company* and later of the *Raytheon Manufacturing Company*. He is Chairman of Committee B4-VIII-A of the American Society for Testing Materials, and is a senior member of the Institute of Radio Engineers.



DR. ARTHUR ELDRIDGE FOCKE has been appointed head of the Chemistry and Metallurgy Department of the *Fairchild Engine and Airplane Corporation's* Nuclear Energy for Propulsion of Aircraft Division. Dr. Focke, a graduate of Ohio State University, is noted for his work in translating metallurgical research and development into production practices, and was formerly Chief Metallurgist of the *Diamond Chain Company* in Indianapolis.



DR. JAMES L. LAWSON has been appointed manager of the newly formed Electron Physics Division of the *General Electric* Research Laboratory. Dr. Lawson received his Ph.D. from the University of Michigan in 1939 and served there as a research physicist until 1940 when he joined the Radiation Laboratory at M.I.T. In 1945 Dr. Lawson joined *GE* as research associate in physics and was later appointed head of nuclear investigations.



WILLIAM C. LILLIENDAHL has been appointed research advisory engineer for the *Westinghouse Lamp* Division at Bloomfield, N. J. Active in *Westinghouse* research involving uranium and other rare metals for 22 years, Mr. Lilliendahl received an atomic bomb citation in 1946. He is the author of many technical articles, and is a member of the ACS and the Institute of Mining and Metallurgical Engineers.



JOSEPH P. SPALDING, formerly with the Naval Research Laboratory, has joined the staff of NBS where he will do research in the Ordnance Development Division. Mr. Spalding's new duties will include the investigation of new principles and components of advanced types of electronic ordnance devices. He received his B.S. in chemistry from the University of Maryland and has written numerous articles in the field of electronics.

Pulse Waveform

(Continued from page 11A)

The other two gauges were installed on an aluminum plate of approximately the same thickness. The bridge output was measured with an oscilloscope. The power supply to the bridge consisted of a 2050 thyatron which was allowed to conduct three 60-cycle half wave pulses and was then cut off for a period of three to four seconds. This allowed the instantaneous temperatures to exceed the ratio listed in Table 1 at most input levels. At 190 volts the ratio is approximately 19 and should not have exceeded $1\frac{1}{2}$ to 2 depending upon cooling time between the pulses.

The peak input voltage to the bridge was varied from 60 to 190 volts. For each voltage level input a series of equal loads was applied to the beam. The load at no time was made sufficiently high to cause strain which was not proportional to the load. Fig. 2 indicates the bridge output as a function of load for a series of test loads. The slopes of the curves in this figure are the indication of the bridge sensitivity in volts output per unit load. Fig. 3 shows the bridge sensitivity as a function of peak voltage applied to the bridge.

The equation for a strain gauge which has two active legs is:

$$E_{out} = E_{in} (\Delta R/R)$$

where value of R is proportional to the change in strain. This indicates that the output of the bridge, for a given change in strain, should be directly proportional to the voltage input. In the experimental work the sensitivity of the bridge output increased to a peak for a voltage of 100 to 150 volts and then started to decrease. The reason for the nonlinear increase in sensitivity and the eventual dropping off in sensitivity with an increase in input voltage, which is indicated in Fig. 3, is not known for certain, but probably was caused by exceeding the pulse ratio for the pulse duration used.

Determination of thermal constants makes possible the calculation of the ratio of the maximum temperature reached with a direct voltage and with pulsed voltage, or for a given temperature the ratio of gauge d.c. potential to pulsed potential. This is indicated by the following formulas. These values have not been verified empirically.

The ratio of the maximum temperatures reached with the direct voltage and with pulsed voltage is:

$$\frac{\Delta T_{dc}}{\Delta T_{pulsed}} = \frac{1}{(1 - e^{-0.75})}$$

For the same maximum temperatures, the ratio of E_{pulsed} to E_{dc} is the same as the second part of the above expression.



EL-MENCO CM-15 CAPACITOR

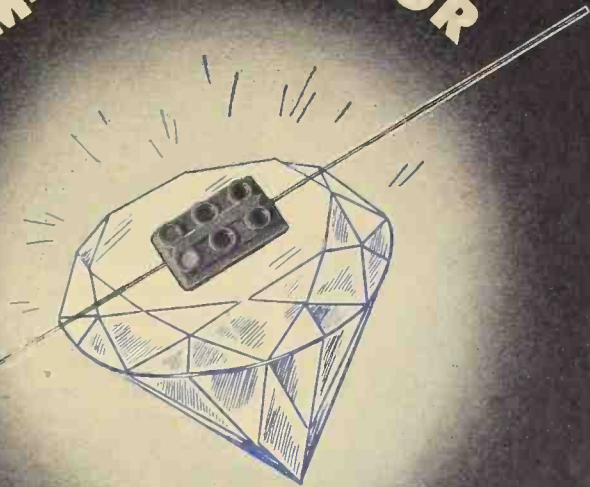

THIS GEM-SIZED UNIT DOES A

GIGANTIC JOB

Each tiny El-Menco CM-15 capacitor performs at maximum efficiency regardless of climate or critical operating conditions. Before leaving the factory, it is tested for dielectric strength at *double* working voltage—for insulation resistance and capacity value. Every gem-sized El-Menco capacitor meets and beats the strictest Army-Navy standards. That's why *you* can always depend on this tiny condenser to give gigantic performance in your product.

A COMPLETE LINE OF CAPACITORS TO MEET EVERY REQUIREMENT

THE ELECTRO MOTIVE MFG. CO., Inc.
WILLIMANTIC CONNECTICUT

Write on your firm letterhead for
Catalog and Samples.

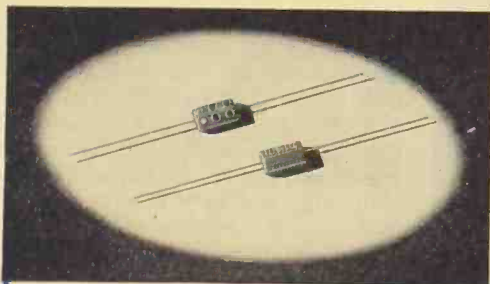

CM-15 MINIATURE CAPACITOR

Actual Size 9/32" x 1/2" x 3/16"
For Television, Radio and other Electronic Applications.
2 to 420 mmf. cap. at 500v DCw.
2 to 525 mmf. cap. at 300v DCw.
Temp. Co-efficient \pm 50 parts per million per degree C for most capacity values.
6-dot color coded.

El-Menco

CAPACITORS

MOLDED MICA

MICA TRIMMER

FOREIGN RADIO AND ELECTRONIC MANUFACTURERS COMMUNICATE DIRECT WITH OUR EXPORT DEPT. AT WILLIMANTIC, CONN. FOR INFORMATION.

ARCO ELECTRONICS, INC. 135 Liberty St., New York, N. Y. — Sole Agent for Jobbers and Distributors in U. S. and Canada.

NEWS BRIEFS

FRENCH PROFESSOR VISITS HERE

Professor Jean-Jacques Trillat, Director of X-ray Diffraction, Sorbonne, Paris, is spending a month in the

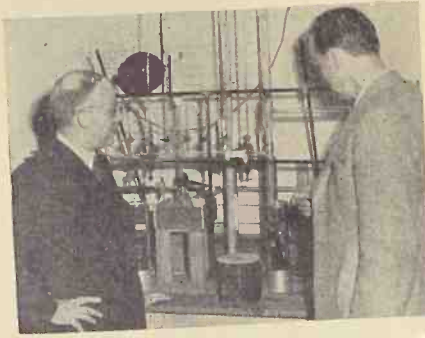

United States visiting a number of educational institutions.

Recently, Professor Trillat visited the New York University College and is shown inspecting a laboratory installation which is being used for Geiger counter research. He was the guest of Dr. Serge Korff (right), Professor of Physics.

PACIFIC ELECTRONIC EXHIBIT

The 1951 show committee of the 7th annual Pacific Electronic Exhibit to be held August 29-31 at the San Francisco Civic Auditorium was announced recently.

A. W. Fry, *Electro Engineering Works*, is committee chairman with two members from Los Angeles and two from San Francisco. Subcommittees were appointed as follows: A. W. Fry, financing, contracts, and management; R. G. Leitner, *U. S. Electronics Corp.*, publicity, prospectus, questionnaires and preliminary program; William Gates, *Dalmo Victor Co.*, IRE relations, field trips, official program, hotel reservations, and education exhibits; Leon Ungar, *Ungar Electric Tools, Inc.*, business conference features, distributor and wholesale relations and program, and representatives participation; Richard Huggins, *Huggins Laboratories*, visitors attendance promotion, folder, registration and facilities, information center, building arrangements and exhibitors services.

The West Coast annual IRE Convention will also be held in the auditorium at the same time and Dr. Leonard J. Black, professor of Electrical Engineering at the University of California,

is the IRE convention chairman for 1951.

RADON TESTING PROGRAM

To protect the health and safety of personnel engaged in work involving the handling or processing of radium, the National Bureau of Standards has set up a radon testing program, checking the quantity of radium ingested by such personnel and the quantity of radon present in their working areas.

The breath of these workers or the air in the work room is sampled periodically and is measured for its content of radon, the gas produced by radioactive disintegration of radium. The quantity of radium ingested in the



system of personnel is indicated by the amount of radon in their exhaled breath. A sample of the worker's breath to be analyzed is obtained by the inflation of a balloon as illustrated. This analysis reveals the amount of radioactivity present and provides the basis for the establishment and maintenance of proper safety measures.

As a result of the cooperative efforts of the Bureau and the officials and hygienists responsible for the protection of the workers from unsealed radium, deaths and injury from radium poisoning such as occurred in the years following the first World War are now being prevented.

IRE ANNOUNCES AWARDS

The Morris Liebmann Memorial Prize for 1951 will be awarded to Robert B. Dome, electrical consultant for the *General Electric Company*, by the Institute of Radio Engineers' Annual Banquet to be held on March 21 at

the Waldorf-Astoria Hotel in N. Y. Mr. Dome will receive the award for his contributions to the intercarrier sound system of TV reception, wide-band phase-shift networks, and various simplifying innovations in FM receiver circuits.

Other 1951 awards to be presented at that time include the Browder J. Thompson Prize which will be awarded to Alan B. MacNee, assistant Professor of electrical engineering at the University of Michigan, for his paper "An Electronic Differential Analyzer." The Harry Diamond Memorial Award, given only to persons in government service, will be bestowed on Marcel J. E. Golay, Signal Corps Engineering Laboratories. Willis W. Harman, associate professor at the University of Florida, will receive the Editor's Award for his paper "Special Relativity and the Electron."

SERVO AMPLIFIER SYSTEM

Now in production at the *Minneapolis-Honeywell Regulator Company* is a servo amplifier system that can be used for correction of error signals, as in standardizing operations of computers, analogs, and similar apparatus.

According to C. C. Roberts, applications engineer for *Honeywell's* Brown division, the system comprises: (1) a converter (if the signal to be detected or measured is d.c.), (2) an amplifier, and (3) a balancing motor.

In broad terms, this servo amplifier and motor can be employed wherever it is required to translate or interpret electrical signals into directional motion. It can also be used for null detection in connection with the bridge or potentiometer circuits used for various functions or apparatus, and as a remote positioning system to provide accurate bi-directional movement.

GE MEASUREMENTS LABORATORY

The new laboratory of the *General Electric Meter and Instrument Division* at Lynn, Mass., described as the



most modern and best equipped of its kind in the world, has unlimited mechanical and electrical services avail-

able to its engineering specialists and technicians. These services are piped in to all work areas by means of pipes and bus ducts suspended from the corridor ceilings. Mechanical services include hot and cold water, vacuum, process steam, nitrogen, oxygen, hydrogen, high-pressure air, and city gas.

The five-story brick, steel, and concrete building houses complete facilities for applied research, product development and design in the field of measurement. Engineers in the new GE Measurements Laboratory are shown putting developmental instruments through electrical tests at a harmonic generator, variable frequency, and d.c. power supply control board.

IMAGE AMPLIFIER

Radiologists at Johns Hopkins Hospital, Baltimore, using a new Westinghouse fluoroscopic image amplifier, are



now able to distinguish between parts of the body which are mere outlines on ordinary fluoroscopic screens. This amplifier increases brightness in the fluoroscopic viewing screen by over 100 times, making possible the movie-like viewing of internal organs and movements from any angle.

Basically, the new fluoroscopic image amplifier is an evacuated cylinder with a fluorescent screen at one end. Backing the screen is a surface which emits electrons when light from the screen hits. These electrons are accelerated inside the tube, and impinge on another fluorescent screen at the other end of the tube.

The image amplifier in use at Johns Hopkins Hospital is an experimental model released for evaluation by the Westinghouse Research Laboratories. Although at the present time the image brightness is approximately 100 times that of an unaided fluoroscope, Westinghouse's goal is a 500-fold increase in brightness.

STUDY ELECTRODYNAMIC AMMETER

A standard electrodynamic ammeter for the v.h.f. range employing a short-circuited ring coupled to a coaxial transmission line has been the subject

of a theoretical and experimental study by Max Solow of the National Bureau of Standards. His work extends a previous study by Turner and Michel at Yale University.

Basically the method depends on a torque measurement on a conducting

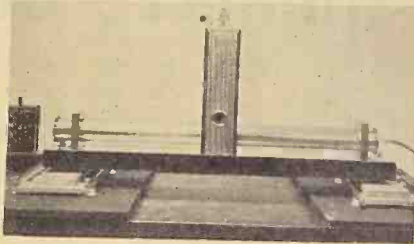

ring immersed in a field which does not change with frequency. This technique provides an absolute, broadband measurement of high-frequency current, but several factors are critical in any actual design.

Shown above is an experimental model now under study at NBS. The horizontal copper tube is the outer conductor of a section of coaxial transmission line. A short-circuited ring, one centimeter in diameter, between the inner and outer conductors of the line, is hung from the central tower by a quartz fiber suspension. Light reflected from a small suspension indicates the

torque on the ring produced by the current flowing in the coaxial line.

MANUFACTURING METHODS

The office of Technical Services of the U. S. Department of Commerce has announced the availability of two important new reports on electronic manufacturing methods. The reports, relating to advanced methods of producing printed circuits and subminiature assemblies, were prepared for the Navy's Bureau of Aeronautics by the National Bureau of Standards.

The report on printed circuits is by Robert L. Henry, and the one on subminiaturization by Gustav Shapiro, both of the Engineering Electronics Section at NBS.

The report on printed circuits discusses characteristics of special components, materials and construction details of the final design.

The report on subminiature assemblies covers the design and production of wide-band i.f. amplifiers, and general problems of subminiaturization.

NEW LITERATURE

Subminiature Tube Data

Sylvania Electric Products Inc., Emporium, Pa., has just released data which provides average characteristics (Continued on page 31A)

ANY SIZE

Spiral Wound PAPER TUBES

from .450" to 2 1/2" I.P.
from 1/2" to 30" Long

SQUARE
RECTANGULAR
TRIANGULAR
HALF-ROUND
ROUND

It pays to check your requirements with PARAMOUNT... because you benefit from PARAMOUNT'S coil-proved design and construction—vast range of stock arbors—wide experience in engineering special tubes! Hi-Dielectric. Hi-Strength. Kraft, Fish Paper, Red Rope, or any combination wound on automatic machines. Tolerances $\pm .002$.

ALSO: Shellac-Bound Kraft paper tubing. Heated shellac forms an adhesive bond between the laminations. Absolutely moisture resistant.

Paramount

PAPER TUBE CORP.

613 Lafayette St., Fort Wayne, Ind.

Mfrs. of Paper Tubing for the Electrical Industry

WRITE ON COMPANY
LETTERHEAD FOR
STOCK ARBOR LIST
OF OVER 1000 SIZES

IMPROVED Ramberg Accelerometer

Increased sensitivity, decreased zero drift, and greater reliability characterize this new model.



The heart of the accelerometer is this twin diode vacuum tube.

RECENT research in the Engineering Mechanics Section of the National Bureau of Standards has resulted in an improvement of the Ramberg vacuum-tube accelerometer which NBS developed in 1946 for the Navy's Bureau of Aeronautics with the cooperation of *Sylvania Electric Products Inc.* The new pickup provides more sensitive and reliable acceleration measurements than did the earlier version which, despite slight erratic changes during its operation, has been successfully applied to both field and laboratory acceleration measurements. Among such uses have been acceleration measurements on pilot ejection devices for high-speed aircraft, in landing impact tests for model aircraft, as well as on aircraft in actual flight.

The vacuum tube acceleration pickup is a twin-diode vacuum tube consisting of a fixed, indirectly heated cathode and two plates, one on each side of the cathode. The plates are elastically mounted so that they will be deflected if the base of the tube is accelerated in a direction perpendicular to the plane of the plates. The new model differs from earlier versions in having stops to limit the motion of the plates, support rods 0.010 inch in diameter to increase the sensitivity of the tube, and a second getter.

The primary design requirement met by the Ramberg vacuum-tube accelerometer is its provision for an electrical signal of sufficient strength to drive directly a high-frequency recording galvanometer and at the same time have a relatively high natural vibration frequency. In the operation of the original model erratic changes or "zero shifts" in its balance point were some-

times encountered. The source of this difficulty has been eliminated in the new model. The "zero shift," resulting from excessive accelerations to the pickup while handling and installing, is prevented by stops which were added to limit the plate excursion and thus prevent overloading. "Zero drift," believed to be due to small fluctuations in the cathode electron emission, has been effectively reduced by three steps: First, the accelerometer was given an aging treatment which made its emission nearly constant; second, two "getters" instead of one were used to improve the electrical characteristics; and third, the sensitivity was increased by a factor of 25 to make the remaining random output negligible compared with the output due to acceleration.

Because of promising results obtained with both the original and improved tube, an extended developmental project on the fundamentals of acceleration measurements is now under way as part of the NBS program on basic instrumentation, which is cooperatively supported by the Office of Naval Research, the Office of Air Research, and the Atomic Energy Commission.

To evaluate the performance characteristics of the accelerometer, its natural frequency was determined experimentally by connecting it to a specially designed Wheatstone bridge circuit which allows the output from each plate to be obtained separately. This output was applied to the vertical plates of an oscilloscope whose horizontal plates were connected to an audio oscillator. The accelerometer was then tapped gently to excite its natural vibration and the audio oscillator adjusted until the oscilloscope showed a Lissajous ellipse. The frequency of the oscillator for this condition was taken as the natural frequency of the particular accelerometer plate being tested. The natural frequencies of the plates of seven different accelerometers were within 1 cycle per second of the average value of 161 cycles.

The plate-to-cathode resistances were measured after a warming-up time of 20 minutes. The heater voltage was set at 7 volts and the plate voltage at 10 volts—the normal operating voltages for which the accelerometer was designed. Resistances were found to range between 118.3 and 263.5 ohms.

The Ramberg accelerometer being used to measure the vibration of a structural model of an airplane wing.

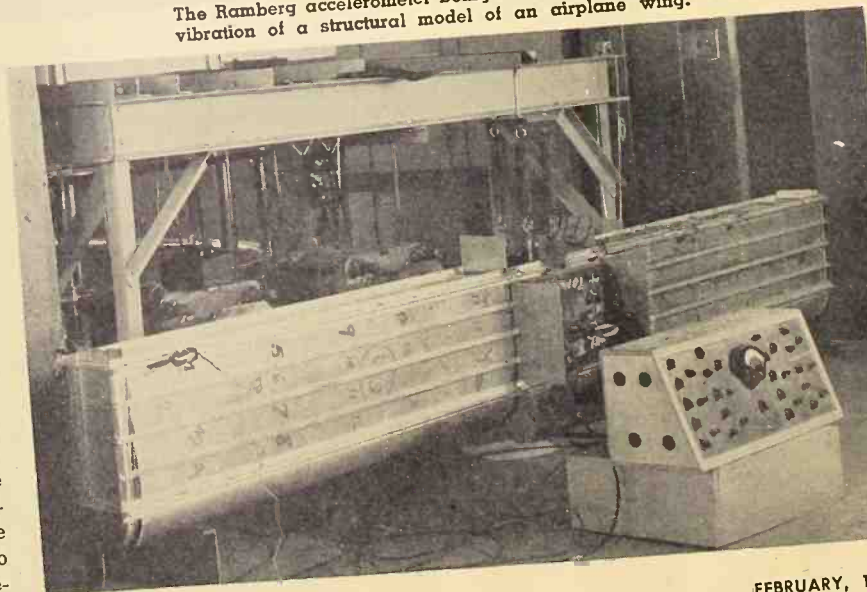

The ratio of the two plate resistances for a given accelerometer fell between 1.01 and 1.91. A calibration factor was computed from measurements of the average percentage change in plate resistance per g when the accelerometer was reversed in the earth's gravitational field. The values of the calibration factor for the seven pickups ranged between 8.6 and 11.6 per-cent per g .

The accelerometer output in the range from $1g$ to $-1g$ was also determined by connecting it in a bridge circuit and mounting the accelerometer so that it could be set at prescribed angles in the earth's gravitational field. The current output per g of the bridge circuit into a 9-ohm galvanometer for the seven accelerometers tested was between 3.5 and 7.3 milliamperes.

The "zero drift" test was conducted after a twenty-minute warm-up by measuring plate resistances and unbalance at ten-minute intervals over a period of four hours. During this test, the vacuum tube was mounted rigidly with the plates in a vertical plane. "Zero drift" in g units was obtained by dividing the "zero drift" in milliamperes by the output of the tube in milliamperes for $1g$ change in acceleration. The largest "zero drift" over the four-hour period for the seven tubes tested was 0.040 g ; the smallest was 0.006 g . This magnitude "zero drift" is appreciably less than that for the earlier type of tubes.

The maximum g for each tube—the g that caused the plates to contact the stops or the cathode—was determined by mounting the tubes on a centrifuge previously developed at the Bureau and applying acceleration until the output reached a maximum. Measurements were taken for accelerations in both directions normal to the plates, placing the maximums for the seven accelerometers tested between 9.3 g and 13.3 g .

Using a bridge battery of negligible internal resistance, the output for all tubes was found to be a linear function of acceleration from 0 g to approximately 6 g . By increasing the resistance of the battery to 70 ohms with necessary increase in voltage, output was linear with g for the entire range of the tube. The greatest "zero shift" recorded after returning to zero g from

maximum output for the seven tubes was 0.45 g . One accelerometer was subjected to 71 g with no apparent damage.

Field Tests

Variations in the vertical accelerations of a freight elevator going from the first to the second floor were readily revealed by the accelerometer. The increase in acceleration when the elevator was put in operation, the nearly zero change in acceleration between floors, and the decrease in acceleration while stopping were clearly shown in the continuous acceleration record. The natural frequency response is very small compared to the acceleration response. In this test, the circuit was modified by replacing a 1400 ohm resistor in the filter circuit by one of 100 ohms. This resulted in a much higher sensitivity with some lowering of the attenuation at the cutoff frequency of the filter circuit.

The circuit used in the field tests of the improved pickup is an adaptation of the Kelvin double-bridge designed to minimize the effect of contact resistance both in the tube socket and in the adjustable rheostats. Because of the convenience of obtaining six volts from a storage battery, six volts were used for the heater voltage in these tests rather than the seven volts for which the heater is designed. A blocking filter was used ahead of the galvanometer to eliminate the possible 160-cycles output at the natural frequency of the accelerometer. The characteristics of the over-all circuit were found to be flat within five per-cent up to 20 cycles per second and to attenuate gradually to nearly 100 per-cent at 160 cycles.

The accelerometer in its present form provides a useful addition to available measuring equipment for conducting field tests similar to those described above where accelerations up to about 5 g at frequencies up to about 20 cycles are to be measured. However, experience with the accelerometer indicates that it would be improved by the addition of a suitable protective cover with a convenient means for attachment, and by the provision of a mechanical means for damping vibration of the plates at their natural frequency.



Variations in vertical acceleration of freight elevator going from first to second floor.

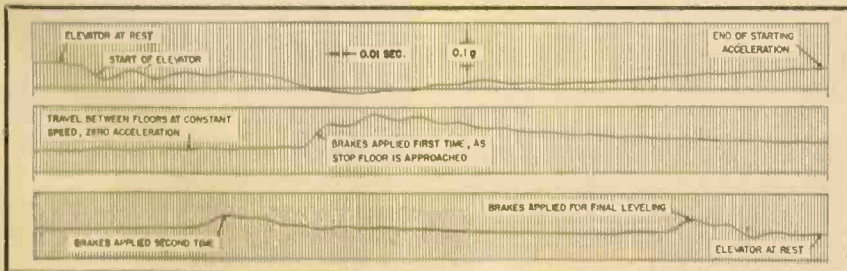

ZOPHAR WAXES COMPOUNDS

Anti-Corona high heat-resistant compounds for Fly Back Transformers.

Waxes and compounds from 100° F to 285° F Melting Points for electrical, radio, television, and electronic components of all types.

Pioneers in fungus-resistant waxes.

Our efficient and experienced laboratory staff is at your service.



ZOPHAR MILLS, INC.
112-130 26th Street,
Brooklyn 32, N. Y.

If You Use Radio Parts



You Need SUN RADIO'S BIG NEW CATALOG

Sun Radio's New Electronic Parts catalog contains latest complete listings of component parts, instruments, tubes, wire, accessories. In an entirely new, easy-to-use, easy-to-file 8 1/2 x 11" format. For industry, research, universities, technical schools, technicians, engineers. Write for your FREE copy. Dept. C-C

Sun Radio
& ELECTRONICS CO. INC.
122-124 DUANE ST. • NEW YORK 7, N.Y.

2 blocks North of Chambers St. - Est. 1922.
Hours: Daily 9-6, Saturday 9-4:30.

NEW PRODUCTS

IMAGE ORTHONIC CAMERA

General Precision Laboratory, Inc., Pleasantville, N. Y., is introducing a new type of image orthicon camera

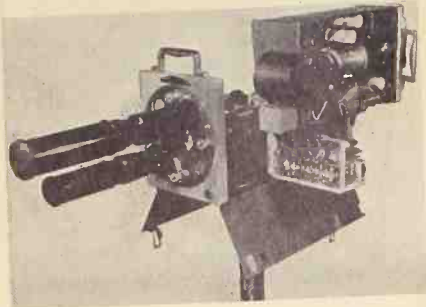

chain which will improve the efficiency and quality of TV camera work.

Four basic elements, instead of the normal six, make up a single GPL camera chain: image orthicon camera, camera control unit, synchronizing pulse generator, and camera power unit. The double chains have been reduced to nine units, as compared with an ordinary 12; and triple chains are 12 units, including switching unit and master monitor, instead of 17 or more units.

The camera itself weighs only 75 pounds and measures only 10 1/4" by 12 1/2" by 22", including its integral view finder. Apertures can be adjusted instantly to changing light conditions as the iris is motor driven and controlled from the back of the camera and also from the camera control unit.

STATIC MAGNETIC MEMORY

A device for recording and storing information in digital calculating machinery has been developed by Harvard Computation Laboratory and is manu-

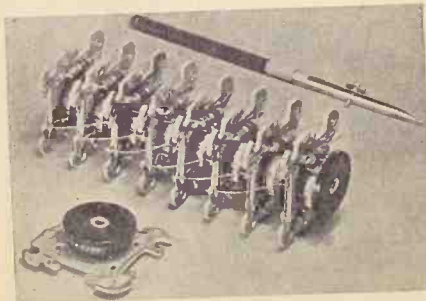

factured by Alden Products Company, 117 North Main St., Brockton, Mass. Based upon the discovery of a ferromagnetic alloy having a fairly rectangular hysteresis loop of low coer-

cive force, the Static Magnetic Memory operates essentially as a magnetic trigger pair which requires no vacuum tubes to maintain position. Features of the SMM storage device include permanent information storage comparable to magnetic drum storage but independent of mechanical movement, a variable information handling rate ranging from zero to 30,000 cycles per second, and pulse information storage without power.

Shown are eight Static Magnetic Memory units connected as a storage line.

RADIATION DETECTION

Now available from the General Electric Company at Electronics Park, Syracuse, N. Y., are four new radiation detecting instruments.

The Beta Gamma Survey Meter, 4SN8A2, shown, utilizes two Geiger-



Mueller tubes operating from an electronic high-voltage supply. The small Radiation Monitor, 4SN11A2, measures the total amount of gamma radiation in a given area over a period of time. It is self-contained and has no batteries or tubes.

The Portable Alpha Survey Meter, 4SN10A2, is a small, completely self-contained instrument for the detection and indication of alpha radiation. The Explosion Proof Ionization Chamber Instrument is a standard type survey meter in a specially designed form to make its suitable for use in Class 1, Group D hazardous atmospheres.

CONTROL PANEL

Now available from the Westinghouse Electric Corporation is an electronic temperature control panel for aircraft designed to control temperature within $\pm 5^\circ\text{F}$. of the nominal setting, which is adjustable between 90°F . and 130°F .

Type AVE-105 is an internally vibration-isolated electronic amplifier and is intended primarily for controlling window temperature in de-icing and de-fogging installations. It can also be

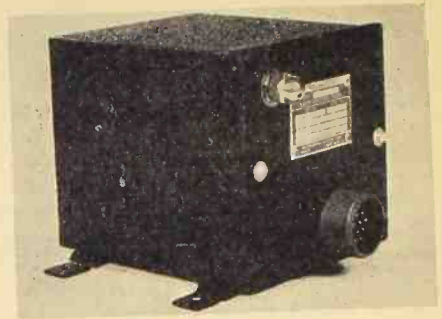

applied to control temperature in various types of heating systems such as electrically conducting glass, hot air, or infrared.

To obtain further information, address inquiries to Westinghouse Electric Corp., Box 2099, Pittsburgh 30, Pa.

THICKNESS GAUGE

Developed by the Research and Control Instruments Division of North American Philips Company, Mt. Vernon, N. Y., the Norelco Geiger-Counter Tin Plating Thickness Gauge conserves critical tin by making possible the maintenance of continuous coatings of satisfactory characteristics.

Thicknesses may be checked on one side of a sheet at a time, or on both sides simultaneously. A point check can be determined in approximately 30 seconds. Thicknesses from 10 to 120 micro-inches can be determined to within about 2% accuracy, or 1 micro-inch. Sheets up to 39" in width may be checked.

MINIATURIZED OSCILLOSCOPE

An oscilloscope containing nine tubes, including rectifiers, and designed for mobile applications is announced by Hycon Manufacturing Co., 2961 E. Colorado St., Pasadena 8, California.

Reported to have features typical of

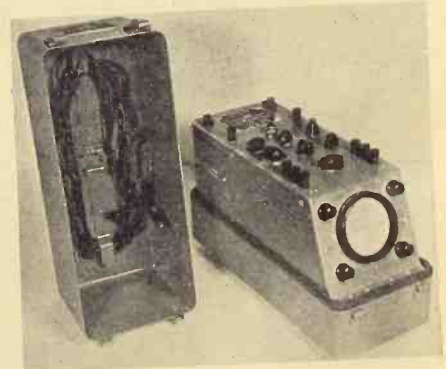

large precision laboratory oscilloscopes, this miniaturized oscilloscope has high

(Continued on page 30A)

High Definition TV

(Continued from page 9A)

tive bandwidth of 5.1 mc., would resolve 649 lines. This represents an increase of 192 lines or about 42%.

The high definition system can be sent over any relay channel providing the bandwidth is 4 mc. If the relay bandwidth is 2.7 mc., no improved definition is possible under the system as described, although it is possible to add somewhat more complex terminal equipment so that the 2.7 mc. relay circuit can be made to have an apparent bandwidth of $2.7 \times 1.42 = 3.84$ mc. This latter band could then be broadcast over a standard monochrome transmitter to provide detail substantially equivalent to local studio signals when using present standards.

The propagation characteristics should be substantially the same for the high definition signal as for a standard transmission. About the worst that could happen would be a fade-out of the re-transposing signal, in which case the resolution would drop from 545 lines to 384 lines. A shift in phase of the re-transposing frequency from its correct phase should not seriously affect resolution because the side bands to be transposed lie adjacent to the re-transposing signal and would be correspondingly shifted in phase to leave a net phase shift of substantially zero.

Compatibility as used here means the ability to receive the high definition system signals on present-day monochrome receivers without alteration of any kind to the receivers. The high-definition system is compatible. Without altering the receiver, high definition signals will provide a service having a horizontal resolution of 384 lines, substantially equivalent to present-day monochrome service. Actually, the signal will not have the quality of present-day transmissions for these reasons:

(1) The retransposing wave will be observable on present-day receivers as a weak fine-grained pattern, (2) The transposed super-high signals cannot be utilized but do exist as spurious signals, which while theoretically self-cancelling, are not quite self-cancelling because the persistence of vision is not infinite in time and hence integration is not 100% perfect, (3) The high video frequencies, since they appear but every other field, will be reduced about 50% in brightness over present-day theoretical levels. Actually, it is possible of course to make use of pre-emphasis so that this loss may be reduced in a practical system to something in the order of 5% to 20%, and hence can be made to be a relatively unimportant factor.

Reverse compatibility, i.e., the ability of the high definition receiver to receive

present-day transmissions, is automatic. Since the retransposing carrier wave is absent in present-day transmissions, the keyed amplifier is never shut off so that the high video frequencies are delivered continuously to the picture tube. No output appears in the super-high band because the detector for those signals is absent. This detector is normally biased beyond cut-off so that spurious signals and moderate interference will not activate it.

Tests conducted on portions of a system such as that described indicate that a complete system of this nature is entirely feasible, and offers sufficient advantages over present-day monochrome to warrant its serious consideration.

TV Link

(Continued from page 6A)

deck is opened, interlocked circuits disconnect the power from the transmitter. The klystron can be easily removed. The tubes above the deck are the video amplifier and clamp circuits. The strip to the right is the C.F.S. system.

Fig 9 is a rack mounted view of the receiver. The top chassis contains the r.f. circuits and the lower chassis the power supply. In the upper right hand corner the two-stub tuner is visible. A scale marking is used to indicate the

position of the stubs. Just visible at the very top of the chassis is the preamplifier and not quite visible to the left of the chassis is the main i.f. In the center of the chassis is the video amplifier system and just above it the klystron local oscillator. The strip to the right contains the center frequency control system. As in the transmitter, cathodes are monitored so that essentially a built-in tube checker is provided. The lower chassis consists of a 150 v. and a 250 v. regulated supply.

For portable operation the transmitter is mounted in three cases. In Fig. 7 the transmitter is mounted in the carrying cases. The case to the right contains the high voltage power supply, the case to the left the low voltage supply, and the center case the r.f. unit. Cables are provided to interconnect the three units and it is possible to connect the r.f. unit to the two power supplies through a cable of about 100 feet in length so that the r.f. chassis can be located in a most convenient position. The average weight of the three units is approximately 75 lbs. so that two men can easily transport them.

The system outlined in this paper has been operated in a practical link and the performance has been adequately observed to justify the validity of the design.



**the
new
PRECISION
COIL
BOBBINS**

*with Anchored Flanges . . .
can't come loose!*

Flanges are securely locked in place on a plastic-coated core to assure coils wound to closer tolerances — fewer rejects. Flange cannot slide to allow crowding of turns — wire cannot slip off coil form. Spiral winding — heavy heat-treated compression — overall impregnation. Made in any shape or size to your specifications of finest dielectric Kraft, fish paper, cellulose acetate or combination.

Write for FREE sample TODAY

**NO INSULATION STRIPS NEEDED
STRONGER MAGNETIC FIELDS
CLOSER WINDINGS**



PRECISION PAPER TUBE CO.

2063 W. Charleston St.Chicago 47, Ill.

Plant No. 2, 79 Chapel St., Hartford, Conn. . . Also Mfrs. of dielectric paper tubes

NEW TUBES

MINIATURE MAGNETRON

The development of a miniature magnetron tube for use in ultra-high frequency television receivers as well as

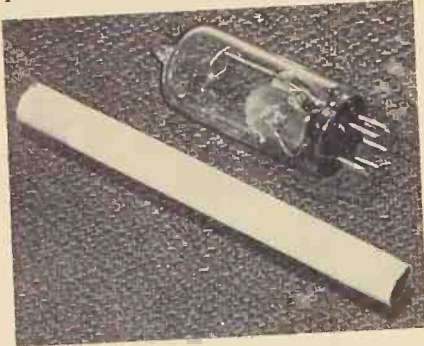

in other equipment in which a low power oscillator is required has been announced by the *General Electric* Tube Divisions.

According to *GE* commercial engineers, this miniature glass magnetron is capable of operating continuously from 30 to 900 megacycles at 250 milliwatts output. In addition to its application in the television home receiver field, the magnetron is expected to find wide use in commercial communication equipment.

Mass production of the *GE* miniature magnetron at the Owensboro Tube Works, Owensboro, Kentucky will be timed to fit into the FCC's release of the new u.h.f. channels. At present limited quantities are available for experimental work.

BEAM POWER PENTODE

National Union Radio Corp., 350 Scotland Road, Orange, New Jersey, has announced a filamentary type beam

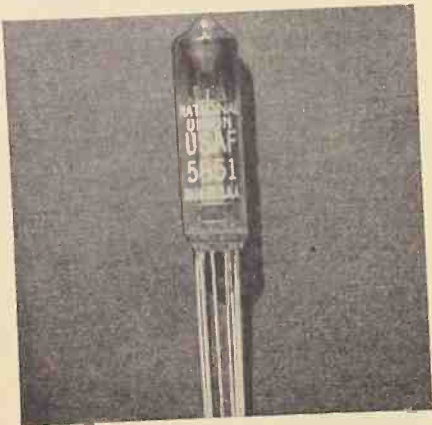

power output pentode suitable for frequency doubler operation up to 400 megacycles, producing 120 milliwatts.

Type 5851 is a T-3 subminiature beam pentode designed for use in military and other applications where the tube is subjected to excessive shock and vibration. It has been tested for shock at 500 g. The filament requires only 55 milliamperes current at 2½ volts and can also be operated at 1¼ volts at 110 milliamperes. As a class "A" amplifier, it will deliver 650 milliwatts audio output at 10% total harmonic distortion.

This tube has an oxide coated filamentary cathode which is center-tapped, permitting operation at either 1.25 volts at 110 ma. or 2.5 volts at 55 ma. The leads may either be soldered into a circuit or used with a standard subminiature socket.

RCA TUBES

Oscillograph Tube

The 7JP1 announced by *RCA's* Tube Department at Harrison, N. J., is a 7-inch cathode-ray tube of the electrostatic focus and deflection type. It is designed to provide exceptional brightness when operated with an anode-No.



2 voltage near the maximum of 6000 volts, and good brightness at anode-No. 2 voltages as low as 1500-2000 volts.

The 7JP1 utilizes an electron gun which has a grid No. 2 operated at anode-No. 2 potential so that the beam current and grid-No. 1 cutoff voltage will not be affected by focusing adjustment.

Other features include separate base-pin connections for each of the four deflecting electrodes, balanced deflecting-electrode input capacitances, full screen deflection with either pair of deflecting electrodes, and a large diameter neck with medium-shell diheptal base.

Monitor Kinescope

RCA has also announced a 7-inch directly viewed cathode-ray tube intended particularly for portable monitor equipment.

Utilizing magnetic focus and magnetic deflection, the 7QP4 kinescope provides pictures having high brightness



and improved focus over the whole picture area. A rounded-end picture 6¼" x 4½" is obtained by utilizing the full-screen diameter; or a rectangular picture 5½" x 4" with rounded corners is obtained within the minimum useful-screen area.

The 7QP4 supersedes the 7CP4 monitor kinescope for use in the design of new monitor equipment.

Projection Kinescope

A projection kinescope for theater television capable of providing a clear, bright, projected picture 20 by 15 ft. when used with a suitable reflective optical system has been announced by *RCA*.

The 7NP4 employs electrostatic focus and magnetic deflection. Operating with a maximum anode voltage of 80,000 volts and a maximum focusing-electrode voltage of 20,000 volts, the 7NP4 features: (1) a bulb having corrugated side walls with insulating coating to provide a long leakage path over its external surface, (2) an inner



cone-neck section to provide adequate vacuum insulation between internal anode coating and outer neck section, and (3) only one high-voltage envelope connection. Other connections are made through a plastic-filled, diheptal 14-pin base.

Microwave Systems

(Continued from page 14A)

tant at microwave frequencies because it represents the simplest and most reliable way of modulating lighthouse triodes and magnetrons. It should be noted that these advantages are obtained at the expense of bandwidth. Unless sufficient bandwidth is available, the above mentioned characteristics are not true.

Pulse Amplitude Modulation (PAM) shown in Fig. 5A is the simplest method of time multiplexing. This system does not offer any signal-to-noise improvement—as it exchanges the pulse peak-to-average carrier power advantage for increased bandwidth. To overcome this disadvantage a system of PAM-FM has been utilized in which the train of PAM pulses acts just as the sub-carrier in the frequency division and frequency modulate the microwave carrier. The output of PAM multiplex terminal represents a waveshape which is, in many cases, comparable to the video output of a television camera. Consequently, a PAM telephone system can be adapted to transmit television signals.

Pulse Time Modulation (PTM), shown in Fig. 5B, is a system which is not only free from cross-talk due to non-linearities in the transmission medium (assuming sufficient bandwidth is used), but also improves the signal-to-noise ratio of the system. This improvement is found⁶ both theoretically and experimentally to be:

$$(S/N)_{out} = \left(\frac{D}{t_r}\right)^2 \frac{S \text{ (carrier peak power)}}{N_f} \quad (14)$$

where t_r , the rise time, and D , the maximum displacement time, are defined in Fig. 2. An important factor to note is that the S/N improvement increases as t_r decreases, but a decrease in t_r increases the bandwidth required. Hence the S/N improvement is not as great as Eq. (14) may seem to indicate at first glance.

Pulse Code Modulation (PCM), shown in Fig. 5C, is a recently developed technique that promises unique freedom from noise and interference in radio link relays. In this system intelligence is transmitted by means of a coded pulse series in a manner similar to the operation of the teletypewriter.

Consider the action of the teletypewriter. Assume that the letter "A" has been actuated. This causes the transmission of a coded signal, say two pulses, two blanks, and one pulse. When the receiver detects this signal, the letter "A" is reproduced on a sheet of paper. Since the receiver has reproduced the original signal exactly, this

system is completely noise free and distortionless. The only way noise can manifest itself is when it is sufficiently large to change a blank to a pulse or vice versa. However, once a minimum signal-to-noise ratio is exceeded, an effectively infinite S/N output will result.

PCM uses a similar system. The audio amplitude is converted into a coded series of pulses. This coded signal is picked up at the receiver and an amplitude equal to the original one is reproduced. Of course, an infinite number of coded signals would be required to cover every possible amplitude. Since this is impossible, the other alternative is to provide a finite number of levels and code each one. In this case the modulating amplitude would be identified with the level into which it falls, and the signal reproduced at the receiver would correspond to the mean value of that level. This introduces some distortion in the system—3.5 per-cent for 31 levels—which decreases as the number of levels increases.

The signal-to-noise ratio of PCM can be determined theoretically upon the basis of the likelihood of a noise pulse exceeding a certain minimum voltage V (which is a function of the input S/N) with sufficient pulse width that it is comparable to the coded pulse duration t_c . The theoretical S/N of a PCM system has been derived⁶ and is shown in Fig. 4 for ft_c equal to 0.5, where f_0 is the cut-off frequency of the audio filter used to filter out the audio component in the demodulator.

PCM is particularly adaptable to long distance radio relays because repeaters do not add distortion or noise to the system. However, a comparatively wide bandwidth and complex circuitry are required. Hence this system is economical, at the present time, only for long distance communication where the cost of the multiplex terminal is but a small fraction of the total expense and reliability, independent of distance, is the primary consideration.

Table I is summary of the characteristics of various multiplex systems when applied to microwave carriers.

REFERENCES

1. Raker, J., "Microwave Antennas," RADIO-ELECTRONIC ENGINEERING, October, 1950.
2. Raker, J., "Microwave Propagation and Site Planning," RADIO-ELECTRONIC ENGINEERING, November, 1950.
3. Raker, J., "Microwave Receivers," RADIO-ELECTRONIC ENGINEERING, July, August, 1950.
4. Raker, J., "Microwave Transmitters," RADIO-ELECTRONIC ENGINEERING, May, June, 1950.
5. Clavier, A. G., "Carrier Power Requirements for Communication by Microwaves," Electrical Communication, March, 1950.
6. Clavier, Panter, & Dite, "Signal to Noise in Pulse Count Modulation," Electrical Communication, September, 1949.



Shown: Bliley Type MC-9

Production...

Delivery . . . Quality!

Three qualifications are needed to assure performance on your orders. PRODUCTION facilities . . . keyed to your DELIVERY dates . . . plus rigid QUALITY control. These factors are basic with Bliley . . . top choice for 20 years.

Bliley
CRYSTALS

BLILEY ELECTRIC COMPANY
UNION STATION BUILDING
ERIE, PENNSYLVANIA

TECHNICAL BOOKS

"DESIGN OF ELECTRICAL APPARATUS," Third Edition, by John H. Kuhlmann, assisted by N. F. Tsang. Published by *John Wiley & Sons.*, 440 Fourth Avenue, New York 16, N. Y. 512 pages. \$6.50.

The third edition of this popular book presenting practical design methods for important types of electrical apparatus follows the same general plan and method of presentation favorable with readers of previous editions. Each type of apparatus is complete with explanation of the construction, presentation of formulas and procedure, review of design limits established by practice, and illustrations with specimen calculations.

Changes in this third edition include the revision of design constants and design limits to conform with the latest design practices. The method of calculating the field current for a specified load and power factor for synchronous machines has been changed to agree with the procedure adopted by the American Standards Association. The section on induction-motor design has been largely rewritten and new methods for determining motor dimensions are given. The circle diagram has been omitted, and all performance values are calculated from the equivalent circuit.

"FUNDAMENTALS OF ACOUSTICS," by Lawrence E. Kinsler and Austin R. Frey. Published by *John Wiley & Sons, Inc.*, 440 Fourth Avenue, New York 16, N. Y. 516 pages. \$6.00.

Presented in this volume are basic facts about the generation, transmission and reception of acoustic waves to familiarize the reader with the fundamental concepts and terminology of the subject.

An analysis of the various types of vibration of solid bodies, and of the propagation of sound waves through fluid media is given in the first nine chapters. The remaining seven chapters are concerned with a number of applications of acoustics. Each important equation is derived from the fundamental laws of physics and shows in some detail the logical processes as well as the mathematical steps involved in the derivation.

Proposed standards of acoustical terminology of the American Standards Association are used throughout and tables of physical constants are given in the appendix. A glossary of symbols is also incorporated in the text.

New Products

(Continued from page 26A)

sensitivity, weighs only seventeen pounds, and measures just 9" high x 6" wide x 14½" long. The sweep frequency range is from 3 cycles to beyond 50,000 cycles per second. Vertical amplifier response is flat within 3 decibels from direct current to 2 mc., while horizontal response is flat within 2 decibels from d.c. to 100 kc.

Now in production for the Air Forces and the Navy in large quantities, this oscilloscope is particularly designed to endure rough handling, and its easy portability makes it especially useful for servicing TV and radar equipment in the field.

MINIATURE ATTENUATOR

The *Daven Company*, 191 Central Avenue, Newark 4, N. J., has developed a "T" Network Attenuator, series 730,

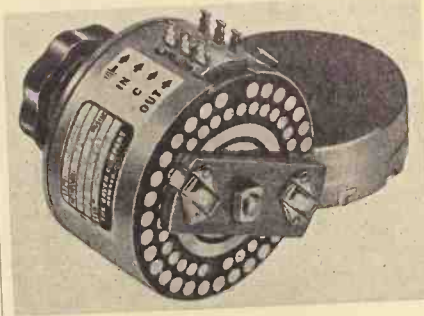

which has 30 steps of attenuation in only 2¼" diameter.

This attenuator has zero insertion loss and constant input and output impedance and is ideal for use where space is of prime importance. It is available in steps of 0.5, 1.0, 1.5, or 2.0 db. It has a flat frequency characteristic to 30 kc., and on special order the frequency range can be extended to 200 kc. Its standard resistance accuracy is $\pm 5\%$. When requested, accuracies as high as $\pm 0.1\%$ are available.

Further information may be obtained by writing the company.

PRESSURE CONTROL

Coral Designs, a division of *The Henry G. Dietz Co.*, 12-16 Astoria Blvd., Long Island City 2, N. Y., has developed a differential pressure or vacuum control designed for use on very low differential pressure where regulation is required in inches of water, either pressure or vacuum, and where a leak path between diaphragm and atmosphere cannot be tolerated.

Units are of small physical size, obtainable in standard ratings ranging from 0" to 20" of water pressure or vacuum with range adjustment and

with fixed differentials from .2" to 2" of water. Electrical ratings are approved by Underwriters Laboratories

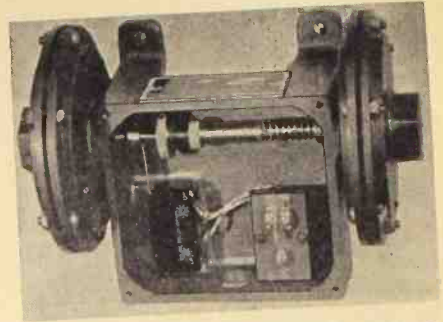

for 10 amperes 125 v. or 5 amperes 250 v.a.c. Contacts are single pole double throw.

Additional information on the Cat. 111-D Differential Pressure or Vacuum Control is obtainable direct from the company.

MARKING DEVICE

The latest development of *M. E. Cunningham Company*, 192 E. Carson St., Pittsburgh 19, Pa., is a marking device for stamping round or curved metal parts.

Designated the PF-20 Periphery Stamping Fixture, this tool features a unique type arrangement which permits the use of regular straight body type for curved marking. The holder can be made suitable for one or two rows of type, which is easily changed by moving the face plate of the holder. The number of characters that can be used is limited by size of characters and radius of the piece to be marked.

These fixtures, usually made to order for marking a specific part, can be manufactured adjustable for use on various shapes and sizes. Construction includes springs which lift the holder off the piece after it has been stamped.

RECORDING CAMERA

An oscillograph-record camera which provides in one minute a complete record of an oscillograph image was

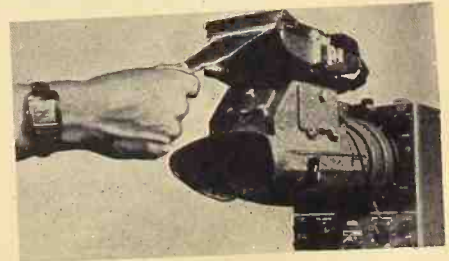

recently announced by the Instrument Division of *Allen B. DuMont Laboratories, Inc.*, Clifton, N. J.

Employing the Polaroid-Land process for delivering a finished print at the termination of each completed exposure or set of exposures, this camera is designed specifically for application

with any standard 5-inch cathode-ray oscillograph.

Size of print is 2¼ x 3¼ inches, with a ratio of dimensions from trace to recording of 2.25:1. The camera is mounted to a standard 5-inch oscillograph by means of a clamping ring which clamps to the DuMont Type 2501 bezel.

POWER SUPPLY

Polarad Electronics Corp., 100 Metropolitan Ave., Brooklyn 11, N. Y., has



announced Model PT-112 regulated power supply designed to provide high current drain at precisely regulated voltages to meet the need of the TV industry.

Adjustable from 250 to 300 volts, Model PT-112 delivers in excess of 800 milliamperes. Ripple is held to the extremely low levels required of TV applications. Regulation is better than .02% and the output impedance is less than 1½ ohms.

TV DEFLECTOR CORE

Westinghouse Electric Corporation now has available a high-permeability



core for deflection of wide-angle, large-screen, television picture tubes. Made

PHOTO CREDITS

Pages

3A, 5A, 6A.....Federal Telecommunication Labs. Inc.

7A.....National Bureau of Standards

12A....Sylvania Elec. Prod., Inc.

of Hipersil, the core is reported to have exceptionally low reluctance at all flux densities.

The core is wound and bonded in circular form from a continuous strip of 5-mil material. It is then cut accurately into two "C" shaped pieces for ease of assembly around the deflection coils. It is reported that the thin laminations plus the magnetic characteristics of the steel result in good linearity and sharper pictures. The cores are completely free from magnetic instability due to change in temperature and are available in sizes to suit the application.

Further information may be obtained from the company at P. O. Box 2099, Pittsburgh 30, Pa.

Micromanometer

(Continued from page 7A)

to an adjustable reference value which is set in calibration for equality with zero differential in the cell. When pressure is applied, the balance is disturbed, and the resulting signal is proportional to gas pressure. This signal is amplified by suitable circuitry, is rectified, and finally appears as a d.c. current through the microammeter on the panel of the instrument.

Alignment of coil form and diaphragm is not critical since, as a result of the linear response, all parts of the useful area of the diaphragm are weighted uniformly.

Because of the linear relationship between variation and electrical output, only two calibration points are required. In practice, the cell is first evacuated to the same pressure as that prevailing in the glass dome. Thus no differential pressure on the diaphragm exists, and the reference mutual inductance may be adjusted for zero reading on the meter scale. Slope, or scale-factor, adjustment is then made upon the introduction of an expanded gas sample of known pressure.

The manometer is capable of measuring pressures in the range of 1 to 100 microns with a sensitivity of about 0.1 micron on a 50 micron scale. Continuous use of the instrument for more than one year on one of the mass spectrometers at the National Bureau of Standards has shown that its sensitivity and zero point are remarkably constant. Frequent observations have disclosed variations in calibration of less than 1 micron over a 24-hour period. A differential pressure of one atmosphere applied externally on the pressure cell has only a slight hysteresis effect while pressures up to several tenths of a millimeter can be applied inside the pressure cell without harmful effects on the diaphragm.

News Briefs

(Continued from page 23A)

of thirty commercially available sub-miniature electron tubes ranging from 0.200" to 0.383" in diameter. Also provided in the characteristic chart are useful suggestions for mounting, shielding and application to obtain maximum life for various tube types.

Two tables are provided for easy cross reference between experimental and RTMA type numbers and classification of types with respect to applications. Information is supplied to identify dimensions of bulb outlines, lead spacing, and base diagrams.

This characteristic chart may be obtained on request from Sylvania's advertising department.

Equipment Catalog

Available to key personnel in the nuclear energy research field is a new catalog entitled "Equipment for Radiation Laboratories," released by the Special Products Division of General Electric's Apparatus Department.

The handbook contains condensed facts, pictures, prices, and ordering information for over thirty special-purpose equipments manufactured by GE. Many new products which will find use in the radiation field are included. Among these is a complete line of ionization chambers which are used in health-monitoring applications.

This catalog may be obtained by contacting any GE Apparatus Sales Office.

HAVE YOU A JOB FOR A TRAINED TECHNICIAN?

We have a number of alert young men who have completed intensive training in Radio and Television Repairing. They learned their trades thoroughly by working on actual equipment under personal, expert supervision.

If you need a trained man, we invite you to write for an outline of our course, and for a prospectus of the graduate. No fees, of course. Address:

Placement Manager, Dept. P-106-2
COMMERCIAL TRADES INSTITUTE
1400 Greenleaf Chicago 26

SPEND YOUR WAY TO \$\$\$ SECURITY!

How you spend what you make is more important than how much you make! How you manage income: control household, personal expenses; organize spending and saving determines degree of your financial peace of mind. The "KWIK-GLANCE" simplified method of keeping track of income and outgo has happily solved money problems for 100,000 users. A year's service in one volume, \$1.25 complete. Write for FREE descriptive folder.

MAY PUBLISHING COMPANY
537-C So. DEARBORN CHICAGO 5, ILL.

ELECTRONIC EQUIPMENT • PARTS

AN Conn.	COILS	RELAYS	LARGE STOCK
APC's	(R. F. A. F.)	RESISTORS	OF OTHER ITEMS
BINDING POSTS	CONTROLS	SHOCK MTS.	LET US QUOTE
CABLE	CRYSTALS	SOCKETS	YOUR NEEDS
CAPACITORS	FILTERS	SOLENOIDS	WRITE, WIRE
CERAMICONS	TUBES	SPAGHETTI	PHONE
CERAMICS	Hardware	SWITCHES	Walker 5 9642
CHOKES	KNOBs	TRANSFORMERS	
CIR. BRKS	POTENTIOMETERS	(Servo-pull-in)	
	(line-sound)	IRON-CORE	
		SLUGS	

Universal general corp. 324 CANAL ST. N. Y. C.

CONSTANT K TYPE HIGH-PASS FILTER DESIGN

By SEIZO YAMASITA

The constants of a "T" or "pi" type constant K high-pass filter may be determined rapidly with acceptable accuracy with the aid of this chart.

IN DESIGNING an electrical filter, it is customary to determine the constants of the elements to a fairly high degree of accuracy. However, the damping characteristic of the constant K type filter is not sharp, so that calculations to an accuracy of better than a few per-cent are seldom required, and effective use can be made of charts to determine inductance and capacitance.

Fig. 1 shows both the "T" and "pi" types of constant K high-pass filter. In this figure:

$$L = R/4\pi f_0$$

$$C = 1/4\pi f_0 R$$

where f_0 is the cut-off frequency and R is the image impedance.

From the chart (Fig. 2) it is possible to determine L and C if f_0 and R are known. For example, the chart shows that a filter with a cut-off frequency of 10,000 cycles and an image impedance of 600 ohms would call for $L = 4.8$ mh. and $C = 0.014$ μ fd.

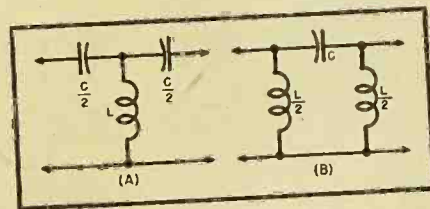

Fig. 1. (A) "T" type and (B) "pi" type constant K high-pass filter.

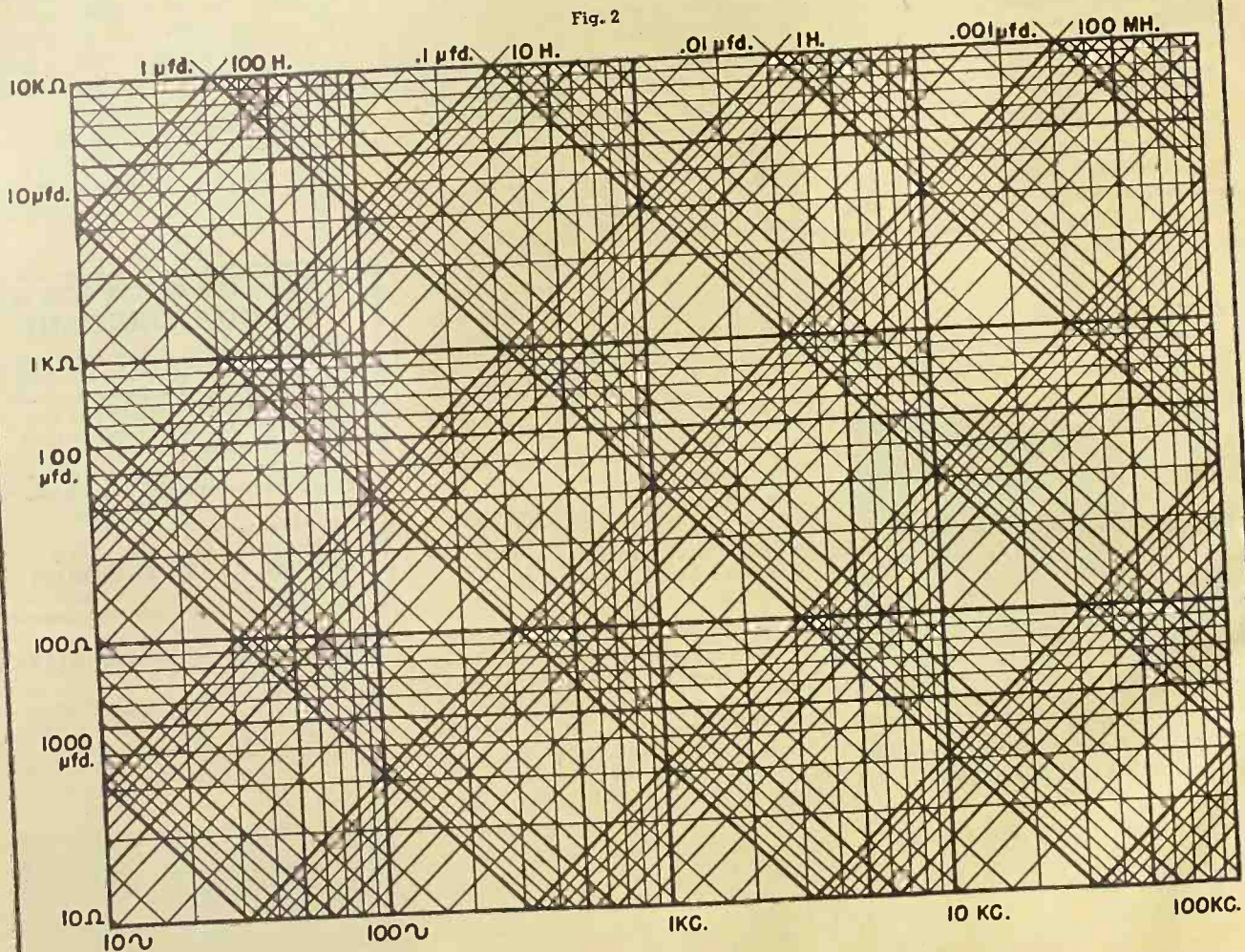
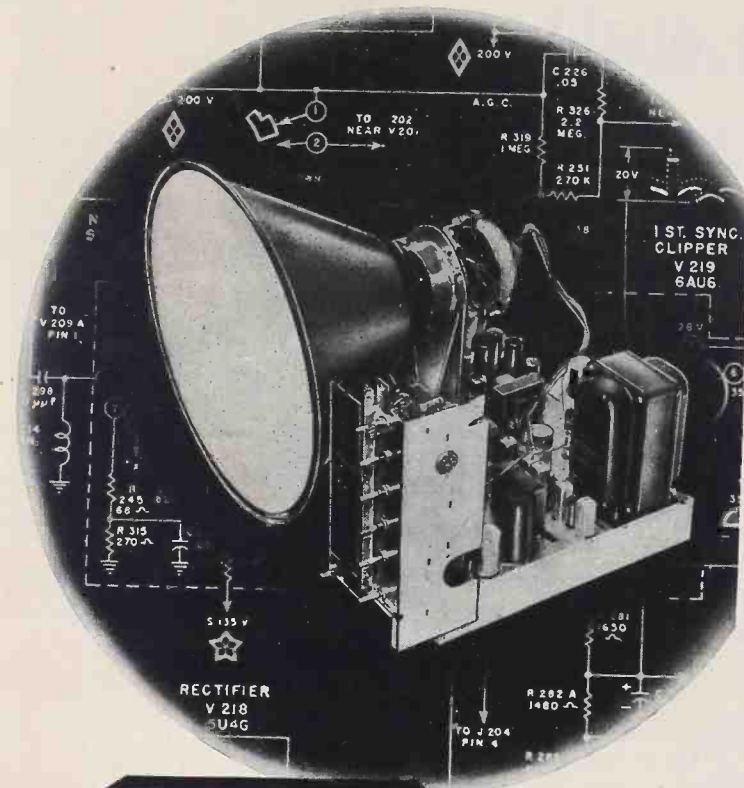

Fig. 2

New Du Mont Steadibeam* . . .

always a clinching sales point



The DU MONT TARRYTOWN, with 17-inch Rectangular tube, combining TV, AM-FM radio, 3-speed phonograph.

One of the pet peeves of television set owners is the program disturbance sometimes caused by moving planes, trains, autos, buses, trolleys, or tropospheric disturbances.

This is where the new Du Mont Steadibeam comes to the rescue. All Du Mont Telesets* without exception have this automatic signal compensator, the most advanced form of automatic gain control in the television industry today.

The Du Mont Steadibeam positively insures uniform signal strength, whether the station is distant or nearby. It compensates automatically for rapid or slow variations in signal, due to any of the hazards mentioned above as well as many others. It retains picture brightness, for example, despite variations as great as 100 to 1!

It is an advantage that makes Du Mont Telesets easier to sell. It is one of those wanted features that a set owner brags about to his friends and neighbors. And that means more Du Mont sales for you.

The new Du Mont Steadibeam, like the Du Mont Sensituner,* the Du Mont Signalock,* the Du Mont Extra tubes, is one of the many Du Mont plus values that result in better performance, longer set life, lower service cost, more satisfied customers.

You'll do better with Du Mont—Television's most coveted franchise

DU MONT *first with the finest in Television*

*Trade Mark

Copyright 1950, Allen B. Du Mont Laboratories, Inc., Television Receiver Division, East Paterson, N. J. and the Du Mont Television Network, 515 Madison Avenue, New York 22, N. Y.